

Birla Central Library

PIYANI R. 100

Class No. 696

Author B. 603 P. 10

Accession No. 53713

Acc. No... ..

ISSUE LABEL

Not later than the latest date stamped below.

--	--	--

PLUMBING

A TEXT-BOOK TO THE PRACTICE OF
THE ART OR CRAFT OF THE PLUMBER

WITH A CHAPTER ON

HOUSE DRAINAGE AND VENTILATION

BY

ERNEST G. BLAKE

M R S I. A B I C C.

MEDALLIST IN SANITARY BUILDING CONSTRUCTION, ETC.
AUTHOR OF "BUILDING REPAIRS," "DAMP WALLS," ETC., ETC.

BASED ON THE WORK OF THE SAME TITLE BY
W. P. BUCHAN

VOL. I.

LEAD LAYING, GUTTERS, ETC.

SECOND EDITION

Second Edition. Thoroughly Revised

LONDON

THE TECHNICAL PRESS LTD.
5 AVE MARIA LANE, LUDGATE HILL, E.C.4

1935

Made and Printed in Great Britain at THE DARIEN PRESS, Edinburgh

P R E F A C E

OF all the different branches in the building industry there is probably none in which more meticulous care is required in executing the work than in plumbing, while the results of inferior workmanship will be equally or more disastrous than would be the case in any of the allied trades. Plumbing can be broadly divided into two main sections, viz., lead laying and sanitary engineering, in both of which the necessity for employing the highest skill in carrying out the work is absolutely imperative. Lead laying is principally concerned with preventing the percolation of rain through roofs, gutters, and other portions of the building that are exposed to the weather, and with the provision of watertight linings to tanks and similar receptacles that are intended for the storage of liquids. Sanitary engineering, on the other hand, is responsible for the provision and installation of the various appliances that are employed in the disposal of waste products from the human body. The absolute necessity for the best class of workmanship and materials in both of these branches of the building trade is indisputable, and the serious effects of neglect cannot be gainsaid.

The art of plumbing covers such a multitude of different operations, that it is only by considerable practical experience that the artisan can hope to achieve

complete mastery over every detail that is likely to arise in the ordinary course of his work, and when—as is so often the case in country districts—hot water fitting is combined with the more legitimate forms of sanitary work, the difficulties are increased in a corresponding degree. It is probably not too much to say that very few mechanics come into actual contact with every phase of the plumbing and hot water engineering trades, even in the course of a long and arduous lifetime, so that it is quite impossible for the average workman to become really familiar with all the various operations from practical personal experience. As, however, most of the principal operations recur in many different jobs, a fairly comprehensive knowledge of the subject can be acquired by diligent practice at the various processes, such as lead working and wiping metallic joints, while the theory of sanitation generally can be gathered from the experiences of others who may be willing to impart their knowledge through the medium of text-books, lectures, etc.

Human endeavour always aims at ameliorating the condition of the individual, and this object can best be attained by so improving the environment in which he lives, that the moral and physical risks which are bound to exist even in the best regulated community shall be reduced to a minimum. This is where the vital necessity for the highest form of sanitary science is so insistent, and the dangers that would be incurred if the recognised standard in these matters was departed from, can be realised without a great strain on the imagination.

As far as lead laying is concerned, no very great alteration has taken place in the methods that are

employed, during recent years; but tremendous advances have been made in the realm of sanitary appliances, and in the measures that are adopted for combating those diseases which arise from foul smells and faulty methods in the disposal of sewage. This progress is still going on, and improvements both for the safety and convenience of the individual and of the nation at large are continually being introduced, so that what was considered to be the best a generation ago is now condemned as dangerous, and present-day practices will be out of date to-morrow.

A text-book on sanitation needs frequent and careful revision if it is to keep pace with the discoveries of modern research, and with this end in view the present volumes have been prepared, so that the latest designs in those sanitary appliances with which the plumber is concerned can be presented for the benefit of the public.

The examples that are described necessarily form only a very small proportion of the large numbers that are procurable at the present day, and they are given as a fair indication of the trend of the efforts that are being put forth for the good of the community at large.

E. G. B.

NOTE TO SECOND EDITION

THE First Edition has been revised and brought up to date, and the appliances described and illustrated in the Second Edition represent the latest patterns that are being produced by the makers concerned at the present time.

E. G. B.,

BY THE SAME AUTHOR

256 pp. 98 Illustrations. 8s. 6d. net

DAMP WALLS

A handbook on the various causes of dampness in house walls, and the best methods for architects, builders, surveyors, and property owners in dealing with this troublesome defect. With a chapter on condensation, and notes on waterproof building construction.

THE TECHNICAL PRESS LTD.

CONTENTS

CHAPTER	PAGE
I. HALF-CIRCLE EAVES GUTTERS - - -	1
II. ORNAMENTAL IRON GUTTERS - - -	7
III. LEAD GUTTERS - - -	13
IV. LEAD GUTTERS (<i>contd.</i>) - - -	21
V. FLASHINGS AND VALLEYS - - -	35
VI. RIDGES AND HIPS - - -	41
VII. LEAD FLATS - - -	49
VIII. ZINC FLATS - - -	57
IX. ZINC ROOFS - - -	63
X. SNOW BOARDS AND GUARDS - - -	73
XI. HATCHES, SKYLIGHTS, AND DORMERS - - -	77
XII. RAINWATER PIPES - - -	89
XIII. PUMPS - - -	103
XIV. THE HYDRAULIC RAM - - -	115
XV. THE SIPHON - - -	133
XVI. THE FLOW OF WATER THROUGH PIPES - - -	137
XVII. GENERAL DRAINAGE AND VENTILATION - - -	143
XVIII. DRAIN TESTING - - -	165
INDEX - - -	173

PLUMBING

CHAPTER I

HALF-CIRCLE EAVES GUTTERS

THE gutters round a building are of the first importance, from a hygienic point of view, for if defective they will probably be the cause of dampness in the walls.

Cast-iron gutters are most frequently used in average work, while zinc is often employed in



FIG. 1.



FIG. 2.

speculative buildings. The width usually varies from 3 in. up to 5 in., and they are cast in 6-ft. lengths, with a faucet at one end. If necessary the gutter can be cut to any length desired, but in this case a new hole for the bolt (Fig. 2) must be drilled through the end. The bolt should be inserted from the inside, the nut being screwed on underneath; the head will then fit into the recess which is countersunk for its accommodation, and there will be no obstruction to collect leaves

and rubbish which may be blown into the gutter, and which would otherwise obstruct the free escape of the water. Fig. 1 shows a section of a half-round gutter. Ornamental patterns are illustrated in the next chapter.

Corner pieces can also be had of various patterns to fit round corners at different angles (Figs. 14 and 16).

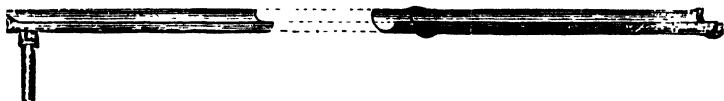

FIG. 3.

Stop ends are used to close the end of the gutter, and an outlet for water is provided by means of a nozzle which is introduced in the length. This is shown in Figs. 3 and 17.

When the gutter discharges into a rainwater head the nozzle is often dispensed with, and the gutter is



FIG 4



FIG. 5.



FIG. 6.

allowed to run openly as in Fig. 4. The nozzle, however, is to be preferred, as it prevents the water running back on the under side of the gutter. Half-round gutter is supported by malleable-iron brackets about 1 in. broad and from $\frac{1}{8}$ in. to $\frac{1}{4}$ in. thick. These brackets are made to fit the outside of the gutter, and while at the higher end the bracket is shallow, at the other end, owing to the slope which the gutter requires for the proper flow of the water, the bracket has to be so much deeper

Fig. 5 is a view of the shallow bracket, and Fig. 6 the deep one, with the two 1-in. screws which fix it to the wooden roof. In some cases the brackets have to be let into a stone coping, when they are either wedged in firmly, or else a hole being cut in the stone, the inner end of the bracket is bent down and inserted into the hole, which is then run full of lead as in Fig. 7. This will be necessary as the exigencies of the case may require and the circumstances allow.

These brackets are often screwed to the side of the rafter feet, which obviates the necessity for making them to different depths, as the fall can be obtained by

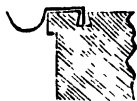

FIG. 7.



FIG. 8.



FIG. 9.

fixing the bracket a little higher or lower as the case may be.

When the brackets are made, two or three holes are punched for the nails as shown in Figs. 5 and 6; they are then brought to a mild heat and tarred, and after cooling are ready for use. In place of tarring, the bracket, when time allows, may be painted, first with a coat of red lead and then a coat of paint of the same colour as the gutters. When galvanised hoop iron is used, heating and tarring and also painting are generally dispensed with. All ironwork should be galvanised after it is made, as the coating of spelter would be damaged by heating or bending.

Each length of gutter has a faucet end and a spigot or plain end, the plain end of the one length fitting

into, and lying upon, the faucet of the next length. The joint is made tight with red lead, the spigot of the one length and the faucet of the other being squeezed together and kept tight by means of the bolt, and nut as in Fig. 8. Putty should not be used, as, being partially soluble in water, it rapidly decomposes and permits the escape of water at the joint.



FIG. 10.



FIG. 11.

The gutters are sometimes secured by means of a strip of hoop iron which is riveted inside the circle of the bracket as in Fig. 9, the ends of the hooping being bent over the edge of the gutter, which is thus clipped securely in place. Zinc gutters, instead of being screwed together with putty, etc., are soldered, and they



FIG. 12.



FIG. 13.

are usually fixed by passing a long screw through the front and back edge and into the fascia board as in Fig. 10, the screw being protected against wet by means of a small piece of tube which has previously been soldered in the required position across the gutter.

Fig. 11 is a cross section of a half-round gutter, with a small bead or moulding along its front edge.

Instead of the brackets being fixed by nails as in Figs. 5 and 6, they may be driven into joints or holes

in the wall, in which case they are formed as in Figs. 12 and 13.

Figs. 14 and 16 show specimens of the angles for half-circle gutters, the former being a square left-hand angle, and the latter an obtuse right-hand angle.

Fig. 15 is a short union faucet. It can be used for joining the two spigot ends s-s of Figs. 14 and 16, the spigot ends lying inside the union faucet, which is

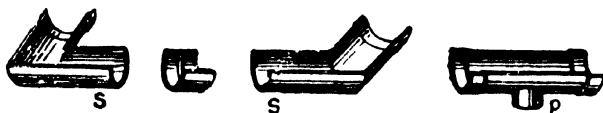

FIG. 14. FIG. 15. FIG. 16. FIG. 17.

consequently wider inside than the width of the spigot ends of the gutters over all.

When the short union piece is intended to go inside the faucet ends of two gutters it is styled a clip, and is simply a short piece of the gutter with two holes in it for the iron screw bolts. The union faucet has also a hole at each end for the bolts.

Fig. 17 shows a nozzle piece with a faucet at each end, and the nozzle or outlet for the rain P in the middle. Angles like Figs. 14 and 16 may also be had with an outlet in the bottom as required.

CHAPTER II

ORNAMENTAL IRON GUTTERS

IN the previous chapter plain semicircle gutters were described. This chapter will treat of ornamental iron eaves gutters which form a part of the cornice mouldings as well as acting as conductors for the rainwater

These ornamental iron gutters do not, generally

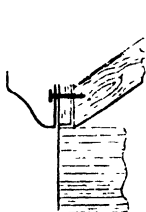

FIG. 18.

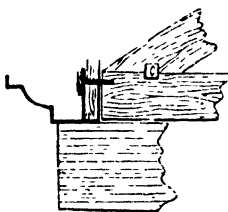

FIG. 19.



FIG. 20.

speaking, require brackets, as provision is made for screwing them to the fascia—a board about 1 in. or $1\frac{1}{4}$ in. thick and about the same depth as the back of the gutter, which is fixed to the feet of the rafters for the purpose. The commonest method is to screw the gutter directly on to the fascia as shown in Fig. 18. The objection to this, however, is the tendency for rust to accumulate round the head of the screw, so that in course of time the hole is enlarged, and the gutter is pulled away from its support by its own weight. The best method

of preventing this is to thread a galvanised washer over the screw before it is passed through the hole in the gutter; this provides a more substantial support, and the gutter is not likely to break away. In other cases the bottom of the gutter lies on a projecting course of brick or stone, and thus obtains the firmest possible support without fear of collapse. This method, which is illustrated in Fig. 19, possesses one serious objection, *i.e.*, that in wet weather water runs down the outside of the gutter and into the joint on top of the

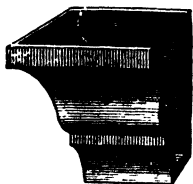

FIG. 21.

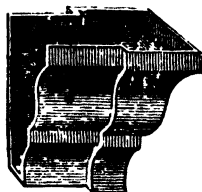

FIG. 22.

brickwork; the result is that the gutter soon rusts and holes appear in the bottom. This could be prevented to a certain extent by well painting the outside of the gutter before it is fixed, but it would only put off the evil day, as the paint could not be renewed without taking the gutter down. A difficulty is also experienced in obtaining sufficient fall to drain the water away, consequently rain stands in the bottom and holes are soon developed.

In the best class of work cast-iron eaves gutters are supported on iron brackets which are screwed to the fascia. These brackets are made in various styles, Fig. 20 showing one pattern which has the back bent over at an angle so that it can also be fixed to the top

of the rafter. This type is not often used. The brackets are shaped to fit round the outside of the gutter, the Ogee pattern being the most common.

The depth of a $4\frac{1}{2}$ -in. half-round gutter is about 2 in., while the depth of ornamental gutters may be



FIG. 23.



FIG. 24.

3 in., 6 in., 8 in., etc., with a corresponding breadth, according to circumstances and as the size of the roof or the character of the building may require.

In order to keep an unbroken line of frontage some ornamental iron gutters have no faucets, the plain

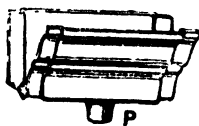

FIG. 25.



FIG. 27.



FIG. 26.

end of one gutter acting as the faucet as in Fig. 21, while the end of the other length is contracted so as to slip into it as in Fig. 22. These illustrations are not full lengths of gutter, but terminal ends; they serve, however, to show the mode of junction. The gutters are put together with red lead and iron bolts as already described, but the head of the bolt is kept outside and the hole is countersunk underneath so as to leave

as little as possible outside to catch the eye. The iron bolts in this case are also a little thicker than for the plain semicircular eaves gutters.

Fig. 23 shows an inside angle for an ornamental

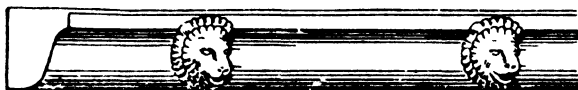

FIG. 28.

iron gutter, and Fig. 24 an outside angle. Fig. 25 is a union piece with an outlet nozzle P fixed vertically in its bottom. Fig. 26 shows the nozzle cast at an angle

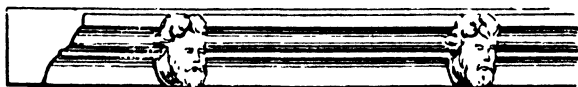

FIG. 29

at the bottom back corner of the gutter. Fig. 27 is a short union or junction piece.

Fig. 28 shows a different style of iron gutter, the



FIG. 30.

casting in this case being ornamented in front with panthers' heads, while Fig. 29 shows men's heads in place of the panthers. Fig. 30 is a plain square or boundary wall iron gutter.

There are so many patterns of these ornamental iron gutters, some with very elaborate mouldings, that

they can only be referred to here. The same principle of fixing obtains in each case, and no useful purpose would be served by describing them at greater length.

Before concluding this chapter a passing reference may be made to iron centre gutters. These are not put up for ornament but simply for use, and can be made with any fall required, the sole or bottom of the gutter being cast tapered, perhaps 6 in.

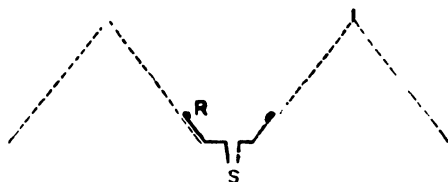

FIG 31.

wide at the outlet and 10 in. or 12 in. at the higher end.

In some cases they are cast without any fall, and are laid level and therefore the same breadth throughout. The two sides, however, in all cases require to be made to suit the pitch or inclination of the roof, or alternatively the inclination of the roof is arranged to suit, if they are selected beforehand. Generally, however, the gutter is made to fit the roof as at R, Fig. 31, where the nozzle S is also shown for the outlet, by which the water may be conveyed away by the rainwater pipes, as circumstances may require.

These iron centre gutters are made with enlarged faucets the same as semicircle gutters, not with contracted ends as the ornamental iron gutters in Fig. 21.

The joints are made with red lead and are tightened up with bolts and nuts, the bolts being $1\frac{1}{2}$ in. long and about $\frac{3}{8}$ in. thick. Three bolts are used for each joint, but in very wide gutters four or more bolts may be required. The gutters may be obtained in 6-ft. or 7-ft. lengths, according to the practice of the foundry from which they are purchased. Shorter pieces may be had to order or to make up the exact length required.

CHAPTER III

LEAD GUTTERS

FIG. 32 is a section of a span roof having projecting stone cornices at the front and back, the line on both sides being uninterrupted throughout its length. In this case M is the stone cornice on the top of the front

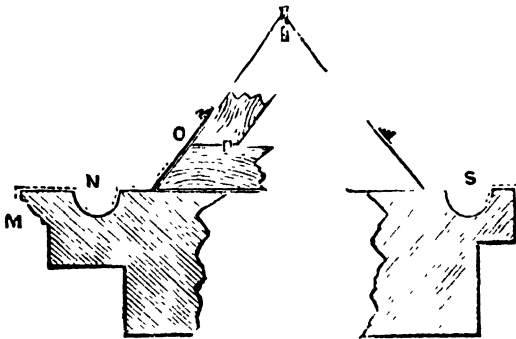

FIG. 32

wall in which the chase for the gutter N is cut, say, to a depth of 1 in. at its upper end, and becoming gradually deeper towards the outlet; at the lower end its depth may be about 3 in., while it may have a uniform breadth of about 5 in. throughout. The slope of the roof is shown at O, and it is necessary to lay the lead so as both to convey the rainwater away

and to ensure a watertight joint at the junction of the roof with the top of the wall.

The lead is laid across the cornice and about 6 in. on to the roof, as shown by the dotted line. The breadth of the lead in this case will therefore be about 2 ft., 1 in. of which is dressed down over the front of the cornice, the distance from the angle to the outer edge of the chase being 5 in., and the chase itself requiring a further 8 in. when the lead is dressed into position; the remaining 10 in. allows 4 in. from the back edge of the chase to the roof and 6 in. up the slope. This is shown in outline in Fig. 33. The length of each

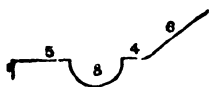

FIG 33.



FIG. 34

separate piece of lead as it is cut from the sheet and laid on the roof should not exceed about 10 ft., or the action of the sun will cause it to expand, and wrinkles will develop; 7-lb. lead should be used for gutters.

When the lead has been cut out it is rolled up and hoisted on to the roof, and after being "dressed" or beaten out flat, a chalk line is snapped down the centre corresponding with the centre of the chase. In Fig. 33 the line should be set 10 in. from the front edge at the deeper end and 9 in. from the front at the other, and the sheet should then be bent to a curve along its whole length as shown in Fig. 31. It is then set in the chase, and the sides are bent back and over so that it can be

properly dressed into its place, after which the edges are cut off straight and the roof side dealt with in a similar manner. When measuring off the length of lead, allowance must be made for any upstand or turnover at the ends of the gutter, according as the site may require. Before the lead is laid the tilting piece must be nailed along the roof about 4 in. from the bottom of the gutter, as illustrated at O in Fig. 32. This tilting piece is made by sawing a slate batten down edgeways, the cut passing obliquely across its width. The two pieces produced are of a right-angled triangular shape, 2 in. wide, and $\frac{3}{4}$ in. thick at the lower edge.



FIG. 35.

The connections between the various lengths of lead are made by a seamed joint, a groove about 1 in. wide and $\frac{1}{2}$ in. deep being dished in the stone across the chase for the purpose ; the lead is then dressed down into the dishing and a soldered joint wiped across, the surface of the solder being just flush with the lead, or obstruction to the flow of water will be caused (See Fig. 35.)

A description of the method of joining two lead gutter pieces *in situ* will not be out of place at this point. When the lead has been placed into its proper position as described above, its surface for about 4 in. on each side of the joint is rubbed with chalk to take off the grease, etc. ; it is then painted over with soil—a mixture of lampblack, size, and sour beer or water, boiled together—and after the soil has dried, the surface of the lead is scraped clean with the “shave-

hook" across the joint. To prevent it from becoming tarnished or oxidised it is immediately rubbed over with fresh grease, often a piece of tallow candle.

The solder pot and soldering irons meanwhile being properly heated, the plumber, by means of his small iron ladle, pours a sufficient quantity of solder on to the joint to raise a heat—all surplus being returned to the pot—and then by the help of his red-hot irons and his soldering cloth he wipes his joint. This is rather

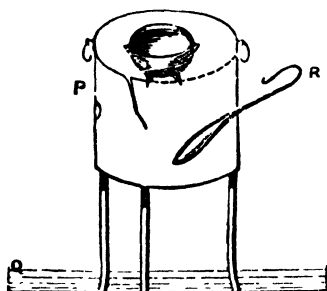

FIG. 36.

a difficult operation to carry out in wet weather; such work should be reserved for a fine day. The soldering cloths are pieces of moleskin, fustian, or strong linen of four, eight, or twelve thicknesses, and various sizes to suit the particular work. These cloths are kept well greased on the

side which comes in contact with the solder, to prevent the adhesion of the hot metal.

The rough sketch (Fig. 36) shows a plumber's fire pot P, as used for melting lead or solder. The soldering iron R is all of malleable iron, and is used for softening up the partially solidified metal after it has been poured over the joint, so that it can be brought to a smoother surface with the cloth. The latest type of fire pot is made on the principle of the plumber's blow-lamp. It burns paraffin oil which generates intense heat, so that very little time is occupied in bringing the metal to a molten condition. These oil

furnaces are comparatively light, convenient, and handy, and cost about £6 or £7.

A distinction must be made between the soldering "iron" and the copper bit, the latter being made with a copper head and iron handle. They can be obtained in pointed or hatchet shapes, the former being most commonly used. Hot or melted solder is used with

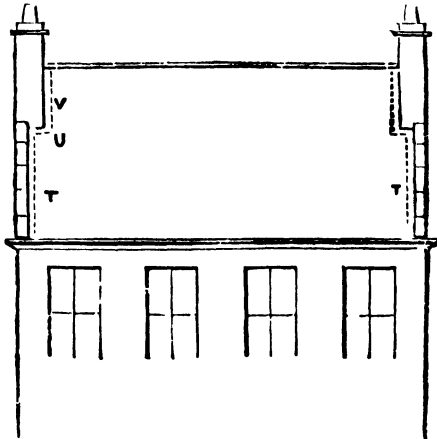

FIG. 37.

the iron, whereas the solder used with the bit is cold, and generally in the form of strips or in small thin cakes.

Self-heating soldering irons have been introduced within the last few years. These are made with a hollow handle, and are connected to an ordinary gas bracket by means of a length of rubber tubing. The gas passes through the handle, and when lighted the flame plays continually on the bit, thus keeping it at a uniform heat. Electric irons can also be obtained.

Good "working solder," used with the ladle and the soldering cloth, is made up by melting pure lead and block tin together in the proportion of 2 lbs. of lead to 1 lb. of tin. "Strap solder," used with the copper bit,

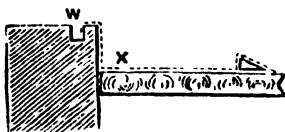

FIG. 38.

is made in the proportion of 1 lb. of tin to fully $1\frac{1}{2}$ lbs. of lead.

When using solder, especially working or plumber's solder, great care must be taken that no zinc is in-

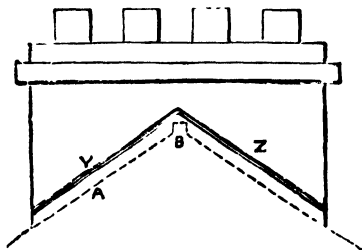

FIG. 39.

troduced by accident or intent, as a very small piece of zinc will spoil a large pot of metal.

The front gutter having been laid, a similar method has now to be adopted with the back gutter, s, Fig. 32; but as there is less breadth of stone to be covered the lead may be narrower, say 18 in. altogether. The length of the back gutter is sometimes less than that of

the front, as the stone gable coping may reach to the outside edge of the back gutter ; in this case the lead must be turned up against the gable wall, making a stop end to the gutter, the outlet being arranged at some intermediate position.

After laying the gutters the lead "flashings" which extend up the roof at each end must be fixed. They should be 13 in. wide, and in the building shown in Fig. 37, 6 in. would lie on the roof, 4 in. up the side of the stone gable at T, and 3 in. across the top of the coping, this being turned over and burnt into a raglet or groove as illustrated in Fig. 7. An alternative method of fastening the edge is to insert small lead wedges at intervals of 9 in. and to fill the groove with mastic.

Fig. 38 is a section of the stone coping, showing the chasing or raglet at W, the dotted line X being the lead.

The method of cutting the chase at the side of the chimney is shown at Y-Z in Fig. 39, the dotted line A being the line or surface of the roof, and B the ridge.

CHAPTER IV

LEAD GUTTERS (*contd.*)

IN Chapter III. the method of laying the lead in stone cornice gutters and up the sides of the gables was explained, both the back and the front gutters being a continuation of the slope of the roof without interruption. When, however, a building has a parapet wall along the front, or when the lead gutter is carried on a string course some distance down from the top, a slightly different arrangement is required, as the lead cannot be laid across the gutter and up the roof in one piece. In this case the lead, instead of going up the roof, stands up against the front of the wall, as shown by the dotted line D in the cross-section (Fig. 40). The lead, however, is not turned over and wedged into the chase E, but is dressed up against the side of the wall, reaching nearly to the bottom of the chase as at G. The edge is then covered with an apron piece F, a narrow strip of lead about 5 in. wide, which is bent lengthways into the shape of an L, the width of one side being 1 in. and the other 4 in. The narrow side is inserted into the chase, being wedged and pointed as already described, while the wider portion is dressed down into intimate contact with the back of the gutter. The apron piece should be dressed round the ends of the building for

2 in. or 3 in., to prevent the entrance of rain between the gutter and the wall.

The reason for providing an apron piece instead of turning the edge of the gutter into the chase, is to allow freedom for the lead to expand and contract without distortion.

The upstanding edge of the gutter must also be returned round the ends of the building, being worked

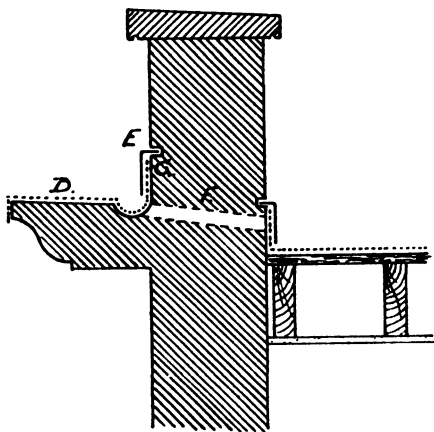

FIG. 40.

slowly and gently with a mallet a little at a time. This must be done carefully, or holes will be made in the lead. It is advisable to take the sharp edge off the corner of the wall before commencing, to reduce the sharpness of the angle, and prevent damaging the lead. The sinking in the stone for the gutter will stop a few inches short of either end of the cornice, so that water cannot drip out. In any event, very little rain will collect in the gutter, except in extremely

heavy downpours. The method of conducting the water away is described in the chapter on rainwater pipes, and is shown in Figs. 128 and 129.

When the cornice is near the top of the building and above the level of a flat roof at the back of the wall, the easiest method of disposing of the water from the gutter is to cut a hole through the wall and insert a short length of 2-in. lead pipe as shown by the dotted line at F (Fig. 40). The pipe would be connected to the upstanding edge of the gutter by means of a wiped joint, and the water would be discharged on to the roof and flow away. If the roof is covered with lead as shown, both ends of the pipe would have a wiped joint, but when the roof is lower than the cornice gutter, the pipe can be bent over and carried down the wall to within an inch of the lead flat. It is most important for the higher end of the pipe to be protected with a wire guard, to prevent leaves or rubbish being washed in, or the pipe may become completely stopped, and the water would then overflow on to the ground below.

With a sloping roof, a gutter is constructed at the back of the wall as at G (Fig. 41). This gutter is generally arranged with a fall of not less than 1 in. in 10 ft., but with very wide roofs it may be necessary to slope each way from the centre. The lead is laid as shown in Fig. 41, 6 in. standing up the wall and being covered with an apron, and the roof being dealt with as shown. If the gutter is so long that it tapers out to less than 6 in. at the lower end owing to the fall, it must be divided into bays not exceeding 8 ft. or 10 ft. in length, the joints between the bays being constructed with drips as shown on pp. 30 and

31. The tilting fillet should be fixed 4 in. up the lay-board on the roof at the highest part of the gutter,

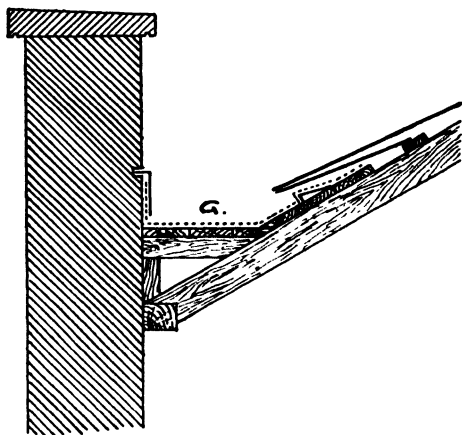

FIG. 41

and the lead should reach 2 in. beyond the top edge of the fillet. A nail may be driven here and there

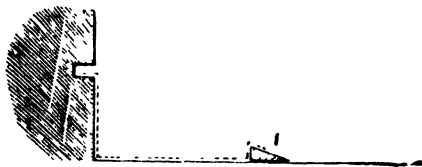

FIG. 42.

through the edge of the lead into the layboard to prevent slipping.

Fig. 42 shows in section a secret gutter at the side of a gable wall. In this case a layboard is provided

reaching from eaves to ridge, the tilting fillet being fixed 3 in. or 4 in. from the wall. The lead is dressed in position as shown by the dotted line in the illustration, and the slates are allowed to project 1 in. over the tilt at the side. In this type of gutter the lead is *under* the slates, while in ordinary flashings it is dressed down on the top.

We come now to a different form of gutter, where, instead of the channel being cut out of the top of the

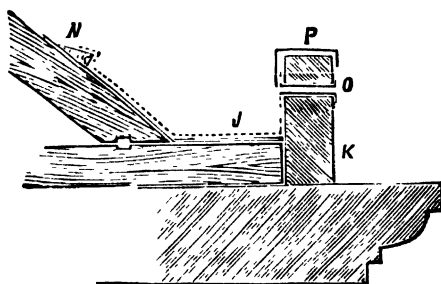

FIG. 43.

cornice as shown at Fig. 32, Chapter III., there is a stone blocking course built up above the cornice, with the gutter at the back. Fig. 43 gives a section of this gutter, the dotted line J representing the lead, and K the stone blocking course. In this case the gutter is of a different shape to that at Fig. 32, although the same quantity of material may be required. When the lead is rolled out on the roof, it is marked off and set up to the shape of the gutter as shown by the dotted line J, Fig. 43, the breadth being taken up by, say, 4 in. perpendicular upstand all along the one side, 13 in. at the high end and 10 in. at the low end for the sole or

bottom of the gutter, and 7 in. at the high end and 10 in. at the low end to lay on the roof. These measurements, of course, will vary with the length and breadth of the gutter.

After the lead has been bent roughly to shape it must be set up at each end to form the upstands for the ends of the gutter. This is done either by working up or bossing each end so that the lead may fit its site, or else by bending up the ends and turning round the corners. The latter is called pig-lugging or dog-earing,

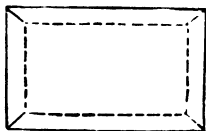

FIG. 44.

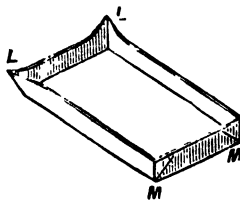

FIG. 45.

and may be explained as follows: Take a piece of white paper 6 in. by 4 in. and draw a line within it and all round it $\frac{1}{2}$ in. from its outer edge as in the dotted line, Fig. 44. Bend up the paper at the dotted line square all round. In doing this it will be found that the corners require to be bent out across or along the diagonals, when they take the form shown at L-L, Fig. 45. Press the corners close together and then turn them round as shown at M-M, and a copy is produced of what is often done with the ends of lead gutters.

This method is never adopted in good class plumbing, but the corners are bossed or worked up at each end so that the angles are brought to a box shape

without being doubled over to the side. This is a delicate operation needing the greatest care and skill. The bossing is carried out by gently striking the outside of the corner with a mallet, working round and round gradually until as much of the lead is disposed of as possible. This will thicken the corner and make it stronger, while the superfluous material can be cut away level with the top of the sides.

After the gutter has been put into its site it is driven well down into the corners with a box-wood wedge, the front side being set close against the blocking course and the back being dressed down on to the lay board and over the tilting fillet as at N, Fig. 43. The upper edge under the slate should be fixed with copper nails at intervals of 18 in.

An apron piece is required to prevent the admission of rain behind the front of the gutter, and an overflow pipe for the escape of water if the outlet should become obstructed. The apron piece is laid over the top of the blocking course as shown at P, Fig. 43, 1 in. being turned down over the front edge, the inside having not less than 4 in. lap over the upstanding side of the gutter. Before the apron is put on holes are cut in the top of the stone blocking course about $1\frac{1}{2}$ in. deep and $\frac{3}{4}$ in. wide, every 2 ft. or 3 ft., and a small round hole about $\frac{3}{8}$ in. in diameter is cut in the lead over the centre of the hole in the stone; this hole is made wider by beating the lead out and up at the same time as shown in Fig. 46; a small ferrule is then put over the hole and molten lead poured in. After this has cooled it is beaten gently on the top with a hammer until it assumes the shape shown at A, Fig. 46, which gives a perpendicular sectional view.

The overflow at O, Fig. 43, is passed through the blocking course in any convenient position. It must be below the bottom of the apron piece, and must not discharge in any direction where damage may be caused by the water.

In some cases, when the gutters are very shallow, *i.e.*, when they are laid within a few inches of the top of the blocking course, no apron is used, the lead being put on in one piece, passing over the blocking course, across the gutter channel, and up the roof as

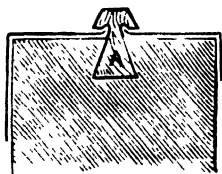

FIG. 46.

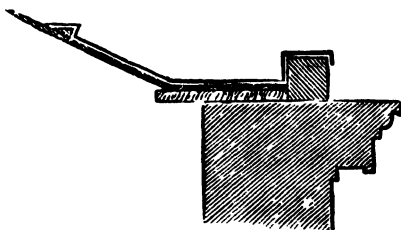

FIG. 47.

in Fig. 47. When gutters are laid in this manner—which is sometimes done for the sake of economy—and no overflow pipe is put in, care must be taken that the lead is carried up the roof a sufficient distance, so that if the gutter gets choked up and overflows, the water may run over the front of the blocking course and not over the top of the lead next to the roof. In other cases, where the gutter channel behind the blocking course is a sufficient distance below its top, the apron, instead of being laid across the top of the blocking course as at P, Fig. 43, may be fixed in a raglet inside the blocking course as at Q, Fig. 48. The object of apron pieces is twofold: (1) to make a watertight joint,

and (2) to leave the gutter free to expand and contract with variations in the temperature.

The expansion and contraction of the lead must always be provided against when laying gutters and similar work. For this reason no single length of gutter must exceed 10 ft. without a transverse joint, the connection being made by means of drips. No soldering, nailing, or permanent fixing of any kind is

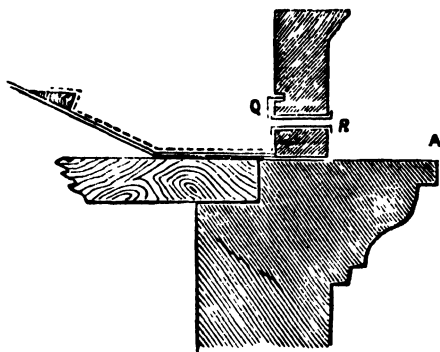

FIG. 48.

permissible. The bottom of the gutter is arranged in a series of steps for this purpose, the number of steps varying with the length of the gutter. When circumstances demand, the distance between the drips should be under, rather than over, 10 ft. Fig. 49 shows a longitudinal section of a lead gutter with drips S-S, the water being taken away from the centre of the gutter by means of a cesspool and outlet pipe, which passes through the wall and discharges into a down pipe, where it is conducted to a drain at the bottom (see T, Fig. 49). An overflow pipe R, Fig. 48, should also be provided.

In some cases, instead of the outlet pipe being situated at the centre as in Fig. 49, the gutter may fall towards each end from the centre as in Fig. 50,

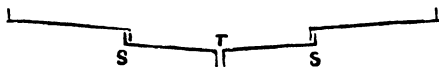

FIG. 49.

so that an outlet will be required at either end. In other cases the fall may be all in one direction, the outlet being situated at the lowest end. The drips



FIG. 50.

s-s, s-s, should be not less than 2 in. deep. If they are less than this, moisture may be drawn up under the overcloak by capillary attraction, and the ceiling and

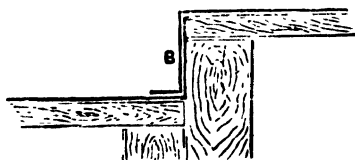

FIG. 51.

wall beneath will be disfigured with a damp patch. The gutter boards and bearers also soon decay and need renewing.

The method of constructing a drip is shown in Fig. 51, B being the overcloak or higher gutter, the

lower one being called the undercloak. It will be seen that the overcloak is carried down to the bottom

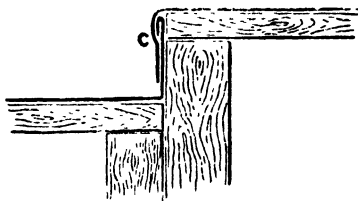

FIG. 52.

of the gutter and projects 1 in. in front of the drip. This is not the best method, as capillary attraction is



FIG. 53.

encouraged, and the rain is apt to creep up between the joint by suction and thus obtain access to the

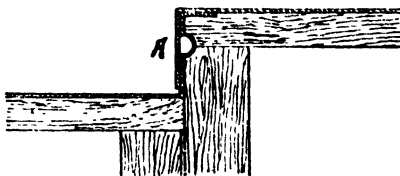

FIG. 54.

ceiling below. The overcloak is also liable to be lifted by the action of strong winds, which are enabled to get under the edge of the lead and force it out of place.

To guard against these contingencies, the overcloak should be cut off $\frac{1}{4}$ in. above the bottom of the lower gutter, so that neither is likely to occur. The undercloak should be turned over into a rebate, 1 in wide, on the end of the top gutter, and be dressed down flush with the board. No nails should be used, the lead remaining in place by its own weight. An improvement upon the simple overlap shown at B, Fig. 51, may be made by turning down the top edge of the undercloak as shown at C, Fig. 52, or it may be welted

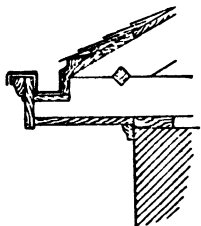

FIG. 55.

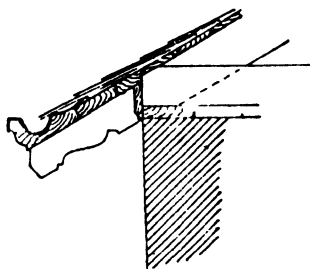

FIG. 56.

as shown at D, Fig. 53. The last two methods are suitable when the gutters are broad and much exposed to wind and rain.

Fig. 54 shows an anti-capillary drip. This is constructed in a somewhat similar manner to Fig. 51, but the undercloak is dressed back into a groove which is worked in the front of the bearer as at A, the overcloak being left quite flat. The space thus left prevents the admission of rain by suction, and is not difficult to arrange. The fall or slope of the gutter should not be less than 1 in. in 10 ft. Too great a fall should be

avoided, as the excessive velocity of the water during heavy rains might result in splashing.

Figs. 55 and 56 illustrate the method of constructing leaden eaves gutters. No difficulty should be experi-

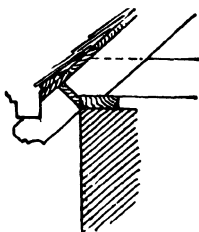

FIG. 57.

enced in following the illustrations, as they speak for themselves. This type of gutter is rarely used nowadays, as cast iron is cheaper, and almost equally effective. Fig. 57 shows a method of supporting a cast-iron gutter without the use of brackets, but this also is very rarely used.

CHAPTER V

FLASHINGS AND VALLEYS

FLASHINGS are employed to protect the joint between the end of a roof and the adjacent wall, and at the sides of chimneys. Cement fillets are often used as a substitute for lead in cheap work, but their employment is not to be advocated, as the cement soon cracks owing to its lack of elasticity, and leakage occurs

When a large volume of water flows down a roof,

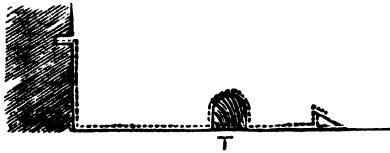

FIG. 58.

the flashing is sometimes arranged as in Fig. 58. In this case the flashing is combined with a secret gutter somewhat wider than that shown in Fig. 42, a wood roll being introduced as illustrated. The gutter may be 9 in. wide, and the rush of water is prevented from washing up over the tilting fillet by the roll, so that double security is obtained.' A different style has to be adopted from that hitherto described when dealing with brickwork, as the edge is turned into the horizontal

bed joints of the wall, instead of into a parallel groove cut in the stone.

The flashing should be 13 in. wide, and after being beaten out flat on a board, a chalk line is snapped down the centre 6 in. from one edge, and it is bent up over a stiff piece of timber into an L shape, and dressed to a right angle. Another line, called the water line, is then marked on the widest side, $2\frac{1}{2}$ in. from the angle, as at A, Fig. 59. When the flashing is laid in its place on the roof, the position and direction of the

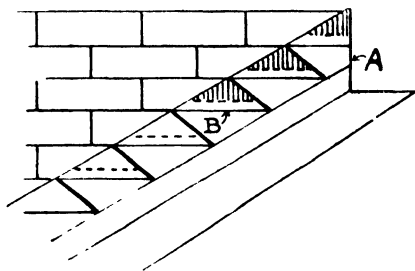

FIG. 59.

horizontal joints can be marked as at B, another line being added afterwards 1 in. above B. This extra piece is later on turned over for insertion in the joint. A mark—shown thickened in the illustration—is then drawn from the intersection of the horizontal line with the water line, to the joint of the brickwork above, the small triangular piece of lead which is shaded in the illustration is cut out, and the spare inch at the dotted line turned over. The flashing is then ready for fixing as in Fig. 60. The top end of the flashing is carried over the ridge and dressed down, that on the opposite slope being treated in a similar

manner. The bottom end is turned round the brickwork or cut off as occasion demands.

The method of fixing the flashing in the joints is with lead wedges and mastic, as already described.

A modified form of flashing is frequently adopted by introducing "soakers." The soaker is a thin sheet of lead or zinc, 8 in. wide; this is bent to a right angle and inserted beneath the slates, being secured by nailing to the batten at the head of the slate. The length of the soaker should be equal to the margin or exposed

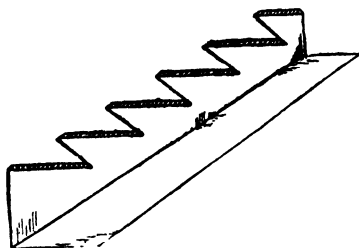

FIG. 60.

portion of the slate plus the lap, 1 in. extra being allowed for nailing; they are fixed flat on the slate and are covered by the next course, this procedure being followed right up to the roof. The soaker should lie 5 in. on the roof and 3 in. against the wall.

The flashing takes the form of an apron, covering the upstanding edges of the soakers. It is cut as described in Fig. 59, with the exception that it does not lie on the roof, and therefore does not need to be bent to an angle. Its width before the steps are cut out should be 7 in.

The valley gutter, which is formed at the centre of two parallel roofs that meet at the eaves on one single

plate, is covered with lead in practically the same way as the parallel gutter already described, the only difference being that the two wings are supported on lay boards at either side as in Fig. 61. Tilting fillets

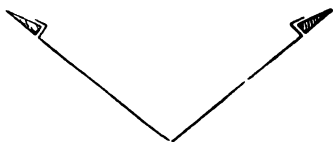

FIG. 61.

are provided as before, and a sole board with drips is laid on bearers which are cut to fit on the back of the rafters.

Parallel or box gutters are constructed in a slightly

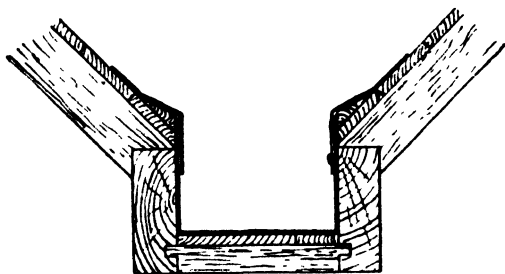

FIG. 62.

different form, and are more expensive ; they are used where the volume of water to be disposed of is excessive. Fig. 62 is an illustration of the arrangement of the timber work and the lead covering.

It will be seen that the feet of the rafters in this case are pitched on to two separate plates. The weight

of the roof is supported on substantial beams which are placed across the building, or on columns which are erected on the floor below, and the plates are set on edge, being wide enough to allow for the depth of the gutter. The plates should be about 12 in. apart, with 2-in. by 3-in. bearers stub tenoned in between. The fall is obtained by increasing the height of the bearers from the bottom, so that the plates being fixed level, the gutter board will fall at a gradient of 1 in. in 10 ft.

The tilting fillet is fixed flush with the inside of the gutter, and the apron pieces are dressed on to the boards and nailed at the top edge. The width of the apron is 6 in. on the roof and 3 in. in the gutter. The apron pieces are usually dispensed with if the gutter is not more than 10 in. deep at the outlet end, the lead being turned over and dressed on to the lay boards in one piece. The weight of the lead should be 7 lbs. per sq. ft. for the gutter and 6 lbs. for the apron.

CHAPTER VI

RIDGES AND HIPS

SHEET lead makes the best covering for ridges and hips, as it is durable, easily worked, and less liable to injury when properly fixed. Clay tiles are more frequently used on the score of expense, but being brittle and made in small units, they are more easily broken or displaced,

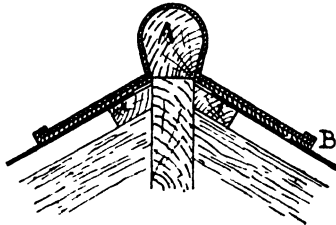

FIG. 63.

and do not afford such an effective protection against wet.

The lead ridge covering is put on after the slates have been fixed. It should be 18 in. wide, thus providing for a lap of 6 in. over the slates on either side. It is secured by dressing it round an oval wood roll which is nailed along the ridge as shown at A, Fig. 63, the corners of the lead being driven well home with a mallet and wedge. The wings are held by narrow strips of lead or tacks about 2 in. wide, which have previously been

nailed to the roof boarding, the ends being turned up and clipping the edge of the wing as at B. Another method of fixing the "tacks" is to cut them 16 in. in length, and to lay them across the top of the ridge and nail them in the centre, before the roll is put on. Thus the tack extends 7 in. on either side, and being in one piece instead of two, is much stronger and less likely to be pulled away.

The length of the separate pieces of ridge should not be more than 8 ft. or 9 ft., as, being in a particularly exposed position, it becomes heated by the sun's rays, and a good deal of expansion takes place. No nails or any rigid fixing must be used except at the joints, where the bottom piece may be secured with copper nails if desired. The lead is then left free to expand without causing any injury to itself or permitting the entrance of water; 6-lb. lead should be used.

The longitudinal joints between the various lengths are made by lapping the end of one piece over the end of the next for a distance of 6 in., the two pieces being clamped together by means of a "tack" described above.

The possibility of the admission of water between the lapped joints can be avoided by turning the end of the under piece over about $\frac{1}{4}$ in. in the shape of a small roll, and dressing the upper piece down in the usual way. This roll will prevent the water from running completely through the joint, and will direct it downwards on to the roof. This, however, is not necessary as a rule.

Hips are covered in a similar manner to the ridge, the free edges being secured by tacks placed 3 ft. apart, and the top end of each length of lead being securely

nailed with copper nails to prevent slipping. Work is commenced at the bottom, each successive length being laid before the next one is commenced. As there is little probability of wet gaining admission through the joints, the turnover on the end of the under piece will not be required, and the length of the lap can be reduced to 4 in. Special care must be taken to work the lead well into the angle between the side of the roll and the roof, as this forms the principal means by which it is held in place.

A more elaborate method of preventing the lead from slipping down the hip is to cut a piece of roll 7 ft. 9 in. long and nail it in position on the hip rafter. The lead, 8 ft. long, is then laid, the extra 3 in. extending beyond the top of the roll and being dressed down round its end. The next roll is laid in place and the second piece of lead put on in a similar manner, 4 in. lap being allowed at its lower end. This method is much superior to nailing, but it entails a good deal of extra labour in dressing down at the top of the rolls.

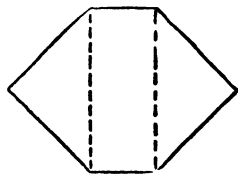

FIG. 64.

Hips can also be covered with soakers cut out of small pieces of lead that are not of much use for other work. The soaker is cut to the shape given in Fig. 64, the longitudinal portion in the centre being dressed round the roll and nailed at the top, while the triangular wings are laid under the slates. The roll is not absolutely necessary in this case, but it forms a better protection to the roof, and has a better appearance than merely laying the soaker flat on the hip. The

soakers must be fixed at the same time as the slates, each one being placed in position before the superimposed slate is nailed.

This method is stronger and more weather resistant than the ordinary plan, but as each soaker laps over the one in the course below the same distance as the slates, more lead is required. When a sufficient number of small pieces of lead are available that would not be of any great use for other purposes, it may be

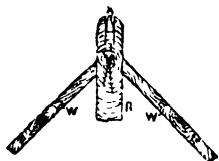

FIG. 65.

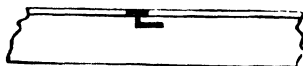

FIG. 66.

an advantage to utilise them in this manner, and thus save cutting long lengths from the roll

The common method of fixing ridge coverings in the past was to allow the wood ridge to project 2 in. above the slates, and after rounding the top edge to cover it with lead. The fixing consisted of large nails that were driven down into the ridge, the head of the nail fitting into a deep dishing that was countersunk round the hole; this was afterwards soldered over. These nails can frequently be seen standing $\frac{1}{4}$ in. or $\frac{1}{2}$ in. above the ridge, having been drawn out by the heat of the sun, bursting the solder off, and leaving a deep cup in which rain can collect. No nails must be driven through lead work on roofs, except under laps where it is covered by the adjacent length.

In Fig. 74 the hip is shown stretching down from the ridge to the gutter.

Zinc ridges were sometimes fixed by grooving out the wood ridge as in Fig. 65, and driving in iron staples as shown at X. Galvanised iron or copper hooks were soldered on inside the zinc ridges at corresponding distances as in Fig. 66, which shows a longitudinal

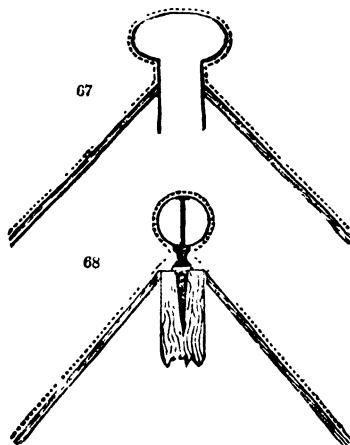

FIGS. 67 and 68.

section, and the zinc ridge was put on and slid along into its place, the hook going through the staple and holding the ridge down. The edge of the wings was held by strips which were nailed over the wood ridge, and the ends bent up to clasp the wings after the zinc ridge was put on.

This plan—which was known as Fox's Underlock Fastening—was found to be, so far as ridges were concerned, more troublesome and expensive than the usual method of nailing a $1\frac{1}{2}$ -in. by $\frac{1}{8}$ -in. iron strap over

the top to keep the zinc ridge down, but it had the advantage of doing without the holes through the ridge, which were inevitable when the straps were used.

Another method of fixing lead ridges is that shown by the dotted line in Fig. 67. The lead is about 18 in. or



FIG. 69.



FIG. 70.

22 in. wide in this case. The capping is about 4 in. wide, so that it is possible to walk right along on the top of the ridge instead of on the sides, and so to save injuring the slates.

Fig. 68 is a section of another style of ridge. The round wood roll is fixed by means of shouldered iron spikes which are first driven down into the ridge below,



FIG. 71.



FIG. 72.

and holes being bored in the roll, it is forced down on the spikes to the shoulder, and the top of the spike projecting through the hole is then bent over to act as a rivet. The lead or zinc is then put on round the dotted line in Fig. 68. Both of these methods are now out of date, and are given merely as an instance of the ideas that were adopted before plumbing had been brought to its present high stage of perfection.

Iron ridges are put on as cast at the foundry. Some foundries cast them in 4-ft. lengths, but they can be made to order to suit the pitch or inclination of the roof.

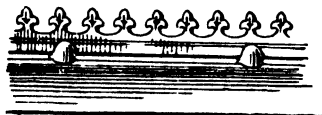

FIG. 73.

They can be had either quite plain as in Fig. 69, or with many different styles of ornament to suit the character of the building as in Fig. 70. Each length

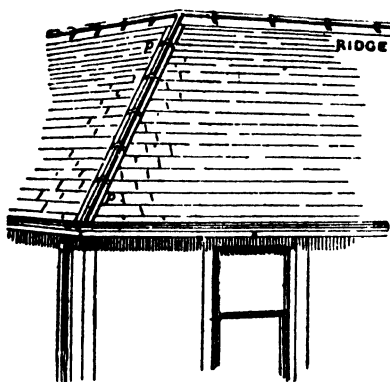

FIG. 74.

overlaps the other with a raised bead at one end and a corresponding raised cover or overlap at the other, the bead on the one length being covered by the overlapping socket of the adjacent piece, and so the junction is made watertight. Figs. 71, 72, and 73 show other patterns of iron ridging.

CHAPTER VII

LEAD FLATS

FLAT roofs should be covered with 7-lb. lead, as they are generally subjected to foot traffic, and any lighter weight would soon be ruined by iron-shod boots. The principal points to remember in this connection are: to provide against leaks, and at the same time to allow every opportunity for the expansion and contraction of the lead.

The type of roof under consideration, which is illustrated in section in Fig. 75, is one that is enclosed all round with parapet walls. The fall is in one direction from right to left, and at the lower end a parallel gutter is constructed to conduct the water away through the waste pipe at A. In very large roofs the fall would either be arranged from the centre each way, with a gutter at both sides, or alternatively the roof could slope towards the centre, and the water be disposed of by one gutter in the middle. In either case the same general principles would be involved, and similar methods of procedure would be required.

Fig. 76 is a cross section of the same roof, showing the method of fixing the rolls, etc. The rolls are fixed not more than 3 ft. apart, and the distance between the drips should be arranged not longer than 9 ft. In practice the lead is cut off to the required length

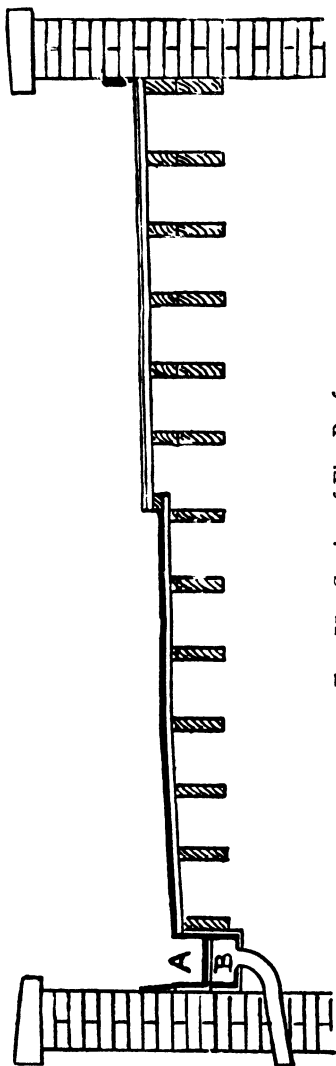

FIG. 75.—Section of Flat Roof.

and width, sufficient material being allowed to cover the rolls at each side and the drips at the top and bottom ends. The dimensions of the bay are then marked off on the lead with a chalk line, and the two sides and one end are turned up square, and after the top corners have been bossed up, the lead is laid in position at the lower end of the flat and driven close up to the wall at the side as at A, Fig. 76. The first roll is then laid as at B, and spiked down to the boarding with large nails, so that the undercloak can be dressed round as shown in the illustration. At the top end the upstanding edge is worked back well into the drip as shown in Fig. 75, while the bottom end is turned down and forms an apron piece for the

edge of the gutter, which has already been completed.

The next bay is laid in a similar manner, the overcloak being dressed over the roll on the left and covering the undercloak of the previous bay. This method is followed until the wall on the opposite side of the building is reached.

The same process is carried out with the higher portion of the flat, with the exception that the bottom

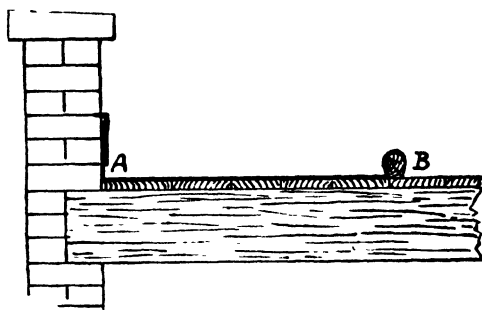

FIG. 76.

end, instead of being dressed down into the gutter, is carried down over the drip as in Figs. 52, 54, and 75, while the top end stands up against the wall. If the flat extends too far for the lead to be laid in two bays, three or more should be arranged. In this case the top end of the intermediate bays will form the undercloak for the drip, and the lower end the overcloak, the edges of the latter being trimmed off at the drip to make a neat finish.

The final operation will be to fix the apron piece round the wall as described in Chapters III. and IV. This should be inserted in the second or third bed

joint in the brickwork, but not less than 6 in. above the surface of the flat. The upstanding edge of the lead on the flat should reach $\frac{1}{2}$ in. below the selected joint. A mistake that is sometimes made by the inexperienced workman is to allow too little material for the vertical edge of the flat or gutter, calculating that when it is covered by the apron no wet can possibly get behind. This is correct so far as it goes, but in the event of the outlet becoming obstructed in wet weather the water heads back, and gradually rises until it flows over the upstanding edge with disastrous results, the apron, of course, being quite ineffective against such a contingency.

Lead flats should be provided with snow boards, or there will be a real possibility of flooding in the winter. These are described in Chapter X.

An outlet to the gutter is usually provided by constructing a cesspool at its lower end as shown at B, Fig. 75. This is a small square box about 6 in. deep, which is fixed with its top edge $\frac{1}{2}$ in. below the sole of the gutter. A circular hole of the same diameter as that of the waste pipe (say 3 in.) is cut through the bottom of the box, and a dishing $\frac{1}{2}$ in. deep and 2 in. wide is sunk round the edge of the hole. The box is lined with lead, the corners being bossed up, and a hole cut in the bottom to correspond with the one in the box. The end of the pipe is then pushed through the opening about 1 in., and turned over all round, forming a flange for its support. After the lead has been scraped and smeared with tallow, the dishing is filled with molten solder and the surface wiped smooth with a cloth. No rough edges should be left, as they are apt to catch any solid matter that may be passing

along the gutter, and thus prevent the escape of the water.

The outlet pipe, after passing through the wall, can either discharge into a cast-iron rainwater head, or it can be carried straight down to the ground in one continuous length. The former is preferable with small gutters as it is less expensive, and facilities for clearing any blockage that may occur in the down pipe is presented by the open top.

The overflow pipe should be situated below the lowest upstanding edge of the gutter, so that no water can flow over the top. The outlet pipe should be protected by inserting a galvanised wire balloon guard in the opening in the cesspool, or by covering the cesspool with a flat wire grating.

The cesspool is often dispensed with as a means of getting rid of the water. In such cases the lower end of the gutter is carried straight through the side wall of the building, a hole being left in the brickwork for the purpose. The sole board of the gutter should project through the opening and be cut off flush with the outside of the wall. The lead is continued about 6 in. beyond this, and is dressed down into a rainwater head that has previously been fixed beneath. This is the most economical method, but it is not always possible, owing to the proximity of adjacent buildings.

When the flat is laid on the top of a mansard roof, the method of procedure is similar to that just described, except at the edges, where a slightly different finish is necessary. In this case the sides of the roof are covered with tiles or slates, the top course being protected by a strip of lead wide enough to lap over the top of the course below ; this strip is nailed along

its upper edge, and is further secured by a wood nosing which is fixed level with the flat. The ends of the rolls are stopped 1 in. from the front of the nosing, and are cut off on the rake as shown at A, Fig. 77,

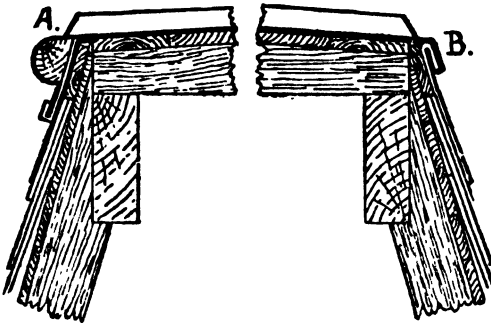

FIG. 77.

to enable the lead to be dressed down and over the front edge as shown. An alternative method is to fold the lead over into a seam as shown at B on the opposite



FIG. 78.



FIG. 79.

side, this being simple and equally effective, although it does not look so well.

It is customary to use wooden rolls for making joints in sheet leadwork, as this method, besides being perfectly watertight, allows ample opportunity for expansion. Rolls, however, can be made without the use of wood, the method being illustrated in Figs. 78

and 79. Here the edges of two adjacent sheets are set up at right angles, one being 6 in. high and the other $7\frac{1}{2}$ in. The longer side is then bent over the shorter one as in Fig. 78, and the two are rolled over as in Fig. 79, making quite a satisfactory job in a comparatively short time. Hollow rolls are not often used on flat roofs, as they soon become damaged when walked upon. In turning over the rolls they should always be turned towards the side which is the least exposed to wind and rain.

CHAPTER VIII

ZINC FLATS

ZINC should not be used in big towns on work that is of a permanent nature, owing to its tendency to chemical decomposition when attacked by the acid fumes which are discharged into the air from chimneys. It is of a more lasting character in country districts, where the air is purer and is not laden with destructive gases, but even then its use is generally confined to speculative work and small houses of the cheaper kind. The general principles that are followed in zinc work are very much the same as with lead, similar provisions being made against the passage of wet, and plenty of room being allowed for expansion. It is cheaper than lead in its initial cost, and, owing to its lightness, does not require such substantial framing in the roof timbers ; its ratio of expansion, however, is considerably in excess of that of lead. Zinc should not be placed in immediate contact with lead or copper, if it can be avoided, as a galvanic action is set up which causes it to decay rapidly.

Zinc is made in sheets of a smaller superficial area than lead, the largest sizes being 8 ft. long by 3 ft. wide. It cannot be bossed or worked up at the angles in the same manner as lead, so that it is necessary to solder the corners of drips, etc., in order to make a watertight joint.

The bays on a zinc flat are laid out in the same manner as that described for lead work, the dimensions and falls being similar; but as zinc is considerably thinner, it is usual to cover the flat with felt as a precaution against possible injury, the rough corners of the boards being planed off before the felt is laid.

The rolls are trapezoidal in section, and are fixed with the widest side down. They are $1\frac{1}{2}$ in. across at the base, tapering slightly on both sides to $1\frac{1}{4}$ in. at the top, and are about 2 in. high. Before they are fixed, strips of zinc 6 in. long are placed at right angles underneath the roll at 3 ft. intervals, their ends projecting square across the bay; these strips are subsequently turned upwards against the sloping sides of the roll, the extreme ends being afterwards bent down to form a clip (see Fig. 80). All the rolls should be fixed before the zinc is laid.

When measuring the bay before cutting the sheet, $\frac{1}{4}$ in. must be deducted from the actual width to allow for expansion. A line is then snapped down on both edges of the sheet, the distance apart being the same as that between the rolls, less the $\frac{1}{4}$ in. The edges should then be turned up nearly at right angles with the sheet, the upstanding portion being $1\frac{3}{4}$ in. high. The drip at the top end should be turned up square and soldered to the sides at the angles, the top being bent over in front to form a flange as shown at A, Fig. 80. The lower end of the sheet projects 1 in. beyond the drip below, and is curled under so that it encircles the lower flange as illustrated. The sheet is placed in position and driven flat so that it fits correctly, a block of wood being used to distribute the force of the blows. The ends of the zinc strips

are then bent over and grip the edges securely to keep it in place.

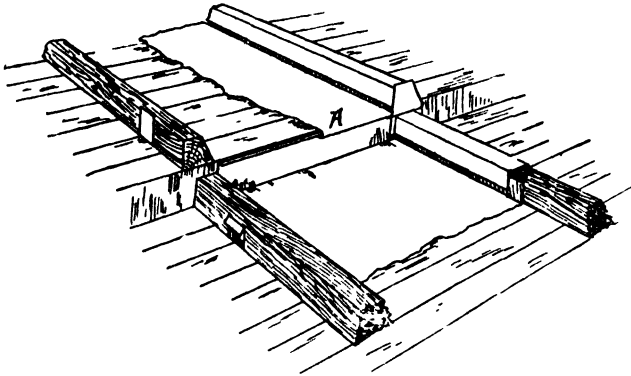

FIG. 80.—Method of Laying a Zinc Flat.

The rolls are covered with a purpose-made cap, this cap being made out of a strip of zinc of the required length, bent up on two sides. The top end is fitted

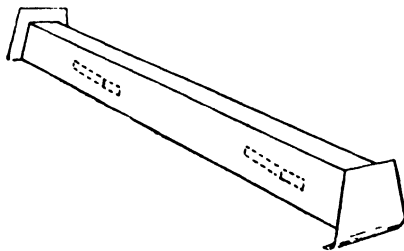

FIG. 81.—Zinc Roll Cap.

with a cross piece which stands up behind the beaded edge of the bay above, and the lower end is closed by a shield which clips over the bottom roll and the flange

in the drip. Small strips of zinc are soldered inside the cap opposite the clips which have been nailed under the roll. These strips—which are fixed at one end only—slip under the clips, and prevent the cap from lifting.

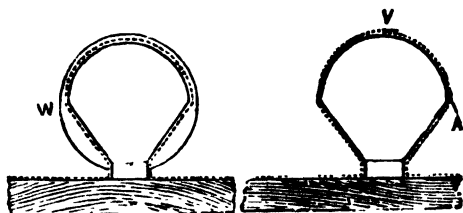

FIG. 82.

The cap is fixed by sliding it over the roll from the lower end towards the top, no further fixing being employed. Fig. 81 is an illustration of the finished cap, the strips on the inside being indicated by the dotted lines.

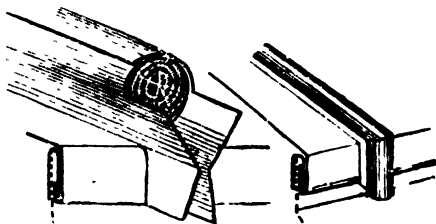

FIG. 83.

FIG. 84.

In the more modern system of laying zinc, soldering is dispensed with, the necessary bends and corners being made by pressing the sheets into the required shape, the corners being dogs-eared as shown in Fig.

45. This method, however, needs special apparatus before it can be carried out, and is not very generally adopted.

A different shaped roll that is sometimes used is illustrated in Fig. 82. The sketch on the right shows the two sides of the bay bent round the roll and overlapping at V, while on the left the circular cap is shown in place, gripping the narrow portion at the bottom of of

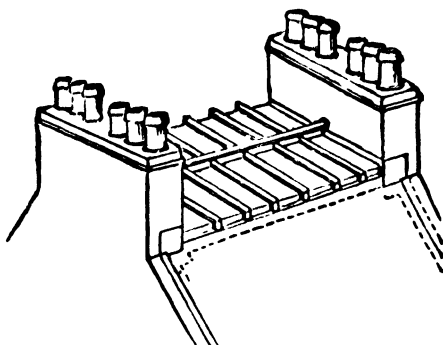

FIG. 85.

the roll. Fig. 83 shows the end of the roll with the edges of the bay projecting in front but with no cap, while Fig. 84 gives the work complete, the cap being returned down the front of the drip. The drip in this case is connected by means of a welded joint.

Fig. 85 is an illustration of a flat roof covered with zinc. The fall being each way, a larger roll or "saddle" is introduced transversely across the centre to break the surface up into shorter bays.

CHAPTER IX

ZINC ROOFS

IN Chapter VIII. the method of covering a flat roof with zinc was described. This chapter is concerned with the method of covering a pitched roof with the same material. Before beginning to place the zinc on the sides of the roof, the gutters have first to be laid, and these may be of the style shown in Fig. 48. The gutters may be either of lead or zinc, and have been described in Chapters III. and IV.

In setting up sheet zinc to the sizes and shape necessary to make it fit its intended site, it is turned over the edge of an iron-faced bench ; or if, as is often the case, the zinc is set up at the job, then in many cases a long, stout, sharp-edged wooden plank is made to serve the purpose in lieu of the bench proper.

In the sketch of the gutter at Fig. 48, the tilting fillet for the slates is shown at the top edge of the lead ; this, however, is dispensed with here, as there are no slates to be fixed. The style of the roof is the common gable or "pent" roof, and it can be pitched at a much lower angle than if it were to be covered with slates or tiles, as there will be no longitudinal joints where leaks may occur.

Before commencing on the roof, the whole of its surface ought to be examined to see if there are any

nails, etc., projecting above its surface, and if there are any they must be punched well down. The gutter being laid and its top edge next the slope of the roof bent over about 2 in. as in Fig. 86, the number and position of the rolls must then be fixed.

Assuming for the purposes of illustration that the distance between the two gables is 10 ft., while from ridge to eaves is 15 ft., and that the 8-ft. by 3-ft. zinc sheets are all to be cut up the middle longitudinally, it follows that there will be seven rolls and eight sheets

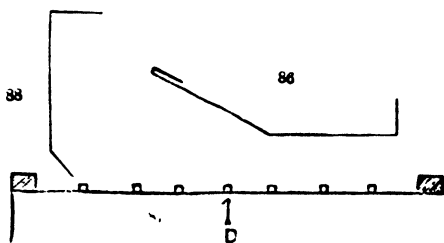

FIGS. 86, 87, and 88.

in the length of the roof. The position for the first roll may therefore be marked off in the centre of the roof as at D, Fig. 87. The full breadth of the sheets after being cut up being 1 ft. 6 in., it follows that as $1\frac{1}{2}$ in. is to be allowed for the upstands on each side of the sheets, there will only be a distance of 1 ft. 3 in. between the rolls, and also that the number of rolls required will be seven, as shown on Fig. 87. The width of the bays will necessarily be determined by the size of the roof, and will usually be more than 1 ft. 6 in. This distance is only selected for the purposes of illustration. As the size of the roll caps is, in this case, to be $1\frac{1}{2}$ in., Fig. 89 shows a full-sized section of

a wood roll suitable for the same. The outer circle shown on Fig. 89 is a full-sized section of the zinc roll cap, and the dotted lines show the zinc sheets turned up against the roll.

The wood roll is about $1\frac{3}{8}$ in. broad by $1\frac{7}{8}$ in. high over all. It is best to be made and put on in two

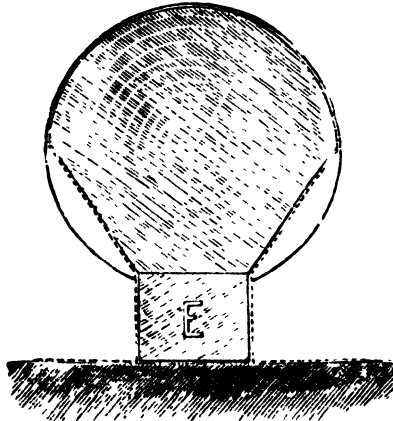
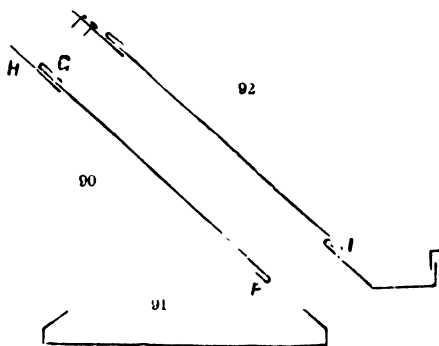

FIG. 89.

pieces, as indicated by the line between the base and the circular portion on top. The long strip E is first nailed in the centre of the roof as at D, Fig. 87, and two similar pieces are fixed at a distance of 1 ft. 3 in. from centre to centre. The remaining strips are then nailed at intervals of 15 in. until the slope of the roof is divided up into eight parallel bays. After these are nailed on, the zinc sheet has to be turned under at the bottom 1 in., as at F, Fig. 90, and also turned over at the top 2 in., as at G in the same figure. The sides of the

sheets must then be set up $1\frac{1}{2}$ in. on each side as in Fig. 91.

A small strip of zinc about 6 in. long by 3 in. broad is now firmly soldered on to the under side of the sheet at the top as at H, Fig. 90. This is fixed in the centre of the width, and its purpose is to support the sheet and to keep it from slipping down after the roof is finished. When the zinc sheet has been placed in its correct



FIGS. 90, 91, and 92.

position, the strip at H is nailed to the boarding and no movement is possible.

The lower portion of the sheet, turned in as at F, Fig. 90, laps on to the top edge of the gutter, which has been turned down to suit as at I, Fig. 92, thus forming a welted joint through which no water can pass. Two other zinc clips about 6 in. by 2 in. are nailed at the top of each sheet as at K-K, Fig. 93, these being afterwards turned under to clip the edge of the sheet as shown.

The eight sheets on the lower half of the roof are

laid in this manner throughout, the only difference being that the edges which stand up against the wall are

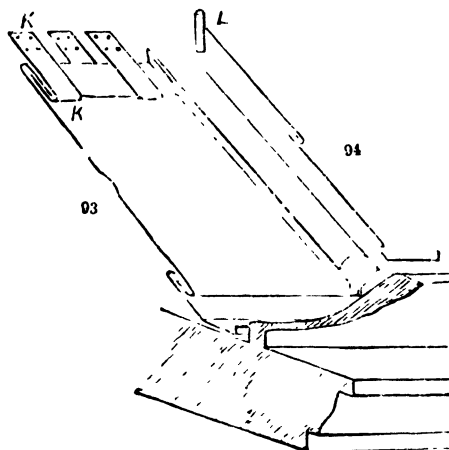

FIGS. 93 and 94.

bent upwards at a right angle to a distance of 4 in. The top half of the roof is then taken in hand, the

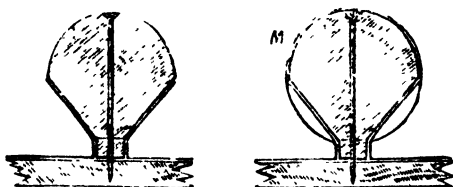

FIGS. 95 and 96.

bottom of the sheets being turned under as before to engage with the one below. The top end can either butt tightly against the ridge as at L, Fig. 94, or it can be set up against the side for about 1 in., with two 6-in.

by 2-in. strips soldered on and nailed to the woodwork as before. The latter is preferable. It will be noticed that Fig. 94 is shown at half the size of scale of Fig. 93.

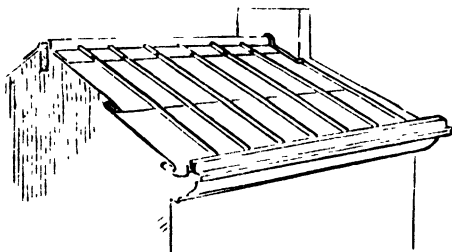

FIG. 97.

Both sides of the roof being covered in the same way, the wooden rolls can be nailed on as in Fig. 95. The zinc roll caps (which are purchased ready made) are then slid down over them as at M, Fig. 96. The

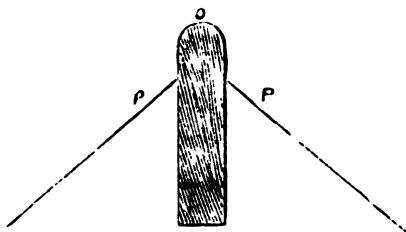

FIG. 98.

caps are generally made in 8-ft. lengths, and as the side of the roof is 15 ft. deep, it follows that there must be a joint in each stretch of roll capping, which joint is made by slipping the upper cap an inch or two over the lower one and soldering the two together. One

nail or small catch put in under the joint at the top of each length is sufficient to hold it in its place, as, if properly put on, the roll cap is secured by its own grip, and allows the sheet to expand and contract without fear of fracture.

The apron pieces are fixed round the gable walls as described in the chapter on lead work. The free edge of the apron can be stiffened and made to lie back closer to the wall if it is set in a little at the bottom, as shown in section in Fig. 88.

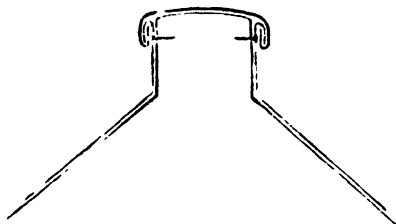

FIG. 99.

The ridge must now be covered. Fig. 98 shows a common type of ridge, the centre piece projecting about 3 in. or so above the sides. The ridge is covered with a piece of zinc placed lengthways, and wide enough to reach down the slope 6 in. on either side as in Fig. 97. Zinc tacks, as described in Chapter VI., should be nailed to the roof beforehand, the ends being bent over the edge of the ridge to prevent it from lifting. An oval roll is required on the top of the ridge to hold the zinc in place. Another method is shown in Fig. 99. In this method the wings are laid first and the capping slipped on afterwards, the connection being made by means of a welt, as illustrated

Another pattern of roll is that shown by Fig. 100, with five zinc clips 2 in. broad in the length of the sheet, these clips being put under the wood roll and turned down as shown.

In the previous examples of laying zinc, the roofs underneath are boarded. In what is known as the "Italian corrugation" no boards are used, wooden rolls 3 in. deep by $1\frac{3}{4}$ in. wide being put on every 1 ft. 3 in. centre to centre, and purlins fixed every

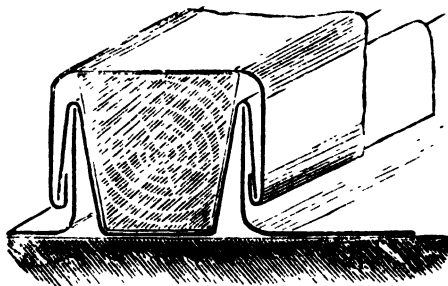

FIG. 100.

10 ft. or so. The overlap at the top and bottom of the sheets is about 4 in., each one being fixed with nails. Fig. 101 is a section of this pattern. The fold in Fig. 102 is an improvement upon the mere overlaps of Fig. 101, especially where the roof is much exposed; it also has the advantage that only the bottom sheet need be nailed. For roofs without boards, Nos. 15 and 16 zinc should be used.

The gutters for zinc covered roofs may be of many patterns, similar to those already described. In addition, there is the zinc caves gutter, Fig. 103, which may be ornamented with various enrichments in stamped

zinc; the boundary wall gutter, Fig. 104; the plain box gutter, Fig. 105; or the same with sloping sides as in Fig. 106 for the centre gutter on double roofs. Fig. 107 is the common style of centre gutter that is used on double roofs in the South-West of Scotland.

In an article on "Zinc" in Gwilt's "Encyclopædia

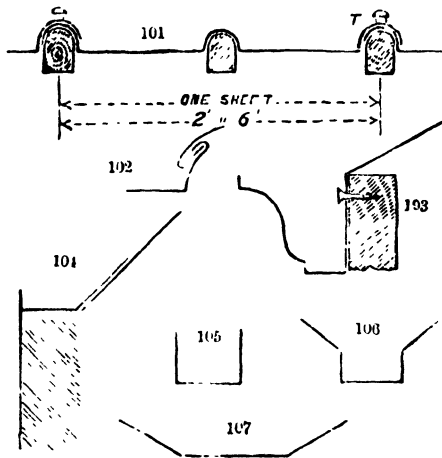

FIGS. 101, 102, 103, 104, 105, 106, 107.

of Architecture," it is stated that: "Zinc, though subject to oxidise, has this peculiarity, that the oxide does not scale off as that of iron, but forms a permanent coating on the metal impervious to the action of the atmosphere, and rendering the use of paint wholly unnecessary. Its expansion and contraction are greater than those of any other metal. Thus, supposing 1·0030 to represent the expansion of zinc, 1·0019 is that of copper and 1·0028 that of lead. Hence, in use, proper

attention must be paid to this circumstance, or a substantial and durable covering of zinc will not be obtained. The method of accomplishing this is, of course, by always allowing plenty of play in the laps. The tenacity of zinc to lead is as 16·616 to 3·328, and to copper as 16·616 to 22·570, Hence, a given substance of zinc is equal in tenacity to five times the same substance in lead, and about three-fourths of copper."

CHAPTER X

SNOW BOARDS AND GUARDS

IN the winter, during bad weather, flat roofs and gutters may soon become covered with a deep layer of snow, which obstructs the outlets and prevents the escape of water. This is of little consequence so long as the temperature is low, but immediately a thaw sets in the snow commences to melt, and a free outlet is of the first importance. If this is not available the lowest

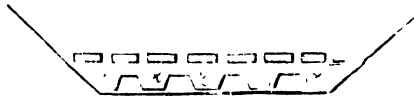

FIG. 108.

portion of the gutter soon fills with the accumulated water, which gradually rises until it creeps up under the apron and soaks through to the room below.

To guard against this contingency, lead flats should be provided with snow boards. They are made by nailing 3-in. by 1-in. wood battens 1 in. apart, transversely across bearers that have previously been cut to fit between the bays. The bearers should be made from oak 4 in. wide by 2 in. thick, and should stand on edge, the under side being hollowed out or checked as shown in the cross section, Fig. 108, to permit the passage of water.

The provision of snow boards serves two useful purposes : (1) it prevents the obstruction of the surface by the snow, which, by settling on the top of the battens, allows the water to run through the joints on to the lead, and to have unrestricted passage to the gutter ; and (2) it prevents injury to the lead by contact with heavy nail-shod boots or iron implements. Snow boards are not always provided, but a serious risk of flooding is run in their absence.

Fig. 109 shows another type of snow board which



Fig. 109.

can be laid over centre gutters. The bearers do not require shaping on the under side, as in this case they are cut to fit the sloping lay boards at the eaves of the roof. Deep gutters, where this kind is not possible, should be provided with extra wide bearers to the snow boards, so that when standing in the bottom of the gutter, plenty of room is available for a sudden rush of water.

Common deal can be used for the battens if oak is considered to be too expensive, but deal is not suitable for the bearers on account of their continual contact with the wet surface on which they stand, and it would soon decay. In any case the snow boards should be well tarred or creosoted after they have been made, to ensure protection against wet. They should fit quite easily into place, so that no damage can be caused to the

lead either by violent wrenching, or through becoming wedged at the ends.

Snow guards are quite distinct from snow boards, and their purpose is quite different. They consist of a low iron or strong galvanised wire fencing about 9 in. high, which is fixed in a vertical position along the eaves of a sloping roof, to prevent the masses of snow from sliding down on to the ground below and breaking

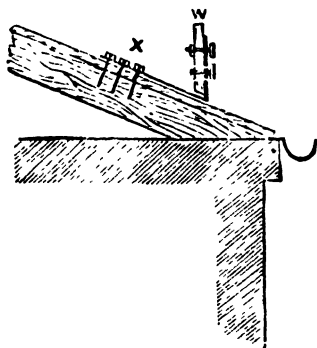

FIG. 110.

the eaves gutter. When a conservatory or greenhouse is built against the wall of the house, it is also advisable to provide a guard along the eaves above, as a precaution against loose slates or broken pieces of mortar which might fall and break the glass.

The wire fencing is fixed to iron brackets which are screwed on to the feet of the rafters before the slates are laid. It is thus situated immediately above the gutter.

Fig. 110 is a section of a wooden guard fixed a few inches up the slope. It is made by bolting a 7-in by

1-in. board on the upstanding arm of the bracket as at w, the longer arm being screwed to the back of the rafter as at x. The brackets are from 3 ft. to 4 ft. 6 in. apart, according to the thickness and strength of the board and the spacing of the rafters. This type of snow guard is rather primitive and is not often used, as a difficulty is experienced in cutting the slates round the vertical arm and in making a watertight joint afterwards.

CHAPTER XI

HATCHES, SKYLIGHTS, AND DORMERS

THE plumbing work that is required round the sides of openings in the roof is carried out on the same principle as the flashing round a chimney, the gutter

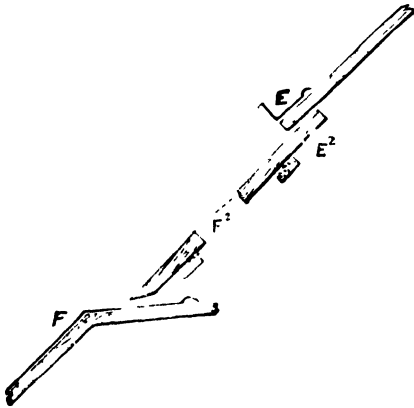
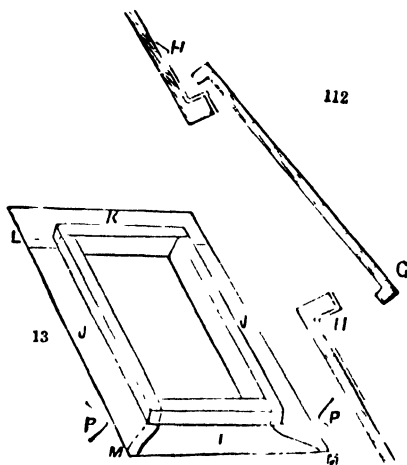

FIG. 111.

side and bottom pieces only varying in the disposition of the top edge.

The simplest form of hatch is known as the sliding hatch, of which Fig. 111 shows a longitudinal section. All the plumbing work that is required is the piece of lead or zinc *E* along the top, and the sole *F* along the

bottom. The top piece will be about 10 in. wide, and if the hatch is, say, 18 in. wide, E. will be 2 ft. 6 in. long. F will be about 18 in. wide, and the same length as E. The sliding portion E² is made out of a wooden board 1 in. thick. Its length may be about 3 ft. or rather more, and its breadth the distance between the rafters. A hole should be cut in its centre,



FIGS. 112 and 113

9 in. long and 6 in. wide, in order to admit light. A piece of strong glass is fixed over this hole as at F², Fig. 111.

This is a very primitive form of hatch. There are no hinges to break, and when it is merely used for the convenience of workmen obtaining access to the roof, it will answer the purpose equally as well as one of a more elaborate construction.

Another form of hatch is that with a movable lid,

HATCHES, SKYLIGHTS, AND DORMERS 79

a section of which is shown in Fig. 112, with the lid G partially open, the lines at H-H being the top and bottom lead flashings. The opening between the rafters is trimmed and finished off with a framed wood lining, which projects above the back of the rafters 3 in. or 4 in. A lay board 9 in. wide is fitted across the rafters at the top of the hatch.

When the slates have been laid close up to the outside of the lining, the lead flashing at I, Fig. 113, is put on. It is dressed closely against the lining, turned

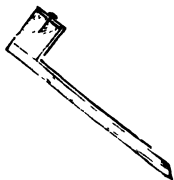

FIG. 114

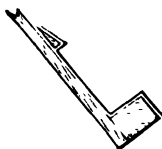

FIG. 115.

over the top edge, and nailed all along with copper nails, $1\frac{1}{2}$ in. apart (see Fig. 114). A couple of lead tacks are nailed to the batten at the lower end of the hatchway, above the head of the slates, these being long enough to be bent up over the bottom edge of the flashing for $\frac{1}{2}$ in. The flashing along the two sides is then laid and fixed in a similar manner. In both cases the flashing is returned round the corners as shown in the illustration at L·M

The top flashing or gutter is then put on as shown in Fig. 115, a thin tilting fillet being provided to ensure that the slates shall lie correctly. The ends of the lead gutter are dressed down on to the row of slates whose head reaches about to the same height as the highest

point in the sole of the gutter, and the succeeding row of slates will lap over the top edge of the lead in the usual way. This row of slates is cut off to project 1 in. over the tilting piece, so that all water is conducted into the gutter.

If the roof is situated in a very exposed position, it may be advisable to introduce a row of soakers in the angle on either side of the opening, to guard against high winds and driving rains; or, in exceptional cases, a 2-in. secret gutter can be constructed instead on the same lines as that shown in Fig. 42.

The covering for the hatchway can be seen in section in Fig. 112. It is made by jointing a sufficient number of boards together with ledges to cover the opening, and to allow $1\frac{1}{4}$ -in. projection at each side. The length is also arranged to show a similar margin or overhang at the top and bottom. A rim is then formed on the under side by nailing strips $1\frac{1}{4}$ in. square all round the edge, the rim being well clear of the linings so that the cover can be lifted off without trouble. The outside of the lid is then covered with 6-lb. lead, bossed up at the corners, and trimmed off flush with the under side of the rim.

In Fig. 113 the dotted lines at M-M show how the two side flashings J-J overlap the bottom piece I, the two side pieces being worked round the lower corners of the frame in the same way as the top piece K is worked round the upper corners. The same lap should be given as at the top, and the lead should be cut away at the angles as at M, to make a better looking job and to save materials. This does not apply to the gutter piece at L, which should run straight across as shown.

To prevent the cover being lifted off by high winds, it is secured by two bolts screwed to the under side, which shoot into holes bored in the side of the linings.

Zinc can be used for the flashing in the place of lead, and also for covering the lid. The method of fixing is the same, except that the corners are cut and soldered instead of being bossed up.

In setting up the bottom piece U, Fig. 116, with zinc, if the roof is to be slated, $\frac{3}{4}$ in. must be allowed

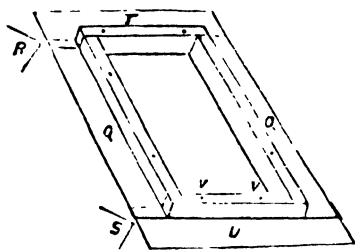

FIG. 116.

for the thickness of the slates which are to go underneath, so that the width of the upstanding edge is that much less than the distance from the top of the linings to the slate battens. The bottom piece U is only fitted in temporarily at first until the slates are put on, so that it can be lifted out while the slates are laid, for zinc cannot be bent up and down in the same easy manner as lead. This also applies to the side pieces Q-Q. After the slater has reached the top of the linings, the bottom piece is replaced and nailed to the frame in the same way as at N, Fig. 114, and as at v-v, Fig. 116, the sides are fixed, and the gutter is put in. The

slater then proceeds with his work, the slates being laid on top of the gutter flashing. When desired, the zinc can be put on to return round the corners as at M-M, Fig. 113, the zinc being left so much longer, and soldered at each corner. The sides should not be soldered to the bottom, however.

Skylights are usually constructed on a rather more elaborate principle than that just described, as when the

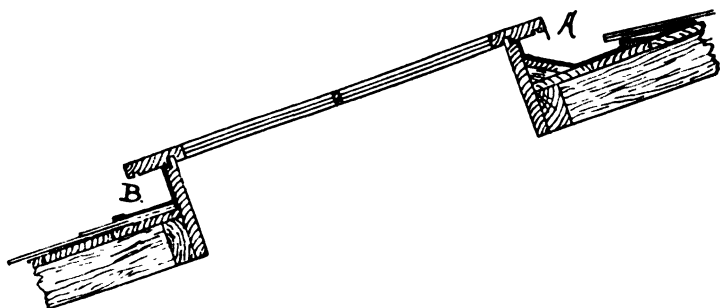

FIG. 117. --Section through Skylight.

light is hinged to open, more difficulty is experienced in preventing the entrance of wet.

Fig. 117 gives a section through a skylight from top to bottom, showing the method of adjusting the lead work, this being represented by the thick black line. The method is almost identical with that illustrated in Figs. 113 and 116, except that in this case a tongue which is worked on the top edge of the linings fits into a corresponding groove which has been ploughed in the under side of the light. This will not present any very great difficulty, as it only means a little extra work in dressing the lead into the rebate. The light is glazed,

and is therefore not covered, but a strip of lead may be nailed along the top end as at A, to prevent rain from running under the light and so into the joint, and causing the timber to decay. The throating groove at B is continued all round the light for the same purpose

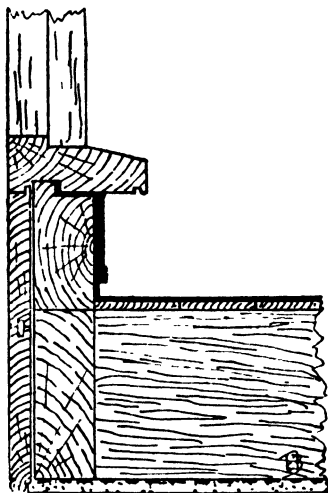

FIG. 118.

Lantern lights are supported on a kerb which is built into the opening in a flat roof, or at the apex of a pitched roof. The kerb is 3 in. thick, and a tongue is formed on the inside by nailing a strip of wood round as shown in section in Fig. 118. The lead is dressed round the kerb to the tongue as before, and when the sill of the lantern is fitted over the tongue, the joint will be quite secure. The bottom edge of the lead forms an apron to protect the upstanding edge of the lead flat

Fig. 119 is a section of an alternative method where the tongue is omitted, the lead work being carried through about $1\frac{1}{2}$ in. beyond the inside of the sill, and curved up into the shape of a small half-round gutter. Slots are cut across the kerb at suitable intervals as shown by the dotted line, and the lead being dressed

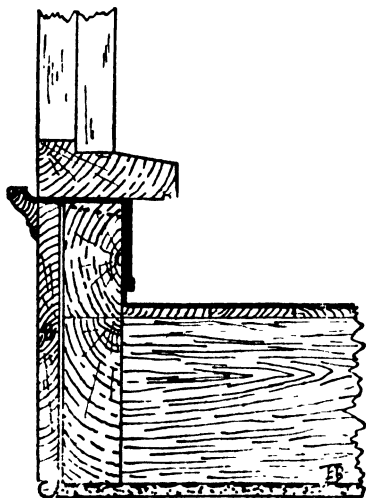

FIG. 119.

down into the slot, an outlet is provided for the escape of condensed water that runs down the inside of the glass into the gutter. Condensation is always especially active in skylights and lantern lights, as the warm air inside naturally ascends to the highest point, and coming into contact with the cold glass, its temperature is lowered and its burden of atmospheric moisture is deposited on the cold surface. The curved edge of the

gutter is supported by a wooden moulding, the top edge of which is hollowed out to fit the shape of the lead.

The dormer (Fig. 120) is a window that projects out of the slope of a roof, and is necessitated when the room inside is situated partly or wholly above the eaves. Connection between the roof of the dormer and the main roof is established by means of a valley, while the side or cheek of the dormer is covered with sheet lead over the whole surface.

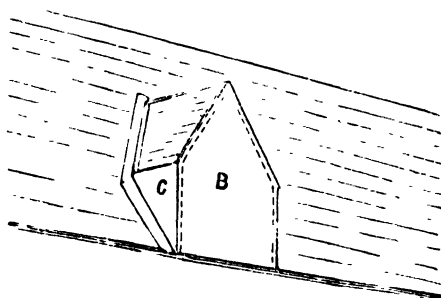

FIG. 120

The valley gutter is laid as in Fig. 61, two lay boards being nailed in the angle to support the lead. The bottom end of the board on the dormer roof is cut off flush with the end of the rafter feet in a line with the eaves, while the one being on the main roof is mitred and carried down by the side of the dormer cheek as shown in Fig. 120. The joint between the two valleys at the ridge is made by lapping the lead from each side 6 in. over the ridge.

The junction between the main roof and the side of the dormer can be made either by laying the slates

close up to the cheek with soakers inserted in each course, or a gutter can be formed as in Fig. 42. In the latter case it would not be necessary to turn the edge of the lead into the raglet or chase as shown, but merely to nail it securely with copper tacks. When slates and soakers are employed they must be continued up the main roof until they reach the valley board. The lead valley is then laid in with its bottom end overlapping, and dressed down on to the slates, so that its water is discharged directly on to the main roof. Both sides of the valley are then covered with slates cut to the correct rake, and projecting 1 in. over the tilting fillet.

Dormer windows are often situated farther up the roof than is shown in Fig. 120, so that the rafters project beneath the window sill. The joint in front of the sill is protected very much in the same way as in a lantern light. No tongue is provided, however, but the lead apron is dressed over the framing before the window is fixed. The lead projects inside the framing 1 in., and when the sill is fixed, the edge of the lead is turned up and nailed all along the inside, and is subsequently hidden when the wood nosing is fixed. Fig. 121 is a section through the sill and framing, showing the lead apron covering the first row of slates, and turned up inside the sill.

One single sheet of lead is used for covering the sides of the dormer ; it is fixed by means of lead dots as follows :—

In three or four selected positions, a circular dishing 3 in. in diameter and $\frac{1}{2}$ in. deep is made in the wood check. The lead is dressed carefully into the depression and a screw is passed through the centre into the stud

behind, a copper washer being slipped on to the screw before it is inserted. A circle of soil, 2 in. wide, having been drawn round the dishing, the hollow is scraped and tallowed, and it is then filled up by wiping molten solder over the place flush with the surface of the lead. Particular care must be taken to ensure a good hold for the screws, or they may be drawn out by the

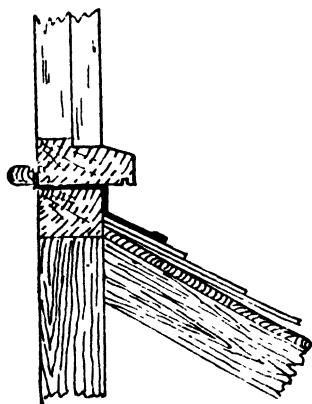

FIG. 121.

weight which they support, and will be difficult to refix.

Dormers are frequently constructed with flat roofs ; in this case they are covered with 7-lb. lead or with zinc, the surface being divided up into bays with rolls and drips if its size demands. The lead is bent and continued up a lay board on the main roof at the back, being dressed over a tilting fillet and covered in turn by the ends of the slates as at T, Fig. 116. The eaves of the roof boards should be protected by turning the

lead down all round, bossing the corners, but not nailing the edge. The lead should be trimmed off $\frac{1}{4}$ in. below the under side of the boards, to prevent rain from running back underneath and saturating the woodwork.

Lead domes are covered in something the same

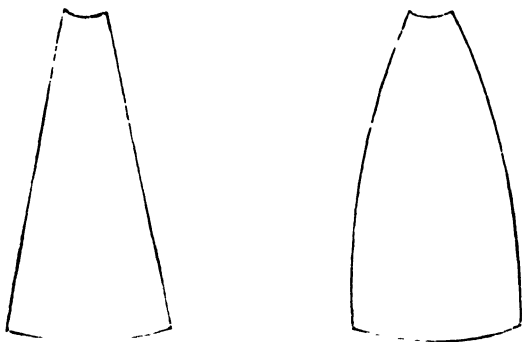

FIG. 122.

manner as flats, so far as the rolls are concerned. In preparing the lead to fit the roof great care must be taken to cut it out properly, or it may be too narrow. The shape shown on the left (Fig. 122) would be useless for the purpose, being much too narrow in the middle. It must be cut out to the shape on the right, and the swell made to correspond with the circle of the dome, allowance being also made for covering the rolls.

CHAPTER XII

RAINWATER PIPES

THERE are various ways of conducting the rainwater off a roof, and the down pipes may be fixed either on the outside or, if necessary, the inside of the building

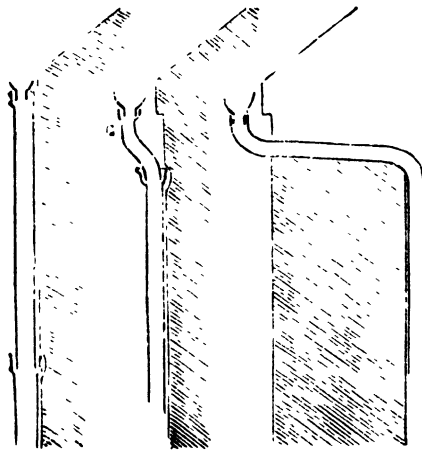

FIG. 123.

FIG. 124.

FIG. 125.

The common half-round eaves gutter (Fig. 3) may have its pipe led down either as in Figs. 123 or 124 on the outside of the building, or it may be carried through the wall and down the inside as in Fig. 125. In the

latter case a recess is generally left in the inside wall, so that the pipe can be set back behind the surface of the brickwork, the front being afterwards covered with a wood casing level with the face of the plaster.

The method that is usually adopted in fixing the pipe is to nail it back tightly against the wall by the

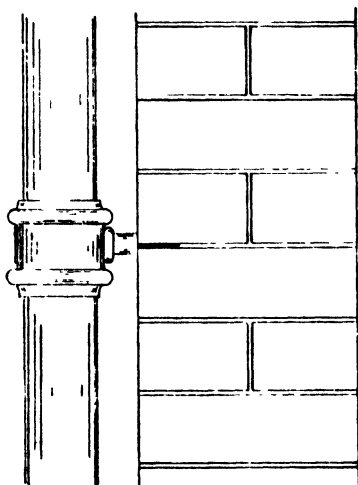

FIG. 126.

ears as in Fig. 123. There is no objection to this, so far as the efficiency of the pipe in carrying out its specific function is concerned, but a much better job can be made by threading a short piece of gas barrel 1 in. long over the nail before it enters the wall. This acts as a distance piece, and keeps the pipe well away from the brickwork so that it can be painted all round—a very important consideration, as it is at the back where the pipe deteriorates by rusting away when it is

not painted. Besides this, if the pipe becomes blocked so that water overflows at the socket joints, there is less likelihood of the brickwork being saturated. Fig. 126 shows the pipe fixed to the wall, with distance piece behind.

Down pipes should be terminated at the foot with a shoe which discharges over a trapped gully (see Fig. 134). Sometimes it is connected directly to the drain by cementing it into a bend as in Fig. 127. This method is not to be advocated, especially when the water discharges into a sewer drain, as no seal is provided to prevent the escape of foul air, and no provision is made for clearing away any obstruction that may arise, and it is necessary either to remove the down pipe or to break open the drain. Another objection is that rust scales off the inside of the pipe and falls to the bottom, where it is caught by the bend and held until the pipe is completely choked by the accumulation.

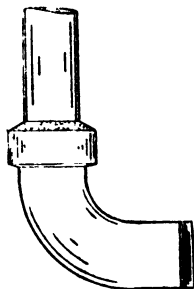

FIG. 127.

Fig. 123 illustrates the method of connecting the down pipe with the gutter outlet when the rafters are cut off flush with the wall. In this case the down pipe is screwed to the fascia board by the ears. In Fig. 124 the feet of the rafters overhang some little distance beyond the wall, so that a swan-neck or offset is required to convey the water back to the pipe. Swan-necks are not usually provided with ears, and they must be secured by wedging them into the socket of the pipe with small pieces of lead, not too much force being used in driving them down, or the socket will split.

Fig. 125 indicates the method that is sometimes adopted when for some reason or other it is not convenient to carry the pipe down the outside of the wall. In this case a longer swan-neck is required, its length being governed by the projection of the eaves beyond the inside of the brickwork. The down pipe should be situated in some out-of-the-way corner, and hidden behind wooden casing as described. A better method

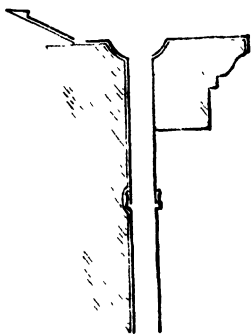

FIG. 128.

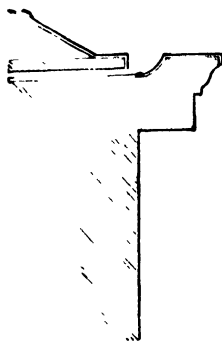

FIG. 129.

than this would be to return the eaves gutter round the corner of the building, and fix the down pipe there if circumstances permit.

There is no need to stop the joints at the sockets of a rainwater pipe, as it is impossible for the water to escape in its downward rush. If the joints were sealed and the pipe became choked, the water would overflow into the gutter at the top, and worse trouble would be caused by the wetting of the brickwork from top to bottom. At one time rainwater pipes were often connected to the sewer drain, and were utilised as a

ventilation pipe for the escape of foul air, so that it was absolutely essential for the joints to be made good. This practice, however, is entirely opposed to the rules of sanitation, and would not be allowed to-day.

In stone cornice gutters the rainwater pipe is often taken down through the cornice as in Fig. 128. At other times it is led away from the back of the gutter as in Fig. 129, and may either go down just inside the wall, or it may be carried between the ceiling joists right through to the gutter on the opposite side of the building. It may also be taken horizontally to the centre of the house and then join some other down pipe. In special cases it may be led into a large cistern which is installed as a receptacle for the rainwater for the use of the house as in Fig. 137, the overflow pipe from the cistern being disconnected from the drain with a shoe as in Fig. 134. When the water is taken across the building through the roof, it should be conducted by means of a lead-lined box gutter along the horizontal portion, to avoid the risk of leakage.

Sometimes the presence of rainwater pipes on the front elevation of the building is objected to, and provision is made for bringing them down inside. In other cases, where the pipes are intended to come down in front of the building, and where they will necessarily come into contact with a string course or other projecting moulding, a hole is made in the string course for the passage of the pipe. This does not apply to the plinth at the base of the building, as the pipe is nearly always carried over the projection by means of an offset, and is finished with a shoe in the usual way.

Rainwater pipes are made of lead, zinc, or more

commonly of cast iron, and they may be either round, square, or of some more ornamental design. They are supported in various ways. The usual method is to nail them to the joints in the brickwork with 3-in. pipe nails. In specially good work, when the

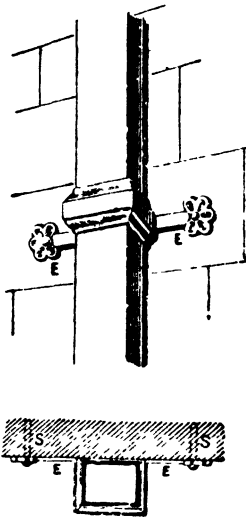

FIG. 130

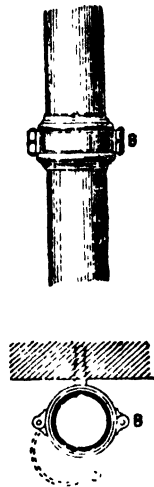
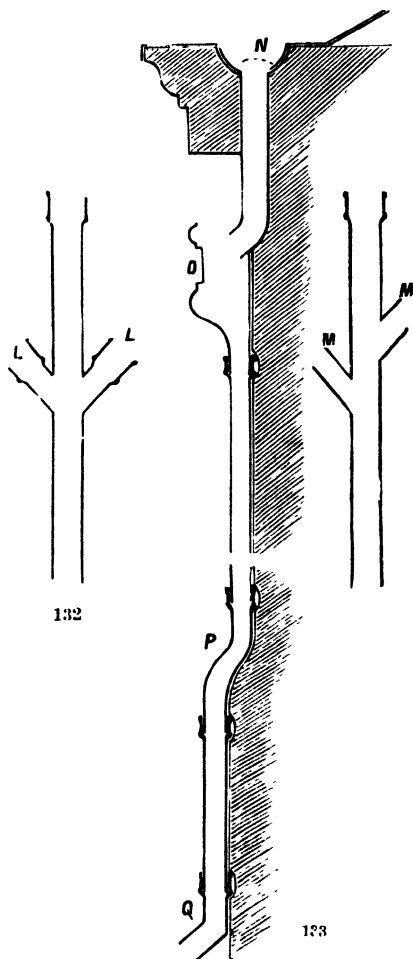

FIG. 131.

pipes are very heavy, they can be supported by holderbats.

Fig. 130 is a vertical sketch of a square iron pipe with cross section below, in which the pipe is supported by a loose iron car E, which is held by two strong iron spikes S, driven into holes which have been made in the stone and filled up with wooden plugs, the plugs being sawn off flush with the surface.



FIGS. 132 and 133.

Fig. 131 shows a round iron pipe supported at the socket by a hinged malleable-iron band or holderbat, having a strong stud at the back which is cemented into the wall. When the pipe has been placed in the holderbat the outer half of the band shown by the dotted lines in Fig. 131 is closed, a bolt is passed through the holes at B, and the pipe is held securely.

This type of support is more artistic than fixing with nails, but is not often used for rainwater pipes.

When the main down pipe has to receive one or more branch pipes, a junction piece, either single or double as in Fig. 132, should be used. The junction pieces with sockets cast on as at L-L may be had of various sizes from 2 in. up to 6 in. diameter. They are not always provided with ears for fastening to the wall, but, being much shorter than the straight pipes, they do not require so much fixing. As a rule it will be sufficient if the spigot of the pipe above is thrust well home in the socket and wedged with lead; by this means the pipe and branch will be held in a rigid position without fear of moving.

Cast-iron pipes are made in 6-ft. lengths, and of various diameters up to 6 in. Rectangular pipes are made from $2\frac{1}{2}$ in. by 2 in. up to 7 in. by 4 in. The offsets are made in many different projections, ranging from 3 in. up to 2 ft. They can also be cast to suit any slope of plinth. Round pipe, 3 in. in diameter, is a size that is largely used in common house work for rainwater pipes, and as waste pipes from baths. Fig. 133 shows a pipe with rainwater head carrying off water from the gutter N, O being the rainwater head, P the offset over the plinth, and Q the shoe at the bottom discharging over a drain. When it is necessary to cut

an iron pipe or gutter, it may be done by filing a deep nick all round with a three-cornered file, and then laying it on a heap of loose sand and tapping it sharply with a hammer and iron chisel which is held in the

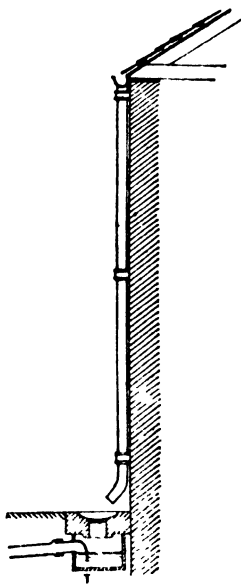

FIG 134.

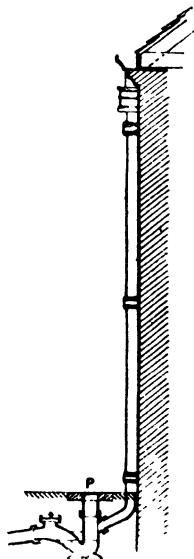

FIG 135.

nick. Not too much force must be used or the cast iron will break in the wrong place. Short pieces of down pipe 3 ft. long complete with socket can be obtained to avoid cutting to waste.

A great many designs for rainwater heads are executed in iron, while both lead and zinc heads are

often used. Iron, however, has largely superseded lead for this purpose.

Figs. 134 and 135 show two modes of disconnecting the down pipes from the drain, so that no bad smells can ascend. In Fig. 134 the pipe discharges above ground over a gully trap T. The gully may also serve to carry off surface water. Fig. 135 shows a 4-in.

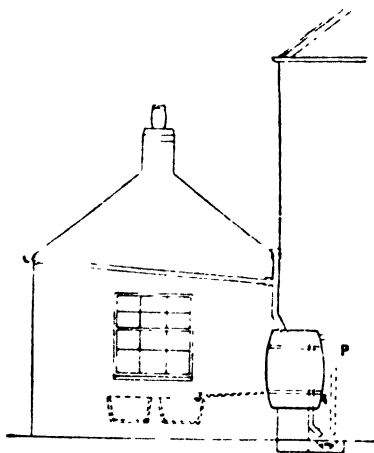

FIG. 136.

Buchan's trap with the down pipe joining it below the ground, the water trap locking off the air from the drain. Access to the house side of the trap is made possible by lifting the movable iron grating P. Rain-water pipes should not be connected to the sewage drains when a separate system is provided for surface water. In country districts the drains can discharge into a convenient ditch or pond.

Perforated gratings or galvanised wire guards should

be placed in the nozzles of the eaves gutter, as shown by the dotted line N, Fig. 133. These gratings are generally made out of pieces of sheet lead perforated with a number of round holes about $\frac{1}{2}$ in. in diameter. Wire guards are the best. Rainwater heads should be similarly protected, to prevent birds from building their nests inside during fine weather.

In many places where the water supply is scarce, the rainwater is conducted into barrels which are set

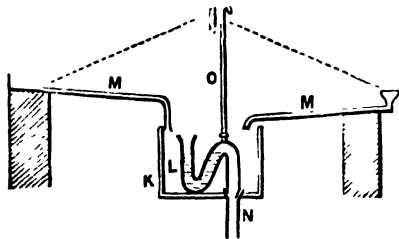

FIG. 137.

up outside the house as in Fig. 136, or in a large cistern placed under the roof as in Fig. 137. Large underground tanks built of reinforced concrete are also frequently used for the purpose. When the rainwater is collected into an underground tank, it has to be pumped up into a cistern set on a higher level if a continuous supply to the taps is desired. Water that is stored in this manner is purified after standing for a week or two. Lead or galvanised iron cisterns are not suitable for the storage of rainwater, as soft water possesses solvent properties which dissolve a minute portion of the metal and makes it unfit for human consumption.

In Fig. 136 the water is supplied from the barrel to two wash tubs supposed to be placed in the building. The overflow pipe to the barrel may either be placed inside (in which case it may be movable), or it may be fixed outside as in the dotted line P. The first plan permits the water being run off at the bottom for cleansing by removing the standing overflow, which is fitted with a ground cone joint. In either case the overflow discharges into a trapped gully.

Short pieces of cast-iron gutter and pipe which have been cut off a 6-ft length are not of much value as they stand, as the faucet is usually missing. They can, however, be turned to account by using a union clip for the gutter as shown in Fig. 15, thus providing a new faucet to the piece and avoiding waste, while rain-water pipes can be treated in the same way, short pieces being connected with a loose socket with ears, which is fastened to the end by filling the annular space with molten lead.

Zinc pipes are fixed with ears which are soldered on at the back of the pipe, these being nailed to the wall in the usual way.

The late Dr William Wallace, F.C.S., of Glasgow, made some interesting remarks with regard to the action of water on lead. He states that he has frequently seen lead pipes eaten through by contact with lime, and explains the phenomenon in this way:—
“Rainwater acts rapidly on lead under certain circumstances, because it contains free oxygen and no carbonic acid. When exposed to the air, however, it rapidly absorbs carbonic acid, which destroys or limits its power of dissolving lead. Rainwater in contact with or passed over lime or mortar (which requires many

years to become completely carbonated) acts on lead with great energy, because every trace of carbonic acid is removed from it.

“On the other hand, it is well known that water highly charged with carbonic acid (as in aerated waters) dissolves an appreciable quantity of lead if passed through a leaden pipe. In the one case a small quantity of carbonic acid protects the metal by forming a film of carbonate upon its surface, in the other, the carbonate of lead dissolves in the excess of carbonic acid. Water containing oxygen and free from carbonic acid dissolves lead much more rapidly than water highly charged with carbonic acid, and its action is usually limited to particular spots where wet lime or mortar is either in contact with the pipe, or immediately above it.” Dr Wallace says that he has seen a thick water pipe eaten through in a few months.

Clay has a similar effect upon lead pipes, and the writer has on many occasions been obliged to have the pipes entirely renewed when they have been buried in clay. The safest precaution, without going to undue expense, is to bed the pipe in sand when passing through a clay stratum.

CHAPTER XIII

PUMPS

THE simplest type of pump will work satisfactorily and will give good results, provided that it is fixed in accordance with certain recognised requirements. Scamping is absolutely fatal in this class of work, especially in connecting up the suction pipe, and the efficiency of the most expensive plant that can be installed would be impaired to some extent by carelessness in this most important operation.

All reciprocating pumps, of whatever type they may be, operate on the same principle, *i.e.*, equilibrium or air pressure. The principle that is involved depends on the fact that a column of water of a given sectional area and 33 ft. high would be exactly balanced by the weight of a column of the earth's atmosphere of the same area. Thus the weight of the water would be the same as that of the atmosphere, *viz.*, 14.7 lbs per sq. in. of area, and equilibrium between the two would be established.

When the suction pipe of a pump is lowered into the water, no air can enter the pipe at the bottom, while the top is hermetically sealed by the tail valve in the pump. Now, if the air is extracted from the top portion of the pipe, the pressure of the external atmosphere on the surface of the water in the well would force it up into the vacuum that has been produced,

and as the weight of the atmosphere is 14.7 lbs. per sq. in., it follows that a similar weight of water would enter the pipe, provided that there was sufficient room. If the pipe projected out of the water for more than 33 ft., equilibrium would be restored at that level, and, the water balancing the air, it would not rise any higher. Thus the efficiency of the pump would be in a direct ratio to the completeness of the vacuum which it is capable of producing, and depends entirely on the condition of the suction pipe.

The most important parts of the pump are the tail valve, the bucket, and the barrel. They operate together as follows :

When the handle of the pump is raised the bucket descends, and the air in the barrel is displaced through the hole in its centre. The hole is covered with a clack valve which opens upwards, and immediately the stroke is completed the clack valve falls back into its place. On the depression of the handle the bucket is raised, and as it fits into the barrel with an airtight joint, a vacuum is produced beneath as it rises. At the bottom of the barrel a tail valve or sucker is situated which also opens upwards, and when the air in the suction pipe has been completely exhausted, the water rushes through to fill the partial vacuum that has been caused by raising the bucket, this being due to the pressure of the atmosphere on the water outside the pipe. At the end of the stroke the tail valve falls back on to its seating, and traps the water that has passed into the barrel. When the handle is again lifted this water passes through the bucket valve and is automatically trapped in the same way, so that at the next downstroke it is lifted by the bucket and discharged

through the spout, the barrel being filled again at the same time. This continues as long as the handle is operated, or until all the water has been drawn out of the well. Fig. 138 represents a pump of this type, and shows the bucket G inside the barrel D, the tail valve H being open at the downstroke of the handle.

It has been said that water will rise under these conditions to a height of 33 ft., and theoretically this is correct; but, as under working conditions it is not possible to produce a perfect vacuum, a certain amount of "slip" must be reckoned with, and in practice from 25 ft. to 28 ft. lift is the most that is allowed. The absolute necessity of making all the joints in the suction pipe perfect, whether it be of lead, iron, or any other material, will be obvious, and too much attention cannot be given to this portion of the apparatus. It is best to provide a foot valve at the bottom of the suction pipe, to support the column of water when it is charged.

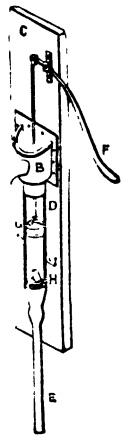

FIG. 138.

In deep wells which penetrate the first impervious stratum in the soil and tap the reservoir which lies beneath, the water has often to be raised from a much greater depth than 33 ft., and the ordinary lift pump just described would be useless for the purpose. In this case it is necessary to employ a lift and force pump for raising the water, and some form of mechanical power will generally be required to operate the bucket.

This type of pump must be placed in the well at a suitable height above the water level, a wood or iron

stage being constructed to which it can be fixed (see Fig. 139). It is operated by specially designed gearing at the head of the well, the pump rod which is connected to the bucket reaching down to the required depth. When the water is raised, instead of being discharged out of the nozzle it passes into a rising main which is taken up to the ground level, and it is then conveyed to its destination through a continuation of the same pipe. It will be noted that in this case also the "lift" must not be more than 25 ft.; 15 ft would be better. The rising main, however, can be of any length, and can reach to any height, provided that the pump is strong enough to force the water to the required level. The pump shown in the illustration (Fig. 139) is one that is supplied by Messrs Nicholls & Clarke, of Shoreditch.

Fig. 140 shows a rather different type of deep well pump. It will be seen that the working barrel is fixed on the bottom of the rising main, through which the pump rod passes, the whole of the working parts being enclosed within the barrel at the bottom of the pipe. This pump is made by Messrs Worthington-Simpson Ltd., of Kingsway, London, and is operated by special gearing at the head, this being driven by a low power "Worthington" oil engine. This type of apparatus is much simpler than the ordinary deep well pump, and requires less fixing, while it is not so liable to get out of order. When repairs are needed the barrel can be disconnected from the gearing and withdrawn without interfering with any other part of the apparatus.

An ordinary lift and force pump for fixing above ground to work in a shallow well is shown in Fig. 141. This is used for forcing water up to a cistern which is

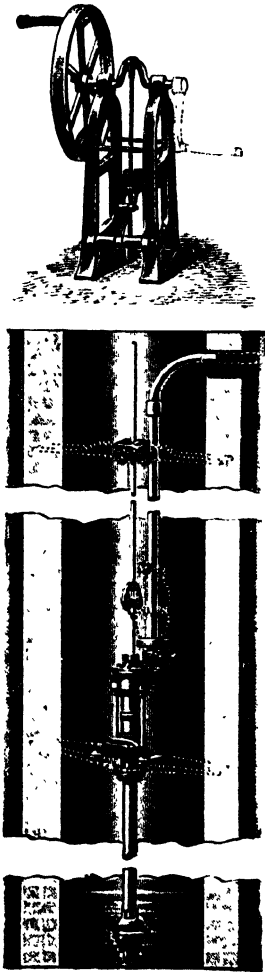

FIG. 139.—Deep Well Pump.

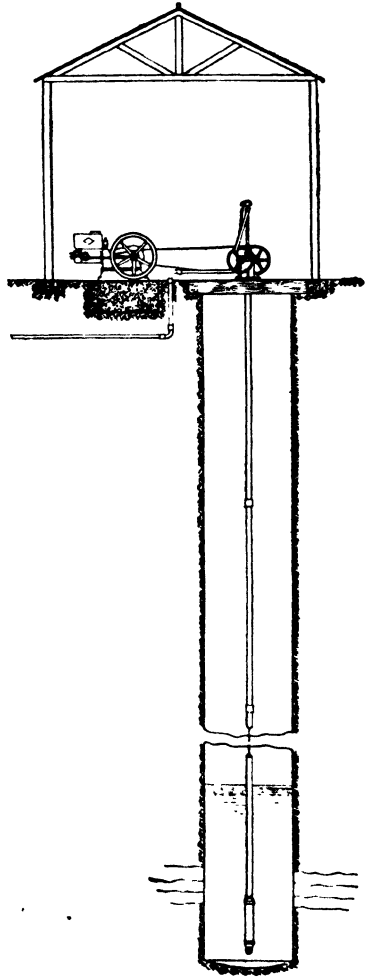

FIG. 140.—Deep Well Pump.

situated at a higher level in the roof, to supply the various taps by gravitation. The rising main D is

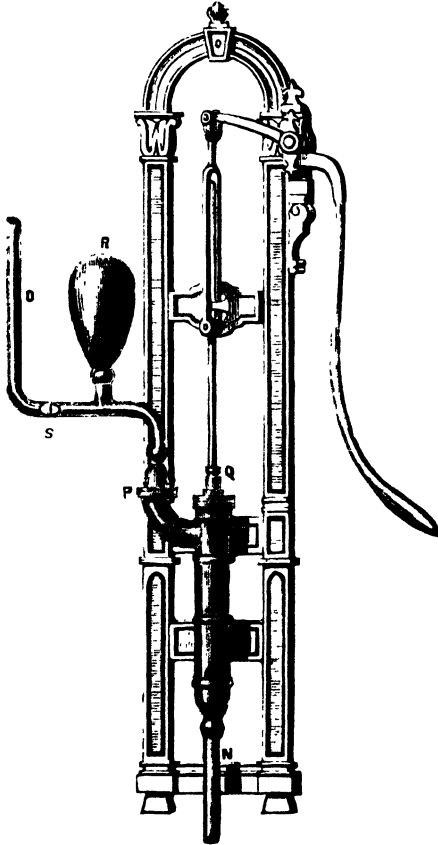

FIG. 141.

shown screwed on to the vertical nozzle P on the left, an air vessel R being fixed as near the barrel as con-

venient. All lift and force pumps should be provided with an air vessel. This pump works on exactly the same principle as those shown in Figs. 139 and 140.

When a pump fails it is generally either the valves or the bucket that needs attention. If it is a case of failure to hold water, the tail valve will be at fault, and the pump should be removed by unscrewing the bolts through the ears at the bottom of the barrel so that the valve can be taken out and repaired. Care should be exercised when the pump is replaced, as if the bolts are tightened up carelessly the ears may be broken off and the pump will be ruined. When the motion of the handle fails to draw water, the bucket should be removed by disconnecting the pump rod from the handle at C, Fig. 138, and withdrawing the bucket. Possibly the clack valve may be out of order, or more likely the bucket leather will be worn out. This can be remedied by taking the bottom portion of the bucket off after unscrewing the small set screw beneath, and putting on a new leather. These are called cup leathers, and can be bought for a fewpence. They should fit the interior of the barrel tightly. Failure is often due to the cup leather becoming dry when the pump has been out of use for some time. A little water poured in the top of the barrel will often remedy this, after it has been allowed to stand a few minutes for the leather to become saturated and swell up so that it fits the barrel.

Leaks or cracks in the working barrel will naturally give a good deal of trouble, and when they are serious, little can be done. A new pump will be required in this case.

If it has been ascertained that the tail valve is in

order but the pump still loses water, a leak will probably be found in the suction pipe. This can be discovered by descending the well on a ladder and listening carefully. A slight hissing noise will be heard when the handle is operated, or a small jet of water spurting out of the side of the pipe will indicate the position of the fault when the handle is still.

When the well is located at some distance from the house, the pump can be fixed in the desired position, the suction pipe being laid underground to reach the source of supply. The horizontal distance does not greatly affect the working of the pump beyond what is caused by the friction of the water against the side of the pipe, providing that the permissible lift is not exceeded. Ordinary cast-iron cottage pumps will draw water from a well two or three hundred yards away, so long as the height from the tail valve to the surface of the water is not more than 20 ft. Long horizontal pipes, however, cause a jerk to be felt on the downstroke of the handle, this being due to the temporary arrest of the momentum of the water in the pipe when the handle is lifted, and the subsequent restarting of the flow at the next stroke. The remedy for this is to fix an air vessel on the suction pipe of a capacity a little larger than the working barrel and as near to the pump as can be arranged. A short piece of iron barrel can be used for an air vessel. The horizontal portion of the suction must always have a fall towards the well, to prevent airlock.

Lead jack pumps are somewhat out of date nowadays, but their use is still continued in country districts. The bucket and sucker (Figs. 142 and 143) are made of wood, and the valves *M*, which are cut from oil-

dressed sole leather, are provided with a tongue on one side by which they are nailed over the opening in the wood block, and which acts as a hinge on which the valve opens and shuts. A small lead weight is fastened to the top side of the valve to accelerate its closing.

The bucket is made to fit the barrel by nailing a strip of leather round the outside in a notch provided for the purpose; it is about $1\frac{1}{2}$ in. wide. When a new leather is required, the old strip is removed and a new

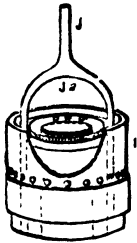

FIG. 142.

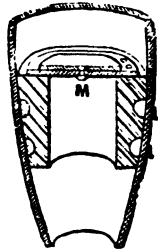

FIG. 143.

one nailed on, the two ends being pared down to a feather edge to make a smooth lap. Copper nails only must be used, and the heads must be driven well home, as the barrel may be damaged if they are allowed to project. The diameter of the wood bucket should be $\frac{3}{8}$ in. less than that of the barrel, to ensure a good fit when the leather is nailed on (see Fig. 142).

The sucker (Fig. 143) is fixed in position at the diminishing portion of the barrel near the floor as shown, by dipping a few strands of hemp in melted tallow and winding them in the grooves which are found round the outside of the sucker at L. It is then lowered carefully into the barrel with a pump hook,

and settled into its place by giving it a few gentle taps with the knob on the reverse end of the hook. The tallow thus makes a watertight joint. To remove the sucker for repairs, the outside of the barrel should be warmed with a blow-lamp to melt the joint, and it can then easily be raised with the pump hook.

After many years of use the interior of the barrel becomes worn and the pump loses its cylindrical shape, so that it will not work properly. In this case the pump should be taken out and the barrel trued up by driving a mandrel through the bore, the outside being worked into shape meanwhile with a dresser.

The practice of connecting two separate pumps on to one suction pipe is not to be recommended. This is sometimes done in cottage work, but if both pumps are in use at the same time the operation would be interfered with, and should a leak develop in either, both pumps would immediately be put out of action. It is much the best plan to provide a separate suction pipe to each one, unless some insuperable objection exists.

Suction pipes should be half the diameter of the working barrel. Thus, a 3-in. barrel would need a 1½-in. suction pipe.

Delivery pipes or rising mains should be a little larger than the suction, 2 in. being suitable in this case. This is to reduce the friction, and thus to save energy in working the pump.

In sandy soils the bottom of the well must be kept clear or it soon silts up, and the foot valve becomes choked. Particles of sand are also drawn up the pipe and will damage the barrel, while the bucket leather will soon be worn out.

It is often dangerous to go down a well which has been closed up for some time. Before doing so a lighted candle should be lowered to see if it will continue burning. If it goes out the air is foul and the well should be left open for a time so that the air can be purified before the descent is made. Dashing down several buckets of clean water helps to improve the air.

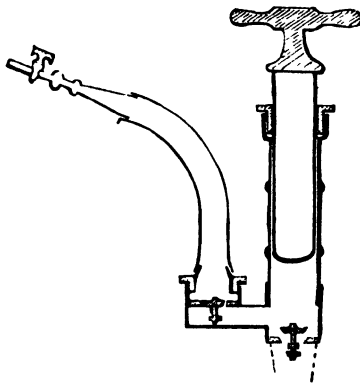

FIG. 144.

Another style of pump is that shown in Fig. 144, which gives a sectional view of a plumber's hand force pump. It will be seen that a solid plunger takes the place of the bucket. When the plunger rises the water follows, the bottom valve opening up and allowing it to pass. When the plunger is pushed down the lower valve closes and the water rushes up the rising main or outlet pipe, forcing open the rising main valve and going out at the tap.

This force pump is generally used for clearing service pipes which have become choked. The small tap with coupling shown on the outlet pipe is intended for a different purpose. In this case, instead of being used to pump water, it serves as a force pump for clearing gas pipes of condensed water or other obstruction, the small stop cock being connected with the gas pipe before the handle is operated.

A better type of pump for this purpose has a conical air chamber at the base which can be charged with air under considerable pressure. The pump is connected to the gas pipe by means of a flexible tube, and the outlet cock is opened suddenly, when the compressed air is discharged with considerable force into the pipe, and clears out any foreign matter it may contain.

CHAPTER XIV

THE HYDRAULIC RAM

THE water supply in towns and urban districts is delivered to the inhabitants through cast-iron mains which are laid in various directions, the service to each individual house being obtained by tapping the main and inserting a ferrule in the hole. The lead service pipe is jointed on to the ferrule as shown in Fig. 145, a

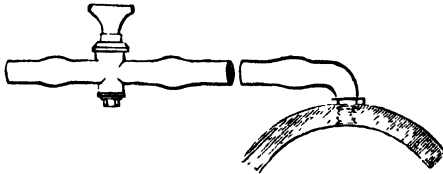

FIG. 145

stop cock being introduced so that the supply can be shut down in case of need.

Rural districts, however, are not so fortunately situated in this respect, and the main source of supply is by means of shallow wells which are sunk at a short distance from the house. The water that is obtained from shallow wells is not considered to be fit for human consumption, and it was classed as "dangerous" in the sixth Report of the Rivers Pollution Commissioners. In spite of this, however, it is calculated that 12,000,000

of the population of the kingdom rely entirely on this source for the supply of their daily needs.

It is not always practicable, however, to obtain even the rather doubtful advantage of shallow well water, owing either to the contamination of the soil or to the extreme depth of the saturation line in the earth, and the difficulty in tapping the water and raising it after it has been found, so that recourse is often had to running streams that may be situated in the neighbourhood for the provision of water for domestic and trade uses. This may appear to be rather a primitive method of supply to those people who have never had to exist away from the vicinity of a water company's main, while the consumption of water drawn directly from a river or brook would appear to be deliberately tempting providence, owing to the many sources of contamination to which it is exposed. This is doubtless true to a very great extent, as it cannot be disputed that there is every opportunity for the pollution of the water by cattle, surface drainage, and various deleterious matter which finds its way into the stream. The contamination is largely neutralised by the fact that the water is considerably purified by its own movement and by the action of the atmosphere as it passes along, so that it is not unpalatable, and no ill effects are felt as a rule by those who use it regularly for drinking and culinary purposes.

A difficulty may often arise even when a plentiful supply of water is obtainable by this means, owing to the fact that as it is situated so far away from the locality where it is needed, an undue amount of labour would be entailed in transporting it from the stream to the dwellings which have to be served. This difficulty

would not exist if the stream happened to be situated at a higher altitude than the area where it is required, so that it could be distributed through pipes by gravitation ; but as the position is usually reversed, the adoption of a gravitation system is obviously precluded, and the assistance of some mechanical means of distribution is made compulsory.

The position thus resolves itself into something very similar to a town supply where the water is forced through pipes by powerful pumping machinery, and a considerable annual expenditure for the maintenance and upkeep of the plant is incurred. Fortunately, however, the quantity of water that is required is so small, owing to the scanty population of the district that it can be delivered without going to the expense of sinking a large capital sum in the undertaking, while the maintenance charges can be reduced to an absolute minimum.

The method to be adopted to obtain these satisfactory results is to utilise the services of the hydraulic ram for driving the water to its destination. This apparatus is eminently adapted for the purpose, and the initial outlay, as compared with the necessary expenditure on adequate pumping plant, is comparatively insignificant. The cost of upkeep hardly exceeds that of the gravitation system, and it is unquestionably the best all-round method which can be adopted, provided that certain material geographical features are available.

Two primary conditions are necessary, *i.e.*, a steady and sufficient supply of water, and a fall in the contour of the land so that the necessary motive power may be obtained and the waste water can be expeditiously

conducted away. The expenditure on structural accommodation for the plant is so low as to be quite a secondary consideration.

The theory of the working of the hydraulic ram is the utilisation of the momentum which is acquired by a body of water in flowing down an inclined pipe, to raise a portion of its own bulk to a greater height than that from which it was drawn, the quantity so raised bearing a fixed relationship to the head of water available and the height to which it is delivered. In practice, the pressure which is exerted by the head of water automatically operates a simple arrangement of valves in the body of the ram, these valves being the only working parts of the apparatus.

The ram is fixed at a given distance from, and as far below, the source of supply as possible, allowance being made for the waste water to flow away. The height to which delivery can be made depends entirely upon the amount of working fall which can be obtained. The quantity of water delivered is in direct relation to the proportions existing between the working fall and the height of delivery together with the amount of supply water that is available. Thus, with a given working fall, more water can be delivered to a low level than to a higher one.

A ram will operate satisfactorily with as little as 2 ft. working fall, and under these conditions will easily deliver to heights of 40 to 50 ft., but the quantity will vary with the amount of power available. The lay-out of the pipes must be designed in accordance with the contour of the land and the relative vertical heights of supply and delivery. The horizontal length of the delivery pipe can be ignored, as no energy is

absorbed in driving the water along the level beyond the slight impediment to the flow which is caused by friction; but care should always be exercised to have the pipes of ample capacity, in order to minimise the friction as much as possible.

The development and utilisation of the accumulated energy is explained in the accompanying sectional

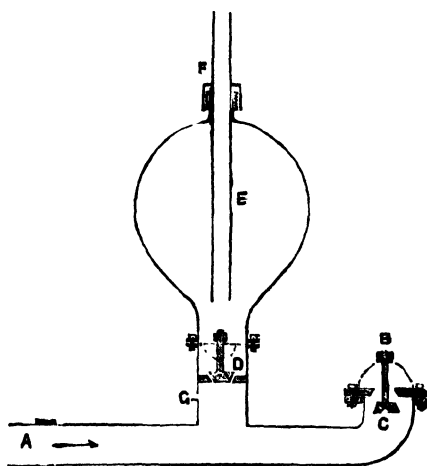

FIG. 146.—Hydraulic Ram. (Old type.)

diagram (Fig. 146), which illustrates the construction of a primitive type of ram. In this figure all unimportant subsidiary details have been omitted, in order that a simple and intelligible idea of its operation may be conveyed.

The intake from the stream is situated in some convenient position, and the water is conducted along the drive pipe A to the ram, where its latent energy

is converted into the power which is the fundamental source of its efficiency.

At C is a valve of a simple pattern which is suspended loosely by means of a spindle and nut through a hole in the bridge which spans the waste outlet of the ram. This is the pulse or tail valve, and while the ram is at rest it automatically remains open, its own weight causing it to fall away from the seating. The water escapes through the opening at B to the tail race, whence it is discharged into a drain or convenient ditch, probably to rejoin the river again at a point lower down stream.

The rush of water passing through the opening necessarily exerts a certain amount of pressure on the under side of the valve C, and lifts it into contact with its seating, thus closing the outlet and preventing the escape of the water. At D is another valve similar to that at C. It is, however, much smaller, and as its position is reversed it works in an opposite direction. This valve remains closed by its own weight when the ram is at rest.

When the impetus of the water flowing to waste through B is suddenly arrested by the closing of the pulse valve, a concussion of some intensity is produced and is distributed through the whole body of the ram. Taking the line of least resistance, the force of the concussion lifts the delivery valve D, and a small quantity of water passes through into the air chamber E. The opening of D neutralises the shock and reduces the upward pressure on the pulse valve C, while at the same time the water in the ram and drive pipe recedes and sucks the valve from its seating, which thereupon falls and permits the escape of the water again. Immedi-

ately this occurs, pressure is removed from the delivery valve, which closes and imprisons the water which has passed upwards into the air chamber by the force of the concussion. This action is repeated, and will continue indefinitely at a rate varying from 15 to 200 beats per minute according to the conditions obtaining, so long as the ram is supplied with water.

The rising main F passes up through the top of the air chamber E, its bottom end terminating a little above the delivery valve. The main may proceed in any direction, rising as circumstances demand, to a considerable height above the intake.

The chamber E contains air, and has no outlet but the delivery pipe F. When the stop valve on the drive pipe A is opened and water is forced into the chamber, this air is carried upwards and is compressed against the top and sides of the vessel, the opening at the bottom of the delivery pipe being sealed as soon as the water rises high enough to submerge the end. The air being under compression absorbs the shock of the concussion by its resiliency, and gives it out again on the rebound in the form of energy for driving the water up the rising main to its destination. Hence it will be seen that the motive power is developed by the action of the pulse valve in interrupting the flow of water, and that the generated power is then transmitted by natural laws to the water contained in the delivery pipe, causing it to flow to the required elevation.

A small snifting valve, illustrated in Fig. 147, is fixed in the body of the ram at G for replenishing the air supply as it becomes absorbed by the water. The valve is screwed into the ram by the end H, and the small plunger works backwards and forwards with

each beat, admitting a minute volume of air through the tiny orifice at I.

This is briefly the theory of the working of the hydraulic ram. The few minor details that have been omitted from the diagram are of no practical consequence in illustrating the development and utilisation of the pressure which is exerted by the inertia of the head of water. The type described, although an old pattern, is still in use in many places, and gives good and efficient service. Modern rams are constructed upon

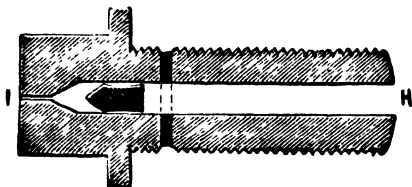

FIG. 147.

greatly improved lines and produce much better results, but they operate upon exactly identical principles.

One of the most efficient modern rams is illustrated in Fig. 148. This is called the "Vulcan," and is manufactured by Messrs Green & Carter, of Winchester, a well-known firm of repute in hydraulic engineering matters. In this apparatus the movable portions of the valves are replaced with fixed india-rubber discs, which are fitted into suitable seatings, and furnished with a very simple means of adjustment to enable the ram to accommodate itself to the fluctuations of winter and summer supplies of power water.

The tail valve R is a flat rubber ring which, being

specially flexible, bends easily. It is held in position by the crown N which encircles the periphery of the disc, the inner edge of the ring being free. When the stop valve on the drive pipe is opened, the inner

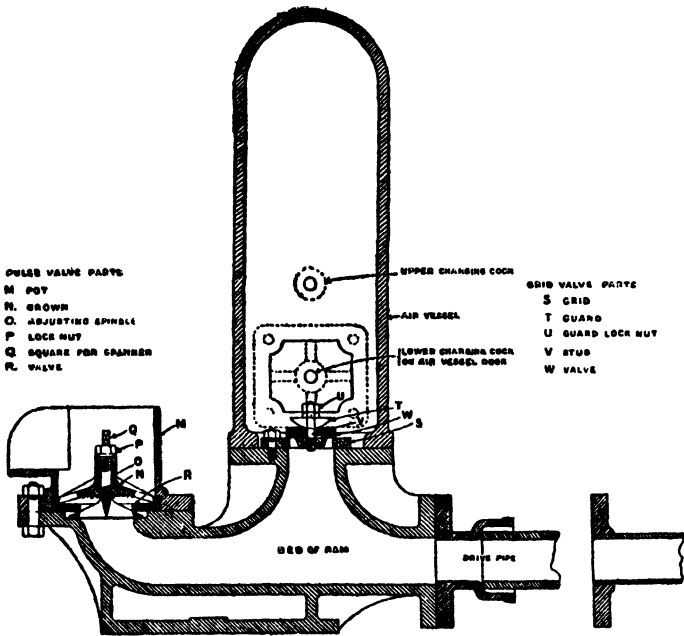

FIG. 148 The "Vulcan" Hydraulic Ram.

edge of the disc is forced upwards by the pressure of the water underneath, thus closing the openings in the crown grid N, and immediately transferring the pressure to the delivery valve.

The delivery valve W is a disc of rubber, rather thicker than the ring. It is fixed over the opening

between the ram and the air chamber by means of the stud V, a circular guard T being interposed between the disc and the lock nut U to prevent damage to the rubber as it rises and falls. The water forces its way into the air chamber by lifting the rubber disc at its circumference, the disc overcoming the momentary distortion by its elasticity, and closing again as soon as the force is expended. The rising main or delivery pipe is connected into the bottom portion of the air chamber, and a snifting cock is also provided just below the valve as in Fig. 146. The transmission of the energy and the alternate ebb and flow of the water in the "Vulcan" ram proceeds in exactly the same way as that already described.

Two charging cocks are screwed into the air vessel as shown by the circular dotted lines in Fig. 148. The chamber should be recharged with air regularly once every three to four weeks, by closing the valves on the drive pipe and rising main and opening the two charging cocks to allow all the water to drain out of the air chamber. They should be left open for about twenty minutes and, after being closed again, the ram is re-started by opening the valves on the drive and delivery pipes and pushing the pulse valve away from its seating with a stick. If the air vessel is not recharged and the air is all absorbed, the continual beat of the ram will cause so much vibration that the apparatus may be wrenched from its foundations.

A ram of this description that was under the control of the writer a year or two back was subject to flooding in the winter, owing to the rise in the level of the stream from which it was supplied. The district was rather flat, and during heavy rains the stream headed back

up the tail race into the chamber in which the ram was housed, until only the top of the air vessel was visible above the water. Sometimes it remained in this condition for two or three months, but the ram never stopped working, the only effects of the submersion being the slowing up of the pulsations of the valve and a consequent reduction in the quantity of water that was delivered, owing to the loss of head. Any attempt at recharging the air vessel was out of the question under these circumstances, so that the air cushion gradually disappeared and the ram was in danger of becoming displaced. The difficulty was overcome by drilling a small hole in the top of the air chamber and screwing an ordinary pneumatic bicycle tyre valve into the opening, so that the air could be renewed with a pump by standing on a ladder at the side of the ram. This was rather a tedious job, but it was the only method that could be adopted short of closing the ram down altogether until the water subsided.

The best results were obtained with this particular ram when it was working at the rate of sixty-eight beats to the minute. It worked with only 5 ft. head, and with a 6-in. drive pipe and a 2-in. rising main it distributed water to a distance of two or three miles. The maintenance expenses covering a period of about seven years after its installation probably did not exceed £10, inclusive of all necessary labour and occasionally a new rubber valve.

The "Vulcan" compound hydraulic ram, also made by Messrs Green & Carter, is built very much on the same principle as the one just described, but it is rather more elaborate, and performs a correspondingly useful purpose.

At times an ample supply of pure water may be available for consumption, but it may be at such a low level as to preclude the idea of a gravitation system, or the supply may be insufficient to drive it to the desired site by the aid of the ordinary hydraulic ram. In such a case it would be essential to install a set of pumps to raise the water, this entailing the expenditure of a considerable sum for the initial outlay, in addition to the yearly cost of maintenance and upkeep. This situation can be met with the aid of the compound ram, illustrated in Figs. 149 and 150, provided that there is another body of water within reasonable distance that is situated at a higher level to generate the motive power. It is not necessary for the latter supply to be pure, as it does not come into contact with the drinking water at any time, but the power that it develops in its fall from the higher ground to the level of the clean supply is utilised to send the latter to its destination. Thus any kind of stream, lake, or pond that has a constant supply can be used, provided that all solid or gritty matter is allowed to settle in a catch pit before the water enters the machine, and the domestic supply can be delivered at the required elevation with the minimum expenditure on upkeep.

It will be seen in the illustrations that there are two supply pipes to the ram, the larger one conducting the impure supply to the lower part, while the smaller pure water pipe is connected just beneath the air chamber valve. The drive pipe is laid in a perfectly straight line to the catch pit, this in turn being connected to the river or lake in such a way as to prevent any tendency for mud and grit to be washed into the pit. When the inlet valve on the drive pipe is opened, the water falls

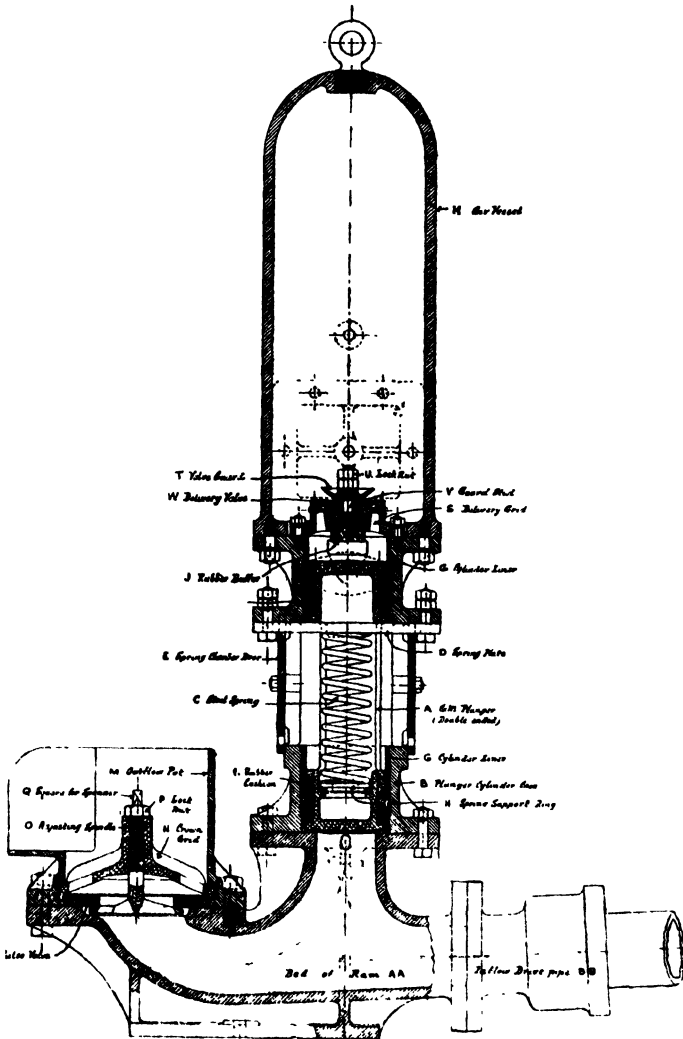

FIG. 149.-The "Vulcan" Compound Hydraulic Ram.

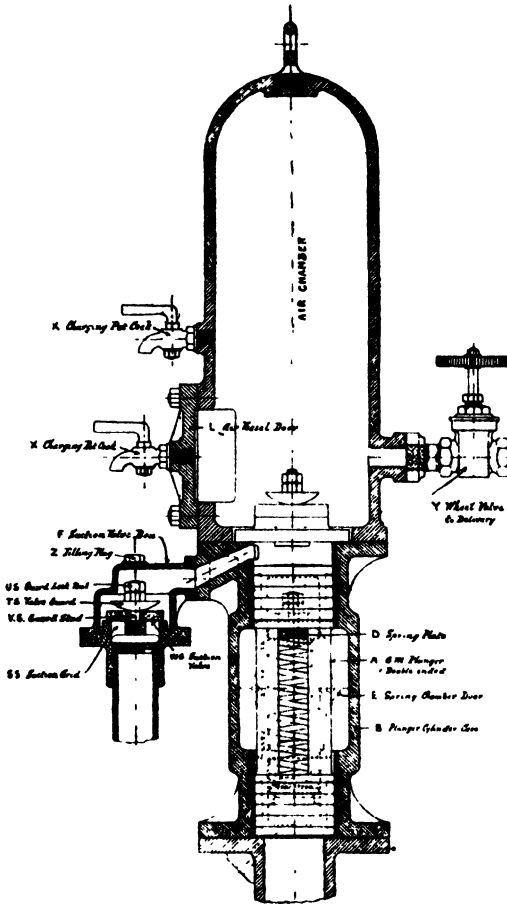

FIG. 150.—The "Vulcan" Compound Hydraulic Ram.

down from the higher level and flows out at the tail valve until it is closed by the rush of water. Immediately this occurs the momentum of the water is instantly arrested and the shock is transmitted to the bottom of the plunger A, Fig. 149, forcing the plunger up and compressing the steel spring C which is situated in its centre.

Above the top of the plunger is another chamber which accommodates the clean water, and the upward motion of the plunger forces a portion of this through the delivery valve W into the air chamber, and thus up the rising main to its destination. As soon as the force of the concussion is equalled by the pressure in the air chamber the delivery valve closes, and at the same time the water in the drive pipe recoils and allows the steel spring to push the plunger down to the bottom of its stroke, thus sucking up a fresh supply of clean water through the suction valve W-S into the top chamber.

The clean water supply is obtained by running the suction pipe into a catch pit or well where it is collected, and as it is forced through the delivery valve W by the strokes of the plunger, a further supply is drawn up the suction pipe as described. Thus the ram is really similar to an ordinary lift and force pump operated solely by the force of gravity, the power being derived from the weight of the falling body of impure water without any mechanical aid.

A catch pit on the drive pipe is quite essential to any make of ram, in order to separate the solid matter from the water before it goes to the machine. The pit should be sunk in the ground in as high a position as possible, the intake pipe from the river being well below the summer water level, so that its supply is not

cut off when the water falls during continuous dry weather. This pipe should be laid with the least incline possible to the catch pit so that the working fall is not unduly reduced, and it must discharge into the pit at least 2 ft. above the bottom. The drive pipe leads out of the opposite side of the pit at a slightly lower level than the intake pipe, and falls straight to the ram ; thus the full force of the water is utilised without any loss of power from bends in the pipe. The mouth of the drive pipe should be covered with a grating, and a perforated strainer of small mesh should be fixed completely across the centre of the catch pit between the inlet and the outlet to intercept any leaves and rubbish that may gain admission. If these precautions are not taken, the working of the ram may be impeded by the entrance of small particles of extraneous matter, which are apt to become fixed under the valves and prevent them from closing properly.

This system of water distribution is perfectly simple and effective in operation. When the ram has once been started it will continue to work day and night without ceasing, so long as the supply of water is maintained. The paramount advantage which the ram possesses over pumping machinery lies probably not so much in the low initial outlay that is required, as in the wholesale elimination of prospective running expenses. Two hours' work once a month for recharging the air chamber is all the attention that is required, and even this can often be neglected with impunity when the exigencies of the case demand.

There is one important factor which should be remembered when planning any system for distributing water through underground conduits whether by

gravitation, hydraulic rams, or what not. This is the possibility of airlock occurring, a contingency to which any unvented water pipe under a low pressure is liable when rises and falls occur in its course. Theoretically, the pipe should be laid with a continuous slope from start to finish, so that air could escape in one definite direction; but as this is quite impossible over a long stretch of undulating country, back falls are unavoidable and must be provided against. An automatic air valve should be fixed at the highest point in each section of the pipe line to permit the escape of accumulated air, which, if not vented, would entirely obstruct the flow of water. The valves must receive periodic attention, to ensure that they are working properly.

A new kind of apparatus for raising water has been invented recently by a Mr Allen. It is known as the "Hydrautomat," and utilises water and air pressure in turn to drive the water upwards through a series of alternately closed and open tanks, which are connected by water-sealed pipes. The action is quite automatic once the inlet pipe is opened, the power being derived from the pressure and suction which result from the downward flow of the supply water. Very little has been heard of this apparatus at present, but when its efficiency has been thoroughly demonstrated under working conditions, it will doubtless be available for public use.

CHAPTER XV

THE SIPHON

SIPHONS are used to transfer liquids from one vessel to another, and, on a large scale, to empty locks or pits where the water at the outflow end can be discharged at a sufficiently lower level than the water to be emptied.

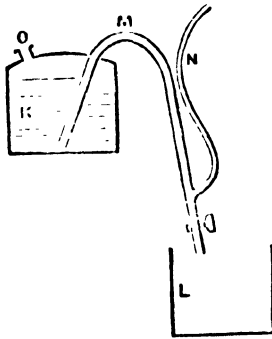

FIG. 151.

The power or force which causes a siphon to operate is the pressure of the atmosphere on the surface of the water on the inlet side, combined with the greater weight of water at the other end, the outlet leg of the siphon always being the longer of the two. Hence, the greatest height over which a siphon will lift water is about 30 ft. The action of the siphon can be seen from Fig. 151, which

represents a bent tube that is frequently used for transferring small quantities of liquid from one vessel to another at a lower level. At K is the vessel to be emptied into the receptacle at L. M is the bent tube or siphon, and N is a branch tube for starting the flow. At O a short pipe is provided, through which liquid or air may be admitted into the vessel K. The higher vessel being full and the lower one empty, the short leg of the siphon is immersed in the liquid, and the end of the long leg is either closed up with the hand, or by shutting the stop cock when one is provided, as in the illustration. The air is then sucked out of the siphon M through the small pipe N until water is drawn into the mouth; the bottom end is then opened, and the water from K passes up and down the siphon into the bottom vessel. It will be seen that a vacuum is produced in the siphon by sucking the air out at N, and that the pressure of the atmosphere on the liquid forces it over the bend at M, when it flows down the longer leg by gravity, drawing the remainder after it. The flow can be stopped by closing the orifice at O, which excludes the air pressure from the interior of the vessel. In Fig. 151 the top of the vessel K is arched. If it was flat and not very strong, and the flow of the water was stopped by closing the inlet at O, the top would collapse owing to the pressure of the atmosphere on the outside.

In Fig. 151 the pipe N is shown as long as the siphon, but it may be used much shorter, and may be provided with a small stop cock at its junction with the siphon. The discharge would be greater with this stop cock shut. This pipe is not absolutely necessary, for the siphon can be charged by sucking the lower end at M or by blowing violently, the disturbance of the water

causing it to surge over into the longer leg, thus starting the flow.

The method of charging and starting a siphon when the pipe is of considerable length and bore is to fix a stop cock or sluice valve on each end, and a tee-piece at the highest part of the bend, the opening in the tee-piece being hermetically sealed with a suitable plug. The two cocks being shut, the plug is removed, and water is pumped into the pipe until the siphon is quite full. The plug is then replaced and the cocks are opened simultaneously, when the water immediately flows out at the longer end. In other cases siphons are charged with a force pump.

The statement that the greatest height over which the water will flow is 30 ft., refers to the height above the surface of the water to be lifted.

If for some reason the siphon has to dip down or traverse a valley before rising over a hill, the perpendicular height from the bottom of the valley to the top of the hill might be much more than 30 ft.

Fig. 152 is known as the "Wirtemberg" siphon. When once filled with liquid it remains filled, so long as it is held perpendicularly. If one end of the siphon is immersed in water the balance is disturbed, as the water in the other end is so much lighter (compared with the atmosphere) than the liquid in the immersed end is (compared with that in the vessel), that siphonic action is started by the flow of the water from the free end.

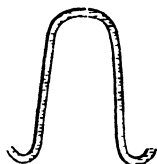

FIG. 152.

CHAPTER XVI

THE FLOW OF WATER THROUGH PIPES

A DIFFICULTY may sometimes be experienced in persuading water to flow through the pipe by which it is conducted from one cistern to another, or from the cistern to the various taps. This may be due to the

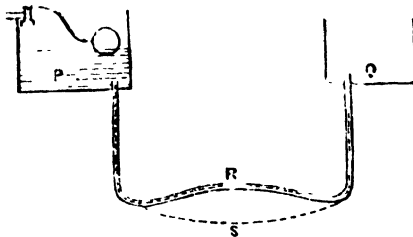

FIG. 153

pipe having become choked with some foreign substance, or it may be caused by totally different conditions.

Fig. 153 represents two cisterns, P and Q, which are joined together by the pipe R, this being connected into the bottom of the tank in each case. The water supply is delivered into the left-hand cistern, its level being regulated by an equilibrium ball valve as shown. When the supply is turned on, the water should normally flow down the pipe R and up into the cistern Q, and theoretically the level of the water should be the same

in each cistern, and should rise at the same rate. This, however, may not always occur, and it may be found that although the left-hand cistern is full and the pipe is known to be clear, the one on the right remains empty, and therefore no water can be drawn from the branches which it serves.

The failure of the water to pass into the right-hand cistern is due to the fact that the horizontal portion of the pipe, instead of being quite straight or with a slight downward curve as shown by the dotted line *s* in Fig. 153, is fixed with a rise in the centre as at *R*, and when the water runs down from *P*, some of it passes over the rise and fills up the pipe beyond. This imprisons the air at the apex of the curve and it is unable to escape, being confined by the water on each side. If the vertical portion of the pipe leading from *P* was of some considerable length, the pressure of the column of water would force the air through, and airlock would not occur. In the illustration both cisterns are on the same level, and as the head of pressure is very small, the flow of water would be completely stopped by the presence of the imprisoned air at *R*.

There are two methods by which the difficulty can be surmounted. The permanent remedy would be to straighten the pipe at *R*, so that the confined air can escape up the pipe *Q*. No further trouble would then be experienced on account of airlock. If this is not possible owing to the fact that the pipe is of very great length and is perhaps laid underground across hilly country, the air can be displaced by pumping water through the pipe under considerable pressure, all cocks and outlets being opened before pumping is commenced. It will often be found convenient if a

branch is inserted into the lower end of the pipe line and a suitable union provided by which the pump can be connected to the branch ; thus no time is wasted in getting to work, and no damage is caused to the pipe by cutting to obtain a connection. A pipe of this description that is subject to airlock is a continual source of trouble, as it will need "blowing through" at frequent intervals. This can be avoided by fixing

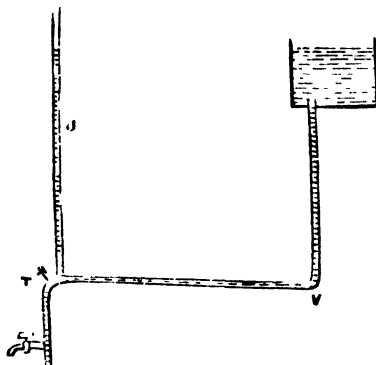

FIG. 154.

an automatic air valve at the top of each rise in the pipe, so that the air can escape without assistance. A small pipe, as illustrated in Fig. 153, can be cleared by connecting a force pump similar to Fig. 144 with the end at P, and forcing the air through into the cistern at Q. Temporary relief can be obtained by pricking the pipe at R to release the air, the hole being afterwards filled up with a small wood plug and the lead riveted over the top.

Fig. 154 shows a supply pipe from the cistern which has been fixed with a rise in the wrong direction so

that air accumulates at T. The proper remedy in this case would be to refix the pipe with a fall from V to T so that the air could escape into the cistern, and no trouble would then arise from airlock. If this is impossible, a vent pipe should be connected at T as shown in the sketch, the pipe being carried upwards to a point well above the water level in the cistern. Thus no air can collect at T, and the flow of water will not be obstructed. All water pipes should be fixed with a fall of 1 in. in 10 ft., and no further attention would then be necessary.

The flow of water in very long pipes is retarded by its friction against the sides of the pipe, so that the velocity of the outflow is very much reduced as compared with that at the inlet. This is known as "loss of head." The following interesting observations on the subject were part of a leading article in the *Building News* some years ago :-

"When water is conveyed from one tank or reservoir to another, by means of a long pipe, there is a certain amount of resistance offered to it by the surface of the pipe. This resistance is proportional to the surface of the pipe, and will therefore be greater for a small than a large pipe. It is also very nearly proportional to the square of the velocity at which the water is moving. The retardation caused by this resistance prevents water from rising to the same height again after passing through a long pipe, and occasions what is termed a *loss of head*, the head of water being the height of the surface of the reservoirs above the orifice of discharge at the lower end of the pipe.

"To find the velocity of discharge from a pipe, multiply the head by the diameter of the pipe, and

divide by its length (all in feet), then multiply the square root of this quantity by the constant number of 50, and the result is the velocity in feet per second. If this velocity is multiplied by the area of section of the pipe (also in feet), the number of cubic feet discharged in a second of time is obtained; this multiplied by $6\frac{1}{4}$, gives the number of gallons. For example, if the head is 32 ft., the diameter of the pipe $\frac{1}{2}$ ft., and its length 100 ft., the velocity of discharge will be 20 ft. per second, and the area of section being $\frac{1}{4}$ ft., the discharge will be 5 cub. ft., or 25 gals. per second. The pipe is assumed to be quite straight, without curves or bends, but as these are usually of frequent occurrence in pipes of considerable length, a much smaller amount of retardation takes place, and the velocity of discharge is decreased thereby."

CHAPTER XVII

GENERAL DRAINAGE AND VENTILATION

THE principles of drainage, in common with all other branches of sanitary science, have altered a great deal during the last forty or fifty years, and not before a change was required, for many of the methods that were adopted in the past could only be described as insanitary in the last degree. It is unnecessary to recapitulate the obvious errors that were common at that time in the light of modern knowledge, as they can all be avoided by a strict adhesion to the practices that are in use at the present day.

The most common method that is now employed for the removal of fæcal products is the water-carriage system, by which all solid and liquid matter is conducted to some suitable locality which is situated far enough away from human habitations to prevent the possibility of a nuisance arising from offensive smells. All sewerage systems aim at this object, and the more completely it is attained the more successful the system will be. The alternative to the water-carriage method of disposal is the conservancy system, in which the excreta is collected by hand in pails or other receptacles, and carted away for disposal by drying or by some other means. This process is almost too primitive to be classed in the same category with the highly developed

sewage disposal methods of to-day, and need not be discussed here.

The principal object to be held in view in the planning and lay-out of a house drainage system is to convey the sewage away from the site to some distant spot without danger to those living in the vicinity. This is effected by arranging the drain in such a way that no obstruction is offered to the free passage of its contents on their way to the sewer, and by providing ample means of ventilation for the whole system from end to end. The workmanship and materials must be of the best, or a serious handicap will be placed on the successful working of the arrangements.

House drains are usually constructed with 4-in. glazed socketed pipes which collect the waste products from water-closets, sinks, baths, and lavatories. Rain-water is sometimes included, but occasionally it is dealt with by a separate system of pipes which are connected to a special storm water drain instead of to the sewer. The branch drains from the various conveniences are carried to a 6-in. main drain which runs direct into the sewer, this being disconnected by means of an intercepting trap as illustrated in Fig. 155. In order to ensure that the drain shall be self-cleansing, it is usual to allow a fall of 1 in 40 for a 4-in. drain, 1 in 60 for a 6-in., and other sizes in a similar proportion. If less fall than this is allowed, the velocity of the flow will be reduced so much that the solid matter may lodge on the sides of the pipe and remain there to decompose; while with more, the velocity might be increased to such an extent that the liquid would drain away so quickly as to leave the solid matter behind in the pipe.

In bygone days it was always considered necessary to introduce a trap at the junction of the drain with the foot of the soil pipe. This method has now been superseded, the connection being made with a stoneware

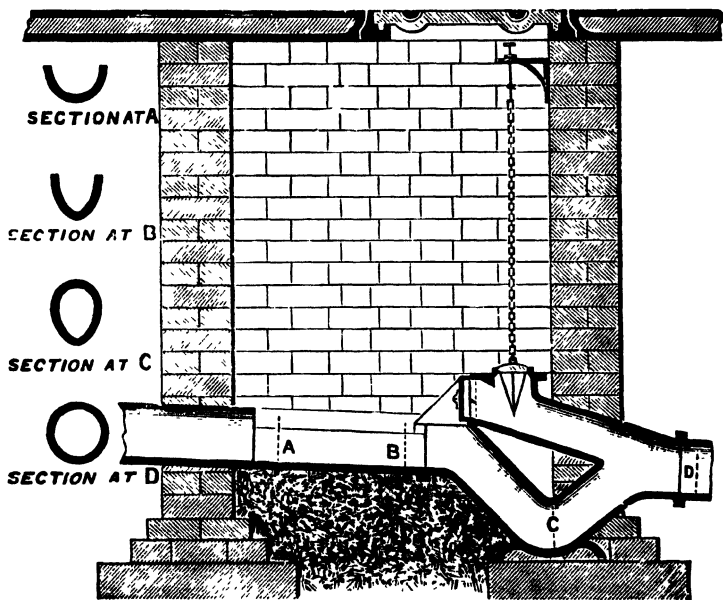

FIG. 155.—Crapper's Intercepting Chamber.

bend as illustrated in Fig. 1, Vol. II. The presence of a trap at this particular point is undesirable for two reasons, the most important being that it would entirely prevent the passage of the current of air throughout the whole length of the drain and soil pipe; in addition to this, the trap would break the flow of the sewage, and would interfere with the rapid conveyance of solid matter

away from the house. The method of ventilating the drain by means of the soil pipe is described in Chapter I., Vol. II.

Drain pipes must be laid with their barrels resting firmly on the bottom of the trench. The practice of laying the sockets on the ground generally ends in disaster, for the weight of the earth after the trench is filled in is apt to fracture the pipes, owing to the absence of sufficient support in the centre. The method that is usually adopted in laying the drain is to scoop a small hole out of the ground for the socket to rest in, so that



FIG. 156.—Drain Pipes supported on Bricks.

the pipe lies firmly on the barrel. With this method a difficulty arises in making the under side of the joint, as often there is not sufficient room for the fingers to encircle the pipe and manipulate the jointing material properly. The quickest and easiest method is to lay the socket end of each pipe on a brick which is placed flat on the bottom of the trench, the spigot end being supported by the socket of the one previously fixed as shown in Fig. 156. In this case the bottom of the trench must be filled in with 4 in. of cement concrete, which is well tamped under the pipes after the joints have set hard. In soft yielding ground it is necessary to provide a concrete foundation to prevent fracture of the pipes from settlement, and in some districts it is compulsory to deposit a bed of concrete all round

the drain, of a thickness equal to its bore. In hard solid earth this is unnecessary, and the sockets must be let into the ground as described, ample room being provided for making the joint. The pipes must be laid with the sockets at the highest end.

The joint is made with neat cement pressed tightly into the socket and splayed off to a slope as in Fig. 156. Any cement which may have been squeezed through the inside of the joint into the pipe must be carefully removed with a "badger," or with a wad of sacking tied on the end of a stick.

The top of the drain must be not less than 2 ft below the surface of the ground, and the bottom of the trench should be straightened through with boning rods after the levels at each end have been settled to the required fall.

Connection with the sewer is established by cutting a hole in the side and bedding a special junction eye on with cement. An inspection chamber similar to Fig. 155 is built in the ground as near to the sewer as the boundary of the property will permit, the outlet of the interceptor at D being connected to the junction eye with the necessary pipes in the usual way. The improved "Kenyon" interceptor in the illustration, made by Crapper & Co., has a special vertical valve on top of the clearing arm, this valve being closed by a plug which is suspended at the end of the chain. Its purpose is for emptying the chamber if it should become flooded by the blockage of the trap, this being effected by lifting the knob at the top and allowing the water to escape without passing through the trap. This would be impossible if it were not for the special valve, and the chamber would

have to be emptied by pumping, a rather costly and tedious operation.

The portion of the drain which passes through the manhole is constructed of glazed channel pipes A-B, so that every facility is offered for inspecting the drain, the sides being benched up with fine concrete as shown in Fig. 157. The benching should be at least 4 in

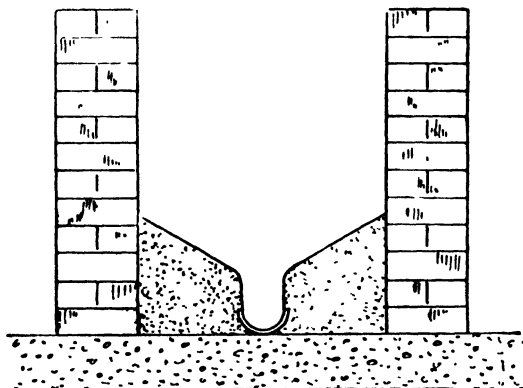

FIG. 157.—Section of Manhole showing Benching.

high, the corners being carefully rounded and the top sloped off at an angle. If the manhole is situated at a bend in the drain as in Fig. 166, so that the channel pipe curves round as it passes through, the benching should be 6 in. high, to prevent solid matter from being washed up on top when the force of the water hits the curve. It should also be sloped off at a steeper angle, so that anything that may be washed up will roll back into the channel to be carried along at the next flush.

A manhole should be provided at each alteration in

the direction of the drain, and at intervals of not more than from 80 yds. to 100 yds. in all straight runs. This will enable any obstruction to be cleared by rodding the drain. The minimum dimensions of the chamber should be 2 ft. 3 in. wide by 3 ft. long, the size being increased when the drain is at a considerable depth. A close-fitting cover should be bedded securely on top to prevent the escape of bad air. A 4-in. ventilating

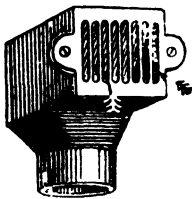

FIG. 153.

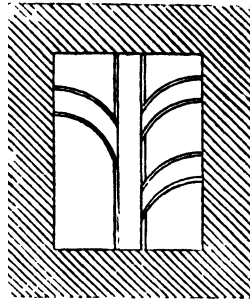

FIG. 159. -Plan of Inspection Chamber.

branch is carried from the manhole nearest to the sewer (Fig. 166), this branch being taken a few feet to an out of the way corner, where it rises out of the ground with a bend which supports a short vertical pipe terminating with a fresh air inlet as shown in Fig. 158, 1 ft. above the ground. This is intended for the admission of air, which passes into the manhole and thence completely through the drain, escaping into the atmosphere at the top of the soil pipe. No traps must be placed at any point in the drain.

Branch drains from sinks, baths, etc., must be disconnected at the head with a gully, and must enter

the main drain with a curve which points in the same direction as the flow. The branches should rest on the edge of the centre channel instead of being cut to fit on the same level, so that, being a little above the invert, the contents are discharged into the main drain with a cascade action to accelerate the flow. Fig. 159 shows a plan of an inspection chamber with branches entering from both sides.

All cast-iron covers to inspection chambers should be sealed with grease to make a tight joint.

A few years ago a good deal of discussion centred round the necessity or otherwise for interposing a water seal between the sewer and the house drain. Those who were in favour of this precaution argued that, if the interceptor was omitted, sewer gas would have unrestricted access to the drain, and might be the means of causing serious harm to the people in the vicinity. It was also contended that the water seal acted as an efficient barrier to the swarms of rats by which many sewers are infested. The latter argument is by far the most weighty of the two, as it cannot be denied that the trap offers a valuable protection against vermin, but the former was completely demolished by the findings of a Departmental Committee which reported on the matter in 1912. The Report stated, *inter alia*, that, as drain air is far more dangerous than sewer gas, and that as in any case the whole system is freely ventilated through the soil pipe, no additional harm could arise by the admission of sewer gas to the house drain, and that if all waste pipes which discharge into the system are disconnected by means of a gully, and all water-closets are protected with an efficient and permanent water seal, the interceptor is superfluous

and could be dispensed with. If this recommendation was adopted, no fresh air inlet would be required at the lowest inspection chamber, as the house drain would be ventilated directly from the sewer. It cannot be disputed that the presence of the interceptor causes a certain amount of obstruction to the flow of sewage, as a glance into the chamber at any time will testify.

When, owing to the geographical disposition of the neighbourhood, it is impossible to obtain sufficient fall to cause the drain to be self-cleansing, a serious danger may arise from the noxious gases which are evolved during the decomposition of the sewage that has been left behind in the drain, owing to its sluggish flow. This danger can be provided against by the installation of an automatic flushing apparatus at the head of the drain. These flushing tanks or chambers are made to work either on the siphonic system or by means of tippers, and can be regulated to discharge at pre-arranged intervals, the quantity of water being governed by the necessities of the case.

When a drain is laid beneath a building, or across a road that is used extensively by heavy vehicular traffic, cast-iron socket and spigot pipes should be used instead of the ordinary stoneware variety. In the latter case there is a decided risk of fracturing the pipes if they are not of a very substantial character, while in the former every endeavour should be made to ensure that, once the drain is finished, it will not require any attention in the future. Both of these contingencies will be provided against by the use of iron pipes. The method of making the joint in this case is to wind a number of lengths of gaskins round the spigot after it has been placed in position, and to drive

it tightly into the socket. The opening is then filled with molten lead, which is caulked well home with a specially shaped caulking chisel. These joints are practically everlasting when they are shielded from variations of temperature, and rarely need attention. In soft ground the pipes can be supported at each end on small brick piers which are erected on a concrete foundation, care being taken that the spread of the concrete is sufficient to prevent any settlement occurring.

Branch drains must enter the main with an oblique junction where no manhole is provided. No right angled

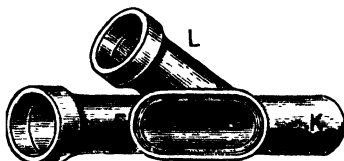

FIG. 160

connections should be permitted under any conditions, as this will be likely to cause a stoppage. As a general rule an inspection chamber should be provided at all junctions, but as this is not always practicable, or even necessary with surface water drains, the chamber can be omitted if circumstances demand. In this case, however, an access pipe, as shown in Fig. 160, should be introduced to facilitate the removal of deposit in case of a stoppage. The system should be planned so that all branches meet at one or more central points, so that each one can be included in a single manhole (see Fig. 166). Bends should also be arranged to come in an inspection chamber, and should be of as wide a radius as possible.

Intercepting traps for disconnecting the house drains from the sewer can be obtained in various patterns. Fig. 161 represents a cast-iron trap manufactured by Messrs Burn Bros., with branches, which is connected directly on to the main drain. These

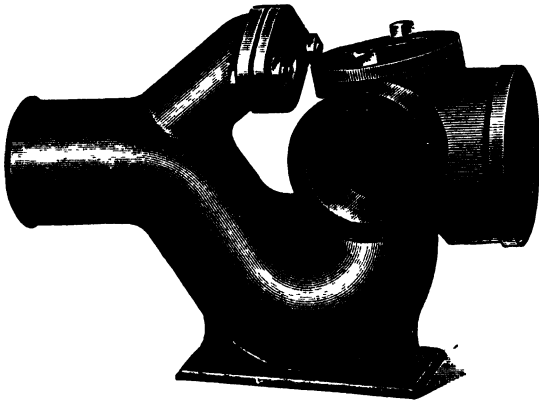

FIG. 161.
Burn Bros'. Cast-Iron Interceptor.

fittings merely need the brickwork to be carried up all round, and save a good deal of labour, but they are not so accessible as the inspection chamber. They have the advantage of lasting for many years without deteriorating.

There are many different patterns of traps on the market, each one being designed for some special purpose, and a brief consideration of their various features will not be out of place. The patterns that are

used most frequently in drain work are the intercepting trap and the gully, the former being placed at the lower end of the drain, and the latter at the head of the branches.

The siphon trap, illustrated in Fig. 162, is sometimes employed for isolating stretches of drain, but it is not by any means a satisfactory appliance from a sanitary point of view. In its original form this trap was made without the vertical cleaning eye A; and this feature was introduced in order that facilities

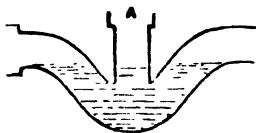

FIG. 162.

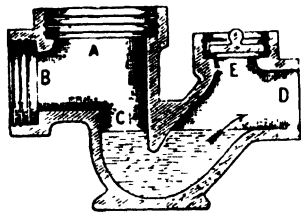

FIG. 163.

might be provided for clearing obstructions in the event of a stoppage. The eye is, however, of very little practical use, and it is even a disadvantage, because the flush through the trap being very sluggish, the floating faeces are apt to become lodged in the central branch and remain there to decompose. This trap is also subject to the further objections that it does not provide any inlet for the ventilation of the drain, as each end is sealed off with water; the water seal is too shallow, and might be "blown" by the pressure of air from the sewer; and no provision is made for rodding the drain at either side in case of necessity.

Fig. 163 is a Buchan's trap, and is a considerable

improvement on the one just described. Its principal features are (1) a square base, which prevents the trap being set so much out of level as to destroy the water seal, this constituting a real danger when the bottom is rounded ; (2) the outlet at D is of a larger bore than the body of the trap at C, so that the risk of blockage is reduced to a minimum ; (3) the invert of the drain at B is 2 in. above the level of the standing water, so that a cascade action is produced, and the solid matter is washed through the trap more thoroughly ; (4) the exposed surface of the water is very small, so that less risk is incurred of the seal being destroyed by evaporation ; and (5) the openings at A and E provide means for ventilating the drain, or for the introduction of rods to clear obstructions. In later types of this trap the cleaning eye at E is made on the rake, so that it is almost in a straight line with the bore of the drain for convenience in rodding, while a small lip projects at C, which shoots the sewage directly into the water instead of allowing it to run down the side of the trap. An up-to-date trap should possess all the above features to be satisfactory from a sanitary point of view.

Intercepting traps, which are generally used for disconnecting the drain from the public sewer as shown in Fig. 155, have a long clearing arm in alignment with the drain, the mouth of the clearing arm being closed with a stoneware stopper set in mortar or bitumen. The "Kenyon" interceptor seen in the illustration is one of the later types in which the shape of the bore varies as shown by the sections at the left, the contraction of the channel being for the purpose of concentrating the flush in order to scour the trap more thoroughly. The ordinary interceptor does not

possess these improvements, but its general shape is very similar to that given in the sketch.

Gully traps are employed for the reception of waste water from sinks and baths, and from rainwater pipes. They are also used for the disposal of surface water from yards and paved walks. The primary object of the gully is to cut off the house from direct communication with the drain, this being effected by a water seal about 2 in. in depth. Fig. 164 represents the old mason's dipstone trap which was used many years ago before the present type of gully had been introduced. This trap can sometimes be found in country districts at the present time, but it should be condemned at sight, as it is extremely insanitary.

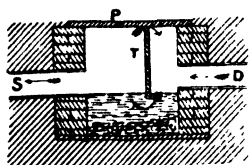

FIG. 164.

Fig. 165 represents Crapper's "Kenwhar" reversible gully trap, with 4-in. back inlet and outlet and two 2-in. side inlets.

A galvanised iron grating fits into the rim at the top above the inlets, so that if the grating becomes choked with leaves or rubbish the flow from the branches is not obstructed. The ordinary gully is square in plan, being made in one piece, and is not reversible.

The lay-out of the drains from a small house is shown in Fig. 166, a combined system being adopted for both rainwater and sewage disposal. Inspection chambers are situated at each bend in the drain, and the water-closet, sink and bath waste, and rainwater branches all discharge into the main drain within the chambers, the junctions curving round in the direction of the

flow. The drain is ventilated from end to end, the current of air entering at the fresh air inlet near the boundary fence and passing completely round the system to the highest water-closet, the soil pipe from which is continued up above the eaves, and acts as an outlet from which the foul air can escape.



FIG. 165.—The "Kenwhar" Reversible Gully Trap.

The ventilation of the interior of large buildings is a subject which needs a considerable amount of study and experience before it can be dealt with successfully. In the case of small houses it is less difficult, as the windows, doors, and fireplace, acting in conjunction, provide an admirable system of ventilation without the provision of elaborate mechanical contrivances. Many people are in complete ignorance of the value of the chimney as an outlet for vitiated air, and when the fireplace is not in use the flue is frequently stopped with

a bag of straw to prevent draughts. This is a mistaken proceeding, for normally the chimney operates as a

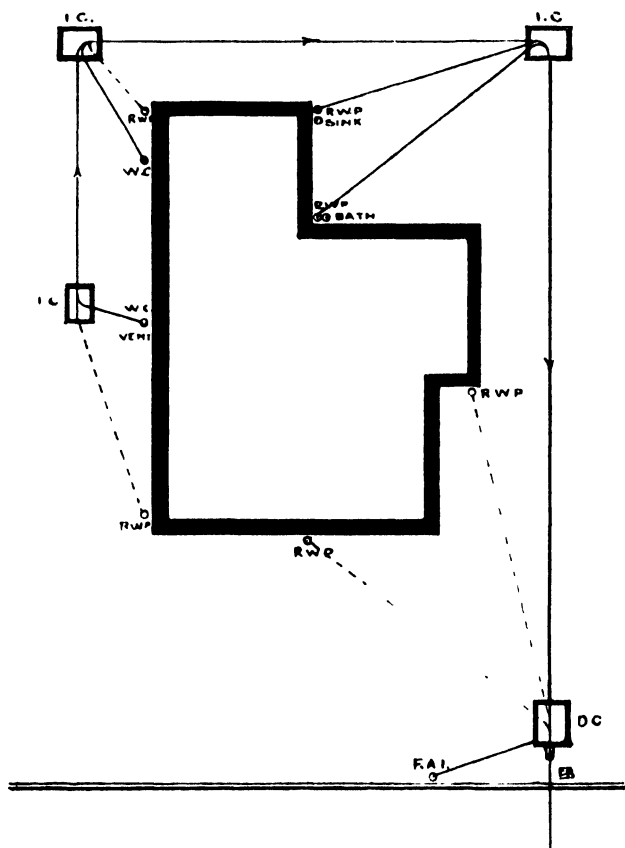

FIG. 166. Plan of House Drainage.

natural outlet for the effete products of respiration and other impurities, which, if not removed, would cause

headaches, listlessness, and general depression of the system.

In large buildings the ventilation is carried out by artificial means, one of two different methods being generally employed, *i.e.*, the "Plenum" or pressure system, by which fresh air is forced into the building, or the "Vacuum" or extraction system, by which it is drawn up to a central outlet generally in the roof, the circulation in each case being maintained by large electrically driven fans. In both systems the air is conducted to the various portions of the building by means of circular tubes or ducts, and is discharged into the different rooms through gratings which are situated a little above the floor. Outlets are provided near the ceiling for the escape of the foul air, after it has fulfilled its specific function.

In the winter the discharge of volumes of cold air into the building would cause a great deal of discomfort and danger to health owing to the draughts that would be experienced, and to obviate this the air is generally passed over steam or hot water pipes before it is admitted. In very hot weather this procedure is reversed, and the air is cooled by passing it over large blocks of ice or through a curtain of falling water. Impurities, such as dust, soot, etc., with which the atmosphere in large towns is usually loaded, are removed by filtering the air through screens of cotton wool before it is discharged into the circulating tubes.

In the extraction system various appliances are employed at times in place of fans, the motive power being supplied by heat, which, by raising the temperature of the air near the ceiling, induces a steady draught

towards the outlet. The large "Sun" lights or clusters of gas jets which are often situated high up near the ceiling in large halls are designed for this purpose, and serve two objects, for besides providing a considerable portion of the artificial illumination that is required, they also carry off large volumes of contaminated air through a central shaft beneath which they are fixed. Steam is also employed as an extracting agent

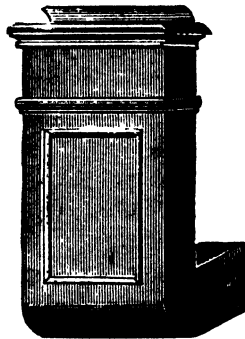

FIG. 167.—Tobin's Tube.

by discharging it into the outlet shaft, so that a current of air is set up which circulates in the required direction, drawing a fresh supply from the inlets below in its wake. A notable instance of ventilation by heat was in operation at the Houses of Parliament some few years ago. In this case the circulation of air was maintained by the action of large fires which were situated at the base of the Clock Tower, and which caused a powerful up-draught to pull in all directions. This system has only recently been discarded in favour of mechanical ventilation.

The air supply in dwelling houses and small halls where a natural circulation is depended upon, is obtained—apart from the door and window openings—by means of air-bricks which are inserted in the exterior walls, the current being directed upwards by a “Tobin’s” tube which is fixed over the inlet opening, thus preventing the access of cold draughts to the

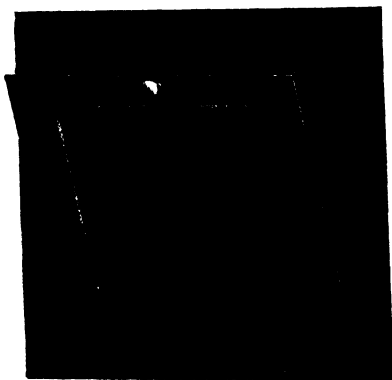

FIG. 168. —Inlet Ventilator.

occupants, or by valve boxes which are fixed 6 ft. or 7 ft. above the floor. Exit is provided by a mica flap ventilator which is situated near the ceiling, and frequently in the chimney breast where it communicates directly with the flue. The efficiency of these appliances depends entirely upon the principle of equilibrium, the warmer and consequently lighter air within the building rising and drawing a current of fresh air from the outside to take its place. The average amount of inlet ventilation that is required is

generally calculated to be 24 sq. in. for each person. Fig. 167 is an illustration of a short "Tobin's" tube, and Fig. 168 represents a valve box, both of which are made by Messrs Harvey & Co., of Woolwich Road, London.

When these appliances are not powerful enough

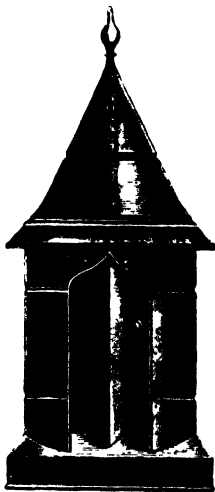

FIG. 169.

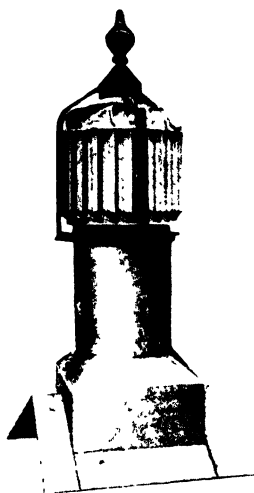

FIG. 170.

to cope with the duty of renewing the air in a building at frequent intervals, an extracting ventilator is usually fixed on the ridge of the roof to create an up-draught. There are no moving parts in these extractors as a rule, the current of air being induced by an ingeniously designed system of vertical louvres and shutters in the interior, by which motion is set up, and which continues in operation without ceasing. Fig. 169

shows Harvey's No. 102 Extractor Ventilator, which is made in steel, planished copper, or zinc. Fig. 170 is an "Archimedean" ventilator by the same firm, the principle of which consists of a "lifting screw in a circular shaft surmounted by a revolving head, which is so sensitive that it will act in the slightest wind," causing a strong up-draught as long as it is in motion.

Ventilating shafts and tubes should be circular in section and as large in diameter as possible, to minimise the friction of the air currents against the sides of the shaft. Angles should be avoided if circumstances permit, but must in any case be given as wide a radius as can be arranged. The outlets should be of sufficient area to completely change the air in the room four times in every hour without causing draughts, this of course depending entirely on the comparative velocity and temperature of the air currents.

CHAPTER XVIII

DRAIN TESTING

THERE are four different methods of testing the soundness of drains, all of which aim at the detection of the slightest leak either in the joints or in the materials themselves.

The "Hydraulic" test is the one most commonly adopted for underground drains, as very little special apparatus is required, while the method is so reliable that leaks can be discovered in a very short time. The drain is dealt with in sections, starting at the highest end and working from manhole to manhole down to the disconnecting chamber.

As a preliminary to applying the test, the bottom end of the first section is plugged by inserting an expanding stopper in the mouth of the drain as it enters the second inspection chamber, the stopper being screwed up tightly so that it is not likely to slip out, as shown in Fig. 171. All taps are then turned on and allowed to run until the pipes are filled with water nearly up to the top of the first chamber. This is left for half an hour, and if the water has not subsided from its original level the section can be considered sound. The next section is then dealt with by plugging it in a similar manner at the next manhole with another stopper, and then slowly releasing the water in the first

section. Thus, by working down hill one lot of water can be used for the whole drain, and waste will be avoided. A slight fall in the level of the standing water does not necessarily mean that the drain is leaking, as there is almost sure to be a certain amount of absorption in the joints and the rendering of the manholes which would account for the fall.

If more pressure is required than can be obtained in a shallow manhole, a graduated vessel is connected by means of a length of rubber tube to a stopper, which

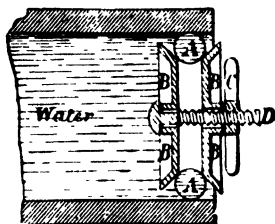

FIG. 171.

is inserted at the top end of the drain. The vessel is filled with water and is raised high enough to give the required pressure. In the event of a leak the extent of the trouble can be ascertained by the rate at which the level of the water falls on the graduated scale which is marked on a glass panel in the side of the vessel. This method is usually adopted when careful tests are made.

Glazed socketed drains should not be tested under very severe pressure; 3 ft. or 4 ft. head of water is sufficient for the purpose. The minimum head of pressure that is required under the by-laws of the London County Council is 2 ft.

When there are branch drains on the section with a gully at the head, the branch will necessarily fill with water and will be tested at the same time as the main drain ; but, as the water in rising from the lower end of the branch is bound to imprison the air which it drives before it, a short piece of rubber tube must be inserted **into** the gully and pushed through the trap until it projects into the drain. The pipe must be blown through after being inserted, to expel the water that has entered during its passage through the gully, and it will then serve as an exit for the air as the drain fills. An alternative plan is to draw the water out of the trap so that the gully can fill as the water rises in the drain. A small cushion of air is left at the top of the bend by this method. If the gully is situated at a lower level than the manhole, the water will overflow out of the trap before the main drain is full. This can only be prevented by plugging either the gully or the branch at its entrance into the inspection chamber, or by standing a pipe vertically in the mouth of the gully and plastering the joint round with clay.

The water test can be applied either before or after the trench has been filled in. The former is the best, as leaks can then be discovered and made good with very little trouble.

The "Pneumatic" test is not very frequently employed by itself for stoneware drains. It is perhaps the most sensitive test of any, but it needs special care in making the preliminary preparations, and a good deal of time is wasted in what is, after all, unnecessary work.

The test consists of pumping air into the drain, a siphon gauge indicating the pressure that is attained.

The reading of the gauge must remain constant for the whole period of the test before the drain can be passed as airtight. Very little pressure must be applied, or the water seal in the various traps and gullies would be "blown." If a specially severe test is needed, all closets and gully traps must be plugged. With the pneumatic method the whole of the drainage system can be tested at once, but all manhole covers must be carefully sealed down with grease joints, the tops of soil pipes must be plugged, and all communicating traps filled with water. Fig. 172 illustrates the method of connecting Crapper's pressure gauge to the top of the soil pipe with a special plug.

This test is subject to the disadvantage that an apparent leak may be caused by air escaping from a faulty joint in the apparatus when the drain is quite sound. In addition to this, while any fault in the drain will be indicated by the movement of the gauge, there is no visible evidence of its location, and other steps must be taken to find the actual situation of the leak.

The "Smoke" test is generally adopted for soil and waste pipes above ground, when the water pressure would be too severe for the strength of the materials. It is also used for underground drains before the trench is filled in. The simplest way of applying the test is to insert a stopper at each end of the drain, a smoke rocket having previously been lighted and placed in the lower end. The rocket gives off dense volumes of smoke which soon fills the drain, and can be seen issuing from any leaks that may exist. This method is useless when the pipes are buried out of sight, as the escaping smoke is the only evidence there is of a leak.

The usual method of applying the smoke test is in combination with the pneumatic method already

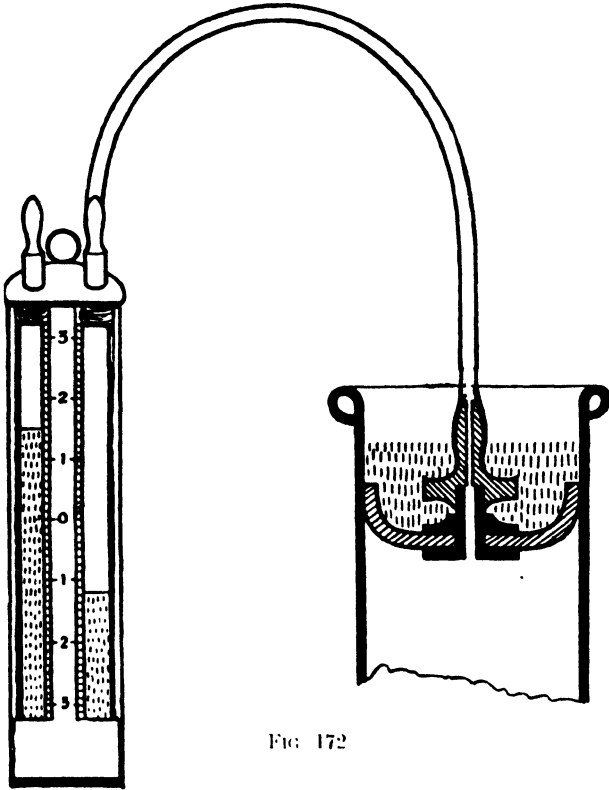

FIG. 172

described, special machines being made for the purpose. Fig. 173 represents Burn Bros'. "Eclipse" smoke machine, which both indicates leakage in underground pipes on the pneumatic principle and shows their

position when the pipe is exposed. The machine consists of a double action bellows and a copper cylinder which is used as a combustion chamber. The cylinder stands in a tank that is filled with water and is covered with a deep copper float or lid, the rim of which is submerged and makes an airtight joint. The cylinder and bellows are joined by a pipe with stop valve. Connection between the machine and the drain is established by means of a flexible tube, the

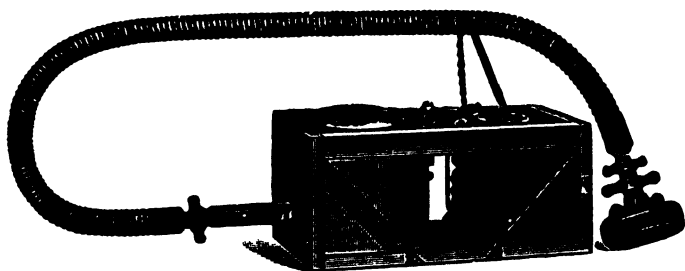

FIG. 173. The "Eclipse" Smoke Machin

top end being fixed and passing through the bottom of the cylinder, where it projects upwards nearly to the top.

To prepare for making the test, the drain is plugged at each end, a special stopper which fits on to the flexible tube being used at the lower manhole to connect the machine to the drain. The tops of soil pipes are also closed with a ball of clay. The float is then removed, and a small quantity of smoke paper or prepared waste is placed in the cylinder and lighted, and after gently blowing it for a few moments with the handle to promote combustion, the cover is replaced

and the handle manipulated until the drain is full of smoke which passes down the tube.

It will be noticed that a gentle air pressure—equal to about $1\frac{1}{2}$ in. of water—is obtained in the drain or soil pipe when the machine has been operated for a short time, the pressure being equal throughout the system under test, including the inside of the cylinder. This causes the float to rise, and so long as it remains stationary the drain is tight, a leak being indicated by the falling of the float. Thus a most sensitive test is applied to the drain, the slightest defect being immediately reflected in the movement of the float. The position of the leak can easily be discovered by the emission of smoke, provided that the pipe is exposed. The "Eclipse" machine is also made in an improved pattern which develops 8 in. of pressure and is specially useful for tracing minute leaks in new work before it is covered up. The pneumatic test can be employed without smoke if desired, any suspected leaks being detected by applying soapy water to the place with a rag, when the escaping air will form soap bubbles.

The "Olfactory" or smelling test is carried out by first plugging the ends of the drains and all openings to soil pipes, and seeing that the gullies are filled with water. A small package of prepared essence—generally oil of peppermint—is then washed through the trap of the water-closet with hot water, so that the drain is charged with a very strong odour which can be smelt immediately it escapes from the smallest hole. Ordinary oil of peppermint is sometimes used without being enclosed in a hermetically sealed package, but this method has the disadvantage that the smell of the

essence will probably pervade the place so strongly as to prevent the detection of any odour that may issue from a leak. The smelling test is not very often used as it is not so reliable as the other methods.

In some districts all new drains are tested for alignment by the local Sanitary Authority before they are approved. The test consists of passing a hard wood ball into the highest end of the drain and allowing it to roll through to the next manhole, the diameter of the ball being $\frac{1}{4}$ in. less than that of the pipes. Should the ball stop at any point in the drain, a pail of water is thrown gently into the top manhole to assist its progress, and if this is successful so that the ball rolls right through, the alignment of the drain in that section is passed as satisfactory. This test is rather severe on poorly constructed drains, as insufficient fall, rough cement joints, or pipes which are not truly cylindrical will impede the progress of the ball, and in bad cases will necessitate the taking up and relaying of the pipes. No fear need be entertained of a well-laid drain failing under the test, provided that accurately shaped pipes have been used.

INDEX

A

Access pipe, 152
Acid, carbonic, 100
Action of clay on lead, 101
— of rainwater on lead, 99, 100
Airlock, 110, 131, 138
Air-bricks, 161
Air chamber, 114, 120, 121, 129
— filtered, for ventilation, 159
— foul, in wells, 113
— heated, for ventilation, 159
— pressure, 103, 133, 134, 171
— valve, 131, 139
— vessel, 108, 110, 124
— weight of, 103
Alignment test for drains, 172
Angles, gutter, 5
Anti-capillary drip, 32
Aprons, lead, 22, 27, 37, 39, 50, 51,
83, 86
— zinc, 69
Archimedean ventilator, 163
Artificial ventilation, 159
Atmospheric pressure, 103, 133,
134
Automatic air valve, 139

B

Badger, 147
Badly constructed drains, 172
Balloon guard, 53, 98
Ball test for drains, 172
— valve, 137
Barrels, cracked pump, 109
Beat of hydraulic ram, 122, 124,
125
Benching, 148
Bit, copper, 17
Blocking course, 25
Boards, snow, 52
Bossing, 26, 50, 52, 80, 88
Boundary wall gutter, 10, 71

Boxes, valve, 161
Box gutters, 38, 49, 71, 93
Brackets, gutter, 2
Bricks, air, 161
“Buchan's” trap, 98, 154
Bucket, pump, 104, 109, 110, 111
Burns Bros interceptor, 153
— smoke machine, 169, 170

C

Capillary attraction, 30
Caps, zinc, 59, 68
Carbonic acid, 100
Cast-iron drain pipes, 151
— gutters, 17, 33, 97
Catch pit, 126, 129, 130
Cement fillets, 35
Centre gutters, 11, 71, 74
Cesspools, 29, 52, 53
Chamber, air, 114, 120, 121, 129
Charging cocks, 124
Checks, dormer, to cover, 86
Cisterns, flushing, 151
— rainwater, 93, 99
Clack valve, 109
Clay, action of, on lead, 101
Clip, union, 100
Cloths, soldering, 16
Cocks, charging, 124
Condensation, 84
Condensed water in gas mains, 114
Connecting down pipe to drain, 91,
92, 98
— to gutters, 91
Conservancy system, 143
Contamination of rivers and
streams, 116
Continuous water supply, 99
Cooled air for ventilation, 159
Copper bit, 17

Corners, bossed, 26, 50, 52, 80, 88
 — dogs-eared, 26, 60
 — pig-lugged, 26
 Cornice gutters, 13
 Corrugation, Italian, for roofs, 70
 Cottage pumps, 110
 Course, blocking, 25
 Covers, manhole, 149, 159, 168
 Cracked pump barrels, 109
 Crapper's intercepting chamber, 145
 — "Kenwhar" gully trap, 156
 — "Kenyon" interceptor, 147, 155
 — pressure gauge, 168
 Cup leathers, 109
 Cutting rainwater pipes, 97

D

Decomposition of zinc, 57
 Deep wells, 105
 Delivery pipes, 106, 108, 112, 118, 121, 124, 125
 — valve, 120, 121, 123, 129
 Diameter of pump bucket, 111
 Dipstone trap, 156
 Discharge, velocity of, 140
 Disconnecting drains, 98
 Dishing in lead work, 52, 86
 Distance pieces for down pipes, 90
 Dogs-eared corners, 26, 60
 Domes, lead covered, 88
 Dormers, 77, 85
 — cheeks, to cover, 86
 Dots, lead, 86
 Down pipes, 29, 89
 Drainage and ventilation, 143
 — lay-out, 156
 Drain joints, 147
 — laying, 146
 — pipes, cast-iron, 151
 — stopper, 166, 171
 — testing, 165
 Drains, badly constructed, 172
 — benching, 148
 — diameter of, 144
 — fall in, 144
 — leaks in, 166
 — plan of house, 158

Drains, sewer, 91
 — storm water, 144
 — ventilation of, 149, 151, 157
 Drip, anti-capillary, 32
 — welted, 32
 Drips, 29, 30, 50, 58
 Drive pipe, 119, 126, 130

E

Eaves gutters, 1, 33, 70
 "Eclipse" smoke machine, 169, 170
 Equilibrium ball valve, 137
 — of air, 103
 — — — and water, 103
 Expansion of lead, 29, 42, 49, 54, 71
 — of zinc, 58, 69, 71
 Extraction system of ventilation, 159
 "Extractor" ventilator, No. 102, 163
 Eye junction, 147

F

Fall in drains, 144
 — in gutters, 32
 — working, 118, 130
 Faucetless gutters, 9
 Ferrules, 27, 115
 Fillets, cement, 35
 — tilting, 15, 23, 25, 33, 38, 63, 79, 87
 Filtered air for ventilation, 159
 Fire pot, plumber's, 16
 Fixing gutters, 3, 7
 Flashings, 19, 23, 35, 36, 37, 79
 — stepped, 23, 36, 37
 Flat roof, 50, 87
 Flats, lead, 49, 54, 83
 — zinc, 57
 Flooding of hydraulic ram, 124
 Flow of water through pipes, 137, 140
 Flushing tanks, 151
 Foot valve, 105, 112
 Force, lift and, pumps, 105
 Force pump, 113
 Foul air in wells, 113

"Fox's Underlock Fastening," 4
 Fresh air inlet, 149, 151
 Friction of water, 110, 112, 119, 140

G

Galvanic action in zinc, 57
 Gas mains, condensed water in, 114
 — sewer, 150
 — "Sun" lights, 160
 Gauge, Crapper's pressure, 168
 Glazed skylights, 82
 Gravitation system, 117, 126, 131
 Grease joints in manhole covers, 168
 Green & Carter's hydraulic ram, 122, 125
 Groove, throating, 83
 Guard, balloon, 53, 98
 Guards, snow, 73
 Gullies, 91, 98, 100, 149, 156, 167
 Gutter angles, 5
 — bolts, 1
 — boundary wall, 10, 71
 — brackets, 2, 8
 — fixing, 3, 7
 Gutters, centre, 11, 71, 74
 — cornice, 13
 — eaves, 1, 33, 71
 — half-circle, 1
 — joints in, 4
 — lead, 13, 21, 24, 29
 — ornamental, 7
 — parallel or box, 38, 49, 71, 93
 — secret, 24, 33, 80
 — to cut cast-iron, 97
 — valley, 37
 — zinc, 4

H

Half-circle eaves gutters, 1
 Harvey & Co.'s ventilators, 162, 163
 Hatches, lead covered, 77
 — zinc covered, 81
Head, loss of, 140
 Head of water for testing drains, 166
 — rainwater, 53, 96

Heated air for ventilation, 159
 Hips, 41
 Holderbats, 94, 96
 Hollow rolls, 55
 Hook, pump, 111
 Horizontal suction pipe, 110
 House drains, plan of, 158
 Houses of Parliament, ventilation of the, 160
 Hydraulic ram, 115
 — — beat of, 122, 124, 125
 — — flooding of, 124
 — — (old type), 119
 — — theory of the, 118
 — — "Vulcan," 122
 — — "Vulcan compound," 125
 Hydraulic test for drains, 165
 Hydraulomat, the, 131

I

Inlet, fresh air, 149, 151
 — ventilation, amount of, 161
 — ventilator, 161
 Inspection chamber, 147, 149, 150
 152, 166, 171
 Intake pipe, 129, 130
 Intercepting chamber, 150
 — — Crapper's, 145
 — traps, 153, 155
 Interceptor, "Kenyon," 147, 155
 Iron centre gutters, 11
 — ridges, 47
 — soldering, 17
 Italian corrugated roofs, 70

J

Jack pumps, lead, 110
 Jointing pipe to water mains, 115
 Joints, drain, 147
 — flanged, 52
 — grease, to manhole covers, 168
 — in cast-iron drain pipes, 151
 — in gutters, 4, 9, 12, 15
 — in ridges and hips, 42
 — lapped, 42, 68, 70, 85
 — seamed, 15
 — welted, 61, 66, 69, 71

Junction eye, 147
 Junctions, rainwater pipe, 96

K

"Kenwhar" gully trap, 156
 "Kenyon" interceptor, 147, 155

L

Lantern lights, 83
 Lapped joints, 42, 68, 70, 85
 Lay-out for drains, 156
 Lead covered domes, 88
 — deterioration of, 99, 100, 101
 — dots, 86
 — expansion of, 29, 42
 — flashings, 19, 23, 35, 36, 37, 79
 — flats, 49, 54, 83
 — gutters, 13, 21, 24, 29
 — jack pumps, 110
 — rainwater pipes, 93
 — ridges, 41
 — rolls, 54
 — weight of, 39, 42, 49, 80, 87
 Leak in suction pipe, 110
 Leaks in drains, 166, 171
 Leather, oil dressed, 111
 Leathers, cup, 109
 "Lift," 105, 106
 Lift and force pump, 105, 108
 — pump, 104
 Lights, lantern, 83
 — "Sun" gas, 160
 Loose sockets, 100
Loss of head, 140

M

Machine, "Eclipse" smoke, 169, 170
 Main, rising, 106, 108, 112, 118, 121, 124, 125
 Manhole, 149, 166, 171
 — covers, 149, 150, 168
 Mansard roof, 53
 Mastic for pointing, 19, 37
 Mica flap ventilator, 161
 Momentum of water, 118

N

Nozzles, gutter, 2, 5, 10, 11, 99
 Nicholls & Clarke's pump, 106

O

Obtuse gutter angles, 5
 Offsets, 91, 93, 96
 Ogee gutters, 9
 Oil dressed leather, 111
 Olfactory test for drains, 171
 Ornamental iron gutters, 7
 — — — ridges, 47
 Outlet pipe, 29, 53
 Overcloak, 30, 32, 51
 Overflow, 28, 29, 53, 109
 — standing, 100
 Oxidation of lead, to prevent, 16

P

Painting down pipes, 90
 Parallel gutters, 38, 49, 71, 93
 Pig-lugged corners, 26
 Pipe, access, 152
 — down, 29
 — drive, 119, 126, 130
 — intake, 129, 130
 — outlet, 29, 53
 Pipes, delivery, 106, 108, 112, 118, 121, 124, 125
 — flow of water through, 137, 140
 — rainwater, 89, 93
 — waste, 96
 Pit, catch, 126, 129, 130
 Plan of house drains, 158
 "Plenum" system of ventilation, 159
 Plinths, 93, 96
 Plumber's fire pot, 16
 Pneumatic test for drains, 167
 Pollution of water, 116
 Poorly constructed drains, 172
 Pressure, atmospheric, 103, 133, 134
 — for testing drains, 166, 168, 171
 — gauge, Crapper's, 168
 Pulse valve, 120, 121, 124
 Pump, force, 113
 — hook, 111

Pumps, 103
 Purification of water, 116
 Putty for gutter joints, 4

R

Race, tail, 120, 125
 Raglet, 19, 28, 86
 Rainwater cisterns, 93, 99
 -- head, 53, 96
 -- pipes, 83, 93
 -- -- painting, 90
 -- solvent properties of, 99, 100
 -- storage of, 99
 Ram, beat of, 122, 124, 125
 -- hydraulic, 115
 Rectangular pipes, 96
 Report of Rivers Pollution Commissioners, 115
 Ridges, iron, 47
 -- lead, 41
 -- zinc, 45, 69
 Rising main, 106, 108, 112, 118, 121, 124, 125
 Rivers Pollution Commissioners, Report of, 115
 River water for consumption, 116
 Rocket, smoke, 168
 Rolls, lead, 54
 -- wood, 33, 41, 46, 49, 54, 58, 64, 65
 -- zinc, 60, 64, 70
 Roof, flat, 50, 87
 -- Italian corrugation, 70
 -- Mansard, 53
 -- zinc, 63

S

Saddles, 61
 Saturation line, 116
 Seamed joint, 15
 Secret gutters, 24, 33, 80
 Sewer drains, 91, 98, 143
 -- gas, 150
 Shallow wells, 115
 Shoes, 91, 93, 96
 Siphon, 133
 -- trap, 154
 -- Wirtemberg, 135
 Size of drains, 144

Skylights, 77, 82
 " Slip," 105
 Sluice valve, 135
 Smelling test for drains, 171
 Smoke machine, "Eclipse," 169, 170
 -- rocket, 168
 -- test for drains, 168
 Snifting valve, 121, 124
 Snow boards, 52, 73
 -- guards, 73
 Soakers, 37, 43, 80, 86
 Sockets, loose, 100
 -- rainwater pipe, 92, 96, 100
 Soil, plumber's, 15, 87
 Solder, 18
 Soldering cloths, 16
 -- iron, 17
 Solvent properties of rainwater, 99, 100

Standing overflow, 100
 Steam for ventilation, 160
 Stepped flashings, 23, 36, 37
 Stop ends, 2
 Stopper, drain, 166, 171
 Storage of rainwater, 99
 Storm water drains, 144
 Strainers, 130
 Strap solder, 18
 Suckers, 110, 111
 Suction pipe, horizontal, 110
 -- -- leak in, 110
 -- -- size of, 112
 " Sun " lights, gas, 160
 Swan-necks, 91, 93, 96

T

Tacks, 41, 42, 58, 69, 79
 Tail race, 120, 125
 -- valve, 104, 109, 120, 122, 129
 Testing drains, alignment, 172
 -- -- ball, 172
 -- -- hydraulic, 165
 -- -- olfactory, 171
 -- -- pneumatic, 167
 -- -- smoke, 168
 Theory of hydraulic ram, 118
 Throating groove, 83
 Tilting fillet, 15, 23, 25, 33, 38, 63
 79, 87

Tobin's tube, 161
 Trapped gully, 91, 98, 100, 149.
 156, 167
 Traps, 145, 153
 — Buchan's, 154
 — dipstone, 156
 — siphon, 154
 Tube, Tobin's, 161

U

Undercloak, 31, 32, 50
 "Underlock Fastening, Fox's," 45
 Union clip, 100

V

Vacuum, 103, 104, 134
 — system of ventilation, 159
 Valkys, 33, 85
 Valley gutters, 37, 85
 Valve, air, 131, 139
 — ball, 137
 — boxes, 161
 — clack, 104, 109
 — delivery, 120, 121, 123, 129
 — foot, 105, 112
 — india-rubber, 122
 — pulse, 120, 121, 124
 — sluice, 135
 — snifting, 121, 124
 — tail, 104, 109, 110, 120, 122, 129
 Velocity of discharge, 140
 Ventilation and drainage, 143
 — artificial, 159
 — house, 157
 — of drains, 149, 151, 157
 — plenum system, 159
 — vacuum system, 159
 — pipe, 93
 — at the Houses of Parliament, 160
 — with cooled air, 159
 — with filtered air, 159
 — with heated air, 159
 — with steam, 160
 — with "Sun" lights, 160
 Ventilator, Archimedean, 163
 — Harvey & Co.'s, 162, 163
 — inlet, 161
 — mica flap, 161
 — No. 102 extractor, 163

Vessel, air, 108, 110, 124
 "Vulcan" compound hydraulic
 ram, 125
 — single acting hydraulic ram, 122

W

Waste pipes, 96
 Water carriage system, 143
 — flow of, through pipes, 137, 140
 — friction of, 110, 112, 119, 140
 — line, 36
 — main, jointing pipe to, 115
 — momentum of, 118
 — pollution of, 116
 — purification of, 116
 — river, for consumption, 116
 — supply, continuous, 99
 — test for drains, 166
 — weight of, 103
 Weight of air, 104
 — of lead, 39, 42, 49, 80, 87
 — of water, 103
 Wells, 105, 115
 — foul air in, 113
 Weltd drip, 32
 — joint, 61, 66, 69, 71
 Window, dormer, 86
 Wire guards, 99
 Wirttemberg siphon, 135
 Wood rolls, 33, 41, 46, 49, 54, 58
 64, 65
 Working fall, 118, 130
 — solder, 18
 "Worthington" oil engine, 106
 "Worthington-Simpson" pump,
 106

Z

Zinc, 71
 — caps, 59, 68
 — decomposition of, 57, 71
 — flats, 57
 — gutters, 4, 71
 — in solder, 18
 — rainwater pipes, 93, 100
 — ridges, 45, 69
 — rolls, 60, 64, 70
 — roofs, 63, 87
 — sheets, 57, 64

The
SUNHOT
WATER HEATER

Constant Hot Water to all parts, kitchen, bathroom, wash-hand basin without attention, stoking or cleaning, and at a lower cost than by any other gas storage water-heater.

The cold supply pipe from the water cistern feeds the heater, filling the storage cylinder to its full capacity. The heater unit quickly raises the temperature of the water and delivers it up to the top of the "Sunhot" storage cylinder.

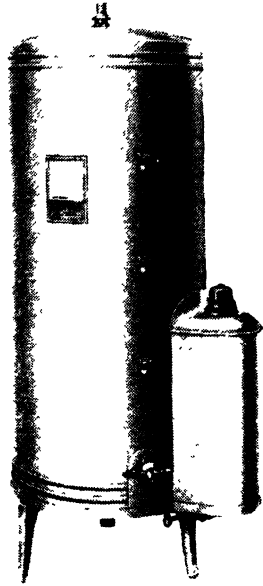

The "SUNHOT" is made in sizes of 12, 20, 30 and 40 gallons capacities, and for both "hard" and "soft" water districts.

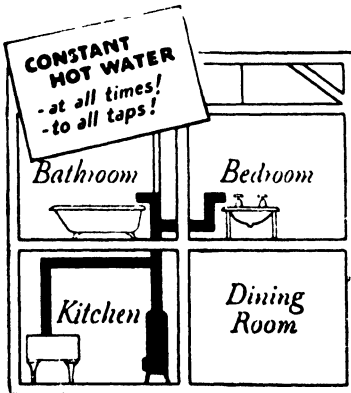

Illustrated literature is available on request to

"P" Dept.

JOHN WRIGHT & Co. LTD.
ESSEX WORKS - ASTON
BIRMINGHAM

Radiation

A SELECTION FROM THE TECHNICAL PRESS LIST

Central Heating and Hot-Water Supply for Private Houses

By G. C. SANFORD, A.M.I.M.E. 180 pages. Illustrated.
Crown 8vo, cloth *Net 8s. 6d.*

CENTRAL HEATING.—AIR SUSPENDED IN WATER—THE MEASUREMENT OF HEAT—QUANTITY OF HEAT REQUIRED—EXPANSION OF WATER—CIRCULATING PRESSURE—HEAT TRANSMISSION—FRICTIONAL RESISTANCE—BOILERS—FULL CONSUMPTION—PRINCIPLES GOVERNING DESIGN OF LOW-PRESSURE GRAVITY—TWO-PIPE RING MAIN SYSTEM—ONE-PIPE RING MAIN SYSTEM—OVERHEAD DROPPING MAIN SYSTEM—TWO-PIPE DROPPING MAIN SYSTEM—RADIATORS.

HOT WATER.—DOMESTIC—QUANTITY REQUIRED FOR DOMESTIC SUPPLY—PRIMARY FLOW AND RETURN PIPES—CYLINDERS AND TANKS—STORAGE TANKS OR SYSTEMS—INDIRECT HEATING—COMBINED HOT WATER AND CENTRAL HEATING WITH DIRECT CYLINDER—INDIRECT CYLINDER—WATER SYSTEM FOR A SMALL HOUSE—TOWEL AIRERS, &C.—FITTINGS, &C.—CALCULATIONS WITH DECIMALS.

Hot Water and Steam Heating and Ventilation

A Practical Work giving Descriptions and Data of all Materials and Appliances used in the Construction of such Apparatus; Rules, Tables, &c. For the Use of Architects, Builders, Heating Engineers, Contractors, Hot Water Fitters, and all interested in Heating and Ventilation. By ALFRED G. KING. Fifth Edition, Revised and Enlarged. 550 pages. 400 Illustrations. Medium 8vo, cloth *Net 20s.*

“... The whole work is fully illustrated, contains tables which are of practical use, and a good index completes a well-presented work.”—*Domestic Engineering.*

Heating and Ventilating

A Manual of American Practice in Heating and Ventilating Dwelling-Houses and other Buildings, with Practical Instruction in Mechanical Details, Operation, and Care of Modern Installations. By C. L. HUBBARD. 230 pp. Illustrated *Net 12s. 6d.*

Gas Installations and Appliances

Their Efficient Maintenance. By A. T. GILBERT, late of The Distribution Staff, South Metropolitan Gas Company. Author of “Gas Meters.” Co-reviser of O’Connor’s “Gas Engineers’ Pocket Book.” 302 pp. 193 Illustrations. Crown 8vo, cloth
Net 8s. 6d

Building Trade Facts

One Thousand Queries and Answers relating to all Sections of the Building Trade, including General Information. A Manual for Builders, House Owners, and Investors. By W. T. SYDNEY SMITH. 128 pages. Crown 8vo Net 2s. 6d.

In compiling this book the Author had in view a work of Questions and Answers, giving essential Points on all branches of the Building Trades that would be of value to the Builder. House Owner, Investor, and Artisan.

GENERAL—FOUNDATIONS AND EXCAVATOR—CEMENTS AND CONCRETE—LIMES—BRICKWORK—DRAINLAYER—TIMBER—CARPENTRY AND JOINERY—SLATER—TILER—PLASTERER—PLUMBER—GLAZIER—PAINTER—PAPERHANGER—IRON AND METALS—MISCELLANEOUS.

"... the man would be a remarkably well-informed person, whether builder, house-owner, or inventor, who would not at times find this handy little book useful. . . ."—*The Estates Gazette*.

How to Plan a House

A Book for all about to Build. By G. GORDON SAMSON. Third Edition. 150 pages. With Plans and numerous Folding Plates. Crown 8vo, cloth Net 3s. 6d.

GENERAL REMARKS ON THE PLANNING AND ARRANGEMENT OF HOUSES—PLANS IN DETAIL—HOUSES WITH FOUR RECEPTION ROOMS—HOUSES WITH THREE RECEPTION ROOMS—DETACHED VILLAS—SEMI-DETACHED VILLAS—TERRACE HOUSES—COTTAGE DWELLINGS FOR THE WORKING CLASSES—STABLES—HINTS ON LAYING OUT GARDENS—HINTS ON PLAN DRAWING

Builders' Calculator

Labour-saving Tables for Estimating the Cubic Contents and Superficial Measure of Building Materials, and also the Weights of Structural Steelwork. By V. P. SMITH. Fifth Edition of "The Public Works Calculator" (Enlarged). 144 pp. 7 in. by 3 in., cloth Net 2s. 6d.

Cabinet-Maker's Guide

The Entire Construction of Cabinet Work. By RICHARD BITMEAD, Author of "French Polishing." Illustrated with Plans, Sections, and Working Drawings. Crown 8vo, cloth Net 3s. 6d.

Bricklaying

General Principles of Practical Bricklaying; Arch Drawing, Cutting, Setting, and Pointing; Paving, Tiling, &c. By ADAM HAMMOND. Fourteenth Edition, Revised. With 68 Woodcuts. Crown 8vo, cloth Net 2s. 6d.

Brickwork

Embodying the General and Higher Principles of Bricklaying, Cutting, and Setting; with the Application of Geometry to Roof Tiling, &c. By F. WALKER. Tenth Edition, Revised by J. P. ALLEN, F.S.I. Crown 8vo, cloth Net 2s 6d.

Arithmetic of Building

By CHAS. G. DOBSON, P.A.S.I. Second Edition, Revised.
94 pages. Illustrated. Crown 8vo, cloth ... Net 2s. 6d.

The primary object of this book is to indicate the lines upon which the calculations ordinarily met with by the builder's office assistant and clerk can most efficiently be performed. A knowledge of elementary arithmetic and mensuration only has been assumed, and the book has throughout been written mainly for those whose acquaintance with building calculations is slender. At the same time, since many of the processes and methods have been approached from an unfamiliar angle, it is thought that much of the matter may prove of interest to those who have spent many years in the building trade.

"We can imagine no more useful book for the young man entering upon the complicated business of building."—*The Estates Gazette*.

"Anyone intelligently interested in the question of building will find this manual of extreme interest; while those who are definitely bound to the practice of the trade are certain to glean some useful hints upon method and system."—*The British Builder*.

Steel Square Applied to Roof Construction

With a Ready Reckoner for the use of Carpenters and Builders.
By J. T. DRAPER. 64 pages. 38 Illustrations. Second Edition,
Revised. Crown 8vo, cloth Net 2s. 6d.

THE STEEL SQUARE AS A CALCULATING INSTRUMENT—EXPLANATIONS AND INSTRUCTIONS—RAFTERS, JACK RAFTERS, VERGE BOARDS, COLLAR-TIES—HIPS AND VALLEYS—HIP BOARDS AND VALLEY BOARDS—PURLINS—TABLES: BEVELS OF RIGHT-ANGLED ROOFS—FORMULÆ FOR OBTAINING BEVEL OBLIQUE-ANGLED ROOFS—LENGTH OF RAFTERS—VALLEYS OR HIPS—CARPENTER'S TRESTLE—OFFICE STOOL—TANK STANDS—WASH TROUGHS, &c.

Decorator's and Renovator's Assistant

Six hundred Recipes and Processes of Practical Utility in the Home, including a variety of information in connection with every class of Interior and Exterior house decoration. Thirteenth Edition, Revised and Enlarged. 170 pp. Crown 8vo Net 2s. 6d.

"The published price is 2s. 6d., and the information given is worth many times that sum. The directions are clear and explicit."—*Blackburn Times*.

"This handy manual gives 600 recipes for all sorts of difficulties and 'gadgets,' and should prove very useful as a handy guide to the handy man."—*Midland Daily Telegraph*.

"How to get the tar off the fingers by a simple home process is one of the 600 things told in the 13th edition. . . . In addition to a volume of homely hints of this kind, the book, which is adequately indexed, gives valuable rules and instructions to the amateur house painter and renovator as to the mixing and preparing of paints and stains, while there is an abundance of information for general work connected with every class of interior and exterior decorations. It is a splendid half-crown's worth."—*Edinburgh Evening News*.

Practical Building Construction

A Handbook for Students Preparing for Examinations, and a Book of Reference for Persons Engaged in Building. By J. P. ALLEN, F.S.I. Seventh Edition. Over 500 pages. Profusely Illustrated. Medium 8vo. Cloth Net 8s. 6d.

A SELECTION OF BOOKS (CONTD)

Carpentry and Joinery

The Elementary Principles of Carpentry. Chiefly composed from the Standard Work of T. TREGGOLD. With Additions and a Treatise on Joinery by E. W. TARN, M.A. New Impression. Crown 8vo, cloth Net 5s.

ATLAS of 35 Plates to accompany and illustrate the foregoing book. With Descriptive Letterpress. 4to ... Net 7s. 6d.

Handrailing

A Practical Treatise showing new and Simple Methods. By GEO. COLLINGS. Third Edition, including a Treatise on Stair-Building. Crown 8vo, cloth Net 3s. 6d.

French Polishing and Enamelling

Including numerous Recipes for making Polishes, Varnishes, Glaze-Lacquers, Revivers, &c By R. BILMEAD. New Impression. Crown 8vo, cloth Net 2s. 6d.

Circular Work in Carpentry and Joinery

A Practical Treatise. By GEORGE COLLINGS. Fourth Edition. Crown 8vo, cloth Net 2s. 6d.

Roof Carpentry

Practical Lessons in the Framing of Wood Roofs. For the Use of Working Carpenters. By GEO. COLLINGS. Crown 8vo, cloth Net 2s. 6d.

Superficial Measurement

Tables calculated from 1 to 200 inches in length, by 1 to 108 inches in breadth. A Guide for the Use of Architects, Surveyors, Engineers, Timber Merchants, Builders, Glass Dealers, &c. By J. HAWKINGS. Eighth Edition Enlarged. Crown 8vo, cloth Net 4s.

Colour Mixing and Paint Work

A Practical Manual for Painters, Signwriters, Artists, Artists' Colourmen, &c. By D. F. CARY, B.A. (Science Hons. Cantab.), Asso. Brit. Water Colour Society. 80 pages. Crown 8vo, cloth Net 2s. 6d.

"The manuals are now known far and wide, and appreciated both for their practical contents and their comprehensive character. There is hardly a trade left upon which they do not treat or a craft that they do not assist and enlighten. This book is no exception to those which have preceded it. Nothing has been sacrificed to bring this little manual within the limits of such a reasonable price as 2s. 6d. The information is most concise and reliable."—*Decorator's and Painter's Magazine.*

Every Man's Own Lawyer

A Handy Book of the Principles of Law and Equity. By a BARRISTER. 63rd Edition (1935), Revised, including New Acts of Parliament, to which is added a concise Dictionary of Legal Terms. 900 pages. Large Crown 8vo Net 15s.

A complete epitome of the laws of England, comprising, amongst other matters :— THE RIGHTS AND WRONGS OF INDIVIDUALS—LANDLORD AND TENANT—VENDORS AND PURCHASERS—CONTRACTS AND AGREEMENTS—CONVEYANCES AND MORTGAGES—JOINT-STOCK COMPANIES—PARTNERSHIP—SHIPPING LAW—DEALINGS WITH MONEY—SURETYSHIP—CHEQUES, BILLS, AND NOTES—BILLS OF SALE—BANKRUPTCY—MASTERS, SERVANTS, AND WORKMEN—INSURANCE: LIFE, ACCIDENT, &c.—COPYRIGHT, PATENTS, TRADE MARKS—HUSBAND AND WIFE, DIVORCE—INFANCY, CUSTODY OF CHILDREN—TRUSTEES AND EXECUTOR—TAXES AND DEATH DUTIES—DOCTORS AND LAWYERS—PARLIAMENTARY ELECTIONS—LOCAL GOVERNMENT—LIBEL AND SLANDER—NUISANCES—CRIMINAL LAW—GAME LAWS—GAMING—INNKEEPERS—FORMS OF WILLS, AGREEMENTS, NOTICES—NATURALISATION AND ALIENS—WAR AND EMERGENCY LEGISLATION—DUTIES, TAXES, AND EXCISE LICENCES.

The object of this work is to enable those who consult it to help themselves to the law ; and thereby to dispense, as far as possible, with professional assistance and advice. There are many wrongs and grievances which persons submit to from time to time through not knowing how or where to apply for redress ; and many persons have as great a dread of a lawyer's office as of a lion's den. With this book at hand it is believed that many a fee may be saved ; many a wrong redressed ; many a right reclaimed ; many a law-suit avoided ; and many an evil abated. The work has established itself as the standard legal adviser of all classes, and has also made a reputation for itself as a useful book of reference for lawyers residing at a distance from law libraries, who are glad to have at hand a work embodying recent decisions and enactments.

"That handy book of law, 'Every Man's Own Lawyer,' appears . . . up to date, with its contents admirably classified. It is an excellent book of reference with a deservedly high reputation, and every succeeding edition bears the stamp of careful revision."—*Morning Post*.

"'Every Man's Own Lawyer' has become a 'pillar' of the book-shelf. The book has now, as in previous years, been revised, and statutory and other amendments have been made where necessary. Since the last edition there has been an unusual output of legislation, but the consequent work of inclusion and revision has been carried out in such a way as to add to the usefulness of this everyday book of reference in the consultation of very complicated laws."—*Daily Telegraph*.

"The amount of information given in the volume is simply wonderful. The continued popularity of the work shows that it fulfils a useful purpose."—*Law Journal*.

"No Englishman ought to be without this book."—*Engineer*.

"Ought to be in every business establishment and in all libraries."—*Sheffield Post*.

"A useful and concise epitome of the law, compiled with considerable care."—*Law Magazine*.

"Admirably done, admirably arranged, and admirably cheap."—*Leeds Mercury*.

LONDON

THE TECHNICAL PRESS LTD

5 AVE MARIA LANE, LUDGATE HILL. E.C.4

