

BIRLA CENTRAL LIBRARY

PILANI (RAJASTHAN)

Call No. 616.01
T158

Accession No. 37306

Acc. No. 37306

ISSUE LABEL

Not later than the latest date stamped below.

Bacteriology

A TEXTBOOK OF MICROORGANISMS

BY FRED WILBUR TANNER
AND FRED WILBUR TANNER, JR.

BACTERIOLOGY

A Textbook of Microorganisms
Fourth Edition. Cloth. $5\frac{1}{2}$ x $8\frac{3}{8}$.
625 pages. 137 illustrations.

BY FRED WILBUR TANNER

PRACTICAL BACTERIOLOGY

An Introduction to Bacteriological Technic
Second Edition. Cloth. $5\frac{3}{4}$ x 9.
235 pages. 72 illustrations.

A TEXTBOOK OF MICROORGANISMS

Bacteriology

FRED WILBUR TANNER

*Professor of Bacteriology and Head of the
Department, University of Illinois, Urbana*

FRED WILBUR TANNER, JR.

*Bacteriologist, Fermentation Division, Northern
Regional Laboratory, Bureau of Agricultural
and Industrial Chemistry, United States Department
of Agriculture, Peoria, Illinois*

Fourth Edition

1 9 4 8

NEW YORK · JOHN WILEY & SONS, INC.

LONDON · CHAPMAN & HALL, LIMITED

COPYRIGHT, 1928, 1933,
BY
FRED WILBUR TANNER¹

COPYRIGHT 1948
BY
FRED WILBUR TANNER
AND
FRED WILBUR TANNER, JR.

All Rights Reserved

*This book or any part thereof must not
be reproduced in any form without the
written permission of the publishers.*

PRINTED IN THE UNITED STATES OF AMERICA

Preface

THE CONTENT OF THIS BOOK is indicated by its title, BACTERIOLOGY — A TEXTBOOK OF MICROORGANISMS. Even though it is intended only for those who are studying microbiology for the first time, it is not elementary in nature. The authors have attempted to allow the student to build his structure on a broad biological basis and to consider only fundamental principles and facts. Consequently, no attempt has been made to present a " treatise " for use by embryo bacteriologists. Many such books are available for students who have laid a firm foundation in biology and bacteriology.

The book is the result of thirty years' active association with students in various curricula. Pathogenic bacteria in relation to disease are discussed only as far as is necessary to round out a general course in bacteriology. The tendency to overemphasize these types of microorganisms in the first course in microbiology is too common.

FRED W. TANNER
FRED W. TANNER, JR.

October 1947

Ever since my life as a man, I do not think I have ever spoken with a student without saying to him, " Work perseveringly; work can be made into a pleasure, and alone is profitable to man, to his city, to his country."

—PASTEUR.

Contents

	PAGE
CHAPTER 1. HISTORY AND DEVELOPMENT OF EARLY THEORIES . . .	1
The Lens and Microscope, 2. Spontaneous Generation, 8. Fermentation, 12. Early Work in Medical Bacteriology, 16. Bacteriology of Sanitation, 22. Animal Pathology, 24. Agricultural Bacteriology, 25. Industrial and Food Micro- biology, 30.	
CHAPTER 2. SYSTEMATIC RELATIONSHIPS OF PLANT AND ANIMAL GROUPS	34
Haeckel, 34. Characteristics of Plants and Animals, 35. Biology of Plants, 40. Animal Biology, 48.	
CHAPTER 3. LIVING MATTER AND THE CELL	51
Biology, Botany, and Zoology, 51. Protoplasm, 54. Mor- phology of Cells, 57. Multiplication of Cells, 59.	
CHAPTER 4. ULTRAMICROSCOPIC FORMS OF LIFE	64
Filterable Forms of Life, 65. Bacteriophage, 65. Viruses, 68. Rickettsiae, 72.	
CHAPTER 5. MORPHOLOGY OF BACTERIA	75
Shape and Size of Bacteria, 77. Organs of Locomotion, 84. Nucleus, 88. Sporulation, 91. Reproduction, 96. Chem- ical Composition, 99.	
CHAPTER 6. VARIABILITY OF MICROORGANISMS	104
Modern Pleomorphism, 106. Genetic Variations, 110.	
CHAPTER 7. NOMENCLATURE AND CLASSIFICATION OF BACTERIA . .	111
Nomenclature, 113. Descriptive Chart and Index Number, 116. Early Classifications, 117. Migula's Classification, 118. Lehmann and Neumann's Classification, 119. Ber- gey's Classification, 121. Identification of Microorganisms, 149.	
CHAPTER 8. MOLDS	151
Structure, 151. Spores, 153. Order Mucorales, 154. Thamnidium, 158. Penicillium Molds, 158. Aspergillus	

	PAGE
Molds, 160. Botrytis, 164. Oidium, 164. Alternaria, 165. Monilia, 165. Fusarium, 166. Actinomyces, 168. Pathogenic Molds, 168.	
CHAPTER 9. THE YEASTS AND RELATED ORGANISMS	171
Shapes, 172. Structure, 174. Reproduction, 177. Hybridization, 180. Classification, 182. Industrial Yeasts, 189. Pathogenic Yeasts, 191.	
CHAPTER 10. THE PROTOZOA	194
Morphology, 194. Reproduction, 194.	
CHAPTER 11. ACTION OF PHYSICAL AGENTS ON BACTERIA	201
Light, 201. Temperature, 205. Moisture, 220. Drying, 222. Pressure, 223. Agitation, 225. Aeration, 225. Gravity, 225. Electricity, 226. Surface Tension, 227. Sound Waves, 227.	
CHAPTER 12. RELATION OF CHEMICAL AGENTS TO BACTERIA	229
Disinfection, 229. Specificity of Disinfectants, 237. The Halogen Compounds, 238. Phenolic Group, 242. Metals and Salts of Heavy Metals, 224. Miscellaneous Compounds, 247. Standardization of Disinfectants, 253.	
CHAPTER 13. MUTUAL RELATIONSHIP — MICROBIAL ASSOCIATIONS	258
Symbiosis, 258. Antibiosis, 260. Metabiosis, 264.	
CHAPTER 14. NUTRITION AND METABOLISM OF BACTERIA	265
Plant Metabolism, 267. Animal Metabolism, 267. Bacterial Metabolism, 267. Foods, 269. Fermentation and Respiration, 270. Cycles of Elements, 273. Special Products of Metabolism, 275.	
CHAPTER 15. GROWTH OF BACTERIA	280
Growth Histories, 281. Factors Influencing Growth, 283.	
CHAPTER 16. BACTERIAL ENZYMES	287
Nature, 288. Nomenclature, 288. Changes by, 289. Structure, 292. Characteristics of, 294. Intracellular (Endoenzymes), 295. Extracellular (Exoenzymes), 295. Practical Applications, 298.	
CHAPTER 17. NITROGEN METABOLISM (CYCLE); SULFUR METABOLISM (CYCLE); CARBON METABOLISM	303
Occurrence of Nitrogen, 303. Nitrogen Cycle, 304. Chemical Methods of Fixation, 305. Biological Methods of Fixation, 305.	

	PAGE
tion, 305. Nitrification, 316. Denitrification, 317. Putrefaction, 319. Sulfur Cycle, 323. Carbon Cycle, 328.	
CHAPTER 18. MICROORGANISMS IN AIR	335
Dust and Microorganisms, 338. Cleaning of Air, 340.	
CHAPTER 19. WATER BACTERIOLOGY	343
Transmission of Diseases, 344. Evidences of Pollution, 345. Methods of Water Examination, 346. Purification of Public Water Supplies, 351. Home Water Supplies, 355. Disin- fection of Small Quantities of Water, 358. Bottled and Mineral Waters, 361. Bacteriology of Ice, 362.	
CHAPTER 20. SEWAGE TREATMENT AND BACTERIOLOGY	364
General Principles of Sewage Treatment, 365. Stream Pollu- tion, 369. Swimming Pools, 372.	
CHAPTER 21. BACTERIOLOGY OF MILK AND MILK PRODUCTS	375
Bacteria in Milk, 375. Improving Milk Quality, 378. Pas- teurization, 381. Diseases Spread by Milk, 383. Butter, 386. Cheese, 387. Ice Cream, 388. Fermented Milk, 389. Concentrated Milk, 391.	
CHAPTER 22. INDUSTRIAL FERMENTATIONS	394
Yeast Fermentations, 394. Alcoholic Beverages, 397. Bread Yeast, 398. Bacterial Fermentations, 400. Vinegar Fer- mentation, 401. Mold Fermentations, 405. Miscellaneous Fermentations, 407. Textile Fibers, 409. Beverages, 412. Bread, 413. By-Products from Industrial Fermentations, 415.	
CHAPTER 23. FOOD PRESERVATION	418
Food and Drug Acts, 420. Drying, 421. Low Temper- ature, 422. High Temperatures, 424. Canning, 427. Satisfactory Canned Foods, 436. Canning Powders, 438. Preservation by Chemicals, 439. Salting and Pickling, 440. Spices, 443. Smoking, 443.	
CHAPTER 24. FOOD INFECTION AND FOOD POISONING	446
Food-Borne Infections, 447. Food-Borne Intoxications, 450. Botulism, 450. Salmonella Food Poisoning, 454. Staphylo- coccus Food Poisoning, 455. Ptomaines, 456. Storage of Food in Open Cans, 458. Foods Containing Metallic Salts, 459. Allergic Reactions, 460. Trichinosis, 461.	
CHAPTER 25. RELATION OF BACTERIA TO DISEASE	463
Theories of Disease, 464. Types of Disease, 465. Specific Bacterial Infections, 468.	

	PAGE
CHAPTER 26. TRANSMISSION OF INFECTING AGENTS	478
Carriers, 479. Fomites, 480. Public Drinking Fountains, 485. Air-Borne Infections, 486. Contact Infection, 487. Insect-Borne Diseases, 489. Animal-Borne Diseases, 492. Preventing Spread of Disease, 495. Quarantine Methods, 496. Epidemiology, 500.	
CHAPTER 27. FACTORS INFLUENCING INFECTION	502
Resistance of Host, 502. Malnutrition, 505. External Defenses, 507. Infecting Agent, 509.	
CHAPTER 28. MODES OF BACTERIAL ACTION	512
Bacterial Toxins, 513. Bacterial Leucocidins, 519.	
CHAPTER 29. PROTECTIVE SUBSTANCES—IMMUNE BODIES, ANTIBODIES	520
Theories of Immunity, 520. Antitoxins (Antitoxic Sera), 524. Agglutinins, 536. Precipitins, 540. Opsonins, 545. Lysins, 546.	
CHAPTER 30. VARIETIES OF IMMUNITY	550
Natural Immunity, 550. Methods of Producing Artificial Immunity, 553. Methods of Passive Immunity, 557.	
CHAPTER 31. BACTERIA IN PLANT DISEASES	569
Blights, 572. Leaf Spots, 575. Rots, 577. Wilts, 579. Galls, 580.	
APPENDIX	587
Bacteriological Literature, 587. Glossary, 579.	
INDEX	611

CHAPTER 1

HISTORY AND DEVELOPMENT OF EARLY THEORIES

It is not always easy or necessary to determine just when a science started. In most sciences a sort of nebulous period existed during which new observations were being made and proved by further experiments and observations. This situation is especially true for bacteriology because for some time it was a part of other well-established sciences. It should not be considered to be a separate science today because it is a part of the broader field of *biology*. Development of bacteriology as we know it today was slow in its early stages. Statements appeared in the writings of early biologists that some of the phenomena which they were observing might be due to smaller organisms than could be seen with the eye. Much evidence pointed to this fact. These early statements lacked experimental proof and were little more than prophesies. Although they lacked this experimental proof, some of them turned out to be surprisingly accurate and were later firmly established by results of study in the laboratory.

Although for the most part the historical development of sciences may be considered to be tiresome by those who are just beginning to study them, the situation is different for bacteriology. More interesting ventures in reading cannot be found. Early bacteriology was involved in diseases of man and animals. Problems such as why sugar solutions decomposed, how vinegar could be made from fruit juices, why foods spoiled and frequently made man sick are a few of the subjects considered in a course in bacteriology.

Leeuwenhoek (1632-1723). Anthony Leeuwenhoek, a Dutch linen draper and later government officer in Delft, Holland, did much to establish the science of microscopy. Because of the fundamental nature of his investigations he had a part in starting some of the other biological sciences as well; for, by careful observations and experiments with crude apparatus, he gathered much

information about microorganisms. He should not be considered to be the first bacteriologist, for the science did not then exist. It remained for Pasteur to give the science of bacteriology a good start. Leeuwenhoek¹ was, however, one of the first to realize the possibilities of the microscope in the laboratory. He recorded his observations in numerous papers, books, and reports. Spermatozoa, blood corpuscles, protozoa, and microorganisms in various materials were described. Leeuwenhoek's observations are more of historical interest than of value in themselves. He did not appreciate the necessity of pure cultures; at least he did not have them, for the illustrations which he published show mixtures of microorganisms. He affiliated with the newly founded Royal Society of London which undoubtedly did much to increase his enthusiasm. Although probably not the first to view microorganisms through the microscope, he may be considered to be the founder of microscopy. He died in 1723 at the age of 90 years and 10 months.

THE LENS AND MICROSCOPE

Discovery of the lens made possible many advances in science and better living. Although many wonderful engineering feats of the ancients were accomplished without instruments with lenses, such achievements as construction of aqueducts, pyramids, and highways, would have been much easier with the use of lenses in levels and transits. Without lenses, we could have no telescopes, cameras, moving pictures, and microscopes. Lenses are the most important parts of the microscope. The science of optics developed slowly even after some of its basic principles had been discovered. Some of the discoveries were accidental but nevertheless important. Just when the science of optics was founded depends largely on what contribution is considered to be the first. In the *Encyclopedia Britannica* it is stated that a convex lens of rock crystal was found among the ruins of the palace of Nimrud. Seneca mentioned the increased brilliancy of colors of fruit when viewed in globes of water.

Singer stated that lenses may be traced back to the 13th century and that an earlier origin is not improbable. He believed that gem cutters of antiquity must have used some apparatus for magnifying objects, else they could scarcely have done such fine cutting. Pliny stated that burning glasses were used by physicians as cauteries. Carpenter believed that the suggestion of the early existence of lenses on the ground that they were necessary

¹ D. F. Harris, Anthony von Leeuwenhoek, The First Bacteriologist, *Sci. Monthly*, **12** (1921), 150-60.

for fine gem cutting was not necessarily valid, for some persons are endowed with greater visual powers than others. He also pointed out that no Greek or Roman writer mentioned their use. Some early Greek physicians stated that myopia was incurable; such statements appeared even toward the end of the 13th century. If the rock crystal mentioned previously was used as a lens, it would place an earlier date for the beginning of the science of optics.

Roger Bacon (1214-1294). Bacon, a Franciscan monk, published several works of interest to students of science. He is given credit for developing the first convergent lens and, therefore, the first simple microscope. Bacon is probably the founder of the science of optics. He emphasized what philosophers of his day ignored, that only by experiment is real progress made in science.

Although Bacon appreciated the necessity of experimentation, it was not until a few centuries later, when such men as Newton, Harvey, and Galileo worked, that experimental method was finally used for seeking truth. Previous to this time scientists were content with discussing the writings of Aristotle and other early writers. Anyone who disagreed with these "authorities" was regarded as revolutionary and not to be trusted. Such is the situation with many later scientists such as Harvey, Jenner, and even Pasteur.

About the year 1300 spectacles were introduced by Salvino d'Amato degli Armati of Florence and Allesandro de Spina of Pisa. Some historians give Bacon credit for introduction of spectacles. According to Carpenter, a manuscript from Florence dated 1299 has this statement:

I find myself so pressed by age that I can neither read nor write without those glasses they call spectacles, lately invented to the great advantage of poor old men when their sight grows weak.

In the 16th century the lens was adapted to the study of many natural phenomena. We shall not attempt a complete review of those who were concerned with the development of the microscope but will single out several of the more important workers.

Some of the early work was done with the simple microscope, a natural development of the lens. The early instruments of this type consisted of a tube of opaque material with the lens in one end and in the other a flat glass plate on which the object was placed. Such an instrument used by Kircher is shown in Fig. 1.

Galileo (1564-1642). Much evidence points to Galileo as the discoverer of the compound microscope. He announced that his "occhiale" made flies

look like hens. He is not often thought of in this connection, but evidence presented by Carpenter is convincing. Galileo apparently did not follow his discovery with reports of its revelations, as did Leeuwenhoek and

others, and therefore does not receive credit due him as one of the discoverers of the microscope.

Borel (1620-1671). Borel was one of the first to use the microscope as an aid in the study of diseases. He probably had little to do with its development but used it in his profession. Singer believed that Borel probably discovered the corpuscles in the blood as early as 1653. Borel published the first book on microscopy as such.

Hooke (1635-1703). The work of Hooke in cytology gives him a prominent place in historical discussions of microscopy. In 1665 he published his "Micrographia" showing his compound microscope. Hooke was well trained but cannot be regarded as a great biologist. He first saw what we know today as cells.

Faber. Giovanni Faber (1625) introduced the name microscope.

Zacharias² (miscalled Jansen, according to Singer). A son of a spectaclemaker discovered the principles of the telescope by

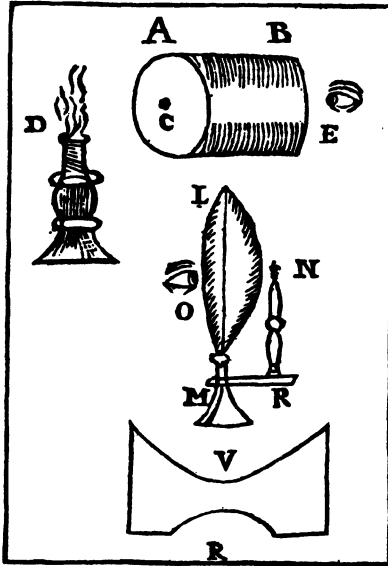

FIG. 1. Simple Microscope of Athanasius Kircherus. (After Singer)

The object to be examined was placed on the glass plate at C; it was illuminated by the candle D; the lens was at the opposite end E of the tube AB.

using an instrument consisting of two lenses in a tube. He was, therefore, one of the originators of the compound microscope.

Kircher (1601-1680). Athanasius Kircher is another pioneer in microscopy who is given little attention by bacteriologists. He made a compound microscope which was used for collection of data published in a number of papers. He made intensive studies in the microscopic world and stated that air and water teemed with a myriad of small organisms. He has reported the presence of "worms" in many materials such as decaying meat and vinegar. Kircher did not publish so detailed reports as did Leeuwenhoek and is consequently not so well known.

Leeuwenhoek. The work of Leeuwenhoek has been considered in the

² Singer stated that use of the name Jansen for this investigator is due to a misunderstanding; Zacharias was, indeed, the son of John the spectacle-maker, but Jansen was not in this case a surname. This man and his son are spoken of by others as Hans Jansen and his son Zacharias.

foregoing. In 1673 this pioneer in microscopy began to send papers for publication to the Royal Society of London. In contrast with Hooke and others Leeuwenhoek was not a university-trained scientist. Loey has given a fine description of this enthusiastic pioneer in microscopy. It seems that microscopy was somewhat of a hobby with him, since he held a minor court position for a livelihood. Nearly all of Leeuwenhoek's lenses were simple ones ground by himself. Loey stated that he possessed not less than 247

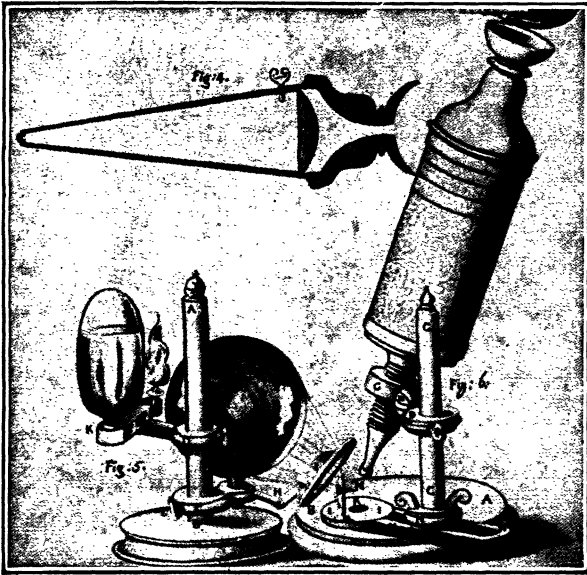

FIG. 2. Hooke's Compound Microscope. (After Singer, 1914)

complete microscopes and 419 lenses which were used in his investigations. One of his microscopes is in the possession of the University of Utrecht. Leeuwenhoek was not a systematic investigator, and consequently his interests were quite diverse.

Malpighi (1628-1694). Marcello Malpighi had a part in founding the science of microscopy. For him, also, the microscope was a hobby; he was among the first to study animal and vegetable materials. In 1661 he viewed for the first time circulation of the blood capillaries. Later he studied the structure of animal tissues and, like Leeuwenhoek, published his results in the *Proceedings* of the Royal Society of London. He should be better known as a pioneer microscopist.

The Electron Microscope. Although great progress has been made with optical microscopes since the days of Malpighi,

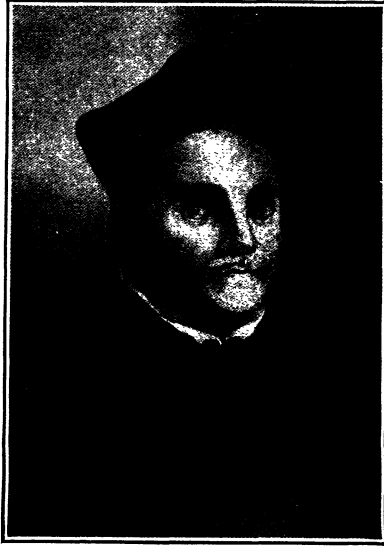

FIG. 3. Athanasius Kircherus. (After Singer, 1914)

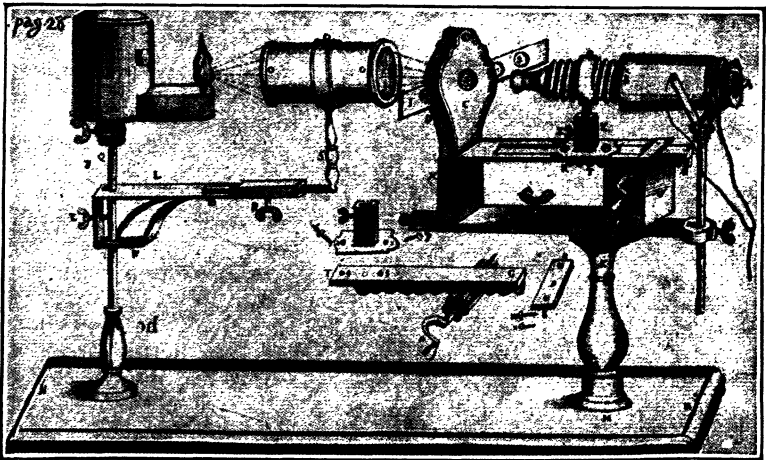

FIG. 4. The Compound Microscope of Athanasius Kircherus Adapted with Coarse and Fine Adjustments and a Substage Condenser. (After Singer, 1914)

scientists have desired means of securing greater and greater magnifying powers. The highest practical magnification which has been possible with optical microscopes has been around 2500, and even then considerable loss of detail results. This is due to the fact that such microscopes depend on light waves, and we cannot see particles which are smaller than wavelengths of light. Many forms of life are smaller than this. When it was found that *electrons* which are infinitesimal bits of electric energy could

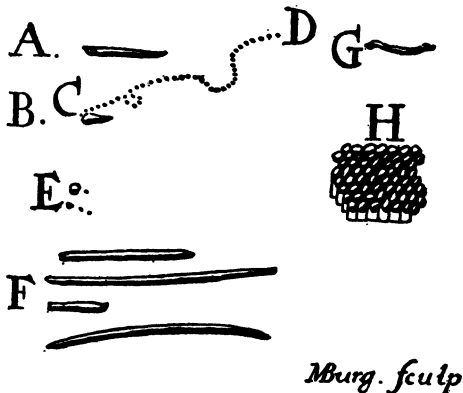

FIG. 5. Bacteria as Reported by Leeuwenhoek, 1683. (After Loeffler)

E, Cocci; *A*, *F*, and *G*, rod-shaped organisms; *H*, Sarcina; *C*, flagellated organisms.

be made to behave in a manner analogous to light, solution of the magnification problem seemed possible. Electrons have the advantage that the wavelength of an electric beam is 1/100,000 that of light. After extensive study and research, the Radio Corporation of America³ perfected an electron microscope with which it is possible to secure magnifications up to 100,000 diameters. Information is now being gathered about various ultra-microscopic agents concerning which little has been known (Fig. 6).

Recent reports have been made that the useful magnifying powers of the electron microscope have been increased from 100,000 diameters to more than 200,000 by an improved magnetic lens. Particles separated by as short a distance as 13 angstroms,

³ V. K. Zworykin and J. Hillier, *Electronic Microscopy*, *Sci. Monthly*, 59 (1944), 165-79.

or about 50 billionths of an inch can be distinguished. This means that 50,000 distinct particles could be recognized in a distance the

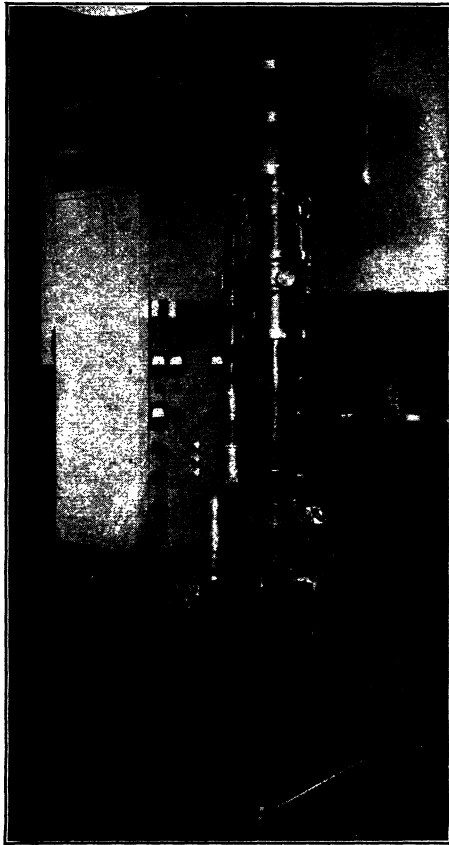

FIG. 6. The RCA Electron Microscope (Type B).

width of a hair. Such high resolving power will require much study by scientists before it can be applied to solution of various technical problems.

SPONTANEOUS GENERATION
BIOGENESIS VERSUS ABIOGENESIS

Early biologists resorted to the explanation of "spontaneous generation" to explain the origin of life where definite methods

of reproduction were unknown. Aristotle was one of the first to expound authoritatively on the subject although there is evidence that the explanation had been used before. The ancient Greeks believed that life originated spontaneously, for did not flies and frogs come from mud and maggots develop from putrefying meat? This was disproved by Redi in 1668. No maggots developed when meat was protected from flies by screens. Anaximander

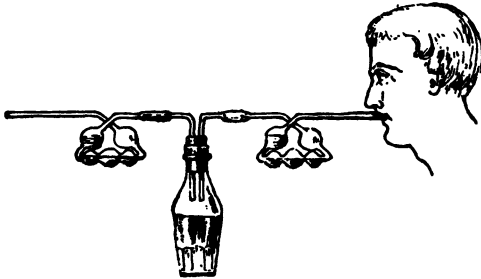

FIG. 7. Apparatus Used by Schulze (1836) to Show that Microorganisms Are Necessary for Decomposition of Organic Matter.

The flask containing a vegetable infusion was sterilized by boiling on a sand bath. The absorption bulbs, one containing concentrated sulfuric acid and the other potassium hydroxide, were connected while steam was issuing from the delivery tubes. This apparatus was placed on a window sill for about 3 months. Schulze applied his mouth to the potash bulb and drew air through the flask. The contents did not spoil because microorganisms had been kept out. The contents of the control flask spoiled because microorganisms were allowed to enter in air.

stated that animals developed from moisture. As late as 1652 van Helmont, the chemist, supported the theory by stating that mice developed from old rags.

The theory of spontaneous generation (abiogenesis) is the result of improperly controlled experiments and faulty logic. Although it developed slowly, many years were required to overthrow it, during which time much experimentation and bitter debate occurred. The discrediting of this theory was accomplished when Pasteur proved that fermentation was a biological phenomenon and not a mechanical one. Strange as it may seem, the early investigators who founded this theory arrived at it through attempts to preserve foods or find the real cause of fermentation. It was indeed an important topic for discussion and a fundamental one as well, the solution of which was necessary before other questions could be answered. Only a few of those who played major roles in the controversy need be men-

tioned here. Readers who desire more detailed information may consult the excellent discussion by Bulloch.⁴

Needham (1713–1781), a Roman Catholic clergyman in England, was perhaps the first to offer experimental data to support the theory of spontaneous generation. He boiled meat and meat juice in corked flasks which were stored for further observation. When their contents spoiled, he said that life had developed

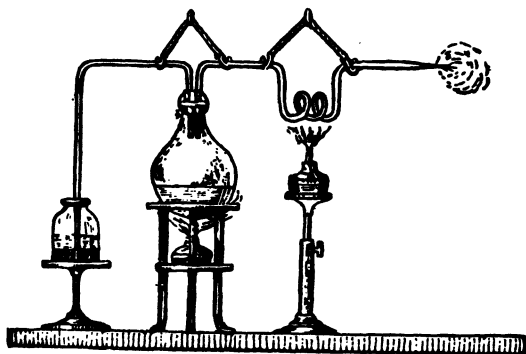

FIG. 8. Schwann's Apparatus for Disproving the Theory of Spontaneous Generation. (After Loeffler)

According to Schwann's technic only sterilized air could enter the flask containing the putrescible substance. The infusion remained sterile for weeks because microorganisms could not enter. At the end of the experiment putrefaction occurred after the system was opened so that microorganisms could enter. Schwann showed, in this manner, that some agent in air and not the air itself was responsible for decomposition.

spontaneously. He believed that boiling had destroyed all of the "eggs" in the meat juice. Of course he was wrong in this assumption; boiling had not done this.

Spallanzani,⁵ one of the most interesting workers of these early days, took issue with Needham. Spallanzani stated that the contents of Needham's bottles had spoiled because he had allowed air which had not been exposed to fire (sterilized) to enter. Spallanzani's opponents claimed that heating air made it unsuitable for growth of microorganisms; they said that his conclusions also, were influenced by questionable technic. Spallanzani

⁴ W. Bulloch, *History of Bacteriology*, Chap. 1, in a *System of Bacteriology in Relation to Medicine*, Vol. I.

⁵ J. B. Hamilton, *The Shadowed Side of Spallanzani*, *Yale J. Biol. Med.*, 7 (1934), 151–70.

answered these arguments by showing that no growth resulted when air sterilized by other methods was admitted. Similar results were also reported by Schulze, who carried out an experiment much like Schwann's; a solution capable of fermentation with yeast did not ferment after thorough heating or exposure to air which had been thoroughly heated. Schwann stated that fermentation was arrested by any factor, such as heat or potassium arsenate, which killed fungi. Because of this statement,

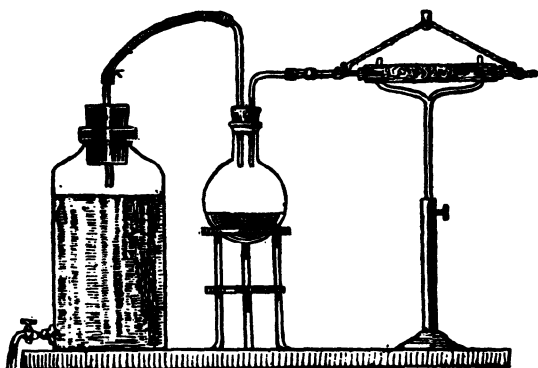

FIG. 9. Apparatus of Schröder and Dusch for Experiments on Spontaneous Generation.

With this apparatus Schröder and Dusch showed that the agents in air which caused vegetable infusions to spoil could be removed by passing the air through cotton. The cotton retained the agents which caused decomposition. Infusions exposed to unfiltered air spoiled.

some have said that Schwann was the founder of the science of disinfection. Schröder and Dusch showed that heating removed from the air "something" that would permit growth of microorganisms. They could not decide whether this agent was itself a living organism or a chemical substance modified by heat. Lamarck, the renowned biologist, believed that simple organisms developed by spontaneous generation and that progressive increase in complexity from the simplest forms up to man occurred. Little progress was made in discrediting this theory until the microscope was perfected to the point where it was no longer a curiosity but a useful instrument in biology. With its introduction started the rapid downfall of the theory of abiogenesis.

Pasteur finally dealt the theory of spontaneous generation a deathblow. He introduced a fermentable liquid into a flask after

which he drew out the neck into a capillary in the shape of a letter S. The flask was then boiled and allowed to cool. It remained sterile for some time, but growth appeared in two days after the neck was broken off. This showed that Pasteur had sterilized the liquid and that it fermented when microorganisms were admitted. As Duclaux has said in his book on Pasteur, those who supported the theory of spontaneous generation propounded it and then attempted to prove it. Pasteur's work was stimulated by an offer of the Academy of Sciences in 1860 for "an attempt by means of suitable experiment to throw new light on the question of spontaneous generation." Pouchet presented a paper before the Academy to show that animals and plants could develop in media in which no germs or other organic bodies existed. His support by other investigators compelled Pasteur to be more vigorous in presenting his arguments.

In leaving this interesting subject of spontaneous generation (abiogenesis), the question—what sort of nature would we have if life did originate spontaneously?—may be asked. Could nature work in such a manner? The answer should probably be no or at least as far as our present ideas of spontaneous generation are concerned.

FERMENTATION

Many theories were proposed and studied before much was known about fermentation, a phenomenon early related to production of fermented beverages and bread. Although some of them were quite without foundation, they had to be studied before they could be discarded.

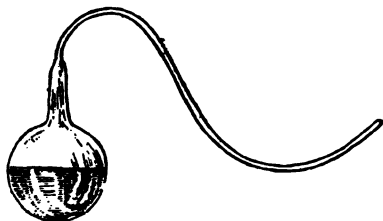

FIG. 10. Flask of a Type Used by Hoffmann and Pasteur in Their Work on Fermentation.

The Germ Theory of Fermentation. Some of the earliest scientific work in bacteriology was concerned with establishment of the germ theory of fermentation. In the proving of it, several other problems were also

settled—the proof for the germ theory of disease and final refutation of the theory of spontaneous generation. Fermentations had been carried out for centuries, and, although man

knew how to maintain them, he did not know just what was going on. Explanation of the process was not attempted until about 1697 when Stahl⁶ proposed the hypothesis which Liebig later attempted to prove. Stahl suggested that fermentation resulted from, or was, a shattering of molecules due to some force set up on them or in the medium about them. This was transferred to other molecules. Finally, parts of the molecules were forced out of the liquid. The difficult part of this theory is to tell just how the phenomenon started. Such a conception seems out of tune with the general manner in which phenomena in nature occur. Fabroni was one of the first investigators to suggest that some form of life was concerned when sugar solutions were fermented. He noticed that deposits in many fermenting solutions were composed of cells of albuminoid nature. This seems to be one of the first observations on that interesting and wonderful yeast cell. Thenard⁷ did not accept Fabroni's report.

In 1810 Appert⁸ reported results of investigations in food preservation which bear directly on this question. In response to an offer of 20,000 francs by the French Government for a method of preserving foods, he founded the modern canning industry by placing various foods in sealed containers which were afterward heated in boiling water. Appert did not attempt to explain the reasons why the food kept, but others who had given more attention to the phenomenon of fermentation did. Appointed by the Government to inquire into these reasons, Gay-Lussac⁹ stated that air was necessary for fermentation and spoilage of food preserved by Appert's method. As long as air was excluded decomposition was impossible. He opened a bottle of grape juice in such a manner that part of it was collected over mercury away from air and the other part in the presence of air. The latter portion fermented. It was, perhaps, logical that air should

⁶ G. E. Stahl, *Zymotechnia fundamentalis*, 1734.

⁷ L. J. Thenard, Mémoire sur la fermentation vineuse, *Ann. chim. phys.*, **46** (1803), 294-320.

⁸ N. Appert, *The Book for All Households or The Art of Preserving Animal and Vegetable Substances for Many Years*, translated by K. G. Bitting, M. S., Glass Container Association of America, Chicago, Ill., August 1920.

⁹ F. J. Gay-Lussac, Extrait d'un mémoire sur la fermentation, *Ann. chim. phys.*, **76** (1810), 245-59.

be selected as the determining factor, for at that time living agents which could cause fermentation were unknown. It is known today that air may harbor many microorganisms which cause decomposition of organic materials.

Berzelius¹⁰ at Upsala gave much support to the *mechanistic* conception of fermentation. His position in the scientific world in 1839 added great weight to any side of a controversy with which he aligned himself. With much scorn he pointed out what he considered to be errors in the experiments of those who believed that fermentation was a biological phenomenon. Berzelius stated that a certain force was functioning by which fermentation was initiated and kept going. Fabroni and later Cagniard-Latour¹¹ stated that fermentation was caused by yeast. This conception was supported by observations of Schwann¹² who showed that heating air and boiling fermenting liquids prevented further decomposition. Schwann's experiments led him to believe that fermentation and putrefaction were biological processes. Kützing¹³ also proposed that yeast cells were necessary in fermentation. He believed that yeast was an organized form of life.

Justus von Liebig and Louis Pasteur had a prolonged discussion on the nature of fermentation. Liebig¹⁴ argued the older contention of Berzelius that fermentation was a mechanical process as opposed to a biological. Berzelius believed that yeast acted in fermentation by virtue of catalytic force in the cell. Liebig did not agree because he believed that yeast cells were unnecessary for fermentation. He believed that air in contact with sugary materials such as plant juices caused formation of a "ferment" which underwent rapid change in the nature of putrefaction or decay. This ability to be in constant state of change was imparted to the sugar molecules. Liebig's theory may, therefore, be regarded as mechanical rather than biological in nature.

¹⁰ J. Berzelius, *Berzelius' Jahresber.*, **18** (1839), 400-03.

¹¹ Cagniard-Latour, *Mémoire sur fermentation vineuse*, *Ann. Chim. phys.*, **68** (1838), 206-22.

¹² T. Schwann, *Vorläufige Mittheilung betreffend Versuche über die Weingärung und Faulniss*, *Ann. Physik.*, **41** (1837), 184-93.

¹³ F. Kützing, *Mikroskopische Untersuchungen über die Hefe und Essigmutter nebst mehreren anderen dazugehörigen vegetabilischen Gebilden*, *J. prakt. Chem.*, **11** (1837), 385-409.

¹⁴ J. Liebig, *Ueber die Erscheinungen der Gärung und die Quelle der Muskelkraft*, *Ann.*, **153** (1870), 1-47, 137-228.

Pasteur¹⁵ stated that this was not a tenable explanation of the forces which caused fermentation; he said fermentation was a biological process brought about by yeast. He published several papers about 1860, all of which dealt with the relation of micro-organisms to fermentation.¹⁶ Pasteur noticed such compounds as amyl alcohol among the products of fermentation.¹⁷ He found it difficult to explain their presence according to Liebig's theory. The structure of amyl alcohol was too different from that of sugar for it to be considered an integral part of the sugar molecule. The details of the controversy are too many to review in this book. The necessity of living cells in fermentation is now accepted.

After the germ theory of fermentation had been established, further experiments were carried out to explain its finer points. Traube¹⁸ made one of the first contributions to the subject by proposing the existence of enzymes. He tried to reconcile opposing views of Pasteur and Liebig. It became apparent that definite agents which could cause fermentation, now known as enzymes, existed in cells. This was finally confirmed by Buchner's work on zymase in 1897. In support of Traube's papers appeared those of Berthelot¹⁹ who isolated the enzyme invertase. The work of Traube stimulated a long line of investigation. Lüdersdorf²⁰ tried to find an explanation by testing the fermenting ability of ground yeast cells. No fermentation resulted. After this, investigators Mayer,²¹ Nägeli, and others added to the information of the day.

The question of the presence of enzymes in yeast capable of inducing alcoholic fermentation was finally settled by Buchner²²

¹⁵ L. Pasteur, Mémoire sur la fermentation appelée lactique, *Compt. rend.*, **45** (1857), 913-16.

¹⁶ L. Pasteur, Mémoire sur la fermentation alcoolique, *Ann. chim. phys.*, **58** (1860), 323-426.

¹⁷ L. Pasteur, Mémoire sur la fermentation lactique, *Ann. chim. phys.*, **52** (1858), 404.

¹⁸ M. Traube, Theorie der Fermentwirkungen, *Dummlers Verlagsbuch* (1858), 119.

¹⁹ M. Berthelot, Sur la Fermentation alcoolique, *Compt. rend.*, **44** (1857).

²⁰ F. Lüdersdorf, Über die Matur der Hefe, *Ann. Physik*, **76** (1846), 408-11.

²¹ A. Mayer, Lehrbuch der Gärungschemie, 3. Aufgabe, Carl Winters, Univ. Buchh., Heidelberg, 1879. C. Nägeli, Theorie der Gärung, München, 1879.

²² E. Buchner, Alkoholische Gärung ohne Hefezellen, *Ber.* **30** (1897), 117-124.

when he produced a "yeast juice" which would cause fermentation of carbohydrate materials. This yeast juice contained no living cells of any sort to which the changes caused by it could be attributed. Buchner's work might indicate that Liebig had some basis for his contention in his controversy with Pasteur. Indeed some chemists have stated that Liebig was partially correct; such a statement is not in accord with the facts. Liebig stated that fermentation was a mechanical phenomenon and that living agents were not concerned. According to Buchner's work, living yeast cells must form the zymase even though it may function away from the cells once it has been separated from them. No one has yet been able to synthesize an enzyme.

In modern times important investigations are being reported. These, of course, will need the perspective of time to show their merits. Chief among these are the researches of Neuberg and his collaborators, who have so greatly elucidated the chemistry of alcoholic fermentation.

EARLY WORK IN MEDICAL BACTERIOLOGY

In the earliest historical records, allusions to the possible relation of microscopic organisms to certain diseases are frequently found. It remained for investigators of the 19th century to supply the basis for knowledge which we now possess. There were few reasonable explanations for disease in early times, and one does not wonder that invisible microorganisms were suggested as a possible cause. Some of these early theories may be found in books, titles of which are given at the end of this chapter. Those by Robinson and Haggard are especially interesting. Some writers credit Geronimo Fracastorio (1484) as being the first to explain disease in accordance with present-day ideas. Kircher, as stated before, also seemed to have a clear conception of the relation of microorganisms to disease. Plenciz, an Austrian physician, proposed a germ theory of disease and even a separate organism for each disease, thus suggesting the specificity which we now recognize.

Robert Koch (1843-1910). Koch was a German trained in medicine. He started practice as a physician but became interested in the work of Pasteur since he had begun to doubt the miasmatic theory of disease causation. His publications on anthrax and staining procedures brought him into such prominence that he was called to the imperial health office in Berlin. Koch

soon brought other workers to his laboratory, all of whom became well known for discoveries in the etiology of disease. Besides the discoveries in this field, he was also interested in sterilization, disinfection, media, and staining, subjects which had to be studied before progress could be made in the field of applied bacteriology. One of the first things for which we may remember Koch was his introduction of liquefiable solid media into bacteriological technic. After development of such media, it became possible to isolate bacteria in pure cultures with greater certainty, making progress in medical bacteriology more rapid. Dilution in liquid media had

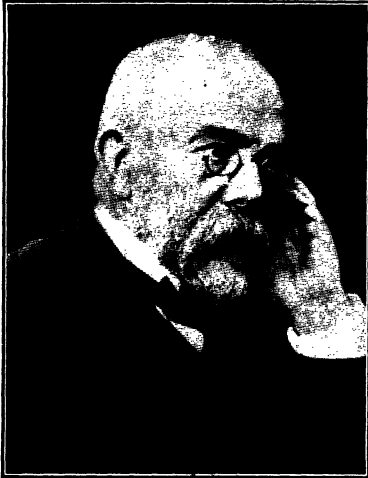

Louis Pasteur, 1822-1895.

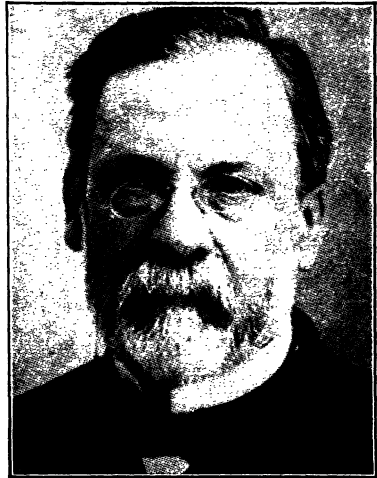

Robert Koch, 1843-1910.

FIG. 11. Two Famous Early Bacteriologists.

been used up to this time, with results that were somewhat uncertain. Books of the present day show the impetus which was given to studies in the causes of disease, for within seven years after this important advance in technic the etiology of many of our common diseases was solved. Some of these were investigated in Koch's laboratory. Koch also gave us what are termed Koch's postulates. They are discussed elsewhere in this book.

Koch is also known as the discoverer,²³ in 1882, of *Mycobacterium tuberculosis*. He described the preparation of tuberculin and believed that it would prevent tuberculosis. The paper in which this discovery was reported has been translated and printed in the English language.²³ His other interests and contributions were:

1876, first report on the etiology of anthrax.

²³ R. Koch, Die Aetiologie der Tuberkulose, *Berliner Klin, Wochschr.*, 19 (1882), 221. Also translated as the Etiology of Tuberculosis, by Robert Koch, published by National Tuberculosis Association, New York, 1932.

1878, first report on etiology of wound infections.

1882, use of gelatin as a liquefiable solid medium.

1882, discovery of *Mycobacterium tuberculosis*.

1883, work with Cholera Commission in Egypt.

Louis Pasteur (1822-1895). This French investigator made many fundamental discoveries in bacteriology and chemistry. Pasteur's first interest was in chemistry, but later his attention was directed to problems in microbiology and biochemistry. His first real contribution to science concerned molecular dissymmetry. He found that racemic modifications of tartaric acid could be resolved into dextrorotatory and levorotatory acids. He further found that the dextrorotatory tartaric acid could be fermented by microorganisms, and by this experiment he was probably introduced to the study of microorganisms.

Pasteur's next contribution concerned fermentation. He believed that it was a biological phenomenon induced by living cells (bacteria, yeasts, and the like) in opposition to the views of the great German dictator in chemistry of that day, Justus von Liebig. Pasteur studied the "diseases" of wine, vinegar, and beer, reporting that these abnormal fermentations could be stopped by heating the bottles to between 55° and 60°C., a process which later became known as pasteurization.

One of Pasteur's first triumphs was solution of the etiology of *pebrine*, a disease of silkworms which was causing havoc in the silk industry. Pasteur and his colleagues spent five or six years in a little laboratory near Alais in intensive research. Although he was reluctant at first to undertake the investigation, promptings on the part of his old teacher caused him to change his mind. Vallery-Radot and Duclaux have given good accounts of this work.^{24,25}

Success in the solution of the silkworm disease stimulated Pasteur to consider other diseases which were causing great losses in France. Anthrax was receiving much study in various places. Anthrax vaccine was prepared, and convincing demonstrations of its value were made. These are well described in the biographies of this great scientist.

In the field of human diseases Pasteur's work forms the solid foundation on which many of our present-day practices rest. He studied anthrax, confirming Koch's theory that the organism, *Bacillus anthracis* could be propagated for many generations under saprophytic conditions to cause the disease when introduced into a susceptible animal. Discovery of anthrax vaccine founded a method of combating disease which has been of great value. This discovery, although not accidental in the strict sense, was unexpected. Pasteur left his laboratory for a time and on returning found that cultures of the virus of chicken cholera had become sterile. They possessed protective powers, however, for, when they were injected into a chicken, this chicken was not susceptible to infection with a virus of known

²⁴ Louis Pasteur: His Life and Labors, by his son-in-law, translated by Lady Claude Hamilton, D. Appleton-Century, New York, 1923.

²⁵ E. Duclaux, Pasteur: the History of a Mind, translated by E. F. Smith and Florence Hodges, W. B. Saunders & Co., Philadelphia, 1920.

virulence. Later in a public demonstration he showed that he could protect sheep from anthrax by vaccination. The account of this in Pasteur's biographies is stimulating and clearly illustrates Pasteur's method of bringing controversies to a head. In numerous instances he offered to resort to demonstration to convince others of his discoveries.

To a student in the sciences Pasteur is a wholesome example.²⁴ He was a loyal son of France, and every discovery which he announced was looked upon as being done for "beloved France." He was profoundly religious and a true gentleman. Despite the fact that today he is revered in all lands as one of the greatest benefactors of the human race, and that he received the highest honors before his death, Pasteur had to defend many of his discoveries in controversies which became very bitter. Many of these heated arguments occurred before the Academy of Sciences where were gathered the most eminent men in France. One can understand the antagonism and criticism that might come from foreign countries, and how Pasteur would feel, but it is more difficult to understand that which came from colleagues in France.

Elie Metchnikoff (1845-1916). Metchnikoff was born in Russia and educated for life work in biology. One of his first contributions to biological literature was in 1865. After working in general biology for years, he became interested in pathology. Study in this field soon led him to propound what is spoken of today as his "theory of immunity," which is discussed later in this book. According to this theory, the white blood cells (*phagocytes*) defend the body against invading bacteria. Having proposed the theory, Metchnikoff had to spend considerable time in his later years defending it. He was connected for a time with a municipal bacteriological laboratory at Odessa. Conditions soon became so unfavorable that he looked for a new location where his researches could be continued in a more peaceful environment. Since Emmerich had attacked his theory of phagocytosis, Metchnikoff visited him at Munich but naturally decided not to locate there. He went on to Paris to visit the great Pasteur where he found a courteous and cordial reception. He requested permission of Pasteur to work in a honorary capacity in his laboratory; Pasteur's cordial welcome made a great impression on him and probably was the main factor in Metchnikoff's decision to settle in Paris. On his way back to Odessa from Paris, Metchnikoff called on Robert Koch to show him some specimens of phagocytosis. Koch gave him an indifferent reception and refused to accept his theory of immunity. In 1888 Metchnikoff arrived in Paris, where he spent the remainder of his life.

Besides his theory of immunity, he is known for his views on some of the causes of premature death. Knowing that one common disease of old age is hardening of the arteries (arteriosclerosis), Metchnikoff tried to reason its cause. He finally concluded that it was due to absorption of toxic products from protein metabolism in the intestines, a phenomenon which has become known as autointoxication. One way to stop this undesirable train of events, according to Metchnikoff, was to reduce intestinal putrefaction; he proposed ingestion of fermented milks for this purpose. Metchnikoff died in 1916, his last years being somewhat unhappy ones. He was depressed by

the World War which took away from the Pasteur Institute so many research workers. His grief was intensified as he heard of their deaths.

Joseph Lister (1827-1912). Lister is another of those pioneers who lived and worked during what may be called the "golden age" of bacteriology. Unlike Pasteur, he was trained in medicine. Lister's contributions were important. As an interne and hospital surgeon, he was impressed by the appalling mortality from infections in hospitals, just where such things should not occur. Hospitals in those days were quite different from those of today. Clean surgery, spoken of as aseptic surgery, was born in 1867. Lister's noteworthy contributions to bacteriology and medical science were related to wounds and operations. Pasteur had already demonstrated that bacteria were concerned with putrefaction and fermentation. Lister discussed these discoveries in relation to his own ideas as follows:

"Turning now to the question how the atmosphere produces decompositions of organic substances, we find that a flood of light has been thrown upon this most important subject by the philosophic researches of M. Pasteur, who has demonstrated by thoroughly convincing evidence that it is not to its oxygen or to any of its gaseous constituents that the air owes this property, but to minute particles suspended in it which are the germs of various low forms of life, long since revealed by the microscope, and regarded as merely accidental concomitants of putrescence, but now shown by Pasteur to be its essential cause, resolving the complex organic compounds into substances of simpler chemical constitution, just as the yeast plant converts sugar into alcohol and carbonic acid."

Pasteur's work thus suggested to Lister a cause for high mortality from wounds. He realized that effort must be made to prevent access of bacteria to such wounds and to destroy those which had gained entrance. For this purpose Lister employed phenol (carbolic acid) without knowing that Semmelweis and Lemaire,²⁶ and perhaps others, had used it before.

In order to appreciate fully the significance of Lister's work, one must know something of surgery in pre-Listerian times. When he was an interne in the University College Hospital, he had opportunity to observe at first hand the infections which followed surgery, childbirth, etc. The surgery of the day was in a pitiable condition. Hospitals of that time (1860) were seething beds of infection. The mortality was terrific, and every precaution taken to check it was to no avail. These attempts had to do mainly with improvements in hospital construction, ventilation, and the like. After careful study Lister was convinced that inflammations and the accompanying suppurations were caused by certain bacteria. If the bacteria could be eliminated, these terrible conditions would be prevented. As has been stated, the chemical with which Lister proposed to do this was phenol or carbolic acid; the actual material which he used was known as German creosote. With respect to one case, Lister wrote:

"There is one of my cases at the infirmary which I am sure will interest thee. It is one of compound fracture of the leg with a wound of consider-

²⁶ J. B. Hill, On "Carbolic Acid," Its Composition, Properties, Uses in Surgery, and as an Internal Remedy, *Am. J. Med. Sci.*, **64** (1874), 17.

able size and accompanied by great bruising and great effusion of blood into the substance of the limb, causing great swelling. Though hardly expecting success I tried the application of carbolic acid to the wound to prevent decomposition of the blood and so avoid the fearful mischief of suppuration throughout the limb.

"Well, it is now eight days since the accident, and the patient has been going on exactly as if there were no external wound—that is, as if the fracture were a simple one. His appetite, sleep, etc., good, and the limb daily diminishing in size, while there is no appearance whatever of any matter forming. Thus a most dangerous accident seems to have been entirely deprived of its dangerous element."

War surgery before 1850 was also in a terrible state. Many know of the incident in which Paré, when the Duke of Guise was struck with an arrow which buried its head in his face, put his foot on the subject's face and by sheer force pulled out the arrow. That was surgery in those days. Wounds were expected to fester and become putrid; the surgery of the day was mostly concerned with external injuries, etc. Very few attempts were made to explore the larger cavities of the body or to perform operations on the internal organs. With introduction of chloroform in 1850, operations increased, and consequently deaths from surgical fever also increased. One lay writer discussed the situation as follows:

"No newspaper would print a faithful description of the surgical wards of the pre-Listerian era. Horrible as the subject is, it is necessary to mention it in order to understand the true proportions of Lord Lister's achievement. What the modern surgeon calls a clean and sweet wound was all but unknown. From any wound, whether surgical or accidental, there was almost invariably a discharge of decomposing matter that frequently led on to gangrene and death. Because such conditions developed only where blood and tissue were exposed to the air, it was assumed that they were due to a contagion in the air; that the patients in a surgical ward poisoned not only each other but also the very rooms in which they lay. It was seriously proposed at one time that the hospitals of the future should be cheap and temporary buildings, which could be burned down as soon as the inmates had saturated them with poison.

"This was the state of the surgical wards, not a few centuries ago, but as recently as the early 1860's, when Lister first heard of Pasteur's great discovery that putrefaction was not due to contact with the air itself but to minute living organisms somewhat vaguely described as 'germs.'"

Before leaving the work of Lister, Semmelweis (1818-1865), who studied the causes of puerperal fever, should at least be mentioned. He used disinfectants in childbirth with satisfactory results. He preceded Lister by about 20 years.

Calmette (1863-1933). Albert Calmette, a great French bacteriologist,²⁷ was director of the Pasteur Institute at Lille during the first World War and later subdirector of the Pasteur Institute at Paris. Among his contributions

²⁷ N. Bernard and L. Negre, *Albert Calmette, sa vie, son oeuvre scientifique*, Masson et Cie., Paris, 1940.

to bacteriology were those on cobra venom, Chinese yeast, antirabic inoculation, and immunization against tuberculosis. His last years were concerned largely with tuberculosis which had become a scourge in France. He did much to rouse the world to many problems in public health.

Roux (1853-1933). Pierre Paul Emile Roux was another French bacteriologist who did much to conquer disease in the world. He was a colleague of Pasteur and spent many years of research with him. He started with Pasteur as a "preparateur" in 1878 in the Pasteur Institute and became its director in 1904, a position which he held until his death in 1933. Roux's name appears on many publications with Pasteur and Chamberland. His early investigations concerned anthrax and rabies. He is renowned, however, for discovery of the toxin of the diphtheria bacillus and the antitoxin which saved millions of lives. Roux was the last of the Pasteur school of bacteriologists to whom the world is greatly indebted. He was a frugal man and lived simply at the Pasteur Institute.

Edward Jenner (1749-1823). Jenner, another pioneer worker in preventive medicine, secured part of his training under the great surgeon, John Hunter. He had to travel a path of resistance which was just as severe as that traveled by a few other investigators who made significant contributions to science. Jenner was repeatedly threatened with death if he dared to practice the discoveries for which he is remembered. He heard of the tradition that milkmaids who contracted cowpox from the animals which they milked never had smallpox. He decided to investigate this rumor and, after convincing himself of its soundness, attempted artificial inoculation of a boy named James Phipp. This boy was later inoculated with active smallpox virus but did not take the disease. Jenner continued his work and published a number of contributions to the subject of vaccination. His ideas were soon taken up by many European students who secured the same satisfactory results. They were not, however, widely accepted by all classes of people. In his day, just as at the present time, some of those regarded as most intelligent fought vaccination.

BACTERIOLOGY OF SANITATION

Sanitation has been defined as the practical application of scientific knowledge to preservation of health or the act of securing healthful conditions. It has generally been thought of in connection with water and sewage but may be extended to any practical effort which results in destruction or control of the agents which cause disease. Clean water and disposal of domestic wastes have always been necessary in civilized states. The great epidemics of water-borne diseases which swept over Europe during the Middle Ages are attributable to neglect of personal and public hygiene. As the density of population has increased in certain sections, notably about London and Boston, it has become

necessary to treat water and sewage. Research institutions also, had to be founded where information could be collected on water and sewage treatment. Among the several institutions of this nature are the Lawrence Experiment Station at Lawrence, Mass.; the Illinois State Water Survey at Urbana, Ill., and the research laboratories of the Metropolitan Water Board, at London, England. Every intelligent citizen should be interested in the source of water and methods of sewage disposal for the community in which he lives.

The American Public Health Association has done much to stimulate study of methods for examination of water and sewage. Through some of its committees, this association has published "Standard Methods for the Examination of Water and Sewage," a revision of which appears about every 5 years.

Moses. The first sanitary code was established by the ancient Hebrews as outlined today in the books of Leviticus and Deuteronomy. The high priests served as health officers and sanitary inspectors. Moses may, therefore, be considered to be pioneer, indeed, in sanitation, as anyone will admit who reads certain chapters in early books of the Bible. He gave adequate advice on camp wastes. Leprosy was such a scourge among these ancient peoples that special attention was given to methods which would prevent it. Those who were infected with it were quarantined, and the houses in which they lived were either destroyed or thoroughly cleaned. Moses also gave strict orders about touching unclean objects and eating unclean foods, especially unclean meats. Especially interesting in these days of fungus infections such as "athlete's foot" were his mandates on preventing the spread of ringworm.

Pettenkofer (1818-1901). Max von Pettenkofer, trained under Liebig, was a professor of chemistry at the University of Munich. He is known today for several tests in biological chemistry. He did much to found the art of public hygiene and preached the gospel of water treatment, waste and sewage disposal, and ventilation. He had much to do with investigations of the cause of cholera in Hamburg and Altoona in 1882²⁸ and became thus one of the early epidemiologists.

Gorgas (1854-1920). William C. Gorgas is known today for his work in sanitation in Panama. It was this work which made the construction of the Panama Canal by the United States possible. The Isthmus of Panama had been such a hotbed of yellow fever that the French engineers had given up construction of a canal years before. Gorgas realized that, before the great engineering problems could be solved, the yellow-fever mosquito must be conquered. In five years he lowered the death rate from yellow fever from 8000 to 19. During the first World War he served as inspector of hospitals and sanitary conditions in the United States Army camps in France.

²⁸ E. E. Hume, Max von Pettenkofer, Paul B. Heober, New York, 1927.

Sedgwick (1855-1921). William Thompson Sedgwick was a biologist who became interested in bacteriology during a visit to European universities when Robert Koch was developing methods of culture and observation of bacteria. Sedgwick brought back Koch's methods to America and soon realized the importance of these small organisms in disease dissemination by various agents and foods. He became affiliated with the Massachusetts

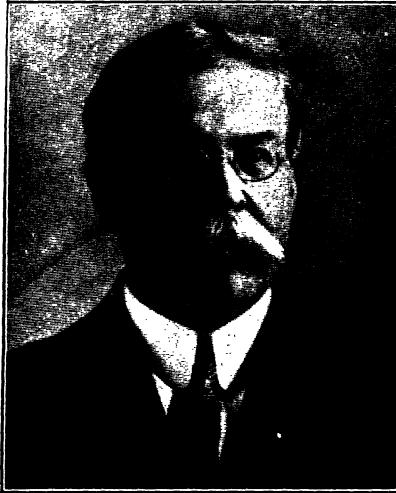

FIG. 12. William Thompson Sedgwick—Pioneer American Sanitarian and Teacher of Public Health.

State Board of Health and the Lawrence Experiment Station where many early problems of water purification and sewage treatment were studied. He laid the foundations of sanitary work in the United States, at least as far as its engineering and bacteriological aspects were concerned. His book, "Sanitary Science and the Public Health," has been an inspiration to many individuals who have prepared themselves for work in sanitation. Sedgwick made many contributions to literature and trained many young men who have made significant contributions to science.

ANIMAL PATHOLOGY VETERINARY BACTERIOLOGY

Diseases of animals and the organisms which cause them are the concern of veterinary bacteriologists. Many such diseases must be the concern of man because they are transmissible to him. Others are transmissible from man to animals. Veterinary bacteriologists have had a great part in stamping out bovine tuberculosis in cattle. This disease was a menace to human

beings and has been fought by eradication programs and by pasteurization of milk. Other diseases of cattle have now become problems, important among which are undulant fever and mastitis.

IMMUNITY AND SEROLOGY

Immunity and serology is another field of knowledge which has been developed largely by bacteriologists. *Immunity* is the term used to express exemption from diseases which certain individuals possess. The term is of broad import. In the type of special interest to bacteriologists and *immunologists*, the tissues and blood of the immune individual contain special agents called immune bodies, or antibodies, which destroy invading bacteria and, in some cases like diphtheria and tetanus, neutralize the toxins which they form. Serology is that branch of science which concerns sera, and especially so-called immune sera which are important in immunity. This branch of microbiology concerns the manufacture and use of vaccines, bacterins, antitoxins, and other preparations which are used to diagnose and to prevent and treat microbial diseases. Immunity and serology have been brought to their present position by the investigations of many bacteriologists among whom are Pasteur, Roux, Bordet, and Wells.

AGRICULTURAL BACTERIOLOGY

The intelligent farmer today is one who controls bacterial development; he prevents development of certain species under certain conditions and favors the development of others under other conditions. Centuries before it was known that hosts of minute microorganisms were active in soil, early farmers learned that certain practices gave greater crop yields. Today knowledge of the activity of bacteria explains them. One of the most important sections of agricultural bacteriology is that dealing with soil microbiology and soil fertility.

Soil Microbiology. Early knowledge on this subject was empirical and lacking in satisfactory explanation. Plinius²⁹ observed that greater crop yields were secured from plots on which legumes had been cultivated. Mention is made in Marshall's "Microbiology" of Columella's statement that Roman farmers knew of the benefits resulting from plowing under legumes to

²⁹ Plinius, *Historia Naturalis*, Book 8.

enrich the soil. Other writers have left records showing that the value of crop rotation was appreciated even in very early times. Centuries later Thær³⁰ suggested that plants took something from the air and left it in the soil. In 1881 Schultz-Lupitz showed that legumes contributed nitrogen to soil. Investigations to determine the reason revealed what we now know as symbiotic and non-symbiotic fixation of atmospheric nitrogen. Hellriegel and Wilfarth³¹ demonstrated that bacteria living in nodules on the roots of legumes could take nitrogen from the air and make it available to the plant. More definite information was published by Hellriegel in 1888. Nodules on leguminous plants had not gone unnoticed. Malpighi in 1687 had noticed them but considered them to be pathological conditions.

Beijerinck³² in 1888 reported the organism which fixed nitrogen symbiotically with legumes to be *Rhizobium leguminosarum*. The fixation of nitrogen without the intervention of symbiosis was also discovered. Winogradsky³³ isolated the organism *Clostridium pasteurianum*. Other organisms have since been found which will fix nitrogen nonsymbiotically. These belong to the genus *Azotobacter* and are discussed in a later chapter.

The subject of nitrification must also be mentioned in this connection. In 1878 Warington³⁴ showed that certain antiseptics such as chloroform and carbon bisulfide would prevent nitrification. He also stated that two steps were involved. However, it remained for Winogradsky³⁵ in 1890 to isolate the organisms which are concerned with this oxidation.

Winogradsky (1856-). Serge N. Winogradsky is a renowned bacteriologist of Russian parentage whose span of life has been long and whose contributions to literature have been many and valuable. He has been interested mainly in agricultural microbiology in its many phases. Among his early contributions to literature were results of investigations on bacteriology of nitrification, retting of flax, anaerobic bacteria, and many others.

³⁰ Thær, *Rationelle Landwirtschaft*, 1 Aufl. Vol. 1, 1809.

³¹ Hellriegel and Wilfarth, see *Lafar's Handbuch tech. Mykologie* (1904-1906), 3, 31.

³² Beijerinck, *Bot. Zeit.*, 46 (1888), 725.

³³ S. Winogradsky. Recherches sur l'assimilation de l'azote libre de l'atmosphère par les microbes, *Arch. des Sci., Biol.*, 3 (1895), 297-352.

³⁴ R. Warington, On Nitrification, *J. Chem. Soc.*, 33, pt. 1, 44-51. Papers also published in the volumes for several succeeding years.

³⁵ S. Winogradsky, Recherches sur les organismes de la nitrification, *Ann. Past. Inst.*, 4 (1890), 213-231, 257-275, 760-771.

Some of his early investigations were carried out with collaboration of Omelianski, another well-known agricultural bacteriologist. After the Russian Revolution following the first World War, Winogradsky moved to France to become director of the Division of Agricultural Microbiology of the Pasteur Institute in Paris. His work is carried on at a farm at Briec-Comte-Rovert, France. Winogradsky is one of the great men in agricultural bacteriology.

Beijerinck (1851-1931). Martinus Willem Beijerinck was a Dutch microbiologist whose name is great in literature and research. He was born in Amsterdam, the son of a tobacconist. He graduated from the Polytechnic

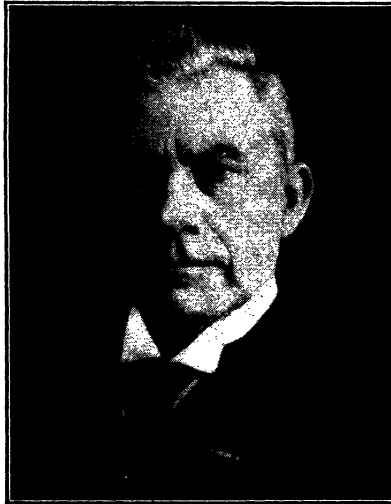

FIG. 13. Martinus Willem Beijerinck.

Institute at Delft as a chemical engineer and the next year accepted a post as lecturer on botany, physiology, and physics in the Agricultural School at Wasfflum. He took his doctor's degree in 1877 from the University of Leyden, his thesis being on the morphology of plant galls. He then went to Delft to work for a fermentation concern. In 1893 he became professor of bacteriology and in 1895 of microbiology at the Technische Hoogeschool in Delft where he spent the next 34 years of his life. What a place Delft has in the history of microbiology with such names as Leeuwenhoek, Beijerinck, and Kluver of today! Beijerinck had many interests in microbiology. He was the first to cultivate *Bacillus radicola* from root nodules of legumes and to discover and prove existence of viruses from blight of the tobacco plant. Beijerinck died in 1931, an honored and respected investigator.

Dairy Bacteriology. This division of the science is concerned with the relation of bacteria to milk and other dairy products. It

was among the first applications of the science to practical work. Conn at Wesleyan University, Middletown, Conn., and Russell at the University of Wisconsin were probably the first dairy bacteriologists in America. Publications of these men stimulated others to enter the field. Almost every agricultural experiment station in America today has a dairy bacteriologist; besides these individuals, numerous others are working in private dairy plants and in city and state departments of health. There are few nations in the world which have better and safer milk supplies and dairy products than America.



FIG. 14. Herbert William Conn. — Teacher of Microbiology and Pioneer Investigator in the Field of Dairy Microbiology.

Conn (1859–1917). Herbert William Conn was a great teacher and investigator in agricultural bacteriology. His early interests were in the field of dairy bacteriology, as well as relation of bacteria to soil fertility and crop production. When the first Agricultural Experiment Station was founded at Wesleyan University in Middletown, Conn., and later moved to Storrs by Wilbur Olin Atwater, Conn became interested in the bacteria which fixed

nitrogen symbiotically. In the field of dairy bacteriology, Conn studied the influence of microorganisms on flavor of dairy products. In his later years he was director of the laboratories of the Connecticut State Board of Health.

Plant Pathology. Plants like other living things are subject to infection by bacteria. Burrill established the relation of bacteria to plant diseases when in 1878 he stated that *Erwinia amylovora* was the cause of pear blight. Healthy trees, when inoculated with the material from diseased trees, were blighted. This work founded what we know today as plant pathology and was one of the first real attempts to relate bacteria to plant diseases. Since that time progress has been rapid, and this phase of the science has become an important one.

Burrill (1839–1916). Thomas Jonathan Burrill was an eminent American botanist, mycologist, and bacteriologist. He started his work in bacteriology at a time when everything was to be done and methods and apparatus were

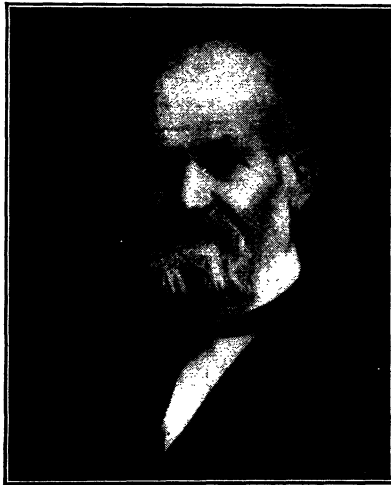

FIG. 15. Thomas Jonathan Burrill — Botanist and Plant Pathologist.

not developed as they are today. He is best known for discovery of the first bacterial disease of plants—blight of the pear tree. He isolated the causal organisms to which he gave the name *Micrococcus amylovorus*, later changed to *Erwinia amylovora*. He was able to reproduce the disease when this organism was placed on healthy stock. Burrill was a great teacher and lives on in the hearts of many students who attended the University of Illinois.

INDUSTRIAL AND FOOD MICROBIOLOGY

Although these applications of bacteriology received attention of some of the early bacteriologists, it is only recently that they have been singled out as special fields of study and research. Both of them may be said to have been founded by Pasteur.

Fermentations are usually thought of when industrial microbiology is mentioned. Pasteur did pioneer work when he studied alcohol and acetic acid fermentations and Hansen when he focused attention on yeasts. Since these, many others have been studied by bacteriologists—butyric acid, citric acid, butanol,

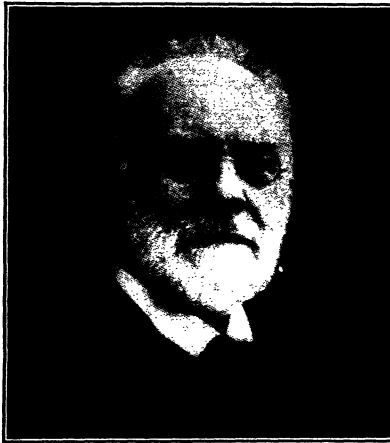

FIG. 16. Emil Christian Hansen. (*Photograph from Wahl Henius Institute*)

actone, lactic acid, penicillin. Microorganisms are important in industries concerning leather, paper, textiles, wood processing and decay, and disposal of wastes. There is scarcely an industry in which microorganisms are not of some significance in manufacture or deterioration.

In the food industries microorganisms are of great interest. They spoil such foods as sugars, canned foods, dried foods, and practically all kinds of fresh foods. In addition they render some foods poisonous. Presence of large numbers of microorganisms, or of certain species, is used as evidence of undesirable manufacturing conditions. Wars and economic emergencies increase problems of food microbiologists.

Scope of Microbiology. The term *microbiology* in the broad sense includes the study of all microorganisms such as bacteria, yeasts, molds, and algae. A microbiologist, then, is an individual who studies such microorganisms. *Bacteriology* is the study of bacteria, and a bacteriologist, therefore, would be one who studies bacteria. Giltner proposed the term "microbiology" as a term "relating to the biology of the small forms of life." This proposal has considerable merit. The term *microbe* in the French means microorganism and probably has somewhat the same meaning in English. *Germ* is a term probably synonymous with the term *bacterium*. All of these terms are used by writers for designating various microorganisms. The field of microbiology is then a broad one, and the term microbiologist is more fitting for the person who works with bacteria and related microorganisms than is the term bacteriologist.

The science of microbiology has developed so rapidly during recent years that, as was the case with other sciences, it is undergoing disintegration. For instance, the science of immunology has developed from pathogenic bacteriology. The emergencies incident to World War I stimulated the use of microorganisms in preparing chemicals which previously had been prepared by chemical methods. Examples are butyl alcohol, acetone, and glycerol. During World War II the fermentologists have developed tremendous production of the remarkable chemotherapeutic agent, *penicillin*, an antibiotic produced by certain molds. Other antibiotics are now under intensive investigation. Each microbial cell may be considered to be a small factory in which chemical changes may be brought about. Soil biologists have drawn the analogy between the nodules of legumes in which bacteria fix nitrogen for plants and the great chemical institutions wherein nitrogen is taken from the atmosphere and made into chemical compounds for industry and agriculture. And, while many bacteriologists are studying ways and means of increasing the usefulness of microorganisms, others are studying the multitude of vital chemical reactions within the cell which are incident to life. These studies have proved to be valuable in the fuller understanding of the metabolic functions of higher plants and animals. Microbiology indeed embraces many fields of human knowledge.

REFERENCES

- BULLOCH, W., History of Bacteriology, Chapter I in Vol. I, A System of Bacteriology, His Majesty's Stationery Office, London, 1930.
- BULLOCH, W., The History of Bacteriology, Oxford Univ. Press, London, 1938.
- BURKE, R. B., The Opus of Roger Bacon: a Translation, Univ. Pennsylvania Press, 1928.
- CAMAC, C. N. E., Epoch-Making Contributions to Surgery and the Allied Sciences, W. B. Saunders & Co., Philadelphia, 1909.
- CARPENTER, W. B., The Microscope and Its Revelations, 8th Edition, J. and A. Churchill, London, 1901.
- CUMSTON, C. G., The History of Medicine from the Time of the Pharaohs to the end of the Eighteenth Century, 1926.
- DANA, C. L., The Peaks of Medical History, Paul B. Hoeber, New York, 1926.
- DAREMBERG, C., Histoire des sciences médicales, Paris, 1870.
- DOBELL, C., Anthony van Leeuwenhoek and His Little Animals, Etc., Harcourt, Brace, New York, 1932.
- DUNGLISON, R., History of Medicine, Philadelphia, 1872.
- GAGE, S. H., The Microscope, Comstock Publishing Co., Ithaca, N. Y., 1920.
- GARRISON, F. H., An Introduction to the History of Medicine, 3d Edition, W. B. Saunders & Co., Philadelphia, 1917.
- HAGGARD, H. W., Devils, Drugs, and Doctors, Blue Ribbon Books, New York, 1929.
- HALE-WHITE, W., Harveian Oration on Gilbert, Baron, and Harvey, *Lancet*, **213** (1927), 847-53.
- HEISER, VICTOR, An American Doctor's Odyssey, W. W. Norton & Co., New York, 1936.
- HEMMETER, J. C., Master Minds in Medicine, Medical Life Press, New York, 1927.
- KELLY, H. A., American Medical Biographies, Norman Remington, Baltimore, 1920.
- KOCH, R., Biography in Annual Report of Smithsonian Institution, 1911, pp. 651-8.
- KOPELOFF, N., Man versus Microbes, Knopf, New York, 1930.
- DE KRUIF, P., The Microbe Hunters, Harcourt, Brace, New York, 1926.
- LIBBY, W., The History of Medicine, Houghton Mifflin, Boston, 1922.
- LOCY, W. A., Biology and Its Makers, Henry Holt, New York, 1915.
- METCHNIKOFF, OLGA, Life of Elie Metchnikoff, Houghton Mifflin, Boston, 1921.
- NEUBERGER, MAX, History of Medicine, Oxford Publications, 1910-25.
- OSLER, W., Evolution of Modern Medicine, Yale Univ. Press, 1921.
- PACKARD, F. A., History of Medicine in the United States, J. B. Lippincott, Philadelphia, 1901.
- PARK, R., Epitome of the History of Medicine, F. A. Davis Co., Philadelphia, 1901.
- PEATTIE, DONALD C., Green Laurels; The Lives and Achievements of the Great Naturalists, Simon and Schuster, New York, 1936.

- ROBINSON, V., *Pathfinders in Medicine*, Medical Review of Reviews Press, New York, 1912.
- SEELIG, M. G., *Medicine—An Historical Outline*, Williams & Wilkins Co., Baltimore, 1924.
- SINGER, C., *Proc. Roy. Soc. Med.* (section on History of Medicine), London, 7 (1913-14), 247-79.
- SMITH, E. F., and FLORENCE HEDGES, *Pasteur, the History of a Mind*, W. B. Saunders & Co., Philadelphia, 1920.
- TURNER, A. LOGAN, *Joseph Baron Lister: Centenary Volume, 1927-1928*, edited for the Lister Centenary Committee of the British Medical Association, Oliver and Boyd, Edinburgh, 1927.
- TRUDEAU, E. L., *An Autobiography*, Doubleday, Page, Garden City, N. Y., 1916.
- VALLERY-RADOT, R., *The Life of Pasteur*, Doubleday, Page, Garden City, N. Y., 1923.
- WITHINGTON, EDWARD T., *Medical History from the Earliest Times*, Scientific Press, London, 1894.

CHAPTER 2

SYSTEMATIC RELATIONSHIPS OF PLANT AND ANIMAL GROUPS

Scientists working with living organisms have found it desirable, if not necessary, to make classifications. Living things are divided into two kingdoms, plant and animal. These divisions are made mainly for convenience since sharp lines of demarcation may not be drawn between such groups. One may ask, "What is an animal or plant?" Such terms are used without much thought by laymen and some scientists. Perhaps they are terms that cannot be defined but can be better described at some length. In early times, when man applied the term plant to one group of living things and the word animal to another, there was little difficulty in using the terms. As knowledge accumulated, however, it soon became evident that there were intermediate forms which could be placed in neither group if all of their characteristics were considered. When the terms plant and animal were introduced it was an easy matter to distinguish a plant from an animal. Discovery of bacteria and other microorganisms, however, caused difficulty. In order to avoid confusion scientists attempt to systematize and group their data and information. Our forefathers in microbiology asked whether bacteria would be placed in the plant or animal kingdom. The question is not an important one on which to spend a great amount of space, but some profit will result if the student gives it a little thought. This thought will help to organize his information as a biologist.

Haeckel's Proposal. Haeckel, a German biologist, attempted to solve the difficulty by proposing a new kingdom to be called *Protista*. He suggested placing in it those microscopic and lower forms of life which are placed with difficulty in the two older kingdoms. This proposal involved the bacteria, yeasts, molds, algae, protozoa, and similar microorganisms. These organisms are intermediate between the animal and plant kingdoms and

possess characteristics and properties which seem to place them with either the plants or animals. Haeckel's proposal did not enjoy wide acceptance, and Haeckel himself, changing the limits of the group in some of his later writings, finally abandoned it. As far as helping to settle the arguments about the location of bacteria it would be of little value. It would probably increase confusion since scientists would then have to decide with regard to three kingdoms instead of two.

Are Bacteria Plants or Animals? The answer to this question is not especially significant. Whether the bacteria are considered to be plants or animals is optional as long as their fundamental characteristics are understood. Some bacteriologists class them with the animals, others with the plants. An algebraic sum of their characteristics would probably place them in the plant kingdom. The tendency to class them with plants is based largely on their ability to form spores and their chemosynthetic power. Bacteria are like some of the algae in several characteristics. Long believed that a very useful purpose is served by efforts to fit all living beings into one or the other class so far as the evolutionary point of view is maintained; attention is thus kept focused on the root of all biological problems. Finding few satisfactory data among either the morphological or physiological characteristics, Long found that the tubercle bacillus contained nucleic acids of the animal type but none of the plant type. If a line of demarcation between plants and animals must be drawn, it may pass through the bacteria. Part of them may be animal-like and part plant-like.

Characteristics of Plants and Animals. As previously stated, arrangement of living beings into groups called kingdoms is mainly for convenience and is, perhaps, the first separation in their classification. Characteristics for separating plants from animals are probably adequate for the more highly developed forms but quite inadequate for lower forms where there is overlapping in structure and function. Older zoologists recognized existence of forms of life intermediate between plants and animals. These were called *zoophytes* or plant-animals. They are now placed with the animals, even though they possess some plant characteristics. In any attempt to classify living organisms, intermediate forms may cause confusion. They are forms possessing characteristics of both groups which prevent placing them satisfactorily.

Interesting discussions of this subject may be found in books on general biology.

DISTINGUISHING CHARACTERISTICS OF THE TWO KINGDOMS

PLANTS

1. Storers of energy.
2. Plant cells have marked cell walls of cellulose.
3. Root hairs and stomata absorb water and gases; no digestion.
4. Motion of liquid in wall ducts; sugars descend in the walls of the inner bark.
5. Plants use carbon dioxide, and water and nitrates. Liberate oxygen. Organic matter built up. Chemosynthetic.
6. Well-developed vacuoles.
7. Nucleoproteins containing a pentose.
8. No sensory organs, and probably no nervous system.

ANIMALS

1. Liberators of energy.
2. Animal cells may be devoid of cell walls, or have walls slightly developed.
3. Have an alimentary canal in which digestion takes place.
4. Circulatory system of heart, blood, and blood vessels in vertebrates and certain invertebrates.
5. Metabolism: Animals use organic compounds; liberate carbon dioxide, water, and urea. Organic matter destroyed. Chemoanalytic.
6. Vacuoles absent or slightly developed.
7. Nucleoproteins containing hexose.
8. Sensory organs and nervous systems.

General Method of Arranging Living Organisms. The science of classification of living beings, whether plant or animal, is known as *taxonomy*. Only general phases of the question are to be considered here. This is necessary in order to give proper setting for a discussion of microorganisms.

The preceding discussion shows why living organisms are classified, but it does not tell how it is done. Whenever anything is classified, or arranged in some system, whether it be flies, trees, automobiles, bacteria, or horses, salient characteristics must be used. For instance, early bacteriologists used shape as the outstanding characteristic in the classification of bacteria. Three large groups were made, consisting of round cells, rod-shaped cells, and corkscrew-shaped cells. Each of these groups was subdivided with other characteristics. Finally, a general classification developed which was useful for known species and for

Phylum IV. SPERMATOPHYTA: the seed-bearing plants.

Subphylum 1. GYMNOSPERMAE: the cone-bearing plants, pines, hemlocks, etc.

Subphylum 2. ANGIOSPERMAE: flowering plants.

Class I. *Monocotyledons*: endogenous plants.

Class II. *Dicotyledons*: exogenous plants.

It should be noticed that plant taxonomists divide the plant world into four large groups or *phyla*.

PHYLUM 1. THALLOPHYTA. The members of this group are generally recognized to be the ancestors of modern more highly organized plants. Their morphology is simpler, and they do not possess such well-developed organs as do the latter. Many Thallophyta are single cells which are not well differentiated from one another. This makes them of interest to the microbiologist. Others are much more complex existing as masses of cells.

SUBPHYLUM I. ALGAE. Four groups are recognized, differentiated mainly by color, as indicated on page 40. Some members of this group are troublesome to man in various ways.

I. *Cyanophyceae* are single-celled forms or groups of single cells. Blue and yellow pigments along with green pigments give them various colors, depending on predominance of any one. *Cyanophyceae* reproduce by fission and produce cells which have been said to be spores. They have characteristics in common with bacteria, and it has been suggested that they are closely related as to evolution. Some species of *Cyanophyceae* are *Gleocapsa*, *Nostoc*, *Oscillatoria*, and *Rivularia*.

II. *Chlorophyceae* are the green algae and include many forms encountered by bacteriologists in water treatment especially. *Spirogyra*, one of the commonest, floats as a scum on the surface of fresh water. This species exists as filaments made up of cylindrical cells. When two filaments lie close together, a cell in one may fuse with a cell in another filament. The cell contents from one cell pass through a little tube into the other cell and fuse with it. The cells are called *gametes*, and the resulting cell, called a *zygote*, has a thick wall and is well endowed with ability to survive unfavorable conditions such as a long winter or drought. This is an example of a sexual phenomenon which is recognized in many small forms of life where it was once unknown.

III. *Phaeophyceae* are brown algae. They may grow to great size and in the ocean are known as brown seaweeds from which

valuable substances are obtained; among them, potassium salts, iodine, and others. In this group are *diatoms*, deposits of shells of which on the ocean floor are of considerable industrial importance. This material is known as "diatomaceous earth." It is used as a filtering medium and polishing agent.

IV. *Rhodophyceae* are red algae and again include species of considerable importance. They are generally marine forms. Agar-agar used as a solidifying agent for culture media by bacteriologists is prepared from the species *Gelidium*. This species grows in salt water near California and Japan.

SUBPHYLUM 2. FUNGI. These are simple plant forms. The group is an indefinite one including many different types of lower plants. It is especially characterized by the absence of chlorophyll, which presages some of the more important characteristics. Lack of chlorophyll prevents fungi from using the energy in sunlight. They must resort to chemical energy, or that produced by chemical decompositions; thus, in order to secure the energy which nature has stored up in such large molecules as sucrose (cane sugar), dextrose (grape sugar), the protein molecule, and the fat molecule, fungi have become known as analytic microorganisms in that they decompose great amounts of organic matter. Fungi are both parasitic and saprophytic. As stated previously, many of the fungi are thread forms, although this is by no means a constant characteristic. Each thread in the mycelium is called a *hypha* (plural *hyphae*). These hyphae may be segmented, or septate, or nonseptate. Reproduction takes place by means of spores.

I. *Schizomycetes, Bacteria*. These are organisms which are the subject of this entire book. Bacteria are widely distributed over the surface of the earth, but there are a few places where they are not present, probably because the conditions are not favorable for their development. Bacteria have been demonstrated to be present in mud at the bottom of the ocean under more than 2000 meters of water. The numbers and types were shown to be quite like those in garden soil. They have been shown to be in the air 13 miles above the surface of the earth as well as in air currents over the Arctic Circle. Bacteria are not limited in their places of existence as they were once believed to be.

Normal Habitat. Some bacteria are more commonly found in certain places than others. Such materials as milk and water

are said to possess a "normal flora" because certain species are likely to be found in them. The lactic-acid-producing bacteria, for instance, are commonly connected with milk and dairy products. Such groups of bacteria are often spoken of as the milk flora, water flora, soil flora, and so on. It is quite a difficult matter to distinguish the normal habitat from the temporary habitat for most of the common bacteria. However, with some of the uncommon species such as *Staphylococcus aureus*, or *Dialister pneumosintes*, a respiratory pathogen, the normal habitat is quite well known.

Temporary Habitat. In contrast to those species which are especially adapted to a certain environment and which one usually expects to find when this environment is examined bacteriologically, there are chance forms or temporary inhabitants. Bacteria are widely distributed and are present in or on most materials. It is not often easy to separate the temporary forms from the normal or regular forms.

Where not Found. Even though we have stated that bacteria are very widely distributed, yet there are some places where they are not usually present, as in the deep layers of the soil or in arid soils. This may be explained in different ways. It has often been stated that body fluids and tissues of healthy animals are sterile. Recent data, however, seem to indicate that bacteria may, at times, be found in tissues of animals which seem to be in good health. Petroleum geologists are also reporting the presence of bacteria in specimens of oil from hundreds of feet below the surface of the ground.

In the last few years results of investigations have been interpreted to indicate that bacteria may have remained in viable condition for hundreds of thousands of years inside rocks and coal deposits. Lipman, who proposed this, believed that the cells had remained in a dormant condition or in a state of "suspended animation" without any semblance of respiration. Such suggestions stimulate thought even though one is inclined to doubt their validity. More recent work on drying of yeast cells suggests that living cells might be able to survive conditions which were once believed to destroy them.

Role of Bacteria in Nature's Plan. A little thought will soon convince a student that nature is a very delicately equilibrated system. Each group of organisms seems to have a definite func-

tion and may be necessary for the existence or growth of other groups. Bacteria are very active, and a discussion of their metabolism will show that they form large amounts of metabolic products in proportion to body weight. The following processes may be mentioned as examples of the useful roles of bacteria in nature.

Putrefaction. Many complex substances such as proteins become useless and would be in the way were it not for the bacteria which split them into simpler substances. The carcasses of dead animals and plant structures, for instance, are attacked by bacteria and soon reduced to simple compounds. The chemical changes brought about by bacteria in putrefaction are discussed later.

Fermentation. This phenomenon is best known in connection with the preparation of fermented beverages. It has, however, a broader meaning since it may be involved in many important changes in nature. Much plant debris is fermented to soluble compounds which disappear. An unhappy condition would result on the face of the earth if this were to accumulate. Fermentation changes are usually a part of the carbon cycle since the compounds fermented are mainly carbon compounds.

Under these two headings may be mentioned most of the desirable chemical reactions which form the basis for the great microbiological industries. In many of them man has not introduced a new reaction but has merely given certain bacteria an opportunity to do in a much larger way what they do all the time in a small way.

Bacteria may play a role in furthering the normal development of animals and plants. Many experiments have been conducted to determine whether plant and animal life is possible without bacteria. This question is discussed in some detail later; it is mentioned here as a part of the idea that bacteria have an important role in the general scheme in nature.

II. Myxomycetes are forms of life claimed by both botanists and zoologists. When considered as simple animals they are called *Mycetozoa*. They have also been given the common name of *slime molds*, because they live on decaying vegetable matter. Their structure is quite indefinite and consists of a naked slimy protoplasm which is multinucleate. They are devoid of chloro-

phyll and are, therefore, unable to use energy in sunlight. They are plant-like in reproduction but animal-like in their nutrition. Food is ingested as by amoebae. Such forms as these illustrate the difficulties of sharply differentiating plants and animals.

III. Phycomycetes. These fungi are characterized by a cotton-like growth called a *mycelium* made up of individual filaments called *hyphae*. Phycomycetes possess the general characteristics of fungi, which have already been discussed. They are thread forms generally without cross walls (nonseptate) and consequently are frequently called algal fungi. Sexual phenomena are exhibited in this group in the formation of zygospores.

IV. Ascomycetes. This group of fungi includes the yeasts and molds, both of which are discussed in separate chapters in this book.

V. Basidiomycetes. These fungi are characterized by a *basidium* on which the spores are produced. They are larger fungi than those in some of the other groups. They are both parasitic and saprophytic. The edible fungi, mushrooms, as well as poisonous species, belong to this group.

Fungi Imperfecti. Fungi which lack well-defined fruiting bodies or reproductive organs have been designated as imperfect fungi or *Fungi Imperfecti*. They are so classed because of failure to demonstrate the presence of these organs. When these organs are demonstrated, the species may then be given its proper place in one of the other groups. Some of the imperfect fungi are *Oidium*, *Monilia*, *Endomyces*, *Torula*, and *Mycoderma*. It may be seen later that these organisms differ in characteristics. Some of them are discussed at different places later in this book. Although little may be known about the affinities of "fungi imperfecti," much may be known about their activities. Some of them play important roles in great industrial processes.

Higher Bacteria. All forms of life intergrade into one another. Sharp lines of demarcation between plants and animals do not exist, and, once definitions have been selected for such terms, many intergrading forms are encountered which have characteristics of both of these groups. In like manner, difficulty is encountered in establishing satisfactory limits for the group of organisms known as bacteria. On both sides of this group, contiguous forms exist which have characteristics like some of those of the true

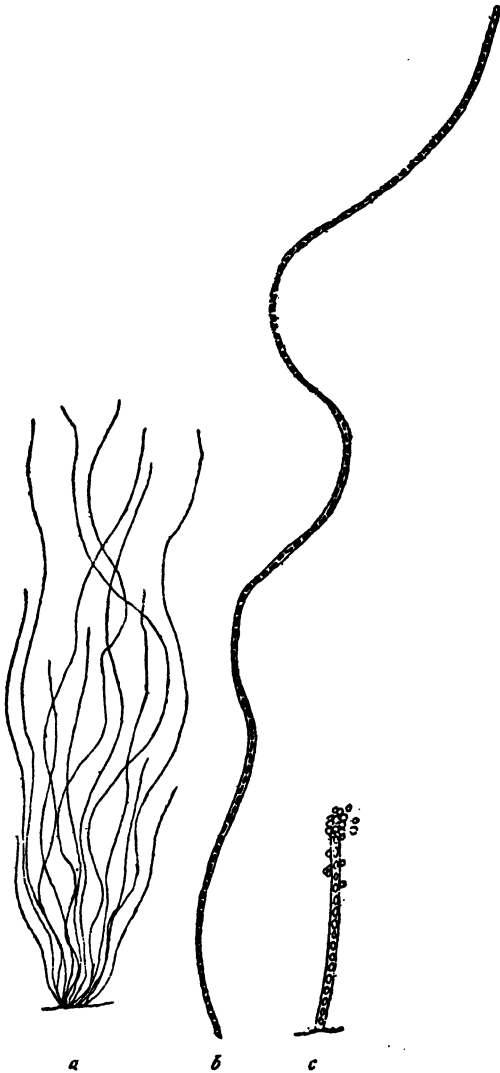

FIG. 17. *Leptothrix hyalina* (*Streptothrix hyalina*). (After Migula)

bacteria. On what may be called the upper or higher side of the true bacteria, we have the *higher bacteria*. These are forms of life midway between bacteria and higher forms, such as algae and

protozoa. Microorganisms which are called *higher bacteria* are in general filamentous and belong to several orders such as Spirochaetales, Myxobacteriales, Thiobacteriales, and Actinomycetales. Those just mentioned are characterized in Chapter 7. The higher bacteria are, then, intermediate between the true bacteria (Eubacteriales) and higher forms of life.

Shape. Higher bacteria may exist as single cells or in masses. They are usually composed of straight threads; branching is uncommon.

Reproduction. The species is reproduced either by spores from various cells in the thread or by special units formed by the cells at the tip of the thread. The latter are like conidia.

Sheath. Frequently the cells composing the thread are surrounded by a structure called a sheath. The cells exist in a sort of tube. Often some special compound is formed and deposited in the sheath as a reserve substance. This is the case with iron in *Crenothrix*. With the sulfur bacteria it is sulfur. Some of these forms which have special significance are mentioned later.

Streptothrix. These organisms have characteristics of both bacteria and molds. They reproduce by spore formation and have branching filaments. *Nocardia* is another name for this group.

Crenothrix. This fungus has branched filaments with no sulfur granules. It possesses a sheath in which cells may be seen to move about. This sheath is usually colored brown by the deposition of iron compounds. *Crenothrix* is usually found in iron-containing waters and may cause trouble in clogging water mains or imparting an undesirable appearance to drinking water.

Cladothrix. The filaments are branched and may also contain iron deposits. The best-known species is perhaps *Cladothrix dichotoma*. So-called swarm spores are formed by the opening of the sheath.

Lower Bacteria. On the other side of the true bacteria, living organisms may exist which are much smaller, probably too small to be seen by ordinary microscopes. They have been called *lower bacteria*. Much evidence has been accumulated to support their existence.



FIG. 18. *Crenothrix polyspora*.
(After Migula)

ANIMAL BIOLOGY

For convenience, distinctions are made between plant and animal biology. When basic fundamental facts are considered, such distinctions are artificial and unsound. Cellular activity and function, the only sound and reasonable bases on which to separate living organisms, are much the same for both groups.

Arrangement of Animal Forms. These may be arranged in several groups as is done with the plants.

Division I. PROTOZOA: unicellular animals.

Class I. *Rhizopoda*: animals with naked protoplasts and pseudopodia.

Class II. *Infusoria*: animals with cilia, flagella, or tentacles, and usually a mouth.

Class III. *Sporozoa*: parasitic animals, producing spores and having a metamorphosis.

Division II. METAZOA: many-celled animals with a differentiation of cells.

Phylum I. PORIFERA: animals with no distinct mouth, but many incurrent openings: the sponges.

Class I. *Calcarea*: with a skeleton of calcareous spicules.

Class II. *Noncalcarea*: with a skeleton of silicious or horny spicules, or none.

Phylum II. COELENTERATA: animals with a mouth, but without an anus and with no body cavity.

Class I. *Hydrozoa*.

Class II. *Syphozoa*: sea nettles.

Class III. *Actinozoa*: corals, anemones.

Class IV. *Ctenophora*.

Phylum III. ECHINODERMATA: radiate animals with complete alimentary canal and a body cavity.

Class I. *Asterioidea*: starfishes.

Class II. *Ophiuroidea*: brittle stars.

Class III. *Echinoidea*: sea urchins.

Class IV. *Crinoidea*: sea lilies.

Class V. *Holothuroidea*: sea cucumbers.

Phylum IV. PLATYHELMINTHES: flat unsegmented worms.

Class I. *Cestoda*: the tapeworms.

Class II. *Trematoda*: the flukes.

Class III. *Turbellaria*: the planarians.

Phylum V. NEMATHELMINTHES: round unsegmented worms: round worms, threadworms.

Phylum VI. MOLLUSCOIDEA.

- Class I. *Polyzoa*: sea mats, corallines.
- Class II. *Brachiopoda*: lamp shells.

Phylum VII. ANNULATA: the segmented worms.

- Class I. *Chaetopoda*: bristle-footed worms.
 - Subclass A. *Polychaeta*: with many bristles.
 - Subclass B. *Oligochaeta*: with few bristles.
- Class II. *Hirudinea*: leeches.
- Class III. *Archannelida*.
- Class IV. *Gephyrea*.
- Class V. *Chaetognatha*.

Phylum VIII. MOLLUSCA.

- Class I. *Pelecypoda* or *Lamellibranchia*; bivalves, clams, oysters, mussels.
- Class II. *Gasteropoda*: univalves, snails.
- Class III. *Amphineura*: many-valved: chiton.
- Class IV. *Cephalopoda*: with long arms: squids, cuttlefishes.

Phylum IX. ARTHROPODA: with jointed feet.

- Class I. *Crustacea*: crabs, lobsters, barnacles.
- Class II. *Onychophora*: centipedes.
- Class III. *Myriopoda*: millipedes.
- Class IV. *Hexapoda*: insects.
- Class V. *Arachnida*: spiders, scorpions, etc.

Phylum X. CHORDATA: animals with a notochord.

- Subphylum, ATRIOZOA: body cavity opening to the exterior.
 - Class I. *Urochorda*: tunicates or sea squirts.
 - Class II. *Cephalochorda*: amphioxus.
- Subphylum, VERTEBRATA: animals with a vertebral column.
 - Class I. *Pisces*: fishes.
 - Class II. *Amphibia*: frogs, toads, salamanders.
 - Class III. *Reptilia*: lizards, snakes, turtles, alligators.
 - Class IV. *Aves*: birds.
 - Class V. *Mammalia*: mammals.

REFERENCES

- BAITSELL, G. A., *Manual of Biology*, 6th Edition, Macmillan, New York, 1941.
- CONN, H. W., *Biology, An Introductory Study*, Silver, Burdett & Co., New York, 1912.
- GUYER, M. F., *Animal Biology*, 3d Edition, Harper, New York, 1941.
- GWYNNE-VAUGHAN, H. C., and B. BARNES, *The Structure and Development of the Fungi*, Macmillan, New York, 1927.
- HALDANE, J. B. S., and J. S. HUXLEY, *Animal Biology*, Oxford Univ. Press, New York, 1927.
- HUXLEY, J. S., *The Size of Living Things*, *Atlantic Monthly*, September 1929.

50 RELATIONSHIPS OF PLANT AND ANIMAL GROUPS

- LILLIE, R. S., *General Biology and Philosophy of Organism*, Univ. Chicago Press, 1945.
- LOCY, W. A., *The Story of Biology*, Garden City Publishing Co., New York, 1925.
- MARSLAND, DOUGLAS, *Principles of Modern Biology*, Henry Holt, New York, 1945.
- MCDUGALL, MARY S., and ROBERT HEGNER, *Biology: The Science of Life*, McGraw-Hill, New York, 1943.
- SCOTT, G. G., *The Science of Biology, an Introductory Study*, Thomas Y. Crowell, New York, 1930.
- THOMSON, J. A., *Biology for Every Man*, E. P. Dutton, New York, 1935.
- WELLS, H. G., J. S. HUXLEY, and G. P. WELLS, *The Science of Life*, 1-Vol. Edition, Literary Guild, New York, 1934.

CHAPTER 3

LIVING MATTER AND THE CELL

Microbiologists are fortunate in working with simple forms of life, single-celled organisms. Although their structure and functions are simpler, they are not to be considered primitive or set apart from higher forms. Some difficult problems of higher forms have been solved by investigations of single-celled organisms. Basic principles of metabolism were worked out with yeasts. Single-celled microorganisms are well suited to studies of structure and physiology for various reasons. They may be grown rapidly in large numbers and maintained in pure culture. They respond quickly to various stimuli in their environment. Metabolism of single-celled organisms is about as simple as possible. Some are able to use most elementary foods such as carbon dioxide, ammonia, and hydrogen sulfide. In view of this ability they have been suggested as the first forms of life on earth, and from them have developed, through the ages, the higher forms of life, including ourselves.

Life. This is the characteristic of living things which differentiates them from inanimate objects. Life is one of those words used by biologists without much attempt at definition. It does not need definition because it is all about us. We are alive. Bacteria, yeasts, and molds are living things. Possession of "life" gives a cell many interesting basic characteristics. How small may a cell be and still be alive? Is life related in any direct way to size? Will it ever be possible to make living matter in the laboratory? The difficulty of answering these questions is illustrated by the fact that biologists are not agreed on whether some forms such as bacteriophage and viruses are alive or not. Perhaps we are wrong in trying to believe that a sharp line exists between living and nonliving organisms.

BIOLOGY, BOTANY AND ZOOLOGY

Study of living things centers in the science of biology. The name comes from the Greek words *bios* meaning life and *logos*

meaning a speech. It is generally considered to be the science of life or of living things. For convenience biology is divided into *botany*, the plant sciences, and *zoology*, the animal sciences. Microbiology is the study of microscopic beings. Fundamental biological principles are the same whether they apply to single cells or to cells in multicellular animals.

In addition, there are a few other terms frequently used by biologists, most of which are from Greek words.

Morphology is the branch of biology which treats of form and structure of living beings. It starts with cellular morphology.

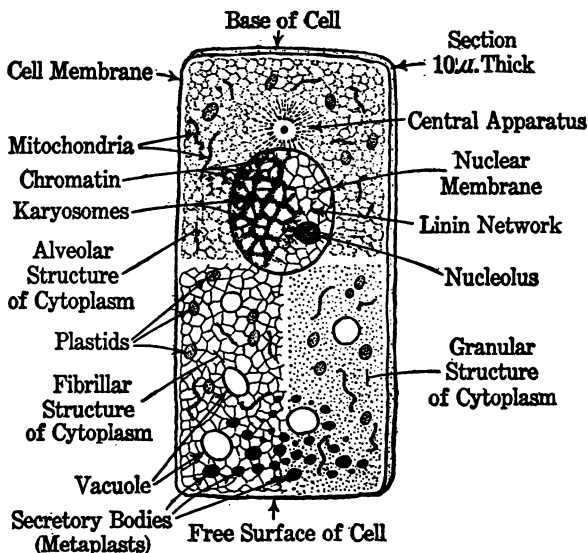

FIG. 19. Diagram of a Section of a Cell Illustrating General Morphology of Cells. (After Scott, *The Science of Biology*, Thos. Y. Crowell Co.)

Anatomy is the branch of morphology which treats of structure as determined by results of dissection. Specialized branches of anatomy are human anatomy, animal anatomy, and plant anatomy. It concerns specifically the internal organs of animals and plants.

Cytology. The branch of biology that treats of cells, their structure and function.

Physiology. The branch of biology which treats of vital phenomena of living beings such as respiration, fermentation, and other metabolic changes.

Pathology. The branch of medical science which treats of morbid conditions, their causes, symptoms, and nature. This involves a study of diseases and diseased tissue.

Taxonomy. The branch of biology which treats of classification and of orderly arrangement of living beings.

Size of Living Things. Smallness of size seems to be the most striking characteristic of microorganisms with which the bacteriologist works. To say, however, that microorganisms are very small means little. Basically, size is not an important function in biology. Scott stated that the giant redwood, Sequoia, is one of the tallest, largest and oldest of all living organisms, the largest and oldest specimen being "General Sherman," a tree in Sequoia National Park which is 280 feet high, 36.5 feet in diameter and nearly 4000 years old. In the animal kingdom, Scott mentioned the large size of the sulfur-bottom whale, specimens of which have been observed to be nearly 100 feet long and to weigh nearly 150 tons.

Volume-surface relationships are very important when macro- and microorganisms are contrasted. Many of the activities of microorganisms are explained by the fact that their surfaces are large in comparison to volume. The smaller the volume of an organism the greater will the surface be, relatively. The surface increases as the square of the diameter, the volume as its cube. A large surface means more rapid loss of heat, and consequently more food must be utilized.

History of Cell Theory. The cell, defined as a nucleus surrounded by protoplasm, is the basic unit of structure of living organisms. Although some early workers, when reporting their observations with the microscope, presented drawings containing structures which might be regarded as cells, Hooke, in 1665, is considered to be the first actually to report the "little boxes of cells distinguished from one another" in cork. The final argument for the existence of cells centers around the studies of two men, Schleiden and Schwann. They are generally regarded as the real founders of the cell theory although, according to Loey, studies of Schwann were more comprehensive. Loey believed that Schwann should have credit for the cell theory, for Schleiden merely assisted him in his work. Schleiden and Schwann placed great importance on the cell wall and believed it to be a necessary part of the cell. This idea, however, had to be given up when

cells without walls were discovered. Schwann and his colleague also explained the formation of new cells by a crystallization process and not by division. Hugo von Mohl and Nägeli showed that a new cell was formed from an old one and that cells originated only in this manner and not by crystallization.

Plant and Animal Cells. Distinctions between plant and animal cells, though often made on the basis of structure, are probably not definite. As has been stated elsewhere, early biologists recognized intermediate forms between plants and animals to which they gave the name *zoophytes*. This might indicate that the characteristics of plant and animal cells might also intergrade. However, some differences may be mentioned. Wilson stated that animal cells are generally characterized by slight development of the membrane; plant cells, on the other hand, show well-developed cell walls. He did not, however, consider this difference to be of much significance. Vacuoles are also much more prominent in the cells of higher plants. In animal cells they are absent or obscure. Plastids are found in plant cells, and centrosomes are absent.

PROTOPLASM

This term was coined by Hugo von Mohl in 1846 for the semi-fluid contents of plant cells. It is derived from the Greek *protos*—first, and *plasma*—formed substance. Before this, Dujardin, a French biologist, in 1838 had used the name “sarcode” for the material in living organisms. Not much was discovered by these investigators about the real character of this substance nor the similarity between animal and vegetable protoplasm. However, in 1861, Max Schultze proclaimed the similarity of protoplasm from different cells, and from this date more rapid progress was made in its study. Today we know that all protoplasm, regardless of the cells from which it comes, is quite alike. It has the same appearance and to a great extent the same properties.

The term protoplasm was sufficiently definite for the time when it was first introduced. However, as knowledge grew and more facts were discovered about the structure of the cell, the term lost its significance, and others were introduced. The term *karyoplasm*, for instance, was introduced for the material within the

nucleus and *cytoplasm* for the material outside of the nucleus. *Nucleoplasm* is also used for the substance in the nucleus.

Chemistry of Protoplasm. Protoplasm is not a chemical compound but a mixture of compounds. The type and concentration of these compounds consequently varies. Besides the chemical compounds which may be considered normal, there may be transitory compounds such as food material and various products of its metabolism in the cell. Certain chemical substances in the cell, reserve products such as sulfur, iron, and fat, may also be present. Their amounts are determined by the conditions under which the cell is propagated. Where there is plenty of food the maximum concentration of various constituents might be expected, whereas under conditions of starvation they might be exhausted. A dozen elements may be found; a few others are present at times. We might also point out that chemical examinations of living matter are difficult to interpret.

One of the outstanding characteristics of protoplasm is its water content. Although the water content of different types of protoplasm may vary, the limits of variation are not wide. Water plays an important role in maintaining turgidity of the cell, carrying in food, and removing waste products.

Salts are present in protoplasm. Larson, who worked with bacteria, reported two kinds of salts—*fixed* salts and *free* salts. The former were bound with the cell tissue whereas the latter could be removed by water. The salts along with the water probably maintain the proper osmotic pressure.

Protoplasm is also said to be in the colloidal state or to contain substances in this state. Findlay stated that 90 per cent of the organic matter of cells and tissues of the human body is made up of colloids. The term *colloid* was introduced by an English physicist, Graham, and applied to substances which would not diffuse through a parchment. Substances which would diffuse through such membranes were called *crystalloids*. Thus Graham recognized two states of matter rather sharply separated. Today the line of demarcation has become less distinct, and the terms denote only different states of matter.

Structure of Proteins. Much of the solid material in protoplasm is protein. Proteins are very complex chemical compounds built up from certain other chemical compounds called *amino acids*. Amino acids as the name indicates are organic acids with

an $-\text{NH}_2$ (amine) group. Acetic acid is a simple organic acid. One of the hydrogen atoms may be replaced by an $-\text{NH}_2$ group giving aminoacetic acid or glycine, the simplest amino acid.

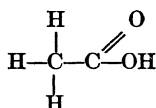

Acetic acid

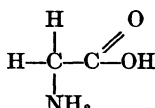

Aminoacetic acid or glycine

There are at least 38 known amino acids, all of which may be combined to form the proteins. A type of union may be shown by letting two molecules of aminoacetic acid react and become united as they would if starting to make a protein. The hydroxyl (OH) group of one molecule reacts with a hydrogen (H) of the amine group of the other molecule to form water (H_2O). This then unites these two amino acids as follows:

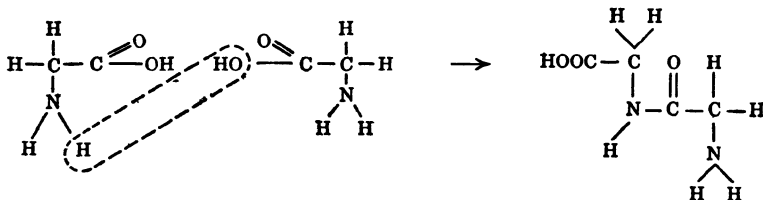

This gives what is known as a dipeptide. When several amino acids are thus linked, they form compounds known as polypeptides. Proteins are very complex polypeptides. The possibilities of complexity may be realized from the fact that the many amino acids may be linked a number of ways.

General Properties of Protoplasm. The properties of protoplasm are those qualities which distinguish living from dead matter.

Movement. Two kinds of movement are recognized in protoplasm. One is a real translocation of the cell, and the other is known as streaming of the granules in the protoplasm. These granules may be seen to move about the cell.

Irritability. This characteristic is well shown by the fact that many agents are known to affect protoplasm. Heat, cold, chemicals, and such all have decided influence. Heat is more harmful than cold. The characteristic of irritability forms the basis for many methods of controlling microorganisms.

Reproduction. Ability of protoplasm to reproduce itself and grow is its outstanding property. Chemists are able to go far towards synthesizing compounds which are found in proteins and may sometime be able to synthesize a typical protein. However, they have not been able to endow any of these complex compounds with *life*.

Metabolism. This is the energy-yielding process and is therefore an important characteristic of living protoplasm. It is essential to life because energy is required for all cell activities. Metabolism is generally considered to consist of *anabolism* by which food materials are built into cell protoplasm and *catabolism* by which cell protoplasm is resolved into waste materials.

Death. This is indeed the final characteristic of protoplasm. The term death is quite difficult to define. One dictionary defines it as "cessation of life." Such a definition is not very satisfactory since definition of the term life is just as elusive. Some biologists state that protoplasm never dies. They claim that, since reproduction involves the division of cells, life is continuous. It is difficult to discuss and define death since it is equally difficult to define life. Lepeschkin has stated that life represents a sum of physiological phenomena which may be observed not only with the whole organism but also with each cell that composes it. Death of multicellular organisms must proceed by degrees because not all cells die at the same moment. Even with single cells, death may be a somewhat progressive phenomenon. Death is known to be concerned with alterations in chemical and physical structure of living matter. Relatively recent developments in the field of colloids give an opportunity for partial explanation, perhaps, for the causes of death. The colloid structure of living matter is changed by death.

MORPHOLOGY OF CELLS

Each cell may contain a number of specific parts called organs. Some of these will be described briefly. Cells differ in size and shape. Some bacterial cells are known which are about 0.2 micron in diameter, whereas others and some yeast cells are many times larger. Size is indeed a variable characteristic.

The Cell Wall. The cell wall is not a necessary structure since some cells are known to be devoid of walls. The wall is probably a protective organ, and it may influence many activities of the

cell. Its chemical composition varies greatly. There are probably two layers on most cells. The outer may assume a thicker sticky consistency to form what is known as the capsule. Some cells are enclosed in a sheath.

Cytoplasm. What we have said about protoplasm may also be applied to cytoplasm. The constitution of the cytoplasm has received much study. Several theories obtain for explaining its structure.

1. *The Filar Theory.* According to this theory the cytoplasm is full of threads embedded in a ground substance.

2. *The Reticular Theory.* This theory is that the threads in the cytoplasm, indicated by the filar theory, are connected end to end.

3. *The Alveolar Theory.* This theory holds that the protoplasm of the cell is filled with droplets giving the appearance of an emulsion.

4. *The Granular Theory.* According to this theory the ground substance is filled with granules.

Wilson, probably the greatest authority on cell structure, claims that cell substance is homogeneous in its first state. Later filar, globular, and granular structures may appear.

The Cell Nucleus. This is an important organ in the cell. The substance in the nucleus, *karyoplasm*, is distinguishable from the cytoplasm by its greater coagulability in some acids. Consequently these acids are used for the demonstration of the nucleus.

The nucleus contains a liquid in which are found *chromatin* and *achromatin*. The chromatin is one of the most important parts of the cell. The *nucleolus* is also contained in the nucleus. About the nucleus is a membrane.

Shape of the Nucleus. The nucleus has different shapes in different cells. In some cells the entire contents seem to be made up of nucleoplasm. In other cells the nucleus is diffused throughout the cell. Cells of higher animals have more complex nuclei.

Role of the Nucleus. One of the important roles of the nucleus is in cell division. It probably carries the hereditary factors of the cell to progeny. The nucleus also functions in regeneration of tissue. When certain protozoan cells are divided into two parts, only that part which contains the nucleus can regenerate itself.

This suggests the question whether an anucleate cell can exist. After knowing the importance of the nucleus in cell activities, one is almost compelled to answer the question negatively. This question is discussed again under cytology of the bacterial cell.

Centrosome. This is a small body in the protoplasm. For some time, on account of its minute size, it was overlooked. As is briefly discussed later in this chapter, the centrosome plays an important role in cell multiplication.

Vacuoles. These are pockets or vesicles in the cytoplasm filled with liquids. They seem to function in regulating the water content of the cell.

Organs of Locomotion. Many unicellular organisms possess organs of locomotion with which they move from place to place. Some cells, however, are able to move without them since they resort to a corkscrew-like motion or a snake motion. Other cells are able to produce an oscillatory motion. Then, in some protozoa there are the pseudopodia for motion. The most characteristic organs for locomotion however, is the *flagellum* or the *cilium*. Flagella are whip-like appendages on the cell which are lashed back and forth in the medium. Cilia have a similar structure and function but exist in greater numbers, covering most of the cell.

Organs in the Cell. Besides the organs which have just been mentioned are others which interest students of cytology. Plastids are found especially in plant cells. They vary in shape, size, and number, and are believed to be synthetic in function. Wilson stated that they were areas of specific chemical transformation producing characteristic products such as starch, fat, and chlorophyll. The different plastids have been named from the products which they are supposed to make. Amyloplastids make starch, chloroplastids make chlorophyll, etc. Granules of different kinds are also found in cells. Metachromatic granules are found; their purpose has been the subject of much discussion.

MULTIPLICATION OF CELLS

All cells reproduce or multiply by division. There is no other method. Spore production is looked on by some as a means of reproduction.

Direct Division. This is also referred to as *amitosis*. It is simpler than mitosis since only one cell is involved—the one

which is about to divide. The division of the cell is preceded by a division of the nucleus. The nucleus changes shape—usually elongates; a constriction appears which finally results in two

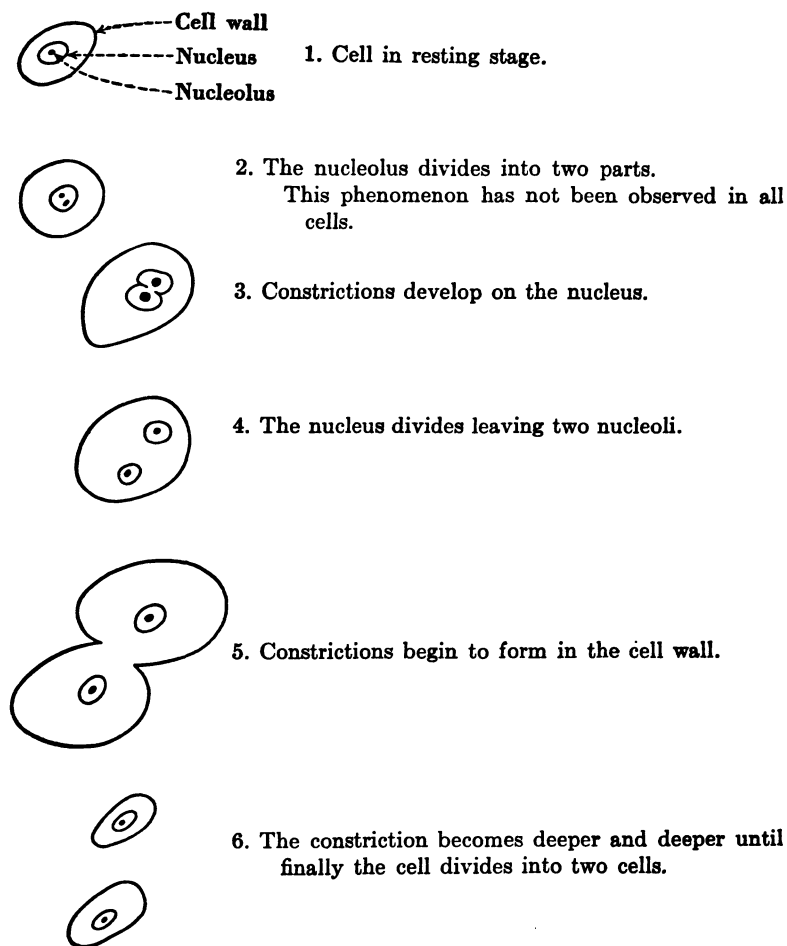

FIG. 20. Showing the Various Steps in Amitosis.

nuclei being formed. These separate, and a constriction appears in the cell. This progresses until the cell divides into two cells each of which has a nucleus. The process may be shown schematically by Fig. 20.

Indirect Division. This is also called *karyokinesis* or *mitosis*. It is more complicated than direct division which has just been discussed. Metcalf devised a very useful chart showing the several stages in mitosis. This is reproduced in Fig. 21. Metcalf discussed the chart as follows:

The process of cell division is represented as a cycle. The cycle is represented by five phases; each phase, excepting the prophase, is represented by stages intended to show an early stage and a late stage.

The prophase *P* is limited to the resting (mitotically speaking) nucleus; enclosed in a nuclear membrane with its chromatin material in the form of granules as usually described; with a large nucleolus; and a centrosphere containing two centrosomes. Emphasis is always placed on the facts that,

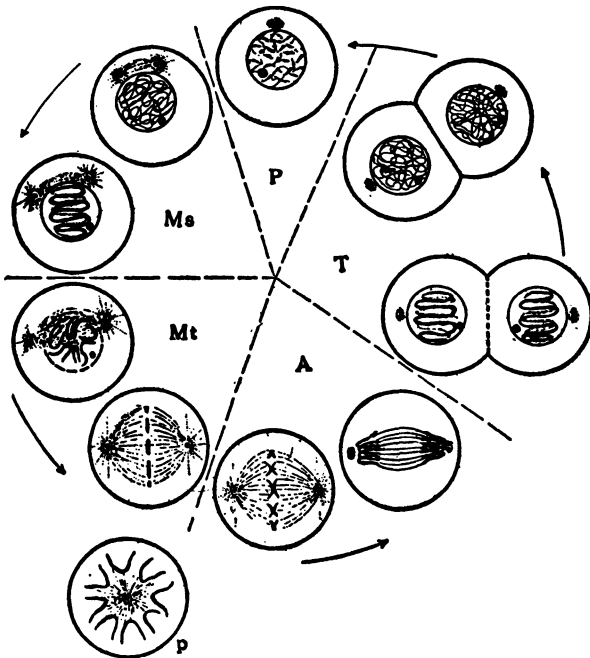

FIG. 21. Showing the Various Steps in Mitosis. (After Metcalf, 1924)

See text for discussion.

although we speak of this as a resting nucleus, we are speaking mitotically; metabolically this is the active phase of the cell, as far as the life of the cell is concerned it is a very long period, and further it is really the end of the cell's existence as a cell and not its beginning.

The term mesophase *Ms* is introduced to designate that phase of the process of mitosis described as spireme-thread formation. The other char-

acteristic feature in this phase is that the centrosomes have commenced to separate. The mesophase is divided into two stages. In the first stage the spireme thread is long, slender, and much coiled. In the second stage the thread has shortened and thickened and has been thrown into a definite number of loops, each loop corresponding to a future chromosome.

The metaphase *Mt* is characterized by the chromosomes. The chromosomes are represented as the broken loops of the short-looped spireme thread. Another character is the disappearance of the nuclear membrane. In the first stage the chromosomes are represented as being scattered in the cell, whereas the centrosomes are about 90° from each other. In the second stage the centrosomes have reached their polar positions, 180° from each other, and the chromosomes have arranged themselves at the equator. Both equatorial and polar views *p* of this stage are shown for the sake of clearness. Attention is usually called to the disappearance of the nucleolus during this stage. Mitosis may be said to have reached its climax with this stage, and all the rest of the process may be described as a process of reconstruction of the chromatin material.

The anaphase *A* means that time during mitosis when there are daughter chromosomes in the cell. It starts with the first indications of the splitting of the chromosomes and ends with them arranged at the poles. The first stage shows the beginning of the splitting, and the second stage shows the chromosomes pulled to the poles and the division of the cytoplasm started. The centrosomes have usually divided by this time in preparation for the next mitosis, and the nucleolus has usually reappeared.

The telophase *T* may be described as the daughter spireme phase. In the first stage we have short thick-looped daughter spireme threads formed apparently by the growing together of the ends of the looped chromosomes. This stage is exactly comparable with the second stage of the mesophase, save that we are now "back-tracking" and have daughter spireme threads instead of a single thread. The nuclear membrane has reformed, and the cytoplasmic division is usually complete. In the second stage we have long daughter spireme threads which are comparable to the first stage of the mesophase, and the interesting process of mitosis is all but finished, for there remains but a single step, the transformation of the thread into scattered granules, and we are back with daughter prophase stages ready to start the whole process over again. Although in the minds of the older students who have learned the old nomenclature we may appear to add to the confusion by introducing new terms and limiting old terms in a new way, and to have simply run round in a circle and arrived nowhere, yet my experience with beginning students leads me to believe that there is some merit in this explanation.

Sexual Phenomena. These occur in many cells although some are said to be devoid of them. They have been recently re-emphasized for the bacteria. In microorganisms such as yeasts, among which they have been especially studied, cell fusion results in a revivification of the cell as shown by more rapid

reproduction or spore formation. Guilliermond has done much to elucidate sexual phenomena among the yeasts. The two units which are involved are spoken of as *gametes*; a copulatory canal is formed between the two gametes through which the contents of one cell is poured into the other. The male gamete is smaller usually than the female gamete and pours its contents into the female gamete. When the gametes are equal in size, the process is spoken of as *isogamy*; when unequal, *heterogamy*. Involved in these sexual unions are the usual nuclear changes so well known for the larger single-celled organisms such as the protozoa.

REFERENCES

- GUILLIERMOND, A., Elements of Microbial Cytology, in Marshall's Microbiology, P. Blakiston's Son & Co., Philadelphia, 1921.
- GUILLIERMOND, A., The Cytoplasm of the Plant Cell, translated by L. R. Atkinson, Chronica Botanica Co., Waltham, Mass., 1941.
- GUYER, M. F., Animal Biology, Revised Edition, Harper, 1941.
- HERTWIG, R., A Manual of Zoology, translated by J. S. Kingsley, Henry Holt, New York, 1930.
- HYLANDER, C. J., The World of Plant Life, Macmillan, New York, 1939.
- KNAYSI, G., Elements of Bacterial Cytology, Comstock Publishing Co., Ithaca, N. Y., 1944.
- SCOTT, G. C., The Science of Biology, an Introductory Study, Thomas Y. Crowell, New York, 1930.
- SHARP, L. W., An Introduction to Cytology, McGraw-Hill, New York, 1934.
- SHIPLEY, A. E., Life, a Book for Elementary Students, Cambridge Univ. Press, 1923.
- THATCHER, R. W. The Physical Chemistry of Protoplasm, Chapter XVI, The Chemistry of Plant Life, McGraw-Hill, New York, 1921.
- WILSON, E. B., The Cell in Development and Heredity, 3d Edition, Macmillan, New York, 1925.
- WOODRUFF, L. L., Foundations of Biology, 6th Edition, Macmillan, New York, 1941.

CHAPTER 4

ULTRAMICROSCOPIC FORMS OF LIFE

These are forms of life which are invisible under the optical microscope. Their structure is consequently unknown, and they are known more by what they do than by what they are. This situation need not worry one because many of the finest things in life cannot be seen. We can only see their results. More is involved when filterability is considered than mere relative sizes of the particles to be filtered and sizes of the pores in the filters. Before the bacteria recognized today as the agents of the many diseases, whose etiology is known, were discovered, predictions were made that a world of microorganisms must exist which could not be seen with the naked eye. Perfection of the microscope and experiments proved this statement to be true. Now we are in about the same position with respect to other diseases in which the microscope has not helped. Although the electron microscope may help us to see these smaller agents, they are still "viruses" to us.

Filters and Filtration. Various kinds of filters and membranes are used. Those of porcelain or diatomaceous earth were used in early work, followed by those made of collodion. The latter were prepared with varying sizes of pores so that it has been possible to secure better information on size of virus particles. Whether particles pass through filters or not depends on other factors than size. The electric charge on the particle and on the particles of matter used for making the filter is important. The type of filter therefore is very important whether it is made of plaster of Paris, diatomaceous earth, or several other materials. The dye Victoria blue, for instance, will not pass through a Berkefeld filter, whereas Congo red, and acid dye, will. Filterability or nonfilterability of bacteria or viruses depends therefore on electric charges on the particles filtered as well as on the filter itself. When the charges are the same, no absorption of the entities filtered occurs, and they pass through. The same results would

be expected if anything is added to the filters which neutralizes their natural charges. In view of these facts, we are forced to realize that size is not the only factor which determines filterability and that electric charges must be considered and perhaps other factors which are not yet known.

FILTERABLE FORMS OF BACTERIA

These are entities in the life cycles of bacteria which pass through very carefully made filters. Although they are generally admitted to be formed by bacteria today, their existence was denied by earlier bacteriologists. Just how they may be related to filterable viruses is not known. Perhaps the two are identical, confusion being caused by multiplicity of names. Filterable viruses might be filterable forms of microorganisms which have a well-known organized stage.

Filterability is also related to age of the culture. One investigator observed that an old culture of *Serratia marcescens* would pass through a filter which was impermeable to a young culture. The nature of the fluid medium in which the cells were also influenced the results. When in certain media filter-passing bodies are demonstrated; when in other media they are not. Filterable forms have been reported for *Mycobacterium tuberculosis* and *Eberthella typhosa*.

BACTERIOPHAGE BACTERIAL VIRUSES

An agent with interesting characteristics was discovered in 1917 by d' Herelle following investigation by others which suggested its existence. It disintegrated bacterial cells in broth and on agar culture media and was believed to be a living entity. It is therefore a virus which attacks bacteria. Its action in liquid culture media was evidenced by clearing of turbid suspensions of bacterial cells or by appearance of clear areas on agar plates heavily seeded with bacteria. One writer said that the phenomenon of bacteriophagy is spectacular. One sees a turbid culture representing several hours' growth suddenly clear and become sterile. A minute amount of the cleared culture when added to a fresh turbid culture of bacterial cells in broth induces the same train of events. In view of these observations d'Herelle believed that bacteriophage was a living agent to which he gave the name

Bacteriophagum intestinale. It was believed to parasitize bacteria just as the bacteria parasitized higher organisms. Other investigators did not agree, and about every possible theory as to its nature has been held at one time or another.

Just what is involved when the cultures clear may not be known. The process is spoken of as *lysis* or *lytic action*. Lysis



FIG. 22. T_2 Bacteriophage for *Escherichia coli*. Magnification 42,700 \times . (Courtesy of Sharp, Taylor, Hook and Beard, 1946)

consists of actual cellular disruption and hydrolytic cleavage of bacterial proteins in some cases. Some bacterial cells have been reported to swell and finally burst, leaving granular debris. The actual process is probably not known. The electron microscope is revealing some information. Within a few minutes following addition of bacteriophage to a culture of bacteria in which it will act, the bacteriophage particles have adhered to the bacterial cells, and some penetrate the cell. This is followed by swelling and loss of opacity. The cell finally ruptures and appears as an empty cell case referred to by some as a ghost cell.

"Species" or Types of Bacteriophage. The fact that bacteriophage which will lyse (attack and disintegrate) one bacterium will not lyse another species has prompted some to believe that different types of bacteriophage exist. These types might be considered to be comparable to species among higher organisms.

Even the strains or types of bacteriophage which attack one species of bacteria act differently on various strains.

General Properties of Bacteriophage. Physical agents affect phage in about the same way that they do living microorganisms. This further suggests the living nature of phage. Phage is particulate in nature because it grows as separate units and form plaques. These are very small, ranging in size similar to virus particles, from 15 to 80 millimicrons or so in diameter.

Since development of the electron microscope, which permits much greater magnification than optical microscopes, attempts have been made to see bacteriophage particles. The particles of one type have been shown to be tadpole-shaped whereas those of another are devoid of the tail. Apparently, the same variation occurs in bacteriophage particles that occurs in all forms of life.

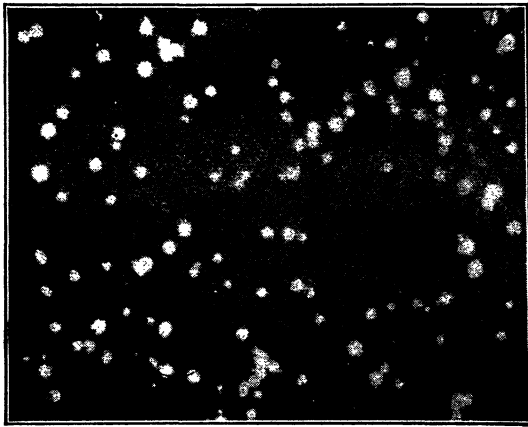

FIG. 23. Showing Clear Plaques Due to Action of Bacterial Virus (Bacteriophage). (Courtesy of Bronfenbrenner, after Muckenfuss)

Technic of Studying Bacteriophage. It is not difficult to prepare cultures of bacteriophage because they are widely spread in nature. Sewage has been found to be an especially good source. A little sewage is added to a culture of bacterium for which a bacteriophage is desired and the mixture incubated, after which it is filtered through a special filter. This filtrate, in which no living microorganism can be demonstrated, will lyse further cultures even when added in small amounts. This does not indicate that the phage is pure. Further work is necessary.

The technic for this resembles that used for preparation of pure cultures of bacteria, since it is virtually a plating technic. It also makes possible quantitative enumeration of phage particles. Known dilutions of the phage filtrate may be spread over the surface of bacterial growth in a Petri dish. Clear areas, called *plaques*, will appear where a phage particle existed and developed. These clear areas are caused by lytic action of the phage on cells of bacteria near it.

Bacteriophage is apparently a protein of high molecular weight; one bacteriophage for *Staphylococcus* is believed to have a molecular weight of 300,000,000.

Since bacteriophage is destructive to microbial cells, there were early suggestions that it could be used for destruction of microorganisms causing disease in animals. Many attempts were made to do this, and, although some success was observed in some cases, it was never sufficiently satisfactory to inspire much confidence. Phage seems to lose some of its effect on bacteria in presence of much organic matter, or the latter protects the cells of bacteria.

VIRUSES

Small forms of life have always interested man. They were frequently used to explain phenomena which could not be attributed to larger visible forms. Our forefathers in bacteriology resorted to such an explanation of diseases for which definite forms visible through the optical microscope could not be seen. In some cases they were nearly able to prove that these forms existed by showing that filtrates in which visible forms could not be seen would reproduce a disease in a plant or animal. Since these filtrates had been "sterilized" as far as larger visible forms were concerned, the agents which passed through the filters were called *filterable viruses*. Now they are called *viruses*.

The term virus comes from the Latin and means a morbid poison. Today, the term is used for a specific agent causing disease in various forms of life. Smith has pointed out that viruses may be distinguished from the visible pathogenic microorganisms by (1) their extremely small size, ranging from just below the limit of vision down to sizes of some molecules; (2) their close association with the living cell—no virus ever having been cultivated in a cell-free medium; and (3) their interesting relationship with

insects on which many viruses are dependent for transportation to new hosts.

Viruses have become very important because they cause serious diseases in man, plants, and animals. All living organisms seem to be susceptible to attack. Before microorganisms which are known now to cause diseases in man, plants, and animals had been discovered, it was customary to use the term *virus* to designate the casual agents; thus, such expressions as "virus of scarlet fever" or "virus of diphtheria" were used. Later the term virus was used for diseases, the causative agent of which was not known—they were the so-called diseases of unknown etiology of which there are now quite a few.

A filterable virus has been called a "particulate agent; probably endowed with life, of a size and carrying an electric charge which permits it to pass through the pores of a filter, and as a rule ultra-microscopic." Whether viruses are living is a subject on which there is difference of opinion. They possess the ability to multiply, a function of living organisms, but also a crystalline structure not possessed by higher living forms. They are apparently in that "middle ground" between living and nonliving forms.

Discovery of Viruses. Following several years of supposition that they existed, viruses were probably first discovered by Iwanowski in 1892 when he was trying to solve the mosaic disease of the tobacco plant. Importance of higher forms of life in animal and human disease had prompted every effort possible to reveal a bacterium as the cause. All these efforts were to no avail. Iwanowski did discover that the juice of crushed diseased plants would reproduce the disease when applied to a healthy plant. Having shown that this filtrate contained no bacterial cells or cells of other forms of life, Iwanowski concluded that an invisible agent was present which could pass through very carefully made filters. Furthermore, he produced evidence that the "filterable entity" multiplied in the plants. Although this was a epochal discovery, the final and convincing proof came when Beijerinck in 1898 studied the problem. He confirmed Iwanowski's observations and called the agent a living "fluidum contagium." When passed through a sterile porcelain filter the juice of the diseased plant, although devoid of bacteria, retained its infective properties. The virus was dried at 40°C. without losing its infective power, but quickly lost its activity when boiled. Since

this pioneer work, viruses have been shown to be involved in diseases of other plants, men, and animals.

What did Beijerinck have to do in order to avoid the possibility of error in his conclusions? We may tabulate the steps as follows:

1. Secure diseased tobacco leaves and emulsify them in some fluid.
2. Filter this emulsion through a sterile diatomaceous-earth filter.
3. Examine the filtrate culturally and microscopically in order to prove the absence of true bacteria or other forms of life visible with ordinary microscopes.
4. Having proved the absence of such forms of life, inoculate healthy tobacco leaves to reproduce the disease.

Size is one of the first characteristics of living agents to attract our attention. Although wide variations in size of virus particles have been reported among the various kinds, they are believed to be quite uniform within each kind. Particles of "vaccinia virus" have been reported to be 125 to 175 millimicrons in diameter, which is relatively large. On the other hand, those of foot-and-mouth disease and poliomyelitis have diameters of from 8 to 15 millimicrons. The latter are said to approximate the size of certain protein molecules which makes one wonder what "life" is and whether it is related in any way to size. We are apparently working in that range where life is being acquired or bestowed on large molecules.

For some time viruses were believed to be similar to one another. As information about them has been amplified and especially since the electron microscope has been used for studying them, it is known that they differ from each other. Each virus seems to be an entity unto itself and different from others. They vary greatly in size as do the members of other groups of living organisms.

Nature of Viruses. Much is yet to be learned. Certain definite facts are known, however, which give us some ideas of the nature of viruses. One investigator who has studied viruses at some length has mentioned three possibilities: (a) They may be inanimate incitants to disease; (b) they may be primitive forms of life quite unfamiliar to us; and (c) the large viruses may be micromicrobes or the midgets of the bacterial world. None of these statements is very informative.

Up to the present time it has been impossible to cultivate viruses in the absence of living cells. They are either formed in living cells or must function as obligate parasites on them. Just why they cannot be propagated in culture media is not known. Whether they multiply freely in nature is also unknown.

In other characteristics such as resistance to chemical substances, heat, and drying, viruses are much like other living cells. Their living nature seems to be indicated. The question persists whether viruses may not be simply a filterable stage in the life cycle of another organism with a well-recognized organized stage. This is a plausible assumption which has much in its favor. In support of this is Rosenow's claim that he can make a streptococcus always present in the brains and spinal fluids of animal and human poliomyelitis victims change into a virus and vice versa. Poliomyelitis is generally regarded to be caused by a virus.

Crystalline Viruses. Early in 1935, Stanley reported preparation of a crystalline protein from plants infected with tobacco mosaic virus which would reproduce the disease in healthy plants. The substance appeared in the form of fine needles which contained 20 per cent of nitrogen and one per cent of ash. It was precipitated by protein precipitants and behaved like a typical protein. The crystals were 1000 times more active than the juice itself; one milliliter of a 1 to 1,000,000,000 dilution infected healthy plants.

Nomenclature and Classification of Viruses. Both these problems are in a confused state. When a plant virus has been shown to infect a plant it has usually been given the name of the host plant. This was satisfactory when little was known about viruses, but, as information grew, better methods were sought. Animal viruses have been named usually from the disease which they cause. In view of use of the host plant name in virus names, such viruses have been grouped by one investigator under the generic name of the host plant, such as *Nicotiana* group, *Solanum* group, *cucumeris* group—51 groups in all. The viruses within the groups were numbered according to the plant species affected. This method of naming plant viruses has been shown to be ambiguous in several instances. One investigator who isolated two viruses from a diseased potato called one virus *x* and

the other virus *y*. Animal viruses' nomenclature is in about the same state. There is, for instance, a virus for encephalitis lethargica, one for Japanese encephalitis, and another for St. Louis encephalitis. Vigorous attempts are being made to arrive at some uniform system of nomenclature.

Diseases Caused by Viruses. Many such diseases are recognized. Some of them may be incorrectly classified as virus-caused diseases because of failure to discover the true etiologic agent. The following are a few typical examples of diseases grouped as virus-caused:

DISEASES OF ANIMALS

Animal poxes
 Dengue fever
 Encephalitis
 Foot-and-mouth disease
 Herpes
 Measles
 Mumps
 Poliomyelitis
 Psittacosis
 Rabies
 Variola and vaccinia
 Warts
 Yellow fever

DISEASES OF PLANTS

Mosaic Disease of:
 Tobacco
 Tomato
 Cucumber
 Cauliflower
 Tulip
 Ringspot:
 Tomato
 Tobacco
 Leaf curl:
 Tobacco
 Cotton

In addition to virus diseases which affect animals and plants are those of insects. The best known are those of bees and butterflies. A virus disease of bees is *sac brood*, so called because the dead larvae look like a sac. Jaundice of silkworm is another virus insect disease. This is one of several so-called "polyhedral diseases" because polyhedral corpuscles or inclusion bodies are present.

RICKETTSIAE

These are also filterable bodies which are believed to be the causative agents of typhus fever. The name commemorates the work of Ricketts who died during the investigations of typhus fever. *Rickettsiae* are probably not so small as some of the other ultramicroscopic forms because they are said to be just a little smaller in size than small coccus forms and consequently are almost visible with ordinary microscopes. They may be stained

by methods used for staining bacteria. Some have been cultivated on culture media. They develop only in the presence of

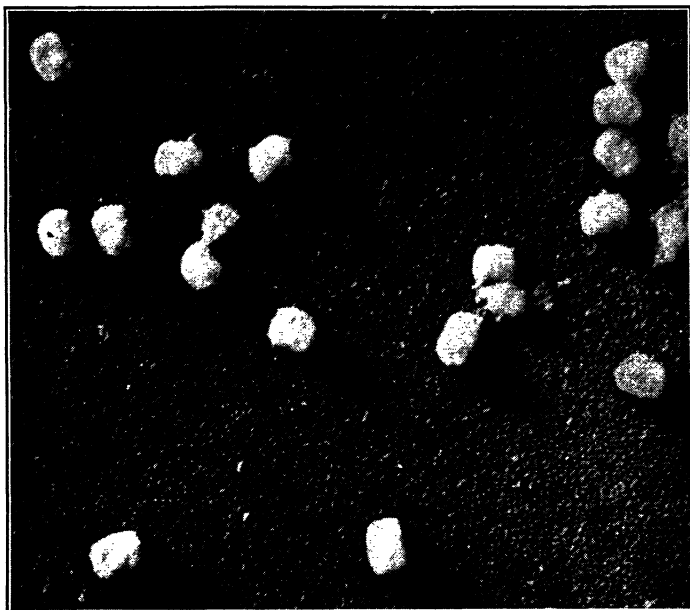

FIG. 24. Vaccinia Bodies (Virus). Magnification 25,000 \times . (Courtesy of Sharp, Taylor, Hook, and Beard, 1946)

living cells and are thus like some of the viruses. Since they are a little smaller than bacteria, they are intermediate between them and smaller forms such as filterable viruses.

INCLUSION BODIES

Inclusion bodies are microscopic bodies which appear in the cytoplasm or nucleus, or in both. Not much seems to be known about them. Some believe that they may be the filterable virus particles, whereas others claim that they may be degeneration products. Some of them are probably granules and other bodies, as mentioned on page 81. The "Negri body" observed in brain tissue of animals affected with rabies and "Bollinger bodies" in fowl-pox lesions are examples. Just what these bodies are and what their function is are not known. Some investigators are relating them to the virus which causes disease in animals.

REFERENCES

- BURNET, F. M., *Virus As Organism: Evolutionary and Ecological Aspects of Some Human Virus Diseases*, Harvard Univ. Monographs in Med. and Pub. Health, Cambridge, Mass., 1945.
- HOLMES, F. O., *Handbook of Phytopathogenic Viruses*, Burgess Publishing Co., Minneapolis, Minn., 1939.
- SEIFFERT, GUSTAV, *Virus Diseases in Man, Animal, and Plants*, Philosophical Library, New York, 1944.
- VAN ROOYEN, C. E., and A. J. RHODES, *Virus Diseases of Man*, Oxford Univ. Press, London, 1940.

CHAPTER 5

MORPHOLOGY OF BACTERIA

Many difficulties arise in the study of morphology of bacteria. Although some of them seem to be almost insurmountable and have caused pronounced differences of opinion, much has been learned about these microscopic organisms. The first difficulty, more apparent, perhaps, to one who is just beginning to study bacteria, is their small size, but improved microscopes and even methods for isolating and studying single cells have helped to overcome it. Much knowledge of bacterial cells has come from observations on great aggregations of single cells; knowledge about morphology has had to come from examination of isolated cells by means of the microscope. Such methods have disadvantages even though they have made possible the securing of considerable accurate information. It is almost impossible for the bacteriologist to make observations on a large scale. He must be content, under ordinary circumstances, with observations on many cells at the same time.

Another disadvantage is the fact that these small single-celled microorganisms are quite likely to assume new characteristics when grown in the laboratory away from their natural habitat. New generations follow one another with great rapidity, and new characteristics may be acquired quickly.

Much of what is known about morphology of bacteria has been learned by means of the optical microscope. Introduction of the electron microscope will undoubtedly correct and greatly amplify our knowledge.

Cultural Study of Bacteria.¹ In order to be studied for characteristics discussed in this chapter, microorganisms must be "cultured" in the laboratory, that is, grown in suitable food materials in pure culture. These cultures are studied for growth

¹ Details of bacteriological technic are given in the author's "Practical Bacteriology," published by Wiley.

characteristics, and cells are taken from them for examination under the microscope. Of these observations which are made in the laboratory, a few are discussed here to illustrate how microorganisms are studied.

Fermentation Reactions. These involve metabolism of various pure sugars under conditions which permit observations as to growth and acid and gas formation. If, for example, one species of bacteria forms acid and gas from sucrose and another does not, this is a method by which they may be differentiated. In addition to sucrose, other sugars may be used which make various fermentation combinations possible.

Colony Characteristics. When a single cell or group of cells is deposited in or on a semisolid culture medium such as gelatin or agar, they increase rapidly in numbers under proper conditions to form a *colony*. These colonies are more or less characteristic for each species when they are developed under similar conditions even on plain solid culture media.

Special ingredients are often added to the solid medium to give the colonies further characteristic appearances. For instance, lactose and the dyes eosin and methylene blue are added to plain agar medium to make possible differentiation of *Escherichia coli* from *Aerobacter aerogenes*. The details of this differentiation may be left for those who study microorganisms in the laboratory.

Growth in Other Culture Media. Plain broth, much like beef bouillon, is also used as a differential medium. Various types of growth are possible. Some bacterial species grow on the surface forming what is called a *pellicle*. Other species grow evenly throughout the medium with no surface growth.

Special substances such as sodium nitrate are added to plain broth. By testing for presence of nitrites after incubation for a day or so, information is secured with respect to reducing properties. Hydrogen sulfide formation may be detected by suspending a piece of bibulous paper impregnated with lead acetate above the medium during incubation.

Examination of Morphology. These observations are made on cells from culture media. They may be examined in two ways, unstained and stained. Results of examination of stained cells must be interpreted with caution because staining might alter their appearance.

SHAPE AND SIZE OF BACTERIAL CELLS

Shape. Bacteria differ markedly in shape. This characteristic was one of the first to be used for classification. Three general shapes are commonly recognized by bacteriologists. They are illustrated by genera in the following families:

Coccaceae: Round or spherical cells.

Bacteriaceae: Rod or cylindrical-shaped cells.

Spirillaceae: Spiral-shaped cells.

The simplest form of life is the round cell. Rod-shaped cells are more complex, and spiral-shaped rods still more so. It is interesting that in the bacterial world the same increasing complexity in form is seen as is seen in the world of macroscopic organisms.

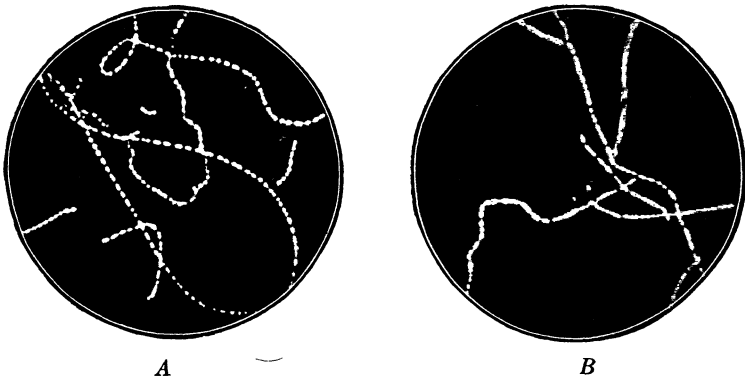

FIG. 25. Showing Chains of *Streptococcus lactis*. India-ink preparation.
(After Orla-Jensen)

A, Cells from a broth culture, three days at 10° C; B, cells from a broth culture, 10 days at 10° C.

Cell shape is usually constant for each species of bacteria; that is, each species has one shape in which it has been recognized in the past. Recent contributions to the literature, however, have shown that some species may grow alternately in different shapes. For instance, Evans reported a rod-shaped bacterium which existed also as a streptococcus and as a filterable form. Many other contributions show somewhat general confirmation for this alternation of shapes which is now considered by some

investigators to be part of a "life cycle." The student who is studying bacteriology for the first time need not be unduly concerned with this until he is ready for advanced work in the science.

Size and Weight of Bacteria. Bacteria are very small organisms—so small that they are invisible to the naked eye. This fact delayed their discovery until special instruments had been devised. The microscope revealed this world of microorganisms for study. Their small size necessitated a new unit of measurement, since to express their dimensions in the older units would cause a great waste of time and great possibilities of error. Consequently microscopists introduced a new unit, the *micron*, which was defined as 1/1000th of a millimeter or about 1/25,000th of an inch. The Greek lower-case letter mu (μ) is taken as the symbol. There are also other ways of expressing the small size of bacteria.² Conn in his "Practical Dairy Bacteriology," stated that a drop of milk may contain as many as 100,000,000 bacteria, and a particle the size of a pinhead 8,000,000.

Although bacteria vary widely in size and weight, many of them are within rather narrow limits. The average bacterial cell is about 0.5 micron in diameter and 1 to 1.3 microns in length. On both sides of this average are microorganisms which are distinctive for either their small or large size. *Dialister pneumosintes*, isolated from certain respiratory infections, is one of the

² Microscopists and physicists who work with very small beings and particles have had to use new units of measurement. It might be useful or interesting, at least, to define several such units.

Micron (μ)—1/1000th of a millimeter, or 1/25,400th of an inch.

Millimicron ($m\mu$)—1/1,000,000 of a millimeter.

Angstrom—1/10,000,000 of a millimeter.

Objects measured in microns are visible with a microscope. An ordinary microscope cannot distinguish particles of less than 0.13 micron in diameter. Very fine dust particles have a size of about 2 microns. Particles less than 4 microns in diameter show the phenomenon of Brownian movement. It is interesting to see the sizes of different cells and particles measured by the units commonly used:

Hydrogen molecule	0.067 $m\mu$
Water molecule	0.113 $m\mu$
Chloroform molecule	0.800 $m\mu$
Bacteriophage	20 to 40 $m\mu$
Starch grains	5 to 7 μ
Red blood corpuscles	7.5 μ

smallest organisms that has been described. Its size is given as 0.15 micron in diameter and 0.3 micron in length. *Spirillum colossus* has cells which were reported as 3.5 microns long. *Clostridium giganteum*, as the name indicates, is a very large microorganism which may vary from 0.75 to 2.0 microns in diameter and 8 to 10 microns in length. Another large bacterium is *Bacillus bütschlii*, reported to attain a cell length of 60 microns and a width of 5 microns.

The size of the cell varies with many factors. For instance, it is known that cells may grow after division so that age is important. Cells which have resulted from binary fission are young cells and must develop into mature cells before they also may divide. Evidence has been published that bacterial cells pass through about the same stages as are recognized for higher forms of life, that is, infancy, adolescence, maturity, senescence, and death. State of nutrition, as would be expected, also has some influence.

MacNeal, Latzer, and Kerr, using *Escherichia coli* in one experiment, found that 55×10^{11} cells (5,500,000,000,000) were required to yield 1 gram of bacterial substance on the dry basis. Other experiments yielded data which were not widely different. Jordan in his contribution to that interesting book, "The Nature of the World and of Man," stated that 12,000 cells of *Eberthella typhosa* would extend an inch long and that a cubic inch would contain about 8,000,000,000,000 such cells.

Rubner reported specific gravity of bacteria to be between 1.038 and 1.065. Another investigator placed the limits at 1.120 and 1.35. Kendall has stated that 1,600,000,000 cells of *Escherichia coli* would weigh a gram. Winslow stated that 400,000,000 cells could be packed into a space occupied by a grain of sugar. Such statements help one to visualize their small size.

Relation of Cell Surface to Mass. Very important in nutrition and energy relationships is surface area of cells of microorganisms. This determines in a large way the amount of food which must be used because the greater the surface areas, the greater is the possibility of loss of heat and energy by radiation. That is the reason why one bacterium has been reported to use its own weight of food every hour and why these small single-celled organisms are so destructive of organic matter. They require large amounts of food for energy.

Variations in Morphology During Growth. Cell shape and function are not constant characteristics. They change with the age of the culture. This is quite apparent when the cells are dividing by ordinary fission. The two cells formed from the first cell must increase to the size of the parent cell before they, in turn, divide. At later stages of growth the cells in a culture decrease in size and become quite uniform. If the species is a spore former, spores will appear in abundance at this time. Staining properties of cells vary with age. During the early phases of growth they stain evenly to become barred and granular in the later phases. In view of these changes, microbial cells have been said to pass through the normal phases of growth for living organisms. Variations in appearance of cells which have caused so much discussion among bacteriologists might be explained in this manner.

Bacteria are such small organisms that it has been impossible to find in them the various mechanisms and organs which are admitted to be in cells of higher organisms. However, great progress has been made toward the solution of what at first seemed unsolvable problems. Less definite information is available for bacterial cells than for yeast and protozoan cells. One difficulty is the necessity of staining bacteria to make them more easily visible. Staining causes changes in the cells which may give them appearances very different from the unstained condition. Unstained bacterial cells reveal very little differentiation.

Cytoplasm. Bacterial cytoplasm is probably little different from that of all cells. It consists of protoplasm having the general properties of this substance. Within the cytoplasm are other organs which are discussed in the following paragraphs. Most studies which have been made on this substance have involved use of very large bacterial cells. In 1889 Bütschli studied the structure of *Chromatium okenii*, in which he distinguished a central body and parietal layer. The central body, by means of hematoxylin, was reported to possess a structure shown in Fig. 26. Granules, to which he gives the name "red grains," were also seen in it. This central body was thought to be the nucleus, and the parietal layer the cytoplasm. Bütschli's statements have been the subject for considerable discussion. Granular bodies or "cell inclusion bodies" in cytoplasm may be due to any of the following agents or bodies:

1. *Metachromatic granules.* These are sometimes called polar bodies when massed at the ends of the cell. They are demonstrated by treating the bacterial cell with methylene blue, the granules staining differently from the cytoplasm. Metachromatic granules may also be distributed throughout the cytoplasm. The real function of metachromatic granules is probably not known. Some have believed them to be reserve substances. They are probably identical with the *volutin* of Meyer.

2. *Glycogen.* This is a carbohydrate, found in liver cells of higher animals and also in many microorganisms, being especially abundant in yeasts. It is a reserve substance plentiful in well-nourished cells, and scarce or absent in starving cells.

3. *Fat droplets or globules.* These are also reserve substances.

4. *Acid-fast particles.* Acid-fast bacteria are those which are decolorized by strong mineral acid solutions with considerable difficulty. They are therefore said to be *acid-fast*. This property has been attributed to acid-fast particles in the cytoplasm. What these particles are may not be known. Some investigations would indicate that they are lipin-protein combinations.

5. *Sulfur granules or iron granules.* These bodies are especially common in cells of the so-called higher bacteria. The sulfur in sulfur bacteria appears as droplets or globules which may be dissolved. The sulfur is stored during times of plenty and used up during periods of poor nutrition.

Cell Wall. The cell wall of bacteria is a protective covering secreted by the cytoplasm. As far as is known all bacterial cells possess cell walls which give them definite form, shape, and turgor. The cell wall should be looked on as semi-permeable, through which food and waste products pass in the general life processes of the cell.

The structure of the cell wall on certain large forms has been studied by bacteriologists. Such studies necessitate use of special methods to make the cell wall visible. Fischer used plasmolysis to separate the cytoplasm from the cell wall. After the cytoplasm had been drawn away from it, the wall appeared as a delicate membrane still intact. By means of such technic,

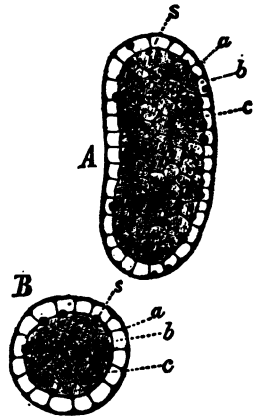

FIG. 26. — *Chromatium okenii*. (After Bütschli.)

A, Longitudinal Section; B, Cross Section. The cell was first killed and then freed from bacterio-purpurin and sulfur granules by solvents, and finally stained with hematoxylin. The reticulated structure appears like a honeycomb and the central body (c) is more reticular than the parietal layer (b). While the under structure of the cell assumes the blue color of alkaline hematoxylin, the chromatin granules (s) are red violet.

Fischer called attention to the fact that cytoplasm in bacterial cells was not connected to the wall and that the osmotic pressure in bacterial cells was half that in cells of the higher plants, since the bacterial cells required solutions only one half as strong for plasmolysis. Fischer was unable to distinguish finer structures in the cell membrane.

Capsules. Some bacteria possess a gelatinous coating about the cell. This is either an excretory product which happens to be of such consistency that it is held about the cell or an outer layer and a constituent part of the wall. It is called a capsule. Not all species of bacteria seem to be provided with well-defined capsules. The material composing the capsule is of a gelatinous mucilaginous consistency causing the cells of a capsulated organism to adhere and stick together. This gives what is spoken of as zooglea formation, a phenomenon of considerable importance in the industries. Capsules were first noticed by Friedlander on his pneumobacillus in 1883.



FIG. 27. Showing Capsules on Cells of *Streptococcus cremoris*.
(After Orla-Jensen)

Several methods are available for determining the presence of capsules: Cultural methods usually give the first information that an organism possesses a capsule. When the organism is transferred from one medium to another, growth is often viscid enough to pull out in short strings. Another method rests on the fact that the capsule resists ordinary staining procedures and consequently appears as an unstained halo about the cell. Chemical studies on the contents of the capsule by early bacteriologists indicated that it was identical with mucin. Recently

it has been reported to consist of galactans. The contradictory data may, perhaps, be due to the fact that the chemical composition varies in capsules of different species of bacteria.

Capsulated bacteria are a nuisance in certain industries where they may cause serious losses. When they occur in flour, they may cause a bread defect known as "ropy bread." "Slimy" or "ropy" milk is the result of development of such bacteria. They form a gum in the sugar industry which interferes with crystallization. The best way to prevent such trouble is thorough sanitation and "good housekeeping" in the manufacturing plant.



FIG. 28. *Salmonella pullorum*. Normal cell as viewed through the Electron Microscope $\times 21,000$. (After Baylor, Severens and Clark)

Several of the most virulent bacteria are capsulated, including those which cause lobar pneumonia (the pneumococcus and Friedlander's pneumobacillus) and anthrax (*Bacillus anthracis*). Capsules appear on *Bacillus anthracis* only in the animal body, an observation which has led some to state that capsules protect the bacterium against the immune bodies. Supporting this opinion is the observation that virulence of bacteria has been shown to be related to capsulation. Noncapsulated cells of capsulated virulent species have been shown to be avirulent.

Perhaps related to capsules are the gums produced by many species of bacteria. These are quite important in certain industries. They are probably related to capsules as far as chemical structure is concerned, in that both consist of complex carbohydrates, the polysaccharides. When they remain about the cell they appear as capsules, but when they diffuse away from the cell

and are formed in large amounts they are known as gums. Many different gums have been isolated, most of which are named from the sugars which they yield on hydrolysis.

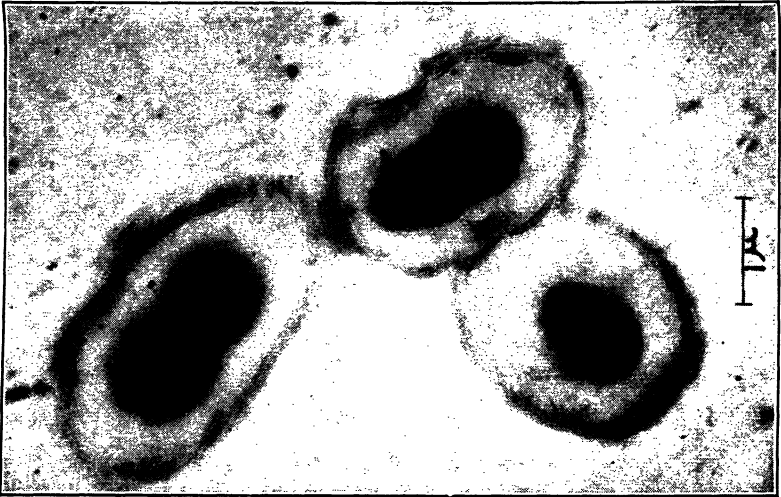

FIG. 29. Showing Capsules on Pneumococcus, Type 1, Swollen by Exposure for 3 Minutes to Diluted Rabbit Antiserum Containing Specific Antibody. (Reproduced by courtesy of Mudd, Heinmets and Anderson)

Organs of Locomotion of Bacterial Cells (Flagella). Some bacteria are provided with whiplash-like appendages on the cell with which they propel themselves through the medium. The names *cilia* (singular cilium) or *flagella* (singular flagellum) are given them. The latter term is most commonly used for bacteria while the former is used for protozoa. It is quite probable that some bacteria are able to move about even though they do not possess definite organs of locomotion. There may be such means as a contractile membrane, or a snake-like movement by which the cell propels itself through the medium, other movements of protoplasm, or other muscular action. Motility seems to be related to complexity of structure. The round forms (Coccaeae) are not motile, the rod forms (Bacteriaceae) show motility in many species, and the spiral-shaped cells (Spirillaceae) are all motile.

Since the location and number of flagella on the bacterial cell are variable, bacteriologists have used this fact as a means of



FIG. 30. Flagella on Bacterial Cells. (After Migula from Schmidt and Weiss)

A, *Pseudomonas syncyanea* with lophotrichous flagella; B, *Spirillum rubrum* with amphitrichous flagella.

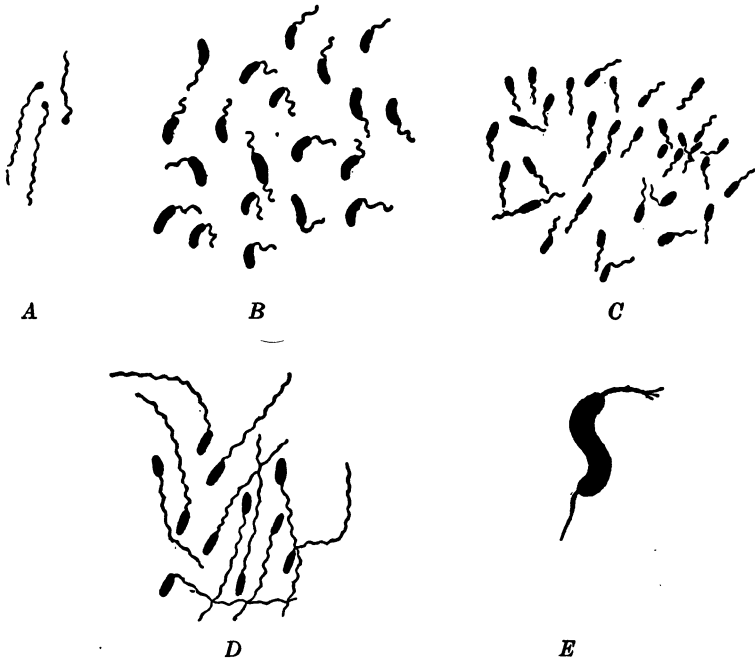

FIG. 31. Monotrichous Flagella. (After Migula from Schmidt and Weiss)

A, *Pseudomonas javanensis*; B, *Microspira cholerae*; C, *Pseudomonas pyocyanea*; D, *Pseudomonas macroselmis*; E, *Spirillum undulata*.

differentiating species. The adjectives used to denote the presence of flagella and their location on the cell when present are:

Atrichous—absence of flagella.

Monotrichous—one flagellum on one end.

Lophotrichous—tuft of flagella on one end.

Amphitrichous—tuft of flagella on each end.

Peritrichous—flagella all about the cell.

In comparison with the higher animals bacteria move more rapidly. Lehmann and Freid measured the distance traveled by several bacteria. It took *Eberthella typhosa* one second to travel 0.018 millimeter. The velocity of motion is dependent on many factors such as temperature, age, and state of nutrition. Specific data secured with one species ought not to be applied to all species.

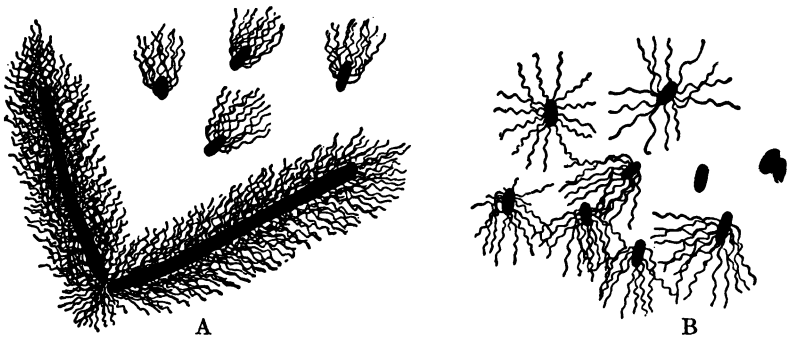

FIG. 32. Peritrichous Flagella. (From Migula after Schmidt and Weiss)

A, *Eberthella typhosa*; B, *Proteus vulgaris*.

Flagella are demonstrated on bacterial cells by microscope examination only with special methods of preparation and staining. More important, probably, than any one particular method of staining, is to prepare the cells for examination in such a manner that the flagella are not broken or disturbed from their natural positions. Flagella may generally be assumed to be present if the organism is motile, but there are exceptions.

The electron microscope is now being used for studies of cytology of bacteria. Presence of and distribution of flagella has been readily demonstrated on certain bacterial cells. This instrument has revealed presence of flagella on the sides of cells of *Treponema pallidum* which were heretofore unknown.

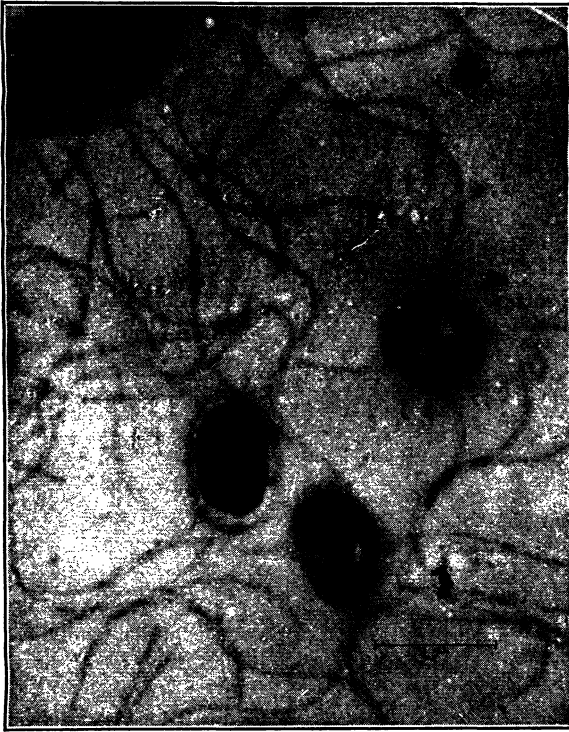

FIG. 33. *Eberthella typhosa*, plus antiserum. Reduced from a magnification of $\times 11,000$.

Showing flagella on bacterial cells as revealed by electron microscope. (Courtesy of Mudd)

Brownian Movement. A phenomenon known as "Brownian movement" which frequently complicates motility studies on bacteria was announced in 1827 by the botanist Brown. While examining fine materials such as pollen under the microscope, he observed that they underwent a constant vibration, the degree of which increased as the particles became smaller. This phenomenon finally became known as Brownian movement, for which a number of explanations have at times been offered. It is now believed that the phenomenon is due to bombardment of the particle under observation by molecules of the liquid in which it is suspended. This vibration is also apparent with bacterial cells and must be distinguished from real motility—a translocation from one part of the microscope field to another.

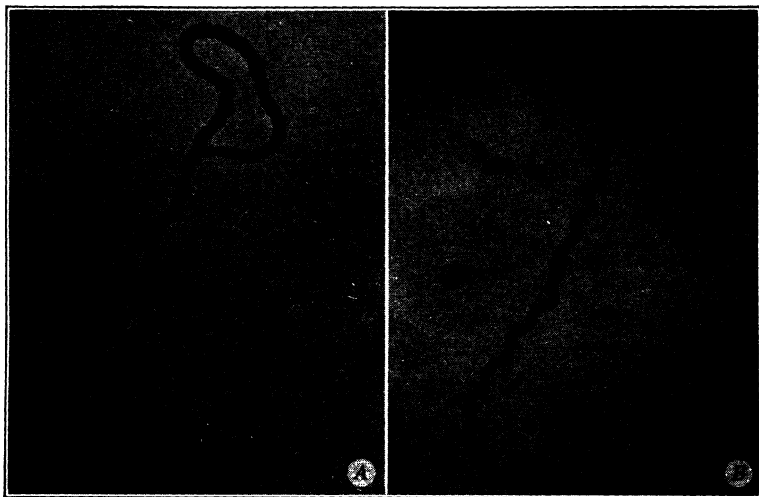

Fig. 34. *Treponema pallidum* and *Leptospira icterohemorrhagiae* as Revealed by the Electron Microscope. (Reproduced by courtesy of Mudd)

A, *Treponema pallidum*. Reproduced from a magnification of $\times 6200$. B, *Leptospira icterohemorrhagiae*. Reproduced from a magnification of $\times 12,400$. Spirochaetes lose their characteristic spiral form when dried as all specimens must be when examined with the electron microscope.

Nucleus. The nucleus is an organ which has a very important role in cytology. It is probably the most important organ in the cell, being concerned with reproduction and transmission to the progeny of characteristics of parent cell or cells. The question of the presence of a nucleus in a bacterial cell is one on which there is much discussion. The situation may be analyzed by considering the several possibilities which have been suggested.

1. The bacterial cell is primitive and is devoid of a nucleus. By analogy, at least, there is little to support this view beyond the fact that a nucleus has not been so satisfactorily demonstrated in all bacterial cells as in the cells of higher microorganisms. Those who contend that bacteria are anucleate explain the bodies reported as nuclei as resulting from the treatment given the cells by heat and stains. It is doubtful what the proponents of this view mean by the term "primitive." Certainly a cell which can reproduce itself every 30 to 60 minutes, eat its own weight every hour or so, and bring about such a great amount of chemical change per unit of time is not primitive.

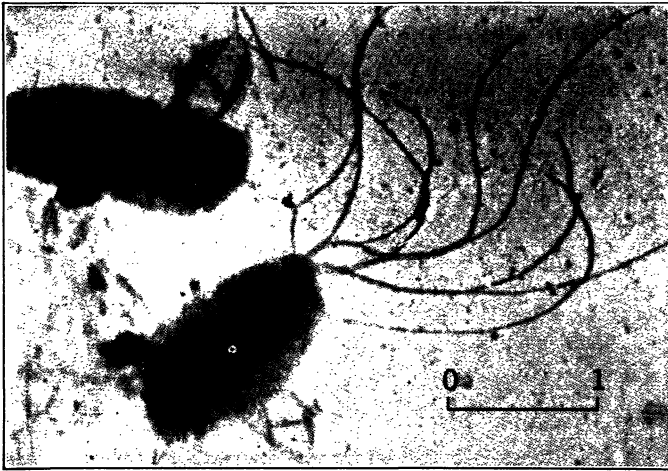

FIG. 35. Flagella on *Achromobacter fischeri* as Revealed by the Electron Microscope. (After Johnson, Zworykin and Warren)

In the study of general biology we learn that the nucleus has great significance in the life processes of the cell, and its existence is usually admitted. Is it reasonable, then to cast doubt on its existence if it cannot be shown to be present in bacteria as convincingly as in yeasts and protozoa, for instance?

2. A nucleus is present but is diffused throughout the cell giving what has been called a diffuse nucleus. Bütschli was one of the important supporters of this view. Lindegren, who has more recently canvassed the matter in light of recent advances in genetics, has denied this theory. He states that those who support it assume that chromatin is an essential nuclear constituent. Many cytologists, according to Lindegren favor the view that chromatin is not the essential nuclear substance. Gene strings, and not chromatin, are essential nuclear constituents and are present in all living forms.

3. A nucleus is present and constitutes practically all of the cell interior.

4. A nucleus, as in any typical cell, is present. This theory then implies that the bacterial cell is no different in constitution from other cells which are more easily studied. Let us consider the evidence from the laboratories of several investigators. Bodies demonstrable by the ordinary nuclear stains have been

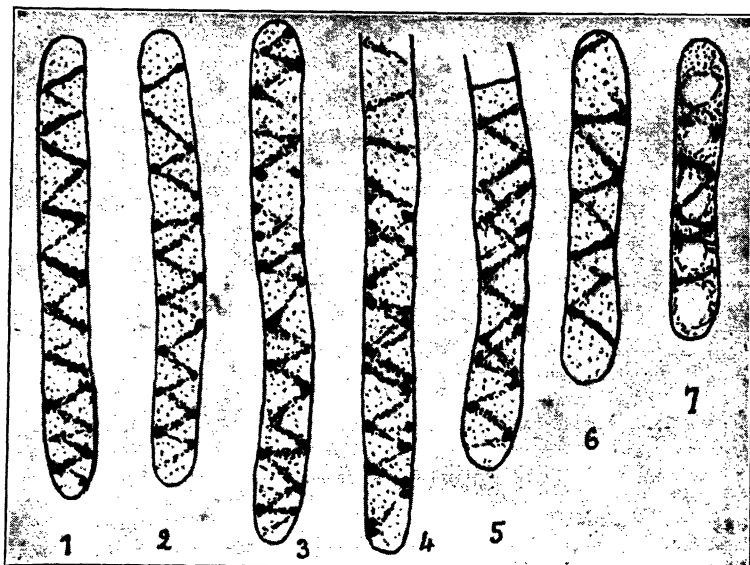

FIG. 36. *Bacillus maximus bucchalis*, Showing the Development and Division (in 4 and 5) of the Chromidial System. (From Guilliermond after Swellengrabel)

reported by many. Dobell, one of the foremost students of microbial cytology, believed that bacteria are nucleate organisms.

Lindgren stated that bacteria may be provided with genes which are present in all living forms. Life without them is impossible. The gene is a substance in the chromosomes which determines specific hereditary qualities.

Some chemical evidence may also be offered to support the presence of a nucleus. Mathews in his "Physiological Chemistry" stated that the proteins of the cell nucleus are sharply differentiated from those in the cell cytoplasm. In the nucleus many of the proteins are nucleoproteins in which are nucleic acids. Mathews sums up the situation by saying that in the nucleus are found nucleoproteins, whereas in the cytoplasm these are probably lacking. If this statement is accepted as applicable to the bacteria, it may be said that nucleic acids have been found in *Escherichia coli* and *Mycobacterium tuberculosis*.

The author believes that several lines of evidence strongly support the presence of nuclei in bacterial cells. Ascending the

evolutionary line of living organisms, we recognize the presence of a nucleus just as soon as organisms that may be studied conveniently, protozoa and yeasts, for instance, are encountered. The nucleus is satisfactorily demonstrated in the members of these two groups, since cells of these microorganisms are considerably larger than bacteria and are more easily studied. The smaller bacterial cells are studied with more difficulty, and, even



FIG. 37. Showing Cell Division and the Formation of Endospores in *Bacillus Bütchlii*. (After Schaudinn)

when the larger bacterial cells are studied, evidence for the presence of a nucleus is not quite satisfactory. Recalling the important role of the nucleus in cytology, we find it difficult to imagine a cell without this important organ. Summation of the several lines of evidence, chemical, staining, as well as circumstantial, justifies the conclusions that bacteria cells are nucleate. In some cases the nucleus may be diffused; in others, organized.

SPORULATION³ OF BACTERIA

Various forms of life enter stages where their life processes are markedly slowed up but not stopped. These are often referred to as resting stages. Certain higher animals hibernate in winter. The encysted stage is also present among protozoa; they remain

³The term arthrospore was introduced by early bacteriologists for a sort of encysted state among the bacteria. This spore was not formed inside the cell like the endospore. The entire bacterial cell was believed to assume the characteristics of a spore by forming a thick wall. The term has not had wide usage among bacteriologists but is frequently seen in some of the older texts. Löhnis has used the term for one of the stages in his life cycle of *Azotobacter*. In contrast to the term arthrospore, as used by the older bacteriologists, is the term endospore. The later spore was formed within the cell in the same manner as is known today. The separation of bacteria into arthrosporous and endosporous groups is not based on good experimental evidence.

in that state until favorable conditions obtain. This makes it possible to distinguish two types of protoplasm, *vegetative* and

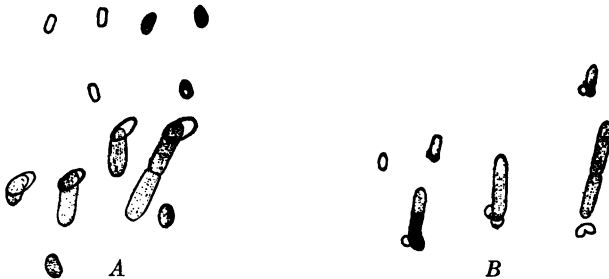

FIG. 38. A, *Bacillus luzosus*, Burchard. (After Burchard) B, *Bacillus simplex*, Gottheil (*Bacillus loxosporus*, Burchard).

sporoplasm. Vegetative protoplasm is the active growing pro-

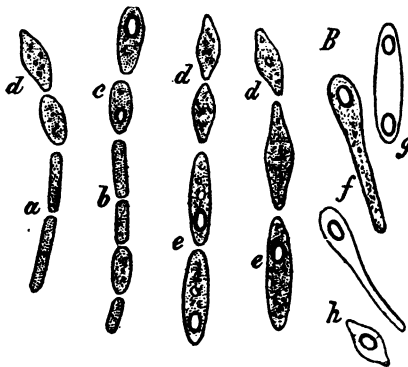

FIG. 39. *Clostridium butyricum* (*Bacillus amylobacter*, van Tieghem), Showing Spore Formation. (After Prazmowski)

a, b, Vegetative cells; d, spore beginning to develop; c-e, further development of spores; f-h, spores completely formed; a-f, granules stained blue with iodine; h, stained with the same reagent devoid of these granules; g, cell with two spores.

toplasm whereas sporoplasm is that which is in the spore. Characterization of the spore as a resting stage might convey the idea that it is absolutely dormant. Such is probably not the case. The spore is composed of living protoplasm which must respire as do other cells. It is known that the enzymes in bacterial spores are active although probably much less active than in vegetative protoplasm.

Formation of a Spore.

Those who have followed the formation of a spore in a bacterial cell have reported concentration of protoplasm; this is eventually surrounded by a membrane which becomes the wall of the spore. This phenomenon was well shown by Schaudinn with *Bacillus bütschlii*. Nuclear changes have also been reported in the formation of the spore.

Spores may be located in the rod in either the end or the center. In the former case they are spoken of as polar spores and in the latter as equatorial spores. Sometimes the spore is so large that it distends the cell wall giving the cell a bulged appearance. Such a cell is called a *Clostridium*. This cell shape has been characterized in different ways by the early bacteriologists. Some of these names used in modern literature, such as drumstick when the swelling is in one end, and spindle-shaped when the swelling is in the middle.

Structure of the Spore. Marked resistance of the spores to unfavorable agents would suggest that they might possess cell structure quite different from that of vegetative cells. The cell wall is probably the first part which is of interest from this viewpoint. The spore wall consists of two layers. The cytoplasm of the spore probably differs from the cytoplasm of the vegetative cell in some way because it is often more refractive under the microscope. It is known to contain less water.

Number of Spores Produced. Generally but one spore is produced by a cell. When an organism is found which forms more than one spore, this is often indicated in the name. Kern's *Dispora caucasia* and *Bacillus inflatus* are examples.

Properties of the Spore. The spore is a very resistant unit in the life cycle of the cell. This marked resistance to a variety of unfavorable agents is explained in different ways, none of which may be the true explanation. It has been suggested that the cell wall is thicker and more dense, preventing passage through it of unfavorable agents.

Increased heat resistance of spores has been attributed to a lower water content than that of vegetative cells. This has seemed to be a reasonable assumption because water is required for coagulation of proteins, and the more water present, the greater would be the protein coagulation. If results of a few investigators are to be accepted, heat resistance of spores is to be attributed to a relatively high percentage of water in the bound state. The total water content of a cell consists of free and bound water. The latter is bound by the solids in the cell and may be part of the cell structure.

On account of its significance in the food industries and sterilization, resistance of spores to heat is, perhaps, their best-known characteristic. As would be expected, marked difference exists

in the heat resistance of vegetative protoplasm and sporoplasm. Brefeld reported that spores of *Bacillus subtilis* were killed by heating for 3 hours at 100°C., whereas vegetative protoplasm was killed in 20 minutes. Spores of *Clostridium botulinum* are especially heat-resistant. Spores of some strains will withstand 4 to 5 hours boiling. Thermophilic bacteria have more heat-resistant spores than *Clostridium botulinum*. The high-temperature optimum of thermophiles gives them a long thermal death time. Such heat resistance causes the microorganisms to be of marked significance in the canned-food industry. While heat has been selected as an important agent to which spores are resistant, they are resistant to other agents. Some chemicals have no effect on spores and consequently cannot be used with safety for the destruction of spore-bearing bacteria.

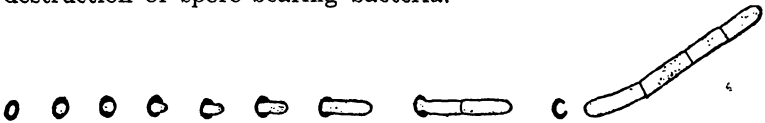

FIG. 40. Equatorial Germination of Spores. *Bacillus subtilis*.
(After Migula)

Germination of the Spores. Spores are supposed to remain dormant as long as they are under unfavorable conditions and to germinate when favorable conditions obtain. This process involves renewed activity on the part of the protoplasm in the spore, an activity which results in rupture of the spore wall. The details of this process as they have been described for certain bacteria will not be reviewed. Some uniformity as to the place where the spore wall is ruptured to permit the protrusion of the germ seems to exist. In some organisms it is in the middle, giving what is called equatorial germination (Fig. 40). Usually the spore envelope disappears, but one or two species have been discovered on which the envelope remains. Another method of spore germination was described by Prazmowski with *Bacillus subtilis* (Fig. 41).

Function of Spores in the Life History of Bacteria. This allows us to consider some of the reasons for spore formation. Several may be mentioned.

1. Spores are formed to carry the cell over unfavorable periods caused by lack of food, accumulation of products of metabolism, and so on. This, then, places on the spore the responsibility of

perpetuating the species under certain conditions. It also means that only certain species are endowed with this ability, for many are known which do not form spores.

2. Spores are reproductive units. There is little doubt about the spore having the ability to reproduce and perpetuate the species. After it has lain dormant for an indefinite period, favorable conditions will cause it to germinate, grow, and produce a plant structure like that from which it originated. In spite of the fact that the spore, when placed under favorable conditions, will reproduce the species and thus function as a reproductive unit, the fact that not all bacteria form

spores causes some confusion. It seems improper to offer as a means of reproduction a process which is not enjoyed by all the members of a group.

Methods of Demonstrating Presence of Spores. We will not attempt in this place to enumerate the details of bacteriologic technic but merely the principles on which some of the methods rest. Most of them are based on, or at least concerned with, the resistance of the spore to some agent.

Staining Methods. Spores are resistant to dyes used for staining bacteria. Consequently, the sporoplasm remains almost colorless in contrast with the vegetative protoplasm which easily takes the color of the dye being used.

Heat Resistance. This method involves the greater heat resistance of spores. A culture of an organism suspected of being a spore former may be heated to such a temperature that the vegetative protoplasm would be destroyed (55–60°C. for 5 minutes). Spores, if present, would resist such treatment. Consequently, if inoculations from this heated culture into sterile media result in growth, one could conclude that the original culture produced heat-resistant spores. This method, of course, is not applicable to thermophilic bacteria. In order to use this test with these organisms the culture should be boiled 5 to 10 minutes.

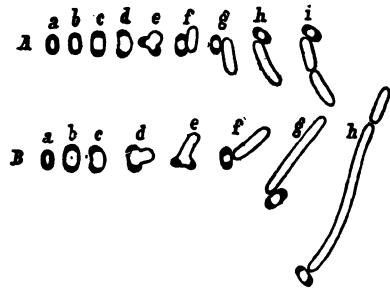

FIG. 41. *Bacillus subtilis*.
(After Prazmowski)

a, Ripe spore; b, when it is placed in a nutrient solution the refraction disappears; c, enlargement begins; d, the equatorial fissure is formed, and the young germ begins to escape; e, in the upper row the central portion of the germ is just protruding; in the lower row one pole is already free; f, the young rod is free; g, it grows to its normal size; h, it reproduces by division.

Dormancy in Bacteria. Bacteria in both the vegetative and spore stage may remain dormant over long periods of time. This condition may be due to lack of something such as moisture in the environment. Dormancy has also been observed in culture media which are suitable as far as can be determined. Just why



FIG. 42. *Bacillus cohaerens*, Gottheil (*Bacillus bipolaris*, Burchard), Showing Bipolar Germination of Endospores. (After Burchard)

the cells do not develop is not known. When this occurs with spores, some have suggested that it is due to the fact that the spore is a resting stage, and a certain amount of time must elapse before it will germinate. It is more difficult to explain dormancy of vegetative cells.

REPRODUCTION OF BACTERIA

The simplest method of reproduction and the one which has been taught in former years is *binary fission*. This means that new bacterial cells are formed by division of a pre-existing cell

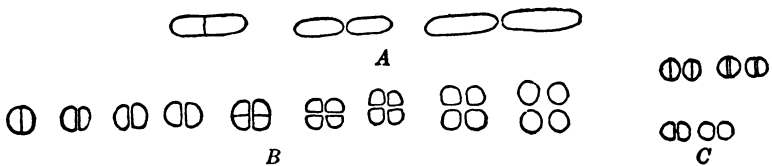

FIG. 43. Diagrammatic Illustration of Cell Division. (After Migula)

A, Rod-shaped cells; B, round cells; C, round cells showing sarcina grouping.

into two cells. These progeny then grow into cells like the original one. With rod-shaped bacteria impending division is first noticeable with the appearance of a stricture in the cell wall which becomes more and more marked until the cell breaks at this point (Fig. 43). For this reason bacteria are often called *fission fungi*. They resemble in this respect certain other forms

of life, such as *Torulæ*, and certain protozoa. This method of reproduction is *asexual* and the characteristics of the organism are handed on almost in their entirety. The progeny may separate and exist as separate units or they may exist together in characteristic groupings which are given on page 178. Bacteriologists have come to recognize in them a means of distinguishing one species from another.

Evidence is also available that bacteria may reproduce in other ways more complicated biologically than simple binary fission.

Branching and Budding. The cells of *Eberthella typhosa* and a few closely related species were shown by Hart to bud and send out branches. Buds are round protrusions on the cells which may break off to exist alone. In some cases the branches may segment, and cells result which may undergo binary fission. Old cultures and cultures under unfavorable conditions may be rich in these forms, a fact which troubled early workers so much because they assumed that bacterial cells always had one shape which was quite constant.

Symplasm. This is an "amorphous" or "symplastic stage" resulting from a melting together of the contents of many cells. New individuals have been said to develop from symplasm in different ways. Regenerative units appear first; they develop into regenerative bodies. Löhnis and Smith gave the "symplastic stage" an important place in their life cycle of bacteria. It has been observed by many investigators in cultures of various bacteria.

Gonidia. These are reproductive units and have been said to be related to the symplastic stage. They may develop into mature cells in the organized stage. Some of the gonidia are filterable and may, therefore, be one explanation of filterable forms. Gonidia develop into normal forms.

Sexuality in Bacterial Reproduction. Early bacteriologists believed that bacteria were devoid of sexual processes which are

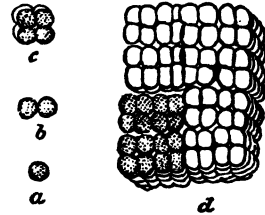

FIG. 44. *Sarcina ventriculi* Goodsir. From the contents of a diseased stomach. (From Schmidt and Weiss after Zopf)

a, Single cell; b, the same after division in one direction; c, the same after division in three directions; d, packet of cells.

recognized as being so important in higher forms of life. They believed that vegetative multiplication or fissions was the sole method. More recently evidence satisfactory to many bacteriologists has been secured to suggest similar cell fusions among bacteria that have been observed among yeasts. These may and

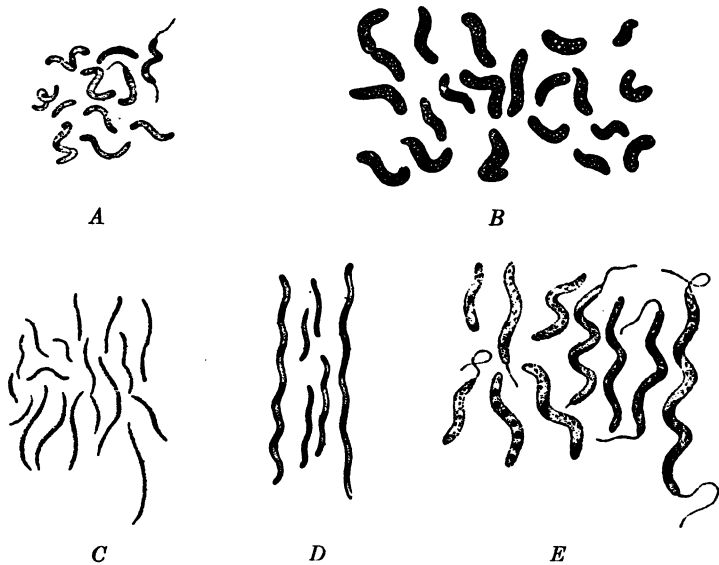

FIG. 45. Showing Various Spiral-shaped Bacteria. (After Warming)

A, *Spirillum undula*; B, *Spirillum Rosenbergtii*; C, *Spirillum serpens*; D, *Spirillum tenue*; E, *Spirillum volutans*.

probably do involve the same nuclear fusions and chromatic changes. Zygospores which result from cell fusion in forms slightly higher than bacteria have been demonstrated in *Escherichia coli*. In addition to much actual evidence which has been reported by many competent observers may be added that which comes from general biology. Bacteria are living organisms and subject to the same laws which govern higher forms. Sexual reproduction is very important. Changes in structure and function which are known to exist among bacteria are best explained on the basis that cell fusions are possible.

Rate of Reproduction. Bacteria reproduce much more rapidly than do higher forms of life. As indicated in another chapter, the

rate of growth is influenced by factors such as available food, temperature, and the nature of the bacterium.

One investigator, Barber, isolated single cells of *Escherichia coli* and placed them in hanging drops under the microscope where he could watch them for a considerable time in order to determine the actual rate of division, or "generation time." He found that the generation time gradually decreased up to 40°C., after which it increased. The following results were secured with this organism.

20°C.	60 minutes
25°C.	41 minutes
30°C.	29.7 minutes
37°C.	17-21 minutes
40°C.	17 + minutes
42°C.	19-20 minutes
45°C.	30-34 minutes
50°C.	No growth

Further information on this question is given in Chapter 15, Growth of Bacteria.

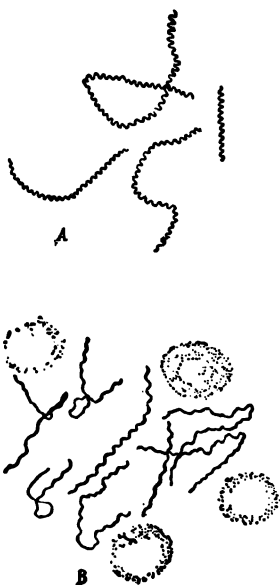

FIG. 46. (After Migula)

A, *Spirochaete plicatilis*; B, *Spirochaete Obermeieri*. A schematic illustration showing the shape of the cells.

CHEMICAL COMPOSITION OF BACTERIA

In order to understand the structure and functions of bacteria better, attempts have been made to learn more about the chemical composition of the cells themselves. It has been found, in general, that the chemical composition of bacterial cells does not vary greatly from that of other cells. The results which have been secured are influenced by various conditions, such as the organism itself, its age, and the medium on which the cells are propagated. Bacterial cells consist of the same constituents which are found in cells of other organisms. Cells of certain bacteria, *Mycobacterium tuberculosis* for instance, are rich in fats.

Elementary Composition. This is quite like that of other cells. Elements such as nitrogen, oxygen, carbon, hydrogen, sulfur, phosphorus, sodium, potassium, calcium, and traces of

other elements are found. Elements which are present are determined somewhat by the chemical composition of the medium in which the cells have been propagated. Storage of cells in physiological sodium chloride solution, for instance, increases the



FIG. 47. *Vibrio comma*. Cells dried from distilled water; reduced from a magnification of $\times 7400$.

Showing flagella on bacterial cells as revealed by the electron microscope. (Courtesy of Mudd)

sodium content. Such would probably be true for most of the common soluble salts. Larson and his colleagues have stated that two types of salts exist in bacterial cells, *free* salts and *fixed* salts. Free salts are those which are easily removed by washing and consequently are transient salts in the cell. Their concentration is perhaps somewhat dependent on the salts which are in the medium about the cells. Fixed salts are those which are bound into the cell material. They are structural salts which

cannot be removed from the cell by washing. Such a distinction explains some of the contradictory data on salt content of bacterial cells reported in the literature.

The effect of culturing bacteria in various media is well shown by the information collected by Dawson in Table 1, especially the data on fat content which is dependent on certain constituents of the media. The members of one group of bacteria contain much more fat than ordinary bacteria and are known as "acid-fast."

Chemical analysis of bacteria requires their cultivation in large amounts. This is not difficult. They may be grown in liquid media or on the surface of solid media. Removal of the cells from liquid media may be accomplished by filtration. This is a method used by manufacturers of pressed yeast to remove the yeast cells from the medium in which they have grown. The suspensions may be further concentrated by centrifugation. Removal of growth from the surface of solid media may be accomplished by scraping or by means of a suction device. The cells may then be washed and prepared for analysis.

Chemical Composition of Different Parts of the Bacterial Cell. The bacterial cell being made up of various organs would not be expected to have a homogeneous chemical composition. Each of the various organs has been examined for its own chemical make-up.

Cell Wall. Much discussion has centered about the chemical constitution of the cell wall and the presence of cellulose and chitin therein. Some have believed that the behavior of bacteria might be explained by knowing more about its composition. On the basis of the presence of cellulose, plant cells have been differentiated from animal cells. Cellulose has not been demonstrated in most bacterial cells; in a few, however, it or a substance chemically similar to it has been reported. Cellulose has been reported in *Mycobacterium tuberculosis*, *Corynebacterium diphtheriae*, and other microorganisms. Cellulose would add to the protective properties of the cell wall and in this respect is not an unexpected substance. The presence of cellulose would tend to emphasize the plant characteristics of the bacteria.

Another substance of significance in protective coverings is chitin. It is present in the shells of certain animals and has been reported in *Acetobacter xylinum*, *Bacillus anthracis*, and other.

The presence of cellulose and chitin is of considerable phylogenetic significance. In the analysis of data to decide whether bacteria are plants or animals it has been stated that the line of

TABLE I
SHOWING VARIATION IN CHEMICAL CONTENT OF *Escherichia coli*
IN RELATION TO CHEMICAL COMPOSITION OF THE MEDIUM
(After Dawson, 1919)*

	MEDIUM							
	I	II	III	IV	V	VI	VII	VIII
	%	%	%	%	%	%	%	%
Water and volatile matter.....	74.84	72.5	60.25	75.01	74.9	60.69	60.32	79.55
Ash.....	4.8	2.7	2.5	4.5	4.5	7.83	7.69	2.1
Sulfur (total).....	0.06	0.0	0.0	0.1	0.09	0.0	0.0	0.14
Sulfur (loose).....	0.0	0.0	0.0	0.02	0.01	0.0	0.0	0.03
Phosphorus, P ₂ O ₅	4.24	3.48	2.38	2.89	3.30	1.69	1.83	0.92
Calcium, CaO.....	2.66	0.05	1.06	2.62	2.60	2.34	2.34	0.19
Nitrogen—total.....	2.843	3.02	6.22	2.405	2.115	4.327	5.005	5.027
Nitrogen—amino.....	0.771	0.891	2.970	0.724	0.691	1.696	1.650	3.012
Protein—coagulation..	2.99	0.97	4.66	2.34	2.47	4.05	5.32	5.54
Protein—acid precip..	7.42	6.61	9.57	7.32	4.61	6.47	6.93	2.08
Protein—alkali precip.	5.60	7.44	2.80	6.05	5.33	6.63	6.80	4.22
Protein—soluble.....	0.05	2.25	1.31	0.07	0.10	0.08	1.21	1.10
Protein—insoluble...	0.05	0.04	0.09	0.06	0.99	0.07	0.10	0.03
Residue—insoluble...	1.00	2.37	2.00	1.40	1.70	0.98	1.49	0.76
Fats.....	3.99	4.32	4.82	5.77	8.00	5.07
Carbohydrate.....	4.00	3.10	2.19	1.38	2.69	3.01	2.88	1.00
Cellulose-like substance.....	1.00	2.42	2.01	1.41	1.75	1.09	1.52	0.81

Composition of Media Used

- I. Peptone 1 per cent, meat extract 1 per cent. Neutral in reaction.
- II. Peptone 0.5 per cent, edestin 5 per cent. Neutral in reaction.
- III. Peptone 0.25 per cent; flour proteins 1 per cent. Alkaline in reaction.
- IV. Peptone 0.25 per cent; meat extract 1 per cent; glucose 1 per cent. Neutral in reaction.
- V. Peptone 0.25 per cent, meat extract 1 per cent; glucose 1 per cent; glycerol 1 per cent, neutral in reaction.
- VI. Peptone 0.25 per cent; butter soap 1 per cent.
- VII. Peptone 0.25 per cent; butter soap 1 per cent.
- VIII. Peptone none; potato juice from whole unskinned potato, freed from starch, 500 grams potato per liter of medium.

* Andrew Ignatius Dawson, Bacterial Variations Induced by Changes in the Composition of the Culture Media, *J. Bact.* 4, (1919), 133-48.

demarcation goes through the bacteria; part of the bacteria may possess more animal characteristics, and part may possess more plant characteristics. The chemical evidence in this case may support this contention. Those bacteria which contain cellulose might be on the plant side, and the chitin-containing microorganisms might fall on the animal side.

Capsule. The capsule is a mucilaginous substance the chemical composition of which may also vary with the species, menstruum, and so on. Some have reported a high content of mucin, a compound which possesses both carbohydrate and protein characteristics. More recently the capsule has been said to consist of galactans.

Cytoplasm. The cytoplasm is protein in nature but may contain substances of widely varying composition. Undecomposed food and the various products of its metabolism may be present. The type of protein is also specific for each species; this is relied on for the identification of bacterial species by reactions which are discussed later in this book.

Spores. Chemical composition of spores probably does not differ from that of vegetative protoplasm. It was once believed that spores contained less water than vegetative protoplasm. Although this may be true, its existence in the free or bound state is more important.

REFERENCES

- BRUNYNOGHE, R., The Twort-D'Herelle Phenomenon, *J. State Med. Assoc.*, **35** (1927), 11.
- BUCHANAN, R. E., and E. I. FULMER, The Physiology and Biochemistry of Bacteria, Williams & Wilkins Co., Baltimore, 1928.
- DUBOS, R. J., The Bacterial Cell in Its Relation to Problems of Virulence, Immunity, and Chemotherapy, Harvard Univ. Monographs in Med. and Pub. Health, Cambridge, Mass., 1945.
- FAIRBROTHER, R. W., Handbook of Filterable Viruses, William Heinemann, London, 1934.
- HENRICI, A. T., The Biology of Bacteria, D. C. Heath, Boston, 1934.
- HUXLEY, J. S., The Size of Living Things, *Atlantic Monthly*, September, 1929, pp. 289-302.
- KNAYSI, G., Elements of Bacterial Cytology, Comstock Publishing Co., Ithaca, N. Y., 1944.
- VAUGHAN, V. C., Protein Split Products in Relation to Immunity and Disease, Lea & Febiger, Philadelphia, 1913.
- See also reference texts in the appendix.

CHAPTER 6

VARIABILITY OF MICROORGANISMS

All forms of life differ in one or more characteristics. At one time some microbiologists believed that the various species then known were simply different growth forms of one species. Others believed that organisms could change their shape at will. These individuals were called *pleomorphists*. Fischer characterized their opinions as follows: "The pleomorphists maintained that a coccus did not necessarily remain a coccus its life long, but it could under certain conditions stretch itself and assume the shape of a bacillus, that this again could become curved and change into a vibrio, to return again later on to the coccus form that it commenced with. Words like *Micrococcus*, *Bacillus*, *Vibrio*, *Spirillum* were in the eyes of the pleomorphists worthless designation of transient changes in shape." This represents a confused state of knowledge which is not unlike that through which many other sciences have passed. Such a conception of nature and life had to pass because it was the wrong approach to biology as we know it today. Nature does not work as the early microbiologists believed. Some of the confusion was caused by mixed and contaminated cultures, poor microscopes, and faulty interpretation of results of observations.

The pendulum soon went to the other extreme of *monomorphism*. Bacteria were then believed to have but one shape which was constant. This view was supported by Robert Koch in various publications. His reputation as a bacteriologist in the 1880's gave his opinions great weight. This hard and fast conception of structure and function of bacteria was also incorrect, and it became necessary to find explanations for variations which were not only to be expected but were even observed. Robert Koch's greatest contribution to the controversy was his introduction of a semisolid culture medium (gelatin) that made it possible to secure pure cultures, a feat which had not been accomplished with certainty before. From observations which were thus made

possible, bacterial species were seen to be more stable than they had been believed to be. This conception of *monomorphism* remained until about 1916, when a newer pleomorphism and probably more sensible one started. It should be mentioned that the modern pleomorphism is quite different from that of the early workers of several hundred years ago. Although it is now generally admitted that bacteria vary greatly in shape and function, considerable difference of opinion has existed concerning explanations. Many terms have been introduced by different investigators. Some of them have come from studies in genetics of higher plants and animals. Others have been coined to meet immediate problems. The variations which we are considering may be profound and rest on fundamental bases, or they may be transitory and result from temporary stimuli in the environment. The former are genetic alterations and are relatively permanent. The latter are transitory.

The whole subject of variation is important in different ways. It is interesting biologically because microorganisms may be used as experimental animals for studies in genetics. They are single celled and reproduce very rapidly. They respond quickly and profoundly to stimuli in their environment. It is possible to isolate single cells and propagate what may definitely be called "pure lines."

Variation may be considered with respect to any salient characteristic. Morphologic variation has been given most attention, to the detriment of other characters. Antigenic and physiological variations are recognized, but much less is known about them. Much attention was given several years ago to colony variation.

Involution Forms. This was the first attempt to explain variations from what was believed to be the normal form and still retain the conception that bacteria were constant in structure and action. Nägeli introduced the term "involution forms" in 1877 for so-called deformed aberrant forms that are often seen in all groups of living beings. One writer referred to them as the halt and maim of the bacterial world, which indicates quite well what they were considered to be. Involution has just the opposite meaning of evolution. It refers to a return to some earlier form, a regression, whereas evolution means development, advancement, and improvement. Early bacteriologists were wont to call any deviation from what they believed to be the

normal form an involution form. Such a conception was predicated on the belief that bacteria were constant, a conception contrary to good biology.

The idea has also grown that involution forms are devitalized decrepit forms. It should be remembered that the term "involution form" refers only to appearance. It has nothing to do with physiology unless it is so indicated. Abnormally shaped cells which occur in fresh young cultures of certain bacteria are far more difficult to explain. Bacteriologists ordinarily assume that young cultures of bacteria held at the optimum temperature are most active and normal in every respect. However, with certain bacteria such as *Azotobacter*, it is sometimes impossible to secure cultures free from those abnormal forms commonly referred to as involution forms. Under such optimum conditions, is it right to consider them as decrepit, diseased, or weakened forms? Such observations cause one to wonder just how useful the term involution form is, whether it should be retained with its old meaning or replaced by newer terms which more adequately fit the facts. Since Nägeli gave us the term newer explanations for the observations which promoted him to introduce it are possible.

The shortcomings of the term "involution form" caused observing bacteriologists to study abnormal forms in cultures. They soon found that they were abnormal only because some other form was arbitrarily considered to be the normal form. From these more recent investigations a *new pleomorphism* has developed—that bacteria vary within certain limits as do other groups of living beings. It is wrong to consider a form weak and diseased because it does not have the shape which one considers normal. Degenerate forms may be just as active physiologically as the latter. In some cultures they are always present, which would seem to indicate that they are to be expected and have a regular place.

VARIOUS EXPLANATIONS OF MODERN PLEOMORPHISM

Once it was established that bacteria varied widely in morphology, attempts were made to explain these variations. Some of them, of course, are quite transitory, owing to temporary effects in the environment. They disappear readily when the stimulus

is removed. Earlier writers used various terms for them such as fluctuations, impressed variations, and modification.

Mutations. These explanations have come to microbiology from investigations with higher forms of life. The mutation explanation originated with de Vries who believed that new species were formed suddenly with well-marked characteristics of their own and that they differed distinctly from the parent strains. It is less well illustrated with microorganisms than with higher forms of plants and animals. With the latter abrupt variations do occur, and they are markedly heritable.

Transmutation of Species Among Bacteria. Early bacteriologists thought they had observed change of one species of bacteria into another. Although this may be possible, a plausible explanation of their observations is that they were working with mixed cultures. At one time one type or species was dominant in their cultures; later another with a different shape may have overgrown the first. Confusion resulted which was easily explained as transmutation—change of one species into another. Although transmutation is possible today, it is probably taking place very slowly and may be restricted to a few species. It is an interesting situation to think about.

Modifications. These are the variations which occur when individuals of the same genotypic constitution are subject to different environments without changing their genetic constitution and without producing lasting changes in their cytoplasmic constitutions (Lindegren). These are transient variations caused by some stimulus in the environment such as presence of undue amounts of salt, higher temperatures, or a cell poison such as mercuric chloride. When the organism is again cultivated in absence of these, it reverts to what was considered the normal form.

Microbic Dissociation. This term which has been widely used for explaining some departures from normal implies that bacterial species are dissociating into new forms which are more or less permanent. This phenomenon of "microbic dissociation" has been studied mainly from the types of colonies formed on solid culture media in Petri dish preparations. In general, two types of colonies are recognized, rough and smooth. The *smooth colony* is just what the name indicates; it is smooth, moist, of even form, and convex in shape. The *rough colony* is quite the

opposite. It has an irregular surface, often wrinkled, and also a quite irregular edge. It is usually quite dull and dry. An interesting question is whether these colonies breed true—whether the cells in rough colonies always give rough colonies or whether smooth colonies always come from smooth. Such, however, is not the case. It has been found that single cells from colonies of both types may give either type.

To some extent, the cells in both colonies have been found to differ fundamentally. In some cases the cells differ so in appearance under the microscope that they would not be considered to be from the same parent strain if such relationship were not definitely known. Other characteristics may also be altered, but they need not be discussed here. These may be left for more advanced study. Certain it is that some of the alterations just discussed are closely related to cell physiology. For instance, the S and R forms differ antigenically, indicating that profound changes have taken place in the cells of the two strains.

Life Cycles. The fact that certain bacteria, even when cultivated under the most favorable conditions, show the presence of abnormal forms has prompted a few investigators to study them. Löhnis and Smith, after studying 42 strains of bacteria, believed that they passed through various stages which constituted a life cycle or series of stages in which one form followed another in approximation to some definite order. Life cycles are known among higher forms of life. The malarial parasite, for instance, has a life cycle involving several hosts. The life cycle of the butterfly is more striking on account of the great variation in shape and habitat of its several stages. The life-cycle hypothesis for bacteria has not been generally accepted, despite the fact that, as we come up the evolutionary line of living beings to forms which are easily studied, even certain microscopic forms, complicated life cycles are recognized. A few paragraphs may be quoted from the first paper by Löhnis and Smith.

All bacteria studied live alternately in an organized and in an amorphous stage. The latter has been called the "symplastic" stage, because at this time the living matter previously inclosed in the separate cells undergoes a thorough mixing either by a complete disintegration of cell wall, as well as cell content, or by a "melting" together of the content of many cells which leave their empty cell walls behind them. In the first case a readily stainable, in the latter case an unstainable "sympiasm" is produced.

According to the different formation and quality of the sympiasm the

development of new individual cells from this stage follows various lines. In all cases at first "regenerative units" become visible. These increase in size, turning into "regenerative bodies," which later, either by germination or by stretching, become cells of normal shape. In some cases the regenerative bodies also return temporarily into the symplastic stage.

Besides the formation of the symplasm, another mode of interaction between the plasmatic substances in bacterial cells has been observed, consisting of the direct union of two or more individual cells. This "conjunction" seems to be of no less general occurrence than the process first mentioned. The physiological significance remains to be studied.

All bacteria multiply not only by fission but also by the formation of "gonidia"; these usually become first regenerative bodies, or occasionally exospores. Sometimes the gonidia grow directly to full-sized cells. They, too, can enter the symplastic stage. The gonidia are either liberated by partial or complete dissolution of the cell wall or develop while still united with their mother cell. In the latter case the cell wall either remains intact or is pierced by the growing gonidia, which become either buds or branches.

Some of the gonidia are filterable. They also produce new bacteria either directly or after having entered the symplastic stage.

The life cycle of each species of bacteria studied is composed of several subcycles showing wide morphological and physiological differences. They are connected with each other by the symplastic stage. Direct changes from one subcycle into another occur, but they are rather rare exceptions. The transformation of spore-free into spore-forming bacteria seems to be dependent on the conditions acting upon the symplasm and regenerative bodies.

The discovery of the full life cycles of bacteria may be helpful in many directions. Systematic bacteriology now can be established on a firm experimental basis. Physiological studies will win considerably in conformity and accuracy when connected with morphological investigations along these new lines. Several problems in general biology are brought under more promising aspects. Agricultural bacteriology and medical also will derive much benefit.

Another investigator used the term "life histories" for the same phenomena.

Cyclogeny. This explanation is much like the "life cycle." It is a hypothetical arrangement of different developmental phases of a bacterium and attempts to explain variations in cultures. Into this explanation, Enderlein the author of cyclogeny brought much more than proponents of life cycles attempted to do. He provided for sexual reproduction of bacteria.

Cytomorphosis. This explanation of variations in morphology relates them to cell changes which occur during growth, senescence, and death, a process called *cytomorphosis*. Once a cell has been "born" it starts to develop through a growth cycle in

which are various shapes. This is just another explanation of the varied forms which were called involution forms by earlier investigators. Henrici, who adapted this theory to the bacteria, believed that it explained the wide variations in form and structure of bacterial cells better than the other explanations here described.

Genetic Variation. Variations have also been explained by Lindgren on the grounds that they are related to genetic composition of bacteria. A sensible approach to this whole situation would be to place it on a genetic basis and to accept the explanation that bacteria are susceptible to the same laws of heredity to which higher forms are susceptible. Bacteria differ, however, in that they multiply much more rapidly, and hereditary changes are thus more readily instituted and made permanent. This means that the "pure culture" for which bacteriologists strive may not be pure but may have different "biotypes" resulting from genetic variation.

Hybridization. This may be a frequent cause of variation in bacteria which are capable of sexual reproduction, and most of them probably are. Some bacteriologists who are not good general biologists and have not studied the literature may not agree with this. No good reasons exist for denying bacteria methods of reproduction which are common to other forms of life. This has been discussed for the yeasts in Chapter 9.

A hybrid results from crossing two distinct but closely related species. It is known in both the animal and plant worlds. In the former the mule is a good example. It results from a cross between a horse (mare) and a donkey. It is not fertile although there have been one or two instances of fertilization. In the plant world hybrid corn is produced by crossing two inbred strains of corn. The resulting progeny is an improved strain but it does not breed true when it is planted the next season.

Bacterial hybrids have been reported by crossing *Eberthella typhosa* and *Shigella dysenteriae*. These would be comparable to the hybrids previously discussed. Much more work needs to be done on bacterial hybrids.

REFERENCE

- STAKMAN, E. C. (chairman), *The Genetics of Pathogenic Organisms*, published by the American Association for the Advancement of Science, Science Press, Lancaster, Pa., 1940.

CHAPTER 7

NOMENCLATURE AND CLASSIFICATION OF BACTERIA

In a former chapter some general principles of classification of living beings were discussed. Now the classification of bacteria may be considered. Difficulties of classification of bacteria are suggested by the number of classifications which have been published and the storm of discussion which each new one stimulates. This need not worry the student who is beginning to study microbiology, for the situation would be much worse without classifications. Such a student need be concerned only with the general principles and, perhaps, with several classifications which have at times been proposed. Advanced students should give more attention to this problem. All scientists are supposed to try to systematize knowledge. Chemists use periodic tables and group closely related elements. They make such groups as halogens, alkali metals, heavy metals, and rare earths. Those who work with living organisms have found it convenient to adopt the same practice in establishing groups composed of forms having salient characteristics in common.

Biologists and bacteriologists should support any effort to organize their chosen fields. Students who are beginning the study of bacteriology will find it easier to progress and to incorporate new knowledge. One difficulty causing considerable trouble is the fact that a few common bacteria have several different names. Another is that some species are inadequately described. To avoid such situations, those who believe that they have discovered a new organism should search the literature of bacteriology to assure themselves that the organism has not been reported before by someone else. If such is found to be the case, they should then describe their organism as completely as possible, prepare drawings, microphotographs, and stained films. A culture should be sent to a "type culture collection" from which others may secure samples. This original culture then becomes the type culture for the species.

Another reason for interest in classification is that bacteria are playing greater roles in industries. Some patents are founded on the activities of bacteria, and it is necessary to describe an organism carefully. Patent litigations may center about the bacterium involved. If an organism has been carelessly described, a patent may be found to be of no value. Present confusion in these matters may be due to the fact that these subjects have not been discussed sufficiently in bacteriology courses in the past.

Difficulties Encountered in Bacterial Classification and Nomenclature. Those who have classified bacteria and other microorganisms have always encountered difficulties. This is borne out by the many classifications which have been proposed since such studies were started. One of the most difficult problems and one which can probably never be changed is that microorganisms are not static either in function or shape. They are continually changing. These changes are accelerated by the fact that microorganisms multiply very rapidly and new characteristics may be acquired or lost in a short time. Another difficulty is that shape of single-celled organisms is markedly influenced by certain conditions in the environment, and cell shape has always been an important characteristic.

The discussions in an earlier chapter on variation in bacterial species should suggest a problem for taxonomists. Morphology has always been an important characteristic for classification. In fact it was the only one used for many years. Since bacteria are definitely pleomorphic, it is necessary to use one form arbitrarily selected. How can it be proved that this is the best or normal form?

Species of Bacteria. A species (plural species) of bacteria is one kind. All bacteria which have the same characteristics are considered as belonging to the same species. Related organisms or species constitute a genus. When a genus contains but one species it is said to be monotypic. Exact definition of the term species is difficult. Different definitions would be selected by different bacteriologists. How greatly must organisms vary to belong to different genera? Provision is made within the species for slight variations in characteristics without excluding the organisms entirely from the genus. These are called varieties or variants, for example, *Bacillus subtilis* var. *thermophilus*. Few

forms of life are sharply separated from other forms. Usually intergrading forms exist which seem to connect to other forms. This may be the result of evolutionary processes.

Nomenclature of Bacteria. This has been a neglected subject among bacteriologists. The value of good nomenclature and the harm done by ignoring well-established rules have not always been appreciated. Fischer stated that the factor to which the progress of bacteriology is mainly due has also been a hindrance, for we have bacteriologists, agriculturists, brewers, botanists, and the like, all vying with one another to report new species. No one should report new species without first making an intensive study of the supposed new organism, carefully comparing with all similar bacteria which have been reported by others, and, finally, noting essential differences between the new form and those already described. Reporting of new species should be regarded as more serious than it is by some bacteriologists. The burden of proof that a new species has been discovered should rest with him who proposed it. He should not compel others to spend months and years to prove that he is wrong. As an example of the confusion which exists, the various names for *Clostridium welchii* may be given: *Bacillus aerogenes capsulatus*, *Bacillus phlegmonis emphysematosae*, *Bacillus perfringens*, *Bacillus enteritidis sporogenes*. Some confusion must be expected, but the present situation may be alleviated to some extent in the future if students are aware of the situation as it exists today.

In order to settle controversial questions as satisfactorily as possible, and classification has been one, scientists have resorted to international congresses at which representatives from all nations express their opinions. These have been useful for botanists and biologists, but have not been employed by bacteriologists to any extent for discussing such questions as classification and nomenclature.¹ These congresses have not entirely eliminated differences of opinion but have resulted in some improvement and uniformity.

The binomial system proposed by Linnaeus has been accepted by scientists as the best one for naming living organisms. According to this system, each living creature has a name composed of

¹ The second International Microbiological Congress met in London in the summer of 1936 and considered classification questions. Bacteriologists have accepted many of the rules adopted by the botanists for naming plants.

two parts—a *generic* name indicating the genus and a *specific* name for the species. The generic name is always capitalized but the specific or species name generally is not. Sometimes the specific name is capitalized when it has been derived from the name of a town or individual, but many authors consistently use the lower-case letter. This is done in the newer classification proposed by Bergey and his committee. It is also proper to append to the name of the organism the name of the discoverer (without punctuation) with the date (set off by a comma), of the earliest report in the literature which contains the name, as *Bacillus anthracis* Pollender, 1849. Often one sees the name of the author in parenthesis. This means that he proposed the specific name but placed it in a different genus than that in which it is now placed; the name of the individual responsible for placing the organism in its present genus is written after the name of the original author of the species. Thus, *Micrococcus luteus* (Schroeter, 1872) Cohn, 1872, means that Schroeter gave the organism its specific name but placed it in another genus (*Bacteridium luteum*). Cohn, however, placed it in the genus in which it now appears.

The species name need not necessarily be appropriate to the organism, although it is probably better if it is. Names are only handles which enable bacteriologists to discuss bacteria conveniently with their colleagues. Names represent groups of characteristics. They have the same function for bacteria that our names have for us. Some bacterial names are decidedly inappropriate just as are the names of some human beings. However, this need not affect the validity of the name if it does not violate unduly the well-established rules of nomenclature. The species name which gives some information about the importance of the organism, if it has any, is more convenient. The name *Eberthella typhosa* is perhaps a good name since it suggests a relation to typhoid fever.

Some bacteria are best known, not by their scientific names, but by names derived from some outstanding property. For instance, we more frequently hear the expression "tubercle bacillus" for *Mycobacterium tuberculosis*, "hay bacillus" for *Bacillus subtilis*, "potato bacillus" for *Bacillus mesentericus*, and so on. Some organisms, such as the "clam bacillus" have not been identified and classified and are known only by this so-called pseudo-

scientific name. Students who wish to know more about this interesting subject of nomenclature should consult the section in Bergey's "Manual of Determinative Bacteriology," 5th Edition, 1939, "How Bacteria are Named and Identified," pp. 39-50.

Names of bacteria are arrived at in accordance with definite rules which have been formulated after much discussion at International Congresses. These rules² are reasonable and should be heeded by anyone who is about to name what he thinks is a new species. Names of bacteria are important to bacteriologists. In the past much confusion has been caused by having, on the one hand, a bacterium with several names, and, on the other, the same name used for different bacteria.

In human society an attempt has been made to avoid such confusion by establishing certain requirements for the naming of human beings. One's name is registered today with registration officials, and a birth certificate is issued. However, no laws exist to prevent a parent from giving a child a name which is already the name of another human being, even when the other human being is not an immediate relative of the child as in the case of father and son. Great confusion is caused when two individuals of about the same age have the same or quite similar names. With microorganisms the confusion is still greater because they cannot help us to identify them readily so that we know which organism is indicated.

The International Rules of Botanical Nomenclature which are generally followed by bacteriologists state that good taste and judgment are shown by attending the following recommendations.

For Generic Names. 1. Do not make names long or difficult to pronounce.

2. Do not dedicate genera to individuals who are unknown to the science.

3. Do not take names from barbarous languages unless they are frequently cited and have an agreeable form readily adapted to the Latin tongue and to the tongues of civilized countries.

4. Avoid using adjectives as nouns.

5. Do not make names by combining words of different languages.

For Species Names. 1. Avoid names which are long and difficult to pronounce.

2. Avoid names which express a character common to all, or nearly all, species in a genus.

² They may be read in *J. Bot.*, June 1934, or in Bergey's "Manual of Determinative Bacteriology," 5th Edition, pp. 52-68.

3. Avoid names of little-known or restricted localities unless the species is quite local.
4. Avoid, in the same genus, names which are much alike, especially those which differ only in their last letters.
5. Do not name a species after an individual who has not studied it nor had anything to do with it.
6. Avoid names which have been used before in any closely allied genus.
7. Avoid hyphenated names.

The Descriptive Chart and Index Number. About 50 years ago a few bacteriologists in America believed that, if bacteria were studied according to a definite outline of procedure, more uniformity would exist, and there might be less possibility of an organism appearing in the literature under different names. This effort finally culminated in the "Descriptive Chart" of the Society of American Bacteriologists. Examination of it will reveal how the salient characteristics of an unknown organism are determined.

One feature of the descriptive chart is the index number formerly called the group number. This index number is the result of an attempt to give numerical expression to the major characteristics of bacteria. It does not mean that this index number will or should replace names. It is convenient, however, for comparing a large number of strains of one organism or the flora of any material. By means of the index number groups of organisms with prominent characteristics in common are formed. For instance, Hucker, in an intensive study of the spherical bacteria, used the index number with very slight modifications.

Characteristics Used for Classifying Bacteria. What characteristics are used for classifying bacteria? Examination of the classifications reproduced in this chapter will reveal that shape of the cell (morphology) was one of the first characteristics to be employed. With this the three large groups mentioned earlier in this chapter were classified. Morphological characteristics were also used for dividing these larger groups. Space relationship has been used for subdividing the round cells, formation of endospores or the presence or absence of organs of locomotion for the cylindrical cells, and degree of bend or twist for the members of the third group. Use of such characteristics gives what are called morphological classifications.

Physiological or functional characters have assumed greater importance in the newer classifications. They are the character-

istics which result from the metabolic activities of the organism and include the action of the organism on carbohydrates, proteins, fats, and so on. They generally require the use of chemical tests, and many of them are carried out by the student in the laboratory. Physiological characters also have been used for establishing large groups of bacteria having some salient property in common. "Lactic acid" bacteria constitute a physiological group since bacteriologists place in this group those which form appreciably large amounts of lactic acid. This is not a safe method of final grouping because the property used for making the group may be exhibited by other bacteria only to a lesser degree. This method also brings together forms which are quite unlike with respect to other characters well established in taxonomic work. Probably all forms of life produce a little lactic acid and might, therefore, be placed in the "lactic acid group." Other groups based on physiological characteristics are chromogenic, zymogenic, acetic acid, and so on.

The pathogenic group is one of marked interest. It is based on the ability of its members to cause infections in animals and plants. The pathogenic group is divided into subgroups mainly on the basis of certain characteristics of the members. In addition to morphological and physiological characteristics, serological or serum reactions may have a limited value in classification of bacteria. These are reactions which are based on certain properties of constituents of the blood serum. They are delicate reactions, for blood serum may be diluted thousands of times and yet give specific reactions. They are discussed later in this book.

Early Classifications of Bacteria. As soon as information accumulated about bacteria and different species were reported, bacteriologists attempted to arrange them in systems called classifications. Many of these early attempts are of historical interest only, since the necessity of pure cultures was not realized, and methods of working which every bacteriologist uses today were not available. One cannot classify mixtures of microorganisms without pure cultures any more than the chemist can determine melting points on impure chemical substances. These earlier classifications may be passed over in a book of this nature. They are reviewed in books on classification of bacteria, a number of which have been recently published.

Two of the older classifications may be mentioned since they have been rather widely used and have some merit. The first, prepared by Migula in 1895, had wide popularity in America, more so than any other. The reason for its popularity may not be apparent, although it may be that Migula's classification was used by Chester in his "A Manual of Determinative Bacteriology," published in 1901. The second one is by Lehmann and Neumann, a revision of which was published by Lehmann in 1927. The old one will be given here because it represents the older ideas in classification.

Migula's Classification of Bacteria. This classification was once used by American bacteriologists.

ORDER EUBACTERIA

Cells without nuclei, sulfur, or bacteriopurpurin, colorless or but slightly colored; some forms chlorophyll green.

FAMILY I. COCCACEAE

Cells when free spherical, in division sometimes elliptical. Division in one, two, or three planes of space without previous elongation of the cell. Motility and endospore formation rare.

1. *Streptococcus*. Spherical cells dividing in one plane, often remaining attached to each other to form pairs or chains. Zooglea-like sheath or capsule common. Nonmotile. No endospores.
2. *Micrococcus*. Division in two planes, sometimes forming bands of cells. Nonmotile. Endospores probably absent.
3. *Sarcina*. Division in three planes at right angles to each other, forming packets when the cells remain attached to each other. Nonmotile. Endospore formation doubtful.
4. *Planococcus*. Division in two planes. Flagella present. Usually 1 to 2 in number. No endospores known.
5. *Planosarcina*. Division in three planes, pairs and tetrads usually seen rather than packets. Flagella present, usually one to each cell. No endospores.

FAMILY II. BACTERIACEAE

Cells cylindrical rods in free condition, dividing in a plane at right angles to their length. Short-celled forms may be distinguished from cocci by elongation before division. Cells may remain united, forming long or short threads. No sheath.

1. *Bacterium*. No flagella. Some form spores, others do not.
2. *Bacillus*. Peritrichic flagella. Spore formation common.
3. *Pseudomonas*. Polar flagella, 1 to 10 in number. Endospores in some forms.

FAMILY III. SPIRILLACEAE

Cells more or less spirally curved, division in one plane at right angles to long axis. Spore formation rare. Most forms motile, with polar flagella.

1. *Spirosoma*. Broad rigid cells, nonmotile, free or in small zooglea groups.
2. *Microspira*. Cells usually comma- or sausage-shaped, motile, with or rarely 2 to 3 polar flagella. Endospores not observed.
3. *Spirillum*. Long or short spirals, lophotrichic flagella, spores sometimes observed.
4. *Spirochaeta*. Slender spiral cells, generally long and flexible, showing serpentine and screw-like motions. Organs of motility unknown. Spores not observed.

FAMILY IV. CHLAMYDOBACTERIACEAE

Cylindrical cells arranged in threads with sheath. Reproduction by conidia which arise directly from the vegetative cells and develop into new threads without any resting stage.

1. *Chlamydothrix*. Unbranched filaments, segments often demonstrable by the use of reagents. Conidia nonmotile.
2. *Crenothrix*. Unbranched filaments with differentiation between base and apex. Sheath thick and in iron waters often permeated with hydrate of iron. Cells cylindrical or flat discoidal, conidia nonmotile.
3. *Phragmidiothrix*. Very long threads with delicate sheath. Conidia nonmotile.
4. *Sphaerotilus*. Cells in dichotomously branched threads, conidia motile.

ORDER THIOBACTERIA

Cells with no nuclei but with inclusions of sulfur; colorless or colored red, rose, or violet with bacteriopurpurin. Never green.

This order includes the families Beggiatoaceae (genera *Thiothrix* and *Beggiatoa*), Rhodobacteriaceae (genus *Thiocystis*), *Thiocapsa*, *Thiosarcina*, *Lamproystitis*, *Thiopedia*, *Amoebabacter*, *Thiothece*, *Thiodictyon*, *Thiopolycoccus chromatium*, *Rhabdochromatium* and *Thiospirillum*, into the classification of which we need not enter here.

Lehmann and Neumann's Classification of Bacteria. Another classification which has enjoyed rather widespread use was prepared by Lehmann³ and Neumann.

³ Dr. Lehmann published a more elaborate classification of bacteria in 1927. The earlier one is given here since it represents in a better way the principles followed a few years ago.

I. COCCACEAE

1. *Streptococcus*. Dividing in one plane.
2. *Sarcina*. Dividing in three planes.
3. *Micrococcus*. Irregular division, including all but clearly marked chains and packets.

II. BACTERIACEAE

1. *Bacterium*. Without endogenous spores, rods usually 0.8-1.0 micron in diameter.
2. *Bacillus*. With endogenous spores, rods often more than 1.0 micron in diameter.

III. SPIRILLACEAE

1. *Vibrio*. Short rigid slightly curved cells, with 1 to 2 polar flagella.
2. *Spirillum*. Long rigid spiral cells, with lophotrichic flagella.
3. *Spirochaeta*. Long flexible spiral cells, flagella unknown, motility accomplished by an undulating membrane.

SUPPLEMENTARY GROUP

ACTINOMYCETES

Thread-like cells with true branching, sometimes even a richly branching mycelium. Young cultures often show only normal unbranched bacterial cells. Many forms show a tendency to the formation of irregular clubbed cells.

1. *Corynebacterium*. Slender often slightly curved rods, often with a tendency to club formation; branching rare in young cultures and often difficult to find even in old ones. Neither flagella nor spores known. With weak stains show barred staining. Not acid-fast.
2. *Mycobacterium*. Same as 1 except for the fact that the cells are acid-fast and take ordinary stains with difficulty, and that club forms are very rare outside the body.
3. *Actinomyces*. Long mycelial threads, showing true branching. Spores formed by fragmentation and cross division of filaments. Many forms produce a mold-like aerial mycelium. Not acid-fast. Motility sometimes present. Most forms produce a moldy odor.

Comparison of these classifications brings out some differences. It may be seen that Migula distinguishes *Bacillus* from *Bacterium* on the basis of motility, the former being motile and the latter nonmotile. Lehmann and Neumann distinguish these genera on the basis of spore formation, *Bacterium* forming no spores and *Bacillus* forming spores. Both classifications are morphological, based on shape and structure. The use of different classifications

thus results in slightly different names for the same organism. These names frequently differ only in the generic portion, and little confusion results.

Classification and Key for Identification of Organisms of the Class Schizomycetes from Bergey's "Manual of Determinative Bacteriology," 5th Edition. Inadequacies of the older classification caused much study of classification in America. This resulted in the appointment of a committee on classification by the Society of American Bacteriologists. This committee after several years of study prepared a classification which was well received by some bacteriologists and not by others. It was modified by Bergey and a committee and appears today in a book known as "Bergey's Manual of Determinative Bacteriology." This classification is widely used today and probably may be considered to be standard for most bacteriologists. It probably has inherent weaknesses, but they are fewer than in the older classification.

This classification recognizes rules of nomenclature and taxonomy which have been used by animal and plant biologists. In general, the International Rules of Botanical Nomenclature adopted by the Fifth International Botanical Congress held in Cambridge, England, in 1930, have been followed. The student will notice that first of all the class *Schizomycetes* is characterized.

In this class are the following orders:

- | | |
|----------------------------------|------------------------------|
| I. EUBACTERIALES. | IV. CAULOBACTERIALES. |
| II. ACTINOMYCETALES. | V. THIOBACTERIALES. |
| III. CHALMYDOBACTERIALES. | VI. MYXOBACTERIALES. |

These orders are subdivided into families and the families into tribes. These are given in the following classification outline.

CLASS SCHIZOMYCETES NÄGELI, 1857

Typically unicellular plants, cells usually small and relatively primitive in organization. The cells are of many shapes, spherical, cylindrical, spiral, or filamentous; cells often united into groups, families, or filaments; occasionally in the latter showing some differentiation among the cells, simulating the organization seen in certain of the blue-green filamentous algae. Multiplication typically by cell fission. Endospores are formed by some species of the Eubacteriales, conidia by some of the filamentous forms. Chlorophyll is produced by none of the bacteria (with the possible exception of a single genus). Many forms produce pigments of other types. The cells may be motile by means of flagella; some of the forms intergrading with the pro-

tozoa are flexuous; a few filamentous forms (as *Beggiatoa*) show oscillatory movement similar to that of certain blue-green algae (as *Oscillatoria*).

ORDER I. EUBACTERIALES BUCHANAN, 1917

Simple and undifferentiated forms, without true branching. Occur as spheres, short or long straight rods, or as curved rods. Motile or nonmotile. Endospore formation occurs in some species. Some species form pigment. Some species store reserve materials as volutin, glycogen, or fat. Sulfur and/or iron are not stored as visible particles.

FAMILY I. NITROBACTERIACEAE BUCHANAN, 1917

Organisms usually rod-shaped, sometimes spherical. Peritrichous or nonmotile. Branched involution forms are sometimes produced. Endospores not formed. Depend on hydrogen, methane, carbon monoxide, ammonia, sulfur or thiosulfates for energy. Nonparasitic, usually water or soil forms.

TRIBE I. NITROBACTEREAE WINSLOW ET AL.

Organisms deriving energy from oxidation of ammonia or nitrates.

Genus 1. Nitrobacter Winogradsky

Cells rod-shaped, nonmotile, not growing readily on organic media, oxidizing nitrites to nitrates. From nitro and Greek *bakterion*, a small stick.

The type species is *Nitrobacter Winogradskyi* Buchanan.

Genus 2. Nitrosomonas Winogradsky

Cells rod-shaped, motile, possessing polar flagella or nonmotile. Capable of securing growth energy by the oxidation of ammonia to nitrites. Growth in artificial media containing organic matter usually scanty or absent. From nitroso and Greek *monas*.

The type species is *Nitrosomonas europaea* Winogradsky.

Genus 3. Nitrosococcus Winogradsky

Large spherical organisms, showing no growth on ordinary culture media. Change ammonia to nitrites in soil and in suitable culture media. From nitroso and Greek *kokkos*, sphere.

The type species is *Nitrosococcus nitrosus* (*Migula*) Bergey et al.

TRIBE II. PROTOBACTERIEAE RAHN

Organisms deriving their life energy from oxidation of simple compounds of hydrogen or carbon.

Genus 4. Hydrogenomonas Orla-Jensen

Short rods capable of growing in the absence of organic matter and securing growth energy by the oxidation of hydrogen, forming water. From Greek *hydro*, water; *geno*, producing; and *monas*, flagellate unit.

The type species is *Hydrogenomonas pantotropha* (Kaserer) Orla-Jensen.

Genus 5. Methanomonas Orla-Jensen

Monotrichous short rods capable of growing in the absence of organic matter and securing growth energy by the oxidation of methane, forming carbon dioxide and water. From methane and Greek *monas*.

The type species is *Methanomonas methanica* (Söhngen) Orla-Jensen.

Genus 6. Carboxydomonas Orla-Jensen

Autotrophic rod-shaped cells capable of securing growth energy by the oxidation of carbon monoxide forming carbon dioxide. From carboxydo and Greek *monas*.

The type species is *Carboxydomonas oligo carbophila* (Beijerinck and van Delden) Orla-Jensen.

TRIBE III. THIOBACILLEAE BERGEY, BREED AND MURRAY

Organisms deriving their life energy from oxidation of sulfur or sulfur compounds.

Genus 7. Thiobacillus Beijerinck

Small rod-shaped organisms deriving their energy from the oxidation of sulfides, thiosulfates, or elementary sulfur, forming sulfur, persulfates, and sulfates under acid or alkaline conditions and deriving their carbon from carbon dioxide or from bicarbonates and carbonates in solution; some are obligate and some facultative autotrophic. One species is anaerobic. From Greek *theion*, sulfur, and Latin *bacillum*, a small rod.

The type species is *Thiobacillus thioparus* Beijerinck.

FAMILY II. RHIZOBIACEAE CONN

Cells rod-shaped. Utilizing dextrose and sometimes other sugars, without producing organic acids in appreciable quantity. A single polar or lateral flagellum, or 2-4 peritrichous flagella, or nonmotile. Have a tendency to be Gram-negative.

Genus 1. Rhizobium Frank

Obligate aerobes capable of producing nodules on the roots of leguminous plants, the symbiosis ordinarily resulting in the fixation of atmospheric nitrogen available to the host plant. Gram-negative rods, 0.5 to 0.9 by 1.2 to 3.0 microns; motile when young, commonly changing to bacteroidal forms (a) on artificial culture media containing alkaloids or glucosides, or in which acidity is increased or (b) during symbiosis within the nodule. Optimum temperature 25°C. Heterotrophic. Addition of yeast, malt, or plant extracts desirable for rapid growth on artificial media. Slight production of nitrates; nitrites not utilized. Gelatin liquefied not at all or only slightly after prolonged incubation.

The type species is *Rhizobium leguminosarum* Frank.

Genus 2. Chromobacterium Bergonzini

Aerobic bacteria producing a violet chromoparous pigment, soluble in alcohol but not in chloroform.

The type species is *Chromobacterium violaceum* (Schroeter) Bergonzini.

Genus 3. Alcaligenes Castellani and Chalmers

Peritrichous to monotrichous or nonmotile rods which generally occur in the intestinal canal, in decaying materials, dairy products, and soil. Do not form acetylmethylcarbinol. Do not produce organic acids from the carbohydrates.

The type species is *Alcaligenes faecalis* Castellani and Chalmers.

FAMILY III. PSEUDOMONADACEAE WINSLOW ET AL.

Cells elongate, straight rods to those that are more or less spirally curved. Cell divisions always transverse, never longitudinal. Cells nonflexuous, without endospores. Usually motile by means of polar flagella, sometimes nonmotile. Gram-negative. Typically water or soil forms. Some species are animal or plant parasites.

TRIBE I. SPIRILLEAE KLUYVER AND VAN NIEL

More or less spirally curved cells. Nonflexuous.

Genus 1. Vibrio Müller

Cells short, bent rods, rigid, single or united into spirals. Motile by means of a single (or, rarely, 2 or 3) polar flagellum, which is usually relatively short. Many species liquefy gelatin and are active ammonifiers. Aerobic, facultative anaerobic. No endospores formed. Usually Gram-negative. Water forms; a few are parasites.

The type species is *Vibrio comma* (Schroeter) Bergey et al.

Genus 2. Cellvibrio Winogradsky

Long slender rods, slightly curved, with rounded ends, show deeply staining granules (arthrospores?) which appear to be concerned in reproduction. Motile with a polar flagellum. Oxidize cellulose, forming oxycellulose. Growth on ordinary culture media is feeble.

The type species is *Cellvibrio ochraceus* Winogradsky.

Genus 3. Cellfalcicula Winogradsky

Short rods or spindles, not exceeding 2.0 microns in length, with pointed ends. Show metachromatic granules. Old cultures show coccoid forms. Motile with a single polar flagellum. Oxidize cellulose, forming oxycellulose. Growth on ordinary culture media is feeble.

The type species is *Cellfalcicula viridis* Winogradsky.

Genus 4. Spirillum Ehrenberg

Cells rigid, rods of varying thickness, length, and pitch of spiral, forming either long screws or portions of a turn. Usually motile by means of a tuft of polar flagella (5 to 20). The flagella occur at one or both poles; the number varies greatly and is difficult to determine. Found in water and putrid infusions.

The type species is *Spirillum undula* (Müller) Ehrenberg.

TRIBE II. PSEUDOMONADEAE KLUYVER AND VAN NIEL

Principally soil and water bacteria, and many plant pathogens. Motile by means of polar flagella or nonmotile. Gram-negative.

Genus 5. Pseudomonas Migula

Principally water and soil bacteria producing a water-soluble pigment which diffuses through the medium as a green, blue, or yellowish-green pigment. Motile or nonmotile. Gram-negative.

The type species is *Pseudomonas aeruginosa* (Schroeter) Migula.

Genus 6. Phytomonas Bergey et Al.

Rods, yellow (36 per cent) or white (64 per cent), motile (93 per cent) or nonmotile, the motile species possessing either mono- or lophotrichous flagella. Many species form a water-soluble green fluorescent pigment (38 per cent). Mostly Gram-negative (90 per cent).

The type species is *Phytomonas campestris* (Pammel) Bergey et al.

Genus 7. Protaminobacter den Dooren de Jong

Motile and nonmotile, Gram-negative rods capable of attacking one or more of the lower alkylamines, growing moderately or poorly on ordinary peptone agar. These bacteria are especially endowed to attack substances

containing the group $\text{HN} \begin{matrix} \diagup \text{C} \\ \diagdown \text{C} \end{matrix}$.

The type species is *Protaminobacter alboflavum* a den Dooren de Jong.

Genus 7. Mycoplana Gray and Thornton

Rods, motile, showing branching cells. Capable of using aromatic compounds, as phenol, etc., as a source of energy. Occur in soil.

Type species *Mycoplana dimorpha* Gray and Thornton.

FAMILY IV. ACETOBACTERIACEAE BERGEY,
BREED AND MURRAY

Cells rod-shaped, but frequently with elongated, branched, or swollen forms. Capable of oxidizing alcohol to acetic acid.

Genus 1. Actobacter Beijerinck

Cells rod-shaped, frequently in chains, motile by means of polar flagella or nonmotile. Usually grow on the surface of alcoholic solutions as obligate

aerobes, securing growth energy by the oxidation of alcohol to acetic acid. Also capable of utilizing many other carbonaceous compounds, as sugar and acetic acid. Elongated, filamentous, club-shaped, swollen, and even branched cells may occur as involution forms.

The type species is *Acetobacter aceti* (Kützing) Beijerinck.

FAMILY V. AZOTOBACTERIACEAE BERGEY, BREED AND MURRAY

Large rods or oval cells which utilize free nitrogen.

Genus 1. Azotobacter Beijerinck

Relatively large rods or even cocci, sometimes almost yeast-like in appearance, dependent primarily for growth energy on the oxidation of carbohydrates. Motile or nonmotile. When motile, with a single or a tuft of polar flagella. Obligate aerobes usually growing in a film on the surface of the culture medium. Capable of fixing atmospheric nitrogen when grown in solutions containing carbohydrates and deficient in combined nitrogen. Grows best on media poor in nitrogen.

The type species is *Azotobacter chroococcum* Beijerinck.

FAMILY VI. MICROCOCCACEAE PRIBRAM

Cells in their free condition spherical; during division somewhat elliptical. Division in two or three planes. If the cells remain in contact after division, they are frequently flattened in the plane of division and occur singly, in pairs, tetrads, packets, or irregular masses. Motility rare. Endospores probably absent. Produce abundant surface growth on ordinary media. Metabolism complex, usually involving the utilization of amino acids and carbohydrates. Many species form lemon-yellow, orange or red pigment. Aerobes, facultative anaerobes, and anaerobes. Generally Gram-positive.

Genus 1. Micrococcus Cohn

Facultative parasites or saprophytes. Cells in plates or irregular masses (never in long chains or packets). Generally Gram-positive. Growth on agar usually abundant; some species form no pigment, but others form yellow or, less commonly, orange, or red pigment. Dextrose broth slightly acid, lactose broth generally neutral. Gelatin frequently liquefied, but not rapidly.

The type species is *Micrococcus luteus* (Schroeter) Cohn.

Genus 2. Staphylococcus Rosenbach

Usually parasitic, cells occur singly, in pairs, and in irregular groups, rarely in packets. Usually Gram-positive. Growth fair to good on the surface of artificial media. As a rule carbohydrates are fermented with the formation of acid. Gelatin commonly liquefied. Nitrites may or may not be produced from nitrates. Produce hemolysis on blood agar. Pigment white or orange or, less commonly, lemon yellow.

The type species is *Staphylococcus aureus* Rosenbach.

Genus 3. Gaffkya Trevisan

Parasitic organisms, occurring in the animal body and in special media as tetrads, while in ordinary culture media they occur in pairs and irregular masses. Aerobic to anaerobic. Gram-positive.

The type species is *Gaffkya tetragena* (Gaffky) Trevisan.

Genus 4. Sarcina Goodsir

Saprophytes and facultative parasites. Division occurs, under favorable conditions, in three planes, producing regular packets. Usually Gram-positive. Growth on agar abundant, usually with formation of yellow or orange pigment. Dextrose broth slightly acid, lactose broth generally neutral. Gelatin frequently liquefied. Nitrites may or may not be produced from nitrates.

The type species is *Sarcina ventriculi* Goodsir.

FAMILY VII. NEISSERIACEAE PRÉVOT

Strict parasites, some species failing to grow or growing poorly on ordinary culture media. Aerobes, facultative anaerobes, and anaerobes. Grow best at 37°C. Some species show no growth at 20°C. Growth fairly abundant on serum media. Cells in pairs and masses. Gram-negative.

Genus 1. Neisseria Trevisan

Paired Gram-negative cocci with adjacent sides flattened which grow as aerobes, facultative anaerobes, or anaerobes. Found on mucous membranes, or invading blood stream and localizing in tissues, joints, or meninges of mammals. Limited biochemical activity; few carbohydrates utilized, indol not produced, nitrites not produced from nitrates, catalase produced abundantly.

The type species is *Neisseria gonorrhoeae* Trevisan.

Genus 2. Veillonella Prévot

Cocci of very small size, average 0.3 micron, occurring in masses, rarely in pairs or short chains. Nonmotile. Gram-negative. Cells undifferentiated and united by an interstitial substance of an ectoplasmic nature. Generally plasmolyzed in hypertonic 5 per cent salt solution in a few hours. The species described thus far are anaerobic.

The type species is *Veillonella parvula* (Veillon and Zuber) Prévot.

FAMILY VIII. PARVOBACTERIACEAE RAHN

Small motile or nonmotile rods which grow well on media containing body fluids. Gram-negative. Usually do not liquefy gelatin. Not active in the fermentation of carbohydrates. Usually parasitic on warm-blooded animals, infection in some cases taking place by penetration of organisms through mucous membranes or skin.

128 NOMENCLATURE AND CLASSIFICATION OF BACTERIA

TRIBE I. PASTEURELLEAE CASTELLANI AND CHALMERS

Small, motile or nonmotile, ovoid to elongated rods showing bipolar staining.

Genus 1. Pasteurella Trevisan

Small, Gram-negative, ovoid to elongated rods showing bipolar staining by special methods; aerobic, facultative; require low oxidation-reduction potential on primary isolation; powers of carbohydrate fermentation slight; no lactose fermentation; no gas production; gelatin not liquefied; milk not coagulated; parasitic on man, other mammals, and birds.

The type species is *Pasteurella avicida* (Gamaleïa) Trevisan (*Pasteurella aviseptica* (Kitt) Schütze).

Genus 2. Malleomyces Pribram

Short rods, with rounded ends, sometimes forming threads and showing a tendency toward branching. Motile or nonmotile. Gram-negative. Tendency to bipolar staining. Milk slowly coagulated. Gelatin may be liquefied. Specialized for parasitic life. Grow well on blood serum and other body fluid media.

The type species is *Malleomyces mallei* (Flügge) Pribram.

TRIBE II. BRUCELLEAE BERGEY, BREED AND MURRAY

Small, motile or nonmotile rods which grow on ordinary media.

Genus 3. Brucella Meyer and Shaw

Minute rods with many coccoid cells, 0.5 by 0.5 to 2.0 microns; motile or nonmotile; Gram-negative; gelatin not liquefied; neither acid nor gas from carbohydrates; parasitic, invading animal tissue, producing infection of the genital tract, the mammary gland, or the lymphatic tissues, the respiratory and intestinal tracts; pathogenic for various species of domestic animals and man.

The type species is *Brucella melitensis* (Hughes) Meyer and Shaw.

TRIBE III. HEMOPHILEAE WINSLOW ET AL.

Minute parasitic forms growing on first isolation only in the presence of hemoglobin, ascitic fluid, or other body fluids, or in the presence of certain growth accessory substances found in sterile unheated plant tissue (potato). Motile or nonmotile. Commonly found in the mucosa of respiratory tract or conjunctiva.

Genus 4. Hemophilus Winslow et Al.

Minute rod-shaped cells, sometimes thread-forming and pleomorphic. Nonmotile. Strict parasites growing best (or only) in the presence of hemoglobin and in general requiring blood serum, ascitic fluid, or certain growth accessory substances. Gram-negative.

The type species is *Hemophilus influenzae* (Lehmann and Neumann) Winslow et al.

Genus 5. Noguchia Olitsky, Syverton and Tyler

Small, slender, Gram-negative rods present in the conjunctiva of man and animals affected by a follicular type of disease; mucoid type of growth which on first isolation takes place with some difficulty in ordinary media; motile, flagellated, and encapsulated; aerobic and facultative anaerobic; optimum temperature for growth 28° to 30°C.

The type species is *Noguchia granulosis* (Noguchi) Olitsky, Syverton and Tyler.

Genus 6. Dialister Bergey et Al.

Minute rod-shaped cells, occurring singly, in pairs, and short chains. Nonmotile. Strict parasites. Growth occurs only under anaerobic conditions in media containing fresh sterile tissue or ascitic fluid.

The type species is *Dialister pneumosintes* (Olitsky and Gates) Bergey et al.

FAMILY IX. LACTOBACTERIACEAE ORLA-JENSEN

Cocci and rods occurring singly, in pairs, and in chains. Ferment carbohydrates readily with the production of lactic acid and some volatile acid. Some types also produce carbon dioxide and ethyl alcohol from dextrose and mannitol from levulose. Rarely motile. Rarely liquefy gelatin. Nitrates not utilized. Pigment, if any, yellow, orange-red, or rusty brown. Aerobic to anaerobic. Do not grow well on the surface of agar media. Gram-positive.

TRIBE I. STREPTOCOCCAE TREVISAN

Parasites and saprophytes. Grow well under anaerobic conditions. Some forms grow with difficulty on serum-free media, none very abundantly. Planes of fission usually parallel, producing pairs, or short or long chains, never packets. Fermentative powers high, producing lactic acid from dextrose, lactose and sucrose. When gas is formed, it is CO₂ without H₂.

Genus 1. Diplococcus Weichselbaum

Parasites, growing poorly or not at all on artificial media. Cells usually in pairs, somewhat elongated, encapsulated, sometimes in chains. Gram-positive. Fermentative powers high, most strains forming acid from dextrose, lactose, sucrose, and inulin. Aerobic species bile-soluble.

The relationships of the strictly anaerobic diplococci placed in this genus by Prévot to pneumococci have not yet been developed sufficiently to justify any authoritative comment. The anaerobic species are included in the genus in the hope that this arrangement will stimulate research.

The type species is *Diplococcus pneumoniae* Weichselbaum.

Genus 2. Streptococcus Rosenbach

Cells spherical or ovoid, rarely elongated into rods, occurring in short or long chains or in pairs. Never arranged in packets and do not form zoogloal masses. Gram-positive, some decolorizing readily. Capsules not

marked as a rule but well developed at times. Growth tends to be slight on artificial media, and some species are aided by the addition of native proteins; isolated colonies are small and translucent; they may be effuse, convex, or mucoid. Cultures are found which produce a rusty red growth in deep agar stabs. Certain strains form a yellow-to-orange pigment in starch broth. Action on blood is variable, but characteristic changes are produced by some species. Little surface growth is produced in stab cultures. Various carbohydrates are fermented with dextrorotary lactic acid as the dominant product. Carbon dioxide, volatile acids, and other volatile compounds are produced in small quantities, if at all, from carbohydrate fermentation. Nitrites are not produced from nitrates, and inulin is rarely attacked. Most species are aerobic and facultative anaerobic; many species are normally parasitic, and some are highly pathogenic. None are soluble in bile.

The strictly anaerobic streptococci, some of which produce gas and foul odors, are not completely defined, and they may merit being separated in a new genus.

The type species is *Streptococcus pyogenes* Rosenbach.

Genus 3. Leuconostoc Van Tieghem emend. Hucker and Pederson

Cells normally occurring as spheres. Gram-positive. Nonmotile. Under certain conditions, as in acid fruit and vegetables, the cells may lengthen and become pointed or even elongated into a rod.

Grow on ordinary media, but growth is enhanced by the addition of yeast cells, extract of yeast, or other vegetable tissues. Generally produce a limited amount of acid. Rarely curdle milk.

Produce mannitol from levulose. By-products of the fermentation of dextrose include carbon dioxide, lactic acid, acetic acid, and ethyl alcohol. Approximately one fourth of the dextrose fermented is converted to carbon dioxide. Levolactic acid is always produced and sometimes dextralactic acid. Certain types grow with a characteristic slime formation in sucrose media. Ordinarily do not increase the amount of soluble nitrogen in the medium even after long period of incubation.

The type species is *Leuconostoc mesenteroides* (Cienkowski) Van Tieghem.

TRIBE II. LACTOBACILLEAE WINSLOW ET AL.

Rods, often long and slender. Nonmotile. Ferment carbohydrates, polyalcohols, and lactic acid. Do not liquefy gelatin, reduce nitrates, or produce indol. Grow poorly, if at all, on potato. Some species grow at relatively high temperatures. Microaerophilic to anaerobic. Surface growth on media is poor. Gram-positive.

Genus 4. Lactobacillus Beijerinck

Rods often long and slender. Always produce lactic acid from carbohydrates. When gas is formed, it is CO₂ without H₂. A number of species are somewhat thermophilic. As a rule, microaerophilic.

The type species is *Lactobacillus caucasicus* Beijerinck.

Subgenera are *Thermobacterium* Orla-Jensen, *Streptobacterium* Orla-Jensen and *Betabacterium* Orla-Jensen.

Genus 5. Propionibacterium, Orla-Jensen

Nonmotile, non-spore-forming, Gram-positive bacteria, growing under anaerobic conditions in neutral media as short diphtheroid rods, sometimes resembling streptococci; under aerobic conditions growing as long, irregular, club-shaped, and branched cells. Metachromatic granules demonstrable with Albert's stain.

Ferment lactic acid, carbohydrates, and polyalcohols with the formation of propionic and acetic acids and carbon dioxide. As a rule strongly catalase positive, sometimes weakly so.

Strong tendency towards anaerobiosis; development very slow, macroscopically visible colonies generally not discernible in less than 5 to 7 days. Nutritional requirements complex. Development best in yeast extract media with addition of lactate or simple carbohydrates. Optimum temperature 30°C.

The type species is *Propionibacterium freudenreichii* van Niel.

FAMILY X. ENTEROBACTERIACEAE RAHN

Gram-negative rods widely distributed in nature. Many animals parasites and some plant parasites causing blights and soft rots. Grow well on artificial media. All species attack carbohydrates forming acid, or acid and visible gas (H₂ present). All produce nitrites from nitrates. When motile, the flagella are peritrichous.

TRIBE I. ESCHERICHEAE BERGEY, BREED AND MURRAY

Ferment dextrose and lactose with the formation of acid and visible gas. Do not liquefy gelatin except slowly in one genus (*Aerobacter*).

Genus 1. Escherichia Castellani and Chalmers

Non-spore-forming, Gram-negative short rods fermenting dextrose and lactose with acid and gas production and growing aerobically. Commonly occurring in the intestinal canal of animals. Widely distributed in nature. Methyl red test positive; Voges-Proskauer reaction negative. Carbon dioxide and hydrogen produced in approximately equal volumes from dextrose.

Genus 2. Aerobacter Beijerinck

Non-spore-forming, Gram-negative short rods, fermenting dextrose and lactose with acid and gas production and growing aerobically. Widely distributed in nature. Methyl red test negative; Voges-Proskauer test positive. Form two or more times as much carbon dioxide as hydrogen from dextrose; trimethylene glycol not produced from glycerol by anaerobic fermentation; citric acid utilized as sole source of carbon.

The type species is *Aerobacter aerogenes* (Kruse) Beijerinck.

Genus 3. Klebsiella Trevisan

Short rods, somewhat plump with rounded ends, mostly occurring singly. Encapsulated. Nonmotile. Gram-negative. Ferment a number of carbohydrates with the formation of acid and gas. Nitrites are produced from nitrates. Encountered principally in the respiratory tract of man. Aerobic, growing well on ordinary culture media.

The type species is *Klebsiella pneumoniae* Trevisan.

TRIBE II. ERWINEAE WINSLOW ET AL.

Plant pathogens. Invade the tissues of plants and produce local lesions; some species killing the host plants. Usually motile with peritrichous flagella. Ferment dextrose and lactose with formation of acid, or acid and visible gas. Usually attack pectin.

Genus 4. Erwinia Winslow et Al.

Characters for the genus as for the tribe. (The type species would be *Erwinia amylovora* Winslow et al.)

TRIBE III. SERRATEAE BERGEY, BREED AND MURRAY

Small aerobic rods, usually producing a red or pink pigment on agar or gelatin.

Genus 5. Serratia Bizio emend. Breed and Breed

Small, aerobic, rapidly liquefying, nitrate-reducing, Gram-negative, peritrichous rods which produce characteristic red pigment. White to rose-red strains that lack brilliant colors are common. Coagulate and digest milk. Liquefy blood serum. Typical species produce CO₂ and frequently H₂ from dextrose and other sugars; also acetic, formic, succinic, and lactic acids, acetylmethylcarbinol, and 2,3 butylene glycol.

The type species is *Serratia marcescens* Bizio.

TRIBE IV. PROTEAE CASTELLANI AND CHALMERS

Ferment dextrose but not lactose with formation of acid and visible gas. Usually liquefy gelatin.

Genus 6. Proteus Hauser

Highly pleomorphic rods. Filamentous and curved rods common as well as involution forms. Gram-negative. Generally actively motile, possessing peritrichous flagella. Characteristically produce amoeboid colonies, etc., on moist media and decompose proteins. Ferment dextrose and generally sucrose, but not lactose. Do not usually yield a positive Voges-Proskauer test. Urea decomposed.

The type species is *Proteus vulgaris* Hauser.

TRIBE V. SALMONELLEAE BERGEY, BREED AND MURRAY

Motile with peritrichous flagella and nonmotile Gram-negative rods. Non-spore-forming. Attack numerous carbohydrates with the formation of

acid, or acid and gas. Certain species of the genus *Shigella* attack lactose. Voges-Proskauer test negative. Gelatin not liquefied (exceptions have been noted, but are very rare). Urea not hydrolyzed. Milk not peptonized. No spreading growth.

Genus 7. Salmonella Lignières

Usually motile, but nonmotile forms occur. Attack numerous carbohydrates with the formation of acid, and usually gas. Lactose, sucrose, and salicin not attacked. Do not form indol or liquefy gelatin.

The type species is *Salmonella choleraesuis* (Smith) Weldin.

Genus 8. Eberthella Buchanan

Gram-negative motile rods. Attack a number of carbohydrates with the formation of acid but no gas. Do not form acetylmethylcarbinol.

The type species is *Eberthella typhosa* (Zopf) Weldin.

Genus 9. Shigella Castellani and Chalmers

Gram-negative nonmotile rods. Attack a number of carbohydrates with the formation of acid but no gas. Do not produce acetylmethylcarbinol.

The type species is *Shigella dysenteriae* (Shiga) Castellani and Chalmers.

FAMILY XI. BACTERIACEAE COHN

Rod-shaped cells without endospores. Motile or nonmotile. Metabolism complex, amino acids being utilized, and generally carbohydrates.

This is a heterogeneous collection of genera whose relationships to each other and to other groups are not clear.

Genus 1. Listerella Pirie

Small rods. Without endospores. Gram-positive. Motile with a single long terminal flagellum. Aerobic to microaerophilic. Grow freely on ordinary media. Certain carbohydrates attacked. Pathogenic parasites. Infection characterized by a monocytosis.

The type species is *Listerella monocytogenes* (Murray et al.) Pirie.

Genus 2. Microbacterium Orla-Jensen

Small rods. Nonmotile. Without endospores. Gram-positive. Produce lactic acid from carbohydrates. May be transition group to types that liquefy gelatin and do not form acid from carbohydrates. Produce nitrites from nitrates. Surface growth on media is good. Produce catalase.

The type species is *Microbacterium lacticum* Orla-Jensen.

Genus 3. Kurthia Trevisan

Long rods occurring in evenly curved chains. Gram-positive. Motile with peritrichous flagella. Proteus-like growth on media. Carbohydrates and gelatin not attacked. Hydrogen sulfide not formed.

The type species is *Kurthia zopfi* (Kurth) Trevisan.

Genus 4. Cellulomonas Bergey et Al.

Small rods, with rounded ends, non-spore-forming, motile with peritrichous flagella or nonmotile, occurring in soil and having the property of digesting cellulose. Growth on ordinary culture media often not vigorous. Gram-negative.

The type species is *Cellulomonas biazotea* (Kellerman) Bergey et al.

Genus 5. Achromobacter Bergey et Al.

Non-pigment-forming (at most no pigment formed on agar or gelatin) rods, occurring in water and soil. Motile with peritrichous flagella or nonmotile. Gram-negative.

The type species is *Achromobacter liquefaciens* (Eisenberg) Bergey et al.

Genus 6. Flavobacterium Bergey et Al.

Rods of medium size, occurring in water and soil, forming a yellow to orange pigment on culture media. Characterized by feeble powers of attacking carbohydrates, occasionally forming acid from hexoses but no gas. Motile with peritrichous flagella or nonmotile. Generally Gram-negative.

The type species is *Flavobacterium aquatile* (Frankland and Frankland) Bergey et al.

Genus 7. Actinobacillus Brumpt

Medium-sized aerobic Gram-negative rods which frequently show much pleomorphism. Coccus-like forms frequent. Acid but not gas usually produced from carbohydrates. Grow best, especially when freshly isolated, under increased CO₂ tension. Pathogenic for animals; some species occasionally attack man. The outstanding characteristic of the group is the tendency to form aggregates in tissues or culture which resemble the so-called sulfur granules of actinomycosis.

The type species is *Actinobacillus lignieresii* Brumpt.

Genus 8. Bacteroides Castellani and Chalmers

Motile or nonmotile rods without endospores. Obligate anaerobes. May or may not require enriched culture media. Gram-negative.

The type species is *Bacteroides fragilis* (Veillon and Zuber) Castellani and Chalmers.

Genus 9. Fusobacterium Knorr

Gram-negative, anaerobic rods usually with tapering ends. Usually nonmotile. Stain with more or less distinct granules.

The type species is *Fusobacterium plauti-vincenti* Knorr.

Genus 10. Bacterium Ehrenberg

The original description of this genus follows:

Bacterium, Novum Genus, Familia Vibrionorum. Character Generis: Corpus polygastricum? anenterum? nudum, oblongum, fusiforme aut fili-

forme, rectum, monomorphum (contractione nunquam dilatatum), parum flexile (nec aperte undatum), transverse in multas partes sponte dividuum.

The type species is *Bacterium triloculare* Ehrenberg.

FAMILY V. BACILLACEAE FISCHER, 1895

Rods producing endospores, usually Gram-positive. Flagella, when present, generally peritrichous. Often decompose protein media actively through the agency of enzymes.

Genus 1. Bacillus Cohn

Rod-shaped bacteria, sometimes in chains. Aerobic. Nonmotile or motile by means of peritrichous flagella. Endospores formed. Generally Gram-positive. Chemoheterotrophic, oxidizing various organic compounds. From Latin *bacillum*, a small stick.

The internationally accepted (*J. Bact.*, **33**, 1937, 445) type species is *Bacillus subtilis* Cohn emend. Prazmowski.

Genus 2. Clostridium Prazmowski

Anaerobes or microaerophiles, often parasitic. Rods frequently enlarged at sporulation, producing clostridium or plectridium forms.

The type species is *Clostridium butyricum* Prazmowski.

ORDER II. ACTINOMYCETALES BUCHANAN

Cells usually elongated, frequently filamentous and with a tendency toward the development of branches, in some genera giving rise to the formation of a definite branched mycelium. Cells frequently show swellings, clubbed or irregular shapes. No pseudoplasmodium. No deposits of free sulfur or iron. No bacteriopurpurin. Endospores not produced but conidia are developed in some genera. Usually Gram-positive. Nonmotile. Some species parasitic in animals or plants. As a rule strongly oxidative. Complex proteins frequently required. Growth on culture media often slow; some genera showing mold-like colonies. No water forms.

FAMILY I. MYCOBACTERIACEAE CHESTER

Slender filaments, straight or slightly curved rods, frequently irregular in form with only slight and occasional branching. Often stain unevenly (showing variations in staining reaction within the cell). No conidia formed. Nonmotile. Aerobic. Gram-positive.

Genus 1. Corynebacterium Lehmann and Neumann

Slender, often slightly curved, rods with a tendency to club and pointed forms, with branching forms in old cultures. Barred uneven staining. Not acid-fast. Gram-positive. Nonmotile. Usually aerobic. No endospores. Some pathogenic species produce a powerful exotoxin. Characteristic snapping motion is exhibited when cells divide.

The type species is *Corynebacterium diphtheriae* (Flügge) Lehmann and Neumann.

Genus 2. Mycobacterium Lehmann and Neumann

Slender rods which are stained with difficulty, but when once stained are acid-fast. Cells sometimes show swollen, clavate, or cuneate forms, and occasionally even branched forms. Growth on media slow for most species. Aerobic. Several species pathogenic to animals.

The type species is *Mycobacterium tuberculosis* (Schroeter) Lehmann and Neumann.

FAMILY II. ACTINOMYCETACEAE BUCHANAN

Branching rods and filamentous forms, sometimes forming a mycelium. Conidia sometimes present. Some species are parasitic. Some are soil forms.

Genus 1. Leptotrichia Trevisan

Thick, long, straight, or curved filaments, unbranched, frequently clubbed at one end and tapering to the other. Gram-positive when young. Filaments fragment into short thick rods. Anaerobic or facultative. No aerial hyphae or conidia. Parasites or facultative parasites.

The type species is *Leptotrichia buccalis* (Robin) Trevisan.

Genus 2. Erysipelothrix Rosenbach

Rod-shaped organisms with a tendency to the formation of long filaments which may show branching. The filaments may also thicken and show characteristic granules. No spores. Nonmotile. Gram-positive. Microaerophilic. Usually parasitic.

The type species is *Erysipelothrix rhusiopathiae* (Migula) Holland.

Genus 3. Proactinomyces Jensen

Slender filaments or rods, frequently swollen and occasionally branched, generally forming in the first stage of growth very small mycelia which, however, early assume the appearance of bacterium-like growths. Shorter rods and coccoid forms are found in older cultures. Conidia not formed. Stain readily, occasionally showing a slight degree of acid-fastness. Nonmotile. Non-spore-forming. Aerobic. Gram-positive. The colonies are similar in gross appearance to those of the genus *Mycobacterium*. Paraffin, phenol, and *m*-cresol are frequently utilized as sources of energy.

The type species is *Proactinomyces agrestis* (Gray and Thornton) Jensen.

Genus 4. Actinomyces Harz

Organisms growing in the form of a much-branched mycelium, which may break up into segments that function as conidia. Sometimes parasitic, with clubbed ends of radiating threads conspicuous in lesions in the animal body. Some species are microaerophilic or anaerobic. Nonmotile.

The type species is *Actinomyces bovis* Harz.

ORDER III. CHLAMYDOBACTERIALES BUCHANAN

Filamentous bacteria, alga-like, typically water forms, ensheathed. They may be unbranched, or show true branching, or false branching, arising

from lateral displacement of the cells of the filament within the sheath, which give rise to a new filament, so that the sheath is branched while the filaments are separate. The sheath may be composed entirely of iron hydroxide or of an organic matrix impregnated with iron, or may be entirely organic. Conidia and motile "swarmers" may be developed, but never endospores. Sulfur granules or bacteriopurpurin absent. Mature cells or filaments not protozoa-like.

FAMILY I. CHLAMYDOBACTERIACEAE MIGULA

Characters for the family as for the order.

Genus 1. Sphaerotilus Kützing

Attached, colorless threads, showing false branching, though this may be rare in some species. Filaments consist of rod-shaped or oval cells, surrounded by a firm sheath. Multiplication occurs both by nonmotile conidia and by motile "swarmers," the latter with lophotrichous flagella.

The type species is *Sphaerotilus natans* Kützing.

Genus 2. Clonothrix Roze

Attached filaments showing false branching as in *Sphaerotilus*. Sheaths organic, encrusted with iron or manganese, broader at the base and tapering toward the tip. Cells colorless, cylindrical. Reproduction by spherical conidia formed in chains by transverse fission of cells; conidia formation acropetal, limited to short branches of the younger portion of the filaments.

The type species is *Clonothrix fusca* Roze.

Genus 3. Leptothrix Kützing

Filaments of cylindrical colorless cells, with a sheath at first thin and colorless, later thicker, yellow or brown, encrusted with iron oxide. The iron may be dissolved by dilute acid, whereupon the inner cells show up well. Multiplication is by division and abstraction of cells and by motile cylindrical swarmers. True branching may occur.

The type species is *Leptothrix ochracea* Kützing.

Genus 4. Crenothrix Cohn

Filaments not branched, attached to a firm substrate, showing differentiation of base and tip. Sheaths plainly visible, thin and colorless at the tip, thick and encrusted with iron at the base. Cells cylindrical to spherical, dividing in three planes to produce the spherical nonmotile conidia.

The type (and only) species is *Crenothrix polyspora* Cohn.

ORDER IV. CAULOBACTERIALES HENRICI AND JOHNSON

Nonfilamentous bacteria growing characteristically on stalks. The cells are asymmetrical in that gum, ferric hydroxide, or other material is secreted from one side or one end of the cell to form the stalk. Multiplying typically

by transverse fission, in one family by longitudinal fission, and by budding. In some species the stalks may be very short or absent, the cells connected directly to the substrate or to each other by holdfasts. Cells occur singly or in pairs, never in chains or filaments; not ensheathed. Typically aquatic in habitat; some may be parasitic in animals.

FAMILY I. NEVSKIACEAE HENRICI AND JOHNSON

Stalked bacteria, the long axis of the rod-shaped cells being set at right angles to the axis of the stalk. Stalks lobose, dichotomously branched, composed of gum. Multiplication of cells by transverse binary fission. Growing in zoogloea-like masses in water or in sugar vats.

Genus 1. Nevskia Famintzin

Description as for the family.

The type species is *Nevskia ramosa* Famintzin.

FAMILY II. GALLIONELLACEAE HENRICI AND JOHNSON

Stalked bacteria, the long axis of the rod-shaped cells being set at right angles to the axis of the stalks. Stalks are slender twisted bands, dichotomously branched, composed of ferric hydroxide, completely dissolving in dilute hydrochloric acid. Multiplication of cells by transverse binary fission. Growing in iron-bearing waters.

There is a single genus *Gallionella*.

Genus 1. Gallionella Ehrenberg

Description as for the family.

The type species is *Gallionella ferruginea* Ehrenberg.

FAMILY III. CAULOBACTERIACEAE HENRICI AND JOHNSON

Stalked bacteria, the long axis of the elongated cells coinciding with the long axis of the stalks. Stalks are slender, flagellum-like, often attached to the substrate by a button-like holdfast, unbranched. Multiplication of cells by transverse binary fission. The outermost cell of a pair may form a stalk before cell division is complete. Periphytic, growing upon submerged surfaces.

There is a single genus *Caulobacter*.

Genus 1. Caulobacter Henrici and Johnson

Description as for the family.

The type species is *Caulobacter vibrioides*.

FAMILY IV. PASTEURACEAE LAURENT EMEND. HENRICI AND JOHNSON

Stalked bacteria with spherical or pear-shaped cells; if cells are elongated, long axis of cell coincides with axis of stalk. Stalks may be very short or

absent, but, when present, are usually very fine and at times arranged in whorls attached to a common holdfast. Cells multiply by longitudinal fission or by budding or by both. Mostly periphytic, one species is parasitic.

Genus 1. Pasteuria Metchnikoff

Pear-shaped cells attached to each other or to a firm substrate by holdfasts secreted at the narrow end, multiplying by longitudinal fission and by budding of spherical or ovoid cells at the free end.

The type species is *Pasteuria ramosa* Metchnikoff.

Genus 2. Blastocaulis Henrici and Johnson

Pear-shaped or globular cells attached to a firm substrate by long slender stalks with a holdfast at the base. Stalks may occur singly or may arise in clusters from a common holdfast. Not cultivated in artificial media.

The type species is *Blastocaulis sphaerica*.

ORDER V. THIOBACTERIALES BUCHANAN

Cells various, typically containing either granules of free sulfur, or bacteriopurpurin, or both, usually growing best in the presence of hydrogen sulfide. The cells are plant-like, not protozoan-like, not producing a pseudoplasmodium or a highly developed resting stage. Spores are rarely or never formed.

FAMILY I. RHODOBACTERIACEAE MIGULA

Cells of various types, not filamentous, containing bacteriopurpurin, with or without sulfur granules.

According to Molisch ("Die Purpurbakterien," Jena, 1907, 64) very few species of this family have been studied in pure culture. Those that have been isolated and studied were found to be able to exist saprophytically and were not able to exist without organic matter.

SUBFAMILY I. CHROMATIOIDEAE BUCHANAN

Cells not filamentous, containing both sulfur granules and bacteriopurpurin.

TRIBE I. THIOCAPSEAE BUCHANAN

Bacteria containing both sulfur granules and bacteriopurpurin. Cells divide in three directions of space, united into families.

Genus 1. Thiocystis Winogradsky

Usually 4 to 30 cells massed into small compact families, enveloped singly or several together in a gelatinous cyst, capable of swarming. When the families have reached a definite size they escape from the gelatinous cyst, the latter swelling and softening uniformly or at some particular spot. The escaped cells either pass into the swarm stage or unite into a large fused complex of families from which they separate later. Cells are light colored,

single cells almost colorless. In masses the cells show a beautiful violet or red color. The cells are frequently filled with sulfur granules.

The type species is *Thiocystis violacea* Winogradsky.

Genus 2. Thiosphaera Miyoshi

Cells spherical-ellipsoidal, relatively large (7 to 8 microns), light violet in color, bound into loose families by a colorless gelatin. Capable of swarming. Sulfur inclusions relatively abundant.

The type species is *Thiosphaera gelatinosa* Miyoshi.

Genus 3. Thiosphaerion Miyoshi

Cells spherical-elliptical, small (1.8 to 2.5 microns), violet in color, with delicate sulfur inclusions. United by means of gelatin into solid spherical families. Capable of swarming.

Genus 4. Thiocapsa Winogradsky

Cell families resembling, in grouping and multiplication, the cells of the alga genus *Aphanocapsa*. Cell division occurs in all directions of space, the cells are spherical, with thick confluent membranes, which unite to form a structureless gelatinous layer. The cells are of a bright rose-red color and contain sulfur granules. The cells do not swarm.

The type species is *Thiocapsa roseopersicina* Winogradsky.

Genus 5. Thiosarcina Winogradsky

Nonswarming cells arranged in packet-shaped families, corresponding to the genus *Sarcina*. Cells red, with sulfur granules.

The type species is *Thiosarcina rosea* (Schroeter) Winogradsky.

TRIBE II. LAMPROCYSTEAEE BUCHANAN

Cells united into families in which division of the cells occurs first in three planes, then in two.

Genus 1. Lamprocystis Schroeter

Cells ellipsoidal, dividing at first in three planes to form spherical cell masses, later in two planes, forming hollow sacks in which the cells lie embedded in a layer in the walls; finally the membrane ruptures, and the whole mass becomes net-like, much as in the algal genus *Clathrocystis*. Usually colored intensely violet. Small sulfur granules present. Capable of swarming.

The type species is *Lamprocystis roseopersicina* (Kützing) Schroeter.

TRIBE III. THIOPEDEIAEE BUCHANAN

Sulfur bacteria in which the cells are united into families, and cell division occurs in two directions of space, resulting in the development of plates of cells.

Genus 1. Thiopedia Winogradsky

Families in form of plates. Capable of swarming. Cells contain bacteriopurpurin and bacteriochlorin.

The type species is *Thiopedia rosea* Winogradsky.

Genus 2. Thioderma Miyoshi

Cells spherical, light rose in color, containing small inconspicuous sulfur granules. United by a thin purplish membrane.

The type species is *Thioderma rosea* Miyoshi.

Genus 3. Lampropedia Schroeter

Cells united into tetrads, forming flat tubular masses, contain sulfur granules and bacteriopurpurin.

The type species is *Lampropedia hyalina* (Kützing) Schroeter.

TRIBE IV. AMOEOBACTERIEAE BUCHANAN

Sulfur bacteria in which the cells are united into families. Cell division occurring only in one direction of space.

Genus 1. Amoebobacter Winogradsky

Cells connected by plasma threads. Families amoeboid, motile. The cell families slowly change form, the cells drawing together into a heap or spreading out widely, thus bringing about a change in the shape of the whole family. In a resting condition a common gelatin is extruded, and the surface becomes a firm membrane.

The type species is *Amoebobacter roseum* Winogradsky.

Genus 2. Thiodictyon Winogradsky

Cells rod-shaped or spindle-shaped, with sharply pointed ends, united into a net. The compact mass of rods finally assumes an appearance like that of *Hydrodictyon*. Slight violet color.

The type species is *Thiodictyon elegans* Winogradsky.

Genus 3. Thiothece Winogradsky

Cells spherical, in families, enclosed in a thick gelatinous cyst. Cells capable of swarming and very loosely embedded in a common gelatin. When the swarm stage supervenes the cells lie more loosely, the gelatin is swollen, and the cells swarm out singly and rather irregularly.

The type species is *Thiothece gelatinosa* Winogradsky.

Genus 4. Thiopolyoccus Winogradsky

Families solid, nonmotile, consisting of small cells closely appressed. Multiplication of the colonies by breaking up of the surface into numerous short threads and lobes which continue to split up into smaller heaps.

The type species is *Thiopolyoccus ruber* Winogradsky.

TRIBE V. CHROMATIEAE BUCHANAN

Sulfur bacteria in which the cells are not united into families, but are free and capable of swarming at any time.

Genus 1. Chromatium Perty

Cells cylindrical-elliptical or relatively thick cylindrical. Cell contents red, containing dark sulfur granules. Cells somewhat variable in shape, straight, more or less bent; short ovoid and longer forms more cylindrical. Motile by means of polar flagella.

The type species is *Chromatium okenii* Perty.

Genus 2. Rhabdomonas Cohn

Differentiated from *Chromatium* by the elongated rod-shaped or spindle-shaped cells. Cells red, with sulfur granules, and flagella.

The type species is *Rhabdomonas rosea* Cohn.

Genus 3. Thiospirillum Winogradsky

Spiral motile bacteria containing sulfur granules and bacteriopurpurin.

The type species is *Thiospirillum sanguineum* (Ehrenberg) Winogradsky.

Genus 4. Rhodocapsa Molisch

Cells free (not united in families); not capable of swarming (nonmotile). In mass, the organisms are cherry red. Contain sulfur granules.

The type species is *Rhodocapsa suspensa* Molisch.

Genus 5. Rhodotheca Molisch

Cells usually spherical and in pairs, each surrounded by a spherical or elliptical capsule. Nonmotile. Cells not united into families. Cells contain bacteriopurpurin and sulfur granules.

The type species is *Rhodotheca pendens* Molisch.

Subfamily II. Rhodobacterioideae Buchanan

Cells not filamentous, containing bacteriopurpurin but no granules of sulfur.

Genus 1. Rhodocystis Molisch

Cells rod-shaped, dividing only in one plane, embedded in a common slimy capsule.

The type species is *Rhodocystis gelatinosa* Molisch.

Genus 2. Rhodonostoc Molisch

Cells spherical or short rods, in rosary-like chains, and embedded in a common gelatinous capsule.

The type species is *Rhodonostoc capsulatum* Molisch.

Genus 3. Rhodorrhagus Bergey et Al.

Cells spherical, nonmotile, free, not united into families.

The type species is *Rhodorrhagus capsulatus* (Molisch) Bergey et Al.

Genus 4. Rhodobacterium Molisch

Rod-shaped cells, nonmotile, not united into families.

The type species is *Rhodobacterium capsulatum* Molisch.

Genus 5. Rhodobacillus Molisch

Rod-shaped cells, solitary, usually motile.

The type species is *Rhodobacillus palustris* Molisch.

Genus 6. Rhodovibrio Molisch

Cells short, comma-shaped, free, actively motile with a polar flagellum.

The type species is *Rhodovibrio parvus* Molisch.

Genus 7. Rhodospirillum Molisch

Cells spiral, actively motile by means of polar flagella.

The type species is *Rhodospirillum rubrum* (Esmarch) Molisch.

FAMILY II. BEGGIATOACEAE MIGULA

Filamentous bacteria, usually showing an oscillating motion similar to *Oscillatoria*. Cells contain sulfur granules. Spore formation and conidia unknown.

Genus 1. Thiothrix Winogradsky

Filaments nonmotile, segmented, with a definite differentiation into base and tip, attached, usually filled with sulfur granules. The threads produce rod-shaped conidia at the ends. These conidia are motile, exhibiting a slow creeping movement; attach themselves, and develop into threads. The habitat is hot sulfur springs.

The type species is *Thiothrix nivea* (Rabenhorst) Winogradsky.

Genus 2. Beggiatoa Trevisan

Threads sheathless, formed of flat discoidal cells, not attached. Multiplication by transverse splitting of the threads. Show undulatory creeping. Cells contain granules of sulfur.

The type species is *Beggiatoa alba* (Vaucher) Trevisan.

Genus 3. Thioploca Lauterborn

Filaments *Beggiatoa*-like, with numerous sulfur granules, motile, lying parallel in considerable numbers, or united in bundles enclosed in a colorless layer of gelatin.

The type species is *Thioploca schmidlei* Lauterborn.

FAMILY III. ACHROMATIACEAE BUCHANAN

Unicellular, large, motile (by means of flagella?). Cells containing granules of sulfur (or in one form possibly oxalate), but no bacteriopurpurin.

Genus 1. Achromatium Schewiakoff

Cells large, nearly spherical (in newly divided cells), to ellipsoidal, 9 to 22 by 15 to 43 microns. Cells closely packed with large granules, at first interpreted as sulfur, but later as calcium oxalate. When granules are dissolved, cells show a coarse structure. Cells are motile. Cell division resembles the constriction of flagellates rather than the fission characteristics of bacteria.

The type species is *Achromatium oxaliferum* Schewiakoff.

Genus 2. Thiophysa Hinze

Spherical cells, the cell membrane of which is loaded with sulfur granules. The protoplasmic layer surrounds a large central vacuole. The oxalate is contained in the vacuole. Cell nucleus not recognized. Flagella lacking. Cells elongate before division, divide into biscuit-shaped cells. Cells 7 to 18 microns in diameter.

In the presence of an excess of oxygen the sulfur drops disappear, and only the oxalate remains. With a lack of oxygen, in the presence of H_2S , the oxalate disappears, and sulfur drops fill the cell.

The type species is *Thiophysa volutans* Hinze.

Genus 3. Thiospira Vislouch

Colorless, motile, slightly bent, somewhat pointed at the ends, with granules of sulfur within the cells, and a small number of flagella at the ends.

The type species is *Thiospira winogradskyi* (Omelianski) Vislouch.

Genus 4. Hillhousia West and Griffiths

Cells very large, 20 to 33 by 42 to 86 microns. Motile by means of peritrichous flagella. Cells packed with large globules of oily amorphous sulfur.

The type species is *Hillhousia mirabilis* West and Griffiths.

ORDER VI. MYXOBACTERIALES JAHN

The cells develop as a colony (pseudoplasmodium or swarm) consisting of slender relatively flexible elongate rods. The cells move together as an advancing mass by the excretion of a slime. No flagella. The fruiting bodies may consist of numerous spores which develop by a shortening of the rods, or of cysts in the interior of which lie more or less shortened rods. Fruiting bodies various, sometimes sessile, frequently stalked. Usually colored, frequently yellow or red.

Usually cultivated on dung media. Most species found on dung, or isolated from soil. One species aquatic, parasitic on *Cladophora*.

FAMILY I. ARCHANGIACEAE JAHN

In the organisms belonging to this family the swarm (pseudoplasmodium) produces irregular swollen or twisted fruiting bodies, or develops columnar or finger-like growths usually without a definitely differentiated membrane.

Genus 1. Archangium Jahn

Etymology, Greek (nouns) primitive and vessel (according to Jahn, this genus is the most primitive).

The mass of shortened rods embedded in slime form a pad-shaped or more rounded superficially swollen or tuberous fruiting body, even with horny divisions. The fruiting body has no membrane. In the interior can be seen a mass resembling coiled intestines. The windings of this coil may be uniform, or irregularly jointed, free or stuck together; the ends may be extended and horny. Instead of a membrane there may be loosely enveloping slime.

The type species is *Archangium gephyra* Jahn.

Genus 2. Stelangium Jahn

Etymology: Greek (noun) = pillar or column and vessel.

Diagnosis: Fruiting bodies are columnar or finger-like, sometimes forked, without definite stalk, standing upright on the substrate.

Type species, *Stelangium muscorum* (Thaxter) Jahn.

FAMILY II. SORANGIACEAE JAHN

Etymology: Greek (nouns) = heap and vessel.

Diagnosis: The shortened rods of the fruiting body lie in angular, usually relatively small, cysts of definite polygonal shape. Often many of these cysts are surrounded by a common membrane. The primary cyst may be differentiated from the angular or secondary cysts. No stalked forms are known.

There is a single genus, *Sorangium*.

Genus 1. Sorangium Jahn

Etymology: Greek (nouns) = heap and vessel.

Diagnosis: As the family. The cysts are united into rounded fruiting bodies.

Five species have been allocated to this genus.

Type species: *Sorangium schroeteri* Jahn.

FAMILY III. POLYANGIACEAE JAHN

Etymology: Greek, many vessels.

Diagnosis: In the fruiting bodies the more or less shortened rods lie in rounded cysts of definite form. The well-defined wall is composed of hardened slime, and is yellow, red, or brownish. The cysts may be united by a definitely visible slime membrane, the remnant of the vegetative slime,

or they may be tightly appressed and cemented by the scarcely visible remnants of the slime, or they may develop singly or in numbers on a stalk. In the more highly developed forms the stalk branches and carries the cysts at the tips of the branches.

Genus 1. Polyangium Link

Etymology: Greek, many vessels, referring to the numerous cysts.

Diagnosis: Cysts rounded or coiled, surrounded by a well-developed membrane, either free or embedded in a second slimy layer. Eleven species are recognized of which the type is *Polyangium vitellinum* Link.

Genus 2. Synangium Jahn

Etymology: Greek (noun), together and vessel, referring to the clustering of the cysts.

Diagnosis: Cysts provided with an apical point, united more or less completely to rosette-shaped, hemispherical, or spherical fruiting bodies. Of the three species described, the first named, *Synangium sessile* (Thaxter) Jahn may be designated as the type.

Genus 3. Melittangium Jahn

Etymology: Greek (nouns) for bee and vessel, because of the honeycomb pattern of the membrane.

Diagnosis: Cysts brownish orange-red, on short white stalk, like a mushroom. Has appearance of a white-stalked *Boletus*. The rods inside stand at right angles to the membrane. On germination the covering membrane is left colorless and with an appearance of honeycomb.

The genus has a single (type) species *Melittangium boletus* Jahn.

Genus 4. Podangium Jahn

Etymology: Greek (noun) foot and vessel.

Diagnosis: Cysts chestnut brown or red-brown, single on a more or less definite white stalk.

Three species described; of which the first *Podangium erectum* (Schroeter) Jahn may be designated as the type.

Genus 5. Chondromyces Berkeley and Curtis

Etymology: Greek (noun) = grain and thread (fungus).

Diagnosis: Cysts compactly grouped at the end of a colored stalk (cystophore). Cystophore simple or branched.

Type species *Chondromyces crocatus* Berkeley and Curtis.

FAMILY IV. MYXOCOCCACEAE JAHN

Etymology: From generic name, *Myxococcus*.

Diagnosis: The rods become short when cysts are formed and develop into spherical spores. On germination they elongate to rods, without rupturing the membrane. The type genus is *Myxococcus*.

Genus 1. Myxococcus Thaxter

Etymology: Greek (noun) = slime and coccus (ball).

Diagnosis: Spherical spores in conical or spherical or occasionally ovoid upright fruiting bodies, united by a loose more or less mobile slime.

Five species, of which *Myxococcus fulvus* (Cohn *emend.* Schroeter) Jahn is the type.

Genus 2. Chondrococcus Jahn

Synonym: A segregate from *Myxococcus Thaxter*.

Etymology: Greek (noun) = grain and ball (coccus).

Diagnosis: Spores embedded in a viscous slime which hardens. Fruiting bodies divided by joints or constrictions, often branched, usually relatively small.

Five species are included, of which the first described by Thaxter and best described, *Chondrococcus coralloides* (Thaxter) Jahn, may be designated as the type. The first species listed by Jahn is regarded as doubtful and should not be considered as the type, for there is no evidence that Jahn ever saw the species.

Genus 3. Angiococcus Jahn

A segregate from *Myxococcus Thaxter*.

Etymology: Greek (noun) = vessel and coccus (ball).

Diagnosis: Fruiting body consisting of numerous round (disk-shaped) cysts, cyst wall thin, spores within.

One species only, hence the type by monotypy, *Angiococcus disciformis* (Thaxter) Jahn.

ORDER VII. SPIROCHAETALES BUCHANAN

Protozoon-like in certain characters. Cells usually slender flexous spirals; multiplication of cells by transverse division; no conclusive evidence of longitudinal division. Motility often characteristic but without polarity.

There is a single family.

FAMILY I. SPIROCHAETACEAE SWELLENGREBEL

Characters those of the order.

Genus 1. Spirochaeta Ehrenberg

Nonparasitic, with flexible undulating body and with or without flagelliform tapering ends. Common in sewage and foul waters.

The type species is *Spirochaeta plicatilis* Ehrenberg.

Genus 2. Saprospira Gross

Nonparasitic forms similar to *Cristispira* but without the flattened ridge or "crista" which is, if present, here replaced by a straight columella or thickening of the periplast.

The type species is *Saprospira grandis* Gross.

Genus 3. Cristispira Gross

Giant forms with undulating body and peculiar flattened ridge erroneously called an undulating membrane which runs the length of the body. Parasitic in mollusks.

The type species is *Cristispira balbianii* Certes.

Genus 4. Borrelia Swellengrebel

Small parasitic spiral forms; flexible, with terminal filaments. The spirals are large, wavy, three to five in number.

The type species is *Borellia gallinarum* Swellengrebel.

Genus 5. Treponema Schaudinn

Parasitic and frequently pathogenic forms with undulating or rigid spirilliform body. Without crista or columella. With or without flagelliform tapering ends.

The type species is *Treponema pallidum* (Schaudinn and Hoffmann) Schaudinn.

Genus 6. Leptospira Noguchi

Parasitic forms. Sharply twisted cylinders with flagelliform tapering ends, one extremity being sharply curved into a hook.

The type species is *Leptospira icterohaemorrhagiae* (Inado and Ido) Noguchi.

The classification just reported is from the 5th Edition of Bergey's "Manual of Determinative Bacteriology." The sixth edition which will probably appear during 1947 will be based on the following outline.

Phylum *Schizophyta* (Fission plants).

Class I. *Schizophyceae* (Fission algae. Blue-green algae).

II. *Schizomycetes* (Fission fungi).

Order I. *Eubacteriales* (True bacteria. Rigid cells that are flagellate when they are motile).

Suborder I. *Eubacteriineae* (Unattached and do not possess photosynthetic pigments. Includes family *Corynebacteriaceae*).

II. *Caulobacteriineae* (Sessile and stalked, attached bacteria).

III. *Rhodobacteriineae* (Sulfur purple and nonsulfur purple bacteria).

Order II. *Actinomycetales* (Branching, nonmotile, mycelial threads).

III. *Chlamydobacteriales* (Filamentous, alga-like bacteria.

App. *Beggiatoceae*).

IV. *Myxobacteriales* (Slime bacteria, creeping motility).

V. *Spirochaetales* (Flexuous, spiral cells).

Supplement: Groups whose relationships are obscure.

Group I. Family *Rickettsiaceae* (Intracellular parasites carried by arthropods).

II. Order *Virales* (Filter passers that grow in living protoplasm).

III. Family *Borrelomycetaceae* (Highly pleomorphic parasitic organisms).

Groups of Bacteria. Bacteriologists have for convenience grouped bacteria which have some characteristic in common. This characteristic may be of significance only in some special way. The "lactic acid group," for instance, includes bacteria which form larger amounts of lactic acid than other bacteria. They are of special interest in the dairy industry. The aerobic spore formers and anaerobic spore formers are self-defined. The latter are important in canned-foods spoilage and in bacteriology of wounds. Many others could be mentioned, such as pathogenic bacteria, colon-typhoid group, thermophilic group, chromogenic group, and acid-fast group.

How Microorganisms Are Identified and Named. New bacterial species are constantly isolated. In some cases attempt is not made to identify them with known species. In other cases, it is desirable to determine whether they are entirely new species or whether they may be identical with or a variety of a species which has already been described. The importance of not giving an already named microorganism a new name has been discussed. The following steps are kept in mind by careful students.

1. Isolation of the microorganism in pure culture. This is absolutely necessary else the characteristics which are reported will be for two or more organisms and will be valueless for one microorganism. A pure culture is one which contains just one type or species of organism.

2. Careful determination of all of its characteristics both morphological and physiological. These should be determined with procedures which have been studied and accepted. When different methods are used, different characteristics may be secured.

3. Careful comparison of the characteristics of the new organism with those which have been reported in the literature for others which may be identical with or like it. This constitutes determination of the *affinities* or kinship of the microorganism.

4. Selection of a name. This must be in accordance with rules of nomenclature adopted by societies and congresses.

5. Publication of the characteristics and name of the organism in an official scientific publication. This is important for controversies may occur later as to priority. One who discovers a new microorganism should be certain that it is properly "published" according to accepted methods.

150 NOMENCLATURE AND CLASSIFICATION OF BACTERIA

6. Deposition of a culture of the new organism under the name which has been proposed for it in a museum or type culture collection from which other microbiologists may secure it. This is important for it is unfortunate to have the description and name of an organism in the literature without the type culture.

REFERENCES

- Bergey's Manual of Determinative Bacteriology, a Key for the Identification of Organisms of the Class Schizomycetes, edited by R. S. Breed, E. G. D. Murray, and A. Parker Hitchins, 5th Edition, Williams & Wilkins Co., Baltimore, 1939.
- BUCHANAN, R. E., General Systematic Bacteriology; History, Nomenclature, Groups of Bacteria, Williams & Wilkins Co., Baltimore, 1925.
- WINSLOW, C.-E. A., *et al.*, The Families and Genera of the Bacteria, *J. Bact.* **5** (1920), 191-229. (This is the report of the Committee of the Society of American Bacteriologists on Characterization and Classification of Bacterial Types.)

CHAPTER 8

MOLDS

Molds are distinguished from yeasts and bacteria by being multicellular organisms. Consequently, their morphology and physiology are more complicated but also more interesting. Macroscopically, vegetation of a mold resembles a bit of cotton and is called the *mycelium*. Each thread or filament of this mycelium is called a mycelial thread or *hypha*. Two kinds of hyphae are formed, depending on their purpose. Fertile hyphae are those which bear fruiting bodies—reproductive organs. Some of them are shown later for the more common genera. Vegetative hyphae are those which are concerned in the nutrition of the mold plant. They are comparable, therefore, to the vegetative or actively growing form in bacteria and other fungi. Mycelial threads are also distinguished from one another by presence or absence of cross walls or *septa* (singular septum). Those threads which have cross walls are said to be septate; those without cross walls, nonseptate or coenocytic. This, then, is one differential characteristic by which molds may be subdivided.

Hyphae may be *submerged* or *aerial*. *Submerged* hyphae extend into the medium on which the mold may be growing; *aerial* hyphae extend into the air. Aerial hyphae probably function in securing oxygen and getting rid of excess moisture. Submerged hyphae anchor the mold more solidly so that it may produce an abundant aerial vegetation.

Structure of Hyphae. Each mycelial thread of a typical mold is made up of numerous cells each of which has various organs found in all typical cells. The cell wall is composed of a resistant substance the chemical nature of which is not generally agreed upon. Some investigators have reported chitin, whereas others have called the structural substance fungus-cellulose.

Distribution of Molds. Molds are as widely distributed as bacteria. This is largely due to the fact that each fruiting body produces vast numbers of conidia which are carried by dust par-

ticles and other agents. They are especially able to take care of themselves under even unfavorable conditions.

Reproduction of Molds. Reproduction among molds is accomplished by special units called spores or *conidia* (singular conidium). The characteristic color of the mold is due to pig-

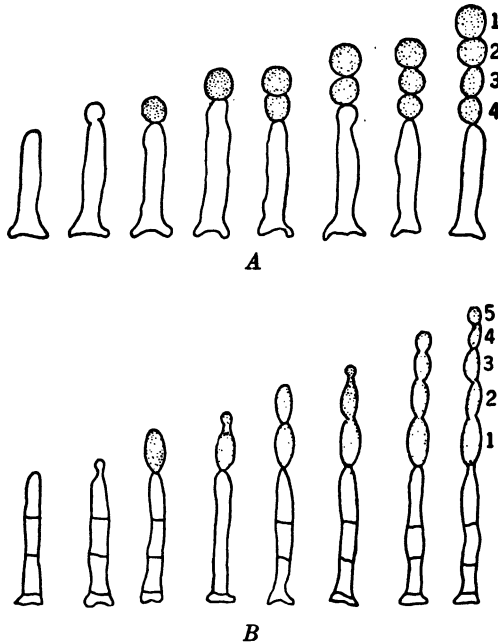

FIG. 48. Diagrammatic Illustrations of Methods of Conidial Fructification. (After Zopf)

A. The conidium is formed first from an enlargement at the tip of the mycelium. Repetition of this process gives rise to the rest of the conidia. B. In this case the conidiophore constricts to form the first spore. Each succeeding spore is formed from a preceding one. They are formed in just the reverse order as in A.

ment contained in the conidium. Each conidium is able to reproduce the species and is therefore comparable, perhaps, to the seeds of higher plants. Great numbers of conidia are formed by each mold plant, and it is easy to understand how molds are so prolific. Hyphae which bear conidia and the organs forming them are called conidiophores. This process of reproduction is often spoken of as fructification by conidia. Conidia are formed at the tips of certain mycelial threads. They are, in many cases,

pushed out into a chain, the oldest conidium, of course, being at the end of the chain farthest from the tip of the hypha.

Two methods of conidium formation have been described. They are illustrated in Fig. 48. The first method (shown in *A*) begins with the formation of an enlargement which becomes round and finally is surrounded by a membrane. The first conidium is thus formed. The process is then repeated, and thus the oldest conidium is at the tip of the chain. The other method (shown in *B*) is different. After the first conidium is formed, this one forms a little bud or projection which develops into the next spore. In this case the oldest conidium or spore may not be at the tip of the chain but next to the mycelium.

Another method of spore production is fructification by sporangia. In this method the spores or conidia are borne within a membrane called a sporangium. This is illustrated by *Rhizopus nigricans*.

Asexual Spores. As the mold plant which develops from the spore grows and becomes older, certain changes may be observed at the tips of certain of the mycelial threads, depending on the species. These threads bear the so-called fruiting bodies or organs which are to form the conidia or spores, as described in the preceding paragraph.

Some molds produce asexual spores without formation of special organs. The whole mycelium seems to be able to break into segments called *oidia* (singular *oidium*). Such cells are possessed of the properties of spores or resting cells.

Sexual Spores. These are formed by many species of molds but may not be formed by all species in a genus. They result from fusion of two cells which function as gametes. The resulting cell, a zygote, then forms a thick wall about it and assumes characteristics of a spore. It remains in this form until favorable conditions occur when it germinates into a growing plant. The resting cell is also known as a zygospore. In *Rhizopus nigricans* it results from fusion of cells in mycelial threads which are of opposite sex.

Properties of Mold Spores. Since the mold spore or conidium is a resting stage in the life cycle of this plant, certain powers of resistance are to be expected. Pasteur showed that moist heat destroyed the spores more quickly than dry heat. Spores of *Penicillium glaucum* were killed quickly by boiling but survived

dry heat at 120°C. for an appreciable time. Mold spores also survive cold and treatment with disinfectants. They are far more resistant than ascospores of yeasts but, perhaps, not quite so resistant as spores of some bacteria. Data on the effect of several physical agents on mold spores are not abundant in the literature. Another investigator by the name of Lode stated that dry heat of 125°C. killed all mold spores in 15 minutes; 80°C. for 70 hours was without effect. Weinzirl reported that mold spores withstood from 58 hours to 5 days continuous exposure to sunlight.

Germination of Spores. Spores are resting stages which are very resistant to unfavorable conditions. When favorable conditions are present the spore may germinate—develop into the active growing stage. This involves, of course, rupturing of the outer wall with often an extrusion of the inner wall. Finally a thread-like structure is formed, and the plant is ready again to reproduce these steps.

ORDER MUCORALES

The members of this group multiply with both sexual and asexual spores. The former are not readily formed by all species and consequently are not commonly used for classification. The mycelia are coenocytic (nonseptate). Conidia are borne at the tips of fertile hyphae which are called *sporangiophores*. They are borne in a sac called a *sporangium*.

Genus Mucor. This is one of the commonest genera of molds, many members of which are of considerable importance. Species of this genus are widely disseminated in nature and are active in destruction of organic matter. One species is used in manufacture of ethyl alcohol by the so-called amylo process.

The general characteristics of members of this group may be briefly stated as follows: There is strong development of threads beneath the surface of the medium which support the aerial structures. These threads, comparable to the runners of strawberry plants, are called stolons. Aerial hyphae, possessing sporangia at their tips, are called sporangiophores. Within the sporangium are formed great numbers of black spores. When the sporangium breaks, these spores are released. The mycelium of mucors is nonseptate, giving one useful characteristic with which to differentiate them from other molds. Great numbers of spores are

liberated by each sporangium. They are disseminated and germinate to reproduce the species when they fall on good soil or media. Such spores are asexual.

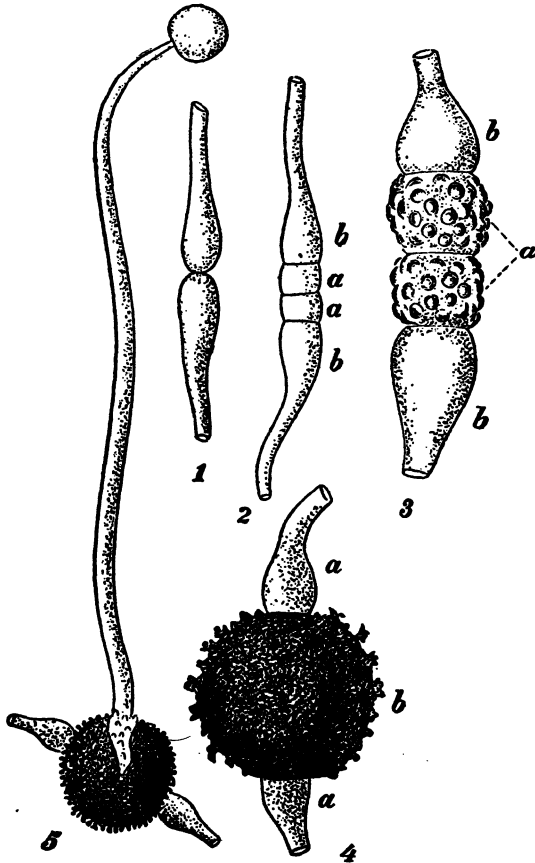

FIG. 49. *Mucor mucedo*, Formation of the Zygospores. (After Brefeld)

1. Two hyphae in terminal contact. 2. Articulation into gamete *a* and suspensor *b*. 3. Fusion of the gametes *a*; the membrane thickens. 4. Ripe zygospore *b* supported by the suspensors *aa*. (Magnification of 1-4, 225.) 5. Germination of the zygospore to a sporangium stem. (Magnification about 60.)

Another type of spore, a sexual spore already discussed as a zygospore, is also formed by *Mucors*. Such a spore is shown in Fig. 49, *Mucor mucedo*. This species is widespread in nature and frequently appears in spoiled-food products in which it

develops with a dark color. Its metabolic activity makes it important.

Mucor rouxii. This mold has been found in material known as "Chinese yeast" used in the preparation of fermented beverages from rice. It and some of its near relatives produce an active amylase which has given the mold importance in several industrial fermentations. On account of its diastasic activity, *Mucor rouxii* was used in the so-called *amylol process* for manufacture of ethyl alcohol from starchy materials. The mold is added to the cooked grain mash after which it is aerated vigorously for 24 hours to cause rapid development of the mold and to develop its amylolytic ability as much as possible. This results in hydrolysis of the starch to fermentable sugars which, in turn, are fermented to alcohol by yeast which is added for this purpose. Other species of molds belonging to the genera *Rhizopus* and *Aspergillus* have also been used.

Genus *Rhizopus*. Members of this genus are widely disseminated especially where organic matter is undergoing decom-

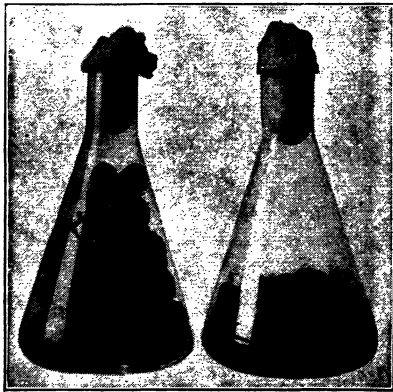

FIG. 50. Effect of *Rhizopus nigricans* on Strawberries of the Missionary Variety Which Had Stood for 2 Days at Room Temperature. Each berry in the flask at the right had been inoculated with *Rhizopus nigricans*. (After Stevens, 1917.)

position under moist conditions. The conidia are formed in large numbers and are carried about by wind and dust. General appearance of the mold is quite like that of the *Mucor* just described. Both aerial and submerged hyphae are formed. When aerial hyphae touch solid agents, they form *rhizoids* which anchor the thread. *Stolons* are also formed which are comparable to runners of certain plants. Mycelium of young growth is usually white, turning to darker hues as the plant ages.

Rhizopus nigricans is perhaps the best-known species because it is widely spread in nature and easily cultivated for study by young mycologists. It is an active destroyer of certain

fruits such as fresh ripe strawberries. It is one of the frequent contaminations of laboratory cultures.

It was characterized as follows by Jensen (1912):

Rhizopus nigricans. Stolons far-spreading, even growing onto and spreading over the culture glass, covering the substratum and its neighborhood with thick cobwebby growth 1-3 cm. long and occasionally still

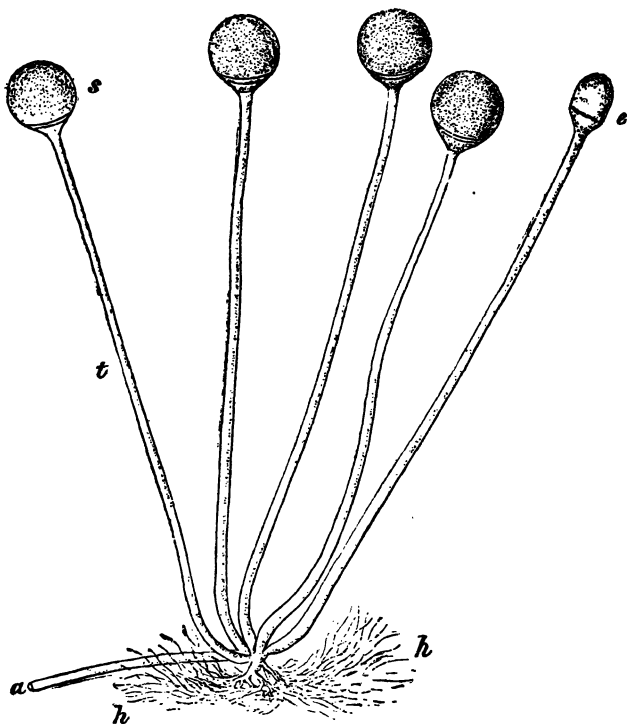

FIG. 51. *Rhizopus nigricans* Ehrenberg. (After Brefeld)

a, Is the extremity of a stolon, which has developed into the appressorium *h*. This latter is the starting point of the sporangiophores *t*, four of which are shown with the sporangia *s* unbroken, while the columella *e* is all that remains of the fifth. Magnification $\times 30$.

longer, simply or sparsely branched, occasionally fork-like internodes, with smooth, at first hyaline, then finally brown, membrane, contents colorless; rhizoids more or less richly branched, at first with colorless, later with brown or black-brown, smooth, thick membrane, as thick as 16μ at base and 5μ at tip, finally uniseptate; sporangiophores seldom single, mostly in clusters of 3-5 occasionally up to 10, unbranched, 0.5-4 mm. high, $24-42 \mu$ thick, with smooth, finally brown or black-brown membrane, contents colorless, with apophysis of sporangium more or less hemispherical, large, $100-350 \mu$ broad, at first snow-white then becoming at maturity black, erect; columella

with broad base, very large, broadly half globose, highly arched, with apophysis 70 μ broad by 90 μ high to 250 μ broad by 320 μ high, with brown smooth membrane, often covered with spores after opening of sporangia, often becoming pileate, spores irregularly globose or broad oval, mostly with one or two blunt corners, variable in size, 6–17 μ in diameter, mostly somewhat longer than broad, with thick double membrane on which are seen meridian-like folds, light pale gray, contents colorless; zygospores globose or barrel-shaped 160–220 μ in diameter; exospore firm, brown-black, opaque, closely beset with half-globose, globose high warts; endospore colorless, thick, with small outgrowths filling the warts of the exospore; suspensors swollen, commonly unequal, almost as broad as the zygospore; azygospore observed.



FIG. 52. *Thamnidium elegans* Link. (After Jensen)

A. Sporangiophore and Haptesporangia; B, Sporangiophore and Nebosporangia; D, ultimate divisions of Sporangiophore with Sporangioles; E, Columella of Hauptsporangium.

phore. At the tips of these branches are also found sporangia filled with spores. The members of this group are frequently found in foods. A representative member of this group is *Thamnidium elegans* (see Fig. 52).

PENICILLIUM MOLDS OR BLUE-GREEN MOLDS

These are common in nature. They may be easily isolated from citrus fruits which have begun to spoil and show the pres-

A sexual method of reproduction is also exhibited by *Rhizopus nigricans*. This mold is dioecious—it possesses both male and female mycelia. When mycelia of the opposite sex approach each other short tubules from each unite and the contents of the cells fuse. A large cell results which is a *zygospore*.

Rhizopus oryzae. This was a significant species in early industrial microbiology. It was once believed to be a good microorganism for manufacture of lactic acid. Mold fermentation for production of this acid has been largely replaced by bacterial fermentations. *Rhizopus oryzae*. produces *d*-lactic acid while the bacterial fermentations produce *d* and *l*-lactic acid. Other organic acids are also produced by fermentation of sugars by *Rhizopus oryzae*.

THAMNIDIUM

This group is much like the *Mucors*. The members possess sporangiophores with a sporangium on the end and also show branching of the sporangiophore.

ence of blue-green spots. The name *Penicillium* comes from the Latin, meaning little brush, and is used because the gross form of the mold is brush-shaped. The mycelium is septate and usually blue-green in color. Toward the tip of the threads branching occurs to such an extent that a thick tuft is formed. At the tip of each of them are formed the spores of conidia. These conidia are formed in great numbers and finally break off to be

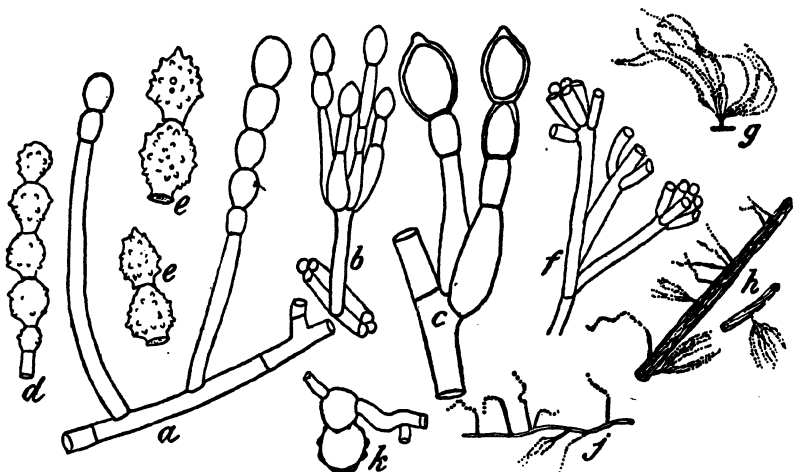

FIG. 53. *Penicillium brevicaulis* Saccardo. (After Thom)

a, Conidiophores and simple conidial chains with spores still smooth ($\times 900$); b, f, more complex conidial fructifications ($\times 900$); c, two young conidial chains, showing thick walls of spores ($\times 1,400$); d, e, conidia after becoming echinulate ($\times 1,400$); g, h, j, sketches of forms and habit of conidial fructifications ($\times 140$); g, from an old culture, sessile or almost so; h and j show trailing hyphae and a rope of hyphae with lateral conidiophores; k, germinated conidium where the old spore wall lies empty beside a growing cell ($\times 1,400$).

disseminated by air and water currents and by other means. Along with the color, the general shape of this mass of conidia-bearing hyphae, called *coremia*, is used in classification of these fungi. The hyphae are septate.

Penicillium roqueforti. This species is used for preparation of Roquefort cheese, as its name would indicate. This type of cheese is filled with bluish-green masses which, if examined microscopically, appear to contain a great number of spores. Unlike Camembert cheese, the preparation of which is described in another paragraph, *Penicillium roqueforti* grows within the cheese and ripens the mass in this manner. Roquefort cheese is made in somewhat the following manner. The mold to be used

as starter is cultivated on some nutrient material such as bread, in order to secure a good crop of spores with which to seed the curd from which the cheese is made. The curd is prepared from milk with rennin. The whey is taken off, leaving the solid portions of the milk. The drained curd is then spread out in a thin layer over which is sprinkled a little of the mold starter. Alternate layers of curd and mold starter are used until the cheese maker has a cake of the desired size. It is then pressed into shape and placed in a machine which punches it full of holes. These holes are necessary to allow the ingress of air essential for the growth of the mold. In this manner the mold is propagated within the cheese and, in its metabolic activities, gives rise to those compounds characteristic of Roquefort cheese. The home of Roquefort cheese is in southern France. "Blue cheese" is the American equivalent of Roquefort cheese.

Penicillium camembertii. This species is used in the preparation of Camembert cheese. As is the case with many molds used in the industries, this species is well provided with enzymes.

Penicillium notatum-chrysogenum Group. These species are known for their ability to synthesize penicillin, an antibiotic, discussed in other places in this book.

ASPERGILLUS MOLDS (ASPERGILLI)

Species of Aspergilli are common in nature. They are always encountered when examinations are made of mold growth on food products. Fertile hyphae are slender but thicken toward the tips to give a club-shaped appearance. About this club-shaped tip called a *basidium* are formed small projections called *sterigmata* at the tips of which appear chains of conidia. The whole surface of the basidium is covered with these organs and their chains of conidia (Fig. 54).

Aspergillus glaucus. This species grows on various food products and is encountered in many cultures of natural materials. The name has been used for many Aspergilli of somewhat diverse characteristics. Owing to lack of preciseness, Thom and Church did not retain the species name in the monograph on Asperigilli

Aspergillus fumigatus. This species and a few closely related to it are involved as etiologic agents in human and animal diseases. It causes an infection known as aspergillosis in fowls and ear infections in man. Conditions in the ear, presence of wax,

temperature, and moisture, are favorable to its development. It may develop slightly in the ear without symptoms; later, if further development occurs, the middle ear may be involved. Severe infections of the respiratory tract are also caused by Aspergilli.

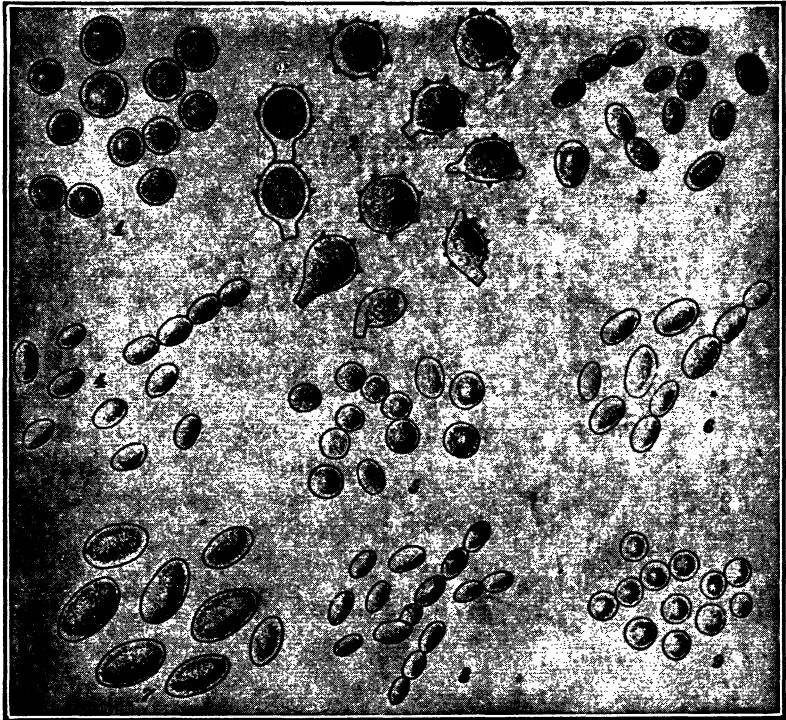
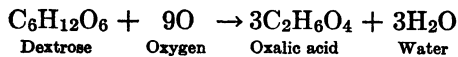

FIG. 54. Conidia of Various Species of *Penicillium* Drawn to the Same Scale. (After Wehmer; in Lafar's *Handbuch der Technischen Mykologie*. By Permission of Gustav Fischer)

1. *P. Camemberti* (conidia 3.1-4.5 μ in diameter); 2. *P. breviaule* (7.10 μ by 5.7-6.8 μ); 3. *P. purpurogenum* (2.8-3.3 μ by 2 μ); 4. *P. claviforme* (3 μ by 2 μ); 5. *P. rubrum* (2.8-3.5 μ in diameter); 6. *P. italicum* (4-5 μ by 2-3 μ); 7. *P. olivaceum* (6-10 μ by 4-6 μ); 8. *P. luteum* (2.3-3 μ by 1.4-2 μ); 9. *P. glaucum* (2.5-3 μ in diameter). Measured on growths from pure cultures on wort gelatin.

Aspergillus niger. This is a widely disseminated species which causes spoilage of certain foods. It causes most trouble in foods which are rich in sugar and organic acids. It develops readily on laboratory media and may be easily studied. It is also the fungus used in the biological preparation of oxalic and citric acids by fermentation. Wehmer stated that the sugar was oxidized

directly to oxalic acid and water, probably in accordance with the equation.



Later Currie working with Thom showed that citric acid was also formed and that it was probably the precursor of oxalic acid.

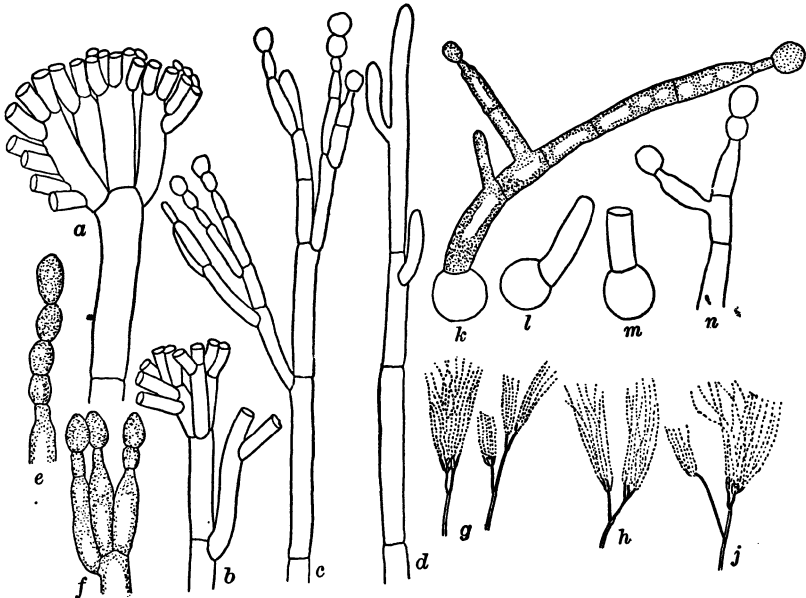

FIG. 55. Roquefort Penicillium (*P. roqueforti*). (After Thom)

a, Part of conidiophore and of base of fructification, highly magnified, showing the production of basidia on the sides as well as at the apex of the basidiophore; *b*, *c*, other types of branching; *d*, young conidiophore just branching; *e*, *f*, basidia and the formation of conidia, highly magnified; *g*, *h*, *j*, diagrams of types of fructification as seen under low power ($\times 80$); *k*, *l*, *m*, *n*, germination of conidia and new conidia produced directly on the first hyphae.

Citric acid is prepared today in this manner. It is necessary to carry out the fermentation in the presence of calcium carbonate.

Citric acid production by mold fermentation has reached such a volume in the United States that this country has been self-sufficient for some years. It has exported large quantities to the detriment of the Mediterranean area which formerly produced citric acid from citrus fruit for importation into the United States. Fermentation citric acid is now produced in millions of pounds at a cheaper price than by the older methods.

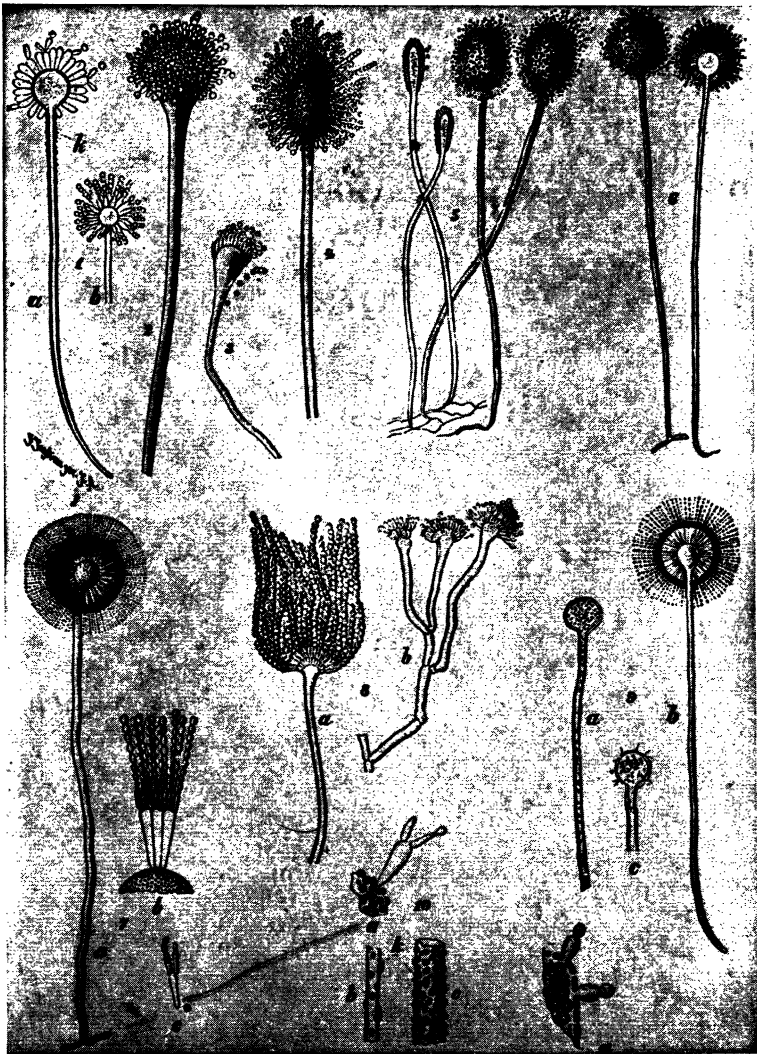

FIG. 56. Conidiophores of *Aspergillus*. (After Wehmer in Lafar's *Handbuch der technischen Mykologie*. By permission of Gustav Fischer)

Heads, globules and sterigmata of *A. Ostianus* (1), *A. glaucus* (2), *A. fumigatus* (3), *A. varians* (4), *A. clavatus* (5), *A. Wentii* (6), *A. sylfureus* (7), *A. nidulans* (8), and *A. candidus* (9). Excretion of granules from stalk and globule in *A. Ostianus* (10). Old sterigmata and globule of *A. candidus* (9, a-c.) Fragment of globule from *A. giganteus* (high and medium adjustment combined). 7 after Zopf, 8 after Eidam, the rest after Wehmer.

Aspergillus clavatus. This species produces *clavacin*, an antibiotic which has some value in treatment of disease. *Fumagacin* is a similar substance produced by *Aspergillus fumigatus*.

BOTRYTIS

This is another fungus frequently found in food materials. One species *Botrytis cinerea*, was studied by pathologists of the U. S. Department of Agriculture as the cause of spoilage of strawberries. This species apparently had a low-temperature range for it grew at refrigeration temperatures. Species of this genus have also been found on frozen meats.

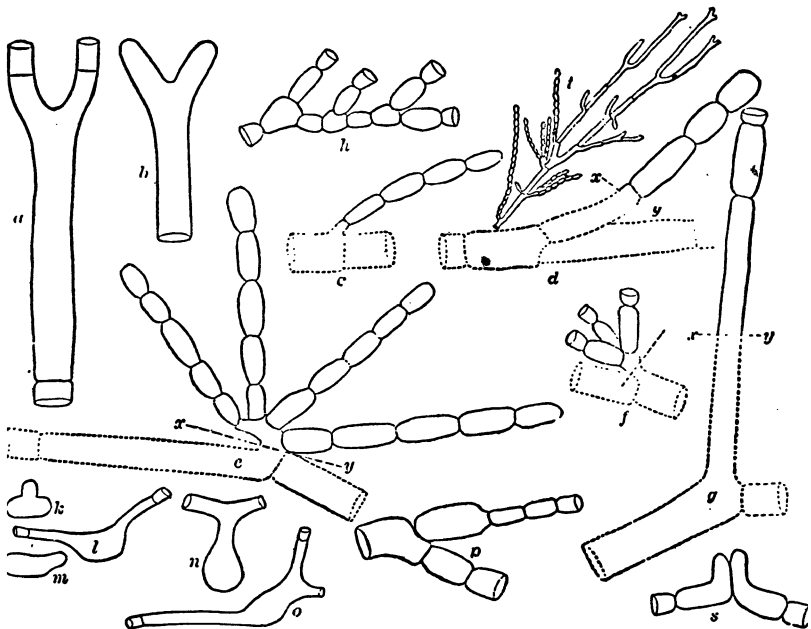

FIG. 57. *Oidium lactis*. (After Thom)

a, b, Dichotomous branching of growing hyphae; c, d, g, simple chains of oidia breaking through substratum at dotted line x-y, dotted portions submerged; e, f, chains of oidia from a branching outgrowth of a submerged cell; h, branching chain of oidia; k, l, m, n, o, p, s, types of germination of oidia under varying conditions; t, diagram of a portion of a colony showing habit of *Oidium lactis* as seen in culture media.

OIDIUM (OÖSPORA)

This mold is differentiated from some of its neighbors in the absence of well-defined bodies. It is a septate mold. Each of the threads is able to break up into "oidia," units quite com-

parable to the spore or conidium. Oidia are usually rectangular with rounded corners. They have the characteristics of spores.

Oidium lactis. This fungus is quite widely distributed in nature. It is easily secured from sour milk on which it grows as a velvety layer. Jensen described the species as follows:

Colonies far spreading, membranaceous, velvety, pure white, often becoming a thick covering over substratum; hyphae simple or branched, creeping or somewhat ascending, hyaline, of variable length and breadth mostly 6-12 μ broad, breaking up into irregular pieces that are to be considered as spores; spores cylindrical to ovate, often also globose, or somewhat irregular in form, mostly 6-20 μ long.

ALTERNARIA

Alternaria are characterized especially by a muriform conidium or spore. Such spores are multicellular and are usually dark in color. They are usually observed in chains. Alternaria are widely disseminated in nature and are frequently isolated from food products. Evidence exists to indicate that some species may be pathogenic.

MONILIA

Monilia species are like the yeasts in many respects. They tend to form long cells which appear as threads under the microscope. The group is not well characterized. Interest in the past was drawn to the group by *Monilia candida* which was identified by Hansen. He found the fungus rather widely distributed on fruits, soil, and cow dung. The fungus grows well on wort showing an abundant film formation and vigorous alcoholic fermentation at the same time. Another interesting fact about this fungus is that it ferments cane sugar; yet several eminent biologists have not been able to demonstrate invertase secretion by the cell. Some evidence is available to show that intracellular invertase is formed and probably retained within the cell.

Mold Defects of Foods. Molds are very troublesome organisms in the food-preservation industry. Although they are probably harmless as agents causing disease, they do render the food unsightly and may even bring about chemical changes which



FIG. 58. *Alternaria fasciculata*. (After Jensen, 1912)

A, Conidiophore and conidial chain; B, Conidia enlarged.

modify its constitution. Many foods which undergo mold spoilage are contaminated after the food has been prepared. For instance, "sweaty or runny" maple sugar has been found to be due to mold growth. Molds were contributed to the sugar by contaminated tin and wooden containers and wrapping papers. Foil-wrapped cheese molds under some conditions and cannot

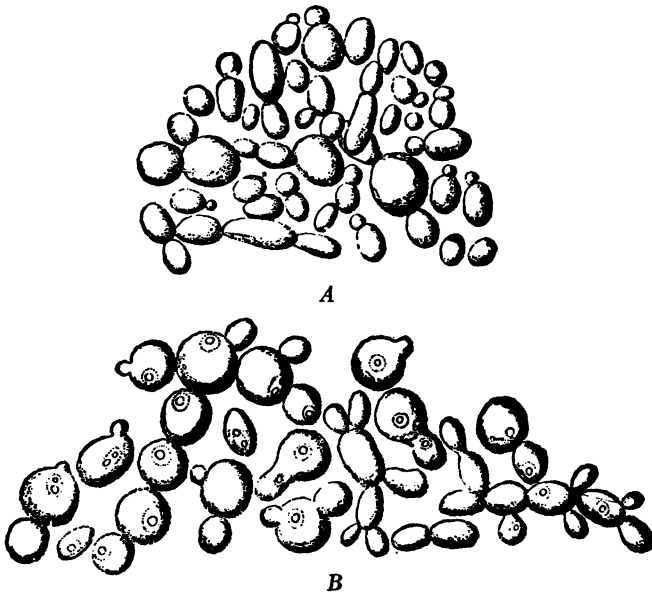

FIG. 59. *Monilia candida*. (After Hansen)

A, Cells from cultures in beer wort; B, cells from a film on the surface of liquid media.

be stored over very long periods. Another food spoilage caused by these organisms is moldy bread. This occurs especially during warm moist periods of the year. Bakers must continually fight molds. Meat packers also have a mold problem because frozen meats and cured meats become covered with mycelial growth. Other instances could be mentioned. The ubiquitous mold spore causes much trouble in food preservation.

FUSARIUM

Species of *Fusarium* are frequently encountered by microbiologists. They have been found to be important in the dry rot of potatoes and other vegetables. *Fusaria* form *macroconidia*

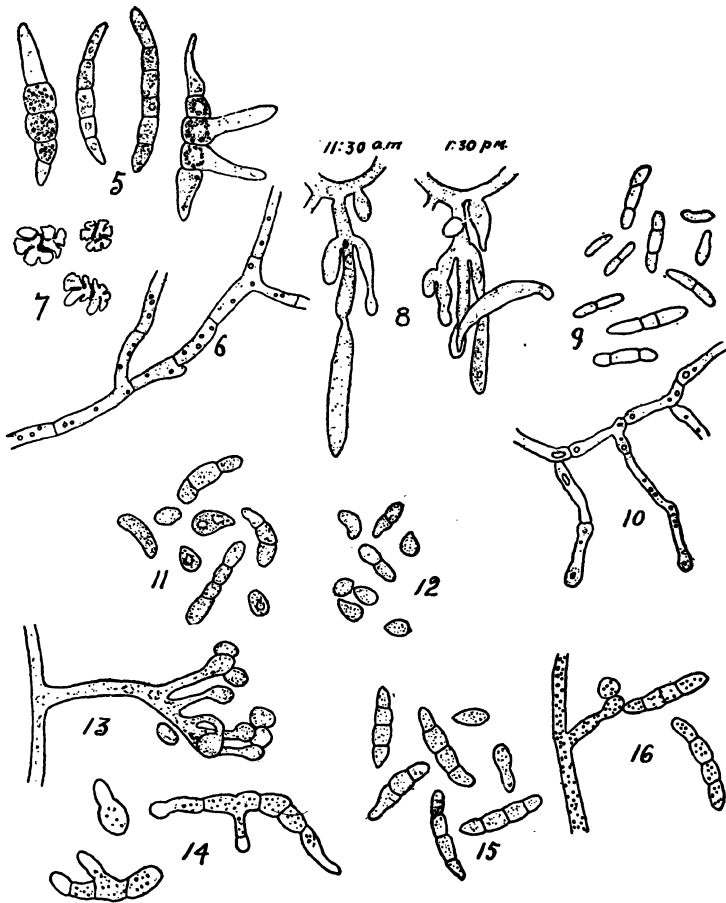

FIG. 60. Showing Various Stages in the Development of *Fusarium*. (After Burrill and Barrett)

5. Macroconidia of *Fusarium II*, some of which are beginning to germinate. 6. Mycelium of the same fungus. 7. Starch grains from a corn kernel infected with *Fusarium II*, showing the corrosive effect. 8. Sporophores of *Fusarium II*, drawn at 11:30 a.m. and at 1:30 p.m. to show the rate of development of the spores in culture. 9. Microconidia and macroconidia of *Fusarium III* from culture. 10. Mycelium of the same from a corn kernel. 11. Microconidia and macroconidia of *Fusarium I* from a prune agar plate. 12. Same from an infected ear of corn. 13. A spore-producing hypha from a young prune juice culture. 14. Germinating spores of *Fusarium I* from a dried diseased embryo ear of corn. 15. A hyphal branch of *Fusarium I* producing both microconidia and macroconidia. 16. A hyphal branch of *Fusarium I* producing both microconidia and macroconidia.

although in certain species *microconidia* appear. These fungi usually grow well on ordinary media yielding vigorous dense growth. The spores germinate much as do other spores. Fusaria are encountered in many products.

ACTINOMYCES

These organisms are characterized in the classification which has been presented in Chapter 7. They are mold-like organisms which include both parasitic and saprophytic species. Several human and animal diseases caused by Actinomyces are discussed in the following paragraphs.

Actinomyces antibioticus. This species has been much studied for production of *actinomycin*, an antibiotic substance antagonistic to disease-producing bacteria. The species was isolated from soil and possesses strong bacteriostatic and bactericidal properties. It produces black and brown pigments in culture media.

PATHOGENIC MOLDS AND MOLD-LIKE FUNGI

Among the molds, as among the bacteria, certain species are pathogenic for man and other animals. Lesions caused by molds are not unlike those caused by bacteria. Diseases caused by them and other fungi are often called mycoses, the specific mycosis being designated either from the etiologic agent or the type of the infections. Thus, such names as bronchiomycosis and actinomycosis are secured. A few of the more common infections caused by fungi will be discussed.

Ringworm. This is a very communicable skin infection and an insidious one to treat. It is caused by a fungus *Trichophyton tonsurans* which burrows into the skin, where different agents, usually employed in its treatment, cannot reach it. It is usually treated with fungicides such as turpentine ointment, X rays, or ultraviolet light. The appearance of the lesion caused early investigators to name the infection ringworm because there is marked tendency for the lesion to heal at the center and spread at the periphery. This gives the ring appearance. When the fungus infects the hairy portions of the body, the infections are treated with difficulty. Other infections are caused by the same agent. Barber's itch, herpes tonsurans, and similar diseases are caused by *Trichophyton tonsurans* or related species. These fungi are also pathogenic for other animals.

The fungus causing ringworm is especially prone to attack the hands and feet. When the feet are infected, the infection is called "athlete's foot." Surgeon-General Cumming of the U. S. Public Health Service has stated that probably at least one half of all adults suffer from it at some time. Those who use swimming pools, athletic clubs, or any places where there are common dressing rooms, may have the infection, usually on the feet. The parasite is quite resistant and may live and grow on other agents than the human body. Cumming stated that 15 minutes' boiling was required to kill it. Such agents as bath mats, stools, and the like may spread the parasite. Infected individuals should not use bath mats but paper which may be burned. It is obvious that strict cleanliness is necessary. Dressing rooms should be thoroughly cleaned and disinfected.

Aspergilloses. Several species of *Aspergillus* cause infection in man and other animals. One of the best-known is *Aspergillus fumigatus*. The disease caused by this mold in fowls is called aspergillosis and is characterized by formation of nodules on the mucous lining of the upper respiratory tract. Each of these nodules contains growth of mold about which is formed a layer of animal cells. As growth increases the surface of the mucosa becomes greenish in color. *Aspergillus fumigatus* which causes this infection is a resistant species, the spores of which seem to be quite widely spread in nature. They are probably disseminated in food and drink of the fowls. It has been stated that foods which are exceptionally dusty and dirty are more likely to cause infection. After the fungus has become established it propagates itself to such an extent that the respiratory tract is filled, causing great difficulty in breathing and finally suffocation.

Members of the genus *Aspergillus* also cause infections among human beings. They may cause lung infections which are much like tuberculosis. Skin infections have also been found to be due to *Aspergilli*.

Alternaria Infections. *Alternaria* have been found to be present in infections in the respiratory tract especially those of chronic pulmonary type. Some of these infections have been inconclusively diagnosed but, since no other etiologic agent could be found, *Alternaria* has been regarded as the important causal agent.

Actinomycosis. Infection with *Actinomyces* is known as actinomycosis, lumpy jaw or wooden tongue. It is a fairly common infection in animals of certain countries. Human beings may also not infrequently become infected with the organism *Actinomyces bovis*. The disease is an insidious one to treat. It is usually characterized by formation of much pus and sloughing away of tissue and bones. The organisms causing actinomycosis are believed to be widespread in nature in grains and similar materials. They get into the subject through an abrasion or into the respiratory tract by inhalation. The disease is not epidemic but appears as isolated cases. This is perhaps one reason why diagnosis is delayed and treatment unsatisfactory. *Actinomyces necrophorus*, or an organism very much like it has been isolated from cases of puerperal infection.

REFERENCES

- BESSEY, E. A., *A Textbook of Mycology*, P. Blakiston's Son & Co., Philadelphia, 1935.
- CASTELLANI, A., and A. J. CHALMERS, *Manual of Tropical Medicine*, Bailliere, Tindall and Cox, London, 1919.
- CONANT, N. F., *et al.*, *Manual of Clinical Mycology*, W. B. Saunders & Co., Philadelphia, Pa., 1944.
- GALLOWAY, L. D., and R. BURGESS, *Applied Mycology and Bacteriology*, Leonard Hill, London, 1937.
- HENRICI, A. T., *Molds, Yeasts, and Actinomycetes*, Wiley, New York, 1930.
- HOPPER, MARY E., *An Introduction to Medical Mycology*, Year Book Publishers, Chicago, 1943.
- JENSEN, C. M., *Fungous Flora of the Soil*, *Cornell Univ. Agr. Exp. Sta. Bull.* 315, 1912.
- LAFAR, F., *Technical Mycology, the Utilization of Microorganisms in the Arts and Manufactures*, Chas. Griffin & Co., London, 1910.
- LANGEBON, M., *Précis de Mycologie*, Masson et Cie., Paris, 1945.
- LEWIS, G. M., and M. E. HOPPER, *An Introduction to Medical Mycology*, Year Book Publishers, Chicago, 1939.
- SKINNER, C. E., C. W. EMMONS, and H. M. TSUCHYA, *Henrici's Molds, Yeasts and Actinomycetes. A Handbook for Students of Bacteriology*, Wiley, New York, 1947.
- SMITH, G., and H. RAISTRICK, *An Introduction to Industrial Mycology*, 3d Edition, Edward Arnold & Co., London, 1946.
- TANNER, F. W., *The Microbiology of Foods*, 2d Edition, Garrard Press, Champaign, Ill., 1944.
- THOM, C., *The Penicillia*, Williams & Wilkins Co., Baltimore, 1930.
- THOM, C., and K. B. RAPER, *Manual of the Aspergilli*, Williams & Wilkins Co., Baltimore, 1945.

CHAPTER 9

THE YEASTS AND RELATED ORGANISMS

The term yeast is used with different meanings. Generally two characteristics are emphasized, formation of appreciable amounts of alcohol and carbon dioxide and reproduction by a process spoken of as budding. These are unsafe criteria, however, for grouping an organism with yeasts. Many organisms in quite different genera form alcohol and some reproduce by budding. It is impossible to establish limits of any group without finding that borderline organisms cause confusion. For convenience, perhaps, yeasts are roughly divided into two groups, true yeasts and pseudo or false yeasts. The former produce ascospores; the latter do not. Pseudo yeasts are also considered as "fungi imperfecti."

Botanical Position of Yeasts. Yeasts are often called budding fungi. The term fungus has been discussed on earlier pages, and the term budding is defined in a later paragraph. True yeasts are Ascomycetes which are able to form endospores or ascospores in a sac called an ascus. At first thought, one might regard this as the same phenomenon which we have discussed for molds, that is, where a sporangium was formed to contain many conidia, or spores. However, this is different. In the sporangium there are many nuclei concerned, but in the ascus only one when the process of sporulation begins. Because of the presence of an ascus with ascospores, true yeasts are Ascomycetes. False yeasts do not form ascospores and are therefore "fungi imperfecti." Evolutionary development of the yeasts is an interesting subject but one which need not concern us here.

Habitat of Yeasts. Yeasts are widely distributed in nature. Their habitat was studied by some of the early investigators, one of whom, Brefeld, stated that they were especially common in excrement. The researches of Pasteur and Hansen greatly amplified our information on this subject. Pasteur reported that

yeasts were present on ripe grapes, which raised the question as to where they spent the winter when there were no grapes. It remained for E. C. Hansen, in 1880-81, to answer the question. Hansen, working first with a species *Saccharomyces apiculatus*, found that it reached the soil by being washed from the fruit by rain, and there it passed the winter. This fact was very



FIG. 61. Showing the Different Shapes of Yeast Cells.
(After Guilliermond)

satisfactorily proved by later investigations. The transportation to the skin of fruits is easily explained. The yeasts may be blown about in dust. One investigator found that insects played a role in helping to disseminate the yeasts. They are probably as widely disseminated in nature as bacteria.

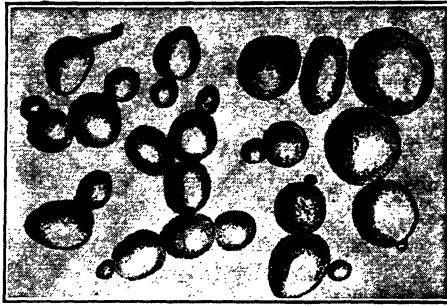

FIG. 62. *Saccharomyces cerevisiae*, Showing the Cell Shapes of Cells from the Sediment of Young Cultures. (After Hansen)

Shapes of Yeast Cells. Yeasts are unicellular organisms varying greatly in shape. Most of them have cells which are round or oval. One species has sausage-shaped cells. Cell shape is one of the first differential characteristics which may be used for the separation of one species from another. A number of names

of shapes have been accepted as types and are convenient when one wishes to indicate shapes of yeast cells:

Cerevisiae—round or globular, isolated cells.

Ellipsoideus—elliptical cells.

Pastorianus—sausage-shaped cells.

Apiculatus—lemon-shaped cells.

Mycelial Structures. Some yeasts show marked tendency toward what are called mycelial formations. These are thread-

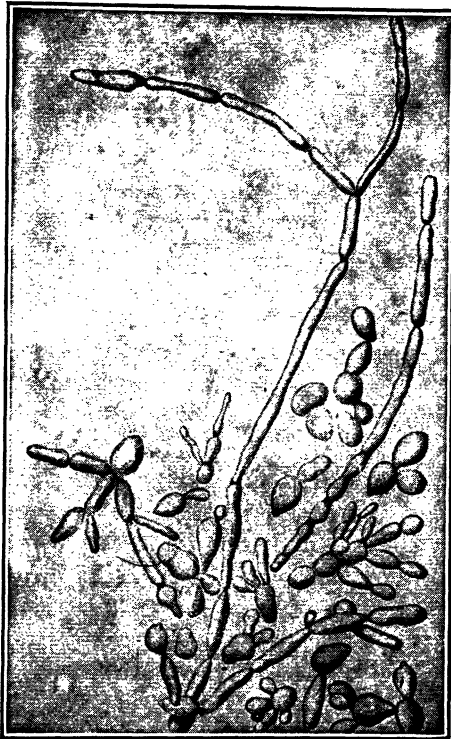

FIG. 63. *Saccharomyces cerevisiae*. Cells from the film of a culture at 15°. (After Hansen)

like and give the yeast the appearance of molds. This tendency, as can be easily understood, caused confusion among the early botanists who were trying to classify and identify various species. Mycelial formations appear especially in pellicles, veils, or films on the top of fermenting liquids—when they are formed. Myco-

derma species are typical film formers. They produce a film in a very short time. Some *Sacchoromyces* form a typical film but require a longer time. Different explanations have been offered for the formation of films by certain species. Some have suggested that the ability to grow on the surface was due to formation of fat by means of which cells resisted wetting. Others have believed that it might be due to demand for free oxygen.

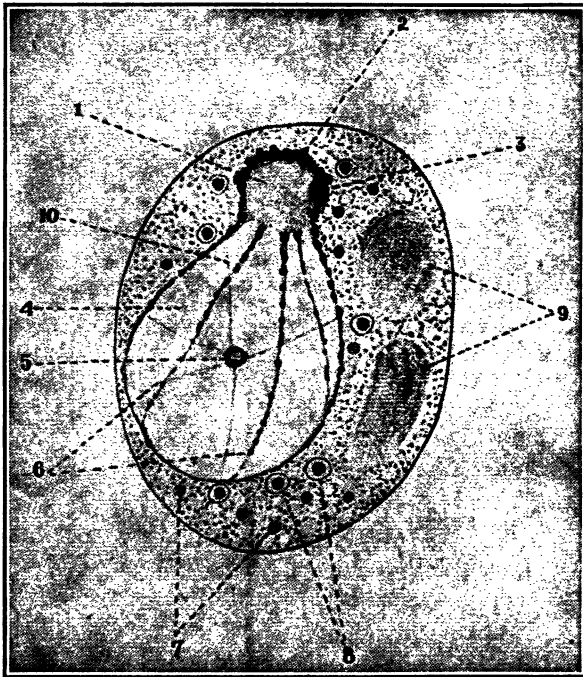

FIG. 64. Diagram of Yeast Cells. (After Wager, 1911)

1, Nucleolus. 2, Peripheral layer of chromatin. 3, Chromatin patch on one side of nucleolus. 4, Nuclear vacuole. 5, Central volutin granules in the vacuole. 6, Chromatin network. 7, Granules of fatty substances. 8, Volutin granules. 9, Glycogen-vacuoles. 10, Delicate suspending threads for the central volutin granule.

Structure of Yeast Cell. The yeast cell is a typical cell possessing all the usual organs. Yeasts are especially useful organisms for the study of cytology for they grow rapidly on ordinary media and are easily studied microscopically. Many of the data secured with the yeast cell have been used as bases for deduction and experiment with the smaller bacterial cells.

Cell Membrane. Yeast cells possess thick easily demonstrated cell walls. Some investigators have reported the presence of a special type of cellulose. The membrane on some yeasts may consist of two layers.

Nucleus. The nucleus of yeasts is large and may take up a considerable portion of the interior of the cell. The nucleus is usually globular, at least in young cells, but may vary in shape as the cell grows older. The nucleus plays an important role in the reproduction of the cell since it undergoes a division, one part remaining in the mother cell and the other going into the bud if the species reproduces by budding.

Vacuoles. These organs are visible in yeast cells as slightly refractive bodies. When the vacuoles increase in number, or when they become quite large, exhaustion of the cell or lack of food is indicated. Vacuoles are filled with a liquid the exact nature of which is not clearly understood.

Granules. Microscopic examination of a yeast cell usually reveals the presence of granules which appear as refractive units. They are usually distributed in the cytoplasm but may also appear in the vacuoles. They seem to be absent in young cells but appear in older cells especially when the glycogen content is reduced.

Reserve Materials. Yeast cells, like the cells of other types of organisms, are able to store appreciable amounts of reserve products, such as glycogen and fat. The former was discovered by the great French physiologist, Claude Bernard, as the carbohydrate in the liver of animals. Since it has somewhat the same function and interest that starch has in plants, it has often been called animal starch. Glycogen is regarded as a reserve material since in times of plenty the content increases and decreases markedly when the cell is in a starved condition. Another reserve product in yeast cells is fat. The content varies greatly. Certain yeasts are known as fat yeasts since they are able to change simple compounds to fat. *Torula lipofera* has been described as such a species. A yeast-like fungus, *Endomyces vernalis* is also a great fat producer. Guilliermond stated that the fat content of old cells may reach as much as 20 per cent on the dry basis.

Ascospores and Ascosporeulation in Yeasts. Ascospores are reproductive units formed by true yeasts. Involved in ascospore formation is nuclear division whether reproduction is sexual or

asexual. The ascospores are enclosed in a sac called an *ascus*. Yeasts are therefore placed in the group of fungi to which the name *Ascomycetes* or sac fungi is given. The number of ascospores which are formed is not uniform but is generally characteristic for each species. The same may be said for shape of ascospores. It varies widely but tends to be uniform for each species and is used to some extent for identification of species. Ascospores of the genus *Hansenula* (*Willia*), for instance, are shaped like a Derby hat. Other shapes are shown in Fig. 65.

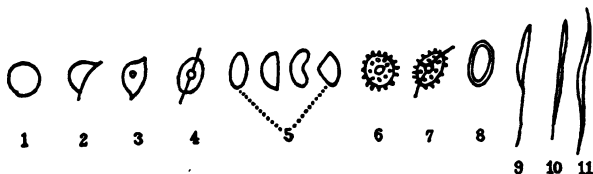

FIG. 65. Showing Various Shapes of Ascospores in Yeasts.
(After Guilliermond-Tanner)

1, *Saccharomyces cerevisiae*; 2, *Hansenula anomala*; 3, *Zygosaccharomyces chevalieri*; 4, *Hansenula saturnus*; 5, *Pichia membranifaciens*; 6, *Debaromyces*; 7, *Schwanniomyces occidentalis*; 8, *Saccharomyces occidentalis*; 9, *Nematospora coryli*; 10, *Coccidiascus legeri*.

Hansen, a Danish fermentologist, and Guilliermond, a French cytologist, showed that the *ascus* and its ascospores may result from fusion of two cells both functioning as gametes—sexual cells which unite with one another (copulation) for reproduction. Two cells close to one another put out little projections which unite to form what may be called a copulation canal. Through this union the contents of one cell pour into the other. Nuclear fusion results and the resulting cell is like a *zygospore*, the nucleus of which soon divides into the required number of parts to form the ascospore. In a few cases this phenomenon of copulation has been observed between ascospores in the same *ascus*. It is described in the following paragraphs.

Hansen, to whom we are indebted for much of our information on yeast cytology, reported the following conditions as influencing ascospore formation:

1. The cells should be healthy and well nourished.
2. There should be an abundant supply of air.
3. Water must be present.
4. Proper temperature must be maintained (about 25°C.).

Germination of Ascospores. The ascospore is a resistant resting stage which remains as such until favorable conditions cause it to germinate and reproduce the vegetative stage in growth. Various methods are followed, depending on the species.

Properties of Ascospores. Yeasts are somewhat less resistant to heat than the bacteria. Vegetative cells of yeasts are destroyed around 60°C. in a comparatively short time. The ascospores are a little more resistant. Most of them, however, are destroyed by temperatures of pasteurization (60–65°C.).



FIG. 66. *Saccharomyces cerevisiae*, Showing the Early Stages in the Development of Ascospores. (After Hansen)

a, b, c, d, and e, Rudiments of ascospores with indistinct walls; f, g, h, i, and j, mature ascospores.



FIG. 67. *Saccharomyces cerevisiae*, Showing the Early Stages in the Germination of Ascospores. (After Hansen)

a, d, e, and g, Formation of walls; e, f, and g, the walls have been broken; an ascospore with several chambers.

Durable Cells or Chlamydo spores in Yeasts. These are cells with thick walls, the cell contents of which are rich in glycogen and fats. They are said to possess a double membrane which may partially account for their resistance. They may be comparable to chlamydo spores which occur in many fungi.

Reproduction of Yeasts. Yeasts are unicellular organisms which reproduce by sexual and asexual methods. The latter is common and is known as budding.

Budding. After the yeast cell has reached maturity it may bud. On a side of this cell, spoken of as the mother cell, a small cell, or bud, appears which is known as the daughter cell. This latter cell grows until it approaches the size of the mother cell when it breaks away and lives as a separate individual. It, in turn, may bud and thus the species is perpetuated. Under optimum conditions of temperature and food supply, each mother cell may form many buds about the cell. If the daughter cells,

or buds, do not separate from the mother cell, a clump or mass of cells is formed. These attached daughter cells may also bud.

Transverse Division (Partition) of Yeasts. This is quite another method of reproduction from the one just described. With budding the progeny are smaller and have to grow to the size of the cell which formed them. The method discussed

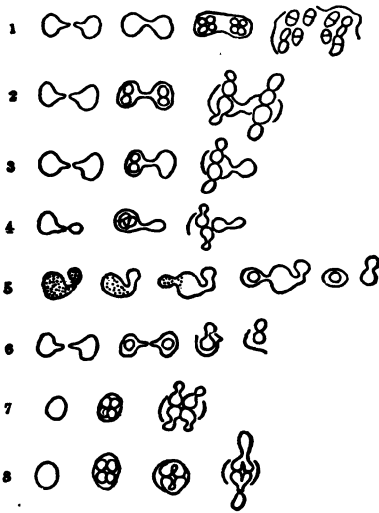

FIG. 68. Scheme Representing the Development of Forms of Yeasts. (After Guilliermond-Tanner)

1. *Sch. octosporus* (isogamic); 2, *Zygosaccharomyces Barkeri* (isogamic); 3, "Yeast 6" of Pearse and Barker (intermediate forms between iso- and heterogamy); 4, *Zygosacch. chevalieri* (heterogamy); 5, *Nadsonia* (heterogamy and asci resulting from the budding of eggs); 6, Yeast of Rose (parthenogamy with traces of sexual attraction); 7, *S. cerevisiae* (parthenogenesis); 8, *S. Ludwigi* (parthenogamy between spores).

here is called transverse division because each cell divides transversely to form two cells which are one half the size of the original cell. Species which reproduce in this manner are grouped in the genus *Schizosaccharomyces*. This division is accomplished by appearance of a cross wall in the middle of the cell after it has elongated. The appearance of the cross wall is followed by a constriction at this point; the cell finally breaks giving two cells. As is the case in budding, the cells often remained attached for a while giving clusters or clumps.

Sexual Phenomena in Yeasts.

For many years it was believed that yeasts were asexual. However, careful observations by a French mycologist, Guilliermond, showed that formation of ascospores in *Schizosaccharomyces octosporus* was preceded by fusion of two

cells. Two cells called gametes close together copulate by putting out little protuberances which unite to form a copulation canal. The contents of the cells then mix, including the nuclei, forming a zygospore. Such a zygospore results from what is called *isogamic* copulation, because the two gametes are about equal in size. Profound changes then occur in the zygospore.

It grows and finally its nucleus divides into four or eight individuals each of which later is the nucleus of an ascospore. The zygosporic is thus on ascus.

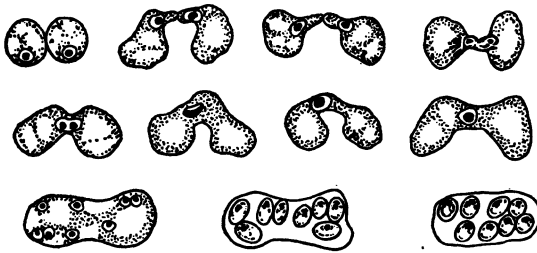

FIG. 69. Conjugation and Formation of Ascus in *Schizosaccharomyces octosporus*. (After Guilliermond-Tanner)

Modifications of the copulation just described are also known. In the species *Schizosaccharomyces pombe* what has just been described for *Schizosaccharomyces octosporus* occurs but it remains incomplete in that the two gametes remain united.

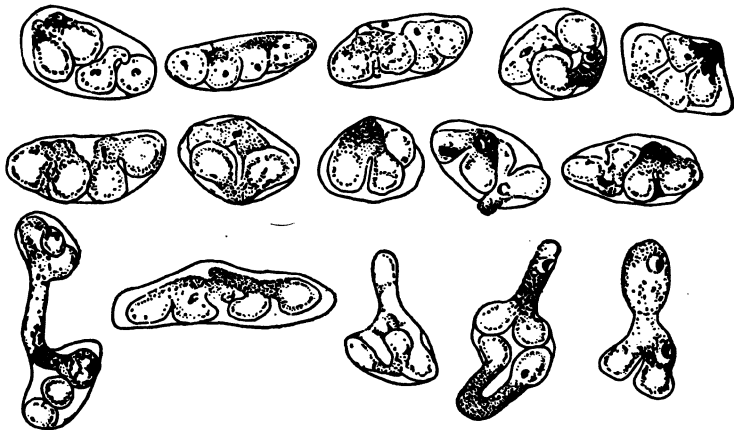

FIG. 70. Showing Conjugation of Ascospores in *Saccharomyces Ludwigii*. (After Guilliermond)

Fusion of contents of the gametes occurs followed by division of the resulting nucleus into two, each of which migrates to one of the connected gametes where it, in turn, divides into two, thus giving four nuclei in an ascus with a typical shape.

A still more striking sexual phenomenon has been observed in a copulation between a mother cell and a daughter cell or bud which is still attached to the mother cell. This has been observed in the species *Zygosaccharomyces priorianus* and is known as *heterogamic* copulation because the two gametes are unequal in size. Owing to the small size of one of the gametes, the ascospores appear in the larger one, in this case in the mother cell. The mother cell is the *macrogamete* and the bud the *microgamete*. Similar sexual phenomena have also been revealed in species of *Nadsonia*.

Copulation of Ascospores. Just as copulations between adjacent yeast cells have been observed, they have also been demonstrated to occur between ascospores. A copulation canal forms between two ascospores in the same ascus through which passes the contents of both cells to result in a thorough fusion. This is isogamic copulation of ascospores in an ascus formed without fusion. In the case of *Saccharomyces Ludwigii*, which forms asci with four ascospores, these copulate two by two through a fusion canal formed between them. This is a true copulation involving nuclear fusion.

Parthenogenesis in Yeasts. Certain yeasts show no evidence whatever of sexual phenomena. It is believed that sexual processes were once possessed but have been lost. Whether this is permanent is not known. This means that what is called fertilization does not then exist. In this case new individuals develop from parent cells. This is an interesting biological phenomenon exhibited also by higher forms of life. Among the yeasts it is recognized in species of *Endomycopsis*, *Pichia*, and *Schwanniomyces*.

HYBRIDIZATION OF YEASTS

A hybrid is a form of life resulting from interbreeding of two distinct species. Hybridization in yeasts could not be considered until definite evidence of sexual phenomena was secured. Although such evidence was secured by early workers with yeasts, its significance was not appreciated largely because modern genetics had not been developed. In 1935 an investigator by the name of Winge, with the help of Laustsen, showed that sporulation of a yeast is associated with a genetic segregation that makes the spores in any ascus differ genetically. Since ascospores copu-

late, as previously described, and the process results in a fertilized cell, entirely new types of yeast may segregate at germination of the ascospores even though one starts with a culture prepared from a single yeast cell.

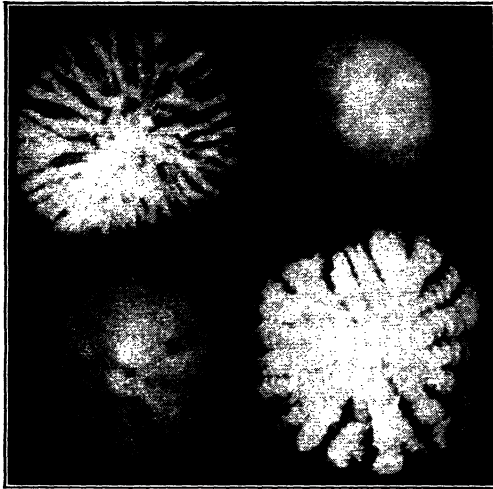

FIG. 71. Showing Giant Colonies Grown from Each of the Four Ascospores in One Ascus of a Baking Yeast. (After Winge, 1939)

This fact has been established for all species of *Saccharomyces* by isolating each of the four ascospores in an ascus, transferring them to the surface of culture media, and allowing giant colonies to develop. Although such isolations are tedious and require considerable skill, it is possible to select with a "micromanipulator" each ascospore and transfer it to another medium. This made it possible for Winge to place two ascospores, each from the ascus of a different species, in the same culture in a hanging drop and observe what happened. In one experiment he used baking yeast (a *Saccharomyces* species) and *Saccharomyces validus*. Two ascospores, one of each, were placed together. The two spores fused into a zygote on which a bud formed, a hybrid between the two yeasts. This was cultivated further, and finally ascospores in turn were isolated for study (Figs. 71 and 72).

Such experiments reveal great possibilities in breeding new yeast types through hybridization for special purposes, just as

has been done with higher plants and animals. Cattle, for instance, are bred today for either milk or beef production. It may be possible now to breed yeasts for bread making or for fermentation by attempts to combine the desirable characters of several yeast types into a single new species.

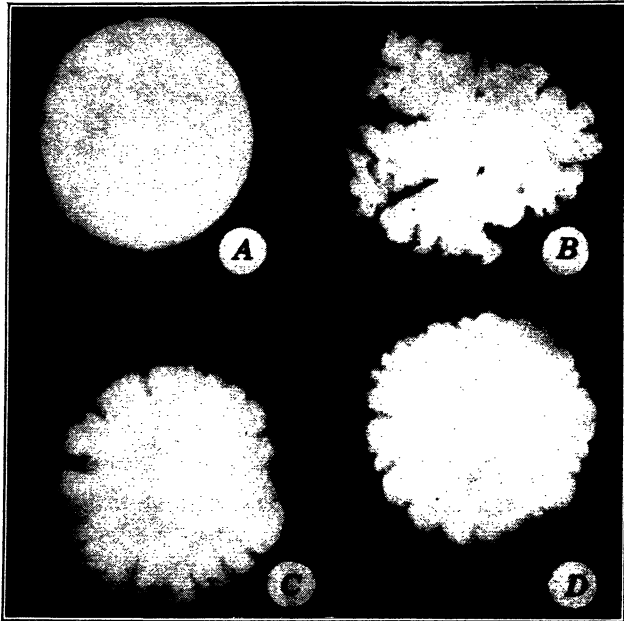

FIG. 72. Showing Giant Colonies of A, A Baking Yeast; B, *Saccharomyces validus*; C and D, Two Giant Colonies of a Hybrid of A and B. (After Winge, 1939)

Classification of Yeasts. Yeasts have been roughly classified into two great groups depending on their ability to form ascospores. True yeasts form ascospores and reproduce by budding or by partition. These "true yeasts" belong to the class Ascomycetes and the family Endomycetaceae. Those yeast-like organisms incapable of ascospore formation, sometimes called "false yeasts," are grouped in the great class of "fungi imperfecti," which includes all fungi unable to form ascospores. Both groups have been studied intensively by taxonomists. Many interesting observations have been made by those who have attempted to unravel the phylogenetic relationships between the Ascomycetes.

Through the years many classification systems have been suggested. The most recent and comprehensive has been the result of a study of the famous yeast collection, a section of the Centraalbureau voor Schimmelcultures, Baarn, maintained at the Technische Hoogeschool, Delft, Holland, under the direction of

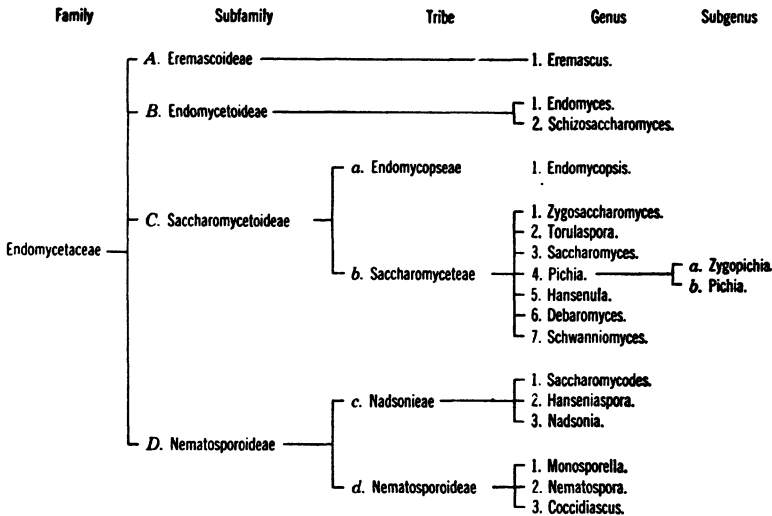

FIG. 73. Graphic Presentation of Various Divisions of Ascospore-Forming Yeasts. (Prepared From Classification by Stelling-Dekker, 1931, as Slightly Modified by Guilliermond; 1937)

A. J. Kluyver. The first monograph, "Die Sporogenen Hefen," by N. M. Stelling-Dekker, appeared in 1931. The second monograph, "Die Anaskosporogenen Hefen," Part 1, by Jacomina Lodder, is in two sections, the first of which was published in 1934. The second, Part 2, with the same title appeared in 1942.

Phylum, THALLOPHYTA

Subphylum, Fungi

Class, *Ascomycetes*

Family, *Endomycetaceae*

Subfamily A, *Eremascoideae*

Genus 1, *Eremascus* Eidam.

Subfamily B, *Endomycetoideae*

Genus 1, *Endomyces* Reess.

Genus 2, *Schizosaccharomyces* Lindner.

Subfamily C, *Saccharomycetoideae*

TRIBE A, *ENDOMYCOPSEAE*Genus 1, *Endomycopsis* Dekker.TRIBE B, *SACCHAROMYCETACEAE*Genus 1, *Zygosaccharomyces* Barker.Genus 2, *Torulaspota* Lindner.Genus 3, *Saccharomyces* Meyen.Genus 4, *Pichia* Hansen.Subgenus 1, *Pichia* Hansen.Subgenus 2, *Zygopichia* Klöcker.Genus 5, *Hansenula* (Willia Klöcker) Sydow.Genus 6, *Debaromyces* Klöcker.Genus 7, *Schwanniomyces* Klöcker.TRIBE C, *NADSONIEAE*Genus 1, *Saccharomycodes* Hansen.Genus 2, *Hanseniaspora* Zikes.Genus 3, *Nadsonia* Sydow.Subfamily D, *Nematosporoideae*Genus 1, *Monosporella* Keilin.Genus 2, *Nematospora* Peglion.Genus 3, *Coccidiascus* Chatton.**STELLING-DEKKER'S (1931) CLASSIFICATION OF
ASCOSPORE-FORMING YEASTS**

Slightly Modified by Guilliermond, 1937

Family *Endomycetaceae*I. Subfamily *Eremascoideae*.Genus *Eremascus* Eidam.

Thallus consists of a mycelium without any evidence of asexual multiplication. Asci formed by isogamic copulation; 8 round ascospores.

II. Subfamily *Endomycetoidea*.

Thallus consists of a typical mycelium; multiplication by means of oidia or thallus consisting of oidia.

Genus 1. *Endomyces* Reess.

Typical mycelium multiplying by oidia. Asci formed by heterogamic conjugation or by parthenogenesis; 4 round ascospores in the shape of a hat.

Genus 2. *Schizosaccharomyces* Lindner.

Thallus reduced to the oidial state. Asci formed by isogamic copulation; 4 to 8 round ascospores.

III. Subfamily *Saccharomycoideae*.

Thallus formed by a typical mycelium; reproduction by means of yeast conidia and sometimes by oidia, or thallus of yeast-like cells.

A. Tribe *Endomycopseae*.

Thallus formed by a typical mycelium multiplying by conidia and sometimes by oidia. Asci formed by heterogamic conjugation or by parthenogenesis, sometimes after a tentative union (traces of sexuality). Ascospores in shape of a hat or sickle, or girded about the middle with a smooth and sometimes verrucose band.

Genus 1. *Endomycopsis* Dekker.

B. Tribe *Saccharomycetaceae*.

Thallus consisting of yeast forms sometimes showing rudimentary mycelium.

Genus 1. *Zygosaccharomyces* Barker.

Round, oval or elongated cells. Asci resulting from isogamic or heterogamic copulation; 1 to 4 round or kidney-shaped ascospores. Fungi developing on liquid media at first as a sediment, not as a film but forming a ring slowly. Producers of alcoholic fermentation.

Genus 2. *Torulaspota* Lindner.

Round cells. Asci resulting from parthenogenesis of cells which have attempted to conjugate; 1 to 2 round and smooth ascospores. Growing as a sediment without a film or ring or producing them only slowly.

Genus 3. *Saccharomyces* Meyen.

Round, oval, or elongated cells, sometimes rudimentary mycelium. Asci formed without conjugation; 1 to 4 round smooth ascospores. Conjugation occurs between ascospores or more commonly between the first cells formed by budding; zygospores are starting point of diploidal cells which, after several generations, develop with asci; vegetating at first in liquid media as a sediment; film or ring formation slow or failing entirely. Producers of fermentation.

Genus 4. *Pichia* Hansen.

Oval or elongated cells. Asci formed by isogamic or heterogamic conjugation or by parthenogenesis; 1 to 4 hemispherical, kidney-shaped, or triangular, smooth; in liquid culture media a film soon forms on the surface; oxidizing sometimes fermentative.

(a) Subgenus *Zygopichia* Klöcker.

Asci result from isogamic or heterogamic conjugation.

(b) Subgenus *Pichia* Hansen.

Asci formed by parthenogenesis.

Genus 5. *Hansenula* (*Willia* Klöcker) Sydow.

Cells usually oval or elongated, rarely round with occasional rudiments of mycelium. Asci formed without conjugation; 1 to 4 ascospores having appearance of a derby hat or with a projecting ring around them (something like the planet Saturn). In certain species as (*Hansenula saturnus*) conjugation occurs between ascospores, or more commonly between the first cells formed by budding resulting in zygospores, the starting point of numerous generations of diploid cells which eventually develop into asci. A liquid-media vegetation is as a film on the surface. Oxidative and sometimes fermentative.

Genus 6. *Debaromyces* Klöcker.

Round or oval cells with occasional rudiments of mycelium. Asci formed by isogamic or heterogamic conjugation; 1 or 2, sometimes 4, round globular ascospores. A sediment is first formed in liquid-culture media; later a film and ring. Sometimes fermenters.

Genus 7. *Schwanniomyces* Klöcker.

Round or oval cells with occasional rudiments of mycelium. Asci formed by parthenogenesis after a tentative union (remnants of sexuality); 1 or 2 ascospores having a girdle around the middle, and often verrucose or warty.

C. Tribe *Nadsonieae*.

Elongated cells, ordinarily apiculate and budding at the ends by a process intermediate between budding and partition.

Genus 1. *Nadsonia* Sydow (*Guilliermondia* Nadson and Konokotina).

Asci formed in a bud derived from a zygote resulting from heterogamic conjugation; 1 or 2, sometimes up to 4, round verrucose ascospores. Growth on liquid media as a sediment; alcohol production.

Genus 2. *Saccharomycodes*.

Asci with 4 round smooth ascospores; conjugation occurs regularly between ascospores. Growth first appears as a sediment in liquid media. Fermentative.

Genus 3. *Hanseniaspora* (*Hansenia* Lindner).

Cells very clearly apiculate; asci formed without conjugation; 1 to 4 hemispherical or round ascospores.

IV. Subfamily *Nematosporoideae*.

Cells yeast-like with variable shapes, and frequently a mycelium. Asci with from 1 to 8 ascospores shaped like long needles.

Genus 1. *Monospora* Keilin (*Monospora* Metchnikoff).

Cells yeast-like; asci in the shape of long needles.

Genus 2. *Nematospora* Peglion.

Cells yeast-like; variable in shape and mycelium; 1 to 8 ascospores in shape of needles provided at one end with a sort of long flagellum.

Genus 3. *Coccidiascus* Chatton.

Oval yeast-like cells; asci apparently result from an isogamic conjugation; 8 ascospores in the shape of long spindles.

**LODDER'S (1931) CLASSIFICATION OF THE
NON-ASCOPE-FORMING YEASTS****Family 1. *Nectaromycetaceae*.**

Producing conidia.

Family 2. *Torulapsidaceae*.

Cells free of carotinoid pigments. No conidia.

A. Subfamily *Torulapsoideae*.

Yeast-like organisms which reproduce only by budding. The cells are round, oval, or elongated, seldom of other shapes. A definite pseudomycelium with special reproduction of blastospores on the hyphae is not produced. Neither ascospores nor blastospores produced. No production of carotinoid pigment.

Genus 1. *Torulapsis* Berlese.

Cells round, oval, and infrequently elongated. Reproduction by peritrichous budding. In wort, a sediment, often a ring and sometimes after a longer time a pellicle. Ability to ferment sugars may or may not be present. Strains which do not ferment will always assimilate dextrose and usually also other sugars. Peptone is usually assimilated, and other nitrogen compounds are also customarily used. Fair to good growth in ethyl alcohol.

Genus 2. *Pityrosporium* Sabouraud.

Cells flask-shaped, oval or short oval. Vegetative reproduction by budding which predominately is on the broad base. Poor growth: slow growth in wort and on wort agar. No fermentation.

Genus 3. *Mycoderma* Persoon-Leberle.

Cells oval or cylindrical, often in cell colonies. Tendency to produce a poorly developed pseudomycelium, seldom the formation of very primitive blastospore apparatus. Vegetative reproduction by peritrichous budding. The cells rapidly produce a pellicle on sugar-containing medium as well as on ethyl alcohol medium. The pellicle contains gas bubbles and is thick, dry, and matted. No fermentation. In synthetic medium growth only with dextrose. Of the investigated nitrogen compounds ammonium sulfate, asparagin, urea, and peptone were assimilated.

Genus 4. *Kloeckera* Janke.

Cells apiculate, short-oval, oval, long oval or sausage-shaped. Vegetative reproduction by bipolar budding. Strong fermentation only of dextrose or dextrose and sucrose. Of the nitrogen compounds tested, only peptone is assimilated. Practically no growth in ethyl alcohol medium.

Genus 5. *Asporomyces* Chaborski.

Cells show traces of a rudimentary copulation; yet they produce neither zygospores nor parthenospores. The ability to produce spores is completely lost.

Genus 6. *Trigonopsis* Schachner.

Cells three-cornered or ellipsoidal, in young cultures the length of one side of the three-cornered cells is 4-5 microns: ellipsoidal cells 2.5-3.5 x 3.5-5 microns. In older cultures the majority of the cells become three cornered. In wort, a sediment, ring, and a few islands of pellicle. No fermentation. In synthetic medium growth only with dextrose and galactose. Of the nitrogen compounds tested, ammonium sulfate, asparagin, urea, and peptone were assimilated. Poor growth in ethyl alcohol. Streak culture on wort agar yellow-brown in middle edge lighter, soft, smooth, and glistening.

Genus 7. *Schizoblastosporion* Ciferri.

Cells polymorphic. Usually two types, oval cells and elongate cylindrical cells. Reproduction by budding; the bud is frequently separated from the mother cell by fission. In wort rapid pellicle formation, ring, and sediment. No fermentation. In synthetic medium growth only with dextrose. Of the investigated nitrogen compounds ammonium sulfate, asparagin, urea, and peptone were assimilated. Streak on wort agar gray-white, glistening, and somewhat wrinkled. Border somewhat transparent and irregular.

B. Subfamily *Mycotoruloideae*. Ciferri and Redaelli.

Yeasts which produce a pseudomycelium and have ability to produce special types of spores.

Subgroup I. Creamy cultures.

Genus 1. *Mycotorula* Will—Ciferri and Redaelli.

Budding cellules irregularly placed along the mycelial hyphae. Blastospores in simple and regular verticilles and in terminal bouquets.

Genus 2. *Mycotoruloides*—Langeron and Talice.

Blastospores in regular verticilles, composite, and spread out and in terminal bouquets.

Genus 3. *Candida* Berkhout.

Budding cellules, with septate mycelial hyphae, blastospores in terminal chainets and in more or less regular verticilles.

Genus 4. *Mycocandida* Langeron and Talice.

Rudimentary verticilles reduced to two blastospores, ramified pseudomycelium, blastospores mostly elongate.

Genus 5. *Blastodendron* Ota.

Verticilles simple or composite, more or less regular, no terminal bouquets. Statagmoid blastospores.

Subgroup II. Membraneous cultures.

Intermediary between the so-called blastospores and arthrospores. Some spores occur in verticilles and some as blastospore-arthrospores.

Genus 1. *Geotrichoides* Langeron and Talice.

Fragile pseudomycelium. Some blastospore verticilles, some blastospore-arthrospores, and some conidia. No pellicle on potato water.

Genus 2. *Geotrichium* Luik.

True mycelium, not fragile before disarticulation; some arthrospores, no blastospores, pellicle on all liquid medium.

Family 3. *Rhodotorulaceae*.

Yeasts without conidia; the cells contain a carotinoid pigment.

Genus 1. *Rhodotorula* Harrison.

Cells round, ellipsoidal, elongate, stalagmoid; vegetative reproduction only by peritrichous budding. Forms a yellow or red carotinoid pigment. No fermentation. Always assimilates dextrose, and usually also some other sugars. Ammonium sulfate, asparagin, urea, and peptone are always assimilated. With ethyl alcohol as medium, poor to good growth was obtained.

INDUSTRIAL YEASTS

The yeast plant is a wonderfully active and useful organism. Each cell of certain species is a manufacturing plant of marvelous efficiency and productivity. By means of fermentations brought about by yeast cells, man, for ages, has brought about desired changes, in foods and beverages. In most of these cases he has not known until recently just what was responsible for the changes, for knowledge with regard to yeasts was not forthcoming until the researches of Pasteur, Hansen, and others.

Industrial Classification of Yeasts. In the fermentation industries yeasts are classified into top, bottom, and distillery yeasts. The groups are not sharply separated nor defined.

Top Yeasts. Top yeasts are those which ferment in the upper layers of the medium. They ferment with a vigorous foam or froth, spoken of as "head" in fermentation industries, which carries many of the cells to the top. Such a fermentation is termed a top fermentation. Most of the yeasts in pressed yeast are top yeasts. Top yeasts, in general, remain attached, giving masses of cells; but bottom yeasts separate. Top yeasts produce more alcohol than bottom yeasts. After active fermentation has stopped, these species may settle to the bottom. Many top-fermentation yeasts are unable to ferment melibiose. Top fermentations induced by top yeasts are accompanied by large quantities of foam (head).

Bottom Yeasts. Bottom yeasts grow and ferment down in the liquid or even at the very bottom of the substrate. They produce lower amounts of alcohol. Bottom yeasts contain an enzyme, melibiase, which allows this species to ferment melibiose.

Distillery Yeasts. These are yeasts which are used for making industrial alcohol and distilled beverages. They are distinguished from other yeasts by marked fermentation ability and alcohol tolerance.

Pressed Yeast. Scarcely a hamlet exists today which does not have its supply of fresh pressed yeast. In former times, homemakers had to prepare their leavening agent for making bread and maintain it. They did this by allowing a mashed potato and cornmeal mash to ferment. This was used as leaven. Today cakes of pressed yeast are available. These are made from yeast cells which are propagated on a wort medium, a clear straw-colored fluid containing extractives from blended grain flours. Flours secured from grinding grains are blended and soaked in clean water. This softens the starch particles and extracts various food materials which are necessary for the yeast plant. Malt is also added to change starch to sugar. A sweet mash, rich in food materials desired by yeasts, results. The mash is next soured by adding pure cultures of lactic acid bacteria which change sugars to organic acids. This acid counteracts putrefaction and makes the mash keep. When the mash has soured sufficiently it is filtered, a clear straw-colored liquor known as "wort" being secured. It is then heated to a high temperature for sterilization. This clear wort is the medium on which the yeast is propagated. It is carried in pipes to fermenters where

after inoculation it is kept at the proper temperature for the growth of the yeast. While fermentation is going on air may be blown through the wort, which removes the carbon dioxide and causes a greater crop of yeast cells. At the end of fermentation, the wort is filtered or centrifuged to remove yeast cells. They are collected as a thick cream and finally carefully dried further in filter presses. The cells from the presses are mixed with about 5 per cent of starch, pressed into cakes, and shipped to centers where they are cut for sale.

Instead of the laborious preparation of wort outlined here some yeast manufacturers have introduced a synthetic wort made from sugar or molasses and ammonium sulfate. This is aerated while the yeast is growing in it. Aeration removes the gaseous products of yeast metabolism as well as stimulates cell division mechanically.

THERAPEUTIC USE OF YEAST

Since very early times yeasts of different types have been used in the treatment of disease and infections. It has been stated that monks used yeast for treatment of several diseases. Hippocrates advised yeast for the treatment of leucorrhœa. Since these times there seems to have been a continuous interest in yeast as a therapeutic agent. The present-day interest began, perhaps, with a paper by Hawk and his colleagues in which they reported beneficial results in infections of the skin and constipation following ingestion of yeast. This stimulated manufacturers of pressed yeast to advertise widely the therapeutic properties of their product. It seems well established that the ingestion of baker's yeast will alleviate constipation. Whether a cure results has not been satisfactorily established. Modern medical science dislikes the continued use of a drug or other agent to relieve constipation. It strives, on the other hand, to correct the cause. One may reasonably question the advisability of prolonged use of yeast for this purpose. Very little, if any, satisfactory evidence exists to indicate the absolute harmlessness of constantly overloading the intestinal tract with living yeast cells.

PATHOGENIC YEASTS

Although some yeasts play an important role in certain industries, species also exist which cause very serious infections in

animals. Far less is known about these forms than about the bacteria which cause disease. It would be out of place to enumerate at great length species which cause these infections in man and animals. The literature of bacteriology contains hundreds of references to such infections. They are probably more important than ordinarily believed. Some severe infections of the lungs closely resembling tuberculosis have been found to be due to yeasts. Skin infections have, at times, been quite common. In fact, there is scarcely an organ in the body which has not been reported to have been infected with yeasts.

Thrush. This is an infection of the mouth and throat especially common in babies. Identification of the etiologic agent is confused. It was first described under the name of *Oidium albicans* by Robin. Later Reess called it *Saccharomyces albicans*, which was probably wrong. Now it is known under the names *Endomyces albicans* and *Monilia albicans*. This same fungus is apparently capable of causing other infections, also, in the animal body. Formerly the disease was thought to be mainly a tropical infection, but more and more reports are appearing in our literature indicating its prevalence in the temperate zones. Some yeast infections of the throat are much like those of diphtheria. Careful laboratory examinations are necessary before the exact nature of the infection may be determined.

REFERENCES

- CHAPMAN, A. C., The Yeasts: A Chapter on Microscopical Science, *J. Roy. Microscop. Soc.* (1925), 1-16.
- CHAPMAN, A. C., The Fungi: Imperfecti, etc., *J. Roy. Microscop. Soc.* (1926), 1-16.
- GALLOWAY, L. D., and R. BURGESS. Applied Mycology and Bacteriology, Leonard Hill, London, 1937.
- GLAUBITZ, M., Atlas der Gärungs Mikroorganismen, Paul Parey, Berlin, 1932.
- GUILLIERMOND, A., Clef dichotomique pour la détermination des levures, Librairie Le François, Paris, 1928.
- GUILLIERMOND, A., La Sexualité, Le cycle de développement, La phylogénie et la classification des levures d'après les travaux récents, Masson et Cie., Paris, 1937. Also: *Botan. Rev.*, 6 (1940), 1-24.
- GUILLIERMOND, A., The Yeasts, Translation by F. W. Tanner, Wiley, New York, 1920.
- HENRICI, A. T., Molds, Yeasts, and Actinomycetes, Wiley, New York, 1930.
- HENRICI, A. T., The Yeasts, Genetics, Cytology, Variation, Classification, and Identification, *Bact. Rev.* 5 (1941), 47-179.

- JORGENSEN, A., *Microorganisms and Fermentation*, Chas. Griffin & Co., London, 1939.
- LAFAR, F., *Handbuch der technischen Mykologie*, 2d Edition, 5 Vols. between 1904 and 1914, Gustav Fischer, Jena, Germany.
- LODDER, JACOMINA, *Die Anaskosporogenen Hefen*, Part 1 (1934), Part 2 (1942), N. V. Noord-Hollandsche Uitgevers Maatschappij Amsterdam, Part 2 was published in 1942.
- SKINNER, C. E., C. W. EMMONS, and H. M. TSUCHIYA, *Henrici's Molds, Yeasts and Actinomycetes, A Handbook for Students of Bacteriology*, Wiley, New York, 1947.
- STELLING-DEKKER, N. M., *Die Sporogenen Hefen*, Akademie van Wetenschappen, Amsterdam, 1931.

CHAPTER 10

THE PROTOZOA

This is a group of animals of interest to bacteriologists because it consists of single-celled microorganisms structurally like many of the bacteria. Because of similarity in structure some biologists believe that bacteria should be classed with animals. A protozoan is a low animal form, single-celled, composed of protoplasm and containing a nucleus. Protozoa constitute the first phylum of the animal kingdom but possess many characteristics which connect them with plant forms. There are good reasons, if one desires controversy, for placing protozoa in the plant or animal kingdom over the location of the bacteria. All protozoa are small, and most of them require a microscope to make them visible.

Morphology of Protozoa. Protozoa are single-celled forms of life which show great variation in size and shape. Similar variation in size and shape exists among the protozoa as exists among the bacteria. Some protozoa are colonial and live in groups or masses. These are often visible without a microscope, but the individual members of these colonies are not.

Cytoplasm. Cytoplasm of a protozoan is not greatly different from that of other cells. It is colloidal in nature and quite fluid. It is separable into two zones, *ectoplasm* and *endoplasm*. The ectoplasm is an outer denser layer about the cell, whereas endoplasm is a thinner less dense zone at the center of the cell.

Nucleus. The nucleus is important in vital phenomena of the cell. It is important in reproduction of protozoa. If a protozoan cell is cut into two parts so that one part has the entire unharmed nucleus, that part will regenerate itself. The portion without the nucleus will not. The nucleus is demonstrable with nuclear stains; it is, also, more refractive than the rest of the cell. Presence of a nucleus in protozoa should be of interest to students of bacteriology in relation to the controversy over the presence of a nucleus in bacterial cells. A protozoan or yeast cell without a

nucleus would be considered impossible. These cells are large enough for study, and many functions have been given the nucleus in the life cycles of these organisms. It is apparent, then, in ascending the evolutionary line of living organisms that, as soon as we reach cells which are large enough for convenient study and examination, the nucleus is quite easily demonstrated, and important functions are attributed to it.

Centrosome. Centrosomes have not been uniformly found in the cells of all protozoa. In those forms of life where it has been proved to exist, it is said to function in reproduction and division of the nucleus.

Nutrition of Protozoa. Protozoa are able to use both liquid and solid food. Most saprophytic forms use solid food or at least are able to convert solid food into a condition in which it may be used. The liquid food passes through the cell wall by osmosis. Waste products are excreted in the same manner in those forms which do not possess definite excretory organs. Some protozoa possess contractile vacuoles which excrete material.

Nutritional requirements of the protozoa are similar to those of the higher animals as well as to those of the single cell microorganisms of the plant kingdom. These requirements are satisfied by certain amino acids, vitamins of the B complex and mineral salts.

Reproduction of Protozoa. The first evidence that reproduction of the cell is about to occur is seen in the nucleus. The nucleus divides into two nuclei; this is followed by division of the cell. This process is called binary fission, a method of reproduction also used by the yeasts.

Conjugation¹ of cells may occur among the protozoa just as it has been observed for yeasts and perhaps bacteria. Hertwig stated that sometimes this did not result in fertilization since only the protoplasm fused; the nuclei did not. At other times there is fusion of the nuclei. When copulating cells are equal in size they are called *isogametes*; when they differ in size the small cells, the males, are called *microgametes*; the larger female cells are called *macrogametes*. The small male microgametes fertilize the larger female macrogametes. After fertilization multiple fission may occur in the new cell (Schizogony).

¹ Copulation is a temporary union between two gametes; conjugation is a permanent union.

Protozoa also divide by fission in about the same manner as yeasts. A small bud appears on the side of a larger cell; it grows in size until it finally breaks away from the parent cell to exist as a separate unit. This is generally an asexual method of reproduction.

Sporulation. Among many forms of life resistant stages are found in a life cycle. These are spoken of as spores, conidia, ascospores, and the like. Similar stages called cysts are also found in the protozoa. Certain cells seem to be able to become encysted by forming a resistant wall about themselves. This process is not unlike the formation of the so-called "arthrospores" among bacteria. While the cell is in the encysted stage it is resistant to unfavorable conditions and may be disseminated by wind and water. When favorable conditions occur again it germinates into an actively growing cell.

Classification of Protozoa. As with bacteria, morphological and physiological characteristics are used for classification. With protozoa, however, most satisfactory classifications have been constructed with the use of morphological characteristics. The following classification is adapted from one by Calkins.

PROTOZOA

Unicellular organisms which reproduce by division or spore formation; solitary or united in colonies; free living or parasitic.

Sarcodina: Protozoa with changeable protoplasmic processes or pseudopodia; naked or shell-bearing; reproduce by fission and spore formation. Genus parasitic for man: *Endamoeba*.

Mastigophora: Protozoa with flagella; many of them possess mouth, nucleus, and contractile vacuole. Genus parasitic for man: *Trypanosma*.

Infusoria: Protozoa with cilia by which locomotion is accomplished; reproduction both by budding and by fusion; possess macronucleus and micronucleus. Genus parasitic for man: *Balantidium*.

Sporozoa: Protozoa without motile organs; reproduction by sporulation; always parasitic. Genera parasitic for man: *Coccidium*, *Piroplasma*, and *Plasmodium*.

PATHOGENIC PROTOZOA

Among protozoa are species which cause serious infections in man and animals. A few of the more common ones are discussed here.

Sleeping Sickness. This is a tropical infection caused by *Trypanosoma gambiense*. This parasite is transmitted by means

of the bite of the tsetse fly. It has been shown that blood of infected animals contains this trypanosome. The parasite remains in the fly for a long time, 12 to 15 weeks or longer. The fly *Glossina palpalis* seems to be the one which is most liable to disseminate the disease, because in localities where the fly is not found there are no cases. Typical symptoms are caused by the trypanosome entering the cerebrospinal fluid. The parasite may be present in the blood for some time before it enters the nervous system. The symptoms, in general, are fever and pronounced somnolence usually followed by death. The characteristics of the parasite may be secured from various reference texts on protozoology and parasitology.

Amoebic Dysentery (Amoebiasis). This disease has been restricted more to tropical than temperate climates, but it should not be considered strictly a tropical disease because many cases have been observed in northern climates. The disease is caused by *Endamoeba histolytica* which occurs in the bowel discharges of infected individuals and carriers. It is acquired by the patient from contaminated water, infected foods, and other agents which have been contaminated with infected material. Flies also spread the organism. The incubation period varies with the size of the dose of organisms. It is usually 3 to 4 weeks. Strict sanitation seems to be the only method of controlling the infection. This includes careful disposal of human excreta, protection of water supplies from contamination with sewage, and protection of foods eaten raw from sewage. The parasite causes large abscesses or ulcers by penetrating the intestinal walls. It may also penetrate the body tissues. Those who prepare food should be careful to keep the hands clean. During the summer of 1933 a striking outbreak occurred in Chicago. This outbreak prompted many investigations in the United States to determine how widely distributed *Endamoeba histolytica* might be. One such investigation of 1060 freshmen at a large university revealed that 4.1 per cent harbored the parasite in their intestinal tracts. The investigators who did this work believed it to be desirable to recognize "carriers" in student groups and food handlers.

One investigator of the disease reported that from 5 to 10 per cent of the population of this country is infected with *Endamoeba histolytica*. The symptoms may be quite varied. Appendicitis, massive hemorrhage, perforation of the intestines with resulting

peritonitis, brain abscess, spleen abscess, lung affections and skin ulcers and abscesses, liver abscess are a few of the 12 conditions that are listed as complications from infection with this parasite. The majority of these diseases are not accompanied by symptoms of dysentery. For that reason the name *amoebiasis* is used for them, whereas, the name *amoebic dysentery* is used for the intestinal infection resulting in dysentery.

Malaria. The name malaria covers several similar communicable fevers to which man is subject. There are several parasites, all protozoan in nature, which are grouped under sporozoa, making the genus *Plasmodium*. Several varieties of malarial parasites make it possible to classify the malarial fevers as follows:

1. Tertian fever caused by *Plasmodium vivax*.
2. Quartian fever caused by *Plasmodium malariae*.
3. Aestivo-autumnal fever caused by *Plasmodium falciparum*.

Separation and identification of these parasites is not a settled matter.

Malaria is an endemic disease in certain sections of the United States. The mosquito is the only means by which man may be infected. Malaria cannot be spread by all mosquitoes, but only by some 60 species of *Anopheles* and a few species of other genera. Consequently, three factors are involved in malaria: malarial parasites, healthy men, and the right species of mosquitoes. Only the female bites, and, if she feeds on a person suffering from malaria, she imbibes some of the parasites; when she feeds on a healthy person, some of the parasites are injected into him. These parasites enter the blood corpuscles where they grow larger and larger and finally reproduce in large numbers. The blood corpuscles in which this occurs then break up, and each of the parasites repeats the process in another corpuscle. The time required for this to occur varies with the parasite. The *tertian* requires 48 hours, the *quartian* 72 hours, and the *aestivo-autumnal* 24 to 48 hours. When the blood corpuscles break up to liberate the parasites, a poison is also liberated which causes chill and fever.

This historical period when the etiology of malaria was being determined is just as interesting as that of other branches of medical science. Years of investigation were required before the mosquito was proved to be so important. Many investigators

had a part in proving this. A complete discussion of this would require much space. Sir Ronald Ross of the Indian Medical Service probably was the first to show that *Anopheles* mosquitoes spread the etiologic agents of malaria. Among the investigations which confirmed this was a convincing experiment carried out by Sanborn and Low. They went to a region which was renowned for its malaria, the Roman Campagna. They lived in a carefully screened hut and refrained from going out at night when the malarial mosquito bites. They did not take the disease. They also sent some mosquitoes which had bitten persons suffering from the disease to London where their bites caused the disease in healthy subjects. Other experiments just as convincing made out the case against the mosquito.

The ultimate source of malaria is the blood of an infected individual. The incubation period varies with the type of species of infecting microorganism; it is usually 14 days in the tertian variety. Control of the disease involves strict isolation of the patient from mosquitoes. Breeding places of mosquitoes should be eradicated and larvae destroyed. This has been an effective method for controlling malaria.

Tropical and Imported Malaria. Since introduction of the airplane for rapid intercourse between nations, new and serious problems have developed with respect to possible importation of new diseases. It is fairly easy to control the infected human being but more difficult to control, for instance, the mosquito which may harbor among other organisms those causing malaria. Airplane travel has made the older quarantine methods obsolete. Special attention has had to be given to the dangerous malaria-carrying mosquito *Anopheles gambiae* whose home is in Africa. Live specimens have been found on airplanes coming from Dakar in Africa to Natal in Brazil. Live specimens were found in dwellings near the Natal airport. Although the airplanes are fumigated before leaving Africa and before leaving Brazil, a few live *gambiae* have apparently been able to stow away. One fertilized mosquito could start an epidemic. The Rockefeller Foundation is devoting much study to international problems such as these.

Malaria is a disease which has had more influence in determining the future of nations than almost any other factor. The decline of the Roman Empire has been attributed to it. The

surrender of Bataan was necessitated by infection of thousands of our troops with malaria. The French had to abandon construction of the Panama Canal because of yellow fever and malaria. Construction of the China-Burma highway was delayed by malaria and not accomplished until some anopheline control had been established. Quinine is the ancient antimalarial remedy. In view of capture of the great quinine-producing areas by the Japanese, other nations had to resort to synthetic antimalarial drugs among which *atabrine* and *plasmochin* are best known. The former is more important because the action of the latter compound is mainly against the gamete or sexual form of the parasite. The advantages of a synthetic antimalarial remedy which may be made almost anywhere over a natural drug from plants grown only in a restricted area of the world are obvious.

Control of malaria and a few other diseases depends on eradication of mosquitoes.

Texas Fever. This is a disease of cattle. It is spread by the bite of a certain tick which, in turn, has fed on the blood of an infected animal. The parasite belongs to the genus *Piroplasma*. The disease is fought by dipping the cattle in arsenic washes and by grazing them in pastures not harboring ticks.

REFERENCES

- BOYD, M. F., *An Introduction of Malariology*, Harvard Univ. Press, 1930.
CALKINS, G. M., *Protozoology*, Lea & Febiger, Philadelphia, 1933.
CHANDLER, A. C., *Animal Parasites and Human Disease*, Wiley, New York, 1940.
HEGNER, R. W., F. M. ROAT, D. L. AUGUSTINE, and C. G. HUFF, *Parasitology*, D. Appleton-Century, New York, 1938.
HERMS, W. B., *Medical Entomology with Special Reference to the Health and Well-Being of Man and Animals*, Macmillan, New York, 1939.
KUDO, R. R., *Protozoology*, 3d Edition, Charles C. Thomas, Springfield, Ill., 1945.
MATHESON, R. M., *Medical Entomology*, Charles C. Thomas, Springfield, Ill., 1932.
RILEY, W. A., and O. A. JOHANNSEN, *Medical Entomology—A Survey of Insects and Allied Forms Which Affect the Health of Man and Animals*, McGraw-Hill, New York, 1932.
STEINHAUS, E. A., *Insect Microbiology*, Comstock Publishing Co., Ithaca, N. Y., 1946.

CHAPTER 11

ACTION OF PHYSICAL AGENTS ON BACTERIA

The fact that bacteria are susceptible to injury by many physical agents gives us methods for coping with the undesirable and controlling the desirable species. Since the bodies of bacteria are protoplasm, and since protoplasm is a delicately equilibrated substance, their life processes may be easily upset. Such agents as heat and light exert a detrimental effect on bacteria. Some physical agents, such as temperature and moisture, are also important in the propagation of bacteria. It is necessary to maintain proper temperature, for instance, to secure good growth of microorganisms.

LIGHT

Many experiments in the laboratory have shown that light is detrimental to bacteria. Considerable work has been carried out to determine how light exerts its harmful effect. One of the earliest explanations suggested that harmful chemical substances were formed in the medium by light. These were suggested to be ozone, hydrogen peroxide, and the like. These agents are poisonous to bacteria, whatever their origin. Later, data were collected which seemed to refute this explanation of the toxic action of light. Another explanation suggested that light acted directly on protoplasm of cells, causing coagulation of protein incompatible with the life of the cell. Another fact interesting to contemplate in this connection is absence of chlorophyll in bacterial cells. This material gives the cells which contain it the ability to convert energy into light for the construction of large molecules from simpler ones. Chlorophyll-containing organisms are thus able to prevent accumulation of this energy. Non-chlorophyll microorganisms, being devoid of this substance, may be unable to prevent this and consequently are harmed by continued exposure to light.

Certain chemical compounds essential for life of microorganisms are known to be destroyed by light. This may explain

why certain microorganisms fail to grow in media exposed to strong light. Riboflavin is rapidly destroyed by light, pyridoxin more slowly.

Sunlight. Strong sunlight is quite destructive to bacteria when it is allowed to reach them directly. It shows similar destructive action on cells of the human body as evidenced by sunburn and tan. It has been advised as a hygienic agent of no mean ability for destruction of undesirable bacteria. This ability has prob-



FIG. 74. Showing the Influence of Sunlight on Bacteria. (After Buchner)

ably been overestimated since bacteria may be protected from its action by bits of organic matter and the like. More reliable agents are available with which to destroy bacteria. Early workers found that diffuse daylight inhibited growth of bacteria and direct sunlight killed them. Destructive action of sunlight has been offered as an explanation for decrease of bacteria in natural bodies of water. Its activity in this case depends on several factors, such as turbidity, reaction, and chemical content.

Buchner in 1897 conducted an experiment with *Eberthella typhosa* which showed the destructive effect of light on bacteria. He heavily seeded a dish containing culture medium. On the bottom of the dish was pasted the word TYPHUS in large block

letters of black paper. The dish was then exposed to sun for an hour and a half, after which it was incubated. After the paper letters had been removed their location was indicated by whitish growth where the opaque paper had prevented the sun's rays from killing the bacteria.

Ultraviolet Light. The various parts of the spectrum are characterized by specific wavelengths, or frequency. The known range of wavelengths varies between 30,000 meters (18.6 miles) and 0.00000000000001 meter. That portion of the spectrum with wavelengths of sufficient magnitude to be visible to the human eye is known as the visible spectrum (from the red to the blue); those wavelengths which cannot be seen by the human eye, but which are demonstrable by physical instruments, are spoken of as the ultraviolet at the blue end of the spectrum and infrared at the red end. Ultraviolet, as the name indicates (beyond the violet), is that invisible ray just beyond the blue. The unit of light wavelength must be so small that ordinary units of measurements would be too cumbersome to use. One would be using such long decimals that there would be greater possibility for error and much time would be lost. Consequently, physicists have done what the microscopists had to do, created a new unit of measurement. This is called the angstrom and is one ten-millionth of a millimeter in length. Besides the angstrom some investigators use the unit of measurement millimicron ($m\mu$). A millimicron is one millionth of a millimeter. For converting millimicrons into angstroms, multiply by 10 or add a cipher. The visible spectrum does not have much effect on bacteria, but the invisible does. Some investigators have reported that various parts of the visible spectrum show a varied effect.

That portion of the spectrum which is invisible to the human eye on account of its short wavelength, may be singled out for special discussion. Recent experimental work indicates that it is endowed with exceptional properties. It is often called the quartz ray since it is emitted from a quartz mercury-vapor lamp. This portion of the spectrum is quite germicidal for bacteria. Once this had been established, many attempts were made to apply the ultraviolet ray for killing undesirable bacteria and for curing disease. Attempts were made to sterilize water. Although under some conditions it was found to be a satisfactory germicide, it was too expensive when compared with other available methods.

It was suggested for pasteurizing milk, but on account of the opacity of milk its use had to be abandoned. During World War I the ultraviolet ray was suggested for sterilizing bacterins. One difficulty in using the ultraviolet ray is the fact that expensive quartz apparatus must be employed since the rays do not pass through ordinary glass.

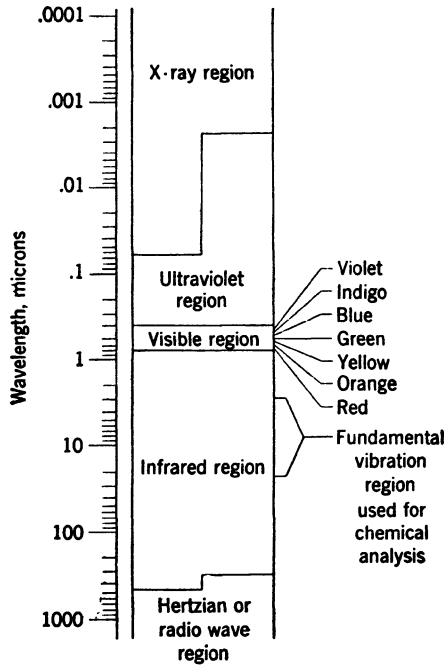

FIG. 75. Section of the Radiation Spectrum (Courtesy of Bausch and Lomb Optical Co.)

X Rays. This form of energy is very toxic to living protoplasm. It is used for treating some of the diseases caused by thread fungi such as ringworm and itch. These fungi, because of a rich filamentous growth, penetrate into deeper layers of the skin where they are reached with difficulty by fungicides and disinfectants. In using the X ray it seems to be difficult to prevent injury of tissue. Some investigators have stated that it is possible to destroy tissue cells without destroying bacteria for which the X rays were used.

TEMPERATURE

This is indeed an important physical agent for all forms of life. Many organisms carry on their life processes at a single temperature. Higher animals are separated into two groups on this basis, the cold-blooded and the warm-blooded animals. Microorganisms are much more susceptible to high than to low temperatures, although the latter are probably more harmful than is ordinarily believed. Here again it is well to point out that our data result from experiments with a great many cells and not from observations on one cell.

Classification of Bacteria according to Temperature Relations.

Reaction of bacteria to temperature gives a means of separating them into groups. These groups, of course, do not have well-defined limits and consequently grade into one another; but they are convenient for designating organisms having like temperature relations.

Thermophilic Bacteria. These are bacteria with high-temperature characteristics. The optimum may be placed between 55 and 60°C., the maximum at 70–75°C., and the minimum at perhaps 45°C., although this is variable. Some authors define obligate or strict thermophiles as those which constantly require a high temperature for growth, and facultative thermophiles as those able to grow at high temperatures and also at temperatures approaching the optimum for mesophilic bacteria. Thermophilic bacteria are interesting since they grow best at a temperature which is lethal for many other types of protoplasm. Many proteins are coagulated at 55–60°C.

Psychrophilic Bacteria. As the name indicates, these are cold-loving bacteria. They grow well at low temperatures. Their optimum might be placed around 5–10°C., with a minimum at just above 0°C., or just where the medium in which they are remains liquid. These forms are significant in the preservation of foods by cold storage.

Mesophilic Bacteria. Between the thermophilic and psychrophilic groups fall a great many species, the mesophilic bacteria, with an optimum about 30–37°C. In this group are pathogenic forms, those causing disease in man and animals, and the soil or water organisms.

Temperature limits for these groups of bacteria are somewhat variable (Table 2).

TABLE 2

	Minimum	Optimum	Maximum	Types or Species
	Deg. C.	Deg. C.	Deg. C.	
Psychrophilic	0	15-20	30	Many water bacteria
Mesophilic	15-25	37	43	Pathogenic and other bacteria
Thermophilic	25-45	50-55	85	Spore-forming bacteria from soil, water, thermal springs, etc.

Temperature Characteristics of Individual Organisms. Like the other characteristics of pure cultures, temperature relations are equally important in describing an organism. The following three temperature characteristics are determinable:

Maximum Temperature. This is usually defined as the highest temperature at which an organism may live and carry on any of its life processes. There may be a different maximum tempera-

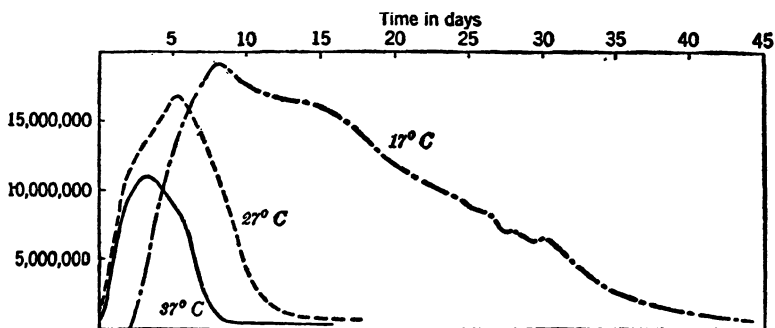

FIG. 76. Showing the Results of Different Temperatures of Incubation on Broth Cultures of *Staphylococcus aureus*. (After Graham-Smith)

ture for every function. Thus, the maximum temperature for growth may be quite different from that for fermentation. When maximum temperatures are given for an organism they usually refer to growth. At maximum temperatures the cell is being driven at a rate which causes great wear. There is probably little opportunity for cell repair, at least for the repair which is necessary to keep the cell in good condition. At maximum temperature, catabolism exceeds anabolism. This is also demonstrable in higher animals. High temperatures in the summer lead to general malaise.

Minimum Temperature. This is the lowest temperature at which functions are carried on. The minimum temperature, of course, would have to be above the freezing point. At its minimum temperature a cell is running very slowly in about the same manner that an automobile engine "idles" when the supply of fuel is reduced. At lower temperatures there is less wear on a cell, and it will live much longer. This is well illustrated in Fig. 76. Curves show the histories of cultures of the same organism grown at 37°, 27°, and 17°C. The organism was *Staphylococcus aureus*. The culture propagated at 17°C.; gave higher numbers of bacteria and maintained them for a longer period. At 37°C. the culture gave its maximum growth in a shorter time, but the cells wore themselves out more quickly.

EFFECT OF FREEZING ON BACTERIA. Bacteria differ in some respects from plants and higher animals in relation to freezing. Bacterial cells may be more resistant to freezing than cells of higher plants. Under the subject of thermal death time, it is pointed out that in connection with heat the time factor is important; it is just as important in relation to extreme cold or any other harmful agent. Cultures of bacteria have been exposed to the temperature of liquid air (—200°C.) and have shown growth in subcultures. This does not mean that there is no loss in numbers. The number of cells decreases very rapidly, and complete sterilization depends on the number of cells with which the experiment was started and other factors. Thomas found that the major portion of cells of *Eberthella typhosa* was destroyed by freezing in about a week. Bacteria in ice cream at first decrease rapidly in number, after which there is a slower death rate. The statements which appear in many texts that bacteria are not killed by freezing rest, perhaps, on faulty technic or false logic. The fact that living cells may be shown to be present in suspensions which have been frozen is no indication whatever that freezing is without effect. Some few cells may be more resistant than others and require longer freezing for destruction.

The medium in which the organisms are frozen seems to influence the results. As might be expected, bacteria are more easily destroyed by freezing in water than in milk. *Eberthella typhosa* was reported to have been destroyed in cherry juice much more quickly than when cherries were present in the juice. Heat is

probably removed more quickly from clear liquids than from liquids in which there are large amounts of solid material. Perhaps hydrogen-ion concentration is just as important in this connection as it is in destruction of bacteria by heat. The physical condition of the organism would also influence its reaction to cold.

When bacteria are frozen in some menstruum it has generally been believed that water necessary for their life processes was crystallized and, therefore, not available for their life processes. Preservation of foods by freezing has focused attention of microbiologists on the behavior of bacteria at temperatures below zero. Evidence has been published from at least two different laboratories to the effect that certain bacteria are able to grow as far below zero as -8.89°C . (16°F). The amount of growth even at the end of a year was slight and about equal to the amount formed in 18 hours at room temperature. There was growth, however, which presents some interesting problems for thought. Even if growth does not take place, many microorganisms remain viable, a fact used in preservation of microorganisms by the lyophile method.

Optimum Temperature. The optimum temperature for growth may be quite different from that for spore formation, fermentation, death, and so on. Statements about optimum temperatures usually apply to growth or multiplication, although the function of the organism should be mentioned. At the optimum temperature the cell is probably working to best advantage, and its machinery is working at such a rate that there is equilibrium between anabolism and catabolism.

Thermal Death Times of Bacteria. The time required to kill an organism at a given temperature is called the "thermal death time." The expression "thermal death point" was used by former bacteriologists because they thought that a point on the temperature scale existed where bacteria were killed. It is probably better to determine how long an organism can survive at a given temperature. Suspensions of cells may then be heated for varying lengths of times. No one temperature exists at which all of the cells in a suspension are killed instantaneously. The time factor must be considered. When studying the lethal action of heat on bacterial suspensions, the following factors are involved.

1. *Time.* Temperature and time cannot be separated, and when but one of these factors is being studied the other must be taken into consideration. There is an indirect relation between these two factors. To accomplish the same results we may use a higher temperature for a shorter time or we may use a lower temperature for a longer time. This is true also for chemical reactions. The chemist brings about reactions with heat that would require years to accomplish at room temperature.

The relation of time and temperature is well illustrated by two possible processes for the pasteurization of milk. One is the *flash* process, in which milk is heated to about 90°C. for 1 to 2 minutes, and the other, in use at present, is the *continuous* process in which a temperature of 62.5°C. is maintained for 30 minutes. In the former method temperature was high and time short; in the latter temperature is lower, necessitating a longer heating period if the same killing effects on bacteria are to be obtained.

Culture number	Initial concentration of spores	PH value	Minutes required to destroy spores of different initial concentrations																	
			120° C		120° C															
			+	-	1	2	3	4	5	6	7	8	9	10	11	12	13	14	15	16
26	40,000	6.0	11	12	_____															
	3,800	6.0	9	10	_____															
	440	6.0	8	9	_____															
	130	6.0	6	7	_____															
1421	33,000	6.0	10	11	_____															
	3,500	6.0	7	8	_____															
	450	6.0	5	6	_____															
	80	6.0	4	5	_____															
1390	26,000	6.0	6	7	_____															
	3,000	6.0	5	6	_____															
	400	6.0	3	4	_____															
	74	6.0	2	3	_____															
4109	130,000	6.0	17	18	_____															
	13,000	6.0	16	17	_____															
	1,300	6.0	14	15	_____															
	130	6.0	10	11	_____															

FIG. 77. Showing the Effect of Initial Concentration of Cells on the Time Necessary to Destroy Spores of Bacteria by Heat. (After Bigelow and Esty, 1920)

2. *Number of Cells.* It is well known from chemistry that concentration of reacting substances has much to do with speed of the reaction. Consequently, in determining thermal death times, where bacteria are being killed with moist heat, for instance, the same information is pertinent. The larger the number of cells present to be killed, the longer it will take to attain sterile conditions. It is also probably true that the greater the number of cells, the greater the possibility of securing very resistant cells which will be able to endure greater amounts of heat than ordinary cells.

3. *Amount of Water Present.* This is one of the essentials in thermal death-time studies. It is known that water is necessary for coagulation of

proteins, and destruction of bacteria by heat is probably due to this change. We have learned before that materials which go to make up protoplasm are colloidal in nature. When such materials are heated a gel is formed. This may be incompatible with continued normal activities of the cell. Frost and McCampbell in their textbook on bacteriology present the following table, which is interesting not only in this connection but also is explaining why such widely different temperatures are used in dry- and moist-heat sterilization.

Egg albumen	50 per cent of water coagulates at 56°C.
Egg albumen	25 per cent of water coagulates at 74–80°C.
Egg albumen	18 per cent of water coagulates at 80–90°C.
Egg albumen	6 per cent of water coagulates at 145°C.
Egg albumen	0 per cent of water coagulates at 160–170°C.

4. *The Age of the Cells.* Old cells are said to be more easily killed. Bacteriologists appreciate the necessity of using comparatively young cells; hence 24- and 48-hour-old cultures are used in experimental investigations unless older cultures are desired because of some special property. It should be remembered that old cultures may contain cells which are worn out and devitalized. On the other hand, cells which are very young might be more susceptible to heat since they might have to mature somewhat before showing a marked resistance to heat.

5. *Reaction of the Medium.* For a long time it has been known that reaction, or hydrogen-ion concentration of the medium, greatly influences the rate of death. Those who preserve foods by canning know that acid foods, such as strawberries, cherries, and rhubarb, are preserved with relatively greater ease than peas and corn. The latter are nearly neutral in reaction. Since hydrogen-ion concentration is so important, it is necessary to control it in thermal death-time studies.

6. *The Type of Organism.* Bacteria differ greatly in their temperature relation, as do other living beings. Animals may differ in their resistance to and tolerance of heat. It has been stated before, for instance, that thermophilic bacteria have their optimum at a temperature which approaches the maximum for other forms. Some human beings are able to tolerate hotter climates than others.

7. *The Presence of Spores.* Presence of spores makes an organism more resistant to heat. Theoretically, then, there may be a thermal death-time for vegetative protoplasm and one for sporoplasm. Practically, however, the distinction, although made by some bacteriologists, is of little importance. Most spores are far more resistant to heat than are vegetative cells.

Thermal death-time studies are important in applied bacteriology. In the canning industry, information is required about the temperature relations of bacteria which spoil food packed in cans. Such bacteria are usually isolated in pure culture, suspended in the liquor of the food from which they were isolated, and subjected to tests to determine their heat resistance. In this way processes or cooks may be secured which will be adequate.

Relation of Temperature to Chemical Changes. What effect does temperature have on chemical changes brought about by

bacteria? It is known that as temperature is raised the speed of chemical reactions is increased. There is a limit, of course, to the general application of this statement, for other factors have to be considered. For instance, if the temperature reaches a certain point the reacting substances may be changed. So with chemical reactions brought about by bacteria, temperature may speed up their reactions only below their maximum temperature above which they are killed. Investigators have shown that yield of certain products of bacterial action increases as temperature is lowered. This was explained by stating that at the higher temperatures the products might have a greater action on the bacterial cells. We may also assume that above the optimum temperature, at least, the cell is being driven too fast by the higher temperature; it wears itself out more quickly because there is no opportunity for repair. At the lower temperature, however, it works more economically because there is opportunity for repair and a better equilibration of cell mechanisms. Thermophilic bacteria are especially suited to studies of this nature. Their optimum temperature is near 55°C . Some of them will grow as low as 37°C . One species, which decomposes cellulose, is found to decompose 40 times as much at 55°C . as at 37°C . At 55°C . these organisms are working at a more rapid rate since they are driven by high temperatures.

The stimulating effect of increased temperatures is just as evident with some of the higher forms of life. Biologists have found that more than twice as many generations of flies (*Drosophila*) are formed at 27°C . as at 17°C . per unit of time.

Destructive Action of High Temperatures (Sterilization by Heat) on Microorganisms. Heat is the cheapest and best agent for destruction of cells of microorganisms. It is used in many great industries, success of which depends on restricting or killing microorganisms. A good example is preservation of foods by canning. Those who use heat for such purposes try to use only amounts which are necessary because heat is expensive and usually produces changes which may be undesirable. In the bacteriology laboratory, heat is used to sterilize all culture media and even to separate species of bacteria. The process of destroying all forms of life on or in any substance by any method is known as *sterilization*. Some have used the term *disinfection* when only pathogenic or disease-producing microorganisms are

destroyed. Distinction between these terms is close and, perhaps, unnecessary. Obviously, all methods of sterilization are methods of disinfection, but methods of disinfection are not necessarily methods of sterilization. Under many conditions they probably are.

In order to affect microorganisms, heat must reach them. When they are on the surface, they are subject to action of heat quickly; but, when they are inside a substance such as a bandage, piece of meat, glass jar of vegetables, or any other similar substance, time is required for the heat to penetrate. This fact has made it necessary for one to know the heating rates of many substances.

In ordinary methods of heating, heat is transferred from a hot substance or area to a colder one by conduction or radiation. In most cases this means that the outside is hot while the center is cold. Heat must flow into the substance from molecule to molecule. Heat is carried into liquids by convection currents and not to any extent by conduction. This explains the necessity of knowing what the rate of heat penetration is so that allowance may be made for it in selecting sterilization times and temperatures.

I. Dry Heat. The term dry in this connection implies the absence of a great amount of water about the cells. There is, of course, the usual amount in the protoplasm. Because of a lower amount of water present, a higher temperature must be used. Data from Frost and McCampbell on page 210 show that with zero per cent of water egg albumen coagulated between 160 and 170°C. This indicates that a temperature above this must be used in dry-heat methods of sterilization.

1. Incineration. This is the most satisfactory method for getting rid of undesirable bacteria, but it has decided limitations. It is used for destruction of dressings, and so on, from wounds and infections. Obviously it cannot be used for materials which must be preserved for future use; some of the other methods must be employed.

2. Heating in Flame. This method has been spoken of as the "incidental" method. It is very useful and is used by bacteriologists for sterilizing needles and loops with which bacteria are transferred from one tube to another. The heating must be even and the cooling slow. When needles and loops are sterilized in

the free flame, care must be exercised to avoid spattering of any material on them and dissemination of infectious matter.

3. *Hot-Air Oven.* The hot-air oven used in the laboratory for sterilization is quite similar in construction to that used in the home for baking. It consists of a sheet-iron box with gas burner or electric heater, either under it or about the sides. Many differ-

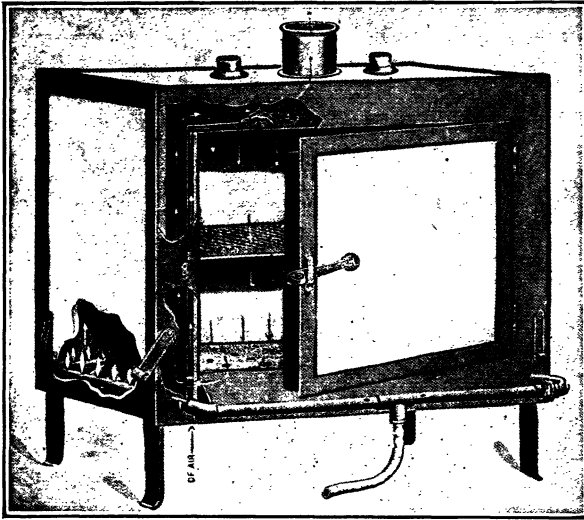

FIG. 78. Hot-Air Sterilizer, Lautenschläger Type.

ent types are available of which the Lautenschläger type is most common. Some hot-air ovens are so constructed that a high temperature is maintained for a long time after the heat has been turned off. This is accomplished by thorough insulation.

4. *Electronic Sterilization.*¹ This is a relatively new method of destruction of bacteria by heat. It involves high-frequency heating or the use of radio waves to generate heat through which they are discharged. High-frequency heating may be applied either by dielectric heating or by induction.

The first is known as *dielectric heat* because the product to be heated is a nonconductor, or dielectric material, as are many substances in industry. Practically all foods are dielectric substances. Dielectric heat is largely frictional heat and results

¹ R. V. Sherman, *Electronic Heat in the Food Industries*, *Food Industries*, April 1946, 90-3.

from the fact that each molecule of the substance is repeatedly stressed by the high-voltage field. The direction of the electric stress is reversed by every alternation of high-frequency voltage. The charges are reversed from 1 to 500,000,000 times per second. This results in a very rapid temperature rise evenly throughout the mass being treated. The temperatures attained are, of

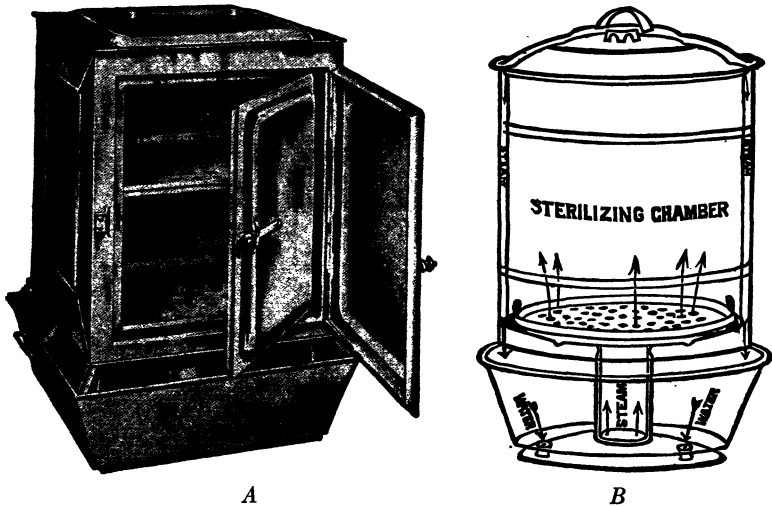

FIG. 79. Showing Free-Flowing Steam Sterilizers.

A, Boston Board of Health type; B, cross section of a similar pattern.

course, below boiling (100°C . or 212°F .) but are sufficiently high (88°C . or 190.4°F .) to destroy many microorganisms. It has been shown that a 3-pound block of frozen food may be thawed in 11 seconds, whereas many hours would be required if other methods were used. Although this process may not completely sterilize foods, it is being used for heating foods, such as defrosting, melting, and baking. A recent development is heating sandwiches as they are sold in an electric grill.

Dielectric heat is different from *induction heat*. In induction heating the heat travels from the colder areas, such as the outside of a food mass slowly to the center. The heating is therefore uneven. Dielectric heating is merely another way of producing heat within a substance. There seems to be no evidence that the radio waves themselves have any other effect.

II. Moist Heat. Presence of adequate water allows sterilization to be accomplished more readily. Consequently, with this

method a lower temperature may be used than with the dry-heat method. Water is necessary for coagulation of proteins, and the more water there is, the more easily is disinfection by heat accomplished. Besides its influence in coagulation of proteins, water may also assist in carrying heat units into the cell. This is nicely shown by an illustration from the canning industry. Such foods are sweet potatoes and roast beef, packed solidly into cans, are sterilized with more difficulty than foods with freed liquid, such as peas and beans. The free liquor in beans and peas carries the heat into the can by convection currents.

1. *Boiling.* The length of boiling required depends on several factors. Practically all factors influencing thermal death-time determinations also influence boiling as a sterilizing procedure. Boiling is a convenient method for sterilizing such things as tableware and linen. Before instruments with cutting edges are placed in water, the water should be boiled to rid it of the dissolved oxygen which might attack the sharp edges and cause rusting.

Although boiling is considered by some to be a safe sterilization procedure, it has certain limitations. Food experts in the Government laboratories have suggested that all canned foods be boiled before use in order to give greater certainty of freedom from illnesses which may be caused by such foods. They have pointed out that canned foods which have supported bacterial growth might be heavily impregnated with gas and that such foods would give the appearance of boiling much below the true boiling point. Another factor which has great influence on the boiling point in certain sections of the United States is altitude.

Boiling water and soap are probably the best cleansing agents available. A committee of prominent sanitarians in the United States recommended them in place of fumigation after cases of communicable diseases in the home. Boiling water and soap suds are undoubtedly more destructive to bacteria than some

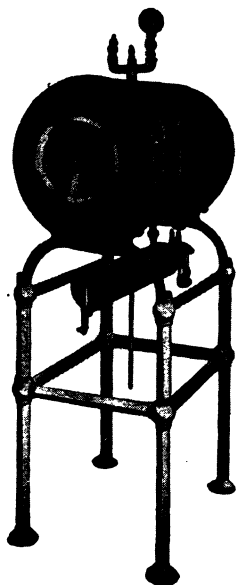

FIG. 80. High-Pressure Steam Sterilizer (Autoclave)

of the supposedly bactericidal procedures used in terminal disinfection.

2. *Free-Flowing Steam.* Such steam is not under pressure and consequently has a temperature of 100°C. The only variable, then, is the time. The apparatus used is simple and consists of

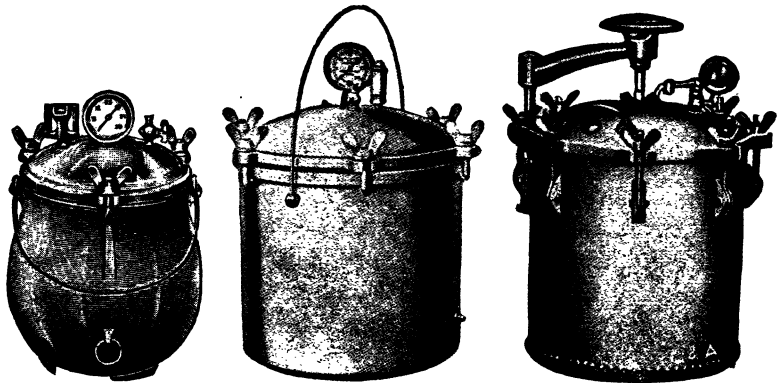

FIG. 81. Various Types of Pressure Cookers Which Are Used for the Sterilization of Canned Foods or Other Materials.

a metallic box with a false bottom through which steam rises. The "steamer" of the kitchen makes a good sterilizer although it is small. The steam supply may be from boiling water or a steam main. Free-flowing steam is used in two different ways.

CONTINUOUS METHOD. In this method steam is applied continuously as long as necessary. The time is quite variable and depends on the materials to be sterilized and the degree of contamination. For ordinary materials a heating period of 1½ to 2 hours should be sufficient. If there is a possibility of very heat-resistant bacteria being present, the heating period should be longer.

INTERMITTENT OR FRACTIONAL METHOD. In this method, the sterilization time is broken into shorter periods. Each heating period—30 minutes to an hour—is applied on successive days. The first day's heating is supposed to destroy vegetative cells—those in the active growing stage. Between the first and second day's heating, any spores which survive the first day's heating will germinate and develop into vegetative cells. These will be destroyed on the second day. The third period is added to give a greater margin of safety and to destroy any cells which may have survived the first two periods.

The intermittent method was advised at one time for preservation of vegetables by canning. Botulism outbreaks, however, from foods treated in this manner, suggest that more reliable sterilization methods should be used.

3. *Ironing.* This common every-day procedure in the home may have considerable hygienic value. Linens and garments are usually washed thoroughly in hot water and soap, dried, and dampened, preparatory to the finishing process—ironing. Under the hot iron steam is generated, and bacteria may be killed. Two German investigators who studied the effect of ironing on bacteria in cloth used mechanical ironing machines which gave a temperature of 100 to 105°C. in a few seconds, and in slightly longer time 125°C. The time factor was so measured that every fabric, according to the thickness, was exposed to steaming for 25 to 30 seconds. Thick overcoat materials which had been heavily inoculated were found to be freed from staphylococci and *Eschericia coli* by the ironing process. The short steam treatment did not destroy spore-bearing bacilli. Large quantities of tubercle bacilli placed in trouser pockets were destroyed by application of steam for 30 seconds. These investigators were able to sterilize woolen and camel's-hair blankets although the ironing period had to be lengthened to 3 minutes. When ironing follows thorough washing in hot water and soapsuds, the laundry becomes of added significance in the home. Two German investigators have recommended the use of American steam pressers for disinfection of blankets, infected clothing, and the like. It was stated that the temperature between the plates was between 100 and 105°C. The steam presser was said to have many advantages which made it of value in small hospitals.

4. *High-Pressure Steam.* It is known that a direct relation exists between pressure and temperature of steam. As pressure is raised above atmospheric pressure by being enclosed in a confined space, the temperature rises. Table 3 on page 218 gives these relations.

A pressure of 15 pounds for 15 minutes has been accepted as satisfactory in some laboratories. However, a pressure of 20 pounds for 15 to 30 minutes gives a greater margin of safety. For materials which may contain very resistant microorganisms, as soil or other substances which have been in contact with soil, a much longer time is necessary.

The apparatus used for sterilizing with high-pressure steam is known under several names—digester, autoclave, retort, dressing sterilizer, and so on. These are boxes or cylinders made to withstand high pressures. The autoclave is generally used in

bacteriological laboratories. The dressing sterilizer is an autoclave used in hospitals. It is usually provided with more nickel plate and is a more striking instrument to look at than the ordinary autoclave, but it is no more efficient. It may also have an attachment for creating a vacuum in the sterilizing chamber by which dressings are dried before removal from the sterilizer. In canning factories, where foods are sterilized in sealed containers by means of heat, the apparatus for sterilizing is spoken of as a retort or cooker.

TABLE 3

Pressure (Gauge)	Temperature	
	Fahrenheit	Centigrade
0	212°	100°
5	228°	109°
10	240°	115.5°
15	251°	121.5°
20	260°	126.5°
40	287°	141.5°

The source of the steam for high-pressure sterilization may be either a steam main or a generator in close proximity to the autoclave. The former saves much time and is cheaper where steam is generated for other purposes. However, those installations which require the generation of steam close to the autoclave are satisfactory. Such installations are often used in hospitals where there may not be a supply of high-pressure steam from a boiler room.

There is no doubt that many high-pressure steam sterilizers are not giving efficient results. A comparative study of four or five sterilizers, two of which were in hospitals, showed that one was not sterilizing, and physicians who used dressings and packs sterilized in it were working with false security. Sterilizers should be frequently tested in order to make certain that materials are being absolutely sterilized. Different methods may be used for checking sterilizers. Mixtures of resistant bacteria may be spread on pieces of cloth in bandages and packings which are then prepared and sterilized in the usual manner. After sterilization, these pieces of cloth may be removed with sterile forceps and placed in flasks of sterile broth for incubation. Another method involves the use of a little tube containing a material the melting

point of which is known. If the contents of these tubes are fused, the sterilizer operator knows that a certain temperature has been reached in the autoclave. Then it behooves him to make certain that the proper time is allowed.

Questions are often raised about the efficiency of the smaller types of steam sterilizers known as pressure cookers. They are in reality small autoclaves. One difficulty has been mentioned, however; these sterilizers are frequently provided with only a pressure gauge. Both a pressure gauge and thermometer as separate gadgets should be used in order that one may be certain of the temperature. With a pressure gauge and thermometer the operator has two methods of checking the temperature and, if he maintains the time, satisfactory results should be secured. Certain precautions must be kept in mind when using high-pressure steam for sterilization.

1. All air should be expelled from the apparatus. It is apparent that, if one has a mixture of air and steam, he will not have the temperature indicated on the gauge. The pressure on the gauge may be adequate, but, if it is due to a mixture of air and steam, the temperature will be too low.

2. There should be a little water to prevent superheating of the steam. This is an almost useless precaution since most steam is too wet and most autoclaves contain more water than operators wish.

3. After the time of sterilization has elapsed, the pressure must be lowered slowly, else the liquid in the containers being sterilized will boil vigorously and may overflow. The cotton plugs in these containers may be blown out or dampened.

4. Lastly may be mentioned a precaution about which formerly considerable confusion existed. It was believed that certain media (food solutions for growing bacteria), containing such substances as lactose and sucrose, would be changed chemically in the autoclave. It was reported that these sugars would be hydrolyzed to simple sugars; it was suggested that such media be sterilized by free-flowing steam. Research, however, showed that the latter method caused more hydrolysis than the autoclave sterilization. The time factor seems to be very important. We now believe that sugars should be sterilized separately in water solution; the necessary amount of this solution may be added to media by means of sterile pipettes.

5. Moist heat is also used at low temperatures. Since a temperature of around 60°C. is used, the time must be greatly lengthened, to 6 or 8 hours for such a medium as blood serum.

5. *Pasteurization.* This is a process of heating materials to temperatures below the boiling point, usually to above 60°C., for about 30 minutes. It was applied to beer and vinegar by Pasteur to cure what he called "diseases" of these products. Pasteuriza-

tion is partial sterilization in that many bacteria are killed but the materials are not completely sterilized. It was this situation which caused trouble in early studies on spontaneous generation when investigators thought they sterilized their products. Fruit juices and a few other foods which cannot be heated to higher temperatures on account of alterations in flavor and appearance are preserved by pasteurization.

MOISTURE

Water is necessary for all living organisms. It carries food materials into the cell and carries waste products out. It also keeps cells in shape and preserves their turgor. The amount of water demanded by cells is probably quite constant, but variations may occur.



FIG. 82. Plasmolysis of Bacteria. (After Alfred Fischer, 1900)

a, *Vibrio comma*. From an agar culture in 1.25 per cent sodium chloride. They are plasmolyzed but still living; the protoplasm is broken up into refringement granules. b, The same highly magnified. c, *Vibrio comma* plasmolyzed with cilium. d, Typhoid Bacilli in 2.4 per cent sodium chloride stained; the cell contents in various positions. e, *Spirillum undula* plasmolyzed protoplasm is black in all cases.

Osmosis and Osmotic Pressure. When two solutions of different substances or two solutions of the same substance in different concentrations are brought together, diffusion takes place. When these solutions are separated by parchment paper or a similar membrane, it can be seen that a pressure results since liquid will pass through it in either direction depending on the properties of the two solutions. Water molecules diffuse much more rapidly than the solute molecules. The pressure which is produced is spoken of as osmotic pressure, and the process which produces it is *osmosis*. Some have suggested that these terms lack clearness and should be dropped from use. Osmotic pressure depends on the number of molecules of

solute in solution—the greater the number, the greater the osmotic pressure. Compounds with large molecules will have lower osmotic pressure than compounds with small molecules. Salt would therefore exert greater osmotic pressure than cane sugar. Larson, Hartzell, and Diehl reported that sudden change in the

osmotic pressure was detrimental to bacterial cells. From the standpoint of the cell, three types of solution are possible:

Isotonic solutions, those having a density equal to that of the cell.

Hypertonic solutions, those having a density greater than that of the cell.

Hypotonic solutions, those having a density less than that of the cell.

Isotonic Solutions. These are solutions of salts having the same density as the cell. Physiological salt solutions used by biologists are isotonic solutions. Certain writers now speak more specifically of these solutions in terms of the salt used for making them. Thus we may have *physiological sodium chloride*, *physiological sodium phosphate solution*, and so on. Such solutions are frequently spoken of as normal salt solutions, a designation which is not good because the term "normal solution" has a well-defined meaning in chemistry. Physiological sodium chloride solutions are generally 0.85 per cent solutions of sodium chloride in water for bacteria. The solutions are necessary in bacteriology for preservation of bacterial cells intact, as in bacterins.

Hypertonic Solutions. Such solutions are more dense than the microbial cell. They therefore contain more salts or other solids. When two solutions of different densities are separated by a membrane, water passes from the less dense to the more dense. Consequently, when a cell is placed in a more dense solution water will pass out of the cell into the solution, and the contents of the cell will become shriveled and granular in nature. The cell loses its turgor. This is spoken of as *plasmolysis*.

The preservation of foods in concentrated solutions is probably due to plasmolysis. Concentrated salt and sugar solutions, and often mixtures of the two, have been used for a long time. Equal weights of sugar and crushed fruit give concentrated solutions which preserve fruit. Meats may be preserved in strong salt solutions spoken of as brines or curing solutions. Microorganisms vary greatly in their reaction to concentrated solutions. Some are inhibited at concentrations at which others will carry on active fermentation.

Plasmolysis has also been helpful in studying structure of bacterial cells. Fischer claimed that contraction of cell protoplasm away from the cell wall by plasmolysis showed that the protoplasm was not attached to the cell wall.

Some bacteria have become acclimated to more concentrated solutions of salts and sugars than have ordinary species. Some

microorganisms in sea water are known to require media with a high salt content for development. They will not develop on culture media prepared for ordinary bacteria. The latter will not develop on media containing so high a concentration of salt. These observations probably explain the statements of earlier investigators who said that sea water was practically devoid of microorganisms. Microorganisms which are able to live in concentrated solutions or which may even require them are spoken of as *halophilic*.

Hypotonic Solutions. In such solutions having a lower density than the cell, water passes from the less dense to the more dense medium. Water, therefore, passes into the cell; the cell swells up and may burst if the pressure on the cell wall becomes great enough. This is *plasmolysis*. Hypotonic solutions cannot be of great value in practical work since they cannot be secured except under laboratory conditions. Although hypotonic solutions are harmful to bacteria, they cannot be used, for instance, in food preservation. Crushed fruit alone would yield a mixture hypertonic for many microorganisms.

DRYING

Absence of moisture under ordinary atmospheric conditions is decidedly detrimental to microorganisms. They die at a regular rate, but not all of them are destroyed even after sojourn under dry conditions for a long time. A few cells seem to be so resistant that they are not killed. In view of these facts, many foods are preserved by drying. Their preservation may not be due entirely to removal of water but to concentrated solutions formed by the water which remains.

Preservation of Bacteria. Bacteriologists find it necessary to preserve cultures and suspensions of bacteria for various reasons. Pure cultures are needed for teaching purposes and suspensions of cells for thermal death-time studies and inoculation of foods in spoilage studies. Pure cultures have, in the past, been preserved by frequent transfer to fresh culture media. This is a time-consuming process, and other methods have been sought. The lyophile process has been developed in which the cells of microorganisms are frozen and dried. The organisms are placed in small tubes and sharply frozen at -80°C ., or so. High vacuum is then quickly and thoroughly applied to remove the moisture.

The tubes are then sealed in a flame. Microorganisms have been found to live for a long time without loss of important characteristics. This statement is especially significant for species of bacteria which are known to be short-lived under ordinary conditions.

PRESSURE

All forms of life find it necessary to adapt themselves to changes in pressure. Fish have been taken from the ocean at depths which have pressures of some 300 atmospheres² or 4600 pounds per square inch. Fish are provided with swim bladders which help them to compensate for minor variations in pressure. Greater variations must be handled in some other manner. Man also encounters striking changes in pressure in mountain climbing, aviation, and deep-sea diving. He seems to be able to endure rather high pressures, but trouble may be caused if he comes back to normal pressure too quickly. Sudden release of pressure causes the appearance of nitrogen gas bubbles in the blood. Serious symptoms of illness called the "bends" or "caisson disease" are caused when divers ascend too quickly to the surface.

The older textbooks reported that bacteria are resistant to great pressures. Fischer reported that putrefaction and fermentation occurred under pressures of 300 to 500 atmospheres and that the spores of *Bacillus anthracis* were unharmed by a pressure of 600 atmospheres applied for 24 hours. The same author stated that because of their small size bacteria had to withstand only a small pressure. He stated that a coccus 2 microns in diameter at a depth of 7086 meters in the ocean would have to withstand only 90 milligrams force. This pressure should not be considered insignificant, for relatively it is large for the bacterium. The older statements to the effect that bacteria are not killed by high pressures are based probably on faulty logic. Growth in subcultures from suspensions which have been exposed to high pressures does not indicate that bacteria are not killed. Quantitative studies indicate that there is great destruction of cells although a few do survive.

Later experiments have given more reliable information. Larson, Hartzell, and Diehl, at the University of Minnesota,

² An atmosphere is 14.7 pounds per square inch or 1 kilogram pressure per square centimeter.

found that direct pressure of 6000 atmospheres killed non-spore-bearing bacteria in 14 hours. A pressure of 12,000 atmospheres for the same length of time was required for killing spores. Having shown that high pressures would destroy bacteria, these authors tried to explain the processes involved. They concluded that destruction of the organisms resulted from sudden change in the osmotic tension of the fluid in which the bacteria were suspended. Bridgman³ exposed egg white to a pressure of 5000 atmospheres (75,000 pounds per square inch) for 30 minutes and found that it was lightly stiffened; increasing the pressure to 6000 atmospheres produced coagulation like curdled milk; 7000 atmospheres caused complete coagulation. It is possible that pressure would have the same effect on bacteria.

At the West Virginia Agricultural Experiment Station experiments were conducted to determine whether pressure could be used for preservation of foods. If it could be used, delicate aromas and flavors of such foods as strawberries, cherries, and apple juice, would not be lost as they are by methods involving the use of heat. Hite and his coworkers found that the microorganisms responsible for the spoilage of sweet ripe fruits were largely destroyed. A pressure of 100,000 pounds per square inch for 10 minutes stopped fermentation of grape juice. A pressure of 30,000 pounds per square inch was regarded as the lowest that could be used with significant results. Apple juice exposed to 60,000 and 80,000 pounds remained sweet without the development of gas. Larson and his colleagues found that the sudden release in carbon dioxide pressure caused many of the Gram-negative bacteria to be broken up. The Gram-positive bacteria did not undergo such a destructive change although they were killed.

Some work has also been done on the influence of gaseous pressure on bacteria. Interest was revived in this subject when it was proposed to freeze ice cream when the air it ordinarily contains had been replaced by carbon dioxide. Two early investigators exposed bacteria in milk to a pressure of carbon dioxide of 52 atmospheres without appreciably harming the bacteria. More recent work also indicates that high pressures of carbon dioxide will not sterilize liquids. The results with other gases are not widely different from those with carbon dioxide.

³ Bridgman, *J. Biol. Chem.*, 19 (1914), 511 and 512.

AGITATION

Agitation and shaking of bacterial cultures might be favorable to multiplication because cells, in the process of division, would separate more quickly, and because gaseous waste products of metabolism might be expelled from the culture fluid. Also, the cells more rapidly come in contact with the energy sources in the medium. Horvath in 1878 carried out experiments which have been reported by most of those who have discussed this topic. Gentle shaking was found to be without effect. Vigorous shaking, however, was found to be detrimental. When the shaking was continued for a sufficient time, bacteria were killed; before that time reproduction was greatly reduced. Meltzer also conducted experiments which indicated that vigorous agitation caused the death of the cells. In most cases those who reported favorable effects of shaking used very gentle motion whereas those who reported harmful effects used more vigorous motion. Meltzer also left some cultures of bacteria in an engine house where they were subjected to constant trembling motion. After four days the bacteria in these flasks were dead. On this evidence it has been stated that both trembling motion and very violent motion may be harmful. These statements have been passed on in textbooks for some time.

AERATION

Related to agitation is aeration of the culture fluids in which bacteria are propagated. Aeration not only agitates the medium but also carries away volatile products of metabolism which would repress growth and multiplication. Manufacturers of pressed yeast aerate the wort in which the yeast is grown in order to increase the crop.

GRAVITY

This physical agent does not have much effect on bacteria. Bacterial cells are mostly water and contain only a small amount of solid matter. Consequently, the specific gravity of bacteria is not much different from that of culture media. We have stated before that our liquid culture media are approximately isotonic solutions. There is a dearth of experimental data on this point. One experiment may be mentioned. Working with an organism called *Bacterium zopfi*, Boyce and Evans were able to influence

the type of growth in gelatin stabs, making the growth go upward by whirling the cultures. In general, the effect of gravity is of negligible significance. With motile organisms the function of movement would, at least, complicate the discussion.

ELECTRICITY

Electricity is a powerful physical agent with which a great number of experiments have been made on bacteria. Some of these have resulted in illogical conclusions. Experiments were made as early as 1875 and consisted in passing the electric current through media in which bacteria were growing or were suspended. Direct currents cause electrolysis with the formation of different substances such as acids, alkalies, and chlorine. These are harmful to bacterial life and have caused the reduction in cells which has been attributed to the electricity. Alternating currents do not cause electrolysis but may cause much heat to be formed. When the temperature is kept low, electricity has almost no effect. To assume that bacterial cells are not directly affected by electricity is about as reasonable as to claim that electricity has no effect on higher animals. Some authors discuss the effects of electricity on bacteria and other microorganisms under two heads, the *direct* effects which are said to be *nil* and the *indirect* effects due to the by-products of the passage of the electric current. This seems to be an unnecessary distinction. The several products of electrolysis are germicidal, regardless of their method of preparation. No experiment has been carried out in which the electric current has been passed through the bacterial cell. Could such an experiment be conducted, there is no reason to suppose that the bacterial cell would not react as does other protoplasm. The fact that bacterial cells are colloidal in nature supports the supposition that its colloidal nature would be markedly upset by the electric current.

Attempts have been made to use electricity for practical purposes. Among these are attempts to pasteurize milk, but the results have not been entirely conclusive, although considerable data are available to favor the process. The element of cost enters into all such practices. Attempts have also been made to treat sewage. The current was introduced into the sewage by means of iron electrodes. Improvement was noted, but it was found to be due to the iron salts from the iron electrodes. It was found to be cheaper to purchase the iron salts as such than to

make them in the sewage tanks from iron electrodes by means of electric current.

Electrophoresis. Under the effect of differences in potential, colloidal particles move toward the anode or cathode in an electric field. Movement of such particles caused by an electric current is called *electrophoresis*. It has been stated that the magnitude of electric charges of bacteria may be calculated from the velocity with which they move in an electric field. Virulent and avirulent bacteria have been found to exhibit different velocities of migration. Consequently, it has been suggested that this method might be used for distinguishing virulent from nonvirulent strains and thus more expensive and cumbersome animal-inoculation methods might be avoided. Much more work must be done, however, before the method may be accepted.

Electronics. An electron is an extremely small particle carrying an electric charge. Streams of electrons may be developed by cathode-ray tubes and such instruments as the cyclotron. Since they possess great energy it has been hoped that they could be used to kill bacteria in foods.⁴ Although they might destroy bacteria, their use might also be harmful to the operator. Several feet of concrete are necessary to insulate a powerful cyclotron. Continued investigations may reveal that microorganisms may be destroyed in this way.

SURFACE TENSION

Little is known about the effect of this physical agent on microorganisms. It is possible that surface tension plays a role in the effect of other agents such as salts and sugars on bacteria. Its effect on growth is discussed elsewhere in this book. Surface tension is an important factor in growth, morphology, staining, motility, and probably other characteristics of microorganisms.

SOUND WAVES

Those which have been investigated for their destructive effects on bacteria are the high-frequency waves, especially those called ultrasonic or supersonic waves. They are waves which are too high for the human ear to detect. Just how they affect bacteria may not be known, but it has been suggested that they cause such

⁴E. S. Yawger, Will Electronics Revolutionize Food Sterilization?, *Canner*, March 18, 1944, 15 and 40.

terrific vibrations in a liquid that they shake the bacterial cells apart. Williams and Gaines were able to kill cells of *Escherichia coli* by exposure in liquid to high-frequency audible sound waves of about 8800 cycles per second. They attributed the lethal effects to a violent agitation set up within the cell. They also reported lysis, or laking, of red blood cells. Later work by other investigators indicated that the various species of bacteria react in a different manner. Some species seemed to be quite resistant to high-frequency sound waves whereas others were equally susceptible to its effects. Much more work will have to be done before such methods become useful for reliable destruction of bacteria.

CHAPTER 12
RELATION OF CHEMICAL AGENTS
TO BACTERIA

DISINFECTION

Relation of chemical agents to life and development of bacteria is an interesting subject for discussion; there is, perhaps, no subject in bacteriology and preventive medicine on which there is a greater lack of sound information or greater confusion. Many substances have been proposed for destruction of undesirable microorganisms, some of which have been found to be devoid of activity. Persons not trained in the sciences are exploited from all sides with different preparations for destruction of bacteria and prevention of disease. The use of preparations which are not reliable may lead to neglect of approved adequate methods.

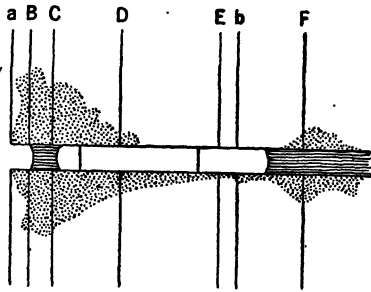

FIG. 83. Showing the Migration of Freely Moving Bacteria to Areas of Higher Oxygen Concentration about an Alga Thread in a Microspectrum. (After Engelmann)

The chlorophyl granules in the thread are not shown; the spectrum lines indicate the position of the spectrum.

Chemotaxis. Microorganisms show marked ability to react to the presence of chemical compounds in their environments. All cells exhibit this ability to respond to chemical stimuli. Various kinds of cells differ in this respect, and various chemicals also show a great difference in their influence on cells. The phenomenon of *chemotaxis* may be defined as the reaction of a microorganism towards chemicals. Some microorganisms seem to be repelled by certain chemical compounds whereas others are attracted by them. Study of this subject requires use of free-swimming cells in order that they may react without hindrance. The phenomenon has been studied with certain salts and with

oxygen. It may be profitable to review several of these experiments.

Englemann studied the subject, using freely moving bacteria that needed oxygen and also bacteria that did not need oxygen. When mixtures of these organisms were placed in water between a cover glass and a slide, those which needed oxygen migrated to

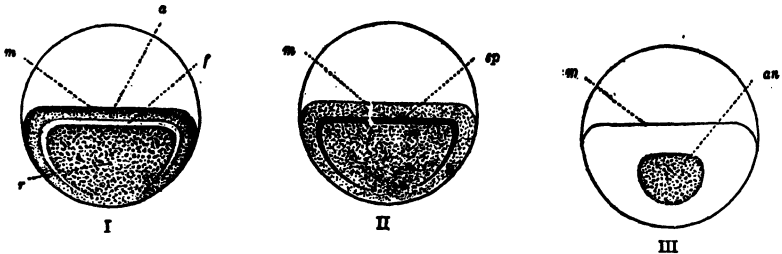

FIG. 84. Respiration Figures of Motile Bacteria. (After Beijerinck)

These three illustrations are horizontal projections of bacterial preparations in water. The large circles represent cover glasses. At the top of the circle (cover glass) a small platinum wire (not shown here) is so placed that a wedge-shaped space occupied by the water is formed. The base lies in the meniscus.

I. This respiration figure is of the aerobic type. The motile bacteria collect in the border zone, *a*; the quiescent ones collect at the center, *r*, leaving a vacant space, *f*, between.

II. Respiration figure of the spirillum type. These bacteria need or tolerate but small amounts of oxygen. Therefore, they collect at the circumference of the drop but a little distance in from the edge, *sp*. Here the oxygen concentration is lower.

III. This is a respiration of the anaerobic type. These bacteria migrate to the center of the drop where there is the lowest concentration of oxygen.

the edge of the cover glass where the oxygen supply was most abundant and also where there was opportunity for its regeneration. Those bacteria in the mixture which did not need oxygen and for which oxygen acted as a poison migrated to the center of the cover glass where they found the oxygen concentration sparse as they preferred. Another unique experiment was carried out to show the same thing. He placed a green-alga thread in a drop of water containing these two groups of bacteria and then directed a small spectrum on it. In those parts of the spectrum where most oxygen was liberated, the bacteria requiring oxygen collected. It may be seen in Fig. 83 that this occurred between the lines *B* and *C* and also at *F*. Beijerinck's so-called "respiration figures" are also interesting; they are shown in Fig. 84. The three parts represent horizontal projections of bacteria in drops of water. A small platinum wire was placed at the part represented by the top of the drawing, between the cover glass and slide, so

as to form a wedge-shaped space which was occupied by the drop of water, the base of which was in *m*, the meniscus.

Pfeffer used another method of demonstrating chemotaxis. He partly filled a small capillary tube, about 5 to 10 millimeters in length and sealed at one end, with the chemical compound to be tested. This tube was inverted in water made turbid with the bacteria to be studied. Positive chemotaxis was indicated by concentration of bacteria about the open end of the capillary tube; finally, the bacteria began to enter the tube. Pfeffer studied several common chemical compounds. No relation exists apparently between disinfecting power and chemotaxis. Chemicals which act as disinfectants might be expected to repel bacteria, but apparently this is not always the case.

Definition of Terms. Some confusion exists today because such common terms as disinfection and sterilization are used with different meanings. Patterson¹ defined these and other terms as follows:

Germicide: Anything that destroys germs (microorganisms); applied especially to agents that kill disease germs.

Bactericide: Anything that destroys bacteria.

Antiseptic: A substance that opposes sepsis, putrefaction, or decay; one that prevents or arrests the growth or action of microorganisms, either by inhibiting their activity or by destroying them; used especially of agents applied to living tissue.

Bacteriostat: An agent which merely inhibits microorganisms but does not destroy them. They remain dormant as long as the bacteriostat is undiluted or not dissipated. When this occurs, the microorganisms grow again. Certain organic dyes and chemical compounds such as sulfa drugs are bacteriostats. In some cases it is believed that bacteriostatic substances hold the bacteria in check until they can be destroyed by natural agents in the body. Bacteriostats interfere with or block one or more specific metabolic functions of the cell.

Disinfectant: An agent that frees from infection; usually a chemical agent which destroys disease germs or other harmful microorganisms (but

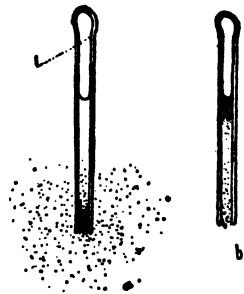

FIG. 85. Chemotaxis.
(After Fischer)

A part of a drop of water containing *Pseudomonas fluorescens* (*Bacillus fluorescens liquefaciens*) and a capillary sealed at one end and partly filled with 5 per cent alkaline peptone solution. Soon after the introduction of the capillary the bacteria have collected about the open end of the tube. This is positive chemotaxis. Later, on account of the need for oxygen, they have collected near the air bubble.

¹ Patterson, *Am. J. Pub. Health* 22, May 1932.

not, ordinarily, bacterial spores); commonly used of substances applied to inanimate objects.

Sterilization: The act or process of sterilizing, or freeing from all living microorganisms.

Deodorant: Anything that destroys or masks offensive odors.

Fungicide: An agent which destroys fungi. A *fungistat* is an agent which merely inhibits fungi as long as it is in strong enough concentration.

Insecticide: A substance that destroys insects, especially a preparation used for this purpose.

Prophylactic: Anything that prevents or contributes to the prevention of disease, a preventive.

A committee² of the American Public Health Association has also defined these terms. *Disinfection* was defined as destruction of vitality of pathogenic microorganisms by chemical or physical

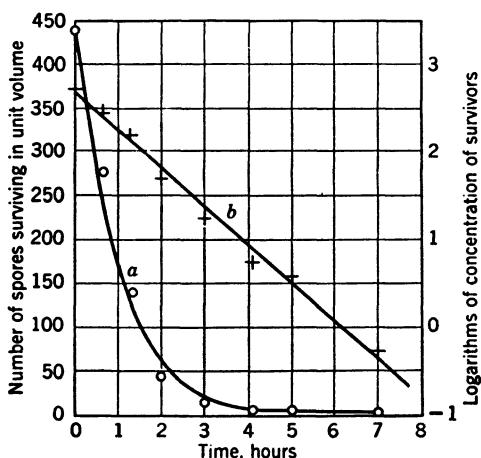

FIG. 86. Disinfection of Anthrax spores with 5 per cent phenol at 33.3° C. (Chick, 1908)

Curve *a*, Survivor-time curve; the number of surviving spores in unit volume plotted against time. The curve is drawn through a series of calculated points, the circles show results of experimental determinations. Curve *b*, Logarithms of concentration of survivors plotted against time.

(From *A System of Bacteriology*. By permission H. M. Stationery Office)

means. *Concurrent disinfection* was defined as the application of disinfectants immediately after the discharge of infectious material from the body of an infected person, or after soiling of

² The Control of Communicable Diseases, American Public Health Association, New York, 1945.

articles with such infectious discharges, all personal contacts with such discharges or articles being prevented prior to their disinfection. *Terminal disinfection* is the process of rendering the personal clothing and immediate physical environment of the patient free from the possibility of conveying the infection to others, at the time when the patient is no longer a source of infection. *Fumigation* was defined as a process of destruction of insects, as mosquitoes and body lice, and animals, as rats, by employment of gaseous agents.

Sharp distinction should be made between an antiseptic and a disinfectant. Study of the previous definitions will indicate that a substance may be a powerful antiseptic but a poor disinfectant. Antiseptics only destroy some special property of an organism such as growth, fermentation, or pigment formation. A disinfectant is supposed to destroy the organism itself. Such distinctions should be kept in mind when the value of statements made on labels of many proprietary preparations is appraised.

Characteristics of a Good Disinfectant. An ideal disinfectant probably does not exist. A good one must possess certain characteristics which may now be discussed. They were listed by Dreyfus in the *American Journal of Public Health* (1912) as follows:

1. *High Germicidal Power.* Unless a substance has appreciable germicidal power, it would not come within the scope of this discussion; it is reasonable, therefore, to list this as the first requirement of a good disinfectant. A chemical compound may be toxic for one bacterium but inactive toward another. It is impossible, therefore, to make general statements about germicidal ability of a substance. Marked specificity may be shown for certain species of bacteria.

2. *Stability.* A disinfectant should be fairly stable and not have marked affinity for organic matter. If it does react readily with organic matter, its ability to destroy bacteria will be dissipated. Some of the disinfectant would have to be used to satisfy the organic matter. Enough to function as a bactericide must remain. A disinfectant should be stable and not subject to decomposition on standing.

3. *Homogeneous Composition.* This is one of the most important requirements of a good disinfectant. Certain compounds would be good disinfectants if it were not for the fact that they form emulsions in water rather than homogeneous solutions. The cresols, for instance, are very poisonous to bacteria but form milky emulsions in water; consequently, as shown later in this chapter, they have been treated to make them miscible with water.

4. *Ready Solubility in the Strength Required for Disinfection.* Before some substances can function as disinfectants they must ionize; this

requires that they be soluble. They need not be soluble enough to yield strong solutions but only such solutions in concentrations as will be toxic for bacteria. The two chlorides of mercury illustrate this point. Mercuric chloride (HgCl_2) is soluble in water and is used in dilute solutions as a disinfectant; mercurous chloride (HgCl) is insoluble in water and cannot be used in this manner.

5. *Nonpoisonous to Animal Life.* An ideal disinfectant would destroy bacteria without harming tissue in which they existed. This would require marked toxicity for bacteria with no action on the tissue of higher animals. Such a chemical compound is difficult to imagine. If it is toxic for one kind of protoplasm, it is for another. Concentration is involved, for even the most active disinfectants lose their activity if diluted too much. Some of them even stimulate bacteria when the dilutions are high enough. This seems to be true for all poisons.

6. *Noncorrosive.* Corrosive chemical compounds would be difficult to store and would attack materials to which they were applied. Their strength would be reduced accordingly. Dilution may reduce corrosive properties without materially lowering disinfecting ability.

7. *Sufficient Power of Penetration.* Few compounds can penetrate to any extent into living tissue. Physicians and surgeons have found it necessary to apply the disinfectant in the immediate vicinity where it is needed. Numerous preparations have been advertised for treatment of pyorrhea. This infection is a deeply seated abscess at the base of the teeth, and it is silly to expect that a disinfectant incorporated in a dentifrice would destroy the bacteria in such abscesses.

8. *Moderate Cost.* This requirement cannot be considered apart from others. Germicidal power must also be considered. Disinfecting ability should be purchased and not bulk. Cost must be considered along with the purpose for which the disinfectant is to be used.

Dreyfus added the following two requirements but it is doubtful whether they should be expected of a disinfectant. They require ability quite apart from the disinfecting property. They are included here only for completeness.

9. *Deodorizing Properties.* Few disinfectants are deodorants. It would be a fine combination of characteristics if disinfectants had deodorizing properties. However, they merely replace one odor with another, and some of our most useful disinfectants, such as the phenolic group, possess odors which are disagreeable to some people.

10. *Power to Remove Dirt and Grease.* This is also an unnecessary demand on a disinfectant. If a detergent is needed it is better to purchase one separately and to follow its use with a good disinfectant. It is extremely difficult to find a compound which will fulfill the eight requirements of a good disinfectant and also the ninth and tenth. This is well emphasized by the low disinfecting ability of soap, even the so-called germicidal soaps.

Factors Influencing Disinfection. Disinfection is in all probability a chemical reaction. At least much good will result from considering it from this viewpoint. Two agents are reacting, the

disinfectant and the bacterial cell or, to express it in another way, bacterial molecules and chemical molecules. What factors influence chemical reactions, and how may they influence the chemical reaction between the molecules of disinfectant and bacteria?

1. Temperature. Chemical reactions are accelerated by raising the temperature. The chemist is able to accomplish in the laboratory in a few minutes with heat what would require many years to accomplish at room temperature. In this sense heat may be looked on as a catalyst, since it accelerates reactions which are taking place very slowly at ordinary temperatures. It has been found to have the same effect in disinfection. With *Salmonella paratyphi* the killing power of carbolic acid has been found to increase from two to four times for each 10° rise in temperature. This increase in disinfecting activity of a compound by raising the temperature is spoken of as its temperature coefficient. We will learn later that disinfection is probably due to coagulation of protein. The effect of heat in coagulation of proteins is nicely illustrated in the cooking of an egg. The protein could be coagulated (cooked) at 70°C. in perhaps two or three hours but, by raising the temperature to 100°C., the coagulation time is shortened to a few minutes. At temperatures below 70°C., the time would be proportionally longer.

2. Time. It is impossible to separate temperature and time, but considerable good will be derived if attempt is made to do so. It has just been shown that raising the temperature may greatly shorten the time required for disinfection. One important practical fact about disinfection is that it is a time process and not an instantaneous reaction. Consequently, much more information is given about the activity of a compound if the time is given. For instance, it does not mean much to say that an organism is killed at 80°C. It means much more to say that it is killed at 80°C. in 5 minutes.

3. Moisture. Disinfection probably results from coagulation of protein. It has been well demonstrated by biochemists that coagulation of protein requires water. It is also possible that water is necessary for carrying heat and chemicals, if they are being used, into the cell. In this way water may serve a two-fold purpose in disinfection. In the chemical laboratory compounds are usually handled as water solutions since their reactivity is markedly increased in the liquid condition. The necessity of water in disinfection was nicely shown by one investigator with chlorine. He exposed dry anthrax spores in an atmosphere containing 44.7 per cent of chlorine for one hour without killing them. When they were moistened, they were killed in this same time by only 4 per cent of chlorine. It is also stated that absolute alcohol is not a disinfectant, but alcohol shows some disinfecting ability when used in 50 per cent solution.

4. Concentration of Reacting Substances. In disinfection reactions, the reacting agents may be considered to be chemical molecules and bacteria molecules. From chemistry it may be seen that, within certain limits, the more concentrated these reacting substances, the more product will be formed. The product in this case is killed bacterial protoplasm. Although

there are important objections, disinfection may be considered as an application of the mass law which states that the amount of reaction depends on the concentration of reacting substances. Consequently, in disinfection the greater number of cells (bacterial molecules) and the more chemical molecules that are present, the greater should be the amount of product or destruction of bacterial cells.

Disinfection is a chemical process and therefore probably follows chemical laws. Chick (1908), among many others, has given considerable study to this subject, and many of her data form the basis for our knowledge of disinfection. The chemical reaction in the present discussion would take place between the disinfectant and the bacterial protoplasm. Chick stated that disinfection followed the well-known law of physical chemistry—the monomolecular law.³ The same equation may be used, provided legitimate substitutions are made in it.

$$\frac{-dc}{dt} = KC$$

or

$$\frac{1}{t_2 - t_1} \log \frac{c_1}{c_2} = K$$

This may be changed to

$$\frac{1}{t_2 - t_1} \log \frac{n_1}{n_2} = K$$

In this equation the numbers of bacteria, n_1 and n_2 at times t_1 and t_2 have been substituted for c_1 and c_2 , referring to concentrations. For such a discussion, the monomolecular law may be defined as one governing a reaction between two substances where the change in concentration of one may be measured. This law seems to be followed in disinfection when any agent is used to destroy bacteria. It is apparent that rate of death is always proportional to the number of cells which are living at any given time. This simply means that, where there are larger amounts of reacting substance, more reaction is secured. Consequently, a greater drop is secured in the curve during the first units of time. Some objections may be raised against considering disinfection in this light. The bacterial cell must be regarded as a molecule. It is quite different since it possesses "life" and is surrounded by a membrane. It is also necessary to neglect the change in concentration of the disinfectant. At present the disinfectant is usually added in such excess that any change which might occur is neglected.

5. *Presence of Extraneous Matter.* The chemist tries to use very pure reagents. He does this in order to be able to secure more trustworthy data and also to allow the reactions to go on more rapidly. A similar situation

³ Students of disinfection are not agreed that this law should be used for explaining it. In an introductory book of this nature it is unnecessary to present all the various opinions. This discussion is presented to stimulate those students who have the necessary background to think over the disinfection process. The various arguments that have centered about the explanation of the process may be left for future study.

exists in disinfection. Presence of much organic matter, other than that in the bacterial cells, greatly reduces the effect of disinfectants. In such cases it is necessary to use amounts of disinfectants far in excess of those required when organic matter is almost absent.

6. *Surface Tension.* This is one of the newer factors that have been found to influence disinfection. Larson and Montank found that, by lowering the surface tension of the medium, *Mycobacterium tuberculosis* became so altered in characteristics that it was more susceptible to action of immune bodies in animals. Investigations in other laboratories have also indicated that surface tension may play an important role in disinfection. Frobisher, for instance, stated that bactericidal powers of phenol and hexylresorcinol were increased by lowering the surface tension.

Several other factors such as previous history of the organism, hydrogen concentration, age of the cells (spores), and kind of organism (species) also influence disinfection.

Specificity of Disinfectants. Some disinfectants are especially poisonous to certain bacteria and relatively harmless for others. Consequently, general statements about disinfecting properties of compounds should be carefully considered. Chlorine compounds, for instance, are known to be almost devoid of action, in ordinary concentrations, on tuberculosis bacteria but quite active on other bacteria. Some students of disinfection have suggested that each chemical compound proposed for use as a practical disinfectant should be studied with the microorganism for destruction of which it is proposed by the manufacturers. This would allow the public to select disinfectants with greater certainty. General statements are of little value.

Action of Disinfectants. Just how are bacteria killed by disinfectants? Several factors which influence disinfection have just been discussed from the viewpoint that disinfection is a chemical reaction following well-established laws. It may be helpful to retain this chemical viewpoint in this paragraph also in trying to determine how bacterial cells are killed. For convenience, the following reactions may be suggested:

I. Oxidation reactions

- (a) Chlorine and other compounds.
- (b) Hydrogen peroxide.
- (c) Ozone.
- (d) Potassium permanganate.

II. Hydrolytic reaction

- (a) Strong acids.
- (b) Hot water.
- (c) Strong alkalies.

- III. Formation of salts with proteins
 - (a) Salts of the heavy metals.
 - (b) Direct halogenation.
- IV. Coagulation of the proteins in the cells.
- V. Adsorption about the cells.

This tabular outline may cover several processes which are involved in the destruction of bacteria. It is not easy to prevent overlapping. Protein coagulation, although singled out as a separate process, may be the explanation of the action of all of the other reactions. Even though a cell is killed by an oxidizing disinfectant, it may finally be destroyed by coagulation of the proteins. It is quite probable that the actual procedure by which bacteria are killed is not known.

The larger groups of chemical compounds which have been used as disinfectants may now be considered. These compounds may be grouped in different ways. Any method of classification or grouping would be arbitrary. Consequently, in this chapter the compounds have been grouped after a scheme used by Dakin and Dunham in their "Handbook of Antiseptics." Only some of the more commonly used compounds will be mentioned.

I. THE HALOGEN COMPOUNDS

Chlorine, bromine, fluorine, and iodine are so active that they do not exist in the free state in nature. They have marked affinity for living proteins—a fact which every student of chemistry soon learns from experience. This affinity for living protoplasm gives some of the halogen compounds a prominent place among disinfectants.

Chlorine Compounds. Several chlorine compounds are important in preventive medicine. They have been used for disinfecting public water supplies, for treatment and disinfection of war wounds, and for general sanitation. Not all chlorine compounds act as disinfectants. In this connection chlorine compounds may be divided into two groups. One group contains those compounds which have the chlorine firmly bound as it is in sodium chloride. The members of the other group have their chlorine loosely bound as in calcium hypochlorite. As has been mentioned elsewhere, this may be a disadvantage, for the com-

pound may deteriorate during storage and later be used with a false sense of security. The mechanism by which chlorine compounds disinfect is explained in two ways. They may act by *oxidation* or by direct *chlorination*. The latter seems to be more obvious than the former. According to this explanation chlorine atoms add themselves directly to the protein molecule or replace constituent atoms such as the hydrogen atoms in $-\text{NH}_2$ groups in the amino acids. Protoplasm which has been chlorinated in this manner cannot function normally. The oxidation explanation involves chemical reactions which are used to explain bleaching of cloth by chlorine compounds. The chlorine reacts with water to form hydrochloric acid and unstable hypochlorous acid. The latter compound releases its oxygen easily in the presence of organic matter.

Liquid Chlorine. This is sold in cylinders and has great use in disinfection of water where it has almost entirely replaced calcium hypochlorite. Liquid chlorine has advantage over calcium hypochlorite in that only active chemical is added to the water. When calcium hypochlorite is added, considerable inactive matter is included. Chlorine is very irritating when it is inhaled in large amounts.

Calcium Hypochlorite. This is also known as chloride of lime, hypo, bleaching powder, or "bleach." This compound has been widely used in sanitation and has been responsible for great saving of life from water-borne diseases. It has been almost entirely replaced in sanitation by liquid chlorine in large-scale disinfection. About the home, however, it still has a place. Hooker (1913) gave the following rules for the use of chloride of lime:

First, do not mix too stiff a paste, otherwise a gelatinizing action takes place and greater difficulty in settling out is encountered. Never mix a paste with less than $\frac{1}{2}$ gallon of water for 1 pound of chloride of lime. Second, it is not necessary nor desirable to grind or break up the lumps too thoroughly; the available chlorine nearly all dissolves readily. Too much agitation is detrimental to prompt settling.

These precautions should be borne in mind in application of chloride of lime to sanitation. The strength of chloride of lime is measured in terms of "available chlorine." This is an unfortunate term since it implies that the disinfecting properties of the compound rest solely in the chlorine. Past work indicates that

it is an oxidation as well as a chlorination. The oxygen is formed in the following manner.

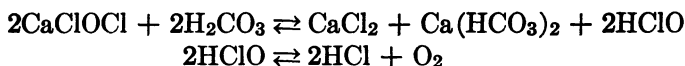

It has been suggested by some sanitarians that the term "available chlorine" be replaced by the term "potential oxygen," because it is the oxygen which plays the important role. Lager (1916) made some interesting statements in regard to the action of calcium hypochlorite. He stated that disinfecting action does not depend on available chlorine nor the length of time the chlorine acts. He stated that the time for killing depends on the resistance of the organism. The United State Pharmacopoeia specifies that chloride of lime shall contain 35 per cent of available chlorine. As it is purchased in small cans on the open market, it may fall far short of this, and the use of such a product fosters a false sense of security. Chlorine or its compounds appear in many forms under various trade names on the American market. Some of them have made places for themselves as disinfectants, and others have not.

The Chloramines. In this group chemists place compounds with amino ($-\text{NH}_2$) or imino ($-\text{NH}$) groups, the hydrogen atoms of which have been all or in part replaced with chlorine. In water treatment the term, according to Berliner, is restricted to the chlorine substitution products of ammonia; in the medical and pharmaceutical fields it refers more or less specifically to the mono- and dichlorine-substituted toluene sulfonamide derivatives called chloramine-T and dichloramine-T. These are:

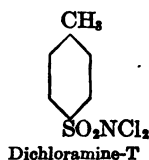
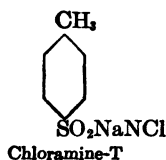

Toluene parasulfondichloramine is formed when nascent chlorine, formed in aqueous solutions of hypochlorite, is brought in contact with suppurating wounds. Dakin (1916-1917) proposed the name dichloramine-T for this compound. He showed that most of the substances containing a $-\text{NCl}$ group are strongly germicidal. Presence of more than one such group does not seem

to increase the germicidal properties to any marked degree. It may be used in stronger concentrations than some of the other disinfectants. It is claimed that its use is as simple as the use of tincture of iodine.

Many other chlorine compounds are on the market for use as disinfectants. Among others may be mentioned B-K and HTH. The latter is a true calcium hypochlorite with a composition in which the active element exists as $\text{Ca}(\text{OCl})_2$. Its concentration of available chlorine is not less than 65 per cent. Because of an inherent stability this concentration is maintained even after months of storage at summer temperatures. It reacts according to these equations:

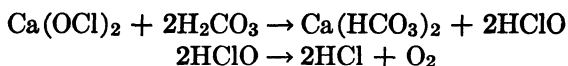

Iodine Compounds. These react in about the same manner as the chlorine compounds.

Iodine. This is considered by many to be a reliable efficient disinfectant used generally as a "tincture" which is a solution in alcohol of varying strength. A 2.5 per cent solution in 70 per cent alcohol was advised by Dakin and Dunham. Iodine has been used for disinfection of wounds and skin. It is quite irritating in certain parts of the body and does not satisfy the requirements that a disinfectant should be efficient and still noninjurious to delicate tissues of the body. Some surgeons have stated that iodine is not so reliable as is generally believed. They have reported serious infections following its use. This may be due to the fact that some disinfectants are more active against one organism and less active against others. Mahon and White (1915) report that iodine in alcohol is about four times as powerful as phenol. Their work was done on naked organisms with *Eberthella typhosa* as the test organism.

Iodoform. This compound has antiseptic properties. It is believed to decompose slowly in the presence of organic matter, forming free iodine to which the action of iodoform may be attributed. Eugling (1912), in studying the germicidal action of iodoform, could not detect a reducing action on bacteria resulting in the liberation of free iodine.

Bromine. Bromine and its compounds have not been used to any extent in disinfection. The compound has marked affinity

for living tissue and has been shown to be quite bactericidal. It was once proposed that a 5 per cent solution of bromine in chloroform or carbon tetrachloride might replace tincture of iodine as a skin disinfectant. Bromine has also been recommended as a deodorant. Whatever bactericidal properties it may possess are counterbalanced by its present high cost. The few experiments which have been carried out with bromine as a swimming-pool disinfectant have indicated that, weight for weight, it is just as efficient as chlorine and no more objectionable to the eye and tongue. Bromine has been too expensive in the past for wide use in disinfection.

II. PHENOLIC GROUP OF COMPOUNDS

Few compounds are more useful in disinfection than those of the phenolic group when all the characteristics of a good disinfectant are considered. They are relatively cheap and very active. However, many of them possess pronounced odors which are objectionable to some persons. The phenolic group of disinfectants includes the so-called "coal-tar" compounds which are prepared by the destructive distillation of coal and wood.

Phenol (Carbolic Acid). As stated in the chapter on the history of bacteriology, phenol or carbolic acid was permanently established in surgery by Lister. Phenol is usually used in a 5 per cent solution although it may be diluted a little more if a 5 per cent solution is too strong. Pure carbolic acid is solid at ordinary temperatures. On account of this, pharmacists dilute it (9 parts of pure phenol to 1 part of water) to make Phenol Liquefactum, U.S.P. Dorset recorded the advantage as follows:

1. It is reasonably effective for destroying non-spore-bearing bacteria.
2. Its action is only slightly interfered with by albuminous substances.
3. It does not destroy metals or fabrics in a 5 per cent solution.
4. It is readily available at all pharmacies.

The following disadvantages may be mentioned:

1. It cannot be depended on to destroy the spores of such bacteria as anthrax and malignant edema.
2. It is expensive.
3. The odor is offensive to some people.

Phenol today is relatively unimportant in disinfection. It is caustic and irritant and when applied to open wounds may cause gangrene. It has been largely replaced by other substances.

Another form of carbolic acid is also available under the name "crude carbolic acid."

The Cresols (Methylphenols). Cresols are methylphenols. Three are possible, depending on the location of the $-\text{CH}_3$ and $-\text{OH}$ groups in the molecule. Cresol on the market is a mixture of these three analogues. Many of them contain impurities which do not greatly impair their disinfecting properties. Most of the commercial cresols are guaranteed as to strength. For general disinfection a 2 per cent solution is used. Cresols are not soluble in water. They have been treated to make them yield homogeneous solutions.

Lysol. Cresols give milky emulsions in water. They have been modified to make them soluble and are sold under different names. The best known is Lysol, which is prepared by saponifying crude cresols with linseed oil in the presence of alcohol. This gives a mixture with soapy characteristics. Lysol is efficient in 2 per cent solution. *Liquor cresolis compositus*, U.S.P., and creolin are other cresol disinfectants like Lysol.

The advantages of Lysol as stated by Dorset are:

1. A 2 per cent solution of cresol is as efficient as a 5 per cent solution of carbolic acid.
2. It is not interfered with by albuminous substances.
3. It is cheaper than carbolic acid.
4. It does not destroy metals or fabric in a 2 per cent solution.
5. It is more effective than carbolic acid for destroying spores of bacteria, such as those of *Bacillus anthracis*.

The action of cresols as disinfectants was studied by Cooper (1912) who found that the introduction of the methyl as well as the nitro group increased the bactericidal and protein-penetrating powers of phenol, whereas the introduction of an hydroxyl group decreased these properties. Solutions of phenol in alcohol and in fat had no bactericidal action on spores and did not penetrate solutions of gelatin. The precipitating action of phenol was increased by adding acids. Cooper pointed out that selective action of phenol on different bacteria is connected with different susceptibilities of proteins to its precipitating action. Adsorption of phenol by bacteria is only the beginning of disinfection. The real explanations for the action of the cresols need not be reviewed in a book of this nature. Cresols are on the market as mixtures of the three, ortho-, meta- and paracresols. If the

disinfecting value of the three cresols varies, as was reported by Cooper, the disinfecting value of any mixture would depend on the concentration of the three components.

Thymol. This is isopropylmethylphenol; although it appears in many compounded products which are supposed to possess germicidal properties, most of them are weak in their action on bacteria. It is especially common in dentifrice preparations.

III. METALS AND SALTS OF HEAVY METALS

Metals and their salts have received considerable study as agents for destruction of bacteria. Lusini (1912) pointed out with regard to the cations that, although disinfecting property is not a function of atomic weight, heavy metals exert the greatest action. With a few exceptions, disinfecting action increases with chemical affinity of combined elements. The alkali group is less active than the alkaline-earth groups. The latter group does not agree with the generalizations previously mentioned, since its disinfecting power is in inverse ratio to atomic weight. Among the other elements of the periodic system iron has a lower activity corresponding to its lower atomic weight; tin has a higher and lead a still higher activity. This has been confirmed, in general, by other investigators. Bitter (1912) found that the following metals exerted an antagonistic action in the order given: Copper, brass, silver, gold, platinum, lead, cast iron, steel, aluminum, nickel, zinc, and tin. The action was found to be the same for both corroded and polished metal. Such data are interesting when it is recalled that some of these metals are used for mouth-pieces on drinking fountains. Under such conditions, however, it is very doubtful whether germicidal properties would be shown.

Interest in the metals as disinfectants probably started with work by Nägeli, who referred to their activity as *oligodynamic action*. This interest has been revived again in a process known as the "Katadyn process" for sterilizing various materials such as fruit juices.

Soluble salts of some of the heavy metals exert destructive action on bacterial protoplasm. In water solutions they ionize, and the metallic ion reacts with the protoplasm of the cell. In this manner salts are formed with the metallic ion and the proteins. These are spoken of as mercury proteinates, silver proteinates, copper proteinates.

Mercuric Salts. *Mercuric chloride.* Mercuric chloride (HgCl_2) has long been used in disinfection. It does not fulfill all requirements of a good disinfectant but does fulfill several of the more important ones. It is very poisonous to higher animals and reacts readily with metals used in containers. The toxicity for higher animals requires that it be used in very dilute solutions in disinfection. Its affinity for proteins has caused its introduction for other purposes. It is used for preservation of zoological specimens. Cases of poisoning in human beings are treated with egg white because of the affinity which mercuric chloride shows for this material. Solutions of different strengths are used in disinfection work. A solution of 1 to 1000 for use in the presence of organic matter is sufficient. Mercuric chloride is soluble in 16 parts of water.

Mercurochrome-220. This is a complex chemical compound known as dibromooxymercury fluorescein which has been introduced into preventive medicine as a disinfectant. It has been especially proposed as a skin disinfectant to replace iodine. It has characteristics which make it more desirable than iodine in that it is not as caustic, and its use, therefore, is not attended with so much pain. It has also been used as an internal disinfectant in urinary and systemic infections. It seems to have marked action on the pyogenic microorganisms. It has one disadvantage of possessing a deep red color which stains the skin. The manufacturers suggest this as an advantage since one can tell more quickly the actual surface which has been disinfected. Results of investigations by several investigators indicate quite clearly that mercurochrome is a relatively weak antiseptic. Its use is apparently limited to certain infections.

Zinc Salts. Zinc salts are feeble antiseptics. They are mentioned here only to emphasize that fact. Some of them like zinc chloride appear in widely advertised dentifrices, the activity of which as disinfectants has been explained on the basis of the zinc chloride content. Some of the printed statements accompanying these preparations are very misleading and may result in neglect of approved methods. Laboratory experiments have, in some cases, shown that such preparations are devoid of action on bacteria. McClintic (1905) found that *Escherichia coli* was not killed after one hour's exposure to a 5 per cent solution of zinc chloride and that it required 10 minutes for a 25 per cent solution

to kill the same microorganism. Spores of *Bacillus subtilis* and *Bacillus anthracis* were found to resist 100 per cent and 50 per cent solutions 30 and 40 days, respectively.⁴ Despite the inactivity of such strong solutions, preparations containing very small amounts of zinc chloride have been recommended to the public as active disinfectants.

Silver Salts. Silver precipitates proteins from solutions as insoluble silver proteinates. It probably acts in the same manner on bacterial protoplasm. Biassoti (1910) reported that colloidal silver electrically prepared would in a few hours kill *Staphylococcus aureus*, *Eberthella typhosa* and *Corynebacterium diphtheriae*. The silver probably combines with protoplasm in some manner since Gram-positive bacteria are made Gram-negative. Simpson and Hewlett (1914) experimented with colloidal silver in the form of "collosols" and found them to be active disinfectants against *Eberthella typhosa*. Collosols were said to be nonpoisonous, slow of action, and very expensive. Silver is also combined with a number of other materials which are used as disinfectants. *Argyrol*, a silver salt of vitellin, is used in concentrations of 1 to 4 per 1000 for disinfection of some of the mucous membranes. *Protargol* is another silver-protein compound. *Albargin* is a silver salt of galactose. It is used to treat certain venereal diseases. It contains 10 to 15 per cent of silver. Argentamin, a 10 per cent solution of silver nitrate in 10 per cent ethylenediamine has been used for the treatment of gonorrheal infections. It is usually diluted to about 1 part in 300 parts of water. *Argentose* is a silver compound of nucleoprotein and is used much as silver nitrate is used. *Argonin*, a silver caseinate, is used in 3 per cent solution for treatment of gonorrhea and ophthalmia neonatorum (eye infections in infants newly born).

Silver Nitrate, AgNO₃. This silver salt has marked affinity for proteins as indicated by darkening effect on the skin. It is not quite so active as mercuric chloride but does not react with extraneous proteins as does the latter. It is quite caustic and in solution of 0.1 to 1.0 per cent is used as an eye disinfectant to prevent congenital blindness in infants.

Copper Salts. Copper salts are less widely used today as disinfectants than formerly. Other substances have been developed which are not only cheaper but also considerably more

⁴ See *J. Am. Med. Assoc.*, 73 (1919), 1380-1.

active. Copper salts are used, however, as algicides for the treatment of water supplies. No general statement can be made about the amount of copper which must be used, because many different factors, such as species of algae to be destroyed, hardness of the water, and temperature, are involved. These amounts, according to Kellermann and Moore, vary from 1 part of copper sulfate in 100,000 for the species in the genera *Beggiatoa*, *Pandorina*, and *Eudorina*, to 1 in 25,000,000 for species of *Spirogyra*, 1 in 20,000,000 for *Uroglena*, and 1 in 15,000,000 for *Navicula*.

Concentrations of about 1 part of copper sulfate in 40,000 parts of water were found to kill intestinal bacteria in water. Another investigator reported that 1 part in 1000 parts of water was required. Copper sulfate is not used today for practical water disinfection and would not be used until sufficient work had been done to prove that water so treated would not be harmful. Federal food-control officials are making great efforts to rid food products of metals of all kinds.

Calcium Salts. With the exception of calcium hypochlorite, which has been discussed previously, and lime, to be discussed now, calcium salts do not hold an important place among disinfectants.

Calcium Oxide. This is known as quick lime and is very caustic in the presence of organic matter. It may be used in two forms, as slaked lime or milk of lime. Slaked lime is prepared by adding a pint, or pound, of water to 2 pounds of lime. The reaction proceeds as follows:

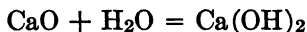

This will react with carbon dioxide to form calcium carbonate according to the following equation:

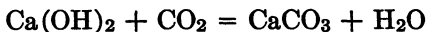

Milk of lime is a thick mixture containing four to six parts of slaked lime. It reacts with carbon dioxide to form the carbonate as does slaked lime. Therefore, these mixtures should be used as soon after preparation as possible.

IV. MISCELLANEOUS COMPOUNDS

Quite a few miscellaneous chemical substances are used in practical disinfection. Only a few of those commonly used by the layman need be considered here.

Acids. Bactericidal action of acids varies with their degree of dissociation, although this does not explain all observations. In general, strong acids such as hydrochloric and sulfuric are more germicidal than weak acids such as benzoic, acetic, and the lactic acids. The latter acids are known to be toxic to some microorganisms while in the molecular state.

Disinfecting activity of acids is usually believed to be related to the degree of ionization. Other factors may be involved because acid dilutions with the same pH may not show the same activity.

Alkalies. Some alkalies are very destructive to microorganisms. Their activity is usually attributed to the OH ion. Therefore, the greater their dissociative ability, the greater their disinfecting ability is supposed to be. With some alkalies the other ion may be more toxic.

Hydrogen Peroxide. This is an oxidizing disinfectant which is probably far less valuable than many think. It must be used in excessive amounts if it is to be active. Peroxide is probably too reactive to be a safe reliable bactericide. It is quickly dissipated in the presence of organic matter. As a surface disinfectant it might have value, but it cannot be regarded as a penetrating disinfectant. The layman believes that the more this substance foams when applied to a wound, the greater the disinfecting power. This visible action means that the hydrogen peroxide is being decomposed at the surface and that very little may reach the deeper recesses of a wound. Safer disinfectants than hydrogen peroxide are available.

Boric Acid. This is a very weak antiseptic which enjoys a reputation as an eye disinfectant. Experimental work with it has shown it to be practically without effect on bacteria. Even in saturated solution it does not destroy common bacteria after considerable time. The Bureau of Chemistry found it to be the main constituent of a canning powder which was advertised for use in home canned foods. This powder, containing 95 per cent of boric acid, was practically without effect on bacteria, and its use might lead to neglect of other important steps in the canning procedure. The fact that it was found to be inert on bacteria is the pertinent information here. Tanner and Funk (1919) made a short study of boric acid in disinfection. Their results indicated that it is decidedly unreliable. Even in satu-

rated solutions, it did not kill common bacteria and many pathogenic types. Where it is absolutely essential to control the bacterial flora some other disinfectant should be used.

Ethyl Alcohol. Comparison with other available compounds indicates that ethyl alcohol is not active on bacteria. Whatever action it may possess may be attributed to dehydration. Other homologues have also been studied, and in the alcohol series there is excellent opportunity for studying the influence of molecular configuration on disinfecting power. The greatest activity of ethyl alcohol is secured in strengths of between 50 and 70 per cent. These concentrations contain sufficient water for the coagulation of the protein. Beyer (1912) found that concentrations of alcohol under 60 per cent and over 80 per cent were practically worthless as disinfectants. Frey (1912) found that treatment with various concentrations of alcohol influenced the swelling and solubility of protein in water. Diluted to 10 per cent, alcohol, dissolved a little of the protein; above 20 per cent, solution of the protein stopped, and swelling decreased; above 90 per cent, the protein dissolved. The greatest action of alcohol on protein is at 50 to 60 per cent, and the greatest disinfecting power is 70 per cent. Frey explains the use of alcohol as a disinfectant in the irreversibility of the coagulation of the protein after treatment in alcohol. This is probably only part of the explanation.

Glycerol. Rosenau found that a 50 per cent solution of glycerol would restrain all bacterial growth and that lower percentages would allow better growth. Bacteria would not grow in media containing 32 per cent of glycerol, but molds grew in stronger solutions of 40 and 49 per cent. Glycerol was found to have distinct but slight germicidal action and probably acted by abstracting water from the bacterial cell. Spores were not killed, and anthrax spores lived 200 days in strong glycerol solutions. The compound may be used as food by many bacteria. It is then probably oxidized to glyceric aldehyde and glyceric acid. Glycerol may be used, however, as a carrier for many other disinfectants such as phenol and cresol.

Dyes as Disinfectants. Dyestuffs have long been known to destroy bacteria. Koch was one of the first to report results of study of these substances. Churchman (1912) published results of interesting experiments with gentian violet. He reported that

in dilutions of 1 to 100,000, when added to media, it would inhibit the development of certain bacteria. Gram-negative bacteria grew fairly well on the gentian-violet media, whereas generally the Gram-positive would not. Malachite green and brilliant green are among the most toxic dyes. The great possibility for changes in molecular constitution give the dyes great interest in disinfection.

Chemotherapy. Chemotherapy is that division of medicine concerned with treatment of diseases with chemical compounds. It is largely a result of synthetic chemistry in which structure of molecules may be altered so as to increase their activities in certain directions. This field of knowledge was probably founded by Ehrlich, who synthesized many compounds which he hoped could be used for cure of diseases. A few may be mentioned.

Salvarsan. This is dioxidiaminoarsenobenzene and is often spoken of as "606"; it contains trivalent arsenic and is one of the so-called "arsenicals." It has had its greatest use in treatment of syphilis. Neosalvarsan, discovered later by Ehrlich, has been more widely used.

Sulfa Drugs. These are relatively new additions to the drugs used in chemotherapy. The first to be synthesized was sulfanilamide, to be followed by the sulfonamides. Among the latter are sulfapyridine, sulfathiazole, sulfadiazine, and sulfasuxidine. These compounds have been shown to be very effective against bacterial pneumonia, streptococcus infections, dysentery, and meningitis. They have superceded the use of sera in many of these infections. Sulfa drugs may be synthesized in a short time, but it takes months to prepare sera. Just how sulfa drugs act may not be known. Some have said that they starve the bacteria and devitalize them. In this condition bacteria are susceptible to destruction by agents in the bodies of infected individuals. Another explanation is that they interfere with availability and utilization of some of the vitamins (particularly *p*-aminobenzoic acid) which are necessary for normal well-being of bacteria. However they may act, they are believed not to destroy bacterial cells but merely to stun them. Such agents are not disinfectants but bacteriostats.

The good which sulfa drugs has done can scarcely be overstated. Such diseases and infections as meningitis, bacterial pneumonia, and streptococcus septicemia which were once highly fatal have

been greatly reduced in severity, and many lives have been saved. In addition, the cost of illness has been greatly reduced because sulfa drugs are much cheaper than antisera. Sulfa drugs are not especially active against Gram-positive bacteria, including staphylococci, but penicillin is.

Penicillin. This is probably the newest drug to be used widely in chemotherapy. It is produced by a mold *Penicillium notatum*. The chemical nature⁵ of the several penicillins has not been elucidated though much progress has been made. Penicillin is one of several "antibiotics" which are now known to inhibit certain bacteria. It was discovered by Fleming in London during investigations of staphylococci as causes of disease. A Petri-dish culture of *Staphylococcus* became contaminated with a mold colony. Study revealed the staphylococci to be dissolved and destroyed about the mold colony. This suggested that some substance harmful to the bacteria was being excreted by the mold. Fleming⁶ gave the name penicillin to this substance which is now being produced in large quantities in the United States.

It is standardized in Oxford units, in honor of the laboratory in which much of the pioneer research was done. The Oxford unit was once defined as the amount of penicillin which when dissolved in 50 milliliters of meat-extract broth just inhibits completely the growth of the test strain of *Staphylococcus aureus*. Another standard was employed, in conjunction with the cylinder-plate assay method, one Oxford unit being the amount of penicillin producing a 24-millimeter zone of inhibition of the test strain of *Staphylococcus aureus*. An International Standard⁷ has now been agreed on by representatives from several nations, one Oxford unit being equivalent to 0.6 microgram (0.0006 mg) of crystalline penicillin G. This is a much more satisfactory definition. By calculation it may be seen readily that 1 milligram of penicillin G is equivalent to 1667 Oxford units.

Four forms of penicillin⁸ are now recognized; they are termed penicillin F, G, X, and K by American workers. According to

⁵ Chemistry of Penicillin, *Science* **102** (1945) 627-9.

⁶ Antibacterial Substances, Penicillin, *Chem. Eng. News*, **21** (1943), 1429-34; 1468; also **22** (1944), 2247.

⁷ Recommendation of the International Conference on Penicillin, *Science* **101** (1945), 42-3, 1945.

⁸ R. D. Coghill, Penicillin, Science's Cinderella, *Chem. Eng. News*, **44** (1944), 588-93.

British terminology they are I, II, III, and IV. Each type of penicillin may have its advantages for certain infections.

Penicillin is used and administered in different ways, depending largely on the disease being treated. It is given by intramuscular, intravenous, intrathecal, and subcutaneous injection, orally when accompanied by a suitable carrier such as oils, or by external application. Slow regular administration is favored because a continuous excess of the antibiotic is desired in the blood.

Penicillin is available today as the impure salt. One milligram of such a salt dissolved in 5,000,000 milligrams of water has been reported by one authority to just inhibit growth of *Staphylococcus aureus*; more concentrated preparations are effective in dilutions of 1 to 80,000,000.

The sulfa drugs and penicillin are powerful weapons for fighting disease. Each possesses special merits. Whereas penicillin gives rise to no complicating toxicities, many people are quite sensitive to the sulfa compounds and develop serious reactions. Penicillin is useful in an increasing number of bacterial diseases. A few diseases caused by Gram-negative bacteria which were once believed to be refractory to penicillin are now yielding to its use. Anthrax is a recent addition to this group. Future progress with penicillin will concern lower cost, greater purification, and perhaps chemical synthesis and production of the different types for use where advantageous.

Germicidal Action of Soap. As a sanitary agent, soap may function in two ways. It acts as a detergent in the removal of visible dirt owing to its low surface tension, and it may also function as a more or less active disinfectant. Although soap solutions are inimical to certain bacteria, other species of bacteria have been found to be quite resistant to its action. The activity of soap in this respect has been shown to be greatly enhanced by high temperatures which gives a firm foundation for the sanitary value of hot water and soap suds as a cleansing agent. Of course, results of investigations on germicidal action of soap⁹ depend on the kind of soap used in experiments, conditions which obtain, species of bacteria used, strength of the soap solution, and chemical constitution of the soap.

Detergent action of soap is of considerable sanitary importance, because it may remove bacteria with the dirt and because

⁹ "Germicidal" Soaps, *J. Am. Med. Assoc.*, **124** (1944), 1195-1201.

it cleans the skin. Clean skin has been shown to be distinctly germicidal for many species of bacteria.

Germicidal action of soaps varies greatly. Those prepared even from pure fatty acids exhibit great variation. There is apparently no difference in the action of sodium and potassium soaps, but the content of saturated and unsaturated fatty acids is important with some species of bacteria.

In order to increase the destructive action of soap on microorganisms, "germicidal" soaps have been prepared by addition of chemical substances which are known to possess germicidal properties when used alone. This has been done to make soaps germicidal to a wider range of microorganisms and in higher dilutions. Among all of the chemical substances which have been attempted, mercuric iodide, first proposed in 1897 appears to be the most effective, as shown by results of several investigators. Ordinary "medicated" soaps are probably worthless as agents for destruction of microorganisms. If a detergent and disinfectant are needed, sound practice would suggest that they be used separately, the detergent first, to remove dirt which might dissipate the disinfectant, and then a disinfectant which does not harm the skin or tissue.

Standardization of Disinfectants. Since it is desirable to know the relative disinfecting value of different substances and agents, methods for determining and expressing these values would be helpful. For this purpose various methods have been proposed, only one or two of which need be mentioned.

Phenol Coefficient. Determination of their "phenol coefficients" is an attempt to rate various disinfectants numerically. As the name indicates, phenol or carbolic acid is the disinfectant used as the standard. Since some particular bacterium must be used, *Eberthella typhosa*, and even a particular strain, has been adopted as the standard test organism. The activity of pure phenol on a pure culture of *Eberthella typhosa* is compared under identical conditions and at the same time with the activity of the compound under investigation on *Eberthella typhosa*. The action of phenol on *Eberthella typhosa* becomes, then, the measuring stick which is used on the unknown compound. The phenol coefficient of phenol is 1, Lysol 2.12, and tricresol 2.62. The comparison is usually made both in presence and absence of organic matter.

Although phenol coefficients were favorably considered when they were first proposed, they are not so popular among disinfection specialists today, because they may yield ambiguous information about disinfecting value of a compound. For instance, a dentifrice a few years ago was advertised as having a phenol coefficient of over 6 which would suggest that it was six times as powerful as phenol. This was not the case. Another difficulty is that disinfectants vary greatly in activity with the conditions under which they are used. A high "phenol coefficient" under one set of conditions would probably not hold for another set. Other reasons also argue against "phenol coefficients." They may be left for those who proceed further with laboratory bacteriology. The United States Food and Drug Administration, empowered under the Food, Drug, and Cosmetic Act of 1938 to determine accuracy of claims of bactericidal and antiseptic properties for

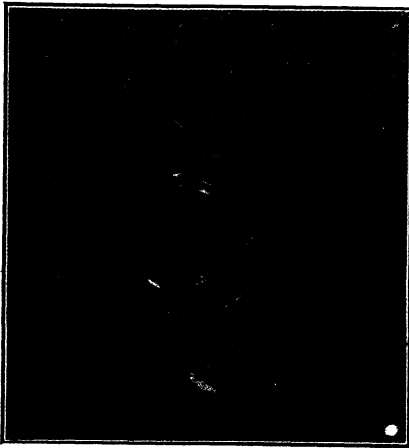

FIG. 87. Agar Cup-Plate Method Showing Antiseptic properties. Definite inhibition zone surrounded by a stimulation zone and a secondary zone of partial inhibition. (After Ruehle, 1931)

preparations shipped in interstate commerce, has modified the older methods for determining phenol coefficients and also developed new methods.

Agar Cup-Plate Method.

Cup plates are prepared by pouring a sterile Petri dish with agar medium heavily inoculated with *Staphylococcus aureus*, or any other organism which is desired. Before it is hardened, a round object such as a cork or glass disk, previously sterilized, is placed in the center of the dish. After the inoculated medium has hardened, this is carefully

removed; a cup is thus formed in the medium into which the compound under investigation can be poured. Antiseptic properties are shown by a clear zone about the cup, width of which gives some information concerning the extent of these properties. This method has been superseded by the cylinder-plate methods in

which the compound under investigation is dispensed into a small glass or metal cylinder resting on the agar.

Terminal Disinfection (Fumigation). It has been the custom to "fumigate" after an infectious disease. Different agents have been used, one or two of which are discussed here briefly.

Formaldehyde. This is available on the market as formalin, a 40 per cent solution of formaldehyde in water. When this is diluted to make a 5 per cent solution of formalin in water it may be directly applied to materials. For fumigation, however, it is generally prepared in the gaseous state. We are concerned here with the methods. Dorset gave the advantages and disadvantages as follows:

1. It is one of the most powerful germicides known.
2. Its action is not interfered with by albuminous substances.
3. It is not poisonous and may therefore be used for disinfecting hay and grain without destroying these for food purposes.
4. It is not injurious to delicate fabrics, paint, or metals. (Formalin solutions will attack iron, but not other metals.)

The disadvantages are, briefly:

1. The gas has a strong tendency to condense in cold weather and is not reliable as a disinfectant when the air temperature is below 50°F.
2. It is necessary to seal tightly all compartments which are to be disinfected with the gas in order that penetration may be secured and that the required concentration may be maintained for a sufficient length of time.

Formaldehyde changes to paraformaldehyde by polymerization when kept at room temperatures or lower. It unites easily with many substances, especially the organic compounds. For instance, when added to gelatin it forms a compound which is insoluble in many of the common reagents. Fermi attempted to secure a gelatin medium in this way which would not melt at room temperature. Formaldehyde may act in the same way on bacterial protein. It is important to have plenty of moisture present when formaldehyde is used as a disinfectant. Koch (1901) reported that a 0.05 per cent solution of this compound would kill growing yeast whereas a 0.005 per cent solution would not. Since carbon dioxide was formed after the cell had been killed the zymase was not destroyed.

Sulfur Dioxide. This gas, generated by the burning of sulfur, is a feeble disinfectant. It has been almost entirely replaced by formaldehyde.

Now the real merits of fumigation as an objective method for preventing spread of disease should be appraised. Prominent sanitarians and students of the question are about agreed that terminal disinfection is without value. This statement may be verified by consulting such books as Park's "Public Health and Hygiene," and Rosenau's "Preventive Medicine and Hygiene." The reasons for not retaining terminal disinfection are:

1. It has very little effect on the control of communicable disease. In cities where terminal disinfection or fumigation has been abandoned, no increase in communicable disease has been observed.

2. The methods and agents used have very little action, if any, on pathogenic microorganisms. These agents of disease might be imbedded in bits of organic matter and thus protected from the action of the gaseous disinfectant. Pathogenic bacteria tend to die rapidly after discharge from the body.

3. It is much more important to destroy infective material throughout the course of the disease than to rely on one attempt at the end.

4. More active attempts should be made to destroy infectious material than are made in methods of terminal disinfection. A committee of the American Public Health Association which prepared a report on 40 or so common diseases discussed terminal disinfection for each disease. In no one instance did this committee composed of eminent sanitarians advise terminal disinfection. After each case of disease, they recommended only *thorough cleaning*, defining this procedure as a generous use of hot water and soap suds.

5. Retention of terminal disinfection in public health work may tend to prevent the use of other procedures far more reliable. The layman may regard terminal disinfection as dependable and thus fail to apply other procedures.

The suggestion to abandon terminal disinfection has caused considerable discussion. Those who have fought this proposal have argued that fumigation does no harm and might do some good. They have suggested that the procedure be retained until a better one could be found. Such an argument cannot adequately support the continuation of terminal disinfection as now practiced. Chapin, who was among the first to criticize fumigation, believed that living and moving human beings were more important in dissemination of pathogenic bacteria than inanimate objects. Consequently, *concurrent disinfection* is desirable throughout a case of communicable disease. This has been defined earlier in this chapter.

Sterilization of Seed. Since some plant diseases are disseminated by spores of fungi which adhere to the seed, agriculturists

have found it desirable to treat the seed with preparations to destroy the spores. The diseases of greatest interest are, smut (*Ustilago*), rust (*Uredo*), and mildew (*Puccinia*). Although several preparations have been studied, copper sulfate, in one-half per cent solution has been especially valuable. The seed is soaked in this solution 8 or 10 hours. If the seed is to be sprinkled with the fungicide, a 10 per cent solution is necessary. With this method the seed must be thoroughly stirred.

Insecticides. These are agents which kill insects. They are important for elimination of insects which destroy foods and which cause diseases in man and other animals. Added to many insecticides which have been used for a long time is a new one, dichlorodiphenyltrichloroethane, called DDT, which bids fair to revolutionize problems caused by insects. One investigator believes that this agent would be to preventive medicine what Lister's use of antiseptics was to surgery. It destroys insects such as body lice and makes clothes insect-free for many days. Although much experimental work will be carried out, present information on the value of this compound in preventive medicine and agriculture is very encouraging.

REFERENCES

- BUSWELL, A. M., *The Chemistry of Water and Sewage Treatment*, Chemical Catalogue Co., New York, 1928.
- GOLDSTONE, I., *Behind the Sulfa Drugs*, D. Appleton-Century, New York, 1943.
- HASSELLTINE, H. E., *The Practical Use of Disinfectants*, *U. S. Pub. Health Service, Pub. Health Repts.*, **30**, July 9, 1915.
- McCULLOCH, E. C., *Disinfection and Sterilization*, Lea & Febiger, Philadelphia, 1945.
- RIDEAL, S. and E. K. RIDEAL, *Chemical Disinfection and Sterilization*, Edward Arnold & Co., London, 1921.

CHAPTER 13

MUTUAL RELATIONSHIPS—MICROBIAL ASSOCIATIONS

Much of the knowledge about bacteria and related microorganisms has come from observations on pure cultures under laboratory conditions which, of necessity, are artificial; nature does her work with mixed cultures of not only microorganisms but also higher forms of life. Results of infection of animals with microorganisms are usually attributed to one species whether this organism is the only one present or not. Infections of the blood stream, for instance, are probably purer than infections of the intestines or throat.

Co-operations and antagonisms are just as common among microorganisms as among other forms. Some species favor development of each other, whereas others are decidedly inimical. For these relationships varying terms have been used. Some of them are not clear-cut and overlap with others.

Symbiosis. This is an harmonious and reciprocally beneficial relationship between two microorganisms or groups. Usually we like to believe that both organisms or groups are benefited, each contributing something to the other or helping to create and maintain conditions which are beneficial to the other. There are many kinds of gradations of symbiosis, depending on the degree of concord. Symbiosis may also occur between others forms of life. It is not a term restricted to bacteriology. Undoubtedly symbioses play an important role in nature's scheme. Bacteriologists are quite likely to think about the activities of bacteria in terms of pure cultures because these are usually used in the laboratory. They may overlook the fact that the vital living nature about them is populated with all sorts of living creatures; so, also, the world of microorganisms is undoubtedly composed of just such a composite of forms.

Symbiosis between Bacteria. Several illustrations may be offered. Growth of anaerobic bacteria with aerobic bacteria is a

typical example. Aerobic bacteria use up oxygen and thus create favorable conditions for development of the anaerobic bacteria, which are unable to grow in the presence of free oxygen. This association is, then, reciprocally beneficial to both groups.

Another modification of symbiosis is the distinctly favorable stimulating effect which one organism may have on another. Several investigators have noticed that a bacterium has grown much better when another was present as a contaminant. This has been observed with hemophilic bacteria and *Staphylococcus aureus*, and also with other species. Schopfer has called this the "satellite phenomenon" or *satellitism*. Various suggestions have been offered to explain it. Some think the effect is due to regular excretory products of the contaminant which could not be made by the stimulated organism. Others believe that a vitamin or vitamin-like substance is the real explanation. This idea has some support in results of recent investigations which show that certain vitamins greatly stimulate certain species of bacteria. This stimulating effect of one cell on another has also been demonstrated by Robertson who secured many more progeny in a hanging drop when two cells of a protozoan were present than when one cell was present. He believed that some substance was secreted from one cell which helped another.

Symbiosis between Bacteria and Plants. Only the best-known illustration need be mentioned, the symbiotic fixation of atmospheric nitrogen. It is discussed more fully in a later chapter. This symbiosis is visually characterized by formation of nodules or tubercles on the rootlets of leguminous plants. In these nodules develop certain bacteria which take nitrogen from the atmosphere and give it to the plant. In return for this nitrogen the plant gives the bacterium carbohydrates and other materials necessary in its metabolism.

Symbiosis between Bacteria and Animals. In the alimentary tracts of animals are countless numbers of bacteria. Although some may be there as transient inhabitants, others, such as *Escherichia coli*, take up permanent abode there. They are spoken of as symbionts. They probably help to break down complex food material and thus aid digestive enzymes in preparation of food for passage through the intestinal walls into the blood to be carried to the cells of the body. In alimentary canals of animals, for instance, cellulase is not secreted, and consequently

the animals are unable to utilize the energy in cellulose. Cellulose is known to be fermented by bacteria in the alimentary tracts of animals. In this case the symbiosis is completed by the fact that the animal maintains a favorable place for the bacteria while the bacteria may make foods more readily available to the animal. Other beneficial effects have been suggested for explaining the presence of bacteria in alimentary tracts of animals, but lack of space makes it impossible to discuss them here. Nutritionists have verified earlier suggestions that bacteria contribute vitamins to the animals. This question would be a good one for the student to search out in the literature. *Commensalism* is another mutual relationship which should probably be mentioned. This relationship obtains when one organism lives on the waste products of another.

Synergism is another term for a modified symbiosis. Holman and Meekison observed that gas might be formed from sugars by two species of bacteria growing together when neither formed it alone.

Antibiosis. This relationship is just the reverse of symbiosis. In this case an antagonism exists between bacteria or groups of bacteria. It gives us an explanation in part, at least, of why bacteria, multiplying as rapidly as they do, do not drive other forms of life from the earth. Some bacteria cannot get along well together, and the more hardy ones kill the others. This is an illustration of the law of survival of the fittest. How may antibiosis be explained? In some cases one group of bacteria may form large amounts of acid. Other bacteria may form other products of metabolism which are objectionable to bacteria life.

Antibiosis between Bacteria. The formation of acids, which has just been mentioned, explains the antagonism between putrefactive bacteria in the intestines and organisms of the lactic acid group (*Lactobacillus acidophilus*) which are used to cure certain intestinal difficulties. Putrefactive bacteria cannot endure an acid environment. When lactic acid bacilli are established in the intestines by proper diet and feeding of microorganisms, putrefactive bacteria which cause illness are driven out. Acid-forming bacteria, together with the lactic acid contained in their cultures, have been advised for clearing of diphtheritic throats. Lactic acid bacteria are believed to be antagonistic to the diphtheria bacilli.

Antibiosis between Protozoa and Bacteria. Many protozoa feed on bacteria; this is, indeed, the most extreme illustration that can be given of one organism devouring another. This fact is made use of in purification of water by filtration; protozoa on the filters feed on the bacteria which are caught on the filters. Protozoa are also responsible for reduction in bacterial population in natural bodies of water in the summer.



FIG. 88. Showing Antagonism between Bacteria Growing on Plain Agar. Note the clear areas about the colonies where the growth of the spreading colony has been prevented.

Definite Antibiotic Substances. Although evidence of antagonisms has been known for a long time among various species of organisms of interest to microbiologists, it is only recently that investigators have determined what some of the substances are. Various names have been given to them. They are chemical substances of definite composition and are known under the general name of "antibiotics," or antimicrobial agents of biologic origin. Among many which have been reported are the following:

Penicillin. This antibiotic substance was discovered by Fleming and developed by Florey. It is formed by *Penicillium notatum*, *chrysogenum* group, and is active against many com-

mon pathogenic bacteria but generally not against Gram-negative rods. It is very active against gonococci, staphylococci, streptococci, meningococci, certain pneumococci, and *Treponema pallidum*, the spirochete which causes syphilis. Use of penicillin for treatment of many human infections has resulted in remarkable recoveries. It has failed in some.

Actinomycin. This is formed by *Actinomyces antibioticus* along with another substance called *actinomycetin*. These organisms are midway between bacteria and fungi. Actinomycin is strongly inhibitory towards many Gram-positive bacteria and some fungi, such as *Penicillium*. Bacteria vary widely in their sensitivity to this antibiotic.

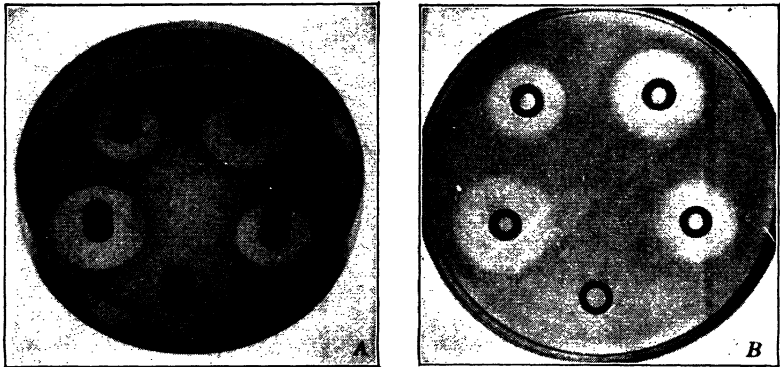

FIG. 89. Showing Cylinders Used for Evaluating the Potency of Penicillin Preparations. (After Schmidt and Moyer, 1944). A, oblique view showing arrangement of cylinders; B, perpendicular view showing various sized zones of inhibition. The Petri dishes contain agar medium-heavily inoculated with *Staphylococcus aureus*. The cylinders are placed on this medium and filled with penicillin solution. The width of the zone of inhibition of development of *Staphylococcus aureus* indicates the strength of penicillin.

Streptothricin. This antibiotic is formed by *Actinomyces lavendulae* which abounds in soil. It was found to be quite inhibitory to Gram-negative bacteria.

Streptomycin. This antibiotic, discovered by Waksman and collaborators, is produced by *Actinomyces griseus*. Although its therapeutic potentialities have not been fully explored, it is of value in several diseases not effectively treated with penicillin. It is active against a variety of Gram-negative organisms. It

has been suggested to have value in the treatment of typhoid fever, brucellosis, tularemia, sulfanamide- and penicillin-resistant urinary-tract infections and perhaps tuberculosis. More clinical tests will be required to substantiate its effectiveness.

Tyrothricin. This is an extract first isolated by Dubos from *Bacillus brevis*, a Gram-positive aerobic spore-forming soil bacterium. Tyrothricin shows antibacterial action against several Gram-positive bacteria. It apparently consists of two components, *gramicidin* and *tyrocidin*. It has some action against staphylococci, pneumococci, and streptococci. It not only devitalizes the bacteria by interfering with metabolism but also lyses them. Its use as a therapeutic agent is said to be fraught with danger. Consequently it should be administered only by physicians.

Pyocyanin. This is formed by a bacterium *Pseudomonas pyocyanea* which has long been known for its harmful effect on other microorganisms. Growth of this bacterium is characterized by a blue-green pigment and characteristic odor. This antibiotic substance has never been found to have any practical significance.

Parasitism. This mutual relationship should also be discussed at this time. The term, of Greek origin, literally means a mess-mate and originally had no odium or contempt attached to it. The meaning has gradually shifted until now it has assumed somewhat the significance of a "hanger-on," or one who gets his living from another. In this sense it is used in biology and botany. Different degrees of parasitism are recognized. *Obligate parasites* are those which cannot grow away from living tissue or cannot be grown on laboratory media. *Facultative parasites* are those which may be grown on laboratory media. In contrast with the term *parasite* is the term *saprophyte*. The latter term is applied to an organism which can live on dead organic matter. The term *parasite* is a broad general term including both plant and animal life which dwell in or on another organism called the host. The term, however, has been monopolized somewhat by the protozoologists who use it for parasitic animal forms. Morrey has contrasted these terms as follows. He stated that those bacteria whose food consisted of dead material, either organic or inorganic, are spoken of as saprophytes. On the other hand those bacteria whose natural habitat, irrespective of their food requirements, is in or on living organisms,

are spoken of as parasites. He called attention to the fact that these terms are often erroneously used as if they were opposites. The term saprophyte has reference to food; the term parasite has reference to place of abode.

Pathogenesis. This term comes from two Greek words (*Pathos*, suffering and *gen*, to give rise to or produce) and is now used in the general sense to indicate development of morbid or disease conditions. It might be looked on as parasitism where the parasite is more aggressive—does not simply secure its living from another living organism but, in addition, does harm to that organism. The subject is discussed more fully in later chapters of this book.

Metabiosis. This term is applied to a situation which is midway between a strict symbiosis and a strict antibiosis. It may be thought of as a condition where only one organism is actively benefited, the other receiving only passive benefit. It might be looked on as half-hearted symbiosis.

REFERENCES

- FREEMAN, E. M., In Praise of Parasitism, *Sci. Monthly*, **44** (1937), 67-76.
SCHOPFER, W. H., Plants and Vitamins, Chronica Botanica Co., Waltham, Mass., 1943.

CHAPTER 14

NUTRITION AND METABOLISM OF BACTERIA

Nutrition of single-celled microorganisms is a useful subject for study; the data found help, in many cases, to elucidate the same problems for higher organisms with which it is often difficult to work. Higher forms of life are multicellular, and consequently their metabolism rests on more intricate factors. In this chapter a broad view of metabolism will be assumed in order to introduce the metabolic characteristics of both plants and animals. This will give a better foundation for understanding the metabolism of the unicellular microorganisms.

Amount of Food Required by Bacteria. This factor is quite variable. It depends on different conditions just as it does with higher organisms. We need not be concerned with detailed discussion of this question, but some profit will result from a consideration of the small amounts of food required by microorganisms. This is best appreciated by considering size or weight of an ordinary bacterial cell and amount of solid matter contained in it. This will strikingly illustrate food and energy requirements of a cell. In a later paragraph Kendall's data and statements about *Vibrio comma* are used to show the possible number of progeny from a cell. His data and statements are also taken to determine how much food a cell of this organism would require. An average cell of *Vibrio comma* is about 1 micron (0.001 millimeter) in diameter and 2 microns (0.002 millimeter) in length. Such a cell would weigh about 0.00 000 002 milligrams, if the specific gravity is assumed to be 1. This means that 1,000,000 of the cells would weigh only 0.002 milligram. Then, if it is assumed that 80 per cent of the bacterial cell is water, it is evident that in 1,000,000 cells there would be only 0.0004 milligram, an extremely small amount, of solid matter. Since this amount is hardly measurable, it is difficult to comprehend the amount of solid matter in a cell.

What Is Food? For the higher organisms food may be defined as material which, when taken into the body and properly pre-

pared by the body fluids, is utilized for repair of old tissue, building of new tissue, and generation of energy. This definition suffices also for bacteria, although we lack detailed information of mechanisms by which food is made available to single-celled bacteria. Their small size makes it difficult to determine some of these facts.

Foods for Growth and Building Purposes. Foods are classified in many different ways, depending on the purpose of classification. Ordinarily they are classified as proteins, fats, and carbohydrates. They may also be classified on the basis of dialyzability. For our discussion they are separated into two groups, *food for energy* and *food for growth*. Such a separation is of course an arbitrary one. The proteins or nitrogenous compounds are generally offered as good examples of foods for growth and carbohydrates as foods for energy purposes. It would be wrong, of course, to assume that fragments of a carbohydrate molecule, broken up by fermentation, could not be used for building and repair, or just as wrong to deny that decomposition of proteins yields no energy.

Metabolism—Catabolism and Anabolism. Metabolism is the broad term including catabolism and anabolism. The processes of metabolism and nutrition are said to consist of conversion of food into body tissue and both food and body material into energy. It is then a change of potential energy into kinetic energy.

Anabolism (Assimilation). This term covers synthetic or building processes in the cell. The reactions involved are endothermic, requiring energy. The energy which is secured by fermentation is utilized for building purposes. Anabolism, of course, is the foundation of growth and repair of tissue.

Catabolism (Dissimilation). The processes involved in and included under the term catabolism are decompositions. They are sometimes spoken of as analytic reactions. As with other cell functions catabolism is best explained as an enzyme phenomenon. Catabolism must not exceed anabolism, else the cell will be destroyed. There may be times, however, when anabolism is reduced to a minimum and catabolism progresses more rapidly. This results in a wasting away of the cell.

Digestion. Here are included those processes by which foods (in the alimentary tracts of animals) are reduced in complexity and made able to pass through the walls into the cell. Under

the discussion of enzymes this term is explained more fully. The action of extracellular enzymes secreted by microorganisms to make foods soluble might be looked on as digestion even though the preparatory changes do not take place in a digestive tube as they do in higher animals. Food in the digestive tubes of higher animals is not inside the body since the alimentary canal is just a tube extending through the body. In the alimentary tracts of animals, insoluble foods are made soluble by means of hydrolyzing enzymes. This change is quite analogous to the action of extracellular enzymes in bacterial metabolism.

After hydrolysis in the animal alimentary tract, absorption must take place. Products of hydrolysis must pass through the intestinal wall into the blood which carries them to the cells.

Plant Metabolism. Metabolism of green plants is sharply set apart from that of animals and fungi. Green plants possess chlorophyll by means of which they are able to utilize energy in sunlight and with it to build up complex body constituents by means of a process called *photosynthesis*. This process is endothermic, meaning that energy is used in putting together carbon dioxide, water, and nitrogen to make proteins and carbohydrates. This energy comes from sunlight. We might say that it is changed from kinetic to potential energy. Each molecule of carbohydrate, protein, or fat is then virtually a storehouse of energy for organisms which cannot utilize sunlight but which must resort to chemical energy latent in large molecules. This subject is fully treated in books on plant physiology.

Animal Metabolism. Animals are devoid of chlorophyll and therefore cannot resort to sunlight for energy. They have to go to the storehouses of energy constructed by plants and secure it by decomposition of proteins, fats, and carbohydrates. They resort to chemical decompositions, and consequently we may speak of this energy as *chemical energy* in contrast with *solar energy* used by plants. In the strict sense, then, at least for the present discussion, the ultimate source of energy is the sun.

✓ **Bacterial Metabolism.** The differences which once seemed to set bacterial metabolism quite apart from metabolism of plants and animals have become less apparent in recent years. For instance, it was once believed that bacteria were unable to use solar energy and had to rely entirely on chemical energy. In

recent years pigments referred to as *bacteriochlorophyll* have been shown to be present in certain bacteria. They seem to function for the bacterial cell as chlorophyll does in the cells of higher plants.

Despite the fact that, as has been stated previously, the single bacterial cell needs a very small amount of food, bacteria change large amounts into simpler substances. They must do this for they have great energy needs. The ratio of surface area to mass is much greater than in higher organisms. Consequently, great loss of heat and energy may occur. As shown elsewhere bacteria leave much energy in incompletely oxidized products. This makes it necessary for them to metabolize greater amounts of food.

Autotrophic, Prototrophic, and Heterotrophic Bacteria. Microorganisms may be divided into three groups, depending on the kind of compounds used as food. Autotrophic organisms use the element in the inorganic condition, *prototrophic* organisms use the uncombined element itself, and *heterotrophic* organisms use the element in organic form. Examination of known species reveals that most microorganisms are heterotrophic with respect to each of the more common elements. Under the discussion of fixation of atmospheric nitrogen *prototrophic* bacteria will be considered. Autotrophic bacteria are those which live in inorganic media. The autotrophic bacteria are especially interesting because their metabolism is unique. They seem to be able to live on inorganic food. They have been thought to have been the first forms of life on earth, because available food at that time would have been inorganic.

All gradations of complexity of nutrition exist among bacteria. Those capable of thriving on the simplest media have the most complex metabolic systems, for they have the ability to synthesize the multitude of complex organic compounds comprising their structure and necessary to their well-being. And conversely, bacteria most fastidious in growth requirements are those which are unable to perform many of the syntheses; they rely on the preformed compounds contained in the medium. This latter group, of course, is the most difficult to cultivate in the laboratory. Bacteria play an important role in nature's scheme. They function in keeping the elements moving through their cycles. Bacteriologists are unconsciously prone to consider bacteria as

more important than other forms of life. This is wrong, for every living creature has a part and is probably just as important as any other.

Foods for Energy. Energy requirements of bacteria are interesting. The bacterial cell, taking *Vibrio comma* ($1\mu \times 2\mu$) as an example, would have a surface area of 0.00001 square millimeter. Since the specific gravity is about 1, the ratio of surface area to weight of bacteria is 2000 to 1. Kendall¹ stated that for comparison a man 200 centimeters tall, weighing 75 kilograms, had a surface area of about 2 square meters. Then, the ratio of surface area to weight is much nearer unity in man than in bacteria. Since energy requirements of living organisms vary with the surface area, bacteria will require proportionately more energy than man.

Erwin F. Smith discussed this question as follows:

The reason the bacterial cell accomplishes work out of proportion to its size is just this, that its oxygen-absorbing surface is enormously greater in proportion to volume of protoplasm than that of any other known organism. The surface of the rods in a cubic centimeter of bacterial slime, such as we frequently obtain in a test-tube on our solid media and observe in the plant, represents an oxygen-absorbing area equal to the surface of an ox. Indeed, we might say that the smallest bacteria are almost all surface.

This helps to explain why bacteria are so active in food decomposition and in certain industrial fermentations such as acetic acid fermentation and acetone butanol fermentation.

Mineral Foods. In a former paragraph the weight of a single cell of a typical bacterium was computed. It was found to be very small. When it was pointed out that only 15 and 20 per cent of this was solid matter, the figure seemed still smaller.

There is every reason for believing that the same elements which are necessary for higher forms of life are necessary for the bacteria and closely related organisms. These are calcium, potassium, phosphorus, sulfur, magnesium, iron, and the like. In carrying out experiments to determine whether certain elements are necessary or not, it is difficult to exclude traces which adhere to apparatus or are in air. Statements, then, to the effect that these compounds are not needed should be accepted with reservation. Mineral foods are often supplied to bacteria in

¹ Kendall, Colloidal Symposium, Monograph, 1925, p. 195.

what are called synthetic media. A better name might be mineral salt-sugar solution, in which sugar is offered as the source of carbon.

Organic Foods. Most of the decompositions that have been discussed in this chapter are those of organic compounds. On this account we need not give much more attention to them. An interesting question in this connection is whether bacteria can live indefinitely away from organic matter and carry out their complete life cycles for indefinite generations in inorganic media. Answers to the question are influenced by a number of factors. We can enumerate several illustrations. The nitrate bacteria, those which oxidize nitrites to nitrates, are believed to live without organic carbon; they are cultivated in a medium in which the only carbon is in the inorganic state as sodium carbonate. It is possible, however, that they secure organic carbon from the atmosphere. The same is probably true for the nitrite bacteria, those oxidizing ammonia or its compounds to nitrites. Vitamins are also in the class of organic foods.

Water Requirements. Water is necessary in the metabolism of living organisms for a number of reasons. It cannot be considered a food but does act as a conveyor of foods. It is necessary for conveyance of foods through the cell wall into the cell for the removal of the waste products of catabolism from the cell. The necessity for water has been considered in several other places also.

Fermentation and Respiration. These terms apply to processes involved in energy transformations brought about by microorganisms. They are, therefore, fundamental terms to which students could well give considerable thought. The terms have taken on a broad indefinite meaning which has apparently changed during the years.

Fermentation. This term is used by various workers with various meanings and is better discussed and understood than defined in a short statement. It comes from the Latin, probably *ferveo* meaning to boil because that was the most obvious characteristic of a fermentation when the term was coined. Large amounts of carbon dioxide were produced in such fermentation. Since then the term fermentation has been applied to decompositions in which "boiling" does not occur. The products are not so completely oxidized.

Some of the early scientists said "fermentation is respiration without oxygen," which is not true. They probably meant that it was not involved for these decompositions took place under what we now call anaerobic conditions. What was happening was that the organism (yeast) was using combined oxygen in the materials fermented instead of free atmospheric oxygen. No living organism can get along without oxygen in some form, either free (O_2) or combined as in nitrates, phosphates, or carbohydrates. Cells live by fermentation because they secure energy from it.

The various definitions of the term "fermentation" which have been used need cause no worry. It is well, however, to know that they exist. One bacteriologist tried to give the term a fundamental definition that a fermentation was any intracellular process which furnished energy to the cell. Another defined the term as any decomposition in which microorganisms were involved. Still another defined it as any enzyme process. Biochemists have been prone to define it as decomposition of carbohydrates, reserving the term putrefaction for decomposition of nitrogenous compounds. Industrial microbiologists apply the term today to various decompositions in which useful products are formed. The decomposition in question is known by the predominant product.

Respiration. In the early days of the science of bacteriology it was believed that free oxygen (atmospheric oxygen) was necessary for all forms of life. This was later shown to be too general a statement, and several terms were introduced into discussions of this subject to cover the different gradations and types of oxygen utilization. The term respiration is used by plant physiologists to indicate the oxidation of reserve organic substances. It is, then, quite similar to combustion. Oxidation of these materials in the plant yields energy just as its combustion outside of the animal body liberates heat (energy). Normal respiration, then, may be regarded as a process dependent on and involving the use of free oxygen. It may be replaced by fermentation which also liberates energy. Respiration tends to result in completely oxidized products and therefore allows generation of more energy, since less is left in end products. The following equation might be taken to illustrate respiration:



Respiratory quotients, the ratio of oxygen consumed to carbon dioxide formed, have been determined for some of the common bacteria.

Aerobic Respiration. The term *aerobic* was introduced in 1861 by Pasteur for describing those bacteria which could use free atmospheric oxygen or required it in their metabolism and multiplication. Because of plenty of available oxygen, aerobic respiration often results in complete combustion of food material. The equation given in the preceding paragraph is a good example. Products of aerobic respiration are usually completely oxidized products, and the microorganisms have been able to drain the large molecule, such as glucose, of all of its energy, leaving fragments which are inactive.

Anaerobic Respiration.² This term was introduced by Pasteur to describe bacteria which did not require atmospheric oxygen in their life processes. Indeed the organism (*Vibrio butyrique*) not only could get along without free oxygen but also was poisoned by it. Such a statement coming at a time when every one believed that atmospheric oxygen was necessary caused much discussion and argument. Pasteur found that free oxygen poisoned these cells and caused them to lose their motility. Consequently the evil effects of free oxygen were demonstrable from the examination of a drop of a culture of this organism under the microscope. At the edge of the drop where oxygen diffused into it, the cells were nonmotile, but at the center they maintained active motility. Organisms which could not use free oxygen and were harmed by it were spoken of as anaerobic and the process as *anaerobiosis*.

From the standpoint of energy liberation anaerobic respirations are less efficient. Since they are carried out in the absence of free oxygen, complete oxidation does not occur. We might use an anaerobic decomposition of glucose to illustrate this:

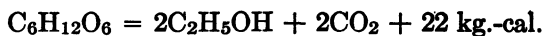

The fact that along with CO_2 are formed two molecules of ethyl alcohol indicates that much of the potential energy in the glucose molecule will remain in the ethyl alcohol. By subtracting the number of calories formed in this equation from the number formed by complete combustion, we find that 652 kilogram-

² W. Seifriz, Anaerobic Respiration, *Science* 101 (1945), 88-9.

calories are not available to the bacterial cell that resorts to anaerobic respiration.

✓ **Aerobiosis and Anaerobiosis.** Oxygen in some form is required by all microorganisms. This oxygen may be combined, or uncombined (free atmospheric oxygen). Variations in ability to use different forms of oxygen permit bacteriologists to arrange the bacteria into groups for which special terms have been introduced. Even though these terms have been used in the preceding paragraphs, they will be defined here.

Aerobic bacteria (aerobes): Those which use free oxygen for growth.

Anaerobic bacteria (anaerobes): Those which cannot grow in or which are injured by free oxygen.

Facultative (for oxygen). Those which are somewhat indifferent to free oxygen—can grow in the absence or presence of it.

Microaerophilic: Those which are able to grow with but infinitesimal amounts of free oxygen.

Study has been given to the question of why anaerobic bacteria cannot grow in the presence of oxygen. Apparently much more is involved than the mere assumption that oxygen is poisonous to anaerobes. A recent explanation was that, in the presence of air, hydrogen peroxide is produced. Since the anaerobes form no catalase, they are unable to decompose this peroxide. It becomes a poison. Another explanation of merit involves the oxidation–reduction potential (EH) of the medium. Anaerobes require a lower potential than aerobes.

AEROBIC BACTERIA

1. Grow in presence of air.
2. Use free (atmospheric) oxygen.
3. Completely oxidize products.
4. Secure more energy from an equivalent amount of food.

ANAEROBIC BACTERIA

1. Do not grow in presence of air.
2. Use combined oxygen.
3. Incompletely oxidize products.
4. Secure less energy from an equivalent amount of food.

CYCLES OF THE ELEMENTS

It has become customary for bacteriologists and agriculturists to discuss nitrogenous metabolism, sulfur metabolism, phosphorus metabolism, and so on, of microorganisms, with the help of an orderly system called a *cycle*. Thus we may have a *nitrogen cycle*, a *carbon cycle*, a *phosphorus cycle*, and such. We will retain this useful method for presenting the facts of nitrogen, sulfur, and phosphorus metabolism of the bacteria. It gives us

a fine method for following the various stages through which compounds of elements pass. It will also help us to correlate our information.

The soundness of this practice rests on the fact that matter is indestructible as is expressed in the law of conservation of matter. Russell and Hastings in their "Agricultural Bacteriology" have stated it in this manner:

An atom of carbon may be in the atmosphere today in the form of CO_2 ; tomorrow it may be in a sugar molecule of a plant; the next day in the tissues of an animal; and the succeeding day it may be again present in the air in a molecule of carbon dioxide, ready for another of its ceaseless passages, carrying with it a supply of energy for the animal and fungus plant.

Cycles then depict the various states of oxidation of elements in an orderly manner. In one of the following chapters nitrogen, carbon, and sulfur cycles are discussed.

Growth Factors and Vitamins. These have just been referred to but deserve a little longer discussion. For many years it was believed that fats, proteins, carbohydrates, and minerals were the main food elements necessary for normal nutrition of animals. In addition to these substances, others now known as vitamins are also important. They seem to function in microbial metabolism in about the same way as they do in animal metabolism. Animal and vegetable extracts have long been added to bacteriological culture media to support growth or to insure maximum rates of multiplication and fermentation. Requirements of microorganisms for these natural substances prompted Wildier, a Belgian microbiologist, to suggest the existence of an "indispensable substance" in development of yeast to which he gave the name "bios." A few years later Funk gave the name "vitamines" to substances which cured cases of beriberi. It became apparent that other "vitamines" existed, and nutritionists classified them into two groups, those which were fat-soluble and those which were water-soluble. This latter group was later shown to be composed of a variety of factors from which the vitamin B complex has been identified.

During this period of about 15 years the suggestion of Wildier received considerable attention of microbiologists. "Bios" was shown to consist of a number of factors. Similarity of certain fraction of "bios" to vitamin B complex was gradually recognized.

When vitamins became known to chemists, they were found to be identical with certain fractions of "bios."

Studies of nutritional requirements of microorganisms resulted in recognition of several growth factors which had been identified as vitamins for animals: Thiamin (B_1), riboflavin (B_2), pantothenic acid, nicotinic acid, *p*-aminobenzoic acid, pyridoxin, inositol, choline, biotin, and folic acid. Study of microbial-growth factors have played a prominent role in eventual isolation and identification of thiamin, inositol, pantothenic acid, biotin, and folic acid. Other components of vitamin B complex have been suggested by nutritionists as well as bacteriologists. These have not been identified.

Vitamins are in general of plant origin. Vitamins of the B complex are required in order that cells may perform their vital functions. Required vitamins not performed and present in the food must be synthesized by the cell. This fact is of paramount importance. The many bacteria normally present in the intestinal tract are performing the vital function of synthesizing a part of the vitamins required by the animal. The quantities of vitamins supplied from this source are still unknown. Such investigations are hampered by difficulties of producing bacteria-free intestines.

Microorganisms are now widely used for rapid assay for individual B-complex vitamins. They have largely replaced the slower assay methods using animals and have certain advantages over some of the chemical methods. Similar assay procedures are being developed for small quantities of amino acids.

SPECIAL PRODUCTS OF METABOLISM

Various products of metabolism have been mentioned at different places in this book. In this chapter attention is given to some which have a different significance from those discussed in the next chapter.

Formation of Pigments. Some bacteria form pigments in their metabolism; this gives another factor for identification. These pigments are probably excretory products which happen to be colored. Most of the common bacteria are white; and, when one is found which is pigmented, that characteristic sets it apart from others. Beijerinck, the Dutch microbiologist, classified pigmented bacteria as follows:

I. Chromophorous Bacteria: Those which contain pigment in the cells for some useful purpose.

II. Chromoparous Bacteria: Those which excrete pigment probably as a waste product. The pigment may be excreted either as a colored product or as the colorless leuco base. The latter may become colored in the presence of either air or other products. Good examples are *Pseudomonas pyocyaneus* and *Pseudomonas cyanogenes*.

III. Parachrome Bacteria: These bacteria retain their pigment in their cells. Good examples are *Pseudomonas violaceus* and *Serratia marcescens*.

Pigments are of little significance except as an aid in identification. Some of them have been responsible for striking coloration of certain foods which caused consternation among early peoples. Harrison, for instance, has studied the history of *Serratia marcescens* and reported that so-called "bloody bread" was due to the growth of microorganisms. Other foods besides bread also became "bloody." Harrison's paper will be interesting for those who desire more information.

Light Formation (Luminescence). Many different forms⁴ of life produce light or compounds which phosphoresce. This is frequently spoken of as cold light. Bacteria producing these compounds have been found to be present in rotting wood, fish, and sea water. The intensity of radiation varies greatly with the species as well as with the conditions under which the microorganisms are grown. Some of these bacteria produce so much light that photographic plate is affected. Molisch even proposed the preparation and use of a lantern in which the source of light was an agar film on which phosphorescent bacteria were growing. This lantern was suggested especially for miners but was never put to practical use. Beijerinck proposed the generic name *Photobacterium* for these organisms. Many of them are halophilic, that is, require the presence of sodium chloride; this explains their presence on fish and the flesh of other marine animals.

Heat Formation. Many bacterial decompositions are exothermic. If heat is formed under conditions that do not allow it to be conducted away, a marked rise in temperature may result, and spontaneous combustion or ignition may occur. It would be wrong to explain all cases of pronounced rise in temperature in organic materials on the basis of the metabolic activities of bacteria and related fungi. Heat probably results from the metabolic activities of most cells. The respiration of grain and vegetable

cells might result in the formation of sufficient heat to be dangerous. A few fermentations may be mentioned wherein appreciable amounts of heat are formed.

Vinegar Fermentation. In the quick vinegar or German method for acetification, temperature in the generator may rise to such an extent that the vinegar bacteria are destroyed. Consequently, the vinegar maker has to control this factor carefully. He does it by reducing the draught in the generator and thus slowing the fermentation.

Heating of Hay. If hay is stored while it is damp it may heat in the underlying layers to such an extent that it will ignite. The heat in this case may come from thermogenic bacteria or from enzymic respiration of the plant cells. Burnt hay has been prepared by piling freshly mown grass into solid heaps. These undergo fermentation and cause the temperature to reach 70°C. The heaps are then opened and the hay cured in the usual manner.

Tobacco Fermentation. During one stage in the preparation of tobacco, it is subjected to a "sweating" process. The bundles are piled and allowed to heat. The temperature rises rapidly and may reach 55° to 60°C. The piles are then taken down and the leaves dried.

Manure Fermentation. That heat is formed in fermenting manure is the basis for the use of manure in hot beds and cold frames. The heating of manure is apparent in the winter time when such heaps steam and do not become frozen in the deeper layers. Manure is also used to keep fresh concrete from freezing.

Silage Fermentation. The formation of heat in silos depends on the same factors that influence its formation in other cases. Too high a temperature destroys the quality of the silage, probably because the necessary bacteria are destroyed.

Aromatic Compounds. Some bacteria form among their various products of metabolism compounds which have an aromatic odor. These have been described as fruity, nutty, and so on. Microorganisms which form desirable odors and aromas have been especially studied in the dairy industry where a desirable odor is beneficial. Such is the case in cream ripening. Use of a microorganism for producing a delicate flavor greatly improves the quality of butter. Some attention has also been given to

this problem in the vinegar industry; presence of a fine aroma in addition to the acetic acid increases the value and desirability of the vinegar.

Formation of Gas. Various gaseous compounds may be formed by microorganisms. The commonest is probably carbon dioxide which is one of the characteristic products of fermentation. Bacteriologists use gas formation as one of the differential tests in the characterization of bacteria. An enlightening experiment is quoted by Morrey in his "Fundamentals of Bacteriology." He packed material taken from the bottom of a pond into a cylinder 5 feet long and 6 inches in diameter. Water was added to within 2 inches of the top. The cylinder was tightly closed after a few days and fitted with a pressure gauge. After six months the gauge showed a pressure of more than 500 pounds per square inch. Morrey believed that this experiment explained formation of natural gas.

Bacteria are also responsible for formation of large amounts of gas in sewage treatment. So much is formed at some sewage-treatment plants that it is burned for useful purposes. Such gas is about 75 per cent methane and 25 per cent carbon dioxide. A small amount of nitrogen may also be present. The heat value of the gas, according to one investigator, is 660 Btu per cubic foot. Attempts have been made to determine the possibility of turning certain waste products on the farm into gas. Gas formed by bacteria from organic matter has also been compressed and used for operating automobiles.

Vitamin Formation by Microorganisms. Various vitamins or their precursors have been synthesized by some microorganisms. The B vitamins have been shown to be formed and stored in cheeses. Yeasts synthesize thiamin, riboflavin and other B vitamins in the course of alcoholic fermentation of grain mashes and thus increase the value of the feed by-products recovered from the mash. *Clostridium acetobutylicum* synthesizes large amounts of riboflavin in the course of the butanol-acetone fermentation. Certain species of the yeast genus *Candida* are capable of remarkable riboflavin synthesis, as is the Ascomycete *Eremothecium ashbya*. Bakers' yeast synthesizes large amounts of thiamin under certain conditions. Synthesis in the intestines and rumen of animals contributes significant amounts of certain vitamins. General statements for all microorganisms cannot be made, for

the species of microorganism as well as the vitamin affect the process.

REFERENCES

- ANDERSON, C. G., *An Introduction to Bacteriological Chemistry*, 2d Edition, William Wood & Co., Baltimore, 1945.
- BUCHANAN, R. E., and E. I. FULMER, *Physiology and Biochemistry of Bacteria*, Vols. 1, 2, and 3, Williams & Wilkins Co., Baltimore, 1930.
- HENRICI, A. T., *The Biology of Bacteria*, D. C. Heath, Boston, 1934.
- KNIGHT, C. J. G., *Bacterial Nutrition, Material for a Comparative Physiology of Bacteria*, Medical Research Council, Special Report Series 219, His Majesty's Stationery Office, London, 1936.
- KLUYVER, A. J., *The Chemical Activities of Microorganisms*, Univ. London Press, 1931.
- PALLADIN, V. I., and B. E. LIVINGSTON, *Plant Physiology*, P. Blakiston's Son & Co., Philadelphia, 1926.
- PREVOT, A. R., *Manuel de classification et de détermination des bactéries anaérobies*, Masson et Cie., Paris, 1940.
- SHIPLEY, A. E., *Life: a Book for Elementary Students*, Cambridge Univ. Press, 1923.
- STEPHENSON, MARJORIE, *Bacterial Metabolism*, Longmans, Green, New York, 1939.
- THATCHER, R. W., *Plant Nutrients*, Chapter I in *Chemistry of Plant Life*, McGraw-Hill, New York, 1921.
- WEINBERG, M., R. NATIVELLE, and A. R. PREVOT, *Les Microbes anaérobies*, Masson et Cie., Paris, 1937.

CHAPTER 15

GROWTH OF BACTERIA

With higher animals and plants it is not difficult to determine whether an organism has grown or not. This may be decided by weighing increase in body weight in pounds or ounces, or by measuring increase in size. Microbiologists cannot resort conveniently to such methods although there are special means by which it can be done. The microbiologist has had to adopt a different conception of growth not always appreciated by those who are not trained in microscopic technic. The conception of the term growth given in relation to higher animals and plants— increase in weight or cell mass—may be retained by microbiologists. However, *multiplication*, an increase in numbers of individuals, should be distinguished from growth. Thus, cells may grow after multiplication as well as just before. Work with yeasts has shown that they may grow to a considerable extent after multiplication. The term reproduction is also used to express increase in mass or numbers. Strictly speaking, it refers to the generation of new organisms from similar ones which have gone before. It depends on the division of the cells. It is apparent that several terms used to express increase in mass, numbers, or volume overlap considerably and may be defined in different ways.

Methods Used for Measuring Growth or Multiplication. Having attempted to define these terms, we may turn our attention to several methods which are used for measuring the phenomena which they represent. Confusion has resulted from misinterpretation of data as well as from comparison of results secured with various methods.

Counting of Plate Colonies. The uninformed layman wonders how bacteriologists are able to report such great numbers of bacteria in food, as milk and ice cream. Buttermilk, for instance, may contain as many as 100,000,000 bacteria per milliter. To secure such information the bacteri-

ologist does not count each cell. The original material (milk, for instance) is diluted with sterile water to such an extent that the number of bacteria in 1 ml. may be counted. This number or count is then multiplied by the dilution factor to secure the total number. Since by this method single cells or clumps which have developed into colonies are counted, it is really a measure of multiplication.

Counting of Individual Cells. Another method of counting involves the use of a chamber called a hemacytometer, originally devised for counting red and white corpuscles in the blood. A small portion of the material, the bacterial content of which is to be determined, is placed on a very finely ruled surface. This is then placed under the microscope and, if the area of the squares is known, the number of bacteria in the sample may be determined. This method also is really a measure of multiplication.

Measuring the Volume Consumed by the Cells. By this method bacterial cells in the sample are thrown to the bottom of a special tube on a centrifuge. The volume of the precipitate gives information on the content of bacteria. It is obvious that this method gives different data from those secured by the methods just described.

Measuring Bacterial Content by Estimations of Turbidity. This method of measurement is, of course, applicable to clear media only or to solutions the turbidity of which is due only to bacterial cells. It requires an instrument known as a nephelometer. Data collected by this method involve both multiplication and growth. The more cells and the larger they are, the greater the turbidity. This method is used for estimating the number of cells in a saline suspension for the preparation of bacterins (bacterial vaccines).

Measurements of Single Cells. Observations may also be made over a period of time of single cells. The increase in length per unit of time gives information on the rate of growth.

Growth Histories of Cultures. The growth history of a culture has been divided into several stages. But three stages of phases need be mentioned—the lag phase, the phase¹ of rapid growth, and the last phase, spoken of by some as the phase of decreasing growth or that in which the cells are dying.

The Lag Phase. This is the phase immediately following the inoculation of fresh sterile media when the culture is started. During this phase bacteria do not multiply but remain constant in numbers or even decrease in numbers. The cells are probably becoming adjusted to conditions in the new medium and do not start to multiply. Many possible explanations have been suggested. It is an important phase in the development of a culture.

¹ The several phases mentioned here are a few taken from a greater number which are recognized in the growth of bacteria. The others are discussed by Buchanan, in *J. Infectious Diseases*, 23 (1918), 109-25.

Phase of Rapid Growth. This phase follows the lag phase. The cells are dividing with the shortest generation time when best conditions of food concentration, temperature, and the like are obtained.

Phase of Decreasing Numbers. A culture eventually reaches a point where the number remains constant for a time, later to decrease. What is responsible for this? Why do not the cells in a culture continue to grow indefinitely? Two reasons are generally given. These, discussed here, will be referred to again in connection with two early explanations of immunity.

Lack of Food. Multiplication in a culture may stop because of lack of food. This has been studied by several investigators and found to explain the situation partially. Graham-Smith found that the addition of fresh food to cultures in which multiplication had stopped would cause it to begin again.

Accumulation of Products of Metabolism. All living animals require food and give off waste matter spoken of as "products of metabolism." Among the latter may be such products as formaldehyde, organic acids, and other poisonous substances. When these are removed, the culture may grow again. Whether this explanation is better than the one in the preceding paragraph is questionable. Both probably are important.

Growth Histories of Single Cells. The separate cells in a culture also pass through a series of stages which may be distinguished from one another. These have received consideration more recently. This work indicates that the cells of a culture show three stages in their development—a period of adolescence, a period of maturity, and, finally, a period of senescence. During each of these phases the shape of the cell may be quite different from that in the others. They have been found to follow one another in regular order in some cases. Lack of appreciation of this caused earlier workers to introduce the term "involution form" for the shapes which were different from what were believed to be normal forms.

Rate of Growth. The rate of growth, as would be expected, is influenced by several different factors. To determine the rate of growth of a culture, the number of bacteria in the beginning, the number at the end, and the time must be determined. If we allow the number at the beginning to be represented by a , the number at the end by b , the number of generations by n , we would

have the following equation:

$$2^n = \frac{b}{a} \quad \text{where } b \text{ equals } 2^na$$

Then, if B is the time required to complete a full generation,

$$G = \frac{t}{n}$$

The validity of data collected with this equation depends on the assumption that each cell divides into two parts and that all the cells in a culture act just alike. Barber studied this question with *Escherichia coli* and found a generation time of 17 minutes at 38°C., under probably the best conditions. Above and below this temperature, formation of new generations required more time. Investigators with other organisms secured similar data. Perhaps the general conclusion might be reached that, under optimum conditions existing in experimental work, the generation time is between 30 and 40 minutes for ordinary bacteria. Ideal conditions may not exist in nature, and the generation time might be much longer. The rate of multiplication would, of course, vary for each species. Kendall stated that *Vibrio comma* formed a new generation every 15 minutes. Since there are 96 periods of 15 minutes in each day of 24 hours, the theoretical descendants of a single bacterial cell would be 2^{96} or, to express it another way, the descendants of one cell at the end of one hour would be 16 and at the end of two hours, 256; at the end of 24 hours the theoretical number would be 8×10^{28} . Such a number of descendants, however, is scarcely ever attained by a single organism in nature, for the factors influencing growth probably retard multiplication and cause the death of many cells.

Factors Influencing Growth and Multiplication. Growth and multiplication are complicated processes. They represent the algebraic sum of the processes which go on in a cell.

1. Concentration of Food. Under ordinary conditions this is an unimportant factor. It has been stated elsewhere that bacteria need only a very small amount of food. They will grow quite well in distilled water, which contains such a small amount of matter that it cannot be detected by ordinary chemical methods. However, under such conditions growth stops more quickly than when greater amounts of food are available.

2. *Hydrogen-Ion Concentration.* Bacteriologists have always known that the reaction of a medium was one of its most important characteristics. Until present methods of determining hydrogen-ion concentration were provided by the physical chemists, bacteriologists had to resort to titration methods with N/20 hydrochloric acid or N/20 sodium hydroxide. As information accumulated, it was apparent that these procedures did not give an accurate picture and that such a factor as reaction (acidity or alkalinity) could be better measured by means of hydrogen-ion concentration determinations. For many of the common organisms the maximum, minimum, and optimum hydrogen-ion concentration has been determined by various investigators.²

3. *Temperature.* This is another important factor influencing growth. Since growth involves chemical reactions, it is apparent that temperature would have an important effect on it. Temperature relations are important characteristics of all bacteria. They constitute one of the important differential characteristics by which microbiologists are able to differentiate pure cultures. The driving effect of temperature on growth and multiplication was recognized by the early investigators. Considerable space has been given to this factor on former pages. Bacteria may be divided into three groups on the basis of their temperature relations, the maximum, optimum, and minimum temperatures.

TABLE 4
HYDROGEN-ION CONCENTRATION RELATIONS OF
SOME OF THE COMMON BACTERIA

Name of Organism	Hydrogen-Ion Concentration Relations	
	Limits	Optimum
<i>Corynebacterium diphtheriae</i>	6.8-8.3	7.3-7.6
<i>Mycobacterium tuberculosis</i>	6.0-7.6	6.8-7.2
<i>Escherichia coli</i>	4.6-9.5	5.2-8.4
<i>Serratia marcescens</i>	5.8-8.0	6.0-7.0
<i>Bacillus anthracis</i>	6.8-8.5	7.0-7.4
<i>Clostridium tetani</i>	5.5-8.3	7.0-7.6
<i>Clostridium botulinum</i>	6.0-8.2	7.0

It is not easy to discuss this important factor in a few paragraphs. Some pioneer work on the influence of temperature was carried out by Ward, the great English botanist. He found that, at the optimum temperature, growth was very rapid and lasted for a long time; at this temperature the organism was able to use its food to best advantage and give the greatest growth or

² No explanation of the meaning of the term "hydrogen-ion concentration" is attempted here. It is given in the author's "Practical Bacteriology," Wiley, New York, 1928.

"crop." However, above the optimum, the growth, at first rapid, lasted for a shorter time. This decrease in growth continued in effect as the temperature was raised until finally a temperature was reached where no growth occurred at all.

4. *Available Moisture.* Water is necessary for all forms of life; it is just as important for the bacterial cell as for higher organisms. However, it seems that the bacteria cell is able to endure the absence of water more easily than higher animals or plants.

5. *Accumulation of Waste Products.* Why do bacteria stop growing in a culture? Why do the cells not continue to grow until they have filled the medium and caused it to lose its properties of a liquid and become a gel? Search for information with which to answer this question has resulted in several answers. Some of the earlier investigators suggested that toxic substances called "autotoxins" were formed. Another suggestion was that peroxides were formed which retarded growth or multiplication. Another theory is that retardation is due to formation of acids and a lethal hydrogen-ion concentration. Perhaps none of these explanations is true; all of them may play a role.

6. *Accessory Substances (Growth Factors).* These have been shown to be very important in normal development of higher forms of life and more recently in development of microorganisms. They vary in their effect. Some are probably necessary for growth and development, whereas others merely accelerate these conditions but are not strictly necessary. Many different names have been suggested for these accessory substances. Some are known chemical compounds; others are not. They are necessary in very small amounts. Just how they function is not known, but they seem to be concerned in some way with the enzyme systems in cells.

7. *Available Amino Acids.* Studies on growth and normal development of higher animals have shown that certain foods are deficient for these purposes because they lack necessary amino acids. For instance, gelatin containing no cystine or tryptophane is inadequate and must be supplemented by these amino acids or material containing them. The purpose of the use of peptones for preparation of bacteriological media is to supply various amino acids as well as vitamins. Peptones and proteoses, chemically speaking, play only a secondary role for most common bacteria. Recently the required amino acids for some species of bacteria have been determined. They are amino acids which cannot be synthesized but must be present and available from the food. So necessary are they in development of certain bacteria that the latter are used as test organisms to determine the presence of specific amino acids. *Lactobacillus arabinosus* is such a test organism.

8. *Surface Tension.* This is one of the more recent factors which have been found to influence growth. Ordinary culture media such as plain broth, according to Larson, have a surface tension of 59 dynes. When this was reduced to 32 dynes by the addition of surface-tension depressants (soaps), interesting alterations in growth were noticed. *Bacillus subtilis*, which ordinarily grows with a pellicle, was found to grow down in the medium when the surface tension was reduced to 45 dynes or below. Details of the effects of surface tension may be left for future study.

Longevity of Bacteria. Bacteria seem to be able to live for many years under conditions which would ordinarily be considered unfavorable. They have been shown to retain their original cultural, immunological, and biochemical characteristics for many years when dried in the frozen state, provided they are well sealed. This is the basis for the *lyophil* process. Microorganisms are frozen, dried under vacuum, and sealed. Even the most fastidious species have been reported to live for a long time.

Bacteria have also been shown to exist for a long time in dry soil. This led Lipman of the University of California to investigate their presence in adobe bricks, coal, rocks, and similar materials. He reported their presence in such materials even though they were thousands of years old. The cells were said to be in state of suspended animation without any respiration occurring at all. This makes necessary a new conception of life.

REFERENCES

- RAHN, OTTO, *Physiology of Bacteria*, Macmillan, New York, 1932.
STEPHENSON, MARJORIE, *Bacterial Metabolism*, Longmans, Green, New York, 1938.

CHAPTER 16

BACTERIAL ENZYMES

Chemical reactions involved in growth and metabolism of microorganisms, plants, and animals are the result of enzyme action. Although our knowledge of the elaborate enzyme systems causing these reactions is still obscure for most enzymes, much information is available concerning a relatively few enzymes. The foundation for enzymology was laid perhaps when Kirchoff in 1814 observed that a glutenous component of wheat was capable of converting starch to sugar and dextrin. Dubrunfaut in 1830 showed similar agents in malt extract, and three years later Payen and Persoz prepared a dry extract to which they gave the name *diastase*. In 1871 Pasteur proved that alcoholic fermentation was caused by living yeast, thereby making a distinction between "organized ferments" such as living yeast, and "unorganized ferments" such as diastase. Kühne proposed the term *enzyme* (Greek, in yeast) for this latter group. When Buchner in 1897 prepared a cell-free extract from yeast (called yeast juice) which was capable of producing alcoholic fermentation, he settled the longstanding Pasteur-Liebig controversy by showing that enzymes existed in "organized ferments."

The great strides made during the past 40 years in the understanding of carbohydrate metabolism were initiated with studies on yeast. It is easily understandable how much simpler the problem became when an enzyme system in a single-cell organism or cell-free extracts from single-cell organisms, was studied. Many principles established from the study of microorganisms have been applied to metabolism in higher plants and animals.

Definition of an Enzyme. Before discussing general properties of enzymes an attempt should be made to define the term. Sumner and Somers have stated that an enzyme is a definite chemical substance of organic nature, thermolabile and elaborated by plants, animals, and microorganisms, and capable of increasing the velocity of a chemical reaction without being used up in the

process or becoming a part of the product formed. Thus, an enzyme is a special catalyst, a biological catalyst.

Nature of Enzymes. Although enzymes are defined as substances of definite chemical nature, little is known about the exact chemical structure. All enzymes are proteins, a fact not fully established until 1926 when Sumner prepared the first crystalline enzyme, urease. Even for a number of years later many enzyme chemists preferred the German point of view of Willstätter and his student, Waldschmidt-Leitz that enzymes were some unknown substance adsorbed on the protein. It has been fully established that the protein part of a particular enzyme is specific. To date some 20 enzymes have been prepared in the crystalline state, and many others have been prepared in relatively pure concentrates.

Because enzymes are composed of a specific protein portion, they are high-molecular-weight substances. Invertase (sucrase) probably has a molecular weight greater than 20,000, while pepsin has a molecular weight of about 35,000. Urease has a molecular weight of 483,000.

Enzymes in the natural state are said to be colloidal. They dialyze through membranes either very slowly or not at all. The colloidal state is associated with their protein nature.

How many enzymes exist in a bacterial cell? Only a few are known, and more are postulated. However, there are undoubtedly a large number. Sumner and Somers have suggested that perhaps a thousand different enzymes may occur in very active tissue cells such as liver cells. Other authorities have suggested perhaps a hundred exist in bacterial cells.

Nomenclature of Enzymes. Even before Buchner had broken down the distinction between "organized" and "unorganized" enzymes, Duclaux (1833) introduced the custom of designating an enzyme by the name of the substance decomposed, known as the substrate, and adding the suffix *ase*. For example, *maltase* is the enzyme which hydrolyzes maltose, *urease* is the enzyme which decomposes urea into ammonia and carbon dioxide. More specific names are also used, which indicate the source of the enzyme as well as its activity, such names are *yeast invertase*, *salivary amylase*, and *malt diastase*. Thus the general rule of enzyme nomenclature is illustrated, that *enzymes are named for what they do and not for what they are*. Some of our better-known enzymes were named before Duclaux's suggestion, and

their names do not conform to his principle of nomenclature. Examples are pepsin, rennin, and trypsin. The term *zymase* is often found in older literature to designate the enzymes of yeast responsible for alcoholic fermentation. It is a collective term representing a multitude of enzyme systems, and can be called an enzyme complex.

Chemical Changes Brought about by Enzymes. The chemical changes brought about by enzymes are involved, and the mechanism of these changes is not understood. Enzymes are capable of many reactions which cannot be accomplished by purely chemical means. Although most enzyme reactions are analytical, for example, they decompose larger molecules into smaller molecules; they are considered to be reversible. Thus, under proper conditions, and these conditions undoubtedly occur within the cells of microorganisms, enzymes are capable of synthesis reactions. Consequently all enzyme reactions are equilibrium reactions; there is always a tendency for the enzyme to establish a definite ratio between the substrate and products of the reaction. The synthesis ability has been demonstrated however with only a few enzymes in laboratory experiments.

Classification of types of reactions brought about by enzymes, although somewhat arbitrary, is convenient in order to facilitate an understanding of the broad aspects of the subject. Some of the more important changes may be outlined as follows. Although only one example will be given, the student must keep in mind that many enzymes exist which are capable of conducting the type reaction, each enzyme being specific for a particular substrate, whether it be a single compound or a particular arrangement of atoms.

I. Hydrolysis. Hydrolysis is a reaction involving the addition of water to a substance, followed by splitting of the molecule. Carbohydrases are hydrolytic enzymes, which catalyze the formation of simple carbohydrates from more complex carbohydrates.

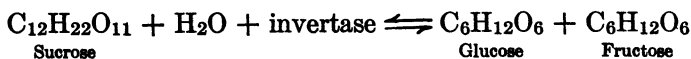

II. Oxidation and Reduction. Formerly enzymes were sometimes spoken of as "oxidases" and "reductases." But reduction is simply the reverse of oxidation. Whenever a substance is oxidized, another must be reduced, and so a particular enzyme

may be called an oxidizing enzyme with respect to one component in the system, or a reducing enzyme with respect to the other component of the system. Weiland (1912) proposed a widely accepted theory that cells carry on oxidation by removal of hydrogen. The substance which furnishes the hydrogen, and is thus oxidized, is the *donator* (donor). The hydrogen is accepted by some easily reduced substance, which is the *acceptor*. The *dehydrogenases* usually exhibit a marked specificity toward the donator, but may be rather unspecific toward the acceptor. Therefore it is named for the more specific compound, that which is being oxidized. The reaction catalyzed by *alcohol dehydrogenase* of yeast may be written as follows:

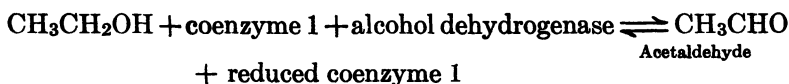

A new term has been introduced, *coenzyme*, which is discussed later.

Although Weiland's theory that biological oxidations and reductions may be accounted for by the removal or addition of hydrogen, respectively, it does not explain all oxidations. By a *second* type of oxidation certain enzymes are able to oxidize apparently by activation of the oxygen. An example is *peroxidase* which in the presence of hydrogen peroxide is capable of oxidizing phenol-type compounds. It is also capable of liberating iodine from iodides.

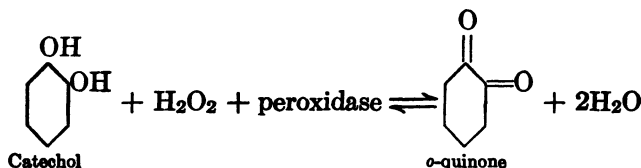

A *third* type of reaction might be mentioned though it is not a true oxidation. Another enzyme often classified among the oxidases, because of its similarity in chemical properties, is catalase. Its only action is that of decomposing hydrogen peroxide, forming water and gaseous oxygen.

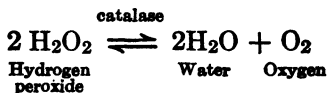

III. Splitting. Whereas hydrolysis involves a splitting of the molecule after addition of water, another type of reaction may be mentioned in which splitting is not accompanied by addition of water. Such enzymes are sometimes called *desmolases*, meaning an enzyme which breaks (or reversibly, forms) a carbon chain. Most frequently they split carbon dioxide from a compound. The simplest example, though not a true desmolase because only one carbon atom is involved, is *carbonic anhydrase* which forms carbon dioxide from carbonic acid.



A true example is *carboxylase*, found in nearly all cells, which splits carbon dioxide from pyruvic acid.

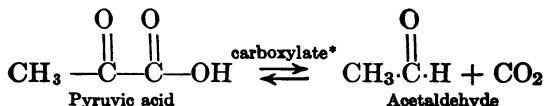

* Coenzyme cocarboxylase required.

This reaction is very important in carbohydrate metabolism.

IV. Hydration. This is a reaction in which water is added to the molecule without subsequent splitting. Two general groups of enzymes are capable of this type of reaction, *hydrases* and *mutases*. In the case of hydrases, one molecule of water is added to one molecule of the organic compound. Thus, methyl glyoxal is hydrated to form lactic acid.

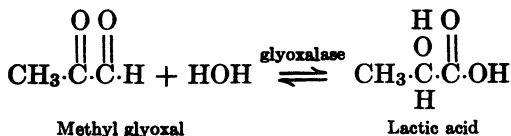

In the case of the *mutases* the molecule of water is added to two molecules of the organic compound; it can be considered that the two hydrogen atoms go to one molecule while the one oxygen atom passes to the other molecule. *Aldehyde mutase* catalyzes the well-known Cannizzaro reaction.

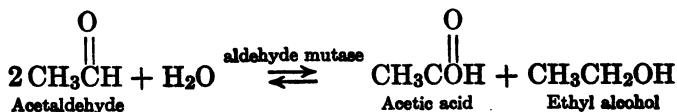

Coenzyme I and coenzyme II are compounds containing nicotinic acid amide (nicotinamide), also a B-complex vitamin. To illustrate the difficulty of distinguishing between coenzymes and prosthetic groups, riboflavin (vitamin B₂) is contained in the prosthetic groups of a number of enzymes commonly called the "yellow enzymes" because of the color imparted to them by the riboflavin. Examples of these are the yellow oxidation enzyme of Warburg and Christian (old yellow enzyme), xanthine oxidase and cytochrome c reductase. In these cases the coenzymes are compounds of riboflavin, phosphoric acid, d-ribose, and sometimes include adenine. Not all coenzymes are compounds containing vitamins. Adenylic acid and adenosin triphosphate, important coenzymes, are composed of adenine, d-ribose, and one and three molecules of phosphoric acid, respectively. Hematin is a prosthetic group of peroxidase and catalase.

The same compound, such as coenzyme I, will activate a number of different enzymes. Thus they are nonspecific portions of the enzyme, in contrast to the protein portions which are very specific. The specificity of the protein is probably related to the internal arrangement of amino acids comprising the protein.

Some biochemists have suggested that the function of B-complex vitamins is to supply the coenzyme requirements of some enzyme systems. Although 12 members of the vitamin B complex are known, only thiamine (vitamin B₁) riboflavin (vitamin B₂) and niacin have been shown to be involved in coenzymes.

Coenzyme I and coenzyme II are compounds containing nicotinic acid amide (nicotinamide), also a B-complex vitamin. To illustrate the difficulty of distinguishing between coenzymes and prosthetic groups, riboflavin (vitamin B2) is contained in the prosthetic groups of a number of enzymes commonly called the "yellow enzymes" because of the color imparted to them by the riboflavin. Examples of these are the yellow oxidation enzyme of Warburg and Christian (old yellow enzyme), xanthine oxidase and cytochrome c reductase. In these cases the coenzymes are compounds of riboflavin, phosphoric acid, d-ribose, and sometimes imidazole adenine. Not all coenzymes are compounds containing vitamins. Adenylic acid and adenosin triphosphate, important coenzymes, are composed of adenine, d-ribose, and one and three molecules of phosphoric acid, respectively. Hematin is a prosthetic group of peroxidase and catalase.

The same compound, such as coenzyme I, will activate a number of different enzymes. Thus they are nonspecific portions of the enzyme, in contrast to the protein portions which are very specific. The specificity of the protein is probably related to the internal arrangement of amino acids comprising the protein.

Some biochemists have suggested that the function of B-complex vitamins is to supply the coenzyme requirements of some enzyme systems. Although 12 members of the vitamin B complex are known, only thiamine (vitamin B1) riboflavin (vitamin B2) and niacin have been shown to be involved in coenzyme systems.

How do Enzymes Act? This question may not be answered accurately although several theories have been proposed at various times. One of the most tenable explanations is that the enzyme unites in some manner with the substrate. An intermediate compound is formed which in turn decomposes, liberating the enzyme again. During the contact with the enzyme, the substrate is changed or broken down. We might illustrate the reactions:

1. Enzyme + substrate = enzyme-substrate compound
2. Enzyme-substrate compound = enzyme + decomposition products

These two reactions are probably oversimplified. Practically no information is available on the type of compound formed when the enzyme and substrate combine. It must be unstable in order that the second reaction may take place. It is entirely possible that each of these general reactions in itself is the result of several complicated reactions.

Characteristics of Enzymes and Enzyme Reactions. Even though we have little knowledge of the mechanisms of enzyme reactions, certain characteristics are generally applicable, all of which demonstrate the complexity of their actions.

1. Enzymes are organic catalysts. The term organic in this sense signifies that they are not alive themselves but are formed by living cells. No one has been able to synthesize an enzyme. Although some of them have been isolated in the pure crystalline

state and have been proved to be protein in nature, not much is known about their finer chemical structure. Enzymes are also like catalysts in that their speed of reaction is increased as the temperature is raised. Agents which greatly stimulate the activity of enzymes are called activators. Those which inhibit enzymes are called inhibitors.

A catalyst, according to Ostwald, is a substance which, without itself appearing in the final product of reaction, alters the velocity with which the reaction takes place. It should be emphasized that a catalyst does not start reactions; it merely accelerates those which are going on so slowly that the rate cannot be measured.

2. ENZYMES ARE SPECIFIC IN THEIR ACTIONS.

This is one of the most interesting facts about an enzyme. It helps to differentiate an enzyme from an inorganic catalyst such as palladium black. Fischer used the lock-and-key analogy for illustrating enzyme specificity. The substrate was considered the lock and the enzyme the key. It takes a certain key to turn each lock; similarly it takes a certain enzyme to decompose each substrate. Each enzyme seems to have only one task to do, and it will not assume others.

3. THEY PRODUCE A GREAT AMOUNT OF REACTION

This is another characteristic which puts enzymes in a class by themselves as active agents. They produce prodigious amounts of reaction without being harmed. For instance,

it has been stated that invertase will invert 1,000,000 times its own weight of sugar and not be harmed.

4. ENZYME REACTIONS ARE REVERSIBLE. Most enzymes are known for their ability to decompose complex substances. However, when some enzymes are put in contact with products which they usually form, they synthesize the substance which they usually split. If maltase is put into dextrose and other proper conditions maintained, maltose is formed. When lactase is put into a mixture of galactose and dextrose, lactose is formed. Demonstration of the synthetic ability of enzymes is extremely difficult in test-tube experiments. Yet suitable conditions are established within the cell with apparent ease, since otherwise protoplasm production would not take place.

5. ENZYMES STIMULATE FORMATION OF ANTI-ENZYMES. When enzymes are injected into the blood stream of an animal, they tend to cause formation of antienzymes. These are bodies which naturalize or prevent the action of the enzyme.

6. ENZYMES POSSESS SOME PROPERTIES OF LIVING CELLS. It is interesting to compare enzymes with living cells. It is seen that they possess many characteristics in common.

LIVING CELLS

ENZYMES

1. Temperature

- (a) Destroyed by high temp:
- (b) Have optimum temp. for action
- (c) Action slowed up at low temp.

2. Require certain salts.

3. Require certain limits of reaction. (pH).

1. Temperature

- (a) Inactivated by high temp:
- (b) Also have optimum temp. for action.
- (c) Action slowed at low temp.

2. Certain salts necessary.

3. Require certain limits of reaction (pH).

7. ENZYMES ARE SENSITIVE TO THE PRESENCE OF ACIDS, ALKALIS, AND SALTS IN THEIR ENVIRONMENT. Some enzymes require the presence of a certain hydrogen-ion concentration. For instance, peptase (pepsin) in the stomach requires 0.2 per cent of hydrochloric acid but, like most enzymes, is inhibited and destroyed by large amounts of acid.

8. ENZYMES MAY REQUIRE THE PRESENCE OF CERTAIN MATERIALS CALLED COENZYMES. These are substances which are necessary for action of enzymes. They are probably the active group of the enzyme which enter into the reaction. Enzymes containing prosthetic groups do not require coenzymes.

9. SOME ENZYMES MUST BE LIBERATED FROM A SUBSTANCE CALLED A PROENZYME OR ZYMOGEN. Proenzyme is inactive and must be activated

IN SOME MANNER. It is not so well established for bacterial enzymes as for certain of the digestive enzymes.

10. ENZYMES ARE COLLOIDAL IN NATURE, USUALLY, AND ARE THEREFORE GENERALLY NONDIALYZABLE. This is a general statement on which more information is desirable. Several highly purified enzymes have been crystallized.

INTRACELLULAR (ENDOENZYMES) AND EXTRACELLULAR (EXOENZYMES) ENZYMES

Enzymes produced by bacteria and higher organisms may be arranged in two groups. From the standpoint of cell nutrition this arrangement is interesting and important.

EXTRACELLULAR ENZYMES. Existence of extracellular enzymes may be shown by growing bacteria in media and filtering them to remove bacterial cells after good growth has occurred. Enzymes which have been secreted by the cell are present in the medium about the cell and consequently appear in the filtrate.

INTRACELLULAR ENZYMES. These were definitely demonstrated by Buchner in 1897. He carefully washed fresh brewer's yeast, mixed it with sterile quartz sand, and ground it in a mortar. This ground mass was then transferred to a press cloth and subjected to a pressure of 90 kilograms per square centimeter. The juice which contained the enzyme was carefully collected and filtered through an earthenware filter to sterilize it. Action of this sterile filtrate was then tested on sugar. If zymase was

present, sugar was fermented. To prove definitely existence of intracellular enzymes the following procedure must be carried out:

1. Crush the yeast or grind with some materials such as sand.
2. Filter resulting yeast juice through sterile filters which will remove the living yeast cells.
3. Prove the absence of cells in the sterile filtrate to which fermentation might be attributed.
4. Test the action of the zymase on sugar to determine whether it would incite fermentation.

It is well known that certain foods cannot pass through a membrane such as a bacterial cell wall but yet are utilized by the bacterium. Before they can be used, they must be broken down into compounds which dialyze and pass into the cell. A food to be of any use to a cell must get inside. That is the purpose of the extracellular enzymes—to break down (by hydrolysis) large molecules, which will not dialyze, to smaller ones, which will. Energy liberated by these agents (exoenzymes) of the cell is of only indirect value; it is not formed in the cell but may warm the medium slightly. Reactions brought about by extracellular enzymes are analogous in some respects to those of digestion in animals. Animals possess an alimentary tract, into which is placed a great amount of food. Such food is not yet in the body, for the alimentary tract may be considered a tube running through the body. Food in this state cannot pass through the walls of

the intestines; it must be hydrolyzed to simpler **chemical compounds** sometimes spoken of as soluble compounds, although the term soluble has a different meaning here from the usual one. It refers to **ability** to pass through the walls of the intestines. In order to bring about hydrolysis, digestive juice, which contain extracellular enzymes, are poured into the alimentary canal. These enzymes are peptase, tryptase, and ereptase. They decompose protein materials to simpler compounds; the latter dialyze through the intestinal wall into the blood which carries them to the cells. After they are taken into the cell, the endoenzymes act.

Intracellular or endoenzymes, on the other hand, as the name indicates, do not pass out of the cell but remain inside and bring about those vital changes which are so necessary in the cell's life. Energy needed by the cell is gained from these internal reactions as are also the foods for construction of new tissue in growth and multiplication. Thus it is evident that intracellular enzymes bring about necessary decompositions.

EXTRACELLULAR
(EXOENZYMES)

1. Act outside the cell which secretes them.
2. Hydrolytic.
3. Liberate small amounts of energy
4. Energy not directly useful to the cell.

INTRACELLULAR
(ENDOENZYMES)

1. Act within the cell.
2. Oxidizing—reducing.
3. Liberate large amounts of energy.
4. Energy liberated within the cell—directly available.

The relationship of these two groups is illustrated by the following steps in the decomposition of starch by enzymes.

1. Amylase changes starch to maltose.
2. Maltase changes maltose to dextrose.
3. "Zymase" changes dextrose to alcohol.
4. Alcoholase changes alcohol to acetic acid which in turn may be burned to CO₂ and H₂O.

The first two changes are brought about outside the cell by means of enzymes. Starch must be broken down to soluble compounds, because it cannot enter the cell in its original state as starch. The last two changes occur inside the cell and are, therefore, the useful and important reactions.

CONSTITUTIVE AND ADAPTIVE ENZYMES

Constitutive enzymes are those which an organism elaborates under all conditions of growth and respiration. They are produced by the organism, irrespective of the medium in which it is cultivated.

On the other hand, some organisms are capable of producing other enzymes, depending on the culture medium. These are *adaptive enzymes*. By such enzymes the organism is capable of utilizing a substrate not ordinarily attacked. For instance, *Streptococcus lactis* when grown in glucose broth does not ferment galactose. However, if the organism is cultivated in galactose

broth, it acquires the ability to form galactase. After growth in glucose broth again, the galactose fermenting ability is lost. Rahn has suggested that adaptive enzymes are produced in most cells under the following conditions: (1) The reaction does not take place unless needed; (2) the mechanism required to produce this reaction is formed only when needed; it is not reformed in the cell; (3) the ability to establish this mechanism is inherited, but the mechanism is not inherited; (4) reactions by adaptive enzymes are highly specific.

PRACTICAL APPLICATIONS OF ENZYME ACTIVITIES

We know that enzymes are vital to life of the organism in which they are formed, be it animal or plant. However, there are many applications of these enzymes, some indirect, which materially aid our own lives. The growing of microorganisms as enzyme sources is an important function of the fermentation industries and is discussed in the chapter on industrial fermentations.

Hydrolytic Enzymes. This is perhaps the largest group of enzymes. As we indicated previously, they bring about decomposition of complex compounds by means of a reaction with water. It is impossible as well as unnecessary to discuss more than a few of these enzymes.

Cellulase. By this enzyme bacteria and molds are able to hydrolyze cellulose, a complex carbohydrate composed mainly of glucose molecules. Cellulase is present in some of the bacteria causing plant disease, especially those diseases which are accompanied by a great amount of tissue destruction. On the other hand, benefits arise from this enzyme through hydrolysis of cellulose in soil which accumulates from plant wastes. The cellulose is decomposed to materials which again support plant growth.

Amylases or Diastases. These are starch-hydrolyzing enzymes. There are many amylases which differ in their completeness of hydrolyzing starch. Two amylases have wide application in industry. α -Amylase rapidly liquefies starch, converting it to compounds of lower molecular weight. It is also called a dextrinogenic amylase because it produces dextrin-like compounds and very little sugar. β -Amylase is the saccharifying enzyme which converts the dextrin-like compounds of maltose. Starch is progressively decomposed through a number of stages. These have been given by Mathews as follows:

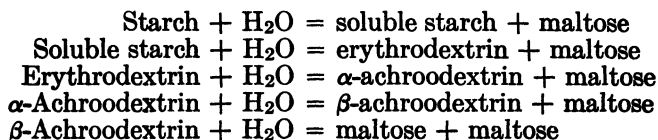

These several products of hydrolysis of starch form different colors with iodine and explain varying shades of blue-lavender and red which are often seen when hydrolysis of starch is followed with iodine. Bacteriologists use the ability to decompose starch as one of the differential characteristics of pure cultures. α - and β -Amylases are present in *malt* which is often added to various materials on account of its starch hydrolyzing ability.¹ Malt is prepared by allowing barley to germinate for a time, after which germination is stopped by heating. This gives a material rich in amylase.

Amylases are also formed by many molds, α -amylase probably predominating. In the manufacture of industrial alcohol by the amylo process, a mold forming very active amylase hydrolyzes starch to fermentable sugars.

Carbohydrases. These enzymes hydrolyze the less complex carbohydrates to the simple sugars. For example, *invertase* (sucrase) hydrolyzes sucrose to glucose and levulose.

It is easily prepared from beer yeast by putting the cells in chloroform to inhibit budding and growth and heating to 30°C. After a short time the mixture is filtered, and the filtrate is tested for its inverting ability. Invertase is quite widely distributed through the world of microorganisms.

Maltase is a carbohydrase which hydrolyzes the disaccharide maltose to two molecules of glucose. The following equation will represent this change:



The enzyme is widely distributed in nature in both animal and plant cells.

Lipase. This enzyme was formerly known as steapsin or lipolytic enzyme. The latter name is probably not a good one since it implies a decomposition by means of fat. Fats are known as triglycerides, by the chemist, or as combinations of glycerol

¹ L. C. Hao, E. I. Fulmer, and Underkofler, Fungal Amylases as Saccharifying Agents in the Alcoholic Fermentation of Corn, *Ind. Eng. Chem.* **35** (1943), 814-18.

with fatty acids. Consequently, when fats are hydrolyzed by lipase, they react with three molecules of water to form glycerol and fatty acids. This enzyme is formed by many microorganisms.

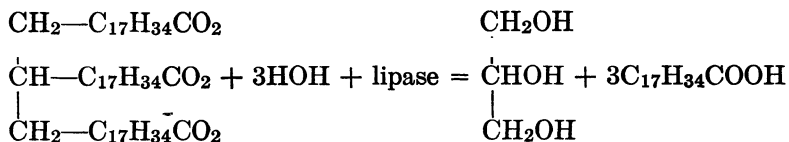

Proteinases. These enzymes, which hydrolyze proteins to soluble forms and to amino acids, are found in many microorganisms. They are extracellular enzymes which solubilize proteins in order that they may diffuse through the cell walls. Animals contain a large variety of bacteria in the intestinal tract, many of which secrete proteinases that will form soluble proteins which will diffuse through the intestinal wall and into the blood stream for further metabolism.

Some proteinases of animal origin are important also in the animal intestinal tract. Four of these are discussed here though they do not bring about the same type of decomposition.

Peptase is present in the gastric juice of animals. It acts on native proteins and demands a medium which is slightly acid. It changes proteins, proteoses, and peptones.

Tryptase hydrolyzes proteins to amino acids and acts best in an alkaline solution. It is secreted into the intestines.

Ereptase hydrolyzes the peptones and some of the polypeptids to amino acids. It cannot hydrolyze the proteins. It is an intestinal enzyme.

Rennin is the coagulating enzyme of the stomach. It is, perhaps, less known under the names *lab* and *chymosin*. It is prepared from stomachs of swine and after purification and concentration is used in cheese making. Casein in milk is changed into paracasein. The latter is a product of hydrolysis and therefore has a smaller molecule. This is indicated by simple experiments in every course in biochemistry. Addition of alkali to an acid curd will restore casein to its original condition, but with a rennin curd this is impossible.

Oxidizing Enzymes. Many oxidizing enzymes are known, and many others are postulated. Oxidizing enzymes function in the making of vinegar, *alcohol dehydrogenase* oxidizing alcohol to acetic acid.

Simultaneous with oxidation, some compound is reduced. Dyes may act as the hydrogen acceptor and thereby become reduced to colorless leuco bases. Such a change is noticeable in litmus milk, where the blue color of litmus is changed to white at the bottom of the tube. It is also demonstrable with other dyes such as methylene blue and resazurin. These tests are often used in the control of quality of fresh milk, for under standard conditions the time of dye reduction is indicative of the bacterial content of the milk.

Enzymes in the Alcohol and Brewing Industries. Yeast is unable to ferment starch until it is hydrolyzed to fermentable sugars. The α - and β -amylases of malt are employed to saccharify gelatinized starch of the grain to glucose and maltose which are fermented by yeast to alcohol.

Considerable interest is being shown in the use of mold amylases for this operation. The mold is grown under controlled conditions on a medium of moist bran until maximum amylase activity is produced, and then the whole product is carefully dried to preserve the amylases. This product is known as "mold bran." Mold amylases are used in the "amylo process" for alcohol production from starchy materials, wherein the mold is grown in the starch-containing medium, or mash, until sufficient saccharification has taken place. Then the yeast is added, and the alcoholic fermentation is continued to completion.

Enzymes in the Textile and Paper Industries. Amylases are also widely used in the textile and paper industries. Starch is often used as a sizing agent, that is, an agent which will strengthen the fiber and lubricate it during the fabrication processes. Amylases modify starches to make suitable sizing agents, and then again to desize the material following fabrication.

Enzymes in the Food Industry. Enzymes are used in several places in the food industry for bringing about desirable changes.

Clarification of Jellies and Fruit Juices by Enzymes. Manufacture of beverages and vinegar from apples leaves a waste material known as pomace. Dried pomace may contain 10 per cent of pectin which is easily extracted with hot water. This pectin is used for making jelly but gives a product which is turbid because it contains, among other materials, starch protein and insoluble pectins. Filtration will not remove this turbidity but enzymes will. The enzyme which will do this is derived from the mold *Aspergillus oryzae* in whose mycelium it is formed after the

fungus has grown for a sufficient time. The enzyme is extracted with water and shows marked ability to hydrolyze starch and protein. In this manner the jelly is cleared because all constituents which cause turbidity are removed.

Rennin in Cheese Making. In order to make cheese, the casein of milk must be coagulated or clotted either by natural souring or by use of rennet, a commercial preparation of the enzyme rennin prepared by extraction of the calf's stomach. The curd is then acted on by microorganisms to produce the desired flavor.

Invertase in Chocolate Creams. Bursting or explosion of chocolate creams is a phenomenon causing candy makers considerable loss at times. One cause is growth of microorganism in the fondant which consists of syrup enveloping closely packed particles of microscopic crystals of sucrose. Each sugar crystal is believed to have a film of syrup about it. If the syrup is sufficiently concentrated, spoilage microorganisms cannot grow. To accomplish this the enzyme *invertase* is added to the fondant. It inverts some of the sugar, thereby forming a heavier syrup which interferes with the activity of spoilage organisms.

Enzymes in Meat Tenderizing. Following death, animal tissues undergo a partial autolysis by enzymes contained in the tissue. Tenderizing of meat is thus accomplished. Papain, a proteolytic enzyme in papaya juice, has been used. Commercially prepared papain concentrates were used. Bromelin, a similar enzyme in pineapple juice, is as effective and has a more desirable odor.

REFERENCES

- FOWLER, G. J., *Bacteriological and Enzyme Chemistry*, Longmans, Green, New York, 1903.
- GORTNER, R. A., *Outlines of Biochemistry*, 2d Edition, Wiley, New York, 1938.
- HAWK, P. B., *Practical Physiological Chemistry*, P. Blakiston's Son & Co., Philadelphia, 1931.
- SALLE, A. J., *Fundamental Principles of Bacteriology*, 2d Edition, McGraw-Hill, New York, 1943.
- SUMNER, J. B. and G. F. SOMERS, *Chemistry and Methods of Enzymes*, Academic Press, New York, 1943.
- SUMNER, J. B., and G. F. SOMERS, *Enzymes*, Academic Press, New York, 1943.
- TAUBER, HENRY, *Enzyme Chemistry*, Wiley, New York.
- TAUBER, HENRY, *Enzyme Technology*, Wiley, New York, 1943.
- WALLERSTEIN, L., *Enzyme Preparations from Microorganisms*, *Ind. Eng. Chem.*, **31** (1939), 1218-24.

CHAPTER 17

NITROGEN METABOLISM (CYCLE); SULFUR METABOLISM (CYCLE); CARBON METABOLISM

Occurrence of Nitrogen. About 80 per cent of the atmosphere is nitrogen. It is also found dissolved in water and in many compounds in the soil. Such nitrogen is spoken of as *free nitrogen* in contrast to *fixed nitrogen*; the latter is in the form of salts such as nitrates, nitrites, and ammonium compounds. Large deposits of fixed nitrogen are not abundant. The best known are the Chile guano deposits containing vast amounts of nitrogen in different forms. Slosson (1923) stated that, since their discovery in 1809, 53,000,000 tons of sodium nitrate, "saltpeter," have been removed. Predictions are that this deposit is giving out and that we must accordingly look elsewhere for large amounts of nitrogen. It is no wonder that scientists turned to the atmosphere in an attempt to fix this incomprehensible supply. In this book we need not be especially concerned with all the methods which man has used for taking nitrogen out of the atmosphere but mainly with those methods which are microbiological in nature.

Above each acre of land are about 75,000,000 pounds of nitrogen, a supply which is always available and which should be utilized. There are about 8.5 metric tons above each square yard of land. Hopkins stated that the brown silt loam of Champaign County, Ill., contained only 4760 pounds of nitrogen per acre; a 100-bushel corn crop for grain alone required 100 pounds of nitrogen. The nitrogen supply, then, is sufficient for only 47 years. On account of this there must be some method of replenishing it. Here is one of modern agriculture's greatest problems. Most nitrogen in the soil is in the form of organic matter. This residual stock is altered in many different ways. Some of it is removed in the crop, some is washed away by drainage water, and some goes into the atmosphere by bacterial changes which are discussed in this chapter.

Significance of Nitrogen for Life. Nitrogen is a very important element for living organisms. It is required by all forms of life for growth and repair. Nitrogenous compounds are present in all kinds of living tissue. According to Lotka, the proportion of nitrogen to carbon in the human body is 1 : 3, and in the atmosphere 5500 : 1.

The Nitrogen Cycle. Cycles are used to show relationship of various stages through which compounds of elements such as nitrogen are made to pass by various agencies. All are founded on the same principles. The cycle shown here is adapted from one given by Fowler in his "Bacteriological and Enzyme Chemis-

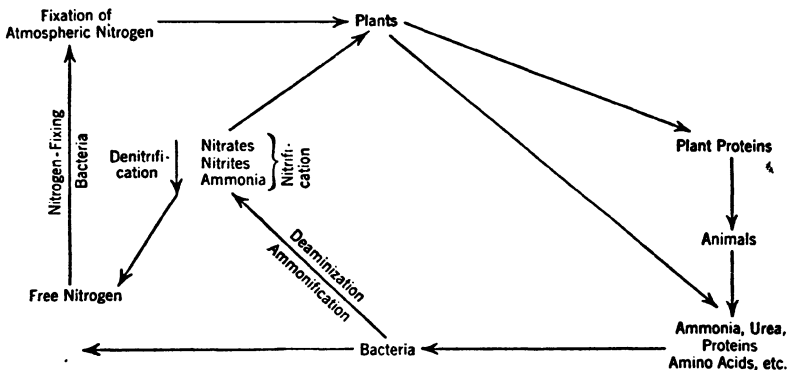

FIG. 90. Nitrogen Cycle. (Adapted from Fowler)

try." Examination of it will reveal that nitrogen may follow one of two paths. It may remain fixed on the surface of the earth, or it may travel a longer circuit or cycle and pass into the air, to return later to the earth by any method of fixation. No single group of living organisms is more concerned with forcing nitrogen along its path than any other. Every microorganism plays a role. Bacteria are, perhaps, more active in taking nitrogen from the atmosphere than other organisms. Continual movement of elements is necessary, else they will accumulate in some form and be removed from circulation. Unless a new supply is continually formed, that which exists must be kept in circulation.

Fixation of Atmospheric Nitrogen. This is a fitting place at which to start discussion of the nitrogen cycle since it involves that tremendous supply of nitrogen in the atmosphere. The term fixation in this case means changing of free nitrogen of the atmos-

phere to the fixed state. It means, then, removal of nitrogen from the atmosphere and its fixation on the earth where it becomes subject to chemical changes of man and animals. World War I greatly stimulated interest in various possible methods of nitrogen fixation. Warring nations found it necessary to have an abundant supply of the element at low cost without hazards of shipping from country to country. Consequently, they turned to the atmosphere and perfected methods of chemical fixation.

Outline of Methods of Nitrogen Fixation. It is best to take a broad view of the whole subject of nitrogen fixation and, at least, mention the more important methods. These are grouped under two main headings, the chemical methods and the biological methods. The chemical methods are mentioned only because they supplement the biological methods.

I. Chemical Methods of Fixation or Securing Pure Nitrogen.

- A. Burning phosphorus in confined air.
- B. Distilling liquid air.
- C. Electrolytic fixation.
- D. Fixation by silent electric discharge.
- E. Fixation by Haber-Claude process (direct union of N and H under pressure).

II. Biological Fixation.

- A. By fungi.
- B. By bacteria.
 - 1. Nonsymbiotic.
 - (a) Aerobic method.
 - 1. Azotobacter.
 - (b) Anaerobic method.
 - 1. Clostridium *pasteurianum*, etc.
 - 2. Symbiotic fixation.
 - (a) Rhizobium *leguminosarum*.

CHEMICAL METHODS OF NITROGEN FIXATION

Man is dependent on an abundant supply of soil nitrogen compounds for the production of food. Annually crops are estimated to remove 5,500,000 tons of nitrogen from the soil of American farms while other losses such as pasturage, drainage, and erosion increase the annual loss to 8,400,000 tons. For continued soil fertility nitrogen compounds must be replaced. It is estimated that only 4,700,000 tons are replaced annually. Of this, 3,000,000 tons are credited to bacterial nitrogen fixation, only 400,000 tons to fertilizers, and the remainder to rainfall.

Pure nitrogen may be prepared by several methods such as fractional distillation of liquefied air or from water gas. Elementary nitrogen is converted by chemical-fixation methods to compounds of value in agriculture and chemical industries. One of the first methods, producing nitrogen oxides, was the arc process of Birkeland and Eyde in Norway in 1904 accompanying the development of low-cost hydroelectric power. This method is now obsolete. The cyanamide process, introduced in Germany in 1897, remains important. It depends on the fact that calcium carbide readily absorbs nitrogen gas to form calcium cyanamide, a valuable fertilizer. By further treatment it may be converted to cyanides and ammonia. The most economical processes for nitrogen fixation involved synthesis of ammonia from elementary nitrogen and hydrogen by means of high-pressure high-temperature catalytic reactions. The methods now used are refinements of the original Haber-Bosch process. The Haber process was conducted at 200 atmospheres pressure and a temperature of 550°C. Other modifications employ pressures up to 1000 atmospheres. One form of catalyst is granular iron oxide containing small amounts of potassium and aluminum oxides.

Chilean nitrates have been valuable sources of nitrogen compounds, but in the face of low-cost synthetic products from the elements the source is of lesser importance today.

BIOLOGICAL METHODS OF NITROGEN FIXATION

These are in sharp contrast with the chemical methods, both with respect to the mechanisms involved and the amounts of nitrogen fixed. Although some of the fungi are known to be able to fix nitrogen, the amounts are so small in comparison with amounts fixed by bacterial species mentioned here, that they will not be discussed at any length.

Nonsymbiotic (Asymbiotic) Fixation of Atmospheric Nitrogen. This method differs from the symbiotic method in that there is no cooperation of organisms in partnership and harmony as in the symbiotic method. In 1885 Berthelot reported that nitrogen increased in soils that were not being cultivated. Later on, Winogradsky isolated several bacteria which could take nitrogen from the atmosphere and fix it for the use of plants. Still later, Beijerinck made distinct contributions to knowledge.

Aerobic Nonsymbiotic Fixation. Winogradsky and Beijerinck both isolated aerobic bacteria which could fix nitrogen alone. Beijerinck described a large aerobic organism to which he gives the generic name *Azotobacter*. He was under the impression that *Azotobacter* had to have some other bacteria present. This was finally disproved and he demonstrated that nitrogen could be fixed alone in pure culture. *Azotobacter chroococcum*, *Azotobacter agilis*, *Azotobacter vinelandii*, and *Azotobacter Beijerinckii* are representative members of the genus. This method of nitrogen fixation is called *azofication*. The term is not a good one, since from the Latin constituents it means the making of nitrogen and not the fixation of nitrogen.

Energy relations of these organisms are especially interesting. Fixation of nitrogen is an endothermic reaction. Bacteria have to secure energy from other compounds. Since they have no chlorophyll, they cannot use energy in sunlight and, as we have learned before, must resort to chemical decomposition of large organic molecules. Carbohydrates or sugars are the best energy-yielding compounds. Numerous students have reported the amount of nitrogen fixed per unit of carbohydrate used. *Azotobacter vinelandii* has been reported to fix between 15 and 20 milligrams of nitrogen for every gram of mannite used for energy. The amount fixed, of course, varies greatly with the species and other conditions.

Anaerobic Nonsymbiotic Nitrogen Fixation. Certain anaerobic bacteria can also take nitrogen from the atmosphere. *Clostridium pasteurianum* is a member of such a group of organisms. They are widely distributed in soil and will grow under anaerobic conditions in presence of carbohydrates and certain mineral matter.

Energy relationships of these organisms are also interesting. Anaerobic nitrogen fixers are not so efficient as aerobic *Azotobacter*. Winogradsky reported that *Clostridium pasteurianum* would fix 2 to 3 milligrams of nitrogen for each gram of sugar used for energy.

Fixation of Nitrogen by Higher Plants and Fungi. Some of the higher plants, such as yeasts and molds, have also been found to fix nitrogen; the amount is so small in comparison with the other methods that it is insignificant. It is also quite possible that the technic used with these other organisms is not above question.

Symbiotic Fixation of Atmospheric Nitrogen. Certain Leguminosae have been used for centuries as soil improvers. It was known that they did something to soil which made it more suitable for crops which followed them. Roman farmers observed that beans enriched soil; they plowed lupines under for further enrichment. The history of this work need not concern us to

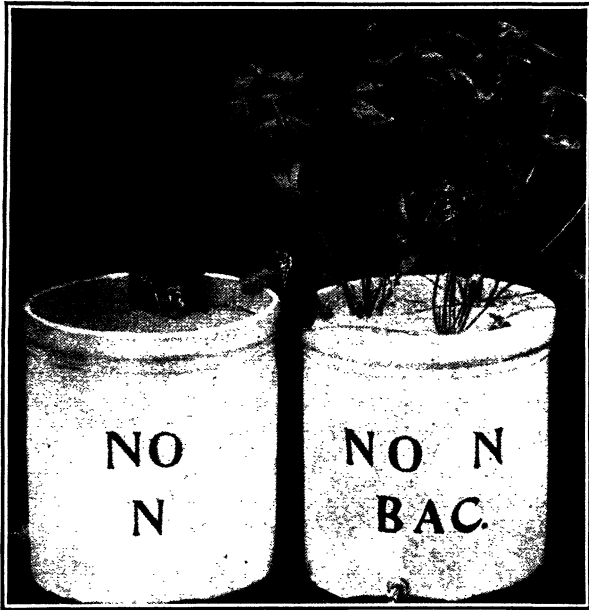

FIG. 91. Red Clover; Effect of Nitrogen-Fixing Bacteria. No nitrogen in the soil of either pot. (After Hopkins, 1904)

any extent; its importance, however, justifies a little space. Thought and study were given to solution of the question of just how legumes were able to enrich the nitrogen supply in soil. Finally it was revealed that nodules on roots of these plants had something to do with this process. Woronin (1866) found that bacteria were present in them but also explained them as pathological processes. Later it was found that sterilization of soil inhibited formation of nodules, thus indicating that they were biological in origin. A distinct contribution was made by Ward, the great English botanist, who found that he could inoculate roots of young legumes by placing them in contact with old

nodules. In Germany soy beans could not be grown until some soil from their natural habitat had been used and allowed inoculation. It was soon evident that the cause of nodule formation came from outside the plant. Discovery of symbiosis between the bacterium and the plant is probably due to the work of Hellriegel and Wilfarth. They found that sterilization of soil



FIG. 92. Showing Cowpea Root Tubercles, Natural Size.
(After Hopkins, 1904)

caused legumes to grow as nonlegumes and eventually to die of starvation. Thus this great provision of nature to maintain a supply of nitrogen in the soil was revealed. Since these reports, an endless line of experiments has been continued to find out more about this relationship.

The amount of nitrogen fixed by bacteria is enormous. Whiting and Fred stated that, if 10 per cent of cultivated land in the United States had been in leguminous crops in 1924 and the average fixation had been 50 pounds per acre, 925,000 tons of nitrogen would have been taken from the air. This indicates

that the growing of leguminous crops is indeed a cheaper source of nitrogen than are the commercial fertilizers.

Nodule (Tubercle) Formation. When proper bacteria are brought into contact with proper legumes, nodules or tubercles appear on the roots of the plants. In them are found the bacteria which take nitrogen from the atmosphere and make it available to the plant. Nodules appear quite early on the plant and are very small at first.



FIG. 93. Showing the Effect of Inoculation of Legumes with Nitrogen-Fixing Bacteria. Vines from a field where peas had not been grown before. (After Whiting, Fred, and Stevens)

Symbiotic Nitrogen-Fixing Bacteria: The Genus *Rhizobium*. Discovery of bacteria in nodules, as the little projections on rootlets of legumes are called, resulted from painstaking research. Although several previous investigators may have seen the bacterium, or thought they did, it remained for Beijerinck, a Dutch bacteriologist, to isolate a pure culture and determine its characteristics. Beijerinck suggested the name *Bacillus radicicola*. This name was widely used by many writers until it was pointed out that Frank, a German bacteriologist, had previously suggested the name *Rhizobium leguminosarum*, although it is quite apparent that he did not have the right organism. On the basis of priority Frank's name is now accepted as the proper one to be used and is recognized in recent classifications of bacteria. An interesting

point in nomenclature is thus brought out, that the first name given to a microorganism carries more weight than names which may come later, even though the former name may have been based on inadequate observations. Some six members of the genus *Rhizobium* are now recognized. All of them are capable of fixing atmospheric nitrogen in symbiosis with plants. Cultures show many branching forms.

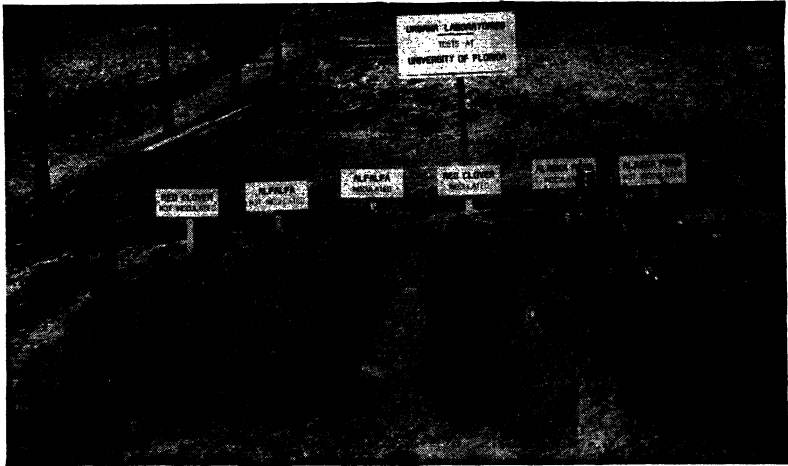

FIG. 94. Showing the Effect of Inoculation of Legumes with Nitrogen-Fixing Bacteria. (Courtesy Urbana Laboratories, Urbana, Ill.)

Note the scant growth of the plants in the two rows at the left which were uninoculated. These plants were starved for nitrogen. The abundant growth of the plants in the rows at the right is due to the fact that their roots carry many nodules in which nitrogen-fixing bacteria live.

Relation of the Organisms to the Plant. What the relation of bacteria to the plant is depends on how the situation is interpreted. Since two organisms living in close proximity are involved, one need not be surprised to learn that different explanations have been given the phenomenon.

Parasitism. Some have suggested a case of parasitism, the legume being the host and the bacterium the parasite. It is a situation in which one living organism exists on another. Both organisms are benefited, however, usually not the case in parasitism.

Mutual Symbiosis. This seems to be the most reasonable explanation. The relation of the two organisms is a partnership

profitable to both forms. Whiting has defined mutual symbiosis as the contiguous association of two or more morphologically distinct organisms not of the same kind, resulting in an acquisition of assimilated food substances. This definition implies that the organisms concerned have the power of independent existence, but that both are benefited by the close association. The question may be asked how one organism benefits the other in this case. Mere living together would hardly explain it. It is explained by the fact that the bacterium secures carbohydrates from the plant and in return gives the plant the nitrogen which is so necessary for its growth. In contrast to nonsymbiotic methods of nitrogen fixation, the symbiotic method is a constructive one since organic matter is bound to increase in soil.



FIG. 95. Showing Effect of Inoculation on Peas for Canning at Story City, Iowa, in 1935. (Courtesy Urbana Laboratories, Urbana, Ill.)

Soil Inoculation Methods. Since it has been shown that symbiotic fixation of atmospheric nitrogen is desirable and since certain soils are poor in bacteria which work with legumes to fix it, methods are used for getting these bacteria either on the land or on the seeds. These are known as inoculation methods. They are playing a great role today in American agriculture. Progressive farmers inoculate legumes when the seeds are planted. They have learned its value.

Soil Transfer Method. Fields which have not grown the legume may be inoculated with the desirable bacteria if some soil (leguminous earth) from a field which has grown legumes is spread over the new field. When seed is sown on such a field and germinates, the young plants soon encounter the bacteria. This method is less direct than the culture method in which the bacteria themselves are applied directly to the seed.¹ The transfer of sufficient soil from an old field to a new one may also be more inconvenient.

Culture Method. Bacteria which are isolated from nodules on roots of legumes may be grown in pure culture on laboratory media and distributed to the farmer in this way. The organisms are grown on special agar media in flat bottles which are shipped to the farmer. He washes the growth from the surface of the medium. Such cultures prepared by reliable laboratories give good results when applied directly to the seed. When the bacteria are applied to the seed, they are ready to infect the rootlets of the young plants during the early stages of growth and thus make atmospheric nitrogen available. This gives the plant a start which it might not enjoy if natural inoculation were relied upon, for the rootlets would have to wait until they had come in contact with the bacteria in the soil. Thus growth is delayed. One of

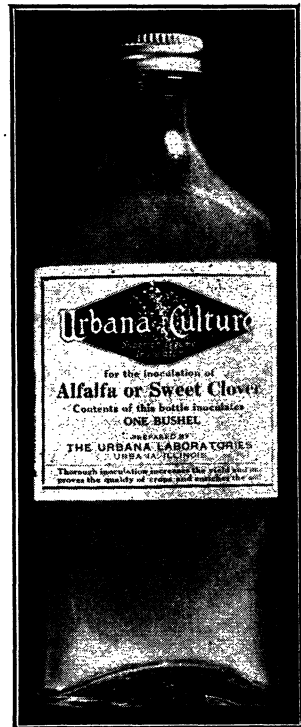

FIG. 96. Showing a Bottle of Culture for Inoculation of Alfalfa or Sweet Clover.

¹ As soon as it had become firmly established that inoculation of such seed caused increases in crop yields, commercial preparations appeared on the market. Many of them were found later to be worthless since they would not bring about the formation of nodules on legumes, the ultimate test for a bacterium which is advertised as fixing nitrogen symbiotically. This situation is not greatly different from that of chemical disinfection, and so-called patent medicines. Some states have been driven to passing legislation for controlling such preparations.

the older methods for getting bacteria on the seed was the so-called glue method devised at the Illinois Agricultural Experiment Station. About two handfuls of glue were dissolved in a gallon of water. After it had been cooled, this was sprinkled over the seed at the rate of one pint per bushel. After being stirred, the leguminous earth in dry powder form was sprinkled over the seed and stuck to the seed. Recent practice indicates that glue is not necessary for bacteria to adhere to the seed sufficiently well.

It is apparent that to secure good inoculation proper bacteria should be used and the culture should be strong and healthy. Inoculation methods received some criticism because in the past agriculturists were given poor cultures. Attempts at inoculation were unsuccessful, and because of this the whole system was regarded as questionable. Reliable laboratories that produce good cultures exist today.

Are There Different Species of Legume Bacteria? Evidence points to the conclusion that different varieties of legume bacteria exist. Planting certain legumes on a field that has not grown them or certain closely related forms may not result in natural inoculation and good nodule formation. Legumes have been arranged in inoculation groups. The same bacterium will infect the members of one group but will rarely infect members of other groups. Some of these groups are:

<i>Group 1</i>	<i>Group 3</i>	<i>Group 5</i>
Red clover	Cow pea	Soy bean
Mammoth clover	Lima bean	
Crimson clover	Peanut	<i>Group 6</i>
Alsike clover	Lespedeza	Navy bean
White clover	Velvet bean	Kidney bean
		String bean
	<i>Group 4</i>	Wax bean
	Garden pea	
<i>Group 2</i>	Field pea	<i>Group 7</i>
Alfalfa	Hairy vetch	Dalea
Sweet clover	Spring vetch	
Hubam	Sweet pea	<i>Group 8</i>
		Lupine

It may be noticed that sweet clover and alfalfa bacteria are in the same group, and will "cross-inoculate." These bacteria are probably quite widespread in nature in growth of wild sweet clover along highways and railroads. The bacteria-inoculating

plants in the other groups are not so common, and the agriculturist may have to resort to artificial inoculation to secure good nodule formation.

Soil bacteriologists have also found that it is important to study strains. Not all strains of bacteria are as active as others. Experiments must be constantly in progress to keep strains active and replace with active ones those which have weakened.

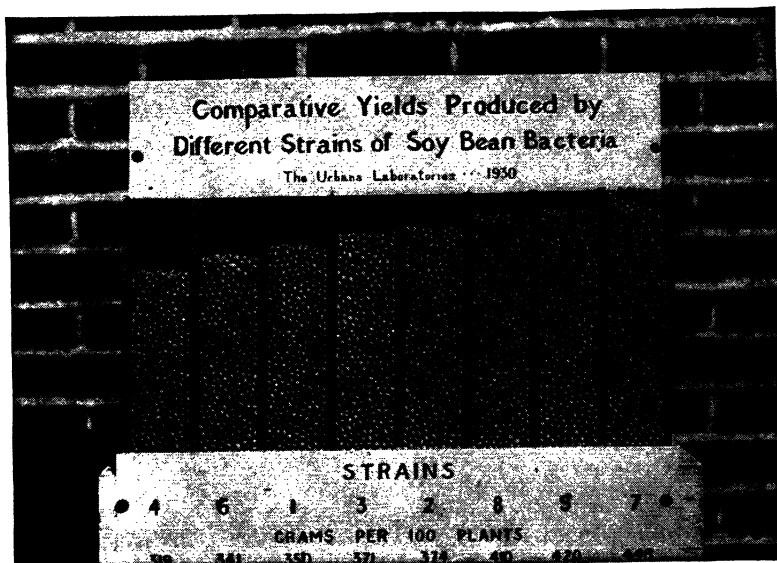
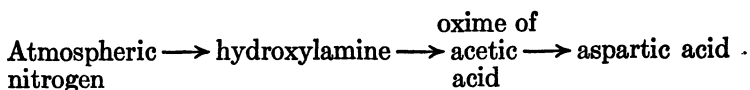

FIG. 97. Showing Comparative Yields Produced by Different Strains of Bacteria for the Inoculation of Soy Beans. (Courtesy Urbana Laboratories, Urbana, Ill.)

How is the Nitrogen Transferred to the Plant? Different explanations have been offered. Perhaps none of them is correct, or perhaps they are all correct to a certain extent. One explanation suggests that bacterial cells are absorbed by the plant. In this manner the organic nitrogenous matter of the bacterial cells is used by the plant. It is made available to the plant perhaps after the bacteria have died. The bacterial cells may disintegrate and the constituents therein be used by the plant. Another explanation is that the bacteria grow in the plant and excrete nitrogenous matter which is taken by the plant.

A recent investigator has shown that amino acids may be the intermediate chemical compounds involved. One half of the

total organic nitrogen excreted from the nodules of leguminous plants was found to be *l*-aspartic acid. The other half was shown to be β -alanine, a secondary decomposition product of aspartic acid. Fixation of atmospheric nitrogen has therefore been postulated to occur quantitatively as follows:



It was shown that excretion of amino acids is from the nodules and not from the roots.

NITRIFICATION

Nitrification is that part of the nitrogen cycle which involves oxidation of ammonia to nitrites and of nitrites to nitrates by nitrifying bacteria. The following equations illustrate the changes:

1. $2\text{NH}_3 + 6 \text{O} = 2\text{HNO}_2 + 2\text{H}_2\text{O}$ (nitritation) by $\left\{ \begin{array}{l} \textit{Nitrosomonas} \\ \textit{Nitrosococcus} \end{array} \right.$
2. $2\text{HNO}_2 + 2 \text{O} = 2\text{HNO}_3$ (Nitritation) by *Nitrobacter*

The bacteria involved in nitrification are members of the family *Nitrobacteriaceae* described on page 122. These are autotrophic bacteria which are primitive in their metabolism in that they are able to use simple foods. Those which oxidize ammonia to nitrites (nitritation) are of two genera, *Nitrosomonas* and *Nitrosococcus*. Nitrites are oxidized to nitrates by members of the genus *Nitrobacter*.

After the process of nitrification had been well established and was supported by results of many investigations, attempts were made to learn the driving forces behind it. At first it was believed to be purely a chemical change. The role of the aforementioned bacteria was revealed by careful logical experiments. Pasteur was probably the first to suggest that nitrification was biological and not purely chemical. Some 15 years later two German bacteriologists, Schlöesing and Müntz, showed that dilute ammonia solutions were oxidized to nitrates by being passed through a tube of soil. All of the nitrogen as ammonia could be accounted for in the nitrate. This showed that some agent was present in the soil in the tube which was oxidative in nature. When the soil in the tube was sterilized by heat and chemical disinfectants, the ammonia went through the tube without

being oxidized, showing that the oxidizing agent was destroyed. Reinoculation of the soil in the tube with fresh soil restored its oxidative ability. These experiments established the biological nature of nitrification. Isolation of the bacteria involved now remained. Although many investigators tried to do this, it remained for Winogradsky in 1890 to succeed. Failure of earlier workers to do this was due to use of wrong culture media in which nitrifying bacteria could not grow.

The afore-mentioned bacteria oxidize ammonia in two stages. Kaserer described a bacterium *Bacillus nitrator* which oxidized ammonia directly to nitrate according to the following equation:

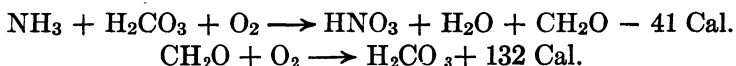

Necessary energy for the oxidation comes from oxidation of formaldehyde. Existence of this bacterium has been doubted by many.

Nitrification is an interesting biological process in relation to the world's constant need for nitrates. Vast amounts have been needed through hundreds of years for manufacture of gun powder. Later it was found to be important in agriculture. Higher plants must have nitrates because they cannot use nitrites. Progressive agriculturists have, in general, found it best to operate their land so that needed plant foods would be built up in the soil. Otherwise they must be purchased and added to the soil, a far more expensive process.

There have been attempts to make nitrates by microorganisms under controlled conditions in large enough amounts to be significant. These have not been very successful. Such attempts always present problems such as adequacy of raw materials, the right microorganisms, and ability to recover the product at a cost which will compete with other methods.

DENITRIFICATION

Denitrification may be defined as reduction of nitrates to free ammonia, oxides of nitrogen, or free nitrogen. It is, therefore, just the opposite of nitrification. The two processes are complementary. If denitrification were impossible, much of the nitrogen on the earth's surface would appear as nitrates, be washed into rivers, and finally accumulate in the ocean. Denitrification prevents this.

The terms *nitrate reduction* and *denitrification* are sometimes used synonymously. The latter term, denitrification, should probably be restricted to decomposition of nitrates and nitrites to free nitrogen. Nitrate reduction would involve simply the reduction of nitrate. Many common bacteria reduce nitrates. This ability is one of the characteristics by which bacteria species are differentiated. Some of the first denitrifying bacteria to be isolated were *Bacillus denitrificans*, α and β . The following equations illustrate how the reduction may occur:

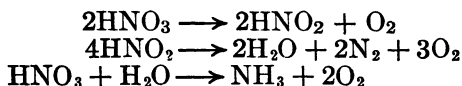

Bacteria denitrify in order to use the oxygen for their own needs. They may use it to oxidize other compounds. Denitrification would be expected to take place most readily under anaerobic conditions or where oxygen supply was reduced.

Denitrification may be important in some soils since it may result in a loss of nitrates, plant foods, and also in formation of nitrites which are toxic to plant life. Generally speaking it is of less importance than other parts of the nitrogen cycle.

One place where it has been important, is in preparation of cured meats. Saltpeter (sodium nitrate) has been added to curing solutions so that meats would have a red color. It must be reduced to sodium nitrite first, however. Bacteria have done this for the meat packer. Now meat packers are adding a little sodium nitrite as such to start the reddening.

AMMONIFICATION

Ammonification is the production of ammonia from various substances. Bacteriologists, especially those primarily concerned with soil bacteriology, have been prone to consider it as production of ammonia during decomposition of organic substances. The name means to make ammonia, irrespective of the source. Practically all microorganisms decompose proteins and make ammonia.

Ammonia Formation From Inorganic Compounds. Ammonia is one of the end products of denitrification. This is biological reduction.

Ammonia Formation from Organic Compounds. Complex organic compounds such as proteins must first be hydrolyzed to

simpler compounds by such a process as putrefaction. This hydrolysis occurs through the proteoses, peptones, polypeptides and finally the amino acids, decompositions of which are discussed here.

DECOMPOSITION OF PROTEINS—PUTREFACTION

The term putrefaction is generally restricted to the decomposition of proteins and the split products of proteins. It is often distinguished from fermentation, which may be considered as decomposition of carbohydrates. This distinction is perfectly arbitrary.

Putrefaction or Anaerobic Decomposition of Proteins. Most typical putrefactions are anaerobic. The products are left in an unstable reduced condition. Such products usually have bad odors and cause nuisances. They include indole, mercaptans, hydrogen sulfide, and ammonia. Products of anaerobic decomposition of proteins are usually incompletely oxidized since they are formed under conditions where oxygen is not available for oxidation. The putrefaction bacteria are many. Among the more common ones are *Clostridium putrificum*, the members of the proteus and coliform groups. Members of the last-mentioned group are inhabitants of the intestines. Practically all bacteria are putrefactive in nature since they hydrolyze proteins. The criteria of typical putrefaction have been expressed as follows by Phelps:

1. Development of offensive odors.
2. Formation of black sediment or residue.
3. Reduction in amount of dissolved or free oxygen.
4. Reduction in amount of available oxygen.
5. Increase in carbonaceous (oxidizable) matter.

Putrefaction and fermentation have general characteristics in common. Both involve decomposition of large molecules, and both yield products which are useful to the cell. Both yield energy but the amount may be much greater from fermentation of carbohydrates. From a practical viewpoint development of offensive odors, is important. They cause nuisances when they result from decomposition of sewage in streams and make it necessary for cities to construct sewage-treatment plants.

Anaerobic bacteria are especially destructive of proteins, so much so, in fact, that many of them are called putrefactive anaerobes. Their physiological economy is such that they have

to decompose great amounts of food in order to secure energy. Aerobic bacteria leave much of their food incompletely oxidized in large molecules which still contain much energy (acetic acid, lactic acid, acetone, and so on), whereas anaerobic bacteria oxidize completely to CO_2 , H_2O , NO_3^- , SO_4^{--} and thus get practically all of it.

Decay or Aerobic Decomposition of Proteins. Decay is a term used to signify aerobic decomposition of proteins. It differs from putrefaction mainly by the state of oxidation in which the products are left. Since decay is an aerobic process, the products are completely oxidized to stable conditions. Where hydrogen sulfide is a product in putrefaction, the sulfur would appear as SO_4^{--} in decay, and ammonia as nitrates.

It is important to point out, without reviewing the experiments, that bacteria are unable to decompose pure native proteins. By this is meant pure washed proteins such as edestin and zein, which have been prepared by most careful technic and added to pure inorganic media. It seems necessary that simpler substances be present for the initial energy and growth requirements of the microorganisms. When growth has started, sufficient enzymes are secreted with which the protein molecules are decomposed. Experimental evidence is also available to show that peptones and proteoses are just as resistant as are proteins.

Decomposition of Protein Split Products. Proteins are such complex substances that many so-called split products, or decomposition products, are possible. Proteoses and peptones may be decomposed into amino acids and a host of other compounds. The protein molecule breaks down through the following stages: Proteins, proteoses, peptones, polypeptides, and amino acids. Destruction of a number of these compounds in bacterial metabolism has been discussed in several different places in this book. Since certain products resulting from putrefaction of amino acids are used by bacteriologists for following bacterial changes in media, it is proper, perhaps, that their origin be explained. We may be concerned with the products of just those amino acids of special interest to bacteriologists; such as tyrosine and tryptophane.

Before we discuss decomposition of specific amino acids, however, some of the general reactions by which all may be decomposed might be given.

Chemistry of putrefactive changes was studied in the early days by bacteriologists interested especially in intestinal bacteriology. Straight-chain acids are among the first to be attacked. The basic chemical reactions are as follows:

1. *Deaminization (Deamination)*. This reaction results in the formation of fatty acids and ammonia. A fatty acid is secured with no reduction in the number of carbon atoms. The reaction may be illustrated with one of the simplest amino acids, glycocoll (glycine).

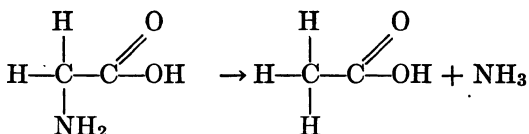

2. *Decarboxylation*. In this reaction the chain is shortened since a carbon atom is removed. The products are carbon dioxide and an ammonium base. Many of the amines isolated from putrefaction mixtures by early chemists originated in this manner. The allegedly poisonous properties of such mixtures were attributed to these amines. The reaction may be illustrated with glycocoll.

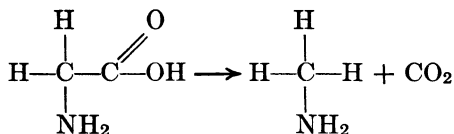

3. *Combined Decarboxylation and Deaminization*. Harden pointed out that the aminodicarboxylic acids are subject to decompositions of combined decarboxylation and deaminization. The products are monobasic nonnitrogenous acids. Harden illustrated the decomposition with aspartic acid.

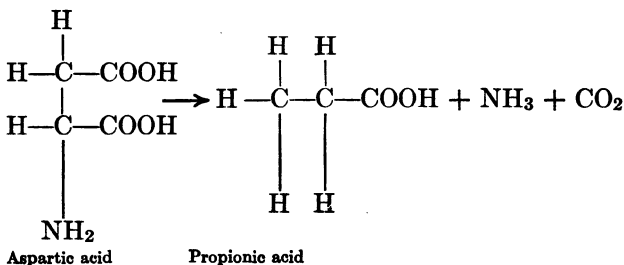

4. *Oxidation of a Fatty Acid.* This reaction results in a shorter chain also, since the products are carbon dioxide and water. It may be illustrated with acetic acid.

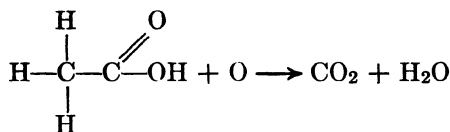

Oxidation of an amino acid might take place as follows:

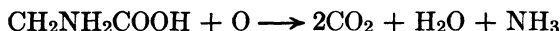

Putrefaction is characterized by formation of various malodorous compounds. Some of them originate in amino acids. Among them indole has a prominent place. Its formation may be shown as follows:

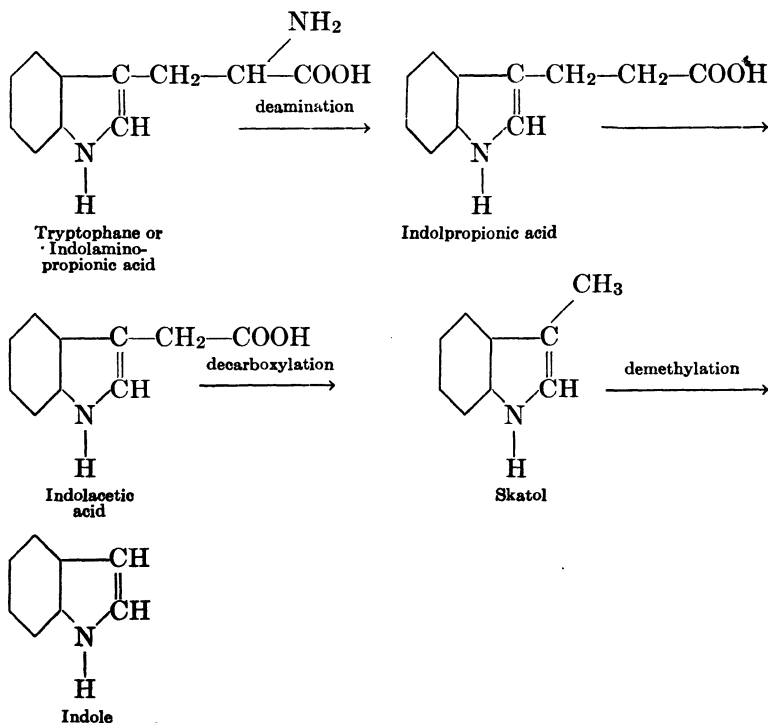

Another amino acid usually thought of in putrefaction is tyrosine. The end product in putrefaction of tyrosine is phenol. This

amino acid also gives compounds on decomposition which are malodorous.

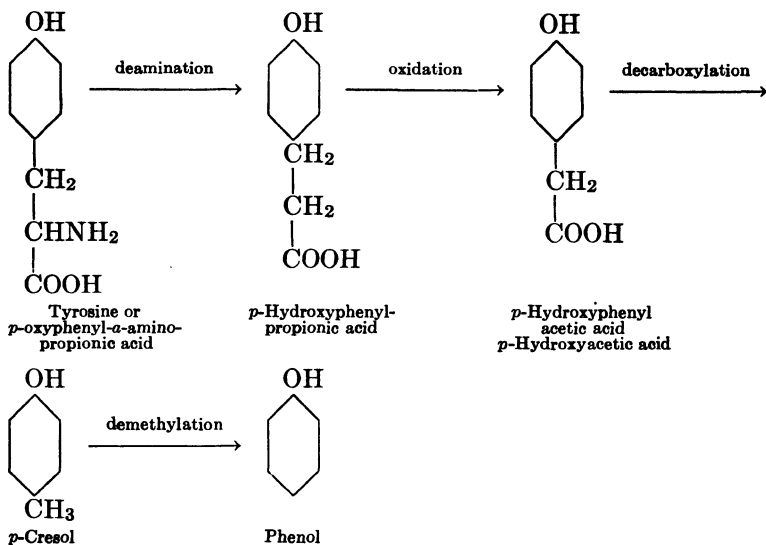

Summary of Nitrogen Cycle. Nitrogen is forced through its cycle by different forms of life. Of these, bacteria are especially important. Nitrogen makes up 80 per cent of the atmosphere; this nitrogen is available for plant life after it has been fixed by bacteria. Plants may be eaten by animals and the nitrogen either built into animal protein or excreted as ammonia, urea, and similar products. Or if plants are not eaten, their bodies fall to the earth where nitrogen is liberated by putrefaction, denitrification, and so on. In all the changes discussed under the nitrogen cycle, much energy is involved, although nitrogen compounds are generally looked on as growth foods rather than energy foods.

THE SULFUR CYCLE

Sulfur is in a different category from nitrogen. Plants need but a small quantity; and there is enough in ordinary soil for crop requirements, so that there is no problem in maintaining an adequate supply. The sulfur cycle has some points in common with the nitrogen cycle and also some differences from it. Plants take up sulfates from the soil just as they take up nitrates in the

nitrogen cycle. Hydrogen sulfide, like ammonia, may be oxidized to sulfates, although the process is not known to take place in two stages as does the oxidation of ammonia. Sulfates, like nitrates may also be reduced. The sulfur cycle differs from the nitrogen cycle in that sulfur is not ordinarily found in the

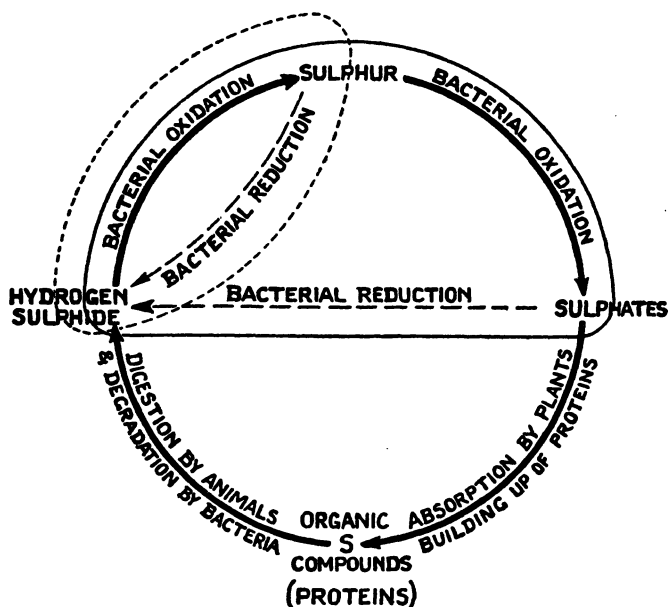

FIG. 98. Sulfur Cycle. (After Bunker, 1936)

Besides the main cycle, there are two subsidiary cycles; in one sulfates are directly reduced to sulfides without intermediary formation of organic sulfur compounds, and in the other direct reduction of sulfur to hydrogen sulfide takes place.

atmosphere. Sulfur metabolism may be discussed from the standpoint of hydrogen sulfide formation and oxidation.

Production of Hydrogen Sulfide. This is a common product of putrefaction, and its odor along with the odors of other reduced compounds gives putrefaction its bad reputation. Formation of this substance takes place in two ways. It may be formed from protein by hydrolysis or by reduction of sulfates. It is formed in the human alimentary tract and when absorbed may cause illness.

Hydrogen Sulfide from Proteins. Most of the proteins contain sulfur either in the cystine or some other linkage. When such

proteins are decomposed by bacteria under anaerobic conditions, or are putrefied, the sulfur appears in the reduced state as H_2S or $\text{C}_2\text{H}_5\text{SH}$, or thio alcohol. Considerable evidence indicates that hydrogen sulfide results from protein decomposition. It is one of the products contributing to the odor of spoiled eggs; it is also formed in varying amounts in Limburger cheese. The mechanism of hydrogen sulfide formation from cystine was explained by Tarr by formation of two molecules each of hydrogen sulfide, ammonia, acetic and formic acids; the formic acid was believed to decompose further to hydrogen and carbon dioxide.

Hydrogen Sulfide from Sulfates. Reduction of sulfates to hydrogen sulfide is not a common characteristic among bacteria. It seems to be a more restricted characteristic than reduction of nitrates. Only a few organisms have been found which reduce sulfates. Beijerinck and van Delden described two species, *Spirillum desulphuricans* and *Microspira aestaurii*. A little thought

will indicate that sulfate reduction involves removal of oxygen from an SO_4^{--} group. This oxygen has to be used for oxidizing some organic substance. Van Delden showed this by using sodium lactate as an example. The following equation was suggested:

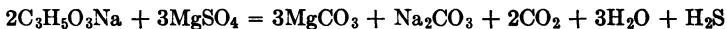

Another especially interesting sulfate-reducing bacterium has been described by Elion. He named it *Vibrio thermodesulfuricans* because it reduced sulfur and was thermophilic. It was said to form hydrogen sulfide overnight, whereas the other two organisms required four or five days. This is characteristic of thermophilic bacteria, for their higher temperature relations cause them to drive reactions more rapidly.

Oxidation of Hydrogen Sulfide. Hydrogen sulfide is oxidized by bacteria, according to the following equation, to water and free sulfur:

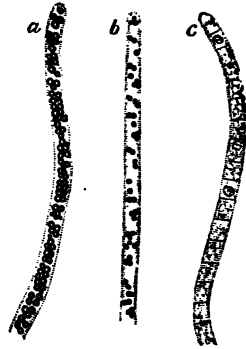
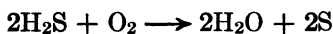
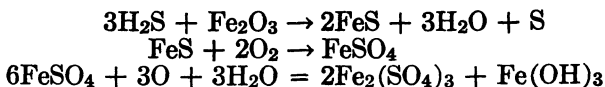

FIG. 99. *Beggiatoa alba*.
(After Beijerinck)

a, Filled with sulfur; b, the sulfur partly used up by the lack of the presence of sulfur in the environment; c, the cells almost free from sulfur.

Fowler stated that this change was hastened by the presence of certain metallic oxides. He gave the following equations, using iron to show the steps in the oxidation:



Oxidation of Sulfur. Sulfur may be oxidized by bacteria to sulfuric acid. Beijerinck and Jacobsen described two species: *Thiobacillus thioparus* and *Thiobacillus denitrificans*, which

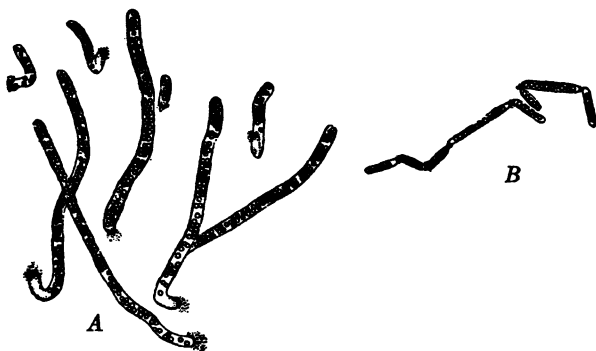
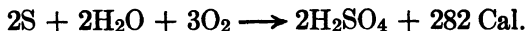

FIG. 100. *Thiothrix nivea*. (After Winogradsky)

A, Threads; B, *Thiothrix tenuis*, threads. Note that the threads are firmly attached to the substratum by means of the sucker (at the lower side).

oxidize sulfur, sulfides, and thiosulfates. In the United States Waksman has reported *Thiobacillus thioxydans*, which could oxidize elementary sulfur to sulfuric acid. It is especially interesting because it is able to live in an acid medium of pH of 0.6 or less.



Sulfur oxidation is an aerobic process yielding energy for the organism which carries it on. Such organisms are autotrophic, requiring no organic matter for growth. They are important in soil, for they help to dissolve the inorganic matter by means of the acid which they form. This is well illustrated by composting of sulfur, rock phosphate, and soil. Sulfuric acid formed by sulfur-oxidizing bacteria dissolves the rock phosphate and makes it available for plants.

Another type of sulfur oxidation is possible with *Thiobacillus denitrificans*. This organism is interesting because it is able to oxidize free sulfur without an abundant supply of free oxygen. The oxidation is carried out as follows:

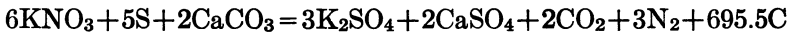

Oxygen is taken from potassium nitrate and used for oxidation of sulfur. The sulfate ion which is formed is neutralized by the calcium carbonate.

Oxidation of sulfur has been called sulfification by some soil bacteriologists. This is not a good term, since the Latin words really mean "the making of sulfur." However, since names are only convenient labels for things and processes, this name is as good as any if everyone uses it.

It is significant to point out that the sulfur dioxide formed by oxidation of sulfur may be changed to sulfuric acid which may react with bases to yield sulfates. This has been used by soil biologists to render insoluble compounds available as plant foods. Compost heaps have been made containing insoluble rock phosphate [$\text{Ca}_3(\text{PO}_4)_2$] and sulfur. The latter was oxidized to sulfuric acid which charged the calcium phosphate to calcium sulfate and soluble phosphoric acid.

Sulfur Bacteria. The term "sulfur bacteria" is generally used for a group of higher bacteria which are especially active in changing sulfur. In the wide sense, any bacterium which changes the state of oxidation of sulfur would be a sulfur bacterium. A discussion of the so-called sulfur bacteria is not necessary here beyond a brief characterization to distinguish them from Eubacteria. These sulfur bacteria are divided into several genera which may be discussed.

Beggiatoa. This genus is characterized by long filaments which are actively motile. The interior of these filaments may be seen to be filled with sulfur granules when the plant is growing in the presence of sulfur. In absence of a sufficient supply of sulfur, sulfur granules within the filaments disappear; the thread also segments into many smaller units. Several species are common: *Beggiatoa alba*, *Beggiatoa minima*, *Beggiatoa mirabilis*, and *Beggiatoa media*. These sulfur organisms are found in sulfur springs and stagnant pools where organic matter is in process of putrefaction.

Thiothrix. This genus was established by Winogradsky. Its members consist of long threads and are not only nonmotile but are anchored to one spot at one end of the thread. *Thiothrix* is also characterized by a sheath which keeps the threads intact, whereas with *Beggiatoa* the filaments break up.

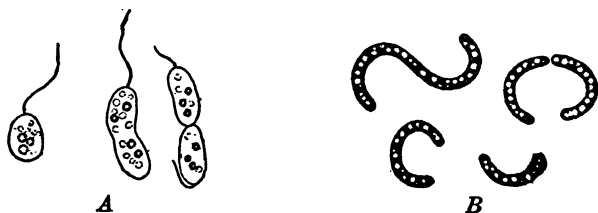
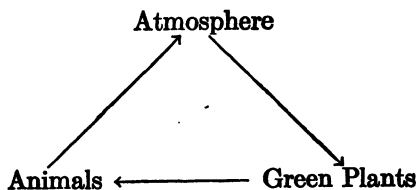

FIG. 101. A, *Pseudomonas Okenii*, Cells with Sulfur Granules. (After Warming) B, *Spirillum undula*, showing the Internal Structure of the Cells. The vacuoles are white, the chromatin granules black, and the protoplasm shaded. (After Fischer)

Nonfilamentous Sulfur Bacteria. These sulfur bacteria, represented by *Chromatium okenii* and *Spirillum volutans*, have been studied and confusingly named. They exist as free single cells. They contain a red pigment called bacteriopurpurin. They store sulfur in their cells as a reserve substance, to use only when the sulfur supply runs out in their environment.

THE CARBON CYCLE

Carbon, of course, is a constituent of all kinds of organic matter. To describe its cycle might, therefore, seem necessary. The carbon cycle may be started at one of several places. There is, perhaps, a less satisfactory starting place in the carbon cycle than in the nitrogen cycle where atmospheric nitrogen was used. The carbon cycle is much simpler or, at least, may be expressed in a simpler manner than the cycles of sulfur, nitrogen, phosphorus, and so on. However, it includes very important phenomena. Lotka stated that the organic carbon cycle reduced to its simplest form could be expressed as follows:



This illustration shows the basic living agents which are concerned with moving carbon through its cycle.

Carbon is a widely distributed element on the earth. It is found in coal and petroleum deposits combined in a great many different chemical compounds. One can scarcely imagine a world without carbon. It does not occur free in the atmosphere as does nitrogen. It is found, however, in small amounts in the

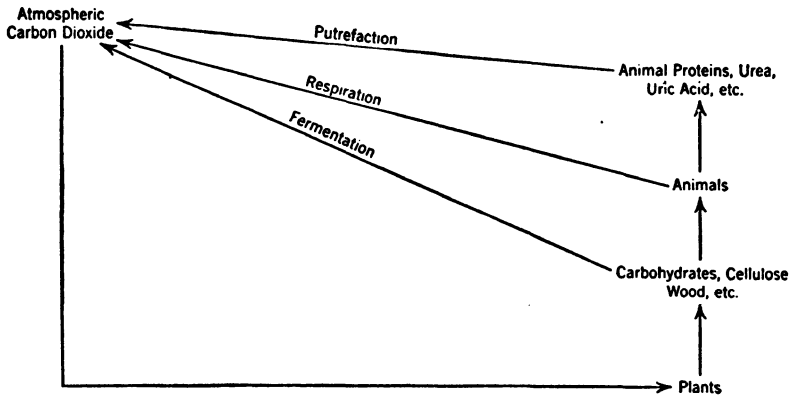

FIG. 102. Carbon Cycle.

atmosphere as carbon dioxide; Greaves stated that it existed in the atmosphere to the extent of 3 parts in 10,000, equivalent to 600 billion tons of carbon. A little thought will reveal that a constant interchange of carbon occurs between atmosphere and earth; coal, burned, is oxidized to carbon dioxide, which is poured into the atmosphere. Respiration of animals also adds small amounts of carbon dioxide. Fortunately, nature has provisions for preventing the unlimited increase of carbon dioxide in the atmosphere which would eventually destroy animal life. The compound is utilized by plants in photosynthetic reactions, and there are probably chemical reactions also by which carbon dioxide is removed from the air.

Fermentation of Carbohydrates. This is one of the important parts of the carbon cycle. Fermentation of carbohydrates removes vast amounts of vegetable debris from the surface of the earth, yields many useful chemical solvents and organic acids, and makes it possible to distinguish one species of microorganism

from another. They are called fermentation reactions and constitute one set of characteristics of a species. Fermentation of carbohydrates has made it possible to prepare many useful organic compounds. These processes are now called industrial fermentations.

Lactic Acid Fermentation. This fermentation is so called because lactic acid is a prominent product. The ability to form lactic acid is not restricted to bacteria, since this acid plays a role in the explanation of many biological phenomena. Certain bacteria, however, cause the fermentation of larger amounts. By use of the lactose molecule, the chemistry of the lactic acid fermentation may be shown as follows:

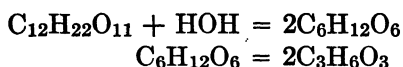

Such a fermentation is usually brought about by facultative anaerobic bacteria. The lactic acid fermentation is especially connected with souring of milk. The bacteria concerned are frequently spoken of as "lactic acid bacteria" because they form larger amounts of lactic acid than the ordinary bacteria.

The chemistry of lactic acid fermentation is interesting to those concerned with chemistry of vital phenomena. Lactic acid has an asymmetric carbon atom which permits the existence of two types of lactic acid, a dextrorotatory type and a levorotatory type. The type formed in bacterial fermentations depends on the species of microorganisms, temperature, and other factors. The typical lactic acid organism is *Streptococcus lactis* Lister; it is known under several other names.

During recent years lactic acid has been made by bacterial fermentation of sugar. It has been necessary to maintain a pure fermentation since contaminating bacteria decompose the lactic acid.

Butyric Acid Fermentation. This acid fermentation is known best by the odor of the acid which is formed. It may be expressed as follows:



This is the simplest method of expressing it but does not show all the changes. Several intermediate reactions take place. These may be added, probably, to give the equation just mentioned.

Microorganisms which are able to bring about butyric acid fermentation are numerous. The most active ones are anaerobic, as would be expected since butyric acid is an incompletely oxidized compound. *Clostridium amylobacter* is one species which forms butyric acid in appreciable amounts.

Citric Acid Fermentation. This acid is made in quantities of several million pounds per year by fermentation processes. Wehmer in 1893 first described citric acid as a metabolic product of a mold called *Citromyces* (now classified as *Penicillium*). It is now known to be produced by molds of several genera including *Aspergillus*, *Penicillium*, and *Mucor*. In 1917 Currie of the U. S. Department of Agriculture reported results of considerable fundamental research concerning citric acid production by *Aspergillus niger*. From this research the industrial fermentation process has been developed (see Chapter 22).

Alcoholic Fermentation. This is the oldest fermentation in which man has been interested. Fermentations in which the principal product is ethyl alcohol are commonly spoken of as alcoholic fermentations. Production of industrial ethyl alcohol is discussed in a later chapter. The most active alcohol-forming microorganisms are yeasts; a few bacteria have been discovered which form appreciable amounts but less than those formed by the yeasts.

Decomposition of Carbohydrates. Carbohydrates are rich storehouses of energy and building materials for microorganisms. At different places in this book, reference has been made to the action of microorganisms on sugars. The decomposition of a few sugars are considered here, and an attempt will be made to summarize the facts. Sugars are classified in different ways. One of the most usable classifications is based on the chemical complexity of the carbohydrates. In the following paragraphs decomposition of these compounds is discussed, beginning with the more complex.

Cellulose. This is one of the most complex carbohydrates; its exact chemical constitution is unknown. The term is probably a collective one applied to a large number of closely related chemical compounds. Cellulose is an important substance in nature. It is found in the cell walls of plants and often appears as structural material in the stems. Many bacteria and other microorganisms possess *cellulase* with which they are able to

bring about hydrolysis of cellulose. Some of them were studied in the early days of microbiology. Bacteria and chemical agents seem to decompose cellulose in the same manner—through several simpler sugars. In general, two groups of microorganisms are involved, aerobic and anaerobic bacteria.

Aerobic bacteria, since they are able to use atmospheric oxygen, decompose cellulose completely. Less is known about the aerobic cellulose-decomposing microorganisms than about those which decompose it anaerobically.

Early work on cellulose decomposition by anaerobic bacteria was concerned mainly with the products of the decomposition. Bacteria are known to play an important role today in decomposition of cellulose in soil, septic tanks, marshes, and so on. Omelianski, who did some pioneer work on cellulose fermentation, discussed it from the standpoint of formation of hydrogen and methane. Methane, often spoken of as marsh gas, is formed in marshes where much organic matter is being decomposed, as well as in septic tanks where the same reactions are going on. Methane is also formed in the intestines of animals by cellulose-splitting bacteria which are present. It is well to point out that ability to decompose cellulose is important so far as the carbon cycle is concerned. Those microorganisms which possess cellulase help to prevent elements from being stopped in the cellulose stage. Plant residues are decomposed to compounds which may be fermented by other bacteria. Some have predicted that cellulose fermentation will help solve the problem of a fuel for the internal-combustion engine when the gasoline supply has been exhausted.

Starch. Starch is decomposed by those microorganisms which possess amylases. These enzymes are rather widespread in nature. They bring about decomposition of starch in a gradual manner. As with cellulose, the simpler sugars are formed. The first step in the fermentation of starch is probably the formation of soluble starch and dextrin. It is believed that a little glucose is formed with each step. After dextrin, maltose is formed, and the maltose is hydrolyzed to glucose by various common bacteria. Besides these better known decomposition products, there are special ones formed by special microorganisms. These are discussed in Chapter 22. Like cellulose, starch is a rich source of energy.

Pectin. Pectins are closely related to cellulose; the term is a collective one used to designate a number of closely related chemical substances. The fermentation of pectin and pectoses is important in the decompositions on which depends the retting of flax. Pectins appear in the flax stem between the cellulose fibers. Flax is subjected to anaerobic fermentation in order to get rid of pectin binders. Pectin-fermenting bacteria also play a role in certain soft rots of plants and vegetables.

Other Carbohydrates. The disaccharides and monosaccharides are easily decomposed by most bacteria. A few seem to be devoid of enzymes with which to decompose certain sugars. The more complex sugars are always broken up into simpler sugars; the latter are fragmented to various products many of which are discussed at different places in the book.

Decomposition of Fats. Fats are another group of carbon-containing compounds which are of interest. The fats or lipids are esters of glycerol and certain organic acids. When three molecules of palmitic acid unite with one molecule of glycerol, the fat palmitin is secured, as follows:

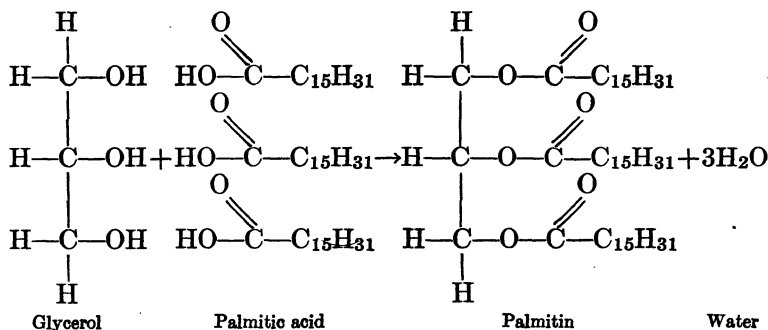

When fats are decomposed by bacteria, enzymes, or chemical reagents, they yield glycerol and fatty acids. The glycerol formed in this process is utilized by bacteria. The fatty acids are also decomposed and used by bacteria. The splitting of fats by bacteria has been offered as one explanation for rancidity of butter and other edible fats.

Cycles of Other Elements. More space has been given to the nitrogen, sulfur, and carbon cycles than need be given to the phosphorus, arsenic, and other cycles. Phosphorus is present in the soil in different forms. Many of them are insoluble in water

but are rendered soluble by bacterial activity. This may take place by the formation of acids by the oxidation of sulfur, for instance, which, in turn, decomposes the insoluble phosphorus compounds. The path which phosphorus travels in its cycle is not unlike that for the other elements. All forms of living cells help to keep the phosphorus atoms moving along their cycle.

REFERENCES

- FRED, E. B., I. L. BALDWIN, and E. MCCOY, *Root Nodule Bacteria and Leguminous Plants*, Univ. Wisconsin Press, 1932.
- GREAVES, J. E., and E. O. GREAVES, *Bacteria in Relation to Soil Fertility*, D. Van Nostrand, New York, 1925.
- LÖHNIS, F., and E. B. FRED, *Textbook of Agricultural Bacteriology*, McGraw-Hill, New York, 1923.
- LÖHNIS, F., and L. T. LEONARD, *Inoculation of Legumes and Non-Legumes with Nitrogen-Fixing and Other Bacteria*, *U. S. Dept. Agr. Farmers' Bull.* 1496, 1926.
- LOTKA, A. J., *Elements of Physical Biology*, Chapter 18, Williams & Wilkins Co., Baltimore, 1925.
- SEARS, O. H., *A Nitrogen Factory on Every Farm*, *Univ. Illinois Agr. Ex. Sta. Circ.* 326, 1928.
- SLOSSON, E. E., *Creative Chemistry*, Chapters II and III, D. Appleton-Century, New York, 1923.
- WAKSMAN, S. A., *Principles of Soil Microbiology*, 2d Edition, Williams & Wilkins Co., Baltimore, 1932.

CHAPTER 18

MICROORGANISMS IN AIR

Considerable attention was given to microorganisms in air by early bacteriologists, for they believed that bacteria in air explained many infections. Later it was shown that air did not contain many bacteria and that pathogenic bacteria were uncommon. Aerial infections were believed to explain appearance of spontaneous disease, especially those of obscure origin in which the etiologic agent was unknown. Infection through the air is possible but probably of much less importance than once believed. Whether air is important would be determined by its content of dust particles themselves. Dust particles settle rapidly and would carry bacteria with them.

Microorganisms in air have been of some significance in several phases of applied bacteriology. In industries involving propagation of living bacteria, such as those with which legumes are inoculated, it is important to use air from which bacteria have been removed. The air which enters the inoculation rooms is carefully filtered. In certain of the food industries attention has had to be given to air in order to reduce spoilage caused by molds. Mold spores are widely distributed from a focus and may cause considerable trouble.

Microorganisms Present in Air. The conditions under which experiments are carried out influence the results. Ordinary country air would probably contain a diverse flora which might include most of the common saprophytic microorganisms. These would consist mainly of the various members of the *Bacillus subtilis* group, the spores of which are resistant enough to persist for some time. Coccus forms are also abundant since plates which are exposed to air contamination often show great numbers of colored coccus forms.

Some of the earliest work on bacteriology of air was done by Pasteur who was busily engaged in disproving the theory of

spontaneous generation. In his argument with Pouchet, Pasteur maintained that air might contain cells of living organisms which his antagonists claimed developed spontaneously. Pasteur carried out experiments with flasks containing sterile media. He found bacteria in air which under certain conditions might be sterile. Furthermore, he found that the higher the altitude the smaller was the number of bacteria. This work has been repeated by many others. A contemporary of Pasteur, Tyndall, also made experiments. He opened flasks on a glacier but secured no inoculation or infection; however, flasks which were exposed to air in a hayloft were infected. Miquel's data are also quoted. One cubic foot of air in Paris was found to contain 150 bacteria; after a rain only 6 were found. A gram of house dust contained 2,100,000 bacteria.

Collections of microorganisms made by Lindbergh on a flight over the Arctic seas during the summer of 1933 were described in the January 1935 issue of *The Scientific Monthly* by Meier, who had been studying air-borne organisms. He had been especially interested in distribution of organisms which cause plant diseases. Specimens collected by Lindbergh showed that air currents might spread spores of pathogenic fungi. On one slide, exposed far north of the Arctic Circle at an altitude of 3000 feet, many different types of objects were observed. From this work, Meier believed that air currents might spread spores which would cause plant diseases.

Press reports of experiments carried out during the summer of 1935 with the co-operation of the Army Air Corps indicate that air is free of bacteria at heights of 20,000 feet.

Twelve plates were exposed, the first at 19,000 feet and the others at intervals of 1000 feet. Two plates were exposed between 26,000 and 27,000 feet.

Ten of the plates showed no bacteria. One exposed at 24,000 feet and another at 26,000 feet, however, each revealed one colony of staphylococcus, a contamination. Similar experiments were carried out in Cambridge, England, results of which were published in 1929. The object of these experiments was to determine how diseases of plants can be spread through the upper atmosphere. The highest altitude at which observations were made was 13,000 feet. Air in summer was found to be more heavily charged with bacteria than air in winter. These investigators reported air to be quite heavily charged with bacteria even at altitudes which other investigators had found to be relatively free. It was believed that diseases of plants might be spread by air currents.

Meier and Lindbergh¹ exposed plates at distances above 20,000 feet up to 28,000 feet. Staphylococci were found on two plates (24,000 and 26,000 feet), but they were believed to be due to contamination. Walker believed that the atmosphere from 20,000 to 28,000 feet is sterile.

Stevens and Anderson also collected data pertinent to this discussion on their famous stratosphere flight over South Dakota on November 11, 1935. They attained the highest altitude ever reached by man, 13.71 miles above sea level. The stratosphere is a "region of cold, clear, thin, dry air, always sun-bathed during daylight hours and usually free from appreciable amounts of dust."² The behavior of spores of fungi in the stratosphere was studied in two ways. Spores of seven species of fungi were carried in quartz tubes fastened to the outside of the gondola. The tubes were open at both ends and plugged loosely with cellulose yarn. In general, vitality of the spores was not impaired; quantitative results were not reported. A special apparatus was also taken aloft to determine presence of spores of fungi. The device was released at 70,000 feet. This work showed the presence of members of the genus *Bacillus* and molds. Ten organisms were reported to have been collected from the region above 36,000 feet. It was suggested that bacteria and fungi may be distributed in this manner, for they might be carried great distances in the stratosphere.

Important studies on the bacterial content of air have been made in connection with production of milk with a low bacterial content and the relation thereto of bacteria in stable air. Investigators at the New York Agricultural Experiment Station found between 50 and 200 bacteria per liter of air.

Although the foregoing discussion is important, the actual content of bacteria in air in rooms in which we live is more pertinent. Much work has been done in the past few years and has shown that pathogenic bacteria may be present in air around individuals who are infected with these bacteria. This has been the case with hemolytic streptococci which cause puerperal fever, scarlet fever, and similar infections. Streptococci were found to be more prevalent in schools and subway cars in New York City

¹ Fred C. Meier and Charles A Lindbergh, Collecting Micro-Organisms from the Arctic Atmosphere, *Sci. Monthly*, 40 (1935), 5-20.

² *Nat. Geo. Mag.*, May 1936, p. 705.

than in other places. These are places where individuals are more crowded. Such information emphasizes the necessity of good ventilation and the possibilities of respiratory infections from overcrowding. It is also confirmed by experiments carried out with animal colonies. Healthy animals placed in the same room as but apart from infected animals have shown considerable infection.

Relation of Dust to the Presence of Microorganisms in Air.

Because dust particles may often be seen in the air, many persons have connected them with the dissemination of harmful bacteria. The relationship seems to be very indirect, if there is any at all. Here again the kind of dust is the important influencing factor.

In the investigations of the bacterial content of stable air, already referred to, attention was given this phase of the discussion. One paragraph may be quoted.

In order to get a much higher germ content in the air than occurred in the air of the station stable even under the worst of the normal conditions, a large number of tests were made in the stable loft. Here it was easily possible, by sweeping up debris from the floor, to secure dusty conditions which were as bad as the worst possible conditions obtainable to commercial dairies. When a heavy dust was raised at the beginning of each test, the germ content of the air was usually between 1000 and 2000 per liter, with an average of 2068, a minimum of 239, and a maximum of 5200 per liter. When the dust was maintained continuously throughout the test, the numbers obtained in the completely satisfactory determination average 9575 bacteria per liter of air, with a minimum of 960, a maximum of 28,200, and a usual range from 2500 to 10,000 per liter.

There need be no direct relation between the amount of dust and the number of bacteria. Some dust might be sterile; other dust might be heavily laden with microorganisms.

Winslow and Kligler reported 49,200,000 microorganisms per gram in street dust of New York City and only $\frac{3}{5}$ millions per gram in indoor dust. The flora of street dust included 51,000 color organisms and 42,500 streptococci. Whipple, who studied the relation of dust to bacteria in air of cities, found great variation, depending on the place where the samples were collected.

Many different physical and chemical factors influence the longevity of microorganisms on dust particles. One investigator stated that vitality was directly proportional to the size of the particle. The smaller the particle the more rapid the death rate.

Moisture and sunlight were especially important. The effect of these agents would be greater on smaller particles. It is probable that our ideas on this subject may have to be modified. One investigator has reported presence of many streptococci in the air of schoolrooms, theaters, and the subway in New York City. It was concluded that streptococci were widely distributed in air both in enclosed places of congregation as well as in the open spaces of a large city. Other investigations at Harvard University have shown that droplets such as those expelled from the mouth and nose may exist as such for some time in the air and be carried about by currents. As these droplets become smaller and smaller by evaporation, solids increase, and they function more as particles of solid matter. Should microorganisms be present, they might be disseminated in this manner. These developments have suggested the necessity of active efforts to control the sanitary condition of air by filtration and by use of ultraviolet light. The latter attempt has not enjoyed the success which was expected. It has been possible to destroy some of the least resistant organisms, but those which are more resistant have not been killed. *Escherichia coli* is apparently easily destroyed.

Various practices have been introduced for reducing the number of dust-borne bacteria in air where large numbers of individuals have collected, as in air-raid shelters, classrooms, hospital wards, and theaters. Oiling the floors was found to reduce immediately the amount of dust and bacteria, among the latter of which were undesirable species. One investigator observed that nasopharyngeal contamination of air could be measured by enumeration of streptococci and that these counts were an index of crowd density. Streptococci were especially high in February when respiratory infections are most common.

Microorganisms in Droplets. Presence of viable microorganisms in droplets of saliva and mucous suspended in the air has revived interest in the possibility of dissemination of diseases by air. Such droplets do not necessarily settle to the ground as was once believed. Whereas it was formerly believed that air played a minor role in spreading infections, it is now known that it might be important.³ Striking demonstrations have shown that sneezing, coughing, and even ordinary speaking project large

³ L. Buchbinder, The Transmission of Certain Infections of Respiratory Origin, *J. Am. Med. Assoc.*, 118 (1944), 718-30. (This is a review.)

numbers of microorganisms into the atmosphere. Wells observed that these droplets may dry to a nucleus in which bacteria may live for a long time. Since they are carried about by air currents, they may infect other individuals. This has been shown to be possible by examination of air in large halls where many individuals were in attendance. Air of churches and school buildings has yielded many bacteria.

Cleaning and Disinfection of Air. Cleaning of air is necessary in certain industries to prevent introduction of dust or microorganisms which might spoil the products manufactured.

Filtration. This is the simplest method of removing objectionable matter from air. Although air filters were introduced into certain industries to remove dust and objectionable vapors, they are now used to remove microorganisms. Various substances have been used, ranging from ordinary screen wire and cheesecloth to the modern materials, glass wool and other inert materials. Adhesives are used in some of these materials to give a better filtering medium. Air filters are very important in manufacture of biologicals, such as antitoxins, penicillin, and bacterins; in the paper-products industries; in the manufacture of legume inoculation, and in oleomargarine industry, to prevent ingress of objectionable microorganisms.

Chemical Disinfection. This is attempted by what are called germicidal mists, or aerosols, and vapors. Liquid aerosols have been said to consist of droplets from 1 to 2 microns in diameter. Larger particles settle quickly. Each droplet of the aerosol contains the same concentration of effective chemical substance as the parent solution. Many chemical compounds have been studied, among which propylene glycol and related glycols have been found to be especially effective. Other agents which have been found to possess considerable value are formalin and the chlorine compounds. Ozone in concentrations which human beings can endure has not been effective against air-borne infections.

Ultraviolet Light. This is a very toxic form of energy when it can reach cells of microorganisms. Quite favorable results have been reported by irradiating air in hospital wards and operating rooms. Results have been influenced by various factors such as the type of bacteria, humidity, and length of exposure period. Results of experiments in operating rooms have been

especially satisfactory. Ultraviolet irradiation has not been accepted by health authorities for disinfecting air in schools, waiting rooms, public gathering places, and large halls, despite the fact that under certain experimental conditions it has been shown to destroy pathogenic bacteria. No evidence has been collected to indicate that incidence of colds, for instance, can be reduced by irradiation of an enclosure occupied by people. In fact, harm might result to a person from prolonged exposure to such irradiation, as has been pointed out. Wider use of ultraviolet light in the food industry has been suggested. Deterioration of bakery products by molds has been reduced by irradiation, and meats have been treated during aging in the cooler. Opinion is not in agreement as to the practical results obtained.

Cleaning Efficiency of Vacuum Sweepers. The vacuum sweeper is a valuable contribution to homemaking as far as the removal of dust and dirt is concerned. Not much work has been done on the ability of these instruments to change the bacterial population in a room. Frost and Armstrong in 1911, worked with both the ordinary portable types and with those permanently installed. The latter were said to be more consistently efficient; the portables were found to vary greatly in efficiency. In the permanently installed types the exhaust takes the bacteria out of the room, and, if this exhaust is properly located, they become of no significance. A different situation exists with the portable types. The bacteria are removed from the room but are entrained in a bag of varying efficiency. In most cases Frost and Armstrong stated that it was impossible to prevent the bacteria from getting back into the room since, in some of the machines examined, the bacteria passed through the cloth bag very rapidly. These investigators used *Serratia marcescens* as the test organism. Some manufacturers of vacuum sweepers have exploited their machines as "air purifiers," quoting bacteriological data to support their arguments. These machines are dirt removers and should not be endowed with powers which they do not and can never possess.

REFERENCES

- EYRE, J. W. H., Vacuum Cleaners, *Public Health Med. Off.*, **39** (1928), **3**.
FROST, W. D., and V. ARMSTRONG, The Cleaning Efficiency or Sanitary Value of Vacuum Cleaners, *J. Infectious Diseases*, **9** (1911), 265-75.

- REUHLE, G. L. A., and W. L. KULP, Germ Content of Stable Air and Its Effect upon the Germ Content of Milk, *N. Y. Agr. Exp. Sta. Bull.* 409, 1915.
- WHIPPLE, M. C., The Results of Studies upon the Dust and Bacteria Content of the Air of Cities, *Am. J. Pub. Health*, 5 (1915), 725-37.
- WINSLOW, C. E. A., Air and Health—Ventilation, Chapter VII, in *Public Health and Hygiene*, by W. H. Park, Lea & Febiger, 1920.
- WINSLOW, C. E. A., and W. W. BROWNE, The Microbic Content of Indoor and Outdoor Air, *Monthly Weather Rev.*, 42 (1914), 452.
- WINSLOW, C. E. A., and I. KLIGLER, A Quantitative Study of the Bacteria in City Dust with Special Reference to Intestinal and Buccal Forms, *Am. J. Pub. Health*, 2 (1912), 663.

CHAPTER 19

WATER BACTERIOLOGY

Water is often the first thing to be blamed in a community or family when an unusual amount of sickness appears. Often this is done without adequate investigation. An abundant supply of safe water is one of the greatest benefits that may be bestowed on a city. The great cities of the United States owe their locations today, in many cases, to an abundant supply of water; for quantity must be considered first, quality after. Rome, during the Golden Age of her history, is said to have used 400,000,000 gallons of water a day in her baths, fountains, and cisterns. Marvelous aqueducts, some of which are being used today, brought this water to the city where it was stored in large basins and pools. After the water had been brought to the city, however, it was necessary to carry it to the homes. Ancient Rome did not have the great distribution systems possessed by modern cities. The water works of the present day are far more complex. We have expensive treatment plants, pumping stations, and distribution systems that are marvelous for their utility.

Definition and Types of Water. From the standpoint of the relation to disease and illness, water is classified and described in different ways. It will be profitable to define some of these terms insofar as definitions are possible. *Pure water*, from the standpoint of health, is water which contains no disease-producing bacteria or other harmful matter. *Safe water* is water which has enjoyed a good reputation for some time and which yields good results on laboratory examination. An *impure water* has been defined as water which contains either substances or organisms which will disturb the functions of the body and cause illness. *Contaminated water* is water which contains sewage. It is not necessarily harmful but is potentially dangerous. *Infected water* contains disease-producing bacteria. These are a few of the terms which have crept into usage; they are, of course, somewhat arbitrary and impossible to define without overlapping. The

consumer desires to know whether the water is safe for drinking, and he cares little about the different terms that may be used. From this it may be concluded that water may be *undesirable* because of turbidity, taste, or odor, and *unsafe* because of the presence of bacteria or harmful mineral ingredients.

Transmission of Diseases by Water. The relation of impure water to disease dissemination needs no special emphasis today. This relationship has been recognized since early times. Two factors are involved: (1) The possibility of pathogenic bacteria entering the water supply, and (2) their ability to develop or remain viable long enough to reach the consumer. If a bacterium cannot grow in water and dies quickly, water will not be important in spreading the disease which the organism causes. Water-borne diseases are, in general, intestinal diseases, the most common of which are typhoid fever and cholera. Under ordinary conditions in the United States cholera is of little importance. It is a disease whose focus is in India and which spreads along the Mediterranean trade routes.

Typhoid fever is the disease which sanitarians have fought for many years in the United States. Although its incidence has been greatly reduced, it has not been stamped out. In a sense, we have had to learn to live with it because it is endemic. When it is caused by water, it means that the water supply has received sewage pollution, or, to express it in another way, a case of typhoid fever indicates that excreta of another individual has been swallowed. This individual may have been a patient with symptoms of typhoid fever, or he may have been a carrier.

The ancients recognized the danger of polluted water and adopted measures to prevent it. Hippocrates, 300 B.C., advised boiling of some waters before use. Alexander during his military campaigns is said to have carried large metal containers of drinking water. The ancients recognized the danger of water which had been conducted through lead pipes. The Romans also recognized the different sanitary qualities of water brought to Rome by the several aqueducts. The best water was used for household purposes. One supply was so bad that it was used only for irrigation and flushing. The Romans also purified water by settling in reservoirs.

Longevity of Disease Producing Bacteria in Water. The length of time that disease bacteria live in water is of great impor-

tance. If organisms do not live long, the danger is somewhat lessened; on the other hand, if an organism not only lives for a long time, but also multiplies, the danger is greater. Probably most bacteria concerned with the so-called water-borne diseases are not very viable in water and die out in a short time. Too long a discussion would be required to analyze the situation for all diseases which may be caused by water-borne bacteria. Consequently we focus attention on typhoid fever and its etiologic agent, *Eberthella typhosa*.

It may be stated that *Eberthella typhosa* probably does not live in natural waters beyond a few weeks. Data from several experiments indicate a much shorter time. This organism also seems to live longer in clean water than in water heavily laden with organic matter. The longevity of this bacterium has been studied in investigations on stream pollution. Most of the results agree that the organism does not multiply in water but decreases, so that it would not be expected in water that had been polluted in the remote past. Less information is available for the other bacteria; however, for those bacteria which are allied to *Eberthella typhosa* results would probably not differ greatly. Certainly such microorganisms as *Corynebacterium diphtheriae*, and *Neisseria gonorrhoeae* would die out very quickly, for they are unable to endure unfavorable conditions.

Evidence of Pollution. How are we to know that water is polluted and unsafe for drinking? It is easy to formulate definitions and standards, but somewhat more difficult to apply them for judging quality of a water, and equally difficult to apply them and to interpret the results. The layman is led to doubt the safety of his water supply only when it has some very evident abnormal characteristic such as a bad odor or turbid condition. If it is clear and cool, he may be satisfied; and yet such water may be most dangerous. The sanitarium, however, uses sounder criteria for judging quality. He knows that water possessing all criteria of high quality, such as coolness, clarity, and tastelessness, may be most dangerous. He appreciates the fact that laboratory examinations may be necessary to detect the most dangerous type of contamination. It will be profitable now to discuss briefly those laboratory tests which are made in the examination of water and to secure the bases for the interpretations which the sanitarian makes.

METHODS OF WATER EXAMINATION

These may be applied to a water supply at its source, or the water may be examined later in the laboratory. Both are used where absolute safety must be assured.

Sanitary Inspection. This involves the use of common sense in judging the quality of water. Few would expect that the water in a river receiving much sewage would be safe for drinking, or that water from a shallow dug well in a barnyard could be classed as a safe water. It would be quite unnecessary to go to the expense of having a laboratory examination. In these instances one would expect evidences of pollution. However, there may be cases where evidences of pollution are not so apparent and where a *sanitary inspection* by a qualified engineer or sanitarian might reveal possible sources of pollution which could be corrected before the laboratory examination was attempted. Thus it may be seen that sanitary inspection should precede laboratory examination of water if information on quality is sought and that it is usually best to leave it to an experienced individual.

Chemical Methods. These include what are known as the sanitary chemical methods for the examination of water. We will present only the arguments on which the chemist bases his methods and interpretations.

Turbidity, Color, and Odor. A good drinking water should, along with other requirements, be *odorless, colorless, and tasteless*. These determinations are the first that were used by man in judging the quality of a water supply. He learned in a general way that illness might follow the use of a water with unsatisfactory characteristics and probably began to exclude such waters. Such tests are often spoken of as organoleptic tests and are among the first used by analysts. The objections to this type of examination are apparent.

Hardness. A hard water is undesirable and may cause severe intestinal disturbances among people not accustomed to it. There are a few data which suggest that the continued use of hard water may be harmful.

Chlorides. Urine contains about 5000 parts per million (milligrams per liter) chlorine as chlorides, and consequently a high amount in water is suggestive that sewage has entered the water. This determination has to be interpreted with care, however, since salt deposits or ocean sprays may cause increased amounts of chlorides.

Reaction. Most waters are alkaline, and this test is usually spoken of as alkalinity determination. An acid water may indicate undesirable conditions somewhere and should be investigated. Industrial wastes are frequently acid.

Oxygen-consuming Capacity. As the term indicates, this refers to the amount of oxygen required to oxidize the organic matter in the water. Generally speaking, this will indicate the amount of sewage which has reached the water.

Ammonia, Free. This is ammonia which is in free or saline conditions. A high amount of free ammonia may indicate much sewage, although there are often other circumstances which explain it.

Ammonia, Combined. This nitrogen is combined in undecomposed compounds. This determination generally indicates the amount of decomposing matter.

Nitrites. A high amount of nitrites may indicate pollution or that decomposition is active. It indicates more remote pollution in respect both to time and distance than the ammonia determination.

Nitrates. High nitrogen as nitrates indicates that much organic matter has undergone decomposition and that considerable time has elapsed for oxidation of reduced nitrogen to oxidized nitrogen.

Bacteriological Methods. These are more direct and concern those agents in water, the bacteria, which are directly concerned with disease. Attempts are not made to determine presence of individual specific disease-producing bacteria. Too much time would be consumed in making the examination, and negative results would be meaningless because available methods of analysis are not perfect. Furthermore, if the methods were always reliable and it could be proved that pathogenic bacteria were absent, the results would hold only for the time when the samples were collected. A water supply might be polluted soon after it had been shown to be free from undesirable bacteria. For these reasons and others discussed in the following paragraphs, attempts are made to determine whether a water supply can at any time receive sewage pollution. Polluted water supplies are always potentially dangerous. In densely populated areas, no surface water is safe for drinking without treatment. Such waters may cause various diseases which have become known as water-borne diseases. Typhoid fever is best known in the United States. It is easy for natural bodies of water to become infected. Rivers and lakes often receive untreated sewage and drainage from polluted land areas. Presence of typhoid "carriers" in the general population makes such pollution very significant.

Escherichia coli—the Indicator of Pollution. This organism has become significant in sanitary work where it serves as an indicator of pollution of foods and water. Its presence indicates not that these materials necessarily contain pathogenic bacteria

but that they may contain them because routes of pollution exist through which harmful bacteria may be acquired. For instance, if *Escherichia coli* is present in a food or beverage, *Eberthella typhosa* may at some time use the same channel. That is the sanitary significance of *Escherichia coli*, which explains why it is searched for rather than *Eberthella typhosa*. There is just a little more to the story. Bacteriological methods for isolation of *Eberthella typhosa* are not thoroughly reliable. If they were, they might not mean much because it takes about two weeks for typhoid fever to appear after infection. Isolation of the organism would be significant only for the time when the sample was collected. It is better, therefore, to determine whether pollution is possible and to apply measures to prevent it than to rely on results of laboratory examinations for specific microorganisms. In general, what has been said for water holds for foods.

Escherichia coli, was discovered by Escherich in 1884, in the feces of a cholera patient, and was at first thought to be the cause of the disease. Further work indicated, however, that it was also present in the intestinal tracts of normal individuals. Because of its presence in fecal matter, its presence in sewage was admitted. When it was found in water or on foods, it was agreed that such food or water had been in contact with sewage or fecal matter. *Escherichia coli*, in this manner, secured its reputation as an indicator of pollution. It was used for a number of years, until reports began to be made that the organism, or one very much like it, was being isolated from water and foods which were known to have a clean history and not to have received evident contamination with sewage or fecal matter. Filter operators and others concerned with the treatment of water asked bacteriologists how they could use an organism as an indicator of pollution, which at times could be found in water known to be clean. This caused bacteriologists to seek information for either defending their position or correcting their methods of analysis and standards.

They sought to answer the question in a very logical and reasonable manner. They decided to isolate from various known sources of pollution such as sewage and excreta from different animals a series of cultures for intensive study, to determine whether these strains possessed characteristics which separated them from apparently similar organisms of other sources.

Another series of cultures was isolated from unpolluted sources such as grain heads and mountain streams. Then, an intensive study was made of both series, and the results were compared. This indicated that bacteriologists had been working with and confusing two very closely related organisms. It may now be profitable to outline briefly the several steps used in the separation of these two organisms. These have resulted in the establishment of two types which are often spoken of as the *grain type*, representative of unpolluted sources, and the *fecal type*, representative of polluted sources. The former, the grain type, became known as *Aerobacter aerogenes*, and latter, the fecal type, as *Escherichia coli*.

The *first* step in the differentiation of these two types was to determine the ratio of the amount of hydrogen formed to the amount of carbon dioxide. The fecal type, *Escherichia coli* formed equal amounts of carbon dioxide and hydrogen. The nonfecal or grain type, *Aerobacter aerogenes*, formed twice as much carbon dioxide as hydrogen. Although this method was an accurate and usable one for research work, it was not suitable for routine work where results are desired as quickly as possible without long laborious technic.

The *second* step involved the discovery that the fecal type, *Escherichia coli*, produced a higher¹ hydrogen-ion concentration than did the nonfecal or grain type, *Aerobacter aerogenes*. An indicator similar to those used in the chemical laboratory is used for following the hydrogen-ion concentration of the cultures. An indicator had to be selected which changed color at that point on the scale where these two organisms functioned. Methyl red was selected, for it was deep red at a hydrogen-ion concentration produced by the fecal type (*Escherichia coli*) and yellow at a hydrogen-ion concentration produced by the grain or nonfecal type (*Aerobacter aerogenes*). Once this was established with pure cultures of known origin, the indicator could then be used for classifying unknown strains.

The *third* step in the differentiation of these two types of organisms is based on formation, or lack of formation of acetylmethylcarbinol. Demonstration of the presence of acetylmethylcarbinol has become known as the Voges-Proskauer reaction. It is carried out by putting a little sodium hydroxide into a buffered dextrose

¹ More acid.

broth tube in which the organisms have grown. The formation of a red color is a positive Voges-Proskauer reaction; no change in color indicates a negative reaction. By studying bacteria from two sources, unpolluted and polluted, it was shown that the fecal type, *Escherichia coli*, was Voges-Proskauer (-) minus and that the nonfecal or grain type, *Aerobacter aerogenes*, was Voges-Proskauer (+) plus.

These characteristics may then be summarized in the following manner:

FECAL TYPE <i>Escherichia coli</i>	NONFECAL OR GRAIN TYPE <i>Aerobacter aerogenes</i>
1. Found in feces, etc.	1. Found in grains, etc.
2. Forms equal amounts of CO ₂ and H ₂ in lactose broth.	2. Forms twice as much CO ₂ as H ₂ in lactose broth.
3. Causes a higher hydrogen-ion concentration.	3. Causes a lower hydrogen-ion concentration.
4. Methyl red +, Voges-Proskauer -.	4. Methyl red -, Voges-Proskauer +.

This tells us how *Escherichia coli* became an indicator of pollution and the things which one must keep in mind when water is examined for it. *Escherichia coli* does not ordinarily produce disease when taken into the intestinal tract. Its presence in water indicates the presence of sewage or other undesirable matter. When *Escherichia coli* is present, *Eberthella typhosa* may be present, for both these organisms may be found together in sewage when the sewer has received excreta from a typhoid patient. Consequently, when *Escherichia coli* is present, *Eberthella typhosa* may use the same channel to reach the water supply.

The 1933 edition of "Standard Methods of Water Analysis" does not provide for the foregoing distinction as an official procedure. It is included among what are called "nonstandard" methods. Water is now judged on demonstration of the presence of members of the "coliform group." This group includes organisms of both the so-called fecal and nonfecal types. The committee considered attempts to evaluate a drinking water on the basis of a distinction between these two types as unwarranted.

Bacteriological examination of water has distinct limits. After typhoid fever has appeared in a community, it is too late to analyze water to determine whether it caused the disease. Since it takes 14 days for the disease to appear after exposure, the

bacteriological condition of the water supply may have greatly changed during this interval.

Plate Count. This is an attempt to determine the number of bacteria which develop on a standard medium under standard conditions. It is not a total count because only aerobic bacteria are counted which develop under the conditions used. Plate counts possess only general sanitary value, because the kind of bacteria is of as much value as mere numbers. The better drinking waters will, however, have few bacteria. The count may be used along with results of other tests.

Bacteriological Standards for Potable Water. Such standards are necessary in order to determine when a water of unknown quality is safe to drink. They become the sanitary measuring stick which is applied to the water supply in question. They are arrived at by examination of many specimens of good and bad waters, the histories of which, are definitely known. In this way the bacteriological condition of a good water may be established. This becomes the *standard* then for use with an unknown water. The laboratory methods which were used are also the result of study in different laboratories. They then become *standard methods*. Standards and standard methods must be used together.

The United States Public Health Service has enforced bacterial standards for potable water served on interstate carriers (trains, vessels, and so on, plying between states) for many years. This standard does not permit more than 1 *Escherichia coli* in 100 milliliters of water. This represents an infinitesimal pollution and is probably as low as can be attained, in general, in treated waters.

Plate-count standards have not been suggested for water. Koch once suggested that a good drinking water should not contain more than 100 bacteria per milliliter when counted on plain gelatin medium. This has never been adopted in the United States by any official body but is probably about as good as any standard. Of course, one objectionable bacterium would be more significant than hundreds of common saprophytes.

Purification of Public Water Supplies. Great waterworks for obtaining water supplies or for purification of water have been used since ancient times. Some of these were deep wells which yielded safe water. These with the great aqueducts which were

built by the Romans show what good engineers the ancients were. Joseph's well at Cairo is a famous ancient well. It was excavated from solid rock to a depth of 297 feet in two stories. The water was lifted with buckets on an endless chain operated by mules at the bottom of the upper lift. The Chinese are credited with digging the deepest wells, some of which were 1500 feet deep.

Aqueducts were also used to bring water to ancient cities, many of which are seen today in Europe. Herodotus mentions one which brought water to the city of Samos. Rome was especially well supplied with water. At one time nine aqueducts, one of which was nearly 40 miles in length and supported for over 1000 feet on arches, supplied the city. It has been said that at one time the city was supplied with 400 million gallons of water per day. An American engineer, however, believed that 50 million gallons or about 50 gallons per capita per day was a more correct estimate. Since these early times all nations have given much attention to adequate supplies of pure water. ◀

Few large bodies of water are clean enough to furnish drinking water which can be used without treatment. Some cities have purchased small lakes and moved the habitations from the watersheds, and, by a system of sanitary inspection and patrol they are maintaining a reasonably satisfactory situation without the elaborate system of treatment outlined in the following paragraphs. The efficiency of this, however, depends on so many variable factors that most cities have insured themselves against polluted water by resorting, at least, to disinfection. This is the safest procedure since there are many opportunities for contamination even under the best systems of control.

Plain Sedimentation. In this step, the water is conducted into large basins or reservoirs where nature is allowed to do what she will toward getting out as much foreign matter as possible. This step also has a leveling effect on the quality by tending to make the water to be handled later more even in constitution. The water is conducted from the river, lake, or other source, into large sedimentation basins where it is allowed to stand quietly or by means of baffles is made to travel slowly over a long route through one or two basins. Much of the heavier suspended matter is removed in this way.

Sedimentation with Coagulation. From the plain sedimentation basins, the water is conducted to "coagulation basins" where

a coagulant is added. This coagulant is a chemical which, in water, is hydrolyzed to a flaky flocculent compound. This latter compound floats in the water in large flakes. When the velocity of the flow is lowered, these flakes settle out and carry with them foreign matter which was not removed in the plain sedimentation basin. Iron and aluminum sulfates are the commonest materials used as coagulants. We may illustrate the chemical changes with aluminum, for instance, as follows:

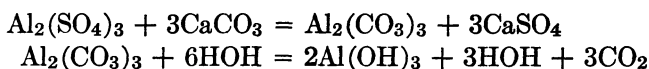

The aluminum hydroxide comes down as a very flocculent precipitate. When alum was first added to water, questions about its possible poisonous effect arose in the public mind. It was shown that the chances of poisoning were very remote, for most of the alum is removed on the filters.

Filtration. Since the two steps just discussed will not remove all of the foreign matter from water, it is next passed to sand filters, of which there are two kinds or types. These are separated according to their nominal capacity or the rate at which water passes through. The filters are usually large concrete basins in the bottom of which are gravel and sand. Beneath this material are the pipes for carrying away the water that has percolated through the sand.

SLOW SAND FILTERS. These filters are constructed with 9 inches of gravel and 30 inches of sand. They are large, perhaps an acre in size. After they have been used for a while, the water goes through so slowly that they are inefficient and must be cleaned. The top 4 or 6 inches of sand with accumulated dirt are removed, washed, and replaced. These filters deliver about 3 million gallons of water per acre per day. They have been almost entirely displaced by mechanical filters.

RAPID SAND OR MECHANICAL FILTERS. Rapid sand filters handle about 125 million gallons of water per acre per day. They differ from the slow sand filter by having a mechanical system for cleaning the sand. Underneath the gravel are two other systems of pipes besides the underdrains previously mentioned for slow sand filters. One delivers clean water to the bottom of the filter and the other compressed air. When the filter has become inefficient because of accumulation of too much foreign matter on

the surface, the sand is washed by clean water pumped backward through the filter. In order to break up the sand, compressed air is also pumped through with the clean water. The clean water washes the sand and carries the dirt with it to the sewer.

The action of filters may be explained in different ways. First, they catch on their surfaces the foreign matter in the water. This gives a thick coating on the surface which is called the "jelly layer." In this are great numbers of protozoa which feed on the bacteria that are strained out of the water. This biological process probably best explains the action of filtration in water purification. Although in most cases undesirable bacteria might be removed by filtration, there might be an occasional instance when they would pass through. This has caused sanitary engineers to follow filtration by a sort of finishing treatment, disinfection.

Disinfection. After water has passed through the steps just outlined, it is disinfected to allow a greater margin of safety to make the water safe. For this purpose the chlorine compounds have been most widely used. Calcium hypochlorite, which was formerly used, has been replaced by liquid chlorine. The actions of these compounds in general disinfection has been discussed in a former chapter and need not be gone over again here. For water disinfection the chlorine compounds approach closely the ideal disinfectant. They have been responsible for a marked reduction in the incidence and mortality of typhoid fever.

The Ammonia-Chlorine Process. This method of water sterilization is yielding better results than the chlorine method alone. Chloramines are produced in water by introduction of ammonia and chlorine and are more germicidal than chlorine alone. Baker depicted the chemistry of the process as follows:

The hypochlorous acid formed when chlorine dissolves in water

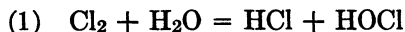

reacts with ammonia thus

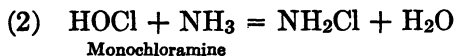

Whether the reaction proceeds according to (2) is apparently dependent on the pH of the water, or according to

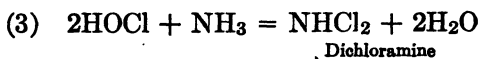

or according to

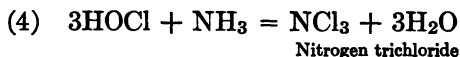

The reaction (4) takes place at pH 4.4 or less, whereas above pH 4.4 a gradually shifting equilibrium occurs in which dichloramine and monochloramine coexist, 100 per cent dichloramine being produced at pH 4.5 and 100 per cent monochloramine at pH 8.5.

Household Filters. These have been offered from time to time for treatment of water for households in cities where municipally treated water is not available. Generally speaking, they are not dependable and may often cause those who use them to feel a false sense of protection. They should not be allowed to replace adequate disinfection. Experiments have been made which showed that bacteria causing typhoid fever and cholera and certain other bacteria could pass through these filters. One extensive investigation involving over 1000 household filters was made in Chicago in 1914, and it revealed that one should not place too much confidence in this type of filter.

Home Water Supplies (Rural Supplies). Where adequately treated city water is not available, much trouble may be necessary to secure enough pure water. Rural communities and country homes generally rely on one of several possible sources, some of which we will now consider.

*Dug, Drilled, and Driven Wells.*² The dug well is a common source of water for rural homes. It may vary in depth and be lined in different ways. It is often open to serious criticism on account of its location. It should not be located where drainage water may run toward it, nor should it be located near privy vaults or barnyards. Underground channels may exist through which pollution may reach the well. Even though the water seems to be of good quality and appearance, this pollution may be dangerous. A *drilled* well is made by forcing an iron pipe or casing into the ground. When a water-bearing area is reached the drilling is stopped. Such water is usually of good quality, although leaky casings have been known to allow pollution.

² Wells, Dug, Drilled, and Driven, *Illinois Dept. Pub. Health, Educational Health Circ.* 14, August 1942.

Sanitation Manual for Public Ground Water Supplies, *U. S. Pub. Health Service, Pub. Health Repts.* 59, 1944, 137-77.

Driven or *drilled* wells are to be preferred to dug wells. The latter, on account of porous sides, are liable to receive drainage water. This is impossible with a properly cased driven, or bored

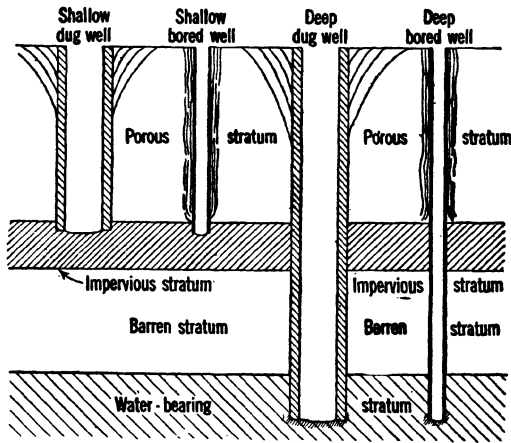

FIG. 103. Showing the Construction of Dug, Driven, and Bored Wells. This indicates the greater safety of drilled wells over dug wells. (After Bartow)

well. The water from these wells has had to pass through a layer of earth which acts as a filter. Drilled wells often pass through a stratum that is impervious to water. This means that the water was collected on some distant watershed and has had to flow some distance under the ground.

Wells must be properly constructed and be adequately protected from contamination. Especially is this true for the dug well which may allow surface water to run back in. Cesspools near such wells are dangerous for they contain much water that must percolate away through the soil. The distance allowable between a cesspool and well depends on several factors such as the height of ground water and the type of soil. When the ground water is high, the distance should be greater between a source of pollution and the well. Consequently, it is far better to put wells deep enough so that there is an impervious stratum above the place from which the water is pumped.

Springs. Water from springs is an underground water and, if properly protected from surface pollution, is safe. Water from

springs is considered by some as pure and by others as open to contamination. The geological strata which cause ground water to flow to the surface may be such that contamination of the water may occur. To a certain extent, spring waters are filtered waters, although the filtration may not be controlled. The number of

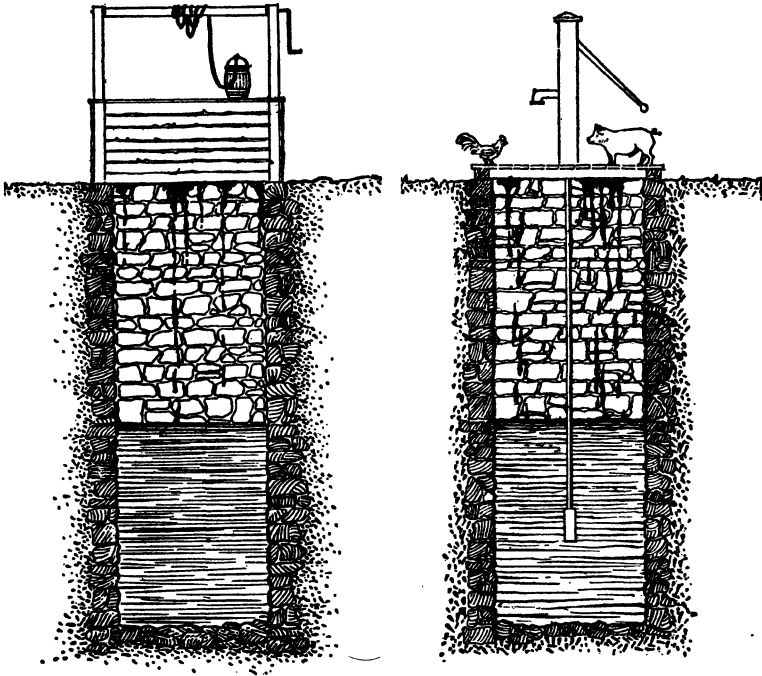

FIG. 104. Showing Dug Wells Not Adequately Protected from Pollution.
(After Hansen)

bacteria would vary greatly and be dependent on the contamination that might occur after the water had come to the surface.

Cisterns. The cistern in certain communities is the main source of water. Rain water from roofs is usually the original source. Cisterns furnish a satisfactory water as long as the cistern is properly constructed to prevent the ingress of surface water and dirt about the top. A properly constructed cistern is shown in Fig. 106.

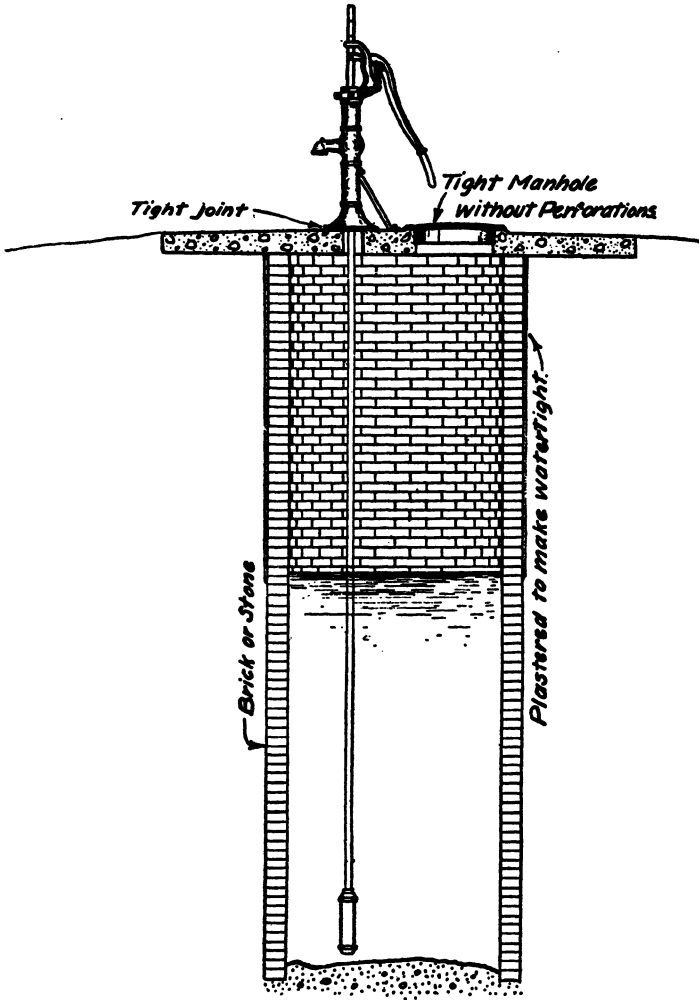

FIG. 105. Dug Well Adequately Protected Against Surface Pollution. (After Hansen)

Disinfection of Small Quantities of Water. It is often desirable to render a small quantity of water safe for drinking and culinary purposes. Such occasions arise on camping trips and vacations. For this purpose, instructions are obtainable from state health departments. Those of the Illinois Department of Public Health are quoted.

Water from a well, cistern, or spring which is suspected of being contaminated should be sterilized before it is used for drinking or culinary purposes. The easiest and surest method is to boil the water. It is not necessary to boil for any great length of time, but be sure that it comes to a distinct boil. The flat taste which results may be partially removed by pouring the water from one vessel into another several times, or by adding a pinch of salt.

Because it is not convenient to boil a large amount of water, it is sometimes more desirable to sterilize the entire well or other supply by the use of calcium hypochlorite, commonly known as chloride of lime, chlorinated lime, or bleaching powder. This chemical can be purchased at any drug store in small sealed tins. Obtain a fresh supply if possible, because the chemical deteriorates somewhat on standing even though sealed. When the can is opened, a decidedly pungent odor should be evident.

Add 1 ounce of chloride of lime for each 1000 gallons of water to be treated. If scales are not available, the material can be measured with a spoon. A moderately heaping tablespoonful of chloride of lime (that is with the powder about 1 inch deep in the center of a spoon) weighs approximately 1 ounce. The amount of water present in a circular well or cistern can be determined from the following table:

Diameter of well in feet	1	2	3	4	5	6	7	8
Gallons for each foot of water in well .	6	24	53	94	147	212	288	376

Rub up the dry powder with a small amount of water to make a thin paste, taking care to break up all lumps, and stir this paste into a bucketful of water. This had best be done out-of-doors to avoid the chlorine fumes which are evolved. Pour the contents of the bucket into the well, and if possible agitate the water with a clean board to insure thorough mixing. Allow the water to stand for a period of several hours before using.

This treatment corresponds to a dosage of 2 parts per million of available chlorine and should impart a slight taste to the water, but this taste is entirely harmless and only serves to indicate that sufficient chlorine has been added to sterilize the water adequately. In fact, unless a pungent odor or taste is evident, repeat the treatment using one-half the dosage indicated. It must be borne in mind that such a procedure will sterilize only the water which is actually present in the well at the time of treatment. If the well is subject to seepage from the surface or from a source of pollution such as a privy vault or sewer, the treatment should be repeated as often as a quantity of water equal to the capacity of the well has been pumped out. Any process of sterilization is at best only a temporary measure, and immediate steps should be taken to reconstruct the well so that it will be protected against further contamination.

For sterilizing small quantities of water rub up a moderately heaping teaspoonful of chloride of lime with a small amount of water in the manner previously indicated, and add sufficient water to make a pint. Of this solution use one tablespoonful for each 10 gallons of water to be treated, or 36 drops to the gallon.

The U. S. Army Medical Corps has found that two drops of ordinary tincture of iodine (7 per cent) added to a quart of water will destroy all disease germs and render the water safe for drinking purposes in one-half hour.

How to Judge Quality of Private Water Supplies. This is not always an easy task. Although the physical appearance is not always a safe criterion, it does yield some information. Laboratory examination is the safest method. This involves, as we have learned, an examination for fecal *Escherichia coli*. Great care must be used to collect the specimen for analysis. The sample may be contaminated during collection when the original water is in satisfactory condition. A single analysis is not conclusive. Several examinations enable a person to arrive at a better opinion of the quality of water. A sanitary inspection is often necessary to find out whether open channels exist which might allow pollution to reach the water supply.

How to Have Water Analyzed. Most states provide for the sanitary examination of water, either free of charge or at a very moderate cost. This may be determined in most cases, by writing to the state board of health. There are several points in this connection which are often overlooked by those who seek such help from laboratories. It is usually best not to send a sample to the laboratory in a container which has not come from the laboratory. *It is best to write to the laboratory first* and state the facts which prompt the request for laboratory examination. Practically all reliable laboratories refuse at the start to examine water bacteriologically which has been shipped in any sort of a container, even though the sender claims to have cleaned and boiled it thoroughly. He may not have boiled it long enough or he may have contaminated it after boiling. His conception of sterilization may be quite different from that of a laboratory worker. If such samples are examined, the laboratory does not know whether satisfactory results are due to the presence of some chemical disinfectant or whether bad results are due to a dirty unsterilized bottle or to the water itself.

Another point is not to ask the laboratory to examine water for typhoid bacilli. It cannot be done readily. "Standard Methods for the Examination of Water and Sewage" does not provide for this in routine water examination. There are no satisfactory routine procedures, and, even if it could be done, absence of this

organism at the time of examination would not prove that the typhoid organism might not appear in the water later. It is better to look for evidences of pollution which show open channels between the source of water and sewers, barnyards, and so on; this gives more information about possible future pollution.

The last point to be mentioned concerns the information which should accompany the sample. Some persons decline to fill out completely the certificate that is sent with each sample bottle. They feel that, if a laboratory worker knows nothing about the source from which the specimen came, he will start his work with no preconceived ideas, and therefore his conclusions will be more trustworthy. This is the wrong attitude. The laboratory worker rarely knows the sources of the specimens on which he works unless he takes the pains to secure them. The specimens pass his hands under numbers. For him to give a trustworthy opinion, he must have all the information called for on the certificate sent out with each sample bottle.

Despite the fact that chemical and bacteriological water examination may be of great value, there are times when such examination should not be made:

1. It is useless to request analysis if it is plain that sewage cannot enter the water supply.

2. Sampling of supplies from new wells or those piped through a new pipe line on which work has been done within a period of three or four weeks is useless, because pollution is attendant on construction. Such systems may be sterilized by flushing with a solution of calcium hypochlorite (1 pound in 10,000 gallons of water), followed by thorough rinsing.

3. Samples should not be taken from supplies with evident defects until such defects have been remedied.

4. Samples should not be taken to explain possible cause of diseases which are not water-borne (measles, scarlet fever, diphtheria, whooping cough, and mumps).

5. The sample should be accompanied by a good description of the surroundings. Such a description is necessary if the analyst is to give a reliable opinion.

Bottled and Mineral Waters. These have enjoyed wide sale in America because of the prevailing opinion in certain localities that they are better than the municipal supply. The Bureau of Chemistry in Washington several years ago made a careful study of the bacteriological condition of these waters and found much to be desired. They found that some springs were being used

for the production of mineral waters which should not be used. Before spring water is put on the market, it is an easy matter to determine whether it is pure and safe for consumption. This may be done by sanitary inspection and laboratory examination. Private homes depending on mineral waters for drinking water should request the vendor to supply a certificate showing that the water has been examined by the local city or state health department.

Bacteriology of Ice. Two kinds of ice are used in America, natural and artificial. Natural ice is harvested from natural bodies of water in the late winter and stored for sale during the summer. Artificial ice³ is made the year around and sold soon after manufacture. The hygienic properties of the latter are obvious, and, if this ice is properly handled, it is safe for consumption. Natural ice, however, needs a little discussion.

When ice crystals form in water, they tend to come down in the pure condition. Any impurities that are in the water are excluded. In the chemical laboratory, this method is used for purifying chemicals. Ice, then, even from relatively polluted bodies of water, tends to be found in the pure condition. This indicates that nature does her part toward making ice safe for consumption. Natural ice is usually stored for months during which time the bacterial content would be markedly lowered. Jordan stated that after three or four months' storage the danger of ice from even highly polluted water would be very slight, and after six months' storage it would be practically negligible. These statements do not condone the harvesting of ice from polluted bodies of water even though such ice has been found to be free from objectionable bacteria. As an added element of safety, ice should be analyzed and certified by competent health authorities.

REFERENCES

- CAMERON, G. M., *The Bacteriology of Public Health*, C. V. Mosby Co., St. Louis, Mo., 1940.
- CUMMING, J. S., *Safe Ice*, *U. S. Pub. Health Service, Pub. Health Repts.* 29, August 7, 1914.
- FREEMAN, A. W., *Good Water for Farm Homes*, *U. S. Pub. Health Service, Pub. Health Bull.* 70, 1915.
- FROST, W. H., *The Sewage Pollution of Streams, Its Relation to Public Health*, *U. S. Pub. Health Service, Pub. Health Repts.* 31, 1916, 2486-97.

³ L. B. Jensen, *The Bacteriology of Ice*, *Food Research* 8 (1943), 265-72.

- GAINNEY, P. L., *An Introduction to the Microbiology of Water and Sewage for Engineering Students*, Burgess Publishing Co., Minneapolis, Minn., 1941.
- HARDENBERGH, W. A., *Water Supply and Purification*, International Book Co., Scranton, Pa., 1945.
- McLAUGHLIN, A. J., *What Is Safe Drinking Water?*, *U. S. Pub. Health Service, Pub. Health Repts.* 29, 1914.
- PHELPS, E. B., *Studies on the Self-Purification of Streams*, *U. S. Pub. Health Service, Pub. Health Repts.* 29, 1914.
- PRESCOTT, S. C., and M. P. HORWOOD, *Sedgwick's Principles of Sanitary Science and the Public Health*, Macmillan, New York, 1935.
- PRESCOTT, S. C., C.-E. A. WINSLOW, and M. H. McCRADEY, *Water Bacteriology with Special Reference to Sanitary Water Analyses*, Wiley, New York, 1946.
- ROSENAU, M. J., *Preventive Medicine and Hygiene*, D. Appleton-Century, New York, 1939.
- RYAN, W. J., *Water Treatment and Purification*, 2d Edition, McGraw-Hill, New York, 1946.
- TANNER, F. W., *Microbiology of Foods*, 2d Edition, Garrard Press, Champaign, Ill., 1944, 1206 pp.
- THEROUX, F. R., E. F. ELBRIDGE, and W. L. MALLMANN, *Laboratory Manual for Chemical and Bacterial Analysis of Water and Sewage*, McGraw-Hill, New York, 1943.

CHAPTER 20

SEWAGE TREATMENT AND BACTERIOLOGY

Sewage has been defined as the used water supply of a community or home. Sewage disposal and treatment are, consequently, constant problems. The difficulties involved are apparent to those who have studied the question. In the early stages of development of the United States and other countries, when population was small, sewage could be emptied into a river and nature allowed to do the rest. Now such a practice makes nuisances for those below on the river.

The object of efficient sewage treatment is to dispose of a large amount of putrescible organic matter in such a manner that nuisances such as bad odors, decomposing river beds, and the like, are avoided.

Bacteria in Sewage. Bacteria in sewage are those which are in the water plus those which are added when the water is used. The flora is, therefore, quite heterogeneous. Ordinary fresh sewage may contain about 3,500,000 aerobic bacteria per milliliter, although there is great variation as would be expected. Pathogenic bacteria cannot live long in sewage because they are unable to endure the conditions which exist and the antagonistic effect of so many other types. Pathogenic bacteria are important in sewage only if the sewage gets into the water supply or on foods. Pathogenic bacteria probably do not multiply to any extent in sewage, although our information on this point is quite meager. They may remain dormant, however, for weeks. *Eberthella typhosa* has been found in sewage sludge which has been dried for some time. Anaerobic bacteria are also common in sewage. They probably play an important role in decomposition of proteins.

Intestinal Bacteria in Sewage. These are contributed to the sewage by the use of water in the home for flushing purposes. As has been pointed out before, they are of marked sanitary significance, and one type, *Escherichia coli*, is used as an indicator that

sewage has reached a water supply or food. Intestinal bacteria may include pathogenic species, for these may leave the body in its excretions.

Soil Bacteria. Soil bacteria are of little significance from the sanitary standpoint. They may be added to sewage by drainage water and similar sources. They may include, however, some of the types which are desired in the biolysis of sewage.

General Principles in Sewage Treatment. The problems of sewage disposal center about the disposal of organic matter and the destruction of pathogenic bacteria which may be present. The organic matter is usually decomposed by bacteria by *hydrolysis*. This results in the formation of products which are in the reduced conditions such as hydrogen sulfide, ammonia and mercaptans. Compounds in these reduced conditions usually have bad odors, and they may become a nuisance. It is necessary to follow *hydrolysis by oxidation* so that the reduced compounds are changed to a stable state. In this state they are usually odorless. Oxidation of hydrogen sulfide to sulfate, for instance, causes a disappearance of the foul odor. Consequently, sewage treatment comprises first hydrolysis and then oxidation. These changes are expressed by sanitary engineers under the term "biolysis" of sewage. This term means the breaking down of complex material by means of living agents, and it is a very useful one to use. The decomposition may be due to living protoplasm or enzymes.

Rideal has given a tabular outline of the stages which are involved in biolysis of sewage. This is sufficiently important to reproduce (Table 5).

This table was discussed as follows by Kinnicutt, Winslow, and Pratt in their "Sewage Disposal":

1. *Proteins.* In the first of Rideal's stages, the proteins are broken down into the albumoses and peptones with the separation of sulfur as hydrogen sulfide, or as mercaptans, sulfur alcohols having very disagreeable odors. The albumoses and peptones have a less complex molecular structure than the proteins; they are soluble in water and are not coagulated by heat. These compounds also during the first stage break down into the so-called amino acids, chiefly acids of the fatty hydrocarbon series containing carbon, hydrogen, oxygen, and nitrogen in which one hydrogen atom is replaced by the amino group (NH_2).

The amino acids thus formed are decomposed during the first and second of Rideal's stages, giving ammonia, phenols, fatty and aromatic acids. All of the nitrogen, however, is not converted into ammonia, for part remains united to hydrogen and carbon, forming amines like tri-methyl amine

(CH₃)₃N, part is liberated as nitrogen, and a certain portion is undoubtedly directly converted into nitrous acid.

The last change in the process of decomposition is a partial or complete oxidation of the organic substances formed by the decomposition of the amino acids, resulting in the production of water, carbon dioxide, nitrous and nitric acids. Gaseous nitrogen is sometimes liberated in large quantities by the action of amines on nitrous acid.

TABLE 5
STAGES INVOLVED IN THE BIOLYSIS OF SEWAGE
From Kinnicutt, Winslow, and Pratt's "Sewage Disposal"

Stages Involved	Substances Dealt With	Characteristic Products
<i>Initial</i>		
Transient aerobic changes by the oxygen of the water supply rapidly passing to	Urea, ammonia, and easily decomposable matters	
<i>First Stage</i>		
Anaerobic liquefaction and preparation by hydrolysis	Albuminous matters Cellulose and fiber Fats	Soluble nitrogenous matter Phenol derivatives Gases Ammonia
<i>Second Stage</i>		
Semianaerobic breakdown of the intermediate dissolved bodies	Amino compounds Fatty acids Dissolved residues Phenolic bodies	Ammonia Nitrites Gases
<i>Third Stage</i>		
Complete aeration; oxidation and nitrification	Ammonia and carbonaceous residues	Carbon dioxide, water, and nitrates

The principal products of the bacterial action on the proteins are amino acids of the fatty hydrocarbon series; relatively small amounts of the aromatic compounds, such as phenyl alanine, tyrosine, tryptophane, phenol, skatole, and indole, are formed.

2. *Carbohydrates.* Sugar and starches are very easily hydrolyzed and broken down by the action of bacteria, and, though alcohol may be one of the products of the decomposition, the principal substances formed seem to be butyric acid, lactic acid, water, carbon dioxide, and hydrogen. Cellulose and woody fiber are also broken down and liquefied, but comparatively slowly, and the action is often so sluggish that they are but little changed in the process of sewage treatment. Hydrolysis plays an important part,

at least during the first stages of the decomposition of cellulose, and the products formed are undoubtedly similar to those produced from the sugars and starches.

3. Fats. The decomposition of fats, brought about by the action of bacteria and molds, is again largely a process of hydrolysis, the fatty acids, stearic, palmitic, oleic, butyric, and glycerol being the chief products. Further hydrolysis converts the fatty acids into carbon dioxide, hydrogen, and methane. The breaking down of the fats takes place very much more slowly than that of proteins, and it appears probable that they must first emulsify before being acted upon by bacteria. The emulsification is at least partly brought about by the ammonia set free in the decomposition of the amino acids. The slow decomposition of fats and greases makes a sewage containing large amounts of these substances very much more difficult to purify than a sewage in which the organic matter is mainly in the form of proteins and carbohydrates.

Preliminary Methods. These include the methods which are hydrolytic in nature. We need not discuss the other preliminary steps such as screening, for they are mainly mechanical. Hydrolyses are brought about mostly by two methods or modifications of these methods.

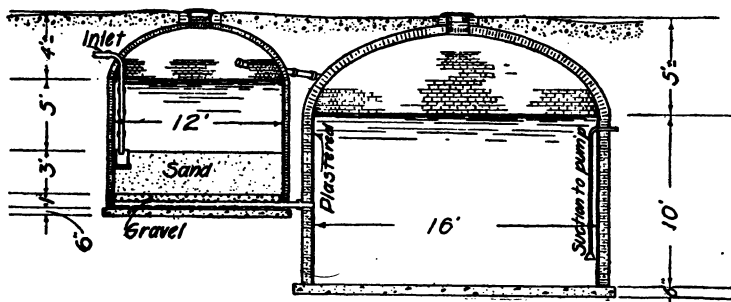

FIG. 106. Suggested Design for a Sand Filter and Cistern Suitable for a Home. (Illinois State Water Survey)

Septic Tank. The septic tank is a concrete basin through which the sewage passes slowly; solid matter settles out and undergoes anaerobic decomposition at the bottom of the tank. This anaerobic decomposition is one of hydrolyses mainly, and the products must yet be made stable by oxidation. The products of these hydrolyses are the various decomposition products of proteins, carbohydrates, and fats. The septic tank is commonly used for disposing of the sewage from rural homes and small communities. These tanks are frequently neglected, since the layman

believes that they are automatic and operate in some mysterious manner. The chemical changes which take place in the septic tank are shown in Table 5 by Rideal.

The Cesspool. This is usually a moderately deep hole, the sides of which are laid up with brick or flat stones without mortar. The organic matter is delivered to it and probably undergoes anaerobic decomposition while the water seeps away into the ground. The cesspool would, of course, be satisfactory for single residences or where a small amount of sewage must be cared for.

Finishing Processes. Under this heading may be mentioned those processes to which the product from anaerobic hydrolyses are subjected. They are, of course, mainly aerobic since they are oxidative in nature. The reduced compounds such as H_2S and NH_3 , which result from the hydrolytic processes, must be oxidized to a stable condition. The following methods are available for this purpose.

Dilution. This is the oldest method for the disposal of sewage. The sewage was usually dumped into a stream below the city, and the forces in nature were trusted to take care of it. Although this method may have been adequate before the population over the United States became as dense as it is today, it long ago reached the limit of usefulness. Its continuation has caused some very bad situations; because of the seriousness of the problem in many places in the country today, we may be justified in giving it a little more attention.

The disposal of sewage by dilution in a river or other body of water resolves itself into consideration of three factors: (1) Organic matter—the sewage itself, (2) bacteria, and (3) oxygen. The oxygen is necessary for oxidation of the organic matter. Organic matter and bacteria are always present and may therefore be dropped from our discussion. The question then comes down to a consideration of what may be called the "oxygen balance." By this is meant the amount of oxygen required for oxidation of organic matter in relation to the amount which is available. Relatively clean river water contains dissolved oxygen, and the question arises, how much sewage can a stream carry and still oxidize it to such a condition that it will not become a nuisance? Although the question can be answered for a given stream only by laboratory analysis, it has been suggested that for every gallon of sewage there should be at least 50 gallons of

relatively clean river water. The determining factors, however, are the concentration of the sewage, the quality of water in the stream, and so on. Such statements are of general significance only.

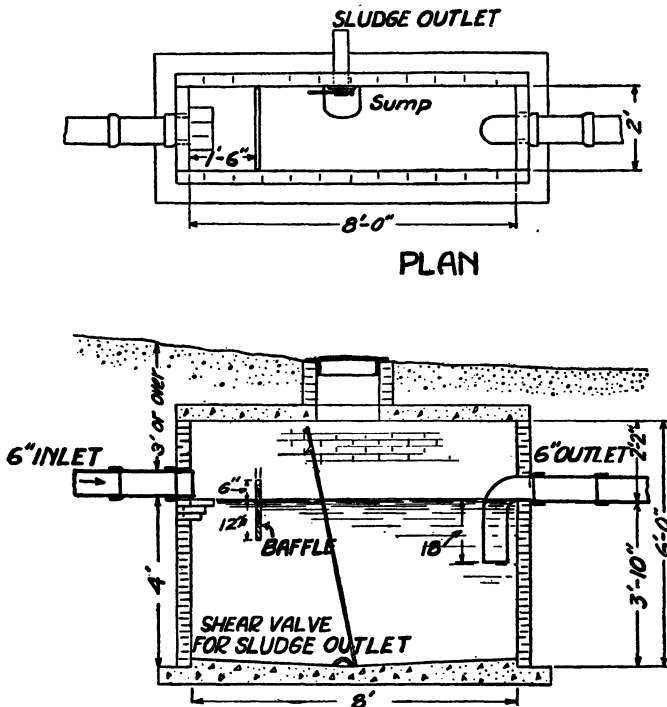

FIG. 107. Suggested Design for the Simplest Form of Sewage Tank for a Farm Residence or Other Home Not Connected with a Sanitary Sewer. (Illinois State Water Survey)

Stream Pollution. Discussion of this subject may seem somewhat out of place in a book of this nature. Since it is closely related to sewage disposal and since it is a subject in which all citizens, especially those who have studied bacteriology, should be interested, it will be given a little space. In their natural condition the great bodies of water were pure and clean. As population became more dense, they have become heavily polluted with wastes of domestic and industrial life. Today there are few natural bodies of water that approach in this way their

original condition. Fish life has been killed, and bodies of water have been spoiled for recreational purposes as well.

The opinion is quite generally held that flowing streams become self-purified; students of the question like to use another term, self-improved, since self-purified is a very strong term. The United States Public Health Service has made a statement on this subject, part of which is given below.

Briefly, it may be stated that a water contaminated with the organic matters found in sewage and in various industrial wastes does gradually rid itself of such pollution, if allowed free access to air. Early studies of this phenomenon of self-purification led to the abandonment of a plausible theory based on the direct action of oxygen on the organic matters, and subsequent research extending over the past 50 years has revealed that self-purification of streams is essentially a biological process. In this sense, the oxygen contained in aerated or running water does not operate as a sterilizing agent, as once believed, but rather as a neutralizing or deodorizing agent for some of the gases resulting from the bacterial decomposition of the organic matters. Dissolved oxygen is also required for the maintenance of fish life. Although thus relegated to a secondary role, the amount and rate of disappearance of the oxygen which is contained in a given water nevertheless serves as an excellent indicator, first of the threatened disappearance of fish life and, with increasing pollution, as a warning of impending nuisance conditions. With the understanding that bacteriological examination is a much better index of wholesomeness or fitness for drinking purposes, it has accordingly become customary to express the pollution of a given water in terms of its demand for dissolved oxygen when reference is made to the threatened disappearance of fish life or to the approach of nuisance conditions.

One of the best-known cases of stream pollution is that of the Illinois River which is made to carry the sewage of Chicago. This situation is especially interesting because of the litigation which took place in 1901 between the State of Missouri and the City of St. Louis versus the State of Illinois and the City of Chicago. The complainants claimed that their water supply would be endangered if Chicago were permitted to empty her sewage into the Illinois River. Another fact making this situation of special interest is that chemical and bacteriological analyses have been made almost constantly on the river, and there is probably no other stream in the world on the sanitary condition of which so many data are available. The situation is briefly this: Chicago, in order to lessen the pollution of Lake Michigan with sewage, pumped her sewage into the DesPlaines

River, which in turn flowed into the Illinois River. To help the situation, water from Lake Michigan was used for diluting the sewage. So much of this was taken that complaints were made that the lake level was being lowered. We have no space for a detailed discussion of all the phases of the controversies; those which have been presented should stimulate people especially interested or concerned to read into the subject.

Sewage Farming. It was soon realized that sewage contained much food material for plants, and attempts were made to utilize it on sewage farms. These farms required sandy porous soil and one which would not become clogged, a condition often described as "sewage-sick." Although at one time the method was rather widely used in some places, it has been replaced by other methods. Such farms are said to be in existence near Berlin and several other cities. It is obvious that human foods should not be raised on such farms. One writer stated that much of the typhoid fever in Paris one summer was due to radishes raised on sewage farms. Certain types of grass have been successfully grown, however, on these farms.

Filtration. Two kinds of filtration are used. One involves the use of trickling filters and the other intermittent filters. Both types aim at as rapid oxidation as possible of the chemical constituents in the sewage.

INTERMITTENT FILTRATION. The effluent from some of the anaerobic methods may also be filtered through sand. The sand must be coarse. The difficulties of the operation and also the scarcity of the proper sand caused the introduction of contact beds. The sewage is applied to the beds very carefully in order that they may not become clogged. The reactions which are sought in the intermittent filter are, in general, nitrification, the oxidation of reduced nitrogen to oxidized nitrogen, and similar changes. These take place mainly when the filters are empty, because air is used for oxidation.

CONTACT BEDS. These are concrete basins which are filled with broken brick, coke, stone, and so on, all of which greatly increase the surface area in the filter. The beds are filled, allowed to stand full for a period, emptied, and allowed to "rest" for a period. The period is known as a cycle. Each of the pieces of filter becomes surrounded with a gelatinous film which during the period when the tank is full adsorbs organic matter from the

sewage. When the tank is empty, the air permeates the filter, and the organic matter is oxidized.

SPRINKLING FILTERS. In this method the hydrolyzed sewage from the anaerobic method is sprinkled periodically on a bed filled with crushed rock. The filters are constructed of such size that, while one half of the filter is receiving sewage, the other half is draining and being aerated. The changes in the sprinkling filter are also oxidative in nature.

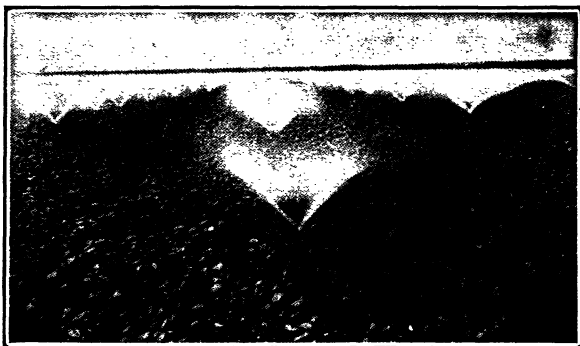

FIG. 108. Showing How the Sewage is Delivered to a Sprinkling Filter.
(Columbus, Ohio)

Aeration. Since one of the main objects in sewage disposal is oxidation, engineers have discovered that sewage may be aerated with very rapid oxidation of reduced substances. The ammonia is rapidly and completely changed to nitrates. Under these conditions one would expect rapid replacement of reduced compounds with oxidized compounds. It was shown by some of the early work that a tank of sewage was more rapidly oxidized if it were seeded with a little sludge from a tank which had been aerated. This indicated that something existed in this sludge which hastened oxidation. Because of this fact, such sludge became known as *activated sludge*, and the process of aeration as the *activated-sludge method* of sewage disposal.

Swimming Pools. The swimming pool has become an important sanitary problem in American life. It is generally admitted that swimming pools may be responsible for serious infections of the eyes and ears. Such infections have made it necessary to disinfect the water in swimming pools. Unfortunately, such disinfection has often been left to untrained individuals who have

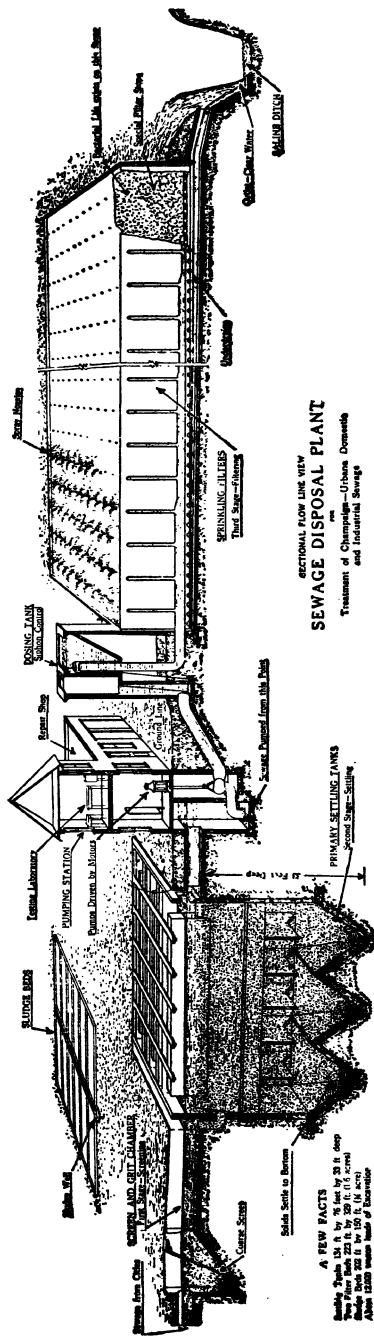

Fig. 109. Showing the Sewage Disposal Plant. (Imhoff Tanks and Sprinkling Filters at Urbana, Ill.)

so overdosed the water that marked discomfort has been caused to those who use the pools. Such a condition is quite unnecessary, for chemical methods of analysis are available to determine accurately the amount of chemical added. In 1926 a report was presented to the Public Health Engineering Section of the American Public Health Association on swimming pools and other public bathing places which embodied the best information on design, equipment, and operation of swimming pools that has been published. Those interested in the details should consult the original report.¹

There appear to be no objections to chlorination of swimming-pool water if excessive doses are not used. With proper control of hydrogen-ion concentration and the use of ammonia and chlorine, complaints should not result, according to some who have studied the matter. The residual chlorine should be maintained as high as 0.6 part per million. Experiments are in progress on the use of bromine for swimming-pool disinfection.⁴

REFERENCES

- HARDENBERGH, W. A., *Home Sewage Disposal*, J. B. Lippincott, Philadelphia, 1924.
- LUMSDEN, L. L., *A Sanitary Privy System for Unsewered Towns and Villages*, *U. S. Pub. Health Service, Pub. Health Bull.* 89, 1917.
- LUMSDEN, L. L., C. W. STILES, and A. W. FREEMAN, *Safe Disposal of Human Excreta at Unsewered Homes*, *U. S. Pub. Health Service, Pub. Health Bull.* 68, 1915.
- PHELPS, E. B., *The Treatment of Sewage from Single Houses and Small Communities*, *U. S. Pub. Health Service, Pub. Health Repts.* 34 (1919), 271-6.
- State Board of Health *Bulletins and Circulars*.
- STILES, C. W., *The Sanitary Privy: Its Purpose and Construction*, *U. S. Pub. Health Service, Pub. Health Bull.* 37, 1910.
- TRULLINGER, R. W., *Water Supply, Plumbing, and Sewage Disposal for Country Homes*, *U. S. Dept. Agr. Bull.* 57, 1914.

¹ Recommended Practice for Design, Equipment, and Operation of Swimming Pools and Other Public Health Bathing Places, American Public Health Association, 1790 Broadway, New York.

CHAPTER 21

BACTERIOLOGY OF MILK AND MILK PRODUCTS

Milk constitutes one of the important foods of man. Its chemical constitution makes it susceptible to bacterial decomposition, the prevention of which has been the subject of much study. As a cause of disease milk is not especially important, for millions of quarts are used daily in the United States without causing an undue amount of illness. There are several diseases, however, the etiologic agents of which, may be disseminated in milk. An important one of them has been tuberculosis.

The Importance of a Wholesome Milk Supply. The characteristics of milk make it necessary that great care be exercised in its production and handling.¹ Unlike many foods, milk is usually taken into the body in the uncooked state—pasteurized milk not being considered cooked milk. Moreover, it is used by almost every one every day, and, if it is unwholesome, there is constant danger of spreading infection. It is easy to see that a few gallons of infected milk might seed a large quantity and make it unfit for consumption. Milk constitutes a large part of the food of children, a portion of our population which is indifferent to quality in foods and therefore must be protected.

Bacteria in Milk. Great numbers of bacteria are not desirable in milk. When large numbers are present, the milk sours more quickly. Milk with large numbers of bacteria may also contain more objectionable bacteria than milk with few bacteria. Consequently, a low-count milk is much more to be desired than one with constantly large numbers of microorganisms. Most of the bacteria that gain entrance to milk are harmless. Only a few are objectional from the standpoint of disease. Conn, one of America's first dairy bacteriologists, stated that good clean milk would have a low number of bacteria; a large number indicate

¹ J. R. Mohler, *The Importance of a Wholesome Milk Supply*, *U. S. Dept. Agr., Bur. Animal Ind., Circ.* 153, 1910.

the presence of dirt or such undesirable conditions of production and handling as high temperatures, lack of cooling, and dirty utensils. The bacteria in milk gain entrance from many sources and, therefore, are heterogeneous in type. It has become customary to speak of a "milk flora" consisting of the bacteria usually encountered in it.

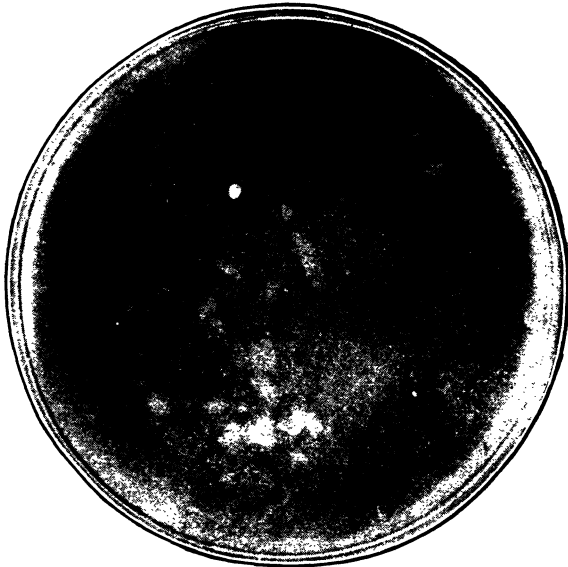

FIG. 110. Petri-Dish Preparation of Milk Collected under Clean Conditions and Properly Handled After Milking. This milk contained about 500 bacteria per cubic centimeter. (After Magruder, 1910)

Germicidal Action of Fresh Milk. Frequent examination of fresh milk revealed the fact that bacteria not only may not develop in fresh milk but actually may be destroyed in it. Various explanations were offered; not all bacteria liked milk, and therefore they died; milk might be actually germicidal owing to the presence of antibody-like substances. Among several such substances which have been reported is *lactenin*. They are in general destroyed by heat and must be short-lived, because the bacteria start to grow in a few hours.

Bacteria in Milk in the Udder. Good fresh milk is known to contain bacteria when it is excreted from the udder. It was once believed that such milk was sterile, but work by one investi-

gator resulted in the knowledge that fresh milk, when it is excreted may contain as many as 1000 bacteria per milliliter. These bacteria are usually of no sanitary significance, especially if the udder of the cow is not diseased. Mastitis, an inflammatory infection, is often caused by streptococci. The streptococci with the pus which they cause may be excreted in the milk. Some

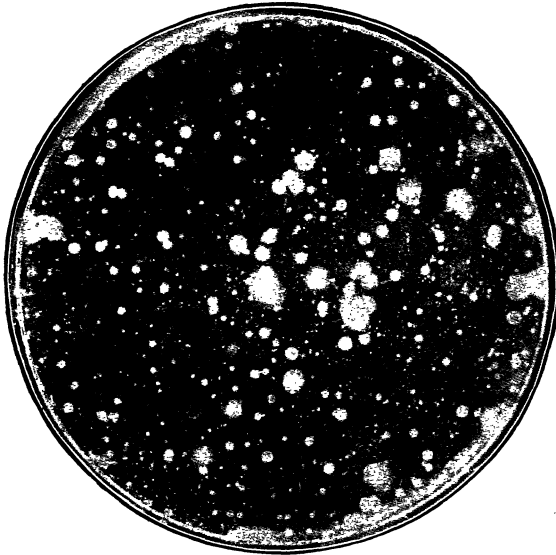

FIG. 111. Petri-Dish Preparation of Milk Not Cooled but Kept at 60° F. for 24 Hours. This milk contained 2,800,000 bacteria per cubic centimeter. (After Magruder, 1910)

outbreaks of septic sore throat and scarlet-fever have been traced to the presence of streptococci from infected udders.

Factors Influencing Bacteria in Milk. Experimental work has indicated that the cow's environment (barn conditions) has less influence on the number of bacteria in milk than was formerly supposed. Attention was given to improvements in barn sanitation and construction, and, although they were to be desired, they did not greatly influence the numbers of bacteria in the milk. This situation made it necessary to carry out expensive research to find the important influences on bacteria in milk so that attention could be given to them. Utensils were found to be the most important agents in this connection. When they were carefully

cleaned, the number of bacteria that gained entrance to milk was low even though the milk was produced under dirty barn conditions. Temperature influences development of bacteria after they have gained entrance to milk. Ideal milk is one which comes from healthy animals, is handled by healthy men, and kept cold until it is delivered. It is far easier to state these requirements than it is to determine whether they have been observed. For production of wholesome milk it is necessary to have constant co-operation of farmers, carriers, distributors, and housewives.

Methods for Improving Milk Quality. Control and improvements of milk supplies have made necessary creation of many bureaus and departments in Federal and state governments. These are concerned with laboratory analyses as well as inspections. Some of the more important methods of controlling quality will be mentioned.

Sanitary Inspection. This step in maintenance of a high-quality water has already been discussed. It was found that sanitary inspection often made laboratory analyses unnecessary. The same stand may be taken in milk work—a sanitary inspection might reveal conditions which would preclude the necessity of laboratory work. Sanitary inspection of dairies has centered about the use of the score card on which are embodied those essentials of sanitation considered to be necessary for production of clean milk.

The score card makes it possible to obtain a numerical rating of the dairy and to stimulate rivalry among producers. The score according to the government score card considers both equipment and methods. The larger cities now have their own score cards.

*Medical Milk Commissions and Certified Milk.*² These commissions represent another important step in the improvement of milk in the United States. The first medical milk commission was organized in New Jersey in 1890. The State Medical Society attempted to secure improvements in production and sale of clean milk by appealing to the state legislature. Although need for such effort was recognized, the State of New Jersey could not, at that time, undertake the work. Consequently, medical men did the next best thing; they suggested the formation of a commission to be composed of prominent health officials and scientists

² Milk Ordinance and Code Recommended by the United States Public Health Service, *U. S. Pub. Health Service, Pub. Health Bull.* 220, 1939.

who had established reputations in the study of milk and dairy products. The commission prepared a set of rules and a sanitary code under which high-grade milk was produced. It was believed that the report of this commission would have great weight on account of the standing of its members. Those who were invited to membership on the commission chose the name Medical Milk Commission. From this first medical milk commission have developed many more scattered all over the country.



FIG. 112. Cap from a Bottle of Certified Milk.

After establishment of the Medical Milk Commission, it was necessary to have some means of designating milk which was produced under supervision of a medical milk commission, and the term *certified* was registered in the United States Patent Office; this was done in order to prevent the term from being degraded by dairymen having no connection with a medical milk commission.³ Certified milk may be defined as milk produced under a legal contract between a medical milk commission and a dairyman; it must therefore meet the requirements of the commission. We need not take space to enumerate all the requirements which must be met in the production of certified milk. Nothing is left undone (with the exception of pasteurization)

³ C. B. Lane, *Medical Milk Commissions and the Production of Certified Milk in the United States*, U. S. Dept. Agr., Bur. Animal Ind., Bull. 104, 1908.

which would raise quality. Three types of examinations are made. A chemist-bacteriologist makes periodic examinations of the milk, samples of which he collects himself. A qualified veterinarian examines the cows periodically. And lastly, representatives of the Medical Milk Commission also inspect the dairy. When these examinations indicate that the milk is free from disease-producing bacteria, has a low bacteria count, possesses the proper chemical constitution, is free from foreign matter, and so on, it is certified by the medical milk commission. Although these are very desirable requirements, it is not easy to determine them. For instance, can even a qualified veterinarian positively say that a cow is free from diseases? Can a dairyman, for instance, always be assured that his hired hands are healthy? They may be examined by physicians and develop disease immediately after the examination, or they may be infected and the infection may have been overlooked. Some of the help may regard a light sore throat as of negligible importance and say nothing about it. It will be apparent after a little thought that although the conditions for the production of certified milk are reasonable and desirable, there may be opportunities for undesirable milk to be certified. This is proved by the several outbreaks of communicable diseases which have been traced to certified milk. Such milk is not necessarily safe milk, although in most cases it probably is. Properly pasteurized milk is safe milk. In the spring of 1935, the Certified Milk Producers Association and the American Association of Medical Milk Commissions, Inc., adopted a resolution in which pasteurization of certified milk was endorsed but not mandatory. Such milk must be labeled on the bottle-cap "Certified Milk—Pasteurized." Pasteurized certified milk would approach the ideal milk more closely than has been possible in the past.

It is well to point out definitely that certified milk is not the result of effort on the part of any government bureau. As stated in one of the pamphlets of the American Association of Medical Commissions, "the standards of cleanliness which govern the production of all certified milk were established by the medical profession. The originators of certified milk were a group of doctors who realized the need for a milk so pure and delivered so fresh that it could be used untreated exactly as nature intended all milk should be." Those interested in the production and use

of certified milk have united to form the Certified Milk Producers' Association of America and the American Association of Medical Milk Commissions.

Pasteurization of Milk. Pasteurization of milk consists in heating it to a certain temperature, holding it at that temperature for a period of time, and cooling it promptly. Health authorities



FIG. 113. Showing the Pasteurizing Room of the Highland Dairy Farms Co., St. Louis, Mo. (Courtesy of the J. G. Cherry Co., Cedar Rapids, Iowa.)

These machines are automatically controlled so that the milk is heated in accordance with the best practice.

are agreed that this is the most practical, economical, positive method for preventing disease dissemination by milk. Pasteurization of milk has been studied for 30 years, and scientists have about agreed that a temperature of 142°F. (61.11°C.),⁴ with a holding period of 30 minutes, will render milk free from disease-producing bacteria. The question will probably arise, why did bacteriologists select just this time and this temperature from many other possible combinations? *Mycobacterium tuberculosis*

⁴This is merely an average temperature. Some cities permit lower temperatures; others require higher temperatures. The U. S. Public Health Service Milk Ordinance and Code recommends 143°F. (61.67°C.).

was, at one time, the important disease-producing bacterium in milk. Consequently much experimental work has centered about this microorganism. It has been found that the aforementioned temperature and time will destroy the *Mycobacterium tuberculosis* in milk. This statement of course implies that every particle of milk will be thoroughly heated and held for the full holding period.

Pasteurization when properly carried out is one of the simplest means of making milk safe. Improperly pasteurized milk gives the consumer a false sense of security. Some states have created bureaus for controlling pasteurization plants and inspecting pasteurizing equipment. This will make pasteurization a still safer procedure. Finally, milk after pasteurization must be handled carefully and protected from contamination.

Pasteurization has made great strides in the United States. Of all milk sold in cities with a population of 500,000 or more, 98 per cent is pasteurized. The tendency in the state of Illinois is toward pasteurization of all milk which is not certified or produced under conditions equivalent to those enforced for certified milk. The City of Chicago requires the pasteurization of all milk which is not certified. Much certified milk is pasteurized today.

Method of Determining Quality in Milk. Since the value of a safe high-quality milk supply has been well established in the United States, some of the methods for attaining it might well be discussed. Details of these procedures may be left for study in the laboratory. Quality and safety of milk are assured by two main efforts: inspection and control of the dairy and processing plant, and laboratory examination of the final product. The former has been discussed; the latter is discussed in the following paragraphs.

The Plate Count. This consists of determining the total number of bacteria which will develop on a semisolid medium under standard conditions of time and temperature. The counts themselves are not especially significant, but they are supposed to indicate the general conditions under which milk has been produced and handled. A plate count of less than 30,000 bacteria per milliliter is considered satisfactory. In most cases it is possible to deliver milk to the consumer with many less bacteria per milliliter. This does not mean that milk with more than

30,000 bacteria per milliliter is dangerous. Most supplies, at one time or another, have more bacteria, but every effort is made to find the reason. The United States Public Health Service Milk Ordinance and Code states that four counts, secured during a "grading period," shall be averaged logarithmically, and the count average secured shall be taken as the count. Such a procedure takes into consideration "sport" counts.

Sediment or Dirt Test. Good milk should be clean. This may be determined quite satisfactorily by the homemaker by carefully examining the bottom of the bottle as she brings it from the doorstep. In the laboratory a pint of milk is forced through a white cotton disk on which visible dirt is retained. These disks may be dried and filed or sent to the dairyman.

Dye Reduction Tests. After much research, methods involving decolorization of dye solutions added to milk samples have been developed for grading milk. They were arrived at by testing milk of all grades of cleanliness and age. A good satisfactory milk was found not to reduce methylene blue in milk in 8 hours, resazurin in 1 hour. These tests are known as the methylene blue reduction test or reductase test and the resazurin test.

Considerable technical knowledge and skill are required to appraise a milk supply. Laymen who are not trained in milk technology are not competent, no matter how informed they may be in other fields. Good judgment must be used, and that comes only from training and experience. Those who try to appraise milk without it, no matter how good their intentions, are little more than agitators and may do much harm.

Diseases Spread by Milk. The diseases spread by milk are caused by bacteria which are contributed to the milk by the cow and bacteria contributed to it by men. Some of the former are tuberculosis, undulant fever, scarlet fever, and streptococcus sore throat; some of the latter are typhoid fever, Salmonella fevers, dysentery, cholera, and diphtheria. Pasteurization destroys the bacteria causing these diseases, else there would be many epidemics each year.

Tuberculosis. This disease attacks the cow, and the tuberculosis microorganisms may appear in the milk. It is now generally admitted that the bovine type of the tuberculosis organism may cause infection in human beings. It was once stated that about one tenth of the tuberculosis of bones, joints, and lymph nodes

in adults and one fourth of tuberculosis of these types in children was due to the bovine type of the microorganism. About 10 per cent of the tuberculosis in human beings under the age of ten years was due to the bovine type of the microorganism spread by milk. One is quite likely to consider such data indifferently until he has an opportunity to study data on definite cases. The report of one case may be reproduced here. It is taken from one of the dairy journals.

_____ of Edgar County had his cattle tested for tuberculosis, and one cow reacted. He did not believe in the tuberculin test and later took the tag out of the animal's ear. The cow looked healthy, and he told his men that there was nothing the matter with her. He talked so much that one of his tenants was induced to take her in payment for work. He used her for a family cow. In his family there were seven children. In the spring some of the children commenced to complain and were sickly. Finally a physician was consulted, and five of the children were found to have tuberculosis. The oldest and youngest children did not take the disease. The youngest child was still nursing and did not use the cow's milk. The oldest child was not allowed to use the cow's milk, since it was thought better to give it to the younger children. The five children were sent to a tuberculosis sanitarium. It was thought that one of them would die. The farmer was fined \$150 for selling a tuberculosis animal. The cow was killed and, when posted, showed a generalized tuberculosis.

Another account quite similar to the one just reported was published by King in the *Journal of the Veterinary Medical Association*. The details in this account are just as convincing. Correspondence with Dr. King revealed that other cases had been found; he believed that it was possible at that time to find them in almost any community if one would take the time to search for them. Such accounts should convince anyone of the value of pasteurization; they should stimulate us to take an active part in all efforts to stamp out the disease.

Tuberculosis in cattle is a deceptive disease.⁵ It progresses insidiously while virulent tubercle bacilli are being excreted in the milk. The United States Department of Agriculture, July 1, 1917, instituted a most aggressive campaign to stamp out the disease among dairy cattle, because the loss of cattle each year had reached the staggering sum of \$40,000,000. This program, it must be admitted, was not primarily the result of an altruistic plan to protect human beings from infection but was greatly

⁵ Control of Bovine in Tuberculosis in the United States, *U. S. Pub. Health Service, Pub. Health Repts.* 61, 1946, 1315-24.

stimulated by the desire to prevent losses and to increase the value of herds. The various states in the Union also joined the eradication program. After 23 years of effort, all counties and Territories of the United States are modified accredited free areas.

Streptococcus Infections. These have been serious at times. The most common infections in human beings caused by streptococci in milk are streptococcus sore throat and scarlet fever. Both of these diseases are caused by similar if not identical streptococci, which show β -hemolysis on blood agar plates. As far as can be determined, septic sore throat and scarlet fever are the same disease with a rash in scarlet fever and none in septic sore throat. The name *Streptococcus epidemicus* has been given to streptococci isolated from infected throats. Some bacteriologists have stated that the etiologic agent in septic sore throat is *Streptococcus pyogenes*. The cause of mastitis in dairy cattle is *Streptococcus agalactiae* which, as far as is known, is not pathogenic for man. Epidemics of septic sore throat and scarlet fever have been largely caused by raw milk.

Undulant Fever (Brucellosis). Members of the genus *Brucella* are etiologic agents. Three species are now recognized: *Brucella abortus*, *Brucella melitensis*, and *Brucella suis*, which are very closely related. *Brucella abortus* was first isolated as the cause of abortion in cattle; *Brucella melitensis* is the cause of Malta fever, which is probably the undulant fever of today; and *Brucella suis* is the cause of abortion in swine. The bacteriological details of undulant fever may be left for more advanced work in bacteriology. Undulant fever is a devitalizing infection which may be either acute or chronic. It is acquired from raw milk, infected meat, and also from discharges. The organisms appear in the milk of infected animals, which makes pasteurization necessary.

Typhoid Fever. Typhoid fever is also a milk-disseminated disease. It differs from tuberculosis in that the etiologic agent is not contributed to the milk by the cow. Milk becomes contaminated with *Eberthella typhosa* in the same manner as do other foods. The infection may be carrier-borne. Typhoid-fever organisms may also multiply in milk. Frost enumerated the following factors which influence the dissemination of typhoid fever by milk:

1. The sources of infection to which milk is exposed.
2. The opportunities afforded for infective material to be introduced into

milk from these sources as well as the precautions taken to safeguard against the introduction of infective material.

3. Circumstances affecting the potentiality of the milk supply in disseminating infection after infective material has once been introduced.

The most important sources of typhoid bacilli in milk are human discharges. The possibility of contaminating with human discharges increases with the number of people who handle the milk. Those individuals with a known history of typhoid fever ought not to handle milk until they have been shown to be free from danger of excreting the bacilli.

BUTTER

Butter is a food the flavor of which depends to a great extent on bacterial activity. The butter maker desires an abundant growth of those bacteria which will improve the flavor of his product. The bacteria play their greatest role in this connection in cream ripening. The cream is pasteurized after separation from the milk to reduce as far as possible the extraneous types of bacteria, or those forms which might harm the flavor of butter. It is then inoculated with a starter, or culture, of desirable lactic acid bacteria that grow in the cream and form products which bestow the desired flavor. The use of such a starter helps to standardize flavor of the butter from batch to batch, makes churning easier, and gives a butter with better keeping qualities. The use of such a starter gives what is called a sour-cream butter. Sweet-cream butters have a milder flavor and are made from cream which has not soured. Methods of butter manufacture in former times yielded in the main sour-cream butter; more recent trends, however, are toward sweet-cream butter.

The bacteria content of finished butter is of little consequence so long as the bacteria are nonpathogenic. Fresh butter may contain as many as 50 million bacteria per gram. This number rapidly decreases until after a month or two only a few hundred thousand are present.

In discussing the bacteriology of milk, *Mycobacterium tuberculosis* was mentioned as one of the important pathogenic microorganisms which might be present in milk. Consequently, if butter is made from tuberculous milk, the tuberculosis organisms will be found in the butter. Experiments have been carried out to determine how long tuberculosis organisms could live in

butter. In one of these experiments cream was inoculated with tubercle bacilli and then churned into butter. After 133 days tubercle bacilli were demonstrable in the butter, indicating that salting and storage did not destroy tubercle bacilli. *Eberthella typhosa*, causing typhoid fever, has also been isolated from butter after long storage. Consequently to have safe butter uninfected ingredients must be used for its manufacture.

CHEESE

Cheese is an important dairy product both from the viewpoint of the dairy industry and as human food. Many different kinds are made, depending on the microorganisms used for ripening and other factors. In the chapter on molds two kinds of cheese ripened by molds were described. Bacteria are used in the preparation of many different kinds. Cheeses are roughly divided into two groups, soft cheeses and hard cheeses. Cheese is, in general, prepared by taking the curd of milk, salting it, and subjecting it to a period of ripening. The ripening process is development of the flavor for which the cheese in question is known. During the ripening period microorganisms added to the curd grow and form compounds which impart the characteristic flavor to the cheese. Some bacteria are undesirable in cheese. They bring about development of undesirable flavors, softening, bad odors, and so on. In a few instances poisonous products have been reported.

Cheese and other dairy products may contain pathogenic bacteria. We have learned that tuberculosis is one of the common diseases disseminated by dairy products. The tubercle bacilli may be spread by cheese. One investigator made cheese from milk which had been inoculated with tubercle bacilli and found the organisms to be alive after 104 days' storage. This is further evidence for using care in selecting our foods and justifying the widespread agitation over disease-disseminating dairy products. It might be of interest to report results of experiments on the examination of ordinary market cheese for tubercle bacilli. Two investigators of the United States Department of Agriculture examined 256 samples of cheese purchased on the open market in Washington, D. C. Nineteen, or 7.42 per cent, caused tuberculosis in guinea pigs when infected according to the usual bacteriological technic. These investigators stated, however, that there was little danger in eating ripened cheese, because most of

the tubercle bacilli were killed during the ripening process. Cream cheese was found to be especially liable to cause tuberculosis since, when the milk is centrifugalized, the bacilli appear in the cream. This indicates that milk used for making of cheese should be pasteurized.

Different Types of Cheese. Many different types of cheese exist, distinguished from one another in various ways. Some are made from curd separated from milk by acids; these are called acid-curd cheeses. Others are made from curd separated by rennin; these are called rennin-curd cheeses. Some are named from the town or locality in which they originated.

Cheddar Cheese. This cheese is the common hard variety which is sold in the United States. It is made in different countries but the greatest amount is made and used in this country. Cheddar cheese is made by curdling milk with rennin, cutting the curdled mass into small pieces, salting it, and pressing it into large cakes or heads. Bacteria continue to grow and produce decomposition products which are characteristic of this type.

Camembert and Roquefort Cheese. These types are discussed in the chapter on molds.

Emmenthaler Cheese. This is also known as Swiss cheese. It is characterized by appearance of numerous large holes containing gases formed by the fermentation of the lactose or milk sugar. The gas is mainly carbon dioxide; propionic and acetic acids are formed in appreciable amounts.

Limburger Cheese. Limburger cheese is a putrefactive product. It is prepared by allowing the decompositions which take place in the making of practically all cheese to go further toward completion. Instead of all proteins being left in the peptone and proteose stages, some are taken to amino acids and other decomposition products which have been discussed in the chapter on the nitrogen cycle. As previously stated, all cheeses are really putrefactive products, the flavor or aroma depending on the special decomposition products which are formed.

ICE CREAM

Ice cream is popular in the United States, and its manufacture is extending rapidly to other countries. Since it is made largely from milk products, it presents somewhat the same problems as do the other dairy products.

It is now quite generally agreed that the number of bacteria in ice cream is determined by the conditions under which it is made. Raw materials with large numbers of bacteria handled in bacteriologically unclean apparatus, will give a product with a high count. On the other hand low-count ingredients (cream, gelatin, eggs, sugar, condensed milk, and flavors) handled in clean

apparatus will give a low-count product. Only in this way is the count itself significant. One investigator who has done much work on ice cream suggested that a bacteriological standard of not more than 100,000 bacteria per milliliter or gram be permitted. Most of the ice cream produced today has fewer than 25,000 bacteria per gram while many plants turn out a product with a daily average of 10,000 bacteria per gram throughout the year. It has been suggested that by rigorous control in manufacture the bacterial content of ice cream may be kept below 1000 per gram.

One important step in ice-cream manufacture is pasteurization of the ice-cream mix. About one half of the states now require it in order to make ice cream safe. More careful control and demands by health authorities have caused a gradual raising of the pasteurization temperature. It is now believed by many in the industry that the mix should be heated to 71.1°C. (160°F.) for 30 minutes.

FERMENTED MILKS

In many countries where herds of lactating animals constitute their owners' wealth as well as main source of food, it is necessary to attempt preservation of milk. The best method of preservation is souring, in which condition the milk will keep for a long period of time. In America milk is soured for therapeutic use; such milk is spoken of as fermented milk. Fermented milks vary from the by-product of butter making, buttermilk, to milks fermented with pure cultures of bacteria. In countries of southern Europe, where soured milks are used to a considerable extent, many kinds are made, depending on whether milk from the mare, sheep or goats, is used, as well as on the microorganism used for fermentation. It is not necessary to discuss all these types.

The use of soured milks in the diet is an old practice, but therapeutic use of these milks is, perhaps, of newer interest, at least in the United States. Metchnikoff once explained longevity of human beings, especially those living in southern Europe, on the ground that they used large amounts of fermented milks. Premature death, according to Metchnikoff, was due to arteriosclerosis (hardening of the arteries); this, in turn, was caused by autointoxication; autointoxication resulted from intestinal putrefaction, and intestinal putrefaction from presence of undue numbers of putrefactive bacteria in the intestines. Metchnikoff

argued that if these putrefactive bacteria could be replaced by saccharolytic bacteria, the evil products of putrefaction would not be formed to be taken into the blood. Therefore, he advised use of fermented milk which contained lactic acid bacteria; these split carbohydrates and replaced those which decomposed protein. It is well known that putrefactive bacteria cannot tolerate presence of bacteria which split carbohydrates because the latter form organic acids which are inimical to putrefactive bacteria.

Metchnikoff also believed that these undesirable bacteria could be replaced by a process called "implantation"; the desirable acid formers were believed to take up their abode in the human intestines to act as continual inhabitants. The organism which was believed to do this best was *Lactobacillus bulgaricus*. These claims of Metchnikoff did not go unnoticed. Numerous investigators tried to confirm them. Investigations, instituted at Yale University under direction of Professor Rettger, were, in the main, concerned with an organism called *Lactobacillus acidophilus*, a very near relative of *Lactobacillus bulgaricus* and probably confused with it by many of the earlier workers.

Milk fermented with *Lactobacillus acidophilus* is known under the name of "acidophilus milk." This fermented milk has been much advised for many different ailments; it seems to be of greatest value when undesirable conditions exist in the alimentary tract. Rettger found that a carbohydrate-rich diet, with a heavy inoculation of the bacilli, would bring about desirable changes in the shortest time. It is generally agreed that daily ingestion of sufficiently large amounts of lactose results in marked increase in the numbers of *Lactobacillus acidophilus*, since they are always present in small numbers; in due course of time other intestinal bacteria are reduced to a negligible number. Bass found, however, that it required more than 300 grams of lactose a day to establish *Lactobacillus acidophilus* as the predominating microorganism. Unfortunately such quantities of sugar are too large to be taken over a long period of time; hence the practical value of this method is quite limited. The investigations made by Bass on the use of cultures of *Lactobacillus acidophilus* for therapeutic purposes, including a large number of experiments on 23 human subjects, have confirmed statements of Rettger and his colleagues. Bass called attention to the danger of making the same kind of mistake with *Lactobacillus acidophilus* that was made with

Lactobacillus bulgaricus. He stated that enthusiastic workers have reported most striking therapeutic results following administration of broth cultures of *Lactobacillus acidophilus* in teaspoonful doses, only a small fraction of the amount of culture that others have found necessary to change, noticeably, the intestinal flora.

The market is flooded with many preparations including acidophilus milk, tablets, and liquid cultures of the organism. Bass examined some of them to determine the number of viable cells therein. In the tablets he could never find more than 1000 viable cells per tablet. If it should be granted that all of these 1000 viable cells were *Lactobacillus acidophilus*, it would take more than one billion tablets, or more than 20 tons, to contain as many living bacilli as are contained in 1000 milliliters, the ordinary daily dose, of acidophilus milk, the quantity found by most investigators to be necessary for the transformation of the flora. Bacteria were somewhat more numerous in the liquid cultures. If all of the viable cells in liquid cultures were *Lactobacillus acidophilus*, a patient would have to drink 7 or 8 gallons daily to get as many as he would secure in 1000 milliliters of properly prepared fresh acidophilus milk. Such information indicates the insidious character of some of these preparations.

The work of Bass is nicely confirmed by James who examined 107 samples of commercial acidophilus preparations of which 13 produced in reasonably pure form the species of microorganism indicated on the label; 15 of the remaining samples were sufficiently pure and presented viable organisms in sufficient numbers to have possible value. The rest were practically worthless as representing cultures of the species indicated.

CONCENTRATED MILKS

Several types of concentrated milks are sold on the American market. Of these *condensed* and *evaporated* are best known, although milk powder is rapidly gaining a place. In the preparation of condensed and evaporated milks much water is driven off in vacuum pans. Sugar is added to the condensed milk, whereas the evaporated milk is unsugared. The sugar helps to preserve condensed milk. Most of such milk is canned for distribution to the public. Some is held under aseptic conditions for the making of ice cream. Bacteriological examinations of cans of condensed

and evaporated milks have shown that they may not be sterile. The bacteria may be dormant and not develop. Such bacteria are of no significance. Bacteria which can grow in the cans and cause spoilage usually do so before the cans reach the consumer.

Milk powder differs from condensed and evaporated milk in that most of the water has been removed. Milk powder is not sterile but may contain varying numbers of bacteria. Some sanitarians have stated that dried milk would eventually replace the present supply of fresh milk.

REFERENCES

- ANDERSON, J. F., Standards for Milk—Their Necessity to the Welfare of the Dairy Industry, *U. S. Pub. Health Service, Pub. Health Repts.* 31, 1916, 2-8.
- ANONYMOUS, Production of Clean Milk, *U. S. Dept. Agr. Farmer's Bull.* 602, 1914.
- ECKLES, C. H., W. B. COMBS, and H. MACY, Milk and Milk Products, McGraw-Hill, New York, 1936.
- FROST, W. H., Relationship of Milk Supplies to Typhoid Fever, *U. S. Pub. Health Service, Pub. Health Repts.* 31, 1916, 3291-3302.
- Grade A Milk, Pasteurized, Raw; Grade A Milk Products Law and Minimum Requirements for Interpretation and Enforcement, *Illinois Dept. Pub. Health, Educational Health Circ.* 135.
- HAMMER, BERNARD W., Dairy Bacteriology, 2d Edition, Wiley, New York, 1938.
- HEINEMAN, P. K., Milk, W. B. Saunders & Co., Philadelphia, 1921.
- HILL, H., Pasteurization, H. K. Lewis & Co., London, 1943.
- KOPELOFF, N., *Lactobacillus acidophilus*, Williams & Wilkins Co., Baltimore, 1926.
- LANE, C. B., Medical Milk Commissions and the Production of Certified Milk in the United States, *U. S. Dept. Agr., Bur. Animal Ind., Bull.* 104, 1908.
- LANE-CLAYTON, JANET E., Milk and Its Hygienic Relations, Longmans, Green, New York, 1916.
- MAGRUDER, G. L., Milk as a Carrier of Contagious Disease, and the Desirability of Pasteurization, *U. S. Dept. Agr. Bur. Animal Ind., Circ.* 153, 1910.
- MATHESON, K. J., and F. R. CAMMACK, Neufchatel and Cream Cheese: Farm Manufacturing and Use, *U. S. Dept. Agr., Farmers' Bull.* 960, 1918.
- Milk and Its Relation to Public Health, *U. S. Pub. Health Service, Hyg. Lab. Bull.* 56, 1909.
- Milk Plant Pasteurization Law and Minimum Requirements for Construction, Equipment Maintenance, and Operation of Milk Pasteurization Plants, Enacted 1939. *Illinois Dept. Pub. Health, Educational Health Circ.* 134.

- Milk Ordinance and Code Recommended by the United States Public Health Service, *U. S. Pub. Health Service, Pub. Health Bull.* 220, 1939.
- MILLER, K. E., Safe Milk for the Small Town, *U. S. Pub. Health Service, Pub. Health Repts.* 33, 1918, 2213-17.
- Ordinance and Code Regulating Eating and Drinking Establishments Recommended by the United States Public Health Service, *U. S. Pub. Health Service, Pub. Health Bull.* 280, 1943.
- PARKER, H. N., City Milk Supply, McGraw-Hill, New York, 1917.
- PRESCOTT, S. C., and M. P. HORWOOD, Sedgwick's Principles of Sanitary Science and the Public Health, Macmillan, New York, 1935.
- ROGERS, L. A., Bacteria in Milk, *U. S. Dept. Agr. Farmers' Bull.* 400, 1912; reprinted as *Bull.* 490, 1912.
- ROGERS, L. A., Fermented Milks, *U. S. Dept. Agr. Bull.* 319, 1916.
- Associates of L. A. Rogers, Fundamentals of Dairy Science, Chemical Catalogue Co., New York, 1923.
- ROSENAU, M. J., Pasteurization—Its Advantages and Disadvantages, *U. S. Dept. of Agr. Bur. Animal Ind., Circ.* 153, 1910.
- ROSENAU, M. J., Preventive Medicine and Hygiene, D. Appleton-Century, New York, 1935.
- SCHROEDER, E. C., The Importance of the Tuberculous Cow to Public Health, *U. S. Dept. Agr., Bur. Animal Ind., Circ.* 153, 1910.
- STILES, G. W., and J. T. LUCKER, Bacterial Infections and Parasites Common to Man and Animals, *U. S. Dept. Agr. Yearbook* (1942) 295-312.
- SWEET, E. A., Safe Milk—an Important Food Problem, *U. S. Pub. Health Service, Suppl. Pub. Health Repts.* 31, 1917.
- TANNER, F. W., Microbiology of Foods, Garrard Press, Champaign, Ill., 1944.
- WILSON, G. S., The Bacteriological Grading of Milk, Medical Research Council, Great Britain, Special Report Series 206, His Majesty's Stationery Office, London, 1935.
- WILSON, G. S., The Pasteurization of Milk, Longmans, Green, New York, 1942.

CHAPTER 22 INDUSTRIAL FERMENTATIONS

MICROORGANISMS FOR THE PREPARATION OF VARIOUS SUBSTANCES

In several places in this book mention has been made of applications of microorganisms for carrying out certain procedures. Bacteria are best known to the layman, as agents causing disease. In this chapter instances are discussed in which they help man to prepare certain materials which are made with difficulty by other methods. These are often spoken of as biological or industrial fermentations.

Although industrial fermentations always face the possibility that a cheaper chemical method for making materials may be found, many are conducted on a large scale. During times of emergency, military or economic, when cost can be given secondary consideration, biological methods are often introduced. Generally these cannot compete economically with other methods of manufacture during normal economic conditions.

Industrial fermentations are conducted with all three common groups of microorganisms: that is, yeasts, bacteria, and molds. We shall limit this discussion to the more important industrial fermentations.

YEAST FERMENTATIONS

Ethyl Alcohol. Production of ethyl alcohol was perhaps the first biological process for the preparation of a chemical compound of industrial significance. It is the most important fermentation in use today. Ethyl alcohol has wide usage in the chemical industries, both as a raw material for other products and as a solvent. It is incorporated in fuel for internal-combustion engines in countries having limited petroleum resources. Adoption of the practice in the United States has been advocated. Other new uses for alcohol undoubtedly will be

developed in time, which will aid chemurgists to fulfill their desires of utilizing more agricultural products in the chemical industries. An excellent example is the use of vast quantities of ethyl alcohol in production of butadiene, a major constituent of butadiene-styrene (Buna S) synthetic rubber during World War II. Considerable industrial alcohol is also produced from petroleum.

Ethyl alcohol is the product of a yeast fermentation of sugars. The raw materials can be those found in a fermentable form in nature, or those which can be converted to a fermentable form. The best examples of the naturally occurring sugars are cane and beet molasses, the former being the most widely used raw material. Both kinds of molasses are by-products of the sugar industry.

Molasses fermentations are conducted by diluting molasses with water to the proper sugar concentration, adding certain yeast-growth-promoting substances such as ammonium and phosphate compounds to insure rapid rates of yeast growth and fermentation, and inoculating with a pure culture of *Saccharomyces cerevisiae*. Much heat is evolved during fermentation, and so means of controlling the temperature in the huge fermenters must be employed. Alcohol fermentations are often conducted in vessels of 100,000 gallons capacity. After the fermentation is completed, the mash is distilled to secure the alcohol, and the residue material is discarded.

Complex carbohydrates are widely used for alcohol production. Cereal grains, used for beverage and industrial alcohol, contain the carbohydrate in the form of starch, which is not fermentable by yeast. Starchy materials are cooked under high pressure to gelatinize the starch and then converted to the fermentable sugars, maltose, and glucose, by enzymes contained in the barley malt added to the cooked mash after cooling. Yeast is added, and the mash is fermented and subsequently distilled to recover the alcohol. Potatoes are used for alcohol production in European countries such as Germany and Poland. Valuable by-products are recovered. These are discussed later.

Besides malt, three other means of converting starch to fermentable sugars are available. The first is the *amylase process* wherein certain molds are employed to saccharify the starch prior to fermentation. The second method employs *mold bran* alone or

in conjunction with small amounts of barley malt. Certain molds, such as *Aspergillus oryzae*, are grown under controlled conditions on bran or other materials until large amounts of amylase are produced. The resultant product is carefully dried to preserve it until used. It is used like malt to saccharify gelatinized starch. The third method, which has received little favorable attention, is hydrolysis of starch with weak acid. Malt is still the most widely used saccharifying agent, but many variations of the procedures are employed, the most recent advance being adoption of continuous cooking and malting. Grain and water mixtures are pumped through a long pipe while being heated by injected steam, then withdrawn at the other end, and suitably cooled to the temperature optimum for malt action. A water suspension of malt is added before the mixture passes through another pipe system used to maintain the proper temperature for rapid amylase action, and then the mash is placed in the fermenter. Operational economies result from this practice.

Another source of alcohol, sulfite liquor, is used in the Scandinavian countries and is receiving serious consideration in the United States and Canada. Sulfite liquor is a waste product of paper making. Wood is shredded and cooked at high temperatures in the presence of sodium sulfite to extract the binding material, lignin. The soluble portion, known as sulfite liquor, is separated from the cellulose fibers which are used for paper. It contains between 1 and 1.5 per cent glucose derived by hydrolysis of hemicelluloses. In the United States and Canada, alcohol from sulfite liquor has not been practical because production costs have not allowed it to compete with alcohol from cheaper sources such as molasses. Recent research has shown improvements with resultant economies; one plant is now operating at Thorold, Ontario. Other agricultural wastes, containing hemicelluloses and celluloses may provide new sources for alcohol in the future. Germany has made sugar and alcohol by acid hydrolysis of wood and wood wastes by the Scholler-Tornesch and Bergius processes. Further improvements on these processes have been made by the Forest Products Laboratory of the United States Department of Agriculture at Madison, Wis. Eventually such a process may allow gainful utilization of substandard wood and sawmill wastes.

Alcoholic Beverages. The manufacture of alcoholic beverages is a large industry. A number of such products are prepared, and these will be discussed briefly. The art is a very old one.

Beer is a beverage containing 3 to 6 per cent alcohol and 3 to 7 per cent solids. It is prepared mainly from malted and unmalted cereals, among which malted barley holds a predominant place. An average grain bill might consist of about 70 per cent malted barley, one to 1.5 per cent hops, and the remainder of adjuncts such as rice and corn. The adjuncts are cooked in water by boiling, and added to an infusion of barley malt where starch saccharification takes place. Then the mash is filtered in a lautering tub, giving a clear straw-colored filtrate known as wort, which is boiled with hops. Hops contain certain resins which are extracted by boiling and give the desired characteristics. The cooled wort is then transferred to fermenters. The yeast, *Saccharomyces cerevisiae*, is added to ferment the sugar to alcohol, giving a "young beer" which is cloudy and possesses undesirable characteristics. These are corrected by aging. After three or four weeks the beer is filtered and carbonated before being dispensed into bottles, cans, or kegs. Bottled and canned beer is pasteurized; keg beer is not.

Spirits. Potable spirits are prepared by distillation of cereal grains fermented in much the same manner as for industrial alcohol. The distillation stage is carefully controlled so that the distillate contains about 80 per cent alcohol. The spirits are manipulated in certain ways during aging. *Whiskey* is made by storing spirits in charred casks from which resins and other materials are extracted to impart the characteristics of that beverage. Whiskey contains about 50 per cent of alcohol. *Gin* is an aromatic potable spirit, the characteristics of which are derived from the juniper berry and other flavoring matter.

Wine. This is another fermented beverage of early origin. It is made from fruit juices rich in carbohydrates. Wine is the product made by the "normal alcoholic fermentation of the juice of sound ripe grapes, and the usual cellar treatment," a definition established by the Food and Drug Administration. A dry wine is one in which fermentation of the sugar is practically complete. A sweet wine is one in which the alcoholic fermentations has been arrested. Fortified wines are those to which brandy has been added to raise the alcohol content, generally to about 20 per cent.

Sparkling wines are those which have had a secondary fermentation in the bottle, so that they will contain considerable quantities of carbon dioxide, which gives the sparkling appearance when the bottle is opened. *Champagne* is a type of sparkling white wine. *Brandy* is prepared by distilling fruit wines.

For the manufacture of wine, the juice of grapes is expressed and transferred to fermenters. A pure culture inoculum of *Saccharomyces cerevisiae* var. *ellipsoideus* is added, and the fermentation is allowed to proceed to completion at low temperatures. Lower temperatures result in slower fermentations which impart better flavors to the wine. After fermentation is complete and the yeast has settled, the wine is racked (decanted) from the lees (containing considerable tartrate salts and yeasts), filtered, and placed in a clean storage tank for aging. Better-quality wines are aged for as long as two or three years. Various cellar practices are followed to give the distinct flavor characteristics of the type of wine to be produced. After aging, the wine is filtered again, bottled, and pasteurized, and is ready for the market. Unless otherwise stipulated, wine is legally the fermented product from grapes. Other fruit wines are made, but the name of the fruit must be mentioned.

Bread Yeast. Manufacture of special yeast for the baking industry is a development of fairly recent times. Formerly brewer's yeast was added to the dough mixture, but only those persons residing near breweries were able to secure yeast.

Bread yeast is produced in the United States from molasses (cane and beet). Molasses is diluted to the desired concentration, usually about 5 per cent sugar, adjusted to pH 4.5 to 5 with sulfuric acid and necessary mineral salts added. After sterilization, it is inoculated with a pure culture of the desired yeast, a strain of *Saccharomyces cerevisiae*. Ammonia is added during the fermentation to supply nitrogen and at the same time maintain the optimum pH. Unlike the alcoholic fermentation, sterile air is forced through the medium in order to stimulate the development of the yeast crop. Little alcohol occurs in the final medium, the yeast metabolizing the alcohol to carbon dioxide and water. Much larger yeast crops are secured by aerated than by unaerated fermentations. At the end of the growing process the yeast is separated from the wort by centrifuges or by filters, and after washing the yeast is finally cut and pressed into the retail

packages. A small amount of flour is sometimes added before pressing to aid in molding of the cake.

Food Yeast. Yeast is a valuable supplement to the diet; it is a good source of protein, though deficient in the essential amino acids, cystine, and methionine, and is a relatively potent source of the vitamin B complex. Since yeast is relatively efficient in converting its own growth substances to cell material, it has been advocated as a means of producing food for higher animals. At the outset of World War II the British Isles were in need of more high-protein foods than could be easily supplied by importation of meats. The English bacteriologist, Thaysen, developed a mutant strain of the nonsporulating yeast *Torulopsis utilis* which was claimed to be even more efficient than common strains of yeast in converting carbohydrates to cell proteins. Since ocean shipping space was at a premium, limiting molasses shipments, the British Government started producing this food yeast in Jamaica. The general procedure is similar to the process of manufacturing bakers' yeast.

The Scandinavian countries also needed considerable protein for food and livestock feed. They also resorted to yeast production, utilizing sulfite liquors, a low-sugar-containing medium which is a waste product from the manufacture of paper pulp.

Glycerol Fermentation. Small amounts of glycerol have been known for a long time to be formed in the fermentation of sugars to alcohol. The exigencies of World War I made it necessary to seek other methods of preparation. Industrial preparation is principally by saponification of fats and oils used in making of soap. Neuberg discovered that acetaldehyde, an intermediate compound in carbohydrate metabolism by yeast, could be reacted with sodium sulfite, and that glycerol then became a major fermentation product:



From this information a number of processes were developed for the manufacture of glycerol by fermentation. Connstein and Lüdecke developed the German process using sodium sulfite. When the weight of sulfite was twice that of sugar, there was a yield of 36 per cent of glycerol. Later Cocking and Lilly modified this method through use of mixtures of sodium sulfite and

bisulfite which resulted in more rapid fermentations and somewhat higher yields. Eoff, Lindner, and Beyer of the Bureau of Internal Revenue developed an American process as a result of reports that glycerol was being made in Germany by fermentation methods. These workers conducted the fermentation in an alkaline medium without sulfite, the reaction being:

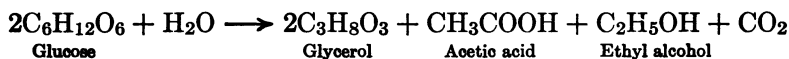

Sodium carbonate was used to keep the medium alkaline. Yields of 20 to 25 per cent were secured. Fermentation methods for glycerol production have not been important owing to the expense of recovery from the mash and the low price of glycerol secured by other means.

BACTERIAL FERMENTATIONS

Acetone-Butanol Fermentation. This is the most important application of bacteria for the preparation of industrially significant compounds. Before 1910 the literature of bacteriology contained statements that bacteria could form acetone and butanol from starch. World War I made it necessary to produce much larger amounts of acetone than were available by the methods in use at that time, one of which was the destructive distillation of wood. Fernbach, a French biochemist, isolated an organism which produced significant amounts of acetone from starch, and Weizmann later perfected a similar process. Since that time considerable study has been given to this fermentation.

In the industrial-fermentation method corn or molasses are used as the raw materials. Corn is ground and cooked in water at high steam pressures to gelatinize the starch and sterilize the mash. The sterile mash is then transferred to sterile fermenters and inoculated with *Clostridium acetobutylicum* Weizmann. Unlike yeast, this organism is able to saccharify starch, and consequently no malting procedure is required. It produces approximately 30 parts of acetone, 60 parts of *n*-butanol, and 10 parts of ethyl alcohol with small amounts of acetic and butyric acids from 100 parts of sugar. Although acetone was the originally desired product, the butanol has become a most valuable product through its use as a solvent in the paint and lacquer industries.

By selecting other organisms of the *Clostridium* group, other fermentation products may be secured. The *Clostridium pas-*

teurianum and *Clostridium saccharobutyricum* groups give rise to large amounts of butyric and acetic acids. Organisms of the type exemplified by *Bacillus macerans* and *Bacillus acetoethylicum* produce mainly acetone and ethyl alcohol as their fermentation products. *Clostridium butylicum* produces butanol and isopropyl alcohol, along with lesser amounts of butyric and acetic acids. These latter groups have not received so much serious attention as have the butanol-acetone organisms.

Vinegar Fermentation. The word vinegar comes from French words meaning sour wine. This indicates one of the first raw materials used for making vinegar. The microbiology of the vinegar fermentation was one of the early subjects for study. Pasteur helped to draw attention to this product by a classic report which still has value for present-day bacteriologists.

Vinegar is probably not a food in the sense in which many other substances are; it is used both as a condiment and a preservative. It is a fermented product containing over 4 per cent acetic acid, along with other substances which give it the proper color, flavor, and aroma.

Any material which has an appreciable carbohydrate content is suitable for the making of vinegar. In the United States apple juice is the common raw material. Grape juice and malt extracts are often used for special-purpose vinegars.

Two main fermentations are involved in the vinegar-making process. The *first* is the *alcoholic fermentation* in which the fermentable sugar is converted to alcohol by yeast. Fresh apple juice in large tanks or vats is inoculated with a pure yeast culture. For each 100 parts of sugar in the substrate there should be 51 parts of alcohol, according to the following equation:

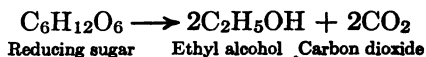

This is the theoretical amount; it is a little more than the amount usually secured, for the yeast uses a small amount for other purposes.

The *second* fermentation is the oxidation of the alcohol of the "wine" to acetic acid. This is spoken of as the *acetic acid fermentation* or as acetification.

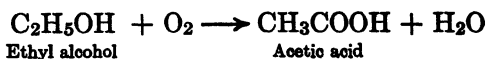

The organisms bringing about this reaction are bacteria grouped physiologically under the name "acetic acid bacteria," and they belong to the genus *Acetobacter*. These bacteria require special conditions to do the greatest amount of work. The material which they ferment should contain not more than 15 per cent of alcohol, preferably less than 10 per cent. For each 100 parts of alcohol, there should be 130 parts of acetic acid formed.

Acetic Acid Bacteria (Acetobacter). Pasteur wrote an early paper on vinegar fermentation, but it remained for Emil Christian Hansen, a Danish bacteriologist, to reveal the more deeply lying facts. Hansen described two microorganisms under the names *Bacterium aceti* and *Bacterium Pasteurianum*. Another organism was described later as *Bacterium Kuetzingianum*. All these organisms differed in salient characteristics which need not be reproduced here, since descriptions are available in various texts. The members of *Acetobacter* are quite pleomorphic, an observation which was made by even the earliest workers with them. Another active organism in the oxidation of alcohol to acetic acid is *Bacterium xylinum*. These names have been changed to *Acetobacter aceti*, *Acetobacter xylinum*, *Acetobacter Pasteurianum*, and so on, in accordance with the more recent classifications of the bacteria. Pure cultures of these bacteria have been found to give better vinegar. They are supplied by some of the agricultural experiment stations.

The organisms concerned in acetification grow on the top of the substrate in a thick jelly layer which is known as "mother of vinegar." This is comparable to the starters which are used in the dairy industry. The "mother" floats on the surface of the acetifying liquid; it is made up of both the bacteria and yeasts which live together.

Methods of Making Vinegar. All the methods of making vinegar differ mainly in respect to the mechanical devices in which the yeasts and bacteria work. They involve special contrivances for giving bacteria optimum conditions in which to live. Man has other situations quite similar to this. Bees are given specially constructed houses in which to lay away honey. There is the septic tank in which anaerobic bacteria decompose organic matter. So the vinegar maker resorts to the same practice if he wishes to have the microorganisms do the greatest amount of work.

DOMESTIC METHOD. This is the commonest method for preparation of vinegar under domestic conditions. The casks are usually 50-gallon barrels fitted as shown in Fig. 114. The barrel should be so filled and constructed that there is plenty of air and an opportunity for drawing off the vinegar and adding more substrate to be fermented. The time required depends on several

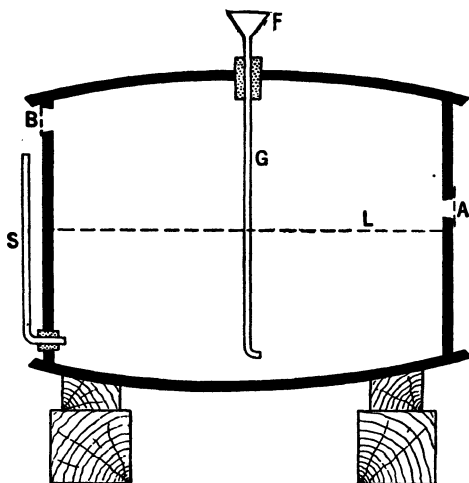

FIG. 114. Cask for Vinegar Fermentation. (After Bioletti)

A, Air inlet, air passes over the surface of the medium; *B*, air outlet; *F* and *G*, funnel and glass tube for filling; *S*, tube for drawing off vinegar. A spigot may be used.

factors. The main disadvantage of the domestic method is that it is regarded as an automatic process which requires very little attention. The use of pure cultures according to directions which may be secured from several experiment stations will give a final product not only richer in acetic acid but also possessed of a better flavor and aroma.

THE QUICK-VINEGAR METHOD OR GERMAN METHOD. In this method the vinegar maker has done what he can to help the microorganism work at a rapid pace. The apparatus used is called a generator. It is an upright cylindrical tank filled with beechwood shavings, or similar materials. This tank is fitted with devices for allowing the alcoholic solution to trickle slowly down through the shavings on which the acetic acid bacteria are living. The tank is not allowed to fill, for that would keep out oxygen. About the bottom of the generator are holes for allow-

ing air to be drawn in; the air rises through the generator and is used by the acetic acid bacteria for oxidizing the alcohol. In

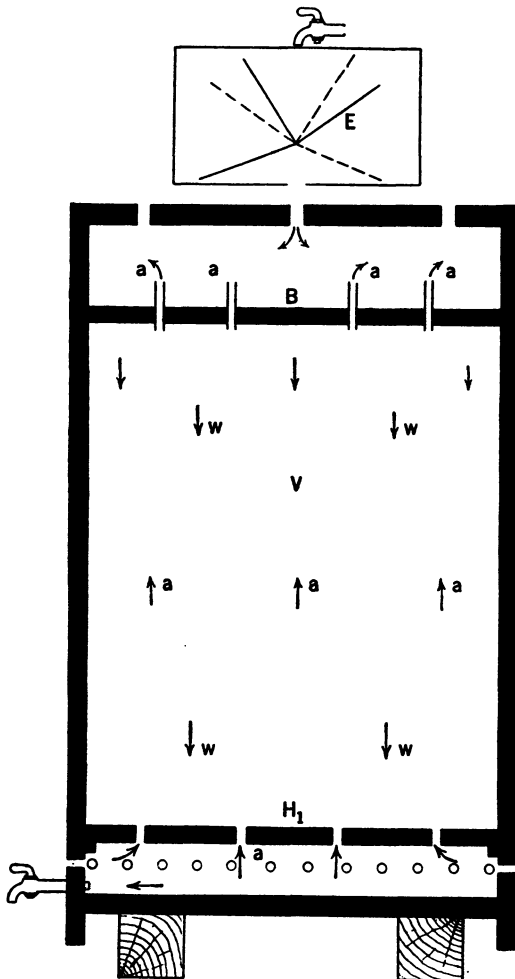

FIG. 115. Cross section of Vinegar Generator. (After Bioletti)

V, Mass of beech chips over which the alcoholic material trickles from the small holes in the false head *H*₁; it becomes acetic; *E*, tilting trough for an intermittent supply of solution to be aceticated; *a*, course of air; *w*, course of alcoholic solution; *t*, thermometer.

many respects the generator is like a furnace. Both are contrivances in which active combustion takes place. Coal is added to the furnace to be chemically oxidized. Alcohol is added to

the vinegar generator to be oxidized by bacterial enzymes. Both yield large amounts of heat. In the furnace that heat is desired; in the vinegar generator too much heat must be avoided, and careful watching is necessary to prevent the temperature from rising too high and destroying the bacteria.

ORLEANS METHOD. The Orleans method is a modification of the domestic method and need scarcely be mentioned as special. It is a continuous method, new unfermented substrate being added as vinegar is drawn off.

PASTEUR METHOD. This was introduced to obviate some of the objections of the domestic and Orleans methods. The "mother of vinegar" is allowed to form on a wooden float. When new substrate is added, the mother is thus not broken up, and the fermentation is not upset.

Lactic Acid Fermentation. Lactic acid is the major acid in sour milk. Its original source was fermented whey. Commercial lactic acid is produced in the United States exclusively by the fermentation of glucose, molasses, and whey.¹ Although a large group of lactic acid bacteria is known (the *Lactobacilli* and *Streptococci*), *Lactobacillus delbrückii* is probably used most frequently. The fermentation is conducted at 50°C., which aids in eliminating contamination.

Glucose or acid-hydrolyzed starch media, containing a minimum amount of nitrogenous nutrients, is sterilized and inoculated with a pure culture of *Lactobacillus delbrückii*. Sterile calcium hydroxide or carbonate is added to neutralize the acid as it is formed and to maintain the optimum pH for fermentation, near neutrality. If the acid is not neutralized, the bacteria would not be able to tolerate the high acidity developed, and the fermentation would be incomplete. The calcium lactate formed is insoluble and is readily separated from the medium. Lactic acid is recovered by addition of sulfuric acid and removal of the calcium sulfate precipitated.

MOLD FERMENTATIONS

Citric Acid Fermentation. Citric acid was formerly produced from citrus fruits and pineapples. Large amounts of natural citric acid were imported by the United States, principally from

¹G. T. Peckham, The Commercial Manufacture of Lactic Acid, *Chem. Eng. News*, 22 (1944), 440-3.

Sicily, Italy, and other Mediterranean countries. The United States is now self-sufficient in production of this important acid as a result of the successful development of the fermentation process.

Though many molds produce significant amounts of citric acid, *Aspergillus niger* is probably the most commonly used. Molasses or technical glucose in 12 to 15 per cent concentrations is used for the commercial process. Certain inorganic salts such as ammonium nitrate, potassium dihydrogen phosphate, and magnesium sulfate serve as other nutrients. The medium is adjusted to a pH of 1.6 to 2.2, sterilized, placed in large shallow pans, and inoculated with a spore suspension of *Aspergillus niger*. A plentiful supply of sterile air must be supplied over the pans. The mold grows as a heavy surface mat. At the conclusion of the fermentation, the liquor is withdrawn and the mycelium pressed to remove any acid contained in it. Calcium citrate is precipitated, and citric acid is recovered by treatment with sulfuric acid, which removes the calcium as calcium sulfate. 4

Penicillin. Antibiotics, substances elaborated by certain microorganisms, are capable of inhibiting the growth of other microorganisms. They are produced by many molds and bacteria; little is known about the vast majority of antibiotics discovered to date. The most striking of the antibiotics is penicillin, a compound elaborated by molds of the *Penicillium notatum-chrysogenum* group.² Penicillin-like antibiotics are apparently produced by many other molds. The action of penicillin was first observed by Fleming, professor of bacteriology at St. Mary's Hospital, London, in 1929. A Petri-dish culture of *Staphylococcus aureus* became contaminated by a colony of *Penicillium notatum*; around the mold colony was a clear zone showing that the mold was producing a substance capable of inhibiting the bacteria. Further work was done by the famous biochemist Raistrick. It was not until the beginning of World War II that workers at Oxford University, Florey, Abraham, Chain, and Heatly, were able to prepare sufficient penicillin for clinical observations. In 1941 these workers enlisted the aid of the United States Government and various pharmaceutical houses interested in penicillin, and an extensive research program was initiated. This culminated in a tremendous production program.

² R. D. Coghill, Science's Cinderella, *Chem. Eng. News*, **22** (1944), 588-93.

Penicillin was first produced by a surface-culture fermentation in which the mold developed as a surface mat on a liquid medium. Thousands of small bottles were used as the first fermenters. Later a submerged-culture process was developed which allowed a great increase in production and at the same time lowered costs. A remarkable aspect of the whole problem is that penicillin occurs in the fermented mash in very small quantities, in the order of magnitude of 0.06 milligram of pure penicillin per milliliter, or approximately 100 units per milliliter. The Food and Drug Administration has established the standard of 1666 units per milligram of penicillin G.

For clinical use the sodium salt of penicillin is used. Fortunately it is nontoxic in the highest dosages needed for effective use. It is used in the treatment of bacteremias, osteomyelitis, pneumonia, gas gangrene, gonorrhea, and syphilis. It is effective in many infections not easily treated by the powerful sulfa drugs. Penicillin is an unstable compound, rapidly destroyed by enzymes and acid conditions. Consequently it is most efficiently administered by injection rather than orally. Oils are not metabolized until they reach the intestine; by incorporating penicillin in such protective vehicles, only small amounts are destroyed during progress through the stomach, where normally the acid conditions and enzymes rapidly destroy the drug. In the intestines the oils are hydrolyzed, and the penicillin is liberated and is readily absorbed into the blood stream. Such administration requires larger amounts of the drug to compensate for small losses encountered in the stomach.

MISCELLANEOUS FERMENTATIONS

In this group of fermentations are certain useful applications of microorganisms which are difficult to classify with the previously described groups. It might be well to recall at this point that many phases of sewage-treatment processes are in reality a type of industrial fermentation, even though they are not pure culture fermentations.

Enzyme Preparation from Microorganisms.³ Many processes used in our civilization depend on enzyme action of microorganisms. In former times these reactions were used unwittingly by

³ Leo Wallerstein, Enzyme preparations from microorganisms, *Ind. Eng. Chem.*, **31** (1939), 1218-24.

custom and trial-and-error methods. As usefulness of microorganisms became more fully realized, an important industry has developed for producing the useful enzymes from microorganisms for specific applications.

Bacterial amylases and proteases have a variety of uses. Most commercial bacterial enzyme preparations are produced from organisms of the *Bacillus subtilis* type. The organism is cultivated in shallow pans on a suitable medium under conditions of controlled aeration so that the bacteria develop as a thin film over the surface of the medium. When maximum enzyme activity has developed the bacterial cells are removed by centrifugation. The medium containing the many enzymes is concentrated and preserved with suitable antiseptics. Further purification may be practiced, depending on the ultimate use of the enzyme preparation.

A variety of amylolytic and proteolytic enzyme concentrates are prepared from the mold *Aspergillus oryzae* and are sold under various trade names. The process is simple. A semisolid medium such as sterile wheat bran is inoculated with a pure culture of the mold. Growth takes place in a rotating drum supplied with adequate sterile air. The bran is later extracted with water to prepare the crude enzyme concentrate. This is quite similar to the process for preparation of "mold bran" used as a saccharifying agent in the grain alcohol industry.

The yeast *Saccharomyces cerevisiae*, under proper conditions of hydrogen-ion concentration, aeration, and medium, will produce significant amounts of the important enzyme, *invertase*. This enzyme is widely used in the candy industry to hydrolyze sucrose to invert sugar for use in soft creams. Invert sugar unlike sucrose does not crystallize readily. Invertase is an endoenzyme, which is liberated from the yeast by autolysis under toluene. The enzyme is purified by precipitation with alcohol, dissolved in glycerol, or other protective liquids, and is finally standardized. Dry invertase preparations are also produced for laboratory uses.

Silage Fermentation. Certain plants which have high water content and yet sufficient food materials to make them valuable for farm animals may be preserved by storage under conditions which prevent putrefaction but permit a desirable fermentation. This fermentation not only preserves them but also causes an improvement in flavor. Such materials as chopped hay, corn-

stalks, and beet leaves are packed into a silo in which the bacteria contained in the raw materials carry on an anaerobic fermentation. A variety of bacteria, yeasts, and molds occur on the surface of the plants and in the juices expressed from them. The small amount of oxygen contained is soon used up by the respiratory enzymes of the plants to be fermented and by the aerobic microorganisms. The anaerobic types then develop and produce an acid fermentation, principally lactic acid along with lesser amounts of acetic and proprionic acids and a little alcohol. The lactobacilli predominate.

Silage spoilage is principally due to aerobic microorganisms, which can grow only on the upper surfaces, or in the lower regions when air leaks occur owing to faulty construction of the silo.

Some plants do not contain sufficient fermentable carbohydrate to give an adequate lactic acid content for preservation. Molasses is mixed thoroughly with the chopped leguminous plants to provide the necessary fermentable sugars.

TEXTILE FIBERS

For ages man has used certain structures in plants for clothing, rope, and the making of materials on which to write.

Linen. *Linum usitatissimum* has been cultivated for thousands of years as a textile-fiber-producing plant. The Egyptians must have raised it, since their mummies are found today wrapped in fine linen. Frequent allusions to flax and linen in the Bible indicate that the ancients were acquainted with the usefulness of the bast fibers in flax and had methods of separating them from the rest of the plant. They were also familiar with other types of fibers, since they are found in their papyri today. The United States cannot be regarded as a great flax- or linen-producing country; it has had to depend mainly on importation to supply the increasing demands for linen. Russia was once the largest flax-fiber-producing country, contributing 80 per cent of the flax fiber used in making linen. Since World War I, however, this has changed, on account of the industrial disorganization in that country.

Flax is raised in the United States mostly for seed which is pressed for linseed oil; a smaller amount is raised for the fiber. Flax raised for seed is of a different quality from that usually required for fiber. Fiber flax is taller and produces less seed.

It requires greater care in cultivation and especially careful handling at the harvest. Some claim that it must be pulled, not cut, and tied carefully in bundles. This may be one reason why it has been difficult to utilize the flax from seed flax for spinning. It might be possible in the future to combine profitably the seed and fiber crop. This might tend to reduce the value of each crop taken by itself, but the value of the combined crops of seed and fiber might compensate for any decrease in the value of the single crop.

The bast fibers, used in making linen, are cemented to the other parts of the stalk and to each other by means of materials, for convenience, called pectins. Undoubtedly this term is used only in a general way to cover several compounds closely related chemically. The aim of the retting process is to remove these "binders" without harming the cellulose fiber. The fermentation must be checked when these fibers have been freed by the hydrolysis of pectins. These binding materials which hold the stalk together are carbohydrate in nature and thus susceptible to the action of microorganisms.

The fibers are prepared from the flax straw by a special process which seems to have been built up after a long period of time without much assistance from the sciences. Proper harvesting is very important. Fiber flax should be pulled either by hand or by machinery and tied into bundles which are shocked for curing. Cutting the flax is claimed by some to leave the ends of the stalk exposed for undesirable decompositions. When the heads are shocked for curing, this cut end becomes susceptible to the attacks of undesirable bacteria. The fibers become badly stained also. This may not be entirely true, however, in actual practice.

After curing, the stalks are "retted." This is really a rotting process, which indicates the origin of our present term. Three general methods may be used to dissolve the binder which holds the cellulose fibers to the woody materials: Dew retting, water retting, and chemical retting. The first two only are of bacteriological interest.

Dew retting was used by our forefathers in the United States for preparing flax fiber for spinning and represents the earliest method. No special apparatus is needed, since the flax straw is merely spread on the ground in the fall and allowed to remain throughout the winter. Dew retting has been used for prepara-

tion of most Russian flax fiber. The greatest objection to it is the time required, but this may be reduced greatly by conducting the process under conditions where the retting organisms may be made to work harder.

Water retting was introduced undoubtedly to get away from certain of the distinct disadvantages of dew retting. It is carried out either in slowly flowing rivers or in ponds and other enclosed bodies of water. The bundles of flax straw are packed into these basins and weighted down. The retting process starts with a gaseous fermentation of the carbohydrate materials in the flax straw. If conditions are favorable, a little over ten days are necessary for the completion of the fermentation. The flax should be removed when all the pectic materials are dissolved, or overretting will result. The bundles are removed and dried in sun and air and are then ready for scutching. The river Lys in Belgium is famous for its flax retting. River retting has certain economic features which limit its wide application. As Kuhnert⁴ has shown, the stream becomes putrescible, which is detrimental to fish life. It carries amounts of organic materials in the reduced conditions and may give off objectionable odors. Water retting has not had wide application in the United States.

Several attempts have been made to improve the water retting. One of the earliest of these was proposed by Schenck in 1846. The flax straw was packed tightly into a tank and the water kept at a temperature of 75° to 95°F. This warm environment was more favorable to the development of the bacteria concerned in this process, and a vigorous fermentation quickly established itself. The vats had all the characteristics of a fermentation mixture. Others have proposed similar methods with a higher temperature.

Scutching is the process by which the woody material is broken away from the cellulose fibers after they have been retted and dried. Different methods have been used, all of which depend on breaking the woody particles and mechanically removing them from the stalk. The fibers are finally combed to separate the "two" from the fibers which are not long enough to remain in line. The latter may be used in paper, coarse linen, and similar products. The fiber from flax may be 30 to 40 inches in length, thus yielding a product which is valuable for spinning.

⁴ Kuhnert, *Landw. Wochbl., Schleswig-Holstein*, 70 (1920), 540-43.

Different bacteria have been found which will ret flax. These microorganisms were investigated as early as 1879 when van Tieghem reported that an anaerobic bacterium named *Clostridium amylobacter* quickly decomposed the pectic substances in the flax stalk. Since that early report many other species have been found to be useful in this respect.

Hemp. Procedures in the preparation of the textile fibers from hemp are not unlike those already described for linen. When the plants have matured, they are pulled and tied into bundles. Retting is similar to the dew retting of flax for the separation of the bast fibers. The use of the fibers in hemp for making textile and rope goes back to ancient times. Frequent references were made to it by ancient writers.

Deterioration of Textile Fibers by Bacteria. Since textile fibers are frequently cellulose in nature, and since there are numerous bacteria which are able to decompose cellulose, it is not unexpected to learn that fabrics may be weakened and destroyed by the action of microorganisms. Moist warm conditions have been found to favor the action of fungi which are significant in this respect. One author has stated that the fungi first appear on the outside of the individual fibers and later send their mycelia through the canals of the cotton fibers. Mildew was found to be nearly proportional to the amount of food materials present in the fabrics. Growth of mildew was reduced by removal of such food materials. Attempts have been made to incorporate a disinfectant in the sizing. Such common bacteria as *Bacillus subtilis* and *Bacillus mesentericus* have been found to have no significance in the decomposition of textile fibers in fabrics.

BEVERAGES

Tea. In the preparation of black tea a fermentation takes place which is mainly enzymatic. Bacteria are not desired, and consequently every attempt is made to keep them out. The presence of bacteria means that products of their metabolism may destroy the color.

Coffee. The coffee bean contains much foreign matter besides the portion which is desired for the making of coffee. To remove the extraneous matter, the fresh bean is subjected to a fermentation to loosen the material about the portion to be saved.

Cocoa. For preparation of cocoa, the seeds of the cocoa fruit are roasted and ground. About these seeds or beans is a great amount of pulp and other matter which is removed most easily by fermentation. This fermentation is induced by piling the seeds on the floor where they heat and an active fermentation takes place. This fermentation also improves the flavor of the product. After the fermentation the beans are dried.

BREAD

The bread or panary fermentation is one of the earliest of which we have written records. It has been carried out in practically all countries. In general there are two kinds of bread, leavened bread and unleavened bread. Unleavened bread is made by fixing flour in water and then baking the resulting mixture. This gave, in olden times, a product not unlike the modern cracker except that coarser meals were often used. Later instead of the dough being baked immediately after mixing, it was allowed to stand in a warm place until fermentation had taken place and the dough was full of gas. This gave leavened bread, the type now used in most countries.

Leavening Agents. Two kinds are available, chemical leavening agents and biological leavening agents. Both cause the formation of gas in the dough or sponge. This gas makes a lighter and more delectable bread.

Chemical Leavening Agents. The chemical leavening agents are those which cause gas formation when they are mixed into the dough and baked. These mixtures are generally called baking powders. One kind is made by mixing cream of tartar (potassium acid tartrate) with baking soda (sodium bicarbonate) and certain other substances added to prevent caking. Sour milk and baking soda also cause the formation of gas.

Vults and Vanderbilt in their "Food Products" enumerated the following advantages and disadvantages of chemical leavening agents:

ADVANTAGES

1. The time is shortened. In a few minutes a light spongy dough can be prepared which would require hours by the use of yeast fermentation.
2. No loss of carbohydrate is involved.
3. It is possible to calculate the amount of gas which will be produced if the composition of the chemical agent is known.

DISADVANTAGES

1. The taste is not so good as that in products raised with yeast.
2. The product is not so readily digested.
3. The residue resulting from the chemical reaction remains in the loaf.

As these residues have no nutritive value, they can only be regarded as waste products. The validity of these disadvantages may be questioned.

Biological Leavening Agents. Biological leavening agents are microorganisms of different kinds. Yeast is probably the best known, although the bacteria have been found, in some cases, to function in a very desirable manner. In the use of yeast as a leavening agent, carbon dioxide is the desired product of fermentation, and not the alcohol as is the case in the fermentation for beverages. Pressed yeast is available in even the smallest hamlets in America. When the pressed yeast is not available, dried yeast can usually be secured. In former times when distribution systems for pressed yeast were not so well developed as they are today, our forefathers had to make their own yeast.

The following advantages and disadvantages of biological leaven were enumerated by Vults and Vanderbilt:

ADVANTAGES

1. Carbon dioxide is generated by the action of the yeast enzyme on the carbohydrate of the meal or flour, and no foreign substance has to be added.
2. The slow liberation of gas causes it to have its full effect as a leavening agent.
3. The by-products produced during the fermentation give a pleasant taste.
4. Bread made with yeast is more digestible.

DISADVANTAGES

1. The time required for leavening is long.
2. Careful watching and study of those conditions necessary for the growth of yeast are necessary; else the fermentation will go amiss, and sour bread may result.
3. A loss of carbohydrates takes place in the formation of the carbon dioxide.
4. As yeast is a living organism, it is impossible to calculate the amount of carbon dioxide which should be produced.

When yeast is used as the leavening agent, it acts on the carbohydrates contained in the dough. Sugar may be added to the sponge, or it may be formed in the sponge by the action of

the flour enzymes. This explains how fermentation is accomplished in a sponge to which sugar is not added. Yeast itself does not contain amylase with which to decompose the starch to fermentable sugars. After yeast has been added, the temperature is kept around 30°C. The little work that has been done on the effects of various yeasts indicated that the strain of yeast used does not influence the flavor of the bread.

Bacteria may also function as leavening agents. Good bread may be made with *Escherichia coli* as the fermenting agent. Koser found that *Clostridium welchii* was being used in a commercial starter for self-raising bread. This organism is an anaerobe and forms large amounts of carbon dioxide.

Bread is susceptible to several types of bad fermentations. One of the best known is slimy or ropy bread caused by presence of aerobic spore-forming bacteria of the *Bacillus subtilis-mesentericus* group. These organisms form spores which are so resistant to heat that they pass through the baking process and grow in the bread during storage. These organisms are capsulated and stick together, giving the slimy appearance. Moldy bread is also quite common since bakeries may become contaminated with mold spores. Some molds grow on the surface of the loaf, giving it a chalky appearance. Sour bread is caused by the overgrowth of the yeast by undesirable bacteria. Red or bloody bread has been mentioned before as due to growth of bacteria which form red pigments; it is an uncommon abnormality in the United States.

BY-PRODUCTS FROM INDUSTRIAL FERMENTATIONS

Recovery of by-products, during recent years, has become an important function of the industrial fermentation industry. During alcoholic fermentation large quantities of carbon dioxide are evolved; almost equal weights of alcohol and carbon dioxide are formed. Fermentations are conducted in closed fermenters in such a manner that the carbon dioxide can be recovered and compressed. Recovered carbon dioxide has many uses, such as in the carbonization of beverages, manufacture of dry ice, and use in fire-fighting equipment. Both hydrogen and carbon dioxide are evolved from the butanol-acetone fermentation; methanol has been manufactured by passing the gases over a suitable catalyst, such as heated carbon.

Where cereal grains supply the carbohydrate substrate for alcohol and butanol-acetone fermentations, there remains in the residue after distillation all the protein contained in the grain. The suspended matter is screened and dried. This is known as "distillers' grains." The soluble matter is evaporated to a sirup, then dried, and is known as "distillers' solubles." In some plants the grains and solubles are dried together to give a product known as "distillers' dark grains" or "grains with solubles." These products are valuable adjuncts to cattle and poultry rations because of their high protein and vitamin-B-complex content. Yeast is capable of limited vitamin synthesis which thereby improves the vitamin content of the solubles.⁵ Under certain conditions *Clostridium acetobutylicum* can synthesize considerable quantities of riboflavin, and the dried solubles from the butanol-acetone fermentations contain larger amounts of this vitamin. Whey and skim milk are fermented with this organism to prepare riboflavin concentrates.

Fusel oils, principally a mixture of amyl and isoamyl alcohols, represent another by-product of value. It may constitute 0.1 to 0.7 per cent of the crude distillate from alcohol fermentations. These alcohols arise through action of the yeast on amino acids; isoleucine is converted to amyl alcohol, and leucine to isoamyl alcohol. Fusel oils are used principally as lacquer solvents without extensive refining.

Yeast has become well recognized as a good source of protein and the vitamin B complex. Yeast must be separated from the wort during brewing operations. After debittering by alkaline washings, the yeast is dried and sold to pharmaceutical and food manufacturers for use as an enriching medium. A modern yeast-recovery method has been described.⁶

⁵ J. C. Bauernfeind, J. C. Garey, W. Baumgarten, L. Stone, and C. S. Boruff, Nutrient Content of Alcohol Fermentation By-Products from Corn, *Ind. Eng. Chem.*, **36** (1944), 76-8.

⁶ J. V. MacDonough and T. C. Haffnerreffer, Some experiments in preparing brewers' yeast for food, *Wallerstein Communications*, **7** (1944), 39-46.

L. V. Burton, Vitamin-Rich Food Made from By-product Yeast, *Food Industries*, **15**, November 1943, 66-9; 144.

REFERENCES

- BUSWELL, A. M., and C. S. BORUFF, *Anaerobic Fermentations*, Dept. of Registration and Education, Division of the State Water Survey, State of Illinois, Urbana, 1939.
- CREUSS, W. V., *Commercial Fruit and Vegetable Products*, 2d Edition, McGraw-Hill, New York. (Excellent chapter on commercial wine making.)
- GALLOWAY, L. D., and R. BURGESS, *Applied Mycology and Bacteriology*, Leonard Hill, London, 1937.
- GLAUBITZ, M., *Atlas der Gärungsmikroorganismen*, Paul Parey, Berlin, 1932.
- HARDEN, A., *Alcoholic Fermentation*, Longmans, Green, New York, 1932.
- HIND, H. L., *Brewing Science and Practice*, Vols. I and II, Wiley, New York, 1938.
- HOPKINS, R. H., and C. B. KRAUSE, *Biochemistry Applied to Malting and Brewing*, D. Van Nostrand, New York, 1937.
- JACOBS, P. B., and H. P. NEWTON, *Motor Fuels from Farm Products*, *U. S. Dept. Agr. Misc. Pub.* 327, 1938.
- JORGENSEN, A., *Microorganisms and Fermentation*, Chas. Griffin & Co., London, 1939.
- MAY, O. E., and H. T. HERRICK, *Production of Organic Acids from Carbohydrates by Fermentation*, *U. S. Dept. Agr. Circ.* 216, 1932.
- PRESCOTT, S. C., and C. G. DUNN, *Industrial Microbiology*, McGraw-Hill, New York, 1940.
- SMITH, GEORGE, *An Introduction to Industrial Mycology*, 3d Edition, Edward Arnold & Co., London.
- TAUBER, H., *Enzyme Technology*, Wiley, New York, 1943.

CHAPTER 23

FOOD PRESERVATION

Man was forced to resort to food preservation when his life became so complex that he had to do other things than hunt and fish. He had to save the abundance of the hunt and harvest during certain seasons for times when he could get little food. Food preservation has become a great industry in all nations. When properly prepared, preserved foods will keep for long periods. Microorganisms are the great trouble makers in food preservation, and all of the various methods are aimed at destroying them or inhibiting them. It is not necessary that microorganisms be entirely eliminated. The general flora must be greatly reduced and certain microorganisms which are especially significant in spoilage must be eliminated or thoroughly controlled.

Relation of Microorganisms to Food Spoilage. Bacteria, yeasts, and molds are the great despoilers of foods. Which group becomes important depends on the constitution of the food, its reaction, and especially its water content. Acid foods are especially subject to spoilage by molds, saccharine foods by yeasts, whereas the bacteria include species which can spoil almost any type. Before spoilage can occur, foods must have about 12 per cent of water. An acid reaction will prevent development of most ordinary bacteria, but special types may be indifferent and cause spoilage. The yeasts develop readily in foods with high sugar content and cause fermentations. Molds also grow well in sugary foods and better when they are quite acid.

Spoiled foods should not be eaten. Although they might not be dangerous to health, spoilage in some cases might have been caused by bacteria which also form poisonous substances. Some of them, such as *Clostridium botulinum*, produce as powerful a poison as is known. This latter organism is also very resistant to heat.

Asepsis. This is not strictly speaking a method of food preservation, but it may greatly affect various procedures which

may be used later. It has to do with preparation of foods and conditions of cleanliness under which they are handled. Modern hygiene and decency demand standards of cleanliness which our forefathers would have regarded as unnecessary. Aseptic preparation of foods is just as important for foods which are to be preserved by one of the methods mentioned here as for foods which are to be eaten fresh.¹ The cleaner the food and the freer from bacterial life, the lighter will be the load on the preservation method. We have already mentioned sanitary inspection in its relation to the production of clean milk and water. Similar inspections are made of the preparation and handling of most foods.

A fine example of the effort to maintain asepsis in preparation and preservation of foods is inspection of meat by the Federal Government. This effort is visualized by the little purple stamp on meat which has been prepared under such inspection. This stamp indicates that the animal from which the meat was prepared was examined before slaughter and that the meat was carefully inspected before approval. If the inspectors, who are well-trained men, find an animal that looks suspicious, it is marked with a tag which may read "U. S. Condemned" or "U. S. Suspect." Condemned animals must not be taken into the slaughter room; suspected animals are slaughtered separately, and the meat is carefully examined before it is allowed to be prepared for sale. It should be stressed that not all meat is inspected. The Federal Government has jurisdiction in interstate matters only. Consequently only meat which is intended for interstate commerce can be inspected by Federal inspectors. It is unfortunate that all meat cannot be subjected to inspection. The opinion that home-killed meat does not need to be inspected may have arisen from malicious advertising of

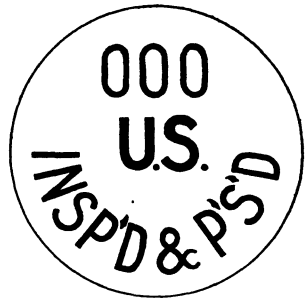

FIG. 116. The Little Purple Stamp Used for Marking Carcasses and Products Passed by the Federal Meat Inspectors. (After Mohler, 1926)

The three ciphers occupy the space where the number of the establishment occurs.

¹ The term "fresh" is often used in contradistinction to the term "preserved." Foods which are not "preserved" need not necessarily be fresh.

those who find it more profitable to buy animals locally for slaughter. Lack of space prevents a recital of the details of this attempt to conserve public health. The student will find them

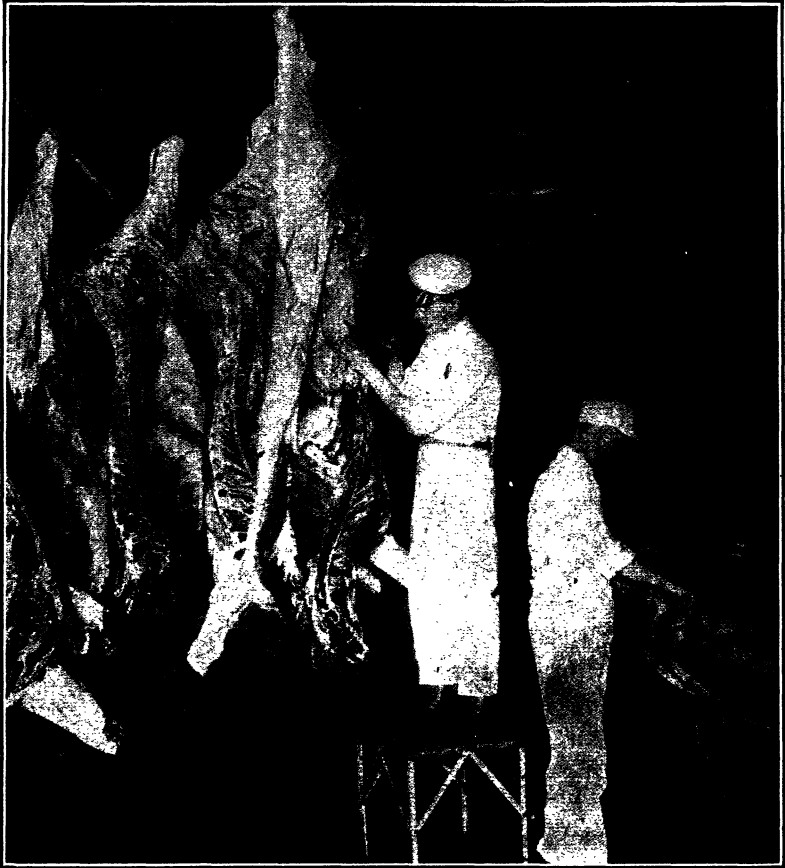

FIG. 117. Federal Inspectors Making the Final Examination of a Beef Carcass. (After Mohler, 1926)

given in a very interesting manner by Mohler in the publication listed at the end of this chapter.

Food and Drug Acts. These have been adopted to prevent adulteration and misbranding and to assure fair dealing. A consumer not only wishes to be given the product he requests but also expects it to be free from any agent which is deleterious to

health. The Federal Food, Drug, and Cosmetic Act of 1938 attempts to secure these conditions for consumers in the United States. The two important parts in the act which do this are those concerned with *adulteration* and *misbranding*.

Adulteration includes all attempts to defraud, such as substituting one article for another, artificially coloring to conceal inferiority, adding any substance which may be deleterious to health, or selling foods in which there is decomposed animal or vegetable substance. *Misbranding* relates to statements on the package which must be strictly in accordance with the facts. The Meat Inspection Act of 1906 does for meat and meat products what the Food, Drug, and Cosmetic Act does for foods and drugs.

DRYING

Drying is one of the oldest methods of food preservation. It was first used alone, and such foods as meats, fruits and vegetables were preserved in this manner. Meats were often smoked in addition, to increase their keeping qualities. Later milk and eggs were added to the list. Great amounts of dried ground beef were shipped overseas during World War II. Although microorganisms seem to be able to get along without any water for a long time, they eventually succumb. In general the moisture content of foods must be kept below about 10 per cent to prevent development of microorganisms.

During difficult times such as military and economic emergencies, dehydration has been used for preserving great surpluses of food. Many dehydrators for use both at home and in factories have been developed. Information concerning the former may be secured from Agricultural Extension Services.

With the outbreak of the second World War the food-dehydration industry expanded many-fold. Large quantities of dehydrated meat,² vegetables, and fruits were sent overseas. Dehydration resulted in great savings in shipping space and weight when great amounts of food, war supplies, and troops had to be transported. With boned and trimmed fresh meat, dehy-

² Meat Dehydration, U. S. Dept. Agr. Circ. 706, Washington, D. C., August 1944.

W. V. Cruess and G. Mackinney, The Dehydration of Vegetables, California Agr. Exp. Sta. Bull. 680, 1943.

dration saves 60 to 70 per cent in weight and 65 to 73 per cent in volume. It has been found that, when good fresh meat is dehydrated to a moisture content of 10 per cent or less and packed in sealed metal cans, it is a safe food from the bacterial standpoint.

LOW TEMPERATURE

Low temperatures have a marked inhibiting effect on microorganisms. Storage life of foods is greatly increased as temperature is lowered. Above freezing, microorganisms are not killed to any extent, but below freezing many are. Low-temperature storage is frequently used for preserving some foods before other methods are applied.

Freezing. This, of course, is the extreme application of cold. The water in frozen foods is crystallized and not available for the bacteria. In this sense preservation by freezing is preservation by drying. No water is available for bacteria so long as foods are frozen. Meat may be preserved for a long time in the frozen condition. Fish and poultry are kept in this manner. In recent years, methods have been developed in the United States for preservation of foods by freezing. A wide variety is preserved in this manner. The older methods permitted only slow freezing, whereas the newer methods permit rapid freezing. The newer methods are more satisfactory because they cause much less change in the conditions of the foods. It is thought that ice crystals are smaller and the physical constitution of the food is therefore, not altered to so great a degree.

Frozen foods are not sterilized foods. They are still perishable unless they are kept frozen until prepared for the table. This introduces the possible hazard that undesirable bacteria may be present and grow if the foods are not properly handled. Frozen foods differ from canned foods in this respect.

Questions have been raised with respect to palatability and safety of foods preserved in "deep-freeze" compartments and freezing storage lockers. Properly prepared and stored frozen foods are safe foods as long as they are kept frozen. They may undergo deteriorative changes such as rancidity and loss of color, changes which do not affect nutritive properties to any extent. These changes may be due to faulty packaging and storing at

too high temperatures. For these reasons it has been recommended that fish and fatty foods such as pork be not stored too long. They do not become harmful but might lose some of their desirable characteristics.

Cold Storage. This is probably the most important method by which great amounts of food are preserved. Cold is the most satisfactory antiseptic which is used in the food-preservation industry. Although it may be more expensive than some of the other procedures, it does have certain advantages. Nothing is added to alter the appearance or condition of the foods. Introduction of this method made many foods available which formerly could not be kept. Cold storage has made apples available almost the entire year. It has also prevented great waste by saving abundance of harvest time for later periods when the supply of fresh foods is exhausted.

Different devices and procedures have been used for preservation of foods by low temperatures, such as wet cloths, cool cellar, and refrigerators. The latter device is used in almost all American homes. The development of the electric refrigerator has revolutionized storage of foods in the home. These devices allow maximum refrigeration all of the time. They give foods which are better preserved and freer from hazards of spoilage and poisoning.

Investigators at Columbia University found that the ice-cooled refrigerator might not be efficient. They suggested that each box be equipped with a thermometer for each shelf and that the upper limit of temperature be between 50° and 55°F. Such a procedure would allow the housewife to follow the temperatures which were being maintained in her refrigerator and to know when they had risen to the danger point.

Period of Preservation. How long may foods be preserved in the refrigerator? A general answer cannot be given to this question. Many factors are involved. One case has been reported where a quarter of beef was kept in cold storage for 14 years. When it was taken from the refrigerator and cut for distribution, the meat was found to be in good condition. Such periods of holding meat are, of course, unnecessary, but they do indicate the possibilities of proper methods of preservation. The fact that bacteria are known to develop slowly at temperatures just above freezing indicates that there are limitations.

HIGH TEMPERATURES

Upper ranges of temperature are much more destructive to bacterial life than lower ranges. To make use of high temperatures, various methods and devices are employed. Some of them such as high-pressure steam or modifications of them have been described in the chapter on the effect of physical agents on bacteria.

Boiling and Cooking. Boiling and cooking are methods of preparation and preservation. They are more commonly used as preparatory steps but function as important sanitary measures. While the application of heat to food has probably, in many cases, prevented dissemination of disease, the limitations should be understood. Different definitions may be used for the terms cooking and boiling. Cooking might vary from slight heating to prolonged boiling. Thorough cooking is one of the most satisfactory methods of rendering foods safer. Baking also has value in this respect. Information on the subject might be more apparent if a few experiments were quoted from the findings on the subject. One investigator studied the effect of broiling, roasting, and braising on bacteria in and on meat. These methods gave unsatisfactory results because the heat did not penetrate. Another investigator confirmed these conclusions by using pieces of metal and tubes of chemicals the fusing points of which were known. These were inserted into the meat to determine the temperatures attained in different places. Another worker boiled a leg of veal for $3\frac{1}{2}$ hours at 101°C . and found that the temperature in the interior had reached only 89°C . A ham weighing 10 pounds after being boiled at 102°C . showed a temperature of only 78°C . at the center. Another good illustration of the fact that cooking does not always sterilize foods is given in Chapter 26 where an account of a typhoid-carrier outbreak of typhoid fever is reported. In this case a viscous pasty food preparation, spaghetti, resisted the penetration of heat and allowed *Eberthella typhosa* to survive.

The belief that certain foods are more nutritious or improved in flavor by insufficient cooking also has bearing on this discussion. Some believe that rare beef is more desirable than well-cooked beef. It is also believed that thorough cooking of oysters should be avoided, else the oysters will be less digestible. In the

latter case it is unfortunate that such ideas prevail, for oysters are frequently harvested from polluted sources. They should be well cooked in order to make them safe at all times.

Cooking is especially significant in destruction of toxins in foods. Such toxins have been important in the United States in connection with outbreaks of botulism caused by *Clostridium botulinum*. This toxin, like the toxins of all bacteria, is destroyed by heat. Boiling for only a few minutes detoxifies toxic material. One precaution, however, should be mentioned. Foods which contain toxin of this microorganism frequently contain large amount of carbon dioxide, for *Clostridium botulinum* forms great amounts of gas. This may be boiled off at temperatures considerably below 100°C. Consequently, such foods will have the appearance of boiling quite below 100°C.

The existence of thermostable gastro-intestinal irritants formed by various bacteria has been quite firmly established. These might not be destroyed by heating.

Pasteurization. This is heating of foods to temperatures below the boiling point but yet sufficiently high for destruction of many bacteria. The idea of partially cooking foods by this process seems to have originated in early days of bacteriology when it was realized that bacteria might be the cause of spoilage. These spoilages were called "diseases" for vinegar, wine, beer, and so on. Heating of these substances to 60°C. was found to destroy organisms which were involved in spoilage and to make them keep longer. This is especially true for fruit juices such as grape juice and apple juice. The best-known case of the use of pasteurization is in the milk industry where it is used to destroy among others the microorganism causing tuberculosis. It should be pointed out that pasteurization does not sterilize and that many bacteria may be left; if it is carried out in such a manner that the material is brought to 60°C. and held at that temperature for the required period, great reduction in the numbers of bacteria will result.

Canning. Sterilization of foods in sealed containers is one of the commonest methods of food preservation. Nicolas Appert is given credit for the discovery of canning as it is known today. In 1810 he received the prize of 12,000 francs which the minister of the interior, Montalivet, had offered for a method of food preservation. This prize was the result of concern which

Napoleon I felt over provisioning the French fleet. Scurvy and other diseases of malnutrition had afflicted the sailors. In 1810

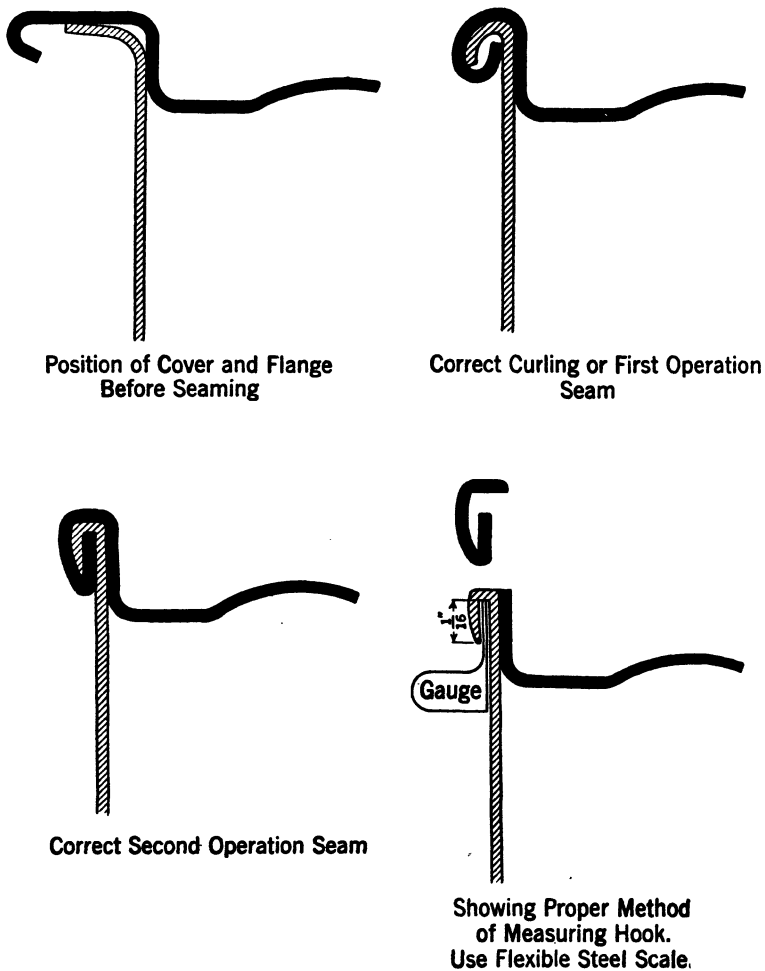

FIG. 118. Showing the Manner in Which the Cover Is Applied to an Open-Top Type of Can.

Appert, when 60 years old, built a factory of his own which suffered from the wars which followed. It was entirely wiped out later. Canning has made available to the consumer all sorts

of foods out of season. There is scarcely a food which cannot be secured today in tin.

The term "canned" has several meanings. Some use it for all methods by which foods are packed in sealed containers, irrespective of the type of container used. Others have suggested that the term canned be applied only to foods packed in tin. In this discussion an attempt will be made to distinguish between these definitions sharply.

Containers may be made of either glass or tin; tin containers are more commonly used under commercial conditions and glass containers under domestic conditions. Both types may be sterilized in about the same manner under pressure if desired, although the glass container gives more breakage.

The tin can commonly used today is known as the open-top or sanitary can. It replaced a type of can which was known as the "hole and cap" can. The present tin can is made from steel plated with tin. The covers are fastened to the side of the can by what are called "double seams," which are shown in Fig. 118. Between the layers of metal is a composition gasket which makes the seam tight. No solder is used in closing this can as in closing the hole-and-cap can. Tin cans are made from steel rolled very thin and covered with a coating of tin. Despite the general belief that the coating of tin is important, experiments have indicated that it is relatively unimportant. Some believe that illness is more liable to result from eating foods from cans with too little tin. There is no foundation for this belief. Some cans are lacquered or enameled on the inside and are spoken of as enameled cans. It is stated by some authors that these cans are used to prevent corrosion or pin holing. With one or two exceptions this is not the reason for the use of these cans. They are used to preserve the natural color of foods packed therein. Such foods as cherries and beets are packed in this type of can. Some foods perforate lacquered cans more rapidly than plain cans since there may be spots where the lacquer has not completely covered the tin, and the contents of the can will then exert an intensive action on such places.

Procedures in Canning. Raw Materials. These should be the best both in quality and state of maturity. Canning factories should be located as near the production fields as possible. This makes it possible to use fresh foods which have not had oppor-

tunity to spoil or even become old. In fish-canning localities, canneries were once constructed on boats so that they could be moved from place to place and kept close to the source of supply.

Preparation. This depends entirely on the product. Fruits are generally quite clean but are treated to remove foreign matter. Fruits with skins are washed and sometimes peeled. Tomatoes from clay soils are washed more carefully than those from sandy soil. Some vegetables require hand washing.

Grading. This is employed to give a uniform product. It is sometimes greatly overdone. There are many grades of peas, cherries, and peaches. Grading is done mechanically.

Blanching. This is a brief exposure to hot water or steam just before the food is placed in the can. It is used for removing sticky matter on the outside of vegetables or fruits as well as to reduce volume. The term might suggest that it is employed to whiten the food product. Such is not the case. Blanching also inactivates enzymes which sometimes give rise to deleterious changes in the food before sterilization. Oxygen destroys ascorbic acid and vitamin A (carotene) if the enzymes are not properly inactivated by blanching.

Filling the Can. With such materials as corn and peas, filling is done mechanically by machinery. Other foods, however, such as pickles and meats, may require hand filling. Hand filling is necessary where foods have to be layered into the can. After the solid portion has been placed in the can, syrup or brine may be added.

Exhausting. This involves heating the filled can to drive out air and raise the temperature as high as possible before closing. This is one of the most important steps in canning; some defects of canned foods may be traced to improper exhaust. For instance, oxygen has been found to accelerate perforation. Defects are greatly reduced, if not entirely avoided, by satisfactory exhaust.

Processing. Processing involves application of heat to the container into which the food to be preserved has been placed and sealed. Under some conditions, especially those which may obtain in the home, the container is only partially sealed, final sealing being done when the container is removed from the sterilizer. "Processing" should be distinguished from "sterilization." The terms are not synonymous. Processed food is not necessarily sterilized food. Canned foods are not always sterile. In fact two investigations made on sterility of canned foods purchased on the open market revealed many unsterile cans. The viable bacteria which were found to be present were probably in the spore stage and dormant. They might not be of significance unless they were spores of some of the organisms forming toxins. This is not probable. Results of processing depend largely on the condition of the raw materials which were canned, penetration of heat into the can, and other factors. When raw materials are fresh and clean, they carry fewer bacteria into the can, and processing is more efficient. Incipient spoilage means a rich growth of bacteria which have to be killed. When the number is low, sterilization is more easily and quickly accom-

plished than when the number is great. A similar situation exists in processing of foods.

Cooling. Cooling is applied to stop the action of the heat. If the cans are not cooled immediately after leaving the retort, they remain hot for long periods, and the action of the heat may continue for some time. Cans

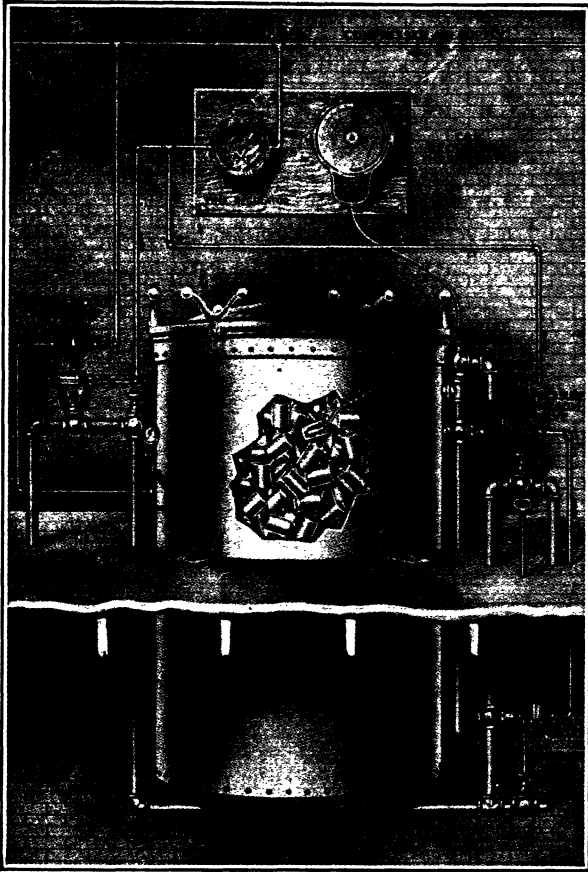

FIG. 119. Showing a Typical Retort or Cooker with Regulators for Controlling the Temperature, Fixing the Time, and Cooling the Product When the Process Is Completed. (*After Bitting*)

are cooled by being drawn through water on a belt or by being on a platform with a slat bottom. Insufficient cooling often results in spoilage of the food product later by thermophilic bacteria which have survived processing.

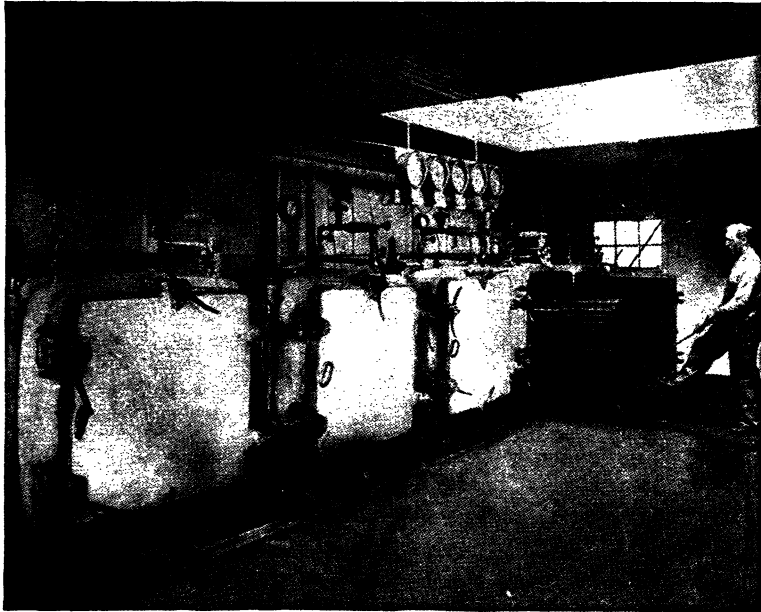

FIG. 120. Showing Retorts or Cookers in Which Cans of Food Are Sterilized.
(*The Appert Process*)

Note, the recording temperature gauges and pressure gauges with which the apparatus is accurately controlled. (*Courtesy William Underwood Co., Boston*)

Keeping Quality of Canned Foods. Since canned foods are supposed to be sterile or at least contain bacteria in dormant condition, they should keep as long as these bacteria do not grow. With some foods, undesirable chemical reactions may take place between the contents and the metal of the container. Such types of spoilage are not discussed here. Several instances are on record where canned foods have been opened many years after packing and found to be in satisfactory condition. One instance is of peas mislaid for 24 years. Another was a can of beef included in the stores of an exploratory voyage of Sir John Franklin. The expedition left England in 1845 and the whole crew perished in the Arctic regions. Rescue parties located an abandoned sledge on which this can of beef was found. The can remained in Liverpool from 1888 until 1926. It was then opened in the presence of a bacteriologist and other food experts. The contents were found to be in apparently perfect condition. Labo-

ratory examination revealed no living bacteria, and no evidence of illness resulted among those who partook of the meat. Other instances could be mentioned but these two should suffice. These cases do not indicate that old canned foods are desirable. It

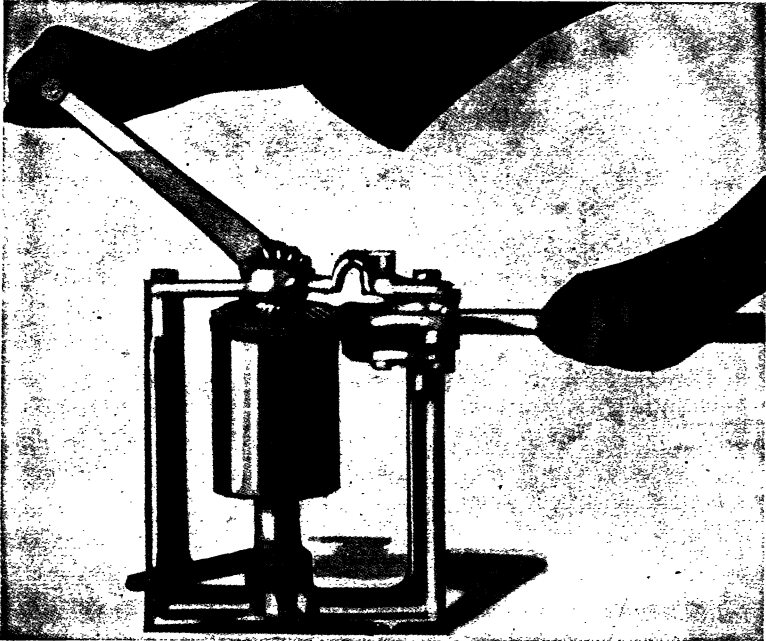

FIG. 121. Sealing Sanitary or Open-Top Cans with a Hand Sealer. (After Stanley)

would be a fine thing if the date of packing were placed on all cans of food. This would be in keeping with the spirit if not the letter of the various food and drug laws. Furthermore, it should not affect the sale of canned foods.

The canning industry has reached a high state of development in the United States. There is scarcely a food that may not be secured packed in tin containers. Canning has made possible the use of certain foods the year round as well as the use of tropical fruits which otherwise might not be available.

Spoilage of Canned Foods. Even though not completely sterilized, canned foods may be held for comparatively long times under proper conditions. In general, the lower the temperature,

the better they will keep. Nonacid vegetables are especially prone to spoilage by thermophilic bacteria which are especially heat resistant because they possess higher temperature characteristics. They also form heat-resistant spores which may survive processing. If the cans are not properly stored in cool warehouses, these spores may germinate and finally spoil the food.

Thermophilic bacteria are of two types as far as canned food spoilage is concerned, *strict thermophiles* growing only at temperatures around 55°C. (131°F.), and *facultative thermophiles* growing at this temperature and also at room temperature or slightly higher, around 37°C. (98.5°F.). A pack of canned foods in which a few strict thermophiles have been left will not spoil if stored at temperatures below 55°C., but, if the food is stored in a hot warehouse where the temperatures approach 55°C., the surviving thermophiles may grow and spoil the food. Cans of food in which a few facultative thermophilic bacteria survive are greater problems to the packer. These organisms may develop under any conditions of storage.

The following are a few types of spoilage recognized in canned foods. The first two are evident in the appearance of the can.

Flat Sour Spoilage. The word flat refers to the container which has flat or concave ends while the word sour refers to the acidic nature of the can contents. This spoilage usually occurs in nonacid vegetables and is caused by development of heat-resistant spore-forming anaerobic thermophilic bacteria. Canned foods which show this spoilage are not dangerous to health. They possess flavors which are abnormal to a sound product.

Hard Swell Spoilage. With this spoilage the ends of the cans are forced out giving the can a bulged appearance. This is an obvious sign of spoilage, and the contents of such cans should not be eaten. This type of spoilage in certain vegetables may be caused by both spore-forming thermophilic bacteria and mesophilic bacteria. In other foods, such as milk products, gas-producing bacteria and yeasts may be the cause.

Sulfide Spoilage. This occurs in certain vegetables and is characterized by a blackened appearance of the food and an odor of hydrogen sulfide. It is caused by an anaerobic thermophilic spore-forming bacterium, *Clostridium nigrificans*. Although packs of canned foods are infrequently attacked, this spoilage is serious for a packer when it occurs.

Home Canning. Domestic methods of canning are not greatly different from those used in the large canning factories. In the home, however, grading, washing, and sorting are performed by hand. Processing may be quite different. Three general methods have been developed for use in the home: the oven, boiling water, and the pressure cooker or steam-pressure canner. Before the merits of each method are discussed, it should be stated that foods have been divided into two groups as far as processing is concerned—*acid* foods such as fruits, and *nonacid* foods such as vegetables and meats. Acid foods are processed more easily than nonacid foods because heat is more effective. Nonacid foods such as vegetables and meats require much more careful processing, for heat is known to be less effective under such conditions. In view of this, canned food technologists are agreed that *nonacid foods should be processed only under steam pressure in properly operated pressure cookers*. This opinion has been forced on them for two reasons—spoilage and the hazards of food poisoning. Anyone who is preserving foods may decide on the amount of spoilage which he is willing to accept. Food poisoning is another matter. Those who desire to study the problem involved at greater length may consult the references given at the bottom of this page.³ It is impossible in a book of this nature to review all the facts involved.

The success of any method of processing depends on penetration of sufficient heat to the innermost recesses, probably the center, of the can to destroy bacteria. Rapidity of heat penetration is influenced by factors such as size of container and consistency of food. In order to show the relative rate of penetration of heat into glass jars processed in the pressure cooker, in boiling water, and in the oven, the curves in Fig. 122 were prepared. Examina-

³ F. W. Tanner, Bacteriological Problems in Home-canning Procedures, *J. Home Econ.* 26 (1934), 365-76.

F. W. Tanner, Home Canning and Public Health, *Am. J. Pub. Health*, 25 (1935), 301-13.

F. W. Tanner, Proper Processes for Home Canners, *J. Am. Dietet. Assoc.*, 11 (1935), 18-27.

F. W. Tanner and G. B. Armstrong, Home Canning Foods for Family Use, *Illinois Agr. Exp. Sta. Circ.* 394, revised October 1937.

Edward Toepfer, Howard Reynolds, Gladys L. Gilpin, and Katherine Taube, Home Canning Processes for Low-Acid Foods, *U. S. Dept. Agr., Tech. Bull.* 930 (1946), Washington, D. C.

tion of these curves will show that processing in the oven and in boiling water permit very slow penetration of heat into the containers.

Oven Processing. This method has been advised especially by stove manufacturers. Processing nonacid foods in the oven will not result in a product which will keep. It is the poorest method

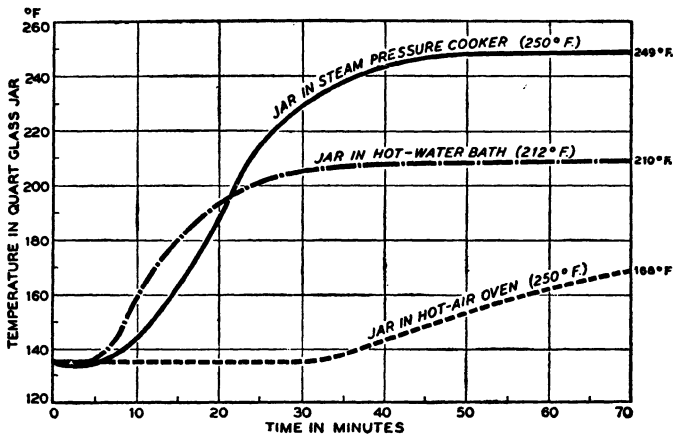

FIG. 122 Temperatures in Quart Glass Jars of Peas Processed in a Pressure Cooker Held at 250° F., in a Hot-Water Bath Held at 212° F., and in a Hot-Air Oven Held at 250° F. (After Tanner and Armstrong, 1935)

To insure safe keeping of nonacid food, processing temperatures above the boiling point of water (212° F.) are desirable. A steam pressure cooker is recommended as the most satisfactory way to secure these temperatures. In tests with peas packed in quart glass jars a temperature of 249° F. was reached in the center of the jar after 70 minutes in a steam pressure cooker, the temperature of which was 250° F. Peas similarly packed reached a temperature of only 210° F. in a hot-water bath held at 212° F. and only 168° F. after the same length of time in a hot-air oven held at 250° F. Oven canning is not advised because of this very slow rate of heat penetration and the difficulty of securing safe processing temperatures.

which can be advised for cooking canned foods. It is both wasteful and dangerous. The temperature attained in the jar does not rise above 212°F. since the jars are not sealed. Although the method may be used with acid foods, it does not destroy all bacteria.

Processing in Boiling Water. This method is widely used today in the United States. It is unsafe for vegetable and meats, for it does not sterilize them. Many of the jars spoil, and those who eat vegetables preserved in this manner face continual hazard of botulism. All of the outbreaks of botulism in America

since 1925 have been caused by home-canned foods. This should convince the most skeptical that such procedures recommended to the home canner are quite inadequate.

Processing in the Pressure Cooker or Steam-Pressure Canner. Nonacid foods should be processed under steam pressure in a pressure cooker. The mere use of such a contrivance is insufficient; it must be properly constructed, equipped, and operated.

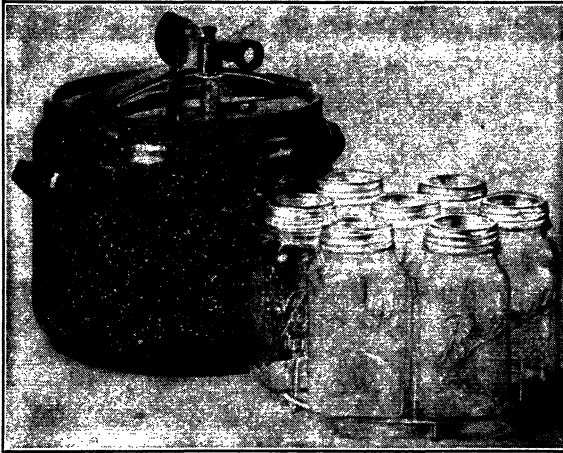

FIG. 123. A Modern Pressure-Cooker Canner (Flex-Seal Type). (Courtesy of Vischer Products Co.)

It should be provided with both a thermometer and pressure gauge as separate instruments. The timetables used for cooking the foods should be only those which have been arrived at by adequate experimental work and consideration of all pertinent bacteriological knowledge.

Processing Times and Temperatures for Home Canning. These are available from many sources to those who wish to can foods in the home. *Farmers' Bulletin 1762* of the United States Department of Agriculture has enjoyed wide circulation. Extension services of most agricultural experiment stations also distribute information. Care must be exercised when selecting such a publication to ascertain whether all problems of the home canner have been considered. Slight differences in recommendations need not cause worry, because they may usually be explained by differences in preparation of the food for canning. For

instance, if the temperature of the foods when placed in the containers is near the boiling point (hot-packed), the processing times and temperatures may be somewhat shorter than if the foods are cold when placed in the containers (cold-packed).

If the pressure cooker is being used for sterilization, allowances must be made if it is used considerably above sea level. Water boils at 100°C. (212°F.) at sea level, but at higher elevations the boiling temperatures are lower. Allowances are made in most publications, and those living at higher altitudes should heed them. Higher pressures or longer times, or both, may be used.

Criteria of Satisfactory Canned Foods. Certain precautions if properly observed will make canned foods perfectly safe. A sound can of food will have concave ends. This does not mean that every can of food with bulged ends is dangerous and will cause illness if eaten. Such cans are abnormal and should be discarded. Ignorance of this or carelessness has caused some of our worst outbreaks of food poisoning. Some cans of spoiled food may not show evidences of spoilage since bacteria concerned might not form gas. In many cases such cans will possess other evidences of decomposition such as bad odors or abnormal appearance. Such cans of food may be just as dangerous as those which have bulged ends. It is a significant fact that almost all the outbreaks of botulism have been caused by foods which were recognized to be abnormal in some respect. Those who were concerned stated that the foods "bit the tongue," "smelled bad," or "had a bitter taste." Consequently, many outbreaks of botulism have been due to carelessness of those who were affected. Thorough boiling would render all canned foods safe. Thom and Hunter of the United States Department of Agriculture advised that the contents of all cans of food be boiled before use, irrespective of whether there were signs of abnormality or not. It is probably better to make certain that the methods of packing are adequate and safe than to have to resort to an expedient before the food is used. The United States Department of Agriculture has discussed this question as follows:

It is the opinion of most bacteriologists that we have not much occasion to dread food poisoning from canned food, provided we make it a rule to look at and smell carefully every can of food when it is first opened. The canning factory maintains a rigid inspection; why not introduce an equally

good inspection service into your own home? Begin by inspecting the container before it is opened. If it is a glass jar look for gas bubbles and note whether the product seems to have changed color or become mushy. The lid should require the application of some force to remove it, for the sealing of the jar while its contents are boiling hot results in the formation of a partial vacuum, and if the seam remains perfect the pressure of the surrounding atmosphere holds the lid down. Similarly the tin can should be flat or slightly drawn in at the ends when cool. If swelled or bulged, the probabilities are that the contents have spoiled as a result of the action of gas-forming organisms. It is a safe rule to discard, without tasting, any canned food which has conspicuously softened or has become mushy to an extent not warranted by the cooking process to which it was subjected; or which contains gas bubbles; or which has a peculiar or unusual smell. If the canned food successfully passes all of these tests but is found to possess an unduly sour taste, or an unusual flavor of any kind, it should at once be rejected; and the portion tasted should also be rejected; without swallowing, to prevent any possible danger of poisoning.

It is a fortunate fact that spores are not as a rule found in those disease-bearing bacteria which are at all likely to occur in canned products, so far as we know at present. The exceptions to this statement are so rare that they should not properly be used as an argument against either commercial or home canning. One hears a great deal about *Bacillus botulinus* poisoning from canned and bottled goods; the danger is a real one in some localities; yet the actual number of outbreaks of botulism at the present date is exceedingly small in comparison with the number of people who consume canned goods. Furthermore, botulinus experts among the bacteriologists state that botulism from canned products can be guarded against by use of four simple expedients, which are:

(1) Make it the absolutely invariable rule never to can any vegetable or fruit not in first-class condition; that is, do not can food which is slightly moldy or specked, oversoft, or "just ready to spoil," or partly rotted. Cutting out the soft spots, and using the rest for canning may prove very poor economy in the end.

(2) Give all canned food a careful and rigid inspection *at the time the can or jar is opened*, and discard any material having an unusually bad appearance or odor, *without even tasting it*. It is a useful precaution to notice the odor of the vegetable while it is boiling; for an odor so slight as to be unnoted while the vegetable mass is cold may be quite plainly perceived when it is intensified by heating.

(3) *Boil the food as it comes from the can before tasting it*. In this type of poisoning, fortunately, most bacteriologists believe that it is not necessary to destroy every bacterial spore, but rather the toxin or poison formed by the growth of the bacteria, which is a much easier matter. It must be clearly understood, however, that this does not warrant us in boiling spoiled food and then consuming it.

(4) The final disposition of canned foods which have spoiled or are suspected of spoilage is a matter of real importance. Chickens and other animals may be and often have been fatally poisoned by eating such

spoiled materials. Even worse than this danger is the possibility of spreading *Bacillus botulinus* (or possibly other dangerous spores) through soil. With such considerations in mind it would seem that spoiled canned foods should be treated as we should treat any sort of infectious material, such as discharges from a typhoid or tubercular patient, or the carcass of an animal which has died of anthrax; that is to say, they should be burned, or, if that is impracticable, they should be boiled for an hour with some efficient disinfectant in order to be sure that all dangerous spores are destroyed. Burying them deeply in soil with a generous covering of quick lime will prevent the poisoning of domestic animals and may have some influence in preventing infection of the soil with a highly dangerous organism.

Spoilage of canned foods is due to various reasons. We need be interested here only in bacteriological spoilage. Canned foods spoil because bacteria grow in the cans. These bacteria may have survived the process, or they may have gained entrance to the can through faulty closure. Inadequate processing may be due to choice of times and temperatures which are too low. This results in slow and inadequate heat penetration. The problem is a little intricate to be discussed completely in a book of this nature.

Different terms are used for describing several types of spoilage. *Swells* are cans in which generation of gas has taken place to such an extent that the ends are bulged. Gas may be due to bacterial activity or to chemical reaction between the contents of the can and the metal. The gas of the chemical reaction is usually hydrogen. A *flat sour* is a can in which the contents have soured because of the activity of so-called "flat sour organisms." There are usually no external evidences of spoilage. The ends of such cans are flat, but the contents possess a sour taste owing to acid from bacterial growth. Other terms have been introduced to describe modifications of these conditions.

Canning Powders. These have been advertised as aids in the canning of foods in the home. The *Bureau of Chemistry* studied one such powder and found it to be composed of 5 per cent of table salt and 95 per cent of boric acid. This powder had little influence on keeping qualities of canned foods; an excess of the powder, it was said, might be harmful and lead to the neglect of other steps known to be necessary in the packing of good foods. Such powders are unnecessary in canning.⁴ If the raw materials are of good quality and properly washed and prepared for the can,

⁴ Thom and Edmonson, *U. S. Dept. Agr. Circ.* 237.

and if they are properly processed and cooled in accordance with well-established practices, there should be no difficulty in obtaining cans of food that will keep and be satisfactory in every respect. Boric acid is a chemical which is prohibited by the Government as a food preservative. It is prohibited in England also.

Preservation of Food by the Addition of Chemicals. Some chemicals are harmful to bacteria; this prompted their introduction to foods as preservation agents. They are known as "chemical preservatives." The great difficulty, however, is to secure a compound which is harmful to bacteria cells and not harmful to persons who partake of the foods. This difficulty is illustrated by the fact that many compounds have been tried for a while only to be prohibited later. Some of these compounds are sulfur dioxide, salicylic acid, and boric acid. The Food, Drug, and Cosmetic Act of 1938 states that any food which contains "added poisonous or other deleterious ingredient which may render such article injurious to health" is adulterated. The interpretation of this part of the law has caused considerable controversy, and, soon after the first food and drug act was passed, experiments had to be carried out to test the poisonous properties of several chemical compounds.

Sodium Benzoate. Much controversy and investigation have centered about the use of this compound in food preservation. Dr. Wiley, when chief of the United States Bureau of Chemistry and later, argued that this compound was a poison and should be prohibited; if the foods were in a good condition when preserved, such a preservative would not be necessary. Because of great difference of opinion, President Theodore Roosevelt appointed a referee board to carry on experiments testing the poisonous properties of sodium benzoate. Folin, to whom this book is indebted for some of the material presented here, gives the conclusions to the first report of the referee board as follows:

1. Sodium benzoate in small doses (under five tenths of a gram per day) mixed with the food is without deleterious or poisonous action and is not injurious to health.

2. Sodium benzoate in large doses (up to four grams per day) mixed with the food has not been found to exert any deleterious effect on the general health, not to act as a poison in the general acceptance of the term. In some directions there were slight modifications in certain physiological processes, the exact significance of which modifications is not known.

3. The admixture of sodium benzoate with food in small or large doses

has not been found to affect injuriously or impair the quality or nutritive value of such food.

Dr. Wiley and his colleagues disagreed with these conclusions. They stated that addition of sodium benzoate was highly objectionable, since it disturbed metabolic functions and caused injury to health. It is difficult to reconcile the conclusions reached by the referee board with those reached by Dr. Wiley. A German investigation to the poisonous properties of sodium benzoate as a food preservative found that sodium benzoate, administered in sufficiently large amounts, caused illness in dogs. It required four tenths of a gram of benzoic acid per pound of dog to cause symptoms of illness. Folin stated that among all preservatives of recent origin there is not one more likely to prove practically harmless to human beings than benzoic acid or benzoates. He called attention to the fact that certain food materials, cranberries for instance, contain benzoic acid or substances which give rise to it in the human body.

Benzoates at best are feeble preservatives. Sodium benzoate is a permitted preservative in America. Studies with pure cultures of microorganisms, yeasts, and bacteria, in fresh apple juice, and the like, showed practically no preservative action.

Boric Acid. As stated before in the chapter on the action of chemical agents on bacteria, boric acid is a very feeble antiseptic. Boric acid and its compounds are not permitted in America as food preservatives on account of poisonous properties. In the writings on food poisoning, frequent references are made to outbreaks of illness which have been traced to boric acid in foods. All nations have barred it from the list of permitted food preservatives. In Great Britain boric acid was not put on the prohibited list until after a thorough investigation.

Salt and Pickling. Common table salt, sodium chloride, has been extensively used as a food preservative.

Common salt is the name given to the native and industrial forms of sodium chloride. Although this substance is widely distributed in nature, occurring in deposits and also in sea water, it appears to have been quite unattainable to primitive man in many parts of the world. Thus, the *Odyssey* speaks of inlanders who do not know the sea and use no salt in their food. In some parts of America and India, salt was first introduced by Europeans; and there are still parts of Central Africa where its use is a luxury confined to the rich.

Since salt appears to have become a necessity very early in the life of nations, it has played an important part in commerce and religion. Some ancient tribes regarded a salt spring as a gift of the gods. The Germans once waged war for saline streams and believed that the presence of salt in the soil invested a district with a peculiar sanctity and made it a place where prayers were most readily heard. The gods were worshipped as givers of kindly fruit, and salt and bread was a common phrase all over the world, being habitually associated with offerings. Homer calls salt divine and Plato names it a substance dear to the gods. Covenants were frequently made with salt as a necessary element; its preservative qualities made it a fitting symbol of enduring compact and fidelity. Every meal which included salt had a sacred character and created a bond of piety and friendship between the guests. Hence, the expression, "there is salt between us," and the phrases, "to eat the salt of the palace," and "untrue to salt." Early in the history of the Roman army—and in later times—salt was rationed to the soldiers.

The beginning of commerce was perhaps a traffic in salt. One of the oldest roads in Italy was built primarily to carry salt into the interior of the country. In Phoenician commerce, salt and salt fish always formed an important item. The economic importance of salt was further indicated by the salt taxes. This often resulted in the salt reaching the consumer in a very impure state; hence the expression in Matthew, "the salt which has lost its savour." This may be regarded as a very early attempt at food adulteration. Cakes of salt have been used as money in certain parts of the world. Even down to the present time salt has been used as a medium of exchange among various tribes. The Roman soldier was given a "Salarium," which was a money allowance to purchase salt. This is probably the basis of our modern term "salary."

Sauerkraut. This food is prepared by fermenting cabbage⁵ tissue under conditions which allow the formation of organic acids; these acids prevent putrefaction in the same manner as they do in other cases already mentioned. In this respect, sauerkraut has much in common with cucumber pickles and silage. In the preparation of sauerkraut, cabbage is shredded and then tightly packed into barrels or tanks with alternate layers of salt. From 3 to 5 pounds of salt per 100 pounds of cabbage are used. The salt draws water from the cabbage tissue to make brine. In this brine lactic acid bacteria grow and ferment the sugars which have diffused from the cabbage. The acids formed are probably lactic and acetic mainly. One difficulty in making sauerkraut is the presence of objectionable microorganisms, such as *Oidium lactis*, which eat the acid and make it possible for putrefactive

⁵ J. L. Etchells and I. D. Jones, Preservation of Vegetables by Salting and Brining, *U. S. Dept. Agr. Farmers' Bull.* 1932, 1943.

bacteria to develop. Abnormal fermentations are not uncommon and give kraut a bad flavor. Pure-culture inoculation with desirable bacteria has helped to raise the quality of sauerkraut.

Cucumber Pickles. Another vegetable preserved by salting is the cucumber. Special species are grown for the manufacture of pickles. When harvested, they are taken to salting stations where they are dumped into large tanks of salt and water brine. This brine, to start with, is of about 20 per cent concentration. In such a concentration the cucumbers float and have to be "keyed

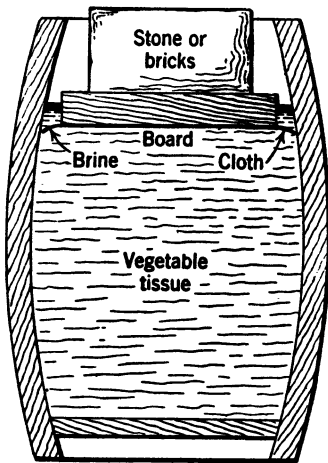

FIG. 124. Showing the Method of Packing Vegetables into the Keg for Fermenting or Salting. (After Round and Lang)

down" by a slat cover being put over them so that all are kept under the brine. If any remain out of the brine or partly out of it, they undergo spoilage and have to be discarded. The strong brine draws sugar out of the cucumbers, which slowly changes into a pickle. The difference between a cucumber and a pickle is easily discernible by comparison. During the first few days the tank appears to boil, so active is the fermentation. After this fermentation, the action slows and the acids formed during the fermentation function as agents of preservation.

The cucumber undergoes distinctly visible changes during the fermentation process. These changes have assumed some importance to the pickle maker who uses them as criteria for judging the progress of the curing process. These changes may be summarized as follows:

1. Change in color from bright green to a duller olive green.
2. Change in the cross section of the cucumber which is first a snow white to a more waxy and partially transparent color or appearance.
3. Change in specific gravity; cucumbers first float and have to be keyed down to keep them under the surface. Later they become heavier than the brine and remain submerged.

Change in the color from a bright green to a duller green is

probably due to action of acid on the chlorophyll. This can be shown by soaking cucumbers in acetic or lactic acid. In a short time they assume the appearance of a cured pickle. Controls require the usual longer time if they are allowed to cure by fermentation.

The second change is largely due to replacement of air in the cucumber by other liquids. Fresh cucumbers always contain much air, which can be easily demonstrated by putting them under a high vacuum. The air imparts to the cucumber a snow-white opaque appearance which changes to a waxy partially transparent appearance after curing.

The change in the specific gravity depends on diffusion of salt into the cucumber and also on progress of the fermentation. During the first few days of fermentation an active osmosis takes place by which the character of the cucumber is markedly altered. After cucumbers have been properly fermented, they may be kept for a long time.

Curing of Meats. Meats have been preserved for a long time by means of curing solutions containing salt, sodium nitrate, sodium nitrite, and sugar. Salt exerts a repressing action on bacteria best explained, perhaps, by plasmolysis. It is the most active ingredient in the curing solution for inhibition of bacteria. The sodium nitrate ingredient is reduced to sodium nitrite by bacteria; the nitrite reacts with certain constituents of the meat to give it a red color.

Spices. Although these condiments are added mainly to improve the flavor of food, some of them have distinct antiseptic value. Cinnamon and cloves are germicidal; pepper and ginger have been found to be practically devoid of action on bacteria. The keeping qualities of foods are greatly enhanced by the presence of spices which are primarily added for flavor. This is probably true for ketchup, mincemeat, and such foods.

Smoking. Preservation of meats by smoking is really a method involving the use of chemicals. In this case the chemicals are sublimed on the meat from smoke, whereas in the other procedures they are added directly. Compounds which preserve meats in smoking are creosotes and formaldehyde, made by causing wood and other materials to smolder in a confined space. In addition to their preservative effect, these compounds also alter the flavor.

Chemicals Formed in Fermentation. In this paragraph some of the information scattered through several preceding paragraphs above is summarized. In fermentation, the chemicals used as preservatives are made by the bacteria themselves. Desirable bacteria have to be favored in some way and the extraneous forms eliminated. Vegetables are preserved by salting to accomplish these results. Salt represses those bacteria which cannot tolerate it but allows the lactic acid formers to develop. Bacteria which can tolerate fairly high concentrations of salt are called halophilic bacteria.

REFERENCES

- AMERICAN CAN Co., The Canned Food Reference Manual, 230 Park Ave., New York, 1943.
- BAUMGARTNER, J. G., Canned Foods—An Introduction to Their Microbiology, J. and A. Churchill, London, 1943.
- BITTING, A. W., Appertizing or The Art of Canning; Its History and Development, Trade Pressroom, San Francisco, 1934.
- CRUESS, W. V., Commercial Fruit and Vegetable Products, McGraw-Hill, New York, 1938.
- DUKES, C., The Bacteriology of Food, H. K. Lewis & Co., London, 1925.
- FABIAN, F. W., Home Food Preservation, Salting, Canning, Drying, Freezing, Avi Publishing Co., New York, 1943.
- FOLIN, O., Preservatives and Other Chemicals in Foods: Their Use and Abuse, Harvard Univ. Press, 1914.
- GARRARD, F., Meat Technology, A Practical Textbook for Student and Butcher, Leonard Hill, London, 1945.
- HERRICK, A. D., Food Regulation and Compliance, Revere Publishing Co., New York, 1945.
- JACOB, H. E., Six Thousand Years of Bread, Doubleday Doran, Garden City, N. Y., 1944.
- JACOBS, M. B., The Chemistry and Technology of Food and Food Products, 2 vols., Interscience Publishing Co., New York, 1944.
- JENSEN, L. B., Microbiology of Meats, Garrard Press, Champaign, Ill., 1944.
- JONES, OSMAN, and T. W. JONES, Canning Practice and Control, Chapman, Hall, London, 1937.
- MOHLER, J. R., The Inspection Stamp as A Guide to Wholesome Meat, U. S. Dept. Agr. *Misc. Circ.* 63, 1926.
- MOULTON, C. R., Meat through the Microscope, Univ. Chicago Press, 1929.
- NICHOLS, P. F., R. POWERS, C. R. GROSS, and W. A. NOEL, Commercial Dehydration of Fruits and Vegetables, *U. S. Dept. Agr. Bull.* 1335, 1925.
- PRESCOTT, S. C., and B. E. PROCTOR, Food Technology, McGraw-Hill, New York, 1937.
- PIERCE, A., Home Canning for Victory, Barrows, New York, 1942.
- TANNER, F. W., The Microbiology of Foods, Garrard Press, Champaign, Ill., 1944.

- THOM, C., and A. C. HUNTER, Hygienic Fundamentals of Food Handling, Williams & Wilkins Co., Baltimore, 1924.
- TRESSLER, D. K., and C. F. EVERS, The Freezing Preservation of Fruits, Fruit Juices, and Vegetables, Avi Publishing Co., New York, 1936.
- TRESSLER, D. K., and C. F. EVERS, The Freezing Preservation of Foods, Avi Publishing Co., New York, 1943.
- TRESSLER, D. K., C. F. EVERS, and LUCY LONG, Into the Freezer and out, Avi Publishing Co., New York, 1946.
- TRESSLER, D. K., M. A. JOSLYN, and G. L. MARSH, Fruit and Vegetable Juices, Avi Publishing Co., New York, 1939.
- VON LOESECKE, HARRY W., Drying and Dehydration of Foods, Reinhold Publishing Corp., New York, 1943.
- VON LOESECKE, HARRY W., Outlines of Food Technology, Reinhold Publishing Corp., New York, 1942.
- WILLIAMS, MIRIAM, Home Canning Made Easy, Macmillan; New York, 1943.
- WOODCOCK, F. H., Canned Foods and the Canning Industry, I. Pitman & Sons, London, 1938.

CHAPTER 24

FOOD INFECTION AND FOOD POISONING

Illness in man caused by various agents in food has been known from early times. Some of the provisions in the Mosaic Code as given in Deuteronomy and Leviticus were aimed at prevention of such illness. Among the many agents which cause it are microorganisms and their products. Before a food is incriminated in illness, careful investigations must be made by those who know what sort of evidence is necessary. Too many diagnoses are made without it.

Care of Food Products. Illness following ingestion of foods means that something wrong has happened; it was of inferior quality at the source, has been mishandled during processing, or has been stored and mistreated after preparation. Processing and preservation are well controlled by Federal and state laws, so that most foods are sound at the source. They are preserved well; else they would not keep, and the manufacturer would lose money. In spite of the care which is used in preserving foods, many are spoiled by carelessness of those who prepare them for the table. They are contaminated and improperly handled without refrigeration. Unfortunately the manufacturer is often blamed for spoilage and illness when he should not be.

Food products must be kept clean which means not only absence of visible dirt but also absence of bacteria which could be kept out by proper care. Personal cleanliness among those who handle food is paramount. A careless cook who is dirty can negate all the good done by a careful manufacturer who has used expensive technical help or a health department which has passed adequate laws.

Types of Illness Caused by Bacteria in Foods. Illness in human beings may be caused by bacteria in foods in two ways: The bacteria themselves may cause infections, or they may form products which are poisonous. The former are called "food-borne infections" and the latter "food-borne intoxications." *Salmonella* bacteria may cause both types of illness.

Food-Borne Infections. These are true infections caused by entrance and growth of a parasite in a host. In this case the parasite, a bacterium, protozoan, and so on, enters the alimentary tract in food. It then reaches the blood stream which carries it to other places in the body. Typical food-borne infections are typhoid fever, dysentery, scarlet fever, streptococcus sore throat, and amebiasis. The outstanding characteristic of these infections is that a "period of incubation" occurs during which bacteria are gaining a foothold in the body. When this is established, symptoms appear. Measures may then be instituted to determine what food caused the infection, how it became contaminated, and what measures should be instituted to prevent recurrence of the epidemic.

Food-Borne Intoxications. An intoxication is a poisoned state of the blood. In this case, the poison enters the body in food. The symptoms of illness may appear in an incredible short time, from a few minutes to a few hours. This is a sharp distinction between a food-borne infection and intoxication. Food-borne intoxications are botulism, *Staphylococcus* food poisoning, and *Salmonella* food poisoning.

FOOD-BORNE INFECTIONS

These are caused by bacteria themselves and some time is required for symptoms to develop. The bacteria may enter the foods in different ways. In some diseases as in scarlet fever and streptococcus sore throat the foods may be contaminated at the source, in these cases by the cow. In typhoid fever *Eberthella typhosa* may enter the food from contaminated utensils, or water, or from individuals who handle the food. They may or may not know that they are carriers.

Contamination of Foods by Carriers. A carrier is an individual who harbors and excretes disease-producing bacteria but who shows no symptoms of illness. Since carriers are discussed in a subsequent chapter, only one or two carrier-food-borne outbreaks of typhoid fever need be mentioned.

The first one was investigated by Sawyer of the California State Board of Health.

The food was found to have been infected by a typhoid carrier who had no knowledge of ever having the disease. A study of the manner in which

the infection reached the food fastened suspicion on a dish of Spanish spaghetti. This dish, which contained a thickening sauce composed chiefly of milk, was prepared by the carrier in her home on the day before the dinner. The baking of the dish was done at the dining hall during the morning before the meal. As there was ample time for it to become infected with *Eberthella typhosa* organisms during its preparation, it was only necessary to prove that the dish was a favorable medium for the growth of the typhoid bacillus and that the final baking of the dish had been insufficient to sterilize it, in order to prove definitely that the spaghetti had been the source of infection. To determine these two points laboratory experiments were conducted which produced valuable data regarding the temperatures reached in baking as carried out by the ordinary household methods.

A dish of spaghetti was prepared in the laboratory under conditions simulating as nearly as possible those under which the original dish had been prepared and inoculated with a broth culture of the typhoid bacillus of the strain obtained from the carrier. This material in a pan 5 inches deep and 9 to 13 inches in diameter, was baked in a hot oven of an ordinary gas range for 15 minutes. At the end of this time the temperature in the middle of the spaghetti had risen from 16° to 17°C. and, after the spaghetti had been in the room for one-half hour it rose to 21°C., as the heat penetrated to the inner portion. Cultures made from the contents of the dish at various depths, after this baking, all developed colonies of *Eberthella typhosa*.

The spaghetti was next introduced into a hot-air sterilizer, which had been heated to between 160° and 170°, and was subjected to this temperature for 30 minutes. At the end of that time the appearance of the dish suggested thorough cooking but the temperature at the top was found to be 54°C., and at the middle only 23°C. Cultures made from the contents of the dish, at various depths, after this baking showed the presence of *Eberthella typhosa*.

The dish of spaghetti was finally introduced into an oven maintained at 207° to 214°C., and subjected to this temperature for one-half hour. Examination of the dish at the end of this period showed the temperature just beneath the surface of the spaghetti to be 83°C., at the middle 28°C., and at the bottom 48°C. After it had stood in the room for one hour, the temperatures were 46°C. near the top, 42.5°C. at the middle, and 43°C. near the bottom. Cultures taken from the middle of the dish showed an abundance of *Eberthella typhosa*. These results showed conclusively that the baking, which the food had received after being infected, was not sufficient to produce sterilization.

Portions of the sauce were sterilized, inoculated with the same strain of the *Eberthella typhosa*, and allowed to incubate. A study of the rate of development of the bacteria showed the sauce to be a good culture medium for the *Eberthella typhosa*, although somewhat inferior to sterilized skim milk.

In the opinion of the author the results of this investigation demonstrate that "cooked dishes must be considered as possible conveyors of infection

unless it can be shown that the method of cooking would produce complete sterilization." The slowness with which heat penetrates dishes like the Spanish spaghetti shows that very prolonged heating would be necessary for sterilization of large dishes of such food.

Another interesting example of a carrier who repeatedly infected foods is so-called "Typhoid Mary." She was a cook who refused to co-operate with health authorities; she finally had to be taken into custody to prevent her from continuing her occupation as a cook. In 1906 Dr. Soper was called to a summer home on Long Island, New York, to investigate the cause of typhoid fever which had appeared. Six individuals in a household of 11 were afflicted with the disease. Evidence pointed to the cook as cause, but no information could be secured from her when she was found. Dr. Soper was able to show that she had caused seven outbreaks in eight families in which she had worked as a cook. In some of them typhoid fever appeared with marked regularity after Mary Mallon took up her duties as cook. Repeated attempts were made, without success, to collect specimens of urine, feces, and blood for examination. Finally she was forcibly removed to a detention hospital of the New York City Health Department where she was detained virtually as a prisoner for three years. The action of the health department was sustained by the courts when attempts were made to release her. Later, she was voluntarily released on her promise to refrain from cooking. She finally broke her parole and disappeared. For nearly five years she was lost but appeared again under very dramatic circumstances. An outbreak of typhoid fever appeared in a hospital in New York City. It was finally traced to the cook who proved to be Typhoid Mary. She was again taken into custody by the New York City Health Department and died later. The total known cases were 51 in 10 outbreaks. Only one's imagination can estimate the number of unknown cases which she caused.

More space need not be given to carriers, although interesting examples could be mentioned almost without end. The Mallon case has lessons for anyone. It shows, first of all, that our foods may easily become contaminated with excrement. Sanitarians state that, for a person to have typhoid fever, he must swallow some of the excrement from a person ill with the disease. Another lesson is that cooks should be selected with great care. Their

past history should be known, at least as far as their disease record is concerned.

FOOD-BORNE INTOXICATION

These are typical poisonings caused by toxins or other agents secreted into the food by bacteria which are growing in it. The symptoms appear quickly. Poisons in foods may result from growth of bacteria or be of other kinds naturally present. The following are a few.

Mushroom Poisoning. This is one of the earliest types of food poisoning to be reported in the writings of the ancients. Deaths of many famous people were attributed to these poisonous fungi. Mushroom or toadstool poisoning may be very serious; the symptoms are, in general, great drowsiness, stupor, pain, and nausea.

White Snakeroot Poisoning. This poisoning, responsible for the death of many people, is also known as "milk sickness" or richweed poisoning. White snakeroot is also poisonous for animals. When the plant is eaten by cows, the poison may appear in the milk and cause serious illness among those who drink the milk. The poison is not destroyed by heat, because plants which have been cooked in the autoclave have caused poisoning. Pasteurization of milk would not, therefore, prevent it. The poison involved has been studied by Couch of the United States Department of Agriculture. He separated three poisonous fractions. Milk sickness was attributed to one of them, apparently a secondary alcohol, to which the name *tremetol* was given.

Mussel Poisoning. Mussels have caused some serious outbreaks of illness. The real cause of the poisoning does not seem to be known. An extensive outbreak at Wilhelmshaven, Germany, in 1885, caused investigations by many chemists and biologists. More recent outbreaks have been reported in the United States which, although not involving a great many cases, have been serious.

Fish Poisoning. Some fish are naturally poisonous, even though they are carefully handled and refrigerated after catching. Most in this category are tropical fish caught in warm waters.

Botulism. This is by far the best illustration of food poisoning that can be offered. It is a true toxemia resulting from eating of food in which *Clostridium botulinum* has grown and formed its

poison. Botulism has received much study in America since 1915 because of numerous striking outbreaks that have occurred. It has enjoyed an interest, however, far out of proportion to its significance as a cause of death. The striking symptoms and high fatality gave it an importance beyond its due.

The symptoms of botulism may best be enumerated by quoting the description of a case from the literature by Dickson in 1918.

Outbreak 12 (one case). On Friday, February 22, 1918, Mrs. H. of Oakdale, Calif., tasted a small portion of a bean pod from a jar of home-canned string beans which she had just opened. The beans had a peculiar irritating taste but she swallowed a small amount. When she placed the beans on the stove to cook, there was an extremely disagreeable odor and she discarded them.

On Saturday morning, February 23, Mrs. H. was dizzy when she first got out of bed, and she staggered when she walked. She noted that vision in the left eye was blurred. By afternoon vision was blurred in both eyes, and the staggering was much worse. The patient became alarmed and consulted Dr. J. B. Thompson of Oakdale, to whom the writer is indebted for the following report.

When first seen by Dr. Thompson, Mrs. H. was almost hysterical but had no complaint other than that which has been detailed. She said that there had been no pain and no gastrointestinal disturbance, and that she had not even been nauseated.

Examination showed complete dilatation of both pupils, which reacted very sluggishly to light, and a pulse rate of about 100 per minute. The temperature was normal. The patient was very weak, and muscular movements were not co-ordinated, but nothing else abnormal was found. Dr. Thompson stated that he was strongly suspicious of belladonna poisoning, as at that time the patient denied having eaten any spoiled food.

After midnight, Saturday, Mrs. H. complained that her tongue was swollen, and she began to have difficulty in talking. On Sunday morning there was bilateral ptosis, and later in the forenoon she began to have difficulty in swallowing. Speech rapidly became unintelligible. About noon on Sunday she began to vomit, and the vomiting continued for the greater part of the afternoon. There were three formed stools during Sunday forenoon and several involuntary liquid stools during the afternoon. All stools were extremely offensive. There were no bowel movements during the last 36 hours of life. Toward evening on Sunday the patient began to have spells of strangling when she attempted to swallow, and she complained bitterly of the accumulation of mucus in the pharynx, which she was unable to raise. Urination was not disturbed except that the patient voided involuntarily during strangling spells.

The temperature varied from normal to 102.6 (rectal) just before death, respiration remained about 24, and the pulse varied from 98 to 120 per minute.

The patient was very restless and did not sleep during Sunday night

or Monday. There was no disturbance of mentality, and the skeletal reflexes were intact. There was no disturbance of sensation except a sense of numbness in the hands. She became rapidly weaker, and the pulse increased in rapidity. At first there was satisfactory response to stimulation, but later there was no appreciable effect. The patient died early Tuesday morning about 88 hours after tasting the beans.

To remove the mucus from the pharynx, Dr. Thompson made use of the aspiration bottle to which a soft rubber catheter was attached. He stated that this appeared to give much greater relief and to cause much less irritation than swabbing.

The beans which caused the poisoning were grown in Oakdale and were picked but a few hours before they were canned. They were washed, strung, broken into small pieces, and boiled in an open kettle for 20 minutes. They were then packed into new freshly boiled one-pint economy jars; one tablespoonful of salt was added to each jar, and the jars were covered, immersed into boiling water, and boiled actively for 3 hours. Twelve jars of beans were canned, and two of them spoiled. The contents of nine of the others were eaten after they had been cooked, and appeared to be good, but there is no record as to whether any one had eaten or tasted any of the beans before they were cooked. One jar was taken to the laboratory for bacteriologic examination, but no evidence of *B. botulinus* was found.

A portion of the beans from the contaminated jar was gathered from the garden where they had been thrown and had lain in the rain for several days. Bacteriologic examination showed no evidence of *B. botulinus*.

Practically all of the botulism in the United States today is caused by improperly processed home-canned foods. Canned foods processed under commercial conditions in the United States have not caused botulism since 1925. One outbreak was caused by mushroom paste which is more of a specialty than a regular canned food. Home canners are still ill advised by many authorities who fail to consider recent bacteriological knowledge on canning technology. This subject has been reviewed in Chapter 23 on food preservation.

Clostridium Botulinum. This anaerobic bacterium, responsible for many outbreaks of botulism, was discovered by van Ermengem during investigations of an outbreak of food poisoning caused by a ham. Since the intoxication had been caused mainly by sausages in Europe, van Ermengem used the Latin word for sausage in naming the disease. It is known today that many other foods, particularly home-canned vegetables not properly processed, may cause it.

The microorganism possesses three major characteristics which give it importance in food poisoning.

1. It forms a powerful poison which is active in very small amounts.

2. It forms very resistant spores which survive processing of canned foods.
3. It is a strict anaerobe, thus finding the conditions in a can of food suited to its development.

If one could create an organism for food poisoning, he could hardly select characteristics which would be more significant than these which have just been named.

The toxin formed by *Clostridium botulinum* is one of the most active poisons known. A small amount will cause death. Some fatal cases have been reported where a little liquor left on the tongue from tasting a portion of a bean pod caused death with typical symptoms. Experiments have shown that this toxin is quite susceptible to heat and is destroyed by boiling for a few minutes. This, then, is a simple method for preventing botulism. The best method is to use canning procedures which destroy the spores, thereby making it unnecessary to heat all canned foods.

The effect of heating foods in prevention of botulism is well indicated by the following report from the *Weekly Bulletin* of the California State Board of Health for March, 1923:

A woman residing in Glendale, Los Angeles County, opened a jar of home-packed string beans a few days ago. She tasted the beans and afterwards cooked them for ten minutes, serving them to the other members of her family consisting of her husband and six children. Three days later this woman developed marked symptoms of botulism—general weakness, disturbed vision, and throat paralysis. After suffering acutely for nearly a week, the patient died in great agony. None of the other members of the family suffered any ill effects from eating the beans, the cooking of which undoubtedly destroyed the toxin so that the other members of the family were not affected. Some of the uncooked beans apparently were thrown out to the chickens, for, about eight hours after the garbage had been thrown out to the chickens, all of them showed symptoms of limberneck and died.

The family was warned immediately not to eat any more of the home-canned product that remained unopened, and samples of beans from the same pack have been sent to the State Hygienic Laboratory for examination.

The spores are exceptionally resistant to heat, perhaps more resistant than spores of any other microorganisms. This allows the organism to survive some processes given canned foods. Esty and Meyer reported the following data on the heat resistance in a phosphate solution of a pH of 7:

4 minutes at 120°C. (248°F.)
10 minutes at 115°C. (239°F.)
32 minutes at 110°C. (230°F.)
100 minutes at 105°C. (221°F.)
330 minutes at 100°C. (212°F.)

It is a very significant fact that, in most of the important outbreaks of food poisoning caused by the toxin of *Clostridium botulinum*, the foods have been admitted to be abnormal in some way. If the consumers had followed the advice of food experts to refuse foods which were not right, poisoning would not have resulted.

Salmonella Food Poisoning. The members of the genus *Salmonella* have caused much trouble in food-borne infection and intoxications. Members of this genus occur in the intestinal canal of animals in various acute and inflammatory diseases. Although they may cause typical infections, often initiated by the organisms being conveyed in foods, our main interest in them as food poisoners results from the fact that they produce agents which cause pronounced symptoms of gastroenteritis. The species which have been especially significant in *Salmonella* food poisoning are *Salmonella schottmülleri*, *Salmonella enteritidis*, *Salmonella aertrycke* and *Salmonella suipestifer*.

These agents to which various names have been given have been called "heat-stable toxins," "gastrointestinal irritants," and enterotoxins. The first name mentioned, "heat-stable toxins," was abandoned by discriminating bacteriologists because they are quite resistant to heat. True bacterial toxins are not—in fact, their best-known characteristic is that they are quickly destroyed by heat. The poisonous agents formed by *Salmonella* are conspicuous for their resistance to heat. They are formed by *Salmonella* as it grows in food.

Various kinds of foods have been involved in *Salmonella* food poisoning. Pastry products containing custard fillings have been especially troublesome. Chopped meat products such as meat pies and sausage have also been incriminated. Milk products have not been without blame.

Salmonella species are quite widely distributed in nature. Isolation has been reported from many different foods, not all of which have been known to possess a questionable sanitary history. *Salmonella* species are known to cause serious infections in animals which would render them unsuitable for food. Flesh of such animals would not ordinarily be prepared for human consumption in the United States. It is possible, of course, that now and then disease in an animal might not be recognized, and the animal might be slaughtered for food. This would probably

not occur with meat prepared for sale under the Federal meat inspection act.

One aspect of *Salmonella* food poisoning which should not be overlooked is the danger which rests in the use of certain species of this genus in what are called "rat viruses." These are preparations for destroying rodents. The fact that rodents are susceptible to infection with certain *Salmonella* species suggested that they might be used to start epidemics among them. So much evidence has accumulated to indicate that such a practice is harmful to human beings that use of *Salmonella* species in "raticides" is to be condemned.

Staphylococcus Food Poisoning. Although members of the genus *Staphylococcus* were early suggested as causes of food poisoning, their importance was not realized until later. It is probable that many *Staphylococcus* outbreaks had been attributed to other bacteria during this time.

Staphylococci form poisonous agents in foods quite like those of *Salmonella* species. The most significant characteristic is that they seem to be quite resistant to heat. It is definitely known, however, that the organism itself is destroyed by temperatures considerably below the boiling point in a few minutes.

Foods involved in *Staphylococcus* food poisoning are quite varied. The first foods to be involved were custard-filled pastry products, eclairs, filled cakes, and custard pies. The constituents of these products, especially the custard, are proper for rapid development of *Staphylococcus aureus*, which seems to be accompanied with production of the toxic agent. In order to prevent outbreaks of food poisoning caused by *Staphylococcus aureus*, many agencies have passed ordinances requiring strict refrigeration of custard-filled pastries during the summer if they are made during that season.

FOODS UNDESIRABLE ON ACCOUNT OF DECOMPOSITION

Decomposed foods have always been considered poisonous, and most people accept without reservation the universal condemnation that is given them. This attitude is often without foundation beyond the fact that they may exhibit disagreeable odors and disgusting appearances. This has given basis for theories which do not rest on well-established facts. The term

"ptomaine poisoning," for instance, is commonly used as a diagnosis for symptoms of illness which appear in the gastrointestinal tract and which cannot be attributed to other causes.

The present position has been so well stated in an editorial from the *Journal of the American Medical Association* that it is reproduced here.

The term "ptomaine poisoning" has become a cloak for ignorance. Jordan says that "ptomaine poisoning is a convenient refuge for etiologic uncertainty." In fact, any acute gastrointestinal attack resulting from a great variety of causes is likely to be called ptomaine poisoning. Selmi, in 1873, first used the word ptomaine (from *πτωμα*, a corpse) to include the poisonous products of putrefaction which gave the reaction then looked on as characteristic of vegetable alkaloids. From the time of Selmi, when ptomaines were regarded as animal alkaloids, our conception of these substances has changed markedly. The last attempt to give precision to the term was by Vaughan, who defined ptomaines as intermediate cleavage products of protein decomposition. Rosenau and his associates at Harvard have been searching in vain for the past year and a half for ptomaines that might cause gastrointestinal or other symptoms. Split products of protein putrefaction are readily isolated. Some of these products have physiologic activity, but none of them thus far have been demonstrated to be poisonous when taken by the mouth. The so-called ptomaines isolated and described by Selmi, Nencki, Brieger, Schmiedeberg, Faust, and Vaughan were usually obtained from putrid organic matter that had decomposed past the point at which it would be used as food. Furthermore, most of these substances were tested by injecting them subcutaneously or intravenously into animals. Many substances are poisonous when thus introduced parenterally, though they may be harmless by the mouth. Again, many of the so-called ptomaines isolated and described have since been shown to contain impurities. Chemists are now seldom confident of the purity of protein fractions even when obtained in crystalline form. The chemical search for split-protein products as the cause of ptomaine poisoning has practically been abandoned. Most of these split products are amines, which are either not poisonous at all, or no more so than their corresponding ammonia salts. The chemical resemblance between muscarin and cholin has directed the work toward the phosphatids, but thus far this line of research has not helped solve the puzzle of ptomaine poisoning. Chemists avoid the use of the word ptomaines, for the reason that it lacks precision. This is a curious instance of the popular use of the technical term that sounds well, but means little. Only clinicians cling to it as a convenient refuge. Ptomaine is a term for chemical substances of uncertain origin, unknown nature, and doubtful existence.

Many of those who read these pages will not like to believe these statements nor give up opinions which have been formed over years of observation and contact with illnesses of various

sorts. Even with danger of repetition and monotony, the author quotes below another editorial from the *Journal of the American Medical Association*, Vol. 90 (1928), p. 1573:

A ptomaine has been defined as a basic organic compound that is formed by the action of bacteria on organic matter. It thus is a chemical entity just as the chemical bases known as alkaloids are. However, the term ptomaine includes a wide variety of compounds some of which are not particularly toxic and none of which are specific in the sense that toxins are. Hence we are reminded by Rosenau that bacteria which are in no sense pathogenic may be capable of producing ptomaines, while others which are highly pathogenic may produce few or none of these basic derivatives. The outcome of present-day consideration is that most of the cases of so-called ptomaine poisoning that cannot be attributed to quite independent clearly defined etiologic factors are recognized as infections with certain bacteria, such as those of the paratyphoid group, or as intoxications with bacterial toxins such as those of the botulinus organism.

As the *Journal* has pointed out, a clinical diagnosis of food poisoning, especially when it is suspected that the food is contaminated with certain bacteria or their toxins, should be supported by epidemiologic, bacteriologic, and toxicologic investigations. The nondescript expression "ptomaine poisoning" should be entirely abandoned. For the most part it is a misnomer; and, as Jordan has stated, it is used to decide an etiologic uncertainty. Illness due to food may arise from bacterial infection of the food, from toxins retained in it, or from a large variety of organic and inorganic contaminants. Infected foods is far more harmful than decomposed food, as a rule. Food is at most a vector of harm which may range from a microbe causing enteritis to the poison of a toxic mushroom or the accidental presence of a noxious element like arsenic or mercury. In any event there is no proper place in any of these diverse categories for the expression "ptomaine poisoning." The haphazard diagnosticians will miss the self-satisfying euphony of these words, and the public may regret the passing of the verbal symbol of the mystery of upset "inner workings" of mankind. Nevertheless the plea for the abandonment of an admittedly inconclusive designation of disease must win.

The following reasons may be offered to explain why ptomaine poisoning is not a satisfactory diagnosis.

1. Foods which would cause it are usually in an advanced state of decomposition. A discriminating consumer would not eat foods which exhibited signs of spoilage. This would tend to prevent such illness as ptomaine poisoning. However, this statement only partly represents the truth. Some of the most typical outbreaks of botulism have been caused by foods which were recognized as "off" in characteristics by the consumers. Some of them were prepared by cooks for service to others, and it is possible that the cooks might be a little more indifferent than the consumers.

2. Certain foods are purposely subjected to decompositions not unlike those which take place in decaying foods. They are carried out to improve flavor of the food product. Cheese, for instance, is prepared from casein of different types of milk; it is "ripened" or allowed to undergo bacterial decomposition in order to improve flavor. Limburger cheese is a typical example of this. It possesses many characteristics of putrefaction which are not at all unlike those of decaying meat or other protein. Use of such foods as Limburger cheese complicates diagnoses of ptomaine poisoning. On one hand putrid food is shunned and considered to be poisonous; on the other it is selected. Wild fowl in some countries is allowed to undergo incipient putrefaction. This is called "ripening" and is supposed to improve flavor. Such fowl are believed to be more desirable on account of improvement of flavor and tenderness. American taste does not look with favor on such practices, for fowls handled in this manner are not "fresh." A missionary in Alaska recounted the practice of the natives who bury fish heads until they have reached an advanced state of decomposition when they are dug up and eaten. Chinese people prepare eggs by storing them in a mixture of lime, salt, and other substances. These eggs are eaten after a lapse of time extending even to several years.

These are several examples of foods which are made to putrefy. If putrefaction in foods causes illness, certainly these that have been mentioned should be dangerous.

3. Better reasons may usually be found for illnesses which are believed to be ptomaine poisoning. Botulism, in some cases, was called ptomaine poisoning. Reports of large outbreaks of illness diagnosed as ptomaine poisoning state that investigations by medical experts found better explanations. In two cases arsenical poisoning was found to be the explanation. Bacterial toxins may be present in foods and cause symptoms called ptomaine poisoning.

4. Symptoms of ptomaine poisoning are too inclusive. Many of them used for diagnosis of ptomaine poisoning are exhibited in other diseases.

5. Laboratory data on harmful effects of the so-called ptomaines have come mainly from injections of these bodies into animals and not from feeding. Before a substance formed in the decomposition of proteins can be considered to be significant as a cause of food poisoning, its poisonous properties must be established by feeding and not by injection into the tissues or under the skin.

These statements about ptomaine poisoning are not supposed to justify the eating of old putrid food. Fresh foods produced under clean conditions should be demanded; but the foregoing discussion should convince one that, when gastrointestinal disturbances occur, the real causes should be determined. Spoiled food should never be eaten.

Storage of Food in the Opened Tin Can. That food allowed to stand in the opened tin can may be poisonous is a fallacy which has descended from former generations. The illness which

was predicted was known as ptomaine poisoning. There is just as much danger in eating foods stored in a sterling silver dish, or in expensive chinaware. Our forefathers had few other kitchen utensils than those made from tin. Milk was often set away in tin pans for the cream to rise before skimming. The cream was made into butter, and the curd was often made into cottage cheese. This type of container caused little worry, but the use of a tin container in the shape of a tin can was tabooed. The type of container is of less importance than the methods in which the containers of foods, irrespective of their composition, are handled. Bacteria which may gain entrance are the agents to which attention should be directed. Objectionable species which may render the food poisonous may enter it in any type of container.

FOODS CONTAINING METALLIC SALTS

The metallic salts which may be contained in foods have been a favorite explanation of illness. Some of the salts of heavy metals are very poisonous, but those generally found in foods are probably not.

Tin. Early medical writings contain many references to poisonings by tin salts. Practically none of them are accepted today. Pharmacologists state that tin salts are not poisonous, and one even states that chronic tin poisoning is unknown. If tin salts were poisonous, there would certainly be more cases and plenty of opportunity to study tin poisoning in these days when so much canned food is used.

Arsenic. Arsenic has caused many outbreaks of food poisoning. The metal may reach foods in different ways. Fruit trees are sprayed with arsenicals to fight ravages of the codling moth. If they are sprayed late in the fall, the fruit may carry appreciable amounts of arsenic. Sugar has been contaminated with arsenic during shipment. The Food and Drug Administration of the United States Department of Agriculture watches very closely the content of metals in foods.

Fluorine. This element, in the form of sodium fluoride, has caused some severe outbreaks of poisoning. It is not added to foods for any purpose but is used in attempts to control insects in establishments where foods are prepared and served. Consequently sodium fluoride is kept where foods are also kept. The

outbreaks and cases of fluoride poisoning have resulted from confusion of the fluoride with foods which look like it. Some states have passed laws which compel manufacturers to color sodium fluoride so that it may be recognized.

ALLERGIC REACTIONS—IDIOSYNCRASIES

These are hypersensitivities or constitutional peculiarities which some people exhibit to proteins. The protein may be injected into the tissues, or it may be ingested in foods. These food idiosyncrasies are often quite serious and for a time may be diagnosed as various ailments. The symptoms may also be very slight and scarcely perceptible. A wide variety of foods have been found to cause them. These idiosyncrasies are due to anaphylaxis, a phenomenon based on the fact that an animal may be sensitized against a foreign protein in such a manner that he may react violently to it later. A guinea pig may be given an injection of diluted egg white which sensitizes it; another injection after an interval of several days will cause marked symptoms such as paralysis, respiratory difficulties, and perhaps death. It is now known that human beings may be sensitized with proteins in the same manner. This reaction is possible, after eating certain proteins as well as after receiving injections of protein preparations, such as antitoxic sera.

Attempts are made to determine what protein is causing the symptoms. A series of cutaneous tests is made on the flexor surface of the forearm with a series of pure proteins. After being cleaned, the area to be tested is lightly cut with lines about $\frac{1}{8}$ inch long and $1\frac{1}{2}$ inches apart. Attempts are made not to draw blood. A little of the protein is rubbed into this area. A positive reaction is indicated by a reddened area about the site of inoculation. When this procedure does not give satisfactory results, Rowe recommended elimination diets. In order to illustrate how this test works, one case will be discussed in some detail. This was a case of wheat asthma. The patient suffered from typical symptoms of bronchial asthma. Cutaneous tests, made according to the technic just outlined indicated that wheat protein was causing the symptoms. The patient stated that the first attack which she could remember had occurred many years before when she inhaled some flour during baking; since that time attacks had recurred at frequent intervals. The

patient was informed that wheat was the cause of her trouble and advised to refrain from eating foods which contained wheat flour, or handling the flour. The results were said to have been magical. The symptoms disappeared almost immediately. This patient was "desensitized" by being given small injections of wheat protein and brought to a condition where she could eat a moderate amount of wheat bread daily. Finally, she could eat bread and pastries as desired. The foregoing illustration concerns wheat. The same phenomena have been observed with eggs, strawberries, cheese, and other foods. Desensitization is not unlike acquiring immunity according to methods discussed later on. If the protein which is objectionable is in an essential food, the problem is more difficult; if it is in a nonessential food, it is more easily dropped from the diet. Desensitization is necessary if it must be eaten or cannot be eliminated from the diet. To simplify detection of the protein which is causing the trouble, mixtures of eight or ten may be used for the first tests. These mixtures may be used until that one is found which gives a reaction; then each protein in the mixture must be tested to find the specific protein.

TRICHINOSIS

Trichinosis is caused by a small coiled worm, *Trichinella spiralis*. It is not a bacterial disease but is mentioned here because it is a food problem and because it is a serious disease, both from the fact that it is very painful and it is widespread in the United States. Over 21 million Americans have been said to have been infested at one time or another. Trichinosis is acquired by man by eating undercooked pork from swine which have been infested. Hogs become infested mainly by eating uncooked garbage. Prevention of trichinosis is not difficult; no uncooked pork should be eaten. Pork should be cooked until it has lost its pink color and has turned gray. *Trichinella spiralis* has been found to be killed at 137°F.

REFERENCES

- DACK, G. M., Food Poisoning, Univ. Chicago Press, 1943.
DEWBERRY, ELLIOTT B., Food Poisoning, Its Nature, History and Causation, Measures for Its Prevention and Control, 2d Edition, Leonard Hill, London, 1947.
DAMON, S. R., Food Infections and Food Intoxication, Williams & Wilkins Co., Baltimore, 1927.

JORDAN, E. O., Food Poisoning, Univ. Chicago Press, 1931.

Meat for Millions, Report of New York State Trichinosis Commission, Albany, N. Y., 1941.

SAVAGE, W. G., Food Poisoning and Food Infections, Cambridge Univ. Press, 1920.

STILES, C. W., What Is Diseased Meat?, *J. Am. Med. Assoc.* **63** (1917).

SOPER, G. A., Typhoid Mary, *Military Surgeon*, July 1919.

TANNER, F. W., Food-Borne Infections and Intoxications, Garrard Press, Champaign, Ill., 1933.

TANNER, F. W., Microbiology of Foods, Garrard Press, Champaign, Ill., 1944.

CHAPTER 25

RELATION OF BACTERIA TO DISEASE

This is bacteria's best-known relationship. Many who have not studied bacteriology believe it to be their most important function. Although many species are pathogenic to man, many others are useful and are put to work for him. These have been discussed in various places in this book.

What Is Disease? The term disease is not an easy one to define. It may be one of those terms definition of which should not be attempted in a few words. It is profitable to analyze some of the different conceptions of it. Some consider disease to be parasitism, the infected organism being the host and the etiologic agent the parasite. Parasitism was discussed in a former chapter. As stated a few paragraphs later in this chapter, it is difficult to distinguish between a parasite and a saprophyte. An organism may exist on a host for a long time without causing illness and eventually cause symptoms of disease when conditions are favorable. Consequently, if disease is considered to be parasitism, some distinction should be made between an organism which is living on a host without causing illness and one which has become aggressive enough to cause disease.

Disease may also be considered to be a conflict between two opposing forces. This conception has some merit. It allows one to correlate many general statements which have been advanced to explain freedom from disease. If disease is a conflict, the outcome will depend on the strength of the invading organisms and the defensive powers of the host. We have long been advised to keep up resistance by proper living habits, good food, fresh air, and so on, if we wish to be free from disease. The size of the dose or in this case the number of microorganisms often determines whether a person will be infected or not. A massive infection often overcomes a grade of resistance to disease which would ordinarily be sufficient to protect.

THEORIES OF DISEASE

Since early times many different theories have been proposed to explain disease. Some of them were quite reasonable for their times. Others, however, were based on neither reason nor experiment and did not consider all the knowledge which was available. A few of the more important theories are reviewed here.

The Demonic Theory of Disease. This was probably the first explanation of disease. It was propounded before any serious attempt was made to determine real causes. According to the demonic theory, disease was due to presence of evil spirits or demons in those who were afflicted. The treatment was often just as unreasonable as the diagnosis. It frequently consisted in making great noise around the patient so that the devils would depart. Certain articles were worn to keep away evil spirits. Remnants, if not large portions of these early theories, have come down through the ages to the present day. During epidemics of disease, it is not uncommon to see individuals wearing bags of drugs about their necks. Other practices, such as the wearing of fetishes and painting themselves are commonly practiced even by informed people today. Such practices, however, seem ridiculous when considered by enlightened people.

Humoral Theory. The humoral theory was proposed by the Greeks for explaining the causes of disease. According to this theory four humors were in the body: blood, mucous or phlegm, black bile, and yellow bile. In health these four humors were believed to be present in equilibrium, but in disease some one predominated. From the information which medical men had in those days, this theory had some merit. Accordingly, when certain symptoms appeared which were thought to indicate the presence of too much blood, the patient was bled. Colds would be explained on the basis of too much phlegm.

Germ or Zymotic Theory. In Chapter 1 the history of bacteriology was reviewed, and some consideration was given to the discussions and experimental work which led up to the germ theory of fermentation. After the theory had been proved, it was not a long step to apply the facts to disease. This resulted in the germ theory of disease. The analogy between a typical fermentation and a case of infectious disease was strikingly shown by Sedgwick as follows:

A FERMENTATION
(APPLE JUICE)

1. Exposure of juice to air, dust, etc.
2. Repose and then slow change (growth of the ferment).
3. Active fermentation of "working." Evolution of gas bubbles, change of sugar to alcohol. Rise of temperature.
4. Gradual cessation of fermentation.
5. No further liability to alcoholic fermentation.

AN INFECTIOUS DISEASE
(SMALLPOX)

1. Exposure of patient to infection.
2. Incubation (slow and insidious progress of the disease).
3. Active disease. Eruption, disturbance of the usual functions. Rise of temperature.
4. Slow convalescence (or death).
5. Immunity to smallpox.

This comparison of smallpox with a fermentation shows the marked similarity between the two. As soon as Pasteur had shown that fermentation was a biological phenomenon and that the silkworm disease was caused by a microorganism, the germ theory of disease was firmly established. Other facts were soon gathered to support it.

Zymotoxic Theory. The germ theory did not explain all the facts which were soon discovered. It did not explain, for instance, the symptoms of illness which result from the presence of toxins. Consequently, the germ of zymotic theory was extended and became the zymotoxic theory. Bacterial toxins are discussed at greater length later in this book. They furnish the basis for the zymotoxic theory of disease.

TYPES OF DISEASE

Diseases to which man is susceptible are described in different ways, and different terms have been introduced for this purpose. An *acute* disease is one which reaches its greatest intensity or crisis quickly. Such diseases are typhoid fever, diphtheria, tetanus, and pneumonia. Conversely, a *chronic* disease progresses slowly and may extend over months and years. Rheumatism is perhaps a good example. On the other hand, a disease like tuberculosis may be either chronic or acute depending on the conditions. Diseases are also classed as endemic, epidemic, and pandemic. A disease is *endemic* when it is constantly present in a small number of cases. Diphtheria is an example. When an endemic disease increases or flares up, so to speak, within a short time and a restricted area, it becomes *epidemic*. A pandemic

disease is a widespread epidemic. Influenza is a good example of a pandemic disease. During 1918, not only did it spread over whole nations but also the whole world was more or less infected.

Contagious, Infectious, and Communicable Diseases. These are terms which have been used in the past to describe diseases with respect to their mode of dissemination. A *contagious disease* is one which may be spread by mediate or immediate contact. An *infectious disease* is one which is caused by some living parasite such as a bacterium, protozoan, or fungus; it may or may not be contagious. These are the definitions given by one standard dictionary of medical terms. These terms are not so satisfactory as was once believed. In many cases absurd distinctions were made. Because of this, present-day sanitarians have suggested substitution of the term "communicable" for the older terms *contagious* and *infectious*. The former is undoubtedly better because it does not bring unnecessary restrictions, but emphasizes only that characteristic in which the sanitarian is interested.

Diseases of Known and Unknown Etiology. Not all diseases are caused by microorganisms. Those which are supposed to be are divided into two groups. One group is composed of those which are said to be of known etiology; that is, the causal organism is known and can be isolated in pure culture. With these diseases great progress has been made in methods of treatment and cure. The other group is composed of diseases of unknown etiology in which the causal organism, or etiologic agent, is unknown. The question may arise in the reader's mind how we are certain that diseases of unknown etiology are caused by living agents. The methods of dissemination and communication in such diseases indicate that some living virus is involved. The etiologic agent, for instance, of smallpox is unknown, but the characteristics of the disease suggest a living agent.

Koch's Postulates. No bacterium can be said to cause a disease until certain facts have been proved. These prerequisites were stated as early as 1840 by Henle. On account of the uncertainty of pure cultures, these prerequisites may not have been adequately tested by Henle. However, Koch was able to fulfill them for tuberculosis and *Mycobacterium tuberculosis*, which causes it. Since then they have been known as Koch's postulates, canons, or laws. They may be stated as follows:

1. The microorganism must be present in all cases of the disease.
2. It must be isolated from the infected animal and grown in pure culture.
3. The original disease must be reproduced with the microorganism when it is injected into a susceptible animal.
4. In this case of the disease the organism must be found as in the original case.

Although fulfillment of these postulates is desirable before a bacterium may be considered to cause a disease, difficulties occur with some common diseases even though the etiologic agent is known and proved. Such a situation may exist to some extent with typhoid fever or leprosy. The microorganisms involved may not grow well under laboratory conditions, or it may be difficult to find susceptible animals. In such cases, however, enough circumstantial evidence and evidence from accidental injections have been accumulated to permit accurate conclusions.

Use of Animals in Experimental Work in Bacteriology. Fulfillment of Koch's postulates and other work in bacteriology require use of animals. Such animals as guinea pigs, rabbits, rats, monkeys, and mice are commonly used. Human beings have been used at times, and it is not difficult to secure human volunteers for experiments. Such was the case during the classic investigations by Reed, Carroll, Agramonté, and Lazear on the relation of mosquitoes to dissemination of the virus causing yellow fever. A sufficient number of privates in the American army offered themselves as subjects for experimentation; they were bitten by mosquitoes which had bitten patients suffering from yellow fever. Experiments on leprosy and scarlet fever have also been made on human subjects. Advances in medicine make experiments on living organisms necessary. The propriety of such use of animals is bitterly attacked in several countries under the term vivisection. Many individuals prominent in other lines of endeavor have considered themselves competent to discuss animal experimentation and in many cases to strive for prevention of it. An enlightening article on vivisection is from H. G. Wells. One paragraph might be quoted:

What is vivisection? It is a clumsy and misleading name for experimentation upon animals for the sake of the knowledge to be gained thereby. It is clumsy and misleading, because it means literally cutting up alive, and trails with it to most uninstructed minds a suggestion of highly sensitive creatures bound and helpless, being slowly anatomized to death. This is an idea naturally repulsive to gentle and kindly spirits, and it puts an

imputation of extreme cruelty upon vivisection which warps the discussion from the outset.

It is well known by those who are familiar with methods used in animal experimentation that there is practically no "vivisection" in animal experimentation in the popular sense. Anesthetics are used when there is any cutting. The arguments of the antivivisectionists are centered about cruelty and pain. They overlook various other practices which may be more painful to animals than laboratory experimentation. Wells called attention to the lives of "fancy" dogs, invalid and grotesque deformations of the canine type, which must be uncomfortable beyond all comparison with creatures inoculated by the physiologist.

This is a question about which the student of biology should think. It is an important topic of discussion today. The whole argument goes down to the question whether a human life is worth the cost in animal experimentation. Many of those who are reading this paragraph would not be alive today if it had not been for diphtheria antitoxin, or antitoxins of other types. These are made in the blood streams of healthy animals and are tested, as are all similar products, by means of animals.

SPECIFIC BACTERIAL INFECTIONS

These may be classified in different ways as follows:

- | | |
|--|-----------------------------|
| 1. Diseases of the Respiratory Tract | |
| Pneumonia | Scarlet fever |
| Streptococcus sore throat | Whooping cough |
| Diphtheria | Tuberculosis |
| Vincent's angina | |
| 2. Venereal Diseases—Genitourinary Tract | |
| Gonorrhoea | Syphilis |
| Yaws | |
| 3. Diseases of the Intestinal Tract | |
| Typhoid fever | <i>Salmonella</i> diseases. |
| Dysentery | Cholera |
| Food poisoning | Botulism |
| 4. Industrial Diseases (Infections) | |
| Anthrax | Staphylococcus infections |

In more advanced books on bacteriology, names of which may be found at the end of this book, these diseases and the microorganisms which cause them are discussed at great length.

Salient characteristics for some of the more common diseases are given in Table 6.

Virus Diseases. The term virus has undergone some change in meaning since it was first introduced. In general it is an agent which communicates an infection or disease. In some diseases it is known, as in typhoid fever; in this disease it is *Eberthella typhosa*, but in poliomyelitis for instance, it is unknown because the etiologic agent has not been proved to be a true bacterium. Nevertheless, in both cases one may speak of the virus of typhoid fever and the virus of poliomyelitis. At the same time another conception was that viruses of diseases of unknown etiology were filterable, and the expression "filterable viruses" was used. In general, the terms virus and filterable virus are synonymous, although a few students of virus diseases do not consider them as diseases of unknown etiology. They believe that, since the real cause is known, they are diseases of known etiology. A few filterable virus diseases are:

Poliomyelitis	Yellow fever
Rabies	Common cold
Smallpox	Chicken pox
Encephalomyelitis	Herpes
Mumps	Dengue fever
Measles	Psittacosis
Influenza	Trachoma

These diseases also are fully described in advanced books on bacteriology which are listed at the end of this book.

TABLE 6
CHARACTERISTICS OF COMMON COMMUNICABLE DISEASES
From a Report of the American Public Health Association, 1945

Disease	Etiologic Agent	Source of Infection	Mode of Transmission	Incubation Period	Immunity	Methods of Control
Actinomycosis	<i>Actinomyces hominis</i>	Not well known	May be from animals to man. May follow the extrusion of carious teeth.	Variable	No acquired immunity in man. Artificial immunity not practicable	Recognition of the disease; concurrent disinfection of the discharge
Ancylostomiasis (Hookworm disease)	<i>Necator americanus</i> <i>Ancylostoma duodenale</i>	Soil contaminated with larvae from ova in stools of infected persons	Infected soil; larvae penetrate skin, usually of feet.	Several weeks	Some degree of immunity after an infection	Sanitary disposal of bowel discharges
Anthrax	<i>Bacillus anthracis</i>	Hides, flesh, and feces of infected animals	Wound infection; inhalation of spores; uncooked foods	4-7 days	Some immunity after an attack of the disease. Artificial active immunity not appropriate for human beings	Disinfection of discharges; cooking of foods and drink; isolation
Chicken pox	A specific filterable virus	Skin lesions of infected person; also lesions in respiratory tract	Direct contact; indirectly by means of articles freshly soiled by discharges	2-3 weeks	An attack confers permanent immunity, with rare exceptions	Recognition; concurrent disinfection; isolation of patient
Cholera	<i>Vibrio comma</i>	Bowel discharges and vomitus of infected persons; excreta of carriers	Food; water; contact with infected persons; flies	1-5 days	Acquired immunity uncertain; active immunity by vaccination	Disinfection of discharges; use of clean water and foods; isolation

Conjunctivitis (pink eye)	Gonococcus; other patho- genic bacteria; filterable virus	Discharges from con- junctivae, adnexa, or genital mucous membranes	Contact with in- fected person or arti- cles freshly soiled by discharges	usually 36-48 hours	Acquired immunity does not follow an attack of the disease	Recognition; con- current disinfection of discharges
Deague fever	A filterable virus	Blood of infected person	Bite of infected mos- quito	3-5 days	Acquired immunity may be temporary; usually permanent	Recognition; erad- ication of mosquito
Diphtheria	<i>Corynebacterium diphtheriae</i>	Discharges from le- sions in throat, con- junctiva, vagina, or wound surface; car- riers	Direct personal con- tact; articles freshly soiled; contaminated foods	2-5 days	Good acquired im- munity developed artificially, passive immunity possible by inoculation, short duration	Isolation; concur- rent disinfection; Schick testing; con- trol of foods and carriers
Dysentery (amoebic) (amoebiasis)	<i>Endamoeba histolytica</i>	Bowel discharges of infected persons	Water, foods, and by direct contact; flies	3-4 weeks	No artificial immu- nity	Food and water sanitation; strict personal cleanliness
Dysentery (bacillary)	Various species of genus <i>Shigella</i>	Bowel discharges of infected carriers	Contaminated food and water; hand-to- mouth transfer of contaminated ma- terial; flies	1-7 days	Transitory immu- nity follows a case of the disease	Recognition; isola- tion; disinfection of bowel discharges; care of food and drink
Encephalitis	Filterable vi- ruses	Unknown	Probably mosqui- toes	2-21 days	Natural immunity and immunity re- sulting from attack doubtful	Isolation and pro- tection from mos- quitoes
German measles	Filterable virus	Secretions of mouth and nose	Direct contact with patient or with arti- cles contaminated by discharges	14-21 days	Permanent immu- nity follows an at- tack	Isolation of patient

TABLE 6 (Continued)

Disease	Etiologic Agent	Source of Infection	Mode of Transmission	Incubation Period	Immunity	Methods of Control
Poliomyelitis	Specific filterable virus	Nose and throat discharges of infected persons; bowel discharges contain the virus	Virus enters body in nose or mouth; perhaps spread by insects and water	7-14 days	Permanent after attack of disease	Isolation; concurrent disinfection of nasal and throat discharges and articles soiled therewith
Psittacosis	Specific filterable virus	Parrots, parakeets, lovebirds, canaries, pigeons, and other birds	Contact with these animals; rarely a human case	6-15 days	One attack confers immunity	Concurrent disinfection of discharges; quarantine of birds
Rabies	Specific filterable virus	Infected animals, chiefly dogs	Bites of infected animals	2-6 weeks, may be 6 months or longer	Prophylactic anti-rabic treatment	Control of dogs
Rocky Mountain spotted fever	<i>Rickettsia rickettsi</i>	Infected ticks	Bite of tick; contact with tick material	3-10 days	One attack confers immunity; may or may not be permanent	Destruction of ticks from patients and infected zones
Scarlet fever	Hemolytic streptococci	Mouth and nose discharges; articles contaminated therewith	Direct; contaminated foods	2-5 days	No antibacterial immunity; probable after attack of disease	Isolation; concurrent disinfection of foods
Septic sore throat	Hemolytic streptococcus	Human cases; infected foods	Human contact; carrier; infected foods	2-5 days	Probably no immunity	Isolation; protection of foods
Smallpox	Specific filterable virus	Lesions of infected persons	Contact; articles contaminated by discharges	7-16 days	Permanent after an attack; artificial after inoculation	Isolation; vaccination of general population

Syphilis	<i>Treponema pallidum</i>	Discharge from lesions	Direct; chiefly by sexual intercourse	by about 3 weeks; may be 10 days to 6 weeks	None	Isolation; education in personal and sexual hygiene
Tetanus	<i>Clostridium tetani</i>	Soil, dust, and animal excreta	Wound infection	4 days to 3 weeks	Short passive immunity after anti-toxin; active after toxoid	General education
Trachoma	Filterable virus	Discharges of eyes and mucous membrane of infected persons	Direct contact; articles freshly soiled with discharges	undetermined	None	Isolation; elimination of common towel; routine eye examination
Trichinosis	<i>Trichinella spiralis</i>	Uncooked pork	Consumption of meat containing viable larvae	1 week	None	Cooking of pork at 160°F. or above; refrigeration below 5°F. for 20 days
Tuberculosis (pulmonary)	<i>Mycobacterium tuberculosis</i> , various types	Persons with open cases of pulmonary tuberculosis	Droplet infection; contaminated eating utensils; by prolonged contact	variable	Generally none; resistance increased by good living conditions	Education of public; good nutrition; concurrent disinfection
Tularemia	<i>Pasteurella tularensis</i>	Wild rabbits and hares and other animals; horseflies	Bites of infected flies; handling infected animals; eating raw rabbit flesh	24 hours to 10 days	Permanent immunity after attack of the disease	Care in handling wild rabbits; thorough cooking of flesh
Typhoid fever	<i>Escherichia typhosa</i>	Bowel discharges of patients; carriers	Direct contact; infected foods and beverages; flies	3-38 days usually 7-14 days	Permanent acquired immunity after recovery from infection; artificial after vaccination	Water treatment; re-milk pasteurization; disinfection of dishes

TABLE 6 (Continued)

Disease	Etiologic Agent	Source of Infection	Mode of Transmission	Incubation Period	Immunity	Methods of Control
Typhus fever	<i>Rickettsia prowazeki</i>	Infected persons	Infectious agent transmitted by lice; dirty clothing, unhygienic surroundings	6-15 days	Immunity after attack not always permanent	Delousing of persons, clothing, and premises; use of insecticides
Undulant fever	<i>Brucella melitensis</i> ; <i>Brucella abortus</i> ; <i>Brucella suis</i>	Tissues, blood, milk and urine of infected animals	Drinking milk from infected animals	6-30 days or more	Uncertain	Concurrent disinfection; milk pasteurization; eradication in herds
Whooping cough (pertussis)	<i>Hemophilus pertussis</i>	Discharges of infected persons—laryngeal and bronchial	Contact with infected persons or articles	10-21 days usually 7	Both passive and active artificial immunity possible	Isolation; concurrent disinfection
Yellow fever	Specific filterable virus	Blood of infected persons, monkeys, and other animals	Bite of infected mosquitoes; perhaps other insects	3-6 days	Permanent immunity after recovery; active following inoculation with living virus	Isolation from mosquitoes; eradication of mosquitoes

REFERENCES

- BELDING, D. L., A. T. MARSON, *et al*, A Textbook of Medical Bacteriology, D. Appleton-Century, New York.
- BIGGER, J., Handbook of Bacteriology for Students and Practitioners of Medicine, William Wood & Co., Baltimore, 1925.
- BROADHURST, J., Home and Community Hygiene, J. B. Lippincott, Philadelphia, 1925.
- CAMERON, G. M., The Bacteriology of Public Health, C. V. Mosby Co., St. Louis, Mo., 1940.
- CARTER, D. F., Microbiology and Pathology, C. V. Mosby Co., St. Louis, Mo., 1939.
- GAY, F. P., *et al*, Agents of Disease and Host Resistance, Charles C. Thomas, Springfield, Ill., 1935.
- GERMAN, W. M., Doctors Anonymous; The Story of Laboratory Medicine, Duell, Sloan, and Pearce, New York, 1942.
- KOPELOFF, N., Why Infections in Teeth, Tonsils, and Other Organs, Knopf, New York, 1926.
- LEIFSON, E., Bacteriology for Students of Medicine and Public Health, Paul B. Hoeber, New York, 1942.
- McFARLAND, J., Fighting Foes Too Small to See, F. A. Davis Co., Philadelphia, 1924.
- MUIR, R., and J. RITCHIE, Manual of Bacteriology, Oxford Univ. Press, London, 1938.
- MUSTARD, J. S., An Introduction to Public Health, 2d Edition, Macmillan, New York, 1944.
- NEWMAN, G., Bacteriology and the Public Health, P. Blakiston's Son & Co., Philadelphia, 1904.
- PARK, W. H., Public Health and Hygiene, Lea & Febiger, Philadelphia, 1928.
- PRESCOTT, S. C., and M. P. HORWOOD, Sedgwick's Principles of Sanitary Science and the Public Health, Macmillan, New York, 1935.
- RICE, THURMAN B., A Textbook of Bacteriology, W. B. Saunders Co., Philadelphia, 1942.
- ROSENAU, M. J., Preventive Medicine and Hygiene, D. Appleton-Century, New York, 1935.
- SEDGWICK, W. T., Principles of Sanitary Science and the Public Health, rewritten and enlarged by S. C. Prescott and M. P. Horwood, Macmillan, New York, 1935.
- SMITH, T., Parasitism and Disease, Princeton Univ. Press, 1930.
- STITT, E. R., Practical Bacteriology, Haematology, and Animal Parasitology, P. Blakiston's Son & Co., Philadelphia, 1938.
- WEINZIRL, J., General Hygiene and Preventive Medicine, Lea & Febiger, Philadelphia, 1937.
- WILSON, C. M., Ambassadors in White, Henry Holt, New York, 1942.
- WILSON, G. S., and A. A. MILES, Topley and Wilson's Principles of Bacteriology and Immunity, in 2 vols., Williams & Wilkins Co., Baltimore, 1946.

CHAPTER 26

TRANSMISSION OF INFECTING AGENTS

The methods by which the agents responsible for disease are disseminated are quite varied. Many are worthy of discussion since they bear quite directly on human welfare and happiness. Some present-day ideas rest on explanations which have been handed down from former times before the days of experimental bacteriology. These are slowly being dispelled, however, and replaced by sounder explanations.

Longevity of Pathogenic Bacteria Away from Their Hosts.

Whether a microorganism can survive long enough in nature to be disseminated to susceptible animals markedly influences its significance as a cause of epidemics. Many different factors are involved; it is impossible to make general statements for all microorganisms as some are more susceptible to one unfavorable agent than others. Information is given in the following paragraphs concerning a few bacteria which cause some of the more common communicable diseases and on which actual results have been secured by experimentation. The longevity of an untoward bacterium in nature determines largely the methods for fighting the disease which it causes and laboratory methods of analysis.

Eberthella typhosa. Because typhoid fever is a disease of epidemiological significance, longevity of its etiologic factor, *Eberthella typhosa*, has received considerable study. The conclusions reached in different investigations differ as might be expected. During investigations incident to the famous controversy in 1901 of the City of St. Louis and the State of Missouri versus the City of Chicago and the State of Illinois, this question was thoroughly studied by both sides. St. Louis contended that Chicago sewage in the Illinois river endangered the sanitary quality of her drinking water. It was contended that disease-producing bacteria might come down the Illinois river and enter the St. Louis intake. Much experimental work was necessary before this argument could be refuted or confirmed. As far as

pathogenic bacteria were concerned, most of the work centered about *Eberthella typhosa*. Data from these experiments seemed to indicate that the organism could survive in pure water (Lake Michigan water) for about eight days and in impure water (Chicago Drainage Canal) for four days. Former experiments had shown a survival period of as long as two months in sterilized water and in unsterilized water up to several weeks. We may then make an algebraic sum of the evidence and reach the conclusion that *Eberthella typhosa* may persist in natural waters for upwards of several weeks. The conditions which obtain during each experiment greatly influence results. The situation for such bacteria as *Vibrio comma* and *Shigella dysenteriae* is probably quite similar.

In marked contrast to the bacteria just mentioned which show some ability to survive in nature are those which die quickly. The bacteria which cause meningitis (*Neisseria intracellularis*), gonorrhoea (*Neisseria gonorrhoeae*), and pneumonia are examples.

Infection by Carriers. The carrier is an individual who, without symptoms of communicable disease, harbors and disseminates specific microorganisms. Although several diseases may be spread by carriers, much more is known about the typhoid carrier, who will be used as a basis for the remarks in this paragraph. As with the missed case, the carrier is a constant menace to the health of any community. One of the worst features of the situation is that he shows no symptoms of infection and often does not know himself that he is a menace to those about him. Reports of detection of carriers are especially interesting, for epidemiological investigations are just as careful and logical as those used to detect criminals. The relation of carriers to food infection has been discussed in Chapter 24.

Although *Eberthella typhosa* in typhoid carriers may localize in several places in the human body, the gall bladder is probably the most common place. From this organ it easily reaches the intestines to appear in sewage. If such infected sewage is able to reach a water supply, a typhoid epidemic may be caused. If, on the other hand, the carrier is employed in the food industry, it is easy to see how he may contaminate foods. Persons usually become carriers as a result of having had typhoid fever at some earlier time. Reports in bacteriological literature indicate that a person who has had typhoid fever may remain a carrier for

practically his whole life thereafter. One carrier has been reported who had typhoid fever 50 years before; another, 30 years; and another, 60 years. Only some 2 per cent of typhoid patients remain in the carrier state, but these may be a great menace if they are not properly instructed and convinced that certain requirements must be rigidly observed. When carriers are unwilling to submit to attempts to cure them or to observe well-established practices for their control, health officers have considered themselves justified in taking away their liberties. This is done in other situations. If an individual does not obey other laws of society, which, for instance, state that he should not kill a fellow being, he is set apart for the rest of his life or even put to death should he disobey the law. Society makes its laws on the basis of the greatest good for the greatest number. The Michigan Department of Public Health had 290 carriers of *Eberthella typhosa* (typhoid carriers) under supervision in 1944. These individuals were not allowed to engage in occupations involving preparation of food, handling of milk or dairy products, or to be concerned with purification of public water supplies. They were required to report four times a year for examination and counsel. Carriers are also probably involved in dissemination of diphtheria, meningitis, and dysentery, on a much smaller scale.

Another insidious situation in preventive medicine are missed cases. These may be responsible for endemic diseases such as diphtheria, colds, and other similar infections. They may result from absence of severe symptoms or indifference on the part of the patient to slight symptoms. Individuals differ in their reaction to symptoms of illness.

Those who are suffering from most of the common communicable diseases, such as amebic and bacillary dysentery, streptococcus sore throat, scarlet fever, paratyphoid fever, poliomyelitis, diphtheria, tuberculosis or typhoid fever, or who reside in a household where there is a case of most of them, or who are carriers, are enjoined from handling in any manner whatever foods are intended for sale.

INFECTION BY FOMITES

A fomite is an inanimate object which may spread material causing disease. They are contaminated by discharges from a

patient, or by handling by the patient. The fomite is probably greatly overemphasized as an agent disseminating pathogenic bacteria. If they are as important as some think, most of us would be ill most of the time. Books have been considered by some to be important agents in dissemination of communicable diseases. The problem is a serious one for libraries and school authorities. It is possible that our information does not rest on sufficient data. It might be profitable to report briefly one or two investigations on this subject. Laubach studied the question in three different ways: (1) An investigation of 75 soiled and torn library books that for several years had been passing through hands of children who had been living in very undesirable sanitary conditions; (2) a search for diphtheria bacilli on 150 books which were known to have been handled by persons ill with diphtheria; and (3) a study of books artificially contaminated with *Escherichia coli*, *Eberthella typhosa*, and *Corynebacterium diphtheriae*. The 75 library books showed only the presence of *Escherichia coli*. It was stated that since *Eberthella typhosa* did not differ much from *Escherichia coli*, the former organism might exist equally long. Examination of 150 books for diphtheria bacilli yielded negative results. Artificial inoculation of books showed that *Escherichia coli*, *Eberthella typhosa*, and *Corynebacterium diphtheriae* remained alive in books for months, as well as on the outside of books kept in the dark. It is difficult and perhaps wrong to attempt specific conclusions from these experiments. From data secured by artificial inoculation of books it would seem best not to use those which have been directly exposed to infectious material until after disinfection. It is interesting to note that sunlight was efficient for this purpose. Kenwood and Dover stated that there is probably no material risk involved in the reissue of books recently read by consumptives unless the books are obviously soiled and even then the risks are very slight.

Money. Experimental work indicates that there is much misinformation on this subject. Because money is rapidly circulated one might expect it to disseminate pathogenic bacteria. If this were true, we might have a difficult problem with which to cope. Fortunately, coins carry very few bacteria. It is known that the metals from which the coins are made allow the formation of salts of heavy metals which are toxic to microorganisms. A

penny is made up of 95 per cent copper and 5 per cent silver and tin; a nickel, 75 per cent copper and 25 per cent nickel; and a dime, 90 per cent silver and 10 per cent copper. The salts of all these metals, with the exception of tin, are known to be bactericidal. As a coin is circulated, it might come in contact with acids and alkalis which would cause salt formation. Even paper bills contain few bacteria, owing perhaps to the fact that the conditions for survival on them are not favorable.

Postage Stamps. Because of the construction of postage stamps they might easily pick up objectionable bacteria. This idea is illustrated in the instructions to postmasters that they shall dispense stamps with the gummed side up to minimize the opportunity of acquiring bacteria from the counter. One study of stamps from 50 different sources showed ordinary bacteria among which were several forms that may, at times, be pathogenic. Danger, however, from postage stamps is very slight since they are not handed about, ordinarily, as are coins. One cannot overlook, however, the practice of moistening the stamp with the tongue. A recent report of a laboratory examination of the bacterial content of postage stamps revealed numerous bacteria. In some cases the colonies were too numerous to count.

Dishes and Tableware. Such fomites come into very close contact with the sick and thus may harbor active disease-producing bacteria. Taylor showed the presence of living tubercle bacilli on eating utensils used by persons ill with tuberculosis. Hemolytic streptococci were isolated from dishes and tableware in restaurants by another investigator. From these data, and others which could be given, the danger of infection that lurks in the utensils for dispensing beverages at public places will be readily appreciated. In the United States the public drinking cup has been eliminated by legislation in practically all places except the so-called soft-drink parlor. Here superficial methods of washing are a menace, and one may be convinced that he is still using common eating utensils unless paper utensils are used.

Effect of Dishwashing on Bacteria. This common procedure in the home may be of considerable hygienic significance. During and since the great epidemic of respiratory infections in 1918-19, much research has been carried out to determine the effect of dishwashing on bacteria. Experimental work has shown that machine-washed dishes are much more satisfactory bacteriologi-

cally than hand-washed dishes. Hand-washed dishes are washed, usually, at a much lower temperature. With machine-washed dishes boiling water may be used. Oram and Broadhurst found that the hottest water which 30 different people could use (49–57°C.) was not germicidal since it was below even pasteurizing temperatures and acted for too short a time. They also reported that hot water alone did not remove or destroy organisms from the throat. Hand-washed dishes, it was advised, should be rinsed in boiling water. A soapy lather was necessary to remove entirely material with which the dishes were contaminated before the washing experiments. The day has come in the United States when attention is being paid by public-health officials to this problem. Glass containers which are only superficially washed will not be tolerated in public drinking places.

Washing Powders. Such powders are frequently used in water for washing dishes and dairy utensils. Doane studied their germicidal properties. Although most of them which were used destroyed bacteria, he stated that choice of a washing powder would rest on the price and not on a superior germicidal activity of any one powder. Discussion of the germicidal activity of soaps given in Chapter 12 also has some bearing here.

It is proper to say at this place that Schroeder and Southerland, who studied the bactericidal effect of soaps in laundering, found them of no value in the strengths used. Their data are indirectly applicable to this discussion. They were able to isolate a staphylococcus from a soap solution which was ten times as strong as the solution used in the washing machine. Such data indicate that, if disinfection is desired, a detergent should be used first, followed by the disinfectant.

Bathroom Appliances. These might be regarded without reservation as suspicious fomites. Some data have been published from which conclusions may be reached. Hirst and Rosenberg studied over 100 tubs in three college dormitories. About 35 per cent of the tubs showed the presence of *Escherichia coli*, which is often used as an indicator of pollution. These investigators reported that the indicator organism was more frequently found on the bottoms of the tubs than on the sides. Especially important, however, was the statement that visual criteria of cleanliness were without value in predicting hygienic condition of the tubs. This paper is of especial interest in con-

nection with a report of Dowd in 1921 of gonorrhoeal infection traced to a bath tub. The author was absolutely convinced of the correctness of his assumption.

Soiled Linens. Relation of such fomites to disease is so close that little evidence need be presented. It is easy to appreciate the possibility that such things as bed linen, sleeping garments, and the like, might harbor pathogenic bacteria. For instance, McIntosh, a British medical health officer, reached the conclusion after a painstaking investigation that soiled linen from a home in which smallpox existed had caused the infection of laundry workers. Several investigations have been reported by Schroeder and Southerland.¹ Their study involved two types of laundries, hand laundries and steam laundries. In general, they found the hand laundries to be unsatisfactory. The methods of sorting and marking the clothes might lead to infection of the employees. They found that in most hand laundries the clothes were placed in large bags or nets and sent to steam laundries where they were washed as units and returned to the hand laundries wet. The drying facilities in hand laundries were not such that death of objectionable bacteria would be secured, if they survived washing processes. In the case of steam laundries there was greater opportunity for satisfactory results, but certain objectionable practices were observed. Soiled and clean clothes were carried in the same wagon. Wet clothes, infected with bacteria and subjected to action of the usual degree of heat found in drying houses, tumblers, mangles, and hot presses, were freed of living bacteria. Such reports, and others that might be mentioned, justify consideration of the public laundry as a possible danger.

Another investigation concerned the bacterial content of undershirts which are worn frequently without frequent washing. From an average bacterial content of 400,000 bacteria per square inch after one use, the number increased to nearly 10 million after the garment had been worn six times. Careful laundering reduced the number to a satisfactory limit. Species most prevalent were staphylococci and streptococci. A few fecal bacteria were found on one specimen. Presence of many hemolytic bacteria suggested to the investigator that underclothing should be frequently

¹ M. C. Schroeder and S. G. Southerland, *Laundries and the Public Health, a Sanitary Study Including Bacteriologic Tests, U. S. Pub. Health Service, Pub. Health Repts. 32, 1917, 225-46.*

changed and laundered by a process which would destroy pathogenic types of bacteria.

It is obvious that the types of soap used and the temperatures and times which are involved would have much to do with the sterilizing value of the laundering process. Three types of bacteria (*Staphylococcus aureus*, *Eberthella typhosa*, and *Clostridium welchii*) which were used in one investigation were destroyed by soap and an alkaline builder in concentrations and at temperatures commonly used in the power laundry. Sodium hypochloride or hydrogen peroxide in low concentrations as used with soap produced complete destruction of these organisms. Water at 160°F. also was quite active in destroying microorganisms. Attention is directed to Chapter II for a discussion of ironing as a means of sterilization.

It is also of interest to note that the complete dry-cleaning process, involving use of dry-cleaning soap, rendered inoculated textile fabrics sterile to ordinary contaminating bacteria. Neither heat alone at the temperature most commonly used in drying fabrics during dry cleaning (120°F.) nor dry-cleaning solvent without soap or other detergent was effective in producing complete sterilization. In general, the investigators, whose work is just quoted, considered dry cleaning to be of distinct value to public health.

Public Drinking Fountains. These were adopted after the public drinking cup had been driven from the street corner into the ice-cream parlor and tavern. Epidemiological investigation of an outbreak of tonsillitis in a dormitory of a large university called attention of bacteriologists to the fact that drinking fountains with vertical jets might harbor for a long time bacteria from the mouths of those who used them. The subject was then investigated by the American Public Health Association and American Water Works Association. Among other recommendations was one that the jet of the fountain should be at an angle so that water would not fall back on the orifice from which it emanated. Guards of metal were also recommended to keep the lips of drinkers away from the orifice.

Other Fomites. Saelhof reported that hemolytic streptococci, and occasionally *Corynebacterium diphtheriae* and pneumococci, were present on the receivers and transmitters of telephones. So-called "court plaster" may be considered a fomite. It is

prepared long before it is used, and, even though it is prepared from sterile materials, it may become objectionable during its sojourn in the home before use. It is quite unsatisfactory for wounds. It is frequently moistened with saliva before application to wounds which makes it still more objectionable.

AIR-BORNE INFECTION

Varying opinions have been held as to the importance of air in spread of agents causing communicable diseases. Our forefathers believed that emanations or some hypothetical agent could be in air. They observed that those who lived in the vicinity of swamps frequently contracted malaria. The disease was called swamp fever and was attributed to emanations or gases from the swamp. Finally, it was shown that these agents were mosquitoes. Location of hospitals and sanitarium has frequently been beset with much opposition from those who resided in the vicinity of the proposed sites because they believed that they would be more liable to infection. There is little sound basis in such a belief, because pathogenic bacteria do not survive long in fresh air and sunlight. So-called pest houses, now called isolation hospitals, were once located at the edge of villages because they were feared. Most health authorities are agreed that such fears were groundless.

The situation in enclosed areas such as classrooms, churches, and theaters, for instance, may be different. Evidence has accumulated in recent years to show that droplets expelled into the air from the nose and throat in sneezing, coughing, and talking may remain suspended for some time. They evaporate quite rapidly and settle to be raised into the air as dust and be widely spread by air currents. Certain pathogenic bacteria which were used in experiments were shown to live for several days in droplet nuclei. It has thus been shown that the nasopharyngeal flora may be exchanged from person to person. This means that pathogenic bacteria which may be present may also be spread. That this is possible has now been proved by various investigators in different laboratories.²

² W. F. Wells and Mildred W. Wells, Air-Borne Infection, *J. Am. Med. Assoc.*, **107** (1936), 1699-1703.

L. Buchbinder, The Transmission of Certain Infections of Respiratory Origin, *Critical Review, Idem.*, **118** (1942), 717-30.

Modern means of travel by airplane, automobile, and railroads has introduced new problems in control of communicable diseases. Rapid expansion of air travel has made it possible for disease-infested rodents and insects to be carried from country to country in a short time. Attention has already been given to the prevention of spread of yellow fever by air traffic by the Pan American Sanitary Bureau. The bureau, keeping abreast with the rapid expansion of the air travel by the lines of the Pan American Airway System, has made arrangements to prevent the international spread of yellow fever by air traffic. Under the terms of the agreement, all flying personnel of the company will be vaccinated against yellow fever. Furthermore, each passenger embarking in a Pan American Airways plane at any point north of 30 degrees south latitude will be required to fill out a form designated as "Certificate of Origin of Passenger." The questions included in this form deal chiefly with an accounting of the passenger's location for the 6 days preceding embarkation at the airport. This period, taken together with the time consumed on the voyage, gives a fairly wide margin of safety. In instances in which the passengers have come from actually infected localities and the 6-day period of incubation since the last possible exposure has not been completed on arrival at destination, the passengers, according to the discretion of the quarantine officer, may be placed in open surveillance, observation, or detention, as may be deemed safest and most expedient. Finally, as an additional precaution, airplanes will be fumigated during the night, when not in use. This recognition of the dangers attending the facilitation of the spread of disease by air traffic and the noteworthy measures taken for its prevention constitute an important chapter in epidemiology.

CONTACT INFECTION

This term implies close association of the sick with the well. The committee which prepared the report on "The Control of Communicable Diseases" defined the term contact as follows: A "contact" is any person or animal known to have been sufficiently near an infected person or animal to have been presumably exposed to transfer infectious material directly, or by articles freshly soiled with such material. This is the best explanation for dissemination of certain diseases, for it is the

direct method. Isolation and quarantine procedure aim to prevent close contact of sick and well. The following account of a smallpox peddler illustrates contact infection and shows what happens when it is not prevented.³ Smallpox is rare today in the United States.

About October 15, 1921, a man arrived in Garnett, Anderson County, from Kansas City, Mo., to work with a road gang whose camp was immediately outside Garnett. He was in the early stage of black smallpox and two or three days later reported sick. The disease was promptly recognized, the man isolated, and all of the other men in the gang vaccinated. The problem then arose as to who was to attend this man. Working with the gang was a man named W_____, who professed to have no fear whatever of smallpox, and to whom the task of nursing a sick man appeared easier than building roads. He therefore offered his services to the county health officer, and it was agreed that he should act as nurse for this man and keep himself rigidly isolated from the outside world.

While the nursing apparently suited W_____’s tastes, the solitude and isolation certainly did not, and he frequently took the liberty of going to town for one reason or another. Being warned by his companions that he was breaking the law and fearing that he should be put under arrest, he boarded a train one night and disappeared.

Nothing was heard of him until two weeks later, when he appeared in Iola, Allen County, and reported sick. His sickness proved to be smallpox, and this was promptly recognized. A vacant house was procured and the man confined there. In the meantime the man in Garnett died, but W_____, more fortunate than his former patient, after ten days or so of fairly severe illness felt practically as well as ever, so well, in fact, that he decided to leave Iola and get married.

The wedding trip included a visit to Thayer, Neochoc County, and in this place he called on three families. This was about November 18. During the first week of December smallpox broke out in these families, and at time of writing fourteen cases of smallpox have occurred, all of which can be directly or indirectly traced to W_____.

During the first week of December also the bride became ill, and later on her sister and mother-in-law (Mrs. W_____, Sr.). It does not seem to have occurred to W_____, however, that all these cases could have had anything to do with his sickness, and, while his wife was sick, and later his mother, he kept constantly leaving the house where they were confined and associating with well people.

From the fact that his operations involved three counties, the association of this man with all these cases was not at first noticed, but, when it became apparent, he was immediately placed under arrest and is now awaiting his trial.

From this man’s ignorance and criminal carelessness have apparently

³ Frank G. Pedley, A Smallpox Peddler, *Kansas State Board of Health Bull.* 17, 1921, 222-223.

arisen at least fourteen cases of smallpox and four deaths—one of them his own mother. The mayor of Thayer, writing to the State Board of Health, stated that some of the cases there were so horribly disfigured by the disease that they "did not look like human beings."

This history is given not only for its interest, but to emphasize the fact that people of the type of W_____ are to be found everywhere. In fact, at times we are completely at their mercy, and the only way to be perfectly safe is to be vaccinated.

Handshaking is another illustration of close contact which may result in dissemination of undesirable bacteria. The danger which lurks in the practice is borne out by the many cases of typhoid fever caused by carriers who prepared the food. In such cases, the hands were the agents by which the foods were infected. The hands which infected the foods may have infected other hands. A little thought will soon convince the most skeptical that the hands may be dangerous agents. All sorts of things and materials are handled from morning until night. Handshaking allows the most intimate contact; the reasons for which it was introduced by our early forefathers no longer exist in most communities. Buice and his colleagues recently reported the occurrence of *Escherichia coli* of intestinal origin on the hands of one out of every 12 food handlers. There is no reason to believe that these observations might not be extended to other groups of people. During World War I, when influenza was raging through practically all nations, its dissemination was said to be by the hands in some cases. The hygienic significance of hand washing is indicated.

INSECT-BORNE DISEASES

Insects may disseminate disease-producing microorganisms in different ways: (1) They may carry the organisms on their bodies and leave them in food or even in wounds: (2) they may carry them in their intestinal tracts and deposit them in their excreta; (3) they may carry them in blood which they have sucked from the blood stream of an infected animal and thus seed a healthy animal; (4) they may take them into their bodies and transmit them to their offspring, bites of which are infectious; and (5) insects may be one of the hosts in which the parasites develop in one of the stages of growth. These means of spreading disease-producing microorganisms overlap in some cases.

Such diseases as yellow fever, malaria, and Rocky Mountain spotted fever are spread by insects. Besides these in which the microorganism seems to develop in the body of the insect are other diseases, such as typhoid fever and dysentery, in which the microorganisms are carried on the insect. The fly, mosquito, cockroach, and bedbug, all more or less common insects, have been studied bacteriologically. During the Spanish-American War, many American soldiers had typhoid fever. A commission appointed to investigate the question decided that flies served as carriers of the typhoid bacteria.

Reports on the bacteriology of flies are numerous. In one case an investigator examined flies for typhoid bacteria near a sick room, in which was a typhoid patient; 5 out of 18 flies showed the presence of this organism. Esten and Mason reported that a single fly could carry from 550 to 6,600,000 bacteria of all kinds. It is unnecessary to quote more data. The case against the fly is well established.

The fly is of interest as an agent for the spread of disease-producing bacteria in two ways, by the mechanical carrying of microorganism on (1) the feet and legs and, (2) in the alimentary tract. The latter method may need a little more discussion than the former. Graham-Smith, who made a careful study of the subject, fed flies a number of pathogenic bacteria and then determined the longest period after which organism could be recovered from various parts of the fly's body. The data were interesting. They appear in Table 7. Graham-Smith called attention to the fact that they come from heavily infected flies.

The cockroach, *Blatta germanica*, has also been incriminated in the dissemination of undesirable bacteria. One investigator stated that the cockroach, by contamination with its feces, is able to play a part in the dissemination of tuberculosis and the pyogenic bacteria. Animal and vegetable parasites have been demonstrated in the digestive tubes of cockroaches. A South American worker found pathogenic bacteria in cockroaches caught in toilet rooms. Barber in 1914 stated that the cockroach should be stamped out. He exposed fecal material which had been inoculated with the organism causing Asiatic cholera; the roaches devoured this greedily. The bacteria were demonstrated in the roaches 6 to 9 hours after feeding. The cockroach might infect food during this time since the cholera parasite will live

for about 16 hours on human food after discharge by the roach. Such data indicate a strong case against the cockroach.

The red ant was shown to harbor the cholera organism 8 hours after it had ingested food containing it.

Working with fleas, Baçot showed that the alimentary tract of the flea larva may become infected with bacteria if these bacteria appear in the food. He also showed that infection of the larval gut might persist during the resting period of the larva in the cocoon and that there was satisfactory evidence that such infection might survive the pupal stage.

TABLE 7
SHOWING THE LONGEST PERIOD AFTER WHICH PATHOGENIC BACTERIA COULD
BE ISOLATED FROM ARTIFICIALLY INFECTED FLIES
(After Graham-Smith)
Time in Days

	Legs	Wings	Head	Crop	Gut	Feces
<i>Eberthella typhosa</i>	6	2
<i>Salmonella enteritidis</i>	7	..	7	8	7	..
<i>Mycobact. tuberculosis</i>	3	16	13
Tuberculous sputum	7	5
Yeast	2.5	2.5	2.5	2	3	2
<i>Corynebacterium diphtheriae</i>	5	5	5	7	5	2
<i>Bacillus anthracis</i>	2	..	4	5	3	2
<i>Vibrio comma</i>	30 hrs.	5 hrs.	2	2	2	30 hrs.
<i>Serratia marcescens</i>	8	12	11	5	17	6
Anthrax spores	20	20	20	13	20	13

Under this heading an opportunity is presented to discuss some of the early work which was done to prove that yellow fever is mosquito-borne. As is true with many of our great discoveries, indefinite statements were made in early medical work that yellow fever was spread by mosquitoes. It remained for some carefully controlled experiments by Reed, Agramonté, Lazear, and Carroll to prove this definitely beyond doubt. By means of experimental work in Cuba these medical officers of the United States Army secured experimental work for the hypothesis expressed by Findlay in 1881. Experiments were outlined in a careful manner and yielded logical conclusions. They involved the use of voluntary human beings who yielded to the bites of infected mosquitoes. First of all, of course, these men had to be carefully isolated for a period greater than the incubation period of yellow fever to

insure that they were healthy individuals for conducting the experiments. Having passed this test, they were placed in screened enclosures, in which infected mosquitoes were released. Yellow fever usually resulted in about 5 days. Other experiments were conducted which confirmed the conclusion that the yellow fever mosquito was the real agent in transmission of the disease.

Experiments were also conducted on other agents, which were at one time or another believed to disseminate the disease. For instance, it was believed at one time that bed linen and articles of clothing could harbor the infectious matter and thus be responsible for dissemination of the disease. This was disproved by allowing healthy men to sleep in beds soiled with excreta from yellow fever patients. Such experiments were negative. These and other experiments too numerous to mention helped to strengthen the case against the mosquito. Once it was proved that the mosquito spread the disease, antimosquito campaigns were instituted in certain tropical cities. These in themselves caused great reduction in the yellow fever rate as well as in the mortality rate. The conquering of yellow fever is one of the greatest triumphs of sanitary science. It has made possible the building of the Panama Canal, a project which was several times defeated by mosquitoes. It has made life and happiness more certain in tropical cities.

Vessels, trains, and especially airplanes are problems in control of insects and, therefore, in control of the diseases which they cause. Evidence has been observed that potentially dangerous mosquitoes as well as other insects have been transported by airplanes. The problem is significant because of the short transit time of the airplane. Another problem here is transport of infected human beings. A traveler may be infected with a disease before departure and become ill soon after reaching his destination. Such possibilities increase the problems of quarantine officers. Compulsory vaccination against as many diseases as possible and more quarantine stations may be required.

ANIMAL-BORNE DISEASES

These diseases, transmissible from animals to man, are some of the most important with which health officers have to deal. They may be transmitted in different ways.

Anthrax. This malignant disease of man and animals is caused by *Bacillus anthracis*. Man may be infected by inoculation from an accidental wound or scratch, by inhalation of the spores, or by eating insufficiently cooked flesh of infected animals. The period of incubation is usually 7 days. Anthrax is communicable during the febrile fever stage or until lesions cease discharging. Anthrax has been caused by cheap unsterilized brushes and by hides. Those who work in industries involving handling of hides are advised to be alert to possibility of infection. Since it may also be food-borne, milk from infected animals should not be used.

Glanders. The etiologic agent in *Pfeifferella mallei*. The disease is spread by discharges from open lesions of human or equine cases. This includes pus and mucus from the nose and throat, feces, and urine. Glanders is mainly a disease of horses. All horses in infected areas should be quarantined, and every possible attention should be given to cleaning and disinfection of stables. The period of incubation is 1 to 5 days.

Tuberculosis. This disease is usually thought of first when one thinks of diseases which are transmissible from animals to man. The discussion has centered around the possibility of transmitting bovine tuberculosis to human beings. In 1898 Smith distinguished the bovine type of tubercle bacillus from the human type. In 1913 Park and Krumwiede gave some figures which probably represent the present-day situation. All pulmonary tuberculosis is caused by the human type of the bacillus; about one tenth of the tuberculosis of bones, joints, and lymph nodes in adults, and a fourth of tuberculosis of these types in children is due to the bovine bacillus. Other data have indicated that 6 to 10 per cent of deaths from tuberculosis in children below 5 years of age are due to the bovine type of tubercle bacillus, probably because milk constitutes a larger part of the food of children than of adults.

Undulant Fever (Brucellosis). This is a disease of relatively recent explanation. Fevers of obscure origin have always troubled physicians. In 1905 a ship sailed from the Island of Malta with a shipment of 61 goats for the United States. Eight of twelve officers and men who drank large quantities of raw goats' milk became ill. Two of the four who escaped illness had boiled the milk; the remaining two had drunk only a little. At the

quarantine station, a bacterium known to cause Malta fever, isolated and described by Bruce in 1887, was found in the goats' milk. Following this, sporadic cases of undulant fever occurred in the United States. About 10 years later Bang, a Danish bacteriologist, isolated an organism, *Bacillus abortus*, as the cause of contagious abortion, frequently called Bang's disease. No relation between these discoveries was evident until Evans of the United States Public Health Service found that these bacteria were identical. She then stated that a disease might exist in the United States resembling Malta fever. This has been found to be true, and the disease in human beings is called *undulant fever*. The organism is known to be present in milk, and the easiest way to prevent infection is to use pasteurized milk. Certified milk from "*abortion-free herds*" may be safe, but pasteurized milk is safer.

The disease in human beings is characterized by slow onset and irregular fever of prolonged duration from which the disease secures its name.

Psittacosis. This is a malignant disease transmitted to man from pet birds such as parrots, parakeets, love birds, and canaries. The etiologic agent is apparently a filterable virus. It may be transmitted by human contact or from infected birds. The period of incubation is 6 to 15 days. Health officers fight the disease by controlling shipment of birds and quarantine of homes and petshops known to have harbored infected birds.

Tularemia. This disease (often called rabbit disease) is spread by different species of wild rodents. The etiologic agent is *Pasteurella tularensis*. Tularemia may be spread by bites of infected flies and ticks, or by inoculation through handling infected animals. The average incubation period is three days, although it may be as short as 24 hours and as long as 10 days. Tularemia has not been transmitted from man to man. Efforts to control the disease involve avoidance of bites of flies and ticks and use of rubber gloves in dressing wild rabbits. The flesh of wild rabbits should be thoroughly cooked or refrigerated for 3 months. Many bacteriologists who have studied the disease in the laboratory have been infected. Those who dress wild rabbits, or perform necropsies on infected laboratory animals, should wear rubber gloves.

Rabies. This is a spectacular disease transmissible to human beings by bites of rabid animals, particularly dogs, cats, wolves, and similar animals. It is spectacular because of the long incubation period which may elapse after exposure from a bite, the extraordinary symptoms, and the usually fatal ending. Rabies is one of the virus diseases in which the central nervous system is especially involved. The virus is present in the saliva of the rabid animal which explains its entrance into the blood of the individual who has been bitten. Although infection with rabies is usually thought of in connection with dogs, other animals such as horses, foxes, cats, cows, raccoons, and goats are known to be susceptible. Control of rabies, however, is best accomplished by rigid control of dogs by quarantine when rabies has appeared and by elimination of stray dogs.

The public becomes aroused when human beings have been bitten, and the tendency is to destroy suspected animals. Health officers are agreed that this is most unfortunate. It is best to capture the animal and keep it under observation. This may make it possible for veterinarians to determine whether it has or has not rabies. If the animal has been killed, this cannot be done, and reliance must be made solely on laboratory examination of the brain of the animal which in many cases has not been properly cared for.

Determination of presence of rabies in a dog which has bitten a human being is necessary to decide whether the Pasteur treatment shall be taken.

METHODS OF PREVENTING SPREAD OF DISEASE

All methods for combating and eradicating diseases may be arranged in two groups—*subjective* and *objective* methods. Well-planned public-health programs involve use of methods from both groups.

Subjective Methods. These are preventive measures applied to the patient, or subject of infection, and consist of the general procedures by which a person may build up his resistance but especially of the methods of preventive inoculation and immune reactions. These are discussed in later chapters.

Objective Methods. Many of the objective methods are discussed at some length in other paragraphs. These are the

methods which may be applied to factors in one's environment such as water disinfection, milk pasteurization, disinfection procedures and quarantine.

QUARANTINE METHODS

These methods are perhaps the most important of objective methods that may be applied for preventing spread of pathogenic bacteria. They involve isolation of infected individuals. Quarantine procedures rest on the same social principles that permit us to jail certain members of society and to place others suffering from mental ill health in hospitals. It is for the greatest good of the greatest number. An early quarantine act was enforced in 1403 by Venice; a small island was used as a quarantine station and incoming vessels were required to remain there 40 days. From this (Fr. *quarantaine*) arose our modern term.

International or Maritime Quarantine. International quarantine is rigidly enforced by the United States of America to prevent entrance of certain diseases. Six are so dreaded by sanitarians that they are watched for in international quarantine work; they are smallpox, leprosy, yellow fever, typhus fever, cholera, and plague. Persons attempting to enter the United States on a vessel from a country where these diseases are epidemic are carefully examined. If a case of one of these diseases appears on board a vessel, that vessel with its crew and passengers is held at a quarantine station until the period of incubation for the disease is exceeded. This gives an opportunity for any who have been exposed to the disease to become ill. Quarantine procedures are well known, but it is advisable to point out that today a quarantine officer may know in a short time the incidence of disease in a foreign country. Those especially interested in this subject should seek information on the United States Bill of Health.

Infectious diseases not included in the previous list are not so greatly feared, and consequently cases are allowed to enter the United States. They become subject to the laws of the state in which the port of entry is located.

Federal or Interstate Quarantine. This type of quarantine can be enforced only by Federal health officers. It has been employed for the control of foot-and-mouth disease in cattle, the interstate shipment of tuberculous cattle, and so on. Although

it is not strictly a matter of quarantine, we may point out that Federal bureaus control the water supplies on interstate carriers, condemnation of unfit food seized in interstate traffic, and the like.

State Quarantine. This is enforced by state laws and is usually administered by state boards or departments of public health. Such state bureaus have jurisdiction only within states, and, although there is usually perfect harmony, they are not subject to the Federal health bureaus.

Municipal Quarantine. This is enforced by city officers and is usually founded on the state quarantine laws. It is the type of quarantine with which the layman is most familiar. It has been defined as follows by a committee of eminent health authorities:

Quarantine: By quarantine is meant the limitation of freedom or movement of persons or animals who have been exposed to communicable disease for a period of time equal to the longest usual incubation period of the disease to which they have been exposed.

Detention Camp. The detention camp is used in times of military emergency, for instance, to prevent the introduction of diseases into large groups of men. If troops are moved from an area where disease is prevalent to an area where it is not, they may be placed in a detention camp for a period longer than the incubation period of the disease.

Sanitary Cordon. A sanitary cordon is a form of quarantine or isolation which is enforced in times of emergency.

Isolation of the Patient. This is the most direct way of segregating the infected person. Could the sick be absolutely isolated until after such time as they can excrete pathogenic bacteria, disease could be more easily controlled. This term was defined by a committee of the American Public Health Association as follows:

By isolation⁴ is meant the separating of persons suffering from a communicable disease, or carriers of the infecting organism, from other persons, in such places and under such conditions as will prevent the direct or indirect conveyance of the infectious agent to susceptible persons.

⁴In view of the various ambiguous and inaccurate uses to which the words isolation and quarantine are not infrequently put, it has seemed best to adopt arbitrarily the word isolation as describing the limitation put on the movements of the known sick, or "carrier" individual, or animal, and the word quarantine as describing the limitations put on exposed or "contact" individuals.

Isolation of the patient is probably the best procedure for stamping out infections. If it were rigidly enforced there would be no opportunity for pathogenic bacteria to be disseminated. However, it seems too difficult to isolate a patient absolutely, for there are some infections, such as influenza, in which isolation in the ordinary sense of the term has not accomplished much. The carrier and missed case greatly complicate the situation.

What has been said about isolation of the patient seems to be true also for communities and groups of people. Marshall made the following statement about the experience of certain of the Fiji Islands during the pandemic of influenza in 1918.

During this epidemic I was a member of the British medical service of the colony of Fiji. Some instances of the effectiveness of isolation against infection of communities with influenza came under my notice at that time which I think might be of interest, as they confirm the conclusion that "it is quite safe to assert that perfect isolation of an individual or group during an influenza epidemic constitutes a complete protection against the disease."

An instance of the effectiveness of isolation by means of quarantine measures occurred in American Samoa, which was under the command of an American Naval officer. The port of entry here is Pago Pago. Efficient quarantine prevented infection of the inhabitants of American Samoa with influenza. Pago Pago is approximately 60 miles distant from Apia, which is the port of that part of the Samoan group administered by the Government of New Zealand. Thus, while the British Samoa was ravaged with influenza, American Samoa did not suffer from the disease.

The little island of Rotumah is located about 200 miles north of the main Fiji group. This island escaped infection during the epidemic for the reason that it was entirely cut off from communication with the outside world. Ordinarily, a schedule of monthly communication among Suva, Fiji, and Rotumah is maintained. During the occurrence of influenza in Suva, this schedule was interrupted, and no boat was dispatched to Rotumah for a period of 3 months. It was then found that this island had escaped the infection.

A resourceful planter who lived and owned a large plantation at a place called Taviuni or Vanua Leva, Fiji, kept his district free of infection by means of an efficient quarantine. Although districts around him were infected heavily, the area which he isolated remained free from infection until long after the peak of the incidence of infection of the epidemic had been reached. The cases that occurred subsequently were of only mild character.

The Makogai Leper Asylum of Fiji also escaped the ravages of the epidemic. I can speak from personal knowledge of the facts concerning this instance, as at that time I was acting medical superintendent of the asylum. The asylum is located on a small island separated from Levuka, the nearest port by 18 miles. At that time it had a population of about

400 persons; 350 patients with leprosy, and 50 personnel. Until August 1919, no cases of influenza occurred. By virtue of the quarantine restrictions which the government had in force regarding the island of Makogai at all times, an efficient quarantine against influenza was carried out easily. It was necessary to make trips to Levuka in order to obtain supplies, but it was possible during these trips to avoid close contacts. Levuka suffered heavily from the infection.

Plant Quarantine. Exclusion of plants from a restricted district is often enforced for the same reasons that animals are excluded. Plant diseases, like San José scale, citrus scale, have spread over the United States. Plant quarantine has been made necessary by the insects which they may frequently carry.

How Disease Bacteria Leave the Body of the Patient. For a sick person to communicate disease to another, the microorganisms causing his illness must leave his body in some way.

From the Mouth. The mouth with its saliva makes a fertile soil for different bacteria. There are some which cause diseases in the mouth. If such diseases exist, bacteria may be easily excreted in discharges from the mouth. The spitting habit is not only disgusting but also a possible source of infection. This has been recognized for a long time in tuberculosis. Persons afflicted with the disease are instructed very early in the care of their sputum. Coughing, sneezing, or even ordinary speaking cause many bacteria to be expelled from the mouth. Winslow found that speaking caused bacteria to be expelled from the mouth for a considerable distance.

In the Stools. The excrement from the alimentary tract is especially important in certain diseases such as typhoid fever and dysentery. This may reach a water course supplying untreated water to a community, or it may reach foods by means of soiled hands to give rise to a carrier-borne outbreak of disease such as those discussed in a former chapter. When epidemiological investigations suggest a carrier as the cause of an undue amount of disease in a locality, search starts with examination of feces from those who are handling food. Besides the diseases in the group previously mentioned, there are others the etiologic agents of which reach the feces somewhat indirectly. Thus tuberculosis bacteria may reach the feces by being swallowed in sputum.

In the Urine. Certain pathogenic bacteria such as *Eberthella typhosa* may be excreted in the urine. In the search for typhoid

carriers both stools and urine have caused confusion in the solution of carrier-caused typhoid fever epidemics. Tubercle bacilli may also be excreted in the urine. The bacteriological examination of urine is often made inaccurate by faulty methods of collecting the sample. Sterile catheters should be used, and every attempt should be made to prevent the ingress of extraneous bacteria.

In the Nasal Excretion. The nasal excretion would, of course, be significant in the respiratory diseases.

In the Milk. Research has indicated that milk of animals may contain pathogenic bacteria. Much work has been done with milk from animals, but from published reports we may conclude that the human mother may also excrete pathogenic bacteria in her milk. In one report *Eberthella typhosa* appeared in the milk of a woman on the 11th day of the disease. The nursling, aged 25 days, died of typhoid fever two weeks later. In another case, coliform bacteria were found in the milk of a woman who suffered from sudden fever and digestive disturbances. An extensive study of the bacteriology of human milk was conducted on 100 women in London. Of the specimens 49 per cent showed streptococci, only 2 per cent of which indicated pathological conditions in the breast. In several cases *Escherichia coli* was isolated. Normal human milk, it was said, might contain *Staphylococcus aureus*, *Staphylococcus albus*, *Streptococci*, and *Escherichia coli*. Such data indicate that human milk, like cow's milk, is not sterile when excreted but may contain bacteria. Human milk, therefore, may be responsible for infections in infants.

EPIDEMIOLOGY OF DISEASE

This has become a significant branch of the fields of medicine and public health. Although the term epidemiology means the science of epidemic disease, it has acquired a more general meaning to include information on the prevalence as well as methods of dissemination of any disease whether it is epidemic or not. Related are *vital statistics* of births, deaths, marriages, and presence of diseases in a city, state, or nation. Vital records are carefully kept by authorities designated for that purpose. An individual's interest in this subject could well start with possession of a copy of his own birth certificate.

REFERENCES

- CHAPIN, C. V., *The Sources and Modes of Infection*, Wiley, New York, 1916.
- DIBLE, J. H., *Recent Advances in Bacteriology and the Study of Infections*, P. Blakiston's Son & Co., Philadelphia, 1932.
- HAGAN, W. A., *The Infectious Diseases of Domestic Animals*, Comstock Publishing Co., Ithaca, N. Y., 1943.
- HEISER, VICTOR, *An American Doctor's Odyssey*, W. W. Norton & Co., New York, 1936.
- HULL, THOMAS G., *Diseases Transmitted from Animals to Man*, Charles C. Thomas, Springfield, Ill., 1941.
- KELSER, RAYMOND B., and HARRY SCHOENING, *Manual of Veterinary Bacteriology*, Williams & Wilkins Co., Baltimore, 1943.
- MARTIN, C. J., *Insect Porters of Bacterial Infections*, *Brit. Med. J.*, **2714** (1913), 1-8; **2715**, 59-68; *ESR*, **30** (1914), 153.
- McLAUGHLIN, A. J., *The Communicable Diseases—How They Spread and How They May Be Controlled*, Harper, New York, 1923.
- ROSENAU, M. J., *Preventive Medicine and Hygiene*, D. Appleton-Century, New York, 1935.
- STILES, G. W., and J. T. LUCKER, *Bacterial Infections and Parasites Common to Man and Animals*, *U. S. Dept. Agr. Yearbook* (1942), 295-312.
- SWEET, E. A., *The Transmission of Disease by Flies*, *U. S. Pub. Health Service, Suppl. Pub. Health Repts.* **29**, 1916.

CHAPTER 27

FACTORS INFLUENCING INFECTION

Microorganisms which cause infections in animal organisms are called pathogens. Sharp lines cannot be drawn between pathogens and nonpathogens. Some of the commonest saprophytes such as *Bacillus subtilis* and *Serratia marcescens*, ordinarily non-pathogenic, have been isolated from infections in which they seemed to have been the etiologic agent. Two opposing forces are involved in infection, the host and the infecting agent. It is impossible to separate them, and one is largely measured in terms of the other. A weak susceptible host would allow the infecting agent or parasite to appear aggressive and virulent. An excessively virulent parasite would suggest a weak susceptible host.

FACTORS INFLUENCING RESISTANCE OF THE HOST

These are in many respects quite general, and are those which are concerned in healthful living. In addition to those mentioned in the following paragraphs are others which are related to tissue structure and chemical properties of body fluids.

Heredity. It is not surprising that many believe infectious disease to be inherited. Spread of disease in a family would, at first thought, lend support to the belief. However, such disease is now best explained by contact. Members of a family have many opportunities for contact infection. Some of the disagreements in opinions over the influence of heredity on disease is perhaps due to different definitions of some of the terms. Heredity probably has something to do with susceptibility and resistance to disease. Davenport¹ has explained it on the same basis as other inheritable characteristics. He stated, "It thus appears that in inheritance of our traits and, among others, in

¹ C. B. Davenport, Heredity and Disease, *J. Am. Med. Assoc.*, **87** (1926), 664-7.

inheritance of those somatic conditions which permit the development of disease, we are to a large extent what our chromosomes make us."

Age. Some diseases also show age incidence. Such diseases as mumps, chicken pox, and measles are more commonly diseases of childhood; others such as heart disease and cancer are diseases of old age. Sharp lines of demarcation cannot be drawn when one is considering characteristics and functions of living organisms, and they will not be drawn here. It is known, for instance, that older people infrequently have some of the diseases of childhood.

Mental State. This is another remote, but often important, factor influencing disease. It probably does not influence greatly the course of an infection unless it prompts one to neglect it; death may follow under such conditions more quickly. Psychic therapy probably has a place in present-day medicine, but it is to be distinguished from many other terms and practices that may be confused with it.

Occupation. Diseases which are directly due to trades or professions are spoken of as occupational diseases. They are often so serious that many states have bureaus empowered by law to study them. Such diseases include lead poisoning, certain types of pneumonia, and furunculosis due to contaminated cutting oils. They are also called vocational diseases.

Housing Conditions. This is perhaps a more indefinite factor influencing infection. Resistance to disease which an individual possesses is lowered by overcrowding in homes. Crowded living conditions cause close contact which give best conditions for spreading infectious material. The influence of living conditions has received much study in tuberculosis, a disease which has reaped vengeance on homes in the crowded tenements. Although the tenements in large cities are easily connected with tuberculosis and kindred diseases, it is not so easy to admit that housing conditions in rural sections may also have significance. Yet such is the case, if the account reported by Palmer² indicates the situation. This is a terrible tale of tuberculosis in a house in the outskirts of a rural community in Illinois. Perhaps the story has been overdrawn but there may be enough foundation

² Geo. T. Palmer, *The Story of a Country House*, *Illinois Health News*, 1 (1915), 69-71.

in fact to stimulate our co-operation in all efforts to reduce and eliminate bad housing.

Bad housing includes overcrowding which leads to increased infection with respiratory diseases. It also involves greater infestation with rats and insects which lead to diseases spread by them. In fact all diseases, those from insect-borne contact, and those due to malnutrition, are increased by substandard housing. Individuals who are forced to live in such homes will always be a focus of infection for those who live in the best homes.

Temperature. Temperature of the environment may also indirectly influence disease incidence and immunity reaction. Vaughan, for many years dean of medicine at the University of Michigan, in his interesting volume, "A Doctor's Memories," stated his belief that the high temperatures of the middle western states in summer and fall greatly increased the incidence of "bloody dysentery," a very common infection 40 or 50 years ago. Winslow and his colleagues also found that temperatures of 84°F. to 89°F. caused distinct decrease in the rate of hemolysin formation on the part of animals. If these observations with hemolysin formation represent the situation for the other immune bodies, we have a more rational explanation of the detrimental effects of higher temperatures.

Closely related to temperature is the seasonal incidence of disease. Respiratory infections are more common in the late fall and winter. Typhoid fever is a later summer-fall infection.

Fatigue. The relation of fatigue to disease has become more and more apparent as investigations have been carried out. This factor in disease was discussed as follows in the *Journal of the American Medical Association* (Vol. 86, 1926, page 753) :

Although fatigue is a phenomenon that every person recognizes readily in a subjective way, physiologists still are struggling with the objective interpretation of its nature. One may read of the alleged accumulation of "fatigue substances," notably in the muscles, and of the circulation of products of overwork that are not ordinarily present in the blood; but a well-founded theory of the nature of fatigue remains to be formulated. It is known that prolonged muscular activity, and particularly contractile effort under the influence of a lessened supply of oxygen, may lead to appearance of unusual quantities of lactic acid, among other demonstrable substances. These can exert noticeable changes on various bodily functions, such as respiration, the heartbeat, and the irritability of the muscle itself. The mere statement of such demonstrable effects, however, gives only partial insight into the far-reaching consequences that may be involved.

One of the "antidotes" to fatigue is rest, which affords an opportunity for recuperation. There is a widespread belief that resistance to infection is promoted by bodily rest, and a common method of combating it consists in promoting rest. A recent writer has even referred to the doctrine that the pain of injuries is beneficial because it secures local rest, which promotes healing; and he suggests that it may reasonably be extended to the general malaise of infections. It might be assumed as a possible corollary of this that fatigue conduces to susceptibility to infection. Experiments to test this hypothesis have not been entirely lacking. Abbott and Gildersleeve,³ observing that animals fatigued by running exhibit a depression of the opsonic index, concluded that they must have a greater susceptibility to bacterial infection. The experiments of Spaeth at Johns Hopkins University lent no support to such a conclusion. On the other hand, observations of Boycott and Price-Jones at the University College Hospital Medical School, London, reopen the entire question. They demonstrate that under certain circumstances fatigue does promote infection. All-inclusive statements should not be made. Thus, an amount of exercise sufficiently severe to delay substantially the normal increase of weight of growing animals did not break down their natural resistance to tuberculosis. The feature deserving of emphasis at this time is the necessity of more exact information on a large variety of specific features of possible interrelations between fatigue and disease. At a period when industrial efficiency and the bodily welfare of the worker is a prominent topic of serious discussion, the bearing of the possible relation of fatigue on the causation and the prevention of infectious diseases in industrial work is sufficiently obvious. Lee⁴ has, indeed, pointed out that the identification and treatment of industrial diseases and the appreciation of industrial hazards to health and ways of preventing them are parts of the general modern recognition of the importance of the individual and the duties of society toward him. Here, Lee adds, the physician, the philanthropist and the legislator have worked in helpful partnership.

Plant pathologists have also reported observations which bear on this discussion. They have found that, if plants which are weakened, are sprayed with spores of an organism which is pathogenic for them, they will be more quickly infected; normal healthy plants sprayed at the same time will not succumb but will remain healthy.

Malnutrition. Undernourishment and an ill-balanced diet are predisposing factors in infection. This condition includes diets which are deficient in certain chemical constituents but especially those which are deficient in accessory substances. Pellagra is

³ Abbott and Gildersleeve, *The Influence of Muscular Fatigue and of Alcohol on Certain of the Normal Defenses*, *Univ. Penn. Med. Bull.* 23, 1910, 169.

⁴ F. S. Lee, *The Human Machine*, Longmans, Green, New York, 1918. *Fatigue and Resistance to Disease*, editorial, *J. Am. Med. Assoc.*, 79 (Dec. 23, 1922), 2165.

a good example of a disease caused by deficient diets. Pellagra-preventive diets include fresh milk, green vegetables, and adequate protein. It is now well established that diets which are deficient in vitamins not only cause the "deficiency diseases" but so reduce the vitality and resistance that an individual is rendered more susceptible to the "communicable diseases." When the vitality is lowered by diets which are deficient in accessory substances, the body is unable to resist the inroads of pathogenic bacteria.

Relation of malnutrition to disease prevalence should not be thought of only with respect to vitamins. Other dietetic factors are also important because they contribute to good health. Addition of milk to the diet has been observed to increase resistance of mice to products of bacteria. This has not been considered to be due to vitamins.

Starvation has a definite role in determining disease incidence. Animals on starvation diets have shown decreased resistance to infection, and observations during famines confirm it.

In sharp contrast to what has been just mentioned, a deficiency of certain vitamins in the diet increases the normal resistance of mice to inoculation of certain viruses. This has been discussed as malnutrition immunity. Adequate explanations have not been developed to explain the apparent paradox of malnutrition immunity to virus diseases and hypersusceptibility to bacterial infections. This is a subject which will probably be studied more in the near future.

Avitaminosis. Lack of the necessary so-called accessory substances, vitamins, in the diet has also been shown to be a predisposing factor in disease and illness. In general, it may be stated that vitamin-deficient diets so reduce the vitality of an individual that he may be more susceptible to the attacks of bacteria. A worker, using rats, pigeons, rabbits, and bacteria causing disease in these animals, was able to observe more consistently lowered resistance among the animals on a deficient diet than among the controls on a normal diet. Six rats suffering from lack of vitamin A and six normal control rats were injected intraperitoneally with *Bacillus anthracis*. All of the test rats died, whereas the control animals lived. Cramer and his colleagues confirmed these observations. They noticed marked decrease in blood platelets among rats fed on vitamin-A-

deficient diets. They believed that resistance to infection was related in some manner to platelet content of blood. Although one may not wish to accept all of the statements in publications on this subject, sufficient evidence exists for one to consider avitaminosis as an important predisposing factor in infection. An investigation has suggested a close relationship between production of rickets and susceptibility to tuberculosis. The white rat is very susceptible to rickets and quite resistant to tuberculosis. Consequently, Grant fed young rats on rations adequate with the exception of calcium and the antirachitic factor. Rickets appeared more readily in cloudy weather than in bright weather. Such animals injected with *Mycobacterium tuberculosis* were easily infected. These experiments seemed to have been sufficiently controlled and indicate that an apparently simple dietary deficiency may lower the resistance to infections. Rickets is a common disease, and such experiments give it added significance.

EXTERNAL DEFENSES

Nature has given man certain external defenses which are quite important in preventing infections.

The Skin. The skin may be considered an impassable barrier to infecting organisms which may lodge on it. As long as the skin is not broken these organisms cannot enter. It is not difficult to isolate from the surface of the body streptococci which are pathogenic when introduced into the blood. In the mouth are frequently found such pathogenic bacteria as Meningococci and Pneumococci. These bacteria are unable to produce infections until they can enter the body.

In addition to its role as a mechanical barrier against pathogenic bacteria, the skin also exerts a definitely destructive action on bacteria which lodge on it. Various investigators have reported that the skin is quite germicidal to "transient" species which reach it but not quite so for the normal "residents." It has also been observed that the germicidal action of clean skin is much superior to that of dirty skin.

Furunculoses (Boils, Pimples, Carbuncles, etc.). These are common infections of the skin quite often looked on as minor matters; they may possess serious consequences. Many theories have been proposed to show origin of boils. One held even today by some is that boils are due to poisons in the blood. The boil

was looked on as an attempt on nature's part to get rid of this poison. In order to assist nature, a poultice was applied which, it was said, would draw out the poison. Such a practice often resulted in the appearance of several other boils about the original one. This was desired and caused no worry. It was said that the poultice was drawing out more poison and that consequently more boils were necessary. At the same time that such a treatment was applied, the patient was given medicine to "purify" the blood.

A sounder more rational explanation now explains boils. Today they are recognized as an infection. Pathogenic bacteria lodge on the skin and, if an abrasion is made, penetrate to establish a focus which we know as a boil. Such information indicates that better methods for treating boils should be used than the older methods just described. If boils are due to infections, great care should be used to prevent bacteria from the first boil infecting adjacent portions of the skin to cause more foci of infection. Poultices are not conducive to this end since they cause the matter extruded from a boil to be spread about adjacent portions of the skin. Boils should be opened by a physician, and a safe disinfectant should be applied about the boil to destroy bacteria. The appearance of boils one after another, or the spreading of one boil over a restricted area, indicates the lack of adequate disinfection.

External Defenses of the Alimentary Tract. The alimentary tract has secretions which may exert detrimental action on some pathogenic microorganisms. The *saliva* has been studied in this respect, and, although one investigator could observe a decrease in the number of cells exposed to its action, the saliva cannot be looked on as a potent factor in disease prevention.

The *gastric juice* in the stomach has received more study. Some writers state that gastric juice is very germicidal. Others very wisely make more cautious statements. Some of the early work on this subject was carried out by Spallanzani, who secured gastric juice by swallowing small sponges with strings attached. After the sponges had been in the stomach long enough to have absorbed gastric juice, they were drawn out, and the juice was expressed. When this gastric juice was rubbed over meat, the meat did not undergo rapid putrefaction. Many years later in investigations of the etiology of cholera, Pettenkofer and

Emmerich drank some water to which living cholera microorganisms had been added. One added sodium bicarbonate, which neutralized the gastric juice, allowing the cholera organisms to pass through the stomach unharmed. A severe case of cholera resulted.

Although some observations indicate that the gastric juice is germicidal, others seem to refute it. The etiologic agents of several common diseases are known to be ingested at times in food and drink; since they produce diseases which are in the intestines, it is obvious that they have survived action of gastric juice. They may escape the action of the gastric juice by passing through the stomach imbedded in food particles or in water which not only dilutes the gastric juice but also passes through the stomach quickly.

The *bile* is germicidal for some bacteria. This is borne out in reports of many investigators who have studied selective action of bile on bacteria. It has been known for some time that immediately below the point where the bile is poured into the intestines a pure culture of *Escherichia coli* exists. This would indicate that bile had an antagonistic action on other bacteria but either no inhibitory action or an accelerating effect on *Escherichia coli*.

CHARACTERISTICS OF INFECTING AGENT INVOLVED IN INFECTIONS

The course of infection depends on the characteristics of the parasite or infecting agent. The sum total of them give the bacterium its aggressive power to combat the host.

Virulence or Infectiosity. Just as with the factor of "resistance of the host," this is a difficult characteristic to measure. Virulence of a bacterium is measured by inoculating some susceptible animal or plant. The grade of virulence, then, is really subject to the grade of resistance which the experimental animal has. Like many other characteristics, virulence is not permanent but varies and, in reality, is a very unsatisfactory characteristic to measure. Many data show that microorganisms vary greatly in virulence. This characteristic is subject to many conditions under which the organism is cultured. It may be purposely reduced or raised by certain methods of culture. Cultures of some pathogenic bacteria become rapidly devitalized by con-

tinued propagation in the laboratory. Such an organism is *Bacillus anthracis*. Animal passage is often used for strengthening the activity of an organism. Variation in virulence has caused the introduction of polyvalent bacterins discussed later.

Number of Cells. This also is another factor on which it is difficult to secure specific experimental data. "How many cells are necessary to produce infection?" Unfortunately, this cannot be easily answered. Here again, resistance of the host has to be considered. It is quite conceivable that for one host one cell might cause disease; for another 100 cells might not. Probably every individual is able to tolerate a certain number of cells of average virulence; a heavy inoculation or massive dose would, however, cause disease despite resistance or immunity, even though it be raised by inoculation procedures. Thus, to a certain extent, disease depends on the same factors as poisoning.

Avenue of Infection. Much depends on this factor. Some microorganisms are significant only when introduced by one avenue. Others cause severe results by one avenue but very light infections by others. This may be nicely demonstrated in the laboratory with *Staphylococcus aureus*. When a virulent strain is injected into the blood stream of a rabbit, a fatal septicemia issues; however, a subcutaneous injection usually causes only a local infection which suppurates and finally heals. Another illustration is tetanus. Probably the spores of *Clostridium tetani* are frequently eaten; they cause no harm in the intestinal tract, but, when they enter the blood stream, a terrible toxemia results.

The Alimentary Tract. Many materials taken into the alimentary tract are not sterile. When such foods and drinks contain harmful bacteria, and when these are able to pass through the stomach, disease may result. That the alimentary tract is an important avenue of infection is indicated by the prevalence of intestinal infections.

The Lungs. Infected dust particles may produce infections in the lungs. The best-known lung infections are pneumonia and tuberculosis. Nature has provided agents in the respiratory tract to help protect the lungs from infection, but these at times may be inadequate.

The Skin. The skin is an impassable covering when it has no abrasions through which bacteria may enter underlying tissue or

the blood stream. These abrasions do not have to be large; even the smallest may allow the entrance of bacteria causing serious infections. These organisms may also reach the hair follicles and establish a focus of infection.

The mucous membranes which line the urinary, alimentary, and respiratory tracts are also said to possess germicidal properties which prevent infection. If such a property exists, it may be due either to a germicidal action of the mucus or to a mechanical wearing away of this membrane. However, there are many observations which suggest that the protective action of the mucosa may be overemphasized. Certain bacteria must be able to penetrate it and cause disease. Gonorrhoea probably results from the penetration of the mucosa by the Gonococcus. There are numerous reports in medical literature indicating that the virus of smallpox may also penetrate the mucosa. Individuals have been accidentally vaccinated in the eyes, nostrils, and so on.

REFERENCES

- BOYD, MARK F., *Boyd's Preventive Medicine*, 7th Edition, International Health Division, Rockefeller Center, New York, 1945.
- ROSENAU, M. J., *Preventive Medicine and Hygiene*, D. Appleton-Century, New York, 1935.

CHAPTER 28

MODES OF BACTERIAL ACTION

Pure and Single Infections. Single infections are caused by one species of microorganism or of parasite. Such infections are often local in character. Infection of the urinary tract by *Escherichia coli* is usually a pure infection. Other infections that are pure infections are cerebrospinal meningitis, anthrax, and furunculosis (boils). Typhoid fever may be a pure or single infection.

Mixed Infections. A mixed infection is one in which two or more species of parasites are concerned. Such infections are much more common on the exposed surfaces of the body where various organisms may enter. Much confusion has occurred in the study of some diseases by the investigators reporting one of the contaminating microorganisms to be the etiologic agent. Many infections which are pure single infections in some stages are mixed infections in other stages. Very often entrance of a pathogenic microorganism may stimulate transformation of bacteria normally present into parasites; this complicates the situation as far as treatment is concerned.

Much evidence shows that one organism not necessarily very pathogenic may pave the way for a second one. Large typhoid fever epidemics are often preceded by many diarrheal cases. Kendall has stated that mild catarrhal inflammations often precede epidemics of cerebrospinal meningitis. It is also known that outbreaks of diarrhea frequently precede typhoid epidemics. Kendall divided bacteria which incite human infections into two groups, sporadic infectants or "opportunists" and those which cause disease progressive from man to man. The former, the opportunists, live normally on mucous membranes, in channels or cavities opening freely to the surface of the body, for they may be regarded as surface growers. They are unable to penetrate to underlying tissue and have to wait for injury. Then they may cause severe infections but not ordinarily epidemics.

The second group, few in number, includes those bacteria decidedly inimical to man. They are tissue growers and are typical pathogenic forms. Unlike the "opportunists," they do not have to wait for injury but are aggressive enough in themselves to gain entrance.

MODES OF BACTERIAL ACTION

One often hears the question, "How do bacteria cause disease?" A general answer cannot be given. It depends on the organism, the avenue of entrance, the experimental animal or patient, and other factors.

Muir and Ritchie in their "Manual of Bacteriology" have answered the question by stating that there are two main factors involved: (a) Multiplication of living organisms after they have entered the body, and (b) production by them of poisons which may act on tissue. The former phenomenon has been given some consideration in another place, and the latter, involved in intoxication, is discussed below.

Incubation Period. The term incubation comes from the Latin verb "incubare" which means "to hatch out." Its use in bacteriology and medicine to indicate that period between infection and appearance of symptoms is of very early origin. The "incubation period" then is the time between entrance of the parasite, whatever it may be, and development of clinical manifestation. In some diseases such as diphtheria and scarlet fever in which the symptoms are due to intoxication, the incubation period is occupied with elaboration of sufficient toxin to produce symptoms. In other diseases, it may be occupied with development of sufficient numbers of cells. Precise statements about length of incubation periods in various diseases may not be made, but general statements are made.

BACTERIAL TOXINS

Toxins are poisons formed by living cells. They are not limited to bacterial cells, for production of poisonous substances is a widespread characteristic among many forms of life. The student will find it profitable to review the subject of enzymes since much of the information on enzymes may be applied to toxins.

Not much is known about the purpose of toxin in the life of the organism which forms it. Different explanations may be offered. Toxins may be products of excretion which happen to be poisonous to other forms. They may be formed by the cell as protective agents, or they may be the result of the action of the microorganism on the medium.

Toxin Formation by Other Species. Several different species of animals and plants form toxins, poisonous substances. The bites of spiders have been said to cause serious illness. *Lathrodectes mactans* has been called the most poisonous species in the United States. Certain jellyfishes are venomous. A coelenterate known as "Portuguese man-o-war" (*Physalia*) causes pronounced symptoms of illness following the sting. Snakes are, perhaps, the best-known animals that produce poisons, although much of our knowledge about them does not rest on sound observations. Rattlesnakes are poisonous American species. Vipers are also known to be poisonous. Snake venoms are not unlike bacterial toxins. They stimulate production of antitoxins when injected into an animal, and antitoxins (antitoxic sera) may be used for treatment of other cases of snake bite.

Considerable similarity exists among poisons or toxins produced by different forms of life such as bee venom, serpent venom, and bacterial toxins. Results of investigations at the University of Berlin show that bee venom, crotalin (rattlesnake poison), and cobra venom are all protein substances.

Plants also form poisons. The poisonous constituent of toadstools has been studied by Ford who reported some properties like those of bacterial toxins. The castor bean has been shown to contain a virulent poison, ricin.

Kinds of Toxins. When enzymes were discussed, it was convenient to separate them into two groups, depending on whether they acted inside or outside the cell. The same separation may be made for the toxins, giving a group known as *extracellular* (*exotoxins*) or *soluble toxins*, and another group known as *intracellular* or *insoluble toxins* (*endotoxins*). This distinction is very useful because it helps us understand the relation of different bacteria to disease, differences between the methods of active and passive immunity, and so on.

Extracellular or exotoxins are those which diffuse through the cell walls and appear in the medium. They are, then, somewhat

more comparable to snake venoms than the intracellular or endotoxins. Once these exotoxins are excreted from the cell, they are free and have no more to do with it.

Bacteria-producing soluble toxins, or exotoxins, with the diseases produced are:

NAME OF ORGANISM	DISEASE PRODUCED
<i>Clostridium botulinum</i>	Botulism
<i>Clostridium tetani</i>	Tetanus (lockjaw)
<i>Corynebacterium diphtheriae</i>	Diphtheria
<i>Streptococcus scarlatinae</i>	Scarlet fever
<i>Clostridium welchii</i>	Gas gangrene

Existence of exotoxins may be easily demonstrated in the laboratory. If any of the bacteria just mentioned are grown in a suitable fluid medium, potent toxins are formed and appear in the medium apart from the cells which formed them. Toxin may be separated from bacterial cells by filtration through a sterile Berkefeld or other type of filter. Bacterial cells are retained on the filter but toxins pass through into the filtrate. Presence of toxin in the filtrate may be proved by injection into susceptible animals.

Intracellular or endotoxins are bound in some way to the cell. They are not excreted through the cell wall. Consequently, to secure such toxins the cells must be ground and the suspension filtered through a sterile porous filter. The toxin appears in the filtrate in which there should be no living cells.

Bacteria-forming insoluble toxins or endotoxins, with the diseases produced are as follows:

NAME OF ORGANISM	DISEASE PRODUCED
<i>Eberthella typhosa</i>	Typhoid fever
<i>Salmonella paratyphi</i>	Paratyphoid fever
<i>Vibrio comma</i>	Cholera
<i>Pasteurella pestis</i>	Plague
<i>Shigella dysenteriae</i>	Dysentery (bacillary)

Characteristics of Toxins and Toxin Reactions. Characteristics of toxins are not unlike those of enzymes. They may be divided into two groups as are enzymes.

1. *Toxins are formed by living cells.* Toxins have never been synthesized by biochemists. They are made only by living cells. Could their chemical constitution be determined, it might be

possible to understand better those agents used for treating intoxications, *antitoxins*.

2. *Toxins and toxin reactions are specific.* Each toxin has special affinity for certain body parts. Specificity is, perhaps, their best-known characteristic and is especially apparent in their reactions with antitoxins. There is special affinity between diphtheria toxin and diphtheria antitoxin. Antitoxin neutralizes or inactivates toxin. However, diphtheria antitoxin has no affinity for tetanus toxin. This specificity is useful in the treatment of disease and also in the identification of unknown bacteria which are toxin formers. Toxin formed in syphilis shows its effect in two ways. It may attack the different conducting portions of the spinal cord to produce locomotor ataxia, or it may attack certain portions of the brain to cause paralysis and insanity. The toxin formed by *Clostridium tetani* shows special attraction for certain neurones.

3. *Toxins are active in minute quantities.* This characteristic is exceptionally interesting. Before one can secure information on this question, it is necessary to control as many variable factors as possible. This is often difficult to do. However, enough data are available to indicate that toxins are active in very very small amounts. The data are also greatly influenced by the method of administration of toxin as well as the size of the animal. The two toxins which have received most study in this respect are those of *Clostridium tetani* and *Clostridium botulinum*. Van Ermengem, who isolated the latter of these organisms, calculated, on the basis of the dose fatal for a rabbit, that $\frac{1}{30}$ milligram of dried toxin would be fatal to a 70-kilogram man, if injected subcutaneously. Brieger and Cohn estimated that if 0.000 000 05 gram of their strongest tetanus toxin was fatal to a mouse weighing 15 grams, the fatal dose for a 70-kilogram man would be 0.000 23 gram, or about one fourth of a milligram.¹ Bengtson, working with the toxin of *Clostridium botulinum*, stated that the strongest toxin which was produced was for the type-B strain, the fatal dose of which for a 250-gram guinea pig was 0.000 000 03 gram. On this basis, she computed the fatal dose for a 70-kilogram man to be 0.000 008 4 gram. As she pointed out, the toxin of *Clostridium botulinum* seems to be more poisonous than the toxin of *Clostridium tetani*.

¹ Quoted from Bengtson.

4. *Toxin reactions are reversible.* When toxin unites with antitoxin, a compound is formed which, stable under ordinary circumstances, is capable of breaking up under certain other conditions.

5. *Toxins stimulate formation of antitoxins.* This characteristic will receive extended discussion later on. It is a very important characteristic. The fact that each toxin is able to stimulate formation of specific antitoxin is used as the basis for certain practices in therapeutics.

6. *Toxins possess certain properties of living cells.* Like enzymes, toxins have some properties of living cells. Toxins are thermolabile—destroyed by high temperatures.

7. *In developing their effects, a period of incubation is required.* A certain period of time seems to be required before the cells in the body of the host are sufficiently poisoned to show symptoms of illness. This depends largely on the strength or potency of the toxins, as well as on the amount which the person receives.

8. *Toxin reactions in the host usually set up characteristic symptoms.* Fever is one of the most common; there are many of these, such as general malaise and wasting away.

Constituents of Toxins. The term toxin is a general one which includes all of the untoward properties of toxic filtrates. As information has increased, this agent has been divided into several parts. For instance, Ehrlich announced two constituents in toxin formed by *Clostridium tetani*. One he called *tetanospasmin*—the portion which acted on the nerves yielding the symptoms for which tetanus is known; the other *tetanolysin*, which destroyed the red blood corpuscles. *Tetanospasmin* was easily destroyed by heat; *tetanolysin* was more resistant. Not all bacterial toxins have been broken up into such constituents. The existence of these constituents in toxin might, at least, explain some of the variations in symptoms.

Absence of information about the structure of toxins has caused bacteriologists to resort to graphic methods of depicting their active components. Ehrlich, trained in organic chemistry, suggested the illustration in Fig. 125. He depicted the toxin molecule as a body with two functioning parts, a *haptophore* group and a *toxophore* group. The *haptophore* group served to bind or anchor the toxin molecule to a body cell, after which the

toxophore portion functioned to poison the cell. This illustration has done much toward making the understanding of the action of toxins intelligible. For instance, it is known that some toxin preparations lose their ability to poison cells but still retain their ability to unite with or bind antitoxin. This means that the toxin molecule has been altered in such a manner as to destroy its toxophore group, whereas the haptophore group has remained intact. Such a toxin molecule, the toxophore group of which has been destroyed, is known as *toxoid*. Ehrlich's theories are not accepted by all bacteriologists. These controversies need not worry the student who is starting the study of bacteriology.



FIG. 125. Showing a Toxin Molecule According to the Conceptions of Ehrlich.

BACTERIAL HEMOLYSINS

These are agents which destroy red blood cells and are probably to be distinguished from hemolysins which result from immune reactions in animal bodies resulting from injection of red corpuscles of another species of animal. The former are *bacterial hemolysins* while the latter are *immune hemolysins*. Bacterial hemolysins are formed by bacteria, while immune hemolysins are formed by the infected animal, or host, as a defense mechanism.

Since bacterial hemolysins are formed by bacteria, they usually are named from them, as *staphylolysin*, *streptolysin*, or the general name *bacteriolysin* is used.

Bacterial hemolysins are both filterable and thermolabile (destroyed by heat). Either they are not specific for particular red blood cells, or more than one is formed, because hemolysins of some bacteria will destroy red blood cells from two animals whereas those of another will destroy them from only one animal. They are probably protein in nature because they are antigenic.

Blood agar plates are used to show bacterial hemolysins by bacteria. Two types of hemolysins are shown, α -hemolysis and β -hemolysis.

- α -hemolysis—Characterized by a greenish colored zone about the growth; a few discolored corpuscles are present (*Streptococcus viridans* and pneumococci).
- β -hemolysis—Characterized by a colorless zone about the colony. Corpuscles are not present in clear zone (Hemolytic streptococci and staphylococci).

BACTERIAL LEUCOCIDINS

These are substances which destroy white blood cells. They are produced by pneumococci, staphylococci, and streptococci. They are concerned with virulence and invasive power of bacteria by, perhaps, destroying the white blood cells which are concerned in immunity. They are closely related to hemolysins and, in general, possess the same characteristics.

Toxins versus Ptomaines. Toxins and ptomaines are often confused in students' minds. If we admit for the moment that ptomaines are poisonous, they may be distinguished from bacterial toxins in several ways. Ptomaines are cleavage products of the materials on which the bacterium grows. Bacterial toxins, on the other hand, are produced probably by internal processes of the bacterial cells. Bacterial toxins are heat-labile whereas the ptomaines probably are not. Ptomaines have played quite a role as an explanation of food poisoning. It is quite generally agreed among students of the question that better explanations should be sought. Within the past few years "heat-stable gastrointestinal irritants" have been found in the growth products of several bacteria. These may cause symptoms of illness which have been attributed to ptomaines.

REFERENCES

- ROSENAU, M. J., Preventive Medicine and Hygiene, D. Appleton-Century, New York, 1935.
- TOPLEY, W. W. C., and G. S. WILSON, The Principles of Bacteriology and Immunity, William Wood & Co., Baltimore, 1936.
- ZINSSER, H., and S. BAYNE-JONES, A Textbook of Microorganisms, D. Appleton-Century, New York, 1939.

CHAPTER 29

PROTECTIVE SUBSTANCES—IMMUNE BODIES, ANTIBODIES

As information accumulated in medical science, it was observed that a person acquired ability to resist disease by having it or receiving preventive inoculation. These observations required explanation, and several theories were advanced. Some of them are of historical interest only; they were accepted for a time but were discarded when better explanations were available or when they were inadequate to explain new facts. In many cases these old explanations were reasonable and fitted well into the structure of knowledge of the time. They are mentioned here in order to acquaint the student with their general features and not because they explain immunity in accordance with modern knowledge.

Exhaustion Theory. According to this explanation of immunity, which seems to have been suggested by Pasteur, some essential substance was necessary for the growth of pathogenic bacteria in the human body. This substance was believed to be present only in certain amounts and not to be regenerated anew. When it was *exhausted*, the etiologic agent causing the infection was unable to grow. Consequently reinfection could not occur.

Noxious Retention Theory. This was, to a certain extent, just the opposite of the exhaustion theory. Instead of some necessary substance being used up, the etiologic agent excreted a substance which accumulated in the subject of infection. This substance was believed to be a noxious excretory product which was inimical to the organism causing the infection. Finally the concentration of this substance became so great that recovery resulted, to be followed by immunity.

Metchnikoff's Theory of Immunity (Phagocytosis). This theory is founded on the activity of the white corpuscles in the blood and is called cellular immunity. In grammar-school physiology one is told that the white corpuscles, or leucocytes, are the policemen or scavengers of the blood stream. They stand ready

to give battle to invading forces which would cause disease. The white corpuscles which act in this manner are called phagocytes and the phenomenon phagocytosis. The phagocytes ingest the invading bacteria and digest them. Metchnikoff found it difficult to fit some new discoveries into this theory; this kept him busy making new explanations and seeking new data.

Ehrlich's Theory. This theory enjoyed rather wide popularity for some time, for it explained in a reasonable manner some of the observations which had been made in immunology. According to Ehrlich, cells consist of two parts, a nucleus on which depends the nature and property of the cell, and a large number of side chains, or *receptors*, by means of which the cell joins chemically with substances reaching it through the circulation, foods, and so on. In infections and intoxications, toxic substances are distributed throughout the blood and are taken up by the receptors for which they have suitable side chains. Certain poisons attack only certain cells, and some are toxic for but one species of animal. Ehrlich's theory provided, in this way, for specific action of poisons. It was especially useful in explaining how antitoxins acted. These, according to Ehrlich, were free receptors which had been formed in such abundance that they broke from the cell and floated free in the blood stream. This occurred in the blood stream of the horse in response to repeated injections of antigen (diphtheria toxin in this case).

Bordet's Theory. This theory avoids difficulties in the theories proposed by others but introduces new ones. Bordet resorted to colloidal chemistry and adsorption to explain neutralization of toxin by antitoxin. According to Bordet this was an adsorption phenomenon between colloids of opposite electric charges. The combination of toxin with antitoxin was said to be similar to that of starch and iodine. When there is an abundant amount of iodine, the starch becomes deep blue, but, with lesser amounts, lighter blue shades are secured, depending on the amount of iodine absorbed. Bordet believed that the toxin molecule was affected in the same manner. In presence of large amounts of antitoxin, the toxin molecule would adsorb sufficient antitoxin to destroy its toxic properties. In presence of smaller amounts of antitoxin, the toxin molecules would only be weakened. Feeble toxic properties of such mixtures would be due to weakened toxin molecules and not to a few unharmed molecules which adsorbed no antitoxin.

Vaughan's Theory. This explanation of immunity has not received the study and advertising that previous theories enjoyed. Understanding of Vaughan's theory presupposes an understanding of his conception of the structure of the protein molecule. Vaughan explained immunity to disease on the basis of the presence of certain enzymes which are formed in body cells. The immunity which results from an attack of disease was explained on the basis of the presence of an enzyme which was formed during the infection and which remained in the patient's body. Immunity (acquired) resulted from the destruction of the infecting agent by the enzyme when it tried to cause subsequent infections. Natural immunity could not be explained in this manner. Vaughan stated that the parasite in this case could not grow in the body tissues. In reality Vaughan's explanation is not very different from some of the others; it is just as reasonable.

Tissue or Local Immunity. Defense mechanisms involved in immunity, are generally considered to protect the entire body. Recent work has yielded information to suggest a local or tissue immunity. This type of immunity is restricted to one area of the body and even to one particular type of tissue. Such local immunity may exist even though there is no general immunity, although it may be increased to some extent. Local or tissue immunity cannot be considered to play any material role in general immunity. It is probably nonspecific, for different agents have been shown to produce it.

It is obvious that immunity cannot be explained by one theory, but that all theories may be partially correct. It is definitely known, for instance, that the cellular theory of Metchnikoff is founded on activity of white blood corpuscles in ingesting invading microorganisms by a process known as *phagocytosis*. This process can be quite easily demonstrated under the microscope. On the other hand, another group of immunologists, while admitting the role which phagocytes play, explain immunity on the existence in the body fluids of specific immune bodies. This is a modern conception of the humoral theory. Plenty of evidence exists to support both of these explanations. Thus it is not a question of accepting one theory but of correlating the good from all of them.

Antigens and Antibodies. These are two convenient terms used by bacteriologists; they are collective terms and permit a

great saving of time. An antigen is a substance which, when introduced into an animal, causes the formation of *immune bodies* or *antibodies*. An *antibody* or *immune body* is an agent formed in the blood of an animal which has received an antigen. The antigen may be either animal or vegetable products, toxin, bacteria, enzymes, and the like. When it was found that certain agents could function as antigens, or were antigenic, attempts were made to learn what components of these agents possessed the antigenic properties. Many of them have been chemically identified, but this subject need not be developed in a book like the present one. Those antigens which have been studied have been found to be protein in nature. Heating does not materially affect the antigenic property, but hydrolysis does. To secure formation of antibodies, the antigen must be injected into a susceptible animal. The antigen functions as a foreign agent which the animal tries to defeat by formation of antibodies. The latter are, therefore, spoken of as immune bodies.

Injection of blood serum from a rabbit into a rabbit will not produce immune bodies because the serum is not foreign. However, injection of blood serum from a cow into a rabbit results in formation of immune bodies.

The following are some of the more common antibody reactions:

ANTIBODIES OR IMMUNE BODIES	ANTIGEN	
1. Antitoxins	+ toxin	= inactivation of toxin
2. Agglutinins	+ bacterial cells	= agglutination (clumping)
3. Precipitins	+ proteins	= precipitation
4. Opsonins	+ bacterial cells	= opsonized bacterial cells
5. Lysins		
Bacteriolysins	+ bacterial cells	= lysis
Cytolysins	+ cells	= cytolysis
Hemolysins	+ red blood corpuscles	= hemolysis (laking)

One of the most important characteristics of both antigens and antibodies is their specificity. Antigens are specific because each antigen is capable of stimulating the formation of an antibody which is reactive with itself and no other antigen. This makes them useful for treating disease. Diphtheria antitoxin, for instance, is useful only for the destruction of diphtheria toxin. It has no effect on tetanus toxin or other toxins.

Although the foregoing statements are essentially correct, bacteriologists have found that closely related bacteria may be

agglutinated if the antiserum is not sufficiently diluted. This gives what are called "*group reactions*." These have been observed especially in the typhoid-colon group in which are several species of bacteria with many characteristics in common. When typhoid antiserum is undiluted, it will agglutinate other members of the group such as *Salmonella paratyphi* and *Salmonella schottmülleri*. Dilution of the antiserum prevents agglutination of these bacteria.

Much confusion exists among terms for agents used in preventive inoculation. A *serum* is material prepared from the blood of some animal. When it contains antibodies, or immune bodies, it is spoken of as an *antiserum* or *immune serum*. When no immune bodies are present, it is called *normal serum*. Two types of antisera are known, *antitoxic sera* and *antibacterial sera*, depending on the antigen which was used for preparing them. For the production of antitoxic sera, toxins are used as the antigens. If tetanus toxin is used, the serum is spoken of as antitetanic serum; another such antitoxic serum is antidiphtheritic serum. With some bacteria, as has been shown, we are unable to prepare the toxin free from the bacterial cells. To prepare an antibacterial serum, the cells themselves have to be used as antigens. These are the antibacterial sera such as antigenococcic serum, anti-streptococci serum and antimeningitic serum. Other terms often confused with those just discussed are vaccine and bacterin. They are discussed later in this chapter. The student should think his way through these definitions, for they can be understood only in this manner.

ANTITOXINS (ANTITOXIC SERA)

Antitoxins are immune bodies which neutralize or counteract the action of toxins. Consequently, they may be used for prevention and cure of diseases caused by toxins which are excreted from the cells. This is not a new idea. Antidotes are always given to counteract poisons. When a person suffers from arsenical poisoning, he is given an antidote; when he suffers from diphtheria, he is also given an antidote. In the latter case, however, an antitoxin or antitoxic serum is resorted to, for chemical compounds as antidotes in bacterial poisoning are unknown. Antitoxins may be used prophylactically or therapeutically. When used in the former manner they are employed to prevent

possible toxemia; in the latter manner, they are employed as curative agents after the poisoning has started.

The nature of the toxin-antitoxin reaction is probably not known. Several suggested explanations have been made. An early one claimed that it was an acid-base reaction. A later one suggested that it was not entirely a chemical reaction but partially an adsorption phenomenon.

Preparation of Antitoxic Sera. Such agents for preventive inoculation must be made in the blood stream of some animal. As has been discussed in an early chapter in this book, Emil von Behring had much to do with the discovery of antitoxins, antidotes for bacterial poisonings. Preparation of antitoxins (antitoxic sera) will be outlined and discussed.

Production of Toxin. In order to cause the body of some animal, such as the horse, to form protective substances (immune bodies, or antibodies) against diphtheria toxin, an antigen, diphtheria toxin, must be used. This toxin is made by growing diphtheria bacilli in a veal-broth medium in which the cells find proper food substances. During growth, they pour out of their cells a potent exotoxin which accumulates in the medium about the cells. During incubation the bacteria grow as a thin pellicle on the surface of the medium. As time continues, the pellicle thickens, and part of it may fall to the bottom of the culture flask. At the end of the incubation period, usually about a week, the medium is sterilized by treatment with an antiseptic and by being passed through a sterile porous filter, such as has been described in an earlier chapter. This yields a filtrate containing the toxin from which the cells have been removed. Manufacturers give much attention to the strains of microorganisms used for this purpose. They are kept active by frequent animal passage and regular subculture. Then, only those cultures are used which can produce a large amount of antitoxin in the body of a horse. In America a strain of *Corynebacterium diphtheriae*, known as Parks' Number 8, is used because it forms an especially active poison or toxin.

Animal Used. For quite obvious reasons the horse is used for antibody formation. The chicken and goat are also useful. It would take about as much time to immunize a chicken or goat as a horse. From the horse a much larger yield of serum is secured. The animals to be used in antitoxin work are carefully selected

and kept under observations for a few months to insure their freedom from disease. After the horse is shown by qualified veterinarians to be free from disease, it enters the antitoxin laboratory where it is given the immunizing treatment against the toxin of the organism causing the disease for which the antitoxic serum is being prepared.

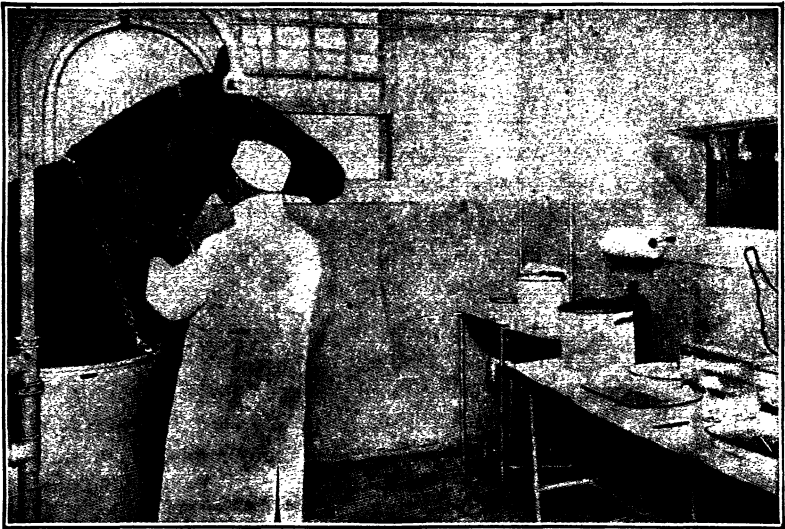

FIG. 126. Injecting Serum Horses. (Courtesy Parke, Davis & Co.)

The injection of horses producing certain types of serum, such as those for meningitis and pneumonia, is made directly into the jugular vein, as shown in this picture. Horses producing antitoxin (diphtheria and tetanus), on the other hand, are injected subcutaneously in the neck or shoulder. In either case immunization is carried out with repeated administrations of increasing amounts of the antigenic material.

Immunizing the Horse. After the strength of toxin has been determined as previously mentioned, it is given to the horse in slowly increasing amounts. It is necessary to start with small doses since a poison is being introduced which, if injected at first in large doses, would cause the death of the horse. The injections are made under the skin to secure slower absorption. The first dose, which may be about 0.5 milliliter, causes a rise in temperature and other symptoms of illness such as a rough coat. Another dose, larger than the first, is given in 24 hours. This process is repeated until the animal can tolerate enormous doses. Toward the end of the immunization period the horses may

receive doses of toxin as large as 1000 milliliters. During these injections, nature is striving to counteract this poison by the formation of an antidote, called an *antitoxin*. One paper reported that the maximum dose of toxin injected into a horse during the immunization process was sufficient to kill 500,000 guinea pigs weighing 250 grams each. Also, if antitoxin formation has gone on successfully, 1 milliliter of the horse's blood serum will neutralize toxin sufficient to kill 50,000 guinea pigs weighing 250 grams each.

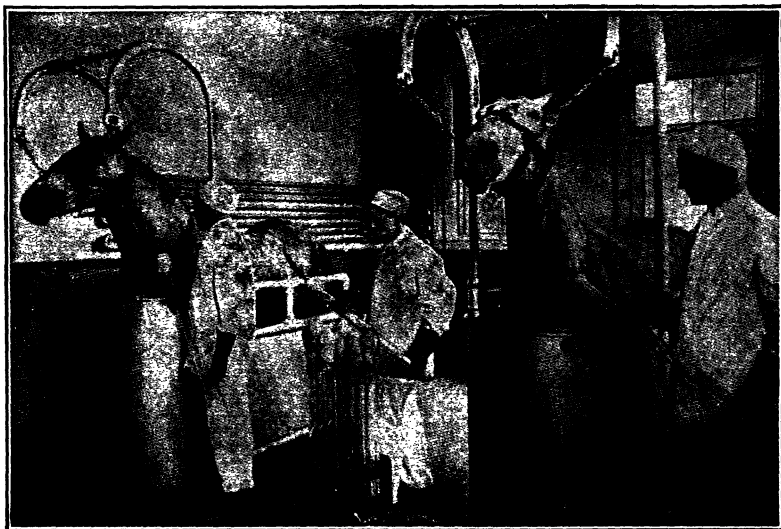

FIG. 127. Bleeding Antitoxin Horses. (Courtesy Parke, Davis & Co.)

A canula introduced into the external jugular vein is attached to a rubber tube which in turn is connected with a glass tube entering the collecting receptacle. All procedures in the operating room are carried out with the same rigid regard for asepsis that would characterize surgical technique in a well-conducted hospital.

Collecting the Blood. After the horses have reached a condition where further injections of toxin are not accompanied by increase in antitoxic content of the blood, they are bled. The rooms in which this is done are usually apart from those in which the animals have been housed and have received the toxin injections. These rooms are substantially constructed with apparatus and appointments similar to those in an operating room in a hospital. They are kept thoroughly aseptic, and all instruments and similar apparatus are carefully sterilized. The horse is bled

by means of a sterile canula inserted into the jugular vein with a trocar. A gallon or more of the blood may be collected without injuring the animal. The blood is collected in sterile glass cylinders in which it is stored in refrigerators until it has clotted. The serum is then drawn off and treated with 0.4 per cent of tricresol. This was an antitoxin of commerce until Gibson and others devised methods of concentrating and purifying it. Some horses are such good antitoxin formers that they may be bled over a long period. Others seem to be unable to produce antitoxins.

Measuring Strength of Toxins and Antitoxins. The necessity of having antitoxin standardized to certain strengths is evident. Physicians must know how strong the product is, else there would be little certainty that enough had been given. For this purpose the United States Public Health Service supplies standard antitoxin with which the new antitoxin may be compared. The method of testing may be briefly described as follows: The materials required are:

1. Diphtheria toxin.
2. Standard antitoxin from United States Public Health Service.
3. The antitoxin to be standardized.

The toxin is first evaluated by means of standard antitoxin. These are combined in such proportions that when the mixture is injected into a 250-gram guinea pig there is enough free toxin to kill the pig in four days. The strength of the toxin does not vary but remains constant for a time. The same test is repeated except that the test antitoxin is substituted for the standard antitoxin. If the guinea pig used in this second test lives beyond four days, the antitoxin is of sufficient strength. It is interesting to note that the Government keeps standard antitoxin in Washington the same as the standard yard measure. Standard antitoxin is necessary in order that there be available a constant unit.

Purified Concentrated Antitoxins. Much study has been given the subject of separating the active constituents from the extraneous material in horse serum. It was believed that if the active constituents could be prepared there would then be no need of injecting into a patient's blood that portion which is inactive. By means of precipitation reactions such as those used by Gibson

and others, globulins, which carry the antitoxins, may be precipitated. In the Gibson process, antitoxic serum is treated with a saturated solution of ammonium sulfate which precipitates the globulins. The serum is discarded. The globulins after removal by filtration are redissolved in saturated sodium chloride. Acetic acid is then used for precipitating the pseudoglobulin; the euglobulin being valueless is discarded. The pseudoglobulin containing the antitoxic principles is collected and dialyzed in water to remove salts. A purified and concentrated antitoxin serum is thus obtained. This must be standardized and checked for purity. Preparation of this antitoxin has done much toward reducing the incidence of serum sickness.

Tests for Purity. After the potency tests are applied, those which will show whether the product is safe to use and free from objectionable bacteria are employed. Serum is injected into guinea pigs to ascertain whether foreign toxins may be present. Then tests are made for the presence of bacteria by inoculating some of the serum into suitable media. If results of these tests are satisfactory, the product is considered safe. Every attempt is made to insure a product free from danger. The success of these attempts is indicated by the few accidents which have occurred in recent years.

Physicians who use antitoxic sera must have assurance that they are safe and of proper strength; else they will use them with a false sense of security. If a physician were well trained in chemistry and bacteriology and had a laboratory and the time, he could examine these products himself. Obviously, the best method is for the physician to be able to use the products without testing them and yet feel certain that the health of his patients will be protected. In 1902, by act of Congress, the United States Public Health Service was empowered to establish a system of control for vaccines, antitoxins, and so on. In general, the procedure is to license certain manufacturers if they comply with requirements laid down by the law and if their products meet certain standards. These standards are very high, and the stamp of approval of the United States Public Health Service is often sought by many foreign manufacturers, even though they do not expect to compete with American manufacturers. At the close of 1942, 58 American manufacturers and 5 foreign establishments held American licenses to manufacture biological products.

The Federal Government is not engaged in manufacture, only control. Before a manufacturer is licensed by the Government, thorough inspection is made of the plant, personnel, and equipment; his products are also examined by the purchase of packages on the open market. In this manner the products are checked from two sides, and the public may use them with great safety.

Use of Antitoxins. The use of antitoxic sera may best be understood by appreciating the position of a physician called to

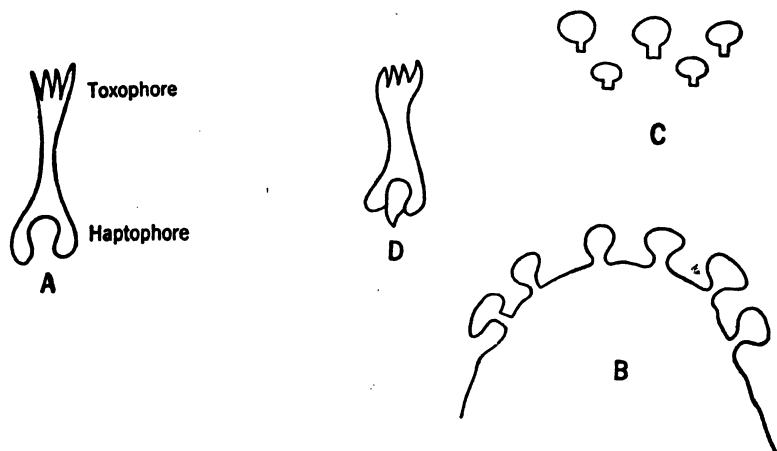

FIG. 128. A Schematic Depiction of How Antitoxins Function in Diseases like Diphtheria, Botulism, etc., according to Ehrlich's Theory.

A, A toxin molecule with a toxophore (poisoning) group and a haptophore (anchoring or binding) group. B, A body cell with a large number of receptors. These are eventually formed in such large numbers that they are thrown off the cell and appear as free receptors in the blood stream. These are antitoxins. C, Free receptors in the blood stream. D, Showing a toxin molecule the haptophore part of which has been filled with a free receptor. This prevents this toxin molecule from uniting with a body cell to poison it. These free receptors are antitoxins.

the bedside of a person ill with the symptoms of diphtheria. Somewhat uncertain about the symptoms or wishing to confirm his clinical diagnosis with laboratory results, he will send a swab from the throat of the patient to the laboratory. On this swab will be carried a specimen of the membrane, if one is present, or other material from the throat. In the throat of a child ill with diphtheria, bacteria, with broken-down tissue, etc., constitute a diphtheritic membrane. The bacteria in this membrane grow and produce a soluble (extracellular) toxin which reaches

the blood stream and is carried about the body. The body cells of the patient are poisoned, and he may die from this toxemia. As soon as toxin appears in the blood stream, the patient's body cells begin to make antitoxin. If they manufacture it rapidly enough to counteract the toxin as it is formed, the patient may get well. This is true only in a small percentage of cases. The physician, however, does not wait for this but decides to inject antitoxin which have been formed in the horse. These antibodies or antitoxin are then ready to neutralize the toxin as it reaches the blood stream from the organisms in the throat. Action of antitoxin may be explained by using Ehrlich's conception of their formation and action as shown in Fig. 128. His general theory is not accepted today, but this part might help the student to appreciate what is involved.

To be effective antitoxins should be injected as early in the disease as possible. Each delay of a day causes a higher mortality. Advanced cases demand high dosages and frequently, with due caution, intravenous injections. Public-health authorities state that there is no reason for a single death from diphtheria, if parents are familiar with the symptoms which appear and if antitoxin is administered promptly.

Allergic Reactions After Use of Sera. After receiving an injection of diphtheria antitoxin, certain individuals who are sensitive to horse serum may suffer from serum sickness. This is characterized by rashes, enlargement of lymph nodes, pyrexia, and the like. The attack is not necessarily serious but is annoying. In persons hypersensitive to the proteins in horse serum, the symptoms may be severe. This is a manifestation of anaphylaxis, other examples of which have been discussed elsewhere in this book. Less trouble results from use of purified concentrated antitoxic serum prepared today, because it has been freed from extraneous proteins and contains only those with which the antitoxins are combined. The foregoing statements indicate why physicians hesitate to give antitoxins unless it is absolutely necessary. Promiscuous administration of antitoxic sera would result in a number of sensitized individuals. Later it might be necessary to administer antitoxin, and they might suffer from serum sickness.

Size of Dose. Antitoxins are standardized in units. The size of the dose depends to a large extent on the symptoms of the

patient, the progress of the disease, and the results which follow the first injection. When little improvement is observed after the first one or two injections, the size of the dose may be increased. Larger doses are also given when the diagnosis is delayed.

Reasons for Failure of Antitoxins. Administration of antitoxins occasionally fails to bring about desired results. Different explanations may be offered. The antitoxic serum may have deteriorated because of age or improper storage conditions. Freezing may markedly reduce potency of antitoxic sera. These products must, therefore, be carefully stored. Antitoxic sera are dated to indicate the age after which they should not be used. Most often the reason for failure is too late administration. If a physician is called too late, after the patient is quite toxic, antitoxin may have no effect.

Duration of Effect of Antitoxin. How long do antitoxins remain in the blood after injection? Accurate data on which to base an answer possibly do not exist. About all that can be done is to quote conclusions of different investigators who have studied the problem. Undoubtedly, persistence will depend on size of the dose of antitoxin which is injected and specific characteristics of the person receiving the injection. It has, in general, been found that antitoxins which have been formed in the blood of the same species as that into which the antitoxin is to be injected persist for a longer time. It would not be feasible, however, to prepare antitoxic sera in human beings.

The Schick Test. This test, or reaction, is used to determine whether an individual is resistant or susceptible to diphtheria. It determines whether an individual possesses antitoxin immunity. The test is made by injecting a small amount of standardized diphtheria toxin *intracutaneously* on the flexor surface of the forearm. Observations are made on this area after 24, 48, 72, and 96 hours. Results are recorded as positive, negative, pseudo-positive or pseudonegative. A *positive* reaction is characterized by a red area about the site of inoculation in about 24 hours. The reaction increases up to the fourth day when it fades to be followed by brown pigmentation and peeling. Such a reaction indicates absence of antitoxic immunity in the individual tested. A *negative* reaction is indicated when no change occurs in the test area. Pseudoreactions are slight reactions due to causes

other than those involving toxin-antitoxins; they must be carefully interpreted by the physician.

The value of such a test rests on the fact that it can detect those who are susceptible to diphtheria in a group which has been exposed to the disease. Such individuals may then be given special immunization treatment.

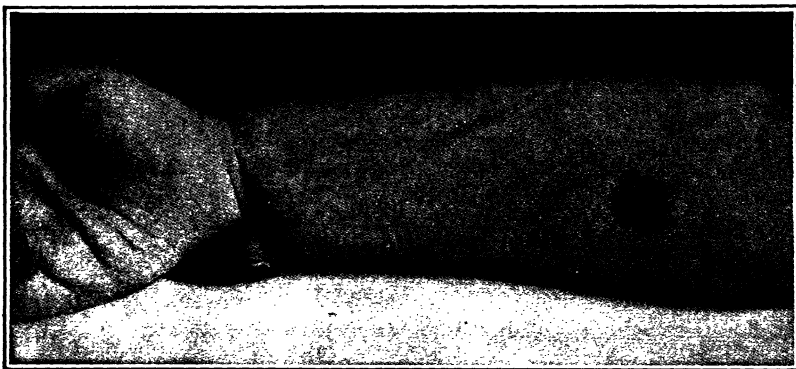

FIG. 129. Showing the "Reaction" in a Schick Test.

Toxin-Antitoxin Administration. After it is learned that a person is susceptible to diphtheria, the next problem is to confer on him sufficient immunity to protect from infection with an ordinary dose of bacteria. This may be done in different ways. It could, perhaps, be done by injecting dead bacteria (a bacterial vaccine) or a small amount of toxin formed by these bacteria. However, mixtures of toxin and antitoxin have been used for stimulating antibody formation. These mixtures are not equal mixtures in which there is just enough antitoxin to combine with the toxin; there is usually a very slight excess of toxin which stimulated body cells of the individual receiving the treatment to make antitoxins. The toxin-antitoxin mixture is not a permanent union but a reversible one which tends to break up, forming free antitoxin, and free toxin. Consequently, this free toxin liberated in this manner acts as an antigen to cause formation of more antitoxin by the body cells.

Immunization with toxin-antitoxin involves three injections of one milliliter each at weekly intervals. A person so treated is believed to be immune for years. This method cannot be used for prevention of diphtheria among those who have been exposed.

Several months are believed to be necessary for establishing a sufficient grade of immunity to protect.

The United States Public Health Service has discussed the use of toxin-antitoxin as follows:

1. *As a general prophylactic measure.* The most suitable age period for testing and immunizing is between 6 months and 2 years. At this time of life the percentage of positive Schick reactions is largest, and the susceptibility to diphtheria as well as the mortality from the disease is greatest. Children of this age period can be reached in the homes, in infant asylums, in the milk stations, and in day nurseries. The children of the next age period are included in the preschool groups. These children can be reached in the public schools, in orphan asylums, and in the various other institutions. Among adults, those who come in contact with diphtheria and are constantly exposed and in danger would also be tested and immunized with toxin-antitoxin if found to give a positive Schick reaction. Included in this group are especially physicians, nurses, and hospital attendants in contagious-disease hospitals.

2. *To control an outbreak of diphtheria.* As the immunity arising from an injection of toxin-antitoxin does not develop until the lapse of 2 to 12 weeks, active immunization cannot be utilized to protect persons from exposure within that period. In institutions, however, where small outbreaks of diphtheria have occurred, or where diphtheria is more or less constantly present and clinical cases and bacillus carriers steadily appear, use of antitoxin alone has often been insufficient to stamp out the disease, but the combined application of the Schick test and active immunization with toxin-antitoxin has given successful and encouraging results. Toxin-antitoxin immunization should not be used with antitoxin immunization in the same individual, as the surplus antitoxin tends to prevent the development of an active immunity.

✓ *Diphtheria Toxoid.* Toxoid has largely superseded toxin-antitoxin as an immunizing agent. It is prepared by destruction of the toxic part of the toxin molecule by means of various agents (such as formalin alum). In other words the toxin is detoxified without its immunizing ability being harmed. Toxoid has shown itself to be superior to toxin-antitoxin. Fewer doses are required, and the resulting immunity develops more rapidly. Toxoid is also more stable than toxin-antitoxin. The usual course of treatment consists of two injections given 3 or 4 weeks apart. Active immunity results in 4 to 6 months. A Schick test should be given 4 or 5 months after the treatment to determine whether the child is protected.

Different Kinds of Antitoxins. Besides diphtheria antitoxin which has been used as a type example for antitoxins in general,

there are other kinds which have been made with the anticipation that they would be useful. In each case the organism causing the toxemia, for which the antitoxin is the antidote, forms a soluble toxin. This appears in the menstuum about the cell.

Botulism Antitoxin. Botulism, an acute toxemia, is caused by an exotoxin formed by *Clostridium botulinum*. It has been of special significance in foods. Botulism antitoxin is prepared by the same procedures which have been outlined for diphtheria antitoxin. The horse is used on account of certain characteristics. Since there are four or five races or strains of *Clostridium botulinum*, of which types A, B, and C are best known, it is necessary either to use a mixture of the types in the antigen with which antitoxin formation is stimulated in the horse, or to use separate toxins on different horses and find out what type of antitoxin is necessary before it is administered. The latter procedure would be time-consuming, and time is very important in the administration of antitoxins, especially in botulism. Owing to inherent characteristics of botulism and to the fact that diagnosis may be delayed until intoxication has progressed to reveal the symptoms, the same success has not followed administration of this antitoxin that has followed its use in diphtheria.

Tetanus Antitoxin. Antitetanic serum is prepared by injecting horses with tetanus toxin in the same manner as has been outlined for diphtheria antitoxin. A slightly different situation exists, oftentimes, in administration of this serum in tetanus than exists when diphtheria antitoxin is given in diphtheria. Tetanus antitoxin may be administered after a person has suffered a deep wound which has been contaminated with considerable dirt. Its purpose is that of a prophylactic or preventive agent, to be used before there are symptoms. It is claimed that such dirt may contain tetanus spores which will germinate in the blood to cause subsequent poisoning. Delay in administration of tetanus antitoxin until the symptoms have appeared results in much higher mortality than is the case where antitoxin is given to prevent potential toxemia. Administration of tetanus antitoxin has become a well-established practice.

Available information seems to indicate that antitoxin does not persist in the blood very long. The immunity is therefore passive and significant only quite soon after its injection.

Gas Gangrene Antitoxin. This antitoxin is prepared in horses with toxin of *Clostridium welchii* as antigen. It is used in the same manner as are other antitoxins. It has been especially useful in treating toxemias resulting from infection of war wounds with *Clostridium welchii*.

Scarlet Fever Antitoxin. The etiologic agent of scarlet fever was once given the name of *Streptococcus scarlatinae* but is now generally considered to be a hemolytic streptococcus which produces a erythrotoxic toxin (rash-producing). Antitoxin is made as has been described previously. It is believed to be valuable in cases of scarlet fever. It lessens the degree of severity of complications and aids in more rapid cure.

✓ **Dick Test in Scarlet Fever.** This test for scarlet fever susceptibility simulates very closely the Schick test for diphtheria. It consists of an intradermal injection of 0.1 to 0.2 milliliter of a dilution of the soluble toxic filtrate obtained from a culture of a specific hemolytic streptococcus. To secure the toxin, the organism is grown for several days in broth containing a little horse blood. Positive Dick reactions, which indicate susceptibility to scarlet fever, are quite similar to the reaction in a positive Schick test. According to Zingher, however, the Dick reaction appears more promptly.

For immunizing those who are shown to be susceptible by the Dick test, scarlet fever toxin in small amounts is used. This causes the appearance of an active immunity. Small amounts of toxin are used at first. Subsequent injections consist of larger doses as the individual becomes accustomed to them and his resistance is increased.

AGGLUTININS

The agglutinins are antibodies which agglutinate or clump their antigens. The antigens in this case are usually bacterial cells. Agglutination takes place in two stages. First there is loss of motility and later clumping of the bacterial cells.

Preparation of Agglutinins. These antibodies are formed in the blood of animals, and are specific in their action, that is, agglutinins formed by the injection of one antigen will not react with another antigen. The antigen may be injected into the veins or body cavities of the animals. The bacterial cells may be dead or alive; if dead, they should have been killed by being

heated to temperatures of 62° to 65°C. Destruction at temperatures above this range causes the cells to lose their antigenic value, or power to stimulate production of agglutinins. If rabbits are used, the bacterial cells may be injected into the ear vein; the blood of the rabbit may be frequently tested to make certain it contains sufficient agglutinins, before the rabbit is finally bled. If satisfactory, the animal is bled aseptically. The blood is allowed to clot and the serum removed and treated with tricresol, which acts as a preservative. The serum is then stored in the refrigerator.

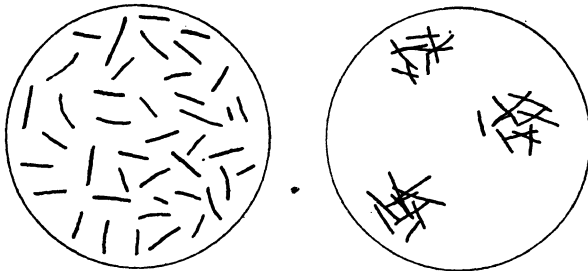

FIG. 130. A Schematic Depiction of an Agglutination Reaction.

A, Freely moving bacteria in a microscopic field. *B*, Another preparation from the same culture with the exception that specific agglutinating serum has been added. The bacteria are agglutinated.

Demonstration of Agglutinins. Agglutination reactions are made by mixing blood serum from an animal which has received injections of bacterial cells as antigen, with some of these cells and then examining the mixture under the microscope for the presence of clumping or agglutination. The blood serum may be diluted even 200 or 300 times and still show its specific action. The reaction is characterized by loss of activity of the cells and drawing together into clumps. There are usually few free bacteria in the field. The laboratory worker, as a rule, makes a control preparation—one which contains the organisms without any added antiserum containing agglutinins. This preparation is made to determine whether spontaneous agglutination of the cells in the culture occurs and serves as a control with which to compare the unknown preparation.

The serum containing agglutinins is usually diluted to overcome the influence of *normal agglutinins*. These are agglutinins which are present in blood of normal persons.

Eberthella typhosa causes the appearance of two types of agglutinins in the blood stream designated as the "O" and "H" types. The "O" agglutinins react with the antigenic substances in the body proper (cell) of the organism; the "H" agglutinin reacts with those in the flagella. A strong agglutination reaction with the "O" type indicates typhoid fever. "H" agglutination reactions are frequently encountered in persons who have recovered from typhoid fever or have received a vaccine prepared from bacteria causing typhoid fever or paratyphoid fevers. The "O" reaction is usually negative or weak in such cases. Many diagnostic laboratories are now carrying out these tests as part of their routine.

Practical Application of Agglutinins. Specificity of the agglutination reaction has caused it to be turned to very useful applications, only two of which are considered here. The basic principles of agglutination may be found in the more advanced texts.

The Gruber-Widal Reaction. This application of the agglutination reaction to diagnosis of typhoid fever was established by Widal, after whom the test is named. The test may be more easily understood if one imagines himself in the place of a physician who is called to the home of a person ill with symptoms of typhoid fever. Clinical symptoms may not be quite characteristic, and he may desire the aid of laboratory data to confirm his diagnosis. The physician knows that, if his patient has typhoid fever, *Eberthella typhosa* is present. The presence of *Eberthella typhosa* will stimulate the production of agglutinins in the patient's blood. Consequently, if agglutinins can be shown to be present, the physician infers the presence of *Eberthella typhosa* and probably typhoid fever. In order to find out whether these agglutinins are present, he takes a small portion of blood from the patient and sends it to the laboratory. The laboratory determines whether or not the blood contains agglutinins for *Eberthella typhosa*.

The blood may reach the laboratory dried on a slide or in a small tube. If dried, it is brought back to about its original volume with sterile physiological sodium chloride solution and

further diluted in order to avoid agglutination which may result from the presence of normal agglutinins. This may require dilution of one part of serum with 50 or 60 parts of sterile physiological sodium chloride solution. Then to a drop of this diluted serum are added some living cells of *Eberthella typhosa*. If agglutinins are present, these cells will be agglutinated or clumped after an hour at 37°C. Presence or absence of agglutination is reported to the physician. This constitutes the Widal reaction, or the so-called "blood test" in typhoid fever.

Interpretation of the Widal or agglutination reaction is influenced by the fact that a person may have received preventive inoculation against typhoid fever; agglutination response may thus have resulted from agglutinins of prophylactic inoculation and not from a natural infection. This possibility must be considered by the physician whose duty it is to weigh the evidence, both clinical and laboratory, before he announces his diagnosis. Although agglutinins are formed during infections, there is considerable evidence that the agglutination titer cannot be taken as an index of the amount of immunity which an individual may possess.

Identification of Bacteria by Agglutination. In the Widal reaction just described, two main factors were concerned: cells of *Eberthella typhosa* and blood serum from a person suspected of having typhoid fever. The unknown factor was the agglutinins in the patient's blood. It is obvious that the same agglutination reaction could be made with the bacterial cells as the unknown factor. In this case, a known antiserum prepared from blood of some animal would be used. This antiserum would be made by injecting a rabbit, for instance, with a pure culture of a known (*Eberthella typhosa*) microorganism. The blood serum would be collected and used to agglutinate the unknown microorganism. If the unknown organism was agglutinated by the antiserum prepared with the known organism, identity of the two organisms would be proved. This test is the final one usually applied for the identification of an organism after the morphological and physiological tests have been determined.

Agglutination Tests in Blood Transfusion. This is discussed at this time because it represents another type of agglutination and because it answers a question often asked by students of bacteriology. Transfusion of blood is frequently necessary. It

has been resorted to in injuries where great amounts of blood have been lost, such as war wounds and hemorrhages. The two principals involved in blood transfusion are the patient, who is spoken of as the recipient, and the donor, who gives the blood. Before taking blood from an individual (the donor) it is necessary to determine whether his blood is compatible with blood of the recipient. To determine this, tests are made to learn whether the red blood cells of the donor are agglutinated by blood serum of the recipient or patient. If they are agglutinated or hemolyzed, this donor cannot be used, for his blood would not benefit the patient; it might even harm him. Blood from different individuals have been classified by investigators into groups, the best known is that by Moss. We need not present here the definitions of these groups. They are given in advanced texts and are usually verified experimentally in advanced courses in practical bacteriology.

PRECIPITINS

Precipitins are antibodies which precipitate their antigens. The exact relation of precipitins to immunity is not understood. They are known only by their reactions, which have most interesting applications.

Preparation of Precipitins. These immune bodies are also prepared in the blood of some animal. Because of the small cost and ease of handling, the rabbit is generally used. The antigen is injected at intervals of 3 to 5 days, usually in the peritoneal cavity. As stated in a subsequent paragraph, precipitins are used especially for the detection of human blood. In this case antisera (or precipitating sera) are made by injecting blood of various species into rabbits.

Practical Applications of Precipitins. Since the action of precipitins is specific, they are used for the detection and identification of proteins. They may be used for identification of blood, detection of horse meat in sausage, separation of natural from artificial honey, and so on. Although the precipitin reaction is very delicate, it has certain limitations. It cannot be used for separating proteins (blood) of closely related animals such as the cow and the goat, the sheep and the goat, or man and other primates.

Detection of Human Blood. A very interesting forensic use of the precipitins has been connected with the identification of blood spots on the garments of suspected murderers. Before precipitins were known, biochemical methods of blood identification were often unsatisfactory. Chemical methods may be used to prove that certain spots are blood spots, and the precipitin reaction will identify the blood as that from a certain species.

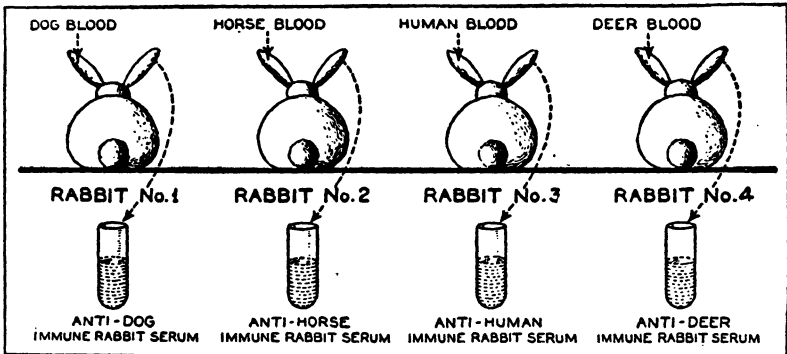

FIG. 131. Showing the Method for Preparation of Each Specific Immune Rabbit Serum Used in the Precipitin Test for Blood. (After Bailey, 1937)

The following cases are from a report by Stokes¹ on the use of the precipitin reaction for the identification of blood:

The first case in which the precipitin test for human blood was used was that of the State of Maryland versus Norman Mable and James Parroway, which was tried in the circuit court for Cecil County on Wednesday, the 4th of March, 1914. The testimony showed that a brutal murder had been committed upon a well-known citizen living near Salisbury in Wicomico County. In traveling from the country store to his home the victim was waylaid by the two men and struck over the head several times with a corn planter, the assault resulting in the death of this man. A great deal of blood flowed from the wounds of the head, and some of the garments of the suspected murderers were brought to the laboratory for examination. A spot of blood on a button of the left sleeve of the coat of one of the garments of the suspected murderers was detected by means of the usual chemical and micro-chemical tests, and 0.4 of a milligram of the blood was scraped from the button and accurately diluted so as to make a dilution of 1/1000, 1/10,000, and 1/20,000. The first dilution was also used as a color comparison for the second test in which no accurate weighing could

¹ W. R. Stokes, The Use of Precipitin Test for the Detection of Human Blood in Criminal Trials, *Boston Med. Surg. J.* (1917).

be made. A spot of blood was also detected on the overalls of one of the murderers, and this spot was cut out and soaked in 2 cc. of salt solution and then diluted to the color of the weighed solution from the button, which equaled a dilution of 1/1000. Other dilutions equaling 1/10,000 and 1/20,000 were then made from this original dilution.

The technic, as described above, was then carried out, including the control tests recommended, and the dilutions of 1/1000 of suspected human blood, as well as the controls, gave a distinct clouding within about two minutes and were distinct at the end of thirty minutes. The higher dilutions of 1/10,000 showed a beginning precipitum in about five minutes and was well marked at the end of thirty minutes. The tests were made at the usual room temperature.

The murder was committed for the sake of robbery, and about fifty dollars was taken from an envelope found in the inside coat pocket of the victim. His coat was extensively stained with blood, and the envelope addressed to him was found at a short distance from the site of the crime. Dilutions of 1/1000, 1/10,000 and 1/20,000 were made by soaking the blood-stained paper of the envelope in salt solution and comparing the lowest dilution by color to the weighed solution of dried blood of 1/1000. The dilutions of 1/1000 and 1/10,000 gave a positive precipitin test, as described above.

In giving the testimony, it was admitted that the test might be positive if the blood had been from some of the higher order of apes, but with that exception the opinion was given that the best was positive for human blood. The finding of blood stains on the button of the coat and the overalls of one of the suspected criminals was considered as important evidence, and the man was convicted of murder and received a long-term sentence.

This murder had stirred up great feeling in the town of Salisbury, and a mob attacked the jail and attempted to remove the prisoners. The attempt was thwarted, however, and the prisoners were removed to another county for safekeeping and trial.

While public opinion was still seething, a woman living just outside of Salisbury reported to the police authorities that while alone in her home she had been attacked by a man, who had then made away with a few trifling articles, having been unable to find any money or valuables. Upon investigation of the doorpost, the threshold of the door, a satchel, and various other articles were found smeared with blood, and the woman claimed that she had defended herself with a knife and had inflicted certain wounds upon the man, who had then escaped. It should be mentioned that the woman was married, that her husband was absent from home, and had been used to leaving her in the house in a lonely part of the country upon various occasions. The wood from the door, the blood-stained satchel, a blood-stained corncob, and a blood-stained knife were brought to the laboratory for examination, and the usual tests soon demonstrated the presence of blood upon all of these materials. Some of the blood, however, was dissolved in normal salt solution and examined. Somewhat to our surprise, it was found that a number of the shriveled corpuscles contained nuclei and this was confirmed by stained specimens. It was thought prob-

ably that the blood might be from a chicken, and rabbits were immunized with chicken blood. When the blood serum of an immunized rabbit had attained a strength sufficient to produce a precipitation in a dilution of 1/20,000, the blood from these various materials was tested in the usual dilutions of 1/1000, 1/10,000 and 1/20,000. They all gave a marked reaction with the blood serum of the rabbit immunized with chicken blood, and the opinion was then expressed that the blood did not come from a human being but was chicken blood.

There had been a great deal of excitement amongst the public concerning the second alleged criminal attack, but when the woman was confronted with the evidence she admitted that she had staged a murder in order to keep her husband at home, as she thought that such an experience might make him more apprehensive of her safety in the future.

No further attempts, therefore, were made to apprehend the criminal, the public excitement subsided, and the husband presumably no longer strayed from his own fireside.

Foreign Proteins in Foods. The precipitin test may be used for detecting sophistication in foods, such as substitutes for natural honey, use of egg substitutes in pastries, presence of horse meat in sausage, as stated before. This application of the test is not so important in the United States where there is probably less substitution of one meat for another, but in some of the foreign countries, where horse meat is sold, the test is useful. The precipitin test in this case has some limitations; it is impossible, for instance, to separate the flesh of the cloven-hoofed animals from species which are very closely related in structure.

Separation of Species of Animals. The precipitin test has also been used for the study of the origin and relationships of different species of higher animals. The test, therefore, has value in bringing useful data to bear on the discussion of evolution. It is quite well established that the precipitin test will not separate the proteins (in the blood or tissue) of closely related animals. For instance, it has just been stated that the flesh of the cloven-hoofed animals cannot be separated. Boyden has stated that building of family trees has practically ceased today not because the problems of animal relationships have settled but because scientists are helpless. There is a general agreement as to the relationship of animals within certain main branches but not as to affinities of many of the invertebrates to each other or to vertebrates. Boyden² pointed out that our present classifications

² A. A. Boyden, The Precipitin Reaction in the Study of Animal Relationships, *Biol. Bull.* 50 (1926), 73-108.

and groupings are based on morphological data; consequently, it may be wrong to attempt to make the serological reactions follow the morphological. Man³ cannot be separated by the precipitin reaction from other primaries, and this may indicate a deeply seated relationship.

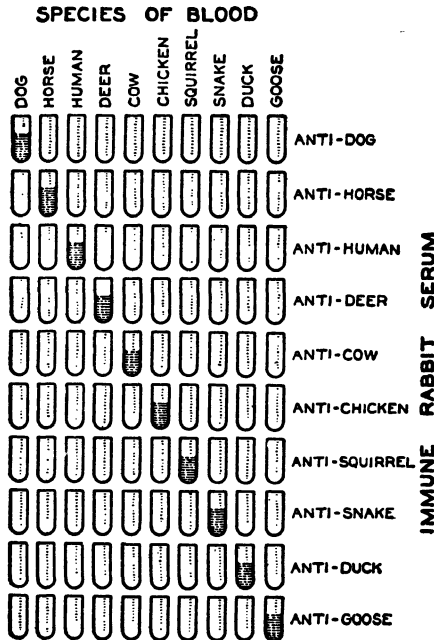

FIG. 132. Showing how the Precipitin Test Is Pursued through 100 Different Tests with 10 Specimens of Blood from Different Animals and 10 Different Immune Sera Prepared with These Blood Specimens. The shaded tubes indicate a positive precipitin reaction.

(After Bailey in *Scientific American*, April 1937)

Uhlenhuth, who did some of the pioneer work with the precipitin reaction, has stated that absence of precipitin formation to a foreign blood is a fine indicator of biological relationship. It is impossible to induce formation of precipitins by injection of asses' blood into horses and vice versa. Rabbits may produce precipitins to hares' blood. Uhlenhuth, therefore, believed that

³ C. E. Bailey, Immunity for the Witness, *Sci. Monthly*, 156 (1937), 213-15.

hybridization of hares with rabbits was impossible. Some of the lower species of monkeys produce precipitins to human blood.

Kahn's Precipitation Test for Diagnosis of Syphilis. This test has won approval of immunologists for diagnosis of syphilis and has largely replaced the Wassermann test described below. It is a flocculation test in which only two reagents are required, serum from the individual suspected of being syphilitic in which are antibodies and the antigen; the latter is alcohol soluble lipoids from normal mammalian tissue usually beef heart. Where the antigen is mixed with blood serum from a syphilitic, under conditions which must be left for later study, flocculation appears which finally results in a precipitate. Mixture of antigen with normal blood serum (from an individual who is not syphilitic) remains clear.

Results of the Kahn test are reported by using an arbitrary combination of plus and minus signs, as follows:

- + + + + strong positive reaction (four plus).
- + + + less strong positive reaction (three plus).
- + + moderate positive reaction (two plus).
- + positive but weak reaction (plus).
- + - doubtful reaction (doubtful).
- negative reaction (negative).

OPSONINS

Opsonins are antibodies (immune bodies, protective substances) which prepare their antigens (bacterial cells) for ingestion by leucocytes or phagocytes. The phenomenon of ingestion of the bacterial cells is spoken of as phagocytosis or opsonification. The antigen (bacterial cells) is altered in some manner, making it easier for the phagocytes to ingest them. When the bacterial cells have been taken into the phagocytes, they are dissolved, probably by enzymes. Opsonins are of significance in connection with the theory of immunity proposed by Metschnikoff.

Normal and Specific Opsonins. Normal persons (those who have not had an attack of disease or received preventive inoculation) have opsonins naturally present in their blood. Such opsonins are, however, quite often nonspecific, showing no special affinity for any one microorganism. In contrast with these normal opsonins are those which appear in the blood after infec-

tion or preventive inoculation. Such opsonins are specific, showing marked affinity for the antigen (bacteria) which stimulated their formation.

Opsonic Index. Determination of the opsonic index is based on a desire to know the opsonic power (or opsonin content) of the blood of an individual who has either suffered an attack of disease or received preventive inoculation. Attempt is made to express this power numerically in order that changes in resistance to disease may be compared or that the results following administration of bacterins may be determined. The opsonic index is the ratio between the average number of bacteria found within 50 to 100 leucocytes in a suspension containing bacteria, blood corpuscles, and the patient's serum, and the average found in the same number of leucocytes in a corresponding suspension containing normal serum, the latter being taken as the standard. It is the quotient of the number of organisms in 100 leucocytes from the patient's serum, divided by the number in 100 leucocytes from the normal serum.

Determinations of opsonic index are less important today than formerly. Kolmer stated that the opsonic power of a normal person to most pathogenic bacteria varies from 0.8 to 1.2. Opsonic determinations, theoretically at least, should be of assistance in vaccination for determining the size of the doses of vaccine and the best time for their administration.

LYSINS

Lysins are antibodies which, when combined with *complement*, cause destruction of cells. In the blood, this combination of complement and lysin destroys bacterial cells and is spoken of as *bacteriolysis*. In a like manner *hemolysis* results in the destruction of red blood corpuscles (erythrocytes). Normal blood from subjects who have not had disease or received preventive inoculation is known to be germicidal. This property is best explained on the basis of its normal lysin and complement content. Such lysins, however, are not specific but may destroy all bacterial cells. Specific or immune lysins may be built up in the blood by some special treatment such as an infection with pathogenic bacteria or inoculation with a bacterin. As with all

immune bodies, lysins are specific and therefore probably play a role in immunity.

Complement. Investigations have revealed that two agents are involved in lysis of cells. One, the immune body, is the thermostable component of an immune serum. It is specific and therefore has some relation to the cells with which the animal was injected. The other component, *complement* or *alexin*, is thermolabile (susceptible to heat); it exists in the blood of all animals. Complement is not specific.

These agents can be demonstrated by injecting a rabbit with red corpuscles from a sheep. Hemolysins for sheep's cells are formed in the rabbit's blood. Presence of these agents can be shown by adding a little of the rabbit's serum to a suspension of red cells from sheep's blood, in a test tube. The cells are dissolved, and the suspension, turbid at first, clears. If the rabbit's blood is heated to 57°C. first, and then added to the suspension of sheep cells, no clearing takes place. This shows that heat has destroyed some agent which is concerned in hemolysis. This is *complement*. Addition of fresh unheated blood serum from any animal restores the ability to dissolve the red corpuscles of the sheep. Blood of the guinea pig is usually used as a source of complement.

Lysis, therefore, is not due to a single substance. Two components exist, one *complement*, which is present in both normal and immune blood; the other, *amboceptor*, a specific immune body, existence of which is due to injection of some antigen.

Complement Fixation Tests. Lysins have been used for diagnosis of certain diseases. If an individual is infected with a certain disease, his blood will contain lysins which are specific for the bacterium causing it. These tests are known facts:

1. Lytic sera (lysins) consist of (a) a heat-labile component called *complement* and (b) a heat-stable component, the immune body.

2. Complement is not specific, is present in both normal and immune blood, and is destroyed by heat.

3. The lytic component is specific and reacts with the particular antigen.

The complement fixation test has been used in the past for diagnosis of disease and, when applied to syphilis, is called the

Wassermann test because a German bacteriologist with that name perfected it. The test is made on a specimen of blood serum collected by the physician and sent to a laboratory. The following steps are carried out.

1. The patient's serum is heated to 60°C. to destroy complement already present.

2. Some of this heated (inactivated) blood serum is added to the antigen.

3. Complement is added.

If the blood serum which the physician sent to the laboratory was from an individual infected with syphilis, the immune body will bind the complement to the antigen. The problem now is to determine whether this has been done. Several different observations might be made, but what is really done is to determine whether the complement has been used. This is done by adding red cells from sheep blood and heated blood serum from a rabbit which has been injected with sheep cells; this latter will contain the heat-stable immune component of the lysins (hemolytic lysin) made in the rabbit against sheep cells. If the test is being made with a specimen of blood serum from a syphilis patient, it will have the immune body in it. The complement just added will unite with it and the antigen. The complement, therefore, cannot unite with the hemolytic lysin and the red corpuscles. The latter remain unchanged and finally settle out. If the blood serum came from an individual who did not have syphilis, there will be no immune body, and the complement will be free to unite the red corpuscles and immune bodies (hemolytic lysin) in the rabbit blood. The blood cells are dissolved and the tube turns to an even clear red color. This shows that the patient's blood was devoid of immune bodies for syphilis and that probably he did not have syphilis.

Immunity in Virus Diseases. Attacks of certain of the virus diseases such as yellow fever, smallpox, mumps, poliomyelitis, leave a pronounced immunity, for second attacks are rare. Less is known about the mechanism of such immunity than about that from some of the bacteria-caused infections. There is little reason to believe that they are markedly different. Both *active* and *passive* antiviral immunity are recognized. The former is acquired by an attack of the disease, whereas the latter is bestowed by injection of antiviral sera.

REFERENCES

- BROADHURST, J., *How We Resist Disease*, J. B. Lippincott, Philadelphia, 1923.
- BOYD, W. C., *Fundamentals of Immunology*, Interscience Publishing Co., New York, 1942.
- GAY, F. P., *et al.*, *Agents of Disease and Host Resistance*, Charles C. Thomas, Springfield, Ill., 1935.
- SHERWOOD, N. P., *Immunology*, C. V. Mosby Co., St. Louis, Mo., 1935.
- TOPLEY, W. W. C., *An Outline of Immunity*, Edward Arnold & Co., London, 1933.
- TOPLEY, W. W. C., and G. S. WILSON, *The Principles of Bacteriology and Immunity*, William Wood & Co., Baltimore, 1936.

CHAPTER 30

VARIETIES OF IMMUNITY

Several varieties of immunity may be distinguished from one another. These may be classified as follows somewhat after a method of Muir and Ritchie.

METHODS AND VARIETIES OF ARTIFICIAL IMMUNITY—ACTIVE IMMUNITY¹

1. Natural Immunity.
2. Artificial Immunity (Acquired)
 - A. Active immunity—that is, produced in an animal by injection, or by a series of injections, of nonlethal doses of an organism or its toxins
 1. Attack of the disease.
 2. By injection of living organisms
 - (a) Attenuated in different ways
 - (1) Growing in presence of oxygen.
 - (2) Animal passage.
 - (3) Abnormal temperatures.
 - (4) Weak antiseptics.
 - (5) Drying.
 - (6) Other methods.
 - (b) Virulent—nonlethal doses.
 3. By injection of dead organisms (Bacterins).
 4. By injection of dead organisms sensitized by an antiserum.
 5. By injection of filtered bacterial cultures, that is, toxins; or of substances derived from such filtrates.
 - B. Passive immunity—that is, produced in one animal by the injection of the serum of another animal immunized by the methods of A
 1. By antitoxic serum, that is, the serum of an animal highly immunized against a particular toxin.
 2. By antibacterial serum, that is, the serum of an animal highly immunized against a particular bacterium in the living and virulent condition.

NATURAL IMMUNITY

Natural immunity may be defined as immunity which an individual possesses without artificial inoculation or without having had the disease. Kolmer defined it as follows:

¹ Adapted from Muir and Ritchie's "Manual of Bacteriology."

Natural immunity is the resistance to infection normally possessed, usually as the result of inheritance, by certain individuals or species under natural conditions. Natural immunity is usually possessed by most members of a species. What is regarded as natural immunity today may be immunity which has been acquired by the species over a long period of time. We may assume that, when a race of people lives in a country where an infectious disease is endemic, the susceptible members of the race will take the disease and either be killed or survive. Those who survive will possess an acquired immunity. When this process is repeated over and over again through centuries, acquired immunity may slowly change to natural immunity. This may be the case with those peoples living in Central America who are now said to be naturally immune to yellow fever. Negroes are known to be much more resistant to yellow fever than white people.

Dr. Vaughan in his "Treatise on Epidemiology" reported introduction of measles into the Fiji Islands in 1875. The disease had been unknown in these islands; among a population estimated to be 150,000, there were 40,000 deaths. Vaughan did not explain this high mortality as due to introduction of a new disease to a people who had had no opportunity to acquire immunity but rather to the fact that during widespread epidemic so many are ill that the sick do not have proper care. Although this may be true as far as the deaths are concerned, it might not satisfactorily explain the case rate. The reason may be that measles was a new disease to these people and that they had had no opportunity to acquire even a slight immunity.

Explanation of natural immunity rests probably within the cell and must be related in some manner to its genetic factors since it is possessed by an animal without resulting from stimulation with an antigen. It may be due to inherent characteristics of the cell and is best explained on the basis of specific antibodies.

Genetic Immunity. This is immunity which an individual possesses by virtue of heredity. Both active and passive immunity are involved. In some cases the fetus may become immune by having an attack of disease in the uterus, from which the mother suffers. This would be active immunity. If the fetus is not afflicted with the disease from which the mother suffers, but receives immune bodies through the placental circulation, passive immunity would result. The subject is more complicated if one wishes to resort to heredity and its underlying principles, much too complicated for those who are just beginning to study bacteriology.

Milk-Borne Immunity. Good evidence has been observed to show that mammary transmission of acquired specific immunity is possible in several diseases. These observations suggest that milk-borne immunity might be possible with other diseases. It has been suggested on quite good evidence that the colostrum might be rich in immune bodies.

Active and Passive Immunity. Two types of acquired immunity are distinguishable, *active* and *passive*. They are definitive terms which nicely cover the facts. By *active* immunity is meant that which results from active participation of body cells themselves in defense of the organism. *Passive* immunity differs in that the body cells remain inactive or passive. They are not stimulated to form immune bodies of any immediate consequence. In active immunity the protective substances, or immune bodies, are made by body cells of the patient or subject of infection; in passive immunity they are injected into the patient after they have been made in some other animal. Establishment of active immunity requires time (perhaps several weeks) and therefore cannot be used where it is necessary to secure immunity within a short time. Passive-immunity methods are used, then, especially for curing disease; whereas active immunity is used for preventing infection. Active participation of the patient's body cells for the building of active immunity is secured by injection of an antigen. These various agents and methods have been tabulated elsewhere.

Active and passive immunity may be contrasted in the following manner:

ACTIVE IMMUNITY

1. The body cells of the patient are activated to form immune bodies.
2. Active immunity requires the administration of an antigen with which to stimulate formation of immune bodies. Is produced by an antigen.
3. Time is required for the appearance of immune bodies.
4. Bacterins (bacterial vaccines) or toxins may be used.
5. Active immunity methods are preventive or prophylactic.

PASSIVE IMMUNITY

1. The immune bodies are injected into the patient.
2. No antigen is required; immunity is produced by an antibody.
3. No time is required since the immune bodies are injected.
4. Antisera may be used for bestowing passive immunity.
5. Passive immunity methods are curative methods.

**METHODS OF PRODUCING ARTIFICIAL (ACQUIRED)
IMMUNITY**

The various methods that may be used for bestowing artificial immunity to disease on an individual are quite diverse. They are used to increase and add to the little immunity which one may possess naturally. Natural immunity might not be sufficiently high to protect a person if he received a large dose of microorganisms. Consequently, it is unsafe to rely on natural immunity for protection against infection. It may be augmented by the so-called subjective methods for the prevention of disease. They are more direct than the objective methods, such as disinfection, sterilization, and pasteurization of milk, but, when employed in addition to the latter, give a person considerable assurance of freedom from disease.

An attack of Disease. General statements cannot be made about the grade of immunity resulting from an attack of disease, since conclusions are influenced by the disease in question as well as by other factors. Perhaps in a few diseases satisfactory immunity follows infection. Such may be the case in measles, as indicated by the following illustration. Vaughan mentioned the experience of the inhabitants of the Faroe Islands with measles. He stated that in 1781 measles disappeared from these islands and did not reappear until 1846. During this interim of 65 years not a single case was reported. Finally in 1846 the disease was introduced, but none of those who had the disease 65 years before were infected. This would seem to indicate permanent resistance to measles. A few other diseases are in the same category.

An attack of communicable disease presupposes the presence, in the body of the patient, of the microorganisms causing it. Bacteria which have gained entrance naturally act as antigens to cause production of antibodies (immune bodies) in the same manner probably as do dead bacteria (bacterins) which are administered for production of artificial (active) immunity. With some diseases, one attack seems to have rendered the individual free from reinfection. Consequently, it is generally believed that one may not have the disease more than once. Such a statement appears in some texts, but it is not in accord with the facts. Recurrent cases of disease are not uncommon in the same individual. It should be stated again that immunity

is relative and not absolute. Massive infection, for instance, may overcome a grade of immunity acquired by an attack of the disease or by preventive inoculation. In a few diseases, however, it is known that an attack produces such immunity that recurrent cases are uncommon.

Although it is possible to have some diseases more than once, recurrent cases of other diseases are uncommon. When sometimes they do recur, the recurrence may be explained in different ways. It is possible for an individual to have diseases with symptoms very much alike. An individual may have malaria, for instance, with a diagnosis of typhoid fever. Confusion is especially possible when laboratory examinations of specimens from the patient are not made. Or the patient may have one of the paratyphoid fevers which have many symptoms in common with typhoid fever, although they are not so severe.

Use of Attenuated Microorganisms. These are microorganisms which have been devitalized (attenuated) in some manner. They have not been killed but have lost their ability to function normally. Such devitalized bacteria have been used for increasing the resistance (immunity in individuals).

Attenuation by Animal Passage. This method of attenuating microorganisms was one of the earliest to be used. It is reasonable that injection of a microorganism into an unusual host would greatly alter the microorganism. Propagation of smallpox virus in the heifer causes attenuation or reduction in virulence. Pasteur showed that the virus of rabies could be strengthened by passage through an animal. This indicates that animal passage will increase as well as decrease virulence of bacteria.

One of the most interesting cases of the use of an organism attenuated by animal passage was Friedmann's cure for tuberculosis, an announcement heralded far and wide in lay literature and discontinuously over a number of years in German medical journals. Friedmann proposed use of a strain of the tuberculosis organism which had been attenuated by passage through a cold-blooded animal. The animal used was the turtle, and the altered strain became known as the turtle bacillus. The United States Public Health Service invited Friedmann to come to America to demonstrate his treatment or cure. He accepted but the demonstrations were not successful enough to warrant accepting

Friedmann's conclusions.² Attenuation of the tuberculosis organism as Friedmann produced it, was not sufficient to allow the altered organism to be used as a curative agent.

Virus Vaccines. These have been prepared for certain of the virus diseases by growing the virus on incubated hens' eggs. The eggs are incubated for some 10 days or so until the embryo is well started. The shell is then punctured over the air cell and the inoculation made into the embryonic fluids. After the seed virus has been introduced, the shell is sealed with paraffin and the eggs reincubated. After incubation, certain of the fluids in the egg are harvested and treated for use as vaccines. Development on the chick embryo results in reduction of virulence. Such vaccines are used in yellow fever and influenza.

Immunity Methods in Smallpox. Centuries before the Christian era the Chinese people observed immunity from disease which followed an attack of smallpox. Consequently, they attempted to confer immunity by artificial inoculation. They rubbed some of the smallpox virus into the skin or placed the scabs in the nostrils. Such practices caused mild cases of smallpox which left the individual immune; it was found, however, that the disease could be spread as easily from these cases as from those which were naturally infected. The history of smallpox has been briefly touched on in the first chapter. The preparation of the vaccine virus will be described now.

Preparation of Smallpox Vaccine Virus. Vaccine virus is a living agent which must be propagated in or on some living material. In former times, it was secured from the arm of a person who had just undergone a successful vaccination. This method was used almost exclusively before modern methods of producing the virus were perfected; it has been said that citizens of Richmond, Va., were asked to be vaccinated during the Civil War in order that a supply of virus be available for soldiers of the Confederate army. Objections to such a practice are apparent. In some cases other diseases were transmitted from the person from whom the virus was taken to the person on whom it was desired to bestow immunity. Other methods, which are now used, for the preparation of a safe satisfactory vaccine virus

² The results of these demonstrations are reviewed in *U. S. Pub. Health Service, Hyg. Lab. Bull.* 99.

had to be developed. Healthy heifers are now used for the propagation of the vaccine virus. They are held in a receiving stable until qualified veterinarians pronounce them free from diseases to which the heifer is subject; during this detention period they are also subjected to laboratory tests and other examinations which cause them to be either rejected or admitted to the next



Fig. 133. Removing Smallpox Vaccine. (Courtesy Parke, Davis & Co.)

Eight days after a vaccine heifer has been inoculated with "seed virus," the heifer is killed and, after prolonged irrigation of the vaccinated area, the vaccine pulp is collected and transferred to sterilized containers.

steps in the production of vaccine virus. If they are healthy in every respect, they are shaved over the abdomen and thoroughly washed and sterilized. They are then taken to the operating room where they are prepared for inoculation. The animal is placed on the operating table in such a manner that the areas on the ventral portion of the body which are usually used are exposed for vaccination. The operators then make linear incisions, taking care that blood is not drawn. Glycerinated vaccine virus is then rubbed into these areas; this material is spoken of as "seed virus." The heifer is then kept under rigid sanitary conditions while the virus grows. The stables are kept strictly sanitary by attendants

who are constantly on duty. At the end of this period, during which the vaccine virus has grown, the lines are found to be covered with small white vesicles which contain the virus. During their growth, all scabs are cleared away as they form in order that none may be collected with the virus. When the virus has grown sufficiently the animal is etherized and placed on an operating table, and the vaccine pulp is scraped off and transferred to sterile containers. This vaccine pulp is then taken to another room where it is thoroughly mixed and treated with glycerol and sterilized distilled water. The material is ground and thoroughly mixed, after which it is stored before it is prepared for the market.

Smallpox virus is examined just as carefully before marketing as are the other biological products. These tests include laboratory examination for the presence of aerobic and anaerobic bacteria and animal inoculations to reveal presence of undesirable bacteria. The animal which has been used for preparation of the vaccine virus is carefully posted by veterinarians after the vaccine pulp has been removed. In this manner the manufacturers do everything possible to make certain that the material comes from healthy animals. They examine the product as well as the animal from which it was collected.

Duration of Immunity after Smallpox Vaccine Inoculation. A teacher frequently hears the question, "How long is a person immune after preventive inoculation for smallpox?" Jenner stated that a person is immune for life after successful inoculation. We know this to be untrue, and today more guarded statements are made. This matter has been discussed by Gillihan,³ whose article should be consulted by those who desire a longer discussion. Experience today seems to indicate that several successful inoculations at different age periods, as during the first year of life, at about the age of seven, and finally during adolescence, will protect the subject for life. In Germany two successful inoculations are required by law, one before the child has reached the age of one year and the second before the age of 12. This practice seems to have stamped out the disease in Germany. Physicians have to go great distances to see a case of smallpox, and

³ A. F. Gillihan, *Duration of Immunity Following Modern Smallpox Vaccine Inoculation*, *Am. J. Pub. Health*, 17 (1927), 906-11.

many of them never see one. Fortunately, this is becoming the situation in the United States.

Reasons for Failure in Attempted Smallpox Inoculation. Various reasons have been advanced to explain why a person sometimes cannot secure successful inoculation or why it may require many attempts before one is secured. Deteriorated vaccine virus may be one reason; faulty technic on the part of the practitioner may be another. Some individuals may be naturally immune. Gillihan described the immune reaction which practitioners should look for before stating that the subject is naturally immune or has acquired sufficient immunity to prohibit successful inoculation. He quoted a report that in the Orient, on account of the virulent type of the disease, reinoculations are made in immunized persons until no reaction at all is secured to the virus. It is also quite probable that some people never reach such a state of resistance. The author just quoted reported a case of a physician in a vaccine plant in England who had to give up this occupation because his hands frequently became inoculated with the virus, and the inoculation (vaccination) ran its normal course each time. We must distinguish, of course, between immunity to vaccine virus and immunity to smallpox.

Attenuation by Abnormal Temperature. This method was used by Pasteur for preparation of anthrax vaccine. *Bacillus anthracis* was incubated at 43°C., instead of 37°C. A culture which originally killed 100 per cent of sheep inoculated with it did not kill any after incubation at 43°C. for 10 or 12 days. The higher temperature of incubation had devitalized the culture.

Attenuation by Drying—Pasteur Treatment for Rabies. This method is best known in connection with preparation of the agent used in the so-called Pasteur treatment of rabies. Pasteur used two terms for the viruses which he prepared. The virus taken from a naturally infected dog was called "street virus"; that which had been exalted in virulence by passage through susceptible animals was called "fixed virus." We have to use the general term virus, for the etiologic agent in rabies is not known. The Pasteur treatment involves the use of this fixed virus. The material to be used in the inoculation to prevent rabies is made as follows:

Rabbits are inoculated with a fixed virus which has been taken

from another rabbit. Just before the inoculated rabbit should die (about the eighth or ninth day), it is killed, and its spinal cord is removed aseptically. This cord is then cut into short pieces which are suspended over potassium hydroxide under aseptic conditions. Pasteur found that storage of spinal cord under these conditions caused it to become so dry that it was no longer infectious. Consequently, he started the prophylactic treatment with an emulsion of spinal cord which had been dried for 14 days. About 0.5 centimeter of the cord was ground in sterile physiological sodium chloride solution. This constituted a dose. Subsequent doses are 0.5 centimeter of the cord dried for decreasing periods. Toward the end of the treatment, after 18 days, the patient receives spinal cord which has been dried for only three days. In this manner a person who has been bitten by a dog believed to be rabid may slowly have his immunity raised. The material with which this has been done has been of increasing virulence.

Whether a person needs the Pasteur treatment or not depends on the circumstances. The situation is often this. A person may be bitten by a rabid animal or one which showed symptoms of rabies. If there are abrasions in the skin, the problem is much worse. The situation is often made more complex by the shooting of the suspected animal. In such a case the subject has the alternative of taking the Pasteur treatment or taking the risk that the animal was not infected with rabies. Health authorities are united that the suspected animal should not be shot but kept for observation by qualified persons. If it later shows no symptoms, the Pasteur treatment need not be taken by those who may have been bitten. If the dog is killed, the head should be sent to a reputable laboratory for examination. The laboratory worker examines the brain of the animal for Negré bodies which have been found to be present when the animal is infected.

These bodies are found in the protoplasm of nerve cells. They are round or oval in shape but are usually irregular. Their size is influenced by their location in the nervous system, and the stage of the disease, as well as the animal from which they come. Negré bodies have become important in diagnosis of rabies. They were once believed to have etiologic relation to the disease, but this is no longer believed.

The history of a case of rabies is so well portrayed by a newspaper report published in 1927 that pertinent portions are given here:

Compassion for a homeless dog shivering outside his police booth in Brooklyn cost Policeman _____ his life. . . . The policeman was bitten by the mongrel and considered the wound so inconsequential that he disregarded it. _____ was on duty when the dog approached, dragging an injured leg. The mercury registered six above zero and the dog whined from cold and hunger. _____ opened the door of his police booth into which the animal crept. _____ entered, and as he started to stroke the dog it snapped savagely at its benefactor. The policeman sprang back, but the mongrel's teeth cut through the cloth of his uniform and nipped him near his groin. The slight scratch seemed so trifling that he said nothing and soon forgot the incident. Two months to a day after he had been bitten, he first felt pain and began to develop symptoms of rabies. He showed extreme hyperexcitability and was unable to swallow. Five days later he was taken to the hospital where he died after continued convulsions. An examination of the brain showed the presence of Negré bodies.

This is a typical case of rabies. The length of the inoculation period may vary. Some authors have reported periods of incubation of several years.

An attenuated strain of *Mycobacterium tuberculosis* has also been prepared by drying. The cells are dried in sealed tubes and then used as a vaccine or bacterin. Black-leg vaccine is also prepared by drying it above 85°C. for 7 hours.

Attenuation by Weak Antiseptics. Weak antiseptics also have ability to weaken organisms. Chamberland and Roux reported that *Bacillus anthracis* could be attenuated by being grown in media containing 1 part of carbolic acid per 600 parts of medium. Another more recent example of attenuation with weak antiseptics might be Calmette's and Guerin's work with *Mycobacterium tuberculosis*.

BCG Treatment for Tuberculosis Prevention. This procedure was devised at the Pasteur Institute. The letters represent the words "Bacillus Calmette Guerin"; the last words commemorate the work done by Calmette and Guerin, workers in the institute laboratories. The vaccine is a living strain of *Mycobacterium tuberculosis* (bovis) which has been rendered avirulent by many passages on bovine-bile medium. The vaccine is prepared by

transferring the organism from the bile medium to a synthetic medium on which, after about 3 weeks, it has developed with a heavy film; the clear subnatant liquid is removed by a pipette. Glass beads and a little dextrose solution are then added to the bacilli which remain in the flask, and the mass is emulsified. This mass is then diluted so that each 2 milliliters contain 0.01 gram of bacilli. This is a single dose which is fed to infants in milk. Three successive doses were advised for each infant at 2-day intervals. Each dose is approximately 400 million attenuated bacilli. This method was criticized, and administration by subcutaneous injection followed. Later intracutaneous injection was recommended and used in animal experiments. Guerin reported that mortality of infants between the ages of 1 and 12 months is one half less in those who have been than in those who have not been vaccinated. In families in which tuberculosis exists, the morbidity is eight times less in infants who have been than in those who have not been vaccinated. Review of the arguments for and against the BCG treatment must be left for advanced courses. It may be said, however, that this method of preventing tuberculosis represents the culmination of the life work of a revered scientist who died in 1933, Albert Calmette. Whether it accomplishes all that its proponents claim is still open to question. Its use in groups for which little can be done by other methods has been recommended.

Besides the various chemical reagents which have been used for attenuating microorganisms, light has also been used. In searching for methods for attenuating the tuberculosis organism, V. and Mme. Henri used ultraviolet light. The results have not been satisfactory. It is definitely established that ultraviolet light destroys bacteria; one may wonder why it may not be used for attenuating them.

Use of Nonlethal Doses of Living Bacteria. This method, although theoretically possible, would be a difficult one to control with many microorganisms. It is very difficult to determine how many bacterial cells are necessary to cause disease. Some reports state that as few as one cell will cause infection. The determining factors probably are the resistance of the host and the aggressive powers of the microorganism. It is possible that one cell of a virulent organism might be given to a subject with low

resistance and cause a serious infection. The safe method, if living organisms are to be used, is to employ an organism which has been attenuated in some manner. Living bacteria may be responsible for immunity of many of us to tuberculosis. Until recently, surgeons who performed many autopsies reported that practically everyone was, at one time or another, infected with tuberculosis. In many cases the lesions had been sealed off by nature and were inactive. This situation seems to have changed somewhat, however, with introduction of better methods for preventing tuberculosis. One, of course, is pasteurization of milk and eradication of infected cattle from dairy herds.

Active Immunity by Injection of Dead Bacteria (Bacterins).

Dead bacterial cells may be used for bestowing active immunity. The cells must be destroyed in a certain manner; else their ability to stimulate the body cells of the subject to form immune bodies will be destroyed. These products are known as "bacterins" or bacterial vaccines and are used as agents in active immunity. Bacterial cells to be used as bacterins are usually killed by heating at 60°C. for one hour. The temperature is kept at this point because a higher temperature will destroy the antigenic properties of the bacterin. Bacterins, or bacterial vaccines, cannot be used for conferring passive immunity.

Preparation of Bacterins (Bacterial Vaccines). Bacterial cells used in the preparation of bacterins are grown in pure culture on the surface of solid media such as plain agar. The medium is usually contained in broad shallow flasks in order that there be as much surface area as possible. After growth has occurred, the cells are washed and scraped off in sterile physiological sodium chloride solution. This suspension is then thoroughly shaken to break up clumps and yield an even suspension. About 0.1 per cent of tricresol is added to the suspension, which is counted and diluted. Two suspensions are generally made; that for the first injection contains 500 million cells per milliliter; the two subsequent injections 1 billion cells per milliliter. The lowest concentration constitutes the first injection; the heavier suspension is used for the second and third injections. It is necessary to distribute the injections over a period of time since the administration of all the cells (2.5 billion) at once would cause too great a reaction.

Confusion frequently exists in students' minds over bacterins and antisera. These products may be contrasted as follows:

BACTERINS

1. Used in active immunity.
2. Prepared from bacterial cells; usually killed by heat.
3. Used to prevent disease.
4. Used in diseases in which the etiologic agents form intracellular toxins.
5. Time required for establishment of immunity.

ANTITOXINS (ANTISERA)

1. Used in passive immunity.
2. Prepared in the body of some animal; usually a horse.
3. Usually used for curing disease.
4. Used in diseases in which etiologic agents form extracellular toxins.
5. Immunity almost immediate.

Stock Bacterins and Autogenous Bacterins. Two types of bacterins or bacterial vaccines are used; one is called a stock bacterin and the other an autogenous bacterin. A stock bacterin is one prepared in large quantities by manufacturers and kept in stock at depositories. They are prepared in the manner previously outlined. In order to increase the value of such bacterins, manufacturers have used a large number of cultures or strains of the same microorganism. This yields what is known as a *polyvalent bacterin*.

An autogenous bacterin is one prepared from the organism causing the infection. It is reasonable to expect a bacterin prepared from the organism which causes an infection to be more specific than a stock bacterin. The organism is isolated from some excretion and propagated in pure culture, and a bacterin is prepared in the same manner as the stock bacterins. This is frequently done in infections of boils. A little pus from a boil is sent to the laboratory. The bacterium causing the infection is isolated, and a bacterin is prepared with it. This bacterin is injected into the patient from whom the pus was received.

The relative advantages and disadvantages of stock and autogenous bacterins are apparent from the previous discussion. Stock bacterins are less expensive and are available in a short time. Autogenous bacterins must be prepared from material taken from the subject to whom they are to be administered, and from 3 to 5 days are usually required to make an autogenous bacterin and test it for purity and sterility. An objection that can be brought against the autogenous bacterins is negated by the fact that they are more specific and give the best results.

The bacterins, or bacterial vaccines, are known as saline bacterins because the cells are suspended in physiological sodium chloride solution. The best practice for administering saline bacterins is to give three injections as outlined. In times of peace, or when there is no emergency, this method may be followed, but in time of war, or other great emergency, it would be more satisfactory to be able to immunize with one injection. Consequently, in order to be able to use one injection and to avoid the reaction which usually follows when a saline bacterin is administered, during World War I the cells were suspended in oil (olive, cottonseed, and so on), to give what was known as *lipobacterins*. The use of lipobacterins, however, was discontinued after the war. The comparative studies which have been made fortunately indicate that the saline bacterins are superior to the lipobacterins.

Results of Prophylactic Inoculation. These are most striking for typhoid fever in large military units. Prior to 1910, when antityphoid bacterin was first used in the United States Army, from 20 to 100 in every 10,000 soldiers had typhoid fever. In two years vaccination had reduced its incidence to three in every 10,000. The first World War demonstrated on a larger scale that vaccination for typhoid fever was of great value. During the Spanish American War, 250,000 men were mobilized, 20,000 of whom had typhoid fever; 2000 of them died. In the first World War about 4 million were called into service. For every one case in our first World War Army, there were 150 cases among soldiers in the Spanish American war. During times of peace, even less typhoid fever occurs in our army. Experience in the civilian population is just as satisfactory.

Duration of Immunity. How long does immunity last after preventive inoculation? This question cannot be answered directly because there are many factors which influence the answer. In the first place, probably no satisfactory methods exist for measuring immunity in any units that could be used. Individuals vary greatly in their response to preventive inoculation. Usually, soon after the first two injections of typhoid bacterin, immunity to typhoid fever is manifest. The opinions of army officers are quite reliable in this connection. They inoculate so many individuals under controlled conditions that they have a better opportunity to study this question than many

civilian medical officers of health. Army officers believe that immunity to typhoid fever begins to decline after 2 to 2½ years, but may last longer since incidence of typhoid fever among inoculated troops is low even after 4 or 5 years.

Reasons for Failure of Preventive Inoculation. The fact that immunity is but a relative matter and may not always prevent infection should be stressed. Numerous reports are available in medical literature, especially that of the war period, dealing with outbreaks of typhoid fever among those who had been inoculated. These outbreaks should not be used as arguments against preventive inoculation, since there are satisfactory explanations. Some of them are discussed here.

Inferior Bacterin. If the bacterin has not been properly prepared, it cannot function as a good antigen or agent with which to stimulate formation of immune bodies. Bacterial cells which are to be used as bacterins should not be killed above a temperature of 63° to 65°C.; the temperature is usually kept below 60°C. They should also be stored in a cool place, although it is known that this is not an important factor over a short time.

Mistaken Diagnosis. Another possible reason for failure is giving the wrong bacterin. Some diseases are very much alike. Typhoid fever and the paratyphoid fevers have symptoms in common. A person may receive prophylactic inoculation against typhoid fever, for instance, and later have paratyphoid fever or even malaria; the diagnosis may be typhoid fever.

Massive Infection. It has been mentioned before that immunity should be regarded as relative and not an absolute means of disease prevention. Everyone possesses a certain amount of natural resistance. This may be raised by inoculation to a level whereby there is no susceptibility to ordinary doses of bacteria. Massive doses, however, frequently overcome such immunity, causing infection. This explanation has been given during recent wars for cases of typhoid fever among inoculated troops.

Lowered Resistance. Fatigue, hunger, and the like help to lower a person's resistance in infection. They may so lower it that the immunity received from inoculation is overcome.

Failure to Respond to an Antigen. Some animals do not form immune bodies in response to an antigen. The same situation may exist in human beings. Even though the bacterin may be satisfactory, the individual may not develop immunity.

Sensitized Bacterins. These are known as serobacterins or sensitized bacterial vaccines. They are made by mixing the bacterin with immune serum, allowing the mixture to stand for 24 hours, and then washing the cells with physiological sodium chloride solution. The bacterial cells are then suspended in salt solution, standardized, and put up in packages for distribution. Such cells are said to be sensitized because they have absorbed from the serum certain agents called *amboceptors* which cause them to be more easily destroyed by the body cells of the individual. Their use is somewhat limited.

Active Immunity by the Use of Bacterial Extracts. This is a broad topic which covers a number of products prepared from bacterial cells. These materials were introduced because it was believed that the immunizing portion of the cells could be secured. They have not yielded much success. The *tuberculins* are, perhaps, the best examples of such preparations.

Tuberculin. In 1890 Robert Koch announced the discovery of a substance in cultures of *Mycobacterium tuberculosis*, which caused a specific reaction in those who were afflicted with tuberculosis. He further stated that this substance, if administered over a sufficiently long time, would cure the disease. Would that further experimental work had confirmed this! The next year Koch's work was repeated by Bujwid, who proposed the name *tuberculin* for this agent. This name was adopted by Koch. Immediately after Koch announced the curative properties of tuberculin, it was generally administered but without the success reported by Koch.

The tuberculin test is a test of sensitiveness of tissues to tuberculo-protein. So far as is known, the only agent which can render the tissues of the body sensitive is *Mycobacterium tuberculosis*. When the tissues are sensitive, good evidence is at hand that tubercle formation is present in some stage of development. As long as foci of infection are present, the test will be positive.

Several different types of tuberculin are known. The first one, now spoken of as "old tuberculin" to distinguish it from tuberculin prepared by modified methods, was prepared from pure cultures of *Mycobacterium tuberculosis*. The organism was grown 5 or 6 weeks on a 5 per cent glycerol broth. After this time the culture was concentrated to about one tenth of its original volume and filtered through sterile filters to remove bacteria.

This "old tuberculin" contained, then, besides glycerol, the substances which were in the cells of *Mycobacterium tuberculosis*, the products of metabolism, undecomposed medium, and so on.

*Use of Tuberculin in Diagnosis.*⁴ Tuberculin has enjoyed some use as a diagnostic agent. It may give indication of the presence of tuberculosis in individuals where other methods are unsatisfactory. When tuberculin, in comparatively large amounts is injected into uninfected individuals, no symptoms result. When, however, it is injected into an individual suffering from this disease, there is malaise with headache, backache, and a distinct rise in temperature. A local reaction is also secured at the site of the injection. The test was once believed to be valuable among infants and young children because it indicated infection earlier. Later it was observed that it did not indicate so much as was once believed, for many of the infants never developed symptoms of tuberculosis. It is used, especially, to detect tuberculosis in cattle. Animals which give rise in temperature after injection with tuberculin are said to be "reactors" and are believed to be infected.

Von Pirquet also used tuberculin in a skin test to show presence of tuberculosis infection. A little tuberculin is applied to a scarified area of the skin; a positive test is indicated by a reddened area varying from a local hyperemia to an inflamed area. Another test, the Calmette test, involved the addition of a little diluted tuberculin to the eye of suspects; the appearance of a congested condition indicates the presence of tuberculosis.

METHODS OF PASSIVE (ACQUIRED) IMMUNITY

The methods of passive immunity, as indicated before, rest on the administration of antibodies, or immune bodies, which have been made in another animal. Methods of active immunity had to be used with the animal. The body cells in the human being to whom the immune bodies are administered remain passive and are not concerned with the immunity which is immediately established. They are not stimulated to form their own immune bodies. Such immunity is also passive in the sense that it is not so permanent as active immunity. It disappears more quickly.

⁴Tuberculin, a Report of a Conference on Its Standardization, U. S. Pub. Health Service, *Suppl. Pub. Health Repts.* 57, 1926.

Two types of antisera are used for the bestowal of passive immunity, antibacterial sera and antitoxic sera. These have been discussed before.

REFERENCES

- BOYD, W. C., *Fundamentals of Immunology*, Interscience Publishing Co., New York, 1942.
- BROADHURST, J., *How We Resist Disease: An Introduction to Immunity*, J. B. Lippincott, Philadelphia, 1923.
- GAY, F. P., *et al.*, *Agents of Disease and Host Resistance*, Charles C. Thomas, Springfield, Ill., 1935.
- IRVINE, K. N., *The BCG Vaccine*, Oxford Univ. Press, London, 1934.
- LANDSTEINER, K., *The Specificity of Serological Reactions*, Charles C. Thomas, Springfield, Ill., 1936.
- Report of the Technical Conference for the Study of Vaccination Against Tuberculosis by Means of BCG, published by the Secretariat of the League of Nations, Geneva, 1929.
- SHERWOOD, N. P., *Immunology*, C. V. Mosby Co., St. Louis, Mo., 1935.
- TOPLEY, W. W. C., *An Outline of Immunity*, Edward Arnold & Co., London, 1933.
- WELLS, H. G., *The Chemical Aspects of Immunity*, Chemical Catalogue Co., New York, 1929.
- ZINSSER, H., J. F. ENDERS, and L. R. FOTHERGILL, *Immunity Principles and Application*, Macmillan, New York, 1939.
- See Appendix for names of other books which may be consulted.

CHAPTER 31

BACTERIA IN PLANT DISEASES

Plants like other living organisms are susceptible to attack by microorganisms and viruses. Just as there are departments and bureaus in government organization for the study of diseases of man and animals, so also, are there departments and bureaus for the study of diseases of plants. Diseases of plants¹ cause great losses to agriculturists, and every attempt is made to fight them. The literature has become voluminous and is reviewed in several books, some of which are listed at the end of this chapter. Only a general statement for the student is attempted here. The discussion may be organized in different ways; however, a few common diseases of several plants are discussed under the heading of the type of infection which is caused.

Anderson gave the general symptoms of diseases of fruits as follows:

1. *Spots on Leaves or Stems.* Spots with more or less regular outlines appear on the surfaces of the leaves. Such diseases are called leaf spots. If the central dead area drops out, a shot-hole effect is produced. *Examples:* Leaf spot of cherry and bacterial shot hole of peach. Similar spots may appear on the stem, as in raspberry anthracnose.

2. *Wilt or Blight.* The ends of branches, or the entire plant, wilt or die rather suddenly without the leaves falling. *Examples:* Twig blight of pear and apple.

3. *Yellow, Sickly Foliage.* This may or may not be followed by defoliation or death of the plant or branches involved. A condition of this nature usually indicates some trouble with the root system or crown of the tree.

4. *Defoliation, or Dropping of Leaves.* *Example:* Cherry leaf spot.

5. *Rusts.* Yellow or orange-colored spots on leaves, fruit, and twigs, without death of the host tissues, are often caused by rust fungi. *Examples:* Orange rust of blackberries and apple rust.

6. *Mildew.* A white or grayish growth on the surface of the leaves of young shoots is produced by the mycelia of certain superficial fungi, the *powdery mildews*. There is also a class of *downy mildews* which produce a more dense grayish growth usually confined to a small area.

¹ F. L. Stevens, *The Relation of Plant Pathology to Human Welfare*, *Am. J. Botany*, 8 (1921), 315-22.

TABLE 8
PLANT DISEASES AND THEIR CAUSE

Name of Disease	Name of Parasite	Date and Discoverer	Type of Disease
<i>Rots.</i>			
Black cabbage rot	<i>Phytomonas campestris</i>	1893, Pammel	Withering and yellowing of leaf
Soft rot of sugar beets	<i>Phytomonas beticola</i>	1893, Smith, Brown & Townsend	Rot of the beet
Soft rot of hyacinth	<i>Bacillus hyacinthi septicus</i>	1899, Heinz	Rot of the bulb
Soft rot of carrot	<i>Erwinia carotovora</i>	1901, Jones	Soft rot
Soft rot of muskmelons	<i>Erwinia melonis</i>	1910, Giddings	Soft rot of melon
Bud rot of the coconut	<i>Escherichia coli</i> *	1912, Johnson	Rot of the bud
Rot of cauliflower	<i>Erwinia oleraceae</i>	1904, Harrison	Soft rot of roots
Stem rot of potatoes	<i>Phytomonas phytophthorus</i>	1904, Appel	Destructive soft rot of stems
Bud rot of cannabis	<i>Phytomonas cannasae</i>	1921, Bryan	Bacterial bud rot
<i>Wills</i>			
Wilt of sweet corn	<i>Phytomonas stewartii</i>	1897, Stewart	Leaves wilt one at a time
Wilt of tomato	<i>Phytomonas solanaceara</i>	1896, Smith	Plant wilts and becomes yellow
<i>Leaf Spots</i>			
Citrus canker	<i>Phytomonas citri</i>	1915, Hasse	Spots on leaves
Bacterial spot of peach	<i>Phytomonas pruni</i>	1903, Smith	Small watery spots
Leaf spot of larkspur	<i>Bacillus delphini</i>	1904, Smith	Black spots on leaves
Leaf spot of cotton	<i>Phytomonas malvacearum</i>	1901, Smith	
Leaf rot of tropical orchids	<i>Erwinia cypripedia</i>	1911, Hari	Dirty depressed spots on leaves
Leaf spot of cow peas	<i>Phytomonas vignasae</i>	1911, Gardner & Kendrick	Bacterial leaf spot
Leaf spot of lima beans	<i>Phytomonas viridifaciens</i>	1911, Tisdale & Williamson	Bacterial leaf spot
Leaf spot of celery	<i>Phytomonas apii</i>	1921, Jagger	Leaf spot

<i>Blight</i>				
Blight of pears and other trees	<i>Erwinia amylovora</i>	1878, Burrill		Blight of blossoms, twigs, etc.
Blight of beans	<i>Phytomonas phaseoli</i>	1897, Smith		Attacks foliage, pods, stems, etc.
Blight of lettuce	<i>Phytomonas viridilivida</i>	1915, Brown		Burned, dried appearance of leaves
Blight of mulberry	<i>Phytomonas mori</i>	1908, Smith		Leaves are attacked and turn black
Blight of tomato	<i>Phytomonas michiganensis</i>	1910, Smith		Wilting and yellowing of leaves
Blight of oats	{ <i>Pseudomonas avenae</i> <i>Bacillus avenae</i>	1909, Manns		Yellowing of the leaf
Blight of peas	<i>Phytomonas pisi</i>	1916, Sackett		Leaves become dark and finally black
Blight of walnut	<i>Pseudomonas juglandis</i>	1893, Pierce		Infection of the stems
Blight of alfalfa	<i>Phytomonas medicaginis</i>	1916, Paddock		Stem infection
Blight of gladioli	<i>Phytomonas gummisudans</i>	1924, McCulloch		Bacterial blight
<i>Galls</i>				
Crown gall	<i>Phytomonas tumefaciens</i>	1907, Smith		Gall formation near ground line

* There is some evidence to refute this organism as the cause of bud rot of the coconut.

7. *Spots, Blotches, or Scab Areas on the Fruit.*

8. *Rots on the Fruit.* Usually starting as a minute water-soaked area, the rot spreads and frequently involves the entire fruit. Rots may be soft or firm, dry or wet, dark or pale, or may vary between these extremes.

The student who is especially interested in these diseases will find an interesting discussion and illustration for all of these symptoms in Anderson's publication.

BLIGHTS

This is a fitting disease with which to start a discussion of specific plant diseases because it was the first definitely proved to be caused by a bacterium. Several common blights are discussed in the following paragraphs. The symptoms are given in each instance.

Pear Blight or "Fire Blight." This serious disease of pear trees also attacks the apple and quince and occasionally the plum. Although the actual loss from this disease is difficult to determine, Anderson estimated that it averages yearly 25 per cent of the potential bearing power of the trees in the United States. He stated that frequently 90 per cent of the blossoms in an orchard are blighted, and the loss of entire orchards is not uncommon.

Fire blight is apparently an old American plant disease since it is known to have been observed in 1794 in orchards along the Hudson River. It seems to have spread rapidly over the United States and Canada, following quite closely the development of orchards.

The organism causing blight of pear trees was discovered by Burrill at the University of Illinois in 1887. The organism was finally named *Bacillus amylovorus*. According to the new classification which has, in general, been followed in this book the name is *Erwinia amylovora*. The generic name in this case memorializes one of America's great plant pathologists whose death occurred in 1927, Erwin F. Smith of the Bureau of Plant Industry, United States Department of Agriculture. The bacterial parasite lives in the host but does not seem to be resistant to unfavorable conditions. Consequently it does not survive long in dead tissue. During the winter it remains dormant in tissues of the host. During the spring when the host is again active, the bacteria multiply rapidly, and many appear in a sticky secretion

from the lenticels. This material is then distributed by insects, and the disease is spread. Undoubtedly, other methods of dissemination exist, but the one just mentioned is an important natural one.

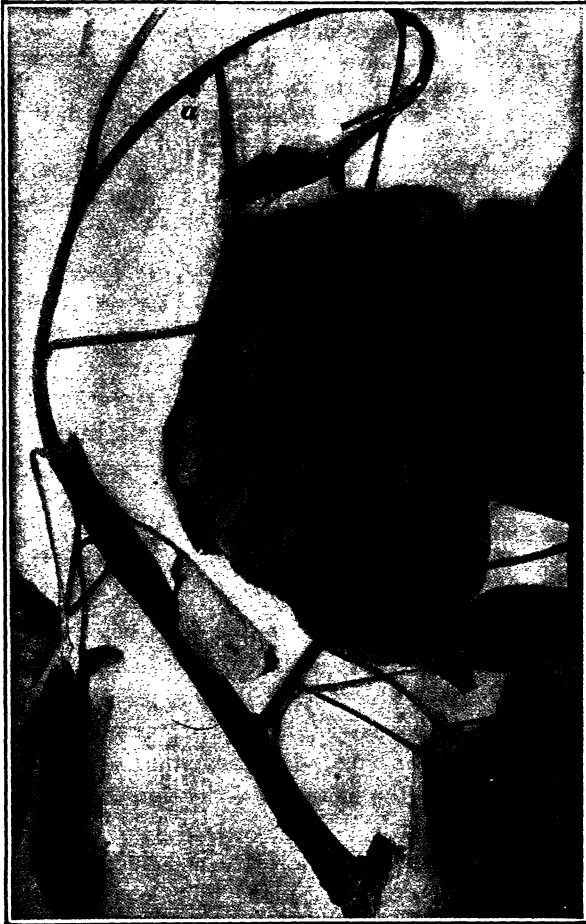

FIG. 134. Twig Blight of the Pear Showing Exuding Drop at *a*. (After Anderson, 1920)

Blight of the pear is characterized by blackening of the leaves and also of the bark on young twigs. Because the leaf or bark appears burned, the disease has also been called "fire blight." All varieties of the pear are susceptible. The blossoms may also

be attacked and readily show symptoms. Better evidence of blight, however, is observed on the twigs.

Anderson reported no successful methods for control of this disease. He mentioned the following about the nature of the disease as related to attempts to control it:

1. It is caused by a bacterium, not by a fungus.
2. It is usually introduced into the flower or twig in such a manner as to preclude the possibility of applying a spray for protective purposes, that is, of meeting the organism before it enters and preventing its multiplication.
3. After the bacteria enter the tissues, it is useless to attempt to kill them by external application of sprays.
4. The disease is usually, but not always, insect-borne.
5. The bacteria may be transferred by wind-blown mist.
6. Infection on twigs most frequently occurs through the puncture of insects.
7. When first introduced into the blossoms, the bacteria multiply rapidly in the nectar of the flowers.
8. High temperatures and dry weather are highly unfavorable for development and spread of the disease.

Blight of Lettuce. This disease was found in the southern part of the United States where about 200 acres of lettuce plants were infected. The fields looked as if fire had swept through them. The disease was evidenced by shriveling of the outer leaves of the head with some of them in a soft rotted condition. The centers of the heads examined by Brown² were sound, but between this sound area and the outer dead leaves were others affected in varying degrees. In some places there were numerous spots of water-soaked appearance. Agar plates were poured, and the etiologic agent was isolated. The organism was proved to be infectious. Brown suggested the name *Bacterium viridilividum*. According to the newer classification this name became *Phytomonas viridilivida*.

Blade Blight of Oats. This disease is evident when the oat plants are from 6 inches to a foot high. The leaves suddenly turn brown and die at the top. The lower leaves are attacked first, and the brown color soon extends their entire length. This condition extends itself, but finally the oat plant may seem to revive, put out new leaves, and mature. The crop, however, is materially reduced, the loss reaching as high as 75 per cent in some cases.

² N. A. Brown, A Bacterial Disease of Lettuce, *J. Agr. Research*, 4 (1915), 475-8.

Manns³ stated that the disease was not restricted to oats, similar troubles having been reported in wheat, grasses, alfalfa, and other crops.

The cause has been found to be symbiosis between two bacteria named *Pseudomonas avenae*, a white organism, and *Bacillus avenae*, a yellow organism. Manns stated that virulence and activity of the white organism depended largely on the presence of the yellow species. The disease could be reproduced by artificial inoculation. Stomatic infection was the chief method by which the plants were afflicted. Bruised plants took the infection much more easily and quickly than healthy plants. Insects may also aid in the dissemination of the bacteria. Other details of the disease together with illustrations, some of which are in color, may be found in the bulletin by Manns.

Bacterial Blight of Beans. The bacterial blight of beans by an organism named *Phytophthora phaseoli* infects the cotyledons, stalks, pods, seeds, and leaves. Gloyer⁴ stated that lesions on the stalk or pod may or may not be associated with leaf blight. The organism is disseminated on the seed. It may apparently infect the bean plant without formation of surface lesions. The cells of the parasite may appear in the cotyledons from infected seed and pass down into the stem of the young plant. This systemic infection is of importance in seed selection and may explain epidemics which appear late in the summer.⁵

LEAF SPOTS

As the name indicates, the lesions of disease appear on the leaves. A few of the more common or serious diseases of this nature are discussed here.

Citrus Canker. This is a serious disease of citrus fruits, study of which has resulted in its control. Stevens⁶ believed it to be the worst citrus disease that was introduced into Florida, but eradication efforts have about rid the state of it. Citrus canker

³ P. F. Manns, The Blade Blight of Oats, a Bacterial Disease, *Ohio Agr. Exp. Sta. Bull.* 210, 1909.

⁴ W. O. Gloyer, Bacterial Blight of Beans under Field Conditions, *Abstracts Bact.*, 6 (1922), abstract 109.

⁵ W. H. Burkholder, The Bacterial Blight of Beans: a Systemic Disease, *Phytopathology*, 11 (1921), 61-9.

⁶ H. E. Stevens, Florida Citrus Diseases, *Univ. Florida Agr. Exp. Sta. Bull.* 150, 1918.

attacks all varieties of citrus trees, except the kumquat. Any part of the tree above the ground may become infected. The distinguishing feature of citrus canker is characteristic spotting of fruit and foliage. Infection usually appears as small light-brown spots from less than $\frac{1}{16}$ to $\frac{1}{4}$ of an inch in diameter. The spots are usually round and may either occur singly or run together, forming irregular areas. The spots are raised above



FIG. 135. Citrus Canker Spots on Leaves and Stem. (After Stevens, 1918)

surrounding healthy tissue and are composed of a spongy mass of dead cells covered with a thin white or grayish membrane. On the leaves lesions first appear as small watery dots with raised convex surfaces. Sometimes spots appear on both sides of the leaf. The spots may also appear on twigs and fruit.

Citrus canker is a bacterial disease caused by an organism called *Phytopomonas citri*. The parasite is found in great numbers in the spots or lesions. When these spots become moist from rain or dew, the bacteria are exuded in masses. These cells may then be disseminated, and, when they come in contact with the tender tissues of twigs and fruit, new canker spots are formed.

The disease is fought by complete destruction of all infected trees and a strict quarantine against the introduction of suspected stock.

Bacterial Leafspot of Celery. This disease⁷ is confined to celery in New York and Michigan. Its cause has been named *Phytomonas appii*. The spots are a rusty-brown color, irregular in outline. Characteristic spots have been reproduced by inoculating healthy plants with the organism.

Bacterial Spot of Tomato. This is a typical plant disease⁸ affecting the fruit, stem, and leaf. It occurs on all varieties of tomatoes as well as on peppers. The organism causing this disease has been named *Phytomonas exitosa*. Foliage infection is stomatal and follows spraying the parasite over the foliage. Fruit infection results from injury; mature fruit, however, is not susceptible, probably on account of high acidity. The organism lives over the winter on the seed.

Bacterial Leafspot of Delphinium. This disease⁹ is characterized by formation of tarry, black spots on leaves, stems, or flower buds. These spots may be one centimeter across and so numerous as to occupy almost the entire leaf. Bacteria enter the tissue by way of the stomata and water pores. The organism which causes this disease has been isolated and named *Bacterium delphinii*. It has not been found to infect other plants. For control it was suggested that all disease material be burned and the soil be sprayed with Bordeaux mixture.

ROTS

These, as the name indicates, are destructive decompositions of plant tissue. Many have been described, but only a few are considered here.

Cabbage Rot. The name of this disease indicates the major characteristics. It is a very destructive disease of cabbage and cauliflower. The chief diagnostic characteristic of the disease is appearance of black streaks in the woody portion of the stem and

⁷ I. C. Jagger, Bacterial Leafspot Disease of Celery, *J. Agr. Research*, **21** (1921), 185-8.

⁸ M. W. Gardner and J. B. Kendrick, Bacterial Spot of Tomato, *J. Agr. Research*, **21** (1921), 123-56.

⁹ M. K. Bryan, Bacterial Leafspot of Delphinium, *J. Agr. Research*, **28** (1924), 261-70.

in the leaf stalks. An epidemic of the disease occurred on Long Island in 1895-96. In some cases entire fields were destroyed. The disease usually appears late in July or when the more advanced plants of late cabbage are beginning to form heads. The first symptoms include appearance of wilted condition and lighter green color. Black streaks are visible in many of the water-carrying fibrovascular bundles. The upward movement of water carries the disease up into the leaves. When the bundles supplying a portion of the leaf becomes infected, the leaf dies for lack of water.

These symptoms are due to growth in the tissue of an organism *Phytomonas campestris*. That this is the real etiologic agent is evidenced by the fact that Koch's postulates may be fulfilled with this organism and healthy plants. The organism is apparently able to live in soil, although attempts to isolate it have not been entirely satisfactory.

Stewart and Harding¹⁰ mentioned at least 3 avenues through which the bacterium gains access to the plant, wounds, cuts caused by feeding insects, and by infection through the water pores.

Satisfactory methods for combating the disease are not known. Certain investigators have advised removal of all affected leaves at frequent intervals, but Stewart and Harding found it worthless for a number of reasons. Such treatment retards the growth of the plant; infection occurs through the roots as well as through the leaves; lastly, infection may occur at the base of the leaf close to the stem and infect the stem.

Cauliflower Rot. This disease was found to affect cauliflower, turnips, and cabbages in an area about Guelph, Canada. About 40 varieties of turnips were tested, all of which were more or less susceptible. This disease was characterized by typical rotting and softening, which need not be described here in great detail. Harrison^{10a} isolated an organism to which the name *Erwinia oleracea* was given, as the etiologic agent. It reproduced the disease when inoculated on healthy plants, and in this manner Koch's postulates were fulfilled.

¹⁰ F. C. Stewart and H. A. Harding, in *N. Y. Agr. Exp. Sta. Bull.* 232, 1903. See also *Wisconsin Agr. Exp. Sta. Bull.* 65.

^{10a} F. C. Harrison, A Bacterial Disease of Cauliflower (*Brassica oleracea*) and Allied Plants. *Cent. Bakt.*, Pt. II, 13 (1904) 46-55, 184-198.

Soft Rot of Carrots. This disease was described by Jones in 1909. Carrot rot is similar to that of other vegetables. Carrots were grown on a field on which they had never been grown before so far as could be determined. During harvest an occasional root was found to have rotted, but during storage rotting increased. The same situation was experienced the next year. The roots showed a rapidly progressing soft rot which had apparently begun either at the crown or at the root tip, progressing rapidly through the core. The decaying portion was found to be softened and brown in color. This decayed portion was found to be swarming with bacteria and cultures indicated almost a pure culture. Sound carrots inoculated with this organism decayed rapidly. The organism was studied and named *Erwinia carotovora*. As remedial measures, Jones advised avoiding use of susceptible plants and contaminated compost or manure. The surfaces of the roots should be allowed to dry thoroughly before storage and benefit would ensue if they were allowed to lie as long as possible to sunlight. The temperature of the storage room should also be kept as low as possible without freezing.

Soft Rot of Muskmelon. This disease¹¹ was discovered in an experimental field. The season had been dry followed by heavy rains. The melons cracked, furnishing excellent portals for the etiologic agent to enter. The succulent tissue, of course, made a good medium on which bacteria could grow. Soft rot resulted, beginning on the under side of the fruit and spreading rapidly. The skin became shrunken over the infected areas but was generally unbroken. When the melon collapsed, there was frothing and disagreeable odor. The organism causing this soft rot was isolated and named *Erwinia melonis*. That the organism was the cause of the soft rot seems to have been confirmed by the fact that inoculation experiments reproduced the disease. In this manner Koch's postulates were fulfilled.

WILTS

Sweet Corn Wilt. This disease was well described by Stewart,¹² to whom this book is indebted for the following facts.

¹¹ N. J. Giddings, A Bacterial Soft Rot of Muskmelon Caused by *Bacillus melonis*, n. sp., *Vermont Agr. Exp. Sta. Bull.* 148, 1910.

¹² F. C. Stewart, A Bacterial Disease of Sweet Corn, *N. Y. Agr. Exp. Sta. Bull.* 130, 1897.

The affected plants wilt and dry up without apparent cause. This generally occurs about the time of flowering. The most distinctive characteristic of the disease is seen when the stem is cut lengthwise. The fibrovascular bundles appear as yellow streaks in the white parenchyma; in plants which have been dead for some time, some of the bundles may be black instead of yellow. When the stem is cut crosswise, a yellow exudate appears; this contains bacteria. The bacterium causing this disease was not named by Stewart, although he proved its etiologic relation to the disease.

GALLS

Galls are large tumor-like growths which appear on certain plants. Large losses have been suffered by nurserymen on account of the disease which, in plants, is probably due to a bacterium.

Crown Gall. This disease is characterized by the formation of galls or tumors usually on the scion just above the roots. They vary in size, depending on the host as well as the conditions which exist in the several hosts. The disease is also known as "root knot" and "hairy root." This disease occurs on a great variety of plants and is not always on the crown, for any part of the the root or shoot may be attacked. Young tissue seems to be more susceptible to attack than older plants. Smith stated that by repeated inoculations over a series of years plants were obtained which seemed to be more resistant to infection. This part of the investigations was not satisfactory but suggests the interesting possibility that immune reactions may occur in plants as well as in animals.

A bacterium by the name of *Phytomonas tumefaciens* is known to be the cause of crown gall. Smith and his colleagues proved the infectious nature of the microorganism in many inoculations. The parasite has been shown to occur in the primary tumor and also in secondary tumors. It grows well on ordinary media but gradually loses its virulence. The microorganism seems to be able to exist in the soil, and attempts should be made to keep the land free from it.

There seems to be no satisfactory method of controlling gall. Anderson stated that cutting off the tumors was not reliable, because internal strands existed which could not be removed. In

nurseries, for instance, he advised avoidance of unnecessary wounding of stems and roots. Instruments used in grafting should be frequently sterilized, and wounds caused by grafting should be wrapped. These instructions have much in common with the treatment of animal diseases.



FIG. 136. Showing Crown Gall on A, Apple, and B, Raspberry. (After Anderson, 1920)

Analogy Between Crown Gall of Plants and Animal Cancer. Evidence of this analogy was reported by E. F. Smith, who since 1907 has been an ardent supporter of the theory of resemblance between crown gall and animal cancer. At first this proposal was not accepted by plant pathologists and medical men, but today it is supported to a considerable extent by many of them. The

situation is confused somewhat because there are several different explanations as to how cancer and tumors are formed. Smith believed that in crown gall there are "peculiarities of neoplastic growth which remove it from all ordinary plant diseases and place it in the category of the true tumors (atypical blastomas)."



FIG. 137. Crown Galls on Sugar Beets 2 Months After Inoculation with *Bacterium tumefaciens*. (After Smith, 1923)

The phenomena of growth in crown gall were said to be surprising and unlike anything hitherto known in plant pathology. Smith believed that for comparative phenomena we must turn to animal pathology, especially to that dealing with malignant tumors. Consequently, Smith in his later writings argues that crown galls were to all intents and purposes cancers.

Animal cancer is now believed to result from irritation, perhaps parasitic in origin, perhaps not. The organs which are subject to the irritation are unable to endure it because of acquired or transmitted weakness. Several different parasites have, at various times, been offered as etiologic agents in cancer. At present, however, cancer is not looked on as a parasitic infection.

Virus Diseases of Plants. Plants are susceptible to virus as are animals. The first of such diseases was probably the mosaic disease of the tobacco plant. Infected plants show chlorotic or necrotic spotting. It was proved to be a virus disease by Beijerinck whose technic has been reviewed in Chapter 4. Since that time many other plant diseases have been shown to be due to viruses. The agents which cause them have been classified by one investigator in about the same way that bacteria have.¹³ The following plant diseases among many others are caused by viruses (after Holmes):

1. Mosaic Group
Tobacco, tomato, cucumber, potato,
tulip, iris, cauliflower, turnip.
2. Ring-spot Group
Tobacco, tomato.
3. Leaf-Curl Group
Tobacco, cotton, cassava.
4. Spotted-Welt Group
Tomato.

Control of Plant Diseases. The various methods of controlling plant diseases are not materially different from those for animal diseases. Anderson enumerated the following practices for dealing with diseases of fruits. These methods may probably be applied to the control of diseases in other plants.

1 *Spraying.* In general, spraying is practiced against fungi which gain entrance to the host through infection by means of a germ tube. It is usually ineffective against bacterial diseases, those caused by adverse environmental conditions, and other so-called physiological diseases. It is also ineffective, as a rule, in canker diseases, where the fungus lives from year to year in the bark or wood. It may aid in the control of these maladies, in that the original infection may be prevented.

Spray mixtures are chemical poisons which are applied to the external surface of the plant in such a manner as to kill the germ tube of the fungus, or prevent the germination of the spore, or, rarely, to kill the superficial mycelium of the fungus. On this account the surface must be thoroughly coated. The spray must be such that it stays on the surface during a fairly long period and must not be easily washed off. It is also essential that it be nonpoisonous to the plant to which it is applied. These conditions are met only when the chemicals which poison the fungus are not readily dis-

¹³ F. O. Holmes, *Handbook of Phytopathogenic Viruses*, Burgess Publishing Co., Minneapolis, Minn., 1939.

solved, and yet go into solution in sufficient quantity to prevent the development of the fungus. Frequently the problem is further complicated by the fact that a spray mixture which will not injure one kind of fruit will seriously damage another. Thus, apple trees may be sprayed with solutions which would seriously injure peach trees.

2. *Cutting Out and Destroying Diseased Parts.* Frequently the disease-producing organism is carried over winter on some part of the host, as for example, in cankers on the limbs. Again, diseased fruit or leaves dropping on the ground may harbor the fungus over winter and furnish a means of reinfection in the spring. Such "starters" should be destroyed insofar as is practical. The labor involved in some cases is so great as to make this method impracticable.

3. *Rotation of Crops.* This method of control is based on the fact that many fungi live in the soil or on decayed parts of the plant which cannot be conveniently removed. If the crop on which the disease occurs is followed for a year or so by crops not subject to it, the fungus frequently dies out to a large extent. This method is not so applicable to a fruit crop as to vegetable and field crops, since the former is scarcely ever a yearly crop. Crown gall of raspberries and certain rots can frequently be controlled in this manner.

4. *Avoiding Regions Where the Disease Prevails to a Destructive Extent.* Orchards planted on land recently cleared frequently suffer severely from *Armillaria* root rot. Such locations should be avoided.

5. *Selecting or Breeding Disease-Resistant Varieties.* It is a matter of common knowledge among fruit growers that some varieties are much more prone to "take" a disease than others. Almost all parasites show this selective action; for example, Jonathan apples blight much more severely than Grimes or Ben Davis. One soon comes to the opinion that this or that variety has in it an inherent quality which makes it more or less subject to a certain disease. Although in the main this is true, there are frequently striking exceptions to any general statement regarding the relative resistance of a variety.

It should not be forgotten, however, that there does exist a varietal resistance among most fruits, and the selection of varieties for commercial orcharding should be governed by this fact as well as by the relative market value of the varieties. It would, for example, be unwise to plant Smith Cider apples in a region where blotch is prevalent, or Cumberland raspberries where anthracnose is known to cause serious damage, if other equally good resistant varieties could be used.

There are few varieties which are absolutely immune to a disease. Relatively speaking, however, those varieties which are highly resistant are said to be "free" from the disease, and from a commercial standpoint they are classed as immune varieties.

Under most of the diseases described the varietal susceptibility is given for conditions as they prevail in Illinois, based on information received from a large number of growers, together with observations extending over a number of years by members of the horticultural staff of the Illinois Experiment Station.

6. *Destroying the Host Plants Which Harbor One Stage of the Parasite.* Destruction of the red cedar to prevent the development of apple rust is an example of this method of disease control.

REFERENCES

- ANDERSON, G. W., Diseases of Illinois Fruits, *Illinois Agr. Exp. Sta. Circ.* 241, 1920.
- HEALD, F. D., Introduction of Plant Pathology, McGraw-Hill, New York, 1943.
- HESLER, L. R., and H. R. WHETZEL, Manual of Fruit Diseases, Macmillan, New York, 1917.
- OWENS, E. C., Principles of Plant Pathology, Wiley, New York, 1928.
- SACKETT, W. G., Microbial Diseases of Plants, division 10, in Marshall's Microbiology, P. Blakiston's Son & Co., Philadelphia, 1921.
- SEIFFERT, G., Virus Diseases in Man, Animal, and Plants, Philosophical Library, New York, 1944.
- SMITH, E. F., An Introduction to Bacterial Diseases of Plants, W. B. Saunders & Co., Philadelphia, 1920.
- SMITH, E. F., Twentieth Century Advances in Cancer Research, *J. Radiol.*, September 1923.
- SMITH, K. M., A Textbook of Plant Virus Diseases, J. and A. Churchill, London, 1937.
- STEVENS, F. L., Plant Disease Fungi, Macmillan, New York, 1925.
- STEVENS, F. L., and J. G. HALL, Diseases of Economic Plants, Macmillan, New York, 1933.

APPENDIX

BACTERIAL LITERATURE

The "literature" of a science consists of all publications dealing with it. Two general groups of publications are available. The first, consisting of textbooks and similar volumes, may be passed over without much discussion for they are based on the publications in the second group. The latter group, consisting of scientific journals, proceedings of the learned societies, monographs, and such, constitutes the final basis on which knowledge in the science rests. Books, unless they report data from research investigations, are founded on such literature. Research workers the world over are recording their data in such publications to which other investigators must go. Writers, also, have to resort to these sources for information. This would be well illustrated for the introductory student if he would page through a volume of the *Journal of Bacteriology*. He would notice published papers on a great many different subjects.

A few of the more important publications in both groups are given below:

Group I: Textbooks

- ALLEN, P. W., *Industrial Fermentations*, Chemical Catalogue Co., New York, 1926.
- AMERICAN CAN Co., *The Canned Food Reference Manual*, 230 Park Ave., New York, 1943.
- ANDERSON, C. G., *An Introduction to Bacteriological Chemistry*, 2d Edition, William Wood & Co., Baltimore, 1945.
- BAITSELL, G. A., *Manual of Biology*, 6th Edition, Macmillan, New York, 1941.
- BALL, M. V., *Essentials of Bacteriology*, W. B. Saunders & Co., Philadelphia, 1919.
- o BAUMGARTNER, J. G., *Canned Foods—an Introduction to Their Microbiology*, J. and A. Churchill, London, 1943.
- BAYNE-JONES, S., *Man and Microbes*, Williams & Wilkins Co., Baltimore, 1932.
- BELDING, D. L., A. T. MARSTON, *et al.*, *A Textbook of Medical Bacteriology*, D. Appleton-Century, New York, 1938.

- BERNARD, N., and L. NEGRE, Albert Calmette, sa vie, son oeuvre scientifique, Masson et Cie., Paris, 1940.
- BESREDKA, A., Histoire d'une idée: L'Oeuvre de Metschnikoff.
- BESSEY, E. A., A Textbook of Mycology, P. Blakiston's Son & Co., Philadelphia, 1935.
- BESSON, A., Practical Bacteriology, Microbiology, and Serum Therapy, Longmans, Green, New York, 1913.
- BIGGER, J. W., Handbook of Bacteriology for Students and Practitioners of Medicine, William Wood & Co., Baltimore, 1932.
- BIRKELAND, JORGEN, Microbiology and Man, Williams & Wilkins Co., Baltimore, 1942.
- BOYD, M. F., An Introduction of Malariology, Harvard Univ. Press, 1930.
- BOYD, WILLIAM C., Fundamentals of Immunology, Interscience Publishing Co., New York, 1942.
- BROADHURST, J., Bacteria in Relation to Man—a Study Text in General Microbiology, J. B. Lippincott, Philadelphia, 1925.
- BROADHURST, J., Home and Community Hygiene, J. B. Lippincott, Philadelphia, 1925.
- BROADHURST, J., How We Resist Disease—an Introduction to Immunity, J. B. Lippincott, Philadelphia, 1923.
- BRYAN, A. H., and C. BRYAN, Principles and Practice of Bacteriology, 2d Edition, Barnes and Noble, New York, 1942.
- BUCHANAN, R. E., Agricultural and Industrial Bacteriology, D. Appleton-Century, New York, 1921.
- BUCHANAN, R. E., General Systematic Bacteriology; History, Nomenclature, Groups of Bacteria, Williams & Wilkins Co., Baltimore, 1925.
- BUCHANAN, R. E., and E. I. FULMER, Physiology and Biochemistry of Bacteria, Vols. 1, 2, and 3, Williams & Wilkins Co., Baltimore, 1928-30.
- BUCHANAN, ROBERT E., and ESTELLE D. BUCHANAN, Bacteriology for Students in General and Household Science, Macmillan, New York, 1938.
- BULLOCH, W., The History of Bacteriology, Oxford Univ. Press, London, England, 1938.
- BURDON, KENNETH L., A Textbook of Microbiology, Macmillan, New York, 1947.
- BURNET, F. M., Virus As Organism: Evolutionary and Ecological Aspects of Some Human Virus Diseases, Harvard Univ. Monographs in Med. and Pub. Health, Cambridge, Mass., 1945.
- CAMERON, G. M., The Bacteriology of Public Health, C. V. Mosby Co., St. Louis, Mo., 1940.
- CARTER, C. F., Microbiology and Pathology, C. V. Mosby Co., St. Louis, Mo., 1939.
- CHANDLER, A. C., Animal Parasites and Human Disease, Wiley, New York, 1940.
- COLIEN, F. E., Principles of Microbiology, C. V. Mosby Co., St. Louis, Mo., 1941.
- CONANT, N. F., *et al.*, Manual of Clinical Mycology, W. B. Saunders & Co., Philadelphia, 1944.
- CONN, H. W., Agricultural Bacteriology, P. Blakiston's Son & Co., Philadelphia, 1901.

- CONN, H. W., *Bacteria, Yeasts, and Molds in the Home*, Ginn & Co., Boston, 1912.
- CONN, H. W., and H. J. CONN, *Bacteriology*, Williams & Wilkins Co., Baltimore, 1926.
- CRUESS, W. V., *Commercial Fruit and Vegetable Products*, McGraw-Hill, New York, 1938.
- DEWBERRY, ELLIOT B., *Food Poisoning, Its Nature, History and Causation, Measures for Its Prevention and Control*, 2d Edition, Leonard Hill, London, 1947.
- DIBLE, J. H., *Recent Advances in Bacteriology and the Study of Infections*, P. Blakiston's Son & Co., Philadelphia, 1932.
- DOBELL, C., *Anthony van Leeuwenhoek and his "Little Animals, etc."* Harcourt, Brace, New York, 1932.
- DOUGHERTY, J. M., and A. J. LAMBERTI, *A Textbook of Bacteriology and Immunology*, C. V. Mosby Co., St. Louis, Mo., 1946.
- DREW, J., *Man, Microbe, and Malady*, Harmondsworth, Middlesex, England, 1940.
- DUBOS, R. J. *The Bacterial Cell in Its Relation to Problems of Virulence, Immunity and Chemotherapy*, Harvard Univ. Monographs in Med. and Pub. Health, Cambridge, Mass., 1945.
- DUKES, C., *The Bacteriology of Food*, H. K. Lewis & Co., London, 1925.
- EBERTSON, F., *The Microbe's Challenge*, Jacques Cattell Press, Lancaster, Pa., 1941.
- ECKLES, C. H., W. B. COMBS, and H. MACY, *Milk and Milk Products*, McGraw-Hill, New York, 1936.
- FABIAN, FREDERICK W., *Home Food Preservation, Salting, Canning, Drying, Freezing*, Avi Publishing Co., New York, 1943.
- FAIRBROTHER, R. W., *A Text-Book of Bacteriology*, William Heinemann, London, 1941.
- FISCHER, A., *Structure and Functions of Bacteria*, translated by A. C. Jones, Oxford, at the Clarendon Press, 1900.
- FORD, W. W., *Bacteriology*, Paul B. Hoeber, New York, 1939.
- FOWLER, G. J., *Bacteriological and Enzyme Chemistry*, Edward Arnold & Co., London, 1911.
- FRANKLAND, MRS. PERCY, *Bacteria in Daily Life*, Longmans, Green, New York, 1903.
- FRED, E. B., I. L. BALDWIN, and E. MCCOY, *Root Nodule Bacteria and Leguminous Plants*, Univ. Wisconsin Press, 1932.
- FROBISCHER, MARTIN, JR., *Fundamentals of Bacteriology*, W. B. Saunders & Co., Philadelphia, 1945.
- FROST, W. D., and E. F. McCAMPBELL, *A Textbook of General Bacteriology*, Macmillan, New York, 1910.
- GAINNEY, P. L., *An Introduction to the Microbiology of Water and Sewage for Engineering Students*, Burgess Publishing Co., Minneapolis, Minn., 1941.
- GALLOWAY, L. D., and R. BURGESS, *Applied Mycology and Bacteriology*, Leonard Hill, London, 1937.
- GARDNER, A. D., *Bacteriology for Medical Students and Practitioners*, Oxford Univ. Press, London, 1944.

- GARRARD, F., *Meat Technology, A Practical Textbook for Student and Butcher*, Leonard Hill, London, 1945.
- GAY, F. P., *et al.*, *Agents of Disease and Host Resistance*, Charles C. Thomas, Springfield, Ill., 1935.
- GERMAN, W. M., *Doctors Anonymous: The Story of Laboratory Medicine*, Duell, Sloan, and Pearce, New York, 1942.
- GERSHENFELD, L., *Bacteriology and Allied Subjects*, Mack Publishing Co., Easton, Pa., 1945.
- GILTNER, W., *Laboratory Manual in General Microbiology*, P. Blakiston's Son & Co., Philadelphia, 1928.
- GILTNER, WARD, *Textbook of General Microbiology*, P. Blakiston's Son & Co., Philadelphia, 1928.
- GLAUBITZ, M., *Atlas der Gärungsmikroorganismen*, Paul Parey, Berlin, 1932.
- GREAVES, J. E., *Agricultural Bacteriology*, Lea & Febiger, Philadelphia, 1922.
- GREAVES, J. E., and E. O. GREAVES, *Bacteria in Relation to Soil Fertility*, D. Van Nostrand, New York, 1925.
- GREAVES, J. E., and E. O. GREAVES, *Elementary Bacteriology*, W. B. Saunders & Co., Philadelphia, 1946.
- GUILLIERMOND, A., *Clef Dichotomique pour la détermination des levures*. Libraire le François, Paris, 1928.
- GUILLIERMOND, A., *The Yeasts*, translated by F. W. Tanner, Wiley, New York, 1920.
- HAGAN, W. A., *The Infectious Diseases of Domestic Animals*, Comstock Publishing Co., Ithaca, N. Y., 1943.
- HAMMER, BERNARD W., *Dairy Bacteriology*, Wiley, New York, 1938.
- HARDEN, A., *Alcoholic Fermentation*, Longmans, Green, New York, 1932.
- HARDENBERGH, W. A., *Water Supply and Purification*, International Book Co., Scranton, Pa., 1945.
- HAUPT, ARTHUR W., *Fundamentals of Biology*, McGraw-Hill, New York, 1940.
- HEALD, F. D., *Introduction to Plant Pathology*, McGraw-Hill, New York, 1943.
- HEGNER, R. W., F. M. ROOT, D. L. AUGUSTINE, and C. G. HUFF, *Parasitology*, D. Appleton-Century, New York, 1938.
- HEINEMANN, P., *Milk*, W. B. Saunders & Co., Philadelphia, 1921.
- HENRICI, ARTHUR T., *The Biology of Bacteria*, D. C. Heath, Boston, 1934.
- HENRICI, ARTHUR T., *Molds, Yeasts, and Actinomycetes*, Wiley, New York, 1930.
- HERMS, W. B., *Medical Entomology, with Special Reference to the Health and Well-Being of Man and Animals*, Macmillan, New York, 1939.
- HEWLETT, R. T., *A Manual of Bacteriology*, J. and A. Churchill, London, 1921.
- HILL, H., *Pasteurization*, H. K. Lewis & Co., London, 1943.
- HILL, H., *Sanitary Science Notes, A Handbook for Students*, H. K. Lewis & Co., London, 1946.
- HILL, J., *Germs and the Man*, G. P. Putnam's Sons, New York, 1940.
- HILLIARD, C. M., *A Textbook of Bacteriology and Its Applications*, Ginn & Co., Boston, 1936.

- HODER, F., *Bakteriologische und Hygiene des täglichen Lebens, Ein Lehr- und Lesebuch für alle*, Gustav Fischer, Jena, Germany, 1937.
- HOLMAN, R. M., and W. W. ROBBINS, *A Textbook of General Botany for Colleges and Universities*, Wiley, New York, 1940.
- HOLMES, F. O., *Handbook of Phytopathogenic Viruses*, Burgess Publishing Co., Minneapolis, Minn., 1939.
- HOPPER, MARY E., *An Introduction to Medical Mycology*, Year Book Publishers, Chicago, 1943.
- HORWOOD, M. P., *Public Health Surveys*, Wiley, New York, 1921.
- HOUDUROY, PAUL, and C. EHRINGER, *Dictionnaire des bactéries pathogènes*, Masson et Cie, Paris, 1937.
- HUDDLESON, I. F., *Brucella Infections in Animals and Man*, Commonwealth Fund, New York, 1934.
- HULL, THOMAS G., *Diseases Transmitted from Animals to Man*, Charles C. Thomas, Springfield, Ill., 1941.
- JACOB, H. E., *Six Thousand Years of Bread*, Doubleday Doran, Garden City, N. Y., 1944.
- JACOBS, MORRIS B., *The Chemistry and Technology of Food and Food Products*, Interscience Publishing Co., New York, 1944.
- JENSEN, L. B., *Microbiology of Meats*, Garrard Press, Champaign, Ill., 1944.
- JONES, OSMAN, and T. W. JONES, *Canning Practice and Control*, Chapman & Hall, London, 1937.
- JORDAN, E. O., *A Textbook of General Bacteriology*, W. B. Saunders & Co., Philadelphia, 1945.
- JORDAN, E. O., and I. FALK, *Newer Knowledge of Bacteriology and Immunology*, Univ. Chicago Press, 1928.
- JORGENSEN, A., *Micro-Organisms and Fermentation*, Chas. Griffin & Co., London, 1939.
- KELSER, RAYMOND B., and HARRY SCHOENING, *Manual of Veterinary Bacteriology*, Williams & Wilkins Co., Baltimore, 1943.
- KENDALL, A. I., *Bacteriology, General, Pathological, and Intestinal*, Lea & Febiger, Philadelphia, 1928.
- KENDALL, A. I., *Civilization and the Microbe*, Houghton Mifflin, Boston, 1923.
- KINNICUTT, L. P., C.-E. A. WINSLOW, and R. W. PRATT, *Sewage Disposal*, Wiley, New York, 1919. (Out of print.)
- KLUYVER, A. J., *The Chemical Activities of Microorganisms*, Univ. London Press, 1931.
- KOLMER, JOHN A., *Clinical Diagnosis by Laboratory Examinations*, D. Appleton-Century, New York, 1943.
- KOLMER, JOHN A., and FRED BOERNER, *Approved Laboratory Technic*, 3d Edition, D. Appleton-Century, New York, 1941.
- KOPELOFF, N., *Lactobacillus acidophilus*, Williams & Wilkins Co., Baltimore, 1926.
- KOPELOFF, N., *Man versus Microbes*, Knopf, New York, 1930.
- LAFAR, F., *Handbuch der technischen Mykologie*, 2d Edition, 5 Vols. between 1904 and 1914, Gustav Fischer, Jena, Germany.
- LANGERON, M., *Précis de Mycologie*, Masson et Cie, Paris, 1945.

- LEIFSON, E., *Bacteriology for Students of Medicine and Public Health*, Paul B. Hoeber, New York, 1942.
- LEWIS, G. M., and M. E. HOPPER, *An Introduction to Medical Mycology*, Year Book Publishers, Chicago, 1939.
- LILLIE, R. S., *General Biology and Philosophy of Organisms*, Univ. Chicago Press, 1945.
- LÖHNIS, F., and E. B. FRED, *Textbook of Agricultural Bacteriology*, McGraw-Hill, New York, 1923.
- MACNEAL, W. J., *Pathogenic Microorganisms; a Textbook of Microbiology for Physicians and Students of Medicine*, P. Blakiston's Son & Co., Philadelphia, 1920.
- MARSHALL, C. E., *Microbiology*, P. Blakiston's Son & Co., Philadelphia, 1921.
- MASON, W. P., *Examination of Water*, 6th Edition revised by A. M. Buswell, Wiley, New York, 1931.
- MATHESON, R. M., *Medical Entomology*, Charles C. Thomas, Springfield, Ill., 1932.
- MCCULLOCH, ERNEST C., *Disinfection and Sterilization*, 2d Edition, Lea & Febiger, Philadelphia, 1945.
- McFARLAND, J., *A Textbook upon the Pathogenic Bacteria and Protozoa for Students of Medicine and Physicians*, W. B. Saunders & Co., Philadelphia, 1919.
- MEDICAL RESEARCH COUNCIL, Great Britain, *A System of Bacteriology*, 9 Vols., His Majesty's Stationery Office, London, 1929.
- MORREY, C. B., *Fundamentals of Bacteriology*, Lea & Febiger, Philadelphia, 1923.
- MUDGE, C. S., and F. R. SMITH, *A Fundamental Approach to Bacteriology*, J. W. Stacey, San Francisco, 1939.
- MUIR, R., *Bacteriological Atlas*, William Wood & Co., Baltimore, 1937.
- Muir and Ritchie's *Manual of Bacteriology*, revised by C. H. Browning and T. J. Mackie, 10th Edition, Oxford Univ. Press, London, 1937.
- MUSTARD, H. S., *An Introduction to Public Health*, 2d Edition, Macmillan, New York, 1944.
- NICOL, H., *Microbes by the Million*, Harmondsworth, Middlesex, England, 1940.
- OBOLD, W. L., and M. M. DIEHM, *Manual of Microbiology for the Study of Bacteria Yeasts and Molds*, F. A. Davis Co., Philadelphia, 1932.
- ORLA-JENSEN, S., *Dairy Bacteriology*, P. Blakiston's Son & Co., Philadelphia, 1921.
- OWENS, E. C., *Principles of Plant Pathology*, Wiley, New York, 1928.
- PARK, W. H., *Public Health and Hygiene*, Lea & Febiger, Philadelphia, 1928.
- PARK, W. H., and A. W. WILLIAMS, *Pathogenic Microorganisms*, Lea & Febiger, Philadelphia, 1933.
- PARK, W. H., and A. W. WILLIAMS, *Who's Who Among the Microbes*, D. Appleton-Century Co., New York, 1929.
- PARKER, H. N., *City Milk Supply*, McGraw-Hill, New York, 1917.
- PERCIVAL, J., *Agricultural Bacteriology*, Duckworth & Co., London, 1920.
- PIERCE, A., *Home Canning for Victory*, Barrows, New York, 1942.

- PRESCOTT, S. C., and C. G. DUNN, *Industrial Microbiology*, McGraw-Hill, New York, 1940.
- PRESCOTT, S. C., and M. P. HORWOOD, *Sedgwick's Principles of Sanitary Science and the Public Health*, Macmillan, New York, 1935.
- PRESCOTT, S. C., and B. E. PROCTOR, *Food Technology*, 2d Edition, McGraw-Hill, New York, 1937.
- PRESCOTT, S. C., C. E.-A. WINSLOW, and M. H. McCRADY, *Water Bacteriology with Special Reference to Sanitary Water Analysis*, Wiley, New York, 1946.
- PREVOT, A. R., *Manuel de classification et de détermination des bactéries anaérobies*, Masson et Cie., Paris, 1940.
- PRUDEN, T. M., *The Story of Bacteria and Their Relations to Health and Disease*, G. B. Putnam's Sons, New York, 1910.
- RACE, J., *The Examination of Milk for Public Health Purposes*, Wiley, New York, 1918.
- RAHN, OTTO, *Microbes of Merit*, Ronald Press, New York, 1945.
- RAHN, OTTO, *Physiology of Bacteria*, Macmillan, New York, 1932.
- RATCLIFF, J. D., *Men Against Microbes*, Jarrolds, London, 1940.
- RICE, THURMAN B., *A Textbook of Bacteriology*, W. B. Saunders & Co., Philadelphia, 1942.
- RILEY, W. A., and O. A. JOHANNSEN, *Medical Entomology—A Survey of Insects and Allied Forms Which Affect the Health of Man and Animals*, McGraw-Hill, New York, 1932.
- ASSOCIATES OF L. A. ROGERS, *Fundamentals of Dairy Science*, Chemical Catalogue Co., New York, 1923.
- ROSENAU, M. J., *Preventive Medicine and Hygiene*, D. Appleton-Century, New York, 1940.
- RUSSELL, H. L., and E. G. HASTINGS, *Agricultural Bacteriology*, D. Appleton-Century, New York, 1921.
- RYAN, W. J., *Water Treatment and Purification*, 2d Edition, McGraw-Hill, New York, 1946.
- SALLE, A. J., *Fundamental Principles of Bacteriology*, McGraw-Hill, New York, 1943.
- SCOTT, GEORGE G., *The Science of Biology, an Introductory Study*, Thomas Y. Crowell, New York, 1936.
- SEIFFERT, GUSTAV, *Virus Diseases in Man, Animals, and Plants*, Philosophical Library, New York, 1944.
- SHRADER, J. H., *Food Control, Its Public Health Aspects*, Wiley, New York, 1939.
- SINCLAIR, C. G., *Microbiology and Pathology*, 5th Edition, F. A. Davis Co., Philadelphia, 1941.
- SKINNER, CHARLES E., CHESTER W. EMMONS, and HENRY M. TSUCHIYA, *Henrici's Molds, Yeasts, and Actinomycetes; A Handbook for Students of Bacteriology*, Wiley, New York, 1947.
- SMITH, GEORGE, *An Introduction to Industrial Mycology*, 3d Edition, Edward Arnold & Co., London, 1946.
- SMITH, K. M., *A Text Book of Plant Virus Diseases*, J. and A. Churchill, London, 1937.

- SMITH, K. M., *A Text Book of Plant Viruses*, 3d Edition, P. Blakiston's Son & Co., Philadelphia, 1946.
- SMITH, K. M., *Recent Advances in the Study of Plant Viruses*, P. Blakiston's Son & Co., Philadelphia, 1934.
- STEINHAUS, E. A., *Insect Microbiology*, Comstock Publishing Co., Ithaca, N. Y., 1946.
- STEPHENSON, MARJORIE, *Bacterial Metabolism*, Longmans, Green, New York, 1939.
- STEVENS, F. L., and J. G. HALL, *Diseases of Economic Plants*, Macmillan, New York, 1933.
- STITT, E. R., P. W. CLOUGH, and M. C. CLOUGH, *Practical Bacteriology, Haematology, and Animal Parasitology*, P. Blakiston's Son & Co., Philadelphia, 1938.
- SUMNER, J. B., and G. F. SOMERS, *Chemistry and Methods of Enzymes*, Academic Press, New York, 1943.
- SWARTZ, JACOB H., *Elements of Medical Mycology*, Grime and Stratton, New York, 1943.
- SWINGLE, D. B., *General Bacteriology*, D. Van Nostrand, New York, 1940.
- TANNER, F. W., *Food-Borne Infections and Intoxications*, Garrard Press, Champaign, Ill., 1933.
- TANNER, F. W., *The Microbiology of Foods*, Garrard Press, Champaign, Ill., 1944.
- TAUBER, H., *Enzyme Technology*, Wiley, New York, 1943.
- THOM, C., and K. C. RAPEL, *A Manual of The Aspergillii*, Williams & Wilkins Co., Baltimore, 1945.
- THOMPSON, L. V., *Introduction to Microorganisms*, W. B. Saunders & Co., Philadelphia, 1944.
- TOPLEY, W. W. C., and G. S. WILSON, *The Principles of Bacteriology and Immunity*, William Wood & Co., Baltimore, 1936. (See Wilson and Miles for a later revision and title.)
- TRESSLER, D. K., and C. F. EVERS, *The Freezing Preservation of Foods*, Avi Publishing Co., New York, 1943.
- TRESSLER, D. K., and C. F. EVERS, *The Freezing Preservation of Fruits, Fruit Juices, and Vegetables*, Avi Publishing Co., New York, 1936.
- TRESSLER, D. K., C. F. EVERS, and LUCY LONG, *Into the Freezer and out*, Avi Publishing Co., New York, 1946.
- TRESSLER, D. K., M. A. JOSLYN, and G. L. MARSH, *Fruit and Vegetable Juices*, Avi Publishing Co., New York, 1939.
- VAN ROOYEN, C. E., and A. J. RHODES, *Virus Diseases of Man*, Oxford Univ. Press, London, 1940.
- VON LOESECKE, HARRY W., *Drying and Dehydration of Foods*, Reinhold Publishing Corp., New York, 1943.
- VON LOESECKE, HARRY W., *Outlines of Food Technology*, Reinhold Publishing Corp., New York, 1942.
- WAKSMAN, S. A., *Principles of Soil Microbiology*, 2d Edition, Williams & Wilkins Co., Baltimore, 1932.
- WEINBERG, M., R. NATIVELLE, and A. R. PREVOT, *Les Microbes anaerobies*, Masson et Cie., Paris, 1937.

- WILLIAMS, MIRIAM, *Home Canning Made Easy*, Macmillan, New York, 1943.
- WILSON, C. M., *Ambassadors in White*, Henry Holt, New York, 1942.
- WILSON, G. S., *The Pasteurization of Milk*, Longmans, Green, New York, 1942.
- WILSON, G. S., and A. A. MILES, *Topley and Wilson's Principles of Bacteriology and Immunity* (in two volumes), Williams & Wilkins Co., Baltimore, 1946.
- WOODCOCK, F. H., *Canned Foods and the Canning Industry*, I. Pitman & Sons, London, 1938.
- ZINSSER, H., *Resistance to Infectious Diseases*, Macmillan, New York, 1931.
- ZINSSER, H., and S. BAYNE-JONES, *A Textbook of Bacteriology*, D. Appleton-Century, New York, 1939.
- ZOBELL, C. E., *Marine Microbiology*, Chronica Botanica Co., Waltham, Mass., 1945.

Abstracts. It would be difficult if not quite impossible for a scientist to follow each of the numerous publications in which articles in his field might be published. In order to assist, so-called abstract journals are published. An abstract might be defined as a short digest of a long paper. It states briefly the pertinent facts in the original paper. These abstracts are sent by those who make them to a central office where they are classified for publication. The following is an abstract taken from an abstract journal. It illustrates the preceding discussion.

The dish towel as a source of tuberculous infection. C. Floyd and L. Sikorsky (*Amer. Rev. Tuberculosis*, 7 (1923), No. 2, pp. 117-119).—The possibility of dish towels being a source of tuberculosis infection in homes where there are active cases of tuberculosis was studied by the inoculation of guinea pigs with washings of dish towels used by tuberculous patients.

In the series of twenty-five cases thus examined, no positive results were obtained. Negative results were also obtained in three control experiments in which gauze was thoroughly impregnated with tubercle bacilli and then thoroughly washed, after which tests were made as in the case of the dish towels. It is thought that the most reasonable explanation of these negative results is that any viable tubercle bacilli which might have been caught in the meshes of the dish towel were either killed or weakened by the strong alkali soap or soap powder used in washing the dishes and towels.

The original article from which this abstract was prepared was three pages in length. The abstractor used only 12 lines for his "digest" or "abstract." A recent volume of *Biological Abstracts* had abstracts of 23,491 published papers in biology. The original articles probably covered over 400,000 printed pages. Another advantage for us of an abstract journal is the fact that articles

in foreign-language journals are abstracted in English. The following is an example:

Madruga, M. Considerações em torno da Salmonella typhimurium. (Notes on *S. t.*) Bol. Inst. Vital Brazil 25:34-40. 1943.—A *Salmonella*, able to infect guinea pigs and mice inoculated "per os," was isolated from pleural pus and feces of a person with fatal infection. It possessed the morph., staining, biochem., and serological characteristics of *S. typhimurium*.—A. Braga.

The following are useful abstract journals.

Abstracts of Bacteriology (Now continued as *Biological Abstracts*).
Chemical Abstracts.
Biological Abstracts.
Experiment Station Record.
Bulletin de l'Institute Pasteur.

Before the present abstract journals had been founded, bacteriologists and biologists used "*Jahresberichts*" (annual reports). These consisted of abstracts of scientific articles published during the year. Two such were:

Baumgarten's *Jahresbericht über die Fortschritte in der Lehre von den Pathogenen Mikroorganismen umfassend Bakterien, Pilze, und Protozoen*.

Koch's *Jahresbericht über die Fortschritte in der Lehre von den Gährungsorganismen*.

JOURNALS AND PERIODICALS

In such journals are published results of original investigations as scientific articles of different lengths. A few of the more important ones are:

American Journal of Public Health.
Annales de l'Institute Pasteur.
Archiv für Hygiene.
Archives of Biochemistry.
Bacteriological Reviews.
Biochemical Journal.
British Medical Journal.
Comptes Rendus des Séances de l'Académie des Sciences.
Comptes Rendus des Séances de la Société de Biologie.
Food Research.
Journal of the American Medical Association.
Journal of Bacteriology.
Journal of Biological Chemistry.
Journal of Dairy Science.
Journal of Hygiene.

Journal of Infectious Diseases.
Journal of Medical Research.
Journal of Pathology and Bacteriology.
Lancet.
Zentralblatt für Bakteriologie.

The journals listed containing results of original investigations are published at regular intervals, that is, weekly, semi-monthly, monthly, and so on. Another type of periodical has become popular and valuable during recent years. This contains concise and exhaustive reviews of several subjects of timely interest prepared by authorities in the respective fields of specialization. Such reviews correlate and offer interpretations of the many individual investigations reported in the current literature. Several such journals are published, probably the more important one for bacteriologists being *Bacteriological Reviews*. Chemists rely on *Chemical Reviews*.

A modification of the review journal has also become popular more recently. Several reviews of timely interest are published yearly in book form, each review being a comprehensive examination of current literature. Such publications of interest to students of the biological sciences are: *Annual Reviews of Biochemistry*, *Annual Reviews of Physiology*, and *Advances in Enzymology*. These books are the counterpart of the "Jahresberichts" appearing several years ago except that they are the results of collaboration by several collaborators.

Much valuable scientific literature appears as bulletins of the many state agricultural experiment stations as well as of the United States Department of Agriculture. These frequently contain information of more practical nature but often report results of original investigations.

GLOSSARY

- Aberrant:** Deviating from a type taken as the normal.
- Abiogenesis:** Spontaneous generation; the production of animate from inanimate matter.
- Abrasion:** A breaking of the skin or other membrane.
- Abscess:** A limited area containing pus.
- Abstract:** A short condensed report of a longer publication.
- Accessory:** Assisting; supplementing.
- Acne:** Inflammation of the sebaceous glands.
- Activator:** A substance which activates, such as cofermnt.
- Acute:** Severe, sharp.
- Acute disease:** One which reaches a crisis quickly.
- Aeration:** Admixture with air.
- Aerial:** Extending into the air; pertaining to air.
- Aerobe:** Organism requiring free oxygen for life.
- Aerobiosis:** Life requiring free oxygen.
- Aerogen:** A microorganism which forms gas during its metabolism.
- Agar (Agar-Agar):** A higher carbohydrate used in media.
- Agglutinate:** Clumping; a bringing together.
- Agglutination:** The act of bringing together.
- Agglutinin:** A substance formed in the blood of animals which agglutinates an antigen; an immune body, an antibody.
- Ague:** Intermittent fever such as occurs in malaria.
- Albicans:** White.
- Albuminate:** A salt formed with albumin.
- Alcoholase:** An enzyme which changes ethyl alcohol to acetic acid.
- Algae:** Microorganisms, mostly aquatic cryptogams.
- Algicide:** An agent which destroys algae.
- Allergy:** The reaction shown by an organism against a substance for which it has been sensitized.
- Alveolar:** A honeycomb structure.
- Amboceptor:** A substance in blood serum which unites complement with cells.
- Amicrobic:** Free of microbes not caused by bacteria.
- Amino acid:** Building stones of proteins; amino compounds of fatty acids.
- Amphitrichous:** Flagella at each end of the cell.
- Anabolism:** Constructive function of living cells.
- Anaerobe:** An organism which does not require air but does require combined oxygen.
- Analytic:** Separation into parts; the destructive function in metabolism is analytic.
- Anaphylaxis:** Hypersusceptibility to a foreign protein.

- Anastomosis:** A union of hollow organs or cells.
- Angina:** Feeling of suffocation.
- Antagonism:** Antibiosis; opposition.
- Anthracoid:** Like anthrax.
- Anti-:** Prefix meaning against.
- Antibiosis:** Antagonism; a harmful association of one or more organisms.
- Antibiotics:** Agents which are inimical to pathogenic bacteria; especially those formed by fungi.
- Antibody:** An agent in the blood of animals which reacts with (destroys in some cases) other substances called antigens.
- Antidote:** A preparation given to counteract a poison.
- Antienzyme:** A substance counteracting the action of enzymes.
- Antifermentative:** Preventing fermentation.
- Antigen:** A substance which, when injected into animals, stimulates the appearance of antibodies or immune bodies.
- Antiseptic:** A substance which represses the development of microorganisms.
- Antiserum:** A preparation from the blood of animals (usually blood serum) which contains specific immune bodies.
- Antitoxin:** A serum which counteracts a toxin.
- Antizymotic:** A substance preventing fermentation.
- Arthritis:** Inflammation at a joint.
- Arthrospore:** A spore form which includes the entire cell.
- Asexual:** Not sexual.
- Ascomycetes:** A group of fungi.
- Ascospore:** A spore formed in an ascus.
- Ascus:** A sac-like structure in which ascospores are borne.
- Asepsis:** Absence of microorganisms or septic material.
- Aspergillosis:** An infection in which an aspergillus is the etiologic agent.
- Assimilation:** *See* Anabolism.
- Atrichous:** Without flagella.
- Attenuate:** To devitalize or weaken.
- Autogenesis:** Self-production.
- Autogenous:** Self-produced; for vaccine one prepared from organism causing infection.
- Autoinfection:** Self-infection.
- Autointoxication:** Self-poisoning by poisons formed within the body.
- Autolysis:** Self-digestion.
- Autotoxin:** A toxin or poison originating within the body.
- Autotrophic:** Bacteria which are able to get along with carbon dioxide and inorganic salts.
- Azymous:** Without fermenting agents; unleavened.
-
- Bacillicide:** An agent which destroys bacilli.
- Bacilliform:** Having the shape of a bacillus; bacillus-like.
- Bacillosis:** A state of having bacilli present.
- Bacillus:** A genus of Schizomycetes; rod-shaped; forming endospores.
- Bacteremia:** The presence of bacteria in the blood stream.
- Bactericidal:** Destructive to bacteria.

- Bacterin:** A bacterial vaccine; suspension of dead bacterial cells in oil, saline, etc.
- Bacteriolysin:** An immune body which dissolves bacterial cells.
- Bacteroid:** Growth forms of *Rhizobium leguminosarum* (*Bacillus radicicola*).
- Biogenesis:** Genesis of living beings from living beings.
- Biolysis:** Decomposition by living beings.
- Bios:** An accessory substance supposed to be necessary for growth of yeasts.
- Blanching:** A preliminary step in the canning of foods.
- Blastomyces:** A genus of fungi reproducing by budding.
- Bovine:** Having to do with cattle.
- Brownian movement:** Oscillatory movement of particles; not a translocation in space.
- Canker:** A diseased area in the bark of trees and shrubs.
- Capsule:** A mucilaginous envelope surrounding certain bacterial cells.
- Carrier:** An individual who harbors and excretes pathogenic bacteria.
- Catabolism:** Breaking down of body tissue.
- Catalyst:** An agent which alters the speed of a reaction which is going on very slowly.
- Cell:** A bit of protoplasm with a nucleus.
- Certified milk:** Milk produced under a legal contract between a dairyman and a Medical Milk Commission.
- Cesspool:** A contrivance for the anaerobic decomposition of the organic matter in sewage.
- Chemoanalytic:** The breaking down of complex compounds releasing energy.
- Chemosynthetic:** Synthetic reactions utilizing energy from chemical changes.
- Chemotaxis:** Reaction of an organism to chemicals, may be positive or negative.
- Chlorination:** Addition of chlorine; use of chlorine in disinfection.
- Chromogenic:** Forming pigments.
- Chromoporous:** Colorless bacteria which secrete a pigmented compound.
- Chronic disease:** A disease of slow onset and progress.
- Cilium:** A thread-like appendage by which certain microorganisms propel themselves.
- Class:** A division in classification of living beings, a group of orders.
- Classification:** A systematic, reasonable arrangement of data or facts.
- Coagulation:** Clotting.
- Coccus:** A round bacterial cell.
- Coenocytic:** Nonseptate structure of molds.
- Columella:** The central axis of the spore case about which the conidia are formed in molds.
- Communicable disease:** A disease which may be transmitted.
- Complement:** A heat-labile substance found in blood.
- Conidiophore:** A thread or stalk bearing conidia.
- Conidium:** An asexual spore formed by fungi.
- Conjugation:** Process in which two cells (gametes) unite, with change of cell contents.

- Contact:** Exposure to a communicable disease.
- Contagious disease:** A disease believed to be transmissible either by direct or indirect contact.
- Contamination:** Infection with septic matter.
- Copulation:** Act of sexual union.
- Crenothrix:** A genus of Schizomycetes.
- Cryptococcus:** A group of pathogenic yeast-like fungi.
- Crystalloid:** Having to do with crystals.
- Cycle:** An orderly succession of the various stages through which elements are made to pass.
- Cyst:** A resistant sac-like structure.
- Cytology:** Science of cell theory.
- Cytoplasm:** The protoplasm in cells.
-
- Decay:** Arobie decomposition of protein matter.
- Denitrification:** Reduction of nitrates with liberation of nitrogen.
- Desensitize:** To rid of susceptibility of anaphylaxis.
- Dichotomy:** Division into two parts; dichotomous branching.
- Digestion:** Breaking down of foods for passage through cell wall.
- Diplococcus:** Two round cells with the adjacent surfaces somewhat flattened.
- Dissaccharide:** A sugar composed of two molecules of monosaccharides.
- Disease:** An abnormal condition of body or mind.
- Disinfect:** To destroy infectious matter.
- Dissemination:** Spreading of pathogenic organisms.
- Dissimilation:** *See* Katabolism.
- Double Seam:** The closure applied to a tin container for preserving food.
- Dysentery:** Inflammation of the intestinal mucosa; bloody stools.
-
- Effluent:** That which flows from.
- Endemic:** Disease which is always present.
- Endo-:** Prefix meaning inside.
- Endospore:** A spore formed in a cell.
- Energy:** Power to do work.
- Enteric:** Having to do with the intestines.
- Enteritis:** Inflammation of the intestines.
- Epidemic:** An unusual number of cases of communicable disease within a restricted area and time.
- Epidemiology:** Science of spread of communicable diseases.
- Erepsin (ereptase):** An enzyme which hydrolyzes peptones to amino acids.
- Etiology:** Science of the causes of disease.
- Exhaust:** The procedure in canning foods by which it is attempted to remove air from the food before the can is closed.
- Extra:** Prefix meaning outside.
- Extracellular:** Outside the cell.
- Extraneous:** Foreign to the consideration.
- Exúdate:** A substance thrown out; pus.
-
- Facultative:** Not obligatory; indifferent.

- Families:** A group of tribes; names of families end in *aceae*.
- Fauna:** The animal life of an area.
- Fecundation:** Fertilization.
- Ferment:** *See* Enzyme.
- Fermentation:** Anaerobic respiration.
- Fertilization:** Impregnation.
- Filamentous:** Thread-like; made up of threads.
- Filar:** Filamentous; thread-like.
- Fission:** Reproduction by division.
- Fixation:** The act of holding fast.
- Flagellum:** A whip-like appendage on a cell.
- Flat sour:** A type of spoilage of certain canned foods; formation of acid without gas.
- Flora:** The plant (bacteria) life of a substance or area.
- Focal:** Having to do with a focus or point.
- Fomite:** An agent, usually inanimate, by which infection is spread.
- Food:** A substance which may be used for growth or repair by living organisms.
- Fruiting body:** A complex, spore-bearing structure, usually with a definite shape.
- Fungus:** A plant of simple structure lacking chlorophyll. It has no root, stem or leaf and reproduces by spores, usually asexual in nature.
- Fusiform:** Spindle shaped.
-
- Gamete:** Any sexual reproductive body.
- Gangrene:** Death of tissue usually accompanied by putrefaction.
- Target:** Inflammation of tissues in cow's udder.
- Gastric:** Having to do with the stomach.
- Gastritis:** Inflammation of the stomach.
- Gelose:** Agar-agar, or the gelatinizing principle thereof.
- Germ:** A microorganism.
- Germ tube:** The first shoot formed in the germination of a fungus spore.
- Germicidal:** Destructive to germs.
- Germination:** The process of germinating; the beginning of vegetation or growth in a seed or plant; the first development of germs either animal or vegetable.
- Gland:** A secretory organ.
- Globulin:** A group of proteins.
- Growth:** Increase in cell mass.
-
- Haptophore:** That portion of toxin molecules which bind them to body cells.
- Health:** State of well-being in body and mind.
- Heliotropism:** Reaction of living organisms to light; chemotaxis induced by light.
- Hemolysin:** The specific lysin which destroys red blood corpuscles.
- Hemolysis:** Destruction of red blood corpuscles (erythrocytes).
- Hemolytic:** The property of causing hemolysis.

Heterotrophic: Said of bacteria which cannot use inorganic nitrogen and carbon for growth.

Homogeneous: Uniform throughout.

Homologous: Having the same function.

Host: A living agent on which another lives as a parasite.

Humoral: Having to do with the natural body fluids.

Hydrolysis: Decomposition by means of water.

Idiosyncrasy: A peculiarity; said of those especially sensitive to certain proteins.

Immune bodies: Agents in the blood and tissues of animals which are responsible for immunity.

Immunity: Possession of resistance against specific infectious diseases above the ordinary.

Immunize: To confer immunity.

Inactivate: To render inactive; to destroy.

Incubation: That period in disease between exposure and the first symptoms; also, the procedure in the culture of microorganisms by which their growth is favored by proper temperature.

Infect: To communicate pathogenic organisms.

Infection: Entrance and growth of a parasite in a host.

Infectiousness: The degree of infectiousness.

Infectious disease. A disease secured by infection with a living cell.

Inflammation: Condition of tissues in response to irritation, accompanied by heat, pain, swelling, etc.

Infra: Below; beneath; under; after. Often used in prefix.

Infundibuliform: Funnel-shaped.

Inject: To force into.

Inoculation: The introduction of material such as a virus into an animal system.

Intercalary: Placed between.

Intoxication: A poisoned state of the blood.

Intracellular: Within the cell.

Intramuscular: Into the muscle.

Intravenous: Within a vein.

Invertase: Enzyme which inverts cane sugar.

Involution: Return to type; a retrogradation.

Isogamy: Sexual union of two gametes of equal size.

Isolate: To separate an individual from others.

Isotonic: A solution having the same density as any cell under study.

Karyokinesis: Indirect (mitotic) division of cells.

Katabolism: Breaking down of body tissue.

Lactase: The enzyme which acts upon lactose.

Laryngeal: Having to do with the larynx.

Lesion: A change in the tissues caused by injury or disease.

Lethal: Deadly, poisonous, fatal.

- Leucocyte:** A white blood corpuscle.
- Lipase:** The enzyme which hydrolyzes fats.
- Liquefaction:** Conversion of a solid or semisolid into a liquid.
- Lobate:** Provided with lobes.
- Lophotrichous:** Tuft of flagella at one end of the cell.
- Lysin:** A cytolytic substance in blood serum.
- Lytic:** The property of dissolving cells.
-
- Macro-:** Prefix meaning large.
- Macrobiosis:** Long life.
- Malt:** Partially germinated barley, rich in amylase.
- Mash:** A decoction of grains or fruits.
- Medical Milk Commission:** A committee of physicians for the control of the production of clean milk; certified milk.
- Medium:** Food materials upon which microorganisms are grown.
- Metabiosis:** The dependence of one organism on another; a partial symbiosis.
- Metabolism:** The processes by which food is altered by living organisms for growth and energy.
- Metatrophic:** Bacteria which use organic matter.
- Micro:** Prefix, meaning small.
- Microbe:** A microorganism.
- Micrococcus:** A genus of Eubacteriales; an isolated round cell.
- Micrometer:** An instrument for measuring microscopic objects.
- Micromillimeter:** One millionth of a meter; a micron.
- Micron:** One one-thousandth of a millimeter; about one twenty-five thousandth of an inch.
- Microscope:** An instrument for viewing microscopic objects.
- Mil:** One cubic centimeter.
- Mille:** One thousand.
- Mitochondria:** Granules in animal cells.
- Mitosis:** Indirect division of the nucleus; karyokinesis.
- Moniliform:** Beaded.
- Monosaccharide:** A sugar which cannot be split into simpler sugars.
- Monotrichous:** One flagellum at one end of the cell.
- Morphology:** Science of the shape and structure.
- Motility:** Ability to move about.
- Multiplication:** Increase in number of individuals in a culture of microorganisms.
- Must:** Expressed juice of the grape unfermented.
- Mutation:** Change in property.
- Mutualism:** Symbiosis.
- Mycelium:** The cotton-like structure of threads of a fungus.
- Mycology:** The science of fungi.
-
- Necrosis:** Death of cells in living tissue.
- Nitrification:** Oxidation of ammonium compounds to nitrates.

- Obligate:** Necessary.
- Oospore:** A sexual spore of downy mildew.
- Oposonin:** An antibody in blood serum which stimulates phagocytosis.
- Order:** A group of families. Names of orders end in *ales*.
- Organic:** (*Different meanings.*) Said of substances derived from living organisms.
- Osmosis:** Passage of liquids through membranes.
- Oxidase:** An enzyme which brings about oxidations.
-
- Pandemic:** A world- or nation-wide epidemic.
- Parasite:** An organism which gets its living from another.
- Parthenogenesis:** Development of an organism asexually (from unfertilized ovum).
- Pasteurization:** The heating of liquids, usually milk, to temperatures below the boiling-point.
- Pathogen:** A disease-producing microorganism.
- Pathology:** The branch of medicine dealing with the structural or functional changes in the body due to disease; the science of disease.
- Pellucid:** Transparent, not opaque.
- Pepsin (peptase):** The enzyme which changes proteins into peptones.
- Peptonization:** The process of converting into peptones.
- Perithecium:** An ascus-bearing fruiting body.
- Peritonis:** Inflammation of the peritoneum.
- Peritrichous:** Having flagella around the cell.
- Phagocyte:** A white blood cell which ingests foreign cells.
- Phagocytosis:** The ingestion of invading bacteria by phagocytes.
- Photosynthesis:** The building of complex substances by the energy in light.
- Phylum:** A division of the plant and animal kingdom.
- Phytozoon:** A zoophyte; plant-animal.
- Plasma:** Fluid portion of the blood.
- Plasmolysis:** The removal of water from a cell causing death.
- Polar:** At the end.
- Pollution:** Making impure; presence of extraneous matter.
- Polymorphism:** Many shapes or structures.
- Polyvalent:** Applied to a bacterial vaccine composed of many strains of the same organism.
- Postulate:** An established truth; a law.
- Precipitin:** An antibody which precipitates or throws down its antigen.
- Preservative:** An agent which represses spoilage of foods.
- Process:** The attempt to sterilize canned foods by heat.
- Proenzyme:** An incompletely formed enzyme.
- Proferment:** A substance from which an enzyme is formed or a substance which is necessary for its action.
- Proliferation:** Multiplication of cells.
- Prophylaxis:** Prevention of infection.
- Proteolysis:** The hydrolysis or decomposition of proteins.
- Proteolytic:** Having the power of hydrolyzing proteins.
- Protista:** A group of lower plant and animal forms proposed by Haeckel.

- Prototrophic:** Bacteria utilizing inorganic substances and organic carbon.
- Pseudo-:** Prefix meaning false.
- Pseudoglobulin:** One of the proteins in globulin; the other is euglobulin.
- Pseudoplasmodium:** A temporary swelling.
- Pseudomonas:** Genus of Eubacteriales with polar flagella.
- Ptomaine:** A nitrogenous base formed in putrefaction.
- Punctuate:** Having numerous points.
- Pus:** Liquid substance consisting of cells and waste matter formed in certain kinds of inflammation.
- Pyemia:** A septicemia characterized with the formation of internal abscesses.
- Pyorrhea:** Pus formation; necrosis of dental alveoli.
- Quarantine:** Restrictions placed on premises and persons where diseases exist.
- Racemose:** Like a bunch of grapes.
- Ramose:** Branching.
- Receptor:** That part of a cell which anchors materials to it.
- Reproduction:** The formation of offspring by living agents.
- Reticular:** Network construction.
- Retting:** The process by which linen is made from flax.
- Rimous:** Cracked, with fissures.
- Saccharification:** Change to sugar.
- Sanitarian:** A public health officer.
- Sanitary:** Promoting health; clean.
- Santitation:** Art of securing and maintaining a clean environment.
- Saprophyte:** An organism living on dead organic matter.
- Schizogony:** Reproduction by multiple fission.
- Schizomycetes:** Fission fungi.
- Science:** An orderly arrangement of facts; classified knowledge.
- Sclerotium:** The blackish mass formed by some fungi.
- Scum:** Surface growth.
- Sedimentation:** The act of settling out.
- Sensitize:** To render sensitive or anaphylactic.
- Septate:** Having cross walls.
- Septicemia:** A diseased condition caused by the development of pathogenic bacteria in the blood; so-called blood poisoning.
- Septic tank:** A contrivance in which the solid matter in sewage is decomposed by anaerobic bacteria.
- Septum:** A wall.
- Serodiagnosis:** Diagnosis with the aid of sera.
- Serology:** The science of disease diagnosis and treatment with sera.
- Serum:** The fluid portion of the blood.
- Sewage:** The waste matter in sewers.
- Sewerage:** System of pipes, etc., for carrying sewage.
- Sexual:** Pertaining to sex.
- Sheath:** A cylindrical tube surrounding organs or cells.

Soluble: Capable of being dissolved; also used to designate penetrability of enzymes through a membrane.

Species: Part of a genus.

Specific: Having a special function.

Spirillum: A genus of bacteria, rigid spiral-shaped cells.

Sporangiophore: The hypha or mycelial thread which bears a sporangium.

Sporangium: A membrane containing asexual spores.

Spore: The resistant stage in the cycle of some cryptogams.

Sporulation: The act of forming spores.

Sterile: Free from living agents.

Sterilization: Destruction of all living matter.

Stratiform: Formed in a layer.

Streptococcus: A genus of cocci; chain of round cells.

Substrate: The material upon which an enzyme or fermenting agent acts.

Suppuration: Formation of pus.

Susceptibility: A disposition to take disease (living agents, proteins, etc.).

Swell: A can of food with bulged ends.

Symbiosis: The harmonious living together of two organisms.

Thallus: Applied to plant structure which is devoid of leaves, stem, and roots.

Therapeutic: The use of a substance in cure of disease.

Thermal: Pertaining to heat.

Thermolabile: Susceptible to heat.

Thermophile: A heat-loving organism.

Thermostabile: Heat-resistant.

Toxemia: Poisoned state of the blood due to toxins.

Toxin: Poison formed by bacteria and other forms of life.

Toxophore: That portion of toxin which carries the poisoning power.

Transfusion: Transfer of blood from one person to another.

Tribes: A group of genera. Names of tribes end in *ae*.

Tubercle: A nodule.

Tubercular: Of the nature and form of a tubercle.

Tuberculous: Used specifically in reference to tuberculosis and its etiologic agent. (To be distinguished from tubercular.)

Ulcer: An open sore; suppuration on the surface.

Ultra: Beyond.

Vaccine: Lymph from cow-pox vesicles; a substance used in prophylactic inoculation.

Vector: Animals, especially insects, which transmit disease-producing organisms.

Vermiform: Worm shaped.

Vesicle: A small blister.

Virulent: Active; poisonous; infectious.

Virus: An agent which may cause disease; applied especially to those which are filterable.

Vivisection: Scientific experimentation on living beings.

Wort: Filtered mass used in fermentation or for the propagation of certain microorganisms.

Zygosporc: A spore resulting from conjugation of two gametes.

Zymogen: A substance from which an enzyme is formed.

Zoophyte: A plant-animal.

Zymotic: A germ disease; having to do with enzymes.

Index

- Abiogenesis, 9
Accessory substances and growth, 285
Acetic acid bacteria, 402
Acetobacter, 125, 131, 402
Acetobacteriaceae, 125
Acetone-butanol fermentation, 400
Achromatiaceae, 144
Achromatium, 144
Achromobacter, 134
Acid-fast particles, 81
Acids in disinfection, 248
Acquired immunity methods, 553
Actinobacillus, 134
Actinomyces, 120, 136, 168
Actinomycetaceae, 136
Actinomycetales, 121, 135
Actinomycosis, 170, 470
Action, of disinfectants, 237
 of enzymes, 293
Active and passive immunity, compared, 552
Active immunity, 550
Acute disease, 465
Adaptive enzymes, 297
Adulteration of foods, 421
Aeration, effect on bacteria, 225
 of sewage, 372
Aerobacter aerogenes in water, 348
Aerobic respiration, 272
Aerobiosis, 273
Aestivo-autumnal fever, 198
Agar cup plates, 254
Age and disease, 502
Agglutinins, 536
Agitation, effect on bacteria, 225
Agricultural bacteriology, 25
Air, bacteria in, 335
 cleaning and disinfection, 340
Air-borne infection, 486
Airplanes in disease dissemination, 492
Alcaligines, 124
Alcohol and brewing enzymes, 301
Alcoholic beverages, 397
Alcoholic fermentation, 331
Algae, 41
Alimentary tract, defense against disease, 508
Alkalies in disinfection, 248
Allergy, after antitoxin injection, 531
 from foods, 460
Alternaria, 165
Alveolar theory, protoplasm structure, 58
Amino acids and growth, 285
Amitosis, cells, 60
Ammonia-chlorine process in water purification, 354
Ammonification, 318
Amoebiasis, 197, 471
Amoebic dysentery, 197, 471
Amoebobacter, 141
Amoebobacteriaceae, 141
Amount of food, 265
Amphitrichous flagella, 86
Amylases, 298
Amylo process, 154
Anabolism, 266
Anaerobic respiration, 272
Anaerobiosis, 273
Anatomy, 52
Ancylostomiasis, 470
Angiococcus, 147
Angstrom, 78
Animal biology, 48
Animal-borne diseases, 492
Animal experimentation, 466
Animal metabolism, 267
Animal pathology, 24
Animals, arrangement, 48
 largest, 53
Anthrax, 470, 493
Antibiosis, 260
Antibiotic substances, 261
Antibodies, 522

- Antigens, 522
 Antiseptic, definition, 231
 Antiserum, 524
 Antitoxic sera, 524
 Antitoxins, 524
 Antivivisection, 467
 Appert, food preservation, 13
 Application of enzyme activities, 298
 Archangiaceae, 145
Archangium, 145
 Arnold steam sterilizer, 214
 Aromatic compounds, 277
 Arrangement, of animals, 48
 of plants, 40
 Arsenic in foods, 459
 Arthrospore, 91
 Artificial immunity, 550
 Ascomycetes, 45, 183
 Ascospore, copulation in yeasts, 180
 Ascosporelation in yeasts, 179
 Asepsis in food preservation, 418
 Aseptic surgery of Lister, 20
 Asexual mold spores, 153
 Aspergillosis, 169
Aspergillus molds, 160
 Avenue of infection, 510
 Avitaminosis, 506
Azotobacter, 126
 Azotobacteriaceae, 126
Asporomyces, 188
 Asymbiotic nitrogen fixation, 306
 Atrichous flagella, 86
 Attack of disease, immunity from, 553
 Attenuated organisms in immunity, 554
 Attenuation, by abnormal temperatures, 558
 by drying, 558
 Autogenous bacterins, 563
 Autotrophic bacteria, 268

 Bacillary dysentery, 471
Bacillus, 118, 120, 135
 Bacon, Roger, 3
 Bacteria, cultural study, 75
 in disease, 463
 in dust, 338

 Bacteria, filterable forms, 65
 higher, 45
 lower, 47
 in milk, 375
 in nature's plan, 43
 in plant diseases, 569
 as plants or animals, 35
 in sewage, 364
 Bacteriaceae, 133
 Bacterial blight of beans, 575
 Bacterial enzymes, 287
 Bacterial extracts in active immunity, 566
 Bacterial fermentations, 400
 Bacterial infections, 468
 Bacterial metabolism, 267
 Bacterial toxins, 513
 Bacterial vaccines, 562
 Bacterial viruses, 65
 Bactericide, definition, 231
 Bacterins, 562
Bacteroides, 134
 Bacteriological literature, 587
 Bacteriological methods of water examination, 347
 Bacteriophage, 65
 general properties, 67
 species and types, 66
 Bacteriophagum intestinale, 66
 Bacteriostat, definition, 231
Bacterium, 118, 120, 134
 Basidiomycetes, 45
 Bathroom appliances, 483
 BCG treatment, 560
 Beans, blight of, 575
 Beer, 397
Beggiatoa, 143, 325
 Beggiatoaceae, 143
 Beijerinck, 27
 Beverages, 412
 Biological leavening agents, 414
 Biolysis of sewage, 366
 Bios, 274
 Binominal system, nomenclature, 38
 Biogenesis, 8
 Biological methods of nitrogen fixation, 306
 Biology, of animals, 48

- Biology, of plants, 40
 Blade blight of oats, 574
 Blanching foods for canning, 428
Blastocaulis, 139
Blastodendron, 189
 Bleaching powder, 239
 Blood, detection of human, 541
 Blue-green molds, 158
 Boiling of foods, 424
 as sterilization procedure, 215
 water processes, 435
 Boils, 507
 Bordet's theory of immunity, 521
 Borel, 4
 Boric acid, 248
 in foods, 440
Borrelia, 148
 Botanical position of yeasts, 171
Botrytis, 164
 Bottled water, 361
 Bottom yeasts, 190
 Botulism, 450
 antitoxin, 535
 Branching of bacteria, 97
 Bread fermentation, 413
 yeast, 398
 Bromine, 241
 Brownian movement, 87
Brucella, 128
 Brucelleae, 128
 Budding of bacteria, 97
 Burrill, T. J., 29
 Butter, 386
 Butyric acid fermentation, 330

 Cabbage rot, 577
 Calcarea, 48
 Calcium hypochlorite, 239
 Calcium salts, 247
 Calmette, Albert, 21
 Camembert cheese, 388
Candida, 188
 Canned foods, keeping quality, 430
 Canning of foods, 425
 Canning powders, 438
 Capsules, 82
 Carbohydrases, 299
 Carbohydrate decomposition, 331

 Carbolic acid, 242
 Carbon cycle, 329
Carboxydomonas, 123
 Carboxylase, 291
 Carbuncles, 507
 Care of food products, 446
 Carriers, in food contamination, 447
 infection by, 479
 Carrots, soft rots, 579
 Catabolism, 266
 Catalysts, enzymes, 294
 Cauliflower rot, 578
Caulobacter, 138
 Caulobacteriaceae, 138
 Caulobacteriales, 137
 Celery, bacterial leaf spot, 577
 Cell, 52
 multiplication, 59
 nucleus, 58
 surface, mass and, 79
 theory, history of, 53
 wall, 57
 bacteria, 81
Cellfalcicula, 124
 Cells, amitosis, 60
 bacterial, shape and size, 77
 weight, 78
 direct division, 59
 indirect division, 61
 morphology, 57
 plant and animal, 54
 sexual phenomena in, 62
Cellulomonas, 134
Cellvibrio, 124
 Centrosome, in cells, 59
 in protozoa, 195
 Certified milk, 378
 Characteristics of enzyme reactions,
 294
 Cheddar cheese, 388
 Cheese, 387
 Chemical changes by enzymes, 289
 Chemical composition of bacteria, 99
 Chemical leavening agents, 413
 Chemical methods, of nitrogen fixation,
 305
 of water examination, 346
 Chemicals in food preservation, 439

- Chemistry of protoplasm, 55
 Chemotaxis, 229
 Chemotherapy, 250
 Chickenpox, 470
 Chlamydobacteriales, 136
 Chlamydospores in yeasts, 177
 Chlamydothrix, 119
 Chloramines, 240
 Chlorine compounds, disinfectants, 238
 Chlorophyceae, 41
 Chocolate creams, enzyme in, 302
 Cholera, 470
Chondrococcus, 147
Chondromyces, 146
 Chromatieae, 142
 Chromatioideae, 139
Chromatium, 142
Chromobacterium, 124
 Chromoparous bacteria, 276
 Chromoporous bacteria, 276
 Chronic disease, 465
 Cisterns, 357
 Citric acid fermentation, 331
 Citrus canker, 575
Cladothrix, 47
 Clarification of jellies by enzymes, 301
 Classes, 37
 Classification, 111
 of animals, 48
 of living organisms, 36
 of plants, 40
 of viruses, 71
 of yeasts, 182
 Cleaning of air, 340
Clonothrix, 137
Clostridium, 135
Clostridium botulinum, 452
 Coagulation of proteins by heat, 210
Coccidiascus, 183, 187
 Cocoa, 413
 Coelenterata, 48
 Coenzymes, 292
 Coffee, 412
 Cold light formation, 276
 Cold storage of foods, 423
 Coliform bacteria in water, 360
 Communicable diseases, 466
 Complement, 547
 Complement fixation tests, 547
 Concentrated milk, 391
 Concurrent disinfection, 232
 Conjugation of ascospores, 179
 Conjunctivitis, 471
 Conn, Herbert W., 28
 Constituents of toxins, 517
 Constitutive enzymes, 297
 Contact, defined, 487
 Contact beds, 371
 Contact infections, 487
 Contagious diseases, 466
 Contaminated water, 343
 Continuous method of sterilization, 216
 Control, of diphtheria, 534
 of plant diseases, 583
 Cooking of foods, 424
 Cooling canned foods, 429
 Copper salts, 246
 Copulation of ascospores in yeasts, 180
Corynebacterium, 120, 135
 Court plaster, 485
Crenothrix, 47, 119, 137
 Cresols, 243
Cristispira, 148
 Crown gall, 580
 Crystalline viruses, 71
 Cucumber pickles, 442
 Cultural study of bacteria, 75
 Curing of meats, 443
 Curves, disinfection, 232
 Cycles of elements, 273
 Cyclogeny, 109
 Cytology, 52
 Cytomorphosis, 109
 Cytoplasm, 58
 in bacterial cells, 80
 in protozoa, 194
 Dairy bacteriology, 27
 DDT, 257
 Deamination, 321
 Death, 57
Debaromyces, 183, 186

- Decarboxylation, 321
 Decay, 320
 Decomposed food and illness, 456
 Definition of enzyme, 287
 Dehydration of foods, 421
 Delphinium, bacterial leafspot, 577
 Demonstration of agglutinins, 537
 Dengue fever, 471
 Denitrification, 317
 Deodorant, definition, 232
 Descriptive chart, 116
 Detection of human blood, 541
 Detention camp, 497
 Deterioration of textile fibers, 412
 Dew retting, 410
Dialister, 129
 Diastases, 298
 Dick test in scarlet fever, 536
 Dielectric heating, 214
 Diphtheria, 471
 control, 534
 toxoid, 534
Diplococcus, 129
 Direct division of cells, 59
 Discovery, of lens, 2
 of viruses, 68
 Disease prevention, methods, 495
 Diseases, from milk, 383
 caused by viruses, 72
 Dishes as infection agents, 482
 Dishwashing, 482
 Disinfectant, definition, 231
 Disinfection, 229
 of air, 340
 curves, 232
 factors influencing, 234
 of potable water, 354
 Distillery yeasts, 190
 Distribution, of bacteria, 499
 of molds, 151
 Division, direct, of cells, 59
 Domestic method for vinegar, 403
 Dormancy of bacteria, 96
 Double seams on cans, 426
 Drilled wells, 355
 Drinking fountains, 485
 Driven wells, 355
 Droplets, bacteria in, 339
 Dry heat sterilization, 212
 Drying, effect on bacteria, 222
 of foods, 421
 Dug wells, 355
 Durable cells in yeasts, 177
 Duration, of immunity, 564
 of smallpox immunity, 557
 Dust and bacteria, 338
 Dye reduction test of milk, 383
 Dyes as disinfectants, 249
 Dysentery, 471
 Early classifications of bacteria, 117
Eberthella, 133
Eberthella typhosa, longevity in
 water, 345
 Echinodermata, 48
 Ehrlich's theory of immunity, 521
 Electricity, 226
 Electronic sterilization, 213
 Electron microscope, 5
 Electrophoresis, 227
 Elementary composition of bacteria,
 99
 Emmenthaler cheese, 388
 Encephalitis, 471
 Endemic disease, 465
Endomyces, 183, 184
 Endomycetaceae, 183
 Endomycetoideae, 183, 184
 Endomycopseae, 183, 185
Endomycopsis, 183, 185
 Endotoxins, 514
 Energy foods, 266, 269
 Enterobacteriaceae, 131
 Enzyme preparation from micro-
 organisms, 407
 Enzyme reactions, 294
 Epidemic disease, 465
 Epidemiology, 500
 Eremascoideae, 183, 184
Eremascus, 183
Erwinia, 132
 Erwineae, 132
Erysipelothrix, 136
Escherichia, 131
Escherichia coli, pollution indicator,
 347

- Escherichia coli*, in water, 348
 Eschericheae, 131
 Ethyl alcohol, 249
 manufacture, 394
 Eubacteriales, 122
 Evidence of pollution, 345
 Exhausting canned foods, 428
 Exhaustion theory of immunity, 520
 Exotoxins, 514
 External defenses, 508
 Extracellular enzymes, 295
- Faber, 4
 Factors influencing infection, 502
 Failure, of antitoxins, 532
 of preventive inoculation, reasons
 for, 565
 Families, 37
 Fat, in bacteria, 102
 decomposition, 333
 droplets, 81
 Fatigue and disease, 504
 Fecal *Escherichia coli*, 350
 Federal quarantine, 496
 Fermentation, 44, 270
 germ theory, 12
 Fermented milk, 389
 Filar theory, protoplasm structure,
 58
 Filterable forms of bacteria, 65
 Filterable viruses, 68
 Filters and filtration, 64
 Filtration, in sewage treatment, 371
 in water treatment, 353
 Fire blight, 572
 Fish poisoning, 450
 Fission, 96
 Flagella, 84
 Flame, sterilization, 212
 Flat sour spoilage, 432
Flavobacterium, 134
 Flax retting, 410
 Flies, bacteria on, 490
 Fluorine in foods, 459
 Fomites, 480
 Food, 265
 concentration and growth, 283
 containers, 427
- Food, and drug acts, 420
 preservation, 418
 Appert's work, 13
 required by bacteria, 265
 spoilage, 418
 yeast, 399
 Food-borne infections, 447
 Food-borne intoxications, 447
 Foreign proteins in foods, 543
 Formaldehyde, 255
 Fractional sterilization, 92
 Fractional sterilization, 216
 Free-flowing steam sterilization, 216
 Freezing, effects on bacteria, 207
 of foods, 422
 Fruit juices, clarification, 301
 Function of spores, 94
 Fungi, 42
 nitrogen fixation by, 307
 Fungi Imperfecti, 45
 Fungicide, definition, 232
 Furunculosis, 507
 Fusarium, 166
Fusobacterium, 134
- Gaffkya*, 127
 Gallileo, 3
Gallionella, 138
 Gallionellaceae, 138
 Galls, 580
 Gametes, 41
 Gas formation by bacteria, 278
 Gas gangrene antitoxin, 536
 Gastric juice, 508
Gelidium, 42
 General properties, of bacteriophage,
 67
 of protoplasm, 56
 Generation, spontaneous, 8
 Generic names, rules, 115
 Genetic immunity, 551
 Genetic variation, 110
 Genus, 37
Geotrichoides, 189
Geotrichium, 189
 Germ theory, of disease, 464
 of fermentation, 12
 German measles, 471

- Germicidal action, of milk, 376
 of soap, 252
 Germicide, definition, 231
 Germination of spores, 94
 Glanders, 493
Gleocapsa, 41
 Glycerol, 249
 fermentation, 399
 Glycogen, 81
 Gonidia, 97
 Gonorrhea, 472
 Gorgas, 23
 Grading foods for canning, 428
 Granular structure, protoplasm
 structure, 58
 Granules, metachromatic, 81
 Gravity, effect on bacteria, 225
 Groups, of bacteria, 149
 of legumes, 314
 Growth, of bacteria, 280
 factors, 274
 history of cultures, 281
 histories of single cells, 282
 morphology and, 80
 rate of, 282
 foods for, 266, 270
 Gruber-Widal reaction, 538

 Habitat of yeasts, 171
 Haeckel, 34
 Halogens as disinfectants, 238
 Hands, bacteria on, 489
 Handshaking, 489
 Hansen, E. C., 30
Hanseniaspora, 186
Hansenula, 183, 186
 Haptophore group, 518
 Hard swell spoilage, 432
 Heat formation, 276
 Heat resistance, of *Clostridium botu-*
 linum spores, 453
 of spores, 93
 Heating of hay, 277
 Hemolysis, 519
 Hemophileae, 128
Hemophilus, 128
 Hemp, 412
 Heredity and disease, 502

 Heterogamic copulation in yeasts,
 180
 Heterotrophic bacteria, 268
 Higher bacteria, 45
 High-pressure steam sterilization,
 215, 217
Hillhousia, 144
 History of cell theory, 53
 Home canning, 433
 Home water supplies, 355
 Hooke, 4
 Hookworm disease, 470
 Horse, immunization, 526
 Hot-air oven sterilization, 213
 Household water filters, 355
 Housing conditions and disease, 503
 Human blood, detection of, 541
 Humoral theory of disease, 464
 Hybridization, 110
 in yeasts, 180
 Hydration by enzymes, 291
 Hydrogen sulfide production, 324
Hydrogenomonas, 122
 Hydrolysis by enzymes, 289
 Hydrolytic enzymes, 298
 Hypertonic solutions, 221
 Hyphae, 42
 structure, 151
 Hypotonic solutions, 222

 Ice bacteriology, 361
 Ice cream, 388
 Identification, of bacteria by agglu-
 tination, 539
 of microorganisms, 149
 Idiosyncracies in the diet, 460
 Illness caused by bacteria in foods,
 446
 Illinois River, pollution, 370
 Immune bodies, 520
 Immune serum, 524
 Immunity, duration of, 564
 in virus diseases, 548
 Immunology and serology, 25
 Impure water, 343
 Incineration, 212
 Inclusion bodies, 73
 Incubation period, 513

- Index number, 116
 Indirect division of cells, 61
 Induction heat sterilization, 214
 Industrial and food microbiology, 30
 Industrial diseases, 468
 Industrial fermentations, 394
 Industrial yeasts, 189
 Infected water, 343
 Infection by carriers, 479
 Infections, food-borne, 447
 Infectiousness of infecting agent, 509
 Infectious diseases, 466
 Influenza, 472
 Inoculation methods, soil, 312
 Insect-borne diseases, 489
 Insecticide, definition, 232, 257
 Insoluble toxins, 514
 Intermittent sterilization, 216
 International congresses, 39
 International quarantine, 496
 Interstate quarantine, 496
 Intestinal tract diseases, 468
 Intoxications, food-borne, 447, 450
 Intracellular enzymes, 295
 Invertase in chocolate creams, 302
 Involution forms, 105
 Iodine compounds in disinfection, 241
 Iodoform, 241
 Iron granules, 81
 Ironing as sterilization procedure, 217
 Isogamic copulation in yeasts, 180
 Isolation of patient, 497
 Isotonic solution, 221

 Jenner, Edward, 22

 Kahn's precipitation test for syphilis, 545
 Keeping quality of canned foods, 430
 Kinds of toxins, 514
 Kingdoms, 37
 Kircher, 4, 6
Klebsiella, 132
Klöcker, 188
 Known etiology diseases, 466
 Koch, Robert, portrait, 17
 Koch's postulates, 466
Kurthia, 133

 Lactic acid fermentation, 330
 Lactobacilleae, 130
Lactobacillus, 130
 Lactobacteriaceae, 129
 Lag phase in growth, 281
 Lamprocysteae, 140
Lamprocystis, 140
Lampropedia, 141
 Leafspot of delphinium, 577
 Leaf spots, 575
 Leavening agents, 413
 Leeuwenhoek, 1, 4
 Legume bacteria, 314
 Lehmann and Neumann's classification of bacteria, 119
 Lens and microscope, 2
 Leprosy, 472
Leptospira, 148
Leptothrichia, 136
Leptothrix, 137
Leptothrix hyalina, 46
 Lettuce blight, 574
 Leucocidins, 519
Leuconostoc, 130
 Liebig, Justus von, 14
 Life cycles, 108
 Light, effect on bacteria, 201
 formation, 276
 Limburger cheese, 388
 Linen, manufacture, 409
 Linnaeus, 37
 Lipase, 299
 Liquid chlorine, 239
 Lister, Joseph, 20
Listerella, 133
 Living matter in the cell, 51
 Living things, size, 53
 Local immunity, 522
 Locomotion, on cells, 59
 organs, 84
 Longevity, of bacteria, 286
 in water, 345
 of pathogenic bacteria, 478
 Lophotrichous flagella, 86
 Lower bacteria, 47

- Luminescence, 276
 Lungs, 510
 Lysins, 518, 546
 Lysol, 243
- Macrogametes, 180
 Malaria, 198, 472
 tropical, 199
Malleomyces, 128
 Malnutrition and disease, 505
 Malpighi, 5
 Maritime quarantine, 496
 Mass and cell surface, 79
 Maximum temperature, 206
 Measles, 472
 Meat, curing, 443
 inspection, 419
 tenderizing enzymes, 302
 Mechanical filtration, 353
 Medical bacteriology, early work, 16
 Medical milk commissions, 378
Melittangium, 146
 Meningitis, 473
 Mental state and disease, 503
 Mercuric salts, 245
 Mesophilic bacteria, 205
 Metabiosis, 264
 Metabolism, 57, 266
 Metachromatic granules, 81
 Metallic salts in disinfection, 244
 Metazoa, 48
 Metchnikoff, Elie, 19
 Metchnikoff's theory of immunity,
 - 520
Methanomonas, 123
 Methods, for growth, 280
 for making vinegar, 402
 of passive immunity, 567
 of sewage treatment, 368
 of spore demonstration, 95
 of water examination, 346
 Methylphenols, 243
Microbacterium, 133
 Microbic dissociation, 107
 Microbiology, 31
 scope of, 31
 Micrococcaceae, 126
 Micrococcus, 118, 120, 126
 Microgametes, 180
 Micron, 78
 Microorganisms, in air, 335
 in food spoilage, 418
 Microscope electron, 6
 Microscope and lens, 2
Microspira, 119
 Migula's classification of bacteria,
 118
 Milk, bacteria from, 499
 bacteria in, 375
 powder, 392
 quality, 378
 sickness, 450
 Milk-borne immunity, 552
 Millimicron, 78
 Mineral foods, 269
 Mineral water, 361
 Minimum temperature, 207
 Mixed infections, 512
 Modes of bacterial action, 513
 Modifications, 107
 Moist heat sterilization, 214
 Moisture, and growth, 285
 effect on bacteria, 220
 Mold fermentations, 405
 Mold spores, 152
 Molds, 151
 Money as infection agent, 481
Monilia, 163
 Monomorphism, 104
Monosporella, 183
 Monotrichous flagella, 85
 Morphology, 52
 of bacteria, 75
 of cells, 57
 of protozoa, 194
 relation to growth, 80
 Moses, 23
 Motility, 84
 Mouth, bacteria from, 499
Mucor, 154
Mucor mucedo, 155
Mucor rouzii, 156
 Mucorales, 154
 Multiplication, 280
 of cells, 59
 Mumps, 473

- Municipal quarantine, 497
 Mushroom poisoning, 450
 Muskmelon, soft rot, 579
 Mussel poisoning, 450
 Mutations, 107
 Mutual relationships, 258
 Mycelial structures, 173
 Mycetozoa, 44
 Mycobacteriaceae, 135
Mycobacterium, 120, 136
Mycocandida, 189
Mycoderma, 187
Mycoplasma, 125
Mycotorula, 188
 Mycotoruloideae, 188
Mycotoruloides, 188
 Myxobacteriales, 144
 Myxococcaceae, 146
Myxococcus, 147
 Myxomycetes, 44
- Nadsonia*, 183, 186
 Nadsonieae, 183
 Naming of microorganisms, 149
 Nasal excretion, bacteria from, 499
 Nature immunity, 550
 Nature of viruses, 70
 Nectaromycetaceae, 187
Neisseria, 127
 Neisseriaceae, 127
 Nemathelminthes, 48
Nematospira, 183, 187
 Nematosporoideae, 183, 186
Neviskia, 138
 Neviskiaceae, 138
 Nitrate reduction, 318
 Nitrification, 316
Nitrobacter, 122, 316
 Nitrobacteriaceae, 122
 Nitrogen, cycle, 304
 fixation by higher plants, 307
 occurrence in nature, 303
 transfer to plants, 315
Nitrosococcus, 122
Nitrosomonas, 122
Noguchia, 129
 Nomenclature, 111, 113
 binominal system, 38
- Nomenclature, of enzymes, 288
 of viruses, 71
 Noncalcarea, 48
 Nonfecal *Aerobacter aerogenes*, 350
 Nonlethal doses of living bacteria,
 561
 Nonsymbiotic methods of nitrogen
 fixation, 306
 Normal and specific opsonins, 545
 Normal habitat of bacteria, 42
 Nose, bacteria from, 499
Nostoc, 41
 Noxious retention theory of immu-
 nity, 520
 Nucleus, 88
 of cells, 58
 in protozoa, 194
 Number of cells, 510
 Nutrition, of bacteria, 265
 of protozoa, 195
- Oats, blade blight, 574
 Objective methods of disease pre-
 vention, 495
 Occupation and disease, 503
Ocellularia, 41
Oidium, 164
 Old tuberculin, 567
Oöspora, 164
 Opsonic index, 546
 Opsonins, 545
 Optimum temperature, 208
 Orders, 37
 Organic foods, 270
 Organs, in the cell, 59
 of locomotion, 59, 84
 Orleans method for vinegar, 404
 Osmosis, 220
 Outbreak of botulism, 451
 Oven processing, 434
 Oxford units, penicillin, 251
 Oxidation of sulfur, 326
 Oxidizing enzymes, 300
- Panama Canal and yellow fever, 23
 Parachrome bacteria, 276
 Parasitism, 263
 Paratyphoid fever, 473

- Parthenogenesis in yeasts, 180
Partition in yeasts, 178
Parvobacteraceae, 127
Pasteur, flask, 12
 method for vinegar, 405
 portrait, 17
 réview of work, 18
 treatment for rabies, 558
 work on fermentation, 15
Pasteurella, 128
Pasteurellaeae, 128
Pasteuria, 139
Pasteuriaceae, 138
Pasteurization, of foods, 425
 of milk, 381
Pathogenesis, 264
Pathogenic bacteria, longevity, 478
Pathogenic yeasts, 191
Pathology, 53
Pear blight, 572
Peddler, smallpox, 488
Penicillin, 251, 261, 406
 cylinders, 262
Penicillium molds, 158
Peritrichous flagella, 86
Pertussis, 476
Pettenkofer, 23
Pettenkofer's experiment with gastric juice, 509
Phase, of decreasing numbers, 282
 of rapid growth, 282
Phenol coefficient, 254
Phenolic compounds as disinfectants, 242
Photosynthesis, 267
Phragmidiothrix, 119
Phycomycetes, 45
Phyla, 37
Physical agents, effect on bacteria, 201
Physiology, 52
Phytomonas, 125
Pichia, 183, 185
Pickles, cucumber, 442
Pickling of foods, 440
Pigment formation, 275
Pimples, 507
Pink eye, 471
Pityrosporum, 187
Plain sedimentation in water purification, 352
Planosarcina, 118
Plant, diseases, bacterial, 569
 largest, 53
 metabolism, 267
 pathology, 29
 quarantine, 499
Plants, and animals, bacteria as, 35
 characteristics, 35
 arrangement, 40
 biology, 40
Plague, 473
Plagues, bacteriophage, 67
Plate count of milk, 382
Platyhelminthes, 48
Pleomorphism, 106
Pneumonia, 473
Policomyelitis, 474
Polluted water, 345
Pollution of Illinois River, 370
Polyangiaceae, 145
Polyangium, 146
Polyvalent bacterin, 563
Porifera, 48
Postage stamps as infection agents, 482
Practical applications of agglutinins, 538
Precipitins, 540
Preservation, of bacteria, 222
 of foods, 423
Preservatives, chemical, 439
Pressed yeasts, 190
Pressure, effect on bacteria, 223
Pressure cookers, 216, 435
Pressure-temperature data, 218
Proactinomyces, 136
Process times, home canning, 435
Processing, in boiling water, 435
 of canned foods, 428
Products of metabolism, 275
Prophylactic, definition, 232
Propionibacterium, 131
Protaminobacter, 125
Proteae, 132
Protective bodies, 520

- Protein decomposition, 319
 Proteinases, 300
 Proteins, effect of heat on, 210
 foreign in foods, 543
 structure, 55
Proteus, 132
 Protista, 34
 Protoplasm, 54
 chemistry, 55
 general properties, 56
 Prototrophic bacteria, 268
 Protozoa, 48, 194
 Pseudomonadaceae, 124
 Pseudomonadeae, 125
Pseudomonas, 118, 125
 Psittacosis, 474, 494
 Psychrophilic bacteria, 205
 Ptomaine poisoning, 456
 Public drinking fountains, 485
 Purification of water supplies, 351
 Purified concentrated antitoxins, 528
 Purity of antitoxins, 529
 Putrefaction, 44, 319
 Pyocyanin, 263
- Quality of water supplies, 360
 Quarantine methods, 496
 Quartian fever, 198
 Quick-vinegar method, 403
- Rabies, 474, 495
 Pasteur treatment, 558
 Radiation spectrum, 204
 Rapid sand filtration, 353
 Rate, of growth, 282
 of reproduction of bacteria, 98
 Redi, 8
 Relation of cell surface to mass, 79
 Rennin in cheese making, 302
 Reproduction, 57 ✓
 of bacteria, 96 ✓
 of molds, 152
 of protozoa, 195 ✓
 in yeasts, 177 ✓
- Reserve materials in yeast cells, 175
 Respiration, 271
 Respiration figures, 230
 Respiratory diseases, 468
- Reticular theory, protoplasm structure, 58
 Retting of flax, 410
Rhodomonas, 142
 Rhizobiaceae, 123
Rhizobium, 123, 310
 Rhizoids, 156
 Rhizopoda, 48
Rhizopus, 156
Rhizopus nigricans, 157
Rhodobacillus, 143
 Rhodobacteriaceae, 139
 Rhodobacterioideae, 142
Rhodobacterium, 143
Rhodocapsa, 142
Rhodocystis, 142
Rhodonostoc, 142
 Rhodophyceae, 42
Rhodorrhagus, 143
Rhodospirillum, 143
Rhodotheca, 142
Rhodotorula, 189
 Rhodotorulaceae, 189
Rhodovibrio, 143
 Rickettsiae, 72
 Ringworm, 168
Rivularia, 41
 Rocky Mountain spotted fever, 474
 Roger Bacon, 3
 Role of bacteria in nature, 43
 Roquefort cheese, 388
 Rots, plant diseases, 577
 Roux, 22
 Rural water supplies, 355
- Saccharomyces*, 183, 185
 Saccharomyceteae, 183, 185
 Saccharomycetoideae, 183
Saccharomycodes, 186
 Saccharomycoidae, 185
 Safe home-canned foods, 436
 Safe water, 343
Salmonella, 133
 fever, 473
 food poisoning, 454
 Salmonelleae, 132
 Salting and pickling of foods, 440
 Salvarsan, 250

- Sanitary cordon, 497
- Sanitary inspection, of milk supplies, 378
 of water, 346
- Sanitation, bacteriology, 22
- Saprosira*, 147
- Sarcina*, 118, 120, 127
- Sauerkraut, 441
- Scarlet fever, 474
 antitoxin, 536
- Schick test, 532
- Schizoblastosporion*, 188
- Schizomycetes, 42, 121
- Schizosaccharomyces*, 183, 184
- Schulze, work on biogenesis, 8
- Schwann, 10
- Schwanniomyces, 183, 186
- Scope of microbiology, 31
- Sedgwick, 24
- Sedimentation and coagulation in water purification, 352
- Seed sterilization, 257
- Sensitized bacterins, 566
- Separation of species by precipitation, 543
- Septic sore throat, 474
- Septic tanks, 369
- Serrateae, 132
- Serratia*, 132
- Serum, 524
- Sewage, bacteria in, 364
 farming, 371
 treatment, principles, 365—
- Sexuality in bacteria, 97
- Sexual mold spores, 153
- Sexual phenomena, in cells, 62
 in yeasts, 179
- Shapes, of bacterial cells, 77
 of yeast cells, 172
- Shigella*, 133
- Significance of nitrogen for life, 304
- Silage fermentation, 407
 heat from, 277
- Silver salts, 246
- Size, of bacterial cells, 77
 of living things, 53
- Skin, external defense, 507
- Sleeping sickness, 196
- Slow sand filtration, 353
- Smallpox, immunity, 555
 pedler, 488
- Smoking of foods, 443
- Soap, germicidal action, 252
- Sodium benzoate, 439
- Soil, inoculation methods, 312
 microbiology, 25
- Soiled linens, 484
- Soluble toxins, 514
- Sorangiaceae, 145
- Sorangium*, 145
- Sound waves, 227
- Species, 37
 of bacteria, 113
 names, rules for, 115
 and types of bacteriophage, 66
- Specificity of disinfectants, 237
- Specific bacterial infections, 468
- Spectacles, introduction of, 3
- Spectrum, radiation, 204
- Sphaerotilus*, 119, 137
- Spices, 443
- Spirilleae, 124
- Spirillum*; 119, 120, 125
- Spirits, 397
- Spirochaeta*, 119, 120, 147
- Spirochaetaceae, 147
- Spirochaetales, 147
- Spirogyra*, 41
- Splitting by enzymes, 290
- Spoilage of canned foods, 431
- Spontaneous combustion, 276
- Spontaneous generation, 8
- Spores, properties, 93
 heat resistance, 453
- Sporoplasm, 92
- Sporozoa, 48
- Sporulation, of bacteria, 91
 of protozoa, 196
- Spraying plants, 583
- Sprinkling filters, 372
- Stamps as infection agents, 432
- Standard antitoxin, 528
- Standardization of disinfectants, 253
- Standards for drinking water, 351
- Staphylococcus*, 126
 food poisoning, 455

- Starch hydrolysis by enzymes, 299
 Starvation and disease, 506
 State quarantine, 497
 Steam-pressure canner, 435
Stelangium, 145
 Sterilization, definition, 232
 by heat, 212
 Stock bacterins, 563
 Stolons, 156
 Stools, bacteria from, 499
 Storage of food in open cans, 458
 Stream pollution, 369
 Streptococceae, 129
Streptococcus, 118, 129
 Streptomycin, 262
 Streptothricin, 262
 Structure, of enzymes, 292
 of proteins, 55
 of space, 93
 of yeast cells, 174
 Subjective methods of disease prevention, 495
 Sulfa drugs, 250
 Sulfide spoilage, 432
 Sulfur bacteria, 327
 Sulfur cycle, 323
 Sulfur dioxide, 255
 Sulfur granules, 81
 Sunlight, 202
 Surface tension, 227
 and growth, 285
 Sweet corn wilt, 579
 Swimming pools, 372
 Symbiosis, 258, 311
 Symbiotic nitrogen fixation, 308
 Sympiasm, 97
Synangium, 146
 Syphilis, 475
 precipitation test for, 545
 Systematic relationships, 34
- Tableware as infection agents, 482
 Taxonomy, living organisms, 36
 Tea, 412
 Temperature, and chemical changes, 210
 and disease, 504
 effects on bacteria, 205
 Temperature, and growth, 284
 Temperature-pressure data, 218
 Temporary habitat, 43
 Terminal disinfection, 233, 255
 Tertian fever, 198
 Tests of antitoxins for purity, 529
 Tetanus, 475
 antitoxin, 535
 Texas fever, 200
 Textile fibers, 409
 industries, enzymes in, 301
 Thallophyta, 40, 41
 Theories of disease, 464
 Therapeutic use of yeasts, 191
 Thermal death times, 209
 Thermophilic bacteria, 205
 spoilage of canned foods, 432
 Thiobacilleae, 123
Thiobacillus, 123
 Thiobacteriales, 139
Thiocapsa, 140
 Thiocapseeae, 139
Thiocystis, 139
Thioderma, 141
Thiodictyon, 141
 Thiopédieae, 140
Thiophysa, 144
Thioploca, 143
Thiopolyococcus, 141
Thiosarcina, 140
Thiosphaera, 140
Thiosphaerion, 140
Thiospira, 144
Thiospirillum, 142
Thiotece, 141
Thiothrix, 143, 326
 Tin as a food poison, 459
 Tissue immunity, 522
 Tomato, bacterial spot of, 577
 Top yeasts, 190
 Torulapsidaceae, 187
Torulapsis, 187
 Torulapsoideae, 187
Torulaspora, 183, 185
 Toxin, formation by animals, 514
 molecule, 518
 production, 525
 Toxin-antitoxin administration, 533

- Toxins, bacterial, 513
 and toxin reactions, 515
 versus ptomaines, 519
 Toxoid diphtheria, 534
 Toxophore group, 518
 Trachoma, 475
 Transmission of infecting agents, 478
 Transmutation of species, 107
 Transverse division in yeasts, 178
 Tremetol, 450
Treponema, 148
 Tribes, 37
 Trichinosis, 461, 475
 Tropical malaria, 199
 True yeasts, 183
 Tuberculin, 566
 Tuberculosis, bovine, 493
 from milk, 384
 pulmonary, 475
 Tularemia, 475, 495
 Type cultures, 39
 Type species, 39
 Types, of cheese, 388
 of water, 343
 Typhoid fever, 475
 Typhus fever, 476
 Tyrothricin, 263
- Udder, bacteria in, 376
 Ultramicroscopic forms of life, 64
 Ultraviolet light, 203
 Undulant fever, 476, 493
 Unknown etiology diseases, 466
 Urine, bacteria from, 499
 Use of antitoxins, 530
- Vaccinia bodies, 73
 Vacuoles in cells, 59
 Vacuum sweepers, 341
 Variability of microorganisms, 103
 Variations in morphology during
 growth, 80
 Varieties of immunity, 550
 Vaughan's theory of immunity, 522
Veillonella, 127
 Venereal diseases, 468
 Veterinary bacteriology, 24
Vibrio, 120, 124
- Vinegar fermentation, 401
 Virulence of infecting agent, 509
 Virus diseases, 469
 immunity in, 548
 vaccines, 555
 Viruses, 68
 bacterial, 65
 classification, 71
 crystalline, 71
 discovery, 68
 diseases caused by, 71
 nature, 70
 nomenclature, 71
 Vitamin formation by bacteria, 278
 Vitamins, 274
 Vivisection, 466
- Washing powders, 483
 Wassermann test for syphilis, 548
 Waste products and growth, 285
 Water, analysis, 360
 requirements of bacteria, 270
 Water-borne diseases, 244
 Wavelengths of spectrum, 203
 Weight of bacteria, 78
 Wells, dug, driven, and bored, 355
 White snakeroot poisoning, 450
 Whooping cough, 476
 Widal reaction, 538
 Wilts, 579
 and blights, 569, 572
 Wine, 397
 Winogradsky, 26
- X-rays, 204
- Yeast cakes, 190
 Yeasts, 171
 classification, 182
 Yellow fever, 476
 experiments, 491
- Zacharias, 4
 Zinc salts, 245
Zygopichia, 183
Zygosaccharomyces, 183, 185
 Zygosporos in yeasts, 178
 Zygote, 41
 Zymtoxic theory of disease, 465

