

BIRLA CENTRAL LIBRARY
PILANI (Rajasthan)

Class No:- 666.3

R

Book No:- N772R

Accession No:- 45387

REFRACTORIES

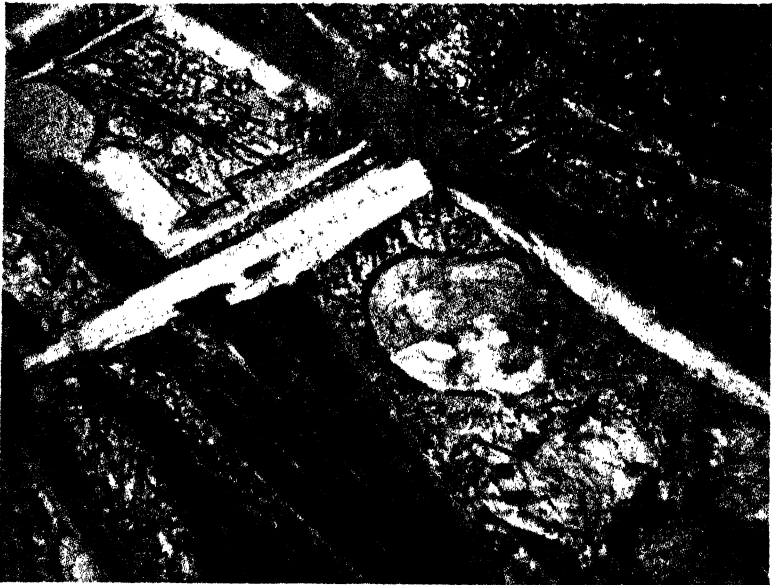

Upper Figure: Photomicrograph of electrically fused mullite. Polarized light, 125 diameters, gypsum plate. Dark red area at lower left is void caused by gas inclusion in melt; black opaque areas are carbon from electrodes.

Lower Figure: Photomicrograph of silica refractory from crown of glass tank between melting and refining section. Polarized light, 125 diameters, gypsum plate. Section shows large tridymite twinned crystals with background of dendritic cristobalite. (Photographs by C. L. Norton, Jr.)

REFRACTORIES

By

F. H. NORTON

*Professor of Ceramics, Massachusetts
Institute of Technology; Consultant
for the Babcock & Wilcox Company*

THIRD EDITION

NEW YORK TORONTO LONDON

McGRAW-HILL BOOK COMPANY, INC.

1949

REFRACTORIES

Copyright, 1931, 1942, 1949, by the McGraw-Hill Book Company, Inc. Printed in the United States of America. All rights reserved. This book, or parts thereof, may not be reproduced in any form without permission of the publishers.

PREFACE TO THE THIRD EDITION

In the seven years since the last edition, much information has become available on the properties and uses of refractories. The Second World War stimulated many important developments in the field, quite a few of which are discussed.

A chapter on laboratory furnaces has been added with particular emphasis on induction heating, as it is felt that this method would be in much greater use if details of its operation were better known. A new chapter has been added to cover the pure, highly refractory materials now of great interest in high-temperature construction. New chapters have been also added on the subjects of refractories for nuclear power and jet propulsion. W. D. Stevens of the Babcock & Wilcox Company has gone to great pains to completely revise and bring up to date Chapter XXIII.

In view of the considerable amount of literature recently published in the field of crystal chemistry and allied subjects, it was felt wise to omit the chapter on fundamental concepts of matter to make room for the added chapters. The reader may consult the following books that cover this subject:

- STILLWELL, C. W.: "Crystal Chemistry," McGraw-Hill Book Company, Inc., New York, 1938.
- WOOSTER, W. A.: "A Textbook on Crystal Physics," Cambridge University Press, London, 1938.
- SLATER, J. C.: "Introduction to Chemical Physics," McGraw-Hill Book Company, Inc., New York, 1939.
- SEITZ, F.: "The Modern Theory of Solids," McGraw-Hill Book Company, Inc., New York, 1940.
- CLARK, G. L.: "Applied X-rays," 3d ed., McGraw-Hill Book Company, Inc., New York, 1940.
- GIBB, T. R. P., Jr.: "Optical Methods of Chemical Analysis," McGraw-Hill Book Company, Inc., New York, 1942.
- BUERGER, M. J.: "X-ray Crystallography," John Wiley & Sons, Inc., New York, 1942.
- BUNN, C. W.: "Chemical Crystallography," Oxford University Press, New York, 1945.
- PHILLIPS, F. C.: "An Introduction to Crystallography," Longmans, Green & Co., Inc., New York, 1946.

The author wishes to thank the many men in the field of refractories who have helped him in this revision. In particular, he is indebted to Isaac Harter, A. M. Kohler, C. L. Norton, Jr., W. D. Stevens, and others of the Babcock & Wilcox Company; S. M. Phelps of the American Re-

fractories Institute; R. E. Birch of the Harbison-Walker Company; L. H. Milligan, G. R. Finlay, and O. J. Whittemore, Jr., of the Norton Company; R. E. Geller of the U.S. Bureau of Standards; R. B. Sosman of Rutgers University, and Louis Navias of the General Electric Company.

Lieutenant Commander F. W. Kinsley and E. G. Schneider have kindly reviewed the manuscript of Chapter XXV, and I. Amdur, Chapter X. The declassification section of the U.S. Atomic Energy Commission has read Chapters XII and XXIV to certify them for release.

P. D. Johnson, W. E. Hauth, Jr., J. A. Stavrolakis, and J. M. Brownlow kindly permitted the use of some data from their theses.

G. H. Whipple was most helpful in gathering material, but particular credit should go to Robert Mainhardt for his painstaking work in assembling data and checking the manuscript, as well as preparing several sections of the text.

F. H. NORTON

CAMBRIDGE, MASS.

July, 1949

PREFACE TO THE FIRST EDITION

This book was written to fulfill the demand for a modern treatise on refractories. In order to keep it within a reasonable size it has been found necessary to deal mainly with the fundamental processes involved in the manufacture and use of refractories. Furthermore, the descriptions of the manufacturing processes have been confined to American practice. The important subject of the proper use of refractories in furnace design and construction has been omitted, since to do it justice a whole volume would be needed. On certain subjects it was found that a great deal of important information was lacking, and the attempt has been made in each case to indicate the direction in which research should be carried to provide the additional data needed for the understanding of the principles involved.

Although a portion of the material contained in this book has been taken from published data, a considerable amount of new material has been included. This has been obtained from the extensive work on refractories carried out in the laboratories of the Babcock & Wilcox Company. Unless otherwise stated, nearly all the experimental data in the book were derived from this source. In all cases the attempt has been made to indicate by the use of references, where additional information may be obtained on any particular subject.

Chapter XVI was prepared by Prof. J. L. Gillson of the Massachusetts Institute of Technology, whose experience in the examination of clays and ceramic products makes him especially well fitted to write on this subject. Chapter XVII was written by Prof. J. T. Norton of the Massachusetts Institute of Technology, who has been carrying on X-ray studies of crystals for a number of years. Chapter XVIII was prepared by Mr. J. B. Romer, chief chemist of the Babcock & Wilcox Company. Mr. Romer has had many years of experience in analyzing clays and ceramic products.

The author wishes to acknowledge the valuable assistance rendered in the preparation of this book by a large number of individuals connected with the refractories industry. I am particularly indebted to Mr. Isaac Harter, vice president of the Babcock & Wilcox Company; Prof. C. L. Norton, Prof. G. B. Wilkes, and Prof. C. E. Locke of the Massachusetts Institute of Technology; Mr. A. M. Kohler, Mr. J. E. Brinckerhoff, and Mr. Robert Richardson of the Babcock & Wilcox Company; and Mr. E. B. Powell of Stone & Webster, Inc.

A considerable number of industrial concerns connected with the refractories industry have cooperated most heartily in supplying up-to-date illustrations. Separate acknowledgment has been made in each case.

The numerous photomicrographs throughout the book are due to the painstaking work of C. L. Norton, Jr., who is carrying on research in ceramic petrography at the Massachusetts Institute of Technology, under a Babcock & Wilcox fellowship.

F. H. NORTON

CAMBRIDGE, MASS.

August, 1931

CONTENTS

| | |
|--|-----|
| PREFACE TO THE THIRD EDITION | v |
| PREFACE TO THE FIRST EDITION | vii |

PART I. INTRODUCTION

CHAPTER

| | |
|--|----|
| I. SCOPE OF THE REFRACTORIES INDUSTRY IN THE UNITED STATES | 3 |
| The Refractories Industry—Refractories in Relation to Other Industries —Recent Developments in the Industry—Future Trends in the Industry. | |
| II. LITERATURE ON REFRACTORIES | 10 |
| Books—Periodicals and Other Publications—Bibliographies—Abstracts. | |
| III. HISTORY OF REFRACTORY DEVELOPMENT IN THE UNITED STATES | 15 |
| Furnace Stone—Glass Pots and Crucibles—Lime—Fireclay Bricks— Silica Refractories—Chrome Refractories—Magnesite Refractories— High-alumina Refractories—Bibliography. | |

PART II. MANUFACTURE

| | |
|--|-----|
| IV. REFRACTORY RAW MATERIALS | 27 |
| Clays—Clays and Minerals High in Alumina—Silica Minerals—Mag- nesite and Lime—Chromite—Less Common Refractory Oxides—Car- bon—Production and Price of Minerals in the Refractories Industry— Summary—Bibliography. | |
| V. THE MINING AND PRELIMINARY TREATMENT OF REFRACTORY MATERIALS | 76 |
| Mining of Clays—The Mining of Ganister—Crushing and Grinding— Screening—Mineral-dressing Methods—Storage of Clay—Bibliography. | |
| VI. MOLDING METHODS | 94 |
| Workability of Clay—The Casting Process—The Soft-mud Process— The Stiff-mud Process—The Dry-press Process—Hydrostatic Molding of Refractory Powders—Molding of Insulating Firebrick—Abrasion- resisting Metals—Grog Sizing—Chemical Bonding—Hot Molding— Bibliography. | |
| VII. DRYING | 157 |
| The Mechanism of Drying—Drying Shrinkage—Dry Strength— Factors Influencing Drying Efficiency—Drier Calculations—Types of Driers—Bibliography. | |
| VIII. THE FIRING OF CLAY AND OTHER REFRACTORY MATERIALS | 175 |
| Effect of Heat on Raw Clay—Firing Properties of Nonclay Refractory Materials—Solid Reactions—Hot Pressing—Firing Properties of Re- | |

CHAPTER

refractory Bodies—Melted and Cast Refractories—Specific Heat—Heat Quantity Required to Raise the Temperature of Clays and Ceramic Bodies—Bibliography.

IX. KILNS FOR BURNING REFRACTORIES 227
 Introduction—General Principles—Periodic Kilns—Continuous Compartment Kilns—Tunnel Kilns—Shaft Kilns—Rotary Kilns—Air Preheaters—Handling and Storage—Bibliography.

X. LABORATORY KILNS AND FURNACES 259
 Combustion Furnaces—Electric Resistance Furnaces—Arc Furnaces—Solar Furnaces—High-frequency Induction Heating—Bibliography.

XI. REFRACTORY MORTARS, PLASTICS, CONCRETES, AND COATINGS 290
 Introduction — Mortars — Plastics — Concretes — Coatings — Bibliography.

XII. SOME SPECIAL REFRACTORY MATERIALS 302
 Introduction—Refractory Metals—Refractory Oxides—Refractory Porcelains—Carbides—Nitrides—Sulfides—Borides—Refractory Selenides, Silicides, and Phosphides—Refractory Single Crystals—Heterogeneous Refractory Systems—Refractory Glasses—Bibliography.

PART III. PROPERTIES

XIII. THE FUSION POINT OF REFRACTORY MATERIALS AND THEIR EQUILIBRIUM DIAGRAMS 347
 Fusion Process—Method of Obtaining Fusion Points—Fusion Point and Composition—Melting Point of Some Refractory Materials—Value of Fusion Points—Equilibrium Diagrams—Bibliography.

XIV. LOAD BEARING CAPACITY OF REFRACTORIES 401
 The Mechanism of Load Failure—Method of Measurement—Load Values for a Number of Refractories—Factors Influencing the Load-bearing Capacity of Refractories—Application of Load-test Results to Design—Bibliography.

XV. SPALLING 420
 Introduction—Temperature Stresses in Solids—Study of Cracks Developed in Spalling—Theory of Spalling Due to Shear Stresses—Theory of Spalling Due to Tensile Stresses—Experimental Confirmation of Theory—Laboratory Spalling Test—Spalling Characteristics of Various Bricks—Effect of the Brick Structure on Spalling—Spalling Fracture in Service—Bibliography.

XVI. THE REACTION BETWEEN REFRACTORIES AND SLAGS OR GLASSES 453
 Chemical Effect of Slag Action—Physical Effects of Slag Action—Laboratory Slag Tests—The Slag Resistance of Refractories—The Products Formed in Slag Reactions—Gases and Refractories—Reaction between Different Refractories in Contact—Slag Erosion in Service—Bibliography.

CHAPTER

| | |
|--|-----|
| XVII. EXPANSION AND SHRINKAGE | 479 |
| Methods of Measurement—Expansion Characteristics of a Number of Refractory Bricks—Expansion of Silica Minerals—Expansion of Other Refractory Materials—Reheat Shrinkage of Refractories—Bibliography. | |
| XVIII. HEAT TRANSMISSION BY REFRACTORIES | 498 |
| Introduction—Laws of Heat Conduction—Theory of Heat Transfer through a Porous Body—Measurement of Thermal Conductivity—Thermal-conductivity Values for Refractories and Insulators—Flow of Heat through Walls under Steady Conditions—Computation of Heat Flow in Cylinders—Flow of Heat through Furnace Walls under Variable Conditions—Bibliography. | |
| XIX. SIZES AND TOLERANCES | 523 |
| Standard Shapes—Special Shapes—Kiln Furniture—Muffles—Retorts—Crucibles—Glass Pots—Refractory Porcelain—Bibliography. | |
| XX. MISCELLANEOUS PROPERTIES OF REFRACTORIES | 537 |
| Measurement of Particle Size—Structure—Permeability—Strength of Refractories—True Density—Abrasion Resistance—Electrical Resistivity—Bibliography. | |
| PART IV. USE | |
| XXI. REFRACTORIES IN THE IRON AND STEEL INDUSTRY | 563 |
| Introduction—Blast Furnace—Cupola—Open-hearth Furnace—Pouring-pit Refractories—Air Furnace—Bessemer Converter—Electric-arc Furnaces—High-frequency Induction Melting Furnaces—Furnaces for Forming Operations—Heat-treating and Stress-relieving Furnaces—Bright Annealing Furnaces—Bibliography. | |
| XXII. REFRACTORIES IN THE NONFERROUS-METAL INDUSTRY | 598 |
| Copper Production—Melting Copper Alloys—Zinc—Lead—Tin—Aluminum—Nickel—Bibliography. | |
| XXIII. REFRACTORIES IN THE GENERATION OF STEAM POWER | 617 |
| Development of Boiler Furnace Design—Modern Furnaces and Boiler Walls—Slag-tap Furnace Floors—Boiler Baffles—Boiler Unit for Multi-fuel Firing—Pulverized Coal-fired Boiler—Cyclone Furnace—Spreader-stoker-fired Boiler—Oil-fired Marine Boiler—Waste-heat Boilers—Black-liquor Recovery Furnaces—Bibliography. | |
| XXIV. REFRACTORIES FOR USE IN NUCLEAR POWER PRODUCTION | 631 |
| Introduction—The Nuclear Fission Process—Nuclear Fuel—Design of Power Piles or Reactors—Survey of Refractories for Potential Use in Power Reactor Development—Summary and Conclusions—Bibliography. | |
| XXV. REFRACTORIES FOR GAS-TURBINE AND JET-PROPULSION ENGINES | 654 |
| Introduction—Types of Power Plants—Combustion Chambers—Nozzles—Guide Vanes and Reactors—Turbine Buckets—Turbine | |

CHAPTER

| | | |
|--------|--|-----|
| | Nozzle Blades—Turbine Rotors—Insulation—External Portions of the Rocket—Summary—Bibliography. | |
| XXVI. | USE OF REFRACTORIES IN MISCELLANEOUS INDUSTRIES | 667 |
| | Kilns—Glass Refractories—Refractories in the Cement and Lime Industry—Gas Production—Incinerators—Domestic Heating—Paper-mill Refractories—Enameling—Bibliography. | |
| XXVII. | BRICKWORK CONSTRUCTION | 684 |
| | Foundations—Floors and Hearths—Walls—Doors, Ports, and Flues—Sprung Arches—Domes—Suspended Arches—Brick Laying—Bibliography. | |

APPENDIX

| | |
|--|-----|
| REFERENCE TABLES | 737 |
| Table 156, Temperature-conversion Table—Table 157, Temperature Equivalents of Orton Pyrometric Cones—Table 158, Standard Calibration Data for Chromel-alumel Couples—Table 159, Standard Calibration Data for Chromel-alumel Couples—Table 160, Standard Calibration Data for Thermocouples from Platinum and Platinum Alloyed with 10 Per Cent Rhodium—Table 161, Standard Calibration Data for Thermocouples from Platinum and Platinum Alloyed with 10 Per Cent Rhodium—Table 162, Standard Calibration Data for Copper-constantan Thermocouple—Table 163, Standard Calibration Data for Copper-constantan Thermocouple—Table 164, Formulas Useful in Calculations. | |

| | |
|-----------------|-----|
| INDEX | 749 |
|-----------------|-----|

Part I
INTRODUCTION

CHAPTER I

SCOPE OF THE REFRACTORIES INDUSTRY IN THE UNITED STATES

1. **The Refractories Industry.** Although the manufacture of refractories is not one of the largest industries, it is a particularly important one, as all processes using high temperatures are dependent upon it. The refractories industry in the United States has shown a rapid growth since the start of the century, as indicated by the production curve in Fig. 1.

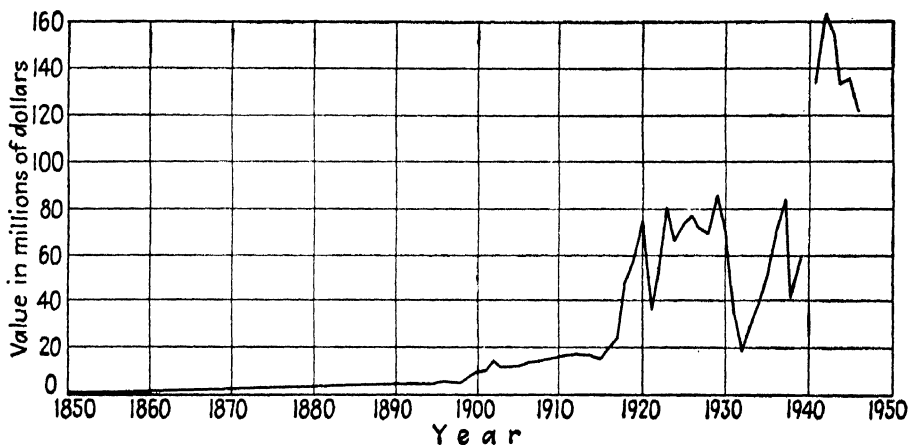

FIG. 1. Total value of refractories produced in the United States.

A more detailed picture of the refractories production in this country is shown in Tables 1 to 4, which give the quantities and values of various classes of refractories turned out each year. These tables indicate that many changes have occurred in refractory production especially if figures before and after the Second World War are compared. Fireclay and silica brick have about the same production volume, but they have increased in price about 50 per cent. High-alumina brick production also shows little volume change, but the price has nearly doubled. On the other hand, basic brick production has doubled both in volume and in price during the Second World War. The most striking change is the great increase in production volume of refractory cements (mortars, plastics, and castables), however, with only a small increase in price.

2. **Refractories in Relation to Other Industries.** Many industries are absolutely dependent upon refractories. For example, the power industry

REFRACTORIES

TABLE 1. REFRACTORIES INDUSTRY STATISTICS—CLAY REFRACTORIES PRODUCTION*
Normal production average based on 1925-1927 = 100

| Year | Fireclay bricks | | | High-alumina bricks | | | Special shapes (clay refractories) | | | Total clay firebricks | | | |
|------|-----------------------------|--------------|----------------------------|-----------------------------|------------|----------------------------|------------------------------------|------|-------|----------------------------|----------------|--------------|----------------------------|
| | Thou- sands | Value | Pro- duc- tion, % | Thou- sands | Value | Pro- duc- tion, % | Thou- sands | Tons | Value | Pro- duc- tion, % | Thou- sands | Value | Pro- duc- tion, % |
| 1919 | 954,765 | | | 8,470 | | | 50,000 | | | | 981,791 | | |
| 1920 | Included in total firebrick | | | Included in total firebrick | | | Included in other clay products | | | | 963,439 | \$38,015,792 | 98.1 |
| 1921 | Included in total firebrick | | | Included in total firebrick | | | Included in other clay products | | | | 1,114,809 | \$3,415,888 | 113.5 |
| 1922 | Included in total firebrick | | | Included in total firebrick | | | Included in other clay products | | | | 621,009 | \$2,833,297 | 63.2 |
| 1923 | 815,286 | \$30,554,262 | 85.3 | 21,438 | \$ 802,479 | 253.1 | 1,334,225 | | | | 836,724 | \$1,356,741 | 85.2 |
| 1924 | 1,105,575 | 45,370,488 | 115.7 | 28,650 | 1,306,149 | 338.2 | 1,334,225 | | | | 1,134,225 | 46,676,637 | 115.5 |
| 1925 | 940,948 | 39,671,315 | 98.5 | 14,451 | 943,628 | 176.4 | 955,339 | | | | 955,339 | 40,620,941 | 97.3 |
| 1926 | 960,113 | 40,727,576 | 103.7 | 4,966 | 436,123 | 55.6 | 1,034,657 | | | | 1,034,657 | 41,163,701 | 101.3 |
| 1927 | 1,007,764 | 40,013,394 | 105.5 | 9,095 | 975,624 | 107.3 | 1,034,657 | | | | 1,034,657 | 42,706,932 | 105.3 |
| 1928 | 866,397 | 34,287,287 | 90.7 | 11,351 | 1,187,096 | 134.0 | 1,034,657 | | | | 1,034,657 | 42,706,932 | 105.3 |
| 1929 | 854,895 | 33,537,128 | 89.5 | 13,860 | 1,336,409 | 163.6 | 1,034,657 | | | | 1,034,657 | 42,706,932 | 105.3 |
| 1930 | 938,218 | 36,168,898 | 98.2 | 23,911 | 2,114,925 | 282.3 | 1,034,657 | | | | 1,034,657 | 42,706,932 | 105.3 |
| 1931 | 738,934 | 29,737,369 | 77.3 | 11,833 | 1,592,300 | 139.7 | 1,034,657 | | | | 1,034,657 | 42,706,932 | 105.3 |
| 1932 | 416,041 | 15,685,507 | 43.5 | 7,020 | 733,579 | 82.8 | 1,034,657 | | | | 1,034,657 | 42,706,932 | 105.3 |
| 1933 | 217,242 | 7,611,372 | 22.7 | 4,864 | 464,020 | 57.4 | 1,034,657 | | | | 1,034,657 | 42,706,932 | 105.3 |
| 1934 | 372,623 | 13,116,090 | 39.0 | 9,553 | 718,387 | 119.7 | 1,034,657 | | | | 1,034,657 | 42,706,932 | 105.3 |
| 1935 | 390,214 | 15,485,175 | 40.8 | 15,719 | 1,023,747 | 188.5 | 1,034,657 | | | | 1,034,657 | 42,706,932 | 105.3 |
| 1936 | 461,679 | 19,896,580 | 50.4 | 13,220 | 1,071,029 | 136.1 | 1,034,657 | | | | 1,034,657 | 42,706,932 | 105.3 |
| 1937 | 615,498 | 26,379,979 | 64.5 | 11,151 | 1,122,117 | 131.7 | 1,034,657 | | | | 1,034,657 | 42,706,932 | 105.3 |
| 1938 | 700,947 | 32,806,495 | 73.4 | 27,459 | 2,153,675 | 324.2 | 1,034,657 | | | | 1,034,657 | 42,706,932 | 105.3 |
| 1939 | 349,155 | 17,235,535 | 36.5 | 16,095 | 1,724,396 | 190.0 | 1,034,657 | | | | 1,034,657 | 42,706,932 | 105.3 |
| 1940 | 506,970 | 25,125,126 | 53.5 | 16,700 | 1,510,707 | 197.1 | 1,034,657 | | | | 1,034,657 | 42,706,932 | 105.3 |
| 1941 | 811,335 | 46,556,000 | 85.0 | 19,059 | 2,864,000 | 225 | 1,034,657 | | | | 1,034,657 | 42,706,932 | 105.3 |
| 1942 | 955,134 | 60,192,000 | 100 | 21,818 | 3,459,000 | 259 | 1,034,657 | | | | 1,034,657 | 42,706,932 | 105.3 |
| 1943 | 828,983 | 53,733,000 | 86 | 27,867 | 4,055,000 | 331 | 1,034,657 | | | | 1,034,657 | 42,706,932 | 105.3 |
| 1944 | 656,787 | 39,566,000 | 66 | 23,668 | 3,365,000 | 279 | 1,034,657 | | | | 1,034,657 | 42,706,932 | 105.3 |
| 1945 | 595,460 | 40,384,000 | 62 | 16,292 | 2,525,000 | 192 | 1,034,657 | | | | 1,034,657 | 42,706,932 | 105.3 |
| 1946 | 671,309 | 50,394,000 | 70 | 19,177 | 3,373,000 | 227 | 1,034,657 | | | | 1,034,657 | 42,706,932 | 105.3 |

* Table prepared by A. M. Kohler, Babcock and Wilcox Co. up to and including 1939. "Facts for Industry" and "Minerals Yearbook," U. S. Department of Commerce, 1948.

TABLE 2. REFRACTORIES INDUSTRY STATISTICS—NONCLAY REFRACTORIES PRODUCTION*
Normal production average based on 1925-1927 = 100

| Year | Silica | | | Magnesite and chrome | | | Other nonclay includes those of alumina and silicon carbide | | | Total nonclay refractories | | | |
|--------|-----------------------------|--------------|----------------------------|----------------------------|-------------|----------------------------|---|--------------|----------------------------|-----------------------------|-------|----------------------------|---------------|
| | Thou- sands | Value | Pro- duc- tion, % | Thou- sands | Value | Pro- duc- tion, % | Thou- sands | Value | Pro- duc- tion, % | Thou- sands | Value | Pro- duc- tion, % | Unit value |
| Normal | 249,389, based on 1925-1927 | | | 14,267, based on 1925-1927 | | | \$4,608,511, based on 1925-1927 | | | 263,653, based on 1925-1927 | | | |
| 1919 | 211,420 | \$10,914,898 | 84.8 | | | | 211,420 | \$10,914,898 | 80.2 | | | | \$ 51.63 |
| 1920 | 250,582 | 15,076,821 | 100.5 | | | | 250,582 | 15,076,821 | 95.1 | | | | 60.17 |
| 1921 | 109,990 | 5,220,640 | 52.5 | | | | No data | | | | | | 70.49 |
| 1922 | 186,547 | 7,533,409 | 74.8 | | | | \$2,533,209 | | | | | | 70.28 |
| 1923 | 255,388 | 12,855,067 | 102.4 | 10,569 | \$2,629,393 | 74.0 | 3,690,794 | | | | | | 74.7 |
| 1924 | 204,338 | 10,084,373 | 81.9 | 13,045 | 4,060,142 | 91.4 | 1,943,501 | | | | | | 69.47 |
| 1925 | 235,877 | 11,280,127 | 94.6 | 12,732 | 3,852,857 | 89.4 | 3,353,142 | | | | | | 79.26 |
| 1926 | 266,409 | 13,614,033 | 106.8 | 12,732 | 3,751,872 | 89.3 | 3,062,156 | | | | | | 72.78 |
| 1927 | 245,881 | 12,756,994 | 98.6 | 16,130 | 4,760,645 | 113.0 | 2,955,14 | | | | | | 83.02 |
| 1928 | 241,523 | 12,187,539 | 96.8 | 13,941 | 3,874,176 | 97.7 | 5,083,373 | | | | | | 85.87 |
| 1929 | 294,402 | 15,165,260 | 118.0 | 14,116 | 4,143,823 | 98.9 | 5,442,924 | | | | | | 85.17 |
| 1930 | 212,640 | 11,523,169 | 85.3 | 17,399 | 5,630,647 | 121.9 | 6,989,217 | | | | | | 89.11 |
| 1931 | 103,557 | 5,131,514 | 41.5 | 13,432 | 3,878,054 | 94.1 | 2,888,71 | | | | | | 89.97 |
| 1932 | 40,111 | 1,762,440 | 16.0 | 8,365 | 2,233,810 | 58.6 | 4,768,749 | | | | | | 108.4 |
| 1933 | 110,889 | 4,654,776 | 44.5 | 3,167 | 845,332 | 22.2 | 2,666,91 | | | | | | 116.0 |
| 1934 | 103,334 | 3,703,244 | 41.5 | 9,027 | 2,579,994 | 63.3 | 2,855,80 | | | | | | 84.90 |
| 1935 | 149,621 | 5,179,990 | 60.0 | 10,040 | 3,091,573 | 74.6 | 2,696,033 | | | | | | 100.66 |
| 1936 | 229,651 | 8,179,330 | 91.9 | 32,112 | 3,424,726 | 85.5 | 3,582,73 | | | | | | 112.54 |
| 1937 | 220,110 | 12,802,063 | 88.3 | 20,403 | 5,767,221 | 143.0 | 6,586,189 | | | | | | 93.99 |
| 1938 | 90,952 | 5,472,542 | 36.5 | 22,758 | 6,726,943 | 159.5 | 8,107,172 | | | | | | 113.79 |
| 1939 | 173,382 | 9,019,478 | 82.0 | 12,090 | 3,675,167 | 84.5 | 2,839,284 | | | | | | 116.36 |
| 1940 | 310,680 | 19,962,000 | 125 | 21,549 | 6,403,237 | 151.3 | 5,889,943 | | | | | | 109.85 |
| 1941 | 344,757 | 24,112,000 | 138 | 15,040 | 5,030,647 | 121.9 | 13,250,000 | | | | | | 48,262,000 |
| 1942 | 320,329 | 21,821,000 | 128 | 45,140 | 17,144,000 | 305 | 14,886,000 | | | | | | 56,142,000 |
| 1943 | 288,289 | 18,673,000 | 115 | 49,567 | 17,638,000 | 357 | 15,637,000 | | | | | | 55,096,000 |
| 1944 | 268,985 | 18,392,000 | 107 | 51,146 | 16,375,000 | 334 | 14,069,000 | | | | | | 49,117,000 |
| 1945 | 246,621 | 19,378,000 | 99 | 47,026 | 16,083,000 | 328 | 22,193,000 | | | | | | 56,678,000 |
| 1946 | | | | 45,506 | 15,789,000 | 319 | 33,619,000 | | | | | | 68,786,000 |

* Table prepared by A. M. Kohler, Babcock and Wilcox Co. up to and including 1939. "Facts for Industry" and "Minerals Yearbook," U. S. Department of Commerce, 1948.

TABLE 3. REFRACTORIES INDUSTRY STATISTICS—CEMENTS AND MORTARS PRODUCTION*
Normal production average based on 1925-1927 = 100

| Year | Refractory cements (clay) plastics and castables | | | | Refractory cements (nonclay) plastics and castables | | | | Total refractory cements plastics and castables | | | | Fireclay (raw and prepared) | | | |
|--------|--|-------|----------------|------------|---|-------|----------------|------------|---|-------|----------------|------------|-----------------------------|-------|----------------|------------|
| | Tons | Value | Pro-duction, % | Unit value | Tons | Value | Pro-duction, % | Unit value | Tons | Value | Pro-duction, % | Unit value | Tons | Value | Pro-duction, % | Unit value |
| Normal | 36,863, based on 1925-1927 | | | | 50,809, based on 1925-1927 | | | | 87,340, based on 1925-1927 | | | | 540,076, based on 1925-1927 | | | |
| 1919 | Included in other than clay or silica refractories | | | | 50,809, based on 1925-1927 | | | | 87,340, based on 1925-1927 | | | | 540,076, based on 1925-1927 | | | |
| 1920 | Included in other than clay or silica refractories | | | | 50,809, based on 1925-1927 | | | | 87,340, based on 1925-1927 | | | | 540,076, based on 1925-1927 | | | |
| 1921 | Included in other than clay or silica refractories | | | | 50,809, based on 1925-1927 | | | | 87,340, based on 1925-1927 | | | | 540,076, based on 1925-1927 | | | |
| 1922 | Included in total cements | | | | 50,809, based on 1925-1927 | | | | 87,340, based on 1925-1927 | | | | 540,076, based on 1925-1927 | | | |
| 1923 | Included in total cements | | | | 50,809, based on 1925-1927 | | | | 87,340, based on 1925-1927 | | | | 540,076, based on 1925-1927 | | | |
| 1924 | Included in total cements | | | | 50,809, based on 1925-1927 | | | | 87,340, based on 1925-1927 | | | | 540,076, based on 1925-1927 | | | |
| 1925 | Included in total cements | | | | 50,809, based on 1925-1927 | | | | 87,340, based on 1925-1927 | | | | 540,076, based on 1925-1927 | | | |
| 1926 | Included in total cements | | | | 50,809, based on 1925-1927 | | | | 87,340, based on 1925-1927 | | | | 540,076, based on 1925-1927 | | | |
| 1927 | Included in total cements | | | | 50,809, based on 1925-1927 | | | | 87,340, based on 1925-1927 | | | | 540,076, based on 1925-1927 | | | |
| 1928 | Included in total cements | | | | 50,809, based on 1925-1927 | | | | 87,340, based on 1925-1927 | | | | 540,076, based on 1925-1927 | | | |
| 1929 | Included in total cements | | | | 50,809, based on 1925-1927 | | | | 87,340, based on 1925-1927 | | | | 540,076, based on 1925-1927 | | | |
| 1930 | Included in total cements | | | | 50,809, based on 1925-1927 | | | | 87,340, based on 1925-1927 | | | | 540,076, based on 1925-1927 | | | |
| 1931 | Included in total cements | | | | 50,809, based on 1925-1927 | | | | 87,340, based on 1925-1927 | | | | 540,076, based on 1925-1927 | | | |
| 1932 | Included in total cements | | | | 50,809, based on 1925-1927 | | | | 87,340, based on 1925-1927 | | | | 540,076, based on 1925-1927 | | | |
| 1933 | Included in total cements | | | | 50,809, based on 1925-1927 | | | | 87,340, based on 1925-1927 | | | | 540,076, based on 1925-1927 | | | |
| 1934 | Included in total cements | | | | 50,809, based on 1925-1927 | | | | 87,340, based on 1925-1927 | | | | 540,076, based on 1925-1927 | | | |
| 1935 | Included in total cements | | | | 50,809, based on 1925-1927 | | | | 87,340, based on 1925-1927 | | | | 540,076, based on 1925-1927 | | | |
| 1936 | Included in total cements | | | | 50,809, based on 1925-1927 | | | | 87,340, based on 1925-1927 | | | | 540,076, based on 1925-1927 | | | |
| 1937 | Included in total cements | | | | 50,809, based on 1925-1927 | | | | 87,340, based on 1925-1927 | | | | 540,076, based on 1925-1927 | | | |
| 1938 | Included in total cements | | | | 50,809, based on 1925-1927 | | | | 87,340, based on 1925-1927 | | | | 540,076, based on 1925-1927 | | | |
| 1939 | Included in total cements | | | | 50,809, based on 1925-1927 | | | | 87,340, based on 1925-1927 | | | | 540,076, based on 1925-1927 | | | |
| 1940 | Included in total cements | | | | 50,809, based on 1925-1927 | | | | 87,340, based on 1925-1927 | | | | 540,076, based on 1925-1927 | | | |
| 1941 | Included in total cements | | | | 50,809, based on 1925-1927 | | | | 87,340, based on 1925-1927 | | | | 540,076, based on 1925-1927 | | | |
| 1942 | Included in total cements | | | | 50,809, based on 1925-1927 | | | | 87,340, based on 1925-1927 | | | | 540,076, based on 1925-1927 | | | |
| 1943 | Included in total cements | | | | 50,809, based on 1925-1927 | | | | 87,340, based on 1925-1927 | | | | 540,076, based on 1925-1927 | | | |
| 1944 | Included in total cements | | | | 50,809, based on 1925-1927 | | | | 87,340, based on 1925-1927 | | | | 540,076, based on 1925-1927 | | | |
| 1945 | Included in total cements | | | | 50,809, based on 1925-1927 | | | | 87,340, based on 1925-1927 | | | | 540,076, based on 1925-1927 | | | |
| 1946 | Included in total cements | | | | 50,809, based on 1925-1927 | | | | 87,340, based on 1925-1927 | | | | 540,076, based on 1925-1927 | | | |

* Table prepared by A. M. Kohler, Babcock and Wilcox Co. up to and including 1939. "Facts for Industry" and "Minerals Yearbook," U. S. Department of Commerce, 1948.

SCOPE OF THE REFRACTORIES INDUSTRY

TABLE 4. REFRACTORIES INDUSTRY STATISTICS—OTHER REFRACTORIES PRODUCTION*
Normal average based on 1925-1927 = 100

| Year | Glass house refractories | | | Cruciblest | | Other fireclay productst | | Total, all refractories | |
|--------|--------------------------|-------------|---------------|----------------------------------|---------------|---------------------------------|---------------|----------------------------------|---------------|
| | Tons | Value | Production, % | Value | Production, % | Value | Production, % | Value | Production, % |
| Normal | | | | | | | | | |
| 1919 | 41,177 | \$2,310,473 | 100.0 | \$2,751,736, based on 1929 | | \$6,460,630, based on 1925-1927 | | \$74,489,583, based on 1925-1927 | |
| 1920 | 35,513 | 1,993,609 | 86.2 | Included in nonclay refractories | | \$ 8,840,492 | 136.8 | \$ 57,771,182 | 77.5 |
| 1921 | 35,192 | 2,276,009 | 85.4 | Included in nonclay refractories | | 8,981,068 | 139.0 | 77,473,777 | 104.0 |
| 1922 | 34,417 | 1,953,644 | 83.5 | Included in nonclay refractories | | 4,586,612 | 71.0 | 37,173,758 | 49.9 |
| 1923 | 22,853 | 1,258,546 | 55.4 | Included in nonclay refractories | | 6,345,985 | 98.2 | 50,807,909 | 68.2 |
| 1924 | | | | Included in nonclay refractories | | 11,183,373 | 173.1 | 81,738,067 | 109.7 |
| 1925 | | | | Included in nonclay refractories | | 8,111,146 | 123.5 | 68,960,739 | 92.6 |
| 1926 | | | | Included in nonclay refractories | | 8,561,014 | 132.5 | 73,371,376 | 98.8 |
| 1927 | | | | Included in nonclay refractories | | 6,585,182 | 101.9 | 77,790,692 | 104.4 |
| 1928 | | | | Included in nonclay refractories | | 4,235,694 | 65.5 | 72,106,682 | 96.8 |
| 1929 | | | | Included in nonclay refractories | | 3,617,377 | 55.9 | 70,095,907 | 94.1 |
| 1930 | | | | \$ 2,751,736 | 100.0 | 4,237,036 | 65.5 | 85,739,283 | 115.1 |
| 1931 | | | | 1,700,000 | 61.7 | 4,150,053 | 64.2 | 69,449,169 | 93.2 |
| 1932 | | | | 1,113,972 | 40.4 | 1,584,548 | 24.5 | 38,817,937 | 52.1 |
| 1933 | | | | 639,207 | 23.2 | 693,643 | 10.7 | 19,264,937 | 25.9 |
| 1934 | | | | 757,996 | 27.5 | 745,089 | 11.5 | 32,652,077 | 43.8 |
| 1935 | | | | 870,855 | 30.9 | 1,293,068 | 20.0 | 38,909,396 | 52.2 |
| 1936 | | | | 1,033,644 | 37.6 | 3,566,875 | 55.2 | 52,830,913 | 70.9 |
| 1937 | | | | 1,880,921 | 68.4 | 4,269,877 | 66.1 | 69,651,707 | 93.5 |
| 1938 | | | | 1,779,303 | 64.7 | 4,203,042 | 65.1 | 83,044,491 | 112.0 |
| 1939 | | | | 1,020,761 | 37.1 | 2,325,246 | 36.0 | 44,232,315 | 59.4 |
| 1940 | | | | 1,666,976 | 60.9 | 3,281,974 | 50.1 | | |
| 1941 | | | | Figures not available | | | | | |
| 1942 | | | | 12,691,000 | 462 | 38,878,000 | 615 | 134,056,000 | 180 |
| 1943 | | | | 13,753,000 | 500 | 49,419,000 | 762 | 161,263,000 | 216 |
| 1944 | | | | 13,543,000 | 490 | 44,042,000 | 680 | 155,711,000 | 209 |
| 1945 | | | | 12,461,000 | 450 | 32,501,000 | 502 | 133,223,000 | 178 |
| 1946 | | | | 11,990,000 | 437 | | | 136,561,000 | 183 |
| | | | | 11,276,000 | 410 | | | 121,602,000 | 163 |

* Table prepared by A. M. Kohler, Babcock and Wilcox Co. up to and including 1939. "Facts for Industry" and "Minerals Yearbook," U.S. Department of Commerce, 1948.

† After 1940 ladle brick, hot tops, sleeves and runners are included. ‡ After 1940 the classification was changed.

uses great quantities in boiler furnaces, even though the tendency has been in the last few years to employ water-cooled walls in the larger units. The use of plastic chrome refractories to line the water walls has become a very general practice in powdered-coal and oil-fired boiler furnaces.

The iron and steel industry is vitally concerned with refractories, as evidenced by the large amount of research and development work in this field that is being carried out by the large companies. It may be said that not only the efficiency of the various units producing steel are vitally affected by the properties of the refractories but in some cases better qualities of steel could be produced if improved refractories were available.

In the nonferrous industry, refractories also play an essential part, both for withstanding high temperatures and for resisting various types of slag.

Refractories are also of vital importance to many other industries such as the kilns for ceramic production, glass furnaces, linings of rotary kilns for manufacture of Portland cement, incinerators, black-liquor furnaces, and even household oil-burner furnaces.

3. Recent Developments in the Industry. Since the publication of the previous edition, there have been some important changes in the manufacture and use of refractories.

While there still seem to be ample supplies of fireclay, the high-alumina clays such as diaspore and bauxite are becoming less available. Magnesite is being obtained from sea water and by chemical means from dolomite. A high-purity silica brick is being made from washed ganister, and the use of mullite and pure alumina brick is increasing. Rotary kilns are finding greater use in burning grog to high temperatures, and the firing temperature of bricks is gradually being increased, particularly for the super-duty brick, which is finding more extended markets. In general, laborsaving devices have come into greater use, especially the lift truck.

In the field of steam-power generation, water-cooled walls are more generally used, with plastics and castables replacing many of the fired shapes. The super-duty silica brick is finding use in the open-hearth roof, and trials of basic roofs are under way. The possible use of oxygen additions to combustion air makes refractories with higher use limits of great interest. Following European practice, a number of our blast furnaces are lined with carbon blocks or a rammed carbon mix, apparently with success. Pebble heaters have opened up a new field of high preheating for chemical processes and for very high temperature combustion.

A new and very active field of development is the refractories for jet-propulsion engines. Almost no refractory has as yet been used in these engines, but the possibilities are there. Then, too, the use of atomic energy will certainly require refractories of a very special kind. Neither of these fields will need any great volume of material, so the larger refractory

manufacturers have not been greatly interested as yet, and most of the work has been carried out by specialty manufacturers and government-sponsored research laboratories.

4. Future Trends in the Industry. It is to be expected that concentration methods will be used to a greater extent to produce more uniform raw materials, especially from high-alumina clays. On the other hand, we must not forget the inexhaustible deposits of pure sedimentary kaolin in the South, which will be called on to an increasing extent as the better fireclays are exhausted. The high-stability materials such as pure oxides, carbides, and nitrides will receive more attention as the need for higher temperatures becomes more acute. This will entail much research of a basic nature, which will later on be of the greatest value to the industry as a whole. The hot pressing of refractories will receive more attention, and developments are to be expected in plastics and castables.

CHAPTER II

LITERATURE ON REFRACTORIES

There is a considerable amount of literature dealing with refractories. Much of it, however, is scattered throughout books and periodicals, which makes it rather inaccessible to the average reader. It is, therefore, considered advisable to include here some information that will help in finding the published works on refractories.

1. **Books.** Probably the most complete book on refractories but quite out of date is

SEARLE, A.B.: "Refractory Materials, Their Manufacture and Uses," J. B. Lippincott Company, Philadelphia, 1924.

The following book is up to date and much used in schools and industrial plants. It is understood that a completely revised edition will soon be published.

ANON.: "Modern Refractory Practice," Harbinson-Walker Refractories Co., 1937.

A number of books deal with the use of refractories. They apply, however, mainly to the steelworking industry. The principal books dealing with the application of refractories are given herewith.

HAVARD, F.T.: "Refractories and Furnaces," McGraw-Hill Book Company, Inc., New York, 1912.

JOHNSON, J.E.: "Blast Furnace Construction in America," McGraw-Hill Book Company, Inc., New York, 1917.

SEARLE, A.B.: "Refractories for Furnaces, Crucibles, etc.," Sir Isaac Pitman & Sons, Ltd., London, 1923.

TRINKS, W.: "Industrial Furnaces," John Wiley & Sons, Inc., New York, 1923.

MAWHINNEY, M.H.: "Practical Industrial Furnace Designs," John Wiley & Sons, Inc., New York, 1928.

SALMANG, H.: "Die physikalischen und Chemischen grundlagen der keramik," Verlag Julius Springer, Berlin, 1933.

PARTRIDGE, J.H.: "Refractory Blocks for Glass Tank Furnaces," Society of Glass Technology, Sheffield, England, 1935.

BUELL, W.C.: "The Open Hearth Furnace," 3 Vols., Penton Publishing Company, Cleveland, 1936-1937.

KOEPPEL, C.: "Feuerfeste Baustoffe," S. Hirzel, Leipzig, 1938.

CHESTERS, J.H.: "Steel Plant Refractories," United States Steel Companies, Ltd., Sheffield, England, 1944.

PEREVALOV, V.I.: "Tekhnologiyo Ogneuporov," Metallurgizdat, Moscow, 1944.

LETORT, Y.: "Produits Réfractaires," Dunod, Paris, 1946.

MANTELL, C.L.: "Industrial Carbon, Its Elemental, Adsorptive and Manufactured Forms," D. Van Nostrand Company, Inc., New York, 1946.

There are a number of books concerned in part with raw refractory materials. The book by Ries is the standard work on clays in the United States, and that by Dana is the accepted authority on minerals. Much of the recent work on raw materials will be found in the U.S. Geological Survey bulletins and reports of state geologists. The following list comprises the more important books on the subject:

BISCHOF, C.: "Die Feuerfesten Tone," Quandt, Leipzig, 1904.

RIES, H.: "Clays, Their Occurrence, Properties and Uses," John Wiley & Sons, Inc., New York, 1908.

DANA, E.S.: "A System of Mineralogy," John Wiley & Sons, Inc., New York, 1914.

LEVY, S.L.: "The Rare Earths," Edward Arnold & Co., London, 1915.

LADOO, R.B.: "Non-metallic Minerals," McGraw-Hill Book Company, Inc., New York, 1925.

RYSCHKEWITSCH, E.: "Graphite," S. Hirzel, Leipzig, 1926.

WILSON, H.: "Ceramics-clay Technology," McGraw-Hill Book Company, Inc., New York, 1928.

BUSS, E.: "Properties of Clay," *Tonind.-Ztg.*, Berlin, 1928.

KNIBBS, N.V.S.: "Industrial Uses of Bauxite," Ernest Benn, Ltd., London, 1928.

BANCO, R.: "Der Magnesit," Steinkopff, Dresden, 1932.

COMBER, A.W.: "Magnesite as a Refractory," Charles Griffin & Co., Ltd., London, 1936.

ANON.: "Industrial Minerals and Rocks," American Institute of Mineral Engineers, New York, 1937.

The manufacture of refractories is treated in a number of books, but little material is available on the most modern manufacturing methods; however, the books listed below give fairly complete descriptions of the past and present methods used in the manufacture of refractories.

LOVEJOY, E.: "Drying Claywares," T. A. Randall and Company, Inc., Publishers, Indianapolis, 1916.

GREAVES-WALKER, A.F.: "Clay Plant Construction and Operation," Brick & Clay Record, Chicago, 1919.

SEARLE, A.B.: "Modern Brick Making," Scott, Greenwood & Sons, London, 1920.

LOVEJOY, E.: "Burning Claywares," T. A. Randall and Company, Inc., Publishers, Indianapolis, 1922.

PEREVALOV, V.I.: "Technology of Refractories," Metallurgizdat, Moscow, 1944.

LETORT, Y.: "Produits Réfractaires," Dunod, Paris, 1946.

A few of the many books that deal in whole or in part with the physics and chemistry of refractories follow.

AUDLEY, J.A.: "Silica and the Silicates," D. Van Nostrand Company, Inc., New York, 1921.

BINGHAM, E.C.: "Fluidity and Plasticity," McGraw-Hill Book Company, Inc., New York, 1922.

- SEARLE, A.B.: "The Chemistry and Physics of Clays and Other Ceramic Materials," D. Van Nostrand Company, Inc., New York, 1924.
- MELLOR, J.W.: "A Comprehensive Treatise on Inorganic and Theoretical Chemistry," Vol. 6, "Silicates," Longmans, Green & Co., Inc., New York, 1926.
- WASHBURN, E.W.: "International Critical Tables," McGraw-Hill Book Company, Inc., New York, 1927.
- SOSMAN, R.B.: "The Properties of Silica," Reinhold Publishing Corporation, New York, 1927.
- BRAGG, W.R.: "The Crystalline State," George Bell & Sons, Ltd., London, 1933.
- HAUSER, E.A.: "Colloidal Phenomena," McGraw-Hill Book Company, Inc., New York, 1939.
- EVANS, R.C.: "An Introduction to Crystal Chemistry," Cambridge University Press, London, 1939.
- EITEL, W.: "Physikalische Chemie der Silikate," Voss, Leipzig, 1941.
- PAULING, L.: "The Nature of the Chemical Bond," Cornell University Press, Ithaca, New York, 1944.

Books concerned with the measurement of high temperature are noted below.

- BURGESS, G.K., and H. LE CHATELIER: "The Measurement of High Temperatures," John Wiley & Sons, Inc., New York, 1912.
- GRIFFITHS, EZRA: "Methods of Measuring Temperatures," J. B. Lippincott Company, Philadelphia, 1926.
- WOOD, W.P., and J.M. CORK: "Heat Measurements," McGraw-Hill Book Company, Inc., New York, 1927.
- FISHENDEN, M., and O.A. SAUNDERS: "The Calculation of Heat Transmission," His Majesty's Stationery Office, London, 1932.
- ANON.: "Temperature: Its Measurement and Control in Science and Industry," Reinhold Publishing Corporation, New York, 1940.
- SOSMAN, R.B.: "Pyrometry of Solids and Surfaces," American Society for Metals, Cleveland, 1940.

The best available work on the history of refractories in the United States is

- RIES, H., and H. LEIGHTON: "The History of the Clay Working Industry in the United States," John Wiley & Sons, Inc., New York, 1909.

There are a number of books dealing with the optical study of crystals, a few of which are noted below:

- LARSEN, E.S.: "Microscopic Determination of the Non-opaque Minerals," Government Printing Office, Washington, D.C., 1921.
- WINCHELL, N.H., and A.N. WINCHELL: "Elements of Optical Mineralogy," Vols. I, II, III, John Wiley & Sons, Inc., New York, 1927.
- WINCHELL, A.N.: "Optic and Microscopic Characters of Artificial Minerals," University of Wisconsin, Studies in Science, Vol. 4, 1927.

2. Periodicals and Other Publications. A great many publications contain information on refractories, but only a few of them are devoted exclusively to refractories. The majority have only occasional articles dealing with this subject. From a scientific and technical point of view

the *Journal of the American Ceramic Society* and the *Transactions of the British Ceramic Society* are of the greatest importance. The periodicals in the following list have important or frequent articles on refractories:

- American Ceramic Society, *Journal, Bulletin, Abstracts*, Columbus, Ohio.
 American Refractories Institute, *Technical Bulletin*, Pittsburgh, Pennsylvania.
 American Society for Testing Materials, *Proceedings*, Philadelphia, Pennsylvania.
Berichte der deutschen keramischen Gesellschaft, Berlin-Halensee, Germany.
Brick & Clay Record, Chicago, Illinois.
 British Ceramic Society, *Transactions*, Stoke-on-Trent, England.
British Clayworker, London, England.
Ceramic Age, The Ceramic Publishing Co., Newark, New Jersey.
Ceramic Industry, Chicago, Illinois.
Ceramique, Paris (10^e), France.
Glustechnische Berichte, Deutschen glastechnischen Gesellschaft, Frankfurt am Main, Germany.
 Iron and Steel Institute, *Publications*, Grosvenor Gardens, London.
 National Bureau of Standards, *Circulars, Scientific Papers, Technical News Bulletins, Technical Papers, Journal of Research*, Washington, D.C.
Ogneupory, Russia.
 Ohio Ceramic Industries Association, *Bulletins*, Ohio State University, Columbus, Ohio.
 Ohio State University Engineering Experiment Station, *Bulletins*, Ohio State University, Columbus, Ohio.
Refractories Journal, Sheffield, England.
Sprechsaal, Müller und Schmidt, Coburg, Germany.
 U.S. Bureau of Mines, *Bulletins, Circulars, Mineral Resources, Reports of Investigations, Technical Papers*, Washington, D.C.
 University of Illinois Engineering Experiment Station, *Bulletins*, University of Illinois, Urbana, Illinois.

3. Bibliographies. There are a number of excellent bibliographies covering the complete ceramic field as well as limited portions of it pertaining directly to refractories. The following bibliographies cover the complete field of ceramics quite thoroughly up to the time of their publication. M. L. Solon gives us critical abstracts of most of the books and also an excellent classification. However, he writes mainly from the point of view of the artist, and the number of references of value on modern refractories is limited.

- BRANNER, J.C.: "A Bibliography of Clays and the Ceramic Arts," American Ceramic Society, Columbus, Ohio, 1906. Covers whole ceramic field up to 1906.
 SOLON, M.L.: "A Bibliography on Ceramic Literature," Charles Griffin & Co., Ltd., London, 1910. Critical abstracts are given of most of the books. Well classified.

In the following list are included a number of up-to-date bibliographies dealing with special refractory divisions, which will be found of more direct value than the preceding list.

- MARDEN, J.W., and M.N. RICH: *Bibliography on Zirconium and Its Compounds*, U.S. Bur. Mines, Bull. 186, 1921. .

- McDOWELL, J.S., and H.S. ROBERTSON: Bibliography of Chrome Refractories, *J. Am. Ceram. Soc.*, **5**, 865, 1922. Covers the field up to 1922.
- ANON.: "Bibliography of Magnesite Refractories," American Ceramic Society, 1924. Covers this field up to 1922.
- ANON.: "Bibliography of Silica Refractories," American Ceramic Society, 1924. Covers this field up to 1922.
- ANON.: Literature on Refractories for the Glass Industry, *Glass Ind.*, **7**, (11), 275-276, 1926.
- NORTON, F.H.: Bibliography on Thermal Conductivity of Refractories, *J. Am. Ceram. Soc.*, **10**, 30, 1927. Up to 1927.
- ANON.: Bibliography of Literature on Refractories, *J. Am. Ceram. Soc.*, **10**, 2, 1927.
- FERGUSON, R.F.: Review of the Literature on Laboratory Slag Tests for Refractories, *J. Am. Ceram. Soc.*, **11**, 90-99, 1928.
- COHN, W.M.: Bibliography of Heat Effects on Ceramic Materials, *J. Am. Ceram. Soc.*, **11**, 296, 1928. From 1919 to part of 1928.
- LITINSKY, L.: Bibliography on Refractory Materials for Iron and Steel Works, *Feuerfest*, **4**, (2), 30-32, 1928.
- McVAY, T.N.: Bibliography of Ceramic Microscopy, *Bull. Am. Ceram. Soc.*, **16**, 33, 1937.
- ANON.: "Refractories Bibliography," 1928 to 1947 inclusive," American Iron and Steel Institute and American Ceramic Society, 1950.

4. Abstracts. The most complete abstracts of the literature on refractories are found in the *Journal of the American Ceramic Society* and the *Transactions of the British Ceramic Society*. In *Science Abstracts* and *Chemical Abstracts* will be found quite a few references to the more scientific and technical phases of this subject.

Throughout this book at the end of each chapter have been placed the more important references and publications dealing with the subject of that particular chapter. The selection of these references was somewhat difficult because of the tremendous mass of available material. However, the choice was guided by the amount of original data included in the reference and its accessibility in the average library. Also the more recent articles were considered in place of the early ones except where an early article was a particularly valuable or an original contribution to the subject.

CHAPTER III

HISTORY OF REFRACTORY DEVELOPMENT IN THE UNITED STATES

The early history of refractories in the United States is shrouded in considerable obscurity. A number of references are given here that throw new light on the subject, but a tremendous field still remains to be explored. A few months spent in examining old publications and records of Boston, Baltimore, Philadelphia, and parts of New Jersey would certainly yield valuable information. A little archaeological study around the sites of old furnaces, kilns, and plants would surely produce specimens of the old refractories used.



FIG. 2. An old iron furnace standing in Bennington, Vermont.

1. Furnace Stone. Undoubtedly the earliest type of refractory used in this country was mica schist or siliceous rock. All the early iron furnaces or forges were constructed mainly of this material. Thus we must study the early history of the iron industry. Fortunately this is quite well known, for an iron furnace was much more likely to be a subject of comment than a brickyard. The first furnaces were built in Virginia, but it is quite certain that they were never completed. The first successful furnace was built in 1645 at Saugus, Massachusetts, and the next year another was operated at

Braintree. They were probably made from local stone, although there are no very satisfactory deposits in this region. The building of furnaces and forges spread rapidly in the next hundred years, and considerable stone must have been quarried. Samuel Robinson^{(1)*} in 1825 states that furnace stone was quarried near Providence, Rhode Island, for forty or fifty years and carried long distances in wagons for use in furnace hearths. There were probably other famous quarries at this time.

Stone was used for the building of furnaces and forges late into the nineteenth century because of the greater cost of firebrick. Even now, stone is used for lining Bessemer converters. A number of the old stone or stone and brick furnaces are still standing in various parts of the country. Two interesting ones stand on Furnace Brook in Bennington, Vermont, one of which is shown in Fig. 2.

Records⁽²⁰⁾ show that sandstone was used for the walls of kilns burning refractories. Probably many of the early glass furnaces were built of stone. In fact Robert Hewes of the Temple Glass Company, Temple, New Hampshire,⁽⁷⁾ states in a letter dated 1781: "I shall have to send sixty miles for stones to build my melting furnace, which will take eight teams." It is believed that these stones came from Uxbridge, Massachusetts, which is about sixty miles from Temple. Samples from the old furnaces confirm this.

2. Glass Pots and Crucibles. Probably the first clay refractories used in this country were glass pots. J. B. Felt⁽⁵⁾ in his "Annals of Salem" in 1827 mentions a glass factory in Salem, Massachusetts, in 1638 and again as producing in 1641. The only other information I have been able to obtain is the names of John and Ananias Conklin as glass blowers. All else seems to be lost in the obscurity of time. We may be sure, however, that glass pots were used. They were probably made from English or German clays as were all the early glass refractories.

A century later, the Wister glassworks were started in New Jersey. Gross Almerode or Klingenberg clay was used for the pots at first, but later New Jersey or Maryland clays were probably used to some extent. J. C. Booth⁽⁴⁾ in 1841 states that a white, highly plastic clay was wrought only in one place, on the Delaware shore below New Castle, and exported for crucibles and glass pots. The clay had been wrought for manufacturing purposes for some forty years. Porcelain crucibles were made of kaolin from New Milford, Connecticut, by a goldsmith in about 1807.

A number of other early glass plants were operated in this country, mainly by Germans. We have the Germantown factory (Braintree, Mas-

* Numbers thus set in parentheses refer to the bibliographies appearing at the end of each chapter.

sachusetts) and the factory of Baron Steigel in 1763, as well as a number of others. German pot clays were probably extensively used as they are even now. In fact, J. F. Amelung, who started a glassworks at Frederick, Maryland, in 1784, brought over pot makers and built a pot works in conjunction with his plant.

A note in the Gaffield Collection at the Massachusetts Institute of Technology library states that the Boston Crown Glass Company, which for a number of years had been using imported clays for pots, attempted between 1810 and 1812 to replace them with domestic (probably New Jersey) clays. The attempt was not successful.

A recipe book of the Boston Glass Mfg. Co. in the Boston Athenaeum Library has an item dated 1791 stating that 200 lumps of clay were received from Amsterdam, undoubtedly for making pots. Another item lists fuel for keeping the glass pots (green) from freezing.

The manufacture of glass pots as an industry separate from the glass plants was started in 1860 by Thomas Coffin in Pittsburgh.⁽¹²⁾ In 1879, the Pittsburgh Clay Pot Company was organized, and after this many other concerns started in Pennsylvania and Ohio.

3. Lime. Lime, often made from shells gathered on the shore, was used in forge walls from very early times. There are references to a number of early lime kilns.

4. Fireclay Bricks. We are still in doubt as to the location of the first American firebrick manufacturer. It may have been New Jersey, Boston, or Baltimore.

New England. Owing to the early development of iron and glass manufacture here, it is to be expected that firebrick would be needed at an early date. Stourbridge firebricks (English) are known to have been imported to some extent, but bricks were also made from New Jersey clay. The recipe book of the Boston Glass Mfg. Co. states that in 1790, two helpers were paid to make furnace tile and, in 1791, two men were paid for burning brick for the glass furnace. In 1793, an item lists the payment of expenses for a man to go to New York to procure clay from South Amboy. This is undoubtedly the earliest direct reference to the manufacture of firebrick from native clay. According to Professor Rogers,⁽⁸⁾ Mr. G. W. Price of New Brunswick, New Jersey, stated that his father carried a vessel load of fireclay from Woodbridge to Boston in 1816 for use in making firebricks. It was thought to be the first shipment for this use. An advertisement in the *Boston Commercial Gazette* of July 6, 1818, by the New England Glass Company, read, "Also—Fire Brick Clay, raw and prepared, constantly for sale." This would seem to indicate that firebricks were then being made in Boston. In 1820, Jacob Felt of Boston bought 50 tons of clay of Jere-

miah Dully, and this was afterward sent regularly from Amboy. Firebricks were made in Boston at this time.

The following advertisement appeared in the *Boston Commercial Gazette* of Mar. 5, 1827. "_____ fire bricks made to all dimensions. For sale by Deming Jarves, No. 88 Water St." (New England Glass Bottle Works.) This probably explains where at least part of the New Jersey clay was used.

In 1835, a patent was taken out by Joseph Putnam of Salem for firebricks and stove linings. We do not know whether or not he manufactured, but it is doubtful if he would have applied for a patent for this type of article without having previously made it. As early as 1829, L. Hine used the kaolin of New Milford, Connecticut, for firebricks and furnace linings.⁽³⁾ He evidently had a considerable business, as \$6,000 per year is mentioned as the value of his product and six workmen were employed. The bricks sold for two-thirds the price of the Stourbridge firebricks and were considered nearly as good.

In 1839, Hiram Harwood of Bennington, Vermont, records in his diary,⁽¹⁸⁾ "Visited works of Judge L. Norton—large low buildings in forwardness for drying newly invented fire bricks—erected N. old works." This business apparently prospered in the next few years and was carried on by Norton and Fenton. It is quite possible that the manufacture of these bricks was started from information obtained from the New Milford enterprise. We are fortunate in having an accurate account of the manufacture of these early bricks by Norton and Fenton. C. B. Adams, state geologist of Vermont, in his first *Annual Report* (1845), page 52, states:

For firebrick, the kaolin is made into paste with water, from which bricks are formed and burnt. These bricks, retaining the whiteness of the kaolin, and becoming very hard, are called "clay bricks." They are next broken up by a mill and sifted, so as to be of the coarseness of fine gravel. This is mixed with unburnt kaolin and arenaceous quartz, pressed in moulds of the required form and size, and burnt in the same manner as before. These firebricks are very white and hard, and when fractured shew their composition of broken claybrick and kaolin.

C. W. Fenton, in a letter to Mr. Adams at this time, gives more particulars:

The character of our fire-bricks is also well known. They are a composition of materials which we find here, consisting of arenaceous quartz and kaolin. Being very pure, they make a good fire-brick, which will stand longer in a strong heat than any other brick known. They are used for blast furnace hearth, and in many places, where no other fire-bricks will endure.

The value of pottery and firebrick produced then was stated as \$20,000 per year.

In 1841 (Feb. 27), the following advertisement appeared in the *State Banner* of Bennington, Vermont:

Bennington
Stoneware Factory
Julius Norton
Manufactures and keeps constantly for sale
.....
Also *Patent Fire Brick*
(the best in the world) at \$50 per thousand

These kaolin bricks were made in Bennington as late as 1855 or 1856 and had a very general sale as a good firebrick. But owing to the lack of coal and the need of twice burning the highly shrinkable kaolin, they could not long compete in cost with bricks of New Jersey and Pennsylvania.

It is also stated that firebrick of kaolin, New Jersey fireclay, crushed brick, and sandstone from Willsboro, New York, were made at Monkton, Vermont, in 1846. These bricks were undoubtedly used in the many charcoal iron furnaces operating in this region, although a large part of the lining was quartzite or mica schist. A reddish firebrick taken from an old furnace standing on Furnace Brook in Bennington, Vermont, fulfills this description quite well. I was also fortunate in finding at the site of the United States Pottery in Bennington a white brick made of coarse calcined grog bonded with kaolin. This brick is marked:

Fire Brick Co's.
No. 1
Bennington, Vt.

Considerable space is given to these early kaolin bricks, because we have a fairly complete account of their manufacture and because they are the first to utilize successfully the pure and refractory but high-shrinking kaolin by the method of double burning. For their time, they were really remarkable bricks and have scarcely been mentioned in histories of refractories.

Firebricks and retorts were probably being made in Boston regularly before 1850. In 1864, the Boston Fire Brick and Clay Retort Manufacturing Company was making bricks and retorts on the site of the present South Station. New Jersey fireclay was brought to their own dock. For some years at about this time, the Morton Fire Brick Plant on K Street at South Boston was in operation. Apparently no firebrick has been made in Boston since 1895.

From the beginning of the nineteenth century, a number of stoneware potteries were operating in New England. In every case, firebrick must have been used in their kilns. It is reasonable to suppose that the bricks were made from stoneware clay, all of which at that time came from New Jersey.

The manufacture of stove linings and firebricks has been carried on at Taunton, Massachusetts, for many years. Now Pennsylvania clays are mainly used.

New Jersey. A stoneware pottery was operated by Coxe at Burlington, New Jersey, in 1684. He probably used English firebrick for his kilns, but some local clay may have been used.

Professor Rogers⁽⁸⁾ states that New Jersey clays were used for making firebricks soon after 1812. We need not necessarily assume, as many have, that the bricks were made in New Jersey. The clay may have been taken to Boston or Baltimore. In 1825, a firebrick plant (Salamanda Works) was started at Woodbridge, New Jersey. In 1836, John R. Watson established a factory for making firebricks at Perth Amboy. From 1845 to 1865, a number of plants were started in the Woodbridge district, and most of them are still operating. Sayer and Fisher, Henry Maurer & Son, and Valentine & Bro. are well-known firebrick manufacturers at the present day.

Delaware and Maryland. In a report⁽²⁾ on the state of Maryland, published in 1834, occurs a most significant statement:

Fire brick so far exclusively made in the United States at Baltimore, has been pronounced by competent judges after repeated trials, to be fully equal, if not superior to the far-famed Stourbridge brick of the same nature.

Later it stated that these bricks were used in iron furnaces to replace silica stone.

We may judge from this statement that a high-grade firebrick of the "same nature" as the well-known Stourbridge firebrick was an established industry in Baltimore at this time. The reference to repeated trials would indicate its use for a considerable number of years previous. The statement that firebricks were made only in Baltimore at this time is perhaps founded on lack of knowledge of the industry in New Jersey and Boston but more probably refers to a time some years prior to this date when the Baltimore industry was started. Further investigation is greatly needed on this point.

As previously mentioned,⁽⁴⁾ considerable white refractory clay was mined in Delaware mainly for crucible and glass pots, but some may well have served for bricks.

In 1837, the famous Mt. Savage fireclay was discovered, and the Union Mining Company soon began operations here.

Florida. Ries⁽¹²⁾ states that records show a shipment of firebrick from Florida to New Orleans in 1827. No more is known of it.

Ohio. According to Stout,⁽²⁰⁾ firebricks were first made in Ohio during 1841 by Andrew Russell near East Liverpool. They were produced there continuously until about 1900 by Russell and later by N. U. Walker. The

clay mined behind the plant was plastic and of medium refractoriness. In 1852, G. and M. Meyers started a firebrick plant near Toronto. A plastic, lower Kittanning clay was used.

The manufacture of firebricks from flint clay was begun during 1863 in Scioto County by Reese Thomas. This brick was a high-grade product, made in updraft kilns with sandstone walls.

During 1866, the Diamond Fire Brick Company was opened in Akron by J. P. Alexander. At about the same time, a three-kiln plant was built at Dover. The Federal Clay Products Company and a number of other plants started about 1872 in this district. J. R. Thomas founded the Niles Fire Brick Company at Niles in 1872.

The Oak Hill Fire Brick Company and Aetna Fire Brick Company started in the Oak Hill district about 1873. Other plants were opened here later.

Pennsylvania. It has generally been believed that the first firebricks were made in Pennsylvania about 1836 at Queens Run. However, the following advertising card⁽¹⁰⁾ would indicate that they were made in Philadelphia before 1832.

American China Manufactory
S. W. Corner of Schuylkill Sixth & Chestnut Sts.,
or at the Depository

Where is constantly kept on hand,.....

.....

also offered for sale
Fire-brick & Tile

Of a superior quality, manufactured in part from the materials of which china is composed.—These have been proved, by competent judges, to be equal to the best Stourbridge brick.

Eight years later the following advertisement⁽¹⁰⁾ appeared.

Abraham Miller
has removed his manufactory
From Zane Street to James, near Broad Street,
Spring Garden

where his works are now in full operation, conducted by his late Foreman, Mr. J. C. Boulter.

.
.
.

A large Assortment of Portable Furnaces, Stove Cylinders, Fire Bricks and Slabs,

.....
.....

Philad'a December 22d 1840.

In 1842, James Glover started the manufacture of refractories at Bolivar. The clay is of good quality, and refractories are still made there. In

1845, Kier Brothers started to manufacture at Salina. In 1859, Soisson and Company began manufacturing at Connellsville; and in 1865, the Star Fire Brick Works were built at Pittsburgh.

After this, so many firebrick plants were opened in the state that it assumed the leading position in the manufacture of refractories. The factors contributing to this great development were the excellent deposits of clay, especially flint clay; the abundance of coal; and the ease of distribution.

Missouri. In the year 1846, the excellent clay deposits of the St. Louis district were opened up. In 1855, the Christy Fire Clay Company was started; and in 1855, both the Evans and Howard and the Laclede Fire Brick Company followed. The St. Louis district was one of the largest producing centers at this time.

Kentucky. This district was not opened up until about 1871, when fireclay from Lewis County was sent to Cincinnati. In 1884, the clays at Amanda Furnace and Bellport Furnace were worked. Two years later the Ashland Fire Brick Company was started at Ashland.

West Virginia. Firebricks were not produced in this state until 1876, when the clays of Marion County were worked.

Colorado. The first firebricks made in this state were manufactured at Golden during 1866. Later clay deposits were opened up at Pueblo and Cañon City and now have a good reputation in the West.

The West Coast. Refractory manufacture was rather late in developing here, but recently many excellent refractories are being made in both California and Washington.

5. Silica Refractories. Probably the first silica bricks made in the United States were manufactured by J. P. Alexander of Akron, Ohio, about 1866, but a patent was granted to Thomas James⁽⁶⁾ in 1858 for a lime-bonded silica brick, and he may have manufactured before Alexander. Of course, in England lime-bonded silica brick was made even before this.⁽²³⁾ J. R. Thomas made silica brick for the steel industry at Niles, Ohio, about 1872. He used quartz pebbles and a Sharon conglomerate and called the bricks "Dinas Silica," as they were similar to the European brick of that name. A. Hall of Perth Amboy made some silica bricks in 1875, but apparently there was no great demand for them. The modern silica brick of lime-bonded ganister is a more recent development. In the year 1899, the first silica-brick plant was started at Mt. Union, which later became a great center. Silica bricks were made later in the Chicago district.⁽²¹⁾

6. Chrome Refractories. Chromite, mainly in the form of bricks, began to be used by the steel manufacturers about 1896, chiefly as a neutral zone between the acid and basic courses. Only a few firms have been manufacturing chrome bricks.

7. Magnesite Refractories. Magnesite as a steel-furnace lining was suggested in Europe as early as 1860 but did not come into regular use until 1880, when it was found that the Austrian material could be fritted down into a good bottom. Styrian magnesite was imported into this country in 1885 and was used by the Otis Steel Company in the first open-hearth steel plant in the United States. However, it was not a commercial success. In 1888, magnesite was used successfully by Carnegie, Phipps & Co. at Homestead. From this time, the use of magnesite increased rapidly because the general advantages of the basic process over the acid process became evident to all.

In the year 1898, 16,000 tons of Austrian dead-burned grain were imported. Bricks were at first imported, but later they were made in this country by a few companies.

8. High-alumina Refractories. The first bauxite discovered in the United States was found near Rome, Georgia, during 1888.⁽¹⁴⁾ The Arkansas bauxite deposits were discovered in 1891. The production from the latter source increased rapidly until now it supplies a considerable part of the domestic demand. Coastal bauxite of Georgia was discovered and described in 1909. A number of small deposits are now being worked.

Missouri diaspore was recognized in 1917 as a source of material for super refractories. This discovery has made Missouri one of the most important producing states.

The importation of gibbsite from Dutch Guiana in the last few years has supplied a very high-grade material to the manufacturers of refractories.

The deposits of sedimentary kaolin on the southern coastal plain have been known from the time of the first settlers. The remarkable beds form probably the largest supply of uniform and pure high-grade clay in the world. The suitability of kaolin for refractories was known as early as 1837 in Bennington, but the southern kaolin is of a purer grade and possesses a high vitrifying point and a very large shrinkage. These properties for many years have prevented its use in a refractory. During the last twenty-five years, however, it has been possible to manufacture a successful refractory out of this pure kaolin.

9. Bibliography

1. ROBINSON, SAMUEL: Notice of Miscellaneous Localities of Minerals, *Am. J. Sci.*, **8**, 232, 1824.
2. DUCATIL, J.T., and J.H. ALEXANDER: "Report on Projected Survey of State of Maryland," Annapolis, 1834.
3. SHEPARD, C.U.: "A Report of the Geological Survey of Connecticut," B. L. Hamlen, New Haven, 1837.
4. BOOTH, J.C.: "Geology of Delaware," pp. 16, 40, 1841.
5. FELT, J.B.: "Annals of Salem," 1827.

6. JAMES, THOMAS: Lime Bonded Silica Brick, U.S. Patent 20,433, 1858.
7. BLOOD, H.A.: "History of Temple, New Hampshire," Boston, 1860.
8. COOK, G.H.: "Report on the Clay Deposits of Woodbridge, South Amboy, and Other Places in New Jersey," 1, 1878.
9. HUNT, A.E.: Some Recent Improvements in Open Hearth Steel Practice, *Trans. Am. Inst. Mining Met. Engrs.*, **16**, 718, 1887.
10. BARBER, E.A.: "Pottery and Porcelain of the United States," G. P. Putnam's Sons, New York, 1893.
11. RIES, H., H.B. KUMMEL, and G.N. KNAPP: The Clay and Clay Industry of New Jersey, *Geol. Survey of New Jersey*, Vol. 6, 1904.
12. RIES, H.: "The History of the Clay Working Industry in the United States," John Wiley & Sons, Inc., New York, 1909.
13. MAYNARD, G.W.: Introduction of the Thomas Basic Steel Process in the United States, *Trans. Am. Inst. Mining Met. Engrs.*, **41**, 289, 1910.
14. SHEARER, H.K.: A Report on the Bauxite and Fuller's Earth of the Coastal Plain of Georgia, *Georgia Geol. Survey Bull.*, 31, p. 22, 1917.
15. McDOWELL, J.S., and R.M. HOWE: Magnesite Refractories, *J. Am. Ceram. Soc.*, **3**, 185, 1920.
16. McDOWELL, J.S., and H.S. ROBERTSON: Chrome Refractories, *J. Am. Ceram. Soc.*, **5**, 865, 1922.
17. ANON.: Die Entwicklung der deutschen Industrie feurfester Erzeugnisse seit 1871 und ihre heutige Lage, *Tonind.-Ztg.*, **49**, 589, 1925.
18. SPARGO, JOHN: "Potters and Potteries of Bennington," Houghton Mifflin Company, Boston, 1926.
19. McDOWELL, J.S.: Progress in the Refractories Industry, *Blast Furnace Steel Plant*, **17**, 88, 1929.
20. STOUT, W.: Refractory Clays of Ohio, *Bull. Am. Ceram. Soc.*, **9**, 29, 1930.
21. KURTZ, T.N.: History of Silica Brick, *Bull. Am. Ceram. Soc.*, **15**, 26, 1932.
22. GREAVES-WALKER, A.F.: History of Development of the Refractories Industry in the United States, *Bull. Am. Ceram. Soc.*, **20**, 213, 1941.
23. SEARLE, A.B.: A Brief History of Refractory Materials Prior to the 19th Century, *Refractories J.*, **21**, 145, 1945.

Part II
MANUFACTURE

CHAPTER IV

REFRACTORY RAW MATERIALS

1. Clays. *Definitions.* It seems impossible to give a definition for a clay that is inclusive and yet free from exceptions. Many of the characteristics generally associated with clays, such as plasticity, water of hydration, and plate structure, are found in other materials. The best that can be done is to define a clay broadly as a hydrated earthy material, containing a considerable portion of alumina or silica and showing the property of plasticity.

More specifically the following definitions have been proposed by the Committee on Geological Surveys of the American Ceramic Society. ⁽¹⁹⁷⁾

Bauxitic Clay: A clay consisting of a mixture of bauxitic minerals, such as gibbsite and diaspore, with clay minerals, the former constituting not over 50 per cent of the total. (The opposite of this would be an argillaceous bauxite.)

Burley Clay: A clay containing burls, oölites, or nodules, which may be high in alumina or iron oxide. As used in Missouri, it refers to a diaspore-bearing clay usually averaging 45 to 65 per cent Al_2O_3 .

Diaspore Clay: A clay usually containing over 60 per cent alumina with the mineral diaspore often in shotlike particles, or "oölites." There may be some gibbsite or eliachite present.

Fireclay: A clay either of sedimentary or residual character that has a P.C.E. of not less than cone 19. It may vary in its plasticity or other physical properties; and while it often fires to a buff color, it does not necessarily do so. It is recommended that clays with a P.C.E. from 19 to 26, inclusive, be called "low heat-duty fireclays" and that fireclays with a P.C.E. of cone 27 or higher be designated "refractory."

The terms "Nos. 1, 2, and 3 fireclay" as sometimes used do not always refer to the same degree of fusibility.

While some fireclays are found underlying coal beds, many show no association with coal; in fact, some clays underlying coal beds do not conform to the description given.

Flint Clay: A clay, usually refractory and hard, with a dense structure and conchoidal fracture. It is difficult to slake and has little plasticity under usual working conditions.

Kaolin: A white-firing clay which, in its beneficiated condition, is made up chiefly of minerals of the kaolinite type. Two types of kaolin may be recognized as follows:

1. *Residual kaolin:* A kaolin found in the place where it is formed by rock weathering.

2. Sedimentary kaolin: A kaolin that has been transported from its place of origin. Sedimentary kaolins show more pronounced colloidal properties than residual kaolins.

The distinction between kaolin and fireclay is not particularly clear, as both contain almost wholly the mineral kaolinite. In this book, *kaolin* will be used for white-burning clays, and *fireclay* for buff-burning clays. Also, bauxite and bauxitic clays will be reserved for those whose gibbsite content predominates over the diaspore content.



FIG. 3. An electron microscope photograph of kaolinite crystals, the larger ones being just over a micron in diameter. (Courtesy of the Georgia Kaolin Company.)

The Nature of Clay. During the last twenty years, tremendous progress has been made in painting a true picture of the nature of clay. At present, although parts of the picture are indistinct, the framework is there and many details are clear. It is now certain that the clay—even to its finest particles—is composed of fragments of definite minerals. Because of the minute size of these crystals, their identification and description are particularly difficult. Great credit is due to mineralogists such as Ross, Kerr, Grim, Hendricks, and Gruner in this country; Marshall in England; and Endell and Nagelschmidt in Germany. Although additional clay minerals will undoubtedly be identified in the future, the classification given in Table 6 seems to be the most logical arrangement at present. It is known that these minerals occur in the clay over a wide range of sizes between 100 and 0.01 μ , but a large majority of the clay particles range

between 0.2 and 10 μ . No general evidence indicates that the finer fraction or colloidal portion (below 0.5 μ) is any different, except in size, from the coarser particles. The particles in a clay are mainly platy, although we cannot, at present, measure the actual shape of the extremely small particles. Fig. 3, showing submicroscopic kaolinite crystals, gives an idea of the particles in a sedimentary kaolin.

The clay particles have attached to their surfaces various adsorbed ions, such as Ca, Na or SO_3 , that markedly affect their physical properties. With the clay minerals is often associated organic matter such as lignite and humus, which may act as protective colloids and influence the physical properties of the clay. Most clays also contain impurities, often of large grain size, such as quartz, mica, feldspar, and other nonplastic minerals. Also the clay minerals themselves can have iron and other metallic atoms in the crystal lattice.

The Origin of Clay. Clay is always an altered product derived by weathering or hydrothermal action from rocks rich in feldspar. There is still no agreement among geologists as to the exact mechanism of clay formation or why various clay minerals are apparently obtained from the same parent rock. In most cases, the action is principally one of removal of the alkalis and decrease of the silica, the former being removed as soluble salts and the latter as colloidal silica. When silica removal is carried to the end point, as a result of the high permeability of the mass to the percolation of ground water, gibbsite or diaspore is the result. We are not sure whether a step-by-step process occurs or the reaction goes directly from the feldspar to an end point.

Clay minerals have been produced in the laboratory⁽⁶⁰⁾ under certain conditions of temperature and acidity from feldspars, the reaction taking place most rapidly at about 300°C. It would have seemed curious a few years ago that under identical reaction conditions, the end product of potash feldspar, for example, is sericite whereas from calcium feldspar, montmorillonite is produced; *i.e.*, the cation in the original rock, the original atomic arrangement, or both together seem to have some control over the type of end product. Geologists now are beginning to believe that in all metamorphic changes, there is some relation between the atomic structure of the original material and its product.

Clays found in the same location as the parent rock from which they were formed are called "residual clays." Such clays usually contain rock fragments and thus require washing, for which reason they are not used to any great extent in refractories. The primary kaolins of North Carolina are a good example of a residual clay.

Transported clays are sediments deposited in lakes, swamps, or the ocean. They may be considerably altered during and after transportation. The sedimentary kaolins of Georgia and most fireclays are examples.

The classification of clays according to origin in Table 5, as suggested by Stout, will be helpful in understanding the process of clay formation.

The excellent chart by Chelikowsky⁽²⁹⁾ gives a picture of geologic distribution of fireclays in the United States, and the maps by Ries⁽⁴²⁾ are complete and up to date.

TABLE 5. CLASSIFICATION OF CLAYS AS TO ORIGIN*

| | | | | |
|-----------------------------|--|---|------------------------|--|
| Residual matter | No movement during formation | Products of ordinary weathering | From crystalline rocks | { Impure residual clay Primary kaolin |
| | | | From sedimentary rocks | { Impure residual clay Kaolinitic clay |
| | | Same as above with additional chemical action | From crystalline rocks | Bauxite |
| | | | From sedimentary rocks | { Bauxite Diaspore |
| Transported matter | Deposited in still water, little or no current action, seas, lakes, bogs, etc. | Products of ordinary weathering | Argillaceous shale | { Argillaceous shale Argillaceous silt |
| | | | Argillaceous silt | |
| | Deposited by slowly moving waters, streams, estuaries, etc. | Same as above with additional intensive chemical action | Sedimentary kaolin | { Sedimentary kaolin Ball clay Some bauxite Coal-formation clay Diaspore |
| | | | Ball clay | |
| | | | Some bauxite | |
| Deposited by glacial action | Products of abrasion with slight weathering | Glacial clay or till | Glacial clay or till | |
| | | Products of abrasion with slight weathering | | |
| Deposited by winds | Products of abrasion with slight weathering | Loess | Loess | |

* Lecture on Clays by W. Stout, at Massachusetts Institute of Technology, 1937.

Clay Minerals. The clay minerals may be divided into definite types; but since various degrees of isomorphism can occur, there is a variability in composition that makes classification and identification difficult. The grouping indicated in Table 6 gives a reasonable picture of their relationship based on our present knowledge. The atomic arrangement shown in Fig. 4 is a probable one, but only in the case of dickite is it uni-

| | | | | | |
|---|---|--|---|---|--------------------------------|
| 1-SILICON TETRAHEDRON | | 2-ALUMINUM OCTAHEDRON | | 3-MAGNESIUM OCTAHEDRON | |
| | 1 O -2 1 Si +4 3 O -6 | | 3 OH -3 1 Al +3 3 OH -3 | | 3 OH -3 1 Mg +2 3 OH -3 |
| 4-HYDRATED SILICA | | 5-GIBBSITE | | 6-BRUCITE | |
| | 4 OH -4 4 Si +16 6 O -12 | | 6 OH -6 4 Al +12 6 OH -6 | | 6 OH -6 6 Mg +12 6 OH -6 |
| 7-HALLOYSITE | | 8-KAOLINITE | | <ul style="list-style-type: none"> • - Si ● - Al ● - Mg ○ - O ⊙ - OH | |
| | 6 OH -6 4 Al +12 6 OH -6 4 OH -4 4 Si +16 6 O -12 | | 6 OH -6 4 Al +12 4 O -10 2 OH -10 4 Si +16 6 O -12 | | |
| 9-PYROPHYLLITE AND MONTMORILLONITE (IDEAL CASE) | | | 10-TALC | | |
| | 6 O -12 4 Si +16 4 O + 2 OH -10 4 Al +12 4 O + 2 OH -10 4 Si +16 6 O -12 | | 6 O -12 4 Si +16 4 O + 2 OH -10 6 Mg +12 4 O + 2 OH -10 4 Si +16 6 O -12 | | |
| 11-NONTRONITE | | 12-MICA (ILLITE) | | | |
| | 6 O -12 4 Si +16 4 O + 2 OH -10 4 Fe ⁺⁺⁺ +12 4 O + 2 OH -10 4 Si +16 6 O -12 | | 1 K 6 O -12 3 Si + 1 Al +15 4 O + 2 OH -10 4 Al +12 4 O + 2 OH -10 3 Si + 1 Al +15 6 O -12 1 K +1 | | |
| 13-MONTMORILLONITE (SUBSTITUTED) | | <ul style="list-style-type: none"> • - Si ● - Al, Fe⁺⁺⁺ ● - Mg ○ - O ⊙ - OH ● - K | | | |
| | 6 O -12 4 Si +16 4 O + 2 OH -10 3 Al + 1 Mg +11 4 O + 2 OH -10 4 Si +16 6 O -12 | | | | |

FIG. 4. Structural data of the clay minerals. First column is schematic drawings (not to scale) of the atoms in a unit cell projected into one plane. Second column gives number and type of atoms in each lattice plane and third column gives the corresponding valence charges. Where (+) and (-) charges are equal, lattice is neutral; where unequal, the charge is equal to the algebraic difference. (From E. A. Hauser, *J. Am. Ceram. Soc.*)

TABLE 6. THE CLAY MINERALS

| Kaolinite group | Montmorillonite group | Micaceous group | Aluminous group |
|--|---|--|--|
| Kaolinite, $Al_2(Si_2O_5)(OH)_4$ | Pyrophyllite, $* Al_2Si_4O_{10}(OH)_2$ Talc, $* Mg_3Si_4O_{10}(OH)_2$ Na _{0,33} ↑ | Muscovite, $* Al_4K_2(Si_6Al_2)O_{20}(OH)_4$ | Gibbsite, $* Al(OH)_3$ Diaspore, $* HAlO_2$ |
| Dickite, $Al_2(Si_2O_5)(OH)_4$ | Montmorillonite, $(Al_{1,67}Mg_{0,33})Si_4O_{10}(OH)_2$ Na _{0,33} ↑ | Bravaisite, $Al_4K_X(Si_{8-X}Al_X)O_{20}(OH)_4$ | |
| Nacrite, $Al_2(Si_2O_5)(OH)_4$ | Beidellite, $Al_{2,17}(Al_{0,83}Na_{1,17})O_{10}(OH)_2$ Na _{0,33} ↑ | Brommellite, $Al_4Na_X(Si_{8-X}Al_X)O_{20}(OH)_4$ | |
| Anauxite, $Al_{2-n}(Si_{2+n}O_5)(OH)_4$ | Nonttronite, $(Fe_{2,00}Al_{0,35}Si_{3,65})O_{10}(OH)_2$ Na _{0,33} ↑ | Attapulgite, $(Mg_5Si_9)O_{20}(OH)_2 \cdot 2H_2O$ | |
| Endellite, $Al_2(Si_2O_5)(OH)_4 \cdot 2H_2O$ | Saponite, $Mg_3(Al_{0,33}Si_{3,67})O_{10}(OH)_2$ Na _{0,33} ↑ | Ordovician bentonites | |
| Halloysite, $Al_2(Si_2O_5)(OH)_4$ | Hectorite, $(Mg_{2,67}Li_{0,33})Si_4O_{10}(F, OH)_2$ Na _{0,33} ↑ | (Most of the minerals in this group are not very specific) | |
| Allophane, Amorphous | Sauconite, $Zn_3(Al_{0,33}Si_{3,67})O_{10}(OH)_2$ | | |

* These minerals are not usually considered among the clay minerals but when finely ground, behave like clays in ceramic processes.

versally accepted. In refractory clays, clay minerals are seldom found other than kaolinite, diaspore, and gibbsite.

The identification of the clay minerals, in many cases, is difficult because of their small size and indefinite composition. Petrographic methods can be used for the coarser grains. X rays may be used to identify the finer fractions with a considerable degree of certainty, especially if specimens are prepared with a preferred orientation of the crystals. Another useful method is thermal analysis, which can be made to give quantitative values, in some cases when the mineral is present in amounts as low as 1 per cent by weight of the total.

If the clay mineral is placed in a furnace beside a neutral body, such as alumina, and heated at a uniform rate (12°C per min), a temperature difference between the two that can be detected by a differential thermocouple will occur at different stages of the heating. The temperatures at which these differences occur are characteristic of the various clay minerals and serve as a means of identification even when they are mixed with others. A convenient apparatus is shown in Fig. 5 for this purpose. Figure 6 gives the differential temperatures for kaolinite, gibbsite, and diaspore plotted against the true temperature. The large endothermic peaks are caused by the energy required to expel the chemically combined water (the OH groups). The area under these peaks can be used as a quantitative measure of the amount of that particular clay mineral. The areas for a 0.4-g sample are as follows:

| Mineral | Area, $^{\circ}\text{C} \times \text{Seconds}$ |
|----------------|--|
| Kaolinite..... | 11,700 |
| Diaspore..... | 11,150 |
| Gibbsite..... | 21,800 |

As an example, consider the thermal curve for a Dutch Guiana clay in Fig. 6. It will be noted that the peaks corresponding to kaolinite and diaspore, which are of small magnitude, occur at the temperatures of the initial parts of their respective reactions and not at the maxima. The area of kaolinite reaction is 700, for the diaspore 700, and for the gibbsite 19,200. This represents 6 per cent kaolinite, 6 per cent diaspore, and 88 per cent gibbsite. When these are converted to silica and alumina, 2.8 and 64.6 per cent are obtained, respectively, as compared with 4.5 and 58.4 per cent from a chemical analysis. If the 3.2 per cent Fe_2O_3 in the chemical analysis is counted as Al_2O_3 , the agreement is good. Recent work has indicated that in some cases where the minerals are fine and intimately mixed, quantitative analysis by this method is difficult. Howie and Lakin⁽¹⁵³⁾ show that this method is also applicable to the analysis of limes, dolomites, and magnesites. Some recent work indicates that thermal analysis may also be used to identify the type of organic matter in a clay.

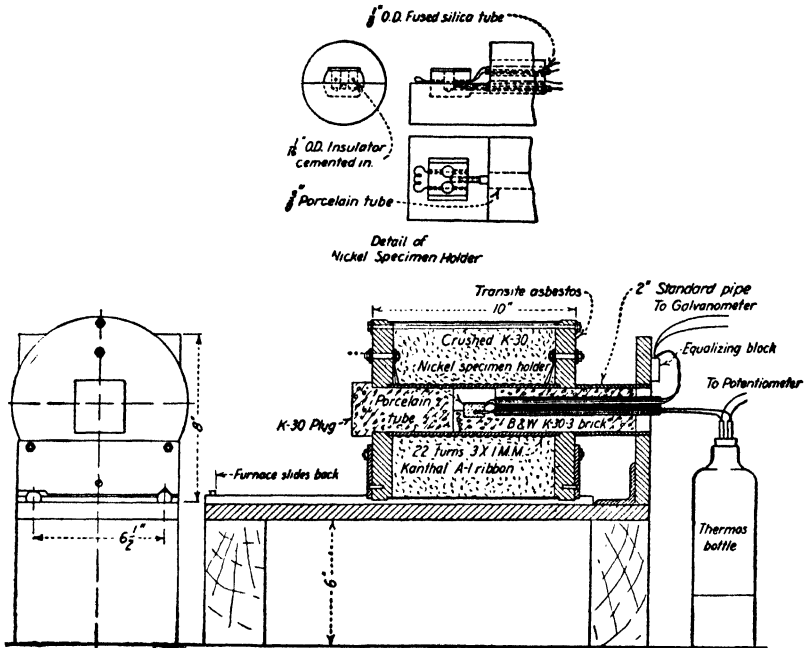

FIG. 5. Differential thermal apparatus. (*J. Am. Ceram. Soc.*)

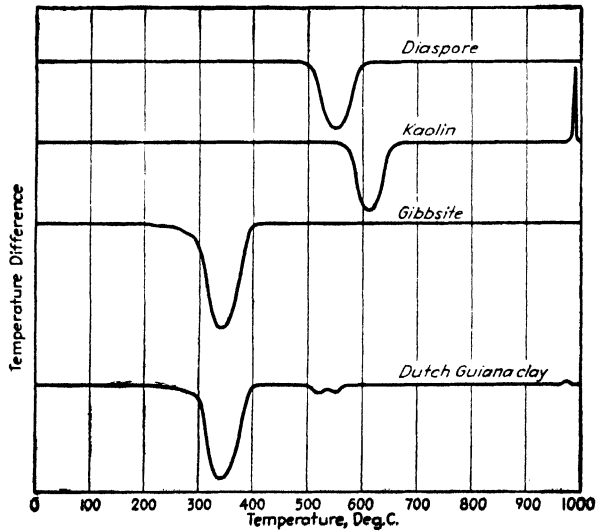

FIG. 6. Thermal curves of clay minerals.

The Exchangeable Bases. Attached to the broken corners and perhaps faces of all clays are ions that are not really part of the crystal structure but are held in place by unsatisfied bonds in the unbalanced lattice and thus can be replaced by other ions. The finer the particle size of the clay the more area is present for the attachment of these cations and the greater the so-called "base-exchange capacity," which is expressed in milliequivalents per 100 g of dry clay. The exchange ions can be replaced

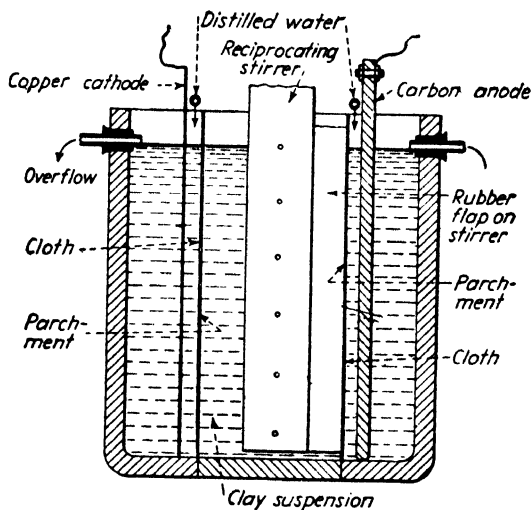

FIG. 7. Three-compartment dialysis cell.

by H^+ and OH^- on a clay by a number of methods, one being the treatment in a dialysis cell shown in Fig. 7. The clay slip, containing 5 per cent solids, is treated for about two weeks, the liquid in the end cells being replaced with distilled water at frequent intervals until a constant value of current is reached. Even with this long treatment there is reason to believe that many adsorbed ions or groups cannot be entirely removed. To produce a really clean clay calls for a more elaborate procedure. The liquid from the end cell can be evaporated and analyzed for the elements extracted. The exchangeable metallic bases reported by Graham and Sullivan⁽⁶³⁾ for several clays are shown below.

| Clay | Exchangeable metallic bases | | | | |
|------------------------------|-----------------------------|-----|-----|-------|-------|
| | Ca | Mg | Na | K | Total |
| Georgia kaolin..... | 0.4 | 0.6 | 0.1 | Trace | 1.1 |
| Pennsylvania flint clay..... | 2.5 | 1.8 | 0.5 | 0.4 | 5.2 |
| Kentucky flint clay..... | 3.4 | 2.0 | 0.9 | 0.8 | 7.1 |
| Kentucky ball clay..... | 7.1 | 3.8 | 0.5 | 0.4 | 11.8 |

The total base-exchange capacity is believed in general to be as follows:

| | Milliequiva- lents per 100 g |
|----------------|---------------------------------|
| Kaolin..... | 2-6 |
| Ball clay..... | 10-20 |
| Bentonite..... | 50-100 |

After a hydrogen clay is produced by dialysis, ions in any amount up to the saturation point can replace the hydrogen and hydroxyl group to give a clay with controlled adsorbed ions. The type of ion present in the clay profoundly influences its physical properties, producing a variable that has not generally been taken into account in the past. Just one example will bring this out for a fine-grained kaolin.

| Milliequivalents of Na ⁺ per 100 g of Clay | Dry Strength Modulus of Rupture, lb psi |
|--|--|
| 0 (hydrogen clay)..... | 430 |
| 7..... | 700 |
| 14..... | 1,000 |

The control of exchangeable bases is particularly important when using clays in casting slips.

Organic Matter. Many clays contain appreciable amounts of organic matter, such as lignite or humic acid. Dark ball clays and less pure bog clays contain especially large amounts. Although little scientific work has been carried out to determine the influence of this matter on the properties of the clay, it is generally agreed that it does influence the plasticity, dry strength, and slip-forming properties, either because of an organic colloid or because of the organic acid. This is an important field for research; the ceramist, the organic chemist, and the soil chemist should cooperate more closely along these lines in the future. Nearly all organic matter can be removed by long digestion with 30 per cent hydrogen peroxide. The only paper treating this subject thoroughly is by Sharratt and Francis.⁽⁶⁸⁾

The aging of clays, though little practiced in the refractories industry, is connected to some extent with bacterial action in the clay mass, which produces substances acting much like the organic acids.

Accessory Minerals. All clays contain mineral fragments of a nonclay type that have an important influence on the properties of the clay. The minerals commonly found are as follows:

Quartz

Feldspars (orthoclase, plagioclase)

Micas (muscovite and biotite)

Iron minerals (hematite, magnetite, limonite, pyrite, siderite)

Titanium minerals (rutile, anatase)

Limestone (calcite, dolomite)

Magnesite
Gypsum
Garnet
Tourmaline

A few of these minerals, such as quartz, act as a refractory nonplastic, whereas the others act more or less as fluxes and reduce the refractoriness of the clay.

Physical Properties. Only within the last few years has it been possible to measure the full range of particle sizes in clays with assurance. The size distributions for a few typical clays are shown in Fig. 8. It will be

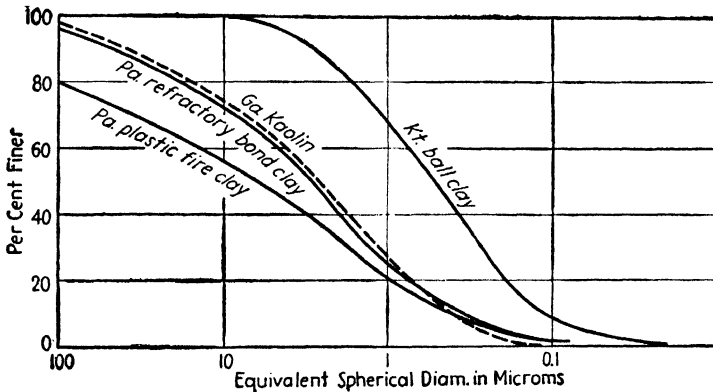

FIG. 8. Particle size distribution for various clays.

noticed, first, that there are few particles below 0.1μ but a large portion are below 10μ . As the surface area increases enormously with even a slight increase in the proportions of fines, careful measurements are needed in this range. It will be noted that the plastic fireclays, though coarser than the kaolin in the larger size range, have more very fine particles, which accounts for their relatively greater plasticity.

In order to study the influence of grain size on the physical properties, it is most convenient to split a clay up into a number of nearly monodisperse fractions for which the mean size can be accurately determined. It will be found that most of the physical properties vary with the particle size, as shown by Whittaker⁽⁵⁷⁾ in Table 7 for a clay containing wholly kaolinite.

The plasticity, or workability, varies greatly among clays. In general, the finer grained clays, free from nonplastics, are most plastic. The plasticity of most clays can be increased by fine grinding, aging, adding organic matter, or mixing in another clay of fine-grain size, such as bentonite.

Whereas some clays readily slake in water, others will remain under water indefinitely without breaking down. The flint clays and shales

TABLE 7. VARIATION OF PHYSICAL PROPERTIES WITH PARTICLE SIZE

| Mean diameter, microns | Surface area per 100 g. sq cm | Drying shrinkage, per cent | Dry strength, psi | Relative plasticity |
|------------------------|-------------------------------|----------------------------|-------------------|---------------------|
| 8.50 | 13×10^4 | 0.0 | 4.6 | None |
| 2.20 | 392 | 0.0 | 14.0 | None |
| 1.10 | 794 | 0.6 | 64.0 | 4,400 |
| 0.55 | 1,750 | 7.8 | 47.0 | 6,300 |
| 0.45 | 2,710 | 10.0 | 130.0 | 7,600 |
| 0.28 | 3,880 | 23.0 | 458.0 | 8,200 |
| 0.14 | 7,100 | 30.5 | 296.0 | 10,200 |

consolidated by chemical action cannot be broken down without considerable grinding, but a plastic fireclay will quickly disperse into its ultimate particles when added to water. Undoubtedly the adsorbed ions have an important influence on the slaking. For example, a hard and a soft kaolin of the same chemical composition, both containing wholly kaolinite, show, in the first case, ten times as much exchangeable calcium ions as in the latter.

In general, the fine-grained plastic clays have a high shrinkage, because they have large numbers per unit distance of interparticle water films, whose elimination causes the shrinkage. Montmorillonite, the mineral in bentonite, increases in the distance between the atomic planes of a single crystal by water molecules entering the crystal structure. This is the reason for the great swelling power of some bentonites.

The finer grained clays generally have high dry strengths, but other factors such as adsorbed ions and organic matter are important. As yet, we have little explanation of the forces holding the particles together in a dry clay. This is a field for interesting research.

The color of clay is of no great importance in refractories manufacture, except as an indication of impurities.

Kaolin $(OH)_4Al_2(Si_2O_5)$. Pure kaolin has a fusion point of 1785°C (3245°F), although this may drop a few degrees if any impurities are present. The residual or true kaolin occurs in many localities in rather small deposits in the Southeastern United States. There are also a few deposits in Vermont and Massachusetts, and Wilson⁽²⁸⁾ describes some producing deposits in the Pacific Northwest. The most workable deposits are the sedimentary or plastic kaolins, which are rather widely distributed in this country in the Southeastern states, where the beds are of great extent, averaging from about 15 to 30 ft in thickness with about the same thickness of overburden. The kaolin is usually mined by stripping off the overburden and taking out the clay by hand or with a power shovel. There

are considerable deposits of kaolin in England, which are mined as English china clay. Excellent deposits also occur in Czechoslovakia and Germany. Typical analyses of some kaolins are given in Table 8, and deposits are shown in the maps of Figs. 9 and 10.

TABLE 8. ANALYSES OF TYPICAL KAOLINS

| Constituent | Georgia kaolin, per cent ⁽¹⁹²⁾ | English china clay (washed), per cent | Vermont residual kaolin, per cent ⁽²²⁾ | North Carolina kaolin (washed), per cent |
|--|---|---------------------------------------|---|--|
| Silica, SiO ₂ | 45.8 | 48.3 | 58.0 | 45.8 |
| Alumina, Al ₂ O ₃ | 38.5 | 37.6 | 26.9 | 36.5 |
| Titanium oxide, TiO ₂ | 1.4 | | 1.4 | 0.0 |
| Ferric oxide, Fe ₂ O ₃ | 0.7 | 0.5 | 1.5 | 1.4 |
| Calcium oxide, CaO..... | Trace | 0.1 | 0.4 | 0.5 |
| Magnesium oxide, MgO..... | Trace | | 0.9 | |
| Alkalies..... | | 1.6 | 2.2 | 0.3 |
| Combined water..... | 13.6 | 12.0 | 8.9 | 13.4 |
| Total..... | 100.0 | 100.1 | 100.2 | 97.9 |

Clays and Minerals Related to Kaolin. There are a number of other hydrated aluminum silicates of the kaolin group, most of which are rare.

Halloysite, (OH)₄Al₂(Si₂O₅), occurs as a fine-grained, soapy, white clay. This mineral has often been confused with fine-grained kaolinite but can be distinguished by its thermal curve,⁽⁷⁹⁾ or by an electron microscope photograph, as the very fine particles are lathlike. A typical analysis is shown in Table 9.

TABLE 9. ANALYSES OF MINERALS RELATED TO KAOLINITE

| Constituent | North Carolina halloysite, per cent | Allophane I, per cent ⁽¹⁹²⁾ | Allophane II, per cent ⁽¹⁹²⁾ |
|--|-------------------------------------|--|---|
| Silica, SiO ₂ | 44.3 | 43.3 | 32.5 |
| Alumina, Al ₂ O ₃ | 37.4 | 39.9 | 46.5 |
| Ferric oxide, Fe ₂ O ₃ | 0.4 | | 0.7 |
| Lime, CaO..... | 0.2 | 0.7 | 0.4 |
| Magnesia, MgO..... | 0.1 | | 0.5 |
| Alkalies..... | 0.2 | 0.6 | |
| Water of constitution..... | 15.1 | 15.5 | 19.4 |
| Total..... | 97.7 | 100.0 | 100.0 |

Allophane, or indianaita, is a waxy white clay found in Indiana and Kentucky with the composition shown in Table 9. It is so fine grained as to be amorphous.

Several other members of the kaolinite group of rare occurrence are mentioned in the tables at the end of the chapter.

Ball Clays. Ball clays are distinguished by their fine grain, lignite content, and high plasticity but are not usually so refractory as kaolins, the

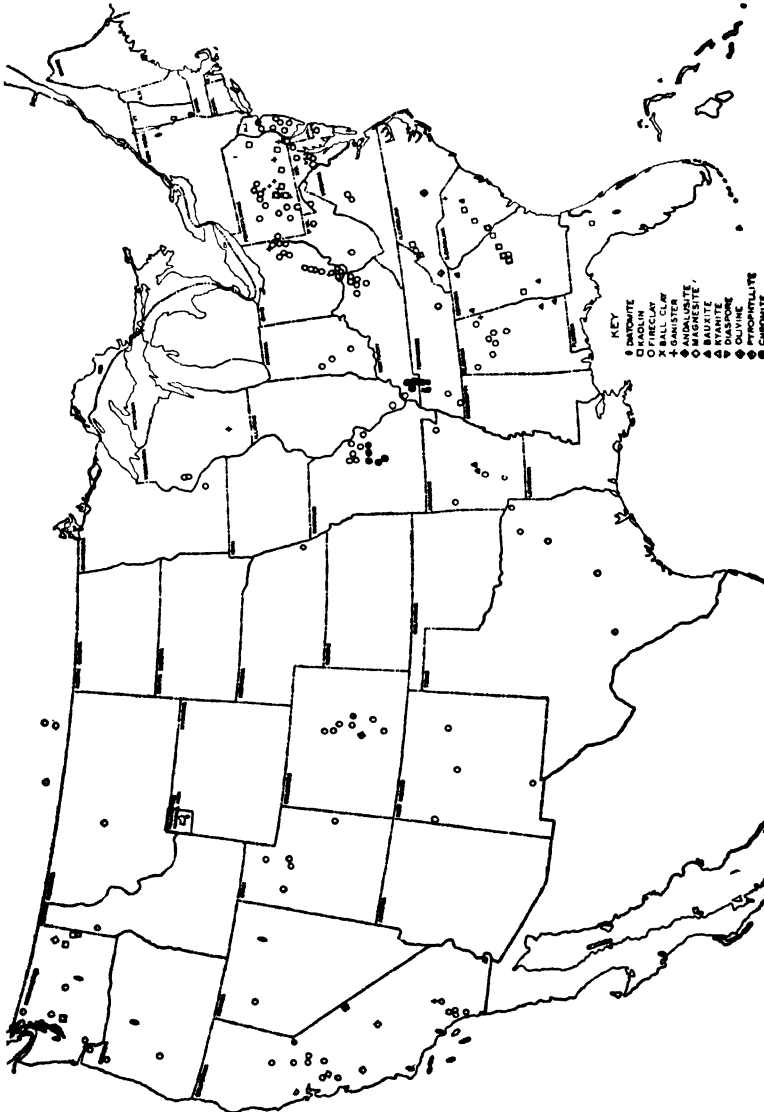

Fig. 9. Working deposits of refractory materials in the United States. (Copyright, American Map Company, Inc., New York, No. 10,074.)

fusion point being around 1675°C (about 3050°F). They are sometimes used in refractories as a bond for harder and less plastic clays, but their greatest use is in whiteware. The analyses of two typical ball clays are given in Table 10. They are found almost exclusively in Kentucky and Tennessee as shown in Fig. 9.

Fireclays. The so-called "fireclays" include nearly all clays that have a fusion point above approximately 1600°C (about 2900°F) and are not

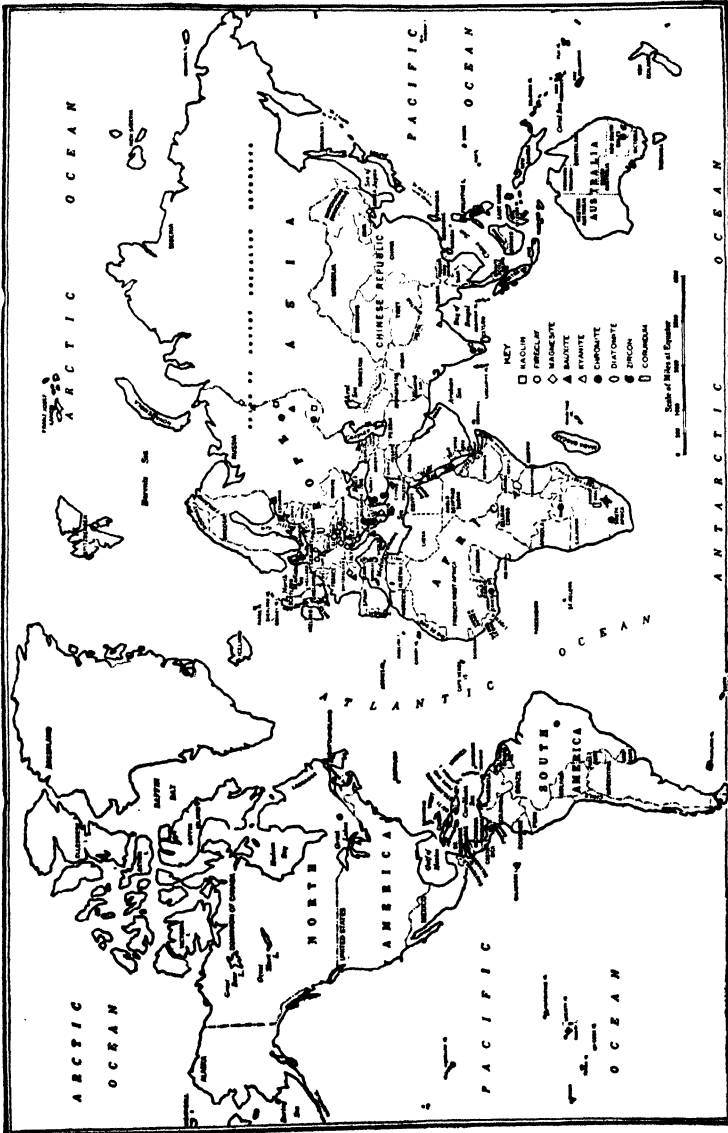

Fig. 10. Important deposits of refractory materials in the world. (Copyright, American Map Company, Inc., New York, No. 10,074.)

white burning. Fireclays are widely distributed and vary greatly in their characteristics. They may be roughly divided into the following types: flint clays, which (owing to great pressure encountered since they were deposited) are compressed into a hard, rocklike mass and require fine grind-

TABLE 10. ANALYSES OF BALL CLAYS

| Constituent | Mayfield, Ky., per cent ⁽¹⁹²⁾ | Tennessee, per cent |
|--|---|------------------------|
| Silica, SiO ₂ | 56.4 | 46.9 |
| Alumina, Al ₂ O ₃ | 30.0 | 33.2 |
| Ferric oxide, Fe ₂ O ₃ | | 2.1 |
| Lime, CaO..... | 0.4 | 0.8 |
| Magnesia, MgO..... | Trace | |
| Potash, K ₂ O..... | 3.3 | 0.7 |
| Soda, Na ₂ O..... | 2.0 | |
| Titanium oxide, TiO ₂ | | |
| Water (combined)..... | 7.9 | 16.5 |
| Total..... | 100.0 | 100.2 |

TABLE 11. ANALYSES OF FIRECLAYS
(Analyses by Downs Shaaf)

| | Plastic, Law- rence, Ohio | Flint, Cam- bria, Pa. | Flint, Carter, Ky. | Semi- flint, Jackson, Ohio | Semi- flint, Clear- field, Pa. | Plastic, Vinton, Ohio | Flint, Mont- gomery, Mo. |
|--------------------------------|------------------------------------|--------------------------------|--------------------------|-------------------------------------|---|-----------------------------|-----------------------------------|
| SiO ₂ | 58.10 | 44.43 | 44.78 | 50.32 | 43.04 | 46.72 | 44.04 |
| Al ₂ O ₃ | 23.11 | 37.10 | 35.11 | 31.53 | 36.49 | 33.06 | 38.03 |
| Fe ₂ O ₃ | 1.73 | 0.46 | 1.18 | 1.02 | 1.37 | 0.68 | 0.63 |
| FeO | 0.68 | 0.55 | 0.74 | 0.35 | 0.83 | 0.55 | 0.22 |
| FeS ₂ | 0.55 | 0.22 | 0.14 | 0.12 | 0.24 | 0.34 | 0.01 |
| MgO | 1.01 | 0.19 | 0.55 | 0.18 | 0.54 | 0.19 | 0.12 |
| CaO | 0.79 | 0.60 | 0.77 | 0.80 | 0.74 | 0.61 | 0.40 |
| Na ₂ O | 0.34 | 0.10 | 0.29 | 0.07 | 0.46 | 0.42 | 0.10 |
| K ₂ O | 1.90 | 0.55 | 0.44 | 0.05 | 1.10 | 1.53 | 0.22 |
| H ₂ O- | 2.27 | 0.80 | 0.84 | 2.47 | 0.82 | 2.21 | 0.78 |
| H ₂ O+ | 7.95 | 12.95 | 13.07 | 11.25 | 12.44 | 11.50 | 13.55 |
| CO ₂ | 0.05 | 0.11 | 0.07 | 0.14 | 0.05 | 0.02 | 0.04 |
| TiO ₂ | 1.40 | 1.84 | 2.22 | 1.45 | 1.79 | 2.20 | 1.82 |
| P ₂ O ₅ | 0.17 | 0.21 | 0.02 | 0.48 | 0.10 | 0.12 | 0.28 |
| SO ₃ | 0.03 | 0.01 | 0.01 | 0.01 | 0.01 | 0.01 | 0.01 |
| MnO | 0.01 | 0.01 | 0.02 | 0.02 | 0.01 | 0.01 | 0.01 |
| ZrO ₂ | 0.01 | 0.01 | 0.01 | 0.01 | 0.01 | 0.01 | 0.01 |
| Org. C | 0.22 | 0.10 | 0.11 | 0.07 | 0.22 | 0.04 | 0.01 |
| Org. H | 0.03 | | | | 0.03 | | |

ing to develop plasticity; plastic clays, which are soft and easily tempered into a plastic mass; and refractory shales, which can usually be made directly into brick without the addition of bonding clay.

Analyses of a number of types of fireclays are given in Table 11, and the distribution in the United States on the map of Fig. 9.

Super-duty fireclay brick are usually made from pure Missouri flint clays with approximately the composition in Table 11. They have a low porosity and show little or no reheat shrinkage.

2. Clays and Minerals High in Alumina. *Hydrated Alumina.* Some of the most important refractory materials are those containing the mineral diasporé, (HAlO_2) usually occurring with kaolinite in varying proportions. The clays vary from nearly pure diasporé to mixtures containing nearly all kaolinite. Most of them occur in Missouri, although there are a few other minor locations. From these clays are made the high-alumina brick having alumina contents of 50, 60, 70, and 80 per cent according to the classification. They may also have some corundum added.



FIG. 11. A gibbsite nodule cut in half; about one-fourth natural size.

There are other high-alumina clays containing gibbsite [$\text{Al}(\text{OH})_3$] or mixtures of gibbsite and kaolinite. The purer materials, such as those from Dutch Guiana (Fig. 11), contain almost all gibbsite, but the aluminous clays from the South have more or less kaolinite mixed with them. The term "bauxite" is used here for clays containing a mixture mainly of kaolinite and gibbsite. The bauxitic clays have not been used for refractories to any extent because of their less favorable shrinkage properties, but may come into use as the diasporé becomes exhausted.

The locations of the principal deposits of high-alumina clays are shown in Figs. 9 and 10. Both the chemical and mineral analyses of some typical high-alumina clays are shown in Table 12. The thermal method is particularly valuable in studying these clays because it readily distinguishes between diasporé and gibbsite.

Sillimanite Types of Minerals. There are a number of minerals having a composition Al_2SiO_5 , which gives a silica content of 37 per cent and an alumina content of 63 per cent. Sillimanite occurs in a number of small deposits in this country, such as California, North and South Carolina, and Georgia, but the largest source of supply is in India. Andalusite has

a different crystal form from sillimanite and is found in small deposits in California and in considerable quantities in Spain. Kyanite occurs in India, in some of the Southern states, and on the West Coast of the United States. All these minerals are decomposed to mullite and silica on heating above 1555°C (about 2830°F) when pure and at a lower temperature when fluxes are present. These materials are being used to a considerable extent as refractories at the present time but commercially are

TABLE 12. HIGH-ALUMINA CLAYS

| Clay | Dutch Guiana gibbsite | First- grade diaspore, Mo. | Bauxite, Ga. | Burley, Flint, Mo. | Second- grade diaspore, Mo. |
|---------------------|-----------------------------|-------------------------------------|-----------------|--------------------------|--------------------------------------|
| Chemical Analyses | | | | | |
| Silica..... | 4.5 | 10.9 | 26.0 | 33.8 | 29.2 |
| Alumina..... | 58.4 | 72.4 | 54.0 | 49.4 | 53.3 |
| Titanium oxide..... | 2.9 | 3.2 | 2.1 | 2.6 | 2.7 |
| Iron oxide..... | 3.2 | 1.1 | 1.0 | 1.8 | 1.9 |
| Lime..... | 0.4 | | | | |
| Magnesia..... | | | | | |
| Alkalies..... | | | | | |
| Combined water..... | 30.6 | 13.5 | 16.1 | 12.0 | 12.0 |
| Total..... | 100.0 | 101.1 | 99.2 | 99.6 | 99.1 |
| Thermal Analyses | | | | | |
| Kaolinite..... | 6 | None | 67 | 71 | 18 |
| Diaspore..... | 6 | 90 | None | 26 | 53 |
| Gibbsite..... | 88 | None | 38 | None | None |

often confused one with another. The great problem is to concentrate⁽¹¹⁹⁾ the ore efficiently and at the same time provide fairly coarse grains. Thin sections of these minerals are shown in Figs. 12, 13 and 14.

Topaz. This mineral has been found in India in some quantity, and recently an important deposit has been discovered in South Carolina.⁽¹²¹⁾ Topaz has the composition $\text{Al}_2\text{SiO}_4(\text{F},\text{OH})_2$ and thus will readily transform to mullite on firing, hence offering attractive possibilities as a raw material.

Pyrophyllite. This talclike mineral is found in a number of deposits in the South and has been used in some refractories in place of clay. Its formula of $(\text{OH})_2\text{Al}_2(\text{Si}_2\text{O}_5)_2$ does not give so high an alumina content as kaolin. However, it has been successful in some cements and plastics.

Forms of Alumina. Alumina occurs in a number of forms. The α -alumina is identical with the natural mineral corundum (Fig. 15), which

is a trigonal crystal with a specific gravity of 4.0. This mineral apparently is very stable and is almost always produced from cooling fusions. γ -alumina is hexagonal but has a spinellike structure and a specific gravity of 3.31 and is generally formed by the heating of hydrous alumina materials such as kaolin or gibbsite. At higher temperatures, it slowly inverts to the α -form. An isometric form of alumina has been described having a specific gravity of 3.47 and is found in some quickly cooled melts. Apparently this form is not found to any extent in refractories.

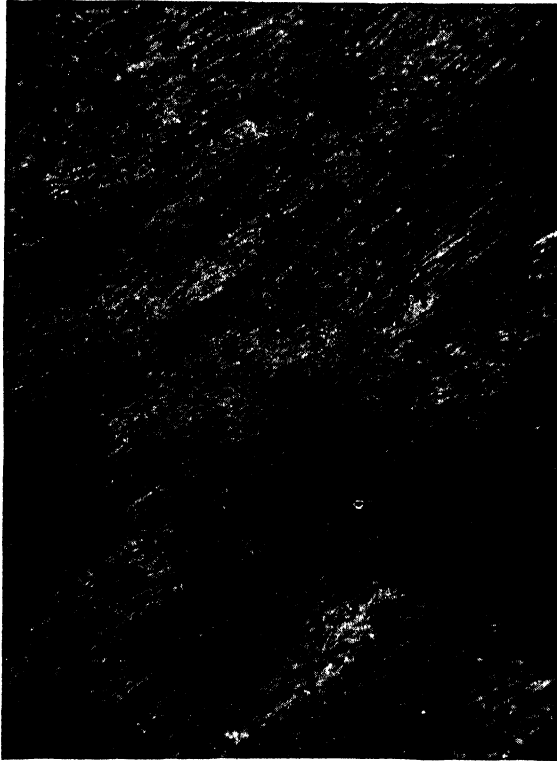

Fig. 12. Thin section of sillimanite. (250 \times)

The so-called " β -alumina" has been found by Beevers and Ross⁽¹¹⁸⁾ to be not a form of alumina but a compound consisting of 11 molecules of Al_2O_3 and 1 molecule of soda or potash. A " ζ -alumina" has been described as occurring only in melts containing lithium. Probably this is similar to the β -alumina, being a compound of lithium oxide and alumina.

Corundum. Corundum, or emery, Al_2O_3 , is found in many small deposits, the most important being in Asia Minor, South Africa, Greece, Ontario, and North Carolina. It has not been used to any extent for a

refractory but would seem to be a material worth more investigation. Crystalline alumina made in electric furnaces is used to a considerable extent as a refractory.

3. Silica Minerals. *Ganister.* The most commonly used silica mineral for refractories is ganister, a common name for true quartzite. Not all quartzites are suitable for making refractories, as they must be of high purity and have good mechanical strength. The principal deposits of



FIG. 13. Thin section of andalusite; 250 \times , with crossed Nicol prisms and gypsum plate.

ganister in this country are the Medina sandstone of Pennsylvania, the Baraboo quartzite of the Devil's Lake region, Wisconsin, and the quartzites of Alabama and Colorado. A quartzite is usually mined from the bodies of talus, or slide rock, occurring on the mountain slopes. A few typical analyses of quartzites are given in the following table, and a thin section is shown in Fig. 16.

The fusion point of quartzite⁽¹²⁷⁾ is very close to 1700°C (about 3090°F); and like mullite, it shows little softening below its melting point. This is its chief value when used as a refractory, as it retains its resistance to load at higher temperatures than fireclay materials. Owing, however,

to their high thermal expansion, silica materials are very sensitive to temperature changes in the low-temperature ranges. Most silica refractories are made in the form of bricks or special shapes, but some ganister

TABLE 13. ANALYSES OF QUARTZITES

| Constituent | Medina quartzite, per cent ⁽¹²⁴⁾ | Baraboo quartzite, per cent ⁽¹²⁴⁾ | Alabama quartzite, per cent ⁽¹²⁴⁾ | Sharon conglomerate ⁽¹²²⁾ |
|--|---|--|--|--------------------------------------|
| Silica, SiO ₂ | 97.8 | 98.2 | 97.7 | 98.0 |
| Alumina, Al ₂ O ₃ | 0.9 | 1.1 | 1.0 | 0.9 |
| Ferric oxide, Fe ₂ O ₃ | 0.9 | 0.2 | 0.8 | 0.9 |
| Lime, CaO..... | 0.1 | 0.0 | 0.1 | 0.3 |
| Magnesia, MgO..... | 0.2 | Trace | 0.3 | Trace |
| Alkalies, K ₂ O, Na ₂ O..... | 0.4 | 0.1 | 0.3 | 0.2 |
| Total..... | 100.3 | 99.6 | 100.2 | 100.3 |



FIG. 14. Thin section of kyanite. The large crystal on the left border is kyanite which shows pronounced cleavage and numerous inclusions. The rest of the field shows a grain of stauralite, three smaller garnet crystals with muscovite, biotite, quartz, feldspar, and magnetite; 40 X, with ordinary transmitted light.

is used in rammed furnace bottoms. Recently quartzites have been washed to bring the total impurities below 0.5 per cent for super-duty silica brick.

Firestone. Natural stone refractories are still used to some extent. They consist of an easily cut sandstone^(134,135,136) or a mica schist. In either case, the stone must have a certain flexibility of structure to reduce the tendency to spall. Firestone is rather wide in occurrence, working

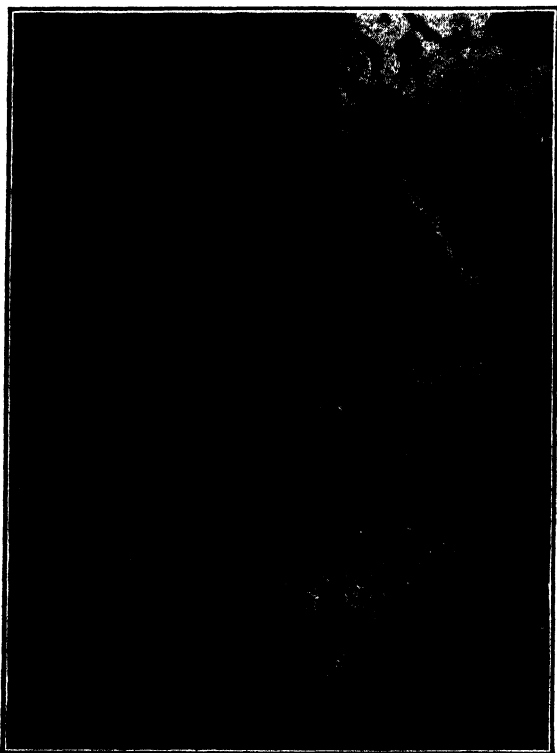

FIG. 15. Thin section showing appearance of corundum crystals formed in the electric furnace; 80 \times , with crossed Nicol prisms.

deposits being found in Pennsylvania, Tennessee, Ohio, and several other states.

Sand. A small amount of beach sand is used for furnace bottoms, as, for example, in the hearth of malleable-iron melting furnaces, but the volume used is very small compared with the refractories made from quartzite. In Europe, glass sand is ground and added to quartzite in the making of silica brick, mainly to increase the purity.

Diatomaceous Earth. Another type of siliceous mineral, used mainly as a heat insulator, is diatomaceous earth (infusorial earth or kieselguhr),

a widely distributed material. It is composed of the skeletons of diatoms, which are microscopic organisms (Fig. 17). The desirable characteristics of this material are its closed cells and high porosity, which gives a low

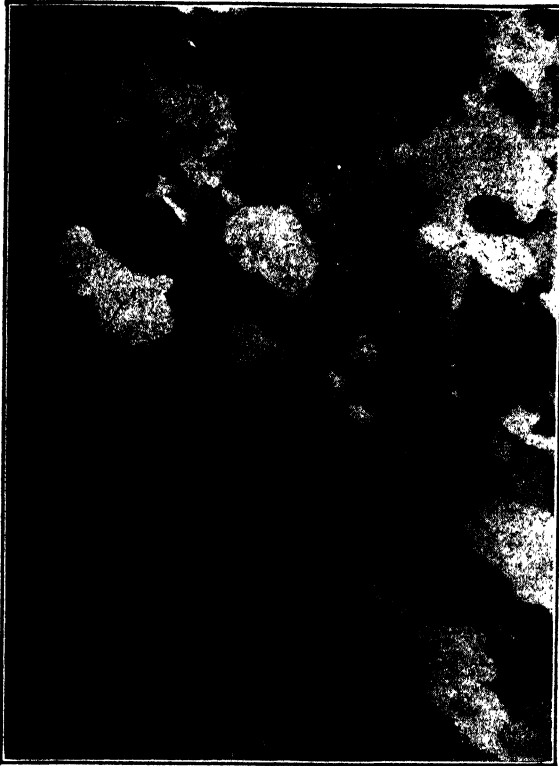

FIG. 16. Thin section of quartzite. The light and dark areas in this photomicrograph show quartz grains at different orientation with respect to the plane of polarization of the Nicol prisms; 80 \times , with crossed Nicol prisms.

TABLE 14. ANALYSES OF DIATOMACEOUS EARTHS

| Constituent | Oberhole, Germany, per cent | California, per cent |
|---|-----------------------------------|-------------------------|
| Silica (SiO ₂)..... | 87.9 | 85.3 |
| Alumina (Al ₂ O ₃)..... | 0.1 | 5.4 |
| Ferric oxide (Fe ₂ O ₃)..... | 0.7 | 1.1 |
| Calcium carbonate (CaCO ₃)..... | 0.7 | 1.1 |
| Organic matter..... | 2.3 | |
| Water..... | 8.4 | 5.6 |
| Total..... | 100.1 | 98.5 |

density and a low thermal conductivity. Analyses of two typical samples of infusorial earth are given in Table 14.

4. Magnesite and Lime. Magnesite refractories are of great importance in the metallurgy of steel and nonferrous metals, as they are used almost exclusively for the part of the furnace that comes in contact with the molten metal and slag, a large volume being used in the bottoms of the basic open-hearth furnaces in the form of lumps and brick.

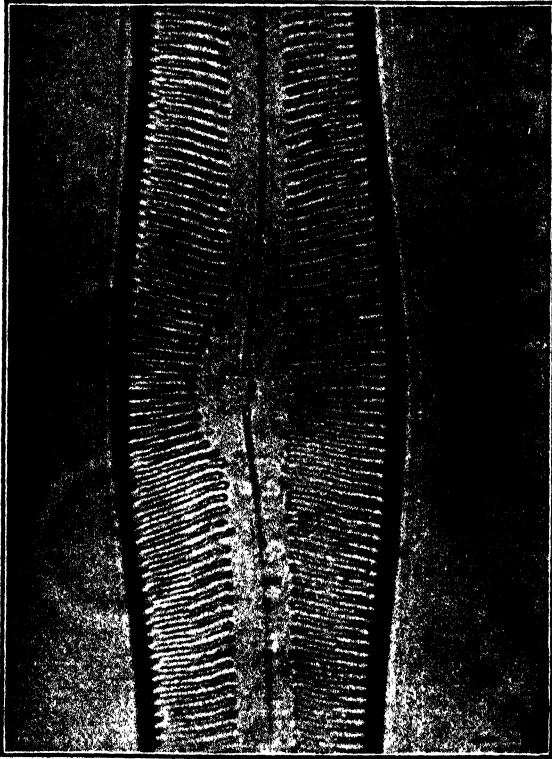

FIG. 17. Photomicrograph of a single diatom showing fine cell structure. This structure is the reason for the excellent heat insulating properties which diatomaceous earth possesses; 800 \times , with ordinary transmitted light.

Magnesite. Magnesite occurs in nature as the carbonate, and two types have generally been recognized, the crystalline and the dense, the latter usually being of greater purity. The crystalline material is found in considerable quantity in Austria, Russia, Manchukuo, Quebec, and the state of Washington. Figures 10 and 9 show the important deposits. The Austrian material usually runs rather high in iron and has been in great demand for metallurgical work because it will frit together into a solid mass at available temperatures. The magnesite from Quebec runs

higher in lime. The Washington magnesite occurs in large quantities and is relatively pure.

The dense type of magnesite usually occurs in veins and lenses, the most important deposits being found on the island of Euboea off the coast of Greece. The purity of this deposit, if carefully selected, is high, running between 94 and 98 per cent magnesium carbonate. Several California deposits have been operating for a number of years and give a pure material. Magnesite from sea water in California and Texas ^(148,149,150) is now assuming importance. Magnesia can also be produced from dolomite such as by the Pike process. ⁽¹⁵⁴⁾

TABLE 15

| Constituent | Austrian | Austrian | Manchu- kuo | Washing- ton | Greece | California sea water |
|--------------------------------|----------|----------|----------------|-----------------|--------|-------------------------|
| SiO ₂ | 5.8 | 1.0 | 3.7 | 4.9 | 6.6 | 5.1 |
| Al ₂ O ₃ | 1.7 | 1.0 | 1.0 | 1.5 | } 4.4 | 0.5 |
| Fe ₂ O ₃ | 4.0 | 6.9 | 1.5 | 3.4 | | 0.2 |
| CaO | 5.0 | 2.1 | 1.6 | 2.8 | 2.4 | 1.8 |
| MgO | 83.0 | 88.6 | 92.0 | 87.1 | 86.4 | 91.7 |
| Ignition loss | 0.2 | 0.3 | 0.1 | 0.1 | 0.2 | 0.3 |
| Total | 99.7 | 99.9 | 99.9 | 99.8 | 100.0 | 99.6 |

Several analyses of burned magnesite are given in Table 15, and a thin section is shown in Fig. 18.

Magnesite is produced as caustic-burned and dead-burned material. The latter is used for refractories and is fired at 1550 to 1750°C (about 2820 to 3180°F) to drive off practically all the CO₂ and form crystals of periclase. An excellent description of the production of dead-burned magnesite is contained in P.B. 37804. ⁽¹⁵¹⁾ The high-iron magnesites are sufficiently magnetic to make concentration by magnetic separators an efficient process. Some of the purer magnesites have iron added by the Alterra ⁽¹⁵¹⁾ process, where calcium ferrite is made and combined with the magnesite in a rotary kiln at 1500°C (about 2732°F). Magnesite can be fused in the electric furnace and, on cooling slowly, forms relatively large periclase crystals.

Dolomite. Dolomite is a solid solution of calcium and magnesium carbonate and, when pure, has an equal number of molecules of both, although all ratios occur in nature. Dolomites are very widely distributed. They have been used to some extent to replace magnesite in open-hearth bottoms but, because of their slaking properties, are not so good as magnesite. Although many experiments have been made on the production of

a successful dolomite brick, as yet all the difficulties have not been overcome.

Lime. Lime, next to magnesite, is believed to be the most refractory commercial oxide and is very widely distributed in deposits of great purity. However, little success has been had with this material as a refractory, for it slakes readily in both air and water. However, if lime is heated to 1800°C (about 3270°F) in an oxidizing atmosphere, it can be crystallized and in this form has a considerable resistance to slaking.

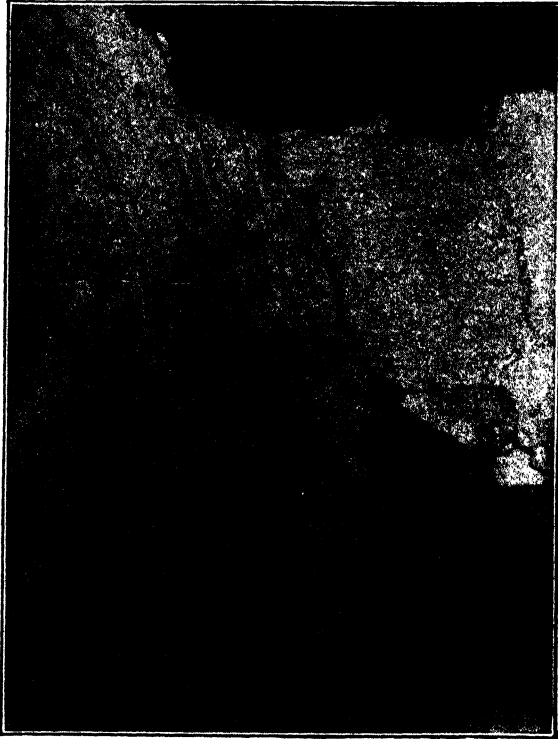

FIG. 18. Thin section of crystalline magnesite. This section shows the high relief and cleavage which this mineral possesses; 80×, with crossed Nicol prisms.

Olivine, Mg_2SiO_3 . This magnesium silicate usually has 5 to 8 per cent of the MgO replaced by FeO in the theoretical formula. By mixing with the correct amount of magnesite, this material has been used in the last few years to make forsterite refractories. Olivine deposits are widespread, but excellent material occurs in the dunite rock of North Carolina.

5. Chromite. The commercial chrome ore contains a solid solution of spinels closely approximating



In most cases, the spinel is balanced, but some cases have been reported where either the R_2O_3 or the RO is somewhat in excess; however, this may be due to difficulty in obtaining uncontaminated chromite grains for analysis. The chromite is always associated with a gangue chiefly of serpentine but also containing small amounts of feldspars, silica, carbonates, etc. Chrome ores are believed to originate both from magmatic

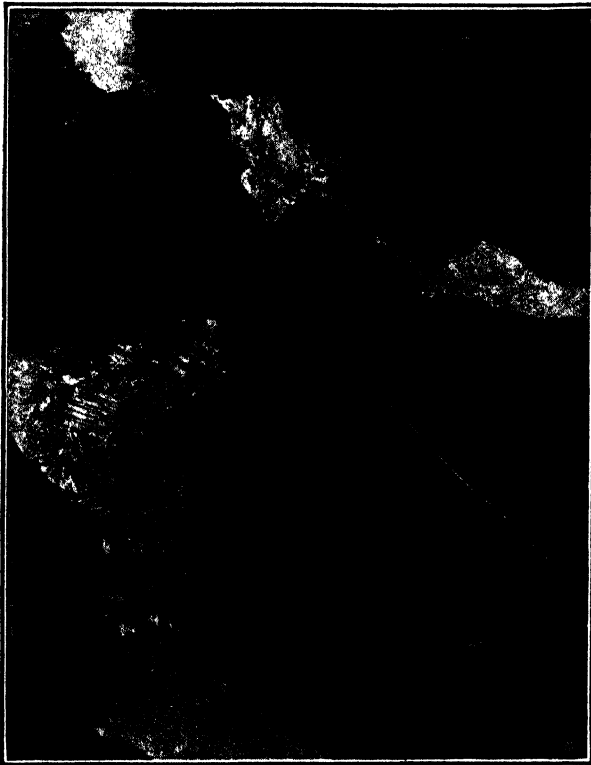

FIG. 19. This photomicrograph is a thin section of chromite with some serpentine associated with it. The chromite is the darker-colored areas, which show very irregular cleavage. Chromite is nearly opaque, and the thin section must be very thin to render it transparent; 250 diameters and wave plate to give second order green, and photographed through a "B" Wratten filter (deep red).

crystallization and by formation from hydrothermal solutions. Concentration methods have not been used much in separating the gangue from the ore, but the addition of MgO will cause the formation of forsterite on firing and thus remove the low-softening siliceous compounds.⁽¹⁶⁰⁾ A thin section of a typical chrome ore is shown in Fig. 19. The outstanding papers by A. T. Green^(165,166) and his associates on chrome ores in *Special Report 32* of the Iron and Steel Institute should be consulted for more detailed information on this subject.

The largest supplies of chrome ore come from Rhodesia and New Caledonia. There are, however, considerable deposits in Turkey, Cuba, the Philippines, Russia, and Greece and small deposits in Canada, California, Oregon, and Alaska. The analyses of several chrome ores are given in Table 16.

TABLE 16

| Constituent | Turkey | Rhodesia | Philippines | New Caledonia | Russia | Cuba |
|--------------------------------|--------|----------|-------------|---------------|--------|------|
| Cr ₂ O ₃ | 46.6 | 45.4 | 32.1 | 54.5 | 46.2 | 30.5 |
| SiO ₂ | 6.7 | 7.5 | 5.3 | 3.1 | 4.0 | 6.1 |
| Al ₂ O ₃ | 12.5 | 13.8 | 27.6 | 11.0 | 14.6 | 27.5 |
| FeO | 12.9 | 15.1 | 13.0 | 19.5 | 15.6 | 14.2 |
| CaO | 1.2 | 0.5 | 1.1 | 1.5 | 0.3 | 0.9 |
| MgO | 17.3 | 13.6 | 18.2 | 8.0 | 15.4 | 18.3 |
| Total | 97.2 | 95.9 | 97.3 | 97.6 | 96.1 | 97.5 |

6. Less Common Refractory Oxides. Many of the so-called "rare elements" may occur in larger percentages than some of our useful metals but, as they are not concentrated at any one place, cannot be so readily extracted. The relative abundance of the refractory elements is shown in the chart of Fig. 20 plotted from the article of Pannell⁽¹⁷⁹⁾ with some additions. It will be seen that thorium and cerium, for example, are as plentiful as copper, and beryllium is as plentiful as cobalt.

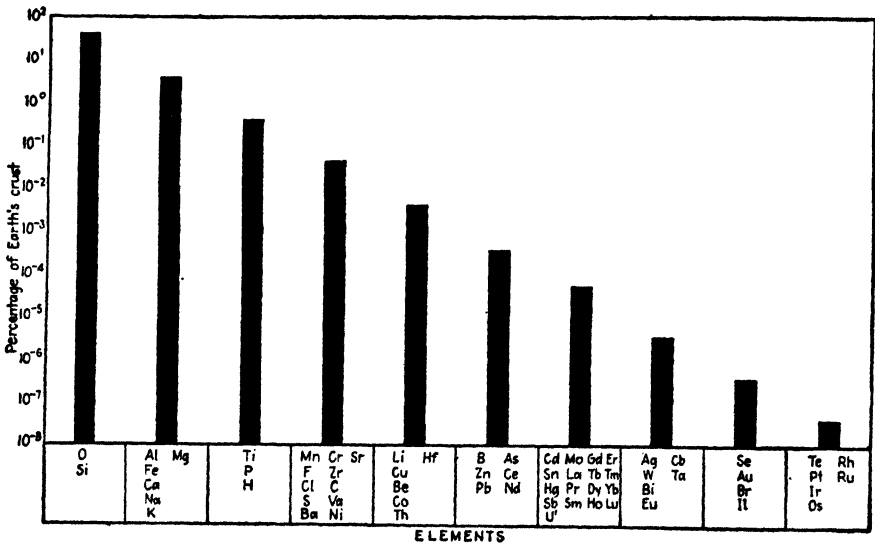

Fig. 20. Relative abundance of the refractory-forming elements in the earth's crust.

Zirconia. The most common minerals are zircite and baddeleyite with the formula ZrO_2 . They are found in considerable deposits in Brazil and Ceylon with a ZrO_2 content of 50 to 80 per cent. An analysis of Brazilian baddeleyite is shown in Table 17.

Zircon, $ZrSiO_4$, is widely distributed, large deposits being found in India, Madagascar, and New South Wales. It is also plentiful in some beach sands of Florida and Australia from which it can be concentrated by tabling. An analysis of a typical sample is shown in Table 17. Both zirconia and zircon have been used for special refractories, their properties being discussed in Chap. XII.

TABLE 17. ANALYSES OF ZIRCONIUM MINERALS

| Constituent | Baddeleyite, per cent | Zircon, per cent |
|--------------------------------|--------------------------|---------------------|
| Ferric oxide, Fe_2O_3 | 1.6 | 0.1 |
| Alumina, Al_2O_3 | 7.8 | 1.4 |
| Lime, CaO | 0.0 | |
| Silica, SiO_2 | 27.3 | 40.4 |
| Zirconium oxide, ZrO_2 | 60.4 | 51.6 |
| Undetermined..... | 2.9 | 6.5 |
| Total..... | 100.0 | 100.0 |

Titania is widely distributed as rutile (TiO_2) or ilmenite ($FeTiO_3$). Titanium is really one of our abundant elements but is so dispersed that it seems rare.

Thoria. This is our most refractory oxide, occurring in the monazite sands and in some other deposits as shown in the map in Fig. 369, Chap. XXIV. The important producers are India, Brazil, Australia, and Ceylon. It has been used for crucibles in the melting of platinum metals. It is slightly radioactive and is a fissionable material, which will undoubtedly be restricted in the future.

Beryllia. This highly refractory oxide is produced mainly from the mineral beryl found in many pegmatites. The chief source of supply is Argentina, Brazil, and India.⁽¹⁷⁸⁾ The extraction of the oxide from the ore is discussed by Motock⁽¹⁸¹⁾ and in references of Chap. XII.

Uranium Oxide. This is a fissionable material and will probably not be available as a refractory, but it is of interest in nuclear power development as discussed in Chap. XXIV. The published sources⁽¹⁸⁰⁾ of the ore are shown on the map in Fig. 369, Chap. XXIV.

The Rare Earths. These oxides are not so scarce as the name implies, as indicated in the chart in Fig. 20, but their separation, one from another, presents great difficulties. The only commercial ore for these materials

is monazite sand,⁽¹⁷⁾ containing 6 to 9 per cent of ceria and lesser percentages of the other rare earths. Many of the rare earth oxides are quite refractory and may be of use in special cases.

7. Carbon. *Graphite.* Carbon in the form of graphite occurs naturally in many localities. In this country, the deposits are usually too small to make it practical to work them commercially. Large deposits occur in Ceylon, Madagascar, Korea, and Czechoslovakia. Artificial graphite is also manufactured to some extent by heating coke to a high temperature in an electric furnace. Graphite is mainly used in crucibles for melting metals.

Coal. Coal of both the anthracite and the bituminous varieties is widely distributed. Before use as a refractory or insulator in electric furnaces, it is coked to drive off the volatile matter. Petroleum coke is used for high-purity purposes.

8. Production and Price of Minerals in the Refractories Industry. In Table 18 are given the production figures and prices of many materials used for refractories as taken from the "Minerals Yearbook." Most of these figures are rounded off, and it should be realized that in some cases, restrictions prevent publication of complete values. In other cases, it is impossible to separate the figures into refractory and nonrefractory uses. Nevertheless some interesting deductions may be drawn from these data.

One of the most striking facts is the very small increase in price of many of the products between the years 1920 and 1945. For example, bauxite, dolomite, magnesite, fireclay, kaolin, and talc show very little variation in price over this period. This is accounted for by more efficient mining methods, offsetting the higher labor costs. On the other hand, products of more limited occurrence show some price increases, such as chromite, beryl, and tantalum concentrates.

Bauxite, a large part of which goes into the manufacture of aluminum, has shown increased production and importation in the last few years, and the same may be said of fireclay. On the other hand, the consumption of kaolin, partly used in the paper trade, has held rather constant, with domestic production increasing to take the place of the greatly decreased importation.

Magnesite is now largely from domestic sources, only small amounts being imported after 1922. On the other hand, except for the years 1942 and 1943, when shipping space was very scarce, most of the chromite was imported. Most of the tantalum ore, zirconium concentrates, and monazite sand is also imported.

The next generation may find many of our natural resources exhausted, and restrictions of others for military purposes may be expected.

9. Summary. In Table 19 there are assembled all the refractory minerals known. The fusion points and occurrence are shown wherever

TABLE 18. PRODUCTION STATISTICS FOR REFRACTORY MATERIALS (Continued)

| Year | Bauxite (crude ore) | | | | Beryllium ore (beryl) | | | | Chromite | | | | Dolomite (dead burned) | | | | Fireclay | | | | Graphite (natural) | | | |
|------|-------------------------------|---|-----------------------|--------------------------------|-------------------------------|---|-----------------------|--------------------------------|-------------------------------|---|-----------------------|--------------------------------|-------------------------------|---|-----------------------|--------------------------------|-------------------------------|---|-----------------------|--------------------------------|-------------------------------|---|-----------------------|--------------------------------|
| | U.S. production, M short tons | Value of U.S. production, dollars/short ton | Imports, M short tons | World production, M short tons | U.S. production, M short tons | Value of U.S. production, dollars/short ton | Imports, M short tons | World production, M short tons | U.S. production, M short tons | Value of U.S. production, dollars/short ton | Imports, M short tons | World production, M short tons | U.S. production, M short tons | Value of U.S. production, dollars/short ton | Imports, M short tons | World production, M short tons | U.S. production, M short tons | Value of U.S. production, dollars/short ton | Imports, M short tons | World production, M short tons | U.S. production, M short tons | Value of U.S. production, dollars/short ton | Imports, M short tons | World production, M short tons |
| 1920 | 583 | 5.58 | 43 | 1,000 | | | | | 3.3 | 13.65 | 1,922 | | 1,380 | 2,262 | 3.12 | | 9 | 69.50 | 21 | | 9 | 69.50 | 21 | |
| 1921 | 157 | 5.67 | 28 | 350 | | | | | 0.3 | 9.15 | 635 | | 499 | 1,196 | 2.98 | | 2 | 48.50 | 8 | | 2 | 48.50 | 8 | |
| 1922 | 347 | 5.79 | 24 | 900 | | | | | 0.1 | 18.50 | 741 | | 1,074 | 1,679 | 2.76 | | 3 | 35.80 | 12 | | 3 | 35.80 | 12 | |
| 1923 | 587 | 5.38 | 119 | 1,200 | | | | | 0.3 | 15.30 | 130 | | 202 | 2,298 | 2.86 | | 6 | 17.60 | 19 | | 6 | 17.60 | 19 | |
| 1924 | 390 | 5.48 | 202 | 1,155 | | | | | 0.3 | 33.60 | 118 | | 288 | 2,444 | 2.75 | | 5 | | 16 | | 5 | | 16 | |
| 1925 | 355 | 5.58 | 354 | 1,286 | | | | | 0.1 | 17.50 | 150 | | 307 | 2,567 | 2.85 | | 5 | 19.40 | 18 | | 5 | 19.40 | 18 | |
| 1926 | 440 | 5.40 | 982 | 1,257 | | | | | 0.2 | 21.30 | 215 | | 362 | 2,819 | 2.88 | | 5 | 45.00 | 16 | | 5 | 45.00 | 16 | |
| 1927 | 247 | 5.06 | 557 | 1,416 | | | | | 0.2 | 23.00 | 222 | | 410 | 2,700 | 2.86 | | 5 | 46.60 | 17 | | 5 | 46.60 | 17 | |
| 1928 | 420 | 5.43 | 550 | 2,200 | | | | | 0.6 | 6.78 | 318 | | 634 | 2,785 | 2.68 | | 5 | | 18 | | 5 | | 18 | |
| 1929 | 410 | 5.53 | 381 | 2,000 | | | | | 0.6 | 6.78 | 318 | | 634 | 3,172 | 2.55 | | 6 | | 24 | | 6 | | 24 | |
| 1930 | 370 | 5.72 | 410 | 1,800 | | | | | 0.3 | 5.62 | 327 | | 550 | 2,571 | 2.38 | | 2 | | 17 | | 2 | | 17 | |
| 1931 | 221 | 5.20 | 306 | 1,147 | | | | | 0.8 | 4.21 | 213 | | 378 | 1,473 | 2.54 | | | | 9 | | | | 9 | |
| 1932 | 109 | 5.10 | 206 | 1,003 | | | | | 0.2 | 9.81 | 89 | | 300 | 726 | 2.83 | | | | 7 | | | | 7 | |
| 1933 | 174 | 5.37 | 150 | 1,098 | | | | 30-40 | 1.1 | 10.50 | 117 | | 884 | 1,134 | 2.77 | 1,000 | | | | | | | | |
| 1934 | 179 | 6.40 | 167 | 1,315 | | | | | | | | | | 1,229 | 3.03 | 1,200 | | | | | | | | |
| 1935 | 262 | 5.95 | 200 | 1,600 | | | | | 0.6 | 9.87 | 259 | | 780 | 1,938 | 2.64 | | | | | | | | | |
| 1936 | 417 | 5.28 | 323 | 394 | | | | | 0.3 | 9.87 | 324 | | 597 | 2,471 | 2.48 | | | | | | | | | |
| 1937 | 114 | 4.00 | 507 | 777 | | 0.2 | | 30 | 2.2 | 6.00 | 534 | | 2,960 | 618 | 8.45 | | | | | | 1 | 140.00 | 18 | |
| 1938 | 87 | 3.62 | 456 | 903 | | 0.2 | | | 0.9 | 12.00 | 352 | | 1,107 | 367 | 8.45 | | | | | | 2 | 107.00 | 30 | |
| 1939 | 114 | 3.48 | 520 | 1,268 | | | | | 4.4 | 11.80 | 318 | | 1,163 | 672 | 8.10 | | | | | | 1 | 115.00 | 18 | |
| 1940 | 571 | 3.10 | 630 | 4,459 | | | | | | | | | | | | | | | | | | | | |
| 1941 | 1,215 | 3.85 | 1,117 | 5,911 | | | | | 3.3 | 8.52 | 737 | | 1,458 | 867 | 8.00 | | | | | | 2 | 91.00 | 31 | |
| 1942 | 2,910 | 4.63 | 844 | 8,424 | | 2 | | | 15.4 | 17.80 | 1,115 | | 1,835 | 1,069 | 8.50 | | | | | | 2 | 74.80 | 41 | |
| 1943 | 6,980 | 4.43 | 1,547 | 14,169 | | 3 | | | 12.3 | 20.43 | 980 | | 1,973 | 1,229 | 8.35 | | | | | | 7 | 55.30 | 43 | |
| 1944 | 3,160 | 4.57 | 560 | 7,476 | | 5 | | | 17.6 | 27.20 | 928 | | 1,761 | 779 | 8.30 | | | | | | 10 | 94.20 | 125 | |
| 1945 | 1,090 | 5.13 | 739 | 3,926 | | 3 | | | 49.5 | 28.90 | 848 | | 1,590 | 6,344 | 2.23 | | | | | | 5 | 60.50 | 26 | |
| | | | | | | 1 | | | 15.4 | 34.60 | 914 | | 1,187 | 8.95 | 0.1 | | | | | | 5 | 54.00 | 36 | |

TABLE 19. NATURAL MINERALS

| Material | Formula | Fusion point (pure) | Occurrence | Specific gravity | Hardness |
|-------------------|---|--------------------------------|-------------------------|---------------------|----------|
| Allophane..... | $Al_2SiO_5 \cdot nH_2O$ | | Few deposits | 1.88-1.94 | 3 |
| Alumina..... | $Al_2O_3 \cdot 2SO_3$ (perhaps) | | Very rare | 2.70-2.78 | 2-3 |
| Aluminite..... | $Al_2O_3 \cdot SO_3 \cdot 9H_2O$ | | Not common | 1.66 | 1-2 |
| Alunite..... | $K_2O \cdot 3Al_2O_3 \cdot 4SO_3 \cdot 6H_2O$ | | Commercial deposits | 2.63-2.73 | 3.5-4 |
| Alunogen..... | $Al_2O_3 \cdot 3SO_3 \cdot 16H_2O$ | | Rare | 1.72-1.74 | 1.5-2 |
| Amesite..... | $(Mg, Fe)_{1-2} Al_{1-2} Si_{1-4} O_{10} (OH)_2$ | | Very rare | 2.77 | 2.5-3 |
| Anauxite..... | $Al_8(Si_4O_{10})_3(OH)_{11} \cdot 3H_2O$ | | Uncommon | 2.59 | 2.5 |
| Ancylite..... | $2CaO \cdot 3SrO \cdot 7CO_2 \cdot 5H_2O$ | | Very rare | 3.82 | 4.5 |
| Andalusite..... | Al_2SiO_5 | 1816°C. (3301°F.) | A few workable deposits | 3.12-3.29 | 7.5 |
| Ankerite..... | $(Ca, Mg, Fe)CO_3$ | | Occurs with dolomite | 2.99-3.19 | 3.5-4 |
| Apjohnite..... | $MnO \cdot Al_2O_3 \cdot 4SO_3 \cdot 22 \pm H_2O$ | | Very rare | 1.78 | 1.5 |
| Aragonite..... | $CaCO_3$ | 2570°C. (4658°F.) | Uncommon | 2.86-3.15 | 3.5-4.0 |
| Augelite..... | $2Al_2O_3 \cdot P_2O_5 \cdot 3H_2O$ | 2700°C. | Very rare | 2.77 | 4.5-5 |
| Aurichalcite..... | $5(Zn, Cu)_2O \cdot 2CO_2 \cdot 3H_2O$ | (4892°F.) | Uncommon | 3.27-3.64 | 2 |
| Baddeleyite..... | ZrO_2 | 1580°C. (2876°F.) | Few deposits | 5.5-6.03 | 6.5 |
| Barite..... | $BaSO_4$ | | Commercial deposits | 4.62 | 2.5-3.5 |
| Barylite..... | $Ba_3Be_2Si_2O_7$ | | Very rare | 4.03 | 7 |
| Beckelite..... | $Ca_3(Ce, La, Di)_2Si_2O_{11}$ | | Very rare | 4.15 | 5 |
| Beidellite..... | $Al_8(Si_4O_{10})_3(OH)_{11} \cdot 12H_2O$ | | Widespread | | |
| Bertrandite..... | $Be_4Si_2O_7(OH)_2$ | | Rare | 2.59-2.60 | 6-7 |
| Beryl..... | $Al_2Be_3Si_6O_{18}$ | 1410-1430°C. (2570-2606°F.) | Commercial deposits | 2.55-2.91 | 7.5-8 |
| Brookite..... | TiO_2 | 1900°C. (3451°F.) | Rare | 3.97 | 5.5-6.0 |

| | | | | | |
|-----------------------------|---|--------------------------------|-------------------------------------|-----------|---------|
| Brucite | $Mg(OH)_2$ | 2800°C. (5072°F.) | Commercial deposits rare | 2.38-2.39 | 2.5 |
| Bunsenite | NiO | 2570°C. (4658°F.) | Very rare | 6.40 | 5.5 |
| Calcite | $CaCO_3$ | | Commercial deposits | 2.70-2.82 | 3.0 |
| Caeserite | SrO_2 | | Commercial deposits (not in U.S.A.) | 6.72-6.91 | 6-7 |
| Celsian | $BaAl_2Si_2O_8$ | | Very rare | 3.3-3.45 | 6-6.5 |
| Cerite | $(Ce, Y, Pr, Nd)_2Si_2O_7 \cdot H_2O$ | | Very rare | 4.86-4.91 | 5.5 |
| Chalcodony | SiO_2 | 1715°C. (3119°F.) | Commercial deposits | 2.55-2.63 | 6 |
| Chalcophanite | $(Mn, Zn)O \cdot 2MnO_2 \cdot 2H_2O$ | | Rare | 3.91 | 2.5 |
| Chondrodite | $Mg_3(SiO_4)_2(OH, F)_2$ | | Rare | 3.18 | 6-6.5 |
| Chromite | $FeCr_2O_4$ | 2180°C. (3956°F.) | Numerous workable deposits | 4.32-4.57 | 5.5 |
| Chrysoberyl | $BeAl_2O_4$ | | Commercial deposits rare | 3.49-3.73 | 8.5 |
| Chrysocola | $CuSiO_3 \cdot 2H_2O$ | | Uncommon | 2.40-2.42 | 2-4 |
| Churchite | $(Ce, Ca)PO_4 \cdot 2H_2O$ | | Very rare | 3.14 | 3-3.5 |
| Clinoenstatite | $Mg_2Si_2O_6$ | | Rare | 3.19 | 6 |
| Clinohumite | $Mg_2(SiO_4)_2(OH, F)_2$ | | Rare | 3.1-3.21 | 6.0-6.5 |
| Columbite | $(Fe, Mn)(Nb, Ta)_2O_6$ | | Uncommon | 5.15-6.85 | 6 |
| Cordierite | $(Mg, Fe, Mn)_2(Al, Fe)_2Si_4O_{13} \cdot H_2O$ | | Commercial deposits | 2.57-2.66 | 7-7.5 |
| Corundum | Al_2O_3 | 2050°C. (3722°F.) | | 3.97-4.03 | 9 |
| Cristobalite | SiO_2 | 1715°C. (3200°F.) | Very rare | 2.32-2.36 | 6-7 |
| Derbylite | $6FeO \cdot Sb_2O_3 \cdot 5TiO_2$ | | Very rare | 4.51-4.53 | 5 |
| Diamond | C | | Very rare | 3.20-3.51 | 10 |
| Diaspore | $AlO(OH)$ | 2035°C. (3695°F.) | Many deposits | 3.39 | 6.5-7 |
| Dickite | $Al_2Si_2O_6(OH)_4$ | 1785°C. (3245°F.) | In some clays; uncommon | 2.62 | 2.5 |
| Dioptase | H_2CuSiO_4 | | Very rare | 3.30-3.32 | 5 |
| Dolomite | $CaMg(CO_3)_2$ | 2570-2800°C. (4658-5072°F.) | Commercial deposits | 2.83-2.99 | 3.5-4.0 |

TABLE 19. NATURAL MINERALS (Continued)

| Material | Formula | Fusion point (pure) | Occurrence | Specific gravity | Hardness |
|-------------------------------|--|------------------------|----------------|---------------------|----------|
| Dumortierite..... | $AlB_2Si_2O_{19}(OH)$ | | Very rare | 3.30-3.36 | 7 |
| Dysanallyte..... | $7(Ca, Ce, Fe, Na_2)O \cdot 6TiO_2 \cdot Cb_2O_3$ | | Very rare | 4.26 | 5-6 |
| Euxenite..... | Columbate and titanite of Y, Er, Ce, U, etc. | | Very rare | 4.59-4.99 | 6.5 |
| Eransite..... | $2AlPO_4 \cdot 4Al(OH)_2 \cdot 12H_2O$ | | Very rare | 1.92-1.93 | 3.5-4 |
| Fergusonite..... | $Y(Nb, Ta)_2O_4$ | | Very rare | 4.98-5.78 | 5.5-6 |
| Ferromite..... | $(Ca, Sr)_4(Ca(OH, F))(P, As)_2O_4$ | | Rare | 3.52 | 5 |
| Fuellite..... | $AlF_3 \cdot H_2O$ | | Very rare | 2.17 | 3 |
| Fluocerite..... | $(Ce, La, Di)F_3$ | | Very rare | 5.73 | 4 |
| Forsterite..... | Mg_2SiO_4 | 1910°C. (3470°F.) | Uncommon | 3.22-3.27 | 6-7 |
| Franklinite..... | $(Zn, Fe, Mn)(Fe, Mn)_2O_4$ | | Uncommon | 5.09 | 5.5-6.5 |
| Gadolinite..... | $(Al, Fe''', Ti)_2Fe''Be_2(SiO_4)_2O_2$ | | Very rare | 4.0-4.6 | 6.5-7.0 |
| Gahnite..... | $ZnAl_2O_4$ | | Rare | 4.48-4.60 | 7.5-8.0 |
| Garnierite..... | Perhaps $H_2(Ni, Mg)SiO_4 + H_2O$ very variable | | Widespread | 2.27-2.87 | 1-3 |
| Gaikielite..... | $(Mg, Fe)TiO_4$ | | Rare | 3.98-4 | 6 |
| Gibbsite (hydrargillite)..... | $Al(OH)_3$ | 2035°C. (3695°F.) | Common | 2.3-2.42 | 2.5-3.5 |
| Goethite..... | $HFeO_2$ | | Widespread | 4.18-4.48 | 5.0-5.5 |
| Goslarite..... | $ZnSO_4 \cdot 7H_2O$ | | Rare | 1.9-2.1 | 2-2.5 |
| Grandierite..... | $2Na_2O \cdot 4FeO \cdot 8(Fe, Al, B)_2O_3 \cdot 5SiO_2$ | | Very rare | 2.99 | 7.5 |
| Graphite..... | C | | A few deposits | 2.22 | 1-2 |
| Greenockite..... | CdS | | Rare | 4.82 | 3-3.5 |
| Grothine..... | Silicate of Ca, Al, Fe (uncertain) | | Very rare | 3.08-3.09 | 2.5-3 |
| Gummite..... | Doubtful composition, alternative product of uraninite | | Rare | 5.08 | |
| Halloysite..... | $Al_2Si_4O_{10}(OH)_2 \cdot H_2O$ | 1775°C. (3227°F.) | A few deposits | 2.44-2.71 | 1-2 |

TABLE 19. NATURAL MINERALS (Continued)

| Material | Formula | Fusion point (pure) | Occurrence | Specific gravity | Hardness |
|--|---|--------------------------------|-------------------------------------|------------------|----------|
| Melanocerite..... | $\text{Ca}_{10}\text{Na}_4(\text{Y},\text{La})_2(\text{Zr},\text{Ce})_6\text{Be}_2\text{Si}_{12}\text{O}_{47}\text{F}_{12}$ | | Very rare | 4.13 | 5-6 |
| Messite..... | $(\text{Fe},\text{Mg})\text{CO}_3$ | >1500°C. (>2732°F.) | Widely distributed | 3.38 | |
| Metavansite..... | $\text{Al}_2\text{O}_3\cdot\text{P}_2\text{O}_5\cdot 4\text{H}_2\text{O}$ | | Rare | 2.54 | 4 |
| Microcline..... | Essentially $\text{Ca}_2\text{Ta}_2\text{O}_7$ | | Very rare | 5.41-5.56 | 5.5 |
| Milosechite..... | $(\text{Al},\text{Cr})_2\text{O}_3\cdot 2\text{SiO}_2\cdot 2\text{H}_2\text{O}$ | 2500°C. (4532°F.) | Very rare | 2.13 | 1.5-2.5 |
| Mossanite (natural) (silicon carbide synthetic). | SiC | | Unique | 3.2 | 9.5 |
| Molybdenite..... | MoS ₂ | | A few extensive commercial deposits | 4.62 | 1-1.5 |
| Monazite..... | $(\text{La},\text{Ce},\text{Y})\text{PO}_4$ | | A few deposits | 5.11-5.31 | 5-5.5 |
| Montmorillonite..... | $(\text{OH})_2\text{Al}_2(\text{Si}_2\text{O}_5)_2\cdot n\text{H}_2\text{O}$ | | Common | 2.04-2.52 | Soft |
| Morenosite..... | $\text{NiSO}_4\cdot 7\text{H}_2\text{O}$ | 1785°C. (3245°F.) | Fairly rare | 2.00 | 2.0-2.5 |
| Nacrite..... | $\text{Al}_2\text{Si}_2\text{O}_7(\text{OH})_4$ | 1526°C. (2779°F.) | Very rare | 2.5+ | 2.5 |
| Nephelelite..... | $(\text{Na},\text{K})(\text{Al},\text{Si})_3\text{O}_8$ | | | 2.53-2.66 | 5.5-6 |
| Nontronite..... | Member of beidellite group | | Uncommon | 2.29-2.30 | |
| Norbergite..... | $\text{Mg}_3(\text{SiO}_4)(\text{OH},\text{F})_2$ | 1900°C. (3452°F.) | Rare | 3.13-3.15 | 6.5 |
| Octahedrite..... | TiO ₂ | | Rare | 3.95 | 5.5-6 |
| Olivine..... | $(\text{Mg},\text{Fe})\text{SiO}_4$ | 1700-1910°C. (3092-3470°F.) | Common | 3.2-3.3 | 6.5-7 |
| Opal..... | $\text{SiO}_2\cdot n\text{H}_2\text{O}$ | 1715°C. (3119°F.) | A few deposits | 2.06-2.22 | 5.5-6.5 |
| Parisite..... | $2(\text{Ce},\text{La},\text{Di},\text{Tb})\text{OF}\cdot\text{CaO}\cdot 3\text{CO}_2$ | | Rare | 4.32 | 4.5 |
| Perciaase..... | MgO | 2800°C. (5072°F.) | Rare | 3.04-3.67 | 5.5-6 |

| Mineral | Chemical Formula | Temperature (°C./°F.) | Commercial Status | Deposits | Specific Gravity |
|----------------|--|-----------------------|---|----------|------------------|
| Ferrovakite | CaTiO ₃ | | known | un- | 5.5 |
| Phenacite | Be ₂ SiO ₄ | 2000°C. (3632°F.) | Rare | | 7.5-8 |
| Picotite | (Mg,Fe)(AlCr) ₂ O ₄ | | Rare | | 4.08 |
| Pigeonite | (Ca,Mg)(Mg,Fe)Si ₂ O ₆ | | Widespread | | 3.2-3.4 |
| Polianite | MnO ₂ | | Rare | | 4.84-5.03 |
| Polycrase | Columbate and titanate of Y, U, Th, Fe, etc. | | Rare | | 4.97-5.04 |
| Polymignite | Columbate, titanate, zirconate of Ce, etc. | | Very rare | | 4.77-4.85 |
| Proseopite | CaFe ₂ Al(F,OH) ₇ H ₂ O | | Rare | | 2.88-2.89 |
| Pseudobrookite | Fe ₂ TiO ₅ | | Rare | | 4.60 |
| Pyroaurite | 6MgO·FeO ₂ CO ₂ ·12H ₂ O | | Rare | | 2.07 |
| Pyrochlore | Columbate and titanate of Ce, Ca, etc. with Th, F, etc. | | Very rare | | 4.2-4.36 |
| Pyrolusite | MnO ₂ | | Uncommon | | 4.75-4.89 |
| Pyrope | Mg ₂ Al ₂ (SiO ₄) ₂ | | Uncommon | | 3.51-3.75 |
| Pyrophanite | MnO·TiO ₂ | | Very rare | | 4.54 |
| Pyrophyllite | Al ₂ Si ₄ O ₁₀ (OH) ₂ | | Rare | | 2.66 |
| Quartz | SiO ₂ | 1715°C. (3119°F.) | Very plentiful | | 2.65-2.70 |
| Ralsstonite | (Na ₂ ,Mg)F ₂ ·3Al(F,OH) ₇ ·2H ₂ O | | Very rare | | 2.61 |
| Retsian | Arsenate of Y, Mn, Ca, etc., and H ₂ O | | Very rare | | 4.15 |
| Rhabdophanite | (Y,Er,La,Dt) ₂ O ₂ ·P ₂ O ₅ ·2H ₂ O | | Very rare | | 3.94-4.01 |
| Rhodochrosite | MnCO ₃ | | Small deposits | | 3.31-3.74 |
| Rhodolite | 3(Mg,Fe)O·Al ₂ O ₃ ·3SiO ₂ | | Rare | | 3.75-3.84 |
| Rhodrite | Cb ₂ O ₅ (Y,Er) ₂ O ₇ ·H ₂ O, some Ta, Ti, Ce, La, etc. | 1720°C. (3128°F.) | Very rare | | 4.18 |
| Rosieresite | Hydrous phosphate of Al, Pb and Cu | | Very rare | | 2.2 |
| Rowlanidite | (Y,Ce,La) ₄ Fe''(Si ₂ O ₇) ₂ F ₂ | 1900°C. (3452°F.) | Very rare | | 4.52 |
| Rutile | TiO ₂ | | Few large deposits but widely distributed | | 4.12-4.27 |
| Saponite | (Mg,Fe) ²⁺ _{2.25} (Al,Fe ³⁺) _{0.75} Si _{1.75} O ₁₀ (OH) ₂ ·nH ₂ O | | | | 2.18-2.31 |
| Sapphirine | Mg ₂ Al ₂ Si ₂ O ₇ | | Rare | | 7.5 |

TABLE 19. NATURAL MINERALS (Continued)

| Material | Formula | Fusion point (pure) | Occurrence | Specific gravity | Hardness |
|-----------------------|--|------------------------|----------------------------|---------------------|----------|
| Schneebergite..... | $2\text{CaO}\cdot\text{Sb}_2\text{O}_4$ | | Rare | 5.41 | 6.5 |
| Schroerterite..... | $3\text{Al}_2\text{O}_3\cdot\text{SiO}_2\cdot n\text{H}_2\text{O}$ | 1816°C. (3300°F.) | Rare | 1.95-2.05 | 3-3.5 |
| Sillimanite..... | Al_2SiO_5 | | A few commercial deposits | 3.23-3.24 | 6-7.5 |
| Sipylite..... | Columbate of Er, La, Di, U, etc. | | Very rare | 4.89 | 6 |
| Smithsonite..... | ZnCO_3 | | Widespread | 4.19-4.41 | 4.5-5 |
| Sphaerocobaltite..... | CoCO_3 | | Rare | 4.02-4.13 | 3-4 |
| Spinel..... | MgAl_2O_4 | 2135°C. (3875°F.) | Small deposits | 3.68-3.92 | 8 |
| Spurrite..... | $5\text{CaO}\cdot\text{CO}_2\cdot 2\text{SiO}_2$ | | Rare | 3.01 | 5 |
| Subbiconite..... | $\text{Si}_2\text{O}_4\cdot n\text{H}_2\text{O}$ | | Rare | 5.1-5.3 | 4-5 |
| Stichuite..... | $6\text{MgO}\cdot\text{Cr}_2\text{O}_3\cdot\text{CO}_2\cdot 12\text{H}_2\text{O}$ | | Rare | 2.16 | 1.75 |
| Symplectite..... | $3\text{FeO}\cdot\text{As}_2\text{O}_5\cdot 8\text{H}_2\text{O}$ | | Very rare | 2.96 | 2.5 |
| Szmitkite..... | $\text{MnO}\cdot\text{SO}_3\cdot\text{H}_2\text{O}$ | | Very rare | 3.15 | 1.5 |
| Tantalite..... | $(\text{Fe}, \text{Mn})\text{O}\cdot(\text{Ta}, \text{Cb})_2\text{O}_4$ | | Very rare | 6.5-8.20 | 6 |
| Tapiolite..... | $\text{FeO}\cdot(\text{Ta}, \text{Cb})_2\text{O}_4$ | | Very rare | 7.19-7.91 | 6 |
| Tavistockite..... | $3\text{CaO}\cdot\text{Al}_2\text{O}_3\cdot\text{P}_2\text{O}_5\cdot 2\text{H}_2\text{O}$ | | Very rare | 4.45 | 6.5 |
| Thalenite..... | $(\text{Al}, \text{Fe}''', \text{Ti})_2\text{Si}_2\text{O}_7$ | | Very rare | 1.85-1.88 | 3.5 |
| Thaumasite..... | $3\text{CaO}\cdot\text{CO}_2\cdot\text{SO}_3\cdot\text{SiO}_2\cdot 15\text{H}_2\text{O}$ | 1660°C. (3020°F.) | Very rare | 9.33 | 6.5 |
| Thorianite..... | Chiefly (Th, U)O ₂ | | | | |
| Thortite..... | Th_2SiO_4 | | Rare | 5.2-5.4 | 4.5-5.0 |
| Topaz..... | $\text{Al}_2\text{SiO}_4(\text{F}, \text{OH})_2$ | | Commercial deposits scarce | 3.35-3.59 | 8 |
| Tridymite..... | SiO_2 | | Rare | 2.28-2.33 | 7 |
| Tungstite..... | $\text{WO}_3\cdot\text{H}_2\text{O}$ | | Rare | 5.5 | 2.5 |
| Turquoise..... | $\text{CuO}\cdot 3\text{Al}_2\text{O}_3\cdot 2\text{P}_2\text{O}_5\cdot 9\text{H}_2\text{O}$ | | Rare | 2.84 | 5 |
| Uraninite..... | A uranate of U, Pb, Th, Zr, and metals of La and Y groups | | Rare | 7.13-9.79 | 5.5 |

TABLE 19. NATURAL MINERALS (Continued)

| Material | Formula | Fusion point (pure) | Occurrence | Specific gravity | Hardness |
|---------------------|---|------------------------|--------------|------------------|----------|
| Uranophane..... | $\text{CaU}_2\text{Si}_2\text{O}_{11}\cdot 7\text{H}_2\text{O}$ | | Rare | 3.81-3.96 | 2-3 |
| Uranothallite..... | $2\text{CaO}\cdot\text{UO}_2\cdot 4\text{CO}_2\cdot 10\text{H}_2\text{O}$ | | Rare | 3.42-3.81 | 2.5-3 |
| Uvarovite..... | $\text{Ca}_3\text{Cr}_2(\text{SiO}_4)_3$ | | Rare | 2.47 | 6.5-7.5 |
| Variscite..... | $\text{Al}_2\text{O}_3\cdot\text{P}_2\text{O}_5\cdot 4\text{H}_2\text{O}$ | | Rare | 1.96 | 4 |
| Vashegyite..... | $3\text{Al}_2\text{O}_3\cdot 2\text{P}_2\text{O}_5\cdot 18 \pm \text{H}_2\text{O}$ (about) | | Rare | 3.06-3.10 | 2-3 |
| Veelckerite..... | $10\text{CaO}\cdot 3\text{P}_2\text{O}_5\cdot \text{P}_2\text{O}_5$ | 1540°C. (2804°F.) | Not common | | |
| Volchonskoite..... | $(\text{Al}, \text{Fe}^{2+}, \text{Cr})_3(\text{Si}_2\text{O}_{10})(\text{OH})_3$ | | Rare | 2.2-2.3 | 2.5 |
| Voltzite..... | $\text{ZnO}\cdot 4\text{ZnS}$ | | Very rare | 3.66-3.80 | 4.0-4.5 |
| Wavellite..... | $3\text{Al}_2\text{O}_3\cdot 2\text{P}_2\text{O}_5\cdot 13(\text{H}_2\text{O}\cdot 2\text{HF})$ | | Uncommon | 2.33 | 3.5-4.0 |
| Whewellite..... | $\text{CaO}\cdot \text{C}_2\text{O}_3\cdot \text{H}_2\text{O}$ | | Rare | 2.23 | 2.5 |
| Wilkieite..... | Columbate, titanate, and silicate of Fe and rare earths | | Very rare | 3.8-4.8 | 6 |
| Willemite..... | ZnSiO_4 | | Uncommon | 3.89-4.19 | 5.5 |
| Xenotime..... | YPO_4 | | Uncommon | 4.55 | 4-5 |
| Yttrialite..... | $(\text{Y}, \text{Th})_2\text{O}_3\cdot 2\text{SiO}_2$ | | Very rare | 4.58 | 5-5.5 |
| Yttrocerite..... | Hydrous titanate of Th, Y, etc. | | Rare | 4.80 | 5.5-6 |
| Zebedassite..... | $5\text{MgO}\cdot \text{Al}_2\text{O}_3\cdot 6\text{SiO}_2\cdot 4\text{H}_2\text{O}$ | | Very rare | 2.19 | 2 |
| Zepharovichite..... | $\text{Al}_2\text{O}_3\cdot \text{P}_2\text{O}_5\cdot 6\text{H}_2\text{O}$ | >1500°C. (>2732°F.) | Very rare | 2.37 | 5.5 |
| Zincaluminite..... | $6\text{ZnO}\cdot 3\text{Al}_2\text{O}_3\cdot 2\text{SO}_3\cdot 18\text{H}_2\text{O}$ | | Very rare | 2.26 | 2.5-3.0 |
| Zincite..... | ZnO | | Rare | 5.43-5.7 | 4.0-4.5 |
| Zircon..... | ZrSiO_4 | 2550°C. (4622°F.) | Few deposits | 4.05-4.75 | 7.5 |
| Zirconite..... | $(\text{Ce}, \text{Fe}, \text{Ca})\text{O}\cdot 2(\text{Zr}, \text{Ti}, \text{Th})\text{O}_2$ | | Very rare | 4.3-5.22 | 5.5 |
| Zunyite..... | $\text{Al}_2(\text{SiO}_4)_3(\text{F}, \text{Cl}, \text{OH})_{12}$ | | Very rare | 2.88 | 7 |

possible to indicate their suitability for any specific purpose. Many of the minerals are far too rare and costly for commercial use, but it is not improbable that some of these may be of use in the laboratory. Many instances have also occurred where a rare mineral became relatively plentiful through the discovery of a new source of supply.

10. Bibliography

Clay Deposits:

1. BLEININGER, A.V., and G.A. LOOMIS: The properties of Some American Bond Clays, *Trans. Am. Ceram. Soc.*, **19**, 601, 1917.
2. RIES, H., and W.S. BAILEY: High Grade Clays of the Eastern United States, *U.S. Geol. Survey Bull.*, p. 708, 1922.
3. ASHLEY, G.H.: The Fire Brick Materials of Pennsylvania, *J. Am. Ceram. Soc.*, **6**, 837, 1923.
4. LOGAN, W.N.: Refractory Clays and Shales of Indiana, *J. Am. Ceram. Soc.*, **7**, 201, 1924.
5. THORNBERRY, M.H.: A Treatise on Missouri Clays, *Bull. Univ. Mo. School of Mines and Met.*, **8**, 9, 1925.
6. BARKER, M.E.: Clay Resources of South Carolina, *Ceramist*, **8**, 249, 1926.
7. BRANNER, G.C.: The Commercial Clays of Arkansas, *Ceramist*, **7**, 250, 1926.
8. CALHOUN, F.H.H.: The High Grade Clays of South Carolina, *Ceramist*, **7**, 224, 1926.
9. JILLSON, W.R.: The Fire Clays of Northeastern Kentucky, *Mfrs' Record*, **89**, 62, 1926.
10. KALBAUNER, O.: Zettlitz Kaolin in Czechoslovakia, *Rev. materiaux construction trav. pub.*, **201**, 21, B; **202**, 145; **203**, 169, 1926.
11. MILOMI, G.: Italian Refractory Clays, *Corriere ceram.*, **7**, 196, 1926.
12. TURNER, C.: Klingenberg Ton, *Tonind.-Ztg.*, **50**, 134, 1926.
13. WEIGEL, W.M.: High Grade Clays of the Southeastern States, *Ceramist*, **8**, 86, 1926.
14. GOMBERT, J.: Die Entwicklung der Tongraberzien, *50 Jahre Tonind.-Ztg.*, p. 26, 1926.
15. HODSON, F.: The Origin of Bedded Pennsylvania Fire Clays in the United States, *J. Am. Ceram. Soc.*, **10**, 721, 1927.
16. ROSS, D.W.: Nature and Origin of Refractory Clays, *J. Am. Ceram. Soc.*, **10**, 704, 1927.
17. ANON.: Fireclay Deposit, British Columbia, *Engineering*, **134**, 188, 1927.
18. HUTT, G.M.: Fireclay Deposits of Saskatchewan, *Power Age*, p. 37, May, 1928.
19. SHAW, J.B.: Fire Clays of Pennsylvania: *Partial Rep.*, *Penn. Topog. Geol. Survey Bull.* M10, 1928.
20. STUCKEY, J.L.: The Kaolins and Kaolin Production of North Carolina, *Ceram. Age*, **12**, 85, 1928.
21. SMITH, R.W.: Sedimentary Kaolins of Georgia, *Georgia Geol. Survey Bull.* 41, 1929.
22. NORTON, F.H.: Clays of New England, *Ceram. Age*, **15**, 271, 1930.
23. HUTT, G.M.: Geology of the Fire Clays of Southern Saskatchewan, *J. Am. Ceram., Soc.*, **13**, 174, 1930.

24. KOHLER, E.: Kaolin as Raw Material for Refractories, *Trans. Ceram. Research Inst. (U.S.S.R.)*, **25**, 44, 1930.
25. STOUT, WILBER: Clarion Clay of Vinton County, Ohio, *J. Am. Ceram. Soc.*, **15**, 397, 1932.
26. DYER, W.S., and A.R. CROZIER: Refractory Clays of Northern Ontario, *Bull. Can. Mining Met.*, **254**, 238, 1933.
27. ENDELL, K., U. HOFMANN, and D. WILM: On the Nature of Ceramic Clays, *Ber. deut. keram. Ges.*, **14**, 407, 1933.
28. WILSON, H.: Kaolin and China Clay of the Pacific North West, *Univ. Wash. Eng. Exp. Sta. Bull.* 76, 1934.
29. CHELIKOWSKY, J.R.: Geologic Distribution of Fire Clays in the United States, *J. Am. Ceram. Soc.*, **18**, 367, 1935.
30. GRIM, R.E.: Petrology of the Pennsylvania Shales and Noncalcareous Underclays Associated with Illinois Coals, Part I, *Bull. Am. Ceram. Soc.*, **14**, 113, 1935.
31. GRIM, R.E.: Petrology of the Pennsylvania Shales and Noncalcareous Underclays Associated with Illinois Coals, Part II, *Bull. Am. Ceram. Soc.*, **14**, 129, 1935.
32. GRIM, R.E.: Petrology of the Pennsylvania Shales and Noncalcareous Underclays Associated with Illinois Coals, Part III, *Bull. Am. Ceram. Soc.*, **14**, 171, 1935.
33. HEINDL, R.A.: Sagger Clays and Sagger Bodies, *Natl. Bur. Standards, J. Research*, **15**, 255, 1935; R.P. 827.
34. HARVEY, F.A.: Problems in the Utilization of Pennsylvania Fire Clays, *Bull. Am. Ceram. Soc.*, **14**, (1), 1, 1935.
35. RIES, H.: Geology and Clay Research, *Bull. Am. Ceram. Soc.*, **14**, 279, 1935.
37. ZVANUT, F.J.: Notes on Missouri Halloysite, *J. Am. Ceram. Soc.*, **20**, 84, 1937.
38. GREAVES-WALKER, A.F.: The Origin, Mineralogy and Distribution of the Refractory Clays of the United States, *Univ. N. C. State Coll. Record*, Vol. 39, No. 4, 1939.
39. GRIM, R.E.: Relation of the Composition to the Properties of Clays, *J. Am. Ceram. Soc.*, **22**, 141, 1939.
40. MITCHELL, L., and E.C. HENRY: Nature of Georgia Kaolin, I, Evidence of Chemical and Colloidal Analysis, *J. Am. Ceram. Soc.*, p. 26; II, Evidence of Mineralogical Analysis, *ibid.*, p. 105, 1943.
41. FOOSE, R.M.: High Alumina Clays of Pennsylvania, *Econ. Geol.*, **39**, 557, 1944.
42. RIES, H.: Report of Committee on Geological Surveys, *Bull. Am. Ceram. Soc.*, **24**, 234, 1945.

Properties of Clay:

43. BOOZE, M.C.: The Chemical and Physical Properties of Fire Clays from Various Producing Districts, *J. Am. Ceram. Soc.*, p. 655, 1925.
44. HEINDL, R.A., and W.L. PENDERGAST: Progress Report on Investigations of Fireclay Brick and the Clays Used in Their Preparation, *J. Am. Ceram. Soc.*, **12**, 640, 1929.
45. RIEKE, R., and W. JOHNE: Variations in Chemical Composition of Some Clays within Given Grain-size Fractions, *Ber. deut. keram. Ges.*, **12**, 203, 1931.
46. LORENZ, R.: Size and Shape of Particles and Degree of Subdivision of Kaolins, *Ber. deut. keram. Ges.*, **13**, 356, 1932.

47. VINTHER, E.H., and M.L. LASSON: On Grain-size Measurements of Kaolins and Clays, *Ber. deut. keram. Ges.*, **14**, 259, 1933.
48. SALMANG, H., and J. KIND: On the Inter-relationship between Various Physical, Chemical and Technical Properties of Clays, *Ber. deut. keram. Ges.*, **15**, 331, 1934.
49. GRIM, R.E.: Recent Findings on the Relation of the Constitution of Clays and Shales to Their Ceramic Properties, *Ceram. Age.*, **25**, 194, 1935.
50. MARSHALL, C.E.: The Chemical Constitution as Related to the Physical Properties of the Clays, *Trans. Ceram. Soc. (Engl.)*, **35**, 401, 1936.
51. BRAY, R.H.: The Significance of Particle Size within the Clay Fraction, *J. Am. Ceram. Soc.*, **20**, 257, 1937.
52. DAVIES, R.J., R.A. GREEN, and H.F.E. DONNELLY: Some Researches on China Clay, *Trans. Ceram. Soc. (Engl.)*, **36**, 173, 1937.
53. GRAHAM, R.P., and J.D. SULLIVAN: Critical Study of Methods of Determining Exchangeable Bases in Clays, *J. Am. Ceram. Soc.*, **21**, 176, 1938.
54. HENRY, E.C., and N.W. TAYLOR: Acid and Base Binding Capacities and Viscosity Relations in Certain Whiteware Clays, *J. Am. Ceram. Soc.*, **21**, 165, 1938.
55. NORTON, F.H., and S. SPEIL: The Measurement of Particle Size in Clays, *J. Am. Ceram. Soc.*, **21**, 89, 1938.
56. LONGCHAMBON, L., and J. ZAJTMAN: On the Colloidal Properties of Refractory Clays, *Arts du feu*, **1**, 203, 1938.
57. WHITTAKER, H.: Effect of Particle Size on Plasticity of Kaolinite, *J. Am. Ceram. Soc.*, **22**, 1, 16, 1939.
58. SHARRATT, E., and MARCUS FRANCIS: The Organic Matter of Ball Clay, Part I, *Trans. Brit. Ceram. Soc.*, **42**, 111, 1943.
59. ROBERTS, A.L.: The Constitution of Refractory Clays, *Trans. Brit. Ceram. Soc.*, **44**, 20, 1945.

The Clay Minerals:

60. ROSS, C.S., and E.V. SHANNON: The Minerals of Bentonite and Related Clays and Their Physical Properties, *J. Am. Ceram. Soc.*, **9**, 77, 1926.
61. McDOWELL, J.S.: Mineralogy of Clays, I, *J. Am. Ceram. Soc.*, **9**, 55, 1926.
62. ROSS, C.S., and P.F. KERR: The Kaolin Minerals, *J. Am. Ceram. Soc.*, **13**, 151, 1930.
63. MARSHALL, C.E.: Clays as Minerals and as Colloids, *Trans. Ceram. Soc. (Engl.)*, **30**, 81, 1931.
64. GRUNER, J.W.: The Crystal Structure of Nacrite and a Comparison of Certain Optical Properties of the Kaolin Group with Its Structures, *Z. Kryst.*, **85**, 345, 1933.
65. HIRSCH, H., and W. DAWIHL: On the Nature of the Combined Water in the Kaolin Molecule, *Keram. Rundschau*, **41**, 172, 1933.
66. HOFMANN, U., K. ENDELL, and D. WILM: Crystal Structure and Swelling of Montmorillonite (The Clay Mineral of the Bentonite Clays), *Z. Kryst.*, **86**, 340, 1933.
67. WARREN, B.E.: The Role of Silicon and Aluminum in Complex Silicates, *J. Am. Ceram. Soc.*, **16**, 412, 1933.
68. MEHMEL, M.: The Structure of Halloysite and Metatalloysite, *Z. Kryst.*, **90**, 35, 1935.

69. CORRENS, C.W., and M. MEHMEL: The Optical and X-ray Determination of Kaolinite, Halloysite, and Montmorillonite, *Z. Kryst.*, **94**, 337, 1936.
70. GRUNER, J.W.: Densities and Structural Relationships of Kaolinities and Anauxites, *Am. Mineral.*, **22**, 855, 1937.
71. HENDRICKS, S.B.: Concerning the Crystal Structure of Kaolinite, $\text{Al}_2\text{O}_3 \cdot 2\text{SiO}_2 \cdot 2\text{H}_2\text{O}$ and the Composition of Anauxite, *Z. Kryst.*, **95**, 247, 1937.
72. HENDRICKS, S.B., and M.E. JEFFERSON: Structures of Kaolin and Talc-pyrophyllite Hydrates and Their Bearing on Water Sorption of the Clays, *Am. Mineral.*, **23**, 863, 1938.
73. HENDRICKS, S.B.: On the Crystal Structure of the Clay Minerals, Dickite, Halloysite, and Hydrated Halloysite, *Am. Mineral.*, **23**, 295, 1938.
74. KEPPELER, G.: Recent Investigations on Clay Minerals, *Ber. deut. keram. Ges.*, **19**, 159, 1938.
75. KERR, P.F.: A Decade of Research on the Nature of Clay, *J. Am. Ceram. Soc.*, **21**, 267, 1938.
76. NOLL, W.: Advances in the Knowledge of the Clay Minerals, *Ber. deut. keram. Ges.*, **19**, 176, 1938.
77. EITEL, W., H.O. MÜLLER, and O.E. RADZWEŃSKI: Uebermikroskopische Untersuchungen an Tonmineralien (Supermicroscopic Investigations on Clay Minerals), *Ber. deut. keram. Ges.*, **20**, 165, 1939.
78. HENDRICKS, S.B.: The Crystal Structure of Naerite, $\text{Al}_2\text{O}_3 \cdot 2\text{SiO}_2 \cdot 2\text{H}_2\text{O}$, and the Polymorphism of the Kaolin Minerals, *Z. Kryst.*, **100**, 509, 1939.
79. NORTON, F.H.: Critical Study of the Differential Thermal Method for the Identification of the Clay Minerals, *J. Am. Ceram. Soc.*, **22**, 54, 1939.
80. NORTON, F.H.: Hydrothermal Formation of Clay Minerals in the Laboratory, Part II, *Am. Mineral.*, **26**, 1, 1941.
81. PINSKER, Z.G., L.I. TARTARINOVA, and V.A. NOVIHOVA: Solubility of Kaolin in Water, *Compt. rend. acad. sci. U.R.S.S.*, **33**, 231, 1941.
82. BRINDLEY, G.W., and K. ROBINSON: The Structure of Kaolinite, *Mining Mag.*, **27**, 242, 1946.
83. BRINDLEY, G.W., and K. ROBINSON: An X-ray Study of Some Kaolinitic Fireclays, *Trans. Brit. Ceram. Soc.*, **46**, 49, 1947.

Diaspore and Bauxites:

84. HOWE, R.M., and R.F. FERGUSON: Composition and Properties of Diaspore, Bauxite, and Gibbsite, *J. Am. Ceram. Soc.*, **6**, 496, 1923.
85. WYSOR, D.C.: Diaspore Clay of Arkansas and Missouri, *J. Am. Ceram. Soc.*, **6**, 501, 1923.
86. EMORY, L.T.: Bauxite on the Gold Coast, *Eng. Mining J.-Press*, **121**, 11, 443, 1926.
87. PECK, A.B.: Dumortierite as a Commercial Mineral, *Am. Mineral.*, **11**, 96, 1926.
88. EMORY, L.T.: Formation of Bauxite, *Eng. Mining J.*, **123**, 771, 1927.
89. HARRASSOWITZ, H.: Bauxite Studies, *Metall u. Erz*, **24**, 181, 1927.
90. ANON.: Bauxite Industry in Hungary, *Eng. Mining J.*, **124**, 455, 1927.
91. EMORY, L.T.: British Guiana, Bauxite Deposits, *Mining and Met.*, **9**, 8, 1928.
92. FORBES, C.R.: Winning of Missouri Diaspore, Burley, and Flint Clays, *J. Am. Ceram. Soc.*, **11**, 204-214, 1928.
93. GREAVES-WALKER, A.F.: Consumption of Diaspore, *Blast Furnace Steel Plant*, **16**, 1481, 1928.

94. DE LAPPARENT, J.: Boehmite, *Mineralog. Mag.*, **21**, 599, 1928.
95. RAO, T.V.M.: A Study of Bauxite, *Mineralog. Mag.*, **21**, 407, 1928.
96. MCQUEEN, H.S.: Geologic Relations of the Diaspore and Flint Fire Clays of Missouri, *J. Am. Ceram. Soc.*, **12**, 687, 1929.
97. EMORY, L.T.: Formation of Bauxite, *Eng. Mining J.*, **123**, 771, 1927.
98. MCQUEEN, H.S.: Geologic Relations of the Diaspore and Flint Clays of Missouri, *J. Am. Ceram. Soc.*, **12**, 687, 1929.
99. GAMON, J.A.: French Bauxite Production and Trade, *Commerce Repts.* 28, pp. 107-109, 1931.
100. LONG, B.: On the Constitution and Properties of Bauxites for Refractory Materials, *Céramique*, **36**, 1, 1933.
101. TOMKEIEFF, S.I.: Clay Minerals and Bauxite Minerals: A Review and Classification Based on a Statistical Method, *Mineralog. Mag.*, **23**, 463, 1933.
102. CHARRIN, V.: Ceramic Bauxite in French West Africa, *Ceram., verrerie, émail.*, **2**, 69, 1934.
103. ALLEN, V.T.: Mineral Composition and Origin of Missouri Flint and Diaspore Clays, *Mo. Geol. Survey, Fifty-eighth Biennial Rept.*, Appendix IV, 1935.
104. EWING, F.J.: Structure of Diaspore, *J. Chem. Phys.*, **3**, 203, 1935.
105. TAUBIN, G.B., and B.E. PINDRIK: Pyrophyllite as Refractory Material, *Ogneupory*, **4**, 708, 1936.
106. GREAVES-WALKER, A.F., C.W. OWENS, JR., T.L. HURST, and R.L. STONE: Development of Pyrophyllite Refractories and Refractory Cements, *Univ. N. C. Eng. Exp. Sta. Bull.* 12, 1938.
107. THOENEN, J.R., and E.F. BURCHARD: Bauxite Resources of the United States, *U.S. Bur. Mines, Repts. Invest.* 3598, 1941.

Nonclay Aluminous Materials:

108. MELHASE, J.: Andalusite in California, *Eng. Mining J.-Press.*, **120**, 91, 1925.
109. HARRISON, H.C.: Cyanite-clay Refractories, I, *J. Am. Ceram. Soc.*, **9**, 257, 1926.
110. REES, W.J.: Some Notes on the Use of Indian Sillimanite, *Trans. Ceram. Soc. (Engl.)*, **26**, 132, 1926-1927.
111. VACHUSKA, E.J., and G.A. BOLE: Notes on Cyanite and Diaspore Refractories, *J. Am. Ceram. Soc.*, **10**, 761, 1927.
112. ANON.: South Africa's Corundum Deposits, *Eng. Mining J.*, **124**, 610, 1927.
113. PAYNE, H.M.: North Carolina Cyanite Deposits, *Cement Mill and Quarry*, **32**, 75, 1928.
114. TAYLOR, W.H.: Structure of Sillimanite and Mullite, *Z. Kryst.*, **68**, 503, 1928.
115. FESSLER, A.H., and W.J. McCAUGHEY: Cyanite as Found in Western North Carolina, *J. Am. Ceram. Soc.*, **12**, 32, 1929.
116. RIDDLE, R.H.: The Possibility of Sillimanite Minerals as Refractories, *Trans. Electrochem. Soc.*, **59**, 35, 1931.
117. SMITH, R.W.: The Kyanite Industry of Georgia, *Am. Inst. Mining Met. Engrs., Tech. Pub.* 742, 1936.
118. BEEVERS, C.A., and M.A.S. ROSS: The Crystal Structure of "Beta Alumina," $\text{Na}_2\text{O} \cdot 11\text{Al}_2\text{O}_3$, *Z. Kryst.*, **97**, 59, 1937.
119. SMITH, R.W.: The Kyanite Industry of Georgia, *Am. Inst. Mining Met. Engrs., Tech. Pub.* 742, 1937.
120. THORNELY, P.C., and W.H. TAYLOR: Coordination of Al in Andalusite, *Mem. Manchester Lit. & Phil. Soc.*, **83**, 17, 1939; *Science Abstracts*, p. 3099, 1939.

121. BRADLEY, R.S., F.W. SCHROEDER, and W.D. KELLER: Study of the Refractory Properties of Topaz, *J. Am. Ceram. Soc.*, **23**, 265, 1940.
122. RAMPACEK, C., *et al.*: Beneficiation of South Carolina Sillimanite Schists, *J. Am. Ceram. Soc.*, **28**, 197, 1945.
123. JELLINEK, M.H., and I. FANKUCHEN: X-ray Diffraction Examination of Gamma-alumina, *Ind. Eng. Chem.*, **37**, 158, 1945.

Silica Minerals:

124. MOORE, E.S., and T.G. TAYLOR: The Silica Refractories of Pennsylvania, *Penn. Topog. Geol. Survey Bull.* M3, 1924.
125. SMITH, C.A.: The Manufacture of an Insulating Brick from Diatomaceous Earth, *J. Am. Ceram. Soc.*, **7**, 52, 1924.
126. ANON.: "Bibliography of Silica Refractories," American Ceramic Society, Columbus, Ohio, 1924.
127. SOSMAN, R.B.: "The Properties of Silica," Reinhold Publishing Corporation, New York, 1927.
128. BECHMANN, O.: Refractory Natural Stone for Lining Cupolas and Converters, *Giesserei-Ztg.*, **25**, 156, 1928.
129. HASTINGS, E.S.: Diatomaceous Earth, *Rock Products*, **32**, 50, 1929.
130. MESSERVEY, J.P.: Diatomaceous Earth, *Can. Chem. Met.*, **13**, 24, 1929.
131. HUGILL, W.: Diatomaceous Earth, Part I, *Trans. Ceram. Soc. (Engl.)*, **30**, 123, 1931.
132. FREDERICK, C.L., JR.: Properties of Silica Brick Manufactured from Sharon Conglomerate, *J. Am. Ceram. Soc.*, **15**, 61, 1932.
133. BOSAZZA, V.L.: South African Materials for Silica Refractories, *Trans. Geol. Soc. S. Africa*, **39**, 465, 1937.
134. RAYNER, HARRY: Firestone as a Refractory, *Blast Furnace Steel Plant*, **25**, 1009, 1937.
135. BURR, E.A.: Refractory Firestones of Ohio, *Blast Furnace Steel Plant*, **26**, 490, 520, 1938.
136. O'BRIEN, W.A.: Silica Firestone, *Refractories J.*, **14**, 171, 1938.
137. BERKELHAMER, L.H.: Differential Thermal Analysis of Quartz, *U.S. Bur. Mines, Repts. Invest.* 3763, 1944.
138. DAVIES, W.: British Resources of Ganister and Silica Rock, *Trans. Brit. Ceram. Soc.*, **47**, 53, 1948.

Magnesite and Lime:

- 138a. McDOWELL, J.S., and R.M. HOWE: Magnesite Refractories, *J. Am. Ceram. Soc.*, **3** (3), 185; (7), 568, 1920.
139. ANON.: "Bibliography of Magnesite Refractories," American Ceramic Society, Columbus, Ohio, 1924.
140. THOENEN, J.R.: Genesis of Grecian Magnesite, *Mining Met.*, **9**, 79, 1928.
141. BIRCH, R.E., and F.A. HARVEY: Forsterite and Other Magnesite Silicates as Refractories, *J. Am. Ceram. Soc.*, **18**, 176, 1935.
142. WINCHELL, A.N.: Cordierite, *Am. Mineral.*, **22**, 1175, 1937.
143. ANON.: Magnesite in Canada, *Chem. Trade J.*, **103**, 610, 1938.
144. SCHAUER, T.: The Significance of the Ferrous and Ferric Oxide in the Formation of a High-iron and a Low-iron Magnesite, *Sprechaal*, **71**, 629, 1938.
145. WHITE, H.E.: Electrically Fused Magnesia, *J. Am. Ceram. Soc.*, **21**, 216, 1938.

146. STONE, R.L.: Thermochemistry of North Carolina Olivine in the Manufacture of Forsterite Refractories, *J. Am. Ceram. Soc.*, **22**, 342, 1939.
147. COLBY, S.F.: Occurrence and Uses of Dolomite in the U.S., *U.S. Bur. Mines, Inform. Circ.* 7192, 1941.
148. FREDERICK, R.E., and R.S. SPENCER: Magnesium Hydroxide from Sea Water, U.S. Patent 2,405,055, 1943.
149. DESCH, C.H.: Magnesia from Sea Water, *J. Roy. Soc. Arts*, **91**, 273, 1943.
150. STEDMAN, G.E.: Magnesium from Sea Water, *Metals & Alloys*, **20**, 941, 1944.
151. SEIL, G.E., *et al.*: The Manufacture of Refractories and Information Concerning Their Use in the Iron and Steel Industry of Western Germany, P.B. 37804, 1946.
152. RIGBY, G.R., H.M. RICHARDSON, and F. BALL: The Mineralogical Composition of Magnesite Bricks, *Trans. Brit. Ceram. Soc.*, **44**, 313, 1947.
153. HOWIE, T.W., and J.R. LAKIN: A Note on the Application of the Differential Thermal Analysis Method to Some Basic Refractory Materials, *Trans. Brit. Ceram. Soc.*, **46**, 14, 1947.
154. ANON.: Magnesite from Dolomite: The Pike Process, *Brick & Clay Record*, **112**, 82, 1948.

Chrome:

155. McDOWELL, J.S., and H.S. ROBERTSON: Chrome Refractories, *J. Am. Ceram. Soc.*, **5**, 865, 1922.
156. ANON.: Chromite from Rhodesia, *Eng. Mining J.*, **123**, 332, 1927.
157. ANON.: Chromite in Turkey, *Refractories J.*, **4**, 69, 1928.
158. MUSGRAVE, J.: Chrome Mining in Southern Rhodesia, *Bull. Inst. Mining Met.*, **410**, 1, 1938.
159. LYNAM, T.R., and W.J. REES: Chrome Ores as Used in the Refractories Industry, *Trans. Ceram. Soc. (Engl.)*, **38**, 211, 1939.
160. SEIL, G.E.: Petrography and Heat Treatment of Chromite Refractories, *Penn. State Coll. Bull.* 14, 1939.
161. ANON.: Turkish Chrome, *Chem. Age*, **48**, 98, 1943.
162. RYNEARSON, G.A., and F.G. WELLS: Geology of the Grey Eagle and Some Nearby Deposits in Glenn Ct. Cal., *U.S. Geol. Survey Bull.* 945A, 1944.
163. SMITH, C.T., and A.B. GRIGGS: Chromite Deposits Near San Luis Obispo, San Luis Obispo Ct., Cal., *U.S. Geol. Survey Bull.* 945B, 1944.
164. RART, J.R.: X-ray Investigation into the Constitution of Chrome Ores, *Iron & Steel Inst., Special Rept.* 32, p. 175, 1946.
165. DODD, A.E., and A.T. GREEN: The Genesis of Chrome Ores, *Iron & Steel Inst., Special Rept.* 32, p. 43, 1946.
166. HUGILL, W., and A.T. GREEN: Constitution of Chrome Ores, I, Composition and Properties of the Chromite Grains, *Iron & Steel Inst. Special Rept.* 32, p. 31, 1946.

Less Common Refractory Oxides:

167. SANDERSON, L.: Zirconium and Its Uses, *Sands, Clays Minerals*, **2**, 47, 1935.
168. CHUDOBA, K., and M.V. STACKELBERG: Density and Structure of Zircon, *Z. Kryst.*, **95**, 230, 1936.
169. MEYER, H.C.: Zircon, *Ceram. Age*, **28**, 7, 1936.
170. PIRUMOV, G.: Zircon Raw Materials for the Refractory Industry, *Ogneupory*, **5**, 134, 1937.

171. KINZIE, C.J., and D.S. HAKE (Titanium Alloy Mfg. Co.): Preparation of a Zirconium Oxycarbide and Silicon Carbide, U.S. Patent 2,110,733, Mar. 8, 1938.
172. LUKS, D.W.: The Uses of Beryl in Ceramics, *Ceram. Ind.*, **30**, 50, 1938.
173. MORGAN, J.D. (Power Patents Co.): Zirconia Zircon Silicon Refractory, U.S. Patent 2,779,982, Nov. 14, 1939.
174. POOLE, W.R.: Zircon Refractories, *Chem. Eng. Mining Rev.*, **31**, 250, 1939.
175. WHITE, H.E., and R.M. SHREMP: Beryllium Oxide: I, *J. Am. Ceram. Soc.*, **22**, 185, 1939.
176. BLISS, L.G.: Beryl: A Case History, *Bull. Am. Ceram. Soc.*, **19**, 159, 1940.
177. KREIDL, N.J.: Rare Earths, *J. Am. Ceram. Soc.*, **25**, 141, 1942.
178. ANON.: Beryllium, *War Met. Comm., Inform. Rel.* 3, 1943.
179. PANNELL, J.H.: Factors Influencing the Distribution of the Elements, *Am. Mineralog.*, **28**, 605, 1943.
180. TOMKEREFF, S.I.: Geochemistry of Uranium, *Science Progress*, **136**, 696, 1946.
181. MOTOCK, A.T.: Extraction and Uses of Beryllium in Germany, *U.S. Bur. Mines, Inform. Circ.* 7357, 1946.

Graphite:

182. LANGRAEBER, W.: German Graphite: Importance and Mining, *Centr. Hütten u. Walzwerke*, **30**, 369, 1926.
183. SPENCE, H.S.: Graphite in Ontario and Quebec, Canadian Department of Mines, Mines Branch, No. 687, Investigation of Mineral Resources and the Mining Industry, pp. 8-11, 1926.
184. BRUMELL, H.P.H.: Canadian Crystalline Graphite, *Eng. Mining J.*, **124**, 494, 1927.
185. PETRASCHECK, W.: Austrian Graphite and Its Sources, *Eng. Mining J.*, **124**, 568, 1927.
186. KAY, H.N.: Industrial Graphite, *Chem. Trade J.*, **82**, 217, 1928.
187. KAUSCH, O.: Graphite, *Monographs Kohle-Koks-Teer*, **24**, 224, W. Knapp, Halle, 1930.
188. SAUFFRIGNON, RENÉ: Graphite, *Mines, carrières, grandes entreprises*, Paris, 1933.
189. STONE, R.H.: Graphite as a Refractory, *J. Am. Ceram. Soc.*, **16**, 96, 1933.
190. RICHARDS, G.G.: Graphite, *Am. Inst. Mining Met. Engrs., Tech. Pub.* 1909, 1945.

General:

191. DANA, J.D.: "System of Mineralogy," John Wiley & Sons, Inc., New York, 1898.
192. RIES, H.: "Clays, Their Occurrence, Properties and Uses," John Wiley & Sons, Inc., New York, 1914.
193. BLEININGER, A.V., and H.G. SCHURECHT: Properties of Some European Plastic Fire Clays, *Natl. Bur. Standards, Tech. Paper* 79, 1916.
194. SEARLE, A.B.: "The Chemistry and Physics of Clays and Other Ceramic Materials," D. Van Nostrand Company, Inc., New York, 1924.
195. JONES, W.R.D.: The Refractory Materials of South Wales, *Brit. Clayworker*, **36**, 55, 1927.
196. HARDERS, F.: Raw Materials Supply for the German Refractories Industry, *Stahl u. Eisen*, **57**, 1127, 1937.
197. Committee on Geological Surveys, *Bull. Am. Ceram. Soc.*, **24**, 234, 1945.

CHAPTER V

THE MINING AND PRELIMINARY TREATMENT OF REFRACTORY MATERIALS

1. **Mining of Clays.** *Open-pit Methods.* Many refractory clays are mined by open-pit methods. Usually the bed of clay is covered by an overburden of gravel or earth, which may run as thick as 10 to 20 ft. If

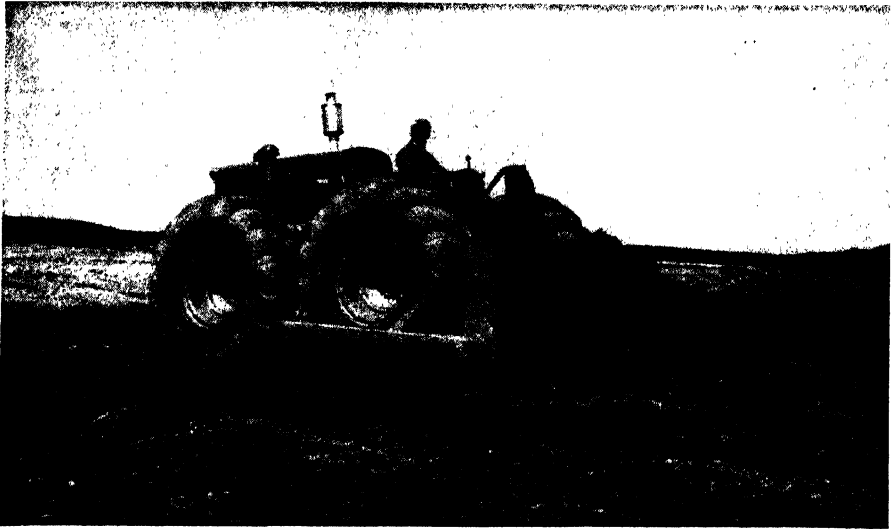

FIG. 21. A rubber-tired bulldozer for clay stripping. (Courtesy of the Le Tourneau Company.)

the thickness of overburden is much greater than 20 ft, it is seldom economical to mine a low-cost clay by this method.

The first process consists in stripping off the overburden in the most economical manner. In small workings where the overburden is thin, this was done by horse-drawn scrapers; but in larger operations, the overburden is stripped by power shovels, tractor-pulled wheel scrapers, bulldozers, or shovel dozers. In other workings, it is found economical to strip the overburden with dragline scrapers with a capacity of $\frac{1}{3}$ to 4 cu yd. This type of scraper is very flexible and can be made to cover a large area by using a movable cable anchor. Lines as long as 500 ft are used; and with a 1 cu yd bucket, 20 to 75 cu yd per hr can be moved, depending upon the length of the haul. A modern bulldozer for stripping

the overburden from a kaolin deposit is shown in Fig. 21, and in Fig. 22 is shown a self-powered scraper of large capacity.

The method of removing the clay itself varies with the conditions. If the clay is fairly soft, the face can be broken with picks or bars and the broken material loaded by hand into carts or cars. In the larger plants, however, this method is not economical, and power shovels are generally used. The shovel capacity varies from $\frac{1}{2}$ to 2 cu yd. The larger shovels are chosen not only for their greater capacity but also for their greater strength and longer reach. Caterpillar treads are almost universally used. A 1 cu yd shovel will load, under good conditions, 500 tons of clay in an 8-hr day. Recently, lighter and more agile shovels are being favored.

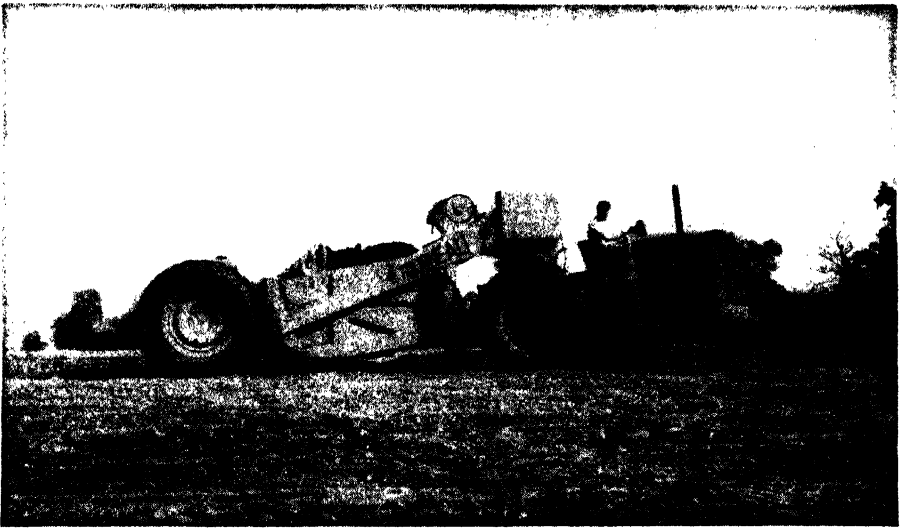

FIG. 22. A self-powered scraper for stripping clay. (Courtesy of the Le Tourneau Company.)

The softer clays can be taken out with dragline scrapers or bucket excavators. Often wheel scrapers are used, as shown in Fig. 23.

Provided the clay is not too hard and yet is firm enough to hold a permanent face, as in the case of many shales, it has been found economical to remove the materials by a planer, which is an endless chain with cutting knives working vertically on the whole face as shown in Fig. 24. This machine has the advantage of removing the material in small pieces and of giving a good average composition by taking the material from the whole face. The cost of removing the material with a machine of this type is comparatively low, as one man can usually operate it and obtain a production of 200 to 400 tons a day.

In Europe, the endless-chain excavator working from the top of the bank is often used. Although the initial investment is large, the low



FIG. 23. Mining clay with a Caterpillar tractor and scraper. (Courtesy of the Allis-Chalmers Manufacturing Company.)

labor and maintenance cost justifies it on large operations. One man can remove 100 tons per hr with an average-sized machine.

In the case of hard clay, it is generally necessary to drill and blast the face in order to obtain small enough pieces to be readily handled. The



FIG. 24. Removing kaolin with a shale planer made by the Eagle Iron Works at the Georgia Kaolin Company. (Courtesy of the Georgia Kaolin Company.)

drilling is done in the smaller pits with hand drills of 1 to 1½ in. in diameter. In the larger mines, however, electric and air drills are used. Recently, portable well drills have been used to a considerable extent to drill deep holes behind the working face so that larger and deeper charges of explosives can be set off. These drills will produce holes from 3 to 5½ in. in diameter, which will allow the use of a considerable quantity of explosive.

When the clay has been loosened from the face, it is loaded into cars or trucks by hand or power shovels as shown in Fig. 25.

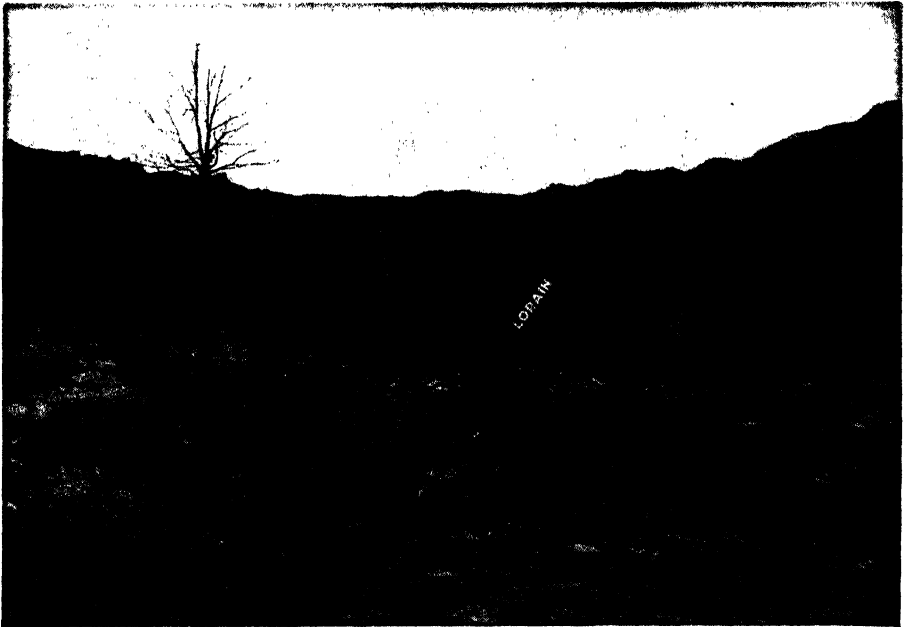

FIG. 25. Mining with a power shovel. (Courtesy of The Thew Shovel Company.)

Underground Methods. When the clay deposit is too deep for stripping, underground mining is used. Most of the productive clay veins are from 5 to 15 ft thick. The room-and-pillar method is generally used, with advance from the entrance, which consists of cutting a mine entry and advancing galleries from that out to the edge of the property. This method has the advantage of not requiring extensive entry development when the mine is started, but it is not so economical as the retreating method, which consists of cutting an entry to the boundary line and then starting the galleries at the farther end. Work is then carried toward the entrance. The pillars can be drawn only where the subsidence of the ground is unimportant. Whenever underground mining is used, it is

important to plan out the workings carefully and have a systematic method before starting to mine.

Practically all underground clay is taken out by drilling and blasting. Hand, electric, or pneumatic drills are used, and the lumps of clay are loaded on the car by hand or, in more modern mines, by car loaders.

The same factors of economical mining apply to clay mines as to other mines. In the first place, drainage must be well cared for, as muddy



FIG. 26. A tractor loader filling a dump car. (Courtesy of the Oliver Tractor Company.)

floors and tracks increase the haulage costs as well as make the timbering difficult. Next, the timbering should be well done with generous posts. The tracks should also be graded and kept in good condition, as the haulage cost mounts up when dirty, poorly laid tracks are used.

Clay is usually transferred to the plant on rails with dump cars ranging in capacity from $\frac{1}{2}$ to 6 cu yd (Fig. 26). The cars are propelled by steam, oil, or gasoline locomotives or sometimes by cable haulage. In a few cases where the distance from the mines to the plant is considerable and the country is rough, it has been found economical to transfer the clay by aerial cableways. Trucks are coming into more general use than formerly.

It is hard to give any definite figures on the cost of mining clay; but in

general, clay can be loaded on cars or trucks from the open pit under the best conditions for 50 cents a ton. Where the overburden is heavy or where hand selection is used, the cost may run as high as \$1 per ton at the plant. In the case of special high-grade clays, the cost may run even higher. It may be said, however, that a great number of plants are getting out their refractory clays for around 50 cents per ton. In underground mining, the cost varies according to the thickness of the vein, the hardness of the clay, the amount of timbering required, and the distance to the plant—the variation in most cases being from \$1.50 to \$2.50 per ton on



FIG. 27. Mining ganister rock. (Courtesy of the Harbison-Walker Refractories Company.)

cars. It may be mentioned that in many of the underground clay mines, coal is obtained at the same time as clay, which, of course, reduces the total cost considerably.

2. The Mining of Ganister. Since the mining of ganister is rather different from clay mining, it will be described separately. The ganister is usually found in flows of loose rock on the mountain sides (Fig. 27). Where the rocks are large, they are broken up by mud capping and blasting; in only a few cases is drilling necessary. The smaller rocks are broken up by sledges into sizes that can be lifted by hand. The broken rock is loaded into dump cars by hand, as some sorting is necessary. One man will load from 15 to 20 tons of rock a day.

The dump cars are trammed either by hand or by locomotive, as the case may be, to a gravity plane and dumped into cars to be lowered down

the plane. In a few cases, ganister is carried long distances by railroad to reach the plant.

In some localities, the ganister is obtained from bedrock, because the flows have been used up or because the rock is more uniform. The ledge rock, however, is usually not thought to be so satisfactory as the flow rock, because the soluble constituents have not been leached out by weathering. Others claim that bedrock gives superior bricks. Regular quarrying methods are used in removing this rock from the hillside. This material will cost 75 cents to \$1.50 a ton on cars.

3. Crushing and Grinding. Practically all clay must be crushed before it is taken to the tempering and brickmaking machinery. The

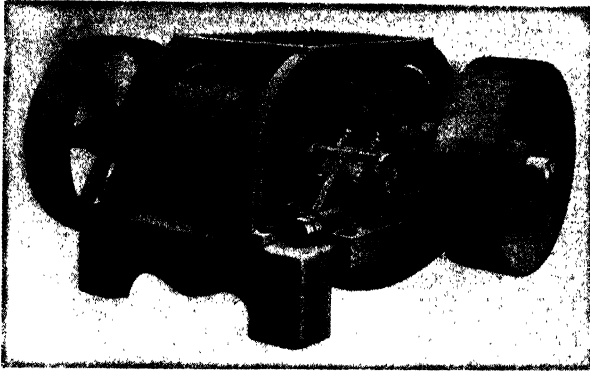

FIG. 28. A roll crusher. (Courtesy of the W. A. Riddell Corporation.)

softer lump clays are usually passed through single or double roll crushers, which rapidly break down the lumps to sizes small enough for wet pans or pug mills. The wear and tear on rolls of this type is very small, so the cost of breaking up the softer types of clays is not great.

Jaw or gyratory crushers are usually used for the harder clays, rocks, and grog. They will crush down to 1 in. with capacities of $\frac{1}{2}$ to 500 tons an hour. These crushers cannot be used for the softer clays containing moisture because of packing in the jaws.

Roll crushers (Fig. 28) are used for crushing hard materials from 1 in. down to $\frac{1}{4}$ or $\frac{1}{8}$ in. For materials like grog, the rolls should be supplied with tires of manganese steel, as the wear is considerable. In order to obtain fine grinding, it is necessary to keep the rolls fairly true cylinders, as flanges tend to form on the ends and the material will be passed through the center uncrushed. Plain rolls should never be used for crushing clays with any moisture, because the material builds up on the rolls and there will be no crushing action.

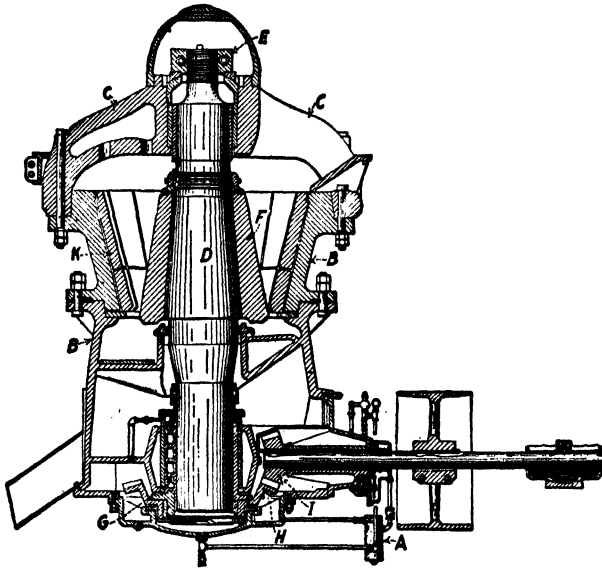

FIG. 29. Sectional view of a gyratory crusher. (From C. E. Locke.)

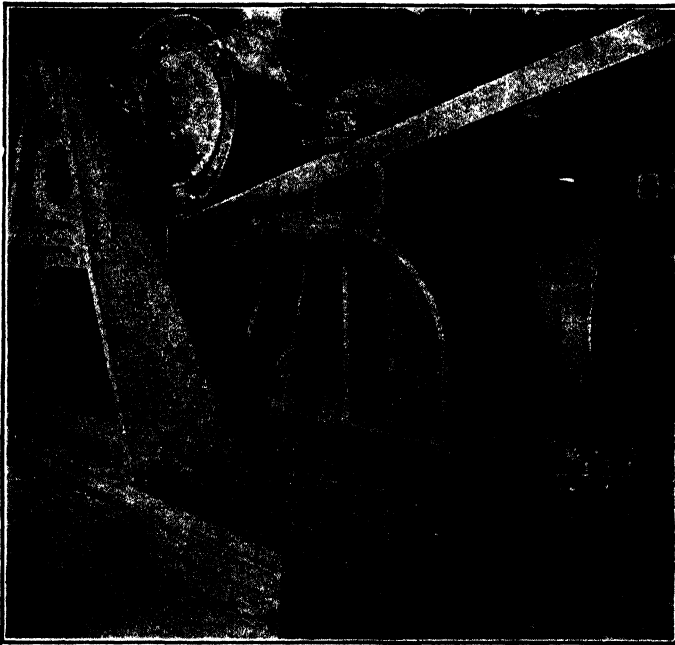

FIG. 30. A dry pan for crushing flint clay. (Courtesy of Clearfield Machine Company.)

Gyratory crushers (Fig. 29) are often used for crushing magnesite and ganister. These crushers have a large capacity but will not take such large rocks as jaw crushers.

Dry pans (Fig. 30) consist of a heavy revolving bed in a horizontal position on which the material is fed; two heavy rolls (mullers) rest on this bed with their own weight, crushing the material underneath. The portion of the bed not directly under the mullers is usually supplied with screens or slits so that crushed material can pass through, permitting con-

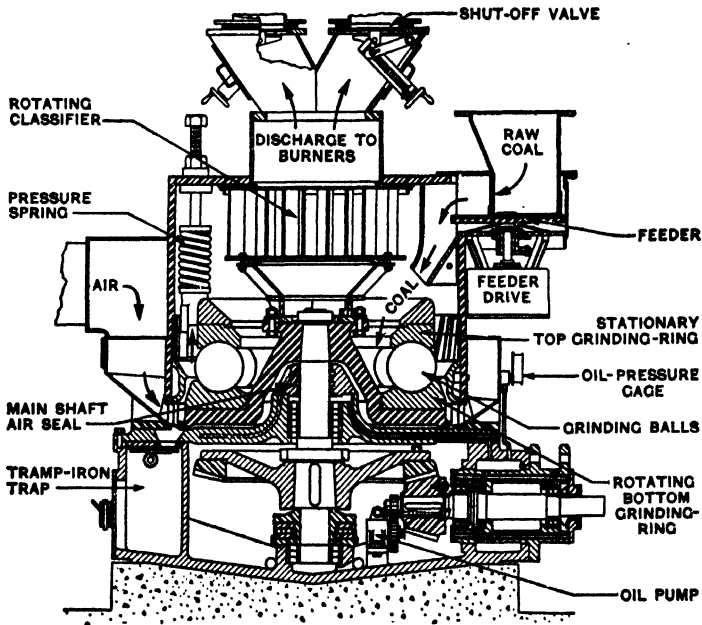

Fig. 31. Babcock and Wilcox pulverizer. (Courtesy of Babcock and Wilcox Company.)

tinuous operation. The dry pan is used for grinding flint clay, ganister, and burned grog. Wet pans are similar machines with a solid bottom so that the mix can be ground wet.

For finer grinding, it is often desirable to use crushers of the B and W, ring-roll, or hammer-mill type, as shown in Figs. 31, 32, and 33. Machines of these types will pulverize down to 100 or 150 mesh and can be used for clays with some degree of moisture.

Ball mills are much used for fine grinding. For large production, the continuous type of mill should be selected. The fine material is removed with an air separator, and the oversize is automatically returned to the mill. A production of several tons per hour of 200-mesh material can be obtained with this type of installation. Even when coarser material is

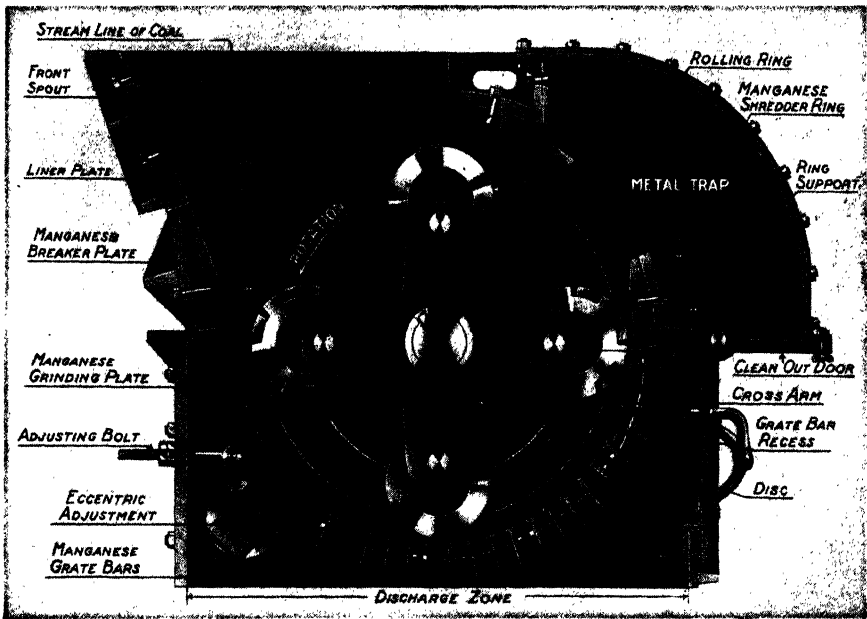

FIG. 32. Cross section of a ring roll crusher. (Courtesy of the American Pulverizer Company.)

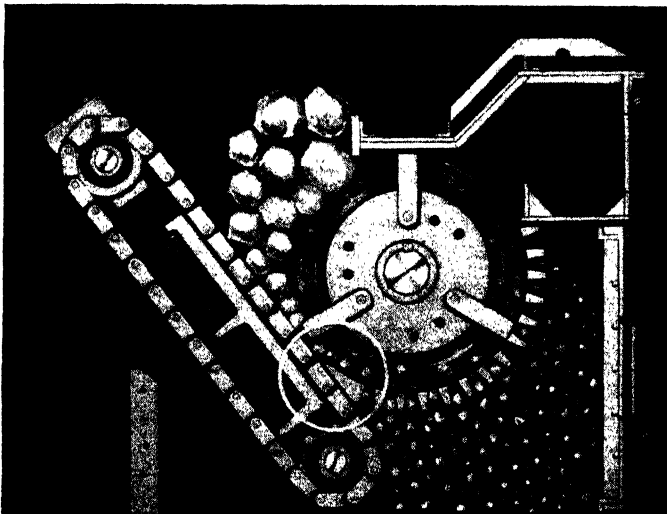

FIG. 33. Cross section of a hammer mill for fine grinding. (Courtesy of Dixie Hammermill Manufacturing Company.)

required, the continuous ball mill is often found suitable. In Fig. 34 is shown a typical closed-circuit, ball-mill installation for continuous grinding. The capacities of some ball mills are shown in Table 20. An interesting development in Germany⁽⁸⁴⁾ described by Dr. Ryschkewitsch is the

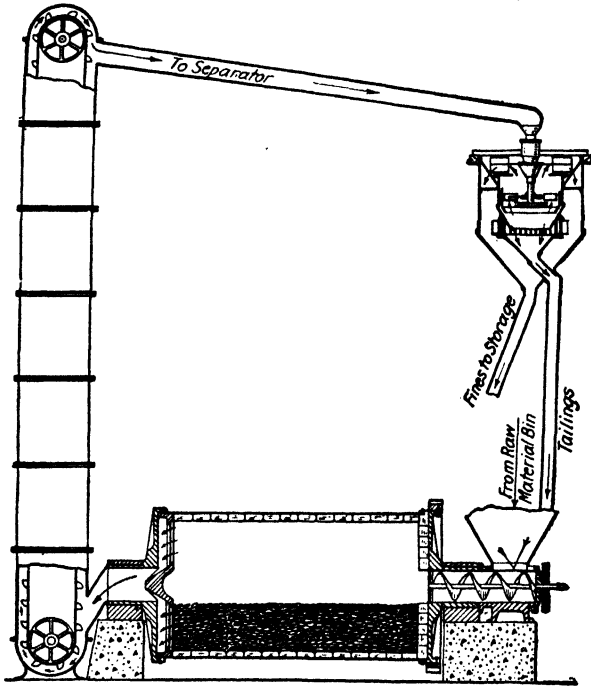

FIG. 34. Cross section of a continuous ball mill. (Courtesy of Patterson Foundry and Machine Company.)

vibrating ball mill. Here there is no rotation but a vibration of five per second, which causes the balls to flow around in a continuous motion. It is claimed that a $2\ \mu$ size can be reached by this method in the same time that $12\ \mu$ can be reached by conventional grinding.

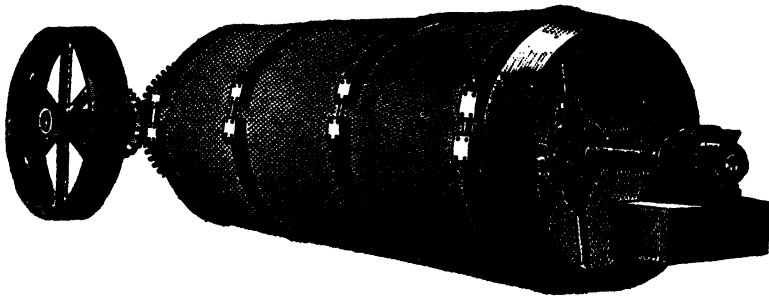

FIG. 35. A revolving screen for classifying coarse material. (Courtesy of Gruendler Rock and Gravel Crushing Equipment Company.)

4. Screening. It is usually necessary to screen the materials being crushed so that the required product can be passed on to the brickmaking machinery and the coarser material returned to the crushers. Various types of screens are used. A revolving screen or trommel is often used for classifying coarser materials (Fig. 35), and screens of several sizes can be

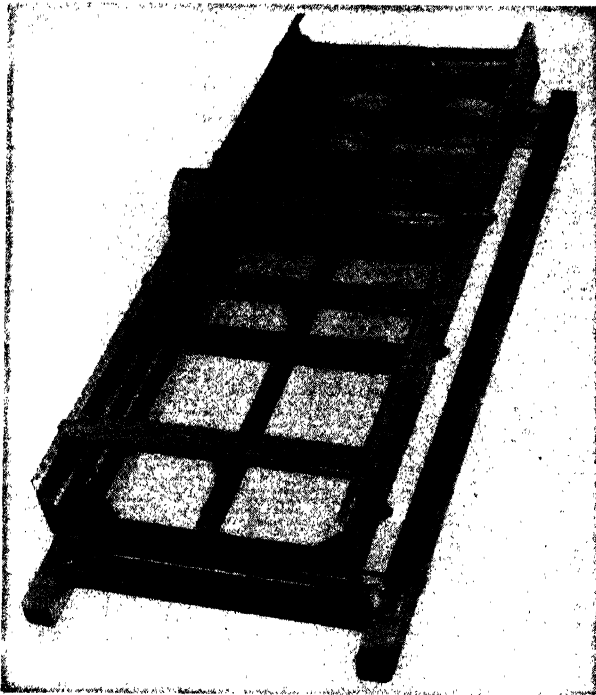

FIG. 36. An open-type shaking screen. (Courtesy of the Universal Vibrating Screen Company.)

TABLE 20
(From G. F. Metz)

| Material | Size and type | Tons per hour | Circuit | Horse-power | Size of feed | Fineness of product | Pebble load, lb. |
|-------------------|-------------------------|---------------|---------|-------------|--------------|----------------------------|------------------|
| Silica (dry)..... | 7 × 22 ft. tube | 3 | Closed | 210 | -20 mesh | 98 per cent minus 200 mesh | 42,000 |
| Sillimanite..... | 3 × 2 ft. conical | ¼ | Closed | 15 | -¼-in. mesh | 80 per cent minus 100 mesh | 14,000 |
| Grog..... | 5 × 22 ft. conical | 4½ | Closed | 40 | -1½-in. mesh | 100 per cent minus 4 mesh | 6,000 |
| Feldspar..... | 7½ × 10 ft. cylindrical | 1.05 | Closed | 85 | -¾-in. mesh | 90 per cent minus 325 mesh | |

applied to the cylinder in order to obtain a product having the desired combination of sizes.

Another type of screen is the shaking screen operated by a weight (Fig. 36). Often several layers of screens of various sizes can be superimposed in order to classify a product into a number of different sizes. Closed-in screens (Fig. 37) are used with dusty materials. For screening materials below 60 mesh, it has been found desirable to use air separators rather than screens, and very satisfactory classification devices can now be obtained to produce material down to 200 mesh or even finer.

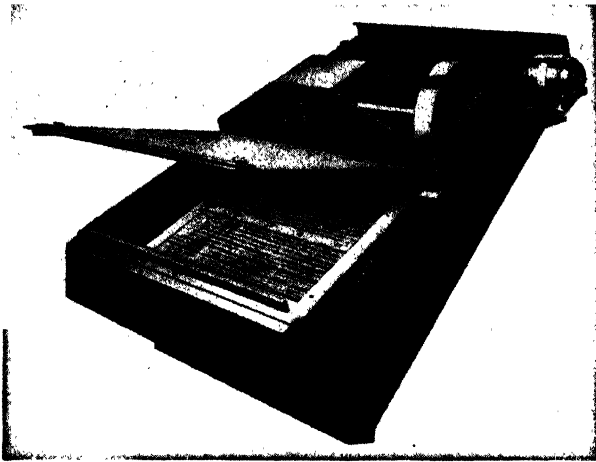

FIG. 37. A closed-type screen. (Courtesy of the Deister Concentrator Company.)

5. Mineral-dressing Methods. Many refractory raw materials can be purified by simple mineral-dressing methods. As the demand for refractories becomes more exacting and our supplies of the better raw materials less plentiful, concentration methods will be increasingly used.

Tabling. Minerals of a different specific gravity from the unwanted material with which they are mixed can often be efficiently separated by an air or water table. The raw material is ground fine enough to unlock the individual grains and then passed over an inclined vibrating table, which will give a more or less clean separation. Although this method has been used in the past mainly for the treatment of ore minerals, it has been quite successful in the concentration of kyanite from our North Carolina deposits.

Settling. Door-type thickeners and centrifuges⁽³³⁾ are used to remove coarse particles from clay slips as well as to dewater these slips.

Magnetic Separation. Powerful magnetic separators are now available that will remove all minerals containing even small amounts of iron.

These include the iron oxides, sulfides, and more complex minerals such as garnet, hornblende, and micas.

The magnetic method of purification is used quite generally with feldspars and other materials for whitewares, but it has not as yet been used extensively for refractory materials. However, there is opportunity of employing it with some refractories, such as those used in melting glass or enamel frits.

Flotation. Froth-flotation methods have been developing with such rapidity since 1920 that many separations can now be made that would have been thought impossible a generation ago. The method, in general, consists in stirring the finely crushed mineral in water with a frothing agent, which provides a multitude of fine bubbles. By selecting the proper agents, it is possible to get a selective action of the bubbles so that they adhere to certain types of particles and float them to the top of the water where they are carried off. Although considerable progress has been made with flotation methods in purification of minerals like feldspar, little has been done yet on refractory materials, but it would seem quite possible that this method would be well adapted to the concentration of chrome ores.

A little laboratory work has been done by flotation methods in removing iron minerals from fireclays, but as yet the results have not been shown to be economically feasible. Nevertheless, there is certainly promise that with further development along this line, second-grade clays can be so beneficiated that first-grade refractories can be made from them. Kellogg⁽²³⁾ describes a method of removing quartz from kaolin by flotation methods.

Electrostatic Separation. The electrostatic separator has been used to purify both feldspar and kyanite. The method consists in separating one type of mineral from another by virtue of the different attractive forces in a high-voltage field. This is a dry method and should not be particularly expensive except that the particles must be fairly fine before treatment. A patent by Weis⁽²⁰⁾ describes a method for removing quartz from kyanite.

Chemical Methods. Chemical methods can be used for the higher priced refractories. For example pure alumina refractories are produced from Al(OH) obtained from bauxite by the Bayer or other of the many processes⁽²⁷⁾ proposed for this purpose. Magnesium, with other chemicals, is being extracted from sea water⁽²⁶⁾ in considerable amounts and also is separated from dolomite. Beryllia is removed from the ore by chemical treatment^(23,24,25) to give highly pure materials. The rarer materials such as zirconia, ceria, and the rare earths are all extracted by chemical means.

6. Storage of Clay. It is usually necessary to store a certain amount of clay to provide for interruptions in mining due to cold or rainy weather or holidays. The amount of needed storage depends on the length of

shutdown in the mining operation. To provide sufficient storage for a large clay plant is rather costly, and it is unusual to store more than a few days' supply.

In many of the ceramic industries, the practice is to weather, or age, the clay supply for a considerable length of time to develop plasticity and dis-

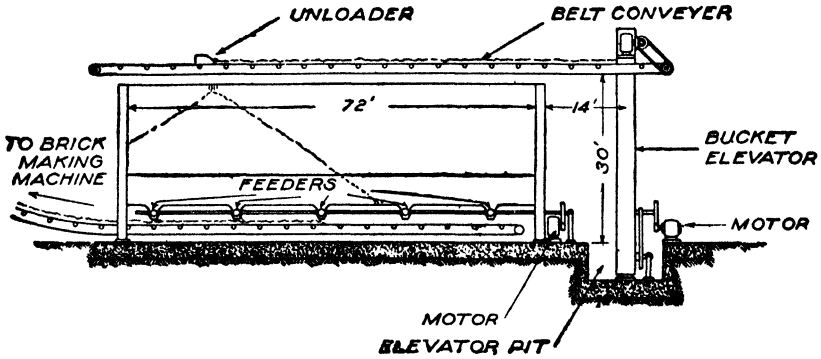

FIG. 38. A method of handling clay in storage bins.

integrate the lumps; but in the case of refractories, the amount of clay used is so large that this cannot be done economically, and only in the case of special high-grade clays can aging be resorted to.

Some of the high-grade refractory clays must be shipped a considerable distance by railroad. In these cases, it is desirable to dry the clay partially in order to reduce the shipping weight. This can be done by storing in

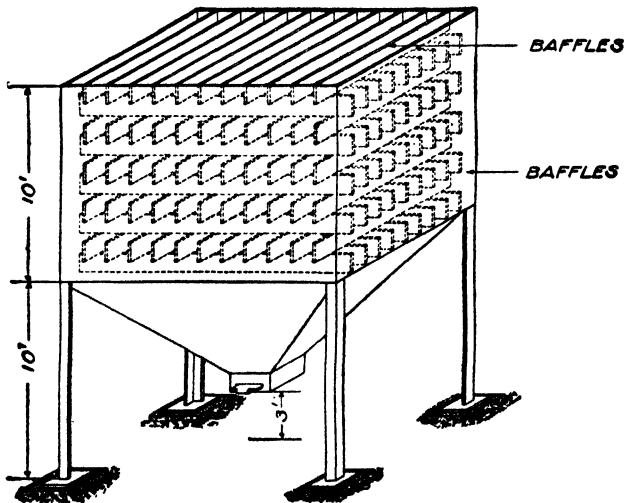

FIG. 39. Baffles for the prevention of segregation in bins.

open sheds or racks, where the moisture in good weather can be reduced to 5 or 10 per cent, or by passing it through a rotary drier.

Storage bins are made in various styles.⁽³²⁾ Some are cylindrical bins having conical bottoms; others are of a rectangular shape with a V bottom with provision for removing the clay from any portion desired (Fig. 38). The clay is usually put in the bin with a bucket elevator, but other handling methods such as grab buckets are occasionally used.

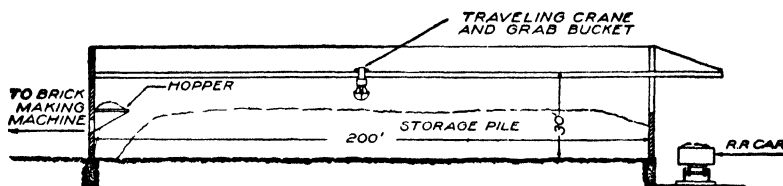

FIG. 40. An overhead crane and grab bucket for handling clay in storage.

When crushed materials such as clay or grog are to be stored, precautions must be taken to prevent segregation of the material in the bin. In nearly all manufacturing processes, it is highly desirable to have the crushed materials of a proper and uniform screen analysis. When the material from the crusher falls into the bin, the larger particles roll to the outside and the finer ones build up into a central cone. The material drawn from the bottom of the bin will contain at first mostly fine and later



FIG. 41. A modern storage system. (Courtesy of A. P. Green Fire Brick Company.)

mostly coarse material. This segregation can be minimized by a number of methods. One consists in moving the point of supply over the surface of the bin so that no cone can form. Another consists in a number of vertical vanes in the bin to prevent the heavy particles rolling to the outside of the bin (Fig. 39).

In some cases, clay is stored in open pits or on floors, from which it is handled with a locomotive crane and grab bucket, a dragline scraper, or, in more recent installations, by a tractor loader. In other cases, the clay is stored in sheds, and the handling is done by an overhead crane and grab bucket (Fig. 40). This gives a very flexible arrangement, as the clay can be dropped onto a conveyor to be taken directly to the crushing or mixing machinery. The clay-storage system of a modern refractory plant is shown in Fig. 41.

7. Bibliography

1. STRAIGHT, H.R.: Planer Economics, *J. Am. Ceram. Soc.*, **7**, 523, 1924.
2. ANON.: Handling Clay Automatically, *Ceram. Ind.*, **3**, 392, 1924.
3. LANE, F.: Notes on Grinding and Crushing Machinery, *Trans. Ceram. Soc. (Engl.)*, **24**, 310, 1924-1925.
4. GARVE, T.W.: Segregation in Bins, *J. Am. Ceram. Soc.*, **8**, 666, 1925.
5. WEBER, R.: Automatic Machinery and Equipment for a Firebrick Plant, *Feuerfest*, **1**, 57, 1925.
6. HULL, W.A.: An Attempt to Secure a Uniform Mixture of Fine and Coarse Particles in Grog from a Bin, *J. Am. Ceram. Soc.*, **9**, 477, 1926.
7. HEARING, R.H., and C.F. TEFFT: Items Requiring Consideration in Underground Clay Mining, *J. Am. Ceram. Soc.*, **10**, 919, 1927.
8. LOVEJOY, E.: Valuation of Clay Properties, *Clay-worker*, **87**, 135, 1927.
9. ANON.: Quarrying Bauxite in Arkansas, *Rock Products*, **30**, 49, 1927.
10. NOLD, H.E.: A Study of Underground Clay Mining, *J. Am. Ceram. Soc.*, **11**, 157, 1928.
11. OTSTOT, E.D.: Practical Mining Principles Which Are Frequently Overlooked, *J. Am. Ceram. Soc.*, **11**, 169, 1928.
12. COALE, C.H.: Blasting Practices in Clay Mines, *J. Am. Ceram. Soc.*, **11**, 173, 1928.
13. BALES, C.E.: Segregation in Storage Bins, *Am. Refractories Inst., Tech. Bull.* **20**, 1928.
14. THOENEN, J.R.: Mining Grecian Magnesite, *Eng. Mining J.*, **125**, 644, 1928.
15. TUPPER, O.M.: Impact Mills for Grinding Fire Clay, *Mining Met.*, **10**, 445, 1929.
16. SMITH, R. PERCIVAL, and A. MCKENDRICK: Sideliights on Refractories, *Trans. Ceram. Soc. (Engl.)*, **32**, 167, 1933.
17. MULLER, R.: On the Grinding Behavior of Ceramic Bodies in Wet Cylinder Grinding, *Sprechsaal*, **68**, 613, 627, 1935.
18. MILLER, W.T.W., and R.J. SARJANT: The Evolution of Various Types of Crushers for Stone and Ore, and the Characteristics of Rocks as Affecting Abrasion in Crushing Machinery, *Trans. Ceram. Soc. (Engl.)*, **35**, 492, 1936.
19. DEAN, R.S.: Recent Advances in Crushing and Grinding, *Bull. Am. Ceram. Soc.*, **16**, 9, 1937.
20. WEIS, J.H. (Feldspathic Research Corp.): Producing Kyanite, U.S. Patent 2,094,440, 1937.

21. COGHILL, W.H., and F.D. DEVANEY: Particle-size Reduction and Separation, *Trans. Am. Inst. Chem. Engrs.*, **34**, 113, 1938.
22. EVERHART, J.O.: Some Special Wear-resisting Materials for Clay Machinery Parts, *J. Am. Ceram. Soc.*, **21**, 69, 1938.
23. ANON. (Seri Holding Society): Cyclic Production of Beryllium Oxide, French Patent 833,418, Oct. 21, 1938.
24. JAEGER, BUSTAV, and ALBERT WILLE (Deutsche Gold- und Silberscheideanstalt vorm. Roessler): Decomposing Beryllium Minerals, Particularly Beryl, U.S. Patent 2,160,547, 1939.
25. WINDECKER, R.E.: Making Beryllium Oxide, U.S. Patent 2,148,520, Feb. 28, 1939.
26. STEDMAN, G.E.: Magnesium from Sea Water, *Metals & Alloys*, **20**, 941, 1944.
27. GROM, R.E., J.S. MACKIN, and W.F. BRADLEY: *Ill. State Geol. Survey, Alumina Extraction Bull.* 69, 1945.
28. KELLOGG, H.H.: *Am. Inst. Mining Met. Engrs., Tech. Pub.* 1753, 1945.
29. BROWN, D.P., and R. HESS, JR.: Screening Efficiency of a Dry-pan Grinding System, *J. Am. Ceram. Soc.*, **29**, 147, 1946.
30. RUSSELL, R.N.: The Electrical and Technical Ceramic Industry of Germany, P.B. 18776, 1946.
31. MOLOCK, G.T.: Extraction and Uses of Beryllium in Germany, *U.S. Bur. Mines, Inform. Circ.* 7357, 1946.
32. KORN, A.H.: Practical Pointers in the Design of Storage Bins, *Chem. Eng.*, **53**, 100, 1946.
33. LYONS, S.C., and A.L. JOHNSON: The Continuous Centrifuge in the Mineral Industry, *Mining Tech.*, **11**, 1947.
34. RUSSELL, R., JR.: The Electrical and Technical Ceramic Industry of Germany, P.B. 18776, 1947.

CHAPTER VI

MOLDING METHODS

1. Workability of Clay. Types of Flow. Before entering into the discussion of workability of clays, it will be well to review a few definitions as adopted by the Society of Rheology.⁽³⁸⁾

Fluid: A substance that undergoes continuous deformation when subjected to any system of finite shearing stress.

Solid: A substance that undergoes permanent deformation or rupture only when subjected to a system of shearing stresses that exceed a certain minimum value.

Simple (Newtonian) Liquid: A liquid in which the rate of shear is proportional to the shearing stress (for laminar flow).

Elastico-plastic Solid (the Clay-water System): A solid that obeys the law of an elastic solid for values of the shearing stress below the critical stress corresponding to the elastic limit in shear and that deforms plastically when the shearing stress exceeds that value.

Viscosity: In a simple liquid, the constant ratio of shearing stress to rate of shear.

Plasticity: That property of a body by virtue of which it retains a fraction of its deformation after the deforming stress is zero.

Elasticity: That property of a body by virtue of which it recovers its original size and shape after deformation.

Thixotropy: That property of a body which causes a decrease in shearing stress with time at a constant rate of shear.

Rheopexy: That property of a body which permits agitation to accelerate the setting up of a gel.

Dilatancy: That property of a body which causes an increase in shearing stress with time at a constant rate of shear.

The following symbols are generally used in flow problems:

F_0 = the yield stress in shear, dynes/sq cm

F = the shearing stress, dynes/sq cm

dv/dr = the rate of shear strain, cm/sec/cm

η_s = the coefficient of apparent viscosity of a suspension (dynes, sec, cm^{-2}) ($\text{ML}^{-1}\text{T}^{-2}$) (Poise)

η_1 = the coefficient of viscosity of suspending medium

η = the basic viscosity of suspension (at infinite rate of sheer strain)

C = the volume concentration of solid in relation to total volume

V = the volume flow, cc/sec

v = the velocity of flow, cm/sec

T = the time

In considering the clay-water system it is usual to separate it into two parts: the slips of low clay content and the plastic masses of high clay content. This is done because the sticky region between is incapable of accurate measurement at present and also because this region is not used industrially, but a more fundamental reason is that different laws seem to apply to the two cases. The slips will be considered first.

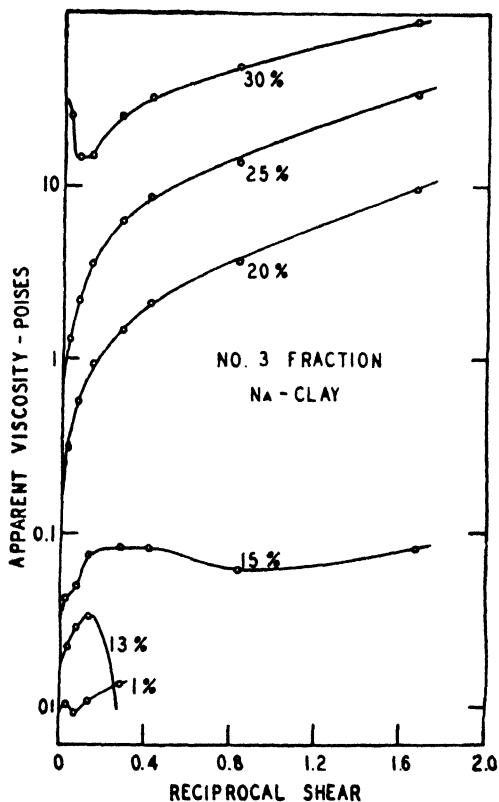

FIG. 42. Apparent viscosity of slips at different rates of shear. (*J. Am. Ceram. Soc.*)

Clay Slips. A simple liquid like water obeys the following relation in the viscous flow region:⁽⁴⁹⁾

$$\eta = k \frac{F}{v}$$

The quantity η can be measured in many ways, but the revolving cup viscosimeter, as shown in Fig. 49, is very satisfactory for ceramic work. Here the viscosity is determined by the twist of calibrated wires, and thus a wide range of values can be covered. The rate of shear can also be varied over a wide range for the measurement of thixotropy in suspensions.

The viscosity of a suspension of spherical particles seems to show no change in apparent viscosity with varying rate of shear strain, but more work needs to be done to confirm this similarity to a liquid. Suspensions of anisotropic particles, such as clay particles, show a pronounced change in apparent viscosity with change in shear strain rate as shown in Fig. 42, and the coefficient of thixotropy θ is determined from the slope A/B of the curve at infinite shear rate.

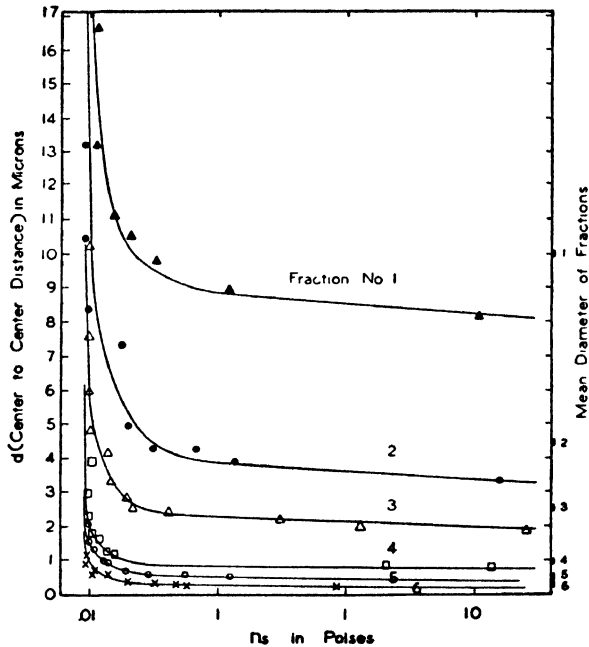

Fig. 43. Relation between viscosity and center-to-center distance of particles of six fractions containing Na kaolinite. (*J. Am. Ceram. Soc.*)

The apparent viscosity of a suspension is due to the sum of

1. The viscosity of the suspending medium
2. The energy absorbed by the individual particles revolving in the velocity gradient of the sheared fluid
3. The energy absorbed by the interference of the particles with each other

It is found that suspensions of monodisperse kaolinite⁽⁴⁹⁾ in either water or a dispersing electrolyte solution obey the following law:

$$\eta_s = (1-C)\eta_1 + k_1C + k_2C^3$$

where k_1 and k_2 are constants varying with the particle size and electrolyte in the suspending medium. The first and second terms predominate at low values of C , while the last term increases rapidly at higher concentra-

tions where the particles interfere. In Fig. 43 is shown the apparent viscosity of several deflocculated (Na-kaolinite) monodisperse suspensions on a basis of center-to-center distance of the particles, and it is clearly evident that as each fraction reaches a concentration such that the center to center distance is equal to the mean diameter of the particle, the viscosity increases rapidly. As a visual guide to the suspension, there are shown to scale in Figs. 44 and 45 two suspensions represented in Fig. 43.

The thixotropy of a suspension is given by

$$\theta = k_3C + k_4C^3$$

In the monodisperse kaolinite fractions, the value of θ is eighteen times the value of the corresponding viscosity. The units of viscosity divided

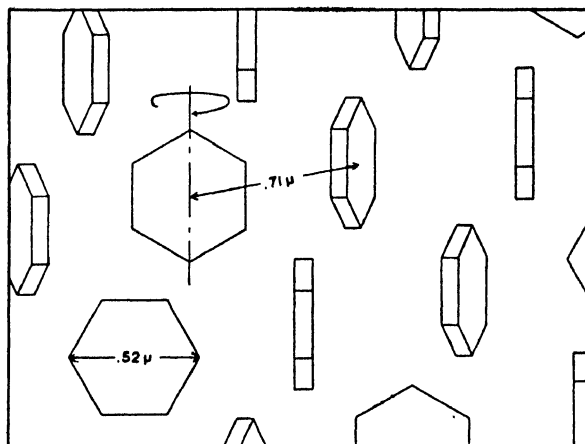

FIG. 44. Cross section of particles of No. 5 fraction containing Na Kaolinite at a viscosity of 0.017 poise and a volume concentration of 0.05 solid. (*J. Am. Ceram. Soc.*)

by the units of thixotropy give T^{-1} , or in this case $T = 0.05$ sec, which probably corresponds to the gelation interval. As yet no completely satisfactory explanation of the mechanism of thixotropy has been advanced, but it is probably due to a scaffold structure formed by the anisotropic particles.

The yield point of suspensions in water (H-kaolinite) may be shown to follow

$$F_0 = k_5C^3$$

over a wide range of concentration, k_5 varying with particle size. Well-deflocculated suspensions (Na-kaolinite), even in high concentration, show no measurable yield point.⁽⁴⁹⁾

Figure 46 shows the influence of particle size and amount of ions added to a slip of constant solid content. The various-size fractions were

separated from a kaolin with a centrifuge and cleaned. Then definite amounts of sodium hydroxide were added in milliequivalents per 100 g of dry clay. The enormous and sudden reduction in apparent coefficient of viscosity on adding sodium hydroxide is evident in all cases. This is the principle of deflocculation, which permits fluid slips with low water content. The exact mechanism of deflocculation is not clearly understood at present, but it is believed that free OH ions over and above those absorbed on the clay are required to lower the particle charge and thus minimize the attraction forces between the particles, as discussed by Johnson and Norton.⁽⁷⁸⁾ These OH ions can be produced by the ionization of bases like NaOH or by the hydrolysis of salts like Na_2SiO_3 . The positive ion accom-

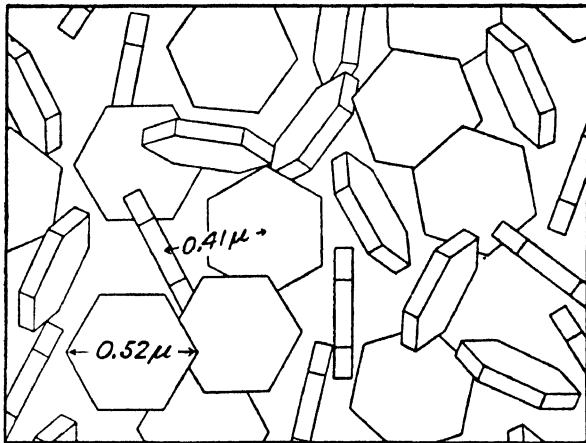

FIG. 45. Cross section of particles of No. 5 fraction containing Na kaolinite at a viscosity of 3 poises and a volume concentration of 0.28 solid. (*J. Am. Ceram. Soc.*)

panying the OH ion must be monovalent; therefore calcium or magnesium salts will not deflocculate. Some of the recent work in colloidal chemistry⁽³⁴⁾ would indicate that the suspended particles are in equilibrium between a repulsion and attractive force and that this equilibrium is varied by added ions. Other factors such as organic matter⁽³⁶⁾ and particle shape⁽³⁴⁾ are undoubtedly important, but at present there is not enough information on which to base any conclusions.

Plastic Masses. Turning now to the plastic masses with a high enough yield point to resist gravity forces, it is well to consider some fundamental principles. In general, the three-component system, clay-water-air, may be expressed in the somewhat conventionalized volume diagram for a low molding pressure shown in Fig. 47. Such a diagram is made up by thoroughly mixing and kneading clay and water batches of successively increasing water content and molding each in a cylindrical

steel die at the given pressure. Provision is made for the escape of excess water. The wet and dry volume and the wet and dry weight will readily allow the volumes of air, water, and clay to be computed, provided the specific gravity of the clay is known.

As the amount of water is increased, the total volume of the mix, which originally consisted of clay and air, shows little change as the pores become filled. At the critical point, all the voids in the clay are filled with

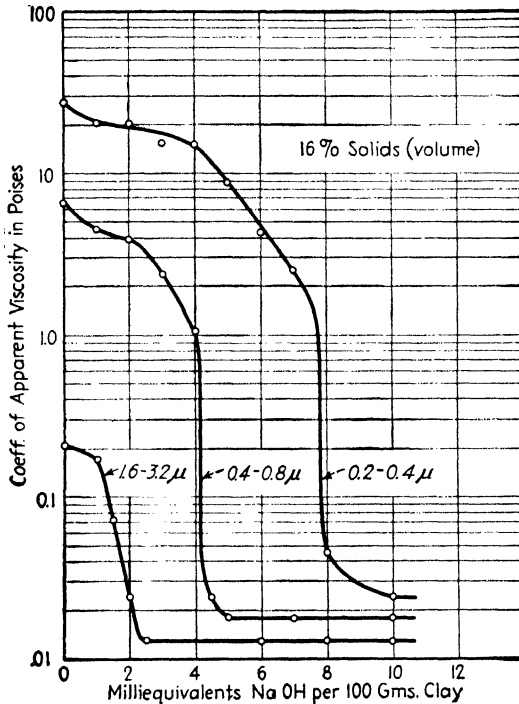

FIG. 46. Viscosity of kaolin slips.

water and the air phase vanishes. As the water is increased still further, the particles are separated by a film of increasing thickness until the maximum for stability is reached at that pressure. This may be termed the "saturation point." If more water than this was originally in the clay, it will be squeezed out in permeable pressing.

The critical point is a very important one, as above this point the mass shrinks on drying owing to the removal of the water films, as discussed in Chap. VII. The thicker and more numerous the films per unit length of clay specimen the greater the shrinkage. Below the critical point, there is little or no drying shrinkage. The critical point also is the dividing point between the consistency of a damp powder and a homogeneous plastic mass.

At a higher molding pressure such as would be obtained in a dry press, for example, the diagram would appear as shown in *a*, Fig. 47. Both the critical and saturation points are moved to low values of water content.

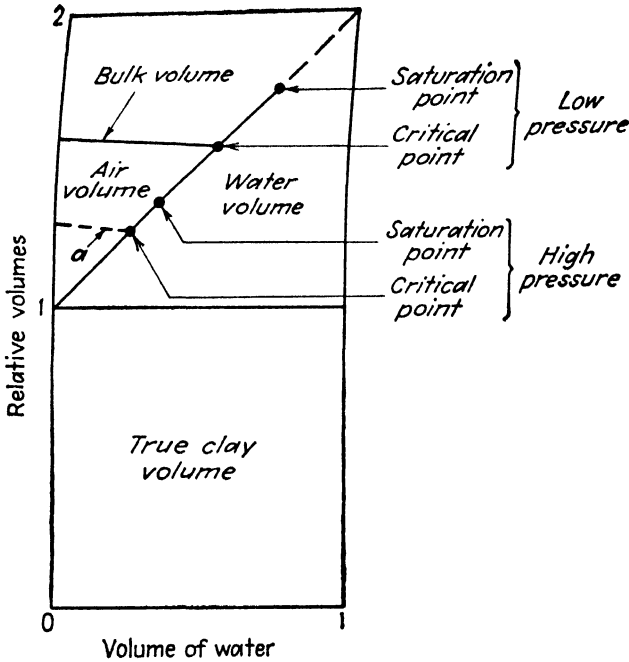

FIG. 47. The clay-water-air system.

There are often slight exceptions to the simplified diagrams shown here. For example, the total volume sometimes decreases slightly as

water is added up to the critical point, for the water acts as a lubricant and allows closer packing. On the other hand, if the clay contains bentonite, the particles of which swell in water, drying shrinkage may occur below the critical point.

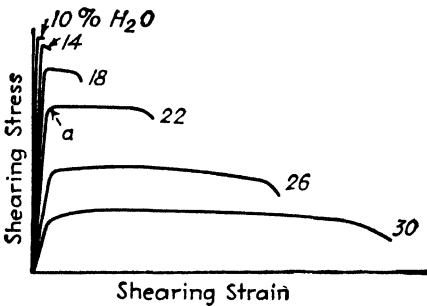

FIG. 48. Flow properties of a plastic body.

The flow characteristics of plastic masses are shown in Fig. 48 for various water contents.^(30,40,48) The flow is elasto-plastic; and as the

water increases, the yield point becomes lower while the maximum strain becomes greater.

Measurement of Workability. The consistency of slips is best measured in a concentric cylinder viscosimeter, such as that developed by Mac-

Michael. A modified instrument is shown in Fig. 49. In this instrument, an outer cup, which can be revolved on a vertical axis at various speeds, holds the slip. An inner cylinder is suspended coaxially with the outer cup on a torsion wire that measures the torque. By suitable calibration with standard sucrose solutions, the dial on the wire can be made to read the apparent viscosity coefficient of the slip in poises. In the case of slips, we have only to measure the apparent viscosity coefficient at various rates of shear to obtain all the desired rheological properties.

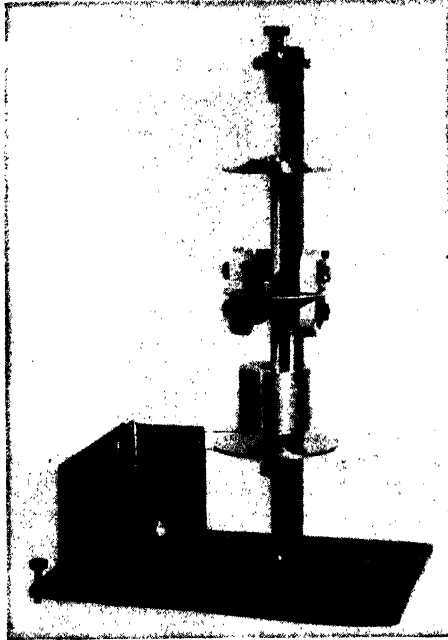

FIG. 49. Modified MacMichael-type viscosimeter.

In the case of plastic masses, not only the deforming force is required but also the maximum deformation at fracture. The most useful method for evaluating the workability factor is to twist a hollow cylinder and obtain the stress-strain diagram in pure shear. A satisfactory machine for accomplishing this, which was developed some time ago in the Ceramic Laboratory at the Massachusetts Institute of Technology,⁽⁴⁰⁾ is shown in Fig. 50.

The specimen *B*, with its brass end pieces, is clamped in the torsion head *C* by means of a wedge, as shown more clearly in the detailed sketch. This offers a simple and secure locking device, which prevents any backlash during the test. The torsion head is rotated by the motor *D* through the reduction gear *E*, the flexible couplings *F*, and the gears *G*. The motor

and reduction unit are mounted on spring suspensions *H* to prevent any vibration from being transmitted to the remainder of the apparatus. This drive gives a constant speed with sufficient power for any of the tests with plastic materials. The speed of the motor can be altered by the voltage

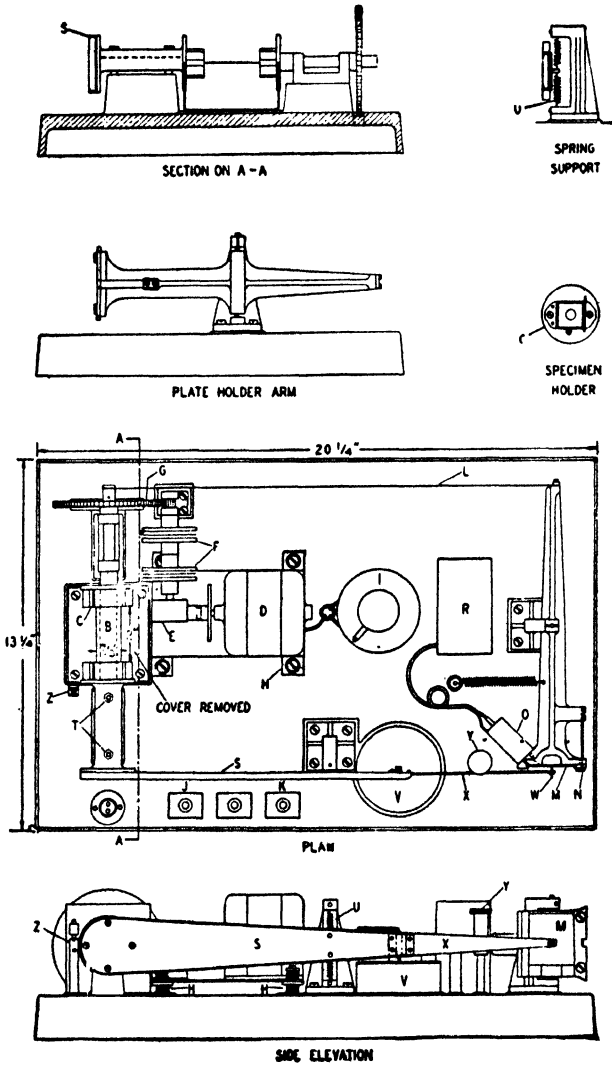

Fig. 50. Apparatus for measuring workability. (Am. Ceram. Soc.)

regulator *I*, and its direction is reversed by switches *J* and *K*, which independently control the separate field coils. In addition, the speed can be changed by various sets of gears at *G*.

The angle of rotation of the specimen is recorded by the steel tape *L*,

one end of which is wound around a drum on the torque shaft and the other attached to the plate-holder arm so that the angular rotation is proportional to the movement of the smoked plate *M*. This plate is held in a spring clip *N* and is illuminated from the back by the light *O* supplied by the 6-volt transformer *R*. This illumination is necessary for close observation of the stylus in relation to the zero line, as will be described later.

The torque on the specimen is measured by the deflection of the light aluminum arm *S*, which is pivoted on the center line of the specimen with the flexible steel emery knife edges *T*. The deflection of the end of the arm is, therefore, free from any friction effects and is proportional to the torque. In the case of the stiffer materials, the springs *U* are necessary to supplement the knife edges. Under these conditions, the vertical movement of the end of the arm *S* is proportional to the torque for the small angles employed. The movement of *S* is controlled by the dashpot *V*, filled with a light oil of a viscosity to give critical damping. Such damping is necessary when rapid movements of the arm occur in the initial portion of the stress-strain diagram.

The recording of the diagram takes place on the smoked glass plate *M* by means of a pointed steel stylus *W* held against the plate lightly by the thin steel spring *X* so that very little friction results.

The stop *Y* allows the stylus to be removed from the smoked-glass plate after the completion of a record.

Referring back to Fig. 48, typical stress-strain diagrams of plastic clay at various water contents will be seen. The points to be noted are the yield point *a*, the twist at the breaking point, and the maximum torque. No one figure will represent the workability, but a high yield point and high deformation will give the best value. Roughly, the product of the yield point and the maximum deformation may be taken as the workability. If this product is plotted against water content, it will show a maximum value at the consistency of best workability,^(30,46) as shown in Fig. 51.

The stress-strain diagram is altered by changing the rate of shear⁽⁴⁰⁾ so it is well to perform the tests at a shear rate comparable with that encountered in a particular forming process. Clay masses are elastic up to the yield point only under rapid deformations.

Numerous other methods have been mentioned for measuring workability, such as the orifice flow of Stull and Johnson,⁽⁴⁷⁾ the tension test of Hyslop,⁽³¹⁾ and the cylinder-compression method of Roller,⁽⁴⁵⁾ as well as the many impression methods similar to the Vicart needle.

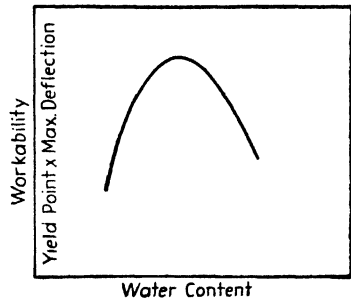

FIG. 51. Workability of a plastic body vs. water content.

Mechanism of Workability. A new theory explaining the workability of clay masses has recently been proposed by Norton,⁽⁶⁵⁾ which may be called the "stretched-membrane" theory. The yield point exhibited by the plastic mass is explained by the compressive force exerted on it by the surface layer of water on the outside of the mass. This layer, as represented in Fig. 52, may be thick in soft masses (a), in which case the surface curvature between the particles is of long radius and the surface tension forces due to capillarity are low. At the same time the particles are widely separated by water films as evidenced by the great drying shrinkage from this condition. On the other hand, if some of the water is removed from the mass (b), it becomes stiffer due to the surface film's becoming thinner

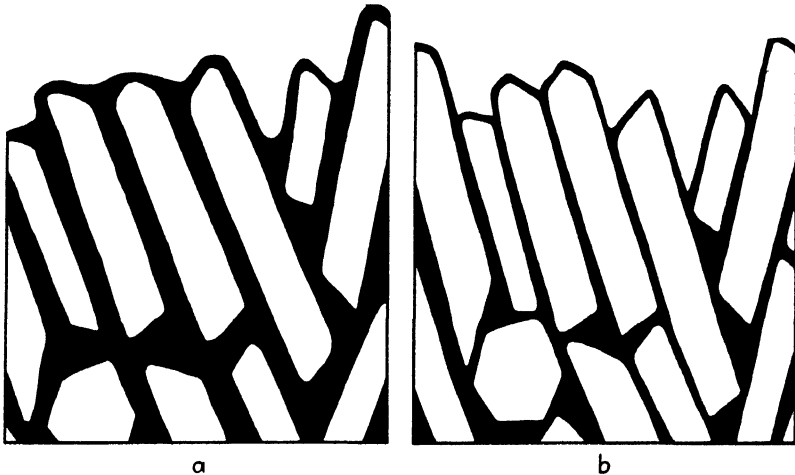

FIG. 52. Enlarged cross section of a plastic mass near the surface with varying amounts of water. (*J. Am. Ceram. Soc.*)

and drawing down into the capillaries with a smaller radius of curvature. This puts the mass of particles under higher compression and thereby forces them closer together. Now unless this compressive force is balanced by an interparticle repulsion force, the particles will come together until they touch. But we know they do not touch, because drying shrinkage occurs, indicating that the separation is something of the order of 100 molecular layers.

In Fig. 53 is shown the force field about a hydrogen clay particle as postulated by Hauser and Hirshon.⁽⁷⁶⁾ A flocked suspension settled out of water would be represented by point *B*, where the attractive and repulsion forces just balance. Under the forces of shearing the particles will be separated slightly, bringing attractive forces into play, which accounts for the yield point found in such a system. On the other hand, if a little water is removed from the system by compressing between porous pistons

(filtering) or by drying, the particles will come closer together, such as at point *C*, so that interparticle repulsion forces are built up just to compensate for the external compression produced either by the pistons or by the surface capillarity. Therefore, it is incorrect to say, as usually stated in colloidal literature, that the particles in a flocked system are held together by attraction forces; rather there is always an equilibrium between the external forces and the interparticle forces, the former compression and the latter repulsion.

It is rather difficult to visualize the forces acting in the clay mass as produced by the stretched membrane; however, the simple mechanical diagrams shown in Fig. 54 should make the picture clearer. In diagram *a* there is shown a series of spheres held apart by compression springs loosely fitting inside of a tube. The spheres represent the clay particles, the springs the repulsion forces, and the water surrounding them, the water in the clay mass. If two tightly fitting pistons close the ends of the tube and P_1 forces them together, it will readily be seen that the forces between the particles are not affected, and therefore, because of the incompressibility of the liquid, force P_1 is resisted entirely by hydrostatic compression forces in the water itself, thus allowing no appreciable contraction of the total volume.

Suppose, however, that we substitute porous pistons as shown in diagram *b*, which represents the case of permeable pressing. In this case, it will easily be seen that now the force P_2 is not resisted by the water, as this can readily flow through the pistons. The force is consequently taken by the springs between the spheres; and if the pressure is large enough, these springs will be compressed until the spheres are actually touching.

Diagram *c* represents the condition occurring in the free plastic mass. Here tight pistons are used; and instead of the force P_1 , a capillary force P_3 acts to put the water in hydrostatic tension. This action on the pistons will draw the particles together, compressing the springs, and gives closer packing *only in so far as water is removed by the capillary*.

Therefore, it can be seen that in the case of the plastic clay mass the capillary forces of the stretched membrane act to draw the particles closer

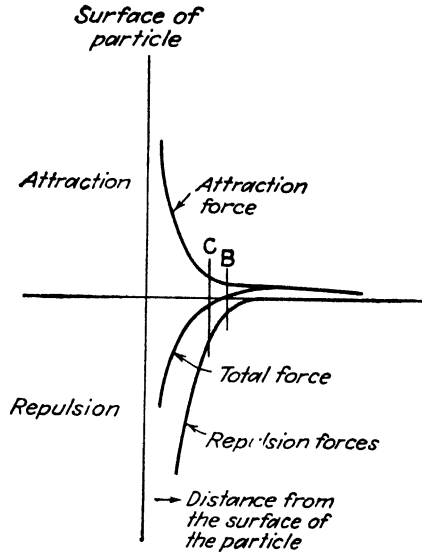

FIG. 53. The field of force about a clay particle when surrounded by water.

together and that this force is balanced by the repulsion forces between the particles.

The high capillary forces in wet clay are clearly brought out in the article by Westman,⁽²⁰⁾ where layers of clay were exposed to water on one side and nitrogen pressure on the other to balance the capillary forces. In this way, it was unnecessary to have a large column of water in tension,

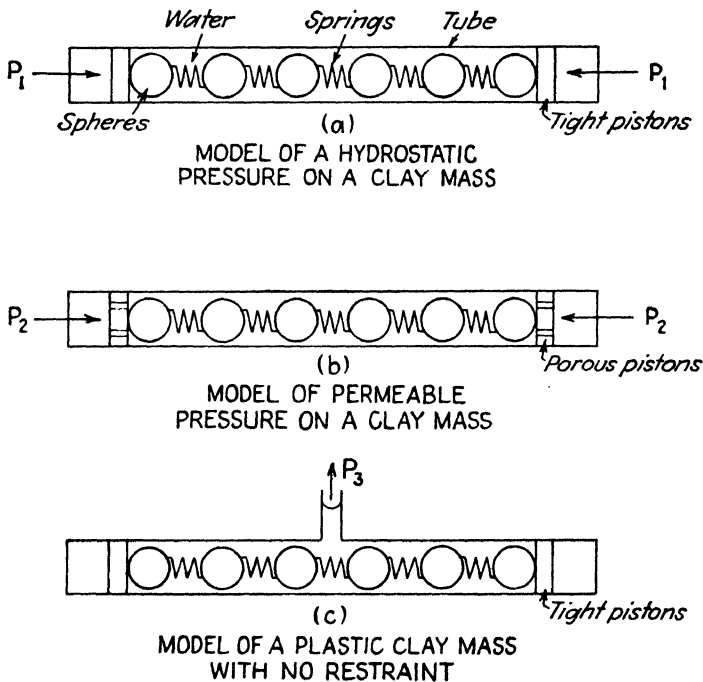

Fig. 54. Mechanical model of the clay-water system.

which was a limiting factor in some of the older tests of this type. Westman found, as we should expect, rather low capillary forces in the coarser grained flint or feldspar but higher ones in kaolin and very high forces in fine-grained ball clay. His values in pounds per square inch are shown in Table 21:

TABLE 21

| Material | Pounds per Square Inch |
|----------------|---------------------------|
| Flint..... | 5 |
| Feldspar..... | 10 |
| Kaolin..... | 263 |
| Ball clay..... | 880 |

This theory will account for the increasing yield point with decreasing water content, as well as for the greater workability in finer grained masses where the capillary forces are higher.

A very simple direct proof of this theory is to fill a thin rubber balloon with dry, powdered clay. The material then will act like a dry powder; but if the balloon is slowly evacuated, so that the atmosphere, pressing on the rubber, forces the clay particles together like the water film, then the mass assumes the identical plastic properties of wet clay.

Of course, the particles making up the mass have an important influence on workability. They should have a small size to produce small capillaries at the surface for a high yield point and numerous water films for good extensibility. Of all the natural materials, clay minerals have the smallest dimensions, a plate thickness of less than 0.1μ . Then again an active surface to stabilize the water film is necessary, and here again the clay minerals seem to be unique in possessing large negative charges. The work of Wilson⁽³⁰⁾ gives some indication of how workability is connected with the size, shape, and composition of the particle, but more work of this nature is needed.

2. The Casting Process. *Casting Slips and Deflocculents.* The casting slip is a mixture of clays, nonplastics, and deflocculents proportioned to give the proper physical properties. A good slip should have in so far as possible the following properties:

1. A low enough viscosity to flow into the mold readily
2. A high enough specific gravity to prevent settling of the nonplastic
3. Ability to drain cleanly (in drain casting)
4. Capable of giving sound casts (in solid casting)
5. Stability of properties with aging
6. Quick release from the mold after casting
7. Rapid casting properties
8. Low drying shrinkage after casting
9. High dry strength after casting
10. High extensibility in the partly dried condition
11. Freedom from entrapped air

Considerable experience is needed to make up a good casting slip, as the selection and proportioning of the clays are of great importance. However, the deflocculation, which was formerly an art, can now be approached systematically. For example, samples of the dried or nearly dry ingredients can be mixed with water to make several series of slips, of different specific gravity, and to each series can be added various amounts of deflocculent. Viscosity measurements are now made on each sample, and the results plotted as shown in Fig. 55. The double minimum is probably due, as suggested by Dr. Hall, to the fact that the ball clay reaches a

minimum viscosity at a different pH from the kaolin. Point *A* might be selected as the conditions for a solid casting slip, and Point *B* for a drain casting.

It is well known that NaOH, as used to deflocculate pure clay fractions, will not work so well with natural clays containing soluble salts, such as calcium and various adsorbed ions. On the other hand, Na₂CO₃ or

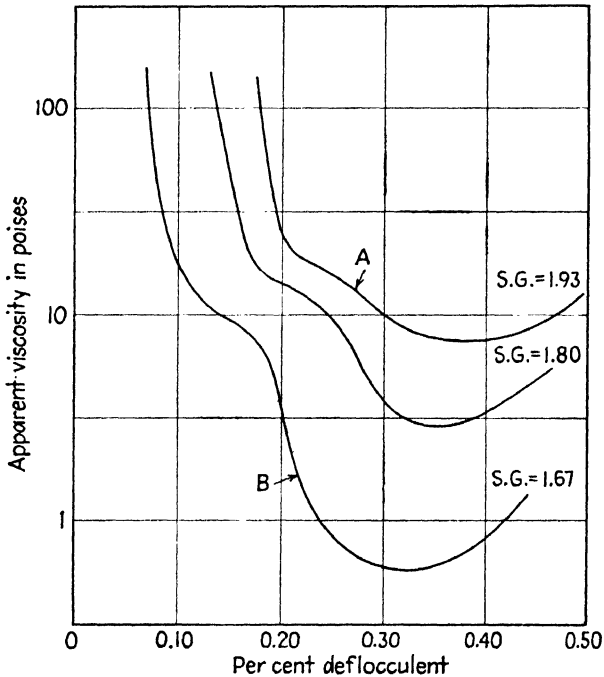
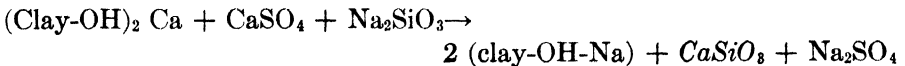
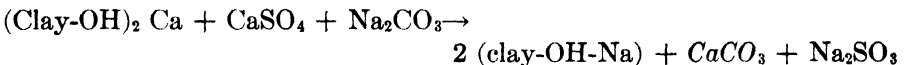

FIG. 55. Viscosity curves for clay casting slips.

Na₂SiO₃ do work well. The reason for this is that the latter deflocculents produce insoluble products while the former does not. For example:⁽⁷⁷⁾



or



The elimination of the troublesome Ca⁺⁺ ions is thus accomplished. If necessary the SO₃⁻ can be taken out by adding a barium salt.

The mechanism of casting has been studied in considerable detail.⁽⁷⁸⁾ It consists essentially in the removal of the water from the slip next to the

plaster mold surface by capillary suction, and this removal continues deeper into the slip with increased time. However, as the water must pass through the layer of solidified slip, the rate of casting decreases with time. Fine-grained clays such as ball clays form a low permeability layer and are thus slow casting. Besides the water removal from the slip, there is also a flocculating action caused by the Ca^{++} and SO_3^{-} ions migrating from the mold surface into the slip, thus stiffening the cast layer.

In casting, there is some selective concentration of the finer materials on the mold surface and especially a preferred orientation of the clay plates parallel to the surface. This is readily proved by noting that a flat plate cast on one surface warps badly in drying and that the drying shrinkage parallel to the mold surface is less than normal to it.

There are many special deflocculents suggested in the literature, though not extensively used in practice. For example, sodium tannate,⁽⁶⁶⁾ salts of sulfonic acid,⁽⁷⁵⁾ humic acid, and many others have been used.

The casting of high-grog bodies such as glass pots, are well described by Heindl, Massengale, and Cossette.⁽⁷⁹⁾ They emphasize the careful sizing of the grog to give close packing and the selection of the clays to give the best casting properties. A typical slip composition is given in Table 22.⁽⁷⁹⁾

TABLE 22. GROG CASTING SLIP FOR GLASS POTS

| Material | Per cent |
|-----------------------------------|----------|
| North Carolina kaolin..... | 13 |
| Georgia kaolin..... | 9 |
| Tennessee No. 5 ball clay..... | 10 |
| Kentucky No. 4 ball clay..... | 10 |
| Maine feldspar..... | 5 |
| Grog: 10-20 mesh..... | 18 |
| 20-40 mesh..... | 16 |
| 40-100 mesh..... | 10 |
| Through 40 mesh..... | 9 |
| Silicate of soda ("S" brand)..... | 0.025 |
| Sodium carbonate..... | 0.012 |

There have recently been considerable developments in the art of casting nonplastics; and under the proper control, slips can be made up having casting properties equal to clay slips for either drain or solid casting. To illustrate, fused alumina is ground in a steel mill until the particles average 2 to 5 μ . The slip is acid treated and washed to remove the iron and then deflocculated with acid to give a pH of about 3 and a specific gravity of 3.0. In Fig. 56 are shown viscosity curves of a series of these slips to show the minima similar to those for clay slips. Properly made slips are non-settling, shrink enough to release from the mold, and have fair dry strength

but must, of course, be handled more carefully than clay bodies. More details of this casting process are given in Chap. XII.

Molds. Space is not available here to go into the question of mold-making to any extent, but a few of the essential facts may be stated. Practically all the ceramic casting is done in plaster of Paris molds made

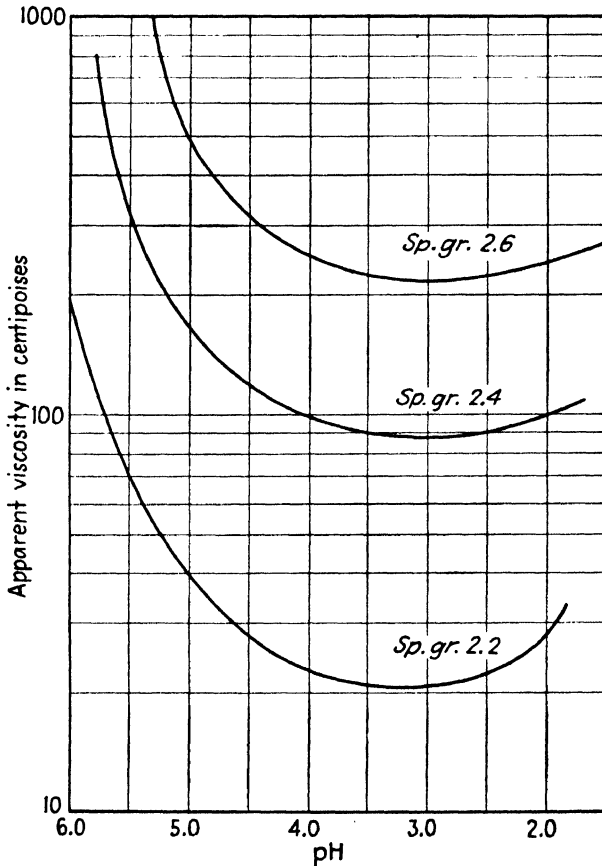

Fig. 56. Viscosity curves for fused alumina casting slips of $2\ \mu$ average particle size.

from a mixture of good pottery plaster and water. In a modern plant, the mixing is carried out with a high-speed mechanical mixer, as it is found that this method gives a more uniform mold and one freer from bubbles. A good average composition for a casting mold would be 36 lb of water and 40 lb of plaster, which is allowed to soak for 2 min and stirred for $3\frac{1}{2}$ min, after which it is poured at once into the case or forms. Of course, the new batch of plaster must be prevented from sticking to the solid plaster case into which it is poured, and general practice in the ceramic industry is to

use a thick solution of soft soap (English Crown soap) and water to coat the surface of the solid plaster against which new plaster is to be poured. Apparently the soap forms an insoluble calcium compound on the surface of the plaster, which gives a polished surface with good wear resistance; consequently it is possible to cast a great many hundred molds from one case without losing accuracy.

The molds are made for two types of casting: The first is called a "drain casting," and the second a "solid casting." In the first type, the slip is poured into the dry mold until it is completely full and allowed to stand for a sufficient length of time to build up on the dry plaster a layer of body of the required thickness, as shown in Fig. 57. This may take anywhere from five minutes to an hour or more, depending on the type of piece. As soon as the required wall is built up, the liquid slip in the center is drained out, leaving a uniform casting. The top edge of the mold has to be designed in such a way that a true upper edge can be obtained readily on the finished piece. As shown in Fig. 57, a spare is generally used, so the level of the slip is somewhat above the top edge. After draining, the body is trimmed with a vertically held knife tangent to the plaster surface, which should project out just to the thickness of the cast wall. In this way, a true edge can be quickly obtained.

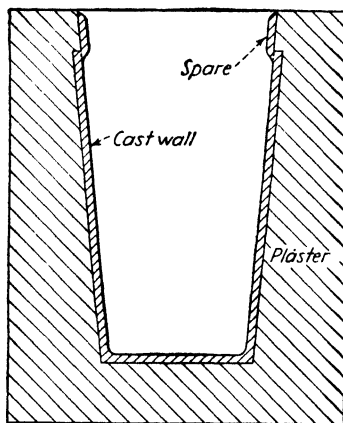

FIG. 57. Section of mold after draining.

When the slips contain large particles of grog, it would be obviously impractical to make drain castings, because the inner surface would be extremely rough. In this case, it is usual to make a solid casting in a mold, somewhat as shown in Fig. 58, for casting saggars. Here the slip is poured into the center of the mold and fills the annular space, rising up into the vent holes. A head of slip must be kept on the mold at all times because the solid casting gradually shrinks as the slip becomes solid and additional material has to be supplied to take up this shrinkage. In other words, the design for a mold for a solid casting is identical in principle with the design of molds for casting metal, where the gate has to be of sufficient volume to supply metal while the piece is solidifying.

Plaster molds naturally are comparatively soft and will wear after long use. It is a little difficult to give any exact figures on the life of a plaster mold, as this will depend on many factors. A mold for casting a fine-grained slip by the drain method may be made to give a hundred casts quite

satisfactorily if no fine detail is involved. Of course, the molds for casting grog bodies must take more wear and tear, but here we can afford to have considerable wear before the mold is discarded. The alkali used as a deflocculent in the slip will cause some deterioration of the mold, due to the salts being drawn into the mold where they become concentrated. It has been found that some of the organic deflocculents give a considerably greater mold life than the sodium carbonate and sodium silicate usually employed.

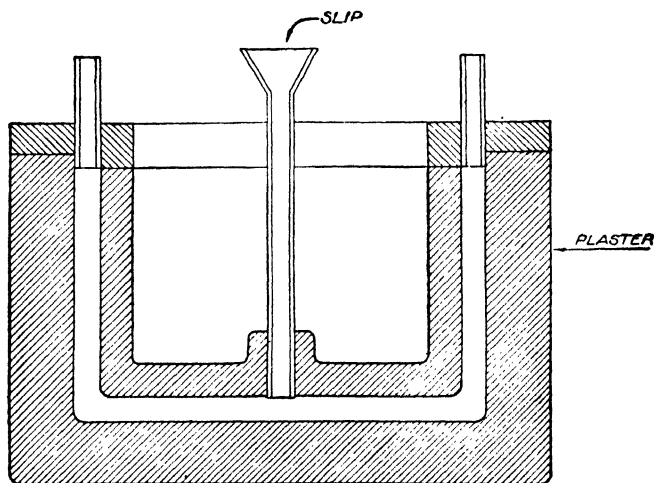

Fig. 58. A mold for solid casting.

Methods of Casting. The casting slip is made up by blunging the solid ingredients with water and a deflocculent. The slip is usually agitated for a considerable length of time in order to be sure that the clay is thoroughly wet and that the air bubbles are well removed. In some cases, the blunging is done with a high-speed mixer; in other plants, it is carried out in large vats with a slow-speed paddle. The fine-grained bodies for drain casting are generally made up in two stages; *i.e.*, the material is blunged up first with water to a rather thin consistency, passed through a screen of around 80 to 120 mesh and over a magnetic separator, and then filter-pressed to remove most of the water. The filter cakes are then reblunged with deflocculent^(58, 62, 66) and some of the screened slip to make up the final slip. These steps are taken in order to make a sufficiently fluid slip to screen before the deflocculent is added. In the case of coarse-grained bodies, the slip is usually made up directly with the deflocculent.

The slip is often handled by pipe lines so that it can be fed under pressure to each casting bench, allowing the workman to fill his molds rapidly. In the case of the heavier slips, this cannot be readily done and the material

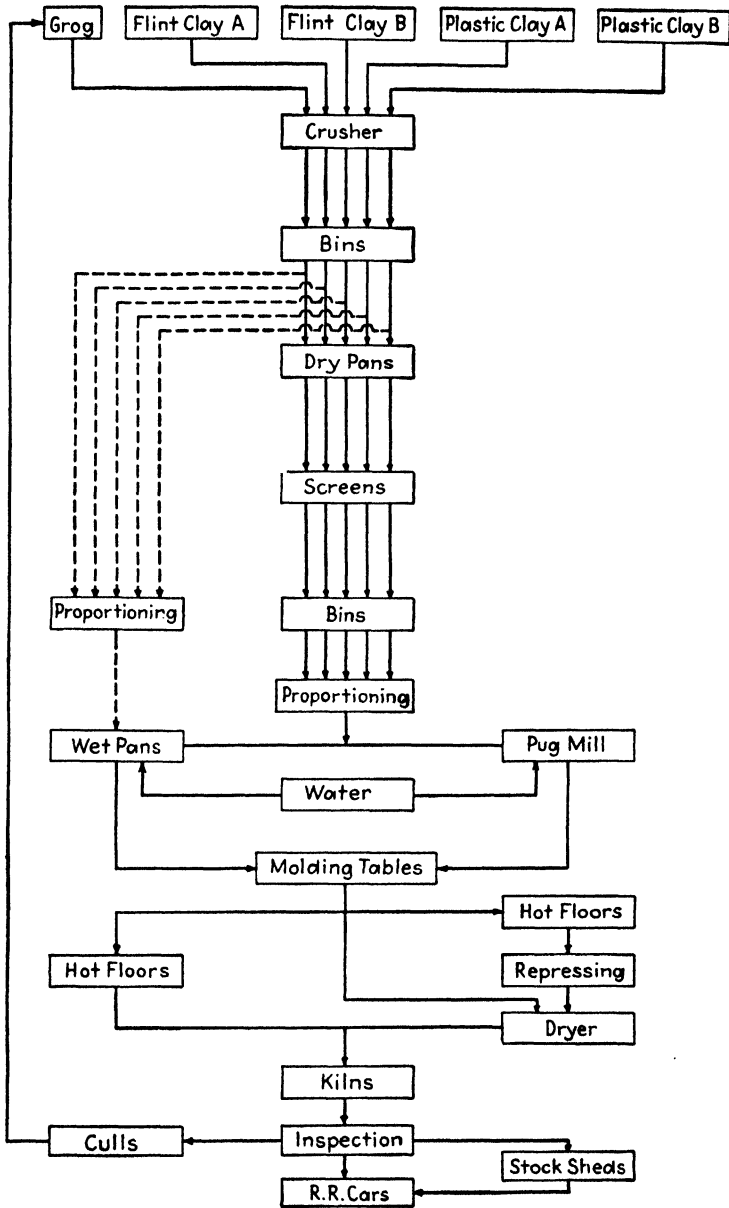

FIG. 59. Flow diagram for the manufacture of handmade brick. (Courtesy of S. M. Phelps, American Refractories Institute.)

is handled in hoppers. Sometimes it has been found desirable to deair the slip in a vacuum before casting in order to make a more dense structure. Some manufacturers prefer to use their slip at an elevated temperature, perhaps 90°F.



FIG. 60. A wet pan for crushing or mixing. (Courtesy of Clearfield Machine Company.)

The handling of the scrap trimmed from the cast pieces presents quite a problem, as it must be mixed back with the original batch in such a way as not to disturb the deflocculation.

3. The Soft-mud Process. The soft-mud process for making bricks, one of the oldest of all molding processes, has been used for making all types



FIG. 61. A pug mill for preparing clay. (Courtesy of E. M. Fresse and Company.)

of brick from the earliest times. Although machines are available for making soft-mud bricks, they are used very little in the refractories industry, being confined to the manufacture of building brick; consequently here we will discuss only the hand-mold process.

The hand-mold method is used for making brick in both small and medium shapes. This process is particularly suitable for making certain types of special shapes, particularly intricate ones where the mold cost would be prohibitive by other processes. However, the total shrinkage is high, running from 6 to 12 per cent. Figure 59 shows a flow sheet of a typical hand-mold process. The individual clays are taken from the storage piles and crushed in a jaw crusher or dry pan, after which they are placed in overhead bins so that they can be removed by gravity. In one



FIG. 62. Interior of a pug mill. (Courtesy of E. M. Freese and Company.)

process, the clays are proportioned in a batch and then fed to a wet pan (Fig. 60), where the whole mass is ground to the proper degree with water. Another method separates the grog into more or less definite-size fractions, which are then mixed together dry and the water mixed in either with a wet pan or with a pug mill (Figs. 61 and 62). The proper amount of water must be added to give a mix of the right consistency. A change of as little as 1 per cent can usually be detected by the molders.

The plastic mix is taken from the mixing machine to the molders' table located near the hot floor. The hand molder rolls a homogeneous slug of clay, sometimes called a "walk," of a little more than the volume of the mold. This slug is then lifted over the head and thrown with considerable force into the mold, where the inertia forces it into every corner. If more than a few pieces are to be made, the mold is usually made of hardwood lined with $\frac{1}{16}$ -in. steel sheets. Sometimes loose pieces line the mold,



a. Building up the "walk."



b. Forming the sides.



c. Forming the ends.

FIG. 63. Method of



(d)

d. Throwing the "walk" into the mold.



(e)

e. The "walk" thrown on the mold.



(f)

f. Bumping.

hand molding shapes.



g. Cutting off the cap.



h. Slicking.



i. Placing on the hot floor.

FIG. 63 (continued). Method



(j)

j. Stripping mold.



(k)

k. Removing loose pieces.



(l)

l. Assembling mold.

of hand molding shapes.

which may be a single mold or may be divided by partitions to make a number of units.

The clay is prevented from sticking to the mold by dusting the wet mold with sand between moldings or oiling it with brush or spray. When the mold has been filled, it is violently bumped to consolidate the clay; then the excess portion is cut off with a wire, and the top slicked down. In the case of the larger shapes, it is necessary to fill the mold with several walks of clay, but care must be taken to avoid lamination. The mold is then dumped either on the hot floor or on a pallet, and the piece is allowed to dry.

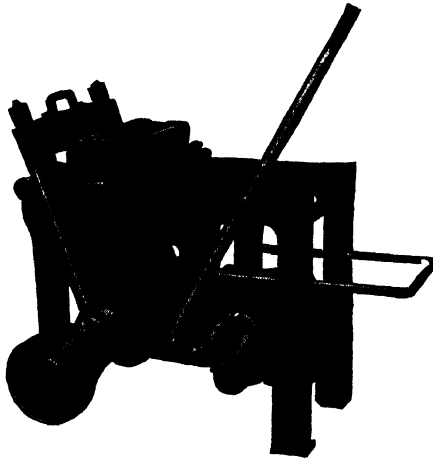

FIG. 64. A hand re-press. (Courtesy of International Clay Machinery Company.)

The fine series of photographs in Fig. 63 shows the steps in molding a shape by this process. Usually, hand-molded pieces in the standard sizes are hand re-pressed; *i.e.*, the hand-molded piece with a water content for stiff-mud consistency is placed in an oiled-steel die box (Fig. 64) and pressed to give an accurate shape and put on the brand.

Perhaps 3 per cent of all standard-shape fireclay refractories are now made by the soft-mud process, a percentage much lower than it was ten or fifteen years ago. In addition, a considerable proportion of the special shapes are made by the soft-mud process. A hand molder and a boy can mold approximately 400 standard bricks per hour, and a hand re-presser and two off-bearers can handle up to 550 bricks per hour, a rate that demands very skillful operation of the re-press. In hand molding special shapes from soft mud, a molder and helper will turn out about seventy-five 9-in. equivalents per hour.

It should be recalled that in the soft-mud process, the clay contains an amount of water somewhere between the critical point and the satura-

tion point, which allows the plastic mass to be deformed with a comparatively small force without rupture and yet permits it to have a sufficiently high yield value to prevent the shape from slumping after it is removed from the mold. However, the yield value is only slightly above the gravity forces, as any shock or jar on the freshly molded shape will make it deform.

The handmade brick are of open structure, quite resistant to spalling, and easily cut by the bricklayer.

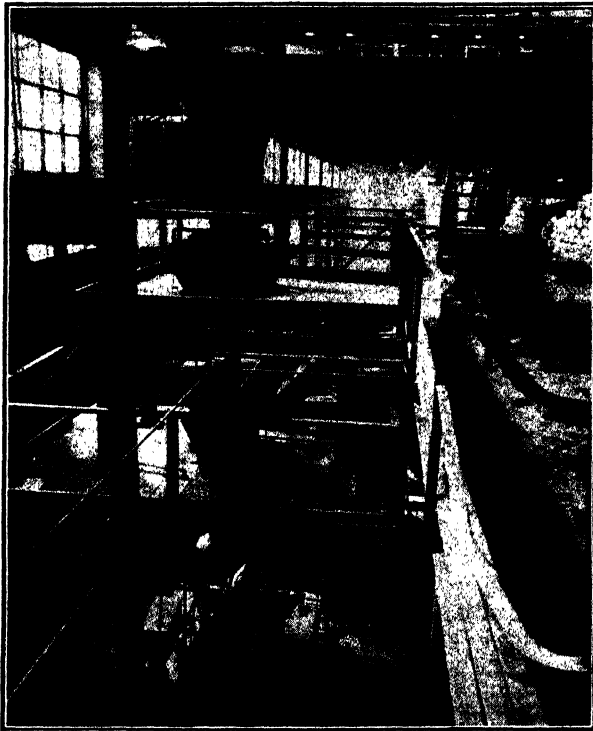

FIG. 65. A machine for molding silica bricks. The mud is dropped from the upper hopper into the mold below. (Courtesy of Harbison-Walker Refractories Company.)

Silica brick are usually made by the soft-mud process. The ganister is given a short treatment in a wet pan, when about 2 per cent milk of lime is added. The comparatively nonplastic mix is thrown into molds in the same way as for hand-molded clay bricks. However, the molds are steel, and push blocks have to be used in stripping because of the low strength of the brick. Since the yield point of the mix is very low, care must be taken not to jar the finished piece until it becomes dry.

Machines are now used for molding silica brick. The hydraulic press is used to some extent in this country and largely abroad, using about

4 per cent water and 5,000 psi pressure, but a dropping machine⁽⁶¹⁾ that simulates hand molding has been quite successful in this country. It (Fig. 65) is entirely automatic, dropping slugs of the silica mix into the mold on a heavy anvil, slicking, and stripping. In this country lime alone is used as a bond, but in Europe sulfite liquor is used in addition.

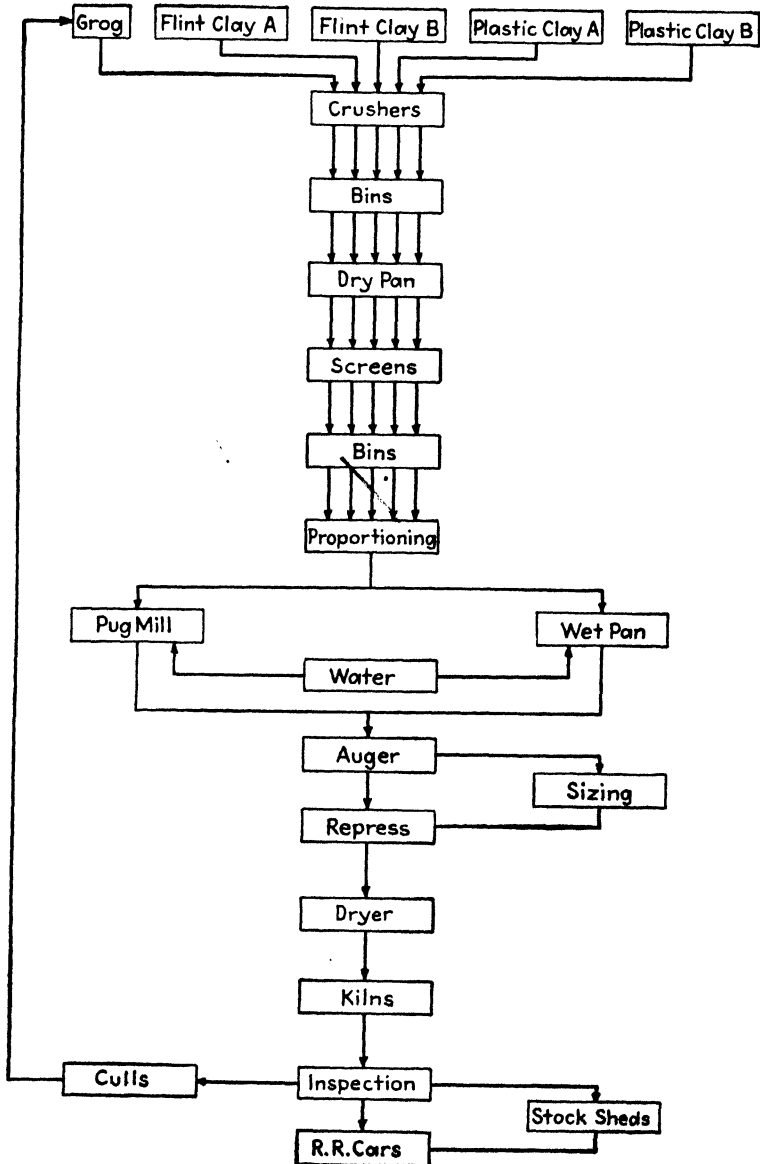

FIG. 66. A typical flow diagram for the manufacture of stiff-mud brick. (Courtesy of E. H. Van Schoick, American Refractories Institute.)

4. The Stiff-mud Process. The stiff-mud brick are made with a consistency just above the critical point; therefore considerable force is required to form the clay. Most of the refractories made by this process are formed by forcing the plastic material through a die from which it emerges as a more or less homogeneous column that can be cut off into definite lengths. This column is generally produced by an auger, consisting of a propeller-shaped screw running in a trough, which forces the clay with high pressure through a die. Steam-pressed brick are forced through a die with a piston operated by steam pressure, an intermittent process.

A flow sheet of the stiff-mud process is shown in Fig. 66, in which the clays are prepared in much the same way as for the handmade bricks.

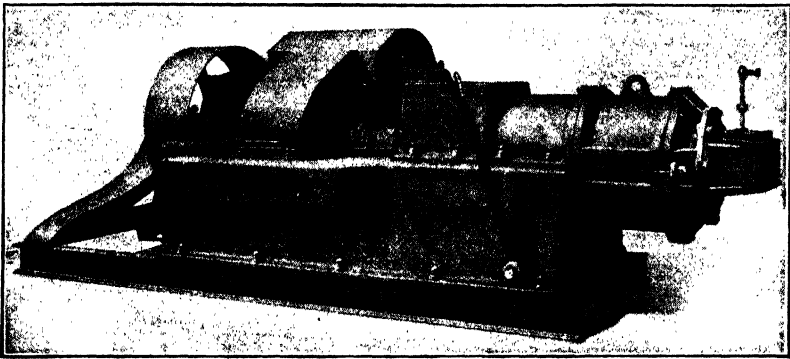

Fig. 67. An auger for producing a uniform column of clay. (Courtesy of W. A. Riddell Company.)

Water is added to the mixture with either a wet pan or a pug mill. The latter is generally preferred because it is a continuous process and better adapted to feeding the auger. The pug mill (Figs. 61 and 62) is a long, trough-shaped container with one or two horizontal shafts running down the center, having attached to them suitable blades for kneading and mixing the clay and propelling it gradually toward the exit end. Water can be added to the material in the pug mill to bring the mixture to the proper consistency.

The auger, as shown in Fig. 67, must be a well-designed machine in order to produce a uniform column. It is important in designing the die to assure an even velocity of the clay in all parts of the stream to prevent strains. Also the auger must be designed so as to prevent laminations, which often occur in the center of the column as an S-shape crack. The die itself is generally lubricated with oil to reduce the friction, and often it is steam heated for the same purpose. It has been found that if the clay is mixed in the auger in a vacuum chamber,^(87,89,93) the air is readily removed and a more dense and homogeneous column is produced in

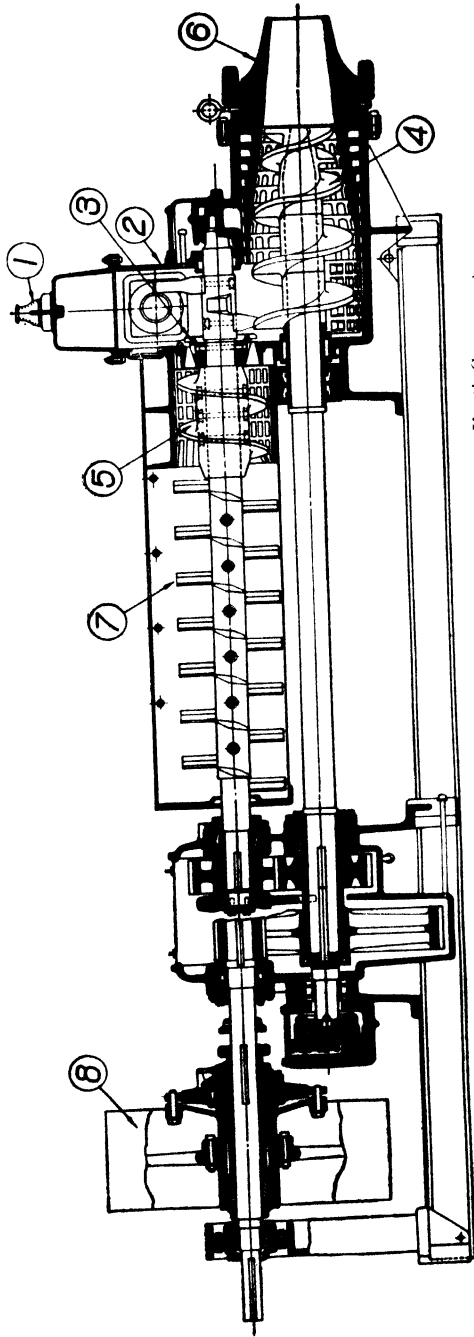

FIG. 68. Section of deairing auger. (Courtesy of The Fate-Root-Heath Company.)

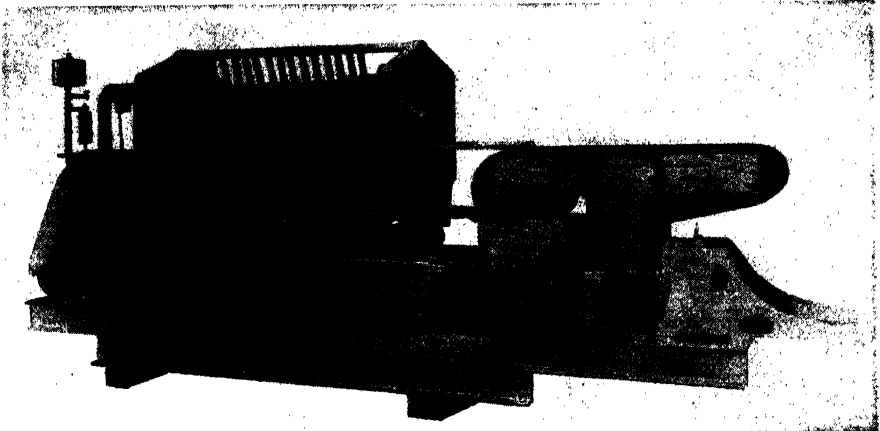

FIG. 69. A multiple-wire cutter for dividing the column of clay from the auger into bricks. (Courtesy of The Bonnot Company.)

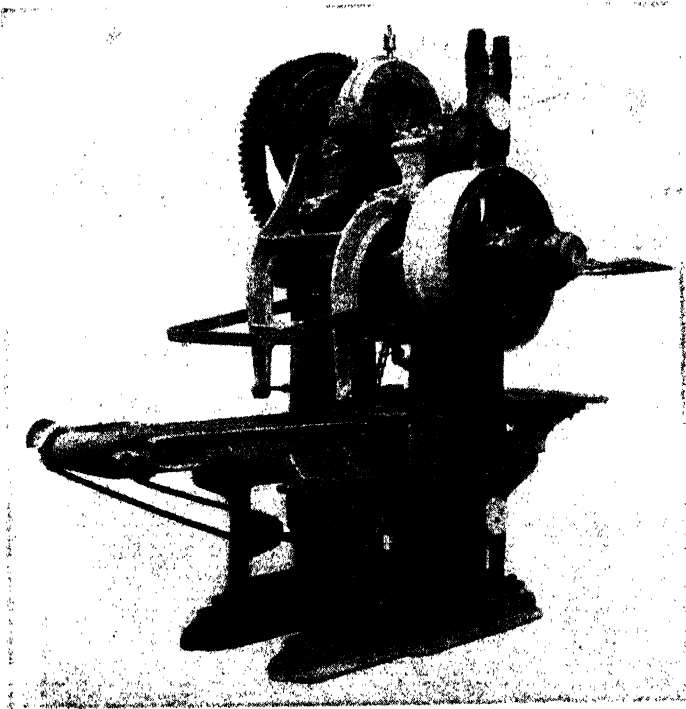
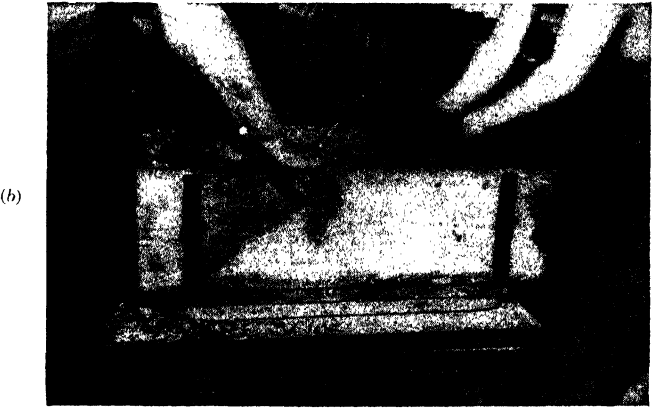

FIG. 70. A machine re-press. (Courtesy of The Bonnot Company.)



a. Ramming (note continuous feeding).



b. Cutting off top.

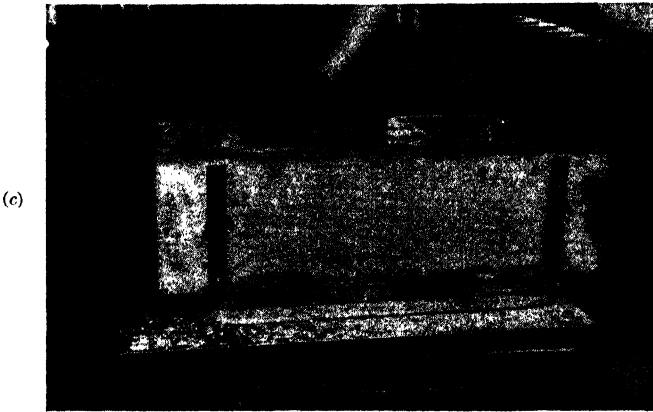

c. Slicking.

FIG. 71. Method of air



(d)

d. Stripping.



(e)

e. Showing loose pieces.

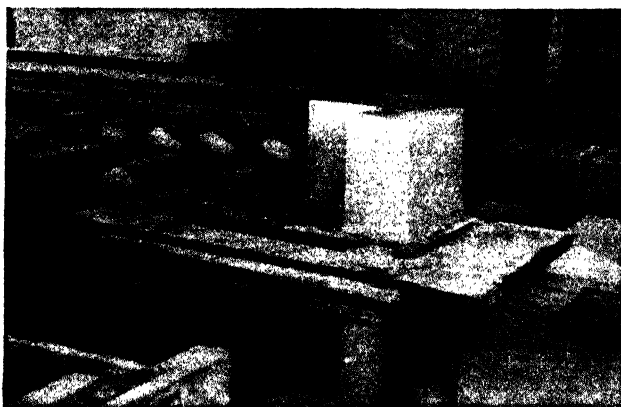

(f)

f. Finished block.

ramming of stiff-mud shapes.

passing through the die. One method of deairing in the auger is shown in Fig. 68. Deairing has now become a very common practice in stiff-mud operation and enables the production of sound bricks from clays that previously could not be readily handled. It also permits a denser structure to be obtained. However, deairing is not necessary for all bodies, as many of them can be handled quite satisfactorily without it. In fact, deairing seems to make some plastic mixes harder to dry and burn.

The column of clay from the auger is cut into uniform sections with a wire cutter, as shown in Fig. 69. Many designs of cutter are available, but they all operate on the principle of passing one or more steel wires through the column. It is difficult to operate a wire cutter satisfactorily if the grog content of the body is very high or if the size of the grog is very large.

There are few cases where the wire-cut brick produced are sufficiently uniform in size for use as refractories. Therefore the general practice is to pass them through a machine re-press as shown in Fig. 70, where they are actually formed to size and the brand put on. After being re-pressed, the brick are quite firm and can be readily handled and stacked on the drier cars.

Since stiff-mud brick have a strong tough structure, are good bricks for cutting, and are quite resistant to abrasion and slag, they can be used wherever a dense, strong brick is needed.

It is estimated that approximately 22 per cent of the fireclay refractories made in this country are produced by the auger and re-press. Inasmuch as an auger will produce as many as 6,000 bricks an hour and one machine re-press will turn out from 1,500 to 2,200 bricks per hour, four re-presses are generally set up with one auger.

Small, fine-grained refractories, such as tubes, can be extruded readily. If the plastic content is low, binders and lubricants can be added to give good flow properties.

A good many shapes, especially the medium and large ones, are made with a stiff-mud mix containing a high grog content because of the small total shrinkage and low warpage, even though the labor cost is higher than for the soft-mud method. Hard maple molds lined with $\frac{1}{16}$ -in. steel are generally used, often with loose pieces. The mix is fed in slowly and continuously by one man while the other consolidates it with an air hammer having a corrugated foot. The whole process is clearly shown in the photographs of Fig. 71.

5. The Dry-press Process. In the dry-press process of making refractories, the clay has the consistency of a damp powder containing perhaps 7 to 10 per cent water. Only by high pressure can it be consolidated into a homogeneous mass. The flow sheet for the dry-press method is

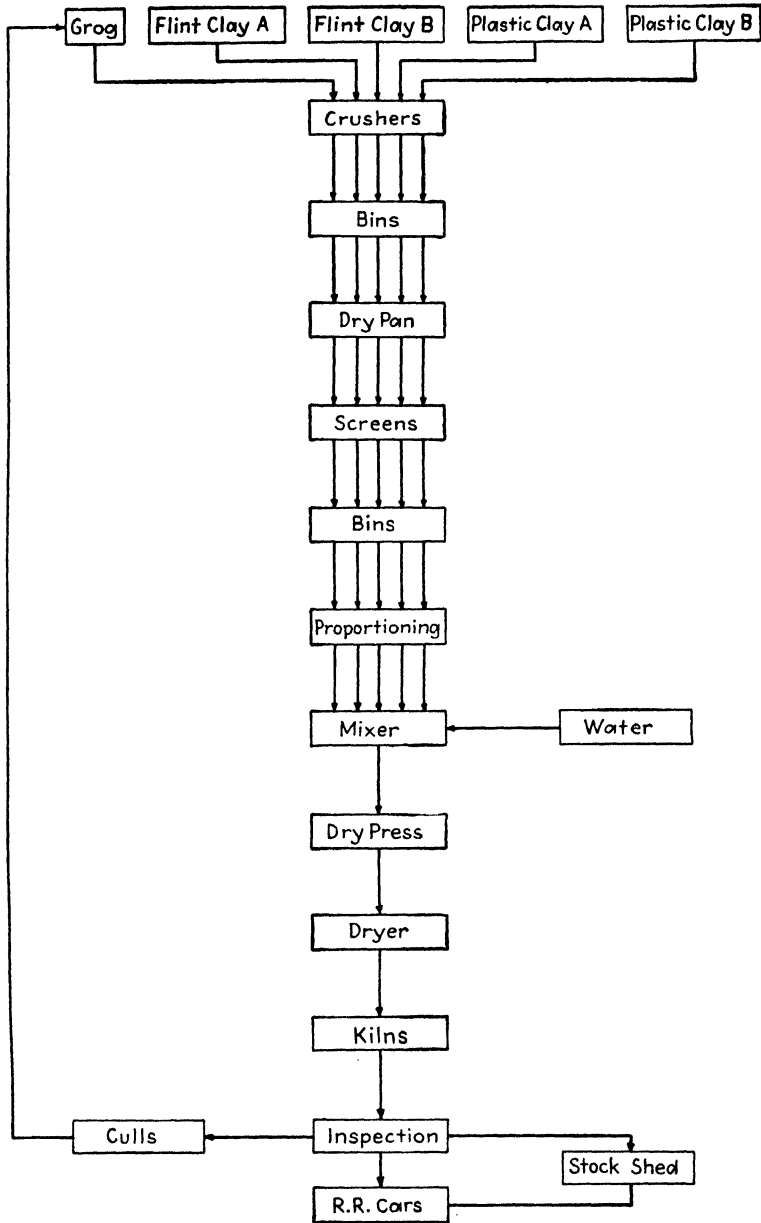

FIG. 72. Typical flow diagram for the manufacture of dry-press refractories. (Courtesy of A. C. Hughes, American Refractories Institute.)

shown in Fig. 72, in which the preparation of the clays is very much the same as for the preceding processes. In the Missouri district, the clays and grogs are often coarsely crushed, stored in bins, and recombined by feeders into dry pans, where they are further ground, screened, and tempered. The mix is aged for 24 hr and then fed to the presses. Modern practice seems to be favoring the more careful control of the sizing of the grog and flint clays by screening and recombining in definite proportions. The mixture of dry materials is then moistened in a pan or a pug mill and brought up to the proper consistency. Certain types of special



FIG. 73. A dry press in operation with the brick set directly on the tunnel kiln car. (Courtesy of the Harbison-Walker Refractories Company.)

mixers⁽⁹⁶⁾ are used to a considerable extent for this purpose. The mixed material is delivered to a hopper over the dry press, where the mixing action is continued, and permitted to flow into the dry press as needed.

The dry press itself (Fig. 73) is usually the toggle type, pressing four standard bricks at one time. However, hydraulic presses are used for certain types of refractory. The operation of the toggle press will be shown clearly by the excellent diagrams, prepared by Dr. G. E. Seil, in Fig. 74, which shows the various cycles in the pressing process. In order to make uniform brick, it is essential that the mix be uniform, that the same weight of the material be always charged into the dies each stroke, and that it be evenly distributed in the die box.^(97,99) For non-plastic mixes like magnesite and chromite, a small amount, about $\frac{1}{4}$ of 1 per cent, of organic binder such as dextrine is used.

Until recently, the exact pressures in the toggle press were not known precisely. Now^(96,97) they can be determined by the stretch of the side arms, which indicate pressures as high as 14,000 psi. With many materials, the maximum pressure is limited by the expansion, which causes pressure cracking, of the entrapped air on releasing the pressure. Recently, many presses⁽⁹⁸⁾ have been fitted with vacuum attachments that pull

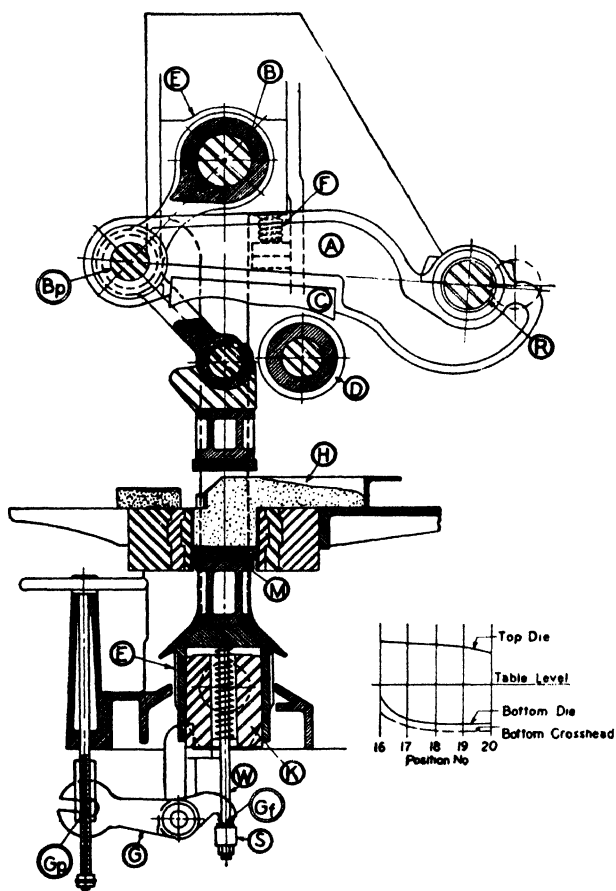

FIG. 74a. This figure shows the various cycles in the operation of a dry press when forming a brick. (a) Represents position No. 18. The crankshaft *R* has reached position No. 18 and has moved connecting beam *A* to its most forward position. The toggle pin *B* and connecting beam have now entered the portion of the cycle where they follow the radius of upper toggle *B* to position No. 2, where the lifting shoe *C* again comes in contact with lifting roller *D*. The side bars *E* have traveled from their topmost point at position No. 13, to their lowest point at No. 18, compressing equalizing spring *F* and bringing with them the upper toggle *B*, the lower crosshead *K*, and the pressure-adjusting mechanism. They pivot at point *G_p*, cause point *G_f* to press on saddle bar *S* and, by the tension placed on saddle rod *W*, they bring the lower die *M* to a level predetermined by the setting of point *G_p*. The charger *H* remains at rest until position No. 14, at No. 18 it has removed the finished brick and has begun to return to rest after it has filled the mold boxes. (Prepared by Dr. G. E. Seil, E. J. Lavino and Company.)

the air out of the die box and mix as soon as the top pad enters the box. Slots about 0.007 in. wide in the pads connect to the vacuum system.

The brick discharged from the dry press can usually be set on the tunnel kiln cars with little or no drying. The rate of forming dry-press brick on the toggle press runs between 1,000 and 2,000 brick per hr. The dry-press process is used very extensively in the industry, and it is

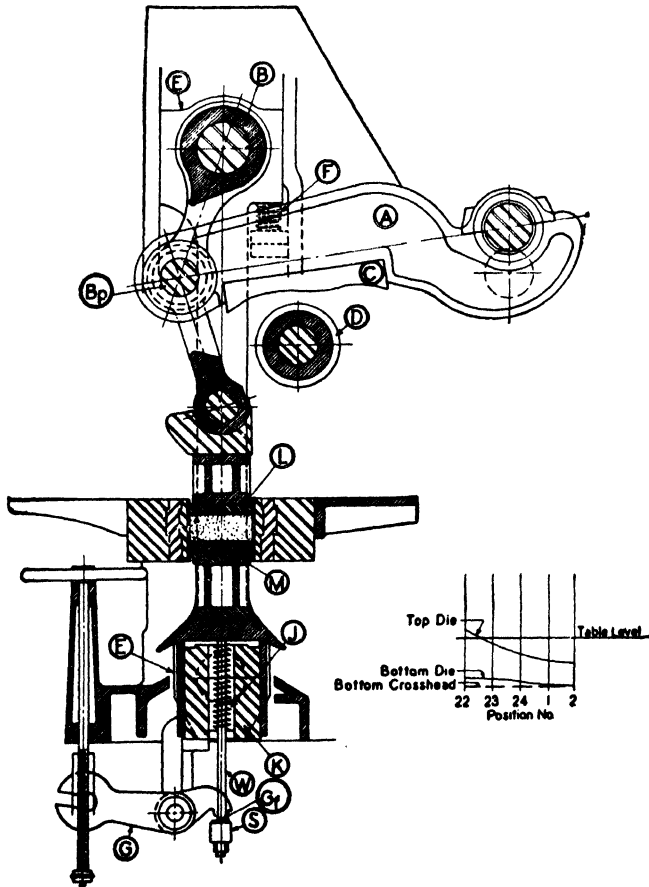

FIG. 74b. Represents position No. 24. At position No. 24 the connecting beam *A* and the upper toggle pin *B*, are about midway along the arc made by the upper toggle *B*. The lifting shoe *C* has not yet come in contact with the lifting roller *D*. The side bars *E*, the upper toggle *B*, the lower crosshead *K*, and the pressure-adjusting mechanism *G* remain in the same position as No. 18. The upper die *L* has moved from its peak position at No. 16 to No. 24, where it has come in contact with the loose material and has slightly compressed it. The lower die *M*, which had been stationary from No. 18 to No. 23, has now moved to a new level owing to the pressure of the upper die on the now partly pressed material. This action compresses saddle springs *J*, lowers saddle rod *W*, and saddle bar *S* from point *G*, on the pressure-adjusting mechanism. The equalizing spring *F* remains as before. The charger *H* has returned to rest at No. 20.

estimated that 70 per cent of the fireclay refractories and practically all the magnesite and chrome refractories are made by the dry-press process.

The bricks produced by dry pressing are very uniform in size, with strong corners and edges and little tendency to warp. They have good spalling resistance and generally good resistance to load.

The thickness of the dry-pressed piece is limited by the side-wall friction to about 4 in. in the conventional press, but numerous attempts have been made to improve this condition. In one method developed in Germany,⁽¹⁷⁶⁾ the bottom platen is vibrated while pressure is applied to

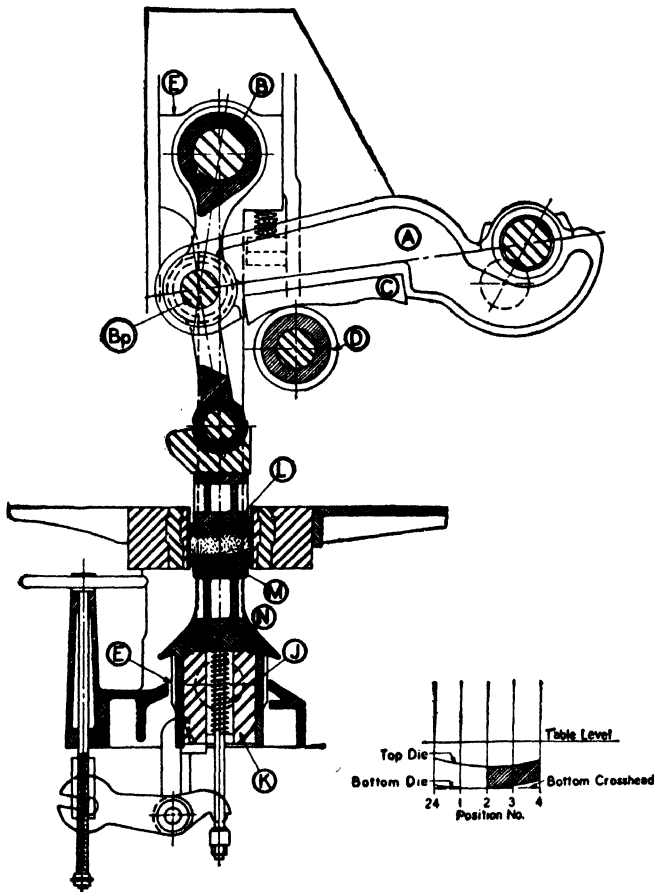

FIG. 74c. Represents position No. 2. At position No. 2 the upper toggle pin B_p and connecting beam A have completed the movement along the radius of upper toggle B , and have now brought the lifting shoe C in contact with lifting roller D . The side bars E remain in the same position as shown in Figs. No. a and No. b . The upper die L has further compressed the material, but has not yet pressed the brick to its finished size. The pressure of the top die on the material has caused the lower die M to compress fully the saddle springs J to where the saddle plate N comes in contact with the lower crosshead K .

the top one. In another, the sides of the mold box are oscillated up and down, so pressure is maintained between the platens in an effort to minimize the wall friction. Much work has been done by the powder metallurgist in studying the pressure distribution in pressed powders by

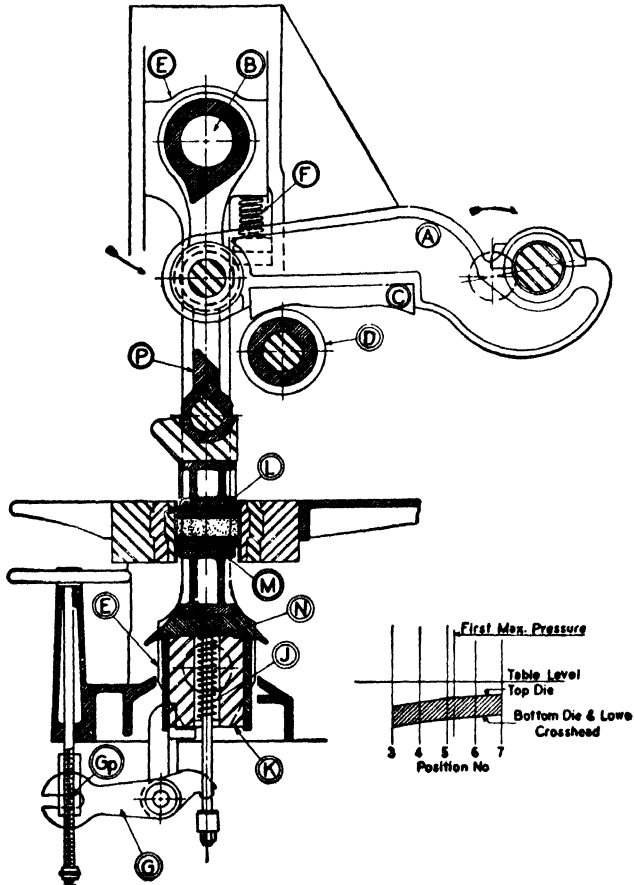

FIG. 74d. Represents position No. 5- $\frac{1}{4}$. At position No. 5- $\frac{1}{4}$ the first maximum pressure is reached and the material is pressed to its finished thickness. The side bars *E*, the upper toggle *B*, the lower toggle *P*, the upper die *L*, and lower die *M*, and lower crosshead *K* have continued to rise owing to the action of the connecting beam *A* and lifting shoe *C* on lifting roller *D*. At this point the side bars have lost contact with equalizing spring *F*, saddle plate *N* is still in contact with lower crosshead *K*, while saddle springs *J* are still fully compressed. The pressure-adjusting mechanism *G* has been rising with the lower crosshead using point *G_p*, as a pivot.

incorporating a lead grid into the mass and later studying its deformation by X-ray pictures.⁽¹⁷⁷⁾ Here it was found that the proper wall lubrication did much to equalize the pressure.

When molding small dry-pressed pieces, it is common practice to use a lubricant or plasticizer to permit a more even distribution of pressure

and to minimize die wear. Some of the lubricants used are waxes, both water soluble and emulsions; stearates; fatty oils; polyvinyl alcohol;⁽¹¹⁴⁾ and cetyl alcohol. Inorganic binders can also be used to increase plasticity and green strength. Commonly used binders are gelatin, dextrin, flour, starch, gums, and cellulose. In addition, an antisticking agent is sometimes added, such as a sulfonic acid, to aid removal from the die. The

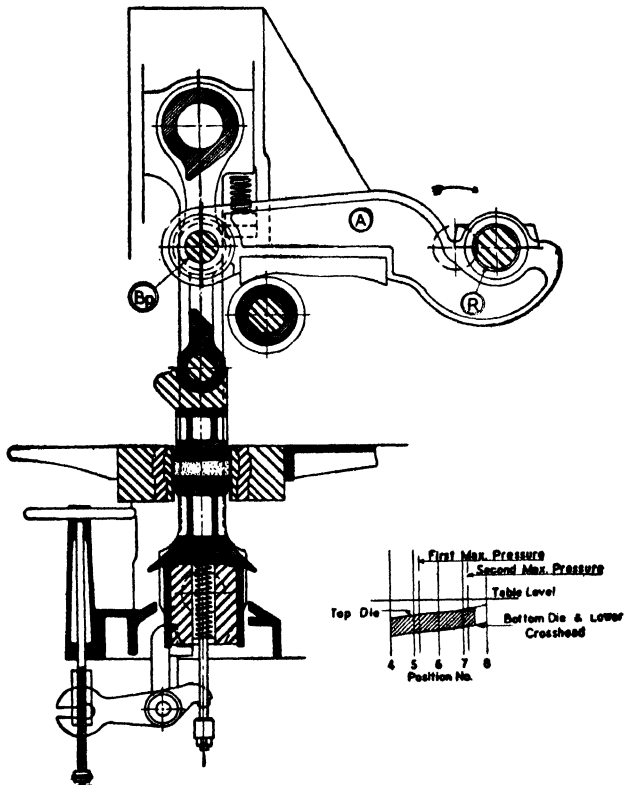

FIG. 74e. Represents position No. 6. Conditions at position No. 6 are changed slightly. The side bars have risen a little higher and the crankshaft *R* has reached its maximum throw, bringing connecting beam *A* to its extreme horizontal movement and toggle pin *B_p* over the center line of the side bars.

total amount of additions to the mix will generally run from 0.1 to 10 per cent. A good description of these organic additions is discussed in the references.^(113,110,111,108)

The molding of carbon blocks is carried out with a heated mix of coke and tar pressed into molds for the smaller pieces and rammed with an air hammer for the larger pieces.⁽¹⁷⁶⁾

Mixes of the dry-press consistency can be molded by hand ramming under special conditions. A patented process known as the Scheidhauer

and Giessing process uses a deflocculated slip of clays⁽¹⁷⁶⁾ muller into carefully sized grog. The resultant mix contains about 90 per cent grog and 10 per cent clay, with a total water content of 5 to 6 per cent. By heavy ramming in rigid steel molds, large shapes can be made with a total shrinkage of not more than $\frac{1}{4}$ of 1 per cent. The photographs in Fig. 75 show clearly how a large tile is made by this process. A modifica-

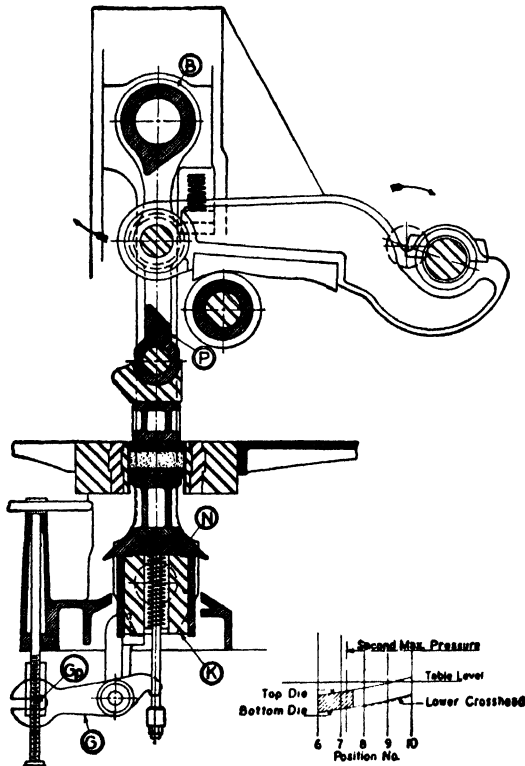

FIG. 74f. Represents position No. 7- $\frac{1}{4}$. At position No. 7- $\frac{1}{4}$ maximum pressure is again developed as upper toggle *B* and lower toggle *P* again pass over the center line of the side bars. The saddle plate *N* is still on contact with the lower crosshead *K*, where it will remain until No. 8 is reached. The pressure-adjusting mechanism *G* is still rising with the side bars *E* and lower crosshead, using *G_p* as a pivot.

tion of this method is described in a patent to Singer and Beken,⁽¹¹²⁾ where the coating slip is flocculated before pressing.

6. Hydrostatic Molding of Refractory Powders. Hydrostatic pressing methods have been used quite successfully in the compaction of metal and refractory powders not particularly adaptable to slip casting or other methods of molding.

The powder to be pressed is graded by the usual methods in order to obtain the correct particle-size distribution offering the best packing

densities. As is shown in Fig. 76, a rubber mold is supported by an aluminum-segmented container, the latter mounted in the loading jig as shown. The steel mandrel, which defines the internal shape of the refractory body to be pressed, is located by means of a recess in the top

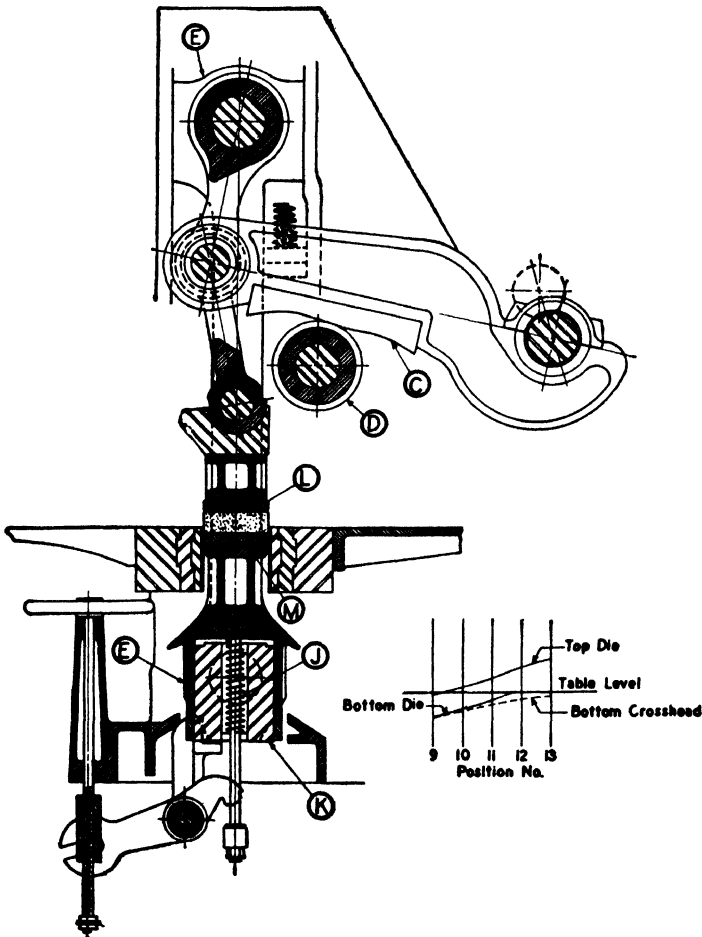

FIG. 74g. Represents position No. 11. At position No. 11 the side bars *E* have almost reached their highest point. The saddle springs *J* have come into action and have begun to push the lower die *M* to table level removing the finished brick. The upper die *L* has been rising slightly faster than the lower crosshead *K*. The brick is held against its face by the pressure of the saddle springs. The lifting shoe *C* is still in contact with the lifting roller *D*.

platen of the jig and held firmly by a stud bolt. The retainer ring, which supports the top of the aluminum segmented container, is also held in position by a recess in the top platen of the jig. The top platen assembly is held securely against the spacer rods by means of large wing nuts.

The dry powder is fed through slots in the top platen and vibrated to obtain good packing. A tamping tool, inserted through the powder-loading slots in the top platen, may also be used to ensure this condition. After the mold is loaded, the upper platen of the jig is dismantled (the steel mandrel is left in the mold) and the rubber retaining cup is slipped

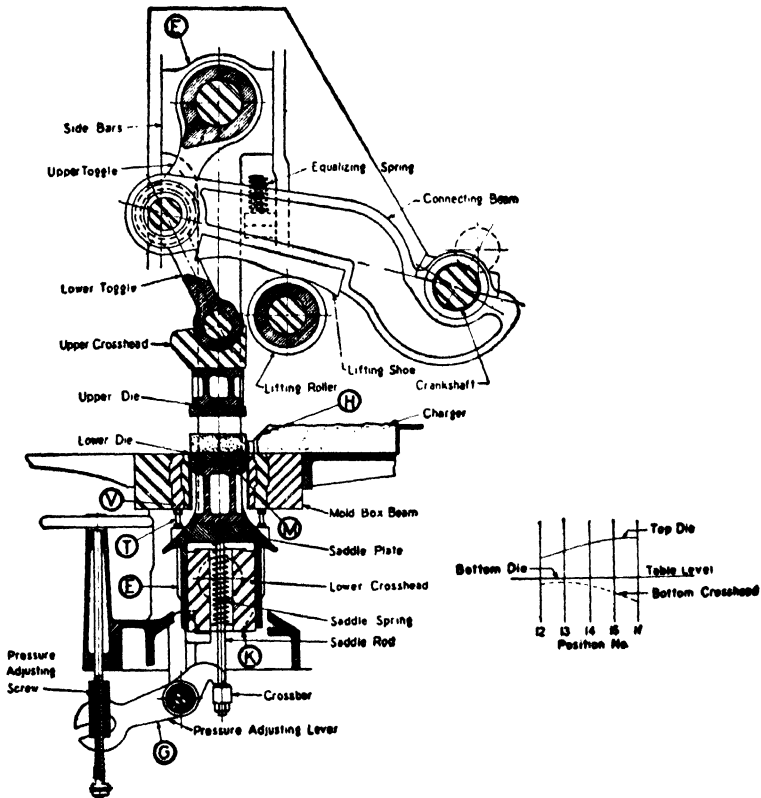

FIG. 74h. Represents position No. 14. The crosshead *K* at No. 14 has passed its highest point. The lower die *M* has been raised to table level where it is stopped by bolts *T* striking mold-box beams *V*. The charger *H* at this point has begun to remove the finished brick. The downward motion of the side bars *E* and crosshead *K* has lowered the pressure-adjusting mechanism *G*.

into place. The stud bolt is used to keep the rubber retaining cup in position, but the retaining ring and aluminum container are removed.

The rubber mold assembly consisting of the rubber wall form, the refractory powder, the rubber retaining cup, the steel mandrel, and stud bolt are now ready for loading into the hydrostatic chamber by a screw eye attached to the top of the stud bolt.

The hydrostatic chamber (Fig. 77) consists of a heavy steel-walled cylinder equipped with a self-sealing plunger, as suggested by Dr.

Bridgeman at Harvard, consisting of a two-piece plunger and a neoprene washer between three triangular-section brass rings. Water, with rust inhibitor added, is put in the chamber with the rubber mold assembly, and the plunger is inserted. As load is applied to the plunger by a hydraulic press, some of the air entrapped in the cavity is allowed to

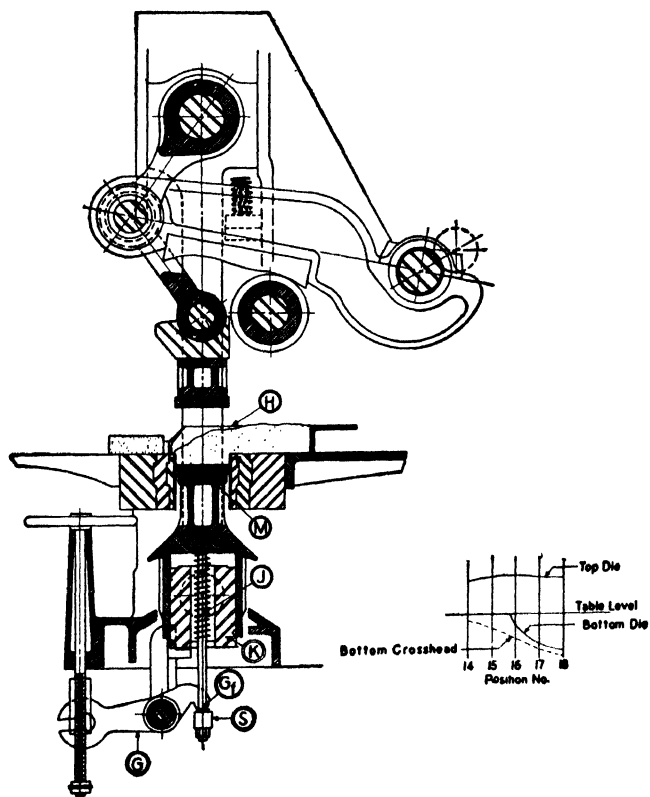
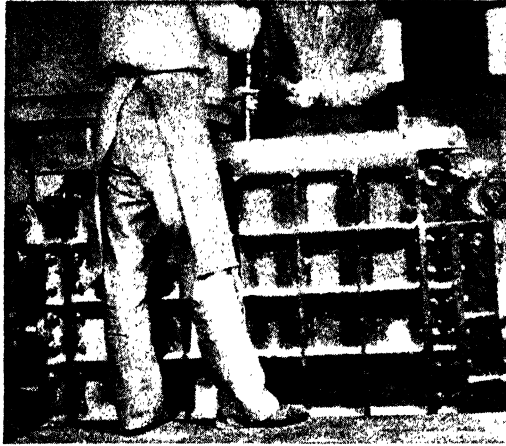

Fig. 74*i*. Represents position No. 16. At position No. 16 the crosshead *K* has continued to move downward taking with it the pressure-adjusting mechanism *G* until point *G*₁ comes in contact with saddle bar *S* and starts to compress saddle springs *J*. The setting of the pressure-adjusting mechanism decides the length of movement of the lower die *M* and allows the mold box to be filled to the desired depth. The charger *H* has further removed the finished brick and has started to fill the mold with loose material.

squeeze out between the plunger and the accurately honed bearing surface of the chamber. As more load is applied, the neoprene washer is deformed and is forced against the cylinder surface. At a very high pressure the brass rings tend to expand and, essentially, reinforce the neoprene seal. In general, pressures of 100,000 psi are used for the hydrostatic pressing operation. After pressing, the load is released, the plunger disassembled and removed, and the rubber mold assembly is lifted from the chamber,

(a)



a. Air ramming.

(b)

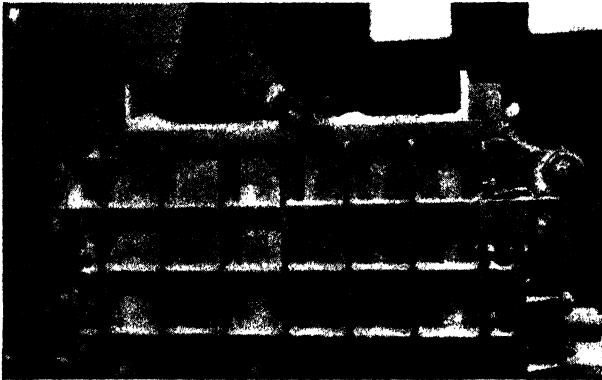

b. Cutting off the top.

(c)



c. Finishing the top.

FIG. 75. Making a large tile



(d)

d. Finished block.

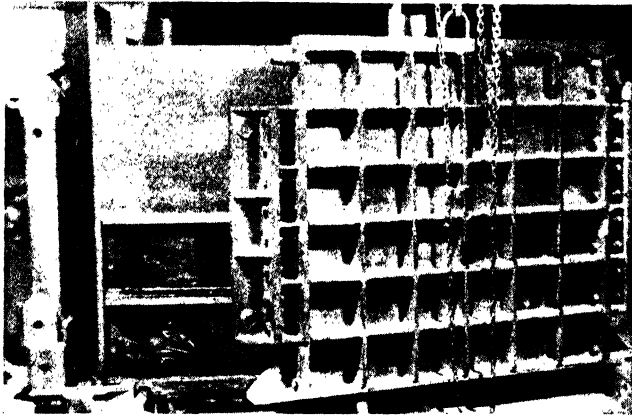

(e)

e. Removing the mold.

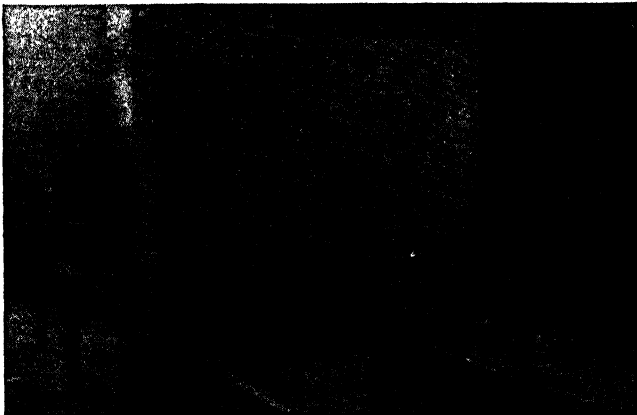

(f)

f. Block ready for drying.

with a low water-content mix.

dried, and, in turn, dismantled. If the surface of the mandrel is smooth, the refractory body can be removed easily and, surprisingly enough, is strong for handling even though no bond is used. On firing, the shrinkage is very uniform, so that any tendency to crack or distort is minimized.

7. Molding of Insulating Firebrick. The production of highly porous, lightweight refractories requires somewhat different methods from that employed for the heavier materials. Therefore, it was thought advisable to devote a special section to the molding of this product. An excellent review of this subject is given by Foster.⁽¹²⁵⁾

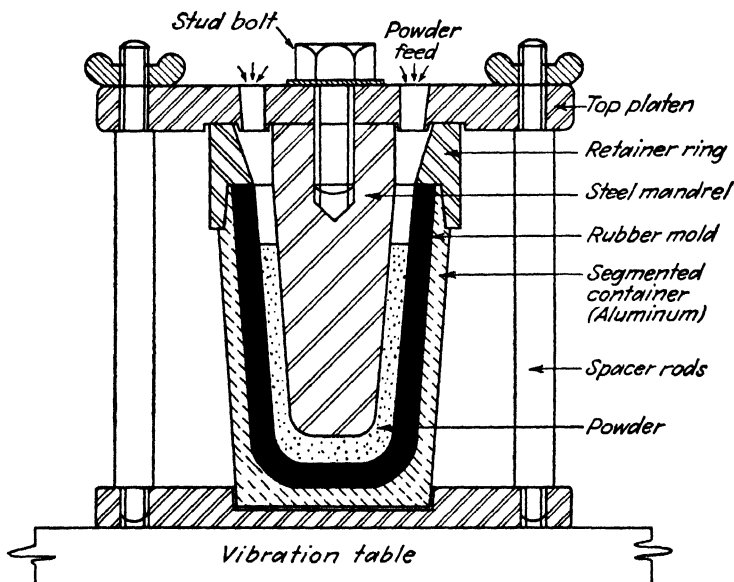

FIG. 76. Method of charging rubber molds.

Method of Obtaining Pores. Perhaps the most common method of producing pores in a fireclay product is to introduce in the plastic mix an organic material that later on can be burned out to leave voids. Sometimes this organic material may be peat, which is naturally mixed with the fireclay, but usually it is necessary to add granular organic material such as ground wood, cork, or other materials of this type. Of course, the properties of the finished product will depend not only on the clay but on the size, shape, and amount of the organic particles.

A somewhat different method of producing pores consists in adding to the clay mix granular sublimable material such as flake naphthalene.⁽¹²¹⁾ When the ware is dried at high temperature, the naphthalene can be sublimed, leaving pores in the dried-clay product. The naphthalene vapor

can be cooled and used over again. Although this process has been employed industrially, it is not in common use at the present time.

Still another method of forming the pores in the clayware is to introduce into the clay, which has been made to the consistency of a thick slip, bubbles of gas that are sufficiently stable to remain in the mix until the

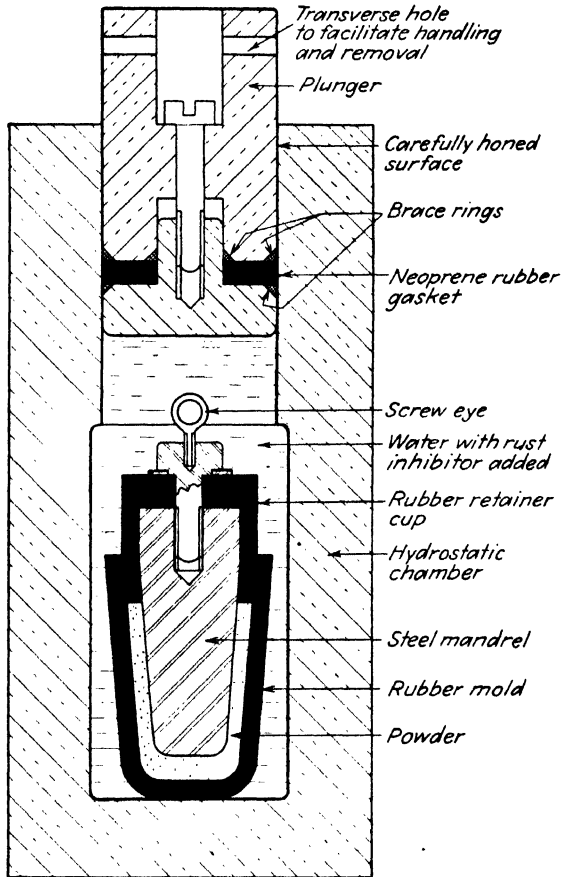

FIG. 77. Hydrostatic chamber for molding.

material is dried and burned. This method seems very attractive, as the cost of the organic material is eliminated; but practically, difficulties are encountered in stabilizing the bubbles so that they are of uniform fine size and evenly distributed throughout the mass. The method patented by Eriksson⁽¹²⁰⁾ produces bubbles in the clay mix by the addition of powdered aluminum or zinc and alkali so that each particle of aluminum is decomposed and forms a bubble of hydrogen. Others accomplish the same effect by stirring finely divided lime into the soft mix and then acidifying, with

the result that each particle of lime is decomposed, forming a bubble of carbon dioxide. Still another method, such as those patented by Ericson⁽¹¹⁹⁾ and Roos,⁽¹²⁴⁾ consists in making a preformed foam, which is then stirred into the clay slip. Such a foam, of course, has to have considerable stability in order that this process may be successful.

All the bubble-structure refractories must have some stabilizing device to hold the bubbles as individuals and prevent their coalescing into larger ones. In the Husain and Bole⁽¹²²⁾ patents, this is accomplished by adding gypsum plaster to the mix and permitting it to set, thus stabilizing the bubbles. In fact, there is probably no successful bubble process that does not use some stabilizing method, either plaster or a flocculent;⁽¹²³⁾ and for this reason, it is difficult, because of the fluxing elements added, to make high-temperature insulating firebrick by the bubble process.

A high porosity can also be obtained by adding to the mix an inorganic refractory material having itself a high porosity. Such materials include diatomaceous earth, bloated clay pellets, or porous grog.

Molding Methods. The molding of the insulating firebrick mixes is not particularly difficult, as the mixtures containing organic matter can be readily molded by the soft-mud method, whereas the bubble method is best carried out by pouring the slip into molds until the mass has set. Use of the stiff-mud or dry-press method for these highly porous materials is difficult; for if they contain organic matter, they are usually rather elastic and difficulties from pressure cracking are troublesome. On the other hand, if the bubble process is used, any considerable amount of pressure would squeeze the air out of the structure and the density would be too high.

Chesters⁽¹²⁶⁾ *et al.* describe the forming of basic insulating brick.

TABLE 23. USE OF WEAR-RESISTING METALS

| | Pug knives | Auger dies | Muller tires | Dry-press pads | Dry-press liners |
|----------------------------------|------------|------------|--------------|----------------|------------------|
| "Ni-hard"..... | × | | | | |
| High-chrome steel..... | | | | × | |
| White cast iron..... | × | × | × | × | × |
| Tool steel..... | | | | × | × |
| Stellited steel..... | | | | × | × |
| Tungsten carbide..... | | × | | | |
| Chrome moly steel (heat-treated) | | | × | | |

8. Abrasion-resisting Metals. In the stiff-mud and dry-press process previously mentioned, numerous metal parts receive considerable wear as

a result of the abrasive action of the grog particles in the mix. These parts include the mullers of the wet and dry pan, the blades of pug mills and augers, auger dies, and the die boxes of re-presses and dry presses. Table 23 gives a summary of a number of wear-resisting metals that have been used.⁽⁸⁶⁾ There is, however, at present no great uniformity in the use of these materials, as some plants will obtain better life with one and some plants with another, owing, perhaps, to the differences in their mixes. A great deal of development work is still to be done in this field.

Dry-press and re-press die wear depends greatly on the mix. One hundred million bricks can be produced from plastic and flint clay in a set of liners; but when high-grog clay bricks or highly burned magnesite or chrome are used, the life may drop to as low as 5,000 bricks.

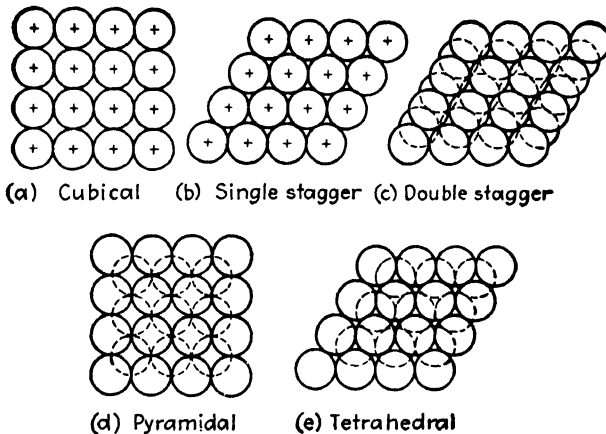

FIG. 78. Various methods of packing spherical particles.

9. Grog Sizing. The manufacturer of refractories is coming more and more to realize the importance of maintaining consistency of particle sizes of the grog or flint clay portion of his mix, especially where he has to make a low-porosity or low-shrinking refractory or an unburned refractory with a chemical bond. It has also been found that proper sizing helps the spalling resistance. Some manufacturers are going so far as to divide their particles by screens into a series of size fractions and then are recombining them by definite weights to produce the desired distribution. Others control size by proper adjustments of screens and crushers.

If the one-component system is considered first, *i.e.*, particles having a single diameter, it will be found that the closeness of packing depends on the arrangement of particles and their shapes. Taking the simplest case, *i.e.*, spheres, there are five different methods of packing, which are shown in Fig. 78 and the results given in Table 24.

In the case of irregular particles as would be obtained from a crusher, the packing varies between 40 and 50 per cent, although theoretically, with perfectly arranged cubes, the voids would be zero.

TABLE 24. VOIDS WITH DIFFERENT METHODS OF PACKING⁽¹²⁸⁾

| Type of packing of spheres, in Fig. 78 | Voids, per cent |
|---|--------------------|
| Cubical..... | 47.64 |
| Single stagger (cubical tetrahedral)..... | 39.55 |
| Double stagger..... | 30.20 |
| Pyramidal..... | 25.95 |
| Tetrahedral..... | 25.95 |

Consider next, the two-component system wherein a coarse grain and a fine grain are mixed and shaken down to the minimum volume; the clearest picture of the situation can be obtained by referring to the packing diagram of Westman^(28,139) shown in Fig. 79. Along the base is plotted the

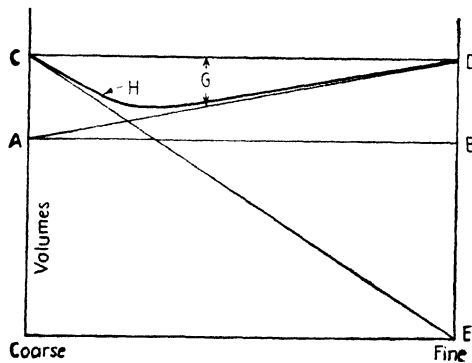

FIG. 79. Packing diagram for two sizes of particles.

proportion of coarse and fine in the mix, giving a constant total weight. On the vertical scale are plotted volumes. A line *AB* represents the true volume of the mixture. Point *C* represents the apparent volume of the coarse mix, and *D* the apparent volume of the fine mix, the apparent volume being the true volume plus the volume of voids. Now suppose that a small proportion of the coarse material is replaced by fine material. It is obvious that up to a certain point, the fines will simply fill the voids between the larger grains and therefore the total apparent volume will decrease in proportion to the amount of fines added. Accordingly, the theoretical apparent volume will follow the curve *CE*. Now starting from the other end of the diagram, if a certain amount of the fine material is replaced by the coarse, the coarse material will displace an equal volume of fine material and the voids existing in the fines. Therefore the total volume will decrease owing to an elimination of a portion of the voids in

the finer material. Consequently, the line *AD* will represent the theoretical apparent volumes. Where the lines *CE* and *AD* cross will be the minimum volume from a mixture of coarse and fine having an infinite ratio between the diameters. Actually, however, we have a finite ratio, and the actual curve of apparent volume will be indicated by *H*. The line *CD* is the apparent volume of the fractions before mixing, and the distance *G* represents the shrinkage in volume during the mixing process.

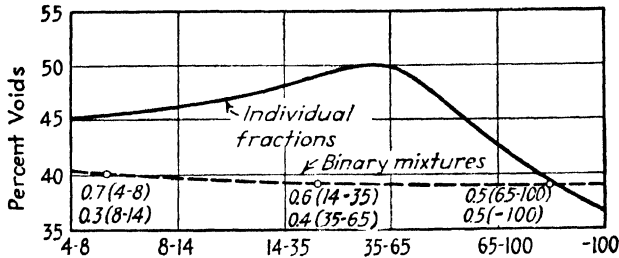

FIG. 80. Porosity diagram for crushed kaolin grog; individual fractions and binary mixtures. (*J. Am. Ceram. Soc.*)

Results obtained on crushed kaolin grog are given in Fig. 80 where are shown individual screened fractions and binary mixtures of these fractions mixed to give the densest packing.

When we come to systems of three components, the apparent volume can be indicated by surfaces. It will be found, however, that from practical considerations, little is gained by using more than two or three components in the mixture because of the impossibility of getting large-

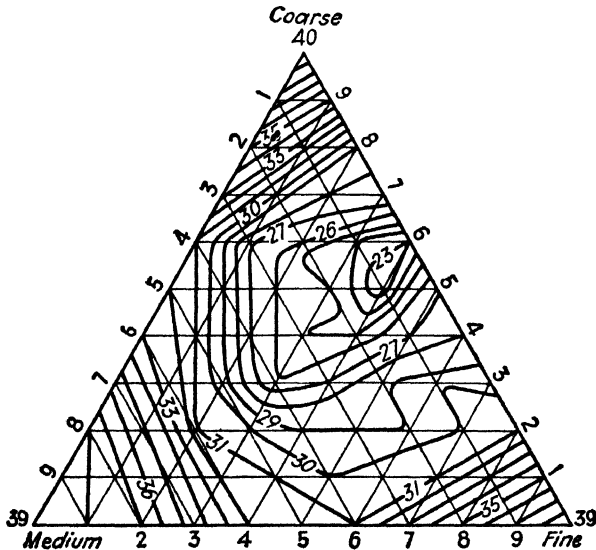

FIG. 81. Porosity diagram for crushed kaolin grog; ternary mixtures. (*J. Am. Ceram. Soc.*)

diameter ratios between the successive sizes. Figure 81 shows a three-component diagram for the crushed kaolin grog of Fig. 80. The densest mix has a proportion of 40 per cent fine, 50 per cent coarse, and 10 per cent medium, giving a porosity of 22 per cent.

10. Chemical Bonding. A great deal of interest has been shown recently in refractories that are chemically bonded with a setting material, which gives to the brick sufficient mechanical strength so that it can be used in the furnace without previous burning. In order to do this, it is necessary to have a large proportion of well-fired nonplastic material in the brick and have it sized in such a way as to give a very dense packing. In addition, the bricks must be pressed under high enough pressure to reduce the voids as far as possible. Bricks of this type have been made of magnesite, chrome, and fireclays.

One type of bond consists of magnesium chloride or magnesium oxychloride, used generally with a magnesite or chrome base. The patent of France^(144,145) is typical of this type. Another bond is phosphoric acid, which has been used with a zirconia base according to the patent of Morgan^(151,158) and with an aluminous material in the patent of Hood.⁽¹⁵³⁾ Bonds have also been suggested, such as silicate of soda⁽¹⁴⁹⁾ and a soluble aluminum salt, according to the patent of Betts.⁽¹⁴⁸⁾ However, one difficulty with the use of soluble salts is their migration to the surface on drying.

A great many organic types of bonds have been suggested. A synthetic resin bond is indicated in the patent of Danehower,⁽¹⁴⁶⁾ and Schwartzwalder⁽¹⁵⁷⁾ suggests the use of bakelite. Aluminum formate is used for bonding silica-alumina materials by Rohde.⁽¹⁶¹⁾ Methyl silicate has also been suggested in a number of occasions as a bond for silica-alumina refractories, since a colloidal silica having considerable strength is precipitated. Other organic materials such as linseed oil and sulfide waste liquor⁽¹⁵⁹⁾ have been suggested. For lower temperature refractories, it is possible to use a high-alumina cement.

In looking over the list of bonds, it will be noted that many of them are at present too expensive for use anywhere except in laboratory-type refractories. Others have some practical difficulties; *e.g.*, the phosphoric acid is so hygroscopic and so hazardous to the health of workmen that it has operating difficulties. Probably the most useful bonds at present are the magnesium oxychloride, sulfate waste, and high-alumina cement.

The chemically bonded refractories in some types of service give results superior to the burned refractories, especially in resistance to spalling; consequently, they have definitely taken a place in our refractory production. Of course, the first thought on considering this type of refractory is the great saving in firing cost; but when the problem is analyzed, it is

usually found that with the additional cost of the bond and the necessity for carefully sizing the nonplastic, which comprises practically the whole brick, the total cost is little, if any, less than for the burned brick.

11. Hot Molding. The suggestion has been put forth from time to time of producing refractories by pressing the heated refractory material in the mold so that the bonding would take place by welding together the particles while they were sufficiently hot to have a certain amount of glass in the viscous condition. Such a method is suggested in the patent of Duffield.⁽¹⁶⁶⁾ Many experimenters have shown that a comparatively strong brick can be made at a temperature much below the burning temperature if pressure is exerted. However, this attractive process of molding refractories has not proved commercially successful because of the great difficulty in providing molds that will operate at the high temperatures necessary and still give a reasonable amount of life. Special refractories such as boron carbide are hot pressed, a process described in Chap. VIII.

12. Bibliography

Plasticity and Workability of Clays:

1. BLEININGER, A.V., and D.W. ROSS: The Flow of Clay under Pressure, *Trans. Am. Ceram. Soc.*, **16**, 392, 1914.
2. BINGHAM, E.C.: An Investigation of the Laws of Plastic Flow, *Natl. Bur. Standards, Sci. Paper 278, Bull. 13*, p. 309, 1916.
3. MELLOR, J.W.: On the Plasticity of Clay, *Trans. Ceram. Soc. (Engl.)*, **21**, 91, 1921.
4. BINGHAM, E.C.: "Fluidity and Plasticity," McGraw-Hill Book Company, Inc., New York, 1922.
5. HALL, F.P.: Methods of Measuring the Plasticity of Clays, *Natl. Bur. Standards, Paper 234*, 1923.
6. BIGOT, A.: Plasticity of Ceramic Materials, *Brit. Clayworker*, **32**, 71, 1923.
7. PFEFFERKORN, K.: The Plasticity of Clays and Kaolins, *Sprechsaal*, **58**, 183, 1925.
8. RIEKE, R., and E. SEMBACK: Plasticity Determinations of Kaolins and Clays, *Trans. Ger. Ceram. Soc.*, **6**, 111, 1925.
9. TERZAGHI, C.: Principles of Soil Mechanics: (1) Phenomena of Cohesion of Clay, *Eng. News-Record*, **95**, 742, 1925.
10. VON BARANOFF, A.: Uber die Plastizität des Thones, *Z. tech. Physik*, **7**, 191, 1926.
11. SALMANG, H., and A. BECKER: Die Rolle des Wassers bei der Verformung der Tone, *Sprechsaal*, **59**, 389, 1926.
12. SALMANG, H., and A. BECKER: Effect of Water on the Workability of Clays, *Sprechsaal*, **59**, 389, 1926.
13. TALWALKAR, T.W., and C.W. PARMELEE: Measurement of Plasticity, *J. Am. Ceram. Soc.*, **10**, 670, 1927.
14. COHN, W.M.: Des Auftreten des Plastischen Zustandes und Versuche zu seiner Deutung, *Keram. Rundschau*, **36**, 771, 873, 1928.

15. NUTTING, P.G.: The Deformation of Granular Solids, *J. Wash. Acad. Sci.*, **18**, 123, 1928.
16. SIMON, A., and W. VETTER: Plasticity of Clay, *Ber. deut. keram. Ges.*, **9**, 216, 1928.
17. McDOWELL, S.J.: Notes on a Method for Determination of Workability of Plastic Clays, *J. Am. Ceram. Soc.*, **11**, 99, 1928.
18. COHN, W.M.: Untersuchungen über die Verarbeitbarkeit von Tonen im plastischen Zustand und über das Auftreten eines kritischen Punktes, *Ber. deut. keram. Ges.*, **10**, 245, 1929.
19. COHN, W.M.: Methods of Determining Numerical Values for the Plasticity of Clays and Ceramic Bodies, *Keram. Rundschau*, **37**, 69, 1929.
20. WESTMAN, H.E.R.: The Capillary Suction of Some Ceramic Materials, *J. Am. Ceram. Soc.*, **12**, 585, 1929.
21. HIND, S.R.: The Plasticity of Clay, I, *Trans. Ceram. Soc. (Engl.)*, **29**, 177, 1930 (Memorial Section).
22. HIND, S.R., and E.P. DEGG: The Plasticity of Clay, II, *Trans. Ceram. Soc. (Engl.)*, **29**, 208, 1930 (Memorial Section).
23. PHELPS, S.M., and C.G. DENNEY: Experiments in Weathering Plastic Fire Clays, *J. Am. Ceram. Soc.*, **14**, 319, 1931.
24. COHN, W.M.: Method of Testing the Workability of Clays and Ceramic Bodies, *Tonind.-Ztg.*, **55**, 238, 1931.
25. GRUNER, E.: Adsorption Systems of Kaolins and Clays with Liquids in Relation to the Phenomenon of Plasticity, *Z. anorg. allgem. Chem.*, **215**, 1, 1933.
26. ENDELL, K., U. HOFMANN, and D. WILM: Nature of Ceramic Clays, *Ber. deut. keram. Ges.*, **14**, 407, 1933.
27. FREUNDLICH, H.: Structures and Forces in Colloidal Systems, *Proc. Roy. Inst.*, **29**, 232, 1936.
28. MARSHALL, C.E.: Chemical Constitution as Related to the Physical Properties of the Clays, *Trans. Ceram. Soc.*, **35**, 401, 1936.
29. ISOMATSU, R.: The Relationship between the Grain-size and Plasticity of Ceramic Bodies, *Repts. Imp. Ceram. Expt. Inst.*, **11**, 13, 1936.
30. WILSON, E.O.: The Plasticity of Finely Ground Minerals with Water, *J. Am. Ceram. Soc.*, **19**, 115, 1936.
31. HYSLOP, J.F.: A Plasticity Diagram for Clays, *Trans. Ceram. Soc. (Engl.)*, **35**, 247, 1936.
32. HAUSER, E.A., and C.E. REED: Thixotropic Behaviour and Structure of Bentonite, *J. Phys. Chem.*, **41**, 911, 1937.
33. HOUWINK, R.: "Elasticity, Plasticity, and Structure of Matter," Cambridge University Press, London, 1937.
34. MARSHALL, C.E.: Colloidal Properties of Clays as Related to Their Crystal Structure, *J. Phys. Chem.*, **41**, 935, 1937.
35. PETERSEN, W.: Experiments on Varying the Plasticity of Kaolins, *Ber. deut. keram. Ges.*, **18**, 299, 1937.
36. WHITTEMORE, J.W., and F.W. BULL: Method for Improving the Physical Properties of Clays, *J. Am. Ceram. Soc.*, **20**, 261, 1937.
37. CASSAN, H., and A. JOURDAIN: Contribution to the Experimental Study of the Plasticity of Clays, *Céramique*, **40**, 117, 1937.
38. American Society for Testing Materials, Tentative Standard E24-37T, 1937.
39. WINKLER, H.G.F.: Thixotropy of Mineral Powders of Microscopic Size, *Kolloid-Beihfte*, **48**, 341, 1938.

40. NORTON, F.H.: An Instrument for Measuring the Workability of Clays, *J. Am. Ceram. Soc.*, **21**, 33, 1938.
41. ANON.: "Second Report on Viscosity and Plasticity," Nordemann Publishing Co., New York, 1938.
42. GOODEVE, C.F.: A General Theory of Thixotropy and Viscosity, *Trans. Faraday Soc.*, **35**, 342, 1939.
43. HARMAN, C.G.: Physical and Chemical Characteristics of Clays Related to Their Working Properties, *Brick*, **94**, 26, 1939.
44. HELZ, A.W.: Viscosity Study of Dickite Suspensions, *J. Am. Ceram. Soc.*, **22**, 289, 1939.
45. ROLLER, P.S.: Plasticity and Plastic Flow of Dispersions, *J. Phys. Chem.*, **43**, 457, 1939.
46. WHITTAKER, H.: Effect of Particle Size on Plasticity of Kaolinite, *J. Am. Ceram. Soc.*, **22**, 16, 1939.
47. STULL, R.T., and P.V. JOHNSON: Relation between Moisture Content and Flow-point Pressure of Plastic Clay, *Natl. Bur. Standards, Research Paper RP1186*, 1939.
48. GRAHAM, R.P., and J.D. SULLIVAN: Workability of Clays, *J. Am. Ceram. Soc.*, **22**, 152, 1939.
49. NORTON, F.H., A.L. JOHNSON, and W.G. LAWRENCE: Fundamental Study of Clay: VI, Flow Properties of Kaolinite-Water Suspensions, *J. Am. Ceram. Soc.*, **27**, 149, 1944.
50. COFFYN, J.E., and G.W. SCOTT BLAIR: Significance of the Power-Law Relations in Rheology, *Nature*, **155**, 171, 1945.
51. HEDVALL, J.A., B. LUNDIN, and F. SANFORD: Increasing the Plasticity of Lean Clays by Additions, *Trans. Brit. Ceram. Soc.*, **45**, 211, 1946.
52. BOSWORTH, R.C.L.: A Definition of Plasticity, *Nature*, **157**, 447, 1946.
53. WILLIAMSON, W.O.: Some Observations on the Behavior of Water in Ceramic Materials, *Trans. Brit. Ceram. Soc.*, **46**, 77, 1947.
54. PRAGER, W.: An Introduction to the Mathematical Theory of Plasticity, *J. Applied Phys.*, **18**, 375, 1947.
55. NORTON, F.H.: Fundamental Study of Clay, VIII, A New Theory for the Plasticity of Clay-water Masses, *J. Am. Ceram. Soc.*, **31**, 1948.

Casting:

56. BLEININGER, A.V., and M.R. HORNUNG: Notes on Casting, *Trans. Am. Ceram. Soc.*, **17**, 330, 1915.
57. WRIGHT, J.W., and D.H. FULLER: Note on the Casting of Porcelain Glass Pots, *J. Am. Ceram. Soc.*, **2**, 659, 1919.
58. SCRIPTURE, E.W., JR., and E. SCHRAMM: The Deflocculation of Clay Slips and Related Properties, *J. Am. Ceram. Soc.*, **9**, 175, 1926.
59. TAYLOR, W.A.: Hydrogen-ion Control in Ceramics, *J. Am. Ceram. Soc.*, **10**, 243, 1927.
60. SHEARER, W.L.: The Requisite Consistency for a Casting Slip, *J. Am. Ceram. Soc.*, **11**, 542, 1928.
61. HALL, F.P.: The Casting of Clay Ware: A Résumé, *J. Am. Ceram. Soc.*, **13**, 751, 1930.
62. WHITLATCH, G.L.: Suggested Relations of Sodium Silicate, Adhesion Tension and Angle of Contact to Liquid Absorption in Clays, *J. Am. Ceram. Soc.*, **14**, 145, 1931.

63. BARTELL, F.E., and H.J. OSTERHOF: Adhesion Tension: Pressure of Displacement Methods, *J. Phys. Chem.*, **37**, 543, 1933.
64. PLOTNIKOV, W.A., and E.M. NATANSSON: Effect of Soluble Phosphates on Viscosity of Kaolin Suspensions, *Zhur. Priklad. Khim.*, **6**, 839, 1933.
65. WEBB, H.W.: Alkaline Casting Slip, Part I, *Trans. Ceram. Soc. (Engl.)*, **33**, 129, 1934.
66. SCHRAMM, E., and F.P. HALL: Notes on Casting Slip, *J. Am. Ceram. Soc.*, **17**, 262, 1934.
67. RICHARDSON, H.K.: Small Cast Thorium Oxide Crucibles, *J. Am. Ceram. Soc.*, **18**, 65, 1935.
68. BAR, A.L.S., and H.J.C. TENDELOO: Double Layer of Clay Colloids, *Kolloid-Beihefte*, **44**, 97, 1936.
69. LARIN, G.B.: Influence of Adsorbed Bases on the Structural Formation of Clay Suspensions (preliminary report), *Zhur. Fiz. Khim.*, **8**, 790, 1936.
70. TRAXLER, R.N., H.E. SCHWEYER, and L.R. MOFFATT: Viscosities of Liquid-Solid Systems, *Ind. Eng. Chem.*, **29**, 489, 1937.
71. KEPPELER, G., and H. SCHMIDT: On the Liquefaction and Temporary Stiffening of Clay Slips, *Sprechsaal*, **70**, 221, 235, 247, 259, 269, 285, 297, 1937.
72. BROUGHTON, G., and C.S. WINDEBANK: Agglomeration and Viscosity in Dilute Suspensions, *Ind. Eng. Chem.*, **30**, 407, 1938.
73. STOTT, V.M.: Gas-tight Sintered Alumina Ware, *Trans. Ceram. Soc. (Engl.)*, **37**, 346, 1938.
74. ROBINSON, J.R.: Viscosity of Colloids, I, Anomalous Viscosity of Dilute Suspensions of Rigid Anisometric Particles, *Proc. Roy. Soc.*, **170A**, 519, 1939.
75. HEPPLEWHITE, J.W.: Use of an Ammoniacal Electrolyte for a Plastic Body, *Bull. Am. Ceram. Soc.*, **18**, 191, 1939.
76. HAUSER, E.A., and S. HIRSHON: Behavior of Colloidal Suspensions with Electrolytes, *J. Phys. Chem.*, **43**, 1015, 1939.
77. JOHNSON, A.L., and F.H. NORTON: Fundamental Study of Clay II, Mechanism of Deflocculation in the Clay-Water System, *J. Am. Ceram. Soc.*, **24**, 189, 1941.
78. JOHNSON, A.L., and F.H. NORTON: Fundamental Study of Clay, III, Casting as a Base Exchange Phenomenon, *J. Am. Ceram. Soc.*, **25**, 337, 1942.
79. HEINDL, R.A., G.B. MASSENGALE, and L.G. COSSETTE: The Slip Casting of Clay Pots for the Manufacture of Optical Glass at the National Bureau of Standards, *Glass Ind.*, **27**, 177, 1946.
80. LEDUC, ROBERT: Tank Block Cast in a Vacuum, *Rev. matériaux construction trav. publ.*, No. 367, p. 71, 1946.

Soft-mud Method:

81. NORTON, C.L.: Machine for Making Molded Shapes from Refractory Material, U.S. Patent 1,523,830, 1925.
82. BALES, C.E.: Hand-made Repressed Fire Brick, *Brick & Clay Record*, **69**, 125, 1926.
83. RUFF, O., and A. RIEBETH: Plastische Massen mit verschiedenen anorganischen stoffen und die Möglichkeiten ihrer keramischen Verwertung, *Z. anorg. allgem. Chem.*, **173**, 373, 1928.
84. RICHARDSON, G.B.: The Causes and Prevention of Bulging in Handmolded Refractory Shapes, *J. Am. Ceram. Soc.*, **13**, 256, 1930.
85. PHELPS, S.M.: An Outline of the Manufacture and Properties of Hand-made Brick, *Am. Refractories Inst., Tech. Bull.* 41, 1933.

86. EVERHART, J.O.: Some Special Wear-resisting Materials for Clay Machinery Parts, *J. Am. Ceram. Soc.*, **21**, 69, 1938.

Stiff-mud Method:

87. BRAND, F.: De-airing as Corrective in Drying, *J. Am. Ceram. Soc.*, **9**, 189, 1926.
88. ACKERMANN, H., and H. KNUTH: Improvements in Preparing and Molding Refractories Especially for Manufacturing Large Blocks, *Trans. Ceram. Soc. (Engl.)*, **29**, 280, 1930 (Memorial Section).
89. LOVEJOY, E., and H.E. COVAN: A Laboratory Equipment for Stiff-mud Tests, Including Exhaustion of the Air, *J. Am. Ceram. Soc.*, **14**, 533, 1931.
90. NAVIAS, L.: Extrusion of Refractory Oxide Insulators for Vacuum Tubes, *J. Am. Ceram. Soc.*, **15**, 234, 1932.
91. VAN SCHOICK, E.H.: An Outline of the Manufacture and Properties of Stiff-mud Fire Brick, *Am. Refractories Inst., Tech. Bull.* 45, December, 1933.
92. HENDERSON, C.H.: Die Design Corrects Lamination, *Brick*, **90**, 329, 1937.
93. GAREIS, F.: De-airing Heavy Clay Bodies, *Ber. deut. keram. Ges.*, **19**, 396, 1938.

Dry-press Method:

94. ANON.: Unusual Processes in Dry Pressing Fire Brick, *Brick & Clay Record*, **66**, 904, 1925.
95. HAGAR, E., and L.W. FLOOD: Manufacture and Use of Semi-dry-pressed Refractory Brick and Shapes, *Bull. Am. Ceram. Soc.*, **8**, 107, 1929.
96. BIRCH, R.E.: Forming Pressure of Dry-pressed Refractories, Part I, *J. Am. Ceram. Soc.*, **13**, 242, 1930.
97. BIRCH, R.E.: Forming Pressure of Dry-pressed Refractories, Part II, The Effect of Pressure Variations on Fired Properties, *J. Am. Ceram. Soc.*, **13**, 831, 1930.
98. RUECKEL, W.C.: Researches in Dry-press Refractories, III, The effect of Vacuum on the Unfired Properties of Some Dry-press Refractory Batches, *J. Am. Ceram. Soc.*, **14**, 764, 1931.
99. DODD, C.M., and M.E. HOLMES: A Study of the Effect of Grog on Pressure Transmission in Dry Pressing, *J. Am. Ceram. Soc.*, **14**, 899, 1931.
100. WESTMAN, A.E.R.: The Effect of Mechanical Pressure on the Imbibitional and Drying Properties of Some Ceramic Clays, I, *J. Am. Ceram. Soc.*, **15**, 552, 1932.
101. WESTMAN, A.E.R.: The Effect of Mechanical Pressure on the Imbibitional and Drying Properties of Some Ceramic Clays, II, *J. Am. Ceram. Soc.*, **16**, 6, 256, 1933.
102. HUGHES, A.C.: An Outline of the Manufacture and Properties of Power-pressed Brick, *Am. Refractories Inst., Tech. Bull.* 44, 1933.
103. WESTMAN, A.E.R.: The Effect of Mechanical Pressure on the Drying and Firing Properties of Typical Ceramic Bodies, *J. Am. Ceram. Soc.*, **17**, 128, 1934.
104. CLEWS, F.H., and A.T. GREEN: Behavior of Sillimanite Mixes on Being Pressed: II, Refractory Materials Joint Committee, Twenty-ninth Report, *Inst. Gas Engrs. Commun.* 193, p. 38, 1938.
105. DODD, C.M.: Dry Pressing for Maximum Density, *Bull. Am. Ceram. Soc.*, **17**, 465, 1938.
106. FIX, F.A.: Application of Dry Mixing in the Whiteware and Refractory Industries, *Bull. Am. Ceram. Soc.*, **17**, 351, 1938.

107. KUKOLEV, G.V., A.T. ZELENSKAYA, and Z.P. SHALOMEEV: Molding High-duty Metallurgical and Complicated Coke-oven Silica Brick by the Method of High-frequency Vibration, *Ogneupory*, No. 8, p. 510, 1937; abstracted in *Trans. Brit. Ceram. Soc.*, **42**, 26A, 1943.
108. McNAMARA, E.P., and J.E. COMEFORO: Classification of Natural Organic Binders, *J. Am. Ceram. Soc.*, **28**, 25, 1945.
109. STONE, R.L.: Binders and Shrinkage Control in Dry Pressed Steatite Porcelains, *N. C. State Coll. Eng. Exp. Sta. Bull.* 28, March, 1945.
110. COMEFORO, J.E.: Migration Characteristics of Organic Binders, *Ceram. Age*, **45**, 132, 1945.
111. BROWN, L., and L. COFFIN: Use of Polyvinyl Alcohol in Ceramics, *Ceram. Ind.*, **44**, 126, 1945.
112. SINGER, F., and F. BEKEN: Method of Bonding Ceramic Bodies, Brit. Patent 570,345, 1945.
113. TREISCHER, C.C., and E.W. EMRICH: Study of Several Groups of Organic Binders under Low-pressure Extrusion, *J. Am. Ceram. Soc.*, **29**, 129, 1946.
114. VAN HORN, H.T.: Petroleum Products in Ceramic Processing Operations, *Bull. Am. Ceram. Soc.*, **26**, 229, 1947.
115. ANON.: Notes on Vacuum Pressing under High Pressure, *Ind. Ceram.*, **376**, 220, 1947.
116. WILSON, D.L.: The Dry Process, *Refractories J.*, **23**, 304, 1947.
117. GREGORY, J.: Some Comments and Problems Relating to the Dry Press Process, *Refractories J.*, **23**, 313, 1947.
118. BOTTOMLEY, A.E.: The Dry Press Process, *Refractories J.*, **23**, 346, 1947.

Porous Bodies:

119. ERICSON, R.: Light-weight Ceramic Material and Process of Making Same, U.S. Patent 1,702,076, Feb. 12, 1929.
120. ERIKSSON, J.A.: Method of Manufacturing Porous Material from Portland Cement, U.S. Patent 1,819,018, Aug. 18, 1931.
121. MANDELL, A.J.: Making Porous Objects, U.S. Patent 1,742,515, Jan. 7, 1930, and reissue 18,506, June 28, 1932.
122. HUSAIN, T., and G.A. BOLE: Method of Producing a Cellular Clay Body, U.S. Patent 1,896,667, Feb. 14, 1933.
123. PARSONS, J.R.: Process of Treating Ceramic Material, U.S. Patent 1,954,889, Apr. 4, 1934.
124. ROOS, C.K.: Cementitious Material, U.S. Patent 2,017,022, Oct. 8, 1935.
125. FOSTER, H.D.: Manufacture of Lightweight Products, *Bull. Am. Ceram. Soc.*, **19**, 468, 1940.
126. CHESTERS, J.H., T.W. HOWIE, and T.R. LYNMAN: The Development of Basic Insulating Bricks, *Trans. Brit. Ceram. Soc.*, **56**, 349, 1947.

Particle Sizing:

127. General Refractories Co.: Refractory Brick, French Patent 699,598, 1930.
128. WESTMAN, A.E.R., and H.R. HUGILL: The Packing of Particles, *J. Am. Ceram. Soc.*, **13**, 767, 1930.
129. SKOLA, V.: The Sizes of Grains in Ceramic Bodies, *Feuerfest*, **6**, 81, 1930.
130. RIEKE, R., and J. GIETH: Study of Necessary Grain-size Composition of Grog to Develop a Maximum Density in Grog Brick, *Ber. deut. keram. Ges.*, **11**, 394, 1930.

131. ANDREASEN, A.R.M.: On the Relation between Gradation of Grains and Interspace in Products of Loose Grains, Royal Technical College of Copenhagen, *Kolloid-Z.*, **50**, 217, 1930.
132. LITZOW, K.: Condition of Grog Particles for Dense Refractory Materials, *Tonind.-Ztg.*, **49**, 709, 1931.
133. SWAIN, S.M., and S.M. PHELPS: Proportioning the Grain Size in Clay Refractories, *J. Am. Ceram. Soc.*, **14**, 884, 1931.
134. HUGILL, W., and W.J. REES: Firebricks with More than Ninety Per Cent of Grog, *Trans. Ceram. Soc. (Engl.)*, **30**, 353, 1931.
135. LUX, E., W.H. DANIELS, and E. KUHN (Koppers Co.): Method and Apparatus for Making Refractory Brick, U.S. Patent 1,937,028, 1933.
136. ERDMANN, K.: Production of Refractory Brick, U.S. Patent 2,063,543, 1936.
137. HEUER, R.P. (General Refractories Co.): High-pressure Nonplastic Refractory and Method of Making, U.S. Patent 2,068,411, 1937.
138. HEUER, R.P. (General Refractories Co.): Silica Brick and Method of Making, U.S. Patent 2,062,005, 1936.
139. WESTMAN, A.E.R.: The Packing of Particles: Empirical Equations for Intermediate Diameter Ratios, *J. Am. Ceram. Soc.*, **19**, 127, 1936.
140. CHESTERS, J.H., and L. LEE: The Grading of Coarse Refractory Aggregates, *Trans. Ceram. Soc. (Engl.)*, **36**, 377, 1937.
141. WHITE, H.E., and S.F. WALTON: Particle Packing and Particle Shape, *J. Am. Ceram. Soc.*, **20**, 155, 1937.
142. MOSER, A.: Grain-size Distribution of Refractories, *Tonind.-Ztg.*, **61**, 1069; **98**, 1083, 1937.
143. HEUER, R.P., and A.E. FITZGERALD (General Refractories Co.): U.S. Patent 2,131,252, 1938.

Chemical Bonds:

144. FRANCE, W.A.: Refractory Material, Can. Patent 219,609, 1922.
145. FRANCE, W.A.: Manufacture of Self-hardening Refractory Articles, U.S. Patent 1,451,540.
146. DANEHWOWER, F.B.: Refractory Article and Method of Making the Same, U.S. Patent 1,450,104.
147. STETTINER, CHAMOTTE: Fabrik, Process for Manufacturing Refractory and Acid-proof Ware, Ger. Patent 521,350, 1924.
148. BETTS, A.G.: Making Refractory Articles and the Like, U.S. Patent 1,533,689, 1925.
149. United States Metals Refining Co.: Refractory Articles, Brit. Patent 276,016, 1927.
150. SCHLOTTERER, G.K., and R.H. YOUNGMAN: Unfired Refractory Brick, U.S. Patent 1,643,181, 1927.
151. MORGAN, J.D.: Refractory, U.S. Patent 1,809,249, 1931.
152. Corning Glass Works: Refractory Pieces, French Patent 716,730, 1931.
153. HOOD, H.P. (Corning Glass Works): Refractory Articles, Can. Patent 324,332, 1932.
154. ACKERMANN, H.: Producing Refractory, Acid-proof, and Other Ceramically Bonded Products, U.S. Patent 1,856,613, May 3, 1932.
155. Austenal Laboratories, Inc.: Refractory Material, French Patent 763,464, 1934.
156. CAVEN, T.M. (Corning Glass Works): Refractory Article, U.S. Patent 1,949,038, 1934.

157. SCHWARTZWALDER, K. (General Motors Corp.): Refractory Body, Can. Patent 362,445, 1936.
158. MORGAN, J.D., and R.E. LOWE (Doherty Research Co.): High Temperature Refractory, U.S. Patent 2,061,099, 1936.
159. STRELETS, V.M., and V.V. RADIN: Possibility of Increasing the Mechanical Strength of Raw Brick by Means of Sulfitic Waste Liquor, *Ogneupory*, **5**, 657, 1937.
160. MELNIKOV, F.I.: Production and Service of Unfired Grogless Refractories from Dsekh Rock, *Ogneupory*, **6**, 1540, 1938.
161. ROHDE, W. (Julius Pintsch Kom.-Ges.): Producing Ceramic Cast Objects and Coverings, Ger. Patent 670,231, 1938.
162. KLYUCHAREV, YA.V., and S.A. LEVENSHITEIN: Unfired Magnesite Brick, *Trudy Vsesoyuz. Inst. Ogneuporov*, **15**, 3, 1938.
163. ANON.: Action of Magnesium and Aluminum Salts as Binders for Refractories, *Brick & Clay Record*, **103**, 43, 1943.
164. SHAW, C., and C. MARSDEN: Developments in the Application of Silica Esters, II, *Ind. Chem.*, **22**, 61, 1946.
165. PERRY, J.S.C., and A.T. PRINCE (Canadian Refractories, Ltd.): Refractory Material for Furnace Linings, Can. Patent 438,046, 1946.

Hot Molding:

166. DUFFIELD, F.L.: Manufacture of Refractory Bricks, etc., from Dolomite or Other Material Possessing Plasticity at High Temperatures, Brit. Patent 223,616, *Brit. Cast Iron Research Assoc. Bull.* **7**, 1925.
167. SALMANG, H., and F. GOETH: Refractory Bodies, Ger. Patent 474,415, 1927.

General:

168. STOVER, E.C.: Bacteria in Clay Mixtures, *Trans. Am. Ceram. Soc.*, **5**, 358, 1903.
169. HUGILL, W., and W.J. REES: The Influence of Exposure on the Chemical and Physical Properties of Certain Fireclays, *Trans. Ceram. Soc. (Engl.)*, **24**, 42, 1924.
170. WESTMAN, A.E.R., and W.H. PFEIFFER: A Comparison of the Uniformity of Strength and Texture of Fire Brick Made by Different Processes, *J. Am. Ceram. Soc.*, **9**, 626, 1926.
171. SMITH, W.O., *et al.*: Packing of Homogeneous Spheres, *Phys. Rev.*, **34**, 1271, 1929.
172. EVERHART, J.O.: Power Consumption in Clay Plant Operation, *J. Am. Ceram. Soc.*, **14**, 669, 1931.
173. GLICK, D.P.: The Microbiology of Aging of Clays, I, *J. Am. Ceram. Soc.*, **19**, 169, 1936.
174. BAKER, D.R., and D.P. GLICK: II, Sterilization Effects on Properties of Clays, *J. Am. Ceram. Soc.*, **19**, 209, 1936.
175. GLICK, D.P.: III, The effects of Various Treatments upon the Aging of a Ceramic Body, *J. Am. Ceram. Soc.*, **19**, 240, 1936.
176. SEIL, G.E.: The Manufacture of Refractories and Information Concerning Their Use in the Iron and Steel Industry of Western Germany, P.B. 37804, 1946.
177. KAMM, R., M. STEINBERG, and J. WULFF: Plastic Deformation in Metal-powder Compacts, American Institute of Mining and Metallurgical Engrs., New York Meeting, March, 1947.

CHAPTER VII

DRYING

1. The Mechanism of Drying. The work of Sherwood^(4,5,8) and his collaborators has done much to give a clear picture of the drying process in porous solids. It is logical to divide the drying into two periods: the constant-rate period and the falling-rate period.

The Constant-rate Period. At the start of the drying process, when the clay contains enough water at least to fill the pores, there will be a continuous film of water over the surface particles, as evidenced by the comparatively dark color of the wet clay. It is therefore not unexpected to find that the rate of drying per unit area of surface is substantially the same as for a free water surface. This rate in terms of temperature, humidity, and velocity of the air is shown in Fig. 82. As the drying proceeds at this rate, it is obvious that water must travel through the pores toward the surface to supply the evaporation loss. In all but exceptional cases, where the drying rate is very high or the clay very fine grained, the water will travel by capillary forces as fast as it is carried away. In the case of clay, the piece will shrink in volume equivalent to the volume of water lost until the particles touch, and thereafter air must enter the pores to take the place of the water. Soon after this happens, it will be found that the water cannot travel to the surface fast enough to maintain an unbroken surface film; so the drying rate starts to decrease. This rather sharply defined point may be called the "critical point" and corresponds approximately to cessation of shrinkage.

It might be thought that a nonshrinking material like sand and water would not show any constant-rate period because the pores would start to empty at once. Experiments show this to be true when the particles are fine; but when the particles are coarse, the resistance to flow is so slight that even with air in the pores, the surface drying rate is the governing factor. This is shown clearly in Fig. 83 for a fine and coarse sand.

The Falling-rate Period. Beyond the critical point, the drying rate is governed by the rate of transfer of water from the interior to the surface and rapidly becomes less as the drying proceeds. It is believed that beyond the critical point, the continuous surface film is broken and the water surface recedes into the capillaries, giving the light color to the clay at this stage. As the drying proceeds, more and more of the water is converted

inside the structure into vapor, making it necessary for this to travel out through the nearly empty capillaries to the surface.

In Fig. 84, an attempt has been made to show how an enlarged section of the clay would look at various stages of the drying process. In A, the

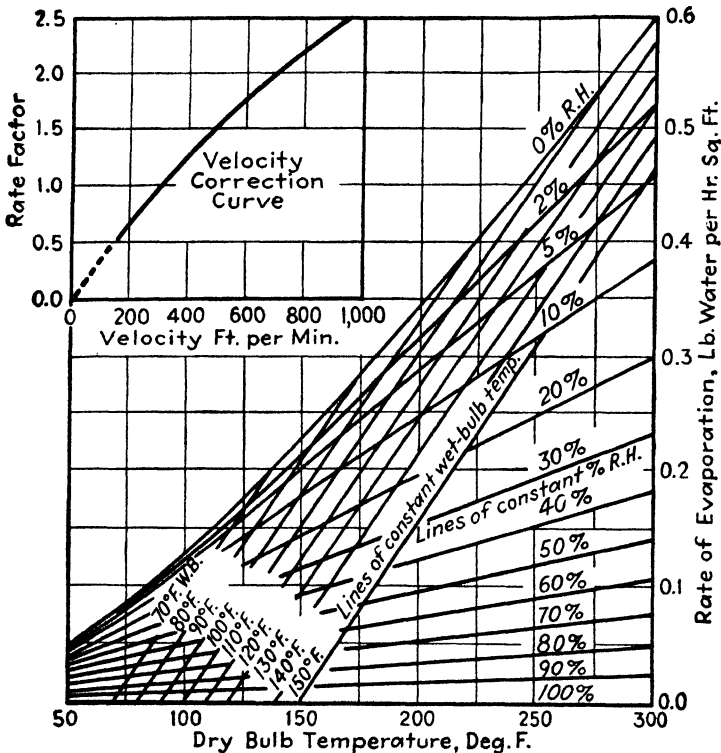

FIG. 82. Evaporation chart for free water surface. (C. B. Shepherd, C. Hadlock, and R. C. Brewer, *Industrial and Engineering Chemistry*, 1938.)

clay particles are well separated by a water film, which also runs continuously over the surface. In B, the amount of water has decreased until the particles touch one another, but there is still a continuous surface film. In

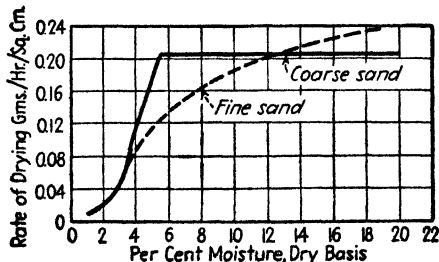

FIG. 83. Drying rates of sand-water mixes. (After Sherwood.)

C, the water has decreased until the surface layer is broken and the level recedes into the capillaries with some air in the structure. Water is brought to the surface by a capillary flow and as vapor. In *D*, the water has still further decreased until it is found only in a few places where the particles

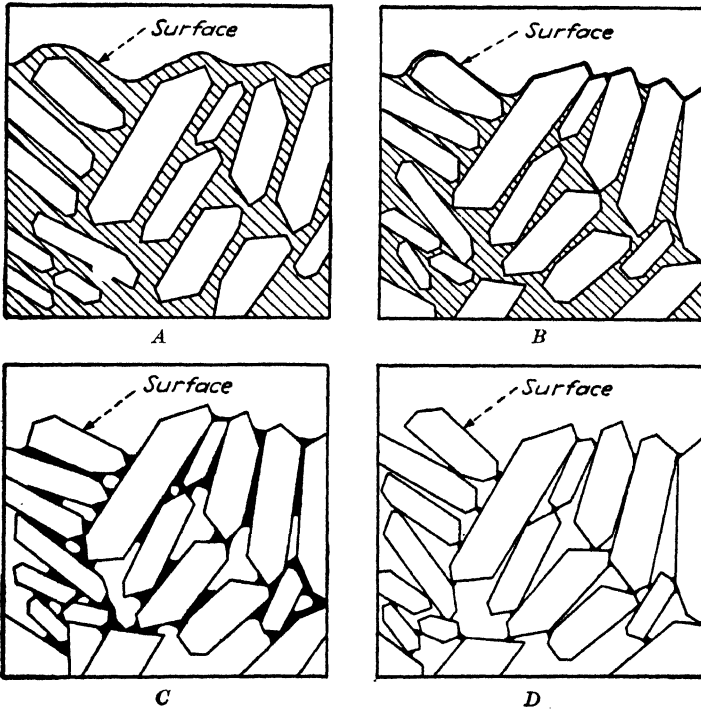

FIG. 84. Enlarged section drawings of clay at various stages of drying.

come closest together. Here all the transfer of water is in the form of vapor. These four conditions are shown on the typical drying-rate curve for a clay in Fig. 85.

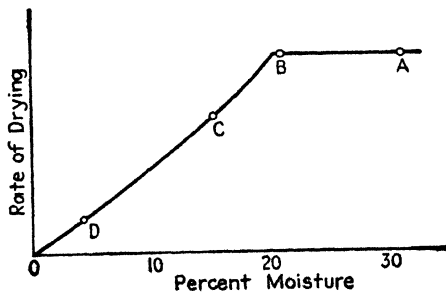

FIG. 85. A typical drying-rate curve for a clay.

The last of the water comes off slowly because it is adsorbed on the surface of the dry particles. Practically, however, it is never necessary to remove the last trace of water. In fact, a bone-dry piece is apt to be brittle and hard to handle.

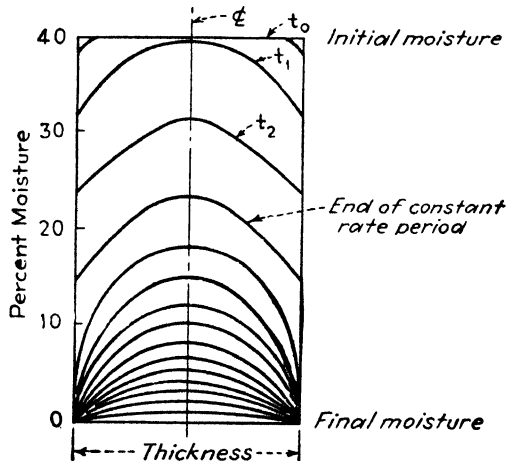

FIG. 86. The moisture distribution across a slab of drying clay.

Moisture Gradient in Clay Body. The moisture distribution across a slab of drying clay may be shown to follow the lines in Fig. 86. At the critical point, the moisture at the surface drops rapidly toward zero. In the constant-rate period, however, the curves are parallel and may be expressed mathematically by Newton's law of diffusion

$$\frac{\delta M}{\delta \theta} = K \frac{\delta^2 M}{\delta x^2}$$

in the same way as for heat flow. Here

M = the moisture concentration per unit volume

θ = the time

x = the distance from the surface

K = a constant

The solution of this equation and its application to the constant-rate period has been carried out by Gilliland and Sherwood,⁽¹⁰⁾ which permits the calculation of the moisture distribution in a slab after any time interval. Reference should be made to the original papers for a full discussion of this calculation.

2. Drying Shrinkage. The drying shrinkage of a clay or body is an important characteristic because it largely governs the maximum safe rate of drying. The drying-shrinkage curve is also very helpful in studying some phases of the clay-water system.

Mechanism of Drying Shrinkage. The mechanism of shrinkage is a very simple one. If the volume shrinkage is plotted against the volume of water in the clay, as in Fig. 87, it will be seen that the shrinkage curve is a straight line with a 45-deg slope. In other words, the volume shrinkage is just equal to the volume of water lost in drying down to the critical point, where the interparticle film becomes so thin that the particles touch one another and shrinkage can go no further. This will be made clearer by referring back to Fig. 84, which shows the condition of the clay and water at the points lettered on the curve of Fig. 87.

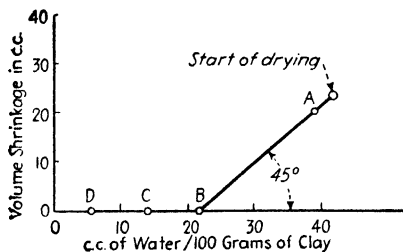

FIG. 87. Theoretical drying-shrinkage curve of clay.

The water lost from the clay in drying between its original condition and the critical point is often referred to as “shrinkage water,” and the remainder as “pore water.”

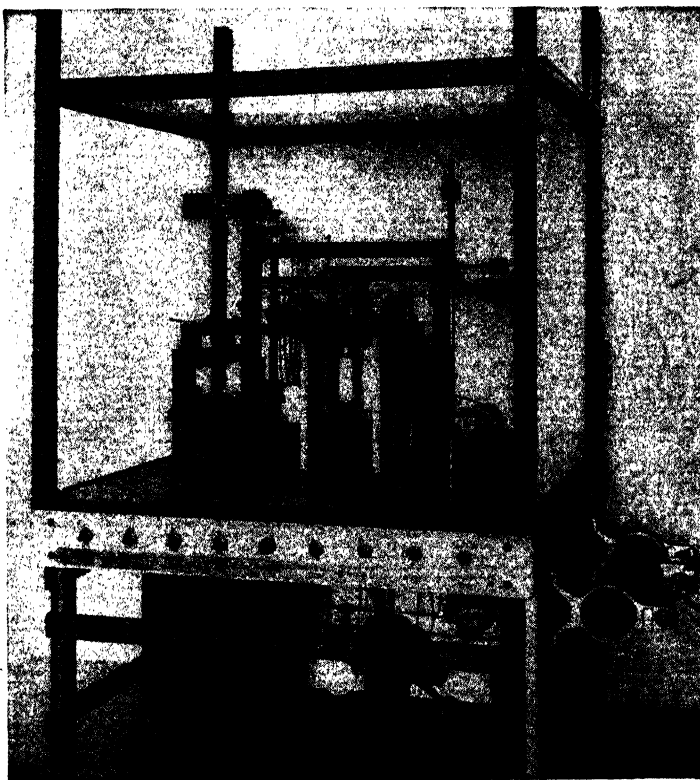

FIG. 88. Apparatus for determining drying shrinkage.

The critical point is not usually so sharply defined as shown in Fig. 87, nor does the lower end of the shrinkage curve always lie along the axis. When clays of the swelling type, such as bentonite, are present, the curve is above the axis and only shrinks the final amount just before dryness, because of the fact that the last of the water is more firmly held between the crystal layers than on the surface of the particles. Other clays have shrinkage curves falling below the axis as a result, at the end of the drying process, of a slight expansion that has not yet been explained but is perhaps due to the opening up of kaolinite books on losing the last trace of water.

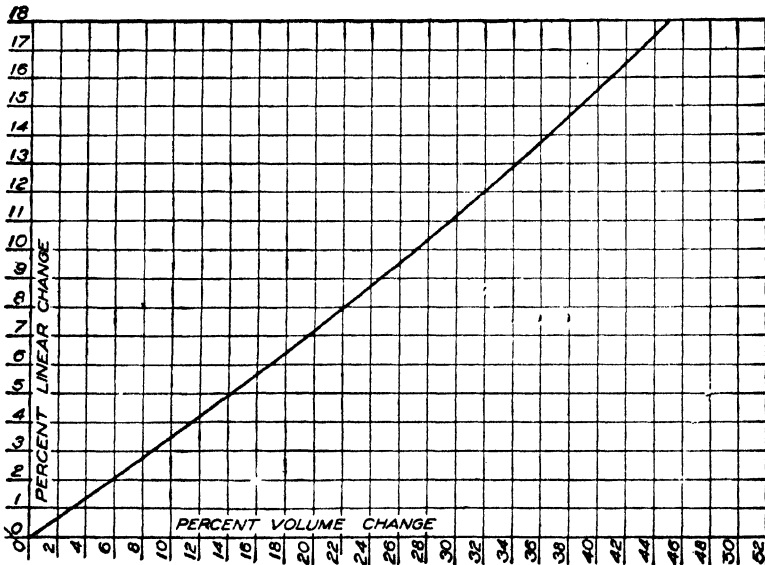

FIG. 89. Curve for the conversion of volume to linear shrinkage based on initial dimensions.

Measurement of Drying Shrinkage. Shrinkage can be measured by either a length change or a volume change. The former is more useful for studying the type of shrinkage curve, whereas the latter gives more accurately the over-all shrinkage.

The apparatus⁽²⁴⁾ shown in Fig. 88 is a convenient one for obtaining shrinkage curves. The test specimen is in the form of a hollow cylinder $\frac{7}{8}$ in. outside diameter, 2 in. long, with a $\frac{1}{8}$ -in. wall. It is placed on an automatic balance in a chamber with controlled humidity and temperature; accordingly the change in length can be precisely determined with a micrometer telescope.

Volume shrinkage is usually measured by placing the specimen, at various stages of dryness, in a mercury volumeter. Volume shrinkage can be converted to linear shrinkage by the curve in Fig. 89 or by Tables 25 and 26.

TABLE 25

Four-figure table for converting:

1. Volume drying shrinkage (percentage of plastic volume) to linear drying shrinkage (percentage of plastic length).
2. Volume of firing shrinkage (percentage of unfired or dry volume) to linear firing shrinkage (percentage of unfired or dry length).
3. Volume of expansion (percentage of final volume) to linear expansion (percentage of final length).

(Courtesy of Dr. A. E. R. Westman, American Ceramic Society)

| Percentage volume change | Percentage volume change | | | | | | | | | | Differences |
|--------------------------|--------------------------|-------|-------|-------|-------|-------|-------|-------|-------|-------|-------------|
| | 0.0 | 0.1 | 0.2 | 0.3 | 0.4 | 0.5 | 0.6 | 0.7 | 0.8 | 0.9 | |
| | Percentage linear change | | | | | | | | | | |
| 0 | 0.000 | 0.033 | 0.067 | 0.100 | 0.134 | 0.167 | 0.200 | 0.234 | 0.267 | 0.301 | 0.034 |
| 1 | 0.334 | 0.368 | 0.402 | 0.435 | 0.469 | 0.503 | 0.536 | 0.570 | 0.604 | 0.638 | 0.034 |
| 2 | 0.672 | 0.705 | 0.739 | 0.773 | 0.806 | 0.840 | 0.874 | 0.908 | 0.942 | 0.976 | 0.034 |
| 3 | 1.010 | 1.044 | 1.078 | 1.112 | 1.146 | 1.181 | 1.215 | 1.249 | 1.283 | 1.317 | 0.034 |
| 4 | 1.352 | 1.386 | 1.420 | 1.455 | 1.489 | 1.523 | 1.558 | 1.592 | 1.626 | 1.661 | 0.034 |
| 5 | 1.695 | 1.730 | 1.764 | 1.799 | 1.834 | 1.868 | 1.903 | 1.937 | 1.972 | 2.007 | 0.035 |
| 6 | 2.041 | 2.076 | 2.111 | 2.146 | 2.181 | 2.216 | 2.251 | 2.285 | 2.320 | 2.355 | 0.035 |
| 7 | 2.390 | 2.425 | 2.460 | 2.495 | 2.530 | 2.565 | 2.600 | 2.636 | 2.671 | 2.706 | 0.035 |
| 8 | 2.741 | 2.776 | 2.812 | 2.847 | 2.882 | 2.918 | 2.953 | 2.988 | 3.023 | 3.059 | 0.035 |
| 9 | 3.095 | 3.130 | 3.166 | 3.201 | 3.237 | 3.273 | 3.308 | 3.344 | 3.380 | 3.415 | 0.036 |
| 10 | 3.451 | 3.487 | 3.523 | 3.559 | 3.594 | 3.630 | 3.666 | 3.702 | 3.738 | 3.774 | 0.036 |
| 11 | 3.810 | 3.846 | 3.882 | 3.918 | 3.954 | 3.990 | 4.027 | 4.063 | 4.099 | 4.135 | 0.036 |
| 12 | 4.172 | 4.208 | 4.244 | 4.281 | 4.317 | 4.354 | 4.390 | 4.426 | 4.463 | 4.500 | 0.036 |
| 13 | 4.536 | 4.572 | 4.609 | 4.646 | 4.683 | 4.719 | 4.756 | 4.793 | 4.830 | 4.866 | 0.037 |
| 14 | 4.903 | 4.940 | 4.977 | 5.014 | 5.051 | 5.088 | 5.125 | 5.162 | 5.199 | 5.236 | 0.037 |
| 15 | 5.273 | 5.310 | 5.348 | 5.385 | 5.422 | 5.459 | 5.497 | 5.534 | 5.571 | 5.609 | 0.037 |
| 16 | 5.646 | 5.684 | 5.721 | 5.759 | 5.797 | 5.834 | 5.872 | 5.909 | 5.947 | 5.984 | 0.037 |
| 17 | 6.022 | 6.060 | 6.098 | 6.136 | 6.174 | 6.212 | 6.249 | 6.287 | 6.325 | 6.363 | 0.038 |
| 18 | 6.401 | 6.439 | 6.477 | 6.515 | 6.553 | 6.592 | 6.630 | 6.668 | 6.706 | 6.745 | 0.038 |
| 19 | 6.783 | 6.822 | 6.860 | 6.899 | 6.937 | 6.975 | 7.014 | 7.052 | 7.091 | 7.130 | 0.038 |
| 20 | 7.168 | 7.207 | 7.246 | 7.284 | 7.323 | 7.362 | 7.401 | 7.440 | 7.479 | 7.518 | 0.039 |
| 21 | 7.557 | 7.596 | 7.635 | 7.674 | 7.713 | 7.752 | 7.791 | 7.831 | 7.870 | 7.909 | 0.039 |
| 22 | 7.949 | 7.988 | 8.027 | 8.067 | 8.106 | 8.146 | 8.185 | 8.225 | 8.265 | 8.304 | 0.039 |
| 23 | 8.344 | 8.383 | 8.423 | 8.463 | 8.503 | 8.543 | 8.582 | 8.622 | 8.662 | 8.702 | 0.040 |
| 24 | 8.742 | 8.782 | 8.822 | 8.862 | 8.903 | 8.943 | 8.983 | 9.023 | 9.063 | 9.104 | 0.040 |
| 25 | 9.144 | 9.184 | 9.225 | 9.265 | 9.306 | 9.346 | 9.387 | 9.428 | 9.468 | 9.509 | 0.040 |
| 26 | 9.550 | 9.590 | 9.631 | 9.672 | 9.713 | 9.754 | 9.795 | 9.836 | 9.877 | 9.918 | 0.040 |
| 27 | 9.959 | 10.00 | 10.04 | 10.08 | 10.12 | 10.16 | 10.21 | 10.25 | 10.29 | 10.33 | 0.040 |
| 28 | 10.37 | 10.41 | 10.45 | 10.50 | 10.54 | 10.58 | 10.62 | 10.66 | 10.71 | 10.75 | 0.040 |
| 29 | 10.79 | 10.83 | 10.87 | 10.91 | 10.96 | 11.00 | 11.04 | 11.08 | 11.13 | 11.17 | 0.040 |
| 30 | 11.21 | 11.25 | 11.29 | 11.34 | 11.38 | 11.42 | 11.46 | 11.51 | 11.55 | 11.59 | 0.040 |
| 31 | 11.63 | 11.68 | 11.72 | 11.76 | 11.81 | 11.85 | 11.89 | 11.93 | 11.98 | 12.02 | 0.040 |
| 32 | 12.06 | 12.11 | 12.15 | 12.19 | 12.23 | 12.28 | 12.32 | 12.37 | 12.41 | 12.45 | 0.040 |
| 33 | 12.50 | 12.54 | 12.58 | 12.63 | 12.67 | 12.72 | 12.76 | 12.80 | 12.85 | 12.89 | 0.040 |
| 34 | 12.93 | 12.97 | 13.02 | 13.07 | 13.11 | 13.15 | 13.20 | 13.24 | 13.29 | 13.33 | 0.040 |
| 35 | 13.38 | 13.42 | 13.47 | 13.51 | 13.55 | 13.60 | 13.64 | 13.69 | 13.74 | 13.78 | 0.040 |
| 36 | 13.82 | 13.87 | 13.91 | 13.96 | 14.00 | 14.05 | 14.09 | 14.14 | 14.18 | 14.23 | 0.040 |
| 37 | 14.27 | 14.32 | 14.36 | 14.41 | 14.46 | 14.50 | 14.55 | 14.59 | 14.64 | 14.68 | 0.050 |
| 38 | 14.73 | 14.78 | 14.82 | 14.87 | 14.91 | 14.96 | 15.01 | 15.05 | 15.10 | 15.14 | 0.050 |
| 39 | 15.19 | 15.24 | 15.28 | 15.33 | 15.38 | 15.42 | 15.47 | 15.52 | 15.56 | 15.61 | 0.050 |
| 40 | 15.66 | 15.70 | 15.75 | 15.80 | 15.84 | 15.89 | 15.94 | 15.99 | 16.03 | 16.08 | 0.050 |
| 41 | 16.13 | 16.18 | 16.23 | 16.27 | 16.32 | 16.37 | 16.41 | 16.46 | 16.51 | 16.56 | 0.050 |
| 42 | 16.60 | 16.65 | 16.70 | 16.75 | 16.80 | 16.84 | 16.89 | 16.94 | 16.99 | 17.04 | 0.050 |
| 43 | 17.09 | 17.14 | 17.18 | 17.23 | 17.28 | 17.33 | 17.38 | 17.43 | 17.48 | 17.53 | 0.050 |
| 44 | 17.57 | 17.62 | 17.67 | 17.72 | 17.77 | 17.82 | 17.87 | 17.92 | 17.97 | 18.02 | 0.050 |
| 45 | 18.07 | 18.12 | 18.17 | 18.22 | 18.27 | 18.32 | 18.37 | 18.42 | 18.47 | 18.52 | 0.050 |
| 46 | 18.57 | 18.62 | 18.67 | 18.72 | 18.77 | 18.82 | 18.87 | 18.92 | 18.97 | 19.02 | 0.050 |
| 47 | 19.07 | 19.12 | 19.18 | 19.23 | 19.28 | 19.33 | 19.38 | 19.43 | 19.48 | 19.53 | 0.050 |
| 48 | 19.59 | 19.64 | 19.69 | 19.74 | 19.79 | 19.84 | 19.90 | 19.95 | 20.00 | 20.05 | 0.050 |
| 49 | 20.10 | 20.16 | 20.21 | 20.26 | 20.31 | 20.37 | 20.42 | 20.47 | 20.52 | 20.58 | 0.050 |
| 50 | 20.63 | 20.68 | 20.74 | 20.79 | 20.84 | 20.90 | 20.95 | 21.00 | 21.06 | 21.11 | 0.050 |

TABLE 26

Four-figure table for converting:

1. Volume of drying shrinkage (percentage of dry volume) to linear drying shrinkage (percentage of dry length).

2. Volume of firing shrinkage (percentage of fired volume) to linear firing shrinkage (percentage of fired length).

3. Volume of expansion (percentage of initial volume) to linear expansion (percentage of initial length).

(Courtesy of Dr. A. E. R. Westman, American Ceramic Society)

| Percentage volume change | Percentage volume change | | | | | | | | | | Differences |
|--------------------------|--------------------------|-------|-------|-------|-------|-------|-------|-------|-------|-------|-------------|
| | 0.0 | 0.1 | 0.2 | 0.3 | 0.4 | 0.5 | 0.6 | 0.7 | 0.8 | 0.9 | |
| | Percentage linear change | | | | | | | | | | |
| 0 | 0.000 | 0.033 | 0.067 | 0.100 | 0.133 | 0.166 | 0.200 | 0.233 | 0.266 | 0.299 | 0.033 |
| 1 | 0.332 | 0.365 | 0.398 | 0.431 | 0.464 | 0.497 | 0.530 | 0.563 | 0.596 | 0.629 | 0.033 |
| 2 | 0.662 | 0.695 | 0.728 | 0.761 | 0.794 | 0.826 | 0.859 | 0.892 | 0.925 | 0.957 | 0.033 |
| 3 | 0.990 | 1.023 | 1.055 | 1.088 | 1.121 | 1.153 | 1.186 | 1.218 | 1.251 | 1.283 | 0.033 |
| 4 | 1.316 | 1.348 | 1.381 | 1.413 | 1.446 | 1.478 | 1.510 | 1.543 | 1.575 | 1.607 | 0.032 |
| 5 | 1.640 | 1.672 | 1.704 | 1.736 | 1.769 | 1.801 | 1.833 | 1.865 | 1.897 | 1.929 | 0.032 |
| 6 | 1.961 | 1.993 | 2.025 | 2.057 | 2.089 | 2.121 | 2.153 | 2.185 | 2.217 | 2.249 | 0.032 |
| 7 | 2.281 | 2.313 | 2.345 | 2.376 | 2.408 | 2.440 | 2.472 | 2.503 | 2.535 | 2.567 | 0.032 |
| 8 | 2.590 | 2.630 | 2.662 | 2.693 | 2.725 | 2.757 | 2.788 | 2.820 | 2.851 | 2.883 | 0.032 |
| 9 | 2.914 | 2.946 | 2.977 | 3.009 | 3.040 | 3.071 | 3.103 | 3.134 | 3.165 | 3.196 | 0.031 |
| 10 | 3.228 | 3.259 | 3.291 | 3.322 | 3.353 | 3.384 | 3.415 | 3.446 | 3.478 | 3.509 | 0.031 |
| 11 | 3.540 | 3.571 | 3.602 | 3.633 | 3.664 | 3.695 | 3.726 | 3.757 | 3.788 | 3.819 | 0.031 |
| 12 | 3.850 | 3.881 | 3.912 | 3.943 | 3.973 | 4.004 | 4.035 | 4.066 | 4.097 | 4.127 | 0.031 |
| 13 | 4.158 | 4.189 | 4.219 | 4.250 | 4.281 | 4.311 | 4.342 | 4.373 | 4.403 | 4.434 | 0.031 |
| 14 | 4.464 | 4.495 | 4.525 | 4.556 | 4.586 | 4.617 | 4.647 | 4.678 | 4.708 | 4.739 | 0.030 |
| 15 | 4.769 | 4.799 | 4.830 | 4.860 | 4.890 | 4.921 | 4.951 | 4.981 | 5.011 | 5.042 | 0.030 |
| 16 | 5.072 | 5.102 | 5.132 | 5.162 | 5.192 | 5.222 | 5.253 | 5.283 | 5.313 | 5.343 | 0.030 |
| 17 | 5.373 | 5.403 | 5.433 | 5.463 | 5.493 | 5.523 | 5.553 | 5.583 | 5.612 | 5.642 | 0.030 |
| 18 | 5.672 | 5.702 | 5.732 | 5.762 | 5.791 | 5.821 | 5.851 | 5.881 | 5.910 | 5.940 | 0.030 |
| 19 | 5.970 | 6.000 | 6.029 | 6.059 | 6.088 | 6.118 | 6.148 | 6.177 | 6.206 | 6.236 | 0.030 |
| 20 | 6.266 | 6.295 | 6.325 | 6.354 | 6.384 | 6.413 | 6.443 | 6.472 | 6.501 | 6.531 | 0.029 |
| 21 | 6.560 | 6.590 | 6.619 | 6.648 | 6.678 | 6.707 | 6.736 | 6.765 | 6.795 | 6.824 | 0.029 |
| 22 | 6.853 | 6.882 | 6.911 | 6.940 | 6.970 | 6.999 | 7.028 | 7.057 | 7.086 | 7.115 | 0.029 |
| 23 | 7.144 | 7.173 | 7.202 | 7.231 | 7.260 | 7.290 | 7.319 | 7.347 | 7.376 | 7.405 | 0.029 |
| 24 | 7.434 | 7.463 | 7.491 | 7.520 | 7.549 | 7.578 | 7.607 | 7.635 | 7.664 | 7.693 | 0.029 |
| 25 | 7.722 | 7.750 | 7.779 | 7.808 | 7.836 | 7.865 | 7.894 | 7.922 | 7.951 | 7.980 | 0.029 |
| 26 | 8.008 | 8.037 | 8.065 | 8.094 | 8.122 | 8.151 | 8.179 | 8.208 | 8.236 | 8.265 | 0.028 |
| 27 | 8.293 | 8.322 | 8.350 | 8.378 | 8.407 | 8.435 | 8.463 | 8.492 | 8.520 | 8.548 | 0.028 |
| 28 | 8.577 | 8.605 | 8.633 | 8.661 | 8.690 | 8.718 | 8.746 | 8.774 | 8.802 | 8.831 | 0.028 |
| 29 | 8.859 | 8.887 | 8.915 | 8.943 | 8.971 | 8.999 | 9.027 | 9.055 | 9.083 | 9.111 | 0.028 |
| 30 | 9.139 | 9.167 | 9.195 | 9.223 | 9.251 | 9.279 | 9.307 | 9.335 | 9.363 | 9.391 | 0.028 |
| 31 | 9.418 | 9.446 | 9.474 | 9.502 | 9.530 | 9.557 | 9.585 | 9.613 | 9.641 | 9.668 | 0.028 |
| 32 | 9.696 | 9.724 | 9.751 | 9.779 | 9.807 | 9.834 | 9.862 | 9.890 | 9.917 | 9.945 | 0.027 |
| 33 | 9.972 | 10.00 | 10.02 | 10.05 | 10.08 | 10.11 | 10.14 | 10.16 | 10.19 | 10.22 | 0.030 |
| 34 | 10.25 | 10.27 | 10.30 | 10.33 | 10.36 | 10.38 | 10.41 | 10.44 | 10.47 | 10.49 | 0.030 |
| 35 | 10.52 | 10.55 | 10.58 | 10.60 | 10.63 | 10.66 | 10.68 | 10.71 | 10.74 | 10.77 | 0.030 |
| 36 | 10.79 | 10.82 | 10.85 | 10.87 | 10.90 | 10.93 | 10.96 | 10.98 | 11.00 | 11.03 | 0.030 |
| 37 | 11.06 | 11.09 | 11.12 | 11.14 | 11.17 | 11.20 | 11.23 | 11.25 | 11.28 | 11.31 | 0.030 |
| 38 | 11.33 | 11.36 | 11.39 | 11.41 | 11.44 | 11.47 | 11.49 | 11.52 | 11.55 | 11.57 | 0.030 |
| 39 | 11.60 | 11.63 | 11.65 | 11.68 | 11.71 | 11.74 | 11.76 | 11.79 | 11.82 | 11.84 | 0.030 |
| 40 | 11.87 | 11.90 | 11.92 | 11.95 | 11.98 | 12.00 | 12.03 | 12.05 | 12.08 | 12.11 | 0.030 |
| 41 | 12.13 | 12.16 | 12.19 | 12.21 | 12.24 | 12.27 | 12.29 | 12.32 | 12.35 | 12.37 | 0.030 |
| 42 | 12.40 | 12.43 | 12.45 | 12.48 | 12.50 | 12.53 | 12.56 | 12.58 | 12.61 | 12.64 | 0.030 |
| 43 | 12.66 | 12.69 | 12.71 | 12.74 | 12.77 | 12.79 | 12.82 | 12.85 | 12.87 | 12.90 | 0.030 |
| 44 | 12.92 | 12.95 | 12.98 | 13.00 | 13.03 | 13.05 | 13.08 | 13.11 | 13.13 | 13.16 | 0.030 |
| 45 | 13.19 | 13.21 | 13.24 | 13.26 | 13.29 | 13.31 | 13.34 | 13.37 | 13.39 | 13.42 | 0.030 |
| 46 | 13.44 | 13.47 | 13.50 | 13.52 | 13.55 | 13.57 | 13.60 | 13.62 | 13.65 | 13.68 | 0.030 |
| 47 | 13.70 | 13.73 | 13.75 | 13.78 | 13.81 | 13.83 | 13.86 | 13.88 | 13.91 | 13.93 | 0.030 |
| 48 | 13.96 | 13.99 | 14.01 | 14.04 | 14.06 | 14.09 | 14.11 | 14.14 | 14.17 | 14.19 | 0.030 |
| 49 | 14.22 | 14.24 | 14.27 | 14.29 | 14.32 | 14.34 | 14.37 | 14.39 | 14.42 | 14.44 | 0.030 |
| 50 | 14.47 | 14.50 | 14.52 | 14.55 | 14.57 | 14.60 | 14.62 | 14.65 | 14.67 | 14.70 | 0.030 |

Water-film Thickness. The ceramist is much interested in the thickness of the water film separating the clay particles. If the total linear shrinkage and the number of films per unit length are known, this factor can be readily calculated. The total shrinkage can be easily determined, but the number of films is more difficult to estimate. The most recent work on this subject is by Norton and Johnson⁽¹⁶⁾ who measured the drying shrinkage of a number of monodisperse size fractions of a kaolin. Provided the size and shape of the particles are known, the number of films are readily computed. In this way, they found a value of about 0.005μ as the film thickness in a plastic mass, or a layer of about 50 water molecules. This value can also

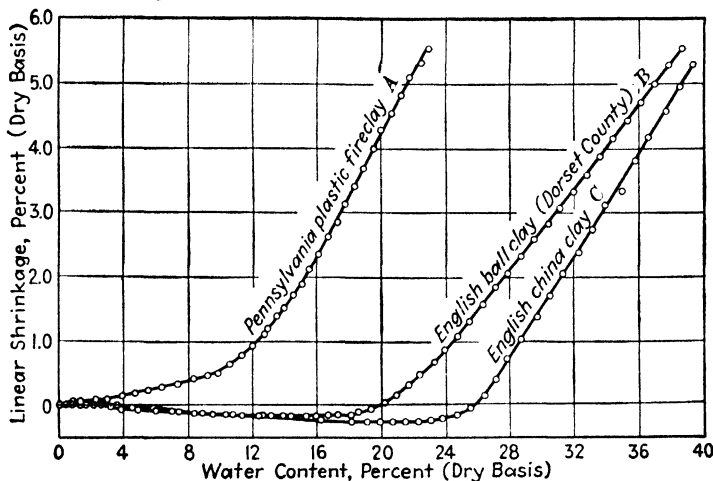

FIG. 90. Drying-shrinkage curves of typical clays.

be computed by determining the thickness of the shrinkage water when spread over an area equal to the surface area of the particles. The result is of the same order of magnitude.

Shrinkage Curves. Figure 90 illustrates drying-shrinkage curves for a few typical clays. Curve A for a fireclay gives the typical secondary shrinkage, and curves B and C show a slight expansion.

3. Dry Strength. The dry, or "green," strength of clays is a unique and more or less unexplained property. Such theories as postulate molecular cohesion, felting of the particles, or organic colloids are not entirely substantiated as yet. It is known that the dry strength increases as the area of the particles increases (finer particles). Also the strength increases with more of some adsorbed ions. For example, a kaolin having a strength (modulus of rupture) of 400 psi when dialyzed showed an increase to 1,000 psi when saturated with sodium ions. These facts indicate that strength is due, at least in part, to attractive forces between the clay mineral crystals. This is an excellent field for further research.

4. Factors Influencing Drying Efficiency. When clayware is dried, the operation must be carried out as rapidly as possible in order to cut down the size and cost of the drying equipment. Great strides have been made in the last ten or fifteen years in increasing the speed and efficiency of drying by means of controlled humidity driers.

Maximum Drying Rate. The maximum drying rate is determined by the stresses set up in the ware and the ability of the body to resist them. The same factors apply as will be discussed in Chap. XV for spalling. The

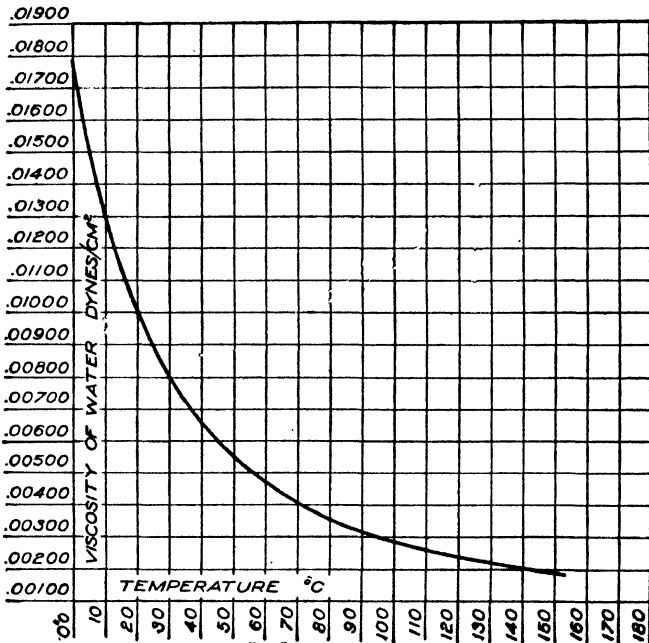

FIG. 91. The variation of the viscosity of water with temperature.

tendency to crack for similar-sized pieces is a function of the moisture gradient, the slope of the shrinkage curve, and the flexibility of the structure. The only variable that can be controlled in the drying operation is the moisture gradient; and for a given rate of drying, this can be decreased only by reducing the viscosity of the water flowing through the capillaries. The viscosity of water decreases quite rapidly with temperature, as shown in Fig. 91, which explains the reason why, in modern driers, the ware is heated rapidly to the maximum temperature in a saturated atmosphere before much drying takes place.

The size of the refractory piece influences the time required to dry. Macey⁽¹³⁾ has shown that under constant drying conditions, various sizes of cubes dry in times proportional to the length of the edge of the cube.

Also the larger the piece the greater will be the tendency to crack under given drying conditions. It should also be realized that when the water content is sufficiently low to come below the critical point, the shrinkage stops and therefore the drying can be carried on as rapidly as desired, provided the vapor can escape from the interior without setting up a bursting pressure.

Examples of Drying. As a concrete example, the problem of drying a brick as rapidly as possible when made from a mechanically weak, high-shrinking clay will be considered. In order to prevent too rapid surface evaporation, no artificial velocity was imparted to the air and the humidity

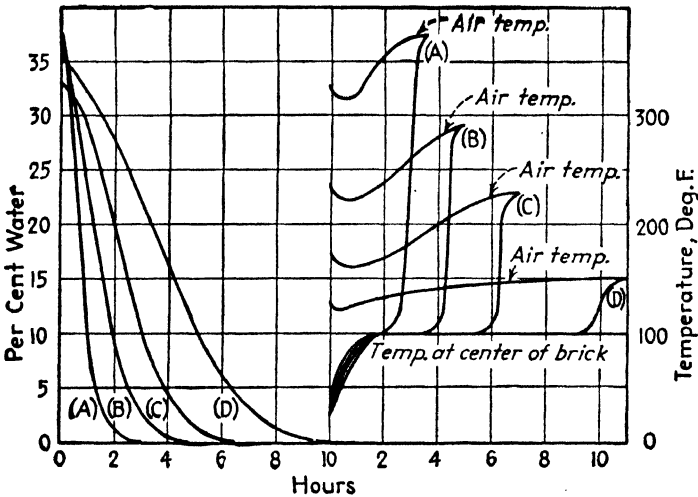

FIG. 92. Curves showing the rate of drying of bricks under various temperature conditions.

was kept at a maximum. It was then necessary only to find the maximum temperature that could be used without cracking the brick. It should be realized that if the brick could be heated uniformly and at a rapid rate, the drying could proceed with extreme rapidity because of the high diffusion rate at elevated temperatures. However, it takes some time for the center of the brick to reach the temperature of the surface, and the resultant temperature gradient will, of course, increase the moisture gradient, which, as explained before, is the limiting factor in the rate of drying.

The apparatus used for the experiments consisted of a closed chamber with the brick suspended on a platform in the center of it. The heat was supplied by an electric heating coil so that any desired temperature could be easily obtained. The chamber, in each case, was brought up to the desired temperature, and the wet, cold brick was put in. Arrangements were made to obtain the weight of the brick continuously throughout the drying process. Figure 92 shows the curves for the rate of drying for

various temperature conditions. A brick dried under condition *D* showed no signs of cracking. Under condition *C*, a few slight cracks appeared on the surface; whereas under conditions *A* and *B*, the bricks were quite badly cracked.

Distribution of Heat. It is quite a step from drying a single brick in the laboratory to drying a full car in a production drier. Circulation of air must be adjusted both to bring heat to the brick at the required rate and, at the same time, to carry away the water vapor. In order to dry all the bricks alike, a large volume of air must be circulated with the proper distribution of velocity.

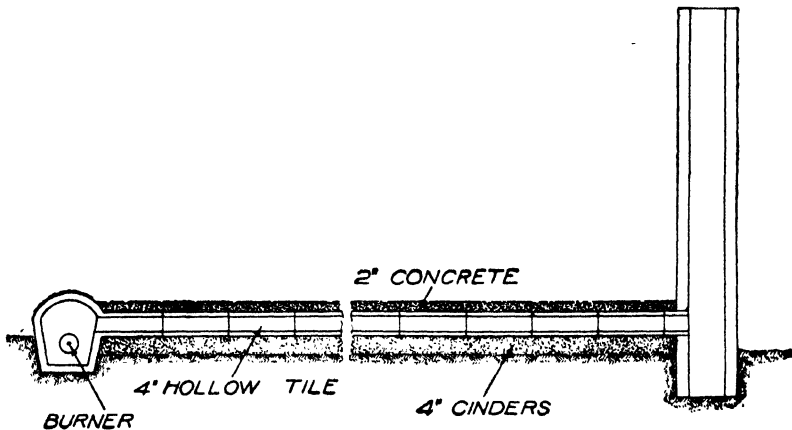

FIG. 93. Section showing construction of a direct-fired hot floor.

Conservation of Heat. A definite amount of heat is required to evaporate the water; but in addition, heat must be supplied for the waste air leaving the drier, for the heat in the bricks, and for the loss through the drier walls. Therefore, an efficient drier will have a minimum volume of exit gases, by means of recirculation, and will have well-insulated walls.

5. Drier Calculations. It is not within the scope of this book to consider drier design, as this is well covered in more general treatises. However, it might be well to point out some of the principles involved. The heat content of the air supplied to the drier, between the entrance and exit temperatures, must be sufficient to provide for the heat required in the drying operation. Also the volume of the air passing through the drier must be so great that the moisture added to it will not bring it above the saturation point at the exit temperature (or temperature of the entering bricks).

6. Types of Driers. The hot floor is used to a considerable extent at the present time for drying and tempering soft-mud bricks and for drying large shapes. The heat is supplied by means of steam pipes running in

conduits or tiles just under the surface of a concrete floor. The temperature of the floor can be controlled by valves, and the floor is usually divided up into small sections so that the temperature can be regulated according to the material drying at any particular point on the floor. Hot floors are sometimes heated by waste heat from the kilns or by direct heat from coal or oil fires, from which the hot gases pass under the floor in tile flues as shown in Fig. 93. These methods, however, are not so satisfactory as steam heating, because it is difficult to control the temperature of the floor and because the temperature will vary considerably from one end of the

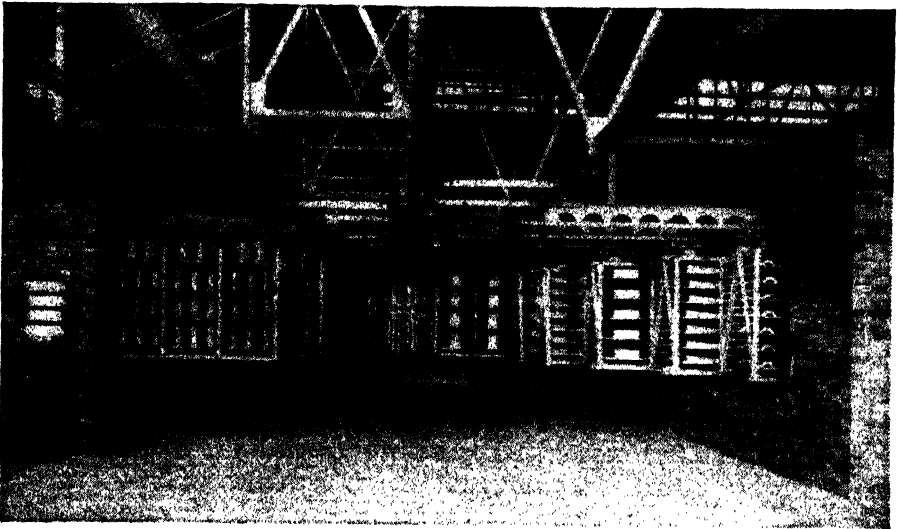

FIG. 94. A continuous drier with the ware on a monorail system. (Courtesy of the A. P. Green Company.)

floor to the other. Sometimes, the thickness of the floor is varied from the hot to the cold end to give a more even surface temperature. From one-half to four 9-in. equivalents can be dried per square foot of floor per 24 hr, depending on the clay, the water content, and the size. In some plants, one-half of the drier capacity is in the hot floor. Recently overhead unit heaters have been used to circulate air from above in order to increase the drying capacity per square foot.⁽⁴⁸⁾

Tunnel driers are used mainly for bricks and small shapes. They consist of a long tunnel in which rack cars of bricks can be placed. Heat is supplied by steam coils under the tracks or, in some cases, by waste heat, which passes through the tunnel. The green bricks are usually pushed into the tunnel at the cooler end and gradually progress to the hotter end until they are completely dry. Figure 94 shows a tunnel of this type. The bricks or shapes are placed on shods that are held in the rack cars. Some-

times perforated shods are used to speed up the drying of the underside of the bricks. They cannot be used, however, with very soft clay, for they will mark the brick. Dry pressed brick are often dried directly on the tunnel kiln cars with a great saving in handling costs.

The more modern type of drier is the continuous-tunnel type, in which the loaded cars are pushed at a uniform rate through a tunnel having carefully regulated temperature and humidity values at each section. Fans or injectors are used to circulate the air around the steam coils and through the bricks in order to ensure a rapid and uniform transfer of heat to the

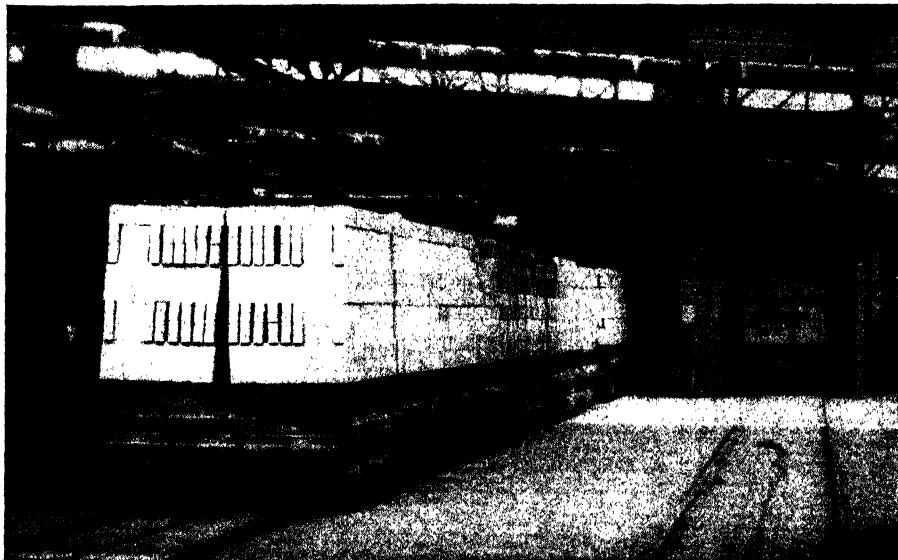

FIG. 95. The entrance to a humidity drier. (Courtesy of the Harbison-Walker Refractories Company.)

drying material. Usually recirculation is used; *i.e.*, the air is passed around a closed circuit, the only vent being a small escape pipe at the top of the tunnel to allow the moisture from the bricks to pass off. The tunnel is divided longitudinally into sections, and each section is controlled for temperature and humidity by automatic controllers. In general, the temperature and humidity are high at the start to heat the brick with little loss of water from the surface. The humidity is then gradually decreased as the bricks pass through the tunnel. The regulation, however, must be determined for the particular kind of clay being dried. Figures 95, 96, and 97 illustrate driers of this type and in Fig. 98 is shown a typical temperature schedule.⁽⁴²⁾

The temperature in driers varies according to the nature of the clay and size of the articles. Generally it is kept as high as possible, 50°C (about



FIG. 96. The end of a continuous drier handling bricks on the tunnel kiln car. (Courtesy of the Allied Engineering Corporation.)

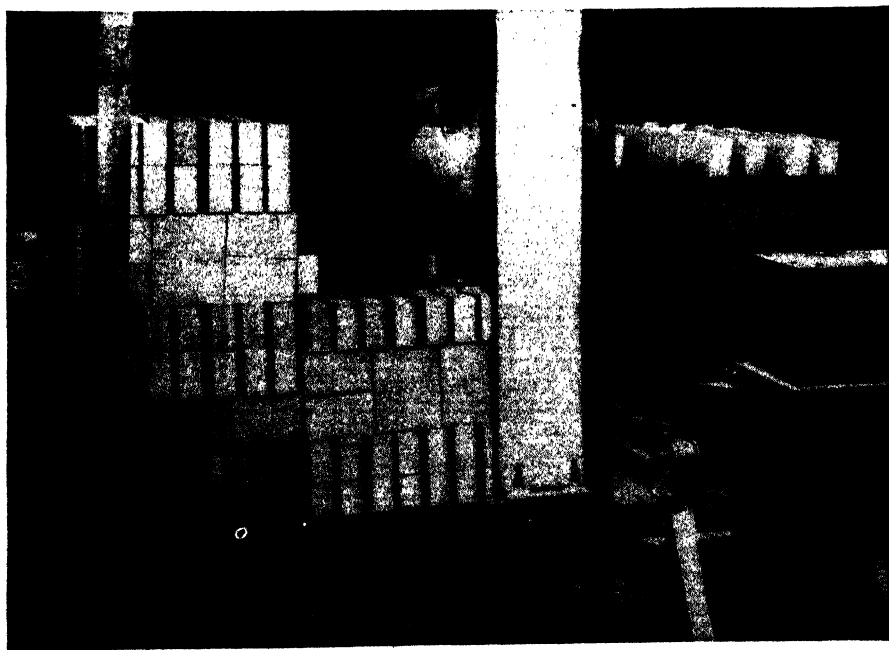

FIG. 97. Bricks from a tunnel drier being set on the tunnel kiln car. (Courtesy of the Swindell-Dressler Corporation.)

120°F) to 90°C (about 190°F). The capacity of a drier depends also upon the clay and the size of the articles. It is an economy to dry as rapidly as possible, as this reduces the investment in the drier, cars, and shods for a given output. Typical drying conditions are shown in Table 27. Infrared driers have been used in the ceramic industry for thin ware, but this principle has not as yet found much use in the refractories field.

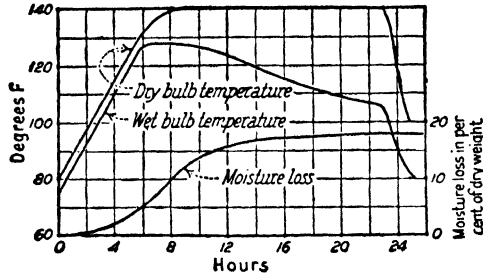

FIG. 98. A typical drying schedule for firebrick in a modern humidity drier. (*J. Am. Ceram. Soc.*)

Since the design and construction of efficient driers require considerable technical knowledge and experience, the amateur drier builder seldom turns out a satisfactory job. The scientific study of drying problems has lately resulted in great advances in this field. The following references should be consulted for the details of drier design.

TABLE 27. DRIER CONDITIONS

| Type of brick | Maximum drier temperature | | Time to dry 9-in. brick, hr. |
|----------------------------|---------------------------|--------|------------------------------|
| | °F. | °C. | |
| Hand-molded..... | 160 | 71 | 48 |
| Stiff mud, re-pressed..... | 160 | 71 | 24 |
| Silica..... | 150-250 | 66-121 | 24 |
| Chrome and magnesite..... | 180 | 82 | 16 |
| Insulating firebrick..... | 180 | 82 | 30 |

7. Bibliography

Principles of Drying:

1. STACEY, A.E., JR.: Theory of Evaporation with Special Reference to the Effect of Air Velocity and of Moisture Diffusion, *J. Am. Ceram. Soc.*, **8**, 457, 1925.
2. PUKALL, W.: Ueber die Vorgänge beim Trocknen keramischer Rohwaren, *Sprechsaal*, **59**, 367, 1926.
3. LIBMAN, E.E.: A Theory of Porous Flow, *Phil. Mag.*, **4**, 7th series, 1285, 1927.
4. SHERWOOD, T.K.: Drying Solids, I, *Ind. Eng. Chem.*, **21**, 12, 1929.
5. SHERWOOD, T.K.: Drying Solids, II, *Ind. Eng. Chem.*, **21**, 976, 1929.

6. HIND, S.R., and F. WHEELER: The Effect of Temperature on the Cracking of Plastic Clay; with Some Notes on Temperature-gradients inside the Clay during Steady Heating in a Saturated Atmosphere and on Drying at 100°C., *Trans. Ceram. Soc. (Engl.)*, **29**, 314, 1930.
7. IGINIO, V.: Physical Principle of Drying, *Corriere ceram.*, **12**, 9, 1931.
8. SHERWOOD, T.K.: Drying of Solids: Application of Diffusion Equations, *Ind. Eng. Chem.*, **24**, 307, 1932.
9. BARBEROT, G.: Theory of Artificial Drying, Calculating the Characteristic Elements, Thermal Balance, and Control of an Artificial Drying Installation, *Rev. matériaux construction trav. publ.*, No. 287, pp. 144-147B, 1933.
10. GILLILAND, E.R., and T.K. SHERWOOD: Drying of Solids: Diffusion Equations for the Period of Constant Drying Rate, *Ind. Eng. Chem.*, **25**, 1134, 1933.
11. MACEY, H.H.: The Principles Underlying the Drying of Clay, *Trans. Ceram. Soc. (Engl.)*, **33**, 92, 1934.
12. MACEY, H.H.: Some Considerations of the Time Factor in Drying, *Trans. Ceram. Soc. (Engl.)*, **35**, 379, 1936.
13. MACEY, H.H.: The Effect of Temperature and Humidity on the Rate of Drying of Clay Shapes, *Trans. Ceram. Soc. (Engl.)*, **37**, 131, 1938.
14. MORGAN, W.R., and R.K. HURSH: The Conditions Governing the Diffusion of Water in Clays, *J. Am. Ceram. Soc.*, **22**, 271, 1939.
15. NORTON, F.H., and A.L. JOHNSON: Fundamental Study of Clay: V, Nature of Water Film in Plastic Clay, *J. Am. Ceram. Soc.*, **27**, 77, 1944.

Drying Shrinkage:

16. GELLER, R.F.: Note on the Effect of Time on the Drying Shrinkage of Clays, *J. Am. Ceram. Soc.*, **4**, 282, 1921.
17. MOORE, C.E.: Drying Cracks in Fire Clay, *Pottery Gaz.*, **53**, 1611, 1928.
18. WESTMAN, A.E.R.: Equations and Tables for Shrinkage, Expansion, and Design Calculations, *J. Am. Ceram. Soc.*, **11**, 715, 1928.
19. HIND, S.R., and F. WHEELER: The Effect of Non-plastics (Grog) on the Shrinkage and Porosity of Fireclay in the Unfired State, *Trans. Ceram. Soc. (Engl.)*, **29**, 10, 1930.
20. WESTMAN, A.E.R.: Effect of Mechanical Pressure on the Imbibitional and Drying Properties of Some Ceramic Clays, I, *J. Am. Ceram. Soc.*, **15**, 552, 1932.
21. CHESTERS, J.H., and W. WEYL: The Drying of Magnesite Bricks—Volume Changes Accompanying Hydration, *Trans. Ceram. Soc. (Engl.)*, **32**, 201, 1933.
22. WESTMAN, A.E.R.: Drying and Firing Shrinkage of Clays, *J. Can. Ceram. Soc.*, **2**, 24, 1933.
23. MELLOR, J.W.: Some Notes on the Shrinkage of Clays during Drying, *Trans. Ceram. Soc. (Engl.)*, **32**, 455, 1933.
24. NORTON, F.H.: Precise Measurement of Drying Shrinkage, *Ceram. Age*, **33**, 7, 1939.
25. WHITTAKER, H.: Effect of Particle Size on Plasticity of Kaolinite, *J. Am. Ceram. Soc.*, **22**, 16, 1939.

Drier Calculations:

26. CARRUTHERS, J.L.: Drier Problems with Calculations, *J. Am. Ceram. Soc.*, **14**, 8, 1931.

27. WILSON, H., and K.G. SKINNER: Equations and Quadrant Charts for Determining the Heat and Air Requirements of Continuous Driers, *J. Am. Ceram. Soc.*, **20**, 99, 1937.

Drying Characteristics of Refractory Materials:

28. LINDSAY, D.C., and W.H. WADLEIGH: Some Observations on the Drying Properties of Clays, *J. Am. Ceram. Soc.*, **8**, 677, 1925.
29. BRAND, F.: De-airing as Corrective in Drying, *J. Am. Ceram. Soc.*, **9**, 189, 1926.
30. TROOP, R.S., and F. WHEELER: The Drying of Clay under Definite Conditions. *Trans. Ceram. Soc. (Engl.)*, **26**, 231, 1926-1927.
31. CASSELMAN, E.J.: A Laboratory Procedure for Determining the Drying Characteristics of Clays, *J. Am. Ceram. Soc.*, **10**, 59, 1927.
32. TROOP, R.S., and F. WHEELER: Some Experiments in Drying Clay, *Trans. Ceram. Soc. (Engl.)*, **27**, 303, 1927-1928.
33. RIEKE, R., and J. GIETH: Some Observations on the Drying of Kaolins and Clays, *Ber. deut. keram. Ges.*, **12**, 556, 1931.
34. NORTON, F.H.: Some Notes on the Nature of Clay, II, *J. Am. Ceram. Soc.*, **16**, 86, 1933.
35. LOVEJOY, E.: Water Movement in Stiff-mud Ware and Its Relation to Drying, *J. Am. Ceram. Soc.*, **16**, 405, 1933.
36. MACEY, H.H.: The Relative Safe Rates of Drying of Some Different Clay Sizes and Shapes, *Trans. Brit. Ceram. Soc.*, **38**, 464, 1939.
37. MACEY, H.H.: Some Observations on the Safe Drying of Large Fireclay Blocks, *Trans. Brit. Ceram. Soc.*, **38**, 469, 1939.

Drier Construction and Operation:

38. LOVEJOY, E.: "Drying Clay Wares," T.A. Randall and Company, Inc., Publishers, Indianapolis, 1916.
39. BARRETT, W.E.: Laboratory Experiments in the Development of a Plant Drier, *J. Am. Ceram. Soc.*, **8**, 239, 1925.
40. STACEY, A.E., JR., and H.B. MATZEN: Ceramic Drying and Driers, *J. Am. Ceram. Soc.*, **8**, 525, 1925.
41. CRONSHAW, H.B.: Notes on Dryers for Clay Products, *Trans. Ceram. Soc. (Engl.)*, **25**, 220, 1925-1926.
42. MATZEN, H.B., and C.E. PARMELEE: Air Conditioning in Ceramics, *J. Am. Ceram. Soc.*, **13**, 856, 1930.
43. ROBSON, J.T.: Notes on Drying and Dryer Operation, *J. Am. Ceram. Soc.*, **14**, 709, 1931.
44. GARVE, T.W.: Modern Waste-heat Tunnel Driers, *J. Am. Ceram. Soc.*, **16**, 118, 1933.
45. SIMIN, W.N.: New Methods of Drying, *Ogneupory*, **3**, 384, 1937.
46. MACEY, H.H., and S.R. HIND: An Experimental Dryer for Claywares, *Trans. Ceram. Soc. (Engl.)*, **36**, 433, 1937.
47. MCKINLEY, J.M., and R.R. ROBINSON: An Investigation of Power Reduction and Moisture Control in Waste-heat Drying, *J. Am. Ceram. Soc.*, **21**, 104, 1938.
48. ANON.: New Hot Floor Dryer Uses Unit Heaters to Cut Drying Time, *Brick & Clay Record*, **99**, 45, 1941.
49. ANON.: The Drying of Clayware—A Discussion, *Trans. Brit. Ceram. Soc.*, **46**, 207, 1947.
50. OLIVER, H.: Some Aspects of Hot Floor Drying, *Trans. Brit. Ceram. Soc.*, **46**, 215, 1947.

CHAPTER VIII

THE FIRING OF CLAY AND OTHER REFRACTORY MATERIALS

1. Effect of Heat on Raw Clay. One of the most important steps in the manufacture of refractories is the firing process, whereby the raw clay is profoundly altered into a strong and partly vitreous mass. The steps occurring in the process are particularly important, as they guide us in the proper heat-treatment of a clay to give the greatest efficiency in firing and the most satisfactory finished product.

Methods of Measuring Heating Changes. The changes that occur in a clay on heating, though not at once evident, can be indirectly observed through a number of secondary alterations that can be detected by the proper type of measurement. One of the most obvious changes taking place in a heated clay is the loss in weight. This weight loss can be measured by placing a sample of clay in a constant-temperature furnace⁽²⁴⁾ and holding it at one temperature until the weight becomes constant, then increasing the temperature another step and holding it again, and so on until the clay loses no further weight. Also, the weight loss can be determined by raising the temperature of the sample at a predetermined rate and recording the weight of the specimen as a continuous function of time.

The weight loss is due (1) to loss of adsorbed water at comparatively low temperatures, (2) to the loss of chemically combined water which occurs at a rather definite temperature for any particular clay mineral, and (3) loss of CO_2 and SO_2 from oxidation of carbon or the breaking up of carbonates and sulfides. The proper interpretation of the weight-loss curve of a clay will give a valuable insight into the clay constituents, as shown by the curves in Fig. 99 for a number of clay minerals. A well-crystallized mineral like kaolinite loses its chemical water substantially at one temperature, whereas an amorphous material like allophane loses it gradually.

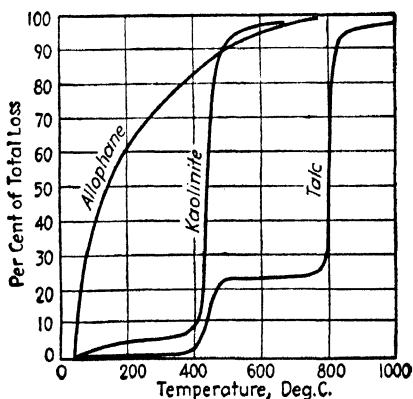

Fig. 99. Weight-loss curves.

Another characteristic of clay when heated is the absorption and evolution of heat⁽³²⁾ at certain temperatures, which can readily be determined by the differential thermal apparatus described in Chap. IV. A typical curve of this type for a fireclay containing only the mineral kaolinite is shown in Fig. 100. The slight heat absorption at 150°C (about 300°F) is due to the driving off of adsorbed water from the surface of the grains. The small heat evolution at approximately 400°C (about 750°F) is caused by the oxidation of a slight amount of organic matter in the clay. The larger absorption peak at 620°C (about 1150°F) is caused by the evolution of the chemically combined water in the kaolinite structure, and the sharp and high peak at 980°C (about 1800°F) is believed to be due to the change of amorphous alumina to the crystalline γ -form. The small peak at 1200°C (about 2190°F) is considered to be the result of the crystallization of cristobalite from the silica glass that has previously formed in the clay.

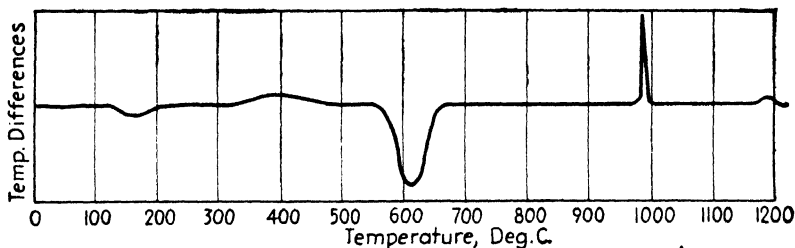

FIG. 100. Thermal curve for a fireclay.

The shrinkage, and conversely the porosity, is a very characteristic property and shows quite clearly the changes that occur in the clay. A typical shrinkage curve for kaolin is shown in Fig. 101. No shrinkage occurs under this slow heating until 450°C (about 840°F) is reached, at which temperature the chemically combined water is driven off, producing a decrease in volume that continues slowly to above 900°C (about 1650°F) where a sharp decrease in volume corresponds to the formation of γ -alumina. At the same time, mullite begins to crystallize. At 1150°C (about 2100°F), glass begins to be formed in larger quantities, which tends to pull the clay grains together, and the shrinkage continues rapidly up to the fusion point of the clay, provided bloating does not occur.

One of the most powerful tools used in studying the changes occurring in a clay is the X ray,^(25,28) which gives us an insight into the atomic arrangements of the clay crystals and the altered products. Briefly, however, the recent results of X-ray analysis indicate that kaolinite is unchanged until the chemically combined water is driven off at 450°C (840°F). Above this temperature, there is a noncrystalline structure called "metakaolin" about which we know very little. At 980°C (about 1800°F), the γ -alumina

crystallizes; and immediately afterward, mullite crystals can be detected^(16,19,28) even though they are very much finer than would be visible in the microscope. Recent work of Comefpro^(37a) and his coworkers indicates that mullite may form directly from the metakaolin without the intermediate γ -alumina.

The microscope does not tell us a great deal concerning the changes occurring in the clay because they take place on such a small scale that an observation of the larger grains shows little. Until the temperature is high enough for large-sized needles of mullite to crystallize out, the microscope is of little help. However, the recently developed electron microscope allows

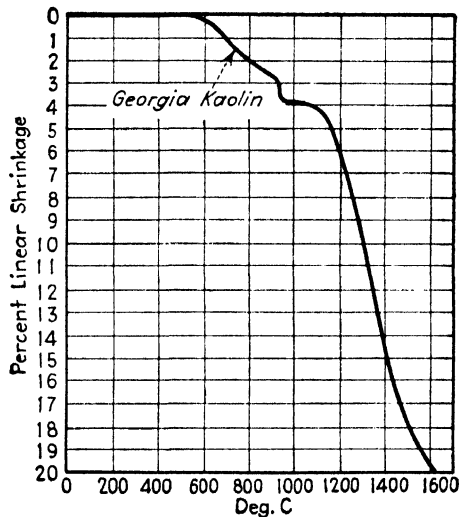

FIG. 101. The shrinkage characteristics of a Georgia kaolin.

us to observe the clay particles at a magnification of as high as 25,000 \times , whereby clay particles as small as 0.1 μ can be readily seen. Recently, a very interesting study with the electron microscope by Eitel, Müller, and Radczewski⁽³¹⁾ has been made of the breakup of kaolinite on heating to various temperatures. This is the first time that we have had direct visual proof of the reactions going on in the clay. The photographs in this paper are remarkably clear even at the very high magnification and indicate the following reactions: The original clay shows definite hexagonal plates of varying size with clear-cut edges, as reproduced in Fig. 3 of Chap. IV. On heating to 500°C (about 930°F), which is sufficient to drive off the chemically combined water, the only change noted is a slight softening of the edges of the plates. At 800°C (about 1470°F), the plates show slight rounding of the corners and apparently some fine-grained material is thrown off from the edges. Whether this occurred directly in the heating or by

mechanical abrasion of the now soft and friable plate is not certain. At 1000°C (about 1830°F), pseudomorphs of the original kaolinite crystals are still seen, but there is a lack of distinctness with no new crystals in evidence. At 1200°C (about 2190°F), the ground mass of the original kaolinite crystals is filled with small mullite crystals imbedded in glass. More recent work^(37a) shows these changes even more clearly.

Another characteristic change in clay on heating is the increase in hardness and mechanical strength after cooling. The raw clay, in many cases, has considerable mechanical strength; but as it is heated to drive off the adsorbed water, this strength usually decreases slightly because of the lessened attraction between the particles. When the chemically combined water is driven from the clay, there is often a further decrease in strength, due to the crystalline breakup; but at 1000°C (about 1830°F) in a pure clay, the strength begins to increase owing to the formation of glass and recrystallization of the remaining components. The strength increases rapidly up to the softening point. In less pure clays, the increase in strength occurs at lower temperatures owing to the earlier glass formation.

Other changes to be noted are variations in color, solubility in acid, and fluorescence of certain dyes in contact with the clay. The last is illustrated by the dye morin, which fluoresces under ultraviolet light when in contact with the alumina group. When clay samples fired to different temperatures are examined in this way, fluorescence will be absent up to 450°C (about 840°F) but will show strongly up to 980°C (about 1800°F) and then less strongly. This indicates the presence of the alumina molecule in the metakaolin.

Picture of the Heat Changes in a Pure Kaolin. In summing up the evidence obtained from the preceding observations of the various changes in the physical properties of a clay, one may start in with a drying temperature of 100°C (212°F). At this temperature, a considerable amount of adsorbed water still adheres to particles, and the finer the clay the larger amount of this water. It is not driven off at any one temperature, but over a considerable range; the more firmly attached water molecules are held until the higher temperatures. This adsorbed water can be removed at low temperatures by confining in an atmosphere free from water vapor, but a considerable amount of time is required. At a temperature of 450°C (about 840°F), the chemically combined water or, more correctly speaking, the OH groups are removed from the kaolinite molecule. It has been shown that with very careful temperature control and long time of heating, this water is driven off very completely at a single temperature, as indicated by the weight-loss curve in Fig. 99, which was taken under carefully controlled conditions. However, even under this condition, there is a small amount of remaining water that is not driven off until 700 or 800°C

(about 1290 or 1470°F) is reached. It is a little difficult to understand just what part of the lattice is occupied by these OH groups which are so firmly held. More probably the gradual weight loss is due to adsorbed water molecules both below and above the crystalline breakup temperature. The condition of the crystal structure between the temperature of removal of the OH groups and the crystallization of alumina has received a great

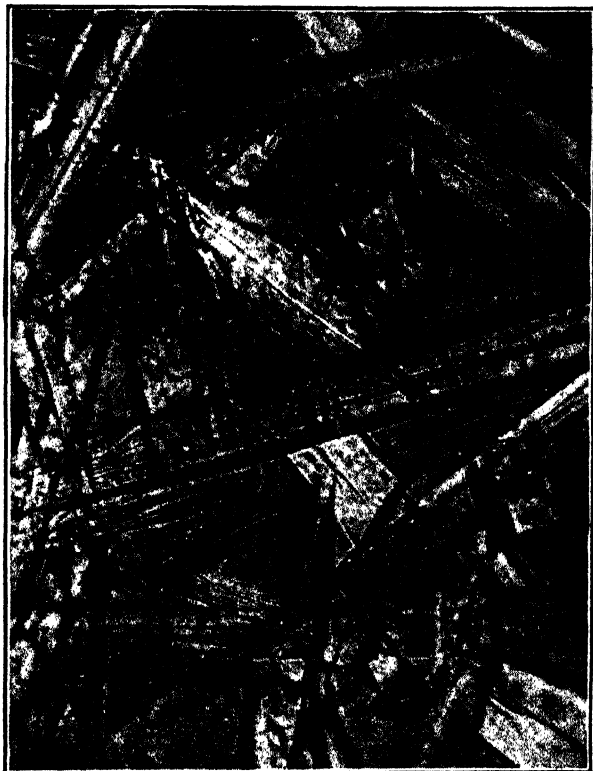

FIG. 102. Thin section of fused kaolin. This microphotograph shows large mullite crystals embedded in silica glass. The nearly square cross section of these crystals can be seen; 750 diameters with crossed Nicol prisms and gypsum plate.

deal of consideration by various authorities; but at the present time, we seem to have no really definite pictures except that there is a noncrystalline arrangement of the atoms. On the other hand, the structure cannot be entirely broken up, as it is possible to replace the water by comparatively simple hydrothermal action, provided the clay has not been heated above 980°C (about 1800°F) and the subsequent mullite crystals are oriented in relation to the original kaolinite structure. Also the evidence of fluorescence indicates that a sort of alumina molecule is still in existence up to this temperature.

At approximately 980°C (about 1800°F), in the case of kaolin, there is a sudden heat evolution, which is believed to indicate the crystallization of the alumina into the γ -form or the direct formation of mullite. It is interesting to note that the heat effect is greatest for a silica-alumina ratio of 2:1 as it occurs in kaolinite. It is shown by Insley⁽²⁸⁾ that if the alumina is higher or lower than this particular ratio, the heat effect occurs over a wider range of temperature and is not nearly so marked. He believes that the silica acts in such a way as to stabilize the amorphous structure and prevent crystallization until a certain temperature is reached. This again would indicate that the structure, after the water is driven off, is not entirely random but must have some arrangement by which the alumina crystallization is influenced by the silica.

Immediately after the formation of the γ -alumina, it apparently starts dissolving in the glass and mullite begins to crystallize out. At first these crystals are so small that they can be detected only by the X rays; but at a somewhat higher temperature, they become large enough to see easily under the microscope (Fig. 102).

The heat evolution at 1200°C (about 2190°F) is believed to be due to crystallization of cristobalite from the glass.⁽²⁸⁾ Such crystals have been detected by Insley, and this seems to be a reasonable explanation. No work has been done to determine this crystallization with less pure clays. Possibly the fluxing effect of such materials as iron oxide and lime might greatly influence it.

TABLE 28. BREAKDOWN TEMPERATURES OF CLAY IMPURITIES

| | °C. | °F. |
|---|-------------------|--------------------|
| $\text{FeS}_2 + \text{O}_2 \rightarrow \text{FeS} + \text{SO}_2$ | 350-450 | 660-840 |
| $4\text{FeS} + 7\text{O}_2 \rightarrow 2\text{Fe}_2\text{O}_3 + 4\text{SO}_2$ | 500-800 | 930-1470 |
| $\text{Fe}_2(\text{SO}_4)_3 \rightarrow \text{Fe}_2\text{O}_3 + 3\text{SO}_3$ | 560-775 | 1040-1430 |
| $\text{C} + \text{O}_2 \rightarrow \text{CO}_2$ | 350 \rightarrow | 660 \rightarrow |
| $\text{S} + \text{O}_2 \rightarrow \text{SO}_2$ | 250-920 | 480-1690 |
| $\text{CaCO}_3 \rightarrow \text{CaO} + \text{CO}_2$ | 600-1050 | 1110-1920 |
| $\text{MgCO}_3 \rightarrow \text{MgO} + \text{CO}_2$ | 400-900 | 750-1650 |
| $\text{FeCO}_3 + 3\text{O}_2 \rightarrow 2\text{Fe}_2\text{O}_3 + 4\text{CO}_2$ | 800 \rightarrow | 1470 \rightarrow |
| $\text{CaSO}_4 \rightarrow \text{CaO} + \text{SO}_3$ | 1250-1300 | 2280-2370 |

Effect of Heat on Clay Impurities. Most of the fireclays contain impurities in the form of sulfides and carbonates and also carbon in the form of lignite or bitumen. As the clay is heated in an oxidizing atmosphere, a great many reactions can take place with the eventual loss of the carbon and sulfur by oxidation. There is no opportunity here to discuss these reactions completely, as they are of much more importance to the manu-

facturers of heavy clay products than to the manufacturers of refractories. However, Table 28 will give the more important reactions and the temperatures at which they occur. The upper limit of the temperature is not a very definite one, as it depends on the amount of excess air in the combustion gases, the permeability of the clay, and the size of the object being fired, as well as the interaction between the various impurities. For example, if the pores of the clay contain CO_2 from oxidation of carbon, the increased partial pressure of this gas will delay the dissociation of a material like

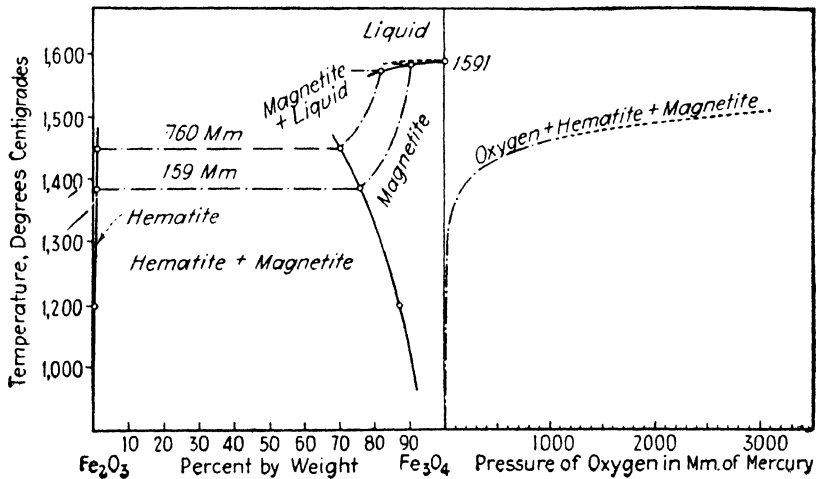

FIG. 103. Equilibrium diagram. The diagram on the left indicates the points that have been determined on the field boundaries by circles or by arrows. The points fixing the isobars are not shown here.

The right-hand diagram gives a curve representing the relationship between the temperature and the pressure of oxygen with which magnetite + hematite can coexist in stable equilibrium. At the lower pressures it represents quite closely the true conditions. In the upper pressure region, however, it can be considered only as giving the order of magnitude of the pressure. (*Greig, Posnjak, Merwin, Sosman, Am. J. Sci.*)

calcium carbonate. In all firing of clays containing considerable amounts of carbon or sulfur, the initial part of the firing process must be carried out sufficiently slowly to oxidize these products completely before the surface pores of the clay are closed; otherwise the well-known black coring will occur.

The system of $\text{Fe}_2\text{O}_3\text{-Fe}_3\text{O}_4\text{-O}_2$ is shown in Fig. 103. As the temperature is increased, a higher concentration of oxygen is required to hold the same ratio of Fe to O.

Effect of Heat on Other Hydrated Minerals. The investigation of the relations between the structures, properties, and crystallographic orientations of minerals with the OH ions and their corresponding oxides is very interesting, but to date only meager information is available.

The crystalline breakup by heat of montmorillonite and illite has been studied by Grim and Bradley.⁽³⁵⁾ Montmorillonite shows a lattice breakdown starting at 600°C (about 1110°F) and complete at 800°C (about 1470°F). A spinel phase appears at 850°C (about 1560°F), but is all dissolved at 1300°C (about 2370°F). Mullite appears at 1050°C (about 1920°F) and increases with increasing temperatures. Illite goes through the same kind of breakup, but mullite does not appear until 1100°C (about 2010°F).

Gibbsite, $\text{Al}(\text{OH})_3$, a common constituent of high-alumina clays, has a layer lattice structure in which the Al atoms lie between six OH ions and the layers are packed in such a way that each OH of one layer is opposite an OH of the next layer. At temperatures as low as 150°C (about 300°F), gibbsite loses some of the OH groups and boehmite $\text{AlO}(\text{OH})$ is formed, which on further heating above 275°C (about 527°F) forms $\gamma\text{-Al}_2\text{O}_3$,⁽²³⁾ a kind of alumina with a spinel-like structure. A parallelism has been found between the crystallographic orientations of the original and the final crystals as in the case of kaolinite.

On the other hand, diaspore, which is also a common constituent of the high-alumina clays, is more stable than gibbsite and does not lose OH groups until a temperature of 350°C (about 660°F) is reached. The reason for this is evident from its crystal structure; X-ray studies show that its formula should be written HAlO_2 , and we must think of the H as a small cation in the structure in twofold coordination between a pair of oxygens. Both boehmite and diaspore are dimorphous. On dehydration of diaspore, γ -alumina is formed and, at 550°C (about 1020°F), starts to transform to corundum. The latter transformation is completed at 950°C (about 1740°F), and again there is a parallelism between the orientation of the original and the final crystals. This parallelism in crystallographic orientation illustrates the important role played by the crystal structure in the treatment of raw materials.

It is interesting to note that in a similar fashion, goethite, HFeO_2 , dehydrates to hematite, Fe_2O_3 , and brucite, $\text{Mg}(\text{OH})_2$, forms periclase, MgO ; in both cases, the original and final crystals are in parallel aggregates. Lepidocrocite, $\text{FeO}(\text{OH})$, transforms to $\gamma\text{-Fe}_2\text{O}_3$, which is magnetic and has a spinel-like structure.

At high temperatures, the oxides remaining from the low-temperature reactions, such as iron oxide, lime, and alkalis, react with the clay and form a glass that has a marked influence on the mechanical properties of the finished piece. The oxides also act to a certain extent as catalyzers or mineralizers to increase the rate of growth of the mullite crystals and thereby influence the finished products. It is highly desirable to produce in the clay body a sufficient amount of glass to allow recrystallization to

take place and act as a bonding agent to give good mechanical strength. The lower the temperature at which this can take place the less expensive will be the burning operation. On the other hand, it is undesirable to have too much or too fluid a glass in the finished refractory; in which case, it will show deformation at temperatures so low that its use will be limited. For example, refractories made from pure kaolin must be fired at comparatively high temperatures in order to complete the firing shrinkage and produce sufficient mechanical strength; but when so fired, they give excellent refractory properties. Less pure fireclays can be initially fired at much lower temperatures owing to the more abundant formation of glass, but this glass limits their upper temperature of use.

Firing Shrinkage and Porosity of Clays. When studying a new clay, one of the most instructive tests is the determination of the shrinkage and porosity when fired at different temperatures. This information enables the prediction of the usefulness of the clay when used in a refractory for any particular purpose.

The methods used for measuring shrinkage are comparatively simple. A series of specimens carefully formed may be fired at a number of temperatures, and a decrease in volume or a linear dimension determined for each one. Also a continuous shrinkage curve for a clay can be made by increasing the temperature at a steady rate and measuring the length of the specimen as described for shrinkage measurements in Chap. XVII. It should be noted that these values include the reversible expansion. As will be explained later, to obtain consistent shrinkage measurements, the original specimens must be formed under exactly the same conditions of water content and pressure.

The porosity of the fired specimen is due to both closed pores and open pores. The usual method of determining porosity, which we call "apparent porosity" because it does not include the closed pores, may be determined by filling the pores with water or air, as described below.

The apparent porosity of a small sample is usually measured by making three weighings: the first, the dry specimen; the second, the saturated specimen immersed in water; and the third, the saturated specimen suspended in air.⁽⁵²⁾ It is quite necessary to be sure that the specimen is thoroughly saturated; and in order to do this, it should be boiled in water for 2 hr. Even with this precaution, there will be some closed pores that the water cannot reach; consequently this method generally gives a low value for the porosity. The porosity is determined from these three weighings by the following formula:

$$P = \frac{W - D}{W - A} \times 100$$

where P = the percentage porosity
 W = the weight of saturated specimen in air
 D = the weight of dry specimen in air
 A = the weight of saturated specimen in water

The volume can be directly measured by a mercury volumeter to give a higher precision. The instrument described by Goodner⁽³⁸⁾ is convenient for this purpose.

When the porosity of the full-sized brick is to be obtained, it will be found that the previous method cannot always be used because the water

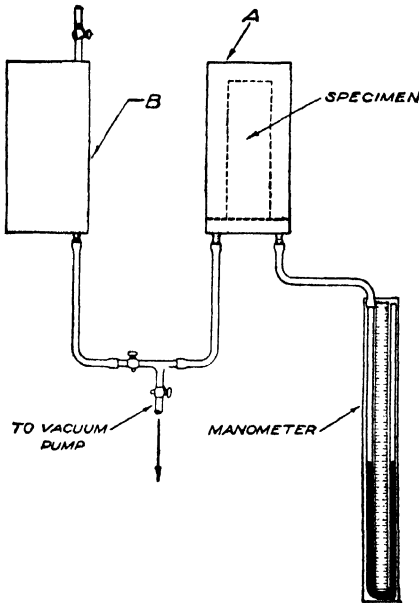

FIG. 104. Apparatus for obtaining the porosity of a brick by the vacuum method.

will run out of the pores when the weighing W is made. The porosity is best obtained in this case by a vacuum method, the principle of which is shown in Fig. 104. A brick is placed in chamber A and sealed tight. The chamber B is empty but of known volume. Chamber A is then connected to a vacuum pump and pumped down to a vacuum of about 700 mm. The connection to the pump is then closed; the connecting cock between the two chambers is opened; and the change in reading of the manometer is noted. The porosity of the brick is then calculated by the following formula, using the constants of the apparatus.

$$S = V_b \frac{P_2}{P_1 - P_2} - (V_a - V)$$

- where S = the pore volume
 V = the volume of specimen (bulk)
 V_a = the volume of chamber A
 V_b = the volume of chamber B
 P_2 = the equilibrium manometer reading
 P_1 = the evacuated manometer reading

The precision of the instrument can be checked at any time by measuring the porosity of a block of iron or any other nonporous material, which should, of course, work out to be zero. This method is rapid and reasonably precise, as air can find its way into smaller pores than can water.

It will be noted in the formula given above that the bulk volume of the brick is required. In some cases where the brick is even and smooth in size,

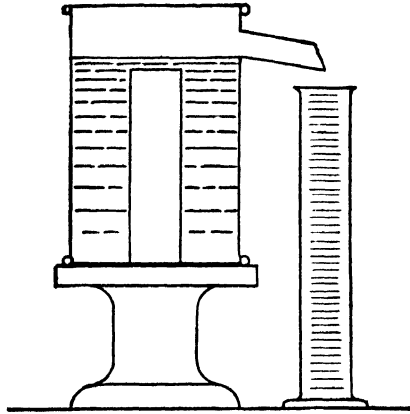

FIG. 105. An overflow can for measuring the volume of a brick.

the volume can be determined by linear measurements, but usually it is better to obtain the volume directly, which is most readily accomplished by saturating the brick with melted paraffin. The surplus is carefully wiped off, the brick is then immersed in an overflow can, as shown in Fig. 105, and the displaced water weighed or measured.

The volume can also be obtained by immersion in mercury⁽⁴⁶⁾ or sand. The former method is accurate but requires considerable clean mercury, which is not always convenient. The latter method is simple but not very precise unless great skill is used in packing the sand to exactly the same extent each time.

The determination of the closed pores is best carried out by grinding the specimen fine enough to break into all the pore spaces and then measuring the true density of the powder by the well-known pycnometer method (Chap. XX). From the values of true density d_t and bulk density d_b of

the original specimen, the true porosity, *i.e.*, the total volume of the closed and open pores in relation to the bulk volume, can be determined by the following formula:

$$p = \frac{d_t - d_b}{d_t}$$

Table 29 shows the relative amount of closed and open pores in some refractories.⁽⁴⁰⁾

TABLE 29. PRECISION OF POROSITY DETERMINATIONS

| Material | Average specific gravity | Average true porosity | Error due to closed pores by water method | Error due to closed pores by vacuum-method |
|-----------------------------|--------------------------|-----------------------|---|--|
| Silica brick..... | 2.31 to 2.33 | 27.2 to 28.3 | 0.3 to 1.9 | -0.15 to -0.18 |
| Magnesite brick..... | 3.54 to 3.56 | 25.6 to 29.5 | 0.3 to 1.1 | 0.0 to 0.3 |
| Flint-clay firebrick..... | 2.67 to 2.72 | 27.7 to 32.6 | 3.7 to 10.2 | 1.5 to 7.0 |
| Plastic-clay firebrick..... | 2.66 to 2.69 | 15.9 to 22.8 | 1.0 to 4.0 | 0.0 to 0.3 |

The firing shrinkage and porosity are influenced quite markedly by the conditions under which the specimen is molded. Obviously, the more densely the raw clay is packed the less will be the firing shrinkage when carried to a given final porosity. Therefore, high pressure in molding, proper water content, and the fineness of the clay all influence the amount of shrinkage.

Figures 106 to 110 show curves of shrinkage and porosity values for a number of typical fireclays. These illustrations give a general picture of

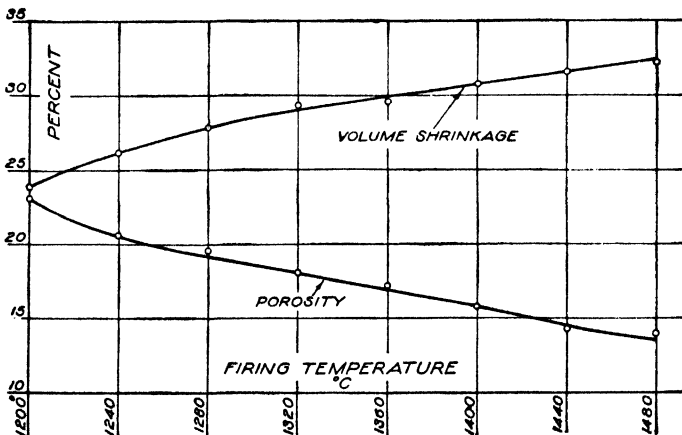

FIG. 106. Raw smooth flint clay, Missouri. (*J. Am. Ceram. Soc.*)

the shrinkage and porosity values of the clays; but for any particular problem, firing tests should be made under the exact conditions to which the clay will be subjected. (67) In Table 30 are given average porosity values for some typical refractories.

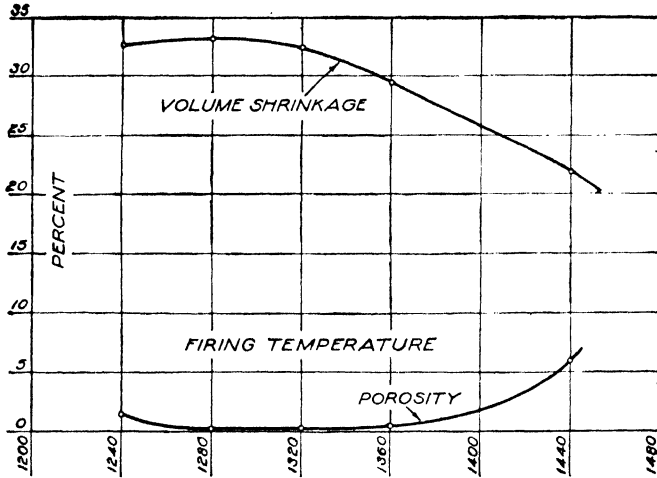

FIG. 107. Raw plastic clay, Missouri. (J. Am. Ceram. Soc.)

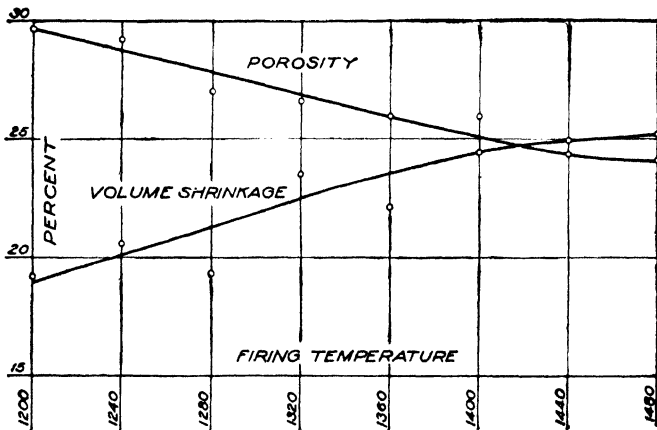

FIG. 108. Raw burley flint clay, Missouri. (J. Am. Ceram. Soc.)

It should always be kept in mind that most ceramic bodies never reach equilibrium in firing. Therefore, the firing schedule, or time held at temperature, is as important to control as the temperature level. It has been found (1,21) that decreasing the temperature by about 30°C is equivalent to increasing the time by tenfold.

2. Firing Properties of Nonclay Refractory Materials. Silica. Silica, one of the most important of refractory minerals, has received a great deal

of study, and consequently more data on its properties are available than on any other mineral. The most complete treatise on silica is that of Sosman,⁽⁷⁵⁾ which the reader should consult for many of the details for which space is not available here.

In nature, silica is very common and most often occurs as the mineral quartz. It is found in many different types of mineral deposits, is an essen-

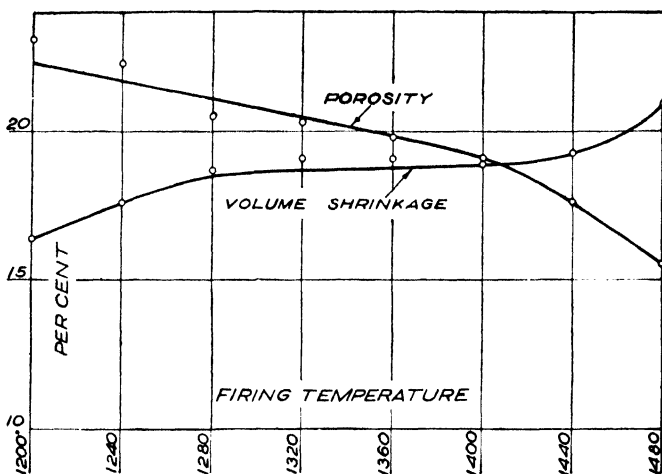

Fig. 109. Plastic bond clay, Cambria County, Pa. (*J. Am. Ceram. Soc.*)

TABLE 30. POROSITY OF REFRACTORIES

| Type of Brick | Average Porosity, Per Cent |
|------------------------------|----------------------------|
| Hand-molded fireclay | 24 |
| Stiff-mud fireclay | 21 |
| Dry-pressed fireclay | 22 |
| Kaolin | 18 |
| High alumina, 70 per cent | 32 |
| Magnesite | 23 |
| Magnesite, chemical bond | 11 |
| Silica | 25 |
| Forsterite | 25 |
| Chrome-magnesite | 25 |
| Chrome | 23 |
| Chrome, chemical bond | 11 |
| Tank blocks: Flux | 20 |
| Grog | 7 |
| Fused | 0 |
| Silicon carbide, clay bond | 20 |
| Insulating firebrick: 2.5 lb | 75 |
| 1 lb | 90 |

tial constituent of such acid igneous rocks as granite and rhyolite, and also occurs in veins, in sedimentary rocks such as sandstones and quartzites, and in unconsolidated river and beach sands.

Quartz can be transformed by heating into a number of polymorphous modifications. These forms, together with their stability ranges, are shown in Fig. 111 taken from Sosman.

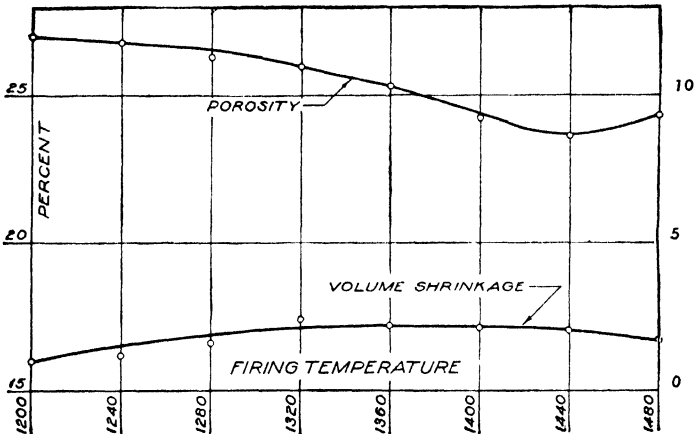

Fig. 110. Dean flint clay, Pennsylvania. (*J. Am. Ceram. Soc.*)

There are at least six crystalline varieties of silica: quartz, tridymite, and cristobalite and each of these has a high- and a low-temperature modification. All the varieties are characterized by a three-dimensional network of SiO₄ tetrahedrons, each corner being shared with neighboring tetrahedrons. Thus a silicon atom is always shared by two oxygens, which checks the formula SiO₂, long ago determined by chemical analysis.

Figure 112 shows models that illustrate the manner in which the atoms are arranged in high- and low-temperature cristobalite, high-temperature tridymite, and high- and low-temperature quartz. The silicon atoms nestle in the center of four oxygen atoms and are not visible in this picture. The

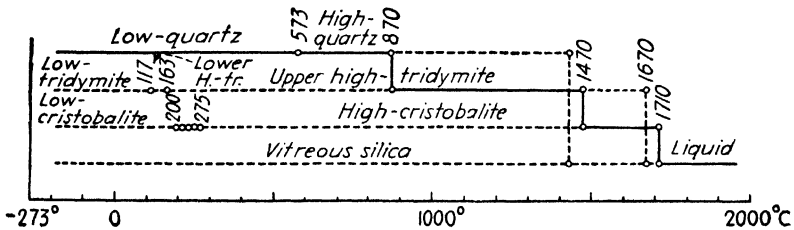

Fig. 111. Polymorphous modifications of silica and their stability ranges. (R. B. Sosman, "The Properties of Silica," New York, Chemical Catalog Company, Inc.; Reinhold Publishing Corporation, 1927.)

models are not arranged in a similar crystallographic orientation but rather to show the major features of each structure. One immediately apparent feature is that cristobalite and tridymite are more open packed and have large holes whereas the atoms in high- and low-temperature quartz are

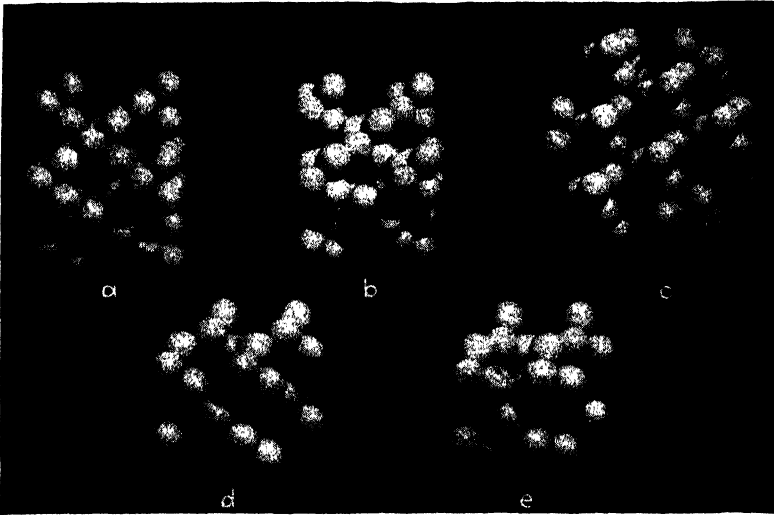

FIG. 112. Models showing the arrangement of atoms in various polymorphic modifications of silica, SiO₂. (a) High cristobalite, (b) low cristobalite, (c) high tridymite, (d) high quartz, (e) low quartz. The silicon atoms are not visible because they are small and nestle in a tetrahedron formed by four oxygen atoms. The models do not have similar crystallographic orientations. Note that the low-temperature forms are more closely packed than the high-temperature forms.

tightly packed together and form a close-packed structure free from large holes. Hence, the density and refractive indices of tridymite and cristobalite are very similar, but they differ considerably from those of quartz, as is shown in Table 31.

TABLE 31. DENSITY OF FORMS OF SILICA
At Room Temperature

| | Index of refraction* | Density † | Density ‡ |
|-------------------|---|-----------|-------------|
| Quartz..... | $\left\{ \begin{array}{l} \epsilon = 1.553 \\ \omega = 1.544 \end{array} \right\}$ | 2.65 | 2.653-2.660 |
| Tridymite..... | $\left\{ \begin{array}{l} \alpha = 1.469 \\ \beta = 1.473 \\ \sigma = 1.470 \end{array} \right\}$ | 2.26 | 2.28-2.33 |
| Cristobalite..... | 1.486 | 2.32 | 2.27 |

* Larsen and Berman.⁽⁶⁶⁾

† Rogers.⁽⁶⁵⁾

‡ Dana.⁽⁶⁷⁾

Quartz is remarkably pure, and consequently the values for its indices of refraction and density are usually very closely alike. There are only meager data on the chemistry of tridymite and cristobalite, but the data that are available indicate that they are usually impure and consequently vary in density and refractive index. On the other hand, it is quite possible that these variations may be due to the little care usually given to the selection of material for such measurements.

In all cases, the high-temperature forms have a higher symmetry than the low-temperature forms. Note that the diagonal groups of tetrahedrons in high-temperature cristobalite form nearly a straight line whereas in low-temperature cristobalite, they form a puckered chain; the same is true in the high- and low-temperature-quartz relationship, although the effect is less apparent in the picture. The differences between the linking of the tetrahedrons in the high- and in the low-temperature forms of each mineral are slight, but they are considerable in quartz, tridymite, and cristobalite. When a high-temperature form is transformed to a low-temperature form, the tetrahedrons are shifted and rotated but none of the links is broken, and consequently the high-low transformations of each mineral are rapid and reversible (see Fig. 111). These inversions are accompanied by volume changes, given in Table 32 below, together with the heat effects that produce them.

TABLE 32. DENSITY CHANGES ACCOMPANYING INVERSIONS

| Form | Density change | Heat effect, g. cal. per g. |
|---------------------------------|----------------|--------------------------------|
| Quartz, low-high..... | -0.02 | 4.5 |
| Cristobalite, low-high..... | -0.04 | 5.0 |
| Tridymite, low-lower high..... | -0.01 | 1.0 |
| Tridymite, lower high-high..... | 0.00 | |

The structures of the minerals quartz, tridymite, and cristobalite are quite different from one another, and the transformation of one to the other requires a marked change in the linking of the tetrahedrons. Consequently these transformations are extremely slow, and tridymite and cristobalite can exist indefinitely in the metastable state at room temperature. In fact, it is impossible to form quartz from either tridymite or cristobalite by strictly thermal reactions.

The sluggish inversions that are so important to the manufacturers of silica refractories can be greatly influenced by other materials called "mineralizers." A great deal of work has been done on the effect of mineralizers in changing quartz to cristobalite or tridymite in the kiln, and

many of these are noted in the references at the end of the chapter.^(68,69,70,72,81,82,83,84,97,99) The most common one is lime, which is used in most of the commercial silica bricks, partly as a bond and partly as a mineralizer, to hasten the conversion of the quartz to cristobalite and tridymite (Fig. 113). Many other mineralizers have been suggested, such as fluorides, titanium dioxide, boric oxide, ferric chloride,⁽⁸⁵⁾ and sodium chloride. It should be



FIG. 113. Thin section of silica refractory showing a typical wedge-shaped twin crystal of tridymite. There are several less distinct crystals in the field. The surrounding material is cristobalite; 750 diameters, with crossed Nicol prisms and gypsum plate.

remembered, however, that in commercial production, it is undesirable to cause the inversion to proceed with too great rapidity; for if the volume change proceeds too fast, it will rupture or make unsound the structure of the brick.

Kyanite and Associated Minerals. Kyanite (triclinic), andalusite (orthorhombic), and sillimanite (orthorhombic) all have the formula Al_2SiO_5 . The structural relations of these minerals are complex, and for a general discussion the reader should see Bragg.⁽¹¹⁰⁾ On heating, they change over to mullite and glass or to mullite, glass, and cristobalite. The crystal-

line breakup of these minerals has been thoroughly studied by Greig,⁽¹⁰⁴⁾ and the temperature ranges are shown in Table 33.

TABLE 33. DECOMPOSITION TEMPERATURES OF SILICA-ALUMINA MINERALS

| Mineral | Kyanite | Andalusite | Sillimanite |
|------------------------------|----------------------|----------------------|----------------------|
| Decomposition starts..... | 1100°C. (2010°F.) | 1410°C. (2570°F.) | 1550°C. (2820°F.) |
| Complete decomposition*..... | 1410°C. (2570°F.) | 1500°C. (2730°F.) | 1625°C. (2960°F.) |
| Peak on thermal curve..... | 1420°C. (2590°F.) | 1510°C. (2750°F.) | 1560°C. (2840°F.) |
| Density before firing..... | 3.6-3.7 | 3.1-3.3 | 3.3 |

* This temperature varies with rate of heating and size of grains.

As the density of the mullite is 3.16 and the density of the silica glass and cristobalite is less, it is obvious that there must be an expansion in volume during the conversion. This expansion is particularly evident in the case of kyanite, which has the highest original density, but shows only to a very small extent with the other two minerals. The expansion of kyanite on heating^(106,111,112) may be a valuable property when combined with clays, as it offsets the shrinkage of the clay. Unfortunately, however, the expansion of the kyanite takes place through a rather small temperature interval, whereas the shrinkage of the clay continues over a much longer range; consequently the two effects do not exactly balance each other. As will be shown later, however, a refractory can be produced that will have exactly the same fired volume as the initial volume. The expansion characteristics of kyanite are greatly dependent on the size of the grains, a fact that should be taken into account when considering the total expansion.

The difficulty in getting kyanite during the last war has led companies in this country and Germany to produce mullite type brick from other materials. The general method seems to be the calcination of bauxite and clay⁽²⁹¹⁾ in a rotary kiln to form grog and then bond this together with raw material and fire to high temperatures.

Topaz. Topaz, $\text{Al}_2\text{SiO}_4(\text{F},\text{OH})_2$, which has recently been found in some quantity in South Carolina, contains enough alumina to form largely mullite on firing.⁽¹¹³⁾ The fluorine accelerates the reaction but is eventually completely driven off together with the water.⁽¹¹⁴⁾

Magnesite. The firing properties of magnesite depend largely on its composition. For refractory purposes, a dense, low-porosity material is desired. On heating the raw magnesite, the CO_2 is driven off at temperatures between 400 and 900°C (about 750 and 1650°F), forming immediately the only known form of MgO , periclase. At first these crystals

are so minute that they can be detected only by means of X rays; but with increasing time and temperature, they grow until they form the usual honeycomb structure shown in Fig. 114. It should be remembered, however, that the periclase crystal is cubic and not hexagonal.

The burned magnesite has a true density of 3.55 to 3.63 and a porosity of 15 to 27 per cent. The greater the impurities present and the higher

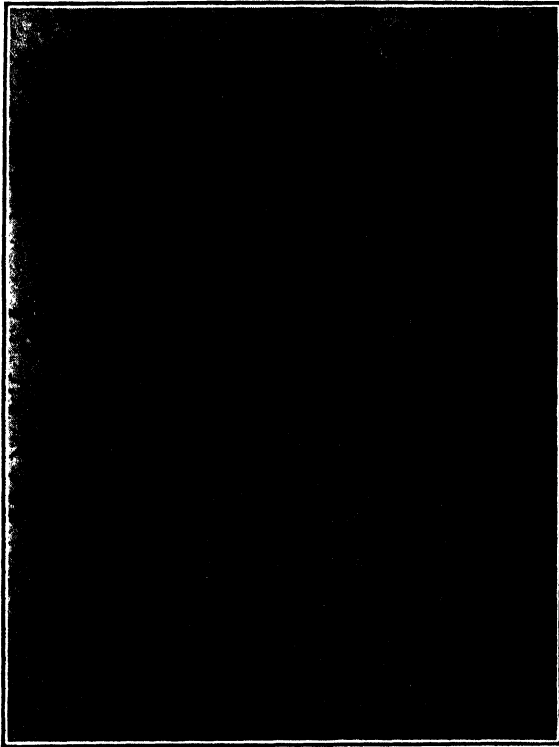

FIG. 114. Thin section of Grecian magnesite burned at 1790°C (3250°F), which shows the rather typical honeycomb structure of calcined magnesite, and, in addition, small birefringence areas between the boundaries of the small grains. The latter is due to small amount of impurities reacting with the magnesite at high temperatures; 60 diameters, with crossed Nicol prisms and gypsum plate.

the firing temperature the lower the porosity. It is desirable to fire the grain well so that no appreciable shrinkage will occur on firing the brick.

The bond in magnesite refractories is mainly glass, but crystalline material such as forsterite does occur. Iron oxide, in the form of finely divided magnesioferrite, $MgFe_2O_4$, occurs to the extent of 7 or 8 per cent in some types of magnesite, which allows the production of a strong and dense product at temperatures very much lower than would be possible with the pure magnesia. Other impurities such as lime, silica, and alumina

form glass, which acts as a bond. The burning process is discussed in the references.^(118,119,123,124)

Lime. Calcium carbonate can be decomposed readily to calcium oxide; and on heating at temperatures as low as 1400°C (about 2550°F), crystals of calcium oxide can be formed. Such crystals are chemically much more stable than the low-calcined lime and undoubtedly would serve as an excellent basic refractory if they could be properly protected from moisture.

Zirconia. There are a number of polymorphous modifications of zirconium dioxide, and for a general review the reader should see the papers by Ruff and Ebert,⁽¹³⁷⁾ Cohn,⁽¹⁴²⁾ and Clark and Reynolds.⁽¹⁴³⁾ The natural mineral baddeleyite is monoclinic. Pure monoclinic ZrO_2 , often called the "C form," is stable up to 1000°C (about 1830°F) where it is transformed to the β form, which is tetragonal; this transformation is reversible. The tetragonal form is transformed irreversibly at 1900°C (about 3450°F) to the α_2 form, which is trigonal. The α_2 form is transformed to the α_1 form, which is also trigonal, at 625°C (about 1160°F), an inversion that is rapid and reversible.

It should be remembered that the inversion temperature and the crystallographic modifications obtained at various temperatures are dependent to a large extent on the composition and impurities that are present. This is again true in the ZrO_2 system. If the nitrate, oxychlorate, oxybate, or certain hydroxides of zirconium are heated, the tetragonal form is obtained at temperatures around 600°C (about 1110°F). This tetragonal form is metastable and is converted to the monoclinic form on further heating. The tetragonal form is also obtained if pure zirconia is heated in the presence of silica at about the same temperature; but whereas the tetragonal form obtained by heating the above-mentioned compounds of zirconium is transformed to the monoclinic form on further heating, the silica-bearing form remains tetragonal up to 1460°C (about 2660°F), where it is transformed to zircon, $ZrSiO_4$. If certain oxides such as MgO and CaO are present, a cubic form is obtained at about 1700°C (about 3090°F). This isometric form does not transform on cooling and is obtained only in the presence of the oxide impurities (other types of impurities might act in the same way). Less than 3 per cent magnesia in solid solution will give rise to the isometric form, and the maximum amount of magnesia that exists in solid solution in ZrO_2 is about 28 per cent, which corresponds to the formula $Mg_2Zr_3O_8$.

The most useful compound of zirconium other than the oxide is zirconium silicate, which corresponds to the natural mineral zircon, $ZrSiO_4$. This is a stable mineral and can serve as a useful refractory material.

Chromite. Chromite is the natural spinel-type mineral of theoretical formula $FeCr_2O_4$. It is thermally stable and apparently undergoes no

polymorphous modifications up to the fusion point. However, the natural mineral always contains impurities in solid solution, such as Ca, Mg, and Al, and admixed mineral impurities such as the silicates. Silica, if in large quantity, is objectionable, as it forms considerable quantities of glass on heating, which lowers the mechanical strength of the chromite refractories at high temperatures. The addition of MgO in the right amount to form the compound forsterite will diminish the amount of glass and provide a superior refractory (see the patents of Seil⁽¹⁶³⁾). Considerable study has been given to bricks of mixtures of magnesite and chromite,^(152, 154, 155, 158, 160) which have given trouble because of a gradual growth due to absorption of iron oxide. Chrome-silica bricks^(150, 151) and chrome-alumina bricks⁽¹⁵³⁾ have been suggested.

Titania. Titanium dioxide also has several modifications and Cohn⁽¹⁴²⁾ has suggested the interesting analogy between SiO₂, ZrO₂, and TiO₂ as shown in Table 34.

TABLE 34.

| | | | |
|------------------|-------------|---|--|
| SiO ₂ | Quartz | Cristobalite | Tridymite |
| ZrO ₂ | Baddeleyite | β -Zr ₂ O ₃ | α -Zr ₂ O ₃ |
| TiO ₂ | Brookite | Anatase | Rutile |

Magnesium Silicate Minerals. There are a number of minerals of this class such as olivine, talc, and serpentine, which may form the basis of forsterite refractories.^(171, 172) In most cases, sufficient magnesite must be added to the natural mineral to convert the low-melting metasilicate to the high-melting orthosilicate. The amount of magnesia added as well as the grain size of the various minerals are quite important and are covered by patents such as that of Goldschmidt.^(167, 168)

Carbon. Blocks made of granular coke and tar are fired in special kilns^(291, 292) where they can be completely surrounded by finely ground coke to prevent oxidation of the block. The firing takes 2 or 3 weeks with a maximum temperature of 700 to 800°C (about 1290 to 1470°F). The finished blocks have a crushing strength of 3,000 to 10,000 psi and a porosity of 20 to 30 per cent.

3. Solid Reactions. Importance in Ceramic Processes. A great many ceramic firing processes take place with little or no liquid phase present; accordingly many believe that the reactions go on entirely between solids. In spite of the great importance of these types of reactions, it was not until recently that a thorough study was made of this phenomenon, although as early as the year 1909, Wright pointed out the fact that calcium oxide

crystals would grow rapidly at least 1000°C (about 1830°F) below their fusion point. Most of the early work in this field has been carried out in Germany by G. Tammann and his coworkers and by Goldschmidt. A very good résumé of the subject is given by Taylor,⁽¹⁹⁷⁾ and some practical aspects of the subject are discussed in Chap. XII.

Mechanism of Solid Reactions. Solid reactions apparently take place because of loosening of the atomic bonds by thermal agitation, which permits mutual diffusion of the various atoms into the adjacent parts of the structure. The solid reactions can be divided logically into two groups; the first in which we simply grow large crystals from small ones and the second group where we produce a new type of crystal from two dissimilar ones.

The process of diffusion is greatly influenced by many factors in addition to the composition of the original crystals. In the first place, it has been found that the solid reaction progresses much more rapidly at a temperature where one of the crystals involved passes through an inversion point.⁽¹⁸⁶⁾ For example, if a solid reaction is going on between quartz and another mineral, the reaction would be greatly accelerated at a temperature of 573°C (about 1060°F) where the low-temperature quartz changes to the high-temperature form. This is probably due to the loosening of the bonds at the inversion point and permitting of much greater rates of diffusion. It has also been found that gases, such as water vapor and fluorine, act as mineralizers and greatly accelerate the solid reaction. Again the reactions proceed much more rapidly, as we should expect, when the reacting particles are fine and in intimate contact. It has also been found that the reaction can be accelerated by seeding the mass of reacting crystals with a few fragments of the new crystal to be formed.

One example of a solid reaction is the production of periclase crystals of considerable size at temperatures far below the softening point. This is the type of reaction where fine crystals are changed into large crystals of the same kind. Another example is the production of spinel from magnesium oxide and alumina. Here an entirely new crystal is formed, and this can be carried out at temperatures far below the point where any liquid could be formed in the system.

The mechanism of sintering of nonglassy refractories is a type of solid reaction, but as yet we know very little about the process. Pure granular particles are pressed together to a porosity of, say, 30 per cent and then fired to 80 or 90 per cent of their melting point. In the firing process the pores disappear and a dense body results. What are the forces that close up these pores? Is it surface tension that closes each pore and forces the enclosed gas into solution in the crystal? Or is it a form of recrystallization where the surface energy causes loss from the small crystals and gain by the

large crystals in the vapor phase? We certainly do not know the answer at present, and fundamental research on this subject is badly needed.

4. Hot Pressing. *Principle.* If a powdered material is heated to a temperature somewhat below its melting point, there is a tendency for the powder to sinter together and gradually approach a nonporous mass. If glass is present, this sintering goes on over a considerable temperature range as with the ordinary refractory or whiteware body; but if there is no glass present, the sintering occurs in a narrower temperature range as discussed in the preceding section on solid reactions. It has been known for a long time that if external pressure is applied to the powder while it is being heated,^(242,243) this sintering is greatly accelerated and the particles coalesce into a solid mass at a very much more rapid rate and at a lower temperature level. Little has been published concerning the mechanism of sintering under pressure, and this is a very fruitful field for research. The work of Buerger,⁽²⁴⁹⁾ Washken,⁽²⁴⁶⁾ and Shaler⁽²⁴⁸⁾ should be consulted as about the only published scientific approach to the subject.

Sintering under pressure has certain obvious advantages, such as the production of low-porosity refractory bodies, which would be difficult to form in the usual firing operation. It is also possible to produce articles very accurately shaped, as there is little shrinkage or distortion during the operation. Another advantage is the fact that the operation can be carried out very rapidly, saving considerable time and labor. Again the raw material does not have to be carefully sized, and binders or lubricants are not needed.

On the other hand, there are certain disadvantages, as a temperature cannot generally be used above the point where the powder will react vigorously with the mold. Then again, at the high temperatures the life of the mold is short. Also, means must be provided for slowly cooling the finished piece to prevent cracking if it is a nonmetal.

Methods. One of the simplest methods of hot pressing is to introduce a heated object, or compact, into a cool mold and press it instantly, which might be called a "coining" process. This method can be used for some of the metals and possibly metal carbides; but as far as is known, it has not been used for other refractories. This method has the advantage of using a cool mold, which can be made of steel or tungsten carbide, but it means that the operation must be carried out very rapidly before the mold has time to chill the compact and also the finished piece must be removed from the mold before it has time to heat the walls.

Most of the hot pressing of nonmetals has been done in heated molds, usually of graphite.⁽²⁴²⁾ The heating can best be carried out by either resistance or induction methods. An example of the former is given in the

Ridgeway and Bailey patent⁽²⁴⁰⁾ illustrated in Fig. 115. The heating cylinder is made of graphite and fitted with two water-cooled electrodes through which the heavy current needed for heating is supplied. The powder to be pressed, in this case boron carbide of 200 mesh, is loaded into the mold as shown. The floating core, mold walls, and plungers are also made of graphite. The load is applied by a lever and weight, although an air cylinder could be used, with pressures up to 5,000 psi and temperatures up to 2350°C (about 4260°F). This furnace can be operated continuously or periodically for production use.

The heating can also be carried out by induction. In the case of a conducting powder, such as a metal, the heat is generated in the charge itself. In most cases, it is necessary to induce the heat in a conducting sleeve, or susceptor, forming the mold wall. A diagrammatic sketch of a suggested apparatus for hot pressing is shown in Fig. 116, where *a* is the powder to be compacted between the plungers, *b*, which are forced together with a hydraulic press. The heat is induced in the graphite susceptor *c*, with a removable graphite liner *d*. The hole *e* is used to measure the temperature with an optical pyrometer. The water-cooled, copper inductor *f* surrounds the quartz tube *g* and is insulated from the susceptor with powdered graphite *h*.

For commercial production, it appears at the present time that graphite is the only material satisfactory for a liner. Therefore, the temperatures are limited to the level at which reaction occurs between the powder and the liner. These reaction temperatures are given in Table 35.

TABLE 35. REACTION TEMPERATURE BETWEEN PURE GRAPHITE AND PURE REFRACTORY MATERIALS*

| Refractory | Temperature | |
|------------------------|-------------|------|
| | °C | °F |
| MgO..... | 1800 | 3270 |
| BeO..... | 2300 | 4170 |
| ZrO ₂ | 1800 | 3270 |
| ThO ₂ | 1950 | 3540 |
| W..... | 1500 | 2730 |
| Mo..... | 1600 | 2910 |

* From thesis of P.D. Johnson, Massachusetts Institute of Technology, 1948.

If the reaction temperature is below the temperature at which the powder becomes plastic, this method of hot pressing cannot be used, but it is believed that many of the high-temperature materials can be pressed in graphite.

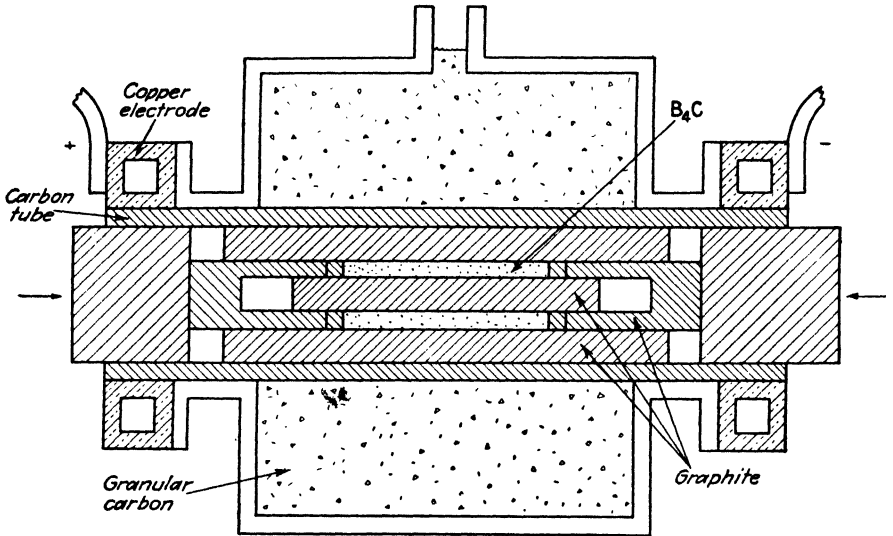

FIG. 115. Ridgeway's method of hot pressing.

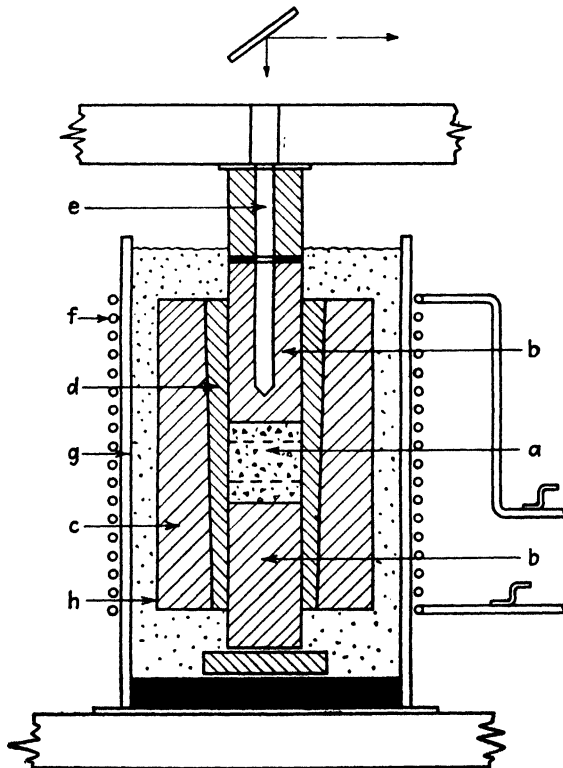

FIG. 116. Induction-heated hot-pressing die.

TABLE 36. PHYSICAL PROPERTIES OF HOT-PRESSED MATERIALS*

| Material | Formula | Density (as molded) | Melting point, °C | Porosity, per cent | Hard- ness (Knoop, 100) | Com- pressive strength, psi | Trans- verse rupture, psi | Electrical resistivity microhm per cm | Thermal expan- sion (20- 800°C) $\times 10^{-6}$ per °C | Young's modulus 10^{12} , dynes per sq cm |
|--------------------------------------|------------------------------------|------------------------|-------------------------|-----------------------|----------------------------------|--------------------------------------|------------------------------------|--|---|--|
| Oxides: | | | | | | | | | | |
| Aluminum oxide... | Al ₂ O ₃ | 3.86-3.99 | 2035 | 0-3 | 2,050 | 373,000 | 22,000 | | 7-9 | 3.7 |
| Beryllium oxide... | BeO | 2.85-3.01 | 2570 | 0-5 | 1,250 | 231,000 | 24,000 | | 8-9 | 3.8 |
| Magnesium oxide... | MgO | 3.4-3.5 | 2800 | 2-5 | | 112,000 | | | 14 | 2.5 |
| Thorium oxide..... | ThO ₂ | 9.55 | 3050 | 5 | | | | | | |
| Zirconium oxide (CaO stabilized). | ZrO ₂ | 5.68 | 2650 | 6 | 1,160 | | | | | 2.2 |
| Chrysoberyl..... | BeO·Al ₂ O ₃ | 3.6 | 1870 | 2 | | | | | | |
| Spinel..... | MgO·Al ₂ O ₃ | 3.5 | 2100 | 2 | 1,270 | | | | | |
| Carbides: | | | | | | | | | | |
| Boron carbide..... | B ₄ C | 2.51 | ca. 2500 | 0 | 2,800 | | | $3 \times 10^5-8 \times 10^5$ | 4.5 | 4.5 |
| Beryllium carbide... | Be ₃ C | 2.20 | | 10 | 2,410 | | | 5.6×10^4 | 12 | |
| Silicon carbide..... | SiC | 2.8 | ca. 2600 (decomp.) | 13+ | 2,550 | | | $5 \times 10^7-2 \times 10^8$ | | |
| Tantalum carbide... | TaC | 13.66 | 3800 ± 150 | 6 | | | | | | 6.3 |
| Titanium carbide... | TiC | 4.80 | 3140 ± 90 | 3 | 2,470 | | | 170 | | |
| Vanadium carbide... | VC | 5.42 | 2800 | 7 | 2,080 | | | 160 | | |
| Tungsten carbide... | WC | 15.61 | 2870 | 0 | 1,880 | | | 50 | | 5.4 |
| Zirconium carbide... | ZrC | 6.27 | 3530 ± 125 | 5 | 2,090 | | | | | 3.4 |
| Nitrides: | | | | | | | | | | |
| Beryllium nitride... | Be ₃ N ₂ | 2.45 | | 17 | 2,040 | | | | | |
| Titanium nitride... | TiN | 5.29 | 2950 ± 50 | 3 | 1,770 | | | | | |
| Zirconium nitride... | ZrN | 6.65 | 2980 ± 50 | 6 | | | | 72 | | |

* Data in this table furnished by the Norton Co., Worcester, Mass. (26)

Applications. The hot-pressing method has already been used to some extent in powder metallurgy with commercial success for some types of articles, but very little information is available in the literature. ^(241,242,248)

Nonmetals can be hot pressed quite satisfactorily, ⁽²⁴⁵⁾ and the data in Table 36, kindly supplied by the Norton Company, ⁽²⁵⁰⁾ Worcester, Massachusetts, give the physical properties of a number of high-temperature refractories formed by a hot-pressing operation. These properties indicate great promise for this method of fabrication.

It has been reported that pieces as large as a standard brick have been formed by the hot-pressing operation, and there is considerable interest in developing this process for the larger shapes, such as nonporous tank blocks. But the cost of heating and the short life of the molds at present do not seem to give much promise of making this a method adaptable to large-scale production. However, it would seem desirable to carry out a great deal more development in this field, as means may be found to overcome these difficulties.

5. Firing Properties of Refractory Bodies. It is seldom desirable to produce a refractory directly from a raw plastic clay because of the large shrinkage and distortion that would occur in firing. A reduction in firing shrinkage is a very desirable accomplishment for the following reasons:

1. It permits the production of a fired refractory that will be close to the desired dimensions.
2. It prevents warping of the refractory on firing.
3. It permits a greater weight of finished bricks to be fired in a given kiln.
4. It makes it unnecessary to control the maximum temperature of firing as carefully as when large shrinkages occur.

Use of Grog. One of the simplest methods of reducing the firing shrinkage of a refractory is by introducing a nonplastic material such as grog, an ancient expedient but one that carries a patent history. ^(220,221,230,232,234,236) As this material has already been fired and has reached a stable volume, it acts somewhat as a skeleton to hold the brick together in a stable form during the firing operation. Figure 117 shows a curve of firing shrinkage and porosity of a mixture of kaolin and grog burned to a temperature of 3000°F (about 1650°C) for 2 hr. The grog was sized for dense packing, bonded with raw Georgia kaolin, and formed in a mold by hand. It is interesting to note that the grog alone has a 3 per cent linear shrinkage when fired at this temperature. Careful microscopic studies of individual pieces of the same grog fired at the particular temperature showed no volume change and no rounding of the corners; but apparently when the grog is formed into a mass of particles in contact, the surface tension or pressure effects are such as to cause rounding of the sharp points and edges sufficient to produce welding and shrinkage.

It is also interesting to note that bond clay can be added up to approximately 25 per cent without any change in the burning shrinkage. As the volume of voids in this grog is approximately 25 per cent of the bulk volume, it will be seen that the bond is simply acting as a filler in the pore spaces and that when it shrinks, it does not affect the volume of the whole piece, since this is governed by the grog. However, when the amount of bond is increased beyond 25 per cent, the total shrinkage begins to increase more and more rapidly until 100 per cent of bond is reached. This is due to the fact that thicker and thicker films of shrinking bond are built up between the grog grains.

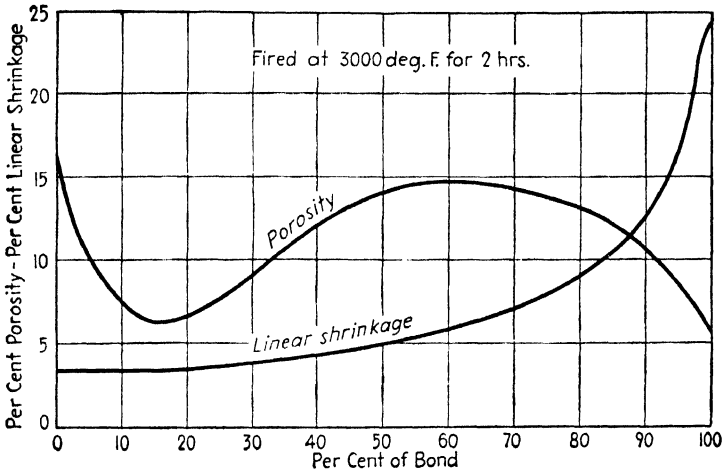

FIG. 117. Shrinkage and porosity curves. Clay-grog mixtures.

Expanding Minerals. The shrinkage of a refractory clay can also be controlled by adding a mineral that expands on firing.⁽¹¹¹⁾ Such a mineral may be kyanite, which, mixed with clay in the raw state or with clay and grog, will give a very definite expansion.

To illustrate this, a few mixes were made by Lane⁽¹⁰⁹⁾ using the proportions given in Table 37.

These mixes were molded in a dry press and fired to various temperatures at which they were held for 3 hr. The shrinkage curves are shown in Fig. 118. It will be seen that the kyanite gives a real expansion over the range from 2350 to 2600°F (about 1290 to 1425°C) but beyond this point shrinks faster than the grog and clay mix—a disadvantage when it is attempted to make a refractory to be volume constant at temperatures higher than the original firing. However, the 12 per cent kyanite mixture has the same volume at a firing temperature of 2975°F (about 1635°C) as when molded. Kyanite having too coarse grains ruptures and weakens the structure, whereas too fine grains give little or no expansion. Grains of all

TABLE 37. KYANITE-CLAY MIXES ILLUSTRATED IN FIG. 118

| Mix | Dense kaolin grog, per cent | Raw N. C. kyanite, per cent | Raw kaolin, per cent |
|-----|--------------------------------|--------------------------------|-------------------------|
| A | 85 | 0 | 15 |
| B | 81 | 4 | 15 |
| C | 77 | 8 | 15 |
| D | 73 | 12 | 15 |

| Grog sizing | | Kyanite sizing | |
|-------------|----------|----------------|----------|
| Screen | Per cent | Screen | Per cent |
| 4-8 | 35 | 14-35 | 50 |
| 8-14 | 15 | 35-60 | 30 |
| 14-35 | 6 | 60-100 | 10 |
| 35-60 | 4 | 100 | 10 |
| 60-100 | 20 | | |
| 100 | 20 | | |

one size break down over a very small temperature range, giving an undesirable peak in the expansion curve.

The minerals sillimanite and andalusite were also tried out in similar mixtures; and although they showed a small amount of expansion, they were not nearly so effective as the kyanite.

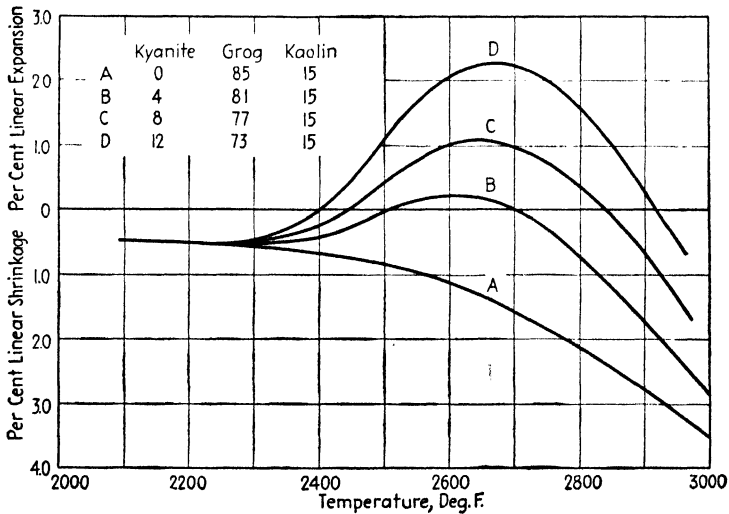

FIG. 118. Expansion caused by kyanite.

It is theoretically possible to add a high-density mineral like fused alumina to a mixture of grog and bond, which after long heat-treatment will dissolve in the glass and form mullite of lower density. Practically, however, this solution goes on with extreme slowness and seems difficult to carry out in a practical way, although such a method is suggested in a patent of Lambie and Ross.⁽⁵⁰⁾

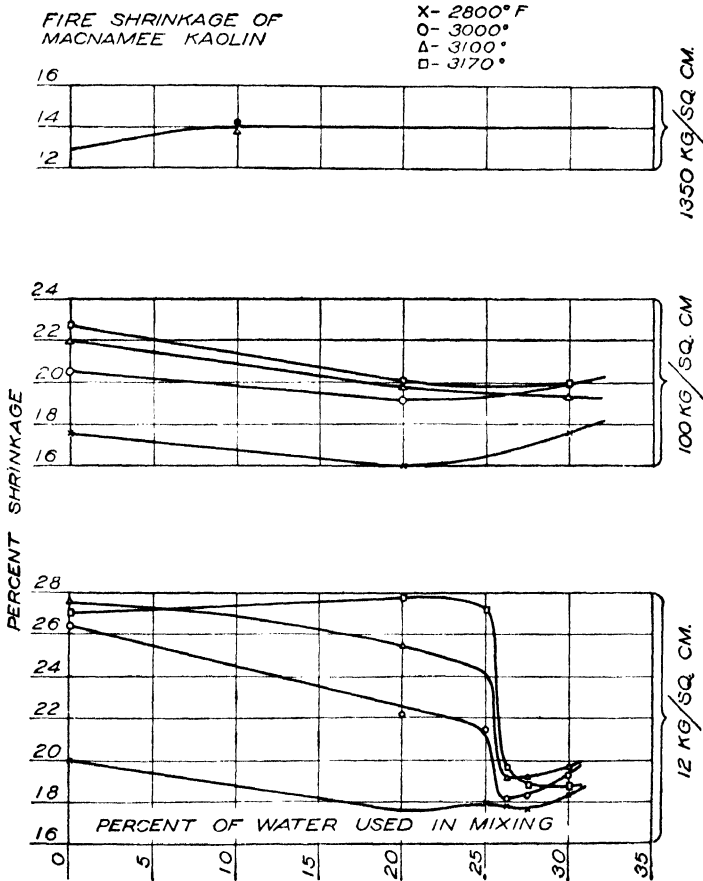

FIG. 119. Curves showing the burning shrinkage of kaolin for various water contents and molding pressures.

Bloating. Reduction of shrinkage can also take place if the clay bloats or forms bubbles in the glass owing to breaking up of sulfides, carbonates, etc. This increase in size by bloating may account for the expansion of some of the high-alumina clays and flint clays in firing, but a great deal more work needs to be done on this question before we shall know the exact mechanism causing it. Bloating, if it occurs to any great extent, is not particularly desirable, as it is hard to control and will not occur under any

appreciable load. Therefore, a shape being fired may show no change in horizontal dimensions but may shrink materially in a vertical direction.

Molding Conditions. Shrinkage is also more or less dependent on the conditions of molding, as shown by the curves in Fig. 119 for various water contents and molding pressures of kaolin and water mixtures. In fact, it will be observed that the burning shrinkage is sharply decreased by increasing the water content beyond the critical value of 25 per cent for low molding pressures. Also, the higher the molding pressure the lower is the

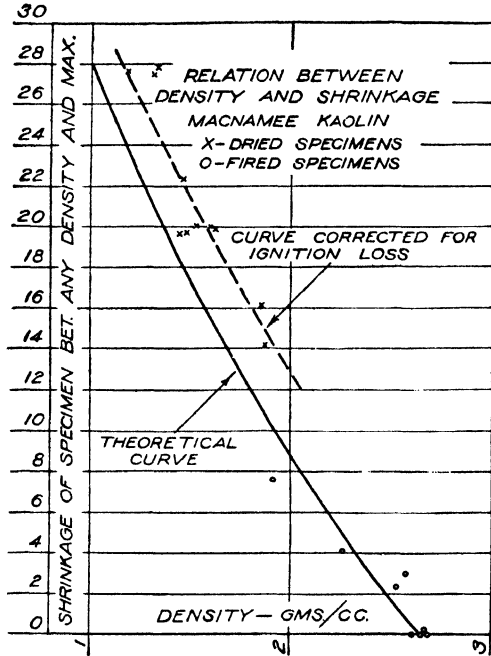

Fig. 120. Curves showing the relation between density and maximum linear shrinkage for kaolin.

burning shrinkage. For a given material, a maximum shrinkage in burning can be determined from the density of the dried or partially fired specimen (allowing for ignition loss). This is shown by the curve in Fig. 120, where the density values are plotted against the maximum linear shrinkage based on the condition of the specimen when the density is determined. This curve applies to both fired and unfired specimens. For example, if an unfired specimen has a density of 1.46, it will eventually shrink 22.0 per cent, to the condition of maximum density.

Control of Porosity. The porosity of a refractory is of great importance, as a low porosity gives better resistance to slag attack and a higher porosity, in general, gives better resistance to spalling. Also, a low-porosity material

has a high thermal conductivity, whereas a high-porosity material such as an insulating brick has a low value. It is important, therefore, that a manufacturer of refractories be able to control the porosity to suit the particular conditions for which the brick is used.

Porosity, in the same way as shrinkage, is controlled to a large extent by the molding conditions; *i.e.*, high pressures in molding give a more densely fired structure. Also, high firing temperatures give low porosities but at the same time are apt to produce distortion.

Perhaps one of the best ways of controlling porosity, especially for producing low-porosity refractories such as glass-tank blocks and slag-resisting brick, is to control the grog size carefully. This is considered so important that many modern refractory plants are controlling the grain size of a grog with great exactness. Much work has been done on the packing of grog particles to produce a structure of the lowest possible density, as noted in

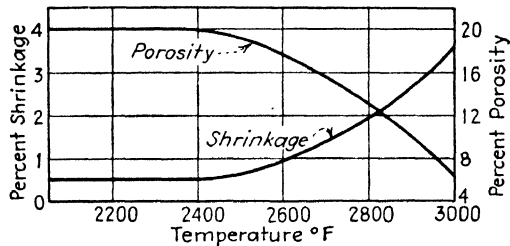

FIG. 121. Shrinkage and porosity curves for a closely packed grog having 15 per cent bond clay.

Chap. VI. Figure 121 shows the shrinkage and porosity curves for a densely packed grog body having 15 per cent of clay bond fired at various temperatures.

Chemical Control. In making certain types of refractories, it is impossible readily to obtain raw materials that are free from a certain objectionable impurity. This impurity can sometimes be converted into a non-objectionable material by adding a mineral that will combine with it and form a higher fusing compound. An example of this which was briefly mentioned before is the addition of magnesium oxide to chrome ore in such an amount that it will combine with the silica and form the mineral forsterite,⁽¹⁶³⁾ the highest melting compound in the magnesia-silica system.

Another example is the production of forsterite refractories, where many of the natural materials, such as olivine, produce excess silica in the form of glass or cristobalite when fired. Magnesium oxide added in the correct amount will combine with the silica to form additional forsterite.

6. Melted and Cast Refractories. For certain purposes, particularly in the production of glass-tank refractories with a minimum of porosity, it has been found desirable to produce refractories by fusing the raw mate-

rials in an electric furnace and pouring the melted refractory into a sand mold to form the desired shape. The melting process itself permits some purification of the raw materials (1) by the reduction of iron oxide to metallic iron and (2) by the elimination of some of the silica by volatilization or combination with the iron to form ferrosilicon. The casting itself is practically nonporous; and by governing the rate of cooling, the size of the crystals can be regulated as desired. This process, though comparatively expensive, seems to be justified for producing special refractories, such as mullite and alumina blocks for glass tanks. ^(253, 254, 255, 258)

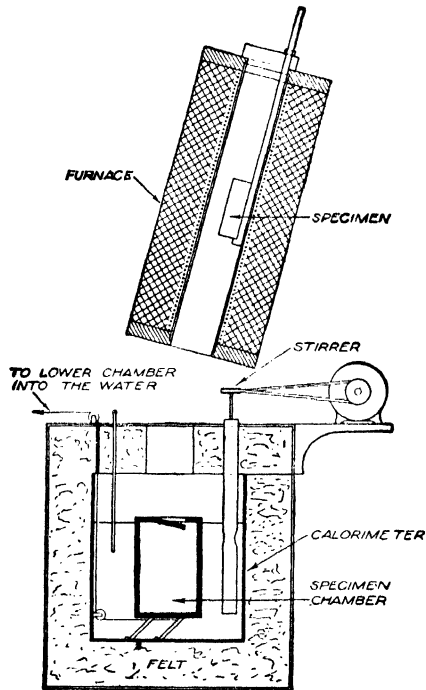

FIG. 122. Apparatus for measuring specific heat by the calorimeter method.

7. Specific Heat. The term "specific heat" has been used in the ceramic literature rather loosely and, in many cases, has been applied not only to specific heat values but to values of latent heat of association, inversion, or crystallization. Specific heat may be defined as a number expressing the ratio of the heat quantity required to raise, respectively, 1 g of the given material 1°C at a definite temperature and 1 g of water from 19.5 to 20.5°C . Specific heat can correctly refer only to the heat required for raising the temperature of a thermally stable material that is free from any changes through the measured interval. We can, therefore, correctly speak of specific heat as applying to stable refractory materials that have been

previously fired to complete all irreversible reactions and that have no reversible changes in the temperature range being measured. For example, the specific heat of quartz is continuous up to 573°C (about 1063°F), where a crystal change takes place giving off a small amount of latent heat of inversion that must be added to the specific heat to give the total heat content. The use of the term specific heat for raw clays, as is often done, is very unfortunate.

Method of Measurement. The measurement of specific heat can be carried out with considerable accuracy by the calorimeter method. In this determination, the specimen is heated in a suitable furnace to a known and uniform temperature and then dropped suddenly into a calorimeter, which can be immediately immersed in water. The heat content of the specimen is then determined by the rise in temperature of the water and the constants of the apparatus. Equipment for the high-temperature measurements of specific heat is shown in Fig. 122. This apparatus, as used by Wilkes,⁽²⁸³⁾ is laid out to give a quick drop of the sample into the specimen chamber with the elimination, necessary for precise work, of splashing and steam losses.

Values. In Table 38 are given values of specific heat for a considerable number of stable refractory materials. Some of the minerals, such as quartz, cristobalite, and zirconia, have reversible inversions, but these are small in effect and are included by the experimenter in the value for specific heat.

8. Heat Quantity Required to Raise the Temperature of Clays and Ceramic Bodies. *Method of Measurement.* The determination of the heat required to raise a clay to a certain temperature is a very difficult measurement because the calorimeter method, which can be used for stable materials, is not applicable here. The heat given up on cooling is quite different from the heat absorption in raising the temperature. It is, therefore, necessary to find some way of actually measuring the heat going into a given specimen as it is raised through definite temperature intervals. A number of methods have been used to make these measurements; but because of the inherent difficulties of measuring the heat directly absorbed by the specimen, the results are not highly precise, and a great deal of work is still to be done in this field before we will feel sure of the values.

One of the methods, used for this purpose by Navias,⁽²⁷¹⁾ consists in heating the specimen of clay with a surrounding platinum coil, which is, in turn, enclosed in a vacuum jacket to prevent possible escape of heat to the outside. Nevertheless, during the rather long period of test, some heat is lost. This is measured by immersing the vacuum jacket in a water bath, which permits the heat escaping to be measured. By calibrating this apparatus with a material of known specific heat, the proportion of heat going into the sample and the proportion going into the container, coil, etc.,

TABLE 38. VALUES OF MEAN SPECIFIC HEAT

| Material | Temperature range, °C. | Mean specific heat | Investigators |
|---|------------------------|--------------------|-------------------------------------|
| Alumina, fused..... | 20-200 | 0.211 | W. Cohn ⁽²⁷⁴⁾ |
| | 20-400 | 0.231 | |
| | 20-600 | 0.251 | |
| | 20-800 | 0.272 | |
| | 20-1000 | 0.304 | |
| Alumina, pure..... | 30-100 | 0.206 | G. B. Wilkes ⁽²⁸³⁾ |
| | 30-300 | 0.226 | |
| | 30-500 | 0.240 | |
| | 30-700 | 0.250 | |
| | 30-900 | 0.258 | |
| | 30-1100 | 0.265 | |
| | 30-1300 | 0.271 | |
| | 30-1500 | 0.276 | |
| Cristobalite..... | 0-200 | 0.213 | R. Wietzel ⁽²⁶⁹⁾ |
| | 0-400 | 0.242 | |
| | 0-800 | 0.260 | |
| | 0-1600 | 0.276 | |
| Chrome brick..... | 30-218 | 0.178 | Y. Tadokoro ⁽²⁶⁸⁾ |
| | 30-318 | 0.195 | |
| | 30-382 | 0.210 | |
| | 30-480 | 0.216 | |
| | 30-894 | 0.215 | |
| Fireclay brick—35 per cent Al ₂ O ₃ | 25-600 | 0.228 | Bradshaw and Emery ⁽²⁶⁷⁾ |
| | 25-1000 | 0.265 | |
| | 25-1200 | 0.284 | |
| | 25-1400 | 0.297 | |
| Fireclay brick..... | 600 | 0.227 | J. W. Mellor and others |
| | 1000 | 0.263 | |
| | 1200 | 0.262 | |
| Fireclay brick..... | 200 | 0.204 | E. Heyn and others ⁽²⁶⁴⁾ |
| | 400 | 0.222 | |
| | 600 | 0.236 | |
| | 800 | 0.248 | |
| | 1000 | 0.256 | |
| | 1200 | 0.263 | |
| Lime, fused..... | 375-400 | 0.181 | P. N. Laschtchenko |
| | 590-680 | 0.193 | |
| Magnesia, pure..... | 30-100 | 0.234 | G. B. Wilkes ⁽²⁸³⁾ |
| | 30-300 | 0.247 | |
| | 30-500 | 0.259 | |
| | 30-700 | 0.269 | |
| | 30-900 | 0.277 | |
| | 30-1100 | 0.283 | |
| | 30-1300 | 0.288 | |
| | 30-1500 | 0.291 | |
| | 30-1700 | 0.294 | |
| 30-1800 | 0.295 | | |
| Magnesite brick—88 per cent MgO..... | 25-605 | 0.265 | A. T. Green ⁽²⁷⁰⁾ |
| | 25-825 | 0.274 | |
| | 25-930 | 0.280 | |
| | 25-1041 | 0.285 | |
| | 25-1115 | 0.292 | |
| Mullite, 3Al ₂ O ₃ ·2SiO ₂ | 20-200 | 0.161 | W. Cohn ⁽²⁷²⁾ |
| | 20-400 | 0.167 | |
| | 20-600 | 0.173 | |
| | 20-800 | 0.175 | |
| Porcelain, fired..... | 20-200 | 0.195 | W. Cohn ⁽²⁷³⁾ |
| | 20-400 | 0.212 | |
| | 20-600 | 0.232 | |
| | 20-800 | 0.264 | |
| | 20-1000 | 0.304 | |

TABLE 38. VALUES OF MEAN SPECIFIC HEAT (Continued)

| Material | Temperature range, °C. | Mean specific heat | Investigators | | | |
|--|------------------------|---|---------------------------|-------------------------------------|---------------------------|-------------------------------|
| Quartz glass, SiO ₂ | { | 0-200 | 0.201 | R. Wietzel ⁽²⁶⁹⁾ | | |
| | | 0-400 | 0.223 | | | |
| | | 0-600 | 0.239 | | | |
| | | 0-800 | 0.251 | | | |
| | | 0-1000 | 0.258 | | | |
| | | 0-1200 | 0.262 | | | |
| | | 0-1400 | 0.269 | | | |
| Quartz, crystalline, SiO ₂ | { | 0-200 | 0.203 | R. Wietzel ⁽²⁶⁹⁾ | | |
| | | 0-400 | 0.223 | | | |
| | | 0-800 | 0.259 | | | |
| | | 0-1600 | 0.271 | | | |
| | | | | | | |
| Silica brick..... | { | 25-600 | 0.226 | Bradshaw and Emery ⁽²⁶⁵⁾ | | |
| | | 25-1000 | 0.263 | | | |
| | | 25-1200 | 0.282 | | | |
| | | 25-1400 | 0.293 | | | |
| Silicon carbide, crystalline, SiC.. | { | 0 | 0.140 | O. Weigel ⁽²⁶⁵⁾ | | |
| | | 200 | 0.233 | | | |
| | | 400 | 0.277 | | | |
| | | 600 | 0.275 | | | |
| | | 800 | 0.225 | | | |
| Spinel: | { | 1000 | 0.129 | | | |
| | | Ferrous aluminate, FeO·Al ₂ O ₃ .. | 50-1025 | 0.25 | Parmelee ⁽¹⁷⁵⁾ | |
| | | Magnesium aluminate, MgO·Al ₂ O ₃ | 50-1025 | 0.29 | Parmelee ⁽¹⁷⁵⁾ | |
| | | Magnesium aluminate, MgO·Al ₂ O ₃ | { | 0-243 | 0.214 | A. E. MacGee ⁽²⁷⁶⁾ |
| | | | | 0-399 | 0.229 | |
| | | | | 0-534 | 0.232 | |
| 0-632 | 0.250 | | | | | |
| 0-783 | 0.255 | | | | | |
| 0-886 | 0.255 | | | | | |
| 0-1042 | 0.257 | | | | | |
| Zinc aluminate, Zr·Al ₂ O ₃ | 50-1025 | 0.22 | Parmelee ⁽¹⁷⁵⁾ | | | |
| Ferrous chromite, FeO·Cr ₂ O ₃ .. | 50-1025 | 0.20 | Parmelee ⁽¹⁷⁵⁾ | | | |
| Magnesium chromite, MgO·Cr ₂ O ₃ | 50-1025 | 0.22 | Parmelee ⁽¹⁷⁵⁾ | | | |
| Manganese chromite, MnO·Cr ₂ O ₃ | 50-1025 | 0.18 | Parmelee ⁽¹⁷⁵⁾ | | | |
| Zinc chromite, ZnO·Cr ₂ O ₃ | 50 1025 | 0.18 | Parmelee ⁽¹⁷⁵⁾ | | | |
| Ferrous ferrite, FeO·Fe ₂ O ₃ | 50-1025 | 0.23 | Parmelee ⁽¹⁷⁵⁾ | | | |
| Magnesium ferrite, MgO·Fe ₂ O ₃ | 50-1025 | 0.20 | Parmelee ⁽¹⁷⁵⁾ | | | |
| Manganese ferrite, Mn·Fe ₂ O ₃ | 50-1025 | 0.21 | Parmelee ⁽¹⁷⁵⁾ | | | |
| Zinc ferrite, ZnO·Fe ₂ O ₃ | 50-1025 | 0.17 | Parmelee ⁽¹⁷⁵⁾ | | | |
| Zirconia—99 per cent, ZrO ₂ | { | 25-600 | 0.137 | Bradshaw and Emery ⁽²⁶⁷⁾ | | |
| | | 25-1000 | 0.157 | | | |
| | | 25-1200 | 0.167 | | | |
| | | 25-1400 | 0.175 | | | |

can be calculated. A test is then made by heating the given sample to a certain temperature and holding it there until equilibrium is reached, the heat input being measured by the number of watts supplied to the heater. The temperature is again raised to another level; the additional heat input measured; etc. From these values, a curve of heat input against temperature can be plotted.

White⁽²⁶⁶⁾ and Cohn⁽²⁷⁴⁾ supported a specimen of the clay in a small container in the center of a wire-wound furnace and determined the heat passing from the furnace wall to the specimen by the temperature difference

TABLE 39. THE HEAT REQUIRED TO BURN UNFIRED BODIES

| Material | Temperature, °C. | Cal.* to heat 1 g. from 20° to t°C. | Investigators | |
|------------------------------|------------------------------------|--|-------------------------------|-----|
| Ball clay (Kentucky)..... | 0-200 | 68 | A. E. MacGee ⁽²⁷⁵⁾ | |
| | 0-400 | 159 | | |
| | 0-600 | 285 | | |
| | 0-800 | 366 | | |
| | 0-1000 | 465 | | |
| Diaspore clay..... | 0-200 | 70 | A. E. MacGee ⁽²⁷⁵⁾ | |
| | 0-400 | 150 | | |
| | 0-600 | 274 | | |
| | 0-800 | 350 | | |
| | 0-1000 | 450 | | |
| Firebrick body..... | 0-200 | 68 | A. E. MacGee ⁽²⁷⁵⁾ | |
| | 0-400 | 145 | | |
| | 0-600 | 268 | | |
| | 0-800 | 337 | | |
| | 0-1000 | 415 | | |
| | 0-1200 | 507 | | |
| Fire clay, raw Chamotte..... | 200 | 35 | W. Cohn ⁽²⁷²⁾ | |
| | 400 | 80 | | |
| | 600 | 201 | | |
| | 800 | 243 | | |
| | 1000 | 326 | | |
| | 1400 | 572 | | |
| Kaolin, Georgia..... | 0-200 | 79 | A. E. MacGee ⁽²⁷⁵⁾ | |
| | 0-400 | 183 | | |
| | 0-600 | 332 | | |
| | 0-800 | 402 | | |
| | 0-1000 | 496 | | |
| Kaolin, Zettlitz..... | 200 | 37 | W. Cohn ⁽²⁷²⁾ | |
| | 400 | 86 | | |
| | 600 | 241 | | |
| | 800 | 333 | | |
| | 1000 | 420 | | |
| | 1400 | 560 | | |
| Porcelain body (green)..... | 200 | 34 | W. Cohn ⁽²⁷²⁾ | |
| | 400 | 81 | | |
| | (Clay substance, 55 per cent)..... | 600 | | 193 |
| | (Quartz, 22.5 per cent)..... | 800 | | 248 |
| | (Feldspar, 22.5 per cent)..... | 1000 | | 331 |
| | | 1200 | | 428 |
| | 1400 | 528 | | |

* In the cases noted the initial temperature is 0°C.

between the specimen and the furnace. By calibrating this apparatus with a specimen of known specific heat, the heat input for any given specimen can be computed.

MacGee⁽²⁷⁶⁾ used a differential thermal method in which a specimen of the clay and a specimen of a neutral substance of known specific heat were placed side by side in a wire-wound furnace. A differential thermocouple recorded the difference in temperature between the two specimens, from which the heat input to the clay sample through any temperature interval could be computed.

Perhaps one of the most satisfactory methods, but one that has not as yet been applied extensively to clays, is that suggested by Smith⁽²⁸⁶⁾ in which a comparatively thick-walled refractory crucible is placed in the center of a wire-wound furnace with the clay sample inside it. A differential thermocouple with the junctions, respectively, on the inside and the outside surface of the crucible is connected to a temperature controller, which raises the furnace at such a rate that a definite temperature difference is always present in the walls of the crucible. The heat input to the sample is always constant for given time intervals, assuming no change in conductivity with small temperature changes. Therefore, a plot of furnace temperature against time will enable a curve of heat input against temperature to be established. It should be noted that unlike the other methods, calibration factors are not necessary provided the thermal conductivity of the crucible wall is known.

A recent paper by Shorter⁽²⁸⁷⁾ makes a critical survey of the subject and analyzes the methods of MacGee and of Cohn.

In Table 39 will be found values for the heat required to raise various types of clays and ceramic bodies to definite temperature levels.

9. Bibliography

Effect of Heat on Clays and Hydrated Aluminates:

1. BROWN, G.H., and G.A. MURRAY: The Function of Time on the Vitrification of Clays, *Natl. Bur. Standards, Tech. Paper 17*, 1913.
2. BROWN, G.H., and E.T. MONTGOMERY: Dehydration of Clays, *Natl. Bur. Standards, Tech. Paper 21*, 1913.
3. BLEININGER, A.V., and E.T. MONTGOMERY: Effect of Overfiring upon the Structure of Clays, *Natl. Bur. Standards, Tech. Paper 22*, 1913.
4. BLEININGER, A.V., and H.G. SCHURECHT: Properties of Some European Plastic Fire Clays, *Natl. Bur. Standards, Tech. Paper 79*, 1916.
5. BLEININGER, A.V.: Properties of American Bond Clays and Their Use in Graphite Crucibles and Glass Pots, *Natl. Bur. Standards, Tech. Paper 144*, 1920.
6. BALES, C.E.: Effect of Impurities in Fireclays, *Brick & Clay Record*, **59**, 723, 1921.

7. MELLOR, J.W., N. SINCLAIR, and P.S. DEVEREAUX: The De-hydration of Dried Clays, *Trans. Ceram. Soc. (Engl.)*, **21**, 104, 1921.
8. HOULDSWORTH, H.S., and J.W. COBB: The Behavior of Fireclays, Bauxites, etc., on Heating, *Trans. Ceram. Soc. (Engl.)*, **22**, 111, 1922; **23**, 277, 1923.
9. VERNADSKY, W.: The Action of Heat on Kaolinite and on Kaolinite Clays, *Trans. Ceram. Soc. (Engl.)*, **24**, 13, 1924.
10. KOZU, S., and M. MASUDA: Thermal Changes of Dehydration Phenomena of Some Hydrous Minerals, *Science Repts. Tôhoku Imp. Univ., Third Ser.*, **3**, 33, 1926.
11. MOORE, C.E.: Some Changes Taking Place in the Low-temperature Burning of Stourbridge Fireclay, (II), *Trans. Ceram. Soc. (Engl.)*, **25**, 127, 1926.
12. YAMAGUCHI, Y., *et al.*: Properties of Bauxite, *Bull. Inst. Phys. Chem. Research (Tokyo)*, **5**, 735, 1926.
13. YAMAGUCHI, Y., *et al.*: Studies on Diaspore, *Bull. Inst. Phys. Chem. Research (Tokyo)*, **5**, 17, 1926.
14. GELLER, R.F., and W.H. WADLEIGH: Some Observations on the Dehydration and Firing Behavior of Clays, *J. Am. Ceram. Soc.*, **10**, 925, 1927.
15. HYSLOP, J.F., and H.P. ROOKSBY: The Effect of Heat on the Crystalline Break-up of Kaolin, *Trans. Ceram. Soc. (Engl.)*, **27**, 93, 1927.
16. DELAPPARENT, J., and E. STEMPFEL: Sur la gibbsite déshydratée, *Compt. rend.*, **187**, 305, 1928.
17. MCVAY, T.N.: The Effect of Temperature on the Optical Properties of Kaolinite, *J. Am. Ceram. Soc.*, **11**, 224, 1928.
18. MIEHR, W., H. IMMKE, and J. KRATZERT: Der Einfluss des Brennens auf die chemischen und physikalischen Eigenschaften feuerfester Tone, *Tonind.-Ztg.*, **52**, 280, 298, 323, 1928.
19. HYSLOP, J.F., and H.P. ROOKSBY: A Further Note on the Crystalline Break-up of Kaolin, *Trans. Ceram. Soc. (Engl.)*, **27**, 299, 1927.
20. KLEVER, E.: Calorimetric and X-ray Investigations of the Dehydration Process of Hydrated Alumina, *Trans. Ceram. Soc. (Engl.)*, **29**, 149, 1930 (Memorial Section).
21. NORTON, F.H., and F.B. HODGDON: The Influence of Time on the Maturing Temperature of Whiteware Bodies, I, *J. Am. Ceram. Soc.*, **14**, 177, 1931.
22. KRAUSE, O., and H. WÖHNER: On the Behavior of Technical Kaolins during Firing, *Ber. deut. keram. Ges.*, **13**, 485, 1932.
23. SCHWIERSCH, H.: Thermal Decomposition of Natural Hydroxides of Aluminum and of Trivalent Iron: A Contribution to the Question of Reactions in the Solid State, *Chem. Erde*, **8**, 252, 1933.
24. NUTTING, P.G.: The Bleaching Clays, *U.S. Geol. Survey Circ.* **3**, 1933.
25. VON GRONOW, H.E., and H.E. SCHWIETE: On the Determination of the Heat of Dehydration as Exemplified on Kaolin at 450°, *Z. anorg. allgem. Chem.* **216**, 109, 1933.
26. AO, T.: Thermal and Hydrothermal Syntheses of Mullite, *J. Soc. Chem. Ind. Japan*, **36**, 546B, 1933.
27. RIDDLE, F.H., and A.B. PECK: The Effect of Repeated Firing upon the Specific Gravity and Microstructure of Some Aluminum-silicate Minerals, *J. Am. Ceram. Soc.*, **18**, 193, 1935.
28. INSLEY, H., and R.H. EWELL: Thermal Break-up of Kaolin Minerals, *Nat. Bur. Standards, J. Research*, R.P. 792, p. 615, 1935.

29. ZVANUT, F.J., and L.J. WOOD: X-ray Investigations of the Pyrochemical Changes in Missouri Halloysite, *J. Am. Ceram. Soc.*, **20**, 251, 1937.
30. MELLOR, J.W.: The Chemical Constitution of the Clay Molecule, *Trans. Ceram. Soc. (Engl.)*, **37**, 118, 1938.
31. EITEL, W., H.O. MÜLLER, and O.E. RADZEWski: Uebermikroskopische Untersuchungen an Tonmineralien (Supermicroscopic Investigations on Clay Minerals), *Ber. deut. keram. Ges.*, **20**, 165, 1939.
32. NORTON, F.H.: Critical Study of the Differential Thermal Method for the Identification of the Clay Minerals, *J. Am. Ceram. Soc.*, **22**, 54, 1939.
33. TSCHUISCHWILI, L., W. BUSSEM, and W. WEYL: On Metakaolin, *Ber. deut. keram. Ges.*, **20**, 249, 1939.
34. HEROLD, P.G., and C.M. DODD: Thermal Dissociation of Diaspore Clay, *J. Am. Ceram. Soc.*, **22**, 388, 1939.
35. GRIM, R.E., and W.F. BRADLEY: Investigation of the Effect of Heat on the Clay Minerals Illite and Montmorillonite, *J. Am. Ceram. Soc.*, **23**, 242, 1940.
36. FREBERG, A.K.: Problem of the Second Exothermal Effect in the Thermal Analysis of Refractory Clays, *Compt. rend. acad. sci. U.R.S.S.*, **28**, 90, 1940.
37. NUTTING, P.G.: Some Standard Thermal Dehydration Curves of Minerals, *U.S. Geol. Survey, P.P.* 197-E, 1943.
- 37a. COMEFORO, J.E., et al.: Mullitization of Kaolinite, *J. Am. Ceram. Soc.*, **31**, 254, 1948.

Firing Shrinkage and Porosity:

38. GOODNER, E.F.: A Mercury Volumeter, *J. Am. Ceram. Soc.*, **4**, 288, 1921.
39. SORTWELL, H.H.: American and English Ball Clays, *Natl. Bur. Standards, Tech. Paper 227*, 1923.
40. PRESSLER, E.E.: Comparative Tests of Porosity and Specific Gravity on Different Types of Refractory Brick, *Am. Ceram. Soc.*, **7**, 447, 1924.
41. BOOZE, M.C.: The Chemical and Physical Properties of Fire Clays from Various Producing Districts, *J. Am. Ceram. Soc.*, **8**, 655, 1925.
42. HARTMANN, M.L., O.B. WESTMONT, and S.F. MORGAN: The Determination of the Bulk and Pore Volume of Refractory Materials, *J. Am. Ceram. Soc.*, **9**, 298, 1926.
43. MACGEE, A.E.: Several Gas Expansion Porosimeters, *J. Am. Ceram. Soc.*, **9**, 814, 1926.
44. WESTMAN, A.E.R.: The Mercury Balance: An Apparatus for Measuring the Bulk Volume of Brick, *J. Am. Ceram. Soc.*, **9**, 311, 1926.
45. ROBITSCHKE, J.: Eine einfache Vorrichtung zur Bestimmung der Porosität feuerfester Erzeugnisse, *Tonin.-Ztg.*, **51**, 907, 1927.
46. WHEELER, E.S., and A.H. KUECHLER: Mercury Volumeter, *J. Am. Ceram. Soc.*, 1927.
47. ANON.: Standard Definitions of Terms Relating to Specific Gravity, *ASTM Standards, Series E*, 12-27, p. 932, 1927.
48. WILLETTTS, P.G.: Method of Making Refractory Blocks, U.S. Patent 1,626,261, 1927.
49. TROSTEL, L.J.: Making Refractory Composition and Articles, U.S. Patent 1,716,295, 1929.
50. LAMBIE, J.M., and D.W. ROSS: Refractory Mixture, U.S. Patent 1,769,297, 1930.

51. PHELPS, S.M.: Study of the Shrinkage of Diaspore Clays, Part II, *J. Am. Ceram. Soc.*, **15**, 96, 1932.
52. ANON.: Standard Method of Test for Porosity and Permanent Volume Changes in Refractory Materials, ASTM C 20-33, revised 1933.
53. OLIVER, H., and K.M. ROBERTS: The Influence of Degree of Vacuum and Time of Soaking on the Determination of Apparent Porosity and True Specific Gravity, *Trans. Ceram. Soc. (Engl.)*, **35**, 337, 1936.
54. EVERHART, J.O.: Secondary Expansion in Refractory Clays, *J. Am. Ceram. Soc.*, **20**, 353, 1937.
55. MACEY, H.H., and F.H. CLEWS: Measurement of Apparent Porosity, Refractory Materials Joint Committee, Twenty-ninth Report, *Inst. Gas Engrs. Commun.*, **193**, 45, November, 1938.
56. HEINDL, R.A., and L.E. MONG: Length Changes and Endothermic and Exothermic Effects during Heating of Flint and Aluminous Clays, *Natl. Bur. Standards, Research Paper RP1243*, 1939.
57. STEVENS, D.K., and R.E. BIRCH: Shrinkage Rates in Firing Fire-clay Refractories, *J. Am. Ceram. Soc.*, **30**, 109, 1947.

Effect of Kiln Atmosphere:

58. JACKSON, F.G.: The Oxidation of Ceramic Ware during Firing (V), A Quantitative Study of the Nature of Sulphur Evolution in Kiln Firing (II), *J. Am. Ceram. Soc.*, **7**, 656, 1924.
59. THEOBALD, L.S., and A.T. GREEN: Observations on the Elimination of Carbonaceous Matter from Fireclay Bricks, *Trans. Ceram. Soc. (Engl.)*, **24**, 159, 1924.
60. VICKERS, A.E.J.: The Influence of Oxidising and Reducing Atmospheres on Refractory Materials, *Trans. Ceram. Soc. (Engl.)*, **29**, 290, 1930.
61. MELLOR, J.W.: The Discoloration of Refractories by "Iron," *Trans. Ceram. Soc. (Engl.)*, **32**, 403, 1933.
62. JACKSON, F.G.: Oxidation of Ceramic Ware during Firing, *Bull. Am. Ceram. Soc.*, **14**, 225, 1935.

Effect of Heat on Silica Refractories:

63. LE CHATELIER, H.: "La silice et les silicates," Hermann & Cie, Paris, 1914.
64. UNENO, Z.: Constitution and Micro-structure of Silica Brick and Chamotte Block Used in Tank Furnaces, *Research Lab. Asaki Glass Co., Rept.* 10, p. 67, 1923.
65. SANDLUND, S.: The Addition of Chromium Oxide to Silica Bricks, *J. Contoret's Annalen*, **109**, 358, 1925.
66. WEIL, R.: Etude microscopique de la transformation de la cristobalite naturelle, *Compt. rend.*, **180**, 1949, 1925.
67. HUGILL, W., and W.J. REES: The Effect of Repeated Burning on the Structure and Properties of Limebonded Silica Bricks, *Trans. Ceram. Soc. (Engl.)*, **25**, 82, 1925.
68. HUGILL, W., and W.J. REES: The Influence of Iron Oxide and Iron Sulphides on the Rate of Quartz Manufacture, *Trans. Ceram. Soc. (Engl.)*, **25**, 309, 1925.
69. REES, W.J.: A Further Note on the Influence of Iron Oxide in Promoting the Inversion of Silica, *Trans. Ceram. Soc. (Engl.)*, **25**, 314, 1925.

70. WOOD, J.F.L., H.S. HOULDSWORTH, and J.W. COBB: The Influence of Foreign Matter on the Thermal Expansion and Transformation of Silica, *Trans. Ceram. Soc. (Engl.)*, **25**, 289, 1925.
71. ENDELL, K., and E. PFEIFFER: Constitution of Silica Brick, *Sitzber. Werkstoff. Ver. deut. Eisenhüt.*, **91**, 8, 1926.
72. ENDELL, K., and R. HARR: The Effect of Oxide Impurities upon the Physical Properties of Silica Brick, *Stahl u. Eisen*, **46**, 1870, 1926.
73. SMIRNOV, N.N.: Microstructure of Dinas, *State Exptl. Inst. Silicates (U.S.S.R.)*, **18**, 5, 1926.
74. TRAVERS AND DE GOLOUBINOFF: Study of Silica Brick, Dilatometric Analysis, Testing of the Raw Materials, *Rev. met.*, **23**, 27, 100, 1926.
75. SOSMAN, R.B.: "The Properties of Silica," Reinhold Publishing Corporation, New York, 1927.
76. STEINHOFF, E.: The Significance of the Silica Transformation in the Firing Process and the Behavior of Refractory Brick in Use, *Gas u. Wasserfach*, **70**, 237; 264, 1927.
77. HUGILL, W., and W.J. REES: A Note on Silica Bricks Made without Added Bond, *Trans. Ceram. Soc. (Engl.)*, **27**, 97, 1927.
78. BUDNIKOV, P.P.: Formation of Tridymite from Quartzite, *Feuerfest*, **4**, 136, 1928.
79. KRANER, H.M.: Effect of Heat Treatment on Diatomaceous Earth, *J. Am. Ceram. Soc.*, **11**, 875, 1928.
80. VAN NIEURVENBURG, C.J., and H.J. ZIJLSTRA: Dilatometric Measurements on Tridymite and Cristobalite, *Rec. trav. chim.*, **47**, 1, 1928.
81. HUGILL, W., and W.J. REES: The Influence of Iron Borate on the Rate of Inversion of Quartz in Silica Bricks, *Trans. Ceram. Soc. (Engl.)*, **29**, 299, 1930.
82. HUGILL, W., and W.J. REES: The Influence of Iron Oxide on the Rate of Quartz Inversion in Lime and Lime-clay Bonded Silica Bricks, *Trans. Ceram. Soc. (Engl.)*, **30**, 321, 1931.
83. HUGILL, W., and W.J. REES: A Further Note on the Influence of Iron Oxide on the Rate of Quartz Inversion in Lime and Lime-clay Bonded Silica Bricks, *Trans. Ceram. Soc. (Engl.)*, **30**, 330, 1931.
84. HUGILL, W., and W.J. REES: The Influence of Titanium Dioxide on the Rate of Quartz Inversion in Lime-bonded Silica Bricks, *Trans. Ceram. Soc. (Engl.)*, **30**, 347, 1931.
85. COLE, S.S.: Method of Making Refractory, U.S. Patent 1,798,972, 1931.
86. SALMANG, H., and B. WENTZ: The Manufacture of Tridymite Bricks, *Ber. deut. keram. Ges.*, **12**, 1, 1931.
87. DANA, E.S.: "Textbook of Mineralogy," John Wiley & Sons, Inc., New York, 1932.
88. COLE, S.S.: Effect of Firing at 1500°C. on the Porosity and Specific Gravity of Quartzites, *J. Am. Ceram. Soc.*, **15**, 87, 1932.
89. LARSEN, E.S., and H. BERMAN: Microscopic Determination of the Non-opaque Minerals, *U.S. Geol. Survey Bull.* 848, 1934.
90. COLE, S.S.: The Conversion of Quartz into Cristobalite below 1000°C. and Some Properties of the Cristobalite Formed, *J. Am. Ceram. Soc.*, **18**, 149, 1935.
91. POHL, H.: Effect of the Grain Size of Quartzites, the Lime Addition, the Pressure, and Firing on the Change on Volume of Silica Brick, Thesis, Tech. Hochschule Stuttgart, p. 64, 1935.

92. CHADEYRON, A.A., and W.J. REES: Tridymitization of Silica Brick, Refractory Materials Joint Committee, *Inst. Gas Engrs., Twenty-ninth Rept.*, p. 68, 1937.
93. DODD, A.E.: The Permanent Expansion of Silica Bricks, Part I, *Trans. Ceram. Soc. (Engl.)*, **36**, 466, 1937.
94. SALMANG, H., and B. WENTZ: Tridymite Stone, U.S. Patent 2,066,365, 1937.
95. ROGERS, A.F.: "Introduction to the Study of Minerals," McGraw-Hill Book Company, Inc., New York, 1937.
96. KOPPERS, H.: Producing Silica Brick, Ger. Patent 659,921, 1938.
97. KOEPEL, C.: Transformation Catalysis of Silicic Acid in the Firing of Silica, *Mitt. Forsch.-Anstalt. Gutehoffnungshütte Oberhausen A.-G.*, **6**, 220, 1938.
98. KONDO, S., and T. YAMAUCHI: Inversion of Quartz to Tridymite, XV-XVI, *J. Soc. Chem. Ind., Japan*, **41**, 221, 1938.
99. CHADEYRON, A.A., and W.J. REES: The Tridymitization of Silica Bricks, *Iron & Steel Inst., Special Rept.* 26, p. 205, 1939.
100. HARVEY, F.A., and R.E. BIRCH (Harbison-Walker Refractories Co.): Silica Refractory, U.S. Patent 2,351,204, 1944.
101. BEALS, M.D., and SAMUEL ZERFOSS: Volume Change Attending Low-to-high Inversion of Cristobalite, *J. Am. Ceram. Soc.*, **27**, 285, 1944.
102. BADGER, E.H.M., W. LEWCOCK, and J.H. WYLDÉ: The Influence of the Glassy Bond on Some Properties of Silica Refractories, *Trans. Brit. Ceram. Soc.*, **45**, 269, 1946.
103. HOLMQUIST, P.F.: Details of the Quartz Transformation in Silica Bricks, *Proc. Roy. Swedish Acad. Eng. Sci.*, No. 192, 1947.

Effect of Heat on Kyanite and Associated Minerals:

104. GREIG, J.W.: Formation of Mullite from Cyanite, Andalusite, and Sillimanite, *J. Am. Ceram. Soc.*, **8**, 465, 1925.
105. NEUMANN, F.: Stability Relations of the Polymorphous System Al_2SiO_5 , *Z. anorg. allgem. chem.*, **145**, 193, 1925.
106. HARRISON, H.C.: Cyanite-clay Refractories, I, *J. Am. Ceram. Soc.*, **9**, 257, 1926.
107. RIDDLE, F.H.: The Possibility of Sillimanite Minerals as Refractories, *Trans. Electrochem. Soc.*, **59**, 35, 1931.
108. RIDDLE, F.H., and ROBERT TWELLS: Sillimanite Kiln Refractories Made from an Andalusite Base, *J. Am. Ceram. Soc.*, **14**, 877, 1931.
109. LANE, R.O.: Thesis, Massachusetts Institute of Technology, 1936.
110. BRAGG, W.L.: "Atomic Structure of Minerals," Cornell University Press, Ithaca, New York, 1937.
111. POLE, G.R., and D.G. MOORE: The Expansion Characteristics of Kyanite and Kyanite-clay Mixtures, When Heated, *Bull. Am. Ceram. Soc.*, **21**, 355, 1938.
112. BARLETT, H.B.: Rate of Decomposition of Kyanite at Various Temperatures, *J. Am. Ceram. Soc.*, **23**, 249, 1940.
113. BRADLEY, R.S., F.W. SCHROEDER, and W.D. KELLER: Study of the Refractory Properties of Topaz, *J. Am. Ceram. Soc.*, **23**, 265, 1940.
114. MCVAY, T.N., W.W. GALBREATH, JR., and D. ALLEN: Substitution of Topaz, Domestic Kyanite and Synthetic Mullite-Corundum for Indian Kyanite IV, *J. Am. Ceram. Soc.*, **27**, 275, 1944.
115. BUDNIKOV, P.P.: Mullite Refractory from a Mixture of Kaolin and Alumina, *Comptes rend. acad. sci. U.R.S.S.*, **54**, 202, 1945.

Effect of Heat on Magnesite and Lime:

116. CHESTERS, J.H., and W. WEYL: The Souring of Dead-burned Magnesite, *Trans. Ceram. Soc. (Engl.)*, **31**, 295, 1932.
117. ENDEL, K.: Gegen Temperaturänderungen unempfindliche Magnesitsteine, *Stahl u. Eisen*, **52**, 759, 1932.
118. SALMANG, H., and K. SCHNITZLER: Einflub der Herstellungsbedingungen von Magnesitsteinen auf ihre Eigenschaften, *Ber. deut. keram. Ges.*, **14**, 61, 1933.
119. CHESTERS, J.H., and C.W. PARMELEE: The Burning of Magnesite Bricks, Part I, *Trans. Ceram. Soc. (Engl.)*, **32**, 349, 1933.
120. CROSS, A.H.B., and W.J. REES: Further Investigations of Basic Refractories for Steel-melting Furnaces, I, *Trans. Ceram. Soc. (Engl.)*, **33**, 379, 1934.
121. SALMANG, H., and P. NEMITZ: Einflub der Kornung von Magnesitsteinen auf ihre Eigenschaften, *Sprechsaal*, 1934.
122. HARVEY, F.A., and R.E. BIRCH: Magnesia Refractory, U.S. Patent 2,026,088, 1935.
123. CHESTERS, J.H., and C.W. PARMELEE: The Burning of Magnesite Bricks, Part II, *Trans. Ceram. Soc. (Engl.)*, **34**, 203, 1935.
124. CHESTERS, J.H., G.L. CLARK, and K.C. LYON: The Burning of Magnesite Bricks, Part III, *Trans. Ceram. Soc. (Engl.)*, **34**, 243, 1935.
125. KONOPICKY, K., and H. KASSELL: Sintermagnesit, I, Quantitative Untersuchung der auftretenden Verbindungen, *Ber. deut. keram. Ges.*, **17**, 465, 1936.
126. Société anonyme des hauts-fourneaux de la Chiers: Brick, French Patent 799,930, 1936.
127. Magnesit-industrie: Magnesite Brick, French Patent 800,521, 1936; *Chem. Abstracts*, **30**, 8552, 1936.
128. KONOPICKY, K.: Sintered Magnesite, II, Sintering Process, *Ber. deut. keram. Ges.*, **18**, 97, 1937.
129. KONOPICKY, K.: Sintermagnesit, III, Sinterungsvorgänge an Magnesit bei ungleichmäßiger Verteilung der Bestandteile, *Ber. deut. keram. Ges.*, **18**, 419, 1937.
130. CHESTERS, J.H., and L. LEE: The Properties of Magnesite and Chrome-Magnesite Bricks, *Trans. Ceram. Soc. (Engl.)*, **36**, 294, 1937.
131. Veitscher Magnesitwerke A.-G.: Refractory Brick, Austrian Patent 153,200, Apr. 25, 1938.
132. LIPINSKI, FRIEDRICH: Technology of Chrome-Magnesia Brick, *Towind.-Ztg.*, **67**, 139, 1943.
133. KEDESZY, H.: Electron-microscopic Investigations on the Firing Phenomena of Tale and Steatite, *Ber. deut. keram. Ges.*, **24**, 201, 1943.
134. Basic Refractories, Inc.: Evanescent Bonding Materials, Brit. Patent 573,939, 1945.
135. Magnesia Refractory: Permanente Cement Company, Brit. Patent 579,098, 1946.
136. RIGBY, G.R., H.M. RICHARDSON, and F. BALL: Mineralogical Composition of Magnesite Bricks, *Trans. Brit. Ceram. Soc.*, **46**, 313, 1947.

Effect of Heat on Zirconia:

137. RUFF, O., and F. EBERT: Die Formen des Zirkondioxyde, *Z. anorg. allgem. Chem.*, **180**, 19, 1929.

138. REES, W.J., and J.H. CHESTERS: A Preliminary Investigation of the Magnesia-Zircon Series, *Trans. Ceram. Soc. (Engl.)*, **29**, 309, May-June, 1930 (Memorial Section).
139. BARLETT, H.B.: X-ray and Microscopic Studies of Silicate Melts Containing ZrO_2 , *J. Am. Ceram. Soc.*, **14**, 837, 1931.
140. COMSTOCK, G.F.: Some Experiments with Zircon and Zirconia Refractories, *J. Am. Ceram. Soc.*, **16**, 12, 1933.
141. Société anonyme des manufactures des glazes et produits chimiques de St. Gobain, Chauny, et Cirey; Brit. Patent 429,367, 1935; *Chem. Abstract*, **29**, 7028, 1935.
142. COHN, W.: The Crystal Modifications of Zirconia, *Trans. Electrochem. Soc.*, **68**, 65, 1935.
143. CLARK, G.L., and D.H. REYNOLDS: Chemistry of Zirconium Dioxide, *Ind. Eng. Chem.*, **29**, 711, 1937.
144. Titanium Alloy Manufacturing Co.: Phosphate Bond for Zircon, Brit. Patent 569,078, 1945.

Effect of Heat on Chromite:

145. McDOWELL, J.S., and H.S. ROBERTSON: Chrome Refractories, *J. Am. Ceram. Soc.*, **5**, 865, 1922.
146. SEIL, G.E.: Chromite Material and Method of Making, U.S. Patent 2,028,017, 1936.
147. SEIL, G.E.: Chromite Refractory Materials, U.S. Patent 2,028,017, 1936.
148. HARVEY, F.A., and J.S. McDOWELL: Refractory, U.S. Patent 2,053,146, 1936.
149. LYNAM, T.R., and W.J. REES: Experiments on Chrome-Silica Bricks, Part I, *Trans. Ceram. Soc. (Engl.)*, **35**, 138, 1936.
150. LYNAM, T.R., and W.J. REES: Experiments on Chrome-Silica Bricks, Part II, *Trans. Ceram. Soc. (Engl.)*, **35**, 153, 1936.
151. SEIL, G.E.: Process of Making Chromite Refractories, U.S. Patent 2,060,697, Nov. 10, 1936.
152. LYNAM, T.R., and W.J. REES: Mixtures of Chromite and Grecian Magnesite, Part II, *Trans. Ceram. Soc. (Engl.)*, **36**, 152, 1937.
153. LYNAM, T.R., and W.J. REES: A Study of Chrome-Alumina Bricks, Part II, *Trans. Ceram. Soc. (Engl.)*, **36**, 133, 1937.
154. HARVEY, F.A., and R.E. BIRCH: Olivine and Magnesite Additions Improve Chrome Refractories, *Brick*, **91**, 44, 1937.
155. LYNAM, T.R., and W.J. REES: Mixtures of Chromite and Grecian Magnesite, Part I, *Trans. Ceram. Soc. (Engl.)*, **36**, 137, 1937.
156. SEIL, G.E.: Refractory Products, French Patent 811,670, 1937.
157. LYNAM, T.R., and W.J. REES: Chrome Refractories for Use in the Neutral Course of the Basic Open-hearth Furnace, *Trans. Ceram. Soc. (Engl.)*, **37**, 481, 1938.
158. CHESTERS, J.H., and T.R. LYNAM: Chrome-Magnesite Brick for Open-hearth Furnaces, *J. Am. Ceram. Soc.*, **22**, 97, 1939.
159. REES, W.J., and T.R. LYNAM: Research on Composite Chrome Refractories: A Summary of Investigations, *Iron & Steel Inst., Special Rept.* **26**, p. 167, 1939.
160. CHADEYRON, A.A.: Some Experiments on Chrome-Magnesite-Dolomite Mixtures, Part I, The Effect of Variations in the Chromite-Magnesite-

- Dolomite Ratio on Firing Shrinkage and Resistance to Hydration, *Iron & Steel Inst. (England), Special Rept. 26*, p. 175, 1939.
161. CHADEYRON, A.A.: Some Experiments on Chrome-Magnesite-Dolomite Mixtures, Part II, The Relationship between Free Lime and Hydration, *Iron & Steel Inst. (England), Special Rept. 26*, p. 185, 1939.
 162. HUGILL, W., and A.T. GREEN: Some Factors Influencing the Durability of Chrome-Magnesite Bricks in Basic Open-hearth Steelmaking Furnaces, *Iron & Steel Inst. (England), Special Rept. 26*, p. 189, 1939.
 163. SEIL, G.E.: Petrography and Heat Treatment of Chromite Refractories, reprinted for E. J. Lavino and Company from *Proc. Ceram. Conf., Bull. 14*, Pennsylvania State College.
 164. POLE, G.R., A.W. BEINLICH, JR., and N. GILBERT: Physical Properties of Some High-temperature Refractory Compositions, *J. Am. Ceram. Soc.*, **29**, 208, 1946.
 165. CURTIS, C.E.: Development of Zirconia Resistant to Thermal Shock, *J. Am. Ceram. Soc.*, **30**, 180, 1947.

Effect of Heat on Magnesium Silicate Minerals:

166. Metallges, Akt.-Ges.: Refractory Substances, Brit. Patent 337,605, 1930.
167. GOLDSCHMIDT, V.M. (R. KNUDSEN, co-inventor): Refractory Compositions, Ger. Patent 583,194, 1933.
168. GOLDSCHMIDT, V.M.: Refractory Products, Ger. Patent 607,591, 1935.
169. EWELL, R.H., E.N. BUNTING, and R.F. GELLER: Thermal Decomposition of Talc, *Natl. Bur. Standards, J. Research*, **15**, 551, 1935.
170. HARVEY, F.A., and R.E. BIRCH (Harbison-Walker Refractories Co.): Refractories, U.S. Patent 2,077,795, 1937.
171. BIRCH, R.E.: Forsterite Refractories: Their Origin and Service in Industry, *Brick*, **92**, 38, 1938.
172. STONE, R.L.: Thermochemistry of North Carolina Olivine in the Manufacture of Forsterite Refractories, *J. Am. Ceram. Soc.*, **22**, 342, 1939.

Effect of Heat on Spinels and Other Minerals:

173. RIEKE, R., and K. Blicke: Development, Properties, and Technical Use of Some Spinels, *Ber. deut. keram. Ges.*, **12**, 163, 1931.
174. GAMBEY, F., and G. CHAUDRON: Contribution to the Study of Refractory Oxides, *Chimie & industrie*, Special Number, p. 397, March, 1932.
175. PARMELEE, C.W., A.E. BADGER, and G.A. BALLAM: A Study of a Group of Typical Spinels, *Univ. Illinois Bull., Eng. Expt. Sta. Bull. Ser.*, No. 248, 1932.
176. CAPE, A.T., and K.B. BOWMAN (Republic Steel Corp.): Stable Dicalcium Silicate Refractory Composition, U.S. Patent 2,015,446, 1935.
177. CHESTERS, J.H., and C.W. PARMELEE: Reaction-Expansion Measurements of Chromite and Allied Spinels, *J. Am. Ceram. Soc.*, **18**, 94, 1935.
178. RYSCHKEWITSCH, E.: German Pure-oxide Refractories, *Chem. Fabrik*, **9**, 12, 1936.
179. HUGILL, W.: Notes on the Preparation and Properties of Some Synthetic Spinels, *Iron & Steel Inst., Special Rept. 26*, p. 201, 1939.
180. TROSTEL, L. J.: Absorption of Magnesia by Chromite Spinel, *J. Am. Ceram. Soc.*, **22**, 46, 1939.

181. HUGILL, W.: Notes on the Preparation and Properties of Some Synthetic Spinels, *Iron & Steel Inst. (England), Special Rept.* 26, p. 201, 1939.

Fluxes:

182. MCKINLEY, J.M., and W.K. CARTER: Refractory Ceramic, U.S. Patent 2,019,618, 1935.
183. Produits réfractaires et céramiques du nord: Refractory Products, French Patent 776,657, *Chem. Abstracts*, **29**, 3799, 1935.
184. NORTON, C.L., JR. (Babcock & Wilcox Co.): Refractories and Method of Making, U.S. Patent 2,051,964, 1936.
185. WOOD, A.R. (Pilkington Bros., Ltd.): Refractory Body, Can. Patent 368,402, 1937.

Solid Reactions:

186. TAMMANN, G.: Chemische Reaktionen im pulverförmigen Gemengen zweier Kristallarten, *Z. anorg. allgem. Chem.*, **149**, 21, 1925.
187. JANDER, W.: Reaktionen im festen Zustande bei höheren Temperaturen, *Z. anorg. allgem. Chem.*, **163**, 1, 1927.
188. JANDER, W.: Reaktionen im festen Zustande bei höheren Temperaturen, *Z. anorg. allgem. Chem.*, **166**, 31, 1927.
189. KRAUSE, H.F., and W. WEYL: Reaktionen im festen Zustand zwischen Na_2CO_3 , BaCO_3 , und SiO_2 . *Z. anorg. allgem. Chem.*, **163**, 355, 1927.
190. JANDER, W., and W. STAMM: Reactions in the Solid State at High Temperatures; Effect of Gases on Reactions in the Solid State, *Z. anorg. allgem. Chem.*, **190**, 65, 1930.
191. TAMMANN, G., and W. OEELSEN: Die Reaktionen beim Zusammenschmelzen von Glassätzen, *Z. anorg. allgem. Chem.*, **193**, 245, 1930.
192. TURNER, W.E.S., and J.T. HOWARTH: The Reaction between Sodium Carbonate and Silica, *J. Soc. Glass Technol.*, **14**, 402, 1930.
193. WAGNER, C., and W. SCHOTTKY: Theorie der geordneten Mischphasen, *Z. physik. Chem.*, **11**, 163, 1930.
194. HEDVALL, J.A.: Über die Rolle der Ionen und kristallographischer Umwandlungen bei Reaktionen im festen Zustande, *Z. anorg. allgem. Chem.*, **197**, 399, 1931.
195. TURNER, W.E.S., and W. MASKILL: The Reaction between Calcium Carbonate and Silica, *Z. anorg. allgem. Chem.*, **16**, 94, 1932.
196. DESCH, C.H.: "The Chemistry of Solids," Cornell University Press, Ithaca, New York, 1934.
197. TAYLOR, N.W.: Reactions between Solids in the Absence of a Liquid Phase, *J. Am. Ceram. Soc.*, **17**, 155, 1934.
198. POLE, G.R., and N.W. TAYLOR: Kinetics of Solid Phase Reactions of Certain Carbonates with Mullite, Silica, and Alumina, *J. Am. Ceram. Soc.*, **18**, 325, 1935.
199. TAYLOR, N.W., and F.J. WILLIAMS: Reactions between Solids in the System CaO-MgO-SiO_2 , *Bull. Geol. Soc. Am.*, **46**, 1121, 1935.
200. HEDVALL, J.A., and G. SCHILLER: Reaction Velocity of Silicates in Powdered Mixtures in Consequence of Dissociation of Metallic Oxides and Crystallographic Changes of Quartz, *Z. anorg. allgem. Chem.*, **221**, 1934; *J. Soc. Glass Technol.*, **19**, A333, 1935.

201. EITEL, W.: Die Reaktionen im festen Zustande in der Silikatindustrie, *Z. angew. Chem.*, **49**, 895, 1936.
202. JANDER, W.: Verlauf von Reaktionen im festen Zustande, *Z. angew. Chem.*, **49**, 879, 1936.
203. WAGNER, C.: Über den Mechanismus der Bildung von Ionenverbindungen höherer Ordnung. *Z. angew. Chem.*, B **34**, 309, 1936.
204. GALLUP, J.L. (Radio Corporation of America): Ceramic Object and Method of Making, U.S. Patent 2,030,200, 1936.
205. HEDVALL, J.A.: Reactions in the Solid State, I, Development of Our Knowledge of the Reactivity of the Solid State, *Z. angew. Chem.*, **49**, 1936; *Chem. Abstracts*, **31**, 598, 1937.
206. BERNAL, J.D.: Geometrical Factors in Reactions Involving Solids, *Trans. Faraday Soc.*, **34**, 834, 1938.
207. JANDER, W., and K. BUNDE: Die Bildung von Magnesium Titanaten aus den Oxyden im festen Zustande, *Z. anorg. allgem. Chem.*, **239**, 418, 1938.
208. HEDVALL, J.A.: "Reactivity of Solids," J. A. Barth, Leipzig, 1938.
209. GARNER, W.E.: Reactions in the Solid State, *Science Progress*, **33**, 209, 1938.
210. HEVESY, G.: Self-diffusion in Solids, *Trans. Faraday Soc.*, **34**, 841, 1938.
211. GARDNER, W.E.: Reactions in the Solid State, *Science Progress*, **33**, 209, 1938.
212. TANAKA, Y.: Solid Reaction between Magnesium Oxide and Titanium Oxide, *Bull. Chem. Soc. Japan*, p. 212, 1939.
213. GIBSON, G., and R. WARD: Reactions in the Solid State, *J. Am. Ceram. Soc.*, **26**, 239, 1943.
214. LONGUET, J., and H. FORESTIER: Velocities of Reaction between Solids below the Recrystallization Temperature, *Compt. rend.*, **216**, 562, 1943.
215. JOSE, W.: "Diffusion and Chemical Reaction in the Solid Phase," T. Steinopf, Leipzig, 1937; Edwards Bros., Inc., Ann Arbor, Mich., 1943.
216. CASTELL, H.C., S. DILNOT, and M. WARRINGTON: Reaction between Solids, *Nature*, **153**, 653, 1944.
217. COHN, G.: Significance of Topochemical Factors on Rate of Reactions between Solid State, *J. Am. Ceram. Soc.*, **27**, 308, 1944.
218. RILEY, H.L.: Reactions in the Solid Phase, *J. Oil & Colour Chemists Assoc.*, **29**, 25, 1946.
219. PETTERSSON, HOLGER: Investigations of the Solubility in the Solid State of the Oxides CaO, MnO, MgO and FeO, *Jemkontorets Ann.*, **130**, 653, 1946.

Firing Properties of Refractory Bodies:

220. KRAUS, L.P., JR.: Process for Making Refractory Products, U.S. Patent 1,453,468.
221. HARTER, L., and A.M. KOHLER: Kaolin Refractory and Process of Making the Same, U.S. Patent 1,530,260, 1925.
222. DALE, A.J.: The Rapid Production of Vitrified Clay Wares by the Combined Effects of Heat and Pressure, *Trans. Ceram. Soc. (Engl.)*, **24**, 262, 1924.
223. GREEN, A.T., and L.S. THEOBALD: An Investigation of the Changes Taking Place during the Industrial Burning of Fireclay Bricks, *Trans. Ceram. Soc. (Engl.)*, **24**, 124, 1924.
224. GREEN, A.T.: The Thermal Properties of Refractory Materials and a Consideration of the Factors Influencing Them, *Trans. Ceram. Soc. (Engl.)*, **25**, 361, 1925.

225. RIDDLE, F.H., and A.B. PECK: An Eighteen Months' High Temperature Test on Refractory Test Specimens, *J. Am. Ceram. Soc.*, **9**, 1, 1926.
226. GREEN, A.T.: The Firing Properties of Refractory Fireclay Products, *Trans. Ceram. Soc. (Engl.)*, **26**, 110, 1926.
227. HARTFORD-EMPIRE Co.: Refractory Substances, Brit. Patent 315,856, 1929.
228. JLLGEN, F.: The Effect of the Quantity and Grain Size of Grog and of the Firing Temperature on the Physical Properties of Refractories, with Special Regard to the Tensile Strength at High Temperatures, *Ber. deut. keram. Ges.*, **11**, 649, 1930.
229. LITZOW, J.: The Effect of Grading the Grog on the Density of Refractory Materials, *Glastech. Ber.*, **8**, 149, 1930.
230. WILLETTTS, P.G.: Refractory, U.S. Patent 1,802,298, 1931.
231. HUGILL, W., and W.J. REES: Firebricks with More than Ninety Per Cent of Grog, *Trans. Ceram. Soc. (Engl.)*, **30**, 353, 1931.
232. WILLETTTS, P.G.: Refractory, U.S. Patent 1,802,296, 1931.
233. WILLETTTS, P.G.: Refractory, U.S. Patent 1,802,297, 1931.
234. WILLETTTS, P.G. (Hartford-Empire Co.): Refractory, U.S. Patent 1,893,313, 1933.
235. MOREY, G.W.: Glass: The Bond in Ceramics, *J. Am. Ceram. Soc.*, **17**, 145, 1934.
236. WILLETTTS, P.G. (Hartford-Empire Co.): Glass-resistant Refractory and Batch Composition for Producing It, U.S. Patent 1,944,856, 1934.
237. MCKINLEY, J.M., and W.K. CARTER (National Aluminate Corp.): Fired Siliceous Tribarium Aluminate Refractory, U.S. Patent 2,017,723, 1935.
238. RYBNIKOFF, W.A., and P.P. ALIMOVA: High Grog Refractories with Mullite Bond, *Stekol'naya Prom.*, **14**, 12, 1938.
239. SULLIVAN, J.D. (Battelle Memorial Institute): Refractory Material, U.S. Patent 2,160,923, June 6, 1939.

Hot Pressing:

240. RIDGEWAY, R.R., and B.L. BAILEY: Boron Carbide Articles Such as Bearings, Dies, or Sand Blast Nozzles, U.S. Patent 2,027,786, 1934.
241. JONES, W.D.: Powder Metallurgy-techniques of Hot Pressing, *Metal Ind. (London)*, 69, 1940.
242. WULFF, J.: Powder Metallurgy, *A.S.M. Pub.*, 1942.
243. BAEZA, W.J.: "A Course in Powder Metallurgy," Chap. 6, Reinhold Publishing Corporation, New York, 1943.
244. WALKER, J.: Carbon as a Refractory, *Eng. Materials*, 108, 1945.
245. The Hot Pressing of Ceramic Materials, *Univ. Illinois, Rept.* 21, Section VI, Part 2, Appendix II, 1946.
246. WASHKEN, E.: Plastic Deformation and Recrystallization of Non-metallic Crystals, abstracted in *Am. Mineral.*, **31**, 508, 1946.
247. KIEFFER, R., and W. HOTOP: "Pulver Metallurgie und Werkstoffe," Verlag Julius Springer, Berlin, 1943; reprinted, Edwards Bros., Inc., Ann Arbor, Mich., 1947.
248. SHALER, A.J.: The Kinetics of the Sintering Process, Ph.D. Thesis, Massachusetts Institute of Technology, 1947.
249. BUERGER, M.J.: Articles of Non-metallic Mineral Compounds and Methods of Producing Same, U.S. Patent 2,362,430, 1947.
250. Norton Company: Private Communication to F.H. Norton, April, 1948.

Melted and Cast Refractories:

251. BENNER, R.C., and G.J. EASTER (Carborundum Co.): Method of Producing Cast Refractory, U.S. Patent 2,048,319, July 21, 1936.
252. SCHROEDER, F.W. (Corhart Refractories Co.): Refractory, U.S. Patent 2,044,817, June 23, 1936.
253. EASTER, G.J. (Carborundum Co.): Refractory Cooling Method, Can. Patent 364,422, Mar. 2, 1937.
254. KRANER, H.M.: Considerations in the Production of Fused Mullite for Refractories, *J. Am. Ceram. Soc.*, **21**, 10, 360, 1938.
255. FULCHER, G.S., and T.E. FIELD (Corhart Refractories Co.): Refractory Zirconia Casting, U.S. Patent 2,352,530, June 27, 1944.
256. LASCH, HANS: Manufacture of Refractory Products, Ger. Patent 738,638, Aug. 25, 1943.
257. FIELD, T.E. (Corhart Refractories Co.): Heat-cast Refractory, Can. Patent 417,384, 1943.
258. FIELD, T.E. (Corhart Refractories Co.): Basic Cast Refractory, U.S. Patent 2,409,844, Oct. 22, 1946.
259. FIELD, T.E. (Corhart Refractories Co.): Cast Refractory Products, U.S. Patent 2,408,305, Sept. 24, 1946.
260. FIELD, T.E. (Corhart Refractories Co.): Alumina Low Silica Refractory, U.S. Patent 2,424,082, 1947.
261. ANON.: Russian Cast Refractory, *Eng. Mining J.*, **148**, 155, 1947.
262. FIELD, T.E. (Corhart Refractories Co.): Cast Refractory Products, U.S. Patent 2,416,472, 1947.

Specific Heat:

263. WILSON, S.T., A.D. HOLDCROFT, and J.W. MELLOR: The Specific Heats of Firebricks at High Temperatures, *Trans. Ceram. Soc. (Engl.)*, **12**, 279, 1912.
264. HEYN, O., BAUER, and WETZEL: Untersuchungen über die Wärmeleitfähigkeit feuerfester Baustoffe, *Mitt. kgl. Material-prüfungsamts*, 1914.
265. WEIGEL, O.: *Nachr. Kgl. Ges. Wiss. Göttingen*, **264**, 320, 1915.
266. WHITE, W.P.: Specific Heat Determination at Higher Temperatures, *Am. J. Sci.*, 4th Series, **47**, 44, 1919.
267. BRADSHAW, L., and W. EMERY: The Specific Heats of Refractory Materials at High Temperatures, Part I, Silica, Fireclay, and Zirconia, *Trans. Ceram. Soc. (Engl.)*, **19**, 84, 1919.
268. TADOKORO, Y.: On the Determination of the Thermal Conductivity, Specific Heat, Density, and Thermal Expansion of Different Rocks and Refractory Materials, *Tōhoku Imp. Univ. Sci. Repts.*, 1st series, **10**, 339, 1921.
269. WIETZEL, R.: *Z. anorg. allgem. Chem.*, **116**, 71, 1921.
270. GREEN, A.T.: The Specific Heat of Magnesite Brick at High Temperatures, *Trans. Ceram. Soc. (Engl.)*, **22**, 393, 1922.
271. NAVIAS, L.: Measurement of the Heat Absorbed and Evolved by Clays during Firing and Cooling, *J. Am. Ceram. Soc.*, **6**, 1268, 1923.
272. COHN, W.M.: The Problem of Heat Economy in the Ceramic Industry, *J. Am. Ceram. Soc.*, **7**, 359, 475, 448, 1924.
273. OKAYA, T.: Les chaleurs spécifique des roches, *Japan J. Astron. Geophys.*, **3**, 45, 1925.
274. COHN, W., and A.E. MACGEE: On the Specific Heats and Heat Contents of Clays, etc., *Ber. deut. keram. Ges.*, **7**, 149, 1926.

275. MACGEE, A.E.: The Heat Required to Fire Ceramic Bodies, *J. Am. Ceram. Soc.*, **9**, 206, 1926.
276. MACGEE, A.E.: The Role of Specific Heat in the Selection of Refractories, *J. Am. Ceram. Soc.*, **9**, 374, 1926.
277. MIEHR, W., H. IMMKE, and J. KRATZERT: Die Spezifischen Wärmen unserer feuerfesten Steine in ihrer Abhängigkeit von der Temperatur, *Tonind.-Ztg.*, **50**, 1671, 1691, 1926.
278. COHN, W.M.: Discussion on Specific Heats and Thermal Reactions of Clays, etc., *J. Am. Ceram. Soc.*, **10**, 347, 1927.
279. GROSSE, W., and W. DINKLER: An Improved Metal Calorimeter for the Determination of the Specific Heat of Metals, Oxides, and Slags, *Stahl u. Eisen*, **47**, 448, 1927.
280. JAEGER, F.M., and E. ROSENBOHM: Accurate Determinations of Specific Heats of Solids between 0° and 1625°, I, Apparatus and Methods, *Verhandel. Akad. Wetenschappen Amsterdam*, **36**, 763, 1927.
281. MACGEE, A.E.: Some Thermal Characteristics of Clays, *J. Am. Ceram. Soc.*, **10**, 561, 1927.
282. SIMPSON, H.E.: The Heat Required to Fire Ceramic Bodies, *J. Am. Ceram. Soc.*, **10**, 897, 1927.
283. WILKES, G.B.: The Specific Heat of Magnesium and Aluminum Oxides at High Temperatures, *J. Am. Ceram. Soc.*, **15**, 72, 1932.
284. THURET, A.: Calculation of the Specific Heats of Mineral Oxides (Vitreous Silica, Lime, Alumina) as a Function of Temperature, *Compt. rend.*, **202**, 1368, 1936.
285. ANDERSON, C.T.: The Heat Capacities of Quartz, Cristobalite, and Tridymite at Low Temperatures, *J. Am. Ceram. Soc.*, **58**, 568, 1936.
286. SMITH, C.S.: A Simple Method of Thermal Analysis Permitting Quantitative Measurements of Specific and Latent Heats, Temperature Symposium, American Institute of Physics, 1939.
287. SHORTER, A.J.: Measurement of Heat Required in Firing Clays, *Trans. Brit. Ceram. Soc.*, **47**, 1, 1948.

General:

288. GELLER, R.F., and E.N. BUNTING: Length Changes of Whiteware Clays and Bodies during Initial Heating, with Supplementary Data on Mica, *Natl. Bur. Standards, J. Research*, **25**, 15, RP1311, 1940.
289. SEIL, G.E., and staff: Orthosilicates of the Alkaline Earths with Special Reference to Their Uses in the Refractory Field, *J. Am. Ceram. Soc.*, **24**, 1, 1941.
290. ZAPFFE, C.A.: Conversion of Certain Refractory Oxides to a Suboxide Form at High Temperatures, *J. Am. Ceram. Soc.*, **27**, 293, 1944.
291. SEIL, G.E., *et al.*: The Manufacture of Refractories and Information Concerning Their Use in the Iron and Steel Industry of Western Germany, P.B. 37804, 1946.
292. ANON.: Carbon Refractories—a Visit to the Works of Carblox, Ltd., Storrs Bridge, Loxley, nr. Sheffield, *Refractories J.*, **22**, 147, 1946.

CHAPTER IX

KILNS FOR BURNING REFRACTORIES

1. Introduction. We know that kilns have been used by man for many thousands of years, as their remains are frequently found in the excavations of ancient sites of early civilization. These primitive kilns were of the updraft type and, in most cases, consisted only of a firing chamber, a perforated floor, and a wall. The construction of a permanent kiln



FIG. 123. A Chinese kiln with a number of sections. It is lighted at the bottom, the waste gases preheating the higher chambers, and the cooling of the lower chambers preheating the combustion air. The fuel is small chips of dry wood fed through the holes in the crown. (*Henry Jewett Greene.*)

roof was too much of a structural problem for most of the early potters, and recourse was made to a temporary roof of green poles and raw clay, which would hold in place long enough for the very low temperature of firing used at that time. There is, however, one exception, as a kiln has recently been found in Tepe Gawra that was believed to have had a permanent roof at a period as early as 4500 to 4000 B.C.

The early Chinese kilns, which consisted of a series of chambers extending up the side of a hill, were remarkably similar to our modern chamber kilns and permitted a considerable degree of recuperation as the fire

advanced from one chamber to another. An interesting kiln of this type is shown in Fig. 123.

It should be remembered that in dealing with these early kilns as well as our modern ones, four essentials must always be present: (1) a means for producing the heat, (2) a support for the ware, (3) a container such as the walls and crown to confine the heat in the working space, and (4) a means to transfer the heat from the source to the ware.

2. General Principles. Production of Heat. As the majority of refractories are fired with coal as a fuel, this method of heating will be discussed first. Coal is used because of its low cost and because most of the refrac-

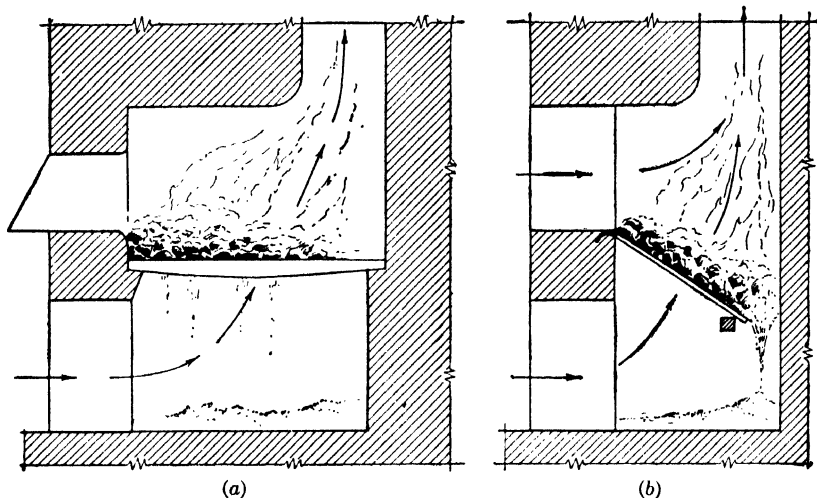

FIG. 124. Kiln furnaces with flat and sloping grates.

tories are not particularly sensitive to impurities in the kiln gases that might arise from using coal as a fuel. The coal is generally burned in furnaces with sloping or flat grates as shown in Fig. 124. The air for combustion passes partly through the fuel bed and partly over the top, the hot gases generally going upward into the kiln over a bag wall, as shown in Fig. 125. In the round or rectangular kilns, a considerable number of furnaces are spaced around the wall of the kiln in order to distribute the heat as evenly as possible.

The manufacturers of refractories generally prefer for their kilns a good grade of bituminous coal giving a long flame; also a low ash content and a high fusion point of the ash is desirable. In most cases, it is necessary to have a low sulfur content so that sulfates will not deposit on the surface of the bricks during the water smoking period.

It has been the practice to fire the coal by hand, although recently mechanical stokers are being used to a considerable extent.

Many of the coal-fired kilns waste a good deal of heat as a result of radiation from the more or less open fire mouths and escaping gases from the fire bed that are not pulled into the kiln by the draft. These condi-

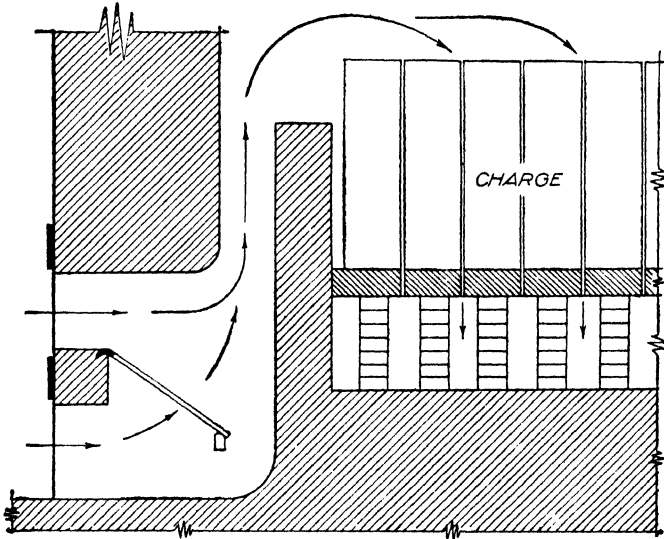

FIG. 125. Passage of gases through a downdraft kiln.

tions have been improved in some of the modern installations by tighter doors and forced draft.

Oil has many advantages as a fuel for firing refractories; and in some localities, the cost compares favorably with coal. Advantages of oil are a

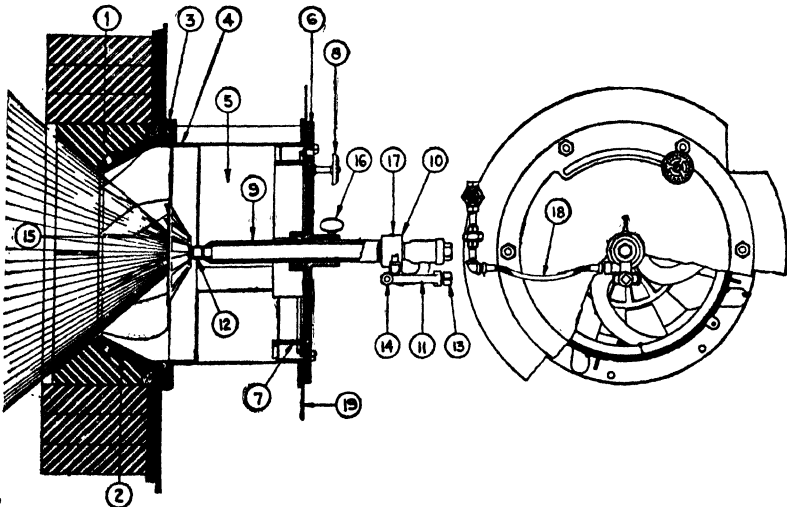

FIG. 126. A mechanical atomizing burner. (Courtesy of Babcock and Wilcox Company.)

more perfect temperature control, the possibility of a higher maximum temperature, a generally cleaner kiln atmosphere, and a smaller labor requirement for the firing operation. Oil is, of course, obtainable in a number of different grades; but from the cost standpoint, the heavier grades of oil, such as Bunker C, are generally used. A number of different types of burner are available for firing with oil. In principle, they all break the oil up into a spray of fine particles and intimately mix them with the combustion air. In burners of the mechanical atomizing type, as shown in Fig. 126, the oil is atomized by forcing it through a fine orifice at relatively

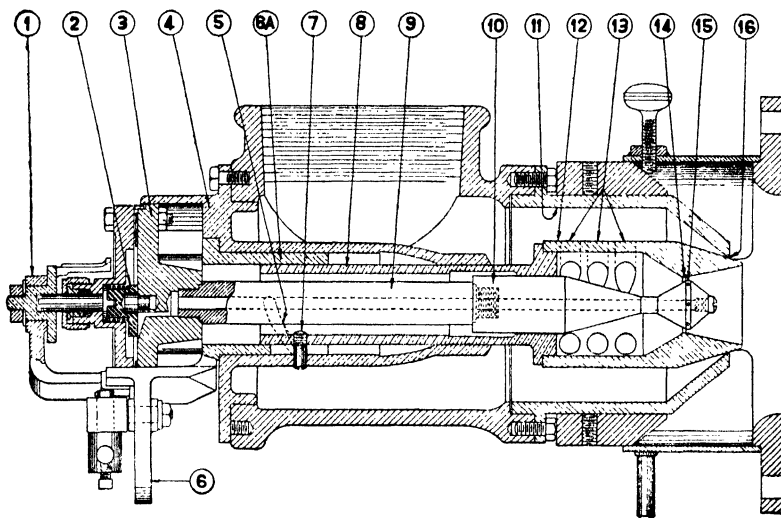

FIG. 127. An air-atomizing oil burner. (1) Oil-control valve lever. (2) Oil-control valve cam. (3) Oil-control valve consisting of a V-groove in a flat surface. (4) Burner backplate. (5) Curved slot. (6) Operating lever. (7) Inner-nozzle operating pin. (8) Inner air-nozzle operating tube. (9) Oil tube. (10) Oil nozzle. (11) Outer air nozzle. (12) Inner air nozzle. (13) Primary air-supply openings. (14) Primary air discharge. (15) Oil nozzle. (16) Secondary air-discharge opening. (Courtesy of Hauck Manufacturing Company.)

high pressure. This method is particularly suitable for burners of high capacity, as the orifice becomes very tiny for small burners and there is apt to be danger of particles getting through the filter and plugging the orifice.

Oil is also fired in air- or steam-atomizing burners where high-pressure air or steam is used to inject the oil into the kiln and at the same time break it up into a fine mist. Secondary air is generally supplied from a low-pressure source. A burner of this type is shown in Fig. 127. In setting up an oil-burning system, care should be taken that it be properly laid out to ensure reliable operation. The heavier oils have to be heated and must be kept hot until they actually reach the burner; otherwise the viscosity will become so great that proper atomization is impossible. A

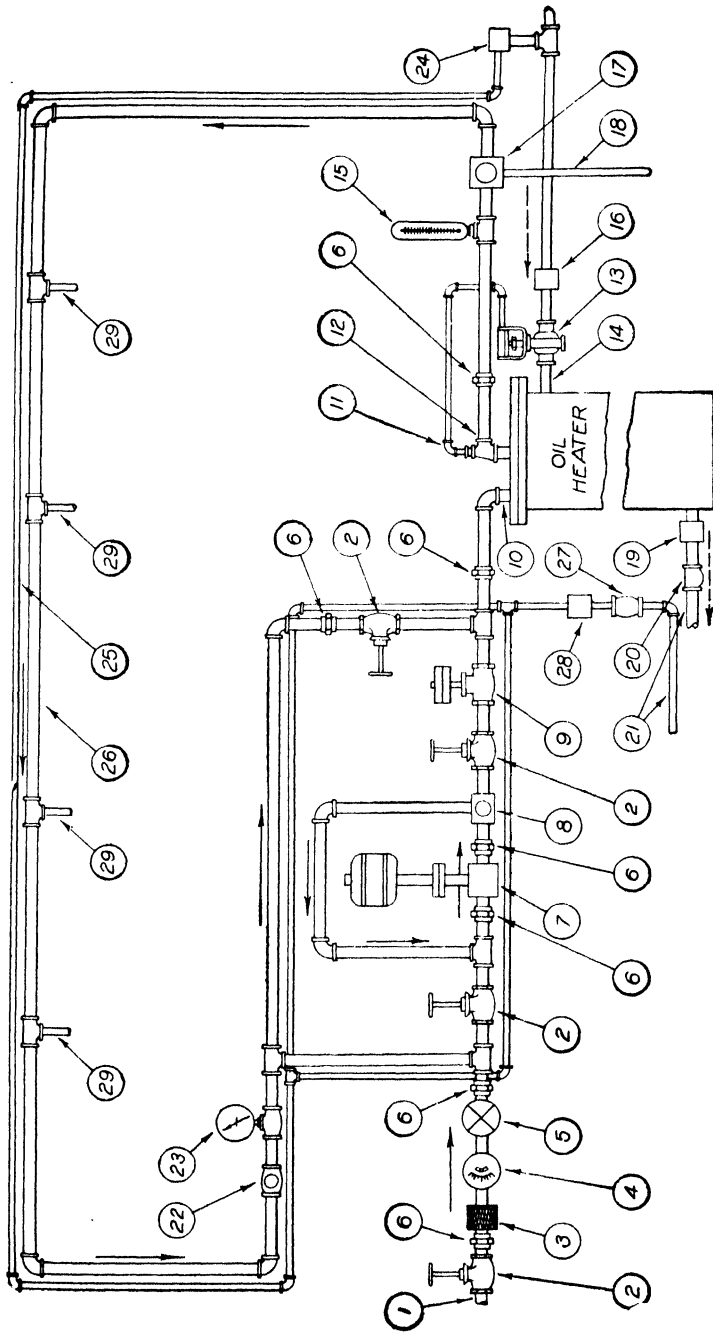

Fig. 128. A complete oil-burner installation. (1) Supply line from oil system. (2) Globe valve. (3) 2-in. edge plate oil filter. Type EF 250 lb. (4) Buffalo oil meter. (5) Reducing valve. (6) Hauck 300 gph circulating-oil pump. (7) Hauck 300 gph circulating-oil pump. (8) Pressure relief valve, 1-in. size. (9) Automatic oil shut-off valve. (10) Oil inlet to oil heater. (11) Automatic oil-temperature control. (12) Oil outlet from oil heater. (13) Automatic oil-temperature steam control. (14) Steam inlet to oil heater. (15) Oil thermometer. (16) Fisher strainer, 1/4-in. size, Type 260. (17) Relief valve, 1-in. size. (18) Relief oil line to sump or barrel. (19) Fisher steam trap, 3/8-in. size, Type ST. (20) Condensate discharge to sump. (21) Check valve. (22) Check valve. (23) Oil pressure gage. (24) Steam-pressure reducing valve, 50 to 5 lb. (25) Steam-tracer line, 1/2-in. iron pipe or copper tubing. (26) Loop oil line to burners. (27) Steam trap, 1/2-in. size, Type ST. (28) Fisher strainer, 1/2-in. size, Type 260. (29) Leads to burners. (Courtesy of Hauck Manufacturing Company.)

good filter that will permit cleaning without shutting down the oil flow is necessary, and often a complete recirculating system is desirable. In Fig. 128 is shown a layout for an oil-fired kiln that has been found quite satisfactory.

In regard to the arrangement of the burners in the kiln, they may fire over the charge in a downdraft kiln, as shown in Fig. 129, or they may fire against the side of the charge, preferably through a checker brick to distribute the heat, as shown in Fig. 130. In setting up the burner, care must be taken to allow sufficient combustion space for the particular burner used; otherwise carbon will tend to build up on the surfaces around the

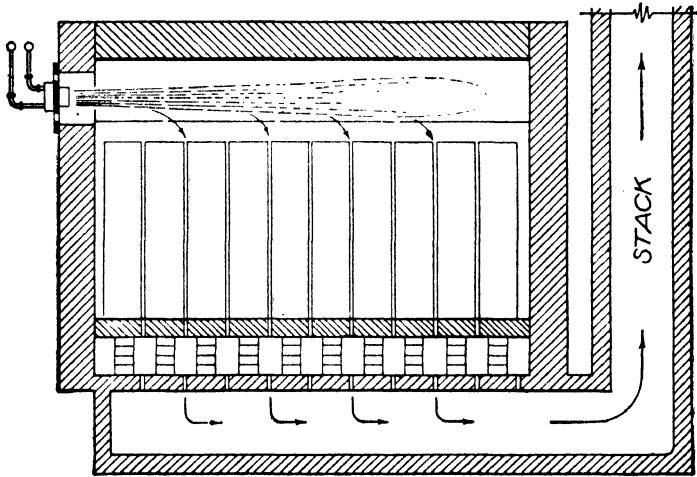

Fig. 129. An oil-fired kiln in which the flame passes above the charge.

flame. The recommendations of the burner manufacturers should be followed when the combustion chamber is laid out.

Natural gas is an excellent fuel for burning refractories, but in only a few localities is it sufficiently plentiful to make its use economical. It has the advantage of making temperature control a simple problem, and the heat produced is very clean. In general, the burner cost for a gas installation will be found less than that for burning oil.

Producer gas is used to some extent in firing kilns, especially in Europe. In most cases, the gas is used hot and without scrubbing; consequently provision must be made for draining and cleaning the connecting pipes between the producer and the burner, as they periodically fill up with tar and soot. In regions where only low-grade coal is available, the producer-gas firing is found to be quite successful. The producer gas gives a comparatively low-temperature flame, so there is little danger of overheating any part of the charge; and as the volume of gas is large because of this

low heat value, it tends to give an even temperature throughout the kiln. The small-unit gas producer has been steadily improved and is a much more reliable and efficient piece of equipment than it was in the past.

There is not space here to go into the principles of combustion, but it should be remembered that the amount of excess air used is of the greatest importance in all kiln firing. The greatest combustion efficiency is reached with very low amounts of excess air; but on the other hand, a large volume flow of gases is needed to carry out the moisture in the water-smoking stage of firing, to provide uniformity of temperature, and to supply

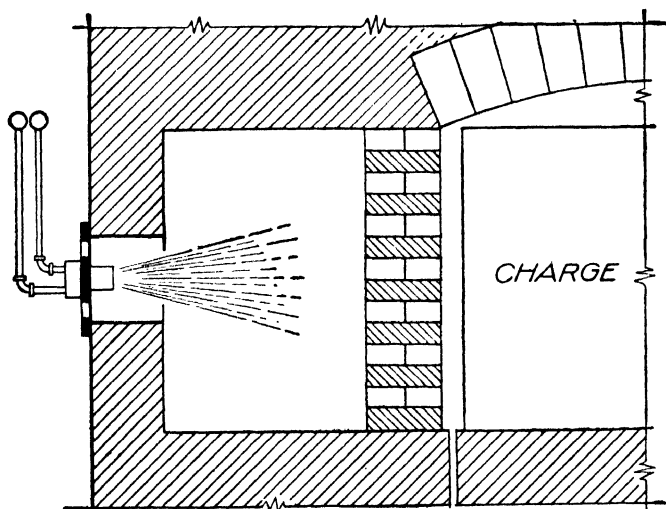

Fig. 130. A kiln in which the oil flame passes through a checkerwork.

enough oxygen to burn away carbonaceous matter. Some of the properties of a typical combustion gas are shown in Table 40.

There is a considerable saving of fuel when preheated air is used. Preheat is seldom used, however, in periodic kilns. In the case of chamber and tunnel kilns, preheat temperatures as high as 2000°F (about 1100°C) are reached with a real saving in fuel. Preheating is used in some cases to attain higher temperatures than would be possible with cold air. The reduced price of commercial oxygen in the last few years also makes possible its addition to the combustion air to aid in reaching high temperatures.

Because of its high cost, electric heating is not used to any extent for firing refractories. An exception to this is the firing of small pieces, such as spark-plug porcelains. A considerable amount of research has been carried out in the last few years to produce resistors for high-temperature electric firing.⁽⁶⁾ The most used elements are, of course, the silicon-carbide rods capable of giving a fairly long life up to temperatures of 1500°C

TABLE 40. PROPERTIES OF TYPICAL COMBUSTION GAS AT ATMOSPHERIC PRESSURE

| Temperature | | Relative volume | Specific heat at constant pressure | Viscosity, poises |
|-------------|------|-----------------|------------------------------------|----------------------|
| °C. | °F. | | | |
| 0 | 32 | 1.0 | 0.22 | 170×10^{-6} |
| 100 | 212 | 1.3 | 0.22 | 220 |
| 200 | 392 | 1.7 | 0.23 | 260 |
| 300 | 572 | 2.0 | 0.24 | 290 |
| 400 | 752 | 2.3 | 0.25 | 320 |
| 500 | 932 | 2.8 | 0.25 | 350 |
| 600 | 1112 | 3.1 | 0.26 | 370 |
| 700 | 1292 | 3.4 | 0.26 | 390 |
| 800 | 1472 | 3.8 | 0.27 | 410 |
| 900 | 1652 | 4.2 | 0.27 | 430 |
| 1000 | 1832 | 4.6 | 0.28 | 450 |
| 1100 | 2012 | 4.9 | 0.28 | 460 |
| 1200 | 2192 | 5.3 | 0.29 | 480 |
| 1300 | 2372 | 5.7 | 0.30 | 490 |
| 1400 | 2552 | 6.1 | 0.30 | 500 |
| 1500 | 2732 | 6.5 | 0.31 | 510 |
| 1600 | 2912 | 6.8 | 0.32 | 510 |
| 1700 | 3092 | 7.2 | 0.33 | 520 |
| 1800 | 3272 | 7.5 | 0.34 | 520 |
| 1900 | 3452 | 7.9 | 0.35 | 530 |
| 2000 | 3632 | 8.3 | 0.36 | 530 |

(about 2730°F). Molybdenum rods sealed in porcelain or sintered alumina⁽⁷⁴⁾ tubes have been experimented with in Germany but apparently were not commercially successful. Work at TVA indicated some promise with carbon rods enclosed in porcelain tubes with a reducing atmosphere. The Nernst resistor, composed of oxides having a low electrical resistance at high temperatures, can be used up to 2000°C (about 3600°F). However, they are costly and have to be initially heated from a separate source.

Transfer of Heat. One of the most difficult problems in kiln design is to transfer the heat efficiently from its source to the ware. The problem is unusually difficult in the kiln because the ware is in small units stacked into a considerable volume and therefore radiant-heat transfer, so important in furnaces such as those used in the metallurgical industry, can play little part. For the same reason, conduction of heat into a bulky charge of small units is of little consequence. Therefore, we must rely almost entirely upon convection for heating of the charge.

The transfer of heat from a moving stream of gas to a solid surface is well understood. The transfer rate depends mainly on the temperature

difference between the gas and solid and the velocity with which the gas is passing by the solid. The curves in Fig. 131 give an idea of the rate of heat transfer under different conditions between a gas and a solid. The transfer of heat from the moving gas by radiation from the gas itself and the incandescent particles that it contains is quite important in furnaces of large volume and great flame thickness, such as would be found in the glass-tank or open-hearth furnace; however, in the kiln, where the gas stream is divided into relatively thin layers, this radiation cannot play a very important part, although attempts are made in practice to use

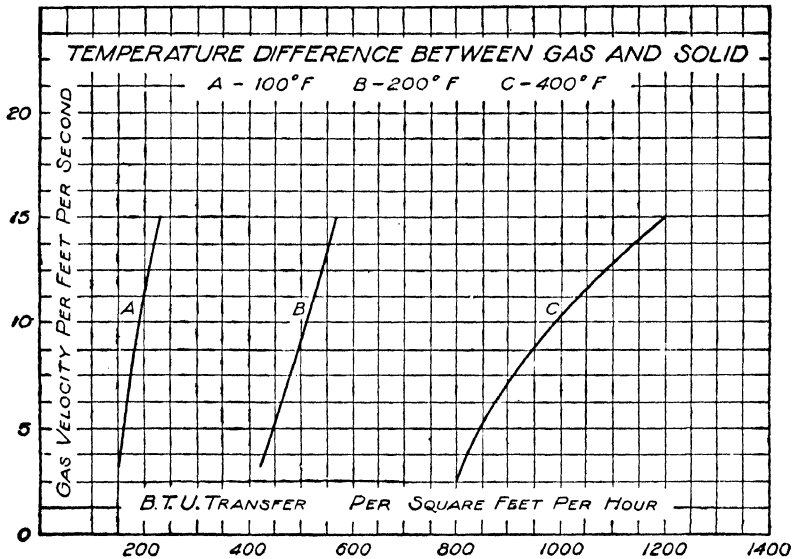

FIG. 131. Rate of heat transfer between a gas and a solid.

long-flame coal to bring the heat down to the bottom of the charge of a downdraft kiln.

Equalization of Temperature. One of the most important problems in kiln design is to produce a uniform temperature throughout the volume of the charge. This is by no means an easy matter, as few large periodic kilns now operating show a difference of less than 50°F from top to bottom of the charge. In tunnel kilns, with their small cross section, the temperature uniformity is better, but here again it is apt to vary from place to place in the car by an appreciable amount.

Considering first the case of a downdraft kiln under equilibrium conditions, it may be readily shown that the temperature difference between top and bottom is related to the mass flow of gases. In Fig. 132, the section *AA* may represent the top of the charge and *BB* the bottom. If *M* equals the weight of gases flowing through the channel in a unit time

and S the heat lost between AA and BB by transfer laterally through the walls per unit time, then

$$S = (t_1 - t_2)c_p M$$

$$t_1 - t_2 = \frac{S}{c_p M}$$

where c_p = the specific heat of the gas

t_1 and t_2 = the temperatures of AA and BB , respectively

We may therefore conclude that a more even temperature is obtained by a large volume flow, which may be realized by the addition of excess air to the products of combustion. This equation also shows that insulation of the kiln side walls will give a more even vertical temperature distribution.

Another method of equalizing the temperature and one that is theoretically very attractive is the recirculation of the combustion gases through the charge. In this way, a large volume flow is obtained, thus decreasing the temperature difference; while at the same time, the volume of gases leaving the kiln is relatively small. The only difficulty with the recirculation method is the practical problem of handling the high-temperature gases. At the lower temperatures encountered in heat-treating furnaces, gases can be recirculated with water-cooled, alloy fans at temperatures close to 1800°F (about 980°C); but above this, the only possible means is by injector action, a method quite successful in driers but one that has not been developed for kilns at the present time. Recently, recirculation has been used successfully in some tunnel kilns at the preheating end.

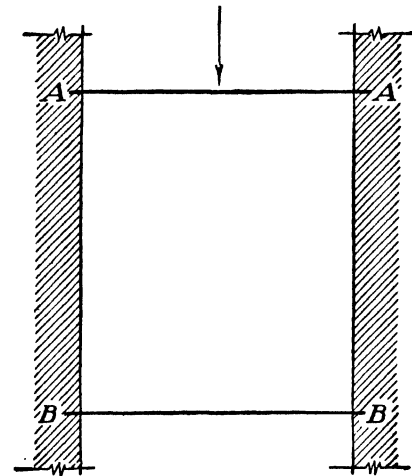

FIG. 132. The effect of flow velocity on temperature distribution.

The equalization of temperature at right angles to the path of flow is readily accomplished by adjustments in the floor openings, so that the hotter areas have the openings reduced and the cooler areas have them enlarged. By trial and error, a very uniform temperature can be attained over the horizontal cross section of the charge.

The equalization of temperature at right angles to the path of flow is readily accomplished by adjustments in the floor openings, so that the hotter areas have the openings reduced and the cooler areas have them enlarged. By trial and error, a very uniform temperature can be attained over the horizontal cross section of the charge.

One often hears the kiln fireman state that he uses a damper or a close-set floor to back up the heat in the kiln and give a more uniform temperature. It is not generally understood, however, just what the effect of dampers and restrictions to the flow accomplish. The curves in Fig. 131

show clearly the great increase in heat transfer from the gas to the charge with increasing velocities. The point in the kiln where the flow is restricted has an increased velocity, and thereby more heat is transferred from the gas to the charge. As the usual problem is to raise the temperature at the bottom of the charge, it is possible to have a relatively open setting in the charge itself and as small floor openings as are permitted by the available draft. Owing to the high velocity through the floor openings, the heat from the gas will be given up to a much greater extent at the floor than in the other parts of the charge and will therefore tend to compensate for the gradual cooling of the gas as it goes down through the charge.

Temperature uniformity can be attained in a muffle kiln by varying the area of contact of the gas with the muffle wall from the burner to the exit point; *i.e.*, at the burner, the passage for the gas would only have a small width in contact with the muffle, whereas in the exit, it would have a large width. By properly adjusting these areas, a muffle kiln with absolute uniformity of temperature can be constructed. Laboratory kilns that have been made in this way, though bottom fired, show a temperature at the top of the muffle within a few degrees of the bottom temperature.

Insulation of the kiln tends to increase the uniformity of inside temperature, because (1) it tends to keep the inside walls of the kiln at a more uniform temperature, and because (2) an insulated kiln requires less fuel and therefore the gases entering the kiln can be at a lower temperature. Also, as explained from the diagram in Fig. 132, the insulation of the walls of the kiln increases the uniformity of temperature by minimizing the heat loss as the gases pass through the charge.

Kiln Efficiency. The efficiency of the kiln is usually defined as the ratio of the heat required to bring up the ware to its maximum temperature divided by the amount of heat supplied by the fuel. This definition is perfectly logical when applied to the periodic kiln; but when it is used under conditions where recuperation occurs, then it may become absurd, as efficiencies of over 100 per cent have been determined on actual kilns. This can perhaps be made clear by the set of heat-balance diagrams shown in Fig. 133 beginning with a nonrecuperative kiln and ending with one having a high recuperative effect. It will be seen that the heat required to bring the ware up to temperature is the same in each case but the external heat supplied to the kiln becomes progressively smaller as the recuperative action increases. It would seem more reasonable to give fuel consumption per thousand standard-sized bricks rather than to express efficiency in percentage.

It should be stated here that a high degree of kiln efficiency is often incompatible with good uniformity of temperature because high efficiency demands a low temperature of exit gases and these, in turn, mean a low

temperature of the charge in the bottom of the kiln. Only by recuperative action or recirculation can good temperature uniformity be obtained together with high efficiency.

It is obvious that the insulation of kilns will increase their efficiency but unfortunately very few data are at hand to show just what the saving might be, as there is seldom an opportunity to compare similar kilns, one of which is insulated and the other not. It should be brought out, however

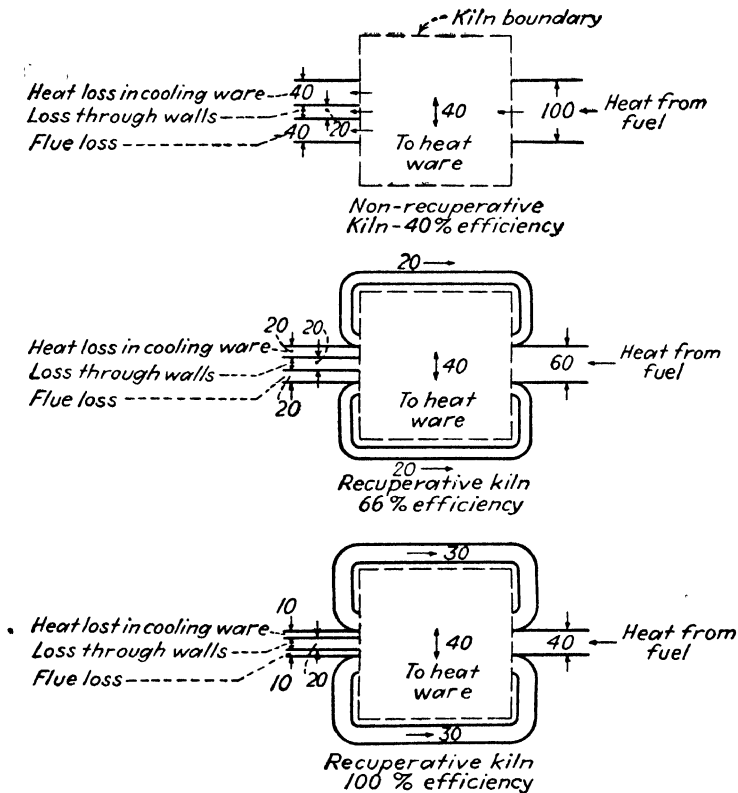

FIG. 133. Heat balance diagrams.

that the effect of insulation is not only to reduce the heat passing through the walls and the crown of the kiln but also to reduce the volume of exit gases in proportion. This fact is little understood, and it may be well to emphasize it with an example, under steady temperature conditions, in Table 41. This follows because, for a constant exit temperature, the heat lost in the flue gases is proportional to the heat input.

3. Periodic Kilns. The periodic kiln has been much used in the refractories industry. Its advantages are a comparatively low first cost and flexibility in operation. The disadvantages are the poor fuel economy

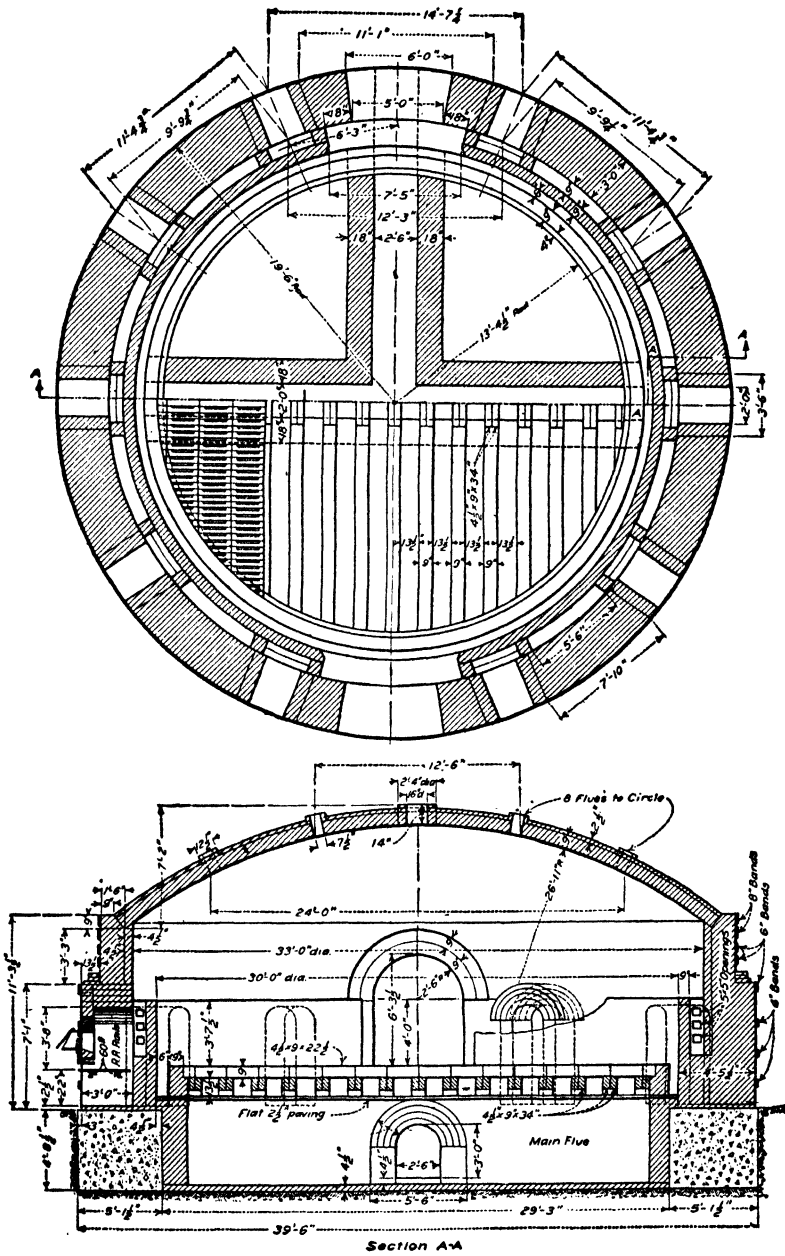

FIG. 134. A round downdraft kiln for firing refractories. (*J. Am. Ceram. Soc.*)

TABLE 41. SAVING DUE TO INSULATION

| | Uninsulated kiln | Insulated kiln | |
|--|------------------|---------------------|--------------|
| | | As usually computed | As it occurs |
| Heat passing through walls, B.t.u. | 50,000 | 25,000 | 25,000 |
| Heat lost in flue gases, B.t.u. | 50,000 | 50,000 | 25,000 |
| Heat supplied to the kiln, B.t.u. | 100,000 | 75,000 | 50,000 |
| Heat saved, per cent. | 0 | 25 | 50 |

secured, the unevenness of temperature when the charge is piled high, and the strain on the brickwork due to the repeated heating and cooling. Although the periodic kiln is being gradually displaced by the tunnel kiln, it will always be used to some extent for burning large shapes and special bricks.

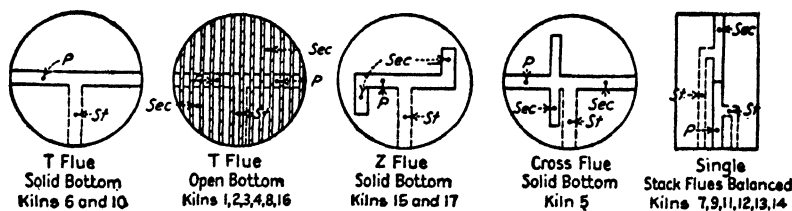

FIG. 135. Flue arrangements for downdraft kilns.

Common Types of Kilns. The periodic kiln generally used to fire refractories is either of the circular downdraft type or of the rectangular type. The former is usually preferred because of the low cost for a given capacity and the even temperature distribution possible. The round kilns are made in sizes of 26 to 42 ft inside diameter, but sizes from 30 to 36 ft are generally preferred. The capacity ranges from 30,000 to 140,000 nine-inch equivalents. The fireboxes are arranged around the kiln and vary in number from 8 to 18 according to the size and type. The construction of the walls and crown is practically the same in all cases, but there is a great diversity of arrangements for the floor and flues.

In Fig. 134 is shown a well-designed, round, downdraft kiln for burning refractories. It will be noted that the flues are arranged in such a way as to give an even draft at all parts of the floor. Figure 135 gives a number of other flue arrangements that are sometimes used.

Although there is considerable variation in the dimensions of this type of kiln, the figures in Table 42 are generally used. It is generally considered good practice to connect two or four kilns to a single stack having

separate flues for each kiln. This method gives a hot stack under all conditions, so that a good draft is produced when starting a kiln. The height of stack generally varies from 30 to 40 ft.

TABLE 42. KILN AREAS

| | |
|---|--------|
| Floor to top of crown, ft..... | 11-19 |
| Height of bag wall above floor, ft..... | 3-5 |
| Area of floor openings, per cent of floor area..... | 2.8-10 |
| Area of grates, per cent of floor area..... | 8-12.6 |
| Area of main flue, per cent of floor area..... | 1.4-3 |
| Area of stack, per cent of floor area..... | 1-1.6 |

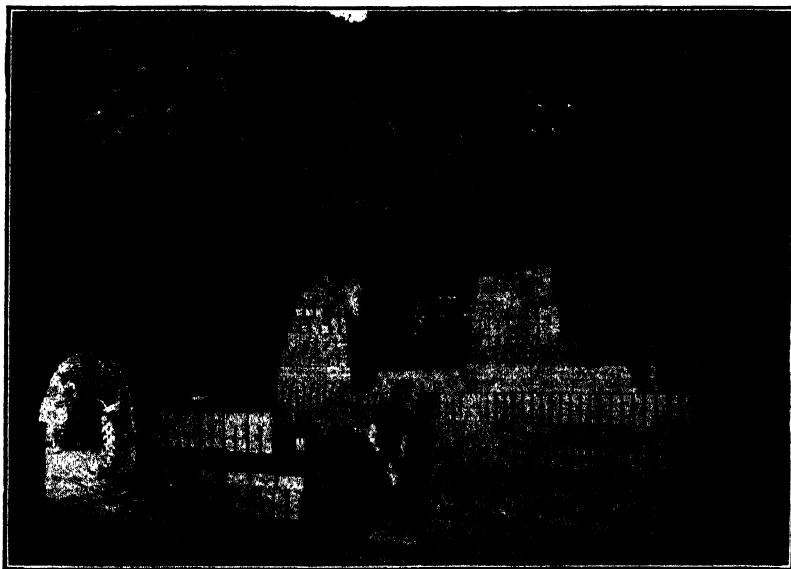

FIG. 136. A typical kiln setting. (Courtesy of Harbison-Walker Refractories Company.)

Usually the turnover time in this type of kiln, burning clay refractories, is approximately 14 days: $4\frac{1}{2}$ days for firing, $5\frac{1}{2}$ days for cooling, 2 days for drawing, and 2 days for setting. When burning silica brick, the kiln is held at the maximum temperature for some length of time, so the turnover time is somewhat longer. A typical kiln setting is shown in Fig. 136.

The modern tendency seems to be toward the use of blowers and suction fans to accelerate the burning and cooling. In this way, as much as 50 per cent can be taken off the burning and cooling time, which means a marked increase in the output of the kiln. There is, however, a limit to the rate of firing, caused by the burning properties of the clay used. On the other hand, the cooling rate is limited because of the strains set up in the kiln itself by a too rapid change in temperature.

There are a number of other types of periodic kilns for burning refractories, but they are not so generally used. Descriptions of them can be found in the references given at the end of this chapter.

Fuel Consumption. The fuel consumption of periodic kilns is comparatively large and varies with the burning temperature and the amount of insulation used on the kiln. In Table 43 are given some figures on the fuel used in a number of periodic kilns.

TABLE 43. FUEL CONSUMPTION OF PERIODIC KILNS

| Type of kiln | Capacity, 9-in. equivalents | Fuel | Maximum temperature | | Firing time, hr | Fuel per 1,000 bricks (9-in. equivalents) |
|---|--------------------------------------|-------------|------------------------|------|-----------------------|--|
| | | | °C | °F | | |
| Round downdraft. | 65,000 32,000 60,000 48,000 | Coal | 1270 | 2318 | 192 | 2,200 lb |
| | | Coal | 1290 | 2350 | 150 | 1,450 lb |
| | | Coal | 1320 | 2408 | 156 | 1,200 lb |
| | | Coal | 1170 | 2138 | 132 | 1,500 lb |
| | | Coal | | 2600 | | 3,000 lb |
| | | Coal | 1150 | 2100 | | 2,100 lb |
| | | Coal | 1250 | 2280 | | 2,500 lb |
| | | Coal | 1316 | 2400 | | 2,400 lb |
| Rectangular downdraft. | 42,000 60,000 | Coal | 1280 | 2336 | 163 | 1,770 lb |
| | | Coal | 1270 | 2318 | 168 | 1,800 lb |
| Round downdraft. | 76,000 | Oil | 1270 | 2318 | 110 | 125 gal |
| | | Oil | 1400 | 2550 | | 115 gal |
| Rectangular (insulated) downdraft. | 10,000 5,000 | Oil | 1650 | 3000 | 115 | 400 gal |
| | | Oil | 1650 | 3000 | 100 | 500 gal |
| Round downdraft. | 50,000 | Natural gas | 1250 | 2280 | 216 | 18,000 cu ft |

The heat losses in periodic kilns are mainly in the flue gases, as shown in Table 44, which gives average figures for periodic kilns burning fireclay bricks with coal.

Setting Methods. The method of setting the brick in the periodic kiln depends on their shape, the type of refractory, and individual plant practice. The setting is usually in a checkerwork pattern, with about $\frac{1}{2}$ in. between bricks, making up a bench extending across the kiln. For straight bricks, this means three set across three others. To prevent the bricks from sticking to one another, silica sand is sprinkled on the top of the bench before placing the next pieces. Brick such as magnesite and

chrome cannot support themselves in a high setting and therefore are commonly boxed with silica brick, which carry the load.

TABLE 44. HEAT BALANCE OF A TYPICAL PERIODIC KILN

| | Per Cent |
|--|----------|
| Heat to raise temperature of bricks, or efficiency | 15-45 |
| Heat to drive off moisture | 0-3 |
| Heat in combustion of ash | 4-10 |
| Heat in combustion in flue gases | 0-5 |
| Heat in dry flue gases | 20-45 |
| Heat in water vapor in gases | 4-7 |
| Heat to raise temperature of kiln walls | 4-15 |
| Heat to raise temperature of kiln crown | 2-4 |
| Heat lost by walls and crown | 3-9 |
| Heat lost in bottom and flues | 4-12 |

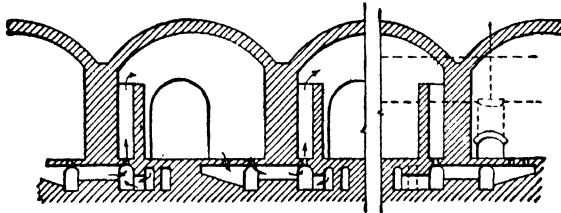

FIG. 137. Section of a typical compartment kiln.

4. Continuous Compartment Kilns. The compartment kiln is designed to provide more economical operation than can be given by the periodic kiln. A great number of methods are used, but the general principle is the same in all cases. In Fig. 137 is shown a portion of a typical compartment kiln. Each chamber is similar to a downdraft periodic kiln; but instead of the gases passing out of the stack, they pass from one chamber to the bag wall of the next, so that the heat from the combustion gases is used to preheat the bricks in the chambers ahead of the fire. In the same way, the heat from the cooling bricks is used to preheat the air for combustion. In some cases, this combustion air is drawn off by blowers and passed through the grates or burners; in other cases, the fuel, usually in the form of fine coal, is introduced through ports directly into the chambers under fire.

This type of kiln has been used to a very small extent for refractories in this country, but abroad, where economy of fuel is more important, the compartment kiln has been extensively employed. The main trouble with the older type of chamber kiln was the slow rate of fire travel, which amounted to only about 6 in. per hr. This was due mainly to the considerable resistance to the flow of gases through the long passages. In the more modern chamber kilns, blowers and suction fans are being used to

increase the gas velocity, which gives a fire travel as high as 3 to 5 ft per hr, with an immense increase in the capacity of a given kiln.

In a well-designed chamber kiln, practically the only heat loss is by transfer through the walls and crown, for nearly all the heat is abstracted from the cooling bricks and from the combustion gases. Although it is difficult to get strictly comparable figures, it may be said that the fuel consumption runs between one-half and one-third of that of a periodic kiln. This, of course, is an important saving. However, the initial cost for chamber kilns is somewhat higher than for periodic kilns of the same capacity; and in general, the firing of a chamber kiln requires more skill to produce an evenly burned product. In regard to the upkeep of the chamber kiln, different operators hold rather conflicting views, but some believe it to be considerably higher than for a periodic kiln.

TABLE 45. FUEL CONSUMPTION OF CHAMBER KILNS

| Ware | Fuel | Maximum temperature | | Fuel per M standard bricks, lb |
|----------------|--------------|---------------------|------|--------------------------------------|
| | | °F | °C | |
| Fireclay..... | Coal | 2450 | 1340 | 750 |
| | Coal | 2325 | 1273 | 1,000 |
| | Coal | 2570 | 1410 | 1,100 |
| | Producer gas | 2590 | 1420 | 1,500 (coal) |
| Silica..... | Coal | 2640 | 1450 | 900 |
| Magnesite..... | Coal | 2680 | 1470 | 1,500 |
| | Coal | 3000 | 1650 | 3,500 |
| | Brown coal | 2730 | 1500 | 4,000 |

The capacity of chamber kilns depends entirely upon the size and number of chambers, as well as rate of fire travel. Kilns with an output of over 100,000 bricks per day have been constructed.

During the Second World War the Didier Werke in Germany constructed a Hoffman-type chamber kiln⁽¹³⁾ with three kiln cars per chamber, so that the setting could be carried out in the open. Such a kiln should receive serious consideration by our manufacturers for burning shapes.

5. Tunnel Kilns. The use of tunnel kilns in burning refractories is extending rapidly, and it may be said that practically all the modern refractory plant units are built around a tunnel kiln. As the design has been improved and experience gained in the operation of tunnel kilns, it is generally recognized that they will produce better bricks at a lower cost than the periodic-kiln unit. This does not mean that the periodic kiln

will not be used, for it still offers advantages in burning large or intricate shapes, where the burning schedule must be different from that of the standard brick. Because of the great importance of the tunnel kiln, some space will be devoted to a consideration of the principles of operation.

In principle, the tunnel kiln consists of an elongated chamber, which is maintained at a steady temperature, graded in the desired manner, from end to end. The charge, mounted on cars, is moved continuously through the chamber and encounters in its passage the desired variations in heat. The economy of the tunnel kiln is obtained by regaining the heat from the combustion gases to heat the incoming charge and by using the heat from the cooling bricks to preheat the combustion air or, in some cases, to dry the bricks.

The advantages of the tunnel kiln are as follows:

1. The tunnel kiln lends itself well to a continuous production process, which minimizes handling.
2. The setting and drawing of the kiln are simple and regular; and with dry-pressed brick, setting can be done directly from the press, eliminating the shods, drier cars, etc.
3. The kiln structure itself, with the exception of the cars, is always at a uniform temperature, so with proper design, upkeep of the refractory of the kiln itself is very low.
4. It is possible by proper design to heat and cool the ware according to any desired schedule, which enables the brick to be burned properly in the shortest possible time.
5. Owing to the relatively small cross section of the charge, the heat is able to penetrate to the center rapidly, thus allowing much more rapid burning than is possible in the bulky charge of the periodic kiln. This rapid burning is an advantage when special orders must be put through rapidly.
6. The tunnel kiln, when properly operated, shows marked economy of fuel in comparison with the periodic kiln.

There are a number of disadvantages to the tunnel kiln, but many of these are gradually being eliminated as more experience is gained with this method of burning.

1. The construction of a tunnel kiln necessitates a considerable capital outlay, as it is impossible to increase the capacity gradually as can be done with a number of periodic kilns. However, the cost per thousand bricks produced is not necessarily higher than that with the periodic kiln.

2. A shutdown on a tunnel kiln is serious, as it will tie up the whole unit for perhaps two to four weeks. With proper operation, a shutdown is very rare, but it does happen occasionally.

3. The upkeep on the car tops is high, because of the fact that they are periodically heated and cooled during each passage through the kiln. Considerable study is being given the problem, and it seems probable that this expense can be greatly reduced by careful design.

4. Some difficulty is experienced in getting a uniform temperature across the section of the tunnel kiln. The top and sides of the charge are often hotter than the bottom. This can be corrected, however, for some tunnel kilns now running give a very uniform temperature distribution.

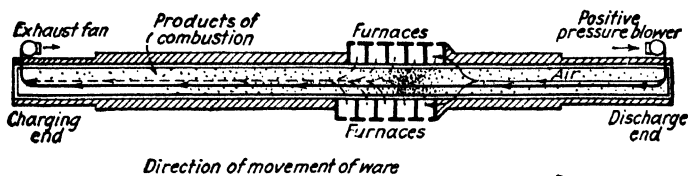

Fig. 138. A plan section of a direct-fired tunnel kiln. (American Refractories Institute.)

5. The tunnel kiln requires a considerable length of floor space, and some plants are so situated that this is not readily available.

6. Another objection to the tunnel kiln is that for most efficient operation, it must be run with a uniform charge, *i.e.*, with straight bricks or 9-in. shapes. It is, of course, possible to vary the burning schedule to accommodate larger shapes or different types of clay, but these changes have a bad effect on the structure of the kiln, and some time is lost in getting the kiln running uniformly after such a change is made.

7. The tunnel kiln cannot be run efficiently at a low capacity and therefore lacks the flexibility of the periodic kiln.

Tunnel kilns are made in the direct-fired and muffle types. Because the average refractory is not very sensitive to impurities in the atmosphere, the muffle type, which is more expensive in first cost and in fuel, would rarely be selected for burning refractories; therefore we shall confine ourselves to the direct-fired type. In Fig. 138 is shown a plan section of a typical direct-fired tunnel kiln. The charge enters the kiln at the left-hand end and is gradually heated, reaching a maximum temperature in the hot zone. It is then cooled as it passes out of the kiln. Cold air is forced into the exit end of the kiln with a blower, and this passes through the charge, cooling it and at the same time picking up heat. This air then passes into the combustion zone, where it is mixed with the combustion gases, and then passes through the incoming charge. In this portion of the kiln, it loses heat to the charge; then it is drawn out at the entrance end of the kiln with a suction fan. The primary air used for combustion in the burners is usually drawn out from the cooling section by a fan, but this is small in volume compared with the total gas flow.

A number of variations may be used. In Fig. 139 the cooling air is drawn out of the kiln and used for heating driers or a hot floor, and the air for combustion is taken from the cooling air at the same point. Figure 140 shows a kiln with indirect cooling. In this case, the bricks are cooled

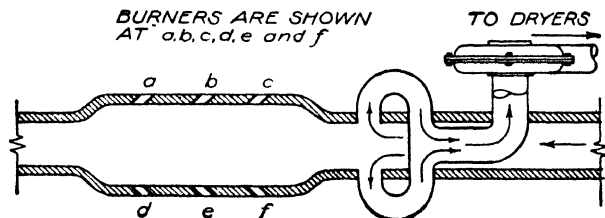

FIG. 139. Tunnel kiln in which the cooling air is drawn out for use in drier.

entirely by radiation, as the cooling air passes through the hollow walls and is used for driers and combustion.

In order to regulate the heating curve of the bricks, the gases are usually not drawn off at one point at the kiln entrance but are taken out at a number of points along the preheating section so that the desired temperature curve may be obtained.

The longer the preheating zone of the kiln the cooler will be the exit gases and the higher the efficiency of the kiln. However, for constructional reasons, the length must be limited; consequently the temperature of the exit gases usually runs between 100°C (about 212°F) and 400°C (about 750°F). In the same way, the outgoing bricks may be cooled to any desired temperature by sufficient length of the cooling zone. It is generally desired to cool the charge sufficiently for easy handling. The bricks usually emerge at temperatures of 50°C (about 120°F) to 150°C (about 300°F).

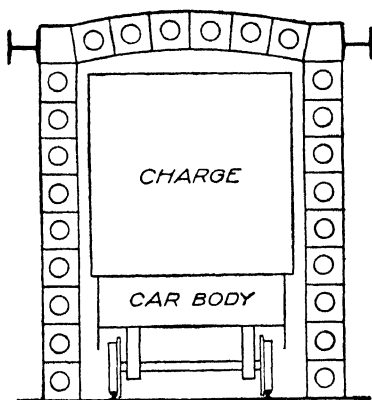

FIG. 140. A tunnel kiln with indirect cooling.

The setting of the charge itself should be so proportioned that a comparatively high gas velocity is maintained throughout the length of the preheating zone, and yet excessive power should not be required to pull the desired volume of gases through. In general, the velocity of the gases through the preheating zone will vary from 500 to 2,000 ft per min, and the draft at the entrance end needed to supply this velocity will vary from $\frac{1}{4}$ to 1 in. of water.

A great many methods are used in setting the charge to provide

longitudinal gas channels. As the sides of the charge have a tendency to heat before the center, it is common practice to provide a gas channel down the center of the charge and to reduce the clearance at the top and sides to a minimum, as shown in Fig. 141. The width of the charge usually ranges from 4 to 7 ft, and the height from 4 to 6 ft. Rather flat arches are used in order to prevent gas from flowing over the charge. It is quite necessary in a kiln of this length to make the sections as airtight as possible. This is accomplished by keeping the wall joints well cemented;

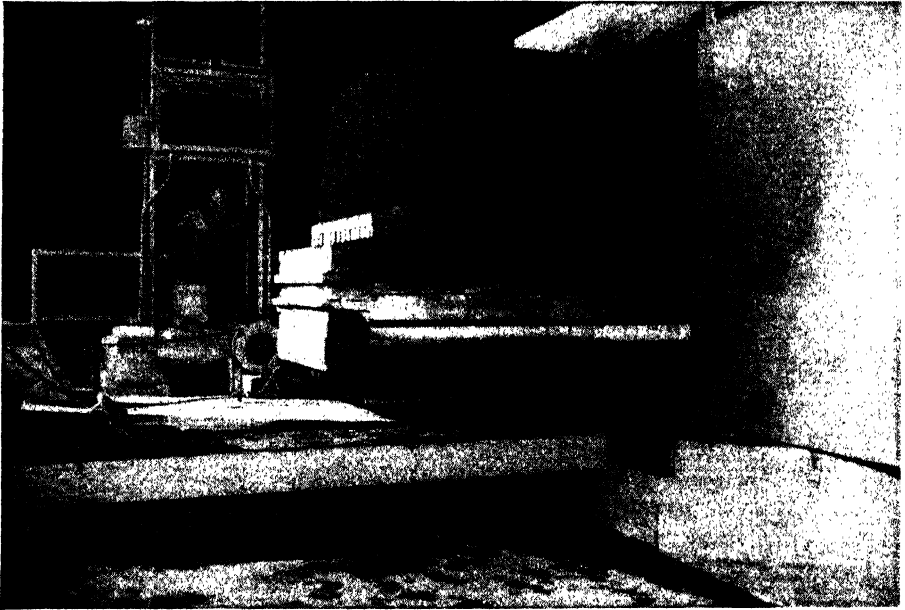

FIG. 141. A car of chrome bricks being pulled from the tunnel kiln onto a transfer car. (Courtesy of the Harbison-Walker Refractories Company.)

and in some cases, airtight coatings are applied to the outside of the insulating material.

There would tend to be a very large leakage between the car bottom and the kiln wall, because the clearance here cannot be made small on account of the change in dimensions of the car top. This leakage is prevented in most kilns by attaching to each car a blade that runs in a trough filled with sand along each side of the kiln, as shown in Fig. 142. This method appears to be quite satisfactory, as sand can be supplied to the entrance end of the trough from which it is gradually carried through to the exit end, where it can be removed and returned.

The furnaces for firing tunnel kilns are arranged along the sides in the firing zone as shown in Fig. 143. The number of furnaces usually varies

between two and seven on each side, and usually they are staggered. For the use of coal, furnaces and grates similar to those used in periodic kilns are employed; but in this case, they may be designed to work at their maximum efficiency with a constant load. Although a number of kilns have been fired directly with coal, in general it is more difficult to maintain a uniform temperature, and better control is obtained with other fuels. Many tunnel kilns are fired with oil. In most cases, the burners are placed in small chambers at the side of the firing zone, and the oil flame is directed into the charge. Due to the necessarily small distance between the burner and the charge, there is danger of overheating the surface of the brick next to the burner. For this reason, a checkerwork, as shown in Fig. 130, is sometimes placed at the mouth of the chamber to distribute the heat more evenly over the surface of the charge.

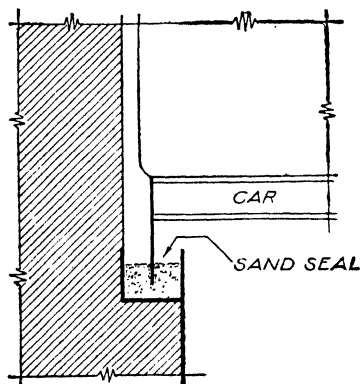

FIG. 142. A sand seal under a tunnel kiln car.

Kilns fired with natural gas need only a small firing chamber, as the flame is comparatively short. As in the case of periodic kilns, natural

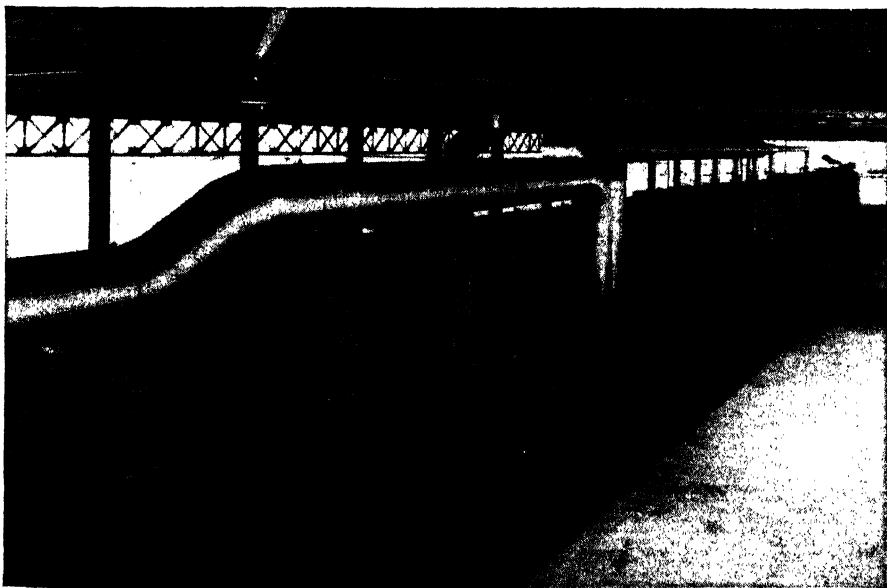

FIG. 143. A modern tunnel kiln designed for firing refractories. (Courtesy of the Allied Engineering Corporation.)

gas is an ideal fuel, and perfect control of temperature and atmosphere can be maintained with it.

Producer gas is often used in firing tunnel kilns. In most cases, the flame can be directed immediately into the charge because of the low temperature of the producer-gas flame. Because of the low heat value of this gas, it is not necessary to use a large amount of secondary air to provide a sufficient volume of gases to carry the heat down the kiln. As previously stated, raw producer gas has the disadvantage of depositing soot and tar in the connecting flues, and provision must be made for cleaning them out periodically.

The position of the burners is usually somewhat below the center of the charge in order to bring up the bottom temperature, which tends to lag behind that of the top. Sometimes burners in the hot zone are varied in height from one point to another in order to give a more equal temperature distribution to the charge. Some kilns have been constructed with hollow car bottoms. In this case, the car tops must be made of excellent material to withstand the high temperatures and loads experienced under these conditions.

The tunnel kiln cars vary from 5 to 7 ft in length and are built of structural steel or made of castings. Generally the cars roll on wheels mounted on roller bearings as in track cars. The track, however, is laid with great care, and there is little side clearance between the flanges and the rails. A number of other methods have been suggested and tried out for supporting the cars, such as balls running in grooves, floats on a canal, and stationary rollers in the kiln.

The cars are pushed through the kiln generally by a hydraulic pusher operated by a small variable stroke pump, as shown in Fig. 144. After one car has been pushed in, the plunger draws back, a second car is inserted by means of a cross transfer, and the process is repeated. At the exit end, the car is taken off on a transfer in the same way. Kilns have been built where the cars are moved continuously rather than intermittently, in which case, they are usually driven by a heavy chain with dogs. Means are provided to transfer the load gradually from the driving dog on the forward car to that on the following car to prevent shock and jars. As it is more expensive to construct a mechanism for continuous operation, it is not generally used, because the wait of four or five minutes while changing cars is not serious.

Nearly all tunnel kilns employ air locks at both ends so that the flow conditions in the kiln will not be disturbed by the entrance or exit of cars. However, kilns can be run with one lock and, in the smaller sizes, without any.

The cars are moved at the rate of from 3 to 8 ft per hr, depending upon the length of kiln and the burning properties of the clay, thus giving a total time in the kiln of from 50 to 100 hr; however, kilns are operating successfully at speeds as high as 20 ft per hr and with a total time in the kiln of 12 hr. If the kiln is properly designed so that the combustion gases are evenly distributed around each brick, the limit in rate of heating for many clays is the time taken for the heat to penetrate from the surface to the center of the brick. In the future, we may see clay refractories burned in a much shorter time than is considered possible at present.

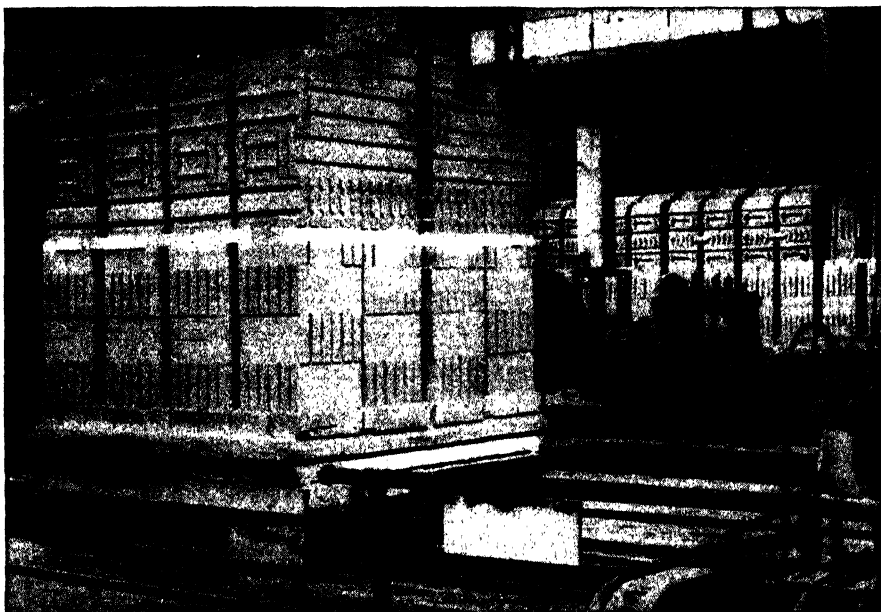

FIG. 144. A tunnel kiln car loaded with special shapes ready to enter the kiln. (Courtesy of the Harbison-Walker Refractories Company.)

The production of tunnel kilns generally used for refractories varies between 20,000 and 35,000 bricks per day. It may be said that the faster the bricks can be run through a given kiln and still be burned properly the more efficient will be the burning conditions. It takes but little more fuel to burn 30,000 bricks per day in a given kiln than it does 20,000 bricks.

Some manufacturers burn all shapes in their tunnel kilns, even up to 45 in. in length. They also change the burning temperature to accommodate different types of clay that may be run through the kiln. Although this procedure can undoubtedly be followed if necessary, a tunnel kiln

can be run efficiently only with one type of setting and one temperature adjustment. Any changes in the setting or in the temperature disturb the balance of the kiln and require a long period for readjustment. Again, if the kiln is running slowly enough to burn large shapes properly, it is running slower than necessary to burn standard bricks. Probably the most desirable condition would be to have one tunnel kiln running on 9-in. sizes and a second kiln on a slower schedule burning only large shapes.

A well-designed tunnel kiln will use from one-half to one-third of the fuel per thousand bricks required for a periodic kiln. In Table 46 are given some figures on the fuel consumption of tunnel kilns.

TABLE 46. THE FUEL CONSUMPTION OF TUNNEL KILNS

| Type of refractory fired | Fuel used | Maximum temperature | | Fuel per 1,000 bricks |
|--------------------------|--------------|---------------------|------|-----------------------|
| | | °C. | °F. | |
| Fireclay | Coal | { 1270 | 2320 | 700 lb. |
| | | { 1335 | 2435 | 900 lb. |
| | | { 1470 | 2680 | 1,250 lb. (stokers) |
| Fireclay | Oil | { 1400 | 2550 | 80 gal. |
| | | { 1670 | 3040 | 150 gal. |
| Fireclay | Producer gas | { 1150 | 2100 | 850 lb. (coal) |
| | | { 1250 | 2280 | 970 lb. (coal) |
| | | { 1420 | 2590 | 1,150 lb. (coal) |
| Fireclay | Natural gas | { 1400 | 2552 | 630 lb. (coal) |
| | | { 1140 | 2080 | 6,000 cu. ft. |
| Chrome | Oil | { 1100 | 2000 | 7,000 cu. ft. |
| | | { 1470 | 2680 | 500 gal. |
| | | { 1525 | 2775 | 600 gal. |

A tunnel kiln reduces the setting and handling cost in a unit by as much as 20 to 35 per cent, through the continuous flow of materials. In the case of dry-pressed bricks, it is general practice to set the tunnel-kiln cars directly from the dry press and then to pass them either through a drier or, in some cases, directly to the kiln. This eliminates drier cars, shods, and storage space for the drying bricks.

It is difficult to state definitely the relative qualities of a tunnel-kiln and a periodic-kiln product because the conditions are so varied. It may be said in general, however, that the tunnel-kiln product is more uniform than that of the periodic kiln, both as to size and as to degree of burning. This is due to a more even temperature in the small cross section of the tunnel kiln and to the fact that the stresses resulting from the height of

the setting and the shrinking of the charge as a whole are much smaller in the tunnel kiln. Kiln marking is rarely found. The tunnel-kiln product is probably no better than the best of the periodic charge, but a large portion of the charge from the periodic kiln will undoubtedly be inferior to any of the tunnel-kiln product.

The cost of building a tunnel kiln to burn refractories will run about \$3,000 to \$5,000 per thousand bricks per day. This cost takes in only the kiln itself, and a complete unit for manufacturing 30,000 clay bricks per day would cost in the neighborhood of \$300,000 to \$400,000.

Undoubtedly, a modern tunnel-kiln unit can turn out bricks at a lower cost than the old periodic unit, because of both the saving of fuel and the saving of labor. This fact and the general belief that the product is superior to the periodic product have led many manufacturers to change over their plants to tunnel-kiln operation.

Tunnel kilns are used successfully to fire refractories other than fireclay. Silica bricks have been burned in tunnel kilns here and abroad for some time. A kiln for burning silica bricks at the rate of 35,000 bricks per day would be approximately 500 ft long to give a comparatively long soak at the maximum temperature, which would run around 1500°C (about 2730°F). Magnesite and chrome bricks are being successfully burned in tunnel kilns. These bricks are not able to support a great load while they are being burned; and in periodic kilns, it is necessary to support them more or less completely with silica bricks. In a tunnel kiln, however, the setting can be made so low that the bricks are well supported during the burning operation, which gives a lower kiln loss and a superior product.

6. Shaft Kilns. Shaft kilns are used to a considerable extent in burning lime, dolomite, and magnesite, although they have been displaced by the rotary kiln in many instances.

Shaft kilns for burning magnesite are described by Seil.⁽¹³⁾ The coal-fired kiln is 6.5 ft in diameter and 40 ft high. The fuel weighs 35 per cent of the clinker. A blast pressure of 1 lb is used, which produces a temperature at the base of the stack of 1500°C (about 2730°F) and 250°C (about 480°F) at the top. The lower lining is magnesite brick, and the remainder firebrick. The producer gas-fired kilns are 8 ft in diameter and 52 ft high.

A small shaft kiln is described by C. L. Norton, Jr.,⁽⁷⁵⁾ for firing pebbles. At a temperature of 1650°C (about 3000°F) only 1000 Btu was required per pound of product—a very high efficiency for such a small kiln. The maximum temperature attainable in this type of kiln is mainly limited by the refractories.

7. Rotary Kilns. Rotary kilns are coming into extensive use in the refractories industry⁽¹³⁾ for firing hard-burned grog of fireclay, bauxite, or diaspore. These kilns are similar in construction to those used in the

Portland cement industry and so need no detailed description. Lump clay is fed into the cool end of the kiln and is fired up to temperatures of around 1650°C (about 3000°F). Considerable experience is needed in operating these kilns at high temperatures to prevent rings forming in the hot zone and so stop the flow of clinker.

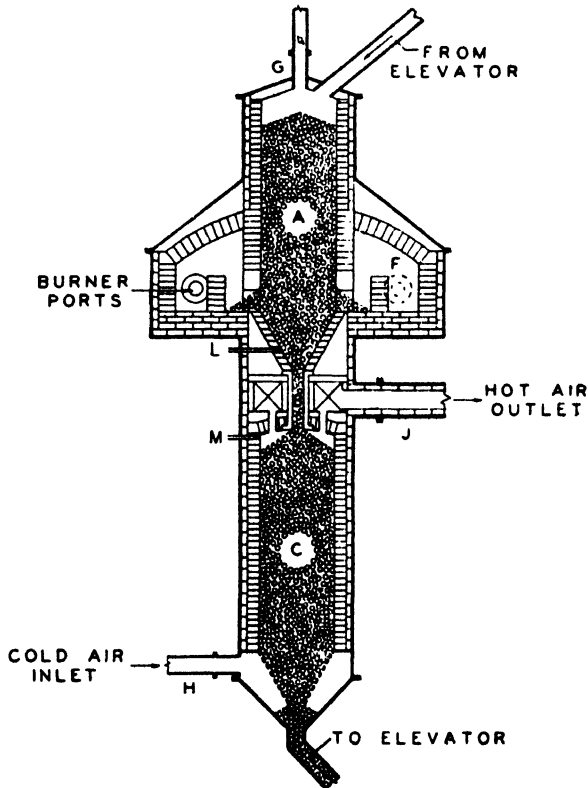

FIG. 145. Arrangement of pebble heater for delivery of air at 2300°F.

8. Air Preheaters. Considerable advances have been made during the last few years in developing high-temperature preheaters to supply combustion air. The most interesting design is the pebble heater,⁽⁷⁵⁾ a section of which is shown in Fig. 145. The pebbles ($\frac{5}{16}$ -in. spheres of refractory) are heated in the upper bed *A* by burners *F* and flow by gravity through the throat *B* into the lower bed *C*, where air is blown through them to pick up the preheat. The cooled pebbles are then returned to the upper bed by a continuous conveyor. Preheat temperatures of 1370°C (about 2500°F) can be obtained in this very compact device. Actual operating data on a small unit is given in Table 47.

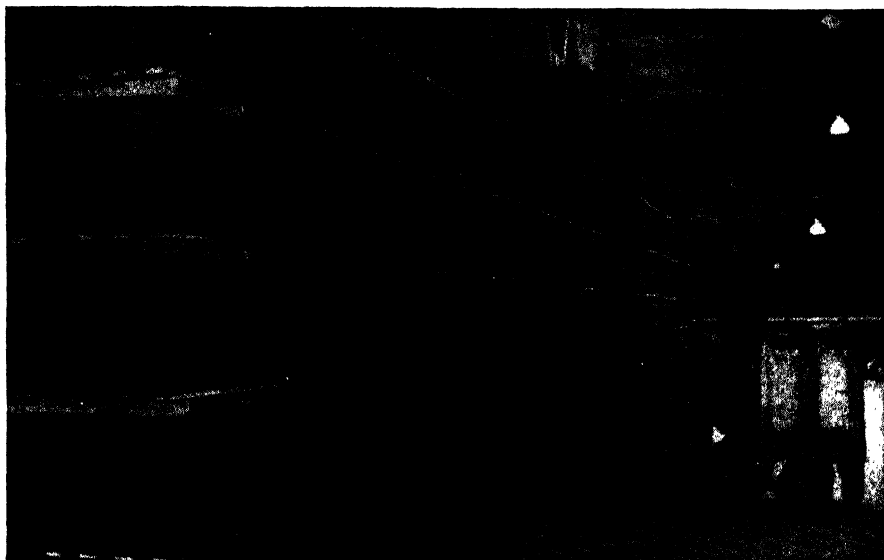

FIG. 146. Showing a modern method of storing fire brick on pallets with a lift truck. (Courtesy of the Harbison-Walker Refractories Company.)

TABLE 47. TYPICAL PEBBLE HEATER OPERATING DATA*

| | Unit No. 1 |
|--|------------|
| Gas being heated | Air |
| Exit gas temperature, °F. | 2,180 |
| Inlet gas temperature, °F. | 100 |
| Weight of gas heated, lb per hr. | 1,800 |
| Btu per hr in fuel. | 1,760,000 |
| Weight of flue gas, lb per hr. | 2,240 |
| Pebble circulation, lb per hr. | 2,150 |
| Flue gas exit temperature, °F. | 750 |
| Lower bed diameter, in. | 19 |

* Computed.

9. Handling and Storage. Products from the kiln are either shipped or put in storage directly. In recent years, nearly every plant employs lift trucks and wooden pallets for handling as shown in Fig. 146. This allows high piling with a minimum of labor. In some cases, the bricks are loaded in the freight cars on the pallets, which are later returned when a carload accumulates.

Insulating firebricks are generally ground to sizes on automatic grinders and then packed in cartons for storage or shipment.

10. Bibliography

Periodic Kilns:

1. LINTON, ROBERT: Notes on Firing in Down-draft Periodic Kilns, *J. Am. Ceram. Soc.*, **10**, 493, 1927.
2. FINZER, CHARLES: Draft in Round Downdraft Kilns, *Clay-Worker*, **89**, 291, 1928.
3. OMUNDSON, D.D.: Application of Continuous-kiln Principles in Down-draft Kiln Firing, *Clay Products News*, **1**, 6, 1928.
4. ANON.: Floor Flues for Uniform Draft in Downdraft Kiln, *Brit. Clayworker*, **37**, 6, 1928.
5. RICE, W.E., and H.C. HARRISON: Observations on the Firing of a Downdraft Kiln with a Stoker Situated outside Thereof, *J. Am. Ceram. Soc.*, **14**, 643, 1931.
6. Siemens and Halske Akt.-Ges: Refractory Tubes for Enclosing Graphite Resistors, Ger. Patent 707,272, 1941; *Chem. Abstracts*, **37**, 2904, 1943.
7. ANDERSON, R.H., D.C. GUNN, and A.L. ROBERTS: Further Experience in the Use of Permeable Refractories in Furnace Construction, *Inst. Fuel Wartime Bull.*, Oct. 19, 1945.
8. LYNMAN, T.R.: A Note on the Fuel Economy in the Firing of Intermittent Silica Tubes, *Trans. Brit. Ceram. Soc.*, **44**, 207, 1945.

Chamber Kilns:

9. MENDHEIM, A., and E. REUTLINGER: Compartment Kilns and Annular Kilns, *Ceramist*, **7**, 142, 1925.
10. DEWITT, H.: Advantages of the New Method of Constructing the Hoffmann Continuous Brick Kiln, *Rev. matériaux construction trav. publ.*, **189**, 125, 1925.
11. ANON.: Firing Grog in Continuous Kilns, *Brit. Clayworker*, **34**, 152, 1925.
12. SEARLE, A.B.: Fire-travel in Continuous Kiln, *J. Am. Ceram. Soc.*, **11**, 143, 1928.
13. SEIL *et al.*: The Manufacture of Refractories and Information Concerning Their Use in the Iron and Steel Industry of Western Germany, P.B. 37804, 1946.

Tunnel Kilns:

14. BALLENTIN, O.: Works Experience with a Tunnel Kiln, *Keram. Rundschau*, **33**, 745, 1925.
15. DRESSLER, P.: Tunnel Kilns in the Refractories Industry, *Fuels and Furnaces*, **3**, 127, 1925.
16. POHL, W.: Tunnel Kilns for Fire Brick Production, *Feuerfest*, **1**, 87, 1925.
17. HIND, S.R.: Tunnel Kiln for Burning Firebricks, (1), *Trans. Ceram. Soc. (England)*, **25**, 154, 1925.
18. MERRITT, L.M.: A Laboratory Muffle Kiln, *J. Am. Ceram. Soc.*, **9**, 324, 1926.
19. RICHARDSON, W.D.: Tunnel Kilns for Firing Firebrick, *Clay-Worker*, **86**, 296, 1926.
20. GREWE, J.: The Firing and Cooling of Silica Brick in a Tunnel Kiln, *Feuerfest*, **3**, 53, 1927.
21. MORITZ, WERNER: Der Tunnel ofen in der Ziegel und feuerfeste Industrie, *Tonind.-Ztg.*, **51**, 1634, 1927.
22. WALTER, GEORGE W.: A Highly Efficient Tunnel Kiln, *Fuels and Furnaces*, **5**, 61, 1927.
23. ANON.: Continuous Tunnel Kilns Installed in Silica Brick Plants, *Mining and Met.*, **8**, 534, 1927.

24. ANON.: Flat "Arch" for Continuous Kilns, *Brit. Clayworker*, **36**, 225, 1927.
25. SYLVANY, R.: Development of the Tunnel Kiln, *Pottery Gaz.*, **53**, 116, 1928.
26. ANON.: Tunnel Kiln Symposium, *Am. Refractories Inst., Tech. Bull.* **23**, May, 1928.
27. HARROP, C.B., and H.S. ORTH: Stoker Application to the Car Tunnel Kiln, *J. Am. Ceram. Soc.*, **12**, 406, 1929.
28. OGDEN, E.P.: Down-draft Tunnel Kiln, *Brick & Clay Record*, **74**, 39, 1929.
29. SEARSON, T.: Symposium on Tunnel Kilns, *Refractories J.*, **4**, 202, 1929.
30. WHITEWELL, B.E.: A Tunnel Kiln Refractories Plant, *J. Am. Ceram. Soc.*, **12**, 96, 1929.
31. HIND, S.R.: Notes on Circulation in Tunnel Kilns and Its Control, *Trans. Ceram. Soc. (Engl.)*, **31**, 179, 1932.
32. HIND, S.R.: The Carder Tunnel Oven, *Trans. Ceram. Soc. (Engl.)*, **33**, 274, 1934.
33. DRESSLER, P.: Problems of Firing Ceramic Ware in Tunnel Kilns, *Bull. Am. Ceram. Soc.*, **18**, 411, 1939.
34. REMMEY, G. BICKLEY: Recent Developments in Tunnel-kiln Refractories, *Am. Ceram. Soc., Bull.* **25**, 140, 1946.

Heat Balance and Efficiency:

35. GROUME-GUIMAILLO: "Flow of Gases in Furnaces," John Wiley & Sons, Inc., New York, 1923.
36. RICE, W.E., and R.A. SHERMAN: Determination of the Distribution of Heat in Kilns Firing Clay Wares, *J. Am. Ceram. Soc.*, **7**, 738, 1924.
37. GALLAGHER, B.J.: Economy and Dependability in Kiln Bonding, *Clay-Worker*, **84**, 411, 1925.
38. MINGLE, J.G.: "Draft and Capacity of Chimneys," D. Van Nostrand Co., Inc., New York, 1925.
39. JOSI, S.E., and A.E. HUBBARD: Insulation of Ceramic Kilns, *Trans. Ceram. Soc. (Engl.)*, **25**, 185, 1925.
40. BAUMANN, H.N., JR.: The Heat-balance Study of Ceramic Kilns, *J. Am. Ceram. Soc.*, **10**, 860, 1927.
41. BUTLER, W.A.: Waste Heat as Air for Combustion in Down-draft Kilns, *Clay-Worker*, **87**, 468, 1927.
42. OLENEW, K.F.: Thermal Calculations Involved in Designing a Kiln for Firing Brick, *Feuerfest*, **3**, 2, 1927.
43. PHOENIX, A.E.: Heat Losses in a Periodic Kiln, *Brick & Clay Record*, **70**, 466, 1927.
44. STEGER, W.: Setting up a Heat Balance for a Coal-fired Ceramic Kiln with Periodic Operation, *Ber. deut. keram. Ges.*, **8**, 224, 1927.
45. ANON.: Conservation of Fuel by the Insulation of High Temperature Installations, *Refractories J.*, **3**, 678, 1928.
46. MANSUR, H.H.: The Heat Balance of Some Ceramic Kilns, *J. Am. Ceram. Soc.*, **14**, 89, 1931.
47. SKINNER, K.G.: Equations and Quadrant Charts for Determining Heat Balances of Kilns Using Solid or Liquid Fuels, *J. Am. Ceram. Soc.*, **22**, 72, 1939.

General:

48. DUCKHAM, A.: Some New Forms of Kilns, *Trans. Ceram. Soc. (Engl.)*, **22**, 298, 1922.

49. TRINKS, W.: Combustion Devices for Gaseous Fuels, *Fuels and Furnaces*, **2**, 1035, 1157, 1249, 1924; **3**, 35, 1925.
50. BARTH, H.: Producers for the Gasification of High and Low Quality Fuels and of Waste Products, *Keram. Rundschau*, **34**, 494, 1926.
51. BLOOM, F.S.: Operation of Gas Producers, *Fuels and Furnaces*, **4** (4), 451, 1926.
52. NORTON, F.H.: The Design of Arches for Kilns and Furnaces, *J. Am. Ceram. Soc.*, **9**, 144, 1926.
53. KENYON, H.C.: Selecting the Best Coal, *Brick & Clay Record*, **68**, 614, 1926.
54. BOLE, G.A., *et al.*: Problems in the Firing of Refractories, *U.S. Bur. Mines, Bull.* 271, 1927.
55. CHAPMAN, W.B.: Progress in Gas Producer Practice, *Glass Ind.*, **8**, 289, 1927.
56. GRAAFEN: Advances in Firing Technique and Increases in Production in Ceramic Kilns, *Keram. Rundschau*, **35**, 75, 1927.
57. HASLAM, R.T.: The Combustion of Solid Carbon, *Proc. Inst. Fuel Tech.*, **1**, 18, 1927.
58. HUFFELMANN, K.: Luminous and Nonluminous Flames in Industrial Gas Furnaces, *Feuerungstech.*, **15**, 145, 1927.
59. LYON, J.B.: Kiln Construction, *J. Am. Ceram. Soc.*, **10**, 185, 1927.
60. ORTH, H.S.: Producer Gas in Connection with Firing Firebrick, *J. Am. Ceram. Soc.*, **10**, 699, 1927.
61. RICE, W.E.: Kilns and Fuels for Firing Refractories, *Am. Refractories Inst., Bull.* 15, September, 1927.
62. WEST, F.: Practical Experience of Firing Refractory Materials with Oil, (I,II), *Trans. Ceram. Soc. (Engl.)*, **27**, 104, 1927.
63. BOLE, G.A.: Some Notes on the Fuel Ratios in the Firing of Refractories, *Am. Refractories Inst., Circ.* 1, March, 1928.
64. BOSLER, L.C.: Relative Merits of High and Low Volatile Coal as Used in Periodic Kilns, *Ceram. Age*, **12**, 144, 1928.
65. DAHLSTROM, B.P.: Gas Burner Design, *Ceram. Age*, **12**, 21, 1928.
66. FURNAS, C.C.: The Flow of Gases through Beds of Broken Solids, *U.S. Bur. Mines, Rept. Invest.*, 2904, December, 1928.
67. STEGER, W.: Flue-gas Analysis in the Ceramic Industry, *Ber. deut. keram. Ges.*, **9**, 175, 1928.
68. STUMBKE, H.: Firing Technique and Heat Technology, *Keram. Rundschau*, **36**, 283, 1928.
69. FIELDNER, A.C.: The Classification of North American Coals, *U.S. Bur. Mines, Information Circ.* 6094, 1929.
70. HIND, S.R.: First Report on Oil Firing, *Trans. Ceram. Soc. (Engl.)*, **29**, 149, 1930.
71. BALES, C.E., and W.T. CHRISTIAN: Firing Clay Refractories with By-product Coke-oven Gas, *Bull. Am. Ceram. Soc.*, **14**, 245, 1935.
72. CHRISTMAN, H.M.: Mechanical Stokerization of Refractory Firing Kilns, *Bull. Am. Ceram. Soc.*, **18**, 369, 1939.
73. DIAMOND, G.S.: Factors Affecting the Life of Kiln Furniture in the Whiteware Industry, *Bull. Am. Ceram. Soc.*, **19**, 371, 1940.
74. RUSSELL, R., JR.: The Electrical and Technical Ceramic Industry of Germany, P.B. 18776, 1946.
75. NORTON, C.L., JR.: The Pebble Heater, *J. Am. Ceram. Soc.*, **29**, 187, 1946.
76. ROWDEN, E.: Fuel Utilization and Economy in the Refractories and Heavy Clay Industry, *Refractories J.*, **22**, 362, 1946.
77. ROWDEN, E.: Review of the Use of Mechanical Stokers in the Heavy Clay and Refractories Industries, *Trans. Brit. Ceram. Soc.*, **47**, 82, 1948.

CHAPTER X

LABORATORY KILNS AND FURNACES

1. Combustion Furnaces. *Types of Gas Burners.* There are a number of types of burners suitable for the efficient combustion of gas. The simplest is the atmospheric type, where the primary air is drawn in by the gas jet. Examples of this are the Bunsen, Tirrill, and Meker type of burner, as shown in Fig. 147. With gas at the usual pressure of 3 to 6 in. of water,



Fig. 147. The Bunsen, Meker, and Tirrill types of atmospheric gas burners. (*Courtesy of Eimer and Amend.*)

it is impossible to draw in enough primary air for complete combustion; consequently a certain amount of secondary air must be supplied in addition. With natural gas, which requires a larger proportion of air, the primary air is quite insufficient for combustion; therefore it is much more difficult to design an efficient burner of this type to burn natural gas. However, by proper design, furnace temperatures as high as 1420°C (about 2590°F) can be obtained with atmospheric burners without preheating the air. If the air is preheated, temperatures as high as 1750°C (about 3180°F) can be obtained. The advantages of the atmospheric type of burner are quietness and reliability, for a burner of this type can be left running unattended quite safely.

Although it is possible to preheat the air for small kilns successfully, fuel saving is usually not an object in such small installations, and the initial cost and maintenance of a suitable recuperator is not often justified; accordingly, when temperatures above the range of the atmospheric burner are desired, it is best to use the air or gas under pressure. By supplying the gas at a comparatively high pressure with a small pump, sufficient primary air can be drawn in to give complete combustion. Under the

conditions of complete combustion at the top of the burner, a much higher temperature can be obtained than when secondary air must be supplied separately. The high-pressure-gas type of burner has the advantage of a very large range of control from the lowest to the highest temperatures.

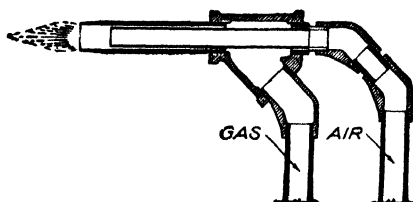

FIG. 148. A blow pipe where the gas and air are mixed at the nozzle.

Fig. 148, and a fairly short flame results. Temperatures as high as 1800°C (about 3270°F) can be obtained with this type of burner. In controlling the heat of the furnace, two adjustments must be made—one on the gas and one on the air—but this has the advantage of allowing the kiln atmosphere to be regulated as desired.

The highest temperatures in laboratory kilns can probably be obtained by premixing the gas and air in the theoretically correct proportions and then burning them at the nozzle, as shown in Fig. 149. Under proper conditions, temperatures up to 1850°C (about 3360°F) can be obtained without preheating. The high temperature is due to the fact that the gas and air are intimately mixed before combustion and that the combustion itself occurs extremely rapidly in a very small volume.

Small Round Kiln for Shrinkage Tests, etc. Figure 150 shows a furnace that is very convenient for heating small specimens. By placing the specimens in open saggars, a very even temperature is attained because of the complete circulation of the gases around the specimens. The use of premixed air and gas gives temperatures up to 1800°C (about 3270°F).

High-temperature Catenary Kiln. In Fig. 151 is shown a small kiln that has proved very successful in firing refractory specimens up to 1850°C (about 3360°F) with city gas and no preheat. Excellent results

The greatest disadvantage is the special apparatus that must be used for compressing the gas.

Perhaps the most common types of gas burners used in laboratory kilns are the ones to which the air is supplied under pressures of from 2 to 12 psi. The gas and air are mixed at the nozzle somewhat as shown in

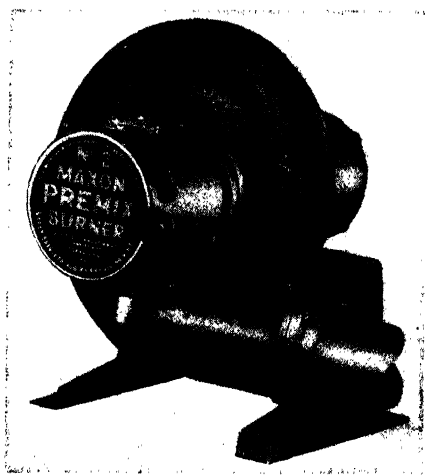

FIG. 149. A gas burner in which the air and gas are premixed and then burned at the nozzle. (Courtesy of the Maxon Premix Burner Company.)

were obtained with a lining of pure, fused alumina bricks insulated with kaolin insulating firebrick. The insulation is omitted for a short distance at the door end of the arch, both to keep this spot from overheating and to equalize the temperature over the whole kiln. When firing, the temperature is brought up to about 1500°C (about 2700°F) overnight with a

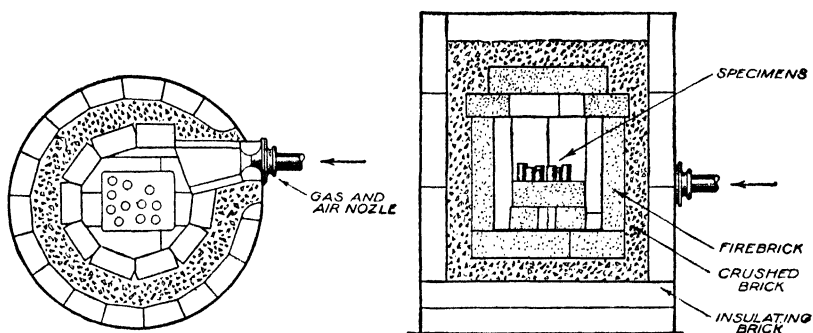

FIG. 150. A gas furnace for temperatures up to 1800°C .

blow pipe, the premix is started in the morning, and 1800°C (about 3270°F) reached in 5 hr.

Large Laboratory Kiln. Shown in Fig. 152 is a drawing of a laboratory kiln of sufficient size to burn 100 to 500 standard-size bricks. This size of kiln is very convenient for making burns on experimental bricks or special shapes, where the schedule is different from that of the production kilns. The kiln can be fired by either gas or oil, and temperatures up to 1750°C (about 3180°F) can be obtained. The temperature distribution

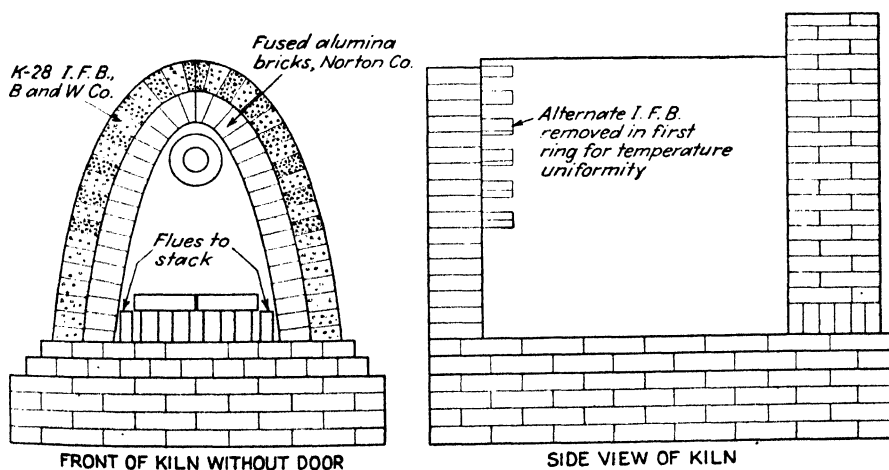

FIG. 151. High-temperature catenary kiln for the laboratory.

can be made quite uniform by varying the floor openings. It will be noted that the elimination of the side walls on this kiln greatly simplifies the construction and makes it unnecessary to use much ironwork.

Oxygen-propane Furnace. The furnace shown in Fig. 153 is used for firing special refractories up to 2000°C (about 3630°F) with a lining of

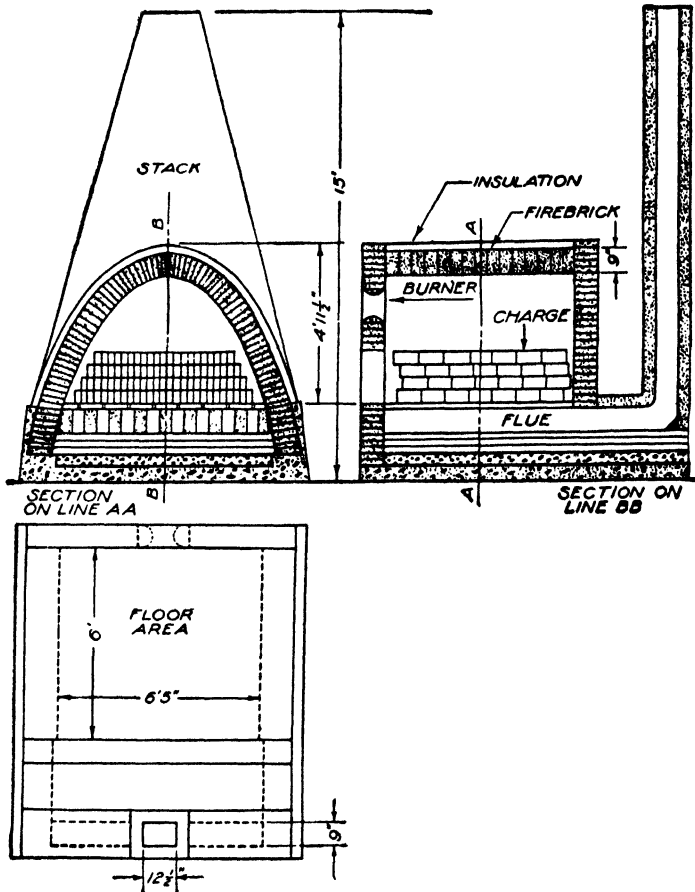

FIG. 152. A laboratory kiln for burning 100 to 500 bricks.

pure fused alumina bricks, which stand up well although there is some melting on the inner surface of the bricks at the highest temperatures. While this furnace is more expensive to run than gas and air furnaces, it reaches high temperatures rapidly and the gas velocity in the furnace is not very high. The temperature uniformity in the furnace is not perfect, and therefore specimens should not be placed in line with the burners. With the use of a zirconia lining, still higher temperatures are possible.⁽⁴⁾

2. Electric Resistance Furnaces. *Global Kiln.* The kiln shown in Fig. 154 is excellent for firing up to 1500°C (about 2730°F), as the temperature and atmosphere can be positively controlled. Also the uniformity of temperature is excellent, as there is a circulation of the gases up around the heating elements and down through the ware. This kiln may be made up in various sizes but a suitable variable voltage power supply is needed. Kilns of this type may be purchased on the market.

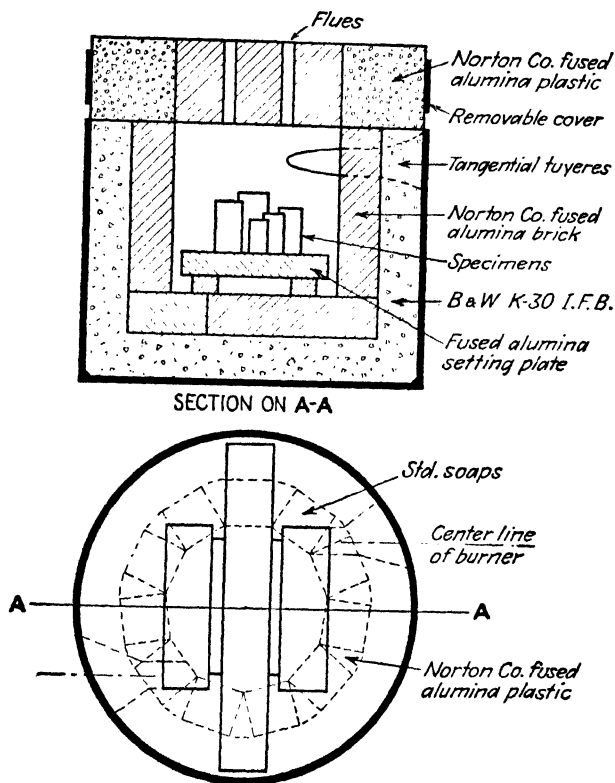

Fig. 153. A small oxygen-propane furnace.

Carbon Tube Furnace. This furnace has been much used in high-temperature research; but as it is rapidly being superseded by high-frequency induction furnaces, it need not be discussed further.

Oxide Resistor Furnace. This furnace developed at the National Bureau of Standards⁽⁹⁾ using resistors of the Nernst type is capable of reaching 2000°C (about 3630°F). This is the only high-temperature electric furnace capable of providing an oxidizing firing, and therefore is valuable for research in spite of its high cost.

3. Arc Furnaces. For extremely high temperatures the arc furnace has been used. The high temperature is concentrated into a small volume of ionized gas heated by the current passing through it; therefore it is difficult to obtain a uniform temperature over a reasonably large volume for research purposes.

4. Solar Furnaces. This type of furnace^(5,6) produces very high temperatures of 3000°C (about 5430°F) by focusing the image of the sun onto a specimen. Some of the melting points of the more refractory substances have been determined in this way, as quick heating and freedom from contaminating gases are achieved. However, the operation is completely dependent on the weather.

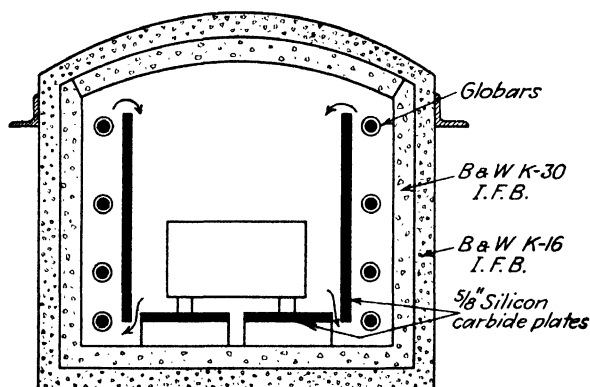

FIG. 154. (Globar kiln.)

5. High-frequency Induction Heating. *Introduction.* It is believed that high-frequency induction heating will be the principal tool of high-temperature research in the future; therefore considerable space will be devoted to this subject.

In 1831, Michael Faraday described an experiment in which two coils of wire were wound on an iron ring, thus making the first transformer on record. This experiment was the first realization of the phenomenon of electromagnetic induction. Shortly after 1850, a large number of patents were issued, both in the United States and abroad, covering high-frequency apparatus for the heating of metals. General interest and the use at that time were for melting, wherein a conducting crucible was heated by induction and the heat of the crucible was transmitted to the charge by radiation and conduction. Today, this same principle, in conjunction with various modifications, is finding wide application in the refractory research field due to the ease in obtaining extremely high temperatures in various atmospheric conditions. Because there seems to be a real lack of specific information to guide the research worker in designing

equipment for extreme temperature levels, the following section gives the general principles as well as four practical designs.

Prior to the entry of the United States into the Second World War, a large part of all high-frequency heating in the refractory research and other fields was accomplished with experimental or custom-built high-frequency generators. However, the requirements of diversified experimentation and production opened new market possibilities, until now there is available a wide range of high-frequency heating equipment in standard commercial models. Practically all these models are applicable, in one way or another, to the refractory research field. In addition, custom-built units are available from nearly all manufacturers of standard models to meet special requirements.

The application of high-frequency heating in the refractory research field divides into two distinct groups: (1) induction heating units for the direct heating of electrically conductive materials (susceptors) and (2) dielectric heating units for the direct heating of electrically nonconductive materials. Since few data are available regarding the dielectric heating of refractory materials to high temperatures, we shall not consider this method in the following discussion. On the other hand, a considerable amount of data is available in regard to the induction heating of susceptors, which, in turn, are used to heat enclosed refractory materials to high temperatures through thermal radiation and conduction phenomena. Applications of this method will be our only concern here.

Principles of Induction Heating. We are interested fundamentally in raising the temperature of the susceptor by transformation of electromagnetic energy to heat energy. The only requirement that a material must have in order that it be capable of responding to induction energy and thereby become heated is that it be an electrical conductor. Materials with properties suitable for susceptors in high-temperature work are listed in Table 48, and reaction temperatures in Table 49. It should be noted that many materials such as glass conduct electricity at elevated temperatures. If, for instance, glass is brought up to an elevated temperature by conventional means, further increase in temperature can be obtained by high-frequency induction-heating methods. The same may hold for some oxide mixtures such as 80 per cent ThO_2 , 10 per cent Y_2O_3 , 10 per cent ZrO_2 ; 90 per cent ThO_2 , 10 per cent Y_2O_3 ; and 85 per cent ZrO_2 , 15 per cent Y_2O_3 , which are good conductors at high temperatures.⁽¹⁰⁾ However, the problem of raising them to a conducting temperature has not been worked out but would be of great importance in providing a means for high-temperature heating in air.

An induction heating circuit is fundamentally a transformer wherein an inductor carrying the high-frequency alternating current from the

generator is the primary and the susceptor to be heated is made the secondary by merely placing it within the confines of the inductor, there being no physical contact between the two. The current flowing through the inductor sets up magnetic lines of force in a circular pattern, which

TABLE 48. PROPERTIES OF SUSCEPTOR MATERIALS

| Material | Symbol | Melting point., °C | Elec. res., micro ohms per cm | Vapor pressure, mm Hg | Rate of volatilization, g per sq cm per sec |
|-------------------|--------|--------------------|-------------------------------|---|--|
| Carbon (graphite) | C | 3500 | 1,000 | 10^{-2} at 3000°C ⁽²²⁾ | |
| Molybdenum | Mo | 2620 | 5.7 | 10^{-2} at 2300°C ⁽²²⁾ 6.43×10^{-9} at 1800°C ⁽²²⁾ 3.96×10^{-6} at 2200°C ⁽²²⁾ 1.60×10^{-2} at 2600°C ⁽²²⁾ | 8.63×10^{-11} at 1800°C ⁽²²⁾ 4.80×10^{-7} at 2200°C ⁽²²⁾ 1.79×10^{-4} at 2600°C ⁽²²⁾ |
| Platinum | Pt | 1774 | 9.83 | Below 10^{-4} at 1700°C ⁽²²⁾ | |
| Tantalum | Ta | 2850 | 15.5 | Between W and Mo, near W ⁴ | |
| Tungsten | W | 3370 | 5.51 | 6.45×10^{-12} at 2000°C ⁽²²⁾ 4.92×10^{-8} at 2400°C ⁽²²⁾ 2.86×10^{-5} at 2800°C ⁽²²⁾ 3.33×10^{-3} at 3200°C ⁽²²⁾ | 1.14×10^{-11} at 2000°C ⁽²²⁾ 7.98×10^{-10} at 2400°C ⁽²²⁾ 4.29×10^{-7} at 2800°C ⁽²²⁾ 4.67×10^{-5} at 3200°C ⁽²²⁾ |
| Columbium* | Cb | 1950 | 20 | | |
| Iridium* | Ir | 2350 | 6.08 | | |
| Osmium* | Os | 2700 | 9 | | |
| Rhenium* | Re | 3000 | 21 | | |
| Rhodium* | Rh | 1985 | 4.93 | | |
| Titanium* | Ti | 1800 | 3 | | |
| Vanadium* | V | 1710 | 26 | | |
| Zirconium* | Zr | 1900 | 41 | | |
| Carbides† | | | | | |
| Nitrides† | | | | | |
| Sulfides† | | | | | |

* For possible future use.

† Few data available.

TABLE 49. REACTION TEMPERATURES IN DEGREES CENTIGRADE FOR SOME PURE MATERIALS IN A VACUUM*

| | W | Mo | MgO | BeO | ThO ₂ | ZrO ₂ | C |
|------------------|------|------|------|------|------------------|------------------|---|
| W | | | | | | | |
| Mo | 2300 | | | | | | |
| MgO | 2000 | 1800 | | | | | |
| BeO | 2100 | 1900 | 1800 | | | | |
| ThO ₂ | 2300 | 2200 | 2150 | 2150 | | | |
| ZrO ₂ | 2100 | 2150 | 1950 | 2000 | 2200 | | |
| C | 1500 | 1600 | 1800 | 2300 | 1950 | 1800 | |

* From Doctor's Thesis by P.D. Johnson, Massachusetts Institute of Technology, 1948.

thread through the susceptor and induce eddy currents therein. Since the high-temperature susceptor materials mentioned are nonmagnetic, heating caused by hysteresis can be ignored, but the eddy-current phenomenon is of primary importance.

Eddy-current losses are resistance losses resulting from small circulating currents within the material. These currents are caused to flow by virtue of differences in potential at various points in the material, these differences in potential being caused by the alternating magnetic field threading through the susceptor. This loss, or heating effect, is proportional to the square of the current flowing and directly proportional to the electrical resistance of the susceptor. Hence, it can be considered to be proportional to the square of the frequency and the field strength, since the potential differences and resulting currents vary in accordance with this relation.

A characteristic of high-frequency heating is its tendency to concentrate energy on the surface of the susceptor. This phenomenon, called "skin effect," is a function of frequency. Other factors being equal, the higher the frequency the shallower will be the depth of penetration of the heat zone.

Close coupling between the inductor and susceptor is important and deserves due consideration. The curve in Fig. 155 shows the increase in over-all efficiency of the inductive combination as the coupling is varied

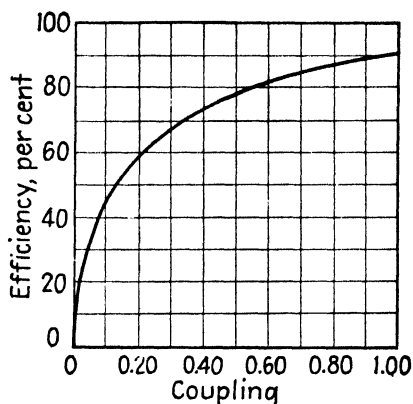

FIG. 155. Effect of coupling on heating efficiency.

from 0 to 1. A coupling of 0 means that the diameter of the inductor is infinitely greater than the diameter of the susceptor; the coupling of 1 (theoretical) means that the inductor is wound tight on the susceptor. In addition, the coupling should be made as close as possible because of the economic advantage of obtaining the highest possible power factor as measured at the inductor terminals. The higher the power factor the less the cost of correcting it with static condensers to give the desired unity power factor at the generator terminals.

Inductors are generally made of high-conductivity copper tubing. The inductor may be made of a single turn of copper or more, depending upon the size and shape of the susceptor and the inductive balance needed to obtain efficiency for the specific purposes. Vaughan and Williamson⁽¹⁴⁾ have worked out many useful data pertaining to the design of inductors for use with nonmagnetic susceptors. We have found that units designed

by means of their equations have final characteristics very close to the desired values, and it is recommended that their work be followed closely in any new design.

High-frequency Generators for Induction Heating. Four different types of equipment are in common use: (1) rotating machines (see Fig. 156A) producing frequencies of 1 to 10 kc per sec and power outputs of 7.5 to 1,500 kw, (2) mercury-arc frequency converters (see Fig. 156B) producing frequencies of 0.50 to 80 kc per sec and power outputs of 2 to 600 kw, (3) spark-gap converters (see Fig. 156C) producing frequencies of 100 to 500 kc per sec and power outputs of 2.8 to 500 kw, and (4) vacuum-tube oscillators (see Fig. 156D) producing frequencies of 100 to 915,000 kc per sec and power outputs of 0.6 to 200 kw. Unfortunately, available technical data on commercial units cannot always be correlated on a comparable basis.

No single rule can be applied to determine which of the various commercial-model high-frequency generators may be suitable for a specific purpose. In general, it may be said that the rotating-machine types offer comparatively good power regulation in the low range independent of the maximum power output rating of the machine. For this reason this type is very good for slow heating, which is advisable with low-thermal-conductivity materials such as refractories. For heating small, thin susceptors, the vacuum-tube types are sometimes preferred. Much can be said about the simplicity of design and low maintenance of the mercury-arc and spark-gap types. Usually direct consultation with any of the manufacturers listed in Table 50 or others, outlining specifically the problems to be met by the generating equipment, is advisable to assure that the costs be kept to a minimum and that the installation operates satisfactorily.

Specific Applications. In review, the methods used in heating refractory materials by means of high-frequency generators employ high-melting-point, electrical-conducting materials as susceptors. In all cases, the susceptor is made to surround the refractory body to be fired. The choice of a generator having the proper characteristics will afford the particular rate and efficiency of heating of the susceptor.

Since some refractories and most susceptor materials react with air at elevated temperatures, firing in high vacuum or special atmospheres usually becomes necessary. These methods along with the ordinary air firing are discussed in detail below.

Furnace for Firing at Atmospheric Pressure. Graphite is used for the susceptor in this furnace. Usually a strong reducing atmosphere is present, but various gases such as nitrogen, hydrogen, helium, and argon can be continuously flushed through the system to vary the conditions. Temperatures up to 3000°C (about 5430°F) have been reached without undue

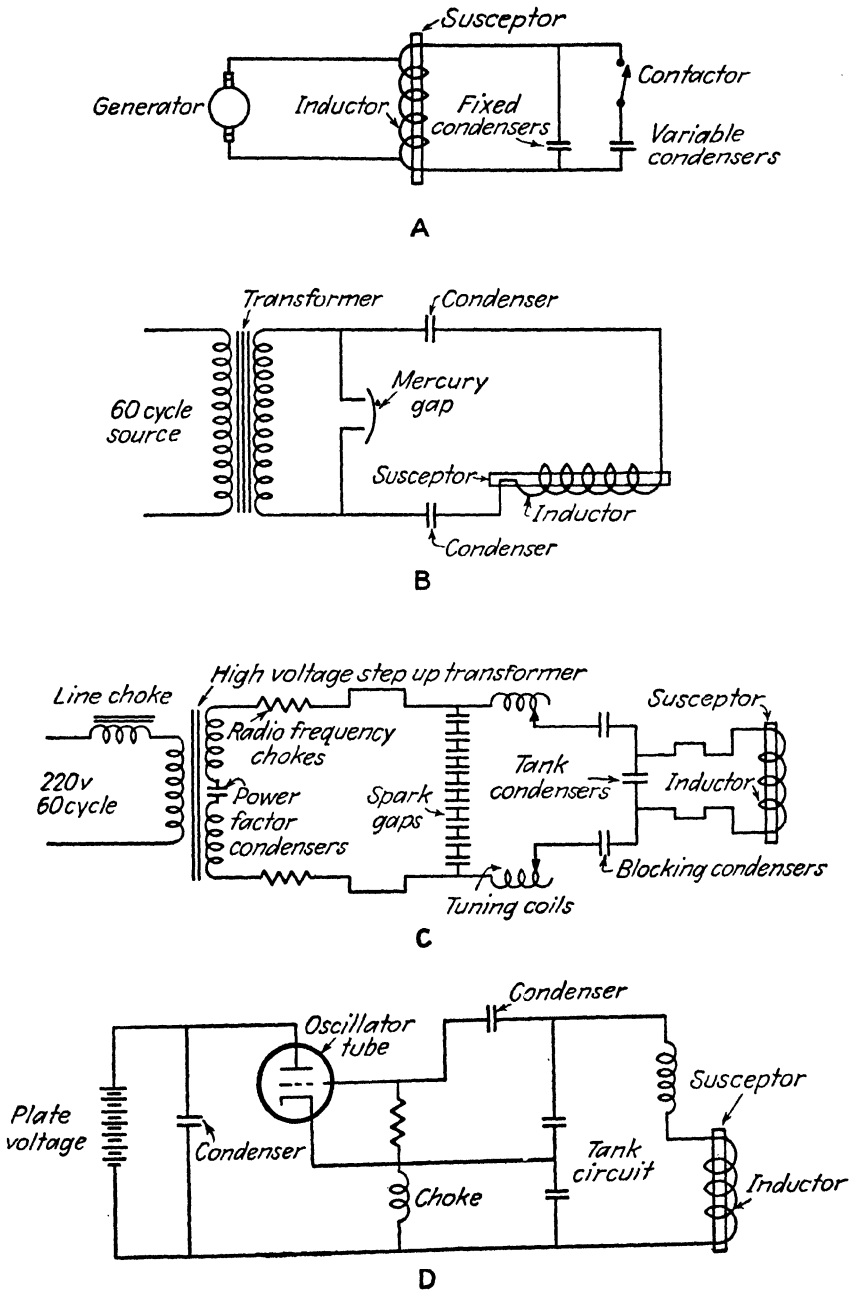

FIG. 156. The four principal types of high-frequency generators.

difficulty. In order to fire refractories in this system, care must be taken to prevent reaction of the graphite with the refractory material in question. Under ordinary conditions graphite will react with various refractories at the temperatures shown in Table 49. The temperatures are not too precise but may be used as helpful guides.

TABLE 50. COMMERCIALY AVAILABLE HIGH-FREQUENCY GENERATORS FOR INDUCTION HEATING (1948)

| Manufacturer | Type of generator | Power output range, kw | Frequency range, kc |
|---|--|--------------------------------|--------------------------------|
| Ajax Electrothermic Corp., Trenton, N.J..... | { Mercury arc Rotating machine | 2-30 50-1,200 | 10-80 1-10 |
| Allis-Chalmers Mfg. Co., Mil- waukee, Wis..... | { Mercury arc Vacuum tube | 300-600 20-100 | 0.5-1.5 400-500 |
| Budd Induction Heating Corp., Detroit, Michigan..... | { Vacuum tube Rotating machine | 20 50-900 | 500 3-10 |
| Ecco High Frequency Corp., North Bergen, N.J..... | { Spark gap Vacuum tube Rotating machine | About 3-30 5-50 20-1,250 | 100-500 100-30,000 3-9.6 |
| General Electric Corp., Schen- ectady, N.Y..... | Vacuum tube | 5-50 | 530-915,000 |
| Illinois Tool Works, Chicago, Ill. | Vacuum tube | 0.5-50 | 2,000-6,650 |
| Induction Heating Corp., New York, N.Y..... | Vacuum tube | 5-25 | 375-20,000 |
| Lepel High Frequency Labora- tories, New York, N.Y..... | { Spark gap Vacuum tube | 2.8-21 1 | 150-400 400 |
| Ohio Crankshaft Co., Tocco Di- vision, Cleveland, Ohio..... | { Rotating machine Vacuum tube | 7.5-200 0.75-20 | 3-9.6 450-3,000 |
| Radio Corp. of America, RCA Victor Division, Camden, N.J. | Vacuum tube | 1-75 | 400 |
| Scientific Electric Div. of "S" Corrugated Quenched Gap Co., Garfield, N.J..... | Vacuum tube | 0.6-150 | 200-1,500 |
| Westinghouse Electric Corp., East Pittsburgh, Pa..... | { Vacuum tube Rotating machine | 5-200 20-1,500 | 200-400 0.96-10 |

Since the reaction temperature and rate of reaction between the graphite and the refractory material are a function of degree of contact, many ingenious methods have been devised to obtain higher firing temperatures than are shown in Table 49. For instance, coarse refractory grog can be placed between the graphite and the refractory body to decrease the degree

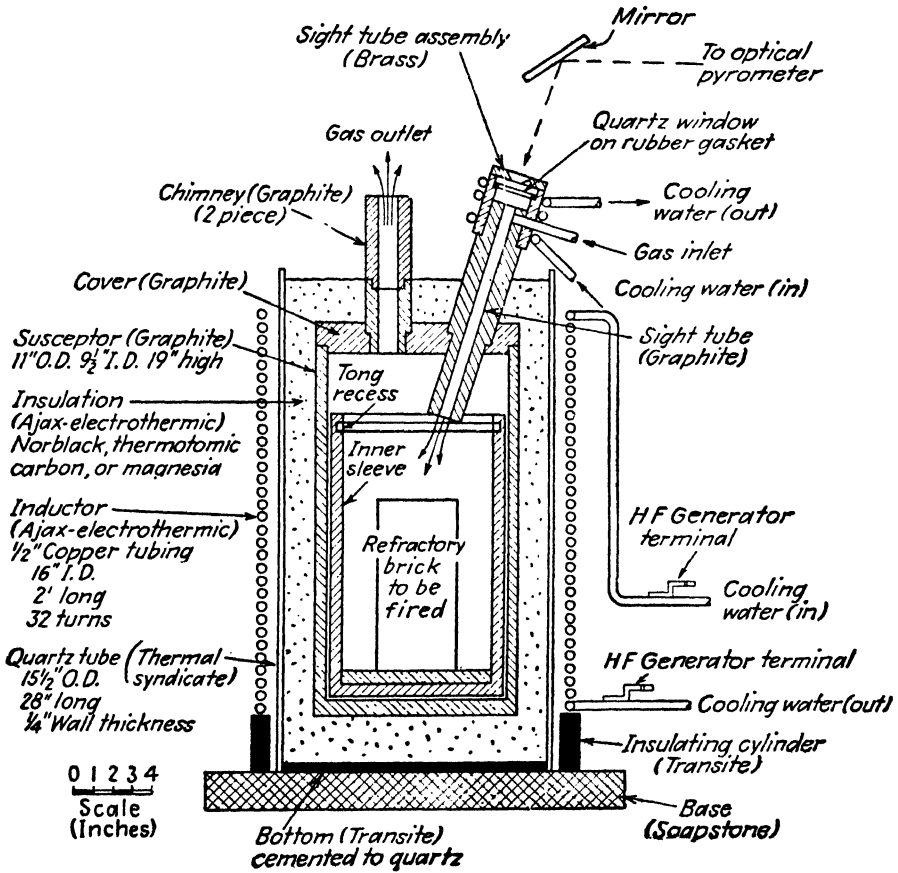

Fig. 157. High-frequency furnace for firing at atmospheric pressure.

of contact. In some instances, (one or more) plates made of the refractory body material or dissimilar materials can be used to separate the graphite from the refractory body; the plate or plates, in many cases, will react but will not affect the refractory body if the time at temperature is not excessive. As can be seen from Fig. 157 the furnace construction is simple. The major components are as follows:

High-frequency generator (Ajax Electrothermic Corp.) 30 kw output, mercury-arc type

Inductor, 16 in. i.d., 24 in. long, 32 turns (standard design, Ajax Electrothermic Corp.)

Silica tube, 15 in. o.d., 14 in. i.d., 28 in. long (Thermal Syndicate); a transite disk may be cemented to the bottom of the tube to retain the finely divided carbon

Insulation, Therm-atomic carbon or Norblack (Ajax Electrothermic Corp.); any other finely divided carbon material or magnesia could be used
Susceptor, graphite (National Carbon Co.)

Sight tube fitting, brass, custom built

Inner sleeve, graphite (National Carbon Co.)

The graphite parts are easily machined from the commercially available bars or billets. The chimney can be made in two parts as shown; the joint should be coated with finely divided carbon to reduce the heat loss due to thermal conductivity, and this can be also done in the case of the graphite sight tube. The water-cooled sight tube head is of simple construction, and a small flow of helium or nitrogen will clear the sight tube of fumes, and hence, accurate optical pyrometer measurements can be obtained. The inner furnace sleeve is removable by means of the tong groove shown, and the finely divided carbon can be extracted by means of a vacuum cleaner.

Table 51 lists data obtained in a typical firing for a standard-size refractory brick to be heated to 2000°C (about 3630°F) in 180 min and held at 2000°C (about 3630°F) for 30 min.

TABLE 51. FIRING CYCLE IN ATMOSPHERIC-TYPE FURNACE

| Time, min | Output of generator, kw | Temperature, °C |
|-------------|-------------------------|-----------------|
| 0 | 13 | |
| 30 | 13 | |
| 60 | 27 | |
| 90 | 27 | 975 |
| 120 | 27 | 1350 |
| 150 | 27 | 1700 |
| 180 | 27 | 2000 |
| 210 | 18 | 2000 |
| Furnace off | | |

Vacuum-firing Systems: General. As was mentioned previously, it may be deemed desirable to fire refractory bodies in high vacuum or controlled atmospheres. In the majority of instances, due to the affinity of the susceptor materials toward oxygen and other gases at elevated

temperatures, the use of high-vacuum or controlled-atmosphere techniques is an absolute necessity.

It has been found that closed systems designed for high-temperature vacuum-firing can readily be used for heating refractory bodies to high temperatures in other gaseous atmospheres at pressures below 1 atm. The following discussion will therefore be limited to the understanding of some of the general design principles utilized in building high-temperature vacuum-firing systems. Three types of such equipment have been found useful and will be described in detail. All types afford vacuums better than 10^{-5} mm Hg if designed and handled properly. In designing any one of these systems, care must be taken to choose not only the most efficient high-frequency generator and allied components but also the proper fore pump, diffusion pump, valves, duct sizes, gages, and other equipment.

In general, a high-vacuum system is a sealed system in which the firing or vacuum chamber is connected by ducts to a diffusion pump in series with a mechanical fore pump. A large portion of the molecules of gas (usually air) in the firing chamber are sucked out of the system by means of the mechanical fore pump. The mechanical fore pump is usually capable of holding a vacuum pressure of 0.10 mm of Hg. In order to obtain a higher vacuum and faster pumping rate, a diffusion pump is placed between the firing chamber and the fore pump. A good percentage of the remaining molecules are literally dragged out of the firing chamber owing to the operating principle of the diffusion pump. Operating principles concerning diffusion pumps are discussed in detail by Strong.⁽¹⁷⁾ The molecules in all cases are exhausted from the fore pump to the atmosphere.

Under ordinary atmospheric conditions (760 mm Hg, 20°C) 1 cc of gas contains about 2.5×10^{19} molecules. If this volume is evacuated to 10^{-6} mm Hg, only 3.3×10^{10} molecules remain. As may be seen from the above figures, all but 1/1,000,000,000 of the original number of molecules are absent. The following may further clarify the concept of high vacuum.

The mean free path of a molecule is the average distance traveled by the molecule before collision by another and may be expressed for a single gas by the following equation:

$$\lambda = \frac{1}{\sqrt{2} \pi n d^2}$$

where λ = the mean free path, cm

n = the number of molecules per cc

d = the molecular diameter, cm

Since the molecular diameter of nitrogen is 3.1×10^{-8} cm, the mean

free paths (at 0°C, found from the above equation) at various pressures are shown in Table 52.

TABLE 52. MEAN FREE PATH OF NITROGEN GAS MOLECULES FOR AMBIENT PRESSURES

| Pressure, mm Hg | Mean Free Path, Cm |
|-----------------|----------------------|
| 760 | 8.5×10^{-6} |
| 1 | 0.0065 |
| 10^{-3} | 6.5 |
| 10^{-4} | 65 |
| 10^{-5} | 650 |
| 10^{-6} | 6500 |
| 10^{-9} | 6,500,000 |

A better understanding of the physical properties of gases may be obtained from the following equations:

$$n = 0.49 \rho v_{av} \lambda$$

$$k = \eta C_v \epsilon$$

where n = the viscosity coefficient, g/sec/cm

k = the thermal conductivity, cal/sec/cm/°C

ρ = the gas density, g/cc

c_v = the heat capacity at constant volume of 1g of gas

ϵ = a constant, 2.5 for monatomic gases, and 1.9 for diatomic gases

$v_{av} = (2.1 \times 10^8 T) / M$ cm/sec = average velocity of the molecules where T is the absolute temperature and M the molecular weight of the gas

It has been found experimentally, somewhat contrary to and therefore limiting the use of the previous equations, that viscosity n decreases quite appreciably at pressures below 0.10 mm, and the thermal conductivity k of a gas essentially disappears below 10^{-4} mm.

Table 53 compares the molecular diameters, viscosity, and thermal conductivity coefficients for five gases commonly used at standard temperature and pressure.

TABLE 53. PHYSICAL PROPERTIES OF VARIOUS GASES

| Gas | Molecular diameter d , cm | Coefficient of viscosity n , g per sec per cm | Thermal conductivity k , cal per sec per cm °C |
|-------------|-----------------------------|---|--|
| Hydrogen... | 2.47×10^{-8} | 86×10^{-6} | 318×10^{-6} |
| Nitrogen... | 3.50×10^{-8} | 166×10^{-6} | 52×10^{-6} |
| Oxygen.... | 3.39×10^{-8} | 187×10^{-6} | 56×10^{-6} |
| Helium.... | 2.18×10^{-8} | 189×10^{-6} | 339×10^{-6} |
| Argon..... | 3.36×10^{-8} | 210×10^{-6} | 39×10^{-6} |

Mechanical Pumps. The ordinary single-stage or compound reciprocating type of mechanical pumps are extremely efficient units at atmospheric pressures but are of little value by themselves if high vacuums are required. Vane-type rotary pumps have been used successfully at pressures below 10 mm Hg, but with appreciable loss in efficiency. Better vacuums can be obtained by using a diffusion pump in series with the reciprocating- or vane-type rotary pumps. On the other hand, eccentric cylinder-type precision high-vacuum pumps, available in single-stage and compound types, maintain their pumping efficiency well below 1 mm Hg. As can be seen from the curve in Fig. 158A high pumping speed is not retained at the lower pressure regions. An excellent description of these pumps is given by Sullivan.^(21a)

Diffusion Pumps. By placing a mercury or oil diffusion pump in series with a mechanical pump not only are larger effective pumping speeds made possible (even at high pressures), as shown in Fig. 158B, but ultimate pressures of 10^{-7} mm or better can be obtained, providing a cold trap is employed to reduce the effective partial pressure of the mercury or the oil.

Pumping speeds for ideal diffusion pumps may be roughly calculated from the following equation:

$$\frac{dv}{dt} = A \sqrt{1.32 \times 10^7 \frac{T}{M}} \text{ cc/sec}$$

where dv/dt = the volume of gas escaping through the area of aperture A , per unit of time

A = the area of aperture

M = the molecular weight of gas = 29 for air at room temperature ($T = 300^\circ\text{K}$)

Therefore the value of dv/dt at room temperature is

$$11,700 \text{ cc/sec} = 11.7 \text{ liters/sec for an aperture of unit area } A$$

Since area A should be considered a hypothetical aperture unit area and if a perfect vacuum is obtained in the chamber, then a perfect pump would have a speed of 11.7 liters per sec. The speed of a diffusion pump is expressed as the volume of gas passing through the throat of the pump at the pressure measured at the throat. The speed factor of a pump is

$$\frac{\text{Speed per unit area of throat}}{11.7 \text{ liters/sec}}$$

Oil diffusion pump values approaching 0.6 have been obtained. On the other hand, mercury pump speed factors are relatively lower, approaching 0.3 generally. The use of mercury as a boiler fluid in the diffusion pump in all cases necessitates the use of a cold trap in the system owing to the

high vapor pressure of the mercury. This is discussed by Blears and Hill.^(21b)

A fore pressure of less than 0.50 mm Hg created by the mechanical pump is usually required for efficient operation of the diffusion pump. The

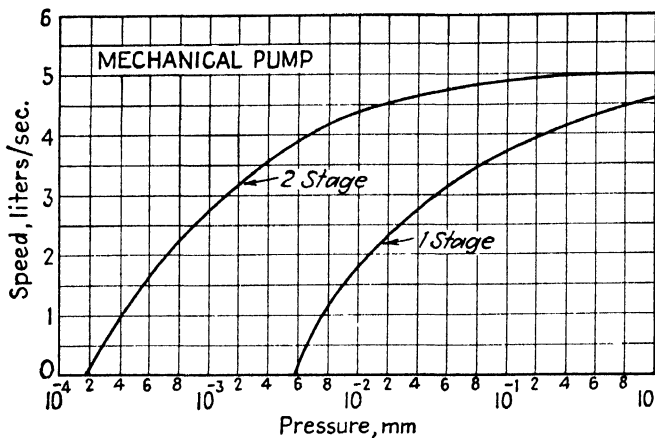

(A)

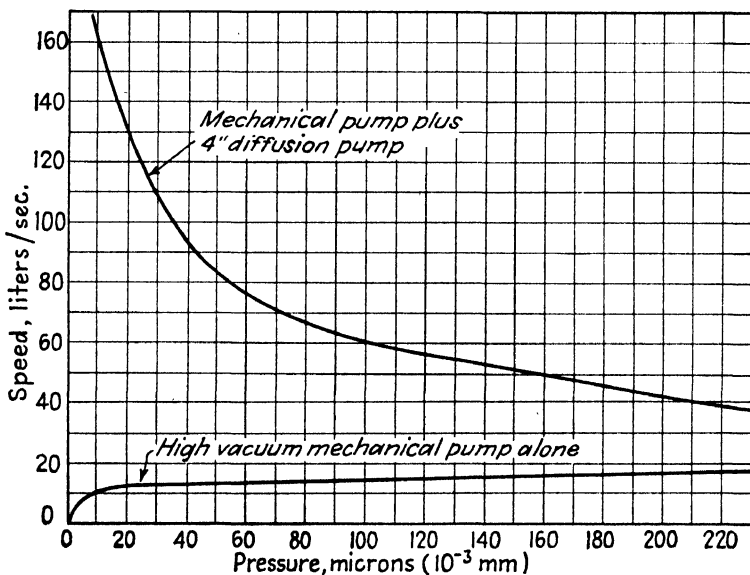

(B)

FIG. 158. Mechanical and diffusion pump characteristics.

curve in Fig. 158B shows the effect of adding a diffusion pump in series with a mechanical pump for evacuating a closed system. The maximum pressure in the fore line against which a pump will maintain its speed is important in

most applications. While this is primarily a function of pump design, it is also dependent on the type of oil used and the amount of heat actually delivered to the oil. The trend between various boiler fluids used in diffusion pumps is for the higher vapor pressure oils to work against the higher fore pressure.

Stability of pump oils can be considered as stability against oxidation when hot and resistance to thermal dissociation in the diffusion pump boilers caused by excessive intensity of heating at the heater and boiler fluid interface. The resistance to oxidation is very high in the case of the silicones and at least equal to that for the chlorinated hydrocarbons. This resistance is, in fact, sufficiently high to make possible distillation at atmospheric pressure as a means for reconditioning the oil.

TABLE 54. RELATIVE MERIT OF DIFFUSION PUMP BOILER FLUIDS⁽²⁰⁾
1 Being Best

| Type oil | With liquid air trap, all pressures | Without cold trap | | Pump fore pressure requirements | Stability to air | Stability to heat |
|---|-------------------------------------|---------------------------------|------------------------------|---------------------------------|------------------|-------------------|
| | | Greater than 5×10^{-6} | Less than 5×10^{-5} | | | |
| Silicone (high boiling). | 3 | 2 | 1 | 3 | 2 | 2 |
| Typical ester. | 3 | 2 | 2 | 3 | 4 | 3 |
| Straight hydrocarbon. | 3 | 2 | 2 | 3 | 3 | 2 |
| Chlorinated aromatic hydrocarbon. | 2 | 1 | 3 | 2 | 2 | 2 |
| Mercury. | 1 | | | 1 | 1 | 1 |

Selection of the best oil for a particular application must be made carefully. Where extremely high vacua are required, silicones give the best performance because their boiling points can be adjusted as required and consequently low vapor pressure can be secured. In addition, the stability remains excellent. In the range of intermediate vacua created by diffusion pumps, all the oils are reasonably satisfactory. Where good speed and exceptional fore-pressure characteristics are required at a sacrifice in ultimate vacuum, the higher vapor pressure compounds remain superior. Table 54 offers an estimate of the relative merits of various oils as applied to vacuum-pumping conditions normally encountered. Listing is in order of apparent merit, 1 being best. No exact values are given because of the uncertainty in the absolute meaning.

Duct Design. No matter how good the vacuum at the pump, it is evident that the pressure in the vacuum or firing chamber may be excessively high if the piping and connections are not designed to handle the flow of gas with an economically low pressure loss due to friction. Flow

of gases at low pressures may be described as streamlined flow, slip flow, or molecular flow. Under conditions where the mean free path of the gas molecule is comparable to the diameter of the duct, the gas flow impedance, or "resistance," will vary linearly with the duct length and inversely as the cube of the diameter of the duct. It is desirable to avoid elbows or bends in the ducts; where necessary smooth bends as opposed to sharp bends tend to minimize frictional losses. At very high pressure, the flow of gas in a duct can be calculated by the conventional means. In the intermediate range of pressures (1 to 100 μ) a more complex relationship exists between pumping speed and pressure. Excellent data on the flow of gases in round ducts at low pressures are available from the work of Brown, DiNaido, Cheng, and Sherwood.⁽²¹⁾

Gages for Measurement of Low Pressure. Pressure is usually expressed in millimeters of mercury by the high-vacuum worker. A pressure of 1 mm thus corresponds to the pressure exerted by a column of mercury 1 mm in height. The term micron (μ) is sometimes used; 1 micron = 10^{-3} mm Hg. Table 55 should tend to establish the working limits of the various types of gages in use today.

TABLE 55. VACUUM GAGE TYPES⁽¹⁹⁾

| Type of gage | Useful range of pressure, mm Hg | |
|-----------------------------|---------------------------------|---------------|
| | Low limit | High limit |
| Mercury manometer | 1.0 | 760 and above |
| Oil manometer | 0.01 | 10 |
| McLeod gage | 10^{-5} | 10 |
| Pirani gage | 10^{-4} | 2.0 |
| Thermocouple gage | 10^{-4} | 2.0 |
| Viscosity gage | 10^{-5} | 10^{-3} |
| Knudsen gage | 10^{-5} | 10^{-3} |
| Ionization gage | 10^{-8} | 10^{-3} |

The conventional mercury U-tube manometer serves as an excellent instrument for the measurement of pressures in the millimeter range. By substituting low-vapor-pressure oils for mercury, a considerable increase in sensitivity can be achieved because of their lower inherent densities.

The McLeod gage has for many years been generally employed for the measurement of low pressures. With this instrument a known volume of gas, the pressure of which is to be measured, is compressed in a capillary tube, and the resulting pressure read in terms of a mercury column. Although such an instrument is not continuous reading, its calibration can be determined from its physical dimensions, and such an instrument thus serves as an excellent primary standard for the laboratory.

The Pirani and thermocouple type are the most useful for the reading of pressures in the micron range. Although both must be frequently recalibrated if the highest accuracy is required, instruments of this class give continuous readings and are physically rugged. The principle of operation in both cases involves the heating of a filament with an electric current. The change in thermal conductivity of the surrounding gas as a function of pressure can then be translated into electrical units in a variety of ways. In the case of the Pirani gage the resistance of the heated filament changes in accordance with the degree of cooling caused by the amount of pressure in the chamber, while the voltage developed by the thermocouple in the thermocouple gage depends on the amount of cooling experienced by the heated filament.

Although a number of ways have been devised for the measurement of the lowest pressures, the ionization gage (with the possible exception of the Knudsen) is the only one now found generally useful. This instrument is essentially a type of three-element radio tube. One of the electrodes serves as an anode, and the resulting electron stream creates positive ions. These ions migrate to the negatively charged "collector," and the resulting current serves as an indication of the pressure within the tube. Although some ionization tubes are capable of operating at pressures above 10^{-3} mm, their usefulness lies in the region below 10^{-5} mm, and even pressure approaching 10^{-9} mm can be determined.

Many problems are involved in the measurement of pressure other than the finding of an instrument capable of reading within the range of interest. A McLeod gage, for example, gives an indication of the pressure exerted by the *gases* in the system on the assumption that Boyle's law is valid at low pressures. Consequently, false readings will be obtained when easily condensable vapors are present. A Pirani, on the other hand, will read the total pressure of the *gases* plus all *volatile* constituents. In the determination of pressures in the region of 10^{-3} mm (and below) such questions as absorption and adsorption of gas and the position of the gage relative to the point in the system at which the pressure is desired must be also considered.

Glass, Vacuum, High-frequency Furnace. The all-glass system shown in Fig. 159 is by far the best for heating small refractory pieces in experimental work when vacua of 10^{-5} and better are desired. Temperatures exceeding 2600°C (about 4710°F) have been reported in this type of system in conjunction with a 10-kw thermonic vacuum-tube-type high-frequency generator. The firing chamber is usually made of clear quartz for high-temperature work, but Vycor or Pyrex glass can be substituted when long-continued runs at temperature are not required.

As can be seen in Fig. 159A, the top of the quartz firing chamber is sealed with a $\frac{1}{8}$ in. thick, optically flat, clear quartz plate through which

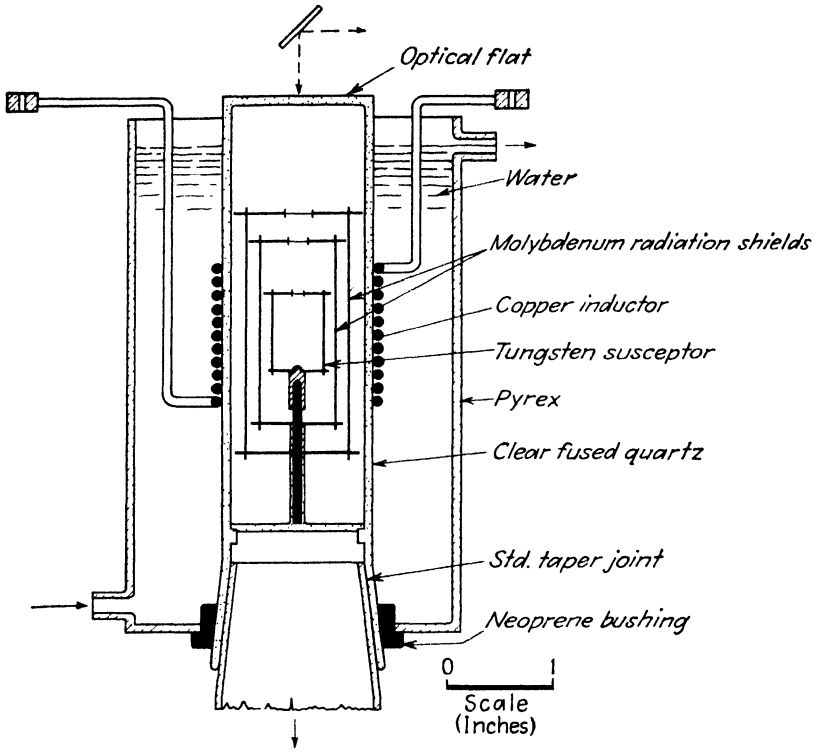

A- CROSS SECTION OF THE FURNACE

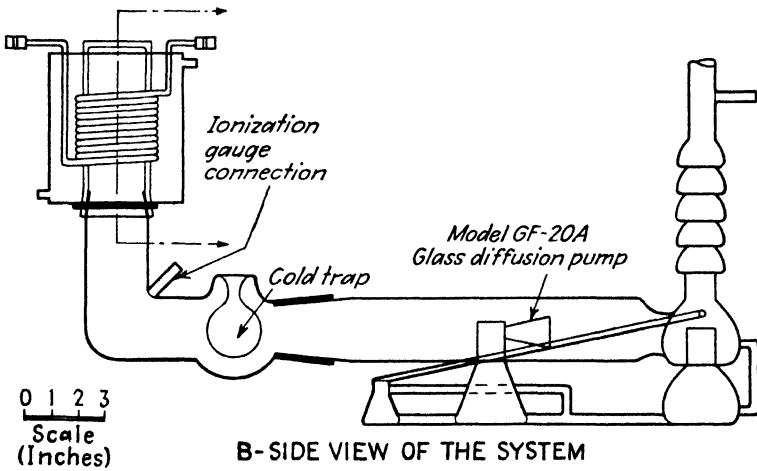

B- SIDE VIEW OF THE SYSTEM

FIG. 159. A glass, vacuum, high-frequency furnace.

optical pyrometer readings are readily obtained. A standard $4\frac{5}{50}$ standard taper full-length quartz joint is fused to the lower end of the firing chamber. A matching $4\frac{5}{50}$ standard taper full-length Pyrex joint (male) is fused to the ducting, which leads to a cold trap and glass diffusion pump. The cold trap is made of Pyrex and is used to condense the vapors coming from the firing chamber so that they will not contaminate the diffusion pump boiler fluid. If mercury is used for the diffusion pump fluid, the cold trap is absolutely necessary due to the high vapor pressure of mercury. In this system the two-stage diffusion pump, model GF-20A made by Distillation Products, Inc., Rochester, New York, uses 125 g of Octoil as the boiler fluid. The rated pumping speed of this pump is 20 liters per sec at 10^{-4} mm; the ultimate vacuum obtainable is 7×10^{-7} mm Hg.

The metal fore pump used to back the diffusion pump can be of any model capable of maintaining a fore pressure of 0.03 mm at a pumping speed of 0.5 liters per sec. If necessary, a smaller diffusion pump can be inserted between the main diffusion pump and the fore pump to guarantee the required fore pressure at the main diffusion pump.

The susceptor and reflectors are made of tungsten and molybdenum in this particular case, but other materials such as are mentioned in Table 48 can be substituted. It should be noted that the reflector must be extremely clean in order that the thermal radiation energy from the susceptor be reflected with highest efficiency. As may be seen from Fig. 159A the metal parts are supported on a molybdenum rod; this rod is, in turn, supported by a glass or quartz tripod mount. The entire assembly is supported on three concave shelves, which are fused to the quartz tube. The reflectors are not continuous cylinders, as might be thought from the drawing, but, on the other hand, are cut longitudinally to prevent their heating. Normally, a conducting cylinder in a changing magnetic field would be heated inductively; but since the flow of current is perpendicular to the lines of flux, a break in the circuit will prevent the eddy current heating from occurring. All reflectors used in induction heating, therefore, should be fabricated with radial or transverse cuts to prevent this flow of eddy currents. On the other hand if the frequency is too high even the cut shields will heat.

The inductor in this system is of unique design (suggested by Dr. L. S. Foster) in that it is made of solid copper wire and not hollow tubing as is used generally. The entire firing chamber including the inductor and quartz-Pyrex joint assembly is cooled by means of a water manifold made of glass as shown. It should be noted that all standard ground joints should be lubricated with silicone or other stopcock lubricant.

An ionization gage, inserted on the firing chamber side of the cold trap, is used to determine the pressures in the range between 10^{-3} and 10^{-7} mm

Hg. A mercury manometer is connected to the system at the position shown in order to ascertain roughly the over-all pressure in the system down to 1 mm Hg. Of course, other gages such as the oil manometer, McLeod, Pirani, or thermocouple types could be added to cover the complete pressure range if required.

The components are more easily disassembled and cleaned than with the all metal or glass-metal systems. The all-glass system also allows the observation of the interior of the vacuum chamber at all times. When small bodies are to be fired at high temperatures in various gaseous atmospheres, this system is also applicable.

Metal, Vacuum, High-frequency Furnace. The system shown in Fig. 160 was assembled and in part manufactured by the National Research Corp., Boston, Massachusetts, with design features as specified by the Watertown Arsenal Laboratories (J. L. Martin, W. H. Titorhook, and L. S. Foster); however, a similar system was developed previously by Prof. I. Amdur at the Massachusetts Institute of Technology. This system eliminates the vacuumtight silica tube, but there is a voltage limitation when the inductor is in a vacuum.

The power source for the inductor is a modified Tocco Junior, 20-kw motor generator set, type 20 STMC10B. The capacitors, originally located in the Tocco housing, were removed and remounted as close to the inductor as possible to reduce power losses sustained in lengthy inductor to condenser leads. It may be mentioned here that this modification could be applied to many of the standard induction generators available today to increase efficiency. The water-cooled inductor consists of 20 ft of $\frac{1}{4}$ -in. standard-weight copper tubing wound into a seven-turn coil, 6 in. i.d. and 8 in. long with leads about 26 in. long. The coil leads entered a chamber through gasketed seals in a Tur-X plate (International Products Corp., Baltimore, Maryland), which, in turn, is gasketed to the vacuum chamber. The vacuum system consists of a cylindrical stainless steel vacuum chamber that is exhausted by means of an oil diffusion pump backed up by a mechanical pump. By means of a butterfly valve and other vacuum-type valves, it is possible to isolate the diffusion pump from the system and to use the mechanical pump for roughing. When the pressure has been reduced to a sufficiently low value (200 μ), the diffusion pump is cut into the system by proper adjustment of the valves. It is thus possible to isolate the diffusion pump without shutting it off, and the chamber is opened to remove specimens.

The vacuum chamber is constructed of stainless steel, consisting of a double-walled, water-cooled cylinder and bottom closed on the top by a large, removable, stainless steel plate, which carries a similar smaller plate.

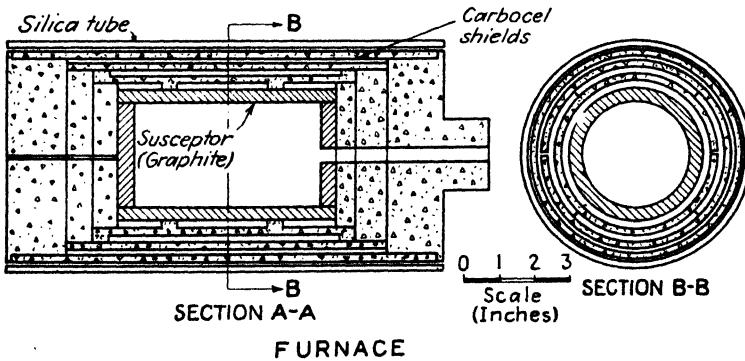
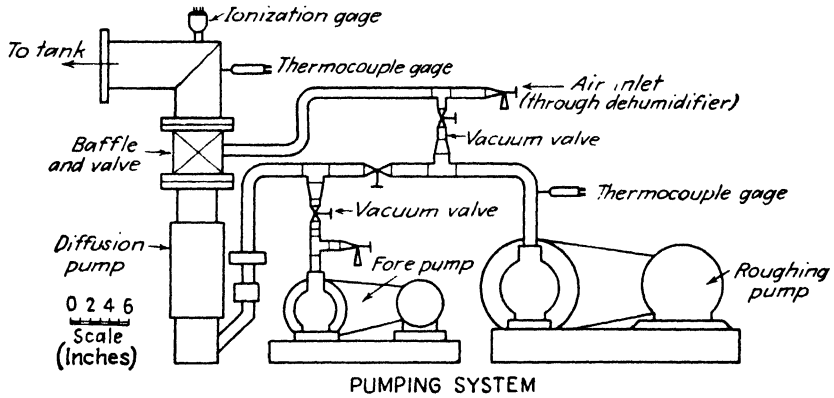
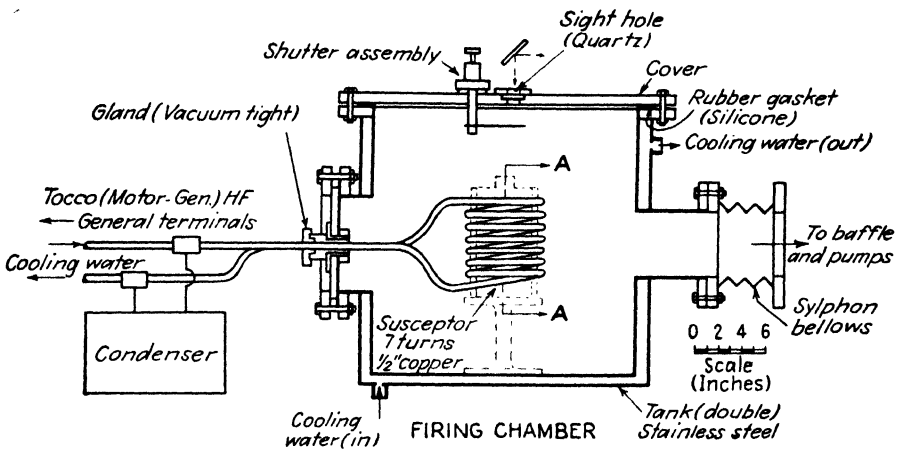

FIG. 160. Metal, vacuum high-frequency furnace.

The chamber is fitted with two diametrically opposed ports: one is used to introduce the inductor leads, and the other carries a flange and siphon bellows for attachment of the pumping system. Mountings are of a design that permit reorientation of the chamber about its axis so that the chamber can be used not only in the vertical position as shown in Fig. 160 but also horizontally.

The diffusion pump used was a type 104-H6 supplied by the National Research Corporation. This pump has a rated capacity of 1,250 cu ft per min at 2 to 0.5 μ pressure and uses the same manufacturer's "Narcoil No. 10."

The mechanical fore pump is a 25 cu ft per min capacity, size 778, type VSD, Kinney pump and is used in series with the diffusion pump. The pumping time required to obtain the necessary reduction of pressure to 200 μ is about 10 minutes. The National Research Corporation, type 706, thermocouple and ion gage control unit is used to measure vacuum system pressures. The vacuum manifold dry-air pressures are measured by means of a thermocouple gage and an ion gage, and the fore-pressure manifold dry-air pressures are measured by means of a single thermocouple gage. A Bourdon-type vacuum gage is used to indicate approximate pressures when gases such as helium are used to "crack" the vacuum.

The susceptor and its insulation are supported on a refractory table inside the vacuum chamber. The furnace is shown in Fig. 160. Section *BB* is cylindrical and consists of a silica tube, Carbolcel components, and graphite susceptor parts. The Carbolcel radiation shields are cut longitudinally to prevent heating by induction. A sight hole through the furnace end permits optical pyrometer readings to be made, while a shutter controlled by hand from the outside of the vacuum chamber prevents the quartz window from becoming cloudy owing to vapors condensed within the furnace.

Quartz-metal, Vacuum, High-frequency Furnace. Many systems of this type have been built. The particular system shown in Fig. 161 was built by P. D. Johnson in partial fulfillment of the thesis requirements at the Massachusetts Institute of Technology.

The quartz-metal vacuum-firing system furnace components were designed in the following way. A temperature of 2200°C (about 3990°F) was required for the heating of a cylindrical refractory body 6 in. high and 2 in. in diameter. The rate of heating had to be slow, owing to the poor thermal conductivity of the refractory material. A rotating type of high-frequency generator was chosen because of the excellent control characteristics at low power output afforded by this design. The following machine was used satisfactorily but, of course, was much larger than needed for this furnace: Tocco machine, Ohio Crankshaft Company, type

50PMG10B motor-generator set. Motor, 100 hp, 3 phase, 220 volt, 240 amp, 60 cycle; generator, 50 kw, 220 v, 228 amp, 9,600 cycle. Owing to the size of the refractory cylinder to be fired a susceptor of 2.5 in. diameter by 8 in. high was chosen. Because of the geometry established by the furnace and vacuum chamber, it was decided to use an inductor with a minimum inside diameter of 4.75 in. It was assumed that approximately

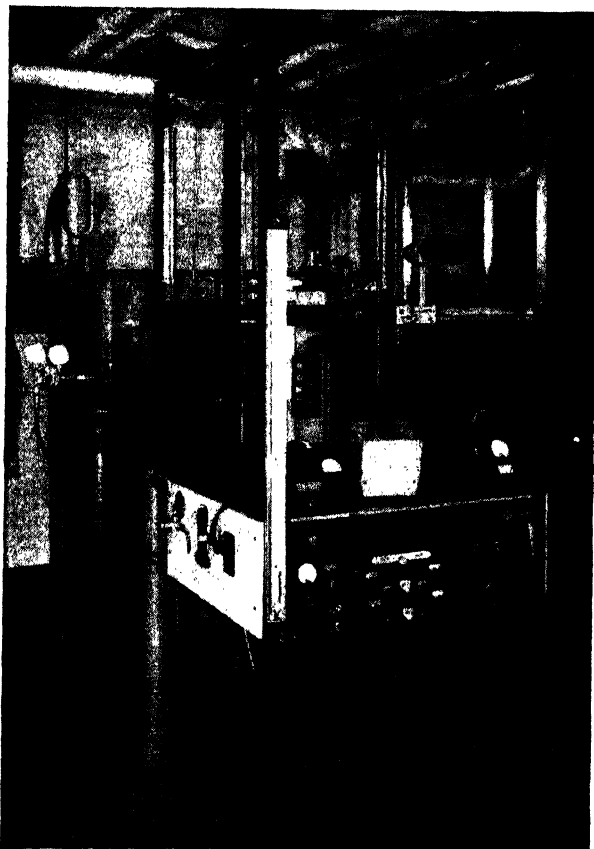

FIG. 161. High-frequency induction furnace.

10,000 watts of electrical energy would be necessary from the generator to be transformed into heat energy within the susceptor. The electrical resistance of copper (used for inductor) at room temperature was reported to be about 0.80×10^{-6} ohm inch; for molybdenum (susceptor) the electrical resistance was reported to be 20.0×10^{-6} ohm inch at 2300°C (about 4170°F).

By substitution in the formulas of Vaughan and Williamson,⁽¹⁴⁾ the value for the measure of current penetration in the inductor was found to

be 0.031 in. for good efficiency. The wall thickness of the inductor tubing should be equal to or greater than a factor of 1.35 times the measured current penetration. This value was found to be 0.042 in., so copper tubing with the next largest wall thickness, $\frac{3}{64}$ in., was chosen.

The measure of current penetration or skin effect on the molybdenum susceptor was found to be 0.0142 in. This meant that the susceptor would have to be at least that thick. General availability of molybdenum sheet and other structural factors influenced the final choice of 0.050-in.-thick material.

It was found through the mathematical formulas that the inductor should consist of nine turns. The power dissipated in the transmission lines was taken as zero, since short heavy, high-conductivity copper bus bars were used. From the above data the subsequent substitution in the formulas established the KVA (rated) for the capacitor at 230. As can be seen, the electrical part of the system was designed with all factors known, thus reducing to a minimum the usual trial-and-error experimentation.

The susceptor, then, is made from 0.050-in. sheet molybdenum, while the radiation shields are made of 0.020-in. molybdenum sheet in a continuous spiral. Refractory oxide insulators are used to separate the spiral shield from the exterior horizontal shields, as shown in Fig. 162, and the entire assembly is supported on molybdenum rods. The efficiency of the radiation shields is greatly increased if they have a bright surface; therefore the molybdenum parts should be heated in hydrogen to remove the oxide that is present in commercial sheet.

The vacuum chamber is made of a translucent quartz tube (Thermal Syndicate Corp.). The top of the chamber is closed with the prism assembly using a silicone or neoprene rubber gasket. The shutter, which protects the prism from radiation and from condensable constituents originating in the furnace during firing, is actuated electrically.

Two ports are supplied at the lower vacuum chamber flange; one is used for the manometer gage connection and gas inlet, and the other is used for the ionization gage. A standard 4-in. water-cooled baffle (Distillation Products, Inc.) and a custom-built valve are situated between the vacuum chamber and the pumping system.

The pumping system consists of an oil diffusion pump having a rated pumping speed of 275 liters per sec at 10^{-4} mm Hg pressure (type MC275, Distillation Products, Inc.) and uses Octoil as the boiler fluid. The fore pump has a rated pumping speed of about 6 cu ft per min at 40 μ pressure and is capable of maintaining an ultimate vacuum of 10 μ . The fore pump used is a model VsD556 manufactured by the Kinney Manufacturing Company, Boston, Massachusetts. A thermocouple gage is inserted

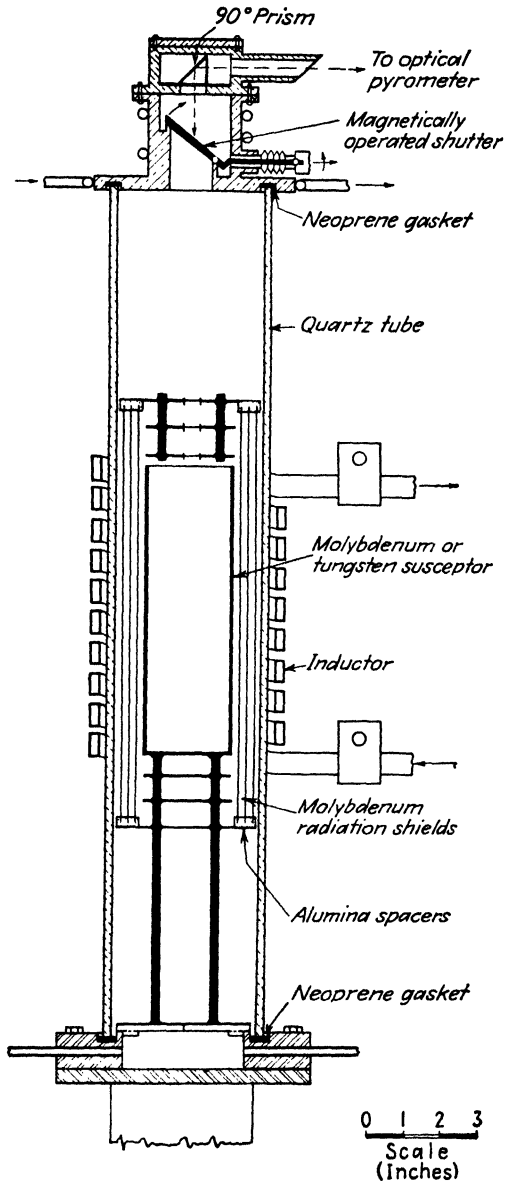

FIG. 162. Quartz-metal, vacuum high-frequency furnace.

between the diffusion pump and the fore pump. In general, the pumping system is similar to the one described for the metal enclosed vacuum-firing system shown in Fig. 160 but is smaller and less complex in design. Typical runs at different power levels for this furnace are shown in Fig. 163.

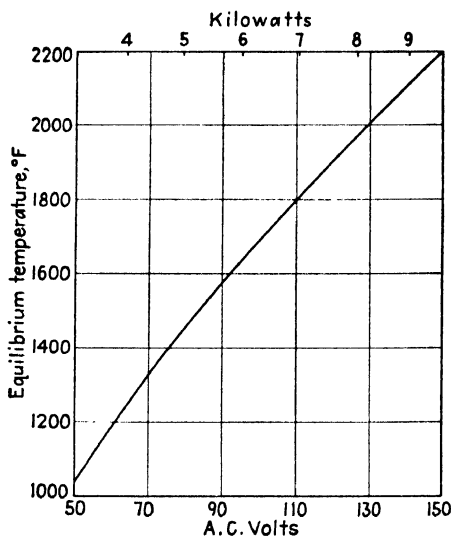

Fig. 163. Performance curves for the quartz-metal vacuum furnace.

6. Bibliography

Combustion Heating:

1. SALMANG, H., and HEINZ BROS.: Vitrification of Refractory Oxides, A High-temperature Furnace with Oxidizing Atmosphere, *Ber. deut. keram. Ges.*, **10**, 529, 1929.
2. NORTON, F.H., and V.J. DUPLIN, JR.: A Muffle Kiln of High Efficiency, *J. Am. Ceram. Soc.*, **16**, 152, 1933.
3. RYSCHKEWITSCH, E.: Methods for Increasing High Temperatures, *Wärme*, **60**, 467, 1937.
4. KEITH, W.P., and O.J. WHITTEMORE, JR.: High Temperature Laboratory Kiln, Chicago Meeting of the American Ceramic Society, 1948.

Solar Heating:

5. COHN, W.M.: Crystal Modification of Zirconia; a Clear Fused Zirconia Produced in the Sun Furnace, *Trans. Electrochem. Soc.*, **68**, 65, 1935.
6. FOEX, F.T.M., and C.H. BLANCHETAIS: Concentration of Solar Energy for the Realization of Very High Temperatures, *Ann. Chem.*, **2**, 385, 1947.

Electrical Resistance Heating:

7. FEHSE, W.: Wolframspiralofen für sehr hohe Temperaturen, *Z. tech. Physik*, **8**, 119, 1927.

8. SYKES, C.: Note on Molybdenum Wire-wound Furnaces, *Trans. Ceram. Soc., (Engl.)*, **29**, 55, 1930.
9. GELLER, R.F.: A Resistance Furnace with Some Preliminary Results to 2000°C., *Natl. Bur. Standards, J. Research*, 555, 1941.
10. GELLER, R.F.: A Resistor Furnace, with Some Preliminary Results up to 2000°C., *Natl. Bur. Standards, J. Research, Research Paper* RP 1443, **27**, 555, 1941.

Induction Heating:

11. NORTHRUP, E.F.: Practical Methods of Induction Heating Solids, Paper presented before the Pittsburgh District Section of the American Institute of Electrical Engineers, January, 1933.
12. CURTIS, F.W.: "High-frequency Induction Heating," McGraw-Hill Book Company, Inc., New York, 1944.
13. DUDLEY, B.: Induction and Dielectric Heating Equipment, *Electronics*, **18**, 110, 1945.
14. VAUGHAN, J.T., and J.W. WILLIAMSON: Design of Induction Heating Coils for Non-magnetic Loads, *Elec. Eng.*, **64**, 587, 1945.
15. OSBORN, H.B., JR.: Induction Heating, Tocco Division, Ohio Crankshaft Corp., Cleveland, Ohio, *Bull.* 220-10M-47 (revised), 1947.

Vacuum Technique:

16. FARKUS, A., and H.W. MELVILLE: "Experimental Methods in Gas Reactions," Macmillan & Co., Ltd., London, 1939.
17. STRONG, J.: "Procedures in Experimental Physics," Prentice-Hall, Inc., New York, Chap. 3, p. 93, 1939.
18. MORSE, R.S.: Baffles for Oil Diffusion Pumps, *Rev. Sci. Instruments*, **11**, 277, 1940.
19. MORSE, R.S.: High Vacuum Technology, Protective and Decorative Coatings, *J. J. Mattiello*, **4**, 259, 1944.
20. BROWN, G.P.: The Use of Silicones as Diffusion Pump Oils, *Rev. Sci. Instruments*, **16**, 316, 1945.
21. BROWN, G.P., and A. DI NAIDO, G.K. CHENG, and T.K. SHERWOOD: The Flow of Gases in Pipes, at Low Pressures, *J. Applied Phys.*, **17**, 802, 1946.
- 21a. SULLIVAN, H.M.: Vacuum Pumping Systems and Equipment, *Rev. Sci. Instruments*, **19**, 1, 1948.
- 21b. BLEARS, J., and R.W. HILL: The Speeds of Diffusion Pumps for Gases of Low Molecular Weight, *Rev. Sci. Instruments*, **19**, 847, 1948.

General:

22. Smithsonian Physical Tables, edited by Fowle, 7th ed., 1920.
23. KELLY, K.K.: Data on Theoretical Metallurgy Series, *U.S. Bur. Mines, Bull.*, 383, 1935.
24. Fansteel Metallurgical Corp., North Chicago, Ill. (Fansteel Products Company, Inc.), *Tech. Data Bull.* RM-17, 1947.

CHAPTER XI

REFRACTORY MORTARS, PLASTICS, CONCRETES, AND COATINGS

1. Introduction. Refractory mortars are used in laying refractory brick and shapes and serve the following purposes: to bond the brickwork into a solid unit so that it will be more resistant to shocks and stresses, to provide a cushion between the slightly irregular surfaces of the brick so that one course of brickwork will have a firm bearing on the course below it, and also to make a wall gastight or to prevent penetration of slag into the joints. The best mortars are combinations of a plastic clay and a volume-constant grog, as the use of raw fireclay alone as a mortar is confined to low-temperature applications.

Mortars are sometimes thinned with water and used as coatings for the face of the refractory walls in order to seal the joints further or to protect the wall from destructive elements in the furnace.

Plastic refractories are used for three general purposes. The first is for making molded refractory shapes to be used in the furnace in the green state; the second is to form a molded monolithic wall or furnace structure; and the third, to repair and patch worn brickwork.

Refractory concretes contain an aggregate and a setting material, such as hydraulic cement, to give them cold-setting properties. The aggregate may be calcined fireclay, which will give a high density to the concrete, or it may be a porous grog, diatomaceous earth, vermiculite, or other porous material to give light weight and low heat conductivity to the resulting concrete.

Hot patching materials are not used very extensively as yet but are intended for forming a stable refractory while the furnace is at operating temperatures.

The general composition of these refractory materials varies a great deal depending upon the application for which they are intended. The majority are made from a fireclay base, but there are many special compositions in which chrome, silicon carbide, silica, and alumina are used. The manufacturer of the brick should be consulted when selecting a mortar or coating.

2. Mortars. *Heat-setting Types.* Mortars in this classification are generally composed of grog and a bond clay. No air-setting ingredient

such as sodium silicate is added, and the mortar obtains its strength by the vitrification of the bond. For low-temperature service or where a strong mortar is needed, a clay high in fluxes should be used for the bond, whereas a mortar for high-temperature service would use a fireclay or kaolin. The nonplastic part is crushed to pass a 40-mesh screen and mixed with the bond. To reduce the shrinkage, the nonplastic ingredient may comprise as much as 60 per cent of the total mortar. Sufficient raw clay must be used, however, to give proper plasticity and workability, and therefore the clays must be carefully selected for this purpose. The size distribution of the nonplastic grog also affects the working properties of the mortar. The ASTM Specification C 105-47 covers ground fireclay mortars specifying four classes, depending on the refractoriness of the clay. Heat-setting mortars are usually shipped in 100-lb moistureproof bags.

Air-setting Mortars. Air-setting mortars are composed of a base of precalcined fireclay or raw flint clay crushed to pass a 35-mesh screen. To this is added a plastic fireclay and from 5 to 20 per cent sodium silicate solution. The choice of plastic bond clay and the soda-silicate ratio of the sodium silicate solution will determine the properties of the mortar. To obtain a mortar for severe temperature conditions, a highly refractory clay and a sodium silicate solution that has a low ratio of soda to silica should be chosen. For more moderate temperature service, a more plastic but less refractory clay combined with a sodium silicate solution richer in soda will give a mortar of better working properties and lower vitrifying point, but it will, of course, have a lower temperature use limit. The grog base should be sized so as to produce in the finished mortar the least drying and firing shrinkage compatible with good workability.

The water content of an air-setting mortar is adjusted until it has the consistency of a thick batter. On air drying, these mortars set to a good strength and form an almost monolithic structure with the brickwork, in some cases the mortar joint being stronger than the surrounding brick.

A batch mixing process is generally used to ensure good control of the tempering water added. After mixing, the mortar is packed in steel drums and sealed with rubber-gasketed steel lids. These containers are sold in 50-, 100-, and 200-lb sizes. ASTM Specification C 178-47 specifies three classes of mortar. The mortar must be fine enough to pass 95 per cent through a 35-mesh screen and when used in a joint should give a dry strength of over 200 psi modulus of rupture as measured by ASTM Specification C 198-47.

Recently air-setting mortars have been developed with aluminum phosphate as the bonding agent. Typical of this product is the composition described in the patent by Greger and Reimer.⁽³³⁾ Barium aluminates

as cements have been suggested as having both high setting strengths and refractoriness.

For some special applications, a dry, air-setting mortar is desired. In this case, dry, powdered sodium silicate is used instead of the wet solution, the rest of the mortar remaining essentially the same. The air-set strength of these dry mortars, however, is not so great as that obtained with the wet mortars. Dry, air-setting mortar is packaged in moistureproof bags, usually in 100-lb sizes.

Some manufacturers have had trouble with air-setting mortars hardening in storage, and considerable research has been carried out to find the cause. It is generally believed now that the hardening is due to a base-exchange reaction between the sodium silicate and the natural clay with adsorbed calcium ions.⁽¹⁷⁾ This is brought out in Table 56, derived from some experiments made in the Ceramic Laboratory of the Massachusetts Institute of Technology. It has also been found that clays containing organic matter may develop an acid reaction in storage and thus cause setting.

TABLE 56. HARDENING PROPERTIES OF AIR-SETTING CEMENTS

| Adsorbed Ions on Clay | Hardening |
|-----------------------|-----------|
| Na ⁺ | None |
| K ⁺ | None |
| Ba ⁺⁺ | None |
| Ca ⁺⁺ | Severe |
| H ⁺ | Severe |

Special Mortars. For special applications, both heat-setting and air-setting mortars are made up using bases other than fireclay. Magnesite, chrome, silica, alumina, and silicon carbide are the more common ones and are used in laying up bricks of their respective materials. Alumina mortars are used where extreme temperature conditions are encountered and where freedom from iron is important. So-called "natural mortars" are much used in Europe. They consist of a naturally occurring clay and sand mixture with good working properties.

Application. Mortar is generally applied in one of three ways, but it should be emphasized that in most cases, the thinnest possible joint is desired. The first method results in the so-called "battered joint," where the mortar is mixed to a batter consistency and the top of the exposed course of brickwork is spread, using a trowel, with a thin coating. The brick to be laid is given a trowel coating on the bottom of one end and then tapped or pushed into place.

The second is known as the "dip" method. The mortar is thinned out with more water than when using battered joints. The brick to be laid is dipped into the thin batter on the bottom and one end and then pushed

into place. The thickness of the joint can be regulated by the consistency of the batter. A combination method sometimes used consists of pouring a batter on to the exposed top course and then dipping the bricks to be laid on them. This results in more completely filled joints than the straight dipping method.

Approximately 400 lb of mortar is required for setting 1,000 bricks.

Tests for Refractory Mortars. A number of methods have been proposed for testing mortars,⁽¹⁴⁾ but it is still difficult to get a quantitative measure of the illusive property called workability.

The fusion point can be determined by the methods described in Chap. XIV; but when silicate of soda is present, a preliminary calcining of the material to 1100°C is recommended by Phelps in order to obtain consistent results. However, the fusion point is not particularly valuable, and the block tests as used for glazes and enamels⁽¹⁴⁾ or the amount of flow of the mortar when used as a bond is more important.

The bonding range is generally determined by cementing two half bricks together on the 2½- by 4½-in. faces with a definite thickness of joint. (ASTM Specification C 198-47.) After drying, they are broken as shown in Fig. 164, or they may be heated to various temperatures and broken while heated or when cooled to room temperature. Care must be exercised to prevent any stresses in the samples due to movement of the pieces while drying; otherwise low values will result from fine cracks.

The shrinkage can be measured on bars of the mortar in the usual way or by the characteristics of a layer dried and fired on a brick. The coefficient of thermal expansion can be measured by the methods described in Chap. XVII.

The workability is an important property, but one difficult to measure. Troweling ability is measured by a machine developed by the National Bureau of Standards,⁽¹⁴⁾ but it is generally better to depend on the reports of experienced bricklayers. Rate of settling is important in mortars used in the pouring consistency and is simple to evaluate. Water-retention values, as measured by Phelps, are determined by cementing two half bricks together with no load and then, after a certain time interval, adding a load and noting the amount of mortar squeezed out. This test is particularly important for insulating refractories.

Resistance to erosion by slags or penetration by gases can be measured by methods described in Chaps. XVI and XX, respectively.

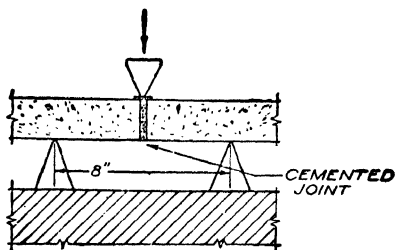

FIG. 164. Method of measuring bonding strength.

3. Plastics. Plastic refractories are now being used in somewhat larger quantities than in the past; in some instances, quite large furnaces have been constructed of monolithic plastic material with good results. It should be noted that the plastic material fires hard only on the hot surface and has a weaker and more flexible zone on the cooler side. Although this may sometimes be a disadvantage, in other cases it actually seems to give a greater life than the burned refractory because of the flexibility of the wall. However, success can be obtained with plastics in large monolithic structures only by skilled application.

Fireclay Plastics. Some of the plastic materials are cold setting; *i.e.*, they develop strength on drying. As in the case of cold-setting mortars, this strength is achieved by the addition of sodium silicate to the mass. Most of the plastics are made up with a base of fireclay grog, either specially prepared or made from waste brickbats and saggars. The maximum size of this grog runs from 4 to 2 mesh in order to reduce the drying and firing shrinkage. The bond clay used must be selected with great care to give good workability and low shrinkage.

It is particularly important that the plastics have a low drying and firing shrinkage; otherwise the structure will be badly cracked after the first firing. For this reason, the proportion of grog is comparatively large, running between 40 and 60 per cent of the total. Not only the maximum size of the grog is important in achieving good results, but the grading of the grog to give the best characteristics is quite important. The plastic mass should be of such consistency that it is coherent and sticks to the brickwork. It should not be crumbly when worked up or get soft and wet when hard rammed. A good plastic can be rammed into a patch in the crown without slumping or pulling away. ASTM Specification C 176-47 calls for two types of plastic varying in refractoriness.

Ladle Mixes. A considerable amount of plastic refractory called "ladle" or "ramming" mixes are used for lining ladles in the iron and steel industry and for pouring spouts and parts of that nature. These refractories must have rather special properties, such as good workability and a softening point approaching the pouring temperature of the metal, so that the surface of the refractory becomes glazed and offers a good resistance to metal and slag attack. Whereas many of these mixes have bases of fireclay grog, others consist of a kaolin base; and in some cases, high-alumina clays have been used.

Special Plastics. Besides the fireclay-base plastics, considerable quantities of chrome-base plastics are used, particularly under conditions of severe slag erosion. The important field for this class of plastics is in the stud walls of boiler furnaces, where it can be rammed around the waterwall tubes to form a refractory capable of withstanding terrific punishment in the way of high temperatures and slag conditions. This type of plastic is

usually made up of raw or calcined chrome ore with some clay bond and often silicate of soda. African or Cuban chrome ore is generally preferred for this use.

Silica ramming mixtures are made from crushed ganister or sandstone and fireclay as a bond. These mixes should be made up to have good workability and are used largely for patching cupolas and other metallurgical furnaces. Silicon carbide ramming mixtures are used where high heat transfer or good slag resistance is desired. Though comparatively expensive, they give excellent service under certain severe conditions. Magnesite ramming mixtures usually consist of dead-burned magnesite grain mixed with some organic bond like tar or dextrine. These are used for the basic electric furnaces, basic open-hearth furnaces, and some of the nonferrous constructions.

Application of Plastics. Satisfactory service cannot be expected from plastic materials unless they are properly applied. The directions given by the maker of the plastic used should be carefully followed in order to ensure a first-class job. Although the methods vary somewhat depending on the type of plastic, in general the following steps should be taken in the application of this material.

In laying a plastic furnace bottom, such as plastic chrome ore in a forging furnace, it is customary to use the following procedure: Take the material out of the cans and dump it on a clean spot on the floor near the furnace, cutting the lumps with a spade but adding no water. If the material has to be left for any length of time, it should be covered with damp burlap bags to prevent its drying out. Beginning on one side of the furnace floor, lumps of the material should be spread out in a layer approximately 50 per cent thicker than the finished layer; *i.e.*, if a 3-in. floor is going to be put in, the thickness of the lump material should be 4 or 5 in. It is well to work in a strip about 30 in. wide beginning at one side of the furnace. A heavy spade then thoroughly cuts through the lumps with deep strokes so that the blanket of material is thoroughly tied together. Then with a heavy tamper, the whole mass is consolidated with heavy strokes. The thickness of the layer should be tested with a rod. If it is too thin, the whole mass will have to be cut up again with a spade before adding more material; otherwise it will not consolidate. The final surface can be put on by laying boards on top and tamping on these. The next 30-in. strip can then be started, care being taken to ensure that it is well cut into the edge of the finished strip to make a bond. More boards can be laid on this, and the procedure repeated until the whole floor is done. The finished surface should not be walked on unless boards are put down.

It is good practice in all plastic construction to punch the layer with small vent holes about 2 in. deep to let out the steam on drying. This can be very conveniently done by making a rectangular frame into which spikes

have been driven on about 3-in. centers. The frame can be readily pressed down on to the surface of the plastic.

In some cases, successful results have been obtained by tamping the hearth while it is hot with a heavy weight on the end of a pipe that can be introduced through the furnace door. If this tamping is carried out every week end, the hearth soon becomes consolidated into an excellent structure.

When using plastic materials in side walls, wooden forms are required in order that the plastic can be rammed in to form a really monolithic

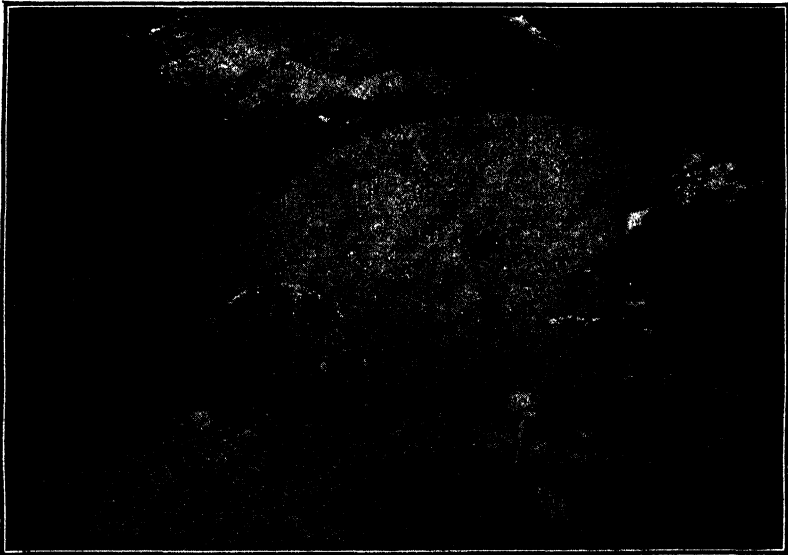

Fig. 165. An example of furnace repairs with a plastic refractory. (Courtesy of A. P. Green Fire Brick Co.)

structure. Sometimes plastic materials have been used for small furnace roofs where the ramming is done on top of a form. Generally, however, a refractory concrete would be used for this purpose.

Plastics are also used for patching walls; and under these conditions, great care must be taken to obtain a satisfactory piece of work. The wall itself must be carefully cleaned of any adhering slag, and the brickwork surface roughed up and, in some cases, undercut to hold the patch. This is usually hammered in with a heavy wooden mallet, precautions being used to build up the layer uniformly and without laminations. Fig. 165 shows a patch of this kind which has been completed in a furnace.

Packing of Plastics. Plastics are usually shipped wet in tightly sealed cans, although manufacturers sometimes pack a cube of the mixture in waterproof paper and ship it in a carton. Occasionally, manufacturers

have had trouble with air-setting plastics hardening in storage, as discussed for air-setting mortars.

Testing of Plastics. The important characteristics of plastic materials are the fusion point, the workability, the reheat shrinkage as determined by the panel test, and the strength when fired to various temperatures. The workability is measured as specified in ASTM C 181-47, which seems to give satisfactory results. The work of Heindl and Pendergast⁽³⁵⁾ may also be referred to.

4. Concretes. Refractory concretes are generally made up with a heavy grog to provide a dense, strong mass or with a porous grog to provide a light refractory. They are widely used for low- and medium-temperature work. Some important applications are the casting of baffles in boiler-tube banks, forming the lining of doors and the tops of tunnel-kiln cars, and, in some cases, the construction of special shapes.

Dense Mixes. These mixes are generally made up with 60 to 80 per cent fireclay grog, perhaps made from crushed brickbats, and 15 to 25 per cent early strength or high-alumina cement and clay for workability. The prepared mixes, of course, are always shipped dry, but often they are made up and mixed by the user, as he generally has available his own brickbats, which can be readily crushed up for grog. It will be found, however, in general, that a carefully prepared batch made by a reliable manufacturer will give better results than mixes made up by the user. Refractory concretes can seldom be used above 2650°F (about 1460°C). ASTM Specification C 213-47 calls for two types, one for high-temperature zones and one for low.

The pure, high-alumina cement described by Pole and Moore,⁽⁴⁹⁾ consisting of $3\text{CaO}\cdot 5\text{Al}_2\text{O}_3$, would seem to have some advantage in raising the use limit of refractory concretes.

Lightweight Mixes. These mixes are made up in a similar way to the previous ones, except that the aggregate is of some lightweight material like lumps of infusorial earth, bloated clay, or porous grog. Lightweight mixes are used in such places as doors of furnaces and similar positions where the temperature is not extreme. Their density runs between 45 and 60 lb per cu ft.

All the refractory concretes have a low strength at a temperature of 1500 to 1800°F (about 820 to 980°C), where the cement is dehydrated and strength has not been attained by vitrification. This will give a weak layer in the structure that has not yet been overcome in this class of material. Nevertheless, these mixes are being used with considerable success in many types of structure.

Tests. The tests of refractory concretes are similar to those mentioned for plastics, *i.e.*, the softening point, the drying and firing shrinkage, and the strength at various temperatures.

5. Coatings. Refractory coatings are used to some extent on the surface of certain types of brickwork to close the pores and present a more homogeneous surface, thus minimizing abrasion and slag erosion. However, unwarranted claims have been made for coatings, claims indicating that a good coating would make a lower grade refractory give the service of a high-grade refractory. This is not generally true, and a coating is by no means a cure-all for refractory troubles.

Natural Coatings. Raw fireclay, which was used to some extent in the early days, has been more or less discarded because of its high shrinkage and tendency to peel off the brickwork. Natural coatings are used extensively in Europe containing clay, quartz, and feldspar in such proportions as to reduce the shrinkage and give a fluxing action. This material is very similar to the natural mortars previously discussed and generally has good working properties with a comparatively low cost.

Prepared Fireclay Coatings. For high-temperature conditions, the coating used most frequently is a mixture of calcined grog with a plastic bond clay. A satisfactory coating should have a low shrinkage and adhere well to the brick so that no peeling or checking is observable on heating to the working temperature. The brick manufacturers' recommendation should be taken, because a coating that may work very well with one type of refractory may not work at all with another type, even though of very similar properties.

Special Coatings. Many special coatings are available such as those with a chromite base or a chrome oxide base which are used to give some additional slag resistance to fireclay or insulating firebrick. There are also coatings having fused alumina or silicon carbide as a base for special purposes. They all must have the property, however, of low shrinkage and adherence to the brick with which they are used.

Application of the Coatings. Coatings can be applied to the brickwork with a brush or with a spray gun. The latter is generally more satisfactory in giving a really good job. The coatings must be applied in comparatively thin layers, $\frac{1}{16}$ to $\frac{1}{8}$ in. being the maximum generally used. Even then, a better job is obtained by applying it in several successive applications if this is possible. About $\frac{1}{4}$ to $\frac{1}{2}$ lb per sq ft of material should be allowed for an average coating job. Particular care should be taken that the brickwork is clean and free from dust before the coating is applied.

6. Bibliography

Mortars:

1. CHESTERS, J.H., and W.J. REES: Application of Tensile Tests to the Study of Bonding of Refractory Materials, *Colliery Guardian*, **141**, 1356, 1930.
2. WHITE, H.E.: Refractories and Refractory Cements for the Non-ferrous Foundry, *J. Am. Ceram. Soc.*, **13**, 219, 1930.

3. COLE, S.S., and D.C. LYNN: Thermal Expansion of Silica Mortars after Firing at 950°, 1200°, and 1500°C., *J. Am. Ceram. Soc.*, **14**, 906, 1931.
4. COSS, H.T.: Compounding Refractory Cements, *Ceram. Age*, **17**, 11, 1931.
5. HUTCHINSON, A.: High-temperature Cement, U.S. Patent 1,787,625, 1931.
6. LAKE, W.O.: Refractory Cements and Lutes, *Sands, Clays, Minerals*, **1**, 56, 1933.
7. HARVEY, F.A., and R.E. BIRCH (Harbison-Walker Refractories Co.): Refractory Mortar Composition, U.S. Patent 2,077,793, 1937.
8. COLE, S.S.: A Study of the Working Properties of Silica Mortars, *J. Am. Ceram. Soc.*, **18**, 61, 1935.
9. KAINARSKII, I.S., and V.A. BROM: Mortar for Coke Ovens, *Ukrain. Nauch.-Issledovatel. Inst. Ogneuporov i Kislotouporov*, **39**, 60, 1936.
10. NAGAI, S., and J. KATAYAMA: Refractory Cements and Mortars, III, *J. Japan. Ceram. Assoc.*, **45**, 447, 1937.
11. SEIL, G.E. (E.J. Lavino & Co.): High-temperature Refractory Cement, U.S. Patent Re. 20, 413, 1937.
12. McMAHON, J.F.: The Development of Laboratory Tests for High Temperature Cements, *J. Can. Ceram. Soc.*, **6**, 55, 1937.
13. CLEWS, F.H., H.M. RICHARDSON, and A.T. GREEN: Jointing Cements, VIII, Refractory Materials Joint Committee, Twenty-ninth Report, *Inst. Gas Engrs. Commun.* 193, November, 1938.
14. HEINDL, R.A., and W.L. PENDERGAST: Properties of Air-setting Refractory-bonding Mortars of the Wet Type, *Natl. Bur. Standards, Research Paper* 1219, 1939.
15. CLEWS, F.H., H.M. RICHARDSON, and A.T. GREEN: A Survey of the Properties of Some Commercial Jointing Cements, *Iron & Steel Inst., Special Rept.* 26, p. 425, 1939.
16. CLEWS, F.H., and A.T. GREEN: Jointing Cements, Summary of Parts I-VII, *Iron & Steel Institute, Special Rept.* 26, p. 401, 1939.
17. MORGAN, W.R., W.I. PESKIN, and S.J. KRONMAN: Mechanism of Hardening of Clay-sodium-silicate Mixtures, *J. Am. Ceram. Soc.*, **23**, 170, 1940.
18. HEINDL, R.A., and W.L. PENDERGAST: Some Properties of the Dry Setting Type of Refractory Bonding Mortar, *Natl. Bur. Standards Research Paper* 1461, 1942.
19. ANON.: Mortar: Air-setting, Refractory, Bonding (Wet and Dry Types), *Am. Fed. Spec.*, HH-M-611a, 1943.

Coatings:

20. WEIGHTMAN, H.E.: Use of Plastic Refractories in Boiler Furnaces, *Power*, **63**, 90, 1926.
21. U.S. Federal Specifications: Mortar: Air-setting, Refractory, Bonding (Wet and Dry Types), *Am. Fed. Spec.*, HH-M-611a, 1930.
22. FABER, L.: Applying Refractory Cement, U.S. Patent 1,751,195, Mar. 18, 1930.
23. WHITE, H.E.: Refractory-maintenance Cements in Nonferrous Foundry, *Brass World*, **26**, 119, 1930.
24. LITINSKY, L.: Refractory Protective Coatings, *Feuerfest*, **7**, 65, 1931.
25. MARTIN, R.H.: Making Refractory Article, U.S. Patent 1,818,903, 1931.
26. REINHART: Refractory Mortars for Furnaces, *Tonind.-Ztg.*, **63**, 54, 617, 1939. Abstracted in *Brit. Clayworker*, **48**, 257, 1939.
27. PETRIE, EARL C., and D.W. KOCHER: Control Testing for Consistency of Refractory Mortars, *J. Am. Ceram. Soc.*, **25**, 459, 1942.

Plastics:

28. MACK, J.R.: Applying Plastic Material to Surfaces, U.S. Patent 1,751,343, 1930.
29. HOPKINS, J.C.: Mud Gun, U.S. Patent 1,774,373, 1930.
30. HARRÆUS: Devices for Applying Refractory Materials on the Interior Walls of Industrial Kilns, *Glashütte*, **62**, 217, 1932.
31. ANDERSON, J.E.: Apparatus for Applying Cementitious Material, U.S. Patent 1,933,543, 1933.
32. ANON.: German Standards for Refractory Materials, Ramming Materials and Cements, *Tonind.-Ztg.*, **66**, 73, 1942. Abstracted in *Trans. Brit. Ceram. Soc.*, **41**, 131A, 1942.
33. GREGER, H.H., and J.J. REIMER (Briggs Filtration Co.): Plastic Refractory, U.S. Patent 2,425,152, 1947.
34. HAYMAN, J.C.: Plastic Refractories—Jointing, Parging and Ramming Cements, *Iron and Steel*, **20**, 137, 1947.
35. HEINDL, R.A., and W.A. PENDERGAST: Reliability of "Workability Index" of Fire-clay Plastic Refractories, *J. Am. Ceram. Soc.*, **30**, 329, 1947.
36. NORTON, F.H.: Finding a Sillimanite Substitute for Use in Wet Patching, *Brick & Clay Record*, **110**, 70, 1947.

Refractory Concrete:

37. KESTNER, P.J.F.: Refractory Cement and Concrete, U.S. Patent 1,573,072, 1926.
38. ANON.: Monolithic Linings for Foundry Cupolas, *Bradley's Mag., Refractories J.*, **8**, 243, 1932.
39. COSS, H.T., and N.J. KENT: Monolithic Refractory Concretes, *Ceram. Age*, **20**, 212, 1932.
40. KNOTE, J.M. (Quigley Co., Inc.): Refractory Material and Method of Making, U.S. Patent 2,051,003, 1936.
41. CHADEYRON, A.A., and W.J. REES: Investigations on the Effect of the Addition of Cement Fondu to Various Refractory Materials, Including Fire Clay, Chrome, Magnesite, Chrome-Magnesite Mixtures, etc., Refractory Materials Joint Committee, *Inst. Gas Engrs., Twenty-eighth Rept.*, p. 76, 1937.
42. McGRUE, W.M.: Refractory Concretes for Coke Ovens and Furnaces, *Blast Furnace Steel Plant*, **25**, 624, 1937.
43. HUSEEY, A.V.: Aluminous Cement as a Bond for Refractory Cements, *Chemistry & Industry*, **56**, 53, 1937.
44. GILES, R.T.: Investigation of Certain Properties of Refractory Concrete, *Bull. Am. Ceram. Soc.*, **18**, 326, 1939.
45. LONGCHAMBON, L.: Refractory Concrete for Furnace Construction, *Compt. rend. dix-huitième congr. chim. ind.*, p. 970, 1938.
46. MOSER, A.: Refractory Concrete, *Tonind.-Ztg.*, **63**, 762, 775, 789, 1939.
47. DIETZ, KARL (vested in Alien Property Custodian): Highly Refractory Mass, U.S. Patent 2,295,637, 1942.
48. CLARK, H.N. (Refractory & Insulation Corp.): Furnace Lining, U.S. Patent 2,407,135, 1946.
49. POLE, G.R., and D.G. MOORE: Electric Furnace Alumina Cement for High Temperature Concretes, *J. Am. Ceram. Soc.*, **29**, 20, 1946.

50. LOBAUGH, F.E.: Topaz as an Admixture in Refractory Concretos, *J. Am. Ceram. Soc.*, **30**, 349, 1947.
51. HADDOCK, G.T.: Refractory Concrete for Furnace Construction, *Metals & Alloys*, **21**, 714, 1945.

Hot Patching:

52. PARDOE, H.: Hot Patching, *Trans. Ceram. Soc. (Engl.)*, **29**, 87, 1930.
53. HACKS, K., and W.S. SPROW: Refractory, U.S. Patent 1,934,263, 1933.
54. HACKS, K., and W.S. SPROW (R. E. Cook and J. G. Copper): Refractory, Can. Patent 363,252, 1937.
55. CLEWS, F.H., H. BOOTH, and A.T. GREEN: Experiments on Hot-patching, Part I, *Trans. Ceram. Soc. (Engl.)*, **35**, 257, 1936.
56. KUZELL, C.R.: Clarkdale Method of Hot-patching Operating Furnaces, *Am. Inst. Mining Met. Engrs., Tech. Pub.* 995; *Metals Technol.*, **6**, 12, 1939.
57. SCHOENLAUB, R.A.: Gunmix, *Am. Inst. Mining Met. Engrs., Proc. Natl. Open Hearth Conf.*, **27**, 326, 1944.
58. NICHOLAS, I.A.: Gun Mixtures, *Am. Inst. Mining Met. Engrs., Proc. Natl. Open Hearth Conf.*, **27**, 331, 1944.

CHAPTER XII

SOME SPECIAL REFRACTORY MATERIALS

1. Introduction. Since the previous edition of this book was published, considerable material has become available on special, high-temperature refractory materials, which, though as yet too costly for tonnage use, have great interest for small-scale applications. These include the pure oxides, carbides, nitrides, borides, and sulfides of high stability. In particular, developments have been rapid in the production of low-porosity bodies from them with little or no fluxes. These bodies are so valuable for certain purposes that a new chapter dealing with them has seemed justified.

2. Refractory Metals. The refractory metals may be divided into two classes: the noble metals that can be heated in air and the tungsten metals for use in a vacuum, neutral, or reducing atmosphere. The former include ruthenium, rhodium, palladium, osmium, iridium, and platinum. Of these, only platinum is plentiful enough for any large-scale use, and it is unfortunate that it does not have a higher melting point. In addition to its laboratory use, it is finding an increasing place in the glass industry for fiber glass and optical glass manufacture. Pots holding up to 100 lb of glass are lined with this metal, and it is said that a small continuous tank is in operation with a complete platinum lining.⁽¹⁵⁵⁾ Because there is no solution of the container, optical glass of very fine quality is claimed. Platinum also has the advantage of being ductile, so that it can be readily formed into any shape.

The second class of metals include tungsten, rhenium, tantalum, molybdenum, columbium, thorium, titanium, vanadium, zirconium, and hafnium. The true melting point of many metals is still not well known. For example, the value for tantalum has gone up from 2850⁽³⁾ to 2996°C⁽⁴⁾ in the last few years, and that for uranium has gone down from 2100⁽¹⁶⁶⁾ to 1150°C.⁽¹⁷⁹⁾ The most useful of these metals are tungsten, tantalum, and molybdenum. The first is most refractory but is difficult to fabricate. Molybdenum can be formed and welded in simple shapes, while tantalum is quite ductile and can be formed into complicated structures. Any of them can be formed by powder metallurgy methods in much the same way as the oxides.

The low vapor pressures of tungsten and tantalum (as shown in Fig. 166) make them particularly suitable for high-temperature work in a vac-

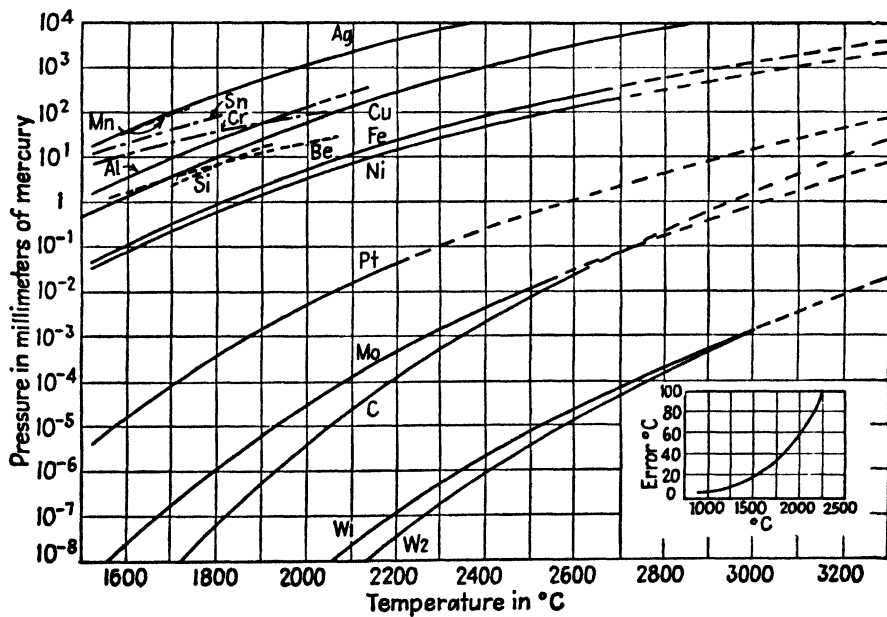
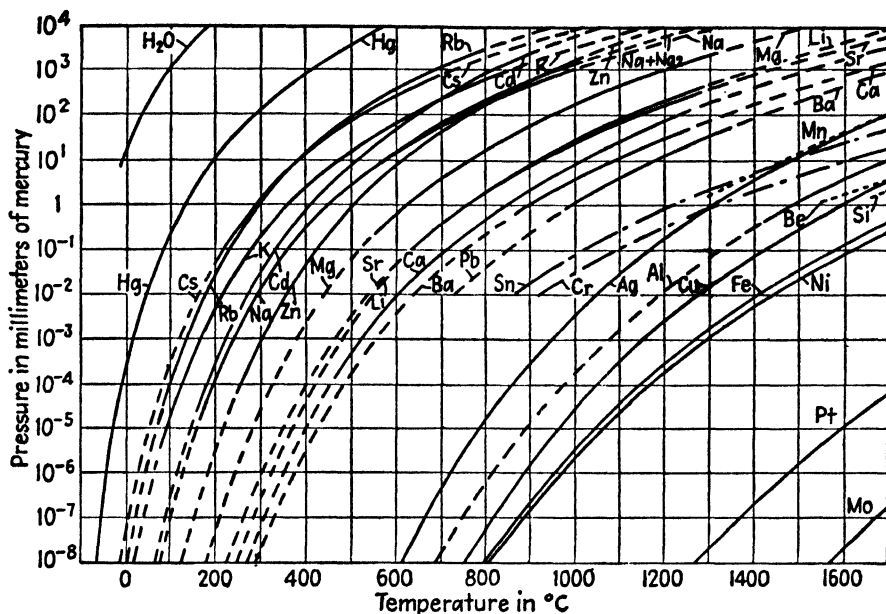

FIG. 166. Vapor pressures of elements at elevated temperatures.

uum. In Table 57 are shown the important properties of the refractory metals.

3. Refractory Oxides. The oxides are particularly valuable, as they are stable in air as well as in less active atmospheres.

Alumina. This oxide is one of the easiest of all to vitrify by means of the solid reaction, and much ware has been made both here and abroad in the form of a pure, nonporous, translucent body with excellent mechanical, electrical, chemical, and refractory properties.

The manufacture seems to follow the original German development of "Sinterkorund," a description of which is given in Report P.B. 18776.⁽¹¹⁾

The raw material is a chemically pure calcined alumina (α -alumina) containing about 0.1 per cent Fe_2O_3 , 0.1 per cent MgO , and 0.2 per cent CaO . This is ground wet in a steel ball mill for 50 to 75 hr until the maximum particle size is 12 to 15 μ and 65 per cent is below 5 μ . The suspension is then digested with 10 to 15 per cent of hot HCl (200 liters of acid to 100 kg of Al_2O_3) for one or more days, then water washed three or four times to eliminate the soluble iron and leaving the suspensions slightly acid. We have found in our laboratories that if the freshly ground slip is passed through a magnetic separator, the acid treatment is greatly shortened. To flocculate the suspension so that it will settle after washing may require the addition of a base to raise the pH. If the grinding is carried out in alumina mills the acid washing is eliminated.

The forming may be done by slip casting into plaster molds. The German practice uses a slip with a specific gravity of 2.0, but we have found it possible to make casts with slips having a specific gravity as high as 3.0 and with a pH of 4.5. P. D. Johnson has shown that alumina gel can be precipitated on the alumina particles, after which casting slips can be made with a pH of 9, much like clay slips. Forming can also be carried out by dry pressing in steel molds with organic binders or lubricants such as wheat flour, gum tragacanth, polyvinyl alcohol, waxes, or rubber latex. Extrusion is also possible if the binder content is high enough. By mixing the alumina with a heated synthetic resin (thermoplastic), injection molding into a cooled die is possible to give an accurately sized piece with a polished surface. The previously mentioned report⁽¹¹⁾ gives the formula used by Bosch for this purpose as taken from the Bosch patent B489,981 (German). By using the proper binders, the dried ware can be accurately turned to size as is common practice with electrical insulators.

The firing in Germany takes place in pure, fused magnesia muffles heated by surface combustion, using city gas and preheated air to temperatures of 1900 to 1950°C and held for 1 to 3 hr. It seems to be common practice to use 0.5 per cent MgF_2 to prevent the growth of large crystals, but most of the fluorine should be eliminated in the firing. If porous ware

TABLE 57. PROPERTIES OF REFRACTORY METALS

| Material | Formula | Sp. gr. g per cc | Hardness* | Tensile strength, M psi | Young's modulus of elasticity, Million psi | Mp, °C | Solubility ^{(1)(2)†} |
|-----------------|------------------|------------------------|--|---|---|-----------------------------|---|
| Actinium..... | Ac (227) | | | | | 1800 d. ⁽¹⁷⁰⁾ | |
| Boron..... | B (10.82) | 2.3 ⁽¹⁷⁶⁾ | 9.5 M ⁽¹⁶⁷⁾ | | | 2300 ± 300 ⁽¹⁷⁸⁾ | i. H ₂ O;s. HNO ₃ , H ₂ SO ₄ ;i. al. eth. alk. |
| Carbon..... | C (12.01) | 2.22 ⁽¹⁷⁶⁾ | | | 0.7 ⁽¹⁷⁶⁾ | 3700 ± 100 ⁽¹⁷⁸⁾ | i. H ₂ O;s. liq. Fe; i. a. alk. |
| Columbium..... | Cb (92.91) | 8.57 ⁽¹⁷⁶⁾ | 75 Br ⁽⁶⁾ 10 Sc | | | 2000 ± 50 ⁽¹⁷⁸⁾ | i. H ₂ O;s. h. H ₂ SO ₄ ;sl. s. HF; i. HCl;HNO ₃ |
| Hafnium..... | Hf (178.6) | 11.4 ⁽¹⁷⁶⁾ | | | | 1700 ⁽¹⁶⁸⁾ | i. H ₂ O |
| Iridium..... | Ir (193.1) | 22.4 ⁽¹⁶⁸⁾ | 6.5 M ⁽¹⁶⁷⁾ | | 74.7 ⁽¹⁷²⁾ | 2454 ± 3 ⁽¹⁷²⁾ | i. H ₂ O; amor. s. aq. reg.; i. a. aq. reg. |
| Masurium..... | Mg (108-99.5) | 11.5 | | | | 2300 ⁽¹⁷²⁾ | |
| Molybdenum..... | Mo (95.95) | 10.2 ⁽¹⁶⁸⁾ | 147 Br ⁽⁶⁾ 12 Sc 7 M ⁽¹⁶⁷⁾ | 260 to ⁽⁴⁾ 350 | 50 ⁽¹⁷⁶⁾ | 2625 ± 50 ⁽¹⁷⁸⁾ | i. H ₂ O;s. h. conc. HNO ₃ , H ₂ SO ₄ ;i. HCl;HF; dil. H ₂ SO ₄ , NH ₃ |
| Osmium..... | Os (190.2) | 22.48 ⁽¹⁶⁸⁾ | | | | 2700 ± 200 ⁽¹⁷²⁾ | i. H ₂ O;sl. s. HNO ₃ ;aq. reg.; i. NH ₃ |
| Platinum..... | Pt (195.23) | 21.45 ⁽¹⁶⁸⁾ | 35-90 Br ⁽⁶⁾ 18 Sc 4.3 M ⁽¹⁶⁷⁾ | 35 to ⁽⁴⁾ 53 | 22 ⁽¹⁷⁶⁾ | 1773.5 ± 1 ⁽¹⁷⁶⁾ | i. H ₂ O; r. aq. reg.; fus. alk. |
| Rhenium..... | Re (186.31) | 20 ⁽¹⁷⁶⁾ | | | | 3000 ⁽¹⁶⁸⁾ | s. conc. HNO ₃ , H ₂ O ₂ |
| Rhodium..... | Rh (102.91) | 12.44 ⁽¹⁷⁶⁾ | | | 42.5 ⁽⁵⁷⁾ | 1946 ± 3 ⁽¹⁷⁶⁾ | i. H ₂ O; s. H ₂ SO ₄ + HCl; h. conc. H ₂ SO ₄ ;sl. s. a. aq. reg. |
| Ruthenium..... | Ru (101.67) | 12.2 ⁽¹⁶⁸⁾ | 6.5 M ⁽¹⁶⁷⁾ | | | 2500 ± 100 ⁽¹⁷⁶⁾ | i. H ₂ O;sl. s. a. aq. reg.; i. al. eth. |
| Tantalum..... | Ta (180.88) | 16.6 ⁽¹⁶⁸⁾ | 75 Br ⁽⁶⁾ 10 Sc | 130 to ⁽⁴⁾ 178 | 27 ⁽¹⁷⁶⁾ | 3090 ± 100 ⁽¹⁷²⁾ | i. H ₂ O; s. HF; fus. alk.; i. a. |
| Thorium..... | Th (232.12) | 11.5 ⁽¹⁷⁶⁾ | | | | 1800 ± 50 ⁽¹⁷⁶⁾ | i. H ₂ O; s. HCl; H ₂ SO ₄ ; a. z. reg.; sl. s. HNO ₃ |
| Titanium..... | Ti (47.90) | 4.54 ⁽¹⁷⁶⁾ | 18R B to ⁽⁶⁾ 25 Rc 290 Br ⁽⁶⁾ 40 Sc | 80 to ⁽⁶⁾ 120 490 to ⁽¹⁾ 600 | 12.1 ⁽¹⁷⁶⁾ | 1820 ± 100 ⁽¹⁷⁶⁾ | i. H ₂ O; s. d. a. |
| Tungsten..... | W (183.92) | 19.3 ⁽¹⁷⁶⁾ | | | 50 ⁽¹⁷⁶⁾ | 3410 ± 20 ⁽¹⁷⁶⁾ | i. H ₂ O; s. h. conc. KOH; sl. s. HNO ₃ ; aq. reg. |
| Vanadium..... | V (50.95) | 5.68 ⁽¹⁷⁶⁾ | | | | 1735 ± 50 ⁽¹⁷⁶⁾ | i. H ₂ O; s. HNO ₃ , H ₂ SO ₄ ; HF; aq. reg.; i. HCl; alk. |
| Ytterbium..... | Yb (173.04) | | 85 Br ⁽⁶⁾ | 42 to ⁽⁶⁾ | 10.7 ⁽⁶⁾ | 1800 ⁽¹⁷⁶⁾ | d. H ₂ O (ev. H ₂) |
| Zirconium..... | Zr (91.22) | 6.4 ⁽¹⁶⁸⁾ | | | | 1860 ? ⁶ | i. H ₂ O; s. HF; aq. reg.; sl. s. a. |

* M. Moh's scale. Rc, Rockwell C. Rb, Rockwell B. Br, Brinell.
† See list of abbreviations Table 63, pp. 318-321.

TABLE 57. PROPERTIES OF REFRACTORY METALS (Continued)

| Material | Ep, °C | Vapor pressure, mm Hg | Sp heat, cal per g | Lin. coef. of therm. exp., °C × 10 ⁻⁶ | Coef. of therm. conduct., cal per sq cm per °C per cm | Resistivity, ohms per cc × 10 ⁻⁸ | Solubility ^{(105)†} |
|-----------------|---------------|--------------------------|-----------------------|--|---|--|---|
| Actinium..... | 1700 d. (106) | | | | | | |
| Boron..... | 2550 (105) | | 0.309 (178) | 2 (108) | | 1.8 × 10 ¹² (168) | i. H ₂ O s. HNO ₃ , H ₂ SO ₄ ; i. al., eth., alk. |
| Carbon..... | 4827 (105) | | 0.165 (178) | 0.6-4.3 (118) | 0.057 (170) | 1400 (168) | i. H ₂ O s. liq. Fe; i. a., alk. |
| (graphite) | sub. | | | | | | |
| Columbium..... | 3300 (105) | | | 7.1 (178) | | 20 (170) | i. H ₂ O s. h. H ₂ SO ₄ ; sl. s. HF; i. HCl, HNO ₃ |
| Hafnium..... | 5395 (105) | | 0.032 (178) | 6.5 (108) | 0.141 (170) | 5.3 (108) | i. H ₂ O i. HF i. H ₂ CO ₃ ; amor. s. aq. reg; i. a., aq. reg. |
| Iridium..... | 4900 (105) | | 0.065 (178) | 4.9 (178) | 0.350 (170) | 5.17 (170) | i. H ₂ O s. h. conc. HNO ₃ , H ₂ SO ₄ ; i. HCl, HF, dil. H ₂ SO ₄ , NH ₃ |
| Mosurium..... | | | | | | | |
| Molybdenum..... | 3560 (105) | | | | | | |
| Osmium..... | 5604 (105) | | 0.031 (167) | 6.1 (108) | | 9 (108) | i. H ₂ O; sl. s. HNO ₃ ; aq. reg.; i. NH ₃ |
| Platinum..... | 3910 (107) | | 0.032 (178) | 8.9 (108) | 0.166 (170) | 10 (20°C) (107) 25 (400°C) (107) | i. H ₂ O s. aq. reg.; fus. alk. |
| Rhenium..... | 5871 (105) | | 0.035 (178) | 12.5 (108) | | 21 (107) | s. conc. HNO ₃ , H ₂ O ₂ |
| Rhodium..... | 4500 (105) | | 0.060 (178) | 4.7 8.1 (108) | 0.213 (170) | 4.69 (0°C) (107) 6.6 (100°C) | i. H ₂ O; s. H ₂ SO ₄ + HCl; h. conc. H ₂ SO ₄ ; sl. s. a., aq. reg. |
| Ruthenium..... | 4900 (105) | | 0.061 (178) | 9.1 (108) | | 10 (108) | i. H ₂ O; sl. s. a., aq. reg.; i. al., eth. |
| Tantalum..... | 6100 (105) | | 0.036 (178) | 6.6 (108) | 0.130 (170) | 14.6 (108) | i. H ₂ O s. HF; fus. alk.; i. a. |
| Thorium..... | 5200 (105) | | 0.028 (178) | 11.1 (108) | | 18.6 (108) | i. H ₂ O s. HCl, H ₂ SO ₄ ; a. z. reg.; sl. s. HNO ₃ |
| Titanium..... | 3100 (105) | | 0.142 (178) | 8.5 (108) | | 3 (108) | i. H ₂ O s. d. a. |
| Tungsten..... | 5590 (105) | | 0.084 (178) | 4.3 (108) | 0.476 (170) | 5.51 (20°C) 98.9 (2700°C) 118 (3200°C) | i. H ₂ O s. h. conc. KOH; sl. s. HNO ₃ ; aq. reg. |
| Vanadium..... | 3000 (105) | | 0.115 (178) | | | 26 (108) | i. H ₂ O s. HNO ₃ , H ₂ SO ₄ , HF; aq. reg.; i. HCl, alk. |
| Ytterbium..... | | | | | | | d. H ₂ O (ev. H ₂) |
| Zirconium..... | 5050 (105) | | 0.066 (178) | 5.6 (178) | | 41 (178) | i. H ₂ O s. HF; aq. reg.; sl. s. a. |

† See list of abbreviations Table 63, pp. 318-321.

is permissible, then lower firing temperatures can be used. Firing in a neutral or oxidized atmosphere seems necessary as shown in the Siemens and Halske patent B339,726 (German).

The properties of sintered alumina ware are given at the end of this section, indicating its low porosity and high strength. These properties have made it particularly valuable as pyrometer tubes, spark-plug insulators, and crucibles for melting metals or glasses.

TABLE 58. PURITY OF COMMERCIAL BERYLLIUM OXIDE

| Constituent | Light fluffy* | High-fire standard purity* | Refractory grade† | Be(OH) ₂ † |
|--------------------------------------|---------------|----------------------------|-------------------|-----------------------|
| BeO‡..... | 99.8 | 99.8 | 99.3 | 53.5 |
| SiO ₂ | | 0.09 | 0.22 | 0.01 |
| Al ₂ O ₃ | 0.01 | 0.01 | 0.22 | 0.01 |
| Fe ₂ O ₃ | 0.10 | 0.10 | 0.07 | 0.01 |
| MgO..... | 0.02 | 0.02 | 0.12 | 0.01 |
| CaO..... | 0.02 | 0.02 | 0.02 | 0.01 |
| MnO..... | | | 0.005 | |
| Alkalies..... | 0.02 | | | 0.01 |
| Ignition loss..... | | | | 46.5 |

* Brush Beryllium Company.

† Clifton Products Company.

‡ By difference.

Beryllia. Considerable research has been done on pure, dense beryllia ware in the Ceramic Laboratory at the Massachusetts Institute of Technology. The details will be quoted at some length⁽²²⁾ from the *Journal of the American Ceramic Society*.

TABLE 59. PROPERTIES OF BERYLLIUM OXIDE

| | |
|--|-----------------------------|
| Melting point..... | 2510°C |
| Specific gravity..... | 3.0 |
| Hardness..... | 9 |
| Thermal conductivity..... | Very high |
| Heat-shock resistance..... | Excellent |
| Thermal expansion (mean up to 1400°C)..... | 9.3×10^{-6} °C |
| Vapor pressure (at 2080°C)..... | 1.8×10^{-3} mm Hg. |

Raw Materials. The production of BeO from beryl is completely described by Potvin⁽²⁰⁾ as carried out in the Degussa plants in Germany, and the ore resources and output are discussed in P.B. 60,386.⁽¹⁶⁾ The purity of available BeO materials is shown in Table 58, and the properties of pure BeO are given in Table 59. Most of this research was carried out with the highly purified hydroxide described in the last column.

The melting point of the highly purified oxide may be somewhat higher than the figures given in the literature. When the oxide is heated in a combustion furnace, it is volatile at temperatures as low as 1800°C; small crucibles fired several hours at this temperature may lose 50 per cent of their weight. The hardness of the fused material is about the same as or greater than that of sapphire, and instances have been noted where it even

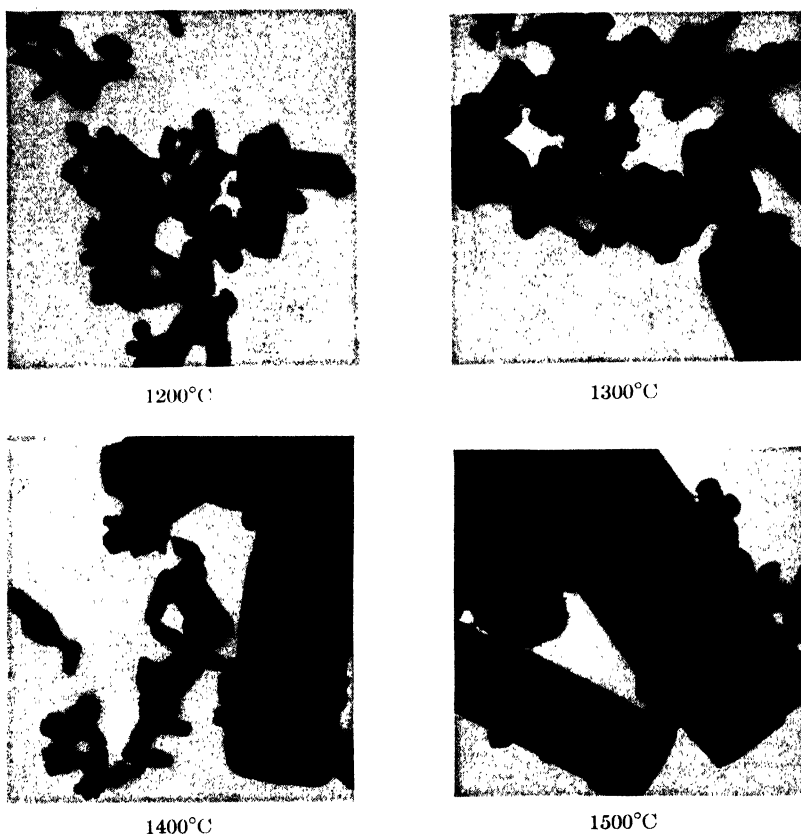

FIG. 167. Electron microscope photomicrographs of beryllia crystals as affected by calcining temperature. (Note: These photomicrographs are similar, but not identical with those in the original article.)

scratched a boron carbide mortar. The thermal conductivity has been reported to be relatively very high compared with other oxides. More work must be done to obtain quantitative data on the thermal conductivity of BeO, but it is known that its heat-shock resistance is unusually good.

Calcining Be(OH)₂. Early work on pressing bodies was carried out with the oxide, but a variability from batch to batch made consistent production impossible. The next step was to calcine the hydroxide at various tem-

peratures to find the conditions best suited to molding dense crucibles because the inherent crystal size is known to increase with calcining temperature.

Electron microscope photographs in Fig. 167 show the beryllia crystals clearly. At 1200°C calcination temperature, most of the crystals are 0.05 to 0.2 μ in size. At 1300°C, many crystals are of the same size, but a number of them are 1.0 to 2.0 μ long. At 1400°C, a few small particles still exist but large ones predominate 2.0 to 4.0 μ long; and at 1500°C, the mass

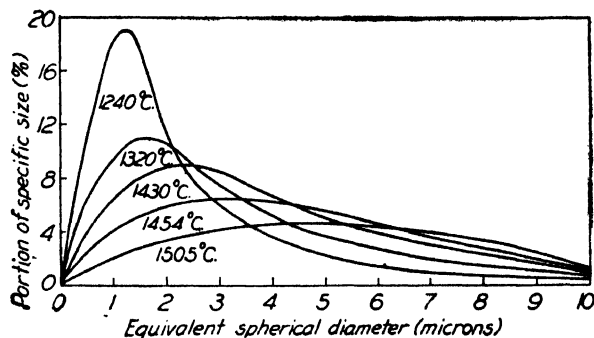

FIG. 168. Particle-size distribution of beryllia calcines determined by sedimentation methods.

consists entirely of crystals 2.0 to 4.0 μ long. The particle-size distribution by sedimentation, as shown in Fig. 168, gives somewhat different results, because clusters are measured rather than individual crystals. The increasing size with temperature, however, is clearly indicated.

The mechanism of crystal growth is a solid reaction whereby atoms or atom groups are dislodged from the crystal face by thermal agitation. Those atoms then are attracted to another nearby face and fall into a position to give the minimum surface energy. As large faces attract atoms more strongly than small ones, the large crystals grow at the expense of the small ones. Owing to the high vapor pressure of BeO in combustion gases, the growth is quite rapid.

Forming Procedures. A refractory body was readily made by bonding high-temperature calcine or fused grog with about one-third of its weight of fine, low-temperature calcined oxide. The mixture was blended with water without a binder and tamped in a mold. For more complicated shapes, an organic binder was required, and David⁽¹⁸⁾ suggests the use of a 4 per cent solution of BeCl₂ for this process.

Drain castings were made in plaster molds by the same casting technique used for clay slips. The 200-mesh fused oxide was ball milled in a 3.5-gal steel mill, the charge being 21 kg of nickel-steel balls, 4 kg of beryllia, and 2.4 kg of water. The mill was rotated at 60 rpm for 25 hr to produce

the particle-size distribution shown in Fig. 169. In the grinding process, a considerable amount of iron was picked up, which was leached out with hydrochloric acid. Three acid treatments and washings were used, and the slip was left with a pH between 4.5 and 5; this should be checked before casting. The specific gravity of the casting slip was 1.9 to 2.0, representing 37 to 33 per cent water, respectively.

Pressed ware has the advantage that it can be made nonporous, an important feature in melting crucibles.

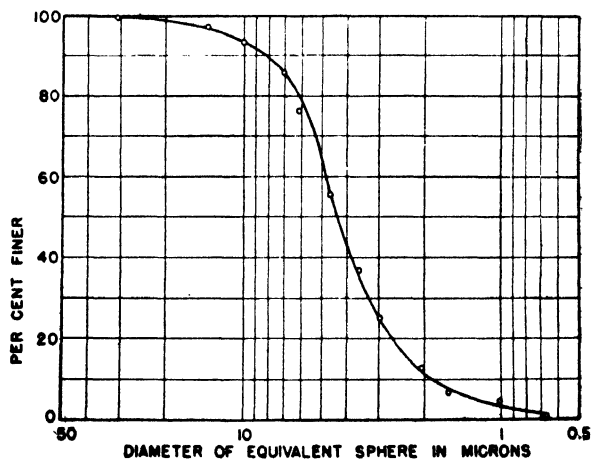

Fig. 169. Typical particle-size distribution for beryllia casting slip.

To press a hard abrasive powder such as beryllia requires an efficient lubricant. Many are available, but satisfactory results were obtained by the use of a water-soluble wax, such as Carbowax 4000, a polyethylene glycol with a molecular weight of 4000. Fourteen per cent of the dry wax was added to the dry ball-milled powder as a 20 per cent solution in water and was thoroughly incorporated. The mix was then partially dried at 80°C, nodulated by rubbing through a 14-mesh screen, and then completely dried, ready for pressing. Antisticking agents were found necessary in order to remove the piece from the die. Daxad No. 23 in the amount of 0.1 per cent of the mix was satisfactory.

Pressing was done in a carbon-chrome steel mold, heat-treated at 58 to 62 Rockwell C hardness. A typical die is shown in Fig. 170. The working surfaces were lapped to a high polish, and a slight taper permitted easy removal of the finished piece. The molding was done in a hydraulic press at 20,000 to 30,000 psi, and a weighed amount of mix was used to produce uniform size of piece.

The pressed pieces were strong and had a highly polished surface. In this state, they could be machined to close tolerances with tungsten carbide tools.

Firing Procedure. To remove the wax from pressed ware, the piece was placed in a closed sagger of insulating firebrick and heated uniformly for a period of 8 hr until a maximum temperature of 500°C was reached. The removal of the wax is a critical operation and must be carefully controlled or cracking will result. The wax may be removed at a much lower temperature in a vacuum.

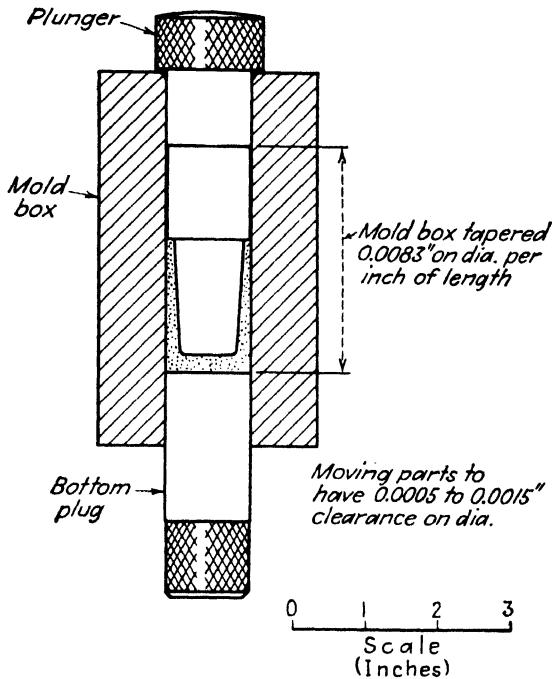

FIG. 170. Steel die used in preparing beryllia crucibles.

Cast pieces can be pre-fired to 1000°C to make them strong enough for finishing.

The preheated ware was next fired to 1800°C and held at this temperature for 30 min to give a maximum density. The rate of heating depends on the size of the piece (small pieces can be fired in 4 or 5 hr). The firing was carried out in catenary kilns made of fused-alumina brick and fired by premixed city gas and cold air to a temperature of 1800°C . A small alumina furnace was also used, which was fired by oxygen and propane where temperatures of 2000°C could be reached. Some runs were made in a vacuum with high-frequency heating. Beryllia is volatile at this temperature, since weight losses of 2 to 4 per cent were usual, while some crucibles, which were fired for several cycles, lost over 50 per cent in weight. The vaporized beryllia condensed in the cooler portions of the furnace.

Little is known definitely about the way in which the pores between the crystals close up, but there seem to be two steps. The first is the approach to a spherical pore either by surface flow due to surface-tension forces or by transfer in the vapor state from the long radius of curvature portions to the more highly curved parts where they may adhere with a lower surface energy. The second step is closing the pore itself by some sort of solid flow under surface-tension forces. It is well known that at very low stresses, pure metals flow viscously, probably by migration of lattice defects. The same may well occur in the heated BeO crystals. The gas in the pores escapes by interconnecting passage until the end, where a small volume is trapped in the remaining closed pores.

If ware with some porosity is required, the firing temperature can be lowered; even 1500°C gives a fairly strong piece.

Properties and Uses. The dense BeO showed no dye absorption but had some closed pores, since the bulk density ranged from 2.7 to 2.9 rather than the theoretical value of 3.0. The body was translucent in thin sections, and the surface was pure white and smooth.

Beryllia is a particularly valuable refractory because of its high working temperature—500°C (about 930°F) above pure alumina—so that it may be used as cores for tungsten-wound furnaces, insulation in high-frequency induction furnaces, and insulators in radio tubes. Its high thermal conductivity gives it excellent heat-shock resistance, and its high stability makes it a valuable crucible material for melting pure metals such as iron, nickel, and the platinum metals. Claussen⁽¹⁵⁾ and Kirby⁽⁶⁴⁾ claim that it is suitable for melting pure beryllium. Also it has been suggested for melting glasses and slags.

BeO is more inert in contact with C or CO than is MgO and thus can be used up to 2000°C⁽¹⁷⁾ as supports and shields with graphite heaters in the induction furnace. Beryllia is claimed to have excellent hot strength⁽¹¹⁾ and therefore should be valuable in the jet-propulsion field. Also this oxide has nuclear properties that make it of great value in atomic power development.

Attention is called here to the extreme health hazard in using beryllium and its compounds. As yet, little is known about the toxic effects, but evidence points to the fact that certain individuals are susceptible to dust or vapors of the metal or its compounds, which causes a serious lung condition. Extreme precautions should therefore be taken to have ample ventilation for any dusty process and to carry off all fumes from furnaces.

Thoria. This oxide, because of its high fusion point, is difficult to fire to a dense mass when of high purity. Except for a higher firing temperature, the procedure described for beryllia can be followed in forming small objects. Swanger and Caldwell⁽⁴⁰⁾ describe tamped crucibles of fused

thoria moistened with a 20 per cent solution of ThCl_4 to form a dense body with an apparent density of 9.5 to 9.7 when fired at 1800°C . Richardson⁽⁴²⁾ describes the casting of thoria crucibles in plaster molds with P_2O_5 as a deflocculant and also a furnace for firing them at 1900°C .

The main use of thoria would be for extremely high temperature use in an oxidizing atmosphere or vacuum, such as melting the platinum metals. On the other hand, as it is a fissionable material, its use may have future restrictions. Richardson⁽⁴²⁾ also states that pure zirconium, thorium, iron, and uranium can be melted in thoria without wetting it. Swanger and Caldwell⁽⁴⁰⁾ state that osmium can be melted in thoria.

Thorium compounds should be handled with care, because on being stored in closed containers, they produce radioactive gases that are a possible health hazard. Therefore, a container of such compounds should only be opened under a hood or in the open air.

Magnesia. This plentiful and highly refractory oxide is perhaps the most promising for work in the high-temperature field. However, it must be of high purity and therefore requires very high firing temperatures to vitrify. The rate of crystal growth on heating is given by Birks and Friedman.⁽²⁵⁾ One to two per cent silica is helpful in bringing down the firing temperature and extending the maturing range.

The casting of MgO is possible in water suspensions but difficult because of the rapid hydration. The method of making slips with absolute alcohol developed at the Bureau of Standards⁽⁴⁵⁾ works very satisfactorily. Extrusion with a cellulose acetate bond is described by Partridge and Lait.⁽⁴⁴⁾

The high thermal expansion of magnesia, however, makes it rather sensitive to thermal shock; and at elevated temperatures, it reacts with carbon, forming magnesium vapor and carbon monoxide. In a vacuum, its high vapor pressure causes it to volatilize rather rapidly above 2000°C . Swanger and Caldwell⁽⁴⁰⁾ state that magnesia crucibles are suitable for melting Ni, Fe, Cu, and Pt without contamination.

Zirconia. This oxide is relatively plentiful and has a melting point about 500°C above alumina, thus making an excellent high-temperature refractory. Because of the rapid inversion of the pure oxide on heating and cooling, it is very sensitive to temperature changes and for practical use must be stabilized by additions to maintain the cubic lattice. The work of Pole, Bernbach, and Gilbert⁽³¹⁾ showed that the inversion could be reduced or eliminated by additions of CaO or MgO . However, Curtis⁽³²⁾ showed that the most heat-shock-resistant body had the inversion only partially eliminated and suggested additions of (1) 8 to 12 per cent CaO , (2) 6.7 per cent CaO , plus 3.7 per cent MgO and (3) 2.3 per cent CaO plus 6.4 per cent MgO . Several companies are now marketing stabilized zirconia, probably with somewhat the above additions.

Few data are available on the production of dense zirconia bodies, but the procedure outlined for beryllia would probably be satisfactory here. In fact, Thompson and Mallet⁽⁴⁵⁾ describe a method of casting zirconia crucibles as well as ramming with a $ZrCl_4$ bond.

Titania. There is little data on pure TiO_2 as a refractory, for most of the published work is concerned with it as an ingredient in electrical insulators. However, with a melting point of $1850^\circ C$ it might have value for special purposes. Siemens describes a dense sintered TiO_2 body prepared like alumina. Reduction of TiO_2 to the suboxide TiO occurs readily in the presence of CO or H_2 .

Chrome Oxide. The pure oxide is seldom used as a refractory but can undoubtedly be used where it is not subject to reducing conditions. On the other hand, the high vapor pressure is a disadvantage. Some work is now being carried out in the Ceramics Laboratory of the Massachusetts Institute of Technology on the production of dense ware from this material as crucibles for melting.

Lime, Baria and Strontia. These oxides have high fusion points but are subject to hydration. It is possible, however, to form dense, pure refractories from them in the same way as for magnesia.

The Rarer Oxides. There are a number of rarer oxides of high melting point such as CeO_2 , La_2O_3 , Y_2O_3 , and HfO_2 that would undoubtedly make excellent refractories if they were more available. Perhaps some of them have properties that would make them useful in the laboratory even in small amounts. There is little information concerning them now, but their properties should be determined.

The Spinels. The spinels of high melting point, magnesia spinel ($MgAl_2O_4$), barium spinel ($BaAl_2O_4$), and chrysoberyl ($BeAl_2O_4$), can all be readily prepared by solid reaction of the constituent oxides, in some cases assisted by boric acid as a fugitive flux.⁽³³⁾ It has been claimed that spinels can be formed only by amorphous starting materials, but this is not strictly true.

There is no reason to believe that these compounds cannot be formed into dense bodies in the same way as described for beryllia. In general, they are quite resistant to attack by slags and glasses and should be excellent refractories. However, we need to know more about their properties.

A patent of General Motors, British Patent 509,516, describes a spinel series with Mn, Ni, or Co that can be fired to a dense body for a spark-plug insulator.

The High-temperature Silicates. $ZrSiO_4$, Be_2SiO_4 , Mg_2SiO_4 , and Ca_2SiO_4 all have high fusion points and for some purposes are excellent refractories. Their forming and firing are similar to the methods described for alumina or beryllia. Some of their properties are given at the end of this section.

The High-temperature Zirconates. ThZrO_4 , BaZrO_3 , CaZrO_3 , MgZrO_3 , and SrZrO_3 are all high-melting-point compounds on which little information is available. The work of Pole, Bernbach, and Gilbert⁽⁶¹⁾ gives some properties of these refractories.

Phosphates. Henry⁽⁶⁷⁾ has suggested cerium and zirconium phosphates as refractories, but they seem unstable and gradually lose P_2O_5 . A few other phosphates are shown in Table 60, but little is known of their stability.

TABLE 60. SOME REFRACTORY PHOSPHATES⁽¹⁶⁸⁾

| Compound | Molecular weight | Melting point, °C | Specific gravity |
|--|------------------|-------------------|------------------|
| $\text{Ca}_6\text{P}_3\text{ClO}_2$ | 520.88 | 1530 | 3.17 |
| $\text{CaF}_2 \cdot 3\text{Ca}_3\text{P}_2\text{O}_8$ | 1,008.84 | 1630 | 3.18 |
| $10\text{CaO} \cdot 3\text{P}_2\text{O}_5$ | 986.844 | 1540 | 2.89 |
| $\text{Ca}_4\text{P}_2\text{O}_9$ | 366.328 | 1630 | 3.06 |
| $\text{Ca}_3(\text{PO}_4)_2$ | 310.258 | 1670 | 3.14 |
| $\text{BaF}_2 \cdot 3\text{Ba}_3\text{P}_2\text{O}_8$ | 1,981.84 | 1670 | |
| $\text{BaCl}_2 \cdot 3\text{Ba}_3\text{P}_2\text{O}_8$ | 2,014.76 | 1584 | 5.949 |

4. Refractory Porcelains. A porcelain body is distinguished from a pure oxide body in general by having small amounts of other materials mixed with the principal oxide to lower the maturing temperature, increase the maturing range, or control the crystal growth. In the early development of refractory porcelains, it was recognized that the glassy phase must be minimized or eliminated and the crystal size kept small.

An improvement over the usual feldspathic porcelain was the Marquardt body having a composition of 35.12 per cent SiO_2 , 63.20 per cent Al_2O_3 , and 1.65 per cent K_2O .⁽⁷¹⁾ Some years later when Bowen and Grieg discovered that the stable crystal in the alumina-silica system was mullite ($\text{Si}_2\text{Al}_6\text{O}_{13}$), porcelains with the composition 28 per cent SiO_2 and 72 per cent Al_2O_3 were found much superior to others for laboratory ware, spark plugs, and thermocouple protection tubes. However, to reach maturity at commercial temperatures a small amount of flux was often used.

While it is generally believed that the pure alumina body previously described gives a structure with the optimum properties, the high firing temperature has caused many experimenters to develop other bodies with lower maturing temperatures, particularly in the field of spark-plug insulators. For example, Jeffery (French Patent 405,270) adds a small amount of lime, magnesia, and silica; Fessler and Schwartzwalder (British Patent 546,770), 10 to 25 per cent silica and 1 to 9 per cent magnesia; McDougal, Schwartzwalder, and Fessler (British Patent 546,759), beryllia and silica; McDougal, Fessler, and Schwartzwalder (British Patent 372,939), 0.5 per

cent Cr_2O_3 ; Bosch (German Patent 705,679) kaolin and silica; and Fessler and Schwartzwaldner (French Patent 368,968), 1 to 15 per cent zircon.

Much work has been done on zircon porcelains—mainly, however, for high electrical properties. Russell and Mohr⁽⁷⁰⁾ give some excellent data on these bodies.

Considerable interest has been shown in cordierite bodies containing theoretically 13.78 per cent MgO , 34.84 per cent Al_2O_3 and 51.38 per cent SiO_2 , because of their very low coefficient of expansion. Wisely and

TABLE 61. PORCELAINS WITH LESS THAN 0.1 PER CENT ABSORPTION⁽⁷¹⁾

| Composition, moles | | | Maturing temperature °C range | Linear shrinkage, range | Absorption | Coefficient of expansion, 700–800°C | Relative thermal conductivity | Crushing strength, M psi |
|--------------------|-------------------------|-------------------------|-------------------------------|-------------------------|------------|-------------------------------------|-------------------------------|--------------------------|
| MgO | BeO | Al_2O_3 | | | | | | |
| 1 | 24 | 1 | 1600–1725 | 15.5–17.6 | 0.1 | 10.8 | 9 | 169 |
| 1 | 16 | 1 | | | 0.1 | | 7 | |
| 1 | 8 | 1 | 1625–1725 | 13.6–14.4 | 0.1 | | 5 | 152 |
| 1 | 4 | 1 | 1680–1725 | 11.2–12.0 | 0.1 | 9.4 | 4 | 142 |
| 1 | 2 | 1 | 1650 | 9.7 | 0.1 | | | |
| 4 | 96 | 1 | 1500–1635 | | 0.1 | 10.3 | 11 | 105 |
| 4 | 48 | 1 | 1500–1635 | 16.8–19.4 | 0.1 | | 11 | |
| 4 | 24 | 1 | 1600–1630 | 14.4–20.5 | 0.1 | | 12.5 | 133 |
| 4 | 16 | 1 | 1630 | 15.5–20.0 | 0.1 | | 9 | |
| BeO | Al_2O_3 | ThO_2 | | | | | | |
| 160 | 2 | 1 | 1650 | | 0.0 | 10.4 | 25 | 244 |
| 48 | 1 | 1 | 1750 | | 0.02 | | | 279 |
| BeO | Al_2O_3 | ZrO_2 | | | | | | |
| 8 | 1 | 2 | | | | 9.3 | | |

Gobler⁽⁷⁷⁾ give some results on this body, finding that B_2O_3 and P_2O_5 are the best mineralizers.

Beryl porcelains also have low expansion coefficients as shown by Hummel and Henry.⁽⁷²⁾ A composition of 80 per cent natural beryl and 20 per cent Florida clay, when fired to 1300°C for 9 hr, had an expansion of about 1.0×10^{-6} (twice that of fused quartz) but deformed above 1350°C, so it would not be useful for really high temperatures.

The most thorough study in the field of high-temperature porcelains is the work of Geller and his associates at the National Bureau of Standards.⁽⁷¹⁾ Some of the more promising bodies in the field of MgO – BeO – Al_2O_3 , together with their properties, are given in Table 61.

The system $\text{BeO-Al}_2\text{O}_3\text{-ThO}_2$ showed complete vitrification in only a limited range up to 1800°C , but probably higher maturing temperatures would give other excellent porcelain bodies.

In the system $\text{Be-Al}_2\text{O}_3\text{-ZrO}_2$ there were no vitrified bodies up to 1800°C , but here again it would be expected that excellent bodies might result from higher firing temperatures.

In Table 62 are shown some high-melting eutectic compounds that might be of interest in the development of porcelains. In Table 63 are shown the important properties of the refractory oxides.

TABLE 62. SOME HIGH-MELTING EUTECTICS⁽⁷¹⁾

| Composition by Weight | Melting Point, $^\circ\text{C}$ |
|---|---------------------------------|
| 27% BeO, 73% Al_2O_3 | 1865 |
| 14% BeO, 86% Al_2O_3 | 1880 |
| 43% BeO, 57% MgO..... | 1850 |
| 20% BeO, 80% ThO_2 | 2200 |
| 19% BeO, 81% ZrO_2 | 2240 |
| 35% BeO, 65% CaO..... | 1450 |
| 28% BeO, 44% MgO, 28% Al_2O_3 | 1640 |
| 19% BeO, 39% Al_2O_3 , 43% ZrO_2 | 1750 |
| 11% BeO, 48% Al_2O_3 , 40% ThO_2 | 1810 |
| 18% BeO, 37% Al_2O_3 , 45% ThO_2 | 1795 |
| 55% Al_2O_3 , 45% ZrO_2 | 1885 |
| 61% Al_2O_3 , 39% ThO_2 | 1910 |
| 85% ZrO_2 , 17% CaO..... | 2260 |
| 55% MgO, 45% Al_2O_3 | 2030 |
| 38% MgO, 62% SiO_2 | 1850 |
| 25% MgO, 75% ZrO_2 | 2250 |
| 75% ZrO_2 , 25% SiO_2 | 2210 |

5. Carbides. The carbides are among the most stable of the solids, as several are believed to have softening points above 3500°C . They are hard, have fair thermal and electrical conductivity, but have only limited stability at high temperatures in air. In Table 64 are listed the available properties of the more stable carbides together with carbon itself.

Production of the Raw Material. Much literature is available on the production of the hard carbides for use in cutting tools. For example, tungsten carbide is made by grinding tungsten powder with 7 per cent carbon black and heated to 1600°C for 2 hr in a graphite container and cooled in an H_2 atmosphere. The cake contains 6.1 to 6.4 per cent combined carbon and 0 to 0.3 per cent free carbon. This material is wet ball milled in carbide mills to the desired size. Titanium carbide is made by adding 80 per cent of the theoretical carbon to titania, with TiO_2 or C added to correct the composition. This charge is then heated to 1900°C . Vanadium and neodymium carbides are made exactly like titanium carbide,

TABLE 63. PROPERTIES OF REFRACTORY OXIDES

| Material | Formula | Sp gr. g per CC | Hardness* | Tensile strength, M psi | Compressive strength, M psi | Young's modulus of elasticity, Mil. psi | Mp, °C | Bp, °C | Solubility ⁽¹⁹³⁷⁾ |
|--|--|-------------------------------|---|---|---|--|----------------------------|-----------------------------------|--|
| Aluminum oxide (<i>α</i> -alumina) | Al ₂ O ₃ (101.92) | 3.97 ⁽¹⁵⁾ | 9 M ⁽¹⁸⁵⁾ 2000 K ⁽¹⁷⁸⁾ | 36 (20°C) ⁽¹¹⁾ 33 (500°C) 18 (1200°C) | 413 (20°C) ⁽¹¹⁾ 70 (500°C) 20 (1200°C) | 52 (20°C) ⁽¹¹⁾ 50 (800°C) 32 (1400°C) | 2050 ⁽¹⁶⁵⁾ | 2380 ⁽¹⁷³⁾ | sl.s. H ₂ O v. sl. s. a., alk. |
| Barium oxide (baria) | BaO (153.37) | 5.72 ⁽¹⁶⁶⁾ | 3.3 M | | | | 1923 ⁽¹⁶⁸⁾ | 2200 ⁽¹⁷³⁾ | d. H ₂ O s. H ₂ O s. dil. a., al. i. NH ₃ acet. |
| Beryllium oxide (beryllite) | BeO (25.02) | 3.00 ⁽¹⁷³⁾ | 9 M ⁽⁵³⁾ 1250 K ⁽¹³³⁾ | 14 (20°C) ⁽¹¹⁾ 8 (500°C) 0.63 (1200°C) | 103 (20°C) ⁽¹¹⁾ 60 (500°C) 25 (1200°C) | 45 (20°C) ⁽¹¹⁾ 28 (800°C) 12 (1400°C) | 2530 ± 30 ⁽¹⁷²⁾ | 3300 ⁽¹⁷³⁾ | sl.s. H ₂ O s. conc. H ₂ SO ₄ fus. KOH i. dil. a., alk. |
| Calcium oxide (lime) | CaO (56.08) | 3.32 ⁽¹⁷³⁾ | 4.5 M | | | | 2572 ⁽¹⁶⁸⁾ | 2850 ⁽¹⁷³⁾ | d. H ₂ O s. H ₂ O s. a. |
| Cerium oxide (ceria) | CeO ₂ (172.13) | 7.13 ⁽¹⁷³⁾ | 6 M | | | | 2600 ⁽¹⁷³⁾ | 3000 ⁽¹⁷²⁾ | i. H ₂ O s. H ₂ SO ₄ , HNO ₃ i. dil. a. |
| Chromic oxide | Cr ₂ O ₃ (152.02) | 5.21 ⁽¹⁶⁸⁾ | | | | | 2435 ± 50 ⁽¹⁷²⁾ | 3000 ⁽¹⁷²⁾ | i. H ₂ O i. a., alk. |
| Cobalt oxide | CoO (74.94) | 6.46 ⁽¹⁷³⁾ | | | | | 1800 ⁽¹⁷³⁾ | 3000 ⁽¹⁷²⁾ | i. H ₂ O s. a., NH ₄ OH i. al. |
| Columbium oxide | Cb ₂ O ₅ (265.32) | 4.46 ⁽¹⁷³⁾ | | | | | 1520 ⁽¹⁷³⁾ | 2595 ⁽¹⁷³⁾ | |
| Ferric oxide (hematite) | Fe ₂ O ₃ (159.68) | 5.20 ⁽¹⁷³⁾ | 5.5-6.5 M ⁽¹⁷⁹⁾ | | | | 1550 ⁽¹⁷³⁾ | | i. H ₂ O s. HCl |
| Gallium oxide | Ga ₂ O ₃ (187.44) | 6.44 ⁽¹⁷⁹⁾ 5.88 | | | | | 1740 ⁽¹⁷³⁾ | | i. H ₂ O s. h. a., alk. |
| Hafnium oxide (hafnia) | HfO ₂ (210.6) | 9.68 ⁽¹⁷³⁾ | | | | | 2810 ⁽¹⁷³⁾ | | i. H ₂ O |
| Lanthanum oxide (lanthas) | La ₂ O ₃ (325.84) | 6.51 ⁽¹⁶⁶⁾ | | | | | 2320 ⁽¹⁷³⁾ | 4200 ⁽¹⁷³⁾ | d. H ₂ O s. H ₂ O s. a., NH ₄ Cl i. acet. |
| Lithium oxide (lithia) | Li ₂ O (29.88) | 2.01 ⁽¹⁷³⁾ | | | | | 1700 ⁽¹⁷³⁾ | 1200 ⁽¹⁷³⁾ (600 mm) | d. H ₂ O s. H ₂ O s. acet. s. al. s. eth. |
| Magnesium oxide (periclase) | MgO (40.32) | 3.58 ⁽¹⁷³⁾ | 6 M ⁽³⁰⁾ | | | | 2800 ⁽¹⁶⁸⁾ | 2830 ⁽¹⁷³⁾ | sl. d. H ₂ O s. H ₂ O s. a., NH ₄ salts: i. al. |

| | | | | | |
|--|--|------------------------|---|----------------------------|--|
| Manganese oxide . . . (manganosite) | MnO (70.93) | 5.40 ⁽¹⁷²⁾ | 5-6 M ⁽¹⁷⁹⁾ | 1785 ⁽¹⁷⁸⁾ | i. H ₂ O s. a. NH ₄ Cl |
| Nickel oxide (bunsenite) | NiO (74.69) | 6.8 ⁽¹⁷³⁾ | 5.5 ⁽¹⁷⁹⁾ | 1990 ⁽¹⁷²⁾ | i. H ₂ O s. a. NH ₄ OH |
| Silicon oxide (high cristobalite) | SiO ₂ (60.06) | 2.32 ⁽¹⁶⁸⁾ | 7 M ⁽¹⁸¹⁾ 820 K ⁽¹⁷⁸⁾ | 1728 ⁽¹⁷⁶⁾ | i. H ₂ O s. HF v. sl. s. alk. |
| Strontium oxide (strontia) | SrO (103.63) | 4.7 ⁽¹⁶⁸⁾ | 3.5 M | 2430 ⁽¹⁶⁹⁾ | d. H ₂ O to Sr(OH) ₂ sl. s. al. i. eth. acet. |
| Tantalum oxide | Ta ₂ O ₅ (441.76) | 8.02 ⁽¹⁷⁸⁾ | | 1875 ⁽¹⁷³⁾ | i. H ₂ O s. fus. KHSO ₄ i. a. |
| Thorium oxide (thoria) | ThO ₂ (264.12) | 9.89 ⁽¹⁶⁸⁾ | 6.5 M | 3050 ⁽¹⁷⁶⁾ | i. H ₂ O s. h. H ₂ SO ₄ i. alk. dil. a. |
| Tin oxide (cassiterite) | SnO ₂ (150.70) | 7.00 ⁽¹⁷³⁾ | 6-7 M | 1825 ⁽¹⁷³⁾ | i. H ₂ O i. KOH. NaOH i. aq. a. |
| Titanium oxide (rutile) | TiO ₂ (79.90) | 4.17 ⁽¹⁷³⁾ | 5.5-6.5 ⁽¹⁷⁹⁾ | 1830 ⁽¹⁷³⁾ | i. H ₂ O s. H ₂ SO ₄ alk. i. a. |
| Tungsten oxide (tungstite) | WO ₃ (231.92) | 7.16 ⁽¹⁷⁸⁾ | | 1473 ⁽¹⁶⁸⁾ | i. H ₂ O s. a. KOH |
| Uranium oxide | UO ₂ (270.07) | 10.75 ⁽¹⁷³⁾ | | 2280 ⁽¹⁷³⁾ | i. H ₂ O s. HNO ₃ conc. H ₂ SO ₄ |
| Vanadium oxide | V ₂ O ₅ (149.90) | 4.87 ⁽¹⁶⁸⁾ | | 1970 ⁽¹⁶⁸⁾ | sl. s. H ₂ O s. HNO ₃ HF. alk. |
| Yttrium oxide (yttria) | Y ₂ O ₃ (225.84) | 4.54 ⁽¹⁷³⁾ | | 2410 ⁽¹⁶⁶⁾ | s. H ₂ O s. a. i. alk. |
| Zinc oxide (zincite) | ZnO (81.38) | 5.66 ⁽¹⁷³⁾ | 4-4.5 M ⁽¹⁷⁹⁾ | 1675 ± 25 ⁽¹⁷²⁾ | s. H ₂ O s. min. a. dil. ac. a. NH ₄ OH |
| Zirconium oxide (zirconia) | ZrO ₂ (123.22) | 6.27 ⁽¹⁷³⁾ | 6.5 M ⁽¹⁷⁹⁾ 1160 K ⁽¹⁷³⁾ | 2060 ± 20 ⁽⁷²⁾ | i. H ₂ O s. H ₂ SO ₄ . AF |

* K = Knoop scale, M = Mohs scale.

† Explanation of abbreviations:

- a. = acid
- alk. = alkali
- d. = decomposes
- dil. = dilute
- i. = insoluble
- min. = mineral
- s. = soluble
- sl. = slightly
- v. = very

TABLE 63. PROPERTIES OF REFRACTORY OXIDES (Continued)

| Material | Sp. heat, cal per g | Lin coef of therm exp. $\times 10^{-6}$ | Coef of therm conductivity, $\text{Btu hr}^{-1} \text{ft}^{-2}$ $\text{in.}^2 \text{F}^{-1}$ | Resistivity, ohms per cc | $F_{250^\circ\text{C}} \text{ (HR)}$ | $H_{250^\circ\text{C}} \text{ (HR)}$ | $S_{250^\circ\text{C}} \text{ (HR)}$ | Solubility (opt) |
|--|--|---|---|--|--------------------------------------|--------------------------------------|--------------------------------------|---|
| Aluminum oxide (α -alumina) | 0.21 (20°C) ⁽¹¹⁾ 0.25 (500°C) 28 (1000°C) | 6 (20°C) ⁽¹¹⁾ 7 (500°C) 9 (1000°C) | 17 (20°C) ⁽¹¹⁾ 6 (500°C) 4 (1000°C) | 2×10^{12} (100°C) ^(11a) 3×10^{12} (300°C) | -365.9 | -388.1 | -74.58 | sl. s. H ₂ O, v. sl. s. a., alk. |
| Barium oxide (baria) | | | | 1×10^8 (300°C) ^(11a) 2.2×10^7 (500°C) | | | | d. H ₂ O, s. H ₂ O, s. dil. a., al. i. NH ₃ , acet. |
| Beryllium oxide (beryllite) | 0.24 (20°C) ⁽¹¹⁾ 0.50 (500°C) | 8 (100°C) ⁽¹¹⁾ 8 (500°C) 9 (1000°C) | 10.4 (1200°C) | 8×10^{13} (1000°C) 3.5×10^{10} (1500°C) 8×10^8 (2100°C) | -132.0 | -139.0 | -23.42 | sl. s. H ₂ O, s. conc. H ₂ SO ₄ , fus. KOH, i. dil. a., alk. |
| Calcium oxide (lime) | | | | | -144.3 | -151.7 | -24.96 | d. H ₂ O, s. H ₂ O, s. a. |
| Cerium oxide (ceria) | | 8.6 (500°C) ^(5a) | | 2.2×10^3 (800°C) ^(5a) 1.9×10^4 (1200°C) | | | | i. H ₂ O, s. H ₂ SO ₄ , HNO ₃ , i. dil. a. |
| Chromic oxide | | 7 (500°C) ^(5a) 12 (500°C) ^(5b) | | 12.7×10^4 (350°C) ^(5a) 7.5×10^4 (750°C) | -251.1 | -270.6 | -65.51 | i. H ₂ O, i. a., al., alk. |
| Cobalt Oxide | | | | | -176.5 | -196.0 | | i. H ₂ O, s. a., NH ₄ OH, i. al. |
| Columbium oxide | | | | | | | | |
| Ferric oxide (hematite) | | | | 3.6×10^{-2} (20°C) ⁽¹²⁾ 2.8×10^{-2} (200°C) | -179.1 | -198.5 | -65.0 | i. H ₂ O, s. HCl |
| Gallium oxide | | | | | | | | i. H ₂ O, s. h. a., alk. |
| Hafnium oxide (hafnia) | | | | | | | | i. H ₂ O |
| Lanthanum oxide (lantania) | | | | | | | | d. H ₂ O, s. H ₂ O, s. a., NH ₄ Cl, i. acet. |
| Lithium oxide (lithia) | | | | | | -9.6 | | d. H ₂ O, s. H ₂ O, s. acet., s. al., s. eth. |
| Magnesium oxide (periclase) | | 11 (100°C) ⁽¹¹⁾ 13 (500°C) 15 (1000°C) | 36 (20°C) ⁽¹¹⁾ 12 (500°C) | 9×10^{12} (1000°C) 7×10^8 (1500°C) 2×10^8 (2100°C) | -138.43 | -146.1 | -25.73 | sl. d. H ₂ O, s. H ₂ O, s. a., NH ₄ salts, i. al. |

| | | | | | | |
|---------------------------------------|--|--|--------|--------|--------|---|
| Manganese oxide. (manganosite) | 0.23 (20°C) ⁽¹¹⁾ 0.26 (500°C) 0.28 (1000°C) | | -87.8 | -93.1 | -17.73 | i. H ₂ O:s. a., NH ₄ Cl |
| Nickel oxide. (bunsenite) | | 6.7 × 10 ³ (600°C) ⁽⁹⁸⁾ 1.4 × 10 ⁴ (1000°C) 2.4 × 10 ⁴ (1250°C) | -51.7 | -58.4 | | i. H ₂ O:s. a., NH ₄ OH |
| Silicon oxide. (high cristobalite) | | 1 × 10 ¹⁵ (20°C) 7 × 10 ⁶ (500°C) | | -12.5 | | i. H ₂ O:s. HF;v. sl.s. alk. d. H ₂ O to Sr(OH) ₂ ;sl. s. al.;i. eth.,acet. |
| Strontium oxide. (strontia) | | | | | | i. H ₂ O;s. fus. KHSO ₄ ;i. a. |
| Tantalum oxide. | | | | | | i. H ₂ O:s.;h. H ₂ SO ₄ ;i.alk.;dil.;a. |
| Thorium oxide. (thoria) | 8 (100°C) ⁽¹¹⁾ 9 (500°C) 9 (1000°C) | 4 × 10 ¹³ (20°C) 1.2 × 10 ¹² (500°C) | | | | i. H ₂ O;d. KOH,NaOH;i. aq. a. |
| Tin oxide. (cassiterite) | 3.3 (500°C) ⁽⁶⁴⁾ | 6.6 × 10 ³ (800°C) ⁽⁹⁸⁾ 2.6 × 10 ² (1000°C) 1.0 × 10 ¹ (1300°C) | | | | i. H ₂ O;s. H ₂ SO ₄ , alk.;i. s. |
| Titanium oxide. (rutile) | 7 (500°C) ⁽⁷¹⁾ | 11.7 × 10 ³ (900°C) ⁽⁹⁸⁾ 7.5 × 10 ³ (1000°C) 4.4 × 10 ² (1300°C) | -205.1 | -218.0 | -43.23 | i. H ₂ O;s. a.;,KOH |
| Tungsten oxide. (tungstite) | | | -59.8 | -66.6 | | H ₂ O;s. HNO ₃ ,conc. H ₂ SO ₄ |
| Uranium oxide. | | | -204.0 | -313.0 | -64.04 | sl. s. H ₂ O;s. HNO ₃ ;HF,alk. s. H ₂ O;s. a.;i. alk. |
| Vanadium oxide. | | | | | | s. H ₂ O;s. min. a.;dil. ac. a.;NH ₄ OH |
| Yttrium oxide. (yttria) | | | -76.5 | -83.3 | | i. H ₂ O;s. H ₂ SO ₄ ;AF |
| Zinc oxide. (zincite) | | 6.7 × 10 ³ (800°C) ⁽⁹⁸⁾ 7.1 × 10 ² (1000°C) 5 × 10 ¹ (1350°C) | | | | |
| Zirconium oxide. (zirconia) | 0.12 (20°C) ⁽¹¹⁾ 0.16 (500°C) | | -246.0 | -258.5 | -41.8 | |

† Explanation of abbreviations:

a. = acid
alk. = alkali
aq. reg. = aqua regia
d. = decomposes
dil. = dilute
i. = insoluble
min. = mineral
s. = soluble
sl. = slightly
v. = very

TABLE 64. PROPERTIES OF REFRACTORY CARBIDES

| Material | Formula | Sp. gr. g per cc | Hardness* | Compressive strength, M psi | Mp, °C | Bp, °C | Solubility† |
|-------------------------|--|---------------------|-------------------------------------|-----------------------------------|------------------------|-----------|--|
| Beryllium carbide..... | Be ₂ C (30.03) | 1.9(179) | 2410 K(189) | | 2100 d. (179) | | d. H ₂ O; s. a. |
| Boron carbide..... | B ₄ C (55.28) | 2.51(188) | 9 M 2800 K(179) | 414 (20°C)(188) | 2330(179) 2300(188) | 3500(179) | i. H ₂ O; s. fus. alk.; i. a. d. to ca(OH) ₂ + C ₂ H ₂ ; not d. by conc. H ₂ SO ₄ |
| Calcium carbide..... | CaC ₂ (64.07) | 2.22(175) | | | | | d. H ₂ O; s. a. |
| Cerium carbide..... | CeC ₂ (292.26) | 5.23(179) | | | 1800(188) | 3800(179) | i. H ₂ O; s. dil. HCl |
| Chromium carbide..... | Cr ₃ C ₂ (180.03) | 6.68(168) | | | 3497(188) | | |
| Columbium carbide..... | CbC (104.91) | | | | 4100(88) | | |
| Hafnium carbide..... | HfC (190.6) | 7.4(168) | | | 1837(168) | | |
| Iron carbide..... | Fe ₃ C (178.54) | 5.02(179) | | | decom. (180) | | i. H ₂ O; s. a. |
| Lanthanum carbide..... | La ₂ C ₃ (162.92) | 1.65 | | | 1197(188) | | d. H ₂ O; s. H ₂ SO ₄ ; i. conc. HNO ₃ |
| Lithium carbide..... | Li ₂ C ₂ (96.95) | 6.89 | | | 2380(179) | 4500(169) | d. H ₂ O; s. a. |
| Manganese carbide..... | Mn ₃ C (188.79) | 8.9(177) | | | | | |
| Molybdenum carbide..... | Mo ₂ C (203.91) | 3.17(166) | 9-9.5 M 2550 K(189) | 82 (20°C)(189) | 2700(168) | 2340(179) | i. H ₂ O; d. fus. KOH; i. a. |
| Silicon carbide..... | SiC (40.06) | | | | 3880 ± 150(190) | 5500(179) | i. H ₂ O; sl. s. H ₂ SO ₄ , HF |
| Tantalum carbide..... | TaC (192.89) | 8.96(179) | | | 2773(179) | 5000(179) | d. H ₂ O; v. sl. s. conc. a. |
| Thorium carbide..... | ThC ₂ (256.14) | 4.25(179) | | | 3140 ± 90(188) | 4300(179) | i. H ₂ O; s. HNO ₃ , HNO ₂ + HCl |
| Titanium carbide..... | TiC (59.91) | 15.7(183) | 8.9 M 2470 K(183) 1880 K(183) | 109 (20°C)(188) | 2777(188) | 6000(179) | i. H ₂ O |
| Tungsten carbide..... | WC (195.93) | 11.28(168) | | | 2400(188) | 4100(179) | d. H ₂ O; s. a. |
| Uranium carbide..... | UC ₂ (262.09) | 5.4(168) | 2080 K(183) | 89 (20°C)(188) | 2830(188) | 3900(179) | i. H ₂ O; s. HNO ₃ ; fus. KNO ₃ ; i. HCl, H ₂ SO ₄ |
| Vanadium carbide..... | VC (62.96) | 4.13(179) | 2090 K(183) | 23.8 (20°C)(188) | 3530 ± 125(190) | 5100(179) | d. H ₂ O i. H ₂ O; s. a.; dil. HF |
| Yttrium carbide..... | YC ₂ (112.94) | | | | | | |
| Zirconium carbide..... | ZrC (103.23) | | | | | | |

* K = Knoop scale; M = Mohs scale.

† See list of abbreviations, Table 63, pp. 318-321.

TABLE 64. PROPERTIES OF REFRACTORY CARBIDES (Continued)

| Material | Lin. coef. of therm. exp., °C × 10 ⁶ | Resistivity, ohms per cc | F _{500°K} (196,198) | H _{500°K} (196,198) | S _{500°K} (196,198) | Solubility (ref) |
|-------------------------|---|--|------------------------------|------------------------------|------------------------------|---|
| Beryllium carbide..... | 12 (20°C) ⁽¹⁹⁸⁾ | 5.6 × 10 ⁻² (198) | | | | d. H ₂ O:s. a. |
| Boron carbide..... | 4.5 (20-800°C) (198) | 0.45 (20°C) 0.02 (300°C) | -8.8 | -7.0 | +5.7 | i. H ₂ O:s. fus. alk. i. a. d. to ca (OH) ₂ + C ₂ H ₂ ; not d. by conc. H ₂ SO ₄ |
| Calcium carbide..... | | | -21.2 | -21.0 | +0.6 | d. H ₂ O:s. a. i. H ₂ O:s. dil. HCl |
| Cerium carbide..... | | | | | | |
| Chromium carbide..... | | | | | | |
| Columbium carbide..... | | | 4.7 | 5.6 | 3.3 | i. H ₂ O:s. a. |
| Iron carbide..... | | | | | | d. H ₂ O:s. H ₂ SO ₄ ; i. conc. HNO ₃ |
| Lanthanum carbide..... | | | -23.1 | -27.8 | -0.6 | d. H ₂ O:s. a. |
| Lithium carbide..... | | | 2.8 | 4.2 | 4.8 | d. H ₂ O:s. a. |
| Manganese carbide..... | | | | | | |
| Molybdenum carbide..... | | | -26.1 | -26.7 | -2.0 | i. H ₂ O:d. fus. KOH; i. a. |
| Silicon carbide..... | | 0.5 (20°C) | | | | i. H ₂ O:sl. s. H ₂ SO ₄ , HF |
| Tantalum carbide..... | | | | | | |
| Thorium carbide..... | | | -50.2 | -45.6 | +15.2 | d. H ₂ O:v. sl. s. conc. a. |
| Titanium carbide..... | | | -56.5 | -57.3 | -2.2 | i. H ₂ O:s. HNO ₃ , HNO ₂ + HCl |
| Tungsten carbide..... | | | | | | i. H ₂ O |
| Uranium carbide..... | | | -3.4 | -3.9 | -1.7 | d. H ₂ O:s. a. |
| Vanadium carbide..... | | 1.6 × 10 ⁻¹ (20°C) ⁽¹⁹⁸⁾ | -38 | -36 | -12 | i. H ₂ O:s. HNO ₃ , fus. KNO ₃ ; i. HCl, H ₂ SO ₄ |
| Yttrium carbide..... | | | | | | d. H ₂ O |
| Zirconium carbide..... | | 5 × 10 ⁻³ (20°C) ⁽¹⁹⁸⁾ | | -35.5 | | i. H ₂ O:s. a.; dil. HF |

* K = Knoop scale; M = Mohs scale.

† See list of abbreviations, Table 63, pp. 318-321.

and molybdenum carbide is made in the same way as tungsten carbide.

Boron carbide, B_4C , is described in the paper of Ridgeway.⁽⁹⁶⁾ Its great hardness makes it of interest for gages, sand-blast nozzles, and polishing powder. It does not seem to be so resistant to oxidation as SiC . This material is made⁽¹¹⁾ from a mixture of boric acid and petroleum coke with 10 per cent excess boric acid to allow for volatilization. The mixture is melted in an arc furnace at about $2600^\circ C$. The product is ground in steel mills, acetone washed, and dried.

Silicon carbide is a well-known refractory, used for its high thermal conductivity, high resistance to spalling, and good resistance to slag attack. It is made in a resistance furnace as shown in Fig. 171. For example, a

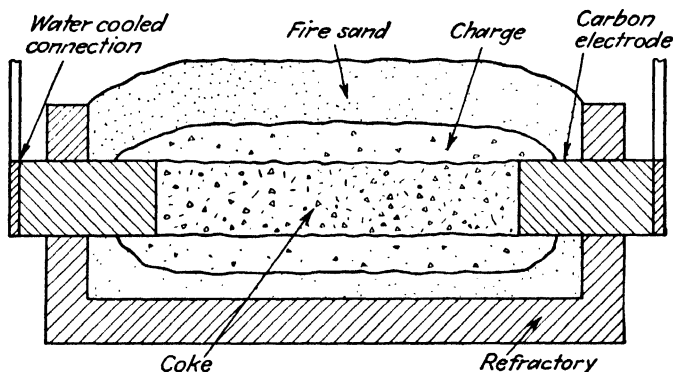

FIG. 171. Cross section of a silicon carbide furnace ready to start.

charge of 1,500 lb of petroleum coke, 9,000 lb of sand, 1,600 lb of sawdust, and 400 lb of salt is packed around the coke heater element, and this, in turn, is surrounded with low-grade SiC as an insulator. The furnace draws a maximum of 25,000 kw, reaches a temperature of $2200^\circ C$, and runs for about 36 hr. Perhaps 25 per cent of the charge is first-quality SiC . The power used is stated to amount to 4 to 5 kw-hr per lb.

Forming. The metal carbides may be formed by pressing the powder together with a few per cent of cobalt in steel or carbide dies at pressures up to 100,000 psi. Lubricants such as camphor, cetol alcohol, or waxes are used. The blocks are often fired or presintered in molybdenum resistance furnaces at 1050 to $1100^\circ C$ for 2 hr in a hydrogen atmosphere. They are then sized and then sintered in a vacuum at $1500^\circ C$ for 2 hr.

While it is difficult to obtain zero porosity in the carbides without using a permanent binder, such as 0.5 to 14 per cent cobalt, for refractory purposes, it should be possible to make pure dense articles by observing the principle described for the oxides and nitrides.

Many of the carbides can be formed by hot-pressing methods⁽¹⁸³⁾ (see Table 36, Chap. VIII). B_4C is especially adapted to this method and can be made into dense articles in graphite molds below $2375^\circ C$.

Silicon carbide is usually bonded with clay or phosphate but can be bonded by recrystallization, a process that is very costly because of the high temperature and long time needed.

Uses. Of course, the great use of the heavy metal carbides is for cutting tools and wear-resisting parts, where their hardness is the chief criterion. Silicon carbide, besides being a very valuable abrasive, is used largely as a refractory where high hot strength, good thermal conductivity, or resistance to slags are needed.

Carbides may also be of use for heaters and shields in high-frequency furnaces, as well as containers for reactions or melting.

It would, of course, be highly desirable if the carbide could be used in air at elevated temperatures. Silicon carbide, because of the viscous silica glass formed on the surface, is quite resistant to oxidation. There is much conflicting evidence as to the resistance of other carbides. Becker⁽⁸⁰⁾ states that Zr, Ti, and Hf carbides are the most resistant metal carbides, but no quantitative data are given. Hummel and Henry⁽⁷²⁾ state that TiC at $1100^\circ C$ for 1 hr showed only surface alteration. Henry⁽⁷³⁾ states that B_4C oxidizes about ten times as rapidly as SiC. Beryllium carbide is also believed quite stable, but much more research is needed to get the facts.

6. Nitrides. The nitrides are more stable at elevated temperatures than is generally appreciated and are, therefore, of considerable interest where heating is not in air. Table 65 gives the available data on the more stable compositions from various references in the literature. It will be seen that several are believed to have melting points of over $3000^\circ C$.
(111, 113, 116, 123, 124)

Titanium nitride can be formed from the tetrachloride by the following reactions:

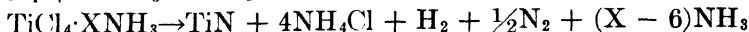
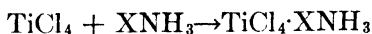

Also it can be made from the oxide as follows:

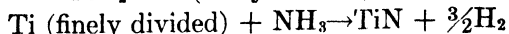
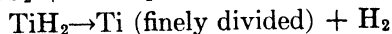
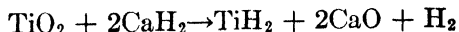

The latter method is simpler and gives a product conforming more closely to the theoretical analysis of 77.4 per cent Ti and 22.6 per cent N. This material is the color of pure gold and shows no tarnish after long exposure.

Zirconium nitride can be prepared in the same way as TiN. It is also stable in air and has the appearance of green gold.

TABLE 65. PROPERTIES OF REFRACTORY NITRIDES

| Material | Formula | Sp gr. g per cc | Mp. °C | Bp. °C | F _{290°K} ^(186,186) | H _{290°K} ^(186,186) | S _{290°K} ^(186,186) | Solubility (mp)* |
|------------------------|--|------------------------|----------------------------|--------------------------|---|---|---|---|
| Aluminum nitride..... | AlN (40.98) | 3.05 ⁽¹⁷⁹⁾ | 2200 d. ⁽¹⁷⁹⁾ | 2200 d. ⁽¹⁷⁹⁾ | -56.3 | -64.0 | -25.8 | d. ev. N H ₃ ; d. a., al. |
| Barium nitride..... | Ba ₃ N ₂ (438.08) | | 2200 | 2240 d. ⁽¹⁷⁹⁾ | -72.9 | -89.9 | -57.4 | d. H ₂ O; a., conc. alk.; i. a. |
| Beryllium nitride..... | Be ₃ N ₂ (55.08) | | 2200 ⁽¹⁸⁶⁾ | 2240 d. ⁽¹⁷⁷⁾ | -121.4 | -133.5 | -40.6 | i. H ₂ O; d. HCl, HF, H ₂ SO ₄ |
| Boron nitride..... | BN (24.83) | 2.25 ⁽¹⁷⁹⁾ | 2730 ⁽¹⁷⁹⁾ | sub. ⁽¹⁷⁹⁾ | -29.7 | -78.8 | -12.9 | d. H ₂ O |
| Cerium nitride..... | Ce ₃ N ₂ (154.13) | | 1770 d. ⁽¹⁸⁶⁾ | | -70.6 | | -25.0 | i. H ₂ O; i. a., alk. |
| Chromium nitride..... | Cr ₃ N ₂ (66.02) | | 1770 d. ⁽¹⁸⁶⁾ | | -53.0 | -59.0 | -20.0 | s. HF + HNO ₃ ; i. HNO ₃ |
| Columbium nitride..... | Cb ₃ N ₂ (106.92) | 8.4 ⁽¹⁷⁹⁾ | 2050 d. ⁽¹⁷⁹⁾ | | -72.0 | -78.3 | -22.0 | |
| Hafnium nitride..... | HfN (192.6) | | 3300 ⁽¹⁸⁶⁾ | | -64.7 | -72.1 | -25.0 | d. H ₂ O |
| Lanthanum nitride..... | La ₃ N ₂ (152.92) | | 1500 d. ⁽¹⁷⁹⁾ | | -96.2 | -110.2 | -47.2 | i. H ₂ O (d.); s. a.; d. al. |
| Magnesium nitride..... | Mg ₃ N ₂ (100.98) | | 1500 d. ⁽¹⁷⁹⁾ | | -10.3 | -16.6 | -21.0 | |
| Molybdenum nitride... | Mo ₃ N ₂ (205.90) | | | | -154.7 | -179.3 | -81.6 | i. H ₂ O; s. HF; i. a. |
| Silicon nitride..... | Si ₃ N ₄ (140.21) | 3.44 ⁽¹⁷⁹⁾ | 2170 sub. ⁽¹⁸⁶⁾ | 1900 ⁽¹⁸⁶⁾ | -60.5 | -68.0 | -25.0 | d. H ₂ O |
| Scandium nitride..... | Sc ₃ N ₂ (59.10) | | 2650 ⁽¹⁸⁶⁾ | | -52.2 | -58.1 | -19.9 | i. H ₂ O |
| Tantalum nitride..... | Ta ₃ N ₂ (194.89) | | 3360 ⁽¹⁷⁹⁾ | | -283.7 | -310.4 | -79.6 | d. H ₂ O; s. a. |
| Thorium nitride..... | Th ₃ N ₄ (152.39) | | 2100 ⁽¹⁸⁶⁾ | | -73.5 | -80.3 | -22.9 | i. H ₂ O; i. a.; s. aq. reg., alk. |
| Titanium nitride..... | TiN (61.91) | 5.29 ⁽¹⁷⁹⁾ | 2900 ⁽¹⁸⁶⁾ | | -192 | -213 | -63 | d. H ₂ O; s. HNO ₃ ; i. conc. HCl, H ₂ SO ₄ |
| Uranium nitride..... | U ₃ N ₃ (770.24) | 10.09 ⁽¹⁷⁹⁾ | | | -34.5 | -40.8 | -21.0 | i. H ₂ O |
| Vanadium nitride..... | V ₃ N ₃ (64.96) | 5.63 ⁽¹⁸⁶⁾ | 2050 ⁽¹⁸⁸⁾ | | -75.3 | -82.2 | -23.2 | |
| Zirconium nitride..... | Zr ₃ N ₂ (105.22) | | 2950 ⁽¹⁸⁶⁾ | | | | | |

* See list of abbreviations, Table 63, pp. 318-321.

Boron nitride, according to Dr. Ryschkewitsch,⁽⁷⁾ is produced from a mixture of lampblack and borax by the following reaction:

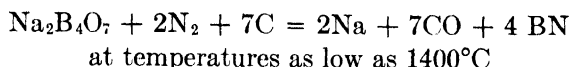

A white powder results much like talc or white graphite, which is quite stable in air.

Thorium nitride⁽¹²⁴⁾ can be formed in the same way as TiN, but it is difficult to approach the theoretical amount of nitrogen of 10.8 per cent.

The nitrides of cerium and lanthanum can be readily made; but as they hydrolyze rapidly in the atmosphere, they are of no great interest at present.

Beryllium nitride is readily formed by allowing the metal to react with NH_3 at 1000°C in a quartz tube, giving close to the composition represented by Be_3N_2 .

Tantalum and vanadium nitrides can be formed by heating the metal in a stream of pure NH_3 .

Forming. The grinding of the nitrides without contamination is somewhat of a problem, but the TiN and ZrN can be ground in steel ball mills and then acid washed. In other cases, grinding can be done in boron carbide mills with little contamination.

The powdered nitrides can be slip cast from water or absolute alcohol suspensions, or they can be pressed with a suitable temporary binder as described for beryllia. By proper sizing, pressing, and firing in ammonia, it is possible to produce nonporous ware. As the nitrides in general are electrical conductors, they can be heated in a high-frequency induction furnace directly.

Uses. The nitrides will find most use as a high-temperature refractory in a vacuum, especially for melting metals without contamination.

7. Sulfides. As sulfur comes next to oxygen in the Periodic Table, it might be thought that sulfides would have the high stability of oxides. There are many stable sulfides, such as CeS, ThS, US, and others as given by Brewer⁽¹⁸⁰⁾ in Table 66. However, it should be mentioned that none of them can be heated to elevated temperatures in air, owing to their rapid oxidation; but for work in high vacua and neutral atmospheres, these materials are very encouraging because of their low vapor pressures.

More specifically, Pauling⁽¹⁴³⁾ states that the sulfides of cerium and thorium, ThS and CeS, as well as related sulfides, have been found valuable as refractory materials. Previously, the lower sulfides were not known, and their initial production was due to the work of Drs. L. Brewer and E. D. Eastman and associates at the University of California. As an example of sulfide preparation, the formation of uranium sulfide will be described.⁽¹⁴²⁾

Preparation of Sulfides. Three methods of preparation for the sulfides of uranium will be described below. By these methods pure US , U_2S_3 , and US_2 have been prepared and other compositions may be prepared similarly.

Method 1

Step A. US_2 and intermediate sulfides all the way down to U_2S_3 may be prepared by treatment of the oxides, UO_2 or U_3O_8 , with H_2S in a carbon system, followed by *Step B*, a vacuum heating, in the case of an intermediate sulfide. The temperature of reaction is 1200 to 1300°C, the rate of reaction at these temperatures being fairly rapid. During the course of the reaction, UOS is first

TABLE 66. SULFIDES⁽¹⁸⁰⁾

| Sulfide | F _{298°K} | H _{298°K} | S _{298°K} | Mp, °C | Sol.* | Volatility |
|-----------------------|--------------------|--------------------|--------------------|--------|-------------------------|-----------------------------------|
| MgS | -92.5 | -71 | (-23.7) | 2000 | d. H ₂ O | |
| CaS | -121.9 | -128.9 | (-23.7) | | d. H ₂ O | |
| SrS | -121.6 | -128.6 | (-23.7) | 2000 | d. H ₂ O | |
| BaS | -119.7 | -126.7 | (-23.7) | 2200 | d. H ₂ O | |
| BeS | -65 | -71 | (-23.7) | | d. H ₂ O | |
| $\frac{1}{3} La_2S_3$ | -107.2 | -114 | (-23.6) | | i. H ₂ O | |
| CeS | | -133.4 | | 2450 | i. H ₂ O | Rapid at 2200°C Slow at 1700°C |
| $\frac{1}{4} Ce_3S_4$ | | -120.9 | | 2050 | i. H ₂ O | |
| $\frac{1}{3} Ce_2S_3$ | | -115.7 | | 1900 | i. H ₂ O | Slow at 1700°C |
| $\frac{1}{3} Nd_2S_3$ | | -114 | | | i. H ₂ O | |
| ThS | | (-135) | | 2200 | i. H ₂ O; sa | Moderate at 2200°C |
| $\frac{1}{3} Th_2S_3$ | | (-125) | | 2000 | i. H ₂ O; sa | Nonvolatile at 1700°C |
| $\frac{1}{7} Th_4S_7$ | | (-114) | | 2000 | i. H ₂ O; sa | Nonvolatile at 1700°C |
| $\frac{1}{2} ThS_2$ | | (-106) | | 1900 | i. H ₂ O; sa | |
| US | | | | 2000 | s. dil. a | Rapid at 2200°C |

* See list of abbreviations, Table 63, pp. 318-321.

formed at lower temperatures with the liberation of H_2O . As the temperature is raised to the maximum value, the H_2S being introduced attacks the carbon-producing CS , which then reacts with UOS , producing CO .

Because of the instability of US_2 at high temperatures, the product of reaction at high temperatures will be somewhat reduced to a lower composition, the extent of reduction depending upon the actual temperature. To insure formation of US_2 after all oxygen has been removed, the final reaction temperature will have to be lowered to below 1000°K, thus allowing the reduced sulfide to pick up sulfur from the H_2S .

Step B. The preparation of U_2S_3 and sulfides between US_2 and US is quite simple because of the US_2 instability. A sample of US_2 heated for 20 min at 1600°C in a vacuum of about 10^{-4} mm Hg is reduced to $US_{1.50}$, indicating the ease of reduction. $US_{1.8}$ heated at 1800°C dissociated to $US_{1.35}$ in 15 min. See US_{2-x} for further detail.

Method 2

When pure metal is available, any of the oxidation states of uranium can be prepared by action of the correct amount of H_2S upon the hydride prepared from the pure metal. The preparation of the hydride of uranium is conducted in a well-degassed bulb using pure hydrogen at a temperature of $300^\circ C$, the product of reaction being a finely divided powder ideal for reaction with a gas. A controlled amount of H_2S is then reacted with the hydride at 400 to $500^\circ C$, in a circulatory system which brings unreacted H_2S continually back over the sample until the required amount of H_2S has reacted. All products of this reaction including US_2 are not stable in air because of the low temperature of production, thus requiring handling in an inert atmosphere. If sulfides below US_2 are being produced, the product of the H_2S reaction will contain finely divided metal as well as a small amount of undecomposed hydride, and an additional heating at a higher temperature is thus necessary to obtain a uniform product. The US may be heated to above $1800^\circ C$ to obtain a uniform product, while the U_2S_3 and higher sulfides must be heated for longer times at much lower temperatures to avoid loss of sulfur.

Method 3

Pure US_2 and uranium hydride may be mixed in the proper proportions to give the desired composition of product. Since the preparation procedures for the sulfide and hydride have been described above, no further comment is necessary. The hydride present in this mixture must first be decomposed to the metal, which is done in a vacuum at 400 to $600^\circ C$, after which the mixture is heated at a higher temperature to bring about complete interaction. This last step must be done at the proper temperature to avoid decomposition of the product through sulfur loss. This method is not usually satisfactory for composition between U_2S_3 and US_2 unless carefully carried out because of sulfur loss.

US_2 . When pure metal is available, this sulfide may be prepared most simply through use of Method 2, since the apparatus may be constructed quite easily. The product from this procedure is less stable in air than that obtained through use of Method 1, however, because of the larger crystal form that results from the higher temperature treatment in the latter method. One advantage of Method 1 over Method 2 is that oxygen impurity is removed during the preparation, which is not the case during the low-temperature reaction of H_2S with the hydride which may contain oxygen.

US_{2-x} . Intermediate compositions between US_2 and U_2S_3 are difficult to prepare by Method 3, since during the vacuum heating, considerable sulfur is lost from the starting US_2 during the dehydriding and from the final melt. If the composition does not have to be fixed closely, Method 1, Step B, is most convenient. If only a small number of samples are to be made, Method 2 is very convenient and the composition can be fixed more closely than by any of the other methods.

In the discussion of Method 1, Step B, it was stated that $US_{1.6}$ was reduced to $US_{1.35}$ by heating to $1800^\circ C$ for 15 min. It should be stated that the original

mixture consisted of U and US_2 with a total composition of $US_{1.6}$ and the reduction to $US_{1.35}$ may be due to loss of sulfur from US_2 before reduction with the U. We have no evidence to indicate that reduction below U_2S_3 can be obtained by vacuum heating at this temperature.

US , the monosulfide, can be best prepared through use of either Method 3 or Method 2 with a subsequent treatment at a high temperature to obtain a uniform product.

TABLE 66a. FLOW SHEET FOR THE PREPARATION OF CERIUM SULFIDE

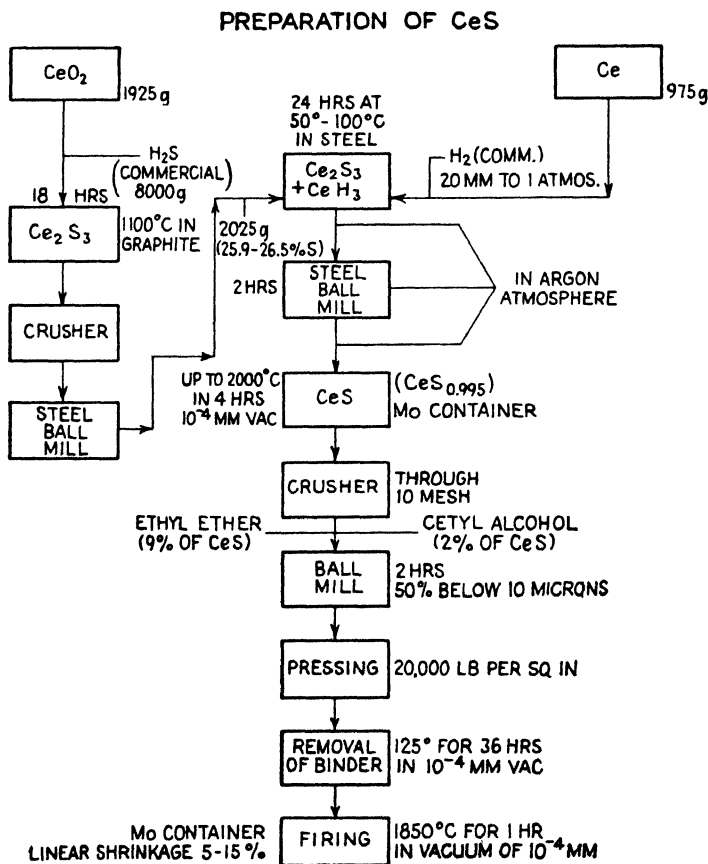

Physical and Chemical Properties of Uranium Sulfide. The monosulfide of uranium is a grayish, metallic-looking solid melting considerably above 2000°C . Like ThS , the crystal structure is cubic with a unit cell dimension determined by Zachariassen, of 5.473 \AA . The calculated density based on the X-ray structure analysis is 10.87. In dilute acid the US is very slowly soluble. The magnetic susceptibility is $4180 \cdot 10^{-8} \text{ emu}$.

CeS can be prepared from the sesquisulfide by the following reaction suggested by Brewer:



In this reaction, it is possible to control the ratio of Ce to S in the final product. The production of CeS from the oxide and metal is given in the flow sheet of Table 66a and the analyses of the materials in Table 66b.

TABLE 66b

| Constituent | Material | | |
|------------------|--|--------------|-------------------------|
| | Cerium oxide lindsay light optical grade | Cerium metal | Cerium sesquisulfide |
| CeO ₂ | 89.4 | | |
| Ce | | 97.3 | 68.1 |
| Ca | 1.93 | 0.09 | 1.17 |
| Mg | 0.77 | 0.08 | 0.15 |
| P | 0.22 | | 0.01 |
| C | | 0.12 | |
| Si | 0.07 | | 0.02 |
| Pb | 0.07 | | 0.01 |
| Fe | 0.03 | | 0.03 |
| S | | | 26.2 |
| Ig. Loss | 1.01 | | |
| Other R.E. | 7.96 | 2.5 | |

Crucibles can be formed by pressing in steel molds in the same way as described for oxides. CeS has a metallic gold color and is quite stable in air. It has a density of 5.1 to 5.8 g per cc and a porosity of 0 to 10 per cent. The melting point is above 2200°C, and it thus makes an excellent container for vacuum melting of metals where freedom from oxygen is essential.

ThS is produced in substantially the same way. It is silvery in color with a density of 9.6 g per cc.

8. Borides. Little is known about the stable borides, but some data are shown in Table 69, Chap. XIII. HfB₆, WB₆, ZrB₃, BC₄, and NB are believed to have high melting points and low vapor pressures. Undoubtedly additional stable borides exist. NB and B₄C have been described in previous sections of this chapter, and little is known about the others. This is an interesting field of research.

9. Refractory Selenides, Silicides, and Phosphides. Very little is known of the compounds of these nonmetallic elements, but there is the possibility of some stable ones at high temperatures.

Brewer⁽¹⁸⁰⁾ records VSi_2 as melting at 1650°C and Ba_3P_2 with a melting point of 3200°C .

10. Refractory Single Crystals. The development of the lower melting crystals, such as the chlorides and fluorides, during the Second World War was brought to a high state of perfection by Dr. D. C. Stockbarger^(144,147) and his associates at the Massachusetts Institute of Technology. However, when temperatures above the useful range of platinum are required, other methods have been developed.

Quartz. During the Second World War, considerable effort was made in Germany to produce synthetic quartz crystals for piezoelectric uses, as their supply of natural crystals was greatly curtailed. In general, two methods may be used to produce quartz: (1) by cooling a siliceous melt containing a mineralizer such as sodium tungstate and (2) by crystallization from a water solution at high temperatures. Sosman⁽¹⁴⁵⁾ mentions a number of methods on page IV 51. Along the same lines, the growing of quartz from SiO_2 dissolved in water that had been acidified by CO_2 and held at 320°C in a pressure vessel was mentioned by Norton.⁽¹⁴⁸⁾

Nacken claims to have grown quartz crystals in the silver-lined autoclave shown in Fig. 172, where the amorphous quartz dissolves at the higher temperature and grows on the seed crystal suspended by a hair at a lower temperature. On the whole, it would seem that few if any quartz crystals of commercial size were made, as much effort was spent on substitutes.

Silverman⁽¹⁵⁵⁾ states that one of our glass companies has grown quartz crystals up to $\frac{1}{2}$ in. on a side by dissolving silica glass (up to 3 per cent) in water at 350°C and then allowing precipitation onto a seed crystal by the foregoing method. The process goes on, as crystal quartz is said to be soluble to only 0.3 per cent under these conditions.

Corundum crystals with or without coloring oxides (sapphires or rubies) have been made for many years by building up a single boule with fine globules of melted alumina passing through an oxyacetylene flame by the well-known Verneuil process. An excellent description is contained in the report by Barnes.⁽¹⁵¹⁾ Recently the Linde Air Products Company⁽¹⁵⁴⁾ has developed a method of growing single crystals of alumina in the form of rods, which can then be cut up for instrument jewels or ball-bearing balls. These rods are also of value in high-temperature expansion furnaces, as they have a much higher use limit than fused silica. Another use developed in the Ceramic Laboratories at the Massachusetts Institute of Technology consists in forming parts of an optical system of sapphires that are used inside a furnace up to 1500°C . A ruby color may be imparted to the crystal by adding about 0.5 per cent Cr_2O_3 to the alumina.

Spinel. Boules and rods of single crystals of spinel ($MgAl_2O_4$) are regularly made in various colors.^(151,154) A hardening process used in Germany is described by Barnes⁽¹⁵¹⁾ consisting of an unmixing with a deposit of fine Al_2O_3 crystals through the mass.

Beryls and Emeralds. Nacken is said to have made excellent beryls and emeralds by hydrothermal methods in a time of 3 or 4 days, using the

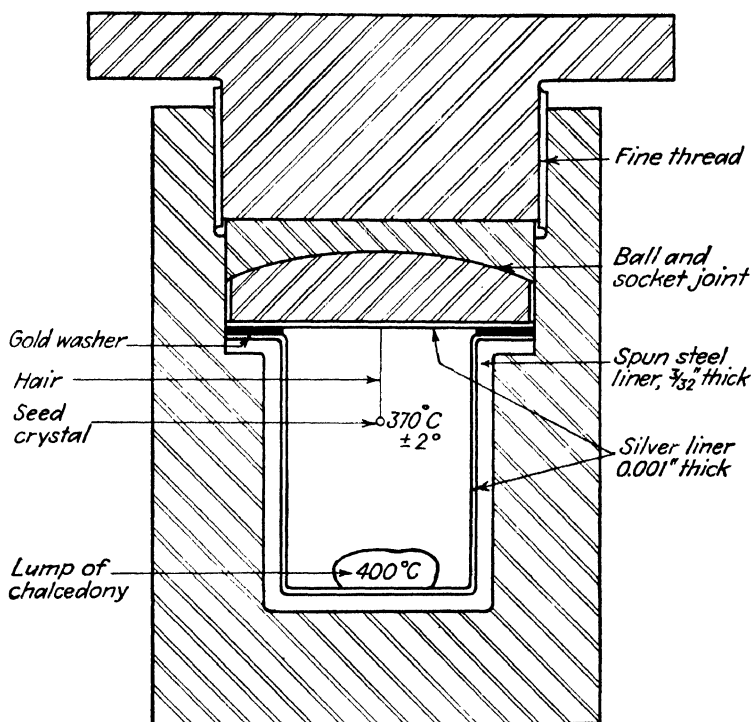

FIG. 172. Autoclave for growing synthetic crystals.

autoclave shown in Fig. 172. It is reported that very fine emeralds are being made in this country by much the same method.

Rutile. Single crystals of rutile (TiO_2) have been grown to fairly large sizes in the same way as for sapphires by the National Lead Company and the Linde Air Products Company. The high index of refraction of this stone, 2.8, gives it great brilliance as a gem and valuable optical and electrical properties.

Mica. While mica is not strictly a refractory material, its production is an important high-temperature problem as supplies of natural mica become exhausted. Considerable efforts have been made to produce it in Germany by Siemans and Halske and by Dr. Dietzel at Ostheim.⁽¹⁵⁰⁾ The

crystals are grown from a slowly cooled melt and from the composition would seem to be a fluorine mica, and not muscovite, as all the OH^- groups are replaced by F^- . It would seem impossible to grow muscovite outside hydrothermal conditions. Dietzel mentions the use of a magnetic field to orient the growing crystal, but there is considerable doubt as to its effectiveness. We have not as yet seen direct evidence of any large mica crystals grown in the laboratory.

It is reported that excellent tourmalines (a complex aluminum borosilicate) have been made in the laboratory.

11. Heterogeneous Refractory Systems. We have considered previously rather simple mixture of oxides with each other, but it is quite possible to mix, for example, metals and oxides. Such combinations are not new, as for many years platinum and porcelain⁽¹⁵⁹⁾ have been fired together to make a conducting body for electrodes, graphite and copper mixture is commonly used for motor brushes, cobalt is used to bond the hard carbides, and clay and graphite crucibles are extensively used for metal melting.

Much work has been carried out recently to produce bodies of good heat-shock resistance for gas turbine parts. For example, finely precipitated metallic iron and alumina^(56,61) are fired together to give a body with excellent heat-shock resistance, but little is known of its creep values or its resistance to oxidation. Silicon carbide bonded with clay or a porcelain has been used for many years and is known to have an excellent heat-shock resistance and fair resistance to oxidation, but its creep value has not been published. Other suggested combinations are SiC-Cr , SiC-Si , $\text{Al}_2\text{O}_3\text{-Ni}$, $\text{Al}_2\text{O}_3\text{-Co}$. As yet we are not able to say whether or not any of these heterogeneous mixtures will be of value as refractories, but undoubtedly there is enough promise to warrant a basic study of this field.

Another type of system is the solid solution, such as TiC-TiO or $\text{US-}\text{UO}_2$. Little work has been done on such systems, but they certainly warrant more extensive study.

12. Refractory Glasses. The structure of glass is a random network of atoms in contradiction to the orderly placing of the atoms in the crystal lattice and may be thought of as an undercooled liquid. Glass is found to a small extent in nearly all of our refractories containing silica and serves a useful purpose in cementing the crystalline material together. On the other hand, for high use limits it is disadvantageous, for it causes flow under stress.

There has always been a demand for high-temperature glasses as containing vessels for vacuum furnaces, gas discharge lamps, and many other purposes where transparency is required, but as yet nothing of higher use limit than fused silica has been developed commercially.

Fused Silica. This glass is well known and generally used for high-temperature installations, but its use limit is about 1000°C due to devitrification. Because of its high viscosity, it must be worked at high temperatures and therefore is much more costly than the lower temperature glasses. The Nieder method⁽¹⁶⁶⁾ produces very clear material from powdered crystals.

Vycor. This glass is a unique development of the composition shown in Table 67. It is made from a soft glass that separates into two phases, one high in silica and the other high in borates. The latter is leached out, and the resulting siliceous framework shrunk by heating into a homogeneous structure much in the same way that porcelain is fired. For many purposes, it may replace the more costly fused silica.

High-alumina Glasses. For use in high-intensity gas discharge lamps, high-alumina glasses have been developed with a relatively high softening temperature and at the same time a reasonable temperature of melting. This is shown by the viscosity values from the Adams⁽¹⁶²⁾ patent in Table 68.

TABLE 67. COMPOSITION OF SOME HIGH-TEMPERATURE GLASSES

| Constituent | Fused ⁽¹⁶²⁾ silica | Vycor ⁽¹⁶²⁾ glass | Pyrex ⁽¹⁶²⁾ glass | High- alumina glass (A) | High- alumina glass (B) | Glass for sodium-vapor lamps ⁽¹⁶²⁾ | | Glass for tungsten seals ⁽¹⁶²⁾ | | Glass for molybdenum seals ⁽¹⁶²⁾ |
|--------------------------------|----------------------------------|---------------------------------|---------------------------------|-------------------------------|-------------------------------|---|------|---|------|---|
| | | | | | | | | | | |
| SiO ₂ | 100 | 96.3 | 80.0 | 51.0 | 43.6 | 21.5 | 88.3 | 77.0 | 71.2 | |
| B ₂ O ₃ | | 2.9 | 12.0 | 1.6 | 11.3 | 40.0 | 8.4 | 15.4 | 14.6 | |
| Al ₂ O ₃ | | 0.4 | 3.0 | 20.0 | 20.4 | 22.0 | 2.9 | 1.0 | 2.4 | |
| Fe ₂ O ₃ | | | 0.1 | | | | | 0.1 | 0.1 | |
| ZnO | | | | | 10.1 | | | | | |
| CaO | | | | 15.4 | 14.6 | | 0.4 | 0.4 | 2.9 | |
| MgO | | | | 6.5 | | 10.0 | | | | |
| BaO | | | | 0.5 | | | | | | |
| Nb ₂ O ₅ | | 0.02 | 3.9 | | | 6.5 | | 4.9 | 3.6 | |
| K ₂ O | | 0.02 | 0.3 | | | | | 1.9 | 4.0 | |
| Soft point, °C | | | | 918 | 840 | | | | | |

TABLE 68. VISCOSITY IN POISES

| Temperature °C | Comm. soda-lime glass | Pyrex glass | High-alumina glass (B) |
|----------------|-----------------------|-------------------|------------------------|
| 900 | | 10 ^{6.6} | 10 ^{9.0} |
| 1000 | 10 ^{4.7} | 10 ^{5.6} | 10 ^{6.5} |
| 1100 | 10 ^{3.3} | 10 ^{4.9} | 10 ^{4.7} |
| 1200 | 10 ^{2.8} | 10 ^{4.3} | 10 ^{3.5} |
| 1300 | 10 ^{2.6} | 10 ^{3.7} | 10 ^{2.8} |

Metal Sealing Glasses. A number of high-silica glasses for sealing metals to fused silica—so-called graded seals—have been developed. A few are shown in Table 67.

Other Glasses. In the search for very refractory glasses, a great deal of effort has been spent in examining all possible glass formers. Cohn⁽¹⁶⁴⁾ reports making ZrO_2 glass in his sun furnace, but other experimenters have failed to form it. It seems to be the consensus of opinion at present that no commercially useful, high-temperature glass is possible without a considerable silica content.

13. Bibliography

Metals:

1. SMITHELLS: "Tungsten," D. Van Nostrand Company, Inc., New York, 1936.
2. BALKE, C.W.: Tantalum and Columbium, *Ind. Eng. Chem.*, **77**, 166, 1935; **30**, 351, 1938.
3. HIGHRITER, H.W.: Refractory Metals, Chap. 37, in "Powder Metallurgy," edited by J. Wulff, American Society for Metals, Cleveland, Ohio, 1942.
4. Fansteel Products Company, Inc.: *Tech. Bull.* RM-17, 1947.
5. FROHLICH, K.W.: Über die Beständigkeit von Platin bei erhöhter Temperatur, P.B. 34989, Department of Commerce, Washington, D.C., 1947.
6. WAGGAMAN, W.H., and E.A. GEE: Titanium and Zirconium-Metals of Industrial Promise, *Chem. Eng. News*, **26**, 377, 1948.

Oxides:

Alumina

7. RYSCHKEWITSCH, E.: Über die Rekristallization der tonerde, *Ber. deut. keram. Ges.*, **20**, 477, 1939.
8. MOORE, R.: Recrystallized Alumina Products, *Ind. Chemist*, **18**, 467, 1942; *Trans. Brit. Ceram. Soc.*, **42**, 13A, 1943.
9. BOSCH, R.: Heat Resistant Ceramic Materials, Belgian Patent 444,977, *Chem. Centr.* II, **25**, 2258, 1943.
10. HEANY, J.A.: Process of Making Aluminous Product, U.S. Patent 2,391,454, December, 1945.
11. RUSSELL, R., JR.: Electrical and Technical Ceramic Industry of Germany, P.B. 18776, Department of Commerce, Washington, D.C., 1947.

Beryllia

12. MOTT, W.R.: Relative Volatilities of Refractory Materials, *Trans. Am. Electrochem. Soc.*, **34**, 255, 1918.
13. WHITE, H.E., and R.M. SHREMP: Beryllia Oxide, I, *J. Am. Ceram. Soc.*, **22**, 185, 1939.
14. WHITE, H.E., R.M. SHREMP, and C.B. SAWYER: Beryllium Oxide Refractories, II, *J. Am. Ceram. Soc.*, **23**, 157, 1940.
15. CLAUSSEN, G.E., and J.W. SKEHAN: Malleable Beryllium, *Metals and Alloys*, **15**, 599, 1942.
16. War Metallurgy Comm.: Release No. 3, Beryllium, P.B. 60386, Department of Commerce, Washington, D.C., 1943.
17. YARHAM, E.R.: Beryllium Oxide, A Special Refractory, I, *Brick & Clay Record*, **105**, 50, 1944.
18. DAVID, L.: Beryllium Oxide, *Metallurgia*, 91, 1944.
19. LUNDIN, H.: Production of Beryllium Oxide, *Trans. Am. Inst. Chem. Engrs.*, **41**, 671, 1945.

20. POTVIN, R.: Production of Beryllia and Beryllium at the Degussa Plants, BIOS Target No. 21/28, 1945.
21. ERWAY, N.D., and R.L. SEIFERT: Vapor Pressure of Beryllium Oxide, *Argonne Nat. Lab.*, MDDC-1030, U.S.A.E.C., Oak Ridge, Tenn., 1946.
22. NORTON, F.H.: Pure Beryllium Oxide as a Refractory, *J. Am. Ceram. Soc.*, **30**, 242, 1947.
23. DUWEZ, P., and F. ODELL: A Study of the Recrystallization of Beryllium Oxide at 2000°C., *J. Am. Ceram. Soc.*, **32**, 1, 1949.

Magnesia

24. ROLLER, P.S., and D. RITTENBURG: Impervious Crucibles of Magnesium Oxide, *Ind. Eng. Chem.*, **24**, 436, 1932.
25. BIRKS, L.S., and H. FRIEDMAN: Particle Size Determinations from X-ray Line Broadening, *J. Applied Phys.*, **17**, 687, 1946.

Zirconia

26. DAVEY, W.P.: The Crystal Structure of Zirconium Oxide, *Phys. Rev.*, **27**, 798, 1926.
27. KREIDL, N.J.: Zirconium Oxide and Thorium Oxide in Ceramics, *J. Am. Ceram. Soc.*, **25**, 129, 1942.
28. SCHLEICHER, H.S., and S. KOPIN: Making Zircon Refractories, U.S. Patent 2,303,304, 1942.
29. JENNINGS, H.W.K.: Zirconium Oxide Refractories and Methods of Making Them, Brit. Patent 578,409, 1946.
30. WAINER, E.: Technology of Zirconium and Titanium and Their Compounds, *Ceram. Age*, **48**, 198, 1946.
31. POLE, G.R., A.W. BERNBACH, JR., and N. GILBERT: Physical Properties of Some High-temperature Refractory Compositions, *J. Am. Ceram. Soc.*, **29**, 208, 1946.
32. CURTIS, C.E.: Development of Zirconia Resistant to Thermal Shock, *J. Am. Ceram. Soc.*, **30**, 180, 1947.

Spinel

33. CHESTERS, J.H., and C.W. PARMELEE: Reaction-Expansion Measurements on Chromite and Allied Spinel, *J. Am. Ceram. Soc.*, **18**, 95, 1935.
34. BAZILEVICH, A.S.: Synthesis and Properties of Artificial Spinel, *Trudy Vsesoyuz., Nauch.-Issledovatel. Inst. Ogneupornykh i Kislotoupornykh Materialov*, No. 6, p. 17, 1936.
35. RIGBY, G.R., G.H.B. LOVELL, and A.T. GREEN: Some Properties of Spinel Associated with Chrome Ores, *Trans. Brit. Ceram. Soc.*, **45**, 137, 1946.
36. RIGBY, G.R., G.H.B. LOVELL, and A.T. GREEN: The Properties of Spinel—Anauxite and Hercynite, *Iron & Steel Inst., Special Rept. 32*, p. 93, 1946.
37. LOVELL, G.H.B., G.R. RIGBY, and A.T. GREEN: Volume Changes Occurring When Binary Mixtures of Spinel Are Heated between 800 and 1400°C., *Iron & Steel Inst., Special Rept. 32*, p. 153, 1946.
38. RAIT, J.R.: An X-ray Investigation into the Constitution of Chrome Ores, *Iron & Steel Inst., Special Rept. 32*, p. 175, 1946.

General

39. JORDAN, L., A.A. PETERSON, and L.H. PHELPS: Refractories for Melting Pure Metals, Fe, Ni, Pt., *Trans. Am. Electrochem. Soc.*, **50**, 115, 1926.

40. SWANGER, W.H., and F.R. CALDWELL: Special Refractories for Use at High Temperatures, *Natl. Bur. Standards, J. Research*, **6**, 1131, 1931.
41. NAVIAS, L.: Extrusion of Refractory Oxide Insulators for Vacuum Tubes, *J. Am. Ceram. Soc.*, **15**, 234, 1932.
42. RICHARDSON, H.K.: Small Cast Thorium Oxide Crucibles, *J. Am. Ceram. Soc.*, **18**, 95, 1935.
43. ROLLER, P.S., D. RITTENBERG, and A. GABRIEL: Preparation of Laboratory Refractory Crucibles, *Ind. Eng. Chem.*, **28**, 486, 1936.
44. PARTRIDGE, J.H., and J.R. LAIT: Manufacture of Refractory Articles from Pure Oxides of High Melting Points, *J. Soc. Glass Technol.*, **20**, 200, 1936.
45. THOMPSON, J.A., and M.W. MALLET: Preparation of Crucibles from Special Refractories by Slip Casting, *Natl. Bur. Standards, J. Research*, **23**, 319, 1937.
46. STEGER, W.: Zur Bestimmung des Widerstandes Keramischer Ergengisse Gegen Shroffen Temperature Wechsel, *Chem. Fabrik*, II, 44-46, 508, 1938.
47. GELLER, R.F.: A Resistor Furnace with Some Preliminary Results to 2000°C., *Natl. Bur. Standards, J. Research*, p. 555, 1941.
48. RYSCHKEWITSCH, E.: Uber die Druckfestigkeit eigiger keramischer Werkstoffe auf der Einstoff-Basis, *Ber. deut. keram. Ges.*, **22**, 54, 1941.
49. RYSCHKEWITSCH, E.: Uber die ZerreiBfestigkeit einiger oxyd keramischer Werkstoffe auf der einstoff-Basis, *Ber. deut. keram. Ges.*, **22**, 10, 363, 1941.
50. RYSCHKEWITSCH, E.: Relation of Tensile Strength of Ceramic Materials to Sintering Temperature, *Ber. deut. keram. Ges.*, **22**, 54, 1941.
51. RYSCHKEWITSCH, E.: Elastizitats model einiger ozykeramischer Werkstoffe auf der einstoff-Basis, *Ber. deut. keram. Ges.*, **23**, 243, 1942.
52. RYSCHKEWITSCH, E.: Plastische Deformabarkert, Sproder Horper, *Ber. deut. Gastechm.*, **20**, 166, 1942.
53. CROATTO, V., and A. MAYER: The Electrical Conductivity of Mixed Crystals of CeO₂ and La₂O₃, *Gazz. chim. Ital.*, **73**, 199, 1943.
54. KIRBY, D.: Pure Oxide Refractories, *Metallurgia*, 65, 1944.
55. BIRCH, R.E.: Refractories of the Future, *Ohio State Univ., Eng. Expt. News*, **17**, 3, 1945.
56. SKORSKI, R.: Some Aspects of German Work on High Temperature Materials, P.B. 20664, Department of Commerce, Washington, D.C., 1946.
57. HENRY, E.C.: Literature Survey, P.B. 60659, Department of Commerce, Washington, D.C., 1946.
58. ANON.: Investigation of Pure Oxide Ceramic Materials Intended for High Temperature and High Stress Applications, *F.I.A.T. Final Rept.* 924, 1946.
59. HUMMEL, H.F., and E.C. HENRY: Physical Properties of Several Refractory Materials, P.B. 60660, Department of Commerce, Washington, D.C., 1946.
60. KISTLER, S.S.: Refractories in Turbine Blades Plus Miscellaneous Apparatus, Comb. Inst. Obj. Corum G-2Dw *SHAEP APO* 413, 1946.
61. DEWITT, G.H.: Development of Ceramic Materials for Use in Gas Turbine Engines, CIOS Target No. 5/223, *SHAEP APO* 413, 1946.
62. SLYH, J.A.: Refractory Oxides as Liners for Combustion Chambers of Rocket Motors, P.B. 60655, Department of Commerce, Washington, D.C., 1946.

Refractory Porcelains:

63. WAINER, E.: Refractory and Method of Making, U.S. Patent 2,306,349, 1942.
64. SEIL, G.E. (E. J. Lavino & Co.): U.S. Patent 2,311,970, 1943.

65. MULLER, G.: Use of Densely Sintering Mixtures for Crucibles for Melting Inorganic Insulating Materials Crystallizing from the Melt, Staatliche Porzellan-Manufaktur, 1943.
66. WAINER, E.: Making Zirconium Oxide Refractories, U.S. Patent 2,335,325, 1943.
67. WAINER, E.: Zirconium Oxide Refractory and Method of Making, U.S. Patent 2,347,225, 1944.
68. THEISS, L.E.: Vitrified Cordierite Bodies, *J. Am. Ceram. Soc.*, **26**, 99, 1943.
69. WAINER, E.: Refractory Composition and Method of Making, U.S. Patent 2,373,864, 1945.
70. AMBERG, C.R.: Properties of Wollastonite and Diopside with Admixtures of TiO_2 , ZrO_2 , and SiO_2 , *J. Am. Ceram. Soc.*, **28**, 137, 1945.
71. GELLER, R.F., P.J. YAVORSKY, B.L. STEINMAN, and A.S. CREAMER: Studies of Binary and Ternary Combinations of Magnesite, Calcite, Barite, Beryllia, Alumina, Thoria, and Zirconia in Relation to Other Uses in Refractories, *Natl. Bur. Standards, J. Research*, **36**, 277, 1946.
72. HUMMEL, A.F., and E.C. HENRY: Investigation of Bodies Containing Beryl, P.B. 60662, Department of Commerce, Washington, D.C., 1946.
73. HENRY, E.C.: Preparation and Physical Properties of Certain Refractory Materials, P.B. 60661, Department of Commerce, Washington, D.C., 1946.
74. GELLER, R.F., and M.D. BURDICK: Progress Report on Strength and Creep of Oxide Ceramic Bodies in Tension at Elevated Temperatures, NACA ARP. No. 6024.
75. TURNER, D.: Bosch Sparking Plug Factories, BIOS, P.B. 18909, Department of Commerce, Washington, D.C., 1946.
76. RUSSELL, R., JR., and W.C. MOHR: Characteristics of Zircon Porcelain, *J. Am. Ceram. Soc.*, **30**, 32, 1947.
77. WISELY, H.R., and H.H. GOBLER: Development of Cordierite Type Ceramic Bodies, *Dept. Ceram., Rutgers Univ., Prog. Rept.* 3, 1947.

Carbides:

78. RUFF, O., and WUNSCH: Arbeiten in Gebiet hoher Temperaturen III, Wolfram und Kohlenstoffe, *Z. anorg. Chem.*, **82**, 292, 1914.
79. ANDREWS, M.R.: Production and Characteristics of the Carbides of Tungsten, *J. Phys. Chem.*, **27**, 270, 1923.
80. FRIEDERICH, E., and L. SITTING: The Preparation and Properties of Carbides, *Z. anorg. allgem. Chem.*, **144**, 169, 1925.
81. FRIEDERICH, E.: Uber bisher unbekannte Eigenschaften einfacher Verbindungen uber die Arten des festen Zustandes, *Z. Physik*, **31**, 813, 1925.
82. FRIEDERICH, E., and L. SITTING: Herstellung und Eigenschaften von Nitriden, *Z. anorg. allgem. Chem.*, **143**, 293, 1925.
83. FRIEDERICH, E., and L. SITTING: Herstellung und Eigenschaften von Carbiden, *Z. anorg. allgem. Chem.*, **144**, 169, 1925.
84. WESTGREN, A., and G. PHRAGMEN: Rontgenanalyse der System Wolfram-Kohlenstoff und Molybdan-Kohlenstoff, *Z. anorg. allgem. Chem.*, **156**, 27, 1926.
85. BECKER, K., and R. HOLBLING: Einige Eigenschaften des Wolfram Carbides — W_2C , *Z. angew. Chem.*, **40**, 512, 1927.
86. BECKER, K.: Uber das System Wolfram-Kohlenstoff, *Z. Metallkunde*, **20**, 437, 1928.

87. ANDRIEUX, L.: Sur la préparation et les propriétés des borures de tantale et de columbium, *Compt. rend.*, **189**, 1279, 1929.
88. AGTE, C., and H. ALTERTHUM: Untersuchungen über Systeme hochschmelzender Carbide nebst Beiträgen zum Problem der Kohlenstoffschmelzung, *Z. tech. Physik*, **11**, 182, 1930.
89. AGTE, C.: *Metallwirtschaft*, **9**, 401, 1930.
90. BECKER, K., and H. EWEST: Die physikalischen und strahlungstechnischen Eigenschaften des Tantalkarbid, *Z. tech. Physik*, **11**, 216, 1930.
91. SYKES, W.P.: The Study of the Tungsten-Carbon System, *Trans. Soc. Steel Treating*, **18**, 968, 1930.
92. AGTE, C., and K. MOERS: Methoden zur Rundarstellung hochschmelzender Carbide, Nitride, and Boride und Beschreibung einiger ihrer Eigenschaften, *Z. anorg. allgem. Chem.*, **198**, 223, 1931.
93. AGTE, C.: Beiträge zur Kenntnis hochschmelzender Stoffe, Dissertation, *Tech. Hochschule Berlin*, 1931.
94. BECKER, K.: Der Physikalischen Eigenschaften hochschmelzender Verbindungen, *Physik. Z.*, **34**, 185, 1933.
95. BECKER, K.: Hochschmelzende Hartstoffe, Berlin, 1933.
96. RIDGEWAY, R.R.: Boron Carbide, *Trans. Electrochem. Soc.*, **61**, 117, 1934.
97. RUFF, O.: Formation and Dissociation of Silicon Carbide, *Trans. Electrochem. Soc.*, **68**, 87, 1935.
98. MCKENNA, P.M.: Hard Intermetallic Compounds for New Metal Cutting Tools, *Metal Progress*, **36**, 152, 1936.
99. MCKENNA, P.M.: Tantalum Carbide, Its Relation to Other Hard Refractory Compounds, *Ind. Eng. Chem.*, **28**, II, 767, 1936.
100. TESTUT, R.: Sur la formation des carbures de chrome, *Compt. rend.*, **203**, 1007, 1936.
101. WOLOSCHTSCHUK, N.N., and A.C. GELFGOT (Helfgot): Versuch zur Anwendung von Tantalcarbid für Glühlampen., *Svetotekhnika*, p. 87, 1937; *Chem. Zentr.*, II, 3356, 1937.
102. KOSTER, W., and W. MULFINGER: Die System des Kobalts mit Bor, Arsen, Zircon, Niob, and Tantal., *Z. Metallkunde*, **30**, 348, 1938.
103. CLARK, F.: Developments in Fatigue, Creep, Age Hardening, Diffusion, Microscopy, Boro Carbides, Powders, Electrodeposition, and Die Castings, *Mining Met.*, **21**, 18, 1940.
104. RIDDLE, F.H.: Alumina and Silicon Carbide Refractory, U.S. Patent 2,388,080, 1945.
105. BERNS, M.H.: Refractory Composition, U.S. Patent 2,314,758, 1943.
106. WULFF, J.: "Powder Metallurgy," American Society for Metals, Cleveland, Ohio, 1942.
107. ELLINGER, F.H.: The Tantalum-carbon System, *Trans. Am. Soc. Metals*, **31**, 89, 1943.
108. KRISTLER, S.S.: The German Abrasive Industry, *FIAT Final Rept.* 370, Office of Military Government for Germany, Oct. 10, 1945, P.B. 1319, Department of Commerce, Washington, D.C., 1945.
109. FLEISCHMANN, M.: Electro Smelzwerke, A.-G., P.B. 936, Department of Commerce, Washington, D.C., 1946.
110. HENRY, E.C., et al.: Quarterly Progress Report on the Investigation of Refractory Materials, No. 14, Pennsylvania State College, 1947.

Nitrides:

111. RUFF, O., and F. EISNER: TiN and a New Class of Titanium Compounds, Titanium Nitrogen Halogenides, *Ber. deut. chem. Ges.*, **41**, 2250, 1908.
112. RUFF, O.: Preparation of TiN, *Ber. deut. chem. Ges.*, **42**, 900, 1909.
113. ANON.: New Titanium Compounds (Ti_3N_4), *Ber. deut. chem. Ges.*, **45**, 1364, 1912.
114. PODSEZUS, E., Production of Strong Bodies from Nitrides, Ger. Patent 282,748, 1913.
115. BOSCH, C., and A. MITTASCH: Purifying Nitrides of Beryllium, Titanium, Aluminum, Zirconium, or Silicon, U.S. Patent 1,102,715, 1914.
116. ANON.: Herstellung und Eigenschaften von Nitriden, *Z. anorg. allgem. Chem.*, **143**, 293, 1925.
117. FOORD and BICHOWSKY: Preparation of Nitrides from Ilmenite, *Chem. Met. Eng.*, **33**, 749, 1926.
118. OBERKAUSER, F.: Preparation of Ti_3N_4 , *Ber. deut. chem. Ges.*, **60B**, 1434, 1927.
119. ANON.: Preparation of Nitrides, Brit. Patent 245,762, 1927; *Chem. Abstracts*, **21**, 304, 1927.
120. CANNERI: Thermal Decomposition of Hydrides, Nitrides, etc., *Giorn. chim. Ind. applicata*, **10**, 73, 1928; *Chem. Abstracts*, **22**, 2333, 1928.
121. LORENZ and WOOLCOCK: Decomposition Pressure of Nitrides, *Z. anorg. allgem. Chem.*, **176**, 289, 1928; *Chem. Abstracts*, **23**, 1343, 1929.
122. HAGG, G.: Characteristics of Phases of Transitional Elements in Binary Systems with Boron, Carbon, and Nitrogen, *Z. physik. Chem.*, **B6**, 221, 1930; *Chem. Abstracts*, **25**, 2615; **24**, 1591, 1930; **12**, 35, 1931.
123. MEYER, O.: Production and Properties of Carbide and Nitride Crucibles, *Ber. deut. keram. Ges.*, **11**, 333, 1930.
124. DUSING and HUNIGER: Preparation and Analysis of Thorium Nitride, *Tech. wiss. Abhandl. Osram-Konz.*, **2**, 357, 1931; *Chem. Abstracts*, **26**, 5025, 1931.
125. VAN ARKEL and BRUIJNES: Incandescent Cathode for Electric Discharge Tubes, U.S. Patent 1,794,810, 1931.
126. ANON.: Sintered Metallic Products Such as Hard Products Containing Carbides or Nitrides, U.S. Patent 1,856,607, 1932.
127. NEUMANN, B., C. KROGER, and H. HAEBLER: Heat of Nitriding of Li, Al, Be, and Mg, *Z. anorg. allgem. Chem.*, **204**, 81, 1932.
128. BECKER, K.: Physikalischen Eigenschaften Hoch Schmelzender Verbindungen, *Physik. Z.*, **34**, 185, 1933.
129. ANON.: Crystal Structure of Nitrides, Phosphides of Bivalent Metals, *Chem. Abstracts*, **27**, 522, 1933.
130. GUNTHERSCHULZE, A., and F. KELLER: Use of Activated Nitrogen in Producing Nitrides, *Z. Physik*, **81**, 528, 1933; *Chem. Abstracts*, **27**, 3392, 1933.
131. VAN ARKEL: Hot Wire Method of Preparing Nitrides, *Metallwirtschaft*, **13**, 511, 1934.
132. BECKER, K.: "Hochschmelzende Hartstoffe," Verlag Chemie, Berlin, 1935. Reprinted by authority of Alien Property Custodian by Edwards Bros., Inc., Ann Arbor, Mich., 1943.
133. ANON.: Manufacture of Nitrides, Carbides, Borides, Silicides, Carbon-nitrides, and Titanides, Brit. Patent 435,754, 1935; *Chem. Abstracts*, **30**, 1350.
134. OSTROUMOV: Analysis of Titanium Nitride, *Zavodskaya Lab.*, **4**, 506, 1935.

135. HANSON, H.: "Aufbau der Zweistoff Legierungen," Verlag Julius Springer, Berlin, 1936. Photo-lithoprint reproduction, Edwards Bros., Inc., Ann Arbor, Mich., 1943.
136. BICHOWSKY, F.R., and F.D. ROSSINI: "Thermochemistry of Chemical Substances," Reinhold Publishing Corporation, New York, 1936.
137. ALEXANDER, P.P.: The Hydride Process, *Metals & Alloys*, **8**, 263, 1937; **9**, 179, 1938.
138. SATO: Heats of Formation of Various Nitrides, *Sci. Papers Inst. Phys. Chem. Research (Tokyo)*, **34**, 1356, 1938.
139. HENZEL, R.F.: Metal Nitride Compositions Suitable for Electrical Contacts, U.S. Patent 2,180,984, 1939.
140. WULFF, J.: "Powder Metallurgy," Chap. 12, Hydride Process and Its Products, by P. P. Alexander, American Soc. for Metals, Cleveland, Ohio, 1942.
141. KIEFFER, R., and W. HOTOP: Pulvermetallurgie und Sinterwerkstoffe, Verlag Julius Springer, Berlin, 1943. Reprinted by authority of Alien Property Custodian by Edwards Bros., Inc., Ann Arbor, Mich., 1944.

Sulfides:

142. EASTMAN, E., *et al.*: Preparation and Properties of Sulphides and Oxysulfides of Uranium, MDDC 193, U.S.A.E.C., Oak Ridge, Tenn. Declassified August, 1946.
143. PAULING, L.: "General Chemistry," W. H. Freeman and Co., 1947.

Single Crystals:

144. STOCKBARGER, D.C.: Artificial Fluorite, *Am. Mineral.*, **12**, 26, 1927.
145. SOSMAN, R.B.: "The Properties of Silica," Reinhold Publishing Corporation, 1927.
146. RINNE, F.: *Jena Jahrb. Min. Geol. u. Pal.*, Berlage Band, **58**, 43, 1928.
147. STOCKBARGER, D.C.: The Production of Large Single Crystals of Lithium Fluoride, *Rev. Sci. Instruments*, **7**, 133, 1936.
148. NORTON, F.H.: Accelerated Weathering of Feldspars, *Am. Mineral.*, **22**, 9, 1937.
149. BURGER, H.: Methods of Manufacturing Artificial Diamonds, Colored Diamonds, etc., P.B. 19058, Department of Commerce, Washington, D.C., 1943.
150. LINK, A.E.: Synthetic Mica Process, Ostheim, Germany, *Rept.* 184, Department of Commerce, Washington, D.C., 1945.
151. BARNES, M.H.: Synthetic Sapphire and Spinel Production in Germany, P.B. 17545, Department of Commerce, Washington, D.C., 1945.
152. SAWYER, C.B.: German Work with Synthetic Crystals, P.B. 14620, Department of Commerce, Washington, D.C., 1945.
153. ANON.: Synthetic Sapphire Production, *Ind. Diamond Rev.*, **6**, 80, 1946.
154. ANON.: Synthetic Sapphire, Ruby and Spinel, Linde Air Products Co., Tonawanda, N.Y., 1946.
155. SILVERMAN, A.: Some Recent Developments in American Glass Manufacture; III, 1938 to 1947, *Bull. Am. Ceram. Soc.*, **26**, 11, 367, 1947.
156. INSLEY, H., H.F. McMURCHIE, W.H. PARSONS, and B.L. STEINMAN: Some Properties of Materials for Jewel Instrument Bearings, *Am. Mineral.*, **32**, 1, 1947; U.S. Patent 988,230; U.S. Patent 1,004,505.
157. VAN PRAAGH, G.: Synthetic Quartz Crystals, *Geol. Mag.*, **84**, 98, 1947.

Heterogeneous Refractory Systems:

158. ROLLFINKE, F.: Metall ceramic; zusammen hange zwischen Metalkeramik und Oxykeramik, *Z. Ver. deut. Ing.*, **84**, 681, 453, 1940.
159. CORKIN, D.H.: Sparking Plug Electrode, Brit. Patent 539,945, 1941.
160. SWENTZEL, J.P.: Bonded Silicon Carbide Refractories, U.S. Patent 2,364,108, 1944.
161. ANON.: Molded Bodies Containing Elemental Silicon, I.G. Farbenind. A-G., Ger. Patent 707,897, 1941; *Chem. Abstracts*, **37**, 2904, 1943.

High-temperature Glasses:

162. ADAMS, G.F.: Refractory Glass, U.S. Patent 2,010,836, 1935.
163. PHILIPS, N.D.: Gloeilanten fabrieken, Brit. Patent 431,923, 1935.
164. COHN, W.M.: Crystal Modification of Zirconia; Clear Fused Zirconia Produced in the Sun Furnace, *Trans. Electrochem. Soc.*, **68**, 65, 1935.
165. HOLLAND, A.J.: Glass in the Service of the Engineer, *Proc. S. Wales Inst. Engrs.*, **42**, 232, 1946.
166. LADOO, R.B.: Clear Fused Quartz, *Mining and Met.*, **28**, 501, 1947.

General:

167. FOWLE: "Smithsonian Physical Tables," 7th ed., 1920.
168. National Research Council: "International Critical Tables," McGraw-Hill Book Company, Inc., New York, 1926.
169. LANDOLT-BORNSTEIN: "Physikalisch-Chemische Tabellen," Verlag Julius Springer, Berlin, 1927.
170. "Metals Handbook," 1939 ed., American Society for Metals, Cleveland, Ohio, 1939.
171. PERRY, J.H.: "Chemical Engineers Handbook," 2d ed., McGraw-Hill Book Company, Inc., New York, 1941.
172. BIRCH, F., *et al.*: "Handbook of Physical Constants," Special Papers 36, Geological Society of America, Washington, D.C., 1942.
173. RYSCHKEWITSCH, E.: The Modulus of Elasticity of Some Ceramic Oxides on the One Component Basis, *Ber. deut. keram. Ges.*, **23**, 243, 1942.
174. THORNE, P.C.L., and E.R. ROBERTS: "Inorganic Chemistry," Fritz Ephraim, 4th ed., Nordeman Publishing Co., New York, 1943.
175. SILVERMAN, A., *et al.*: "Data on Chemicals for Ceramic Use," National Research Council, National Academy of Science, Washington, D.C., 1943.
176. EVERHARDT, J.L., *et al.*: Mechanical Properties of Metals and Alloys, *Natl. Bur. Standards, Cir. CC 447*, December, 1943.
177. SINGER, F.: Some Fundamental Principles of Modern Ceramics, *Commun.* 123, Keramos House, Surrey, England, 1946.
178. THIBAUT, N.W., and H.L. NYQUIST: Measured Knoop Hardness of Hard Substances and Factors Affecting Its Determination, *Trans. Am. Soc. Metals*, 271, 1946.
179. "Handbook of Chemistry and Physics," 29th ed., Chemical Rubber Publishing Co., Cleveland, Ohio, 1947.
180. QULL, L. L., Ed.: "Chemistry and Metallurgy of Miscellaneous Materials: Thermodynamics," (Paper No. 4) McGraw-Hill Book Company, Inc., New York, 1950.
181. SINGER, F., and H. THURNAUER: Sinter Alumina, *Metallurgia*, **36**, 1, 1947.

182. ANON.: Report on Ceramics No. 1, M. W. Kellogg Co., January, 1948.
183. Norton Company: Physical Properties of Hot Pressed Specimens, private communication to the author, 1948.

Thermodynamic Data:

184. KELLEY, K.K.: Vapor Pressures of Inorganic Substances, etc., *U.S. Bur. Mines, Bull.* 383, Washington, D.C., 1935.
185. KELLEY, K.K.: Thermodynamic Properties of Sulphur and Its Inorganic Compounds, *U.S. Bur. Mines, Bull.* 406, 1937.
186. KELLEY, K.K.: Thermodynamic Properties of Metal Carbides and Nitrides, *U.S. Bur. Mines, Bull.* 407, 1937.
187. THOMPSON, M. DEK.: "Total and Free Energies of Formation of the Oxides of Thirty-two Metals," Electrochemical Society, Inc., New York, 1942.
188. GANGLER, J. J.: Some Physical Properties of Eight Refractory Oxides and Carbides. *J. Am. Ceram., Soc.*, **33**, 367, 1950.

Part III
PROPERTIES

CHAPTER XIII

THE FUSION POINT OF REFRACTORY MATERIALS AND THEIR EQUILIBRIUM DIAGRAMS

1. Fusion Process. At the present time, there is very little understanding of the mechanism concerning the fusing of nonmetallic materials. If a curve of viscosity is plotted against temperature, it will be found that for some materials, the change from a solid to a liquid occurs within a very small temperature interval whereas in other materials, especially silicates, the melting process is a more gradual one and occurs over a large temperature range. As shown earlier, it will be found, in the case of materials having a long softening range, that there is a great difference in the bond strength between the various atoms. For example, in the silicates, the bond strength that holds the silicon in the center of an oxygen tetrahedron is very strong and probably will not break up until much higher temperatures are reached than are necessary to break the weaker bonds. Therefore, we may conceive that when a silicate fuses, at first the weaker bonds are broken and a very viscous liquid results, which contains aggregates of the silicon-oxygen groups. As the temperature goes higher, these groups are broken up by the thermal agitation until the viscosity markedly decreases. Unfortunately, we have no experimental evidence to show just what happens in this process and can merely conjecture a mechanism that most nearly fits the facts.

In the literature, it will be found that the terms "melting point," "softening point," and "fusion point" are used more or less indiscriminately in discussing refractories. The best usage would seem to indicate that the term melting point should be reserved for pure materials and fusion or softening point for more complex or impure materials. It is, of course, difficult to draw a sharp boundary between the two; so it was thought best to use the term fusion point throughout this chapter for everything except the pure materials, as the majority of the refractories show a considerable softening range.

2. Method of Obtaining Fusion Points. *Physical Significance of the Fusion Point.* There has been a great deal of confusion in considering just what is meant by the fusion point of the average refractory. We can do no better than refer to the method used by the glass technologist in determining the fusion or softening point of glass. Here, the fusion point

is specified as the temperature at which the particular specimen under a definite stress becomes sufficiently fluid to flow at a specified rate. No other meaning will have any significance in discussing materials that have no sharp boundary between the solid and liquid state.

This definition of fusion point can be made clear by the curve in Fig. 173 in which the deformation in millimeters of the specimen is plotted against the time, under the conditions where the specimen is heated up at

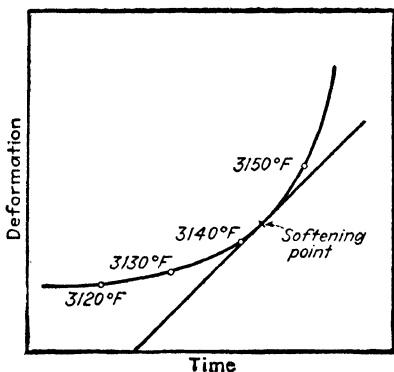

FIG. 173. Method of determining the softening point.

a uniform rate. If we are arbitrarily assuming the fusion point as that temperature at which the rate of flow equals 0.01 mm per sec, a tangent can be drawn to the flow curve with this slope. The point where the curve and tangent meet will represent the fusion temperature, which, in the illustration, is 3143°F. Owing to experimental difficulties, the usual methods of measuring the fusion points do not follow such an exact procedure; consequently, only an approximate value is obtained.

Determination of Fusion Points by Comparison with the Pyrometric Cones.

A common method of determining the fusion point is by comparing the bending characteristics of the sample with those of a series of standard pyrometric cones all run in the same furnace. As it can be carried out by persons not skilled in pyrometric practice and with inexpensive equipment, this method has the advantage of simplicity. It has the disadvantage, however, of not giving the highest degree of precision, because of variations in the furnace atmosphere or from other causes that are not easy to control. Under good conditions, however, a precision of $\pm 15^{\circ}\text{C}$ (27°F) should be obtained. The following quotation gives the standard ASTM softening-point test for refractory materials:

STANDARD METHOD OF TEST FOR PYROMETRIC CONE EQUIVALENT OF REFRACTORARY MATERIALS

ASTM Designation C 24-42¹

ADOPTED, 1920; REVISED, 1928, 1931, 1933, 1935, 1942, 1946

The Standard of the American Society for Testing Materials is issued under the fixed designation C 24; the final number indicates the year of original adoption as standard or, in case of revision, the year of the last revision.

¹ ASTM Standards are subject to revision. The Society's headquarters, in Philadelphia, may be consulted for the latest information.

1. Scope. This method is intended for determining the Pyrometric Cone Equivalent of fireclay, fireclay brick, silica cement, and ground fireclay by comparison of test cones with Standard Pyrometric Cones under the conditions herein prescribed.

2. Preparation of Sample. (a) *Clay or Brick.* The entire sample of fireclay or fireclay brick, in case the amount is small, shall be reduced in size by means of rolls or a jaw crusher to a maximum size of $\frac{1}{4}$ in. In case the amount is large, a representative sample obtained by approved methods shall be so treated. The sample shall then be mixed thoroughly, and the amount reduced to about 250 g (0.5 lb) by quartering. Any magnetic material introduced by crushing or grinding shall be removed by means of a magnet. This portion shall then be ground in an agate, porcelain, or hard steel mortar, and the amount reduced again by quartering. The final size of the sample shall be 50 g, and the fineness such that it will pass a No. 70 (210 μ) ASTM sieve (equivalent to mesh No. 65 of the Tyler standard series). In order to avoid excessive reduction of fines, they shall be removed frequently during the process of reduction by throwing the sample on the sieve and continuing the grinding of the coarser particles until all the sample will pass through the sieve.

b. *Silica Cements.* In the case of silica cements, the sample obtained by approved methods shall be tested as received without grinding or other treatment.

NOTE: For the purpose of this test, silica cement is understood to be the usual finely ground mixture of quartzite, silica brick, and fireclay of various proportions and does not include materials sold under the name of high-temperature mortars.

3. Preparation of Test Cones. a. The dried sample shall be thoroughly mixed and, after the addition of sufficient dextrin, glue, gum tragacanth, or other alkali-free organic binder and water, shall be formed in a truncated trigonal pyramid with its base at a small angle to the trigonal axis and of the following dimensions: over-all height (between planes perpendicular to the trigonal axis) $1\frac{1}{8}$ in.; length of the side of the trigonal tip, 0.075 in.; length of the two longer sides of the base, $\frac{3}{2}$ in.; base at an external angle of 82 deg to one face and perpendicular to the symmetry plane through the opposite edge of the pyramid.

b. When dry, the test cones may be subjected, when necessary, to a preliminary burn at a temperature not exceeding 2370°F (1300°C) for the purpose of sintering them into a firm condition to permit handling.

4. Mounting. The test cones shall be mounted on plaques of refractory material of such a composition as will not affect the fusibility of the cones.* They shall be mounted with the base embedded approximately 3 mm (0.12 in.) in the plaque, and the face of one side inclined at an angle of 82 deg with the horizontal. The arrangement of the test cones with respect to the Standard Pyrometric Cones shall be substantially as shown in Fig. 174, *i.e.*, alternating the test cones with the Standard Pyrometric Cones in so far as practical (Note, p. 350). The plaque may be any convenient size and shape and may be biscuited before using, if desired.

* A mixture of equal parts of a highly refractory clay such as a good grade of china clay and fused alumina which will pass a No. 100 (149 μ) ASTM sieve (equivalent to mesh No. 100 of the Tyler standard series) has been found satisfactory.

NOTE: The number of cones and their mounting so as to face inward as shown in Fig. 174 is typical for gas-fired furnaces of relatively large dimensions and gases moving at high velocity. The practical bore of the muffle tubes in most electric furnaces does not permit cone pats of this size. The static atmosphere prevailing permits the cones being mounted to face outward, if so desired.

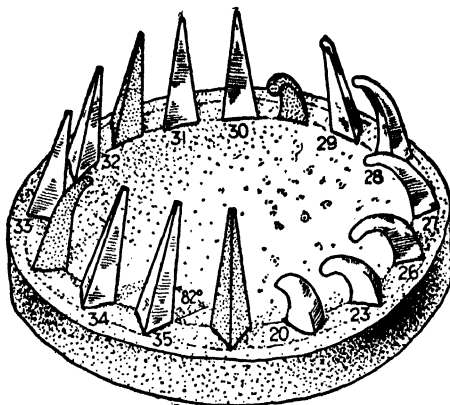

FIG. 174. Method of mounting test cones and appearance after testing.

5. Heating. *a.* The heating shall be carried out in a suitable furnace at a rate to conform to the following requirements:

| | Minutes | | Minutes |
|---------------------------|---------|-------------------|---------|
| To reach cone No. 20..... | 45 | Time interval to: | |
| Time interval to: | | Cone 32..... | 8 |
| Cone No. 23..... | 20 | Cone No. 32½..... | 9 |
| Cone No. 26..... | 6 | Cone No. 33..... | 9 |
| Cone No. 27..... | 4 | Cone No. 34..... | 6 |
| Cone No. 28..... | 4 | Cone No. 35..... | 10 |
| Cone No. 29..... | 10 | Cone No. 36..... | 10 |
| Cone No. 30..... | 4 | Cone No. 37..... | 4 |
| Cone No. 31..... | 12 | Cone No. 38..... | 6 |

NOTE: At 1830°F (1000°C) the old cone pat may be removed and a new one put in without cooling the furnace down below red heat.

b. That type of furnace in which a neutral or oxidizing atmosphere may be maintained is to be preferred. Excessive reducing conditions should be avoided. Care should be taken that the flame does not strike directly against the cone or cone plaque. The furnace should be tested at intervals for the determination of the uniformity of the distribution of the heat.

6. Pyrometric Cone Equivalent. *a.* The softening of the cone will be indicated by the top bending over and the tips touching the plaque. The bloating, squatting or unequal fusion of small constituent particles should always be reported. The Pyrometric Cone Equipment shall be reported in terms of Standard Pyrometric Cones and shall be that cone which most nearly corresponds in time of softening

with the test cone. If the test cone softens later than one Standard Pyrometric Cone but earlier than the next Standard Pyrometric Cone and approximately midway between, the P.C.E. shall be reported thus: Cone No. 31-32.

b. If the test cone starts bending at an early cone but is not down until a later cone, the fact should be reported.

Determination of Fusion Points with the Optical Pyrometer. A more precise determination of the fusion point can be made with the optical pyrometer, which is sighted on the test specimen heated in a furnace under black-body conditions. With ordinary care, a precision of $\pm 7^{\circ}\text{C}$ (about 12.6°F) should be obtained; and with especial care in calibration, a precision of $\pm 4^{\circ}\text{C}$ (about 7.2°F) is possible.

Most of the fusion points have been made on specimens formed into a slender tetrahedron similar in shape to the standard pyrometric cone. This particular form of specimen has commonly been used because the bending can readily be seen without special measuring apparatus, but it does have certain disadvantages for precise work because (1) the size of the specimen varies, depending on the shrinkage of the refractory material; (2) the density of the specimen varies with the material so that the bending forces are variable; and (3) the bending forces vary with the position of the cone.

Apparently a much better form of specimen for fusion-point tests would be a small bar supported at its ends. On heating, this bar will soften and sag in the middle. By sighting on the center of the bar with a reading telescope, it is possible to plot the amount of settling against time and thus obtain a curve capable of giving a precise value of fusion point as shown in Fig. 174. Certain precautions are necessary, however, in this type of test: (1) The material should be precalcined in order to shrink it to a stable volume, and (2) the distance between the supports should be so arranged as to give a definite stress in the specimen based on its density and cross-sectional area.

Furnaces for Determining Fusion Points. Fusion points can be determined in a cylindrical type of furnace heated by a gas and air burner up to temperatures of 1700°C (about 3090°F). Figure 175 shows such a furnace for determining fusion points in comparison with pyrometric cones. For higher temperatures, the same type of furnace can be used with oxygen

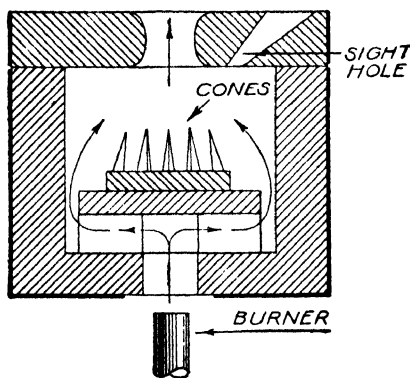

FIG. 175. A gas-fired fusion-point furnace.

instead of air, in which case temperatures as high as 2000°C (about 3630°F) can be reached. The high-frequency induction furnaces shown in Chap. X are excellent for melting-point determinations.

Preparation of Fusion-point Specimens. In making up specimens for fusion-point determinations, it is essential that representative samples be taken. For example, if the fusion point of a brick is desired, the brick should be broken up and a number of random samples taken. These fragments are then ground so that they will completely pass a 65-mesh

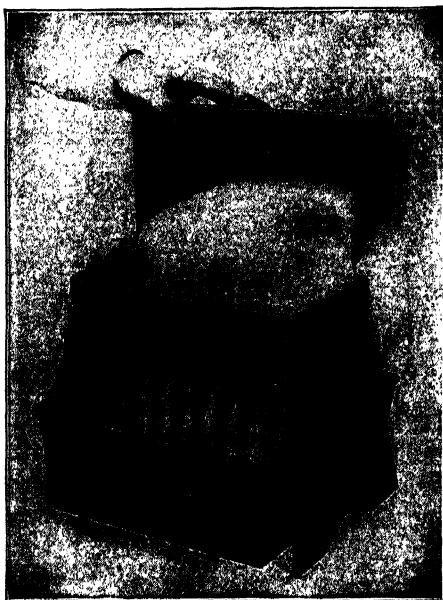

Fig. 176. A riffle sampler. (Courtesy of W. S. Tyler Company.)

screen. Grinding should be carried out at first in a steel mortar; and if the material is very hard, iron specks should be removed with a magnet. The final grinding should be done in an agate mortar. In the case of clay, the usual sampling methods should be employed in order to ensure representative results. In the case of lump clay, such as bauxite, it will be found that the hard nodules have a higher melting point than soft material; therefore a considerable amount must be crushed and split down to a small sample. A riffle sampler such as that shown in Fig. 176 is excellent for the purpose.

The sample is moistened with water and pressed with a spatula into a mold. With nonplastic materials, an organic binder is used. It is usually desirable to make the cones small, as they will more readily follow the temperature of the furnace. A cone 1 in. high with a $\frac{3}{16}$ -in. triangular

base, according to the standard of the American Society for Testing Materials, is very satisfactory. A mold for making these cones is shown in Fig. 177. Considerable manipulative skill is required to make and handle cones made from lean or sandy materials.

The cones should be carefully dried before being placed in the melting furnace; and if they are fragile, they should be given sufficient preliminary heating to frit them together. In placing a cone on a boat, it is a good idea to cut a shallow recess and cement the base of the cone into it, but great care should be taken to make this cement out of the identical material from which the cone is made, as otherwise a reaction may occur that will give a fusion point considerably too low. In every case, the cone should be placed so that the face will make an angle of 82 deg with the horizontal, as shown in Figs. 178 and 179.

Effect of Atmosphere on Fusion Point. The fusion point of pure silica or alumina is little, if at all, influenced by the furnace atmosphere; however, when any impurity is present, especially iron oxide, the atmosphere does

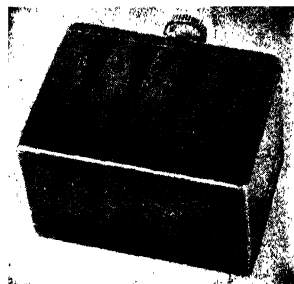

FIG. 177. A mold for making test cones.

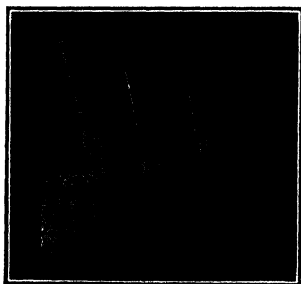

FIG. 178. Cones ready for placing in the kiln. (Courtesy of The Standard Pyrometric Cone Company.)

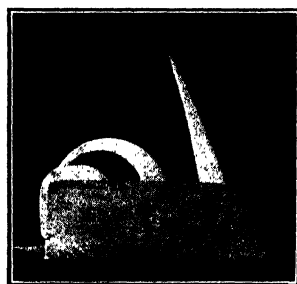

FIG. 179. Cones after firing. Cone 6 is just down. (Courtesy of The Standard Pyrometric Cone Company.)

have a marked effect on the fusion point. Just why the reduced oxide should combine more readily with the other constituents to form a low-melting compound is not known. Fieldner, Hall, and Feild⁽¹⁾ found that when the iron oxide in the mixture was reduced to the metallic condition below the softening temperature, little lowering of the fusion point resulted. Apparently the act of reduction makes the iron oxide more active in combining with the other constituents.

The influence of the atmosphere on the fusion point of fireclay containing very finely divided iron oxide is shown by the results of Vickers and

Theobald.⁽⁶³⁾ The effect of the reducing gases is very marked (Fig. 180) and shows that the lowering of the fusion point increases almost directly with the iron oxide content.

Test cones in a reducing atmosphere seldom bend over smoothly. Often a hard coating forms, allowing the molten center to run out at the

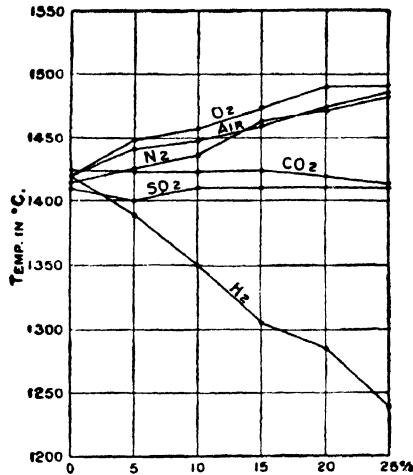

Fig. 180. Curves showing the fusion temperatures of a clay containing various proportions of finely divided ferric oxide in various gases.

base. Fusion points should be taken only when the test cone bends down gradually until the tip touches the base, as in *A* of Fig. 181. When a cone bends only at the base, as in *B*, it is probable that interaction has occurred between the cone and the plaque. Some materials even under the best conditions will not give good readings but will either bloat, *C*, or

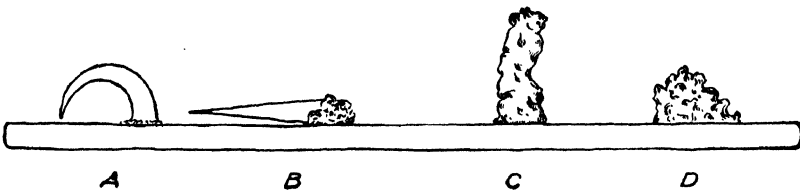

Fig. 181. Behavior of specimen cones on firing.

slump down, *D*. Unless for some special purpose, fusion points should always be made in an oxidizing or neutral atmosphere.

3. Fusion Point and Composition. A number of relations have been suggested to connect the chemical composition of a clay with its fusion point. Perhaps the earliest work on this subject was that of Richter, who showed that various fluxes had equal effects if they were taken in molecular equivalents; *i.e.*, 40 parts of MgO would have the same influence

on a clay as 94 parts of K_2O . He also stated that if a number of fluxes are present, their influence is proportional to the sum of their equivalents. We know now that these relations are not strictly true, but this work was a great step forward in logical procedure.

Richter's law has been applied to fireclay by Ludwig,⁽¹¹⁾ who found the law restricted to certain conditions, such as low concentrations and intimate mixtures.

Schuen⁽¹⁶⁾ gives for the fusion point of a clay, in degrees centigrade, the following formula:

$$\frac{360 + Al_2O_3 - RO}{0.228}$$

The Al_2O_3 and RO are given in percentage weight, so calculated that the Al_2O_3 and SiO_2 equal 100. He finds that although this formula gives fair average results, there are many other important influences, such as grain size and state of oxidation.

H. Salmang⁽¹⁴⁾ and Hohler⁽¹⁷⁾ have studied the influence of grain size on the fusion point. They find that the finer the grain the lower the fusion value.

Many attempts have been made to correlate the atomic structure of a crystal with its melting point, for it should be possible to determine this value from the bond strengths in the lattice. Although certain correlations exist in some of the simple structures like a series of alkali halides, the structures are, in general, too complicated to handle directly. However, it is possible to formulate a few general rules from the data available.

In the first place, the only compounds having high fusion points are borides, carbides, nitrides, oxides, and sulfides. It is interesting to notice that the five elements boron, carbon, nitrogen, oxygen, and sulfur are adjacent to one another in the Periodic Table. Although we do not have particularly accurate values of fusion point for the high-temperature materials, it would seem reasonable to expect that the small number of electrons in the outer shell of this series correspond to the higher fusion point. There are few data on the melting point of the fluorides, and none listed goes above $1400^\circ C$ (about $2550^\circ F$). It should be remembered that most of the nitrides, carbides, borides, and sulfides are unstable in an oxidizing atmosphere.

It will also be noticed that all the high-melting-point compounds have a valence number of 2 or over, and a general tendency indicates that the higher the ionic bonding the higher the fusion point. It may also be noted that many of the refractory materials have a high hardness, generally over 6, if we neglect the unstable materials containing the CO_2 or OH groups. Then again, the refractory materials generally have a high density, very

few being below 3.0. Although very few data are available, there is evidence to indicate that materials having the lowest volume compressibility are the most refractory, which would also follow from our conception of high bond strength.

4. Melting Point of Some Refractory Materials. Table 69 shows the melting points of pure refractory materials in so far as they are at present available, taken largely from the following phase diagrams. It should be realized that the determination of the fusion points of these very refractory materials presents great difficulties and that undoubtedly more refined work will alter many of them in the future. In fact, any value above 2000°C (about 3630°F) may be open to considerable error.

TABLE 69. MELTING POINTS OF PURE REFRACTORY MATERIALS
Elements

| Material | Formula | Melting point | |
|----------------------|---------|---------------|------|
| | | °C | °F |
| Boron | B | 2300 | 4170 |
| Columbium | Cb | 1950 | 3540 |
| Graphite | C | 3700 | 6690 |
| Hafnium | Hf | 1700 | 3000 |
| Iridium | Ir | 2450 | 4440 |
| Molybdenum | Mo | 2630 | 4770 |
| Osmium | Os | 2700 | 4890 |
| Platinum | Pt | 1775 | 3240 |
| Rhenium | Re | 3000 | 5430 |
| Rhodium | Rh | 1966 | 3570 |
| Ruthenium | Ru | 2450 | 4440 |
| Tantalum | Ta | 3000 | 5430 |
| Thorium | Th | 1845 | 3350 |
| Titanium | Ti | 1800 | 3270 |
| Tungsten | W | 3410 | 6170 |
| Vanadium | V | 1710 | 3110 |
| Zirconium | Zr | 1800 | 3270 |

Oxides

| Material | Mineral or common name | Formula | Melting point | |
|---------------------------|------------------------|--------------------------------|---------------|------|
| | | | °C | °F |
| Aluminum oxide | Alumina | Al ₂ O ₃ | 2050 | 3720 |
| Barium oxide | | BaO | 1923 | 3490 |
| Beryllium oxide | Bromellite | BeO | 2530 | 4580 |
| Calcium oxide | Lime | CaO | 2570 | 4660 |
| Cerium oxide | Ceria | CeO ₂ | 2600 | 4710 |
| Chromium oxide | | Cr ₂ O ₃ | 2435 | 4410 |

TABLE 69. MELTING POINTS OF PURE REFRACTORY MATERIALS (Continued)
Oxides (Continued)

| Material | Mineral or common name | Formula | Melting point | |
|---------------------------|------------------------|--------------------------------|---------------|------|
| | | | °C | °F |
| Cobalt oxide | | CoO | 1800 | 2370 |
| Columbium oxide | | Cb ₂ O ₅ | 1520 | 2770 |
| Gallium oxide | | Ga ₂ O ₃ | 1740 | 3160 |
| Hafnium oxide | Hafnia | HfO ₂ | 2810 | 5090 |
| Lanthium oxide | Lanthia | La ₂ O ₃ | 2320 | 4208 |
| Lithium oxide | Lithia | Li ₂ O | 1700 | 3090 |
| Magnesium oxide | Periclase | MgO | 2800 | 5070 |
| Manganese oxide | Manganosite | MnO | 1785 | 3250 |
| Nickel oxide | Bunsenite | NiO | 1990 | 3610 |
| Silicon oxide | Cristobalite | SiO ₂ | 1725 | 3130 |
| Strontium oxide | Strontia | SrO | 2430 | 4410 |
| Tantalum oxide | | Ta ₂ O ₅ | 1875 | 3310 |
| Thorium oxide | Thoria | ThO ₂ | 3050 | 5520 |
| Tin Oxide | | SiO ₂ | 1825 | 3320 |
| Titanium oxide | Titania | TiO ₂ | 1830 | 3330 |
| Tungsten oxide | | WO ₃ | 1470 | 2680 |
| Uranium oxide | | UO ₂ | 1970 | 3580 |
| Vanadium oxide | | V ₂ O ₃ | 1970 | 3580 |
| Yttrium oxide | Yttria | Y ₂ O ₃ | 2410 | 4370 |
| Zinc oxide | Zincite | ZnO | 1975 | 3590 |
| Zirconium oxide | Zirconia | ZrO ₂ | 2690 | 4870 |

Silicates

| | | | | |
|---------------------------------------|--------------------|--|---------------|---------------|
| Aluminum silicate | Mullite | 3Al ₂ O ₃ ·2SiO ₂ | 1810 <i>d</i> | 3290 <i>d</i> |
| Barium silicate | Metasilicate | BaO·SiO ₂ | 1605 | 2921 |
| Barium silicate | | BaO·SiO ₂ | 1420 | 2588 |
| Barium silicate | Orthosilicate | 2BaO·SiO ₂ | >1755 | >3191 |
| Barium silicate | | 2BaO·3SiO ₂ | 1450 | 2642 |
| Barium aluminum silicate | Celsian | BaO·Al ₂ O ₃ ·2SiO ₂ | >1700 | >3092 |
| Barium calcium silicate | | BaO·2CaO·3SiO ₂ | 1320 <i>d</i> | 2408 |
| Barium zirconium silicate | | BaO·ZrO ₂ ·SiO ₂ | 1573 | 2864 |
| Beryllium silicate | Metasilicate | BeO·SiO ₂ | >1755 | >3191 |
| Beryllium silicate | Orthosilicate | 2BeO·SiO ₂ | 2000 | 3632 |
| Beryllium aluminum silicate | Beryl | 3BeO·Al ₂ O ₃ ·6SiO ₂ | 1410 | 2570 |
| Calcium silicate | | 3CaO·SiO ₂ | 1900 | 3452 |
| Calcium silicate | Orthosilicate | 2CaO·SiO ₂ | 2130 | 3866 |
| Calcium silicate | | 3CaO·2SiO ₂ | 1475 | 2687 |
| Calcium silicate | Pseudowollastonite | CaO·SiO ₂ | 1540 | 2804 |
| Calcium aluminum silicate | Anorthite | CaO·Al ₂ O ₃ ·SiO ₂ | 1550 | 2822 |

TABLE 69. MELTING POINTS OF PURE REFRACTORY MATERIALS (Continued)
Silicates (Continued)

| Material | Mineral or common name | Formula | Melting point | |
|-----------------------------------|------------------------|---|---------------|---------------|
| | | | °C | °F |
| Calcium aluminum silicate..... | Gehlenite | $2\text{CaO}\cdot\text{Al}_2\text{O}_3\cdot\text{SiO}_2$ | 1590 | 2894 |
| Calcium magnesium silicate..... | Monticellite | $\text{CaO}\cdot\text{MgO}\cdot\text{SiO}_2$ | 1498 <i>d</i> | 2728 |
| Calcium potassium silicate..... | | $\text{CaO}\cdot\text{K}_2\text{O}\cdot\text{SiO}_2$ | 1620 | 2948 |
| Calcium zirconium silicate..... | | $\text{CaO}\cdot\text{ZrO}_2\cdot\text{SiO}_2$ | 1582 | 2880 |
| Iron silicate..... | Grucnerite | $\text{FeO}\cdot\text{SiO}_2$ | 1550 | 2822 |
| Magnesium silicate..... | Forsterite | $2\text{MgO}\cdot\text{SiO}_2$ | 1890 | 3434 |
| Magnesium silicate..... | Clino-enstatite | $\text{MgO}\cdot\text{SiO}_2$ | 1557 <i>d</i> | 2835 <i>d</i> |
| Magnesium zirconium silicate..... | | $\text{MgO}\cdot\text{ZrO}_2\cdot\text{SiO}_2$ | 1793 | 3260 |
| Manganese silicate..... | Tephroite | $2\text{MnO}\cdot\text{SiO}_2$ | 1320 <i>d</i> | 2408 <i>d</i> |
| Potassium aluminum silicate..... | Kaliophilite | $\text{K}_2\text{O}\cdot\text{Al}_2\text{O}_3\cdot 2\text{SiO}_2$ | 1790 | 3254 |
| Potassium aluminum silicate..... | Leucite | $\text{K}_2\text{O}\cdot\text{Al}_2\text{O}_3\cdot 4\text{SiO}_2$ | 1810 | 3290 |
| Silica..... | Cristobalite | SiO_2 | 1710 | 3110 |
| Sodium zirconium silicate..... | | $\text{Na}_2\text{O}\cdot\text{ZrO}_2\cdot\text{SiO}_2$ | 1708 | 3107 |
| Sodium aluminum silicate..... | Nephalite | $\text{Na}_2\text{O}\cdot\text{Al}_2\text{O}_3\cdot 2\text{SiO}_2$ | 1526 | 2779 |
| Strontium silicate..... | | $2\text{SrO}\cdot\text{SiO}_2$ | > 1700 | > 3092 |
| Strontium silicate..... | | $\text{SrO}\cdot\text{SiO}_2$ | 1580 | 2876 |
| Strontium aluminum silicate..... | | $\text{SrO}\cdot\text{Al}_2\text{O}_3\cdot 2\text{SiO}_2$ | > 1700 | > 3092 |
| Zinc silicate..... | Willemite | $2\text{ZnO}\cdot\text{SiO}_2$ | 1509 | 2748 |
| Zinc zirconium silicate..... | | $\text{ZnO}\cdot\text{ZrO}_2\cdot\text{SiO}_2$ | 2078 | 3773 |
| Zirconium silicate..... | Zircon | $\text{ZrO}_2\cdot\text{SiO}_2$ | 2500 | 4532 |
| Aluminates (Other Than Spinels) | | | | |
| Calcium aluminate..... | | $5\text{CaO}\cdot 3\text{Al}_2\text{O}_3$ | 1455 | 2651 |
| Calcium aluminate..... | | $3\text{CaO}\cdot 5\text{Al}_2\text{O}_3$ | 1720 | 3128 |
| Calcium aluminate..... | | $3\text{CaO}\cdot\text{Al}_2\text{O}_3$ | 1535 <i>d</i> | 2795 |
| Calcium ferric aluminate..... | | $4\text{CaO}\cdot\text{Fe}_2\text{O}_3\cdot\text{Al}_2\text{O}_3$ | 1415 | 2579 |
| Calcium sodium aluminate..... | | $3\text{CaO}\cdot 2\text{Na}_2\text{O}\cdot 5\text{Al}_2\text{O}_3$ | > 1630 | > 2966 |
| Calcium sodium aluminate..... | | $8\text{CaO}\cdot\text{Na}_2\text{O}\cdot 3\text{Al}_2\text{O}_3$ | 1508 <i>d</i> | 2746 <i>d</i> |
| Lithium aluminate..... | | $\text{Li}_2\text{O}\cdot\text{Al}_2\text{O}_3$ | > 1625 | > 2957 |
| Sodium aluminate..... | | $\text{Na}_2\text{O}\cdot\text{Al}_2\text{O}_3$ | 1650 | 3002 |
| Titanium aluminate..... | | $\text{TiO}_2\cdot\text{Al}_2\text{O}_3$ | 1860 | 3380 |

TABLE 69. MELTING POINTS OF PURE REFRACTORY MATERIALS (Continued)
Nitrides

| Material | Mineral or common name | Formula | Melting point | |
|------------------------|------------------------|--------------------------------|---------------|---------------|
| | | | °C | °F |
| Aluminum nitride..... | | AlN | 2200 <i>d</i> | 3990 <i>d</i> |
| Barium nitride..... | | Ba ₃ N ₂ | 2200 | 3990 |
| Beryllium nitride..... | | Be ₃ N ₂ | 2200 | 3990 |
| Boron nitride..... | | BN | 2730 | 4950 |
| Chromium nitride..... | | CrN | 1770 <i>d</i> | 3220 <i>d</i> |
| Columbium nitride..... | | CbN | 2050 <i>d</i> | 3720 <i>d</i> |
| Hafnium nitride..... | | HfN | 3300 | 5970 |
| Magnesium nitride..... | | Mg ₃ N ₂ | 1500 <i>d</i> | 2730 <i>d</i> |
| Silicon nitride..... | | Si ₃ N ₄ | 2170 | 3940 |
| Scandium nitride..... | | ScN | 2650 | 4800 |
| Tantalum nitride..... | | TaN | 3360 | 6080 |
| Thorium nitride..... | | Th ₃ N ₄ | 2100 | 3810 |
| Titanium nitride..... | | TiN | 2900 | 5250 |
| Vanadium nitride..... | | VN | 2050 | 3720 |
| Zirconium nitride..... | | ZrN | 2950 | 5340 |

Titanates

| | | | | |
|-------------------------|-------------|-----------------------|------|------|
| Beryllium titanate..... | | 3BeO·TiO ₂ | 1810 | 3290 |
| Beryllium titanate..... | | BeO·TiO ₂ | 1720 | 3128 |
| Calcium titanate..... | | CaO·TiO ₂ | 1980 | 3596 |
| Calcium titanate..... | | 2CaO·TiO ₂ | 1800 | 3272 |
| Calcium titanate..... | | 3CaO·TiO ₂ | 1840 | 3344 |
| Magnesium titanate..... | | 2MgO·TiO ₂ | 1830 | 3326 |
| Magnesium titanate..... | | MgO·2TiO ₂ | 1670 | 3038 |
| Manganese titanate..... | Pyrophanite | MnO·TiO ₂ | 1404 | 2559 |

Borides

| | | | | |
|-----------------------|--|--------------------------------|------|------|
| Boron nitride..... | | NB | 3000 | 5432 |
| Hafnium boride..... | | HfB | 3065 | 5549 |
| Iron boride..... | | Fe ₂ B ₅ | 1340 | 2444 |
| Iron boride..... | | Fe ₅ B ₂ | 1351 | 2464 |
| Tungsten boride..... | | WB ₆ | 2920 | 5288 |
| Zirconium boride..... | | ZrB ₃ | 2990 | 5414 |

Carbides

| | | | | |
|------------------------|--|--------------------------------|---------------|------|
| Beryllium carbide..... | | Be ₂ C | 2100 <i>d</i> | 3810 |
| Boron carbide..... | | B ₄ C | 2350 | 4230 |
| Calcium carbide..... | | CaC ₂ | 2300 | 4170 |
| Chromium carbide..... | | Cr ₃ C ₂ | 1890 | 3430 |
| Columbium carbide..... | | CbC | 3500 | 6330 |
| Hafnium carbide..... | | HfC | 4160 | 7530 |
| Iron carbide..... | | Fe ₃ C | 1840 | 3340 |

TABLE 69. MELTING POINTS OF PURE REFRACTORY MATERIALS (Continued)
Carbides (Continued)

| Material | Mineral or common name | Formula | Melting point | |
|--------------------------------------|------------------------|--|-------------------|--------|
| | | | °C | °F |
| Molybdenum carbide . . . | | Mo ₂ C | 2380 | 4320 |
| Silicon carbide | | SiC | 2700 | 4890 |
| Tantalum carbide | | TaC | 3880 | 7020 |
| Thorium carbide | | ThC ₂ | 2770 | 5020 |
| Titanium carbide | | TiC | 3140 | 5670 |
| Tungsten carbide | | WC | 2780 | 5036 |
| Uranium carbide | | UC | 2400 | 4350 |
| Vanadium carbide | | VC | 2830 | 5130 |
| Zirconium carbide | | ZrC | 3530 | 6380 |
| Zirconates | | | | |
| Barium zirconate | | BaO·ZrO ₂ | 2620 | 4748 |
| Calcium zirconate | | CaO·ZrO ₂ | 2350 | 4262 |
| Magnesium zirconate | | MgO·ZrO ₂ | 2150 | 3902 |
| Strontium zirconate | | SrO·ZrO ₂ | > 2800 | > 5072 |
| Thorium zirconate | | ThO ₂ ·ZrO ₂ | 2800 | 5072 |
| Phosphates | | | | |
| Aluminum phosphate | | AlPO ₄ | > 1500 | > 2732 |
| Calcium phosphate | | Ca ₃ (PO ₄) ₂ | 1670 | 3038 |
| Calcium phosphate | | Ca ₄ P ₂ O ₉ | 1630 | 2966 |
| Calcium phosphate | | Ca ₁₀ P ₆ O ₁₃ | 1540 | 2804 |
| Calcium phosphate-fluoride | Fluorapatite | CaF ₂ ·3CaP ₂ O ₈ | 1630 | 2966 |
| Calcium silicon phosphate | | 5CaO·SiO ₂ ·P ₂ O ₅ | 1760 | 3200 |
| Spinel | | | | |
| Barium aluminate | | BaO·Al ₂ O ₃ | 2000 | 3632 |
| Beryllium aluminate | Chrysoberyl | BeO·Al ₂ O ₃ | 1870 | 3398 |
| Calcium aluminate | | CaO·Al ₂ O ₃ | 1600 | 2912 |
| Cobalt aluminate | | CoO·Al ₂ O ₃ | 1960 | 3560 |
| Ferrous aluminate | Hercynite | FeO·Al ₂ O ₃ | 1600 | 2912 |
| Ferrous chromite | Chromite | FeO·Cr ₂ O ₃ | > 1770 | 3218 |
| Ferrous ferrite | Magnetite | FeO·Fe ₂ O ₃ | 1538 ^d | 2800 |
| Magnesium aluminate | Spinel | MgO·Al ₂ O ₃ | 2135 | 3875 |
| Magnesium chromite | | MgO·Cr ₂ O ₃ | > 1780 | 3236 |
| Magnesium ferrite | Magnesioferrite | MgO·Fe ₂ O ₃ | > 1780 | 3236 |
| Nickel aluminate | | NiO·Al ₂ O ₃ | 2020 | 3668 |
| Strontium aluminate | | SrO·Al ₂ O ₃ | 2020 | 3668 |
| Zinc aluminate | Gahnite | ZnO·Al ₂ O ₃ | 1950 | 3542 |
| Zinc ferrite | | ZnO·Fe ₂ O ₃ | 1590 | 2894 |

In Table 70, the fusion points of a number of refractory bricks are given. These values were obtained with an optical pyrometer in a tube furnace under reducing conditions and, in many cases, will be slightly lower in value than a corresponding determination made in an oxidizing atmosphere.

TABLE 70. FUSION POINTS OF BRICKS MANUFACTURED FROM NATIVE CLAYS

| Material | Fusion point | |
|---------------------------------|---------------|--------------|
| | °C | °F |
| Alumina, Fused..... | 1750 to 2050 | 3182 to 3722 |
| Bauxite..... | 1732 to 1850 | 3150 to 3362 |
| Carborundum (recrystallized)... | 2200 (decom.) | 3992 |
| Carbon..... | very high | |
| Chrome..... | 1950 to 2200 | 3542 to 3992 |
| Clay, native in: | | |
| Arkansas..... | 1615 to 1625 | 2939 to 2954 |
| British Columbia..... | 1615 to 1645 | 2939 to 2993 |
| California..... | 1657 to 1688 | 3015 to 3070 |
| Colorado..... | 1585 to 1796 | 2885 to 3265 |
| England..... | 1620 to 1657 | 2948 to 3015 |
| Georgia..... | 1685 to 1700 | 3065 to 3092 |
| Idaho..... | 1660 to 1700 | 3038 to 3092 |
| Kentucky..... | 1627 to 1718 | 2961 to 3124 |
| Maryland..... | 1595 to 1640 | 2903 to 2984 |
| Missouri..... | 1610 to 1750 | 2930 to 3182 |
| Montana..... | 1580 | 2876 |
| New Jersey..... | 1582 to 1677 | 2880 to 3051 |
| New York..... | 1685 | 3065 |
| Ohio..... | 1610 to 1782 | 2930 to 3240 |
| Pennsylvania..... | 1630 to 1757 | 2966 to 3195 |
| Texas..... | 1615 | 2939 |
| Washington..... | 1605 to 1638 | 2921 to 2980 |
| Clays high in alumina..... | 1802 to 1880 | 3276 to 3416 |
| Graphite-clay..... | 1605 to 1675 | 2921 to 3047 |
| Kaolins (southern)..... | 1645 to 1785 | 2993 to 3245 |
| Magnesite..... | 2200 | 3992 |
| Mullite..... | 1780 to 1800 | 3236 to 3272 |
| Silica..... | 1700 | 3090 |
| Spinel..... | 1693 to 2100 | 3079 to 3812 |
| Zircon and Zirconia..... | 2200 to 2700 | 3992 to 4892 |

5. Value of Fusion Points. The value of a fusion point in determining the possibility of a material for specific purposes has often been over-estimated. What the fusion point does show is whether or not a material is unsuitable above a certain temperature. For example, if it should be desired to make a firebrick to be used with furnace temperatures of 1600°C (about 2910°F) and various samples of clays were selected, the fusion-point

test would eliminate at once all those with a fusion point equal to or below that temperature. However, a clay softening at 1850°C (about 3360°F) would not necessarily be better for this brick than another clay softening at 1750°C (about 3180°F).

The fusion point of a material is by no means a criterion of its ability to carry a load at high temperatures, which in actual use is of considerable importance in determining the maximum temperature at which it can be successfully used. For example, commercial magnesite has a fusion point of over 2000°C (about 3630°F); yet it will not carry a load at temperatures over 1400°C (about 2550°F) to 1500°C (about 2730°F). On the other hand, a mullite brick that has a fusion point of 1780°C (about 3230°F) will show no deformation at temperatures of 1727°C (about 3140°F).

6. Equilibrium Diagrams. The equilibrium diagrams in the refractory systems are particularly useful in studying problems in the manufacture and use of refractories. A thorough understanding of the equilibrium conditions will allow one to interpret the results of practical tests more accurately, although it should be remembered that ceramic reactions seldom reach complete equilibrium. In this chapter are included nearly all of the equilibrium diagrams that are now available dealing with the refractory systems.

Phase Rule. The construction and interpretation of the equilibrium diagram depend largely on the phase rule, which states

$$P + V = C + 2$$

where P = the number of phases

C = the number of components

V = the number of degrees of freedom

The following definitions applying to the equilibrium system are commonly used:

1. *System:* Any portion of the material universe that we choose to separate in thought from the rest of the universe for the purpose of considering and discussing the various changes that may occur within it under various conditions is called a "system."

2. *Phase:* The physically homogeneous but mechanically separable portions of the system are called its "phases."

3. *Components:* The number of components of a system at equilibrium is defined as the smallest number of independently variable constituents by means of which the composition of each phase can be quantitatively expressed.

4. *Variance of a System (Degree of Freedom):* In the application of the phase rule to the type of systems under consideration, the independently variable conditions usually taken into consideration are temperature, pressure, and concentration. The number of these variables, which must be arbitrarily fixed to define the system completely, is called the "variance" or "degree of freedom" of that system.

5. *Equilibrium:* An equilibrium exists in any system under a fixed set of conditions when the parts of the system do not undergo any change of properties with the passage

of time and provided the parts of the system have the same properties when the same conditions are again arrived at by a different procedure.

6. *Melting Point:* The temperature of transition of solid to liquid state at atmospheric pressure in which the liquid phase is of the same composition as the solid phase is known as the "congruent melting point" of the solid phase. This is in contradistinction to the transition of one solid phase into a second solid phase with the liberation of liquid of a different composition; the latter is called an "incongruent melting point."

7. *Transition Point:* When the pressure is the atmospheric pressure, the temperature at which two solid phases can coexist and at which the relative stability of the two forms undergoes change is known as the "transition point."

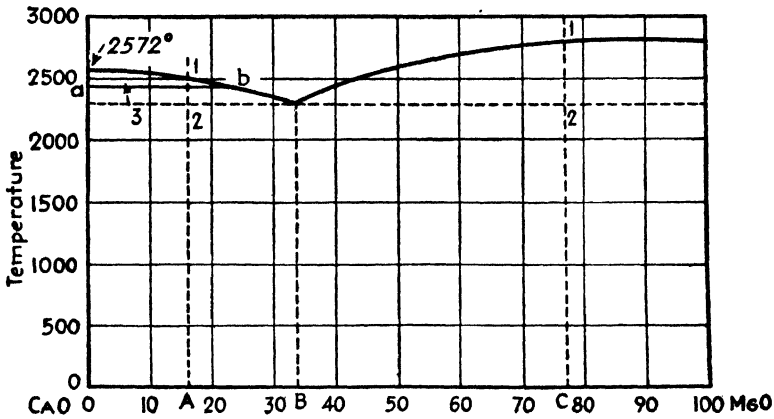

FIG. 182. Equilibrium diagram for lime and magnesia. (Weight per cent.)

Methods of Obtaining High-temperature Equilibrium Diagrams.

Although the method of using cooling curves has been of great aid to the metallurgist, it has not been successful for high-temperature refractory materials because of the great undercooling encountered and the small heat evolved or absorbed compared with radiation exchange. Heating curves are somewhat more reliable but not generally useful for studies of refractories.

The method most used consists in heating the mixture at a given temperature until equilibrium is established and quenching suddenly to fix the structure developed. A microscopic examination will then show the crystalline phases present, if any.

Interpretation of the Equilibrium Diagram. For a full discussion of the interpretation of the equilibrium diagrams, reference should be made to Hall and Insley,⁽⁶¹⁾ from whom the diagrams reproduced here have been taken. However, a very brief outline is given here to indicate the features of the simpler types of diagrams.

Let us first consider a phase diagram composed of two materials completely soluble in each other and forming no compound. As an example, we may take lime and magnesia, shown in the diagram in Fig. 182. It will

be noted that the solution of either material in the other lowers the freezing point and that at a composition of 33 per cent MgO, the lowest freezing point is reached. When a composition represented by *A* is considered, the melt is completely liquid above point 1; but at this point, CaO begins to crystallize out. At point 2, no liquid is left and the solid consists of mixed

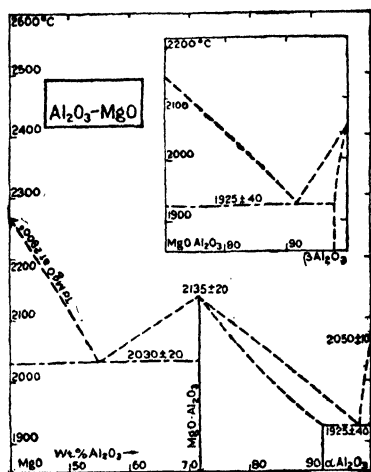

FIG. 183. Equilibrium diagram for magnesia and alumina. (*International Critical Tables.*)

crystals of MgO and CaO. The same thing occurs at composition *C*, except that MgO first crystallizes out. At the composition *B*, CaO and MgO crystallize out simultaneously and there is no mixture of liquid and crystals as there are for all other compositions. This point is called the "eutectic point."

Another example may be considered where two substances are completely soluble in each other but form a single compound, such as magnesia and alumina. The simplified equilibrium diagram for these materials is shown in Fig. 183. The compound spinel is formed of a composition containing 72 per cent MgO and 28 per cent Al_2O_3 .

The diagram may be divided into two portions, each one of which is similar to the preceding diagram.

It is possible to determine the relative amount of liquid and solid at any point of the diagram by the so-called "lever principle." Figure 182 gives the ratio of solid material at point 3 to liquid by

$$\frac{\text{Distance } b3}{\text{Distance } a3}$$

measuring along the horizontal line *ab*.

Equilibrium Diagrams for High-temperature Systems. In Table 71 are listed nearly all the diagrams of interest in the refractories field, together with the figure numbers of the corresponding diagrams that follow. These diagrams were taken from Hall and Insley, published in the *Journal of the American Ceramic Society*.⁽⁶¹⁾

TABLE 71. INDEX TO PHASE DIAGRAMS

| | |
|---|--|
| Binary aluminates | $\text{CoO}\cdot\text{Al}_2\text{O}_3$ (Fig. 207) |
| $\text{BaO}\cdot\text{Al}_2\text{O}_3$ (Fig. 207) | $\text{Cr}_2\text{O}_3\cdot\text{Al}_2\text{O}_3$ (Figs. 195, 200) |
| $\text{BeO}\cdot\text{Al}_2\text{O}_3$ (Fig. 215) | $\text{Cu}_2\text{O}\cdot\text{Al}_2\text{O}_3$ (Fig. 199) |
| $\text{CaO}\cdot\text{Al}_2\text{O}_3$ (Figs. 184, 206) | $\text{Fe}_2\text{O}_3\cdot\text{Al}_2\text{O}_3$ (Fig. 200) |
| $\text{CeO}\cdot\text{Al}_2\text{O}_3$ (Figs. 199, 201) | $\text{Ga}_2\text{O}_3\cdot\text{Al}_2\text{O}_3$ (Fig. 200) |

TABLE 71. INDEX TO PHASE DIAGRAMS (Continued)

| | |
|---|---|
| Binary aluminates (Continued) | TiO ₂ ·ZrO ₂ (Fig. 220) |
| La ₂ O ₃ ·Al ₂ O ₃ (Fig. 200) | ZnO·ZrO ₂ (Fig. 219) |
| MgO·Al ₂ O ₃ (Figs. 196, 207, 213) | Binary Beryllia Systems |
| MnO ₂ ·Al ₂ O ₃ (Fig. 200) | Al ₂ O ₃ ·BeO (Fig. 215) |
| NiO·Al ₂ O ₃ (Fig. 207) | CaO·BeO (Fig. 214) |
| SiO ₂ ·Al ₂ O ₃ (Figs. 187, 199) | CeO ₂ ·BeO (Fig. 216) |
| SrO·Al ₂ O ₃ (Fig. 207) | CoO·BeO (Fig. 214) |
| ThO ₂ ·Al ₂ O ₃ (Fig. 199) | Cr ₂ O ₃ ·BeO (Fig. 215) |
| TiO ₂ ·Al ₂ O ₃ (Figs. 197, 199) | Cu ₂ O·BeO (Fig. 214) |
| ZnO·Al ₂ O ₃ (Fig. 198) | Fe ₃ O ₄ ·BeO (Fig. 215) |
| ZrO ₂ ·Al ₂ O ₃ (Figs. 199, 220) | La ₂ O ₃ ·BeO (Fig. 215) |
| Binary Chromites | MgO·BeO (Fig. 214) |
| Al ₂ O ₃ ·Cr ₂ O ₃ (Figs. 195, 200) | MnO ₄ ·BeO (Fig. 215) |
| CaO·Cr ₂ O ₃ (Fig. 206) | NiO·BeO (Fig. 214) |
| CeO ₂ ·Cr ₂ O ₃ (Fig. 201) | ThO ₂ ·BeO (Fig. 216) |
| ZrO ₂ ·Cr ₂ O ₃ (Fig. 220) | TiO ₂ ·BeO (Fig. 216) |
| Binary Silicates | ZrO ₂ ·BeO (Fig. 216) |
| Al ₂ O ₃ ·SiO ₂ (Fig. 187, 199) | Binary Calcium Oxide Systems |
| BaO·SiO ₂ (Fig. 188) | Al ₂ O ₃ ·CaO (Figs. 184, 206) |
| CaO·SiO ₂ (Fig. 189, 204) | CeO ₂ ·CaO (Fig. 204) |
| MgO·SiO ₂ (Figs. 190, 213) | CoO·CaO (Fig. 205) |
| SrO·SiO ₂ (Fig. 191) | Cr ₂ O ₃ ·CaO (Fig. 206) |
| TiO ₂ ·SiO ₂ (Fig. 192) | Cu ₂ O·CaO (Fig. 205) |
| ZnO·SiO ₂ (Fig. 193) | Fe ₂ O ₃ ·CaO (Fig. 206) |
| ZrO ₂ ·SiO ₂ (Fig. 194) | MgO·CaO (Figs. 202, 205, 208) |
| Binary Thorates | MnO ₂ ·CaO (Fig. 206) |
| BeO·ThO ₂ (Fig. 216) | NiO·CaO (Fig. 205) |
| CaO·ThO ₂ (Fig. 204) | SiO ₂ ·CaO (Fig. 189, 204) |
| MgO·ThO ₂ (Fig. 225) | ThO ₂ ·CaO (Fig. 204) |
| ZrO ₂ ·ThO ₂ (Fig. 217) | TiO ₂ ·CaO (Fig. 204) |
| Binary Titanates | ZrO ₂ ·CaO (Figs. 203, 204) |
| CaO·TiO ₂ (Fig. 204) | Ceria Systems |
| MgO·TiO ₂ (Fig. 210) | Al ₂ O ₃ ·CeO ₂ (Fig. 201) |
| ZrO ₂ ·TiO ₂ (Fig. 220) | BeO·CeO ₂ (Fig. 216) |
| Binary Zirconates | Cr ₂ O ₃ ·CeO ₂ (Fig. 201) |
| Al ₂ O ₃ ·ZrO ₂ (Fig. 220) | Fe ₃ O ₄ ·CeO ₂ (Fig. 201) |
| BaO·ZrO ₂ (Fig. 218) | MgO·CeO ₂ (Fig. 213) |
| BeO·ZrO ₂ (Fig. 216) | Mn ₃ O ₄ ·CeO ₂ (Fig. 201) |
| CaO·ZrO ₂ (Figs. 203, 218) | ZrO ₂ ·CeO ₂ (Fig. 227) |
| CeO ₂ ·ZrO ₂ (Fig. 227) | Binary Magnesia Systems |
| CoO·ZrO ₂ (Fig. 219) | Al ₂ O ₃ ·MgO (Figs. 196, 207, 213) |
| Cr ₂ O ₃ ·ZrO ₂ (Fig. 220) | BaO·MgO (Fig. 212) |
| Fe ₃ O ₄ ·ZrO ₂ (Fig. 220) | BeO·MgO (Fig. 212) |
| La ₂ O ₃ ·ZrO ₂ (Fig. 220) | CaO·MgO (Figs. 202, 205) |
| MgO·ZrO ₂ (Figs. 213, 218) | CeO ₂ ·MgO (Fig. 213) |
| Mn ₃ O ₄ ·ZrO ₂ (Fig. 220) | CoO·MgO (Fig. 208) |
| NiO·ZrO ₂ (Fig. 219) | Cu ₂ O·MgO (Fig. 212) |
| SrO·ZrO ₂ (Fig. 218) | Fe ₃ O ₄ ·MgO (Fig. 213) |
| ThO ₂ ·ZrO ₂ (Fig. 217) | Mn ₃ O ₄ ·MgO (Fig. 213) |

TABLE 71. INDEX TO PHASE DIAGRAMS (Continued)

Binary Magnesia Systems (Continued)

- NiO·MgO (Fig. 209)
- SiO₂·MgO (Fig. 213)
- SrO·MgO (Fig. 212)
- ThO₂·MgO (Fig. 225)
- TiO₂·MgO (Fig. 210)
- ZrO₂·MgO (Figs. 211, 213, 218)

Ternary Aluminates

- BeO·MgO·Al₂O₃ (Fig. 231)
- BeO·ThO₂·Al₂O₃ (Fig. 230)
- BeO·ZrO₂·Al₂O₃ (Fig. 229)
- CaO·MgO·Al₂O₃ (Fig. 232)
- CaO·SiO₂·Al₂O₃ (Fig. 224)
- MgO·Cr₂O₃·Al₂O₃ (Fig. 233)

MgO·SiO₂·Al₂O₃ (Fig. 223)

ZnO·SiO₂·Al₂O₃ (Fig. 222)

Ternary Silicates

- CaO·Al₂O₃·SiO₂ (Fig. 224)
- CaO·MgO·SiO₂ (Fig. 221)
- MgO·Al₂O₃·SiO₂ (Fig. 223)
- ZnO·Al₂O₃·SiO₂ (Fig. 222)

Ternary Zirconates

- BeO·Al₂O₃·ZrO₂ (Fig. 229)
- BeO·CaO·ZrO₂ (Fig. 228)
- BeO·CeO₂·ZrO₂ (Fig. 227)
- CaO·ThO₂·ZrO₂ (Fig. 226)
- MgO·ThO₂·ZrO₂ (Fig. 225)

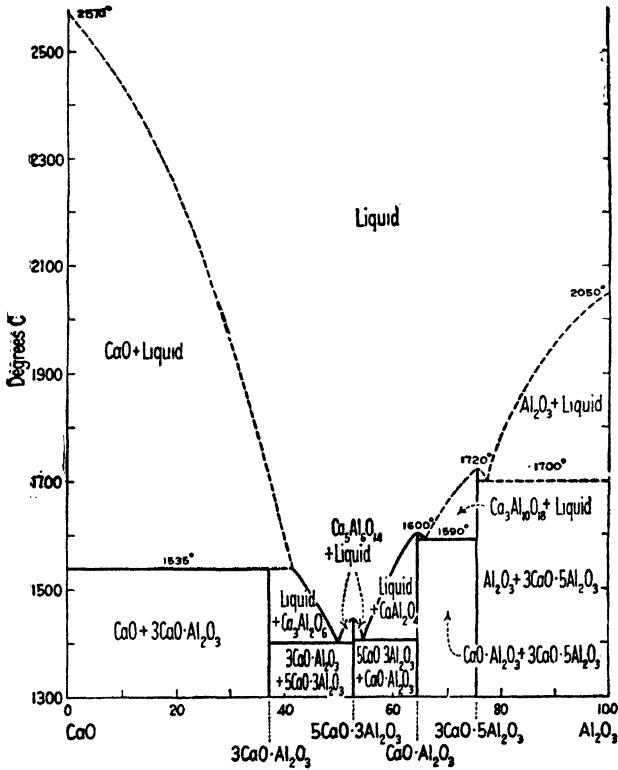

FIG. 184. Mol per cent.

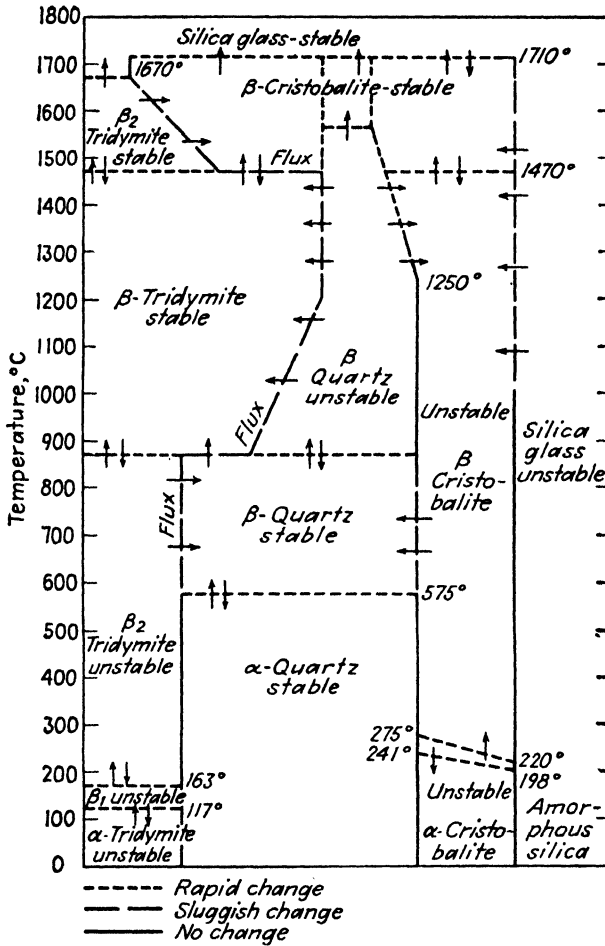

FIG. 185. Stability relations of the silica minerals. (Modified from J. S. McDowell, *Trans. Am. Inst. Mining Met. Engrs.*, 57, 7, 1917.)

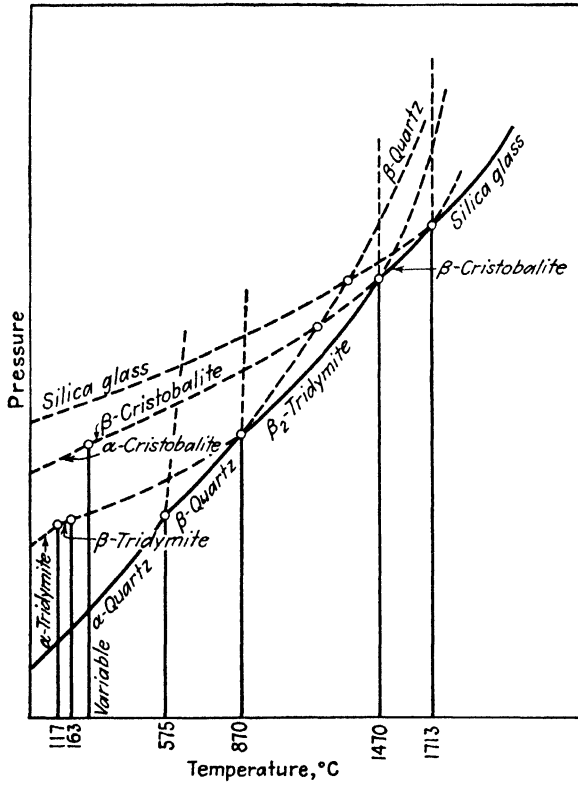

FIG. 186. Vapor pressure (stability) relations of the silica minerals. (C. N. Fenner, *Am. J. Sci.*, 4th Ser., 36, 338, 1913; silica glass- β -cristobalite inversion point from J. W. Greig, *ibid.*, 5th Ser., 13, 1-44, 1927.)

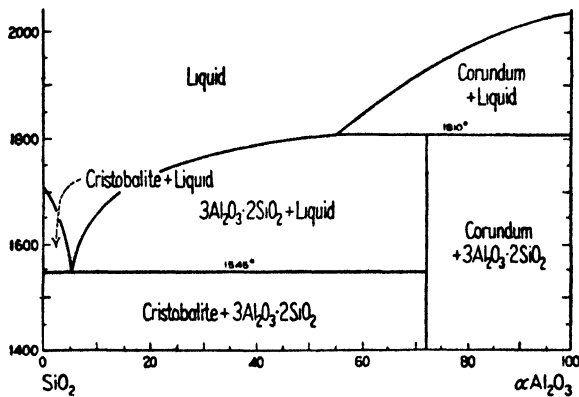

FIG. 187. System α - Al_2O_3 - SiO_2 . (N. L. Bowen and J. W. Greig, *J. Am. Ceram. Soc.*, 7, 4, 242, 1924.)

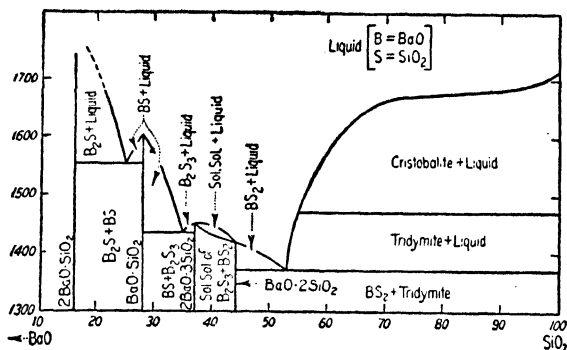

FIG. 188. System BaO-SiO₂. (P. Eskola, *Am. J. Sci.*, 5th Ser., 4, 345, 122; modified by J. W. Greig, *Am. J. Sci.*, 5th Ser., 13, 27, 1927.)

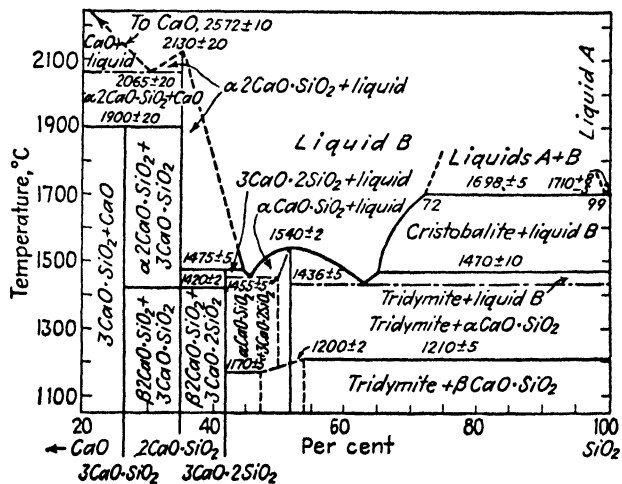

FIG. 189. System CaO-SiO₂. (G. A. Rankin and F. E. Wright, *Am. J. Sci.*, 4th Ser., 39, 5, 1915; modified by J. W. Greig, *ibid.*, 5th Ser., 13, 1-44, 1927.)

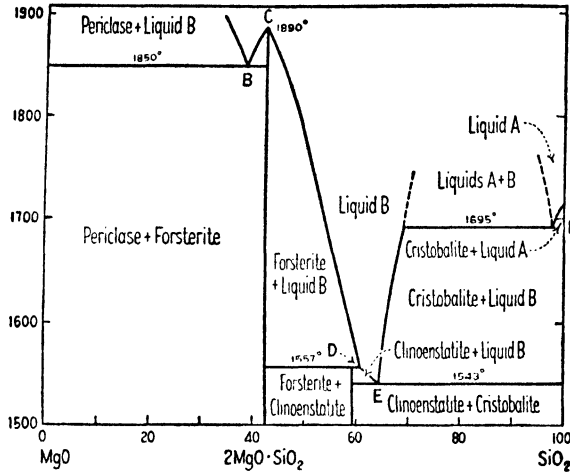

FIG. 190. System $MgO-SiO_2$. (N. L. Bowen and Olaf Anderson, *Am. J. Sci.*, 4th Ser., 37, 488, 1914; modified by J. W. Greig, *ibid.*, 5th Ser., 13, pp. 15, 133-54, 1927.)

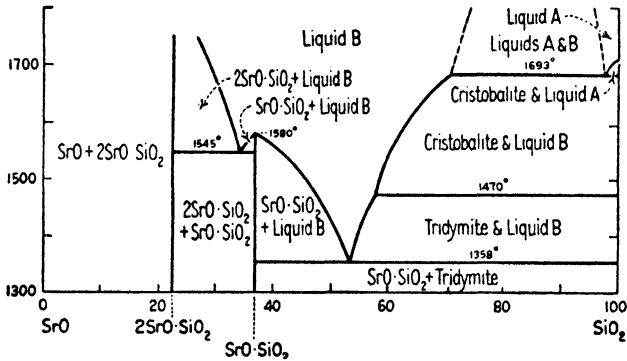

FIG. 191. System $SrO-SiO_2$. (P. Eskola, *Am. J. Sci.*, 5th Ser., 4, 336, 1922; modified by J. W. Greig, *ibid.*, 5th Ser., 13, 19, 1927; see also F. C. Kracek, *J. Am. Chem. Soc.*, 52 (4) 1440, 1930.)

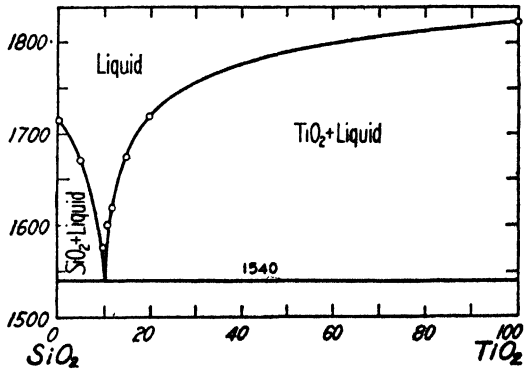

FIG. 192. System SiO_2-TiO_2 . (E. N. Bunting, *Bur. Standards J. Research*, 11, 723, 1933; R. P. 619.)

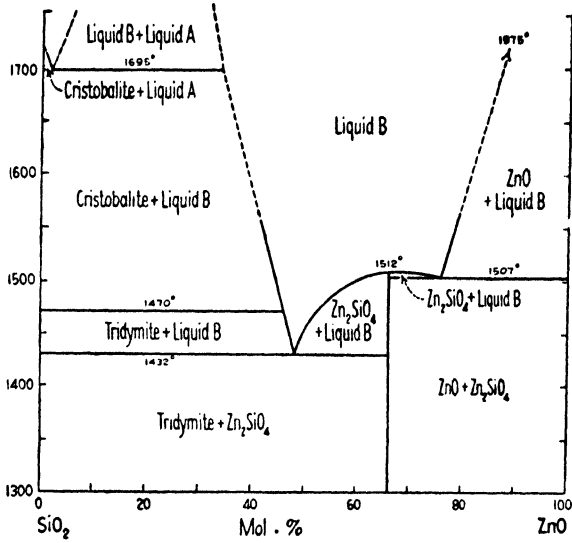

FIG. 193. System ZnO-SiO₂. (E. N. Bunting, *Bur. Standards J. Research*, **4**, 134, 1930; R. P. 136; see also E. N. Bunting, *J. Am. Ceram. Soc.*, **13** (1) 8, 1930.)

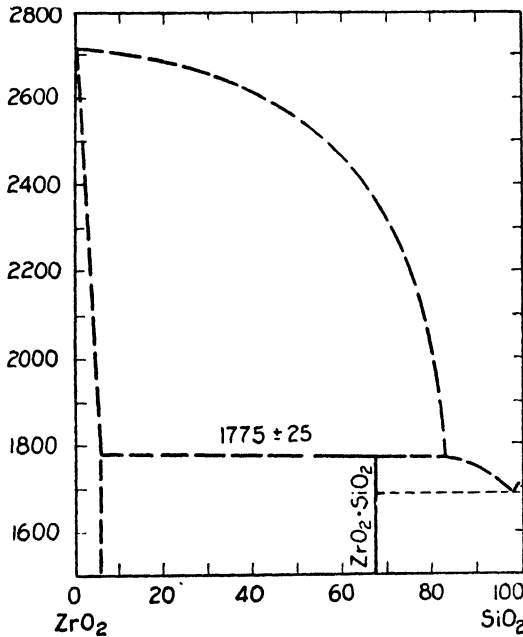

FIG. 194. System SiO₂-ZrO₂. (R. F. Geller and P. J. Yavorsky, *J. Research Nat. Bur. Standards*, **35** (1) 109, 1945; R. P. 1662.)

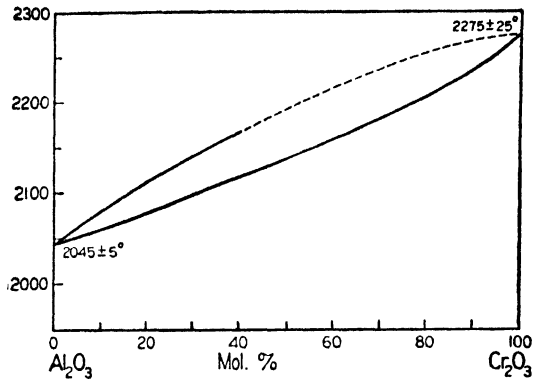

FIG. 195. System $\alpha\text{-Al}_2\text{O}_3\text{-Cr}_2\text{O}_3$. (E. N. Bunting, *Bur. Standards J. Research*, **6** (6) 948, 1931; *R. P.* 317.)

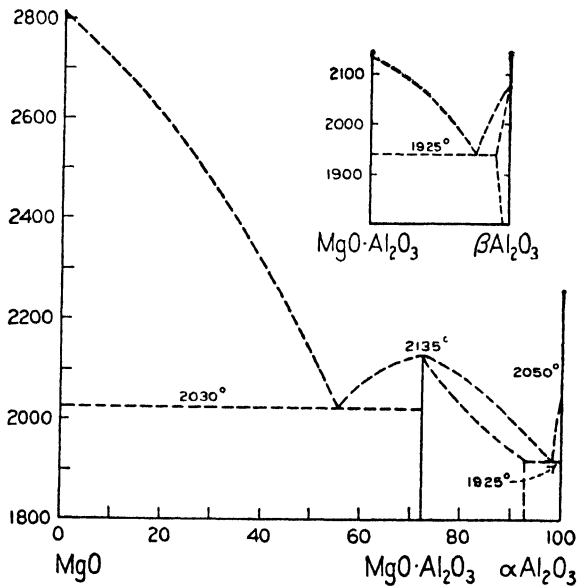

FIG. 196. Systems $\text{MgO-}\alpha\text{-Al}_2\text{O}_3$ and $\text{MgO-}\beta\text{-Al}_2\text{O}_3$. (G. A. Rankin and H. E. Merwin, *J. Am. Chem. Soc.*, **38**, 571, 1916.)

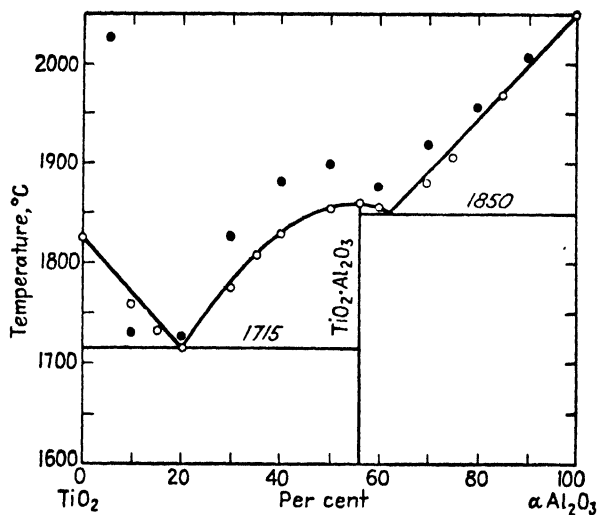

FIG. 197. System α - Al_2O_3 - TiO_2 . (E. N. Bunting, *Bur. Standards J. Research*, **11**, 725, 1933; solid dots by H. v. Wartenberg and H. J. Reusch, *Z. anorg. u. allgem. Chem.*, **207**, 10, 1932.)

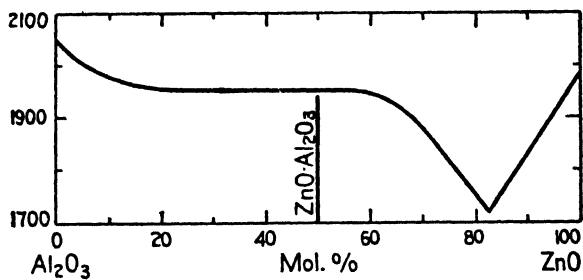

FIG. 198. Liquidus curve and system ZnO - Al_2O_3 . (E. N. Bunting, *Bur. Standards J. Research*, **8** (2) 280, 1932; R. P. 413.)

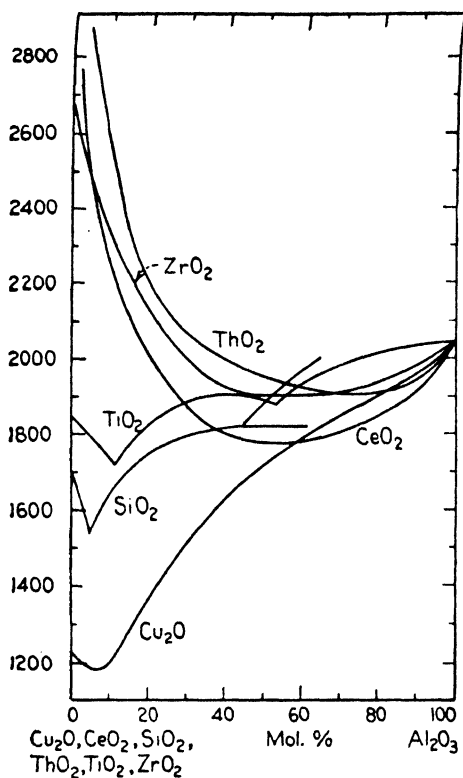

FIG. 199. Liquidus curves of systems $\text{Cu}_2\text{O}-\text{Al}_2\text{O}_3$, $\text{Al}_2\text{O}_3-\text{CeO}_2$, $\text{Al}_2\text{O}_3-\text{SiO}_2$, $\text{Al}_2\text{O}_3-\text{ThO}_2$, $\text{Al}_2\text{O}_3-\text{TiO}_2$, and $\text{Al}_2\text{O}_3-\text{ZrO}_2$. (H. von Wartenberg and H. J. Reusch, *Z. anorg. u. allgem. Chem.*, **207**, 18, 1932.)

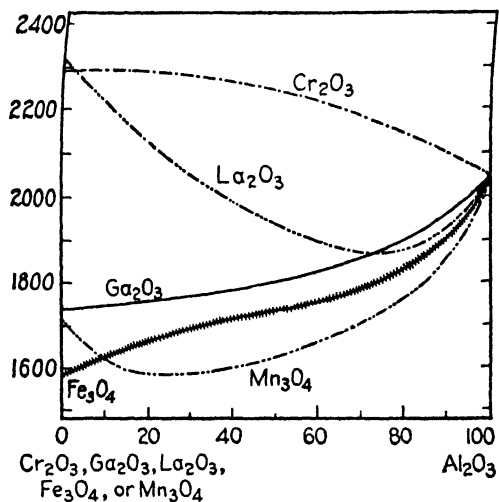

FIG. 200. Liquidus curves of systems $\text{Al}_2\text{O}_3\text{-Cr}_2\text{O}_3$, $\text{Al}_2\text{O}_3\text{-Ga}_2\text{O}_3$, $\text{Al}_2\text{O}_3\text{-La}_2\text{O}_3$, $\text{Al}_2\text{O}_3\text{-Fe}_3\text{O}_4$, and $\text{Al}_2\text{O}_3\text{-Mn}_3\text{O}_4$. (H. von Wartenberg and H. J. Reusch, *Z. anorg. u. allgem. Chem.*, **207**, 19, 1932.)

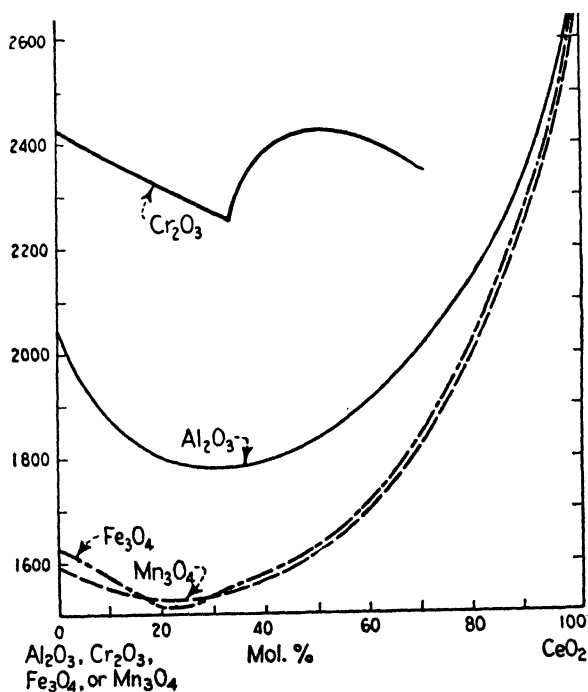

FIG. 201. Liquidus curves of systems $\text{CeO}_2\text{-Al}_2\text{O}_3$, $\text{CeO}_2\text{-Cr}_2\text{O}_3$, $\text{CeO}_2\text{-Fe}_3\text{O}_4$, $\text{CeO}_2\text{-Mn}_3\text{O}_4$. (H. von Wartenberg and K. Eckhardt, Part VIII, *Z. anorg. u. allgem. Chem.*, **232**, 184, 1937.)

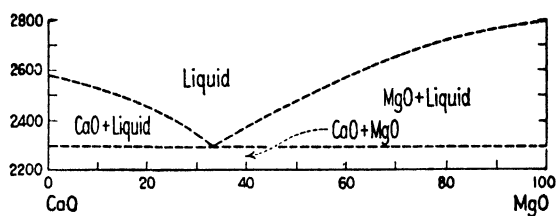

FIG. 202. System CaO-MgO. (G. A. Rankin and H. E. Merwin, *J. Am. Chem. Soc.*, **38**, 571, 1916.)

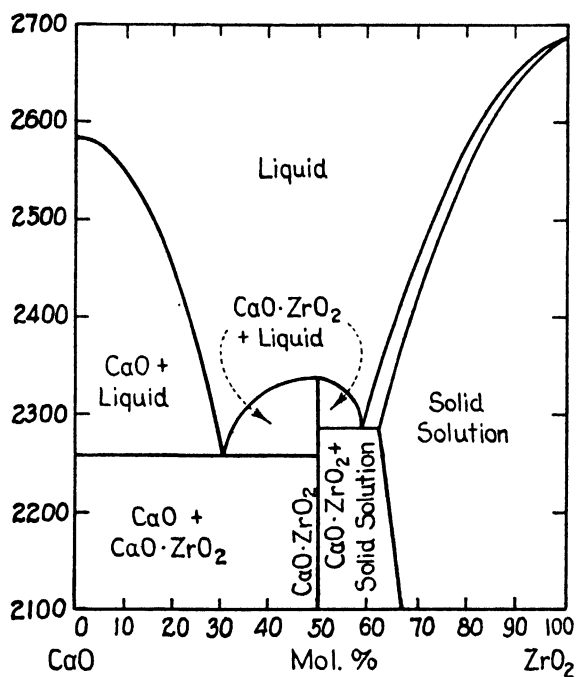

FIG. 203. System CaO-ZrO₂. (O. Ruff, F. Ebert, and E. Stephan, *Z. anorg. u. allgem. Chem.*, **180**, 219, 1929.)

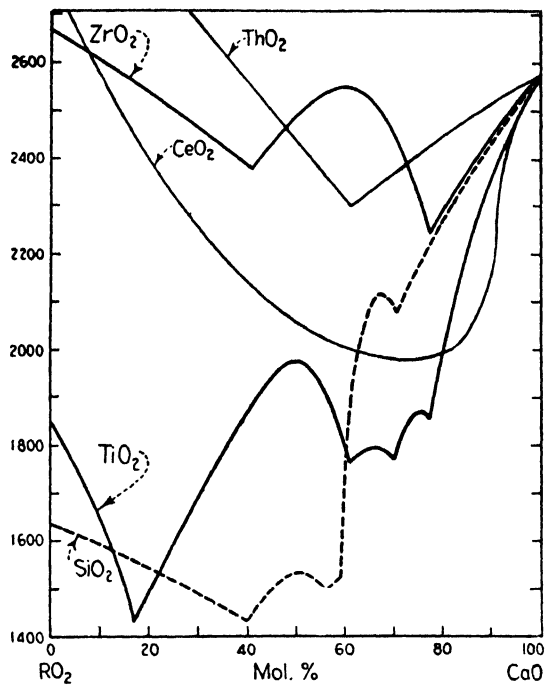

FIG. 204. Liquidus curves of systems CaO-CeO₂, CaO-SiO₂, CaO-ThO₂, CaO-TiO₂, and CaO-ZrO₂. (H. v. Wartenberg, *Z. anorg. u. allgem. Chem.*, **230**, 267, 1937.)

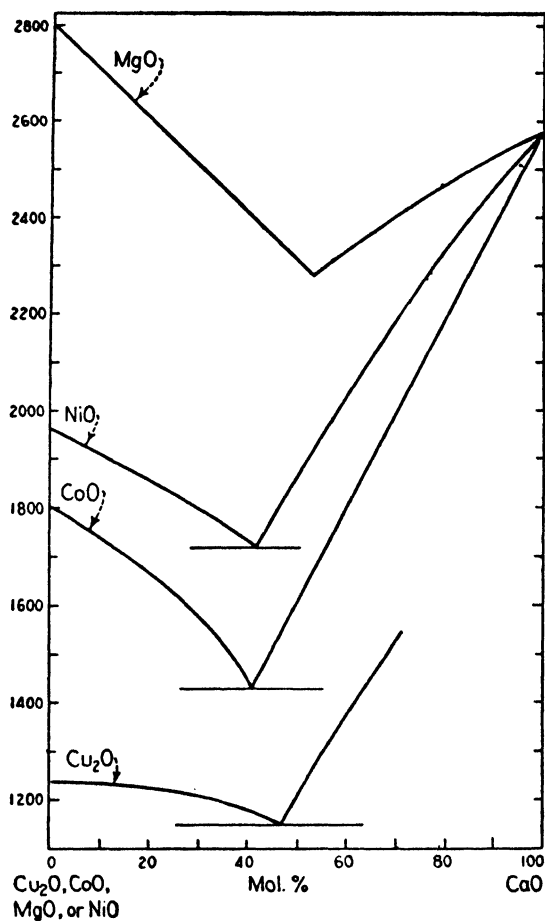

FIG. 205. Liquidus curves of systems Cu₂O-CaO, CaO-CoO, CaO-MgO, and CaO-NiO. (H. v. Wartenberg, H. J. Reusch, and E. Saran, Part VII, *Z. anorg. u. allgem. Chem.*, **230**, 265, 1937.)

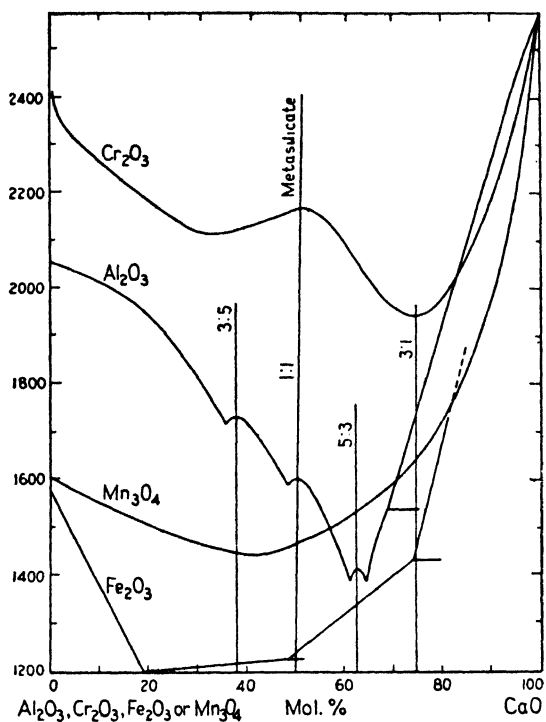

FIG. 206. Liquidus curves of systems CaO-Al₂O₃, CaO-Cr₂O₃, CaO-Fe₂O₃, and CaO-Mn₃O₄. H. v. Wartenberg, H. J. Reusch, and E. Saran, Part VII, *Z. anorg. u. allgem. Chem.*, **230**, 266, 1937.)

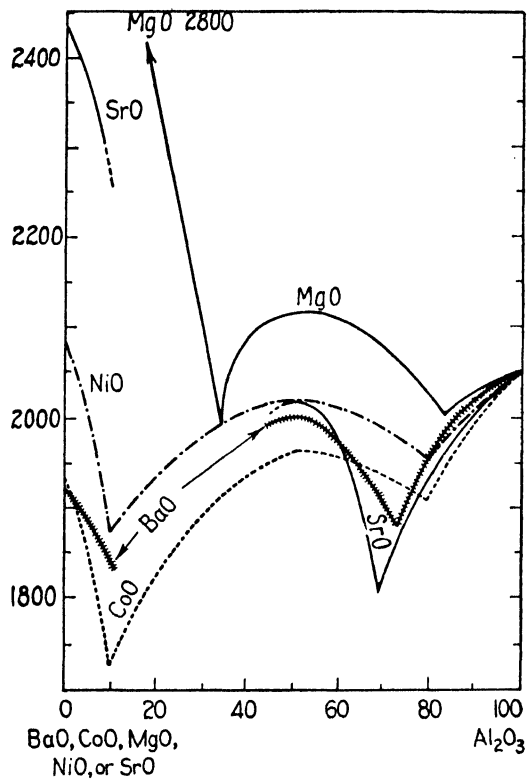

FIG. 207. Liquidus curves of systems BaO-Al₂O₃, CoO-Al₂O₃, MgO-Al₂O₃, NiO-Al₂O₃, and SrO-Al₂O₃. (H. von Wartenberg and H. J. Reusch, *Z. anorg. u. allgem. Chem.*, **207**, 18, 1932.)

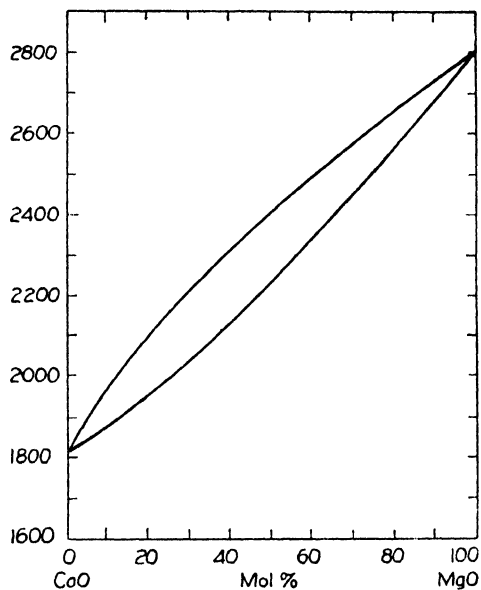

FIG. 208. System CoO-MgO. (*H. v. Wartenberg and E. Prophet, Z. anorg. u. allgem. Chem.*, **208**, 379, 1932.)

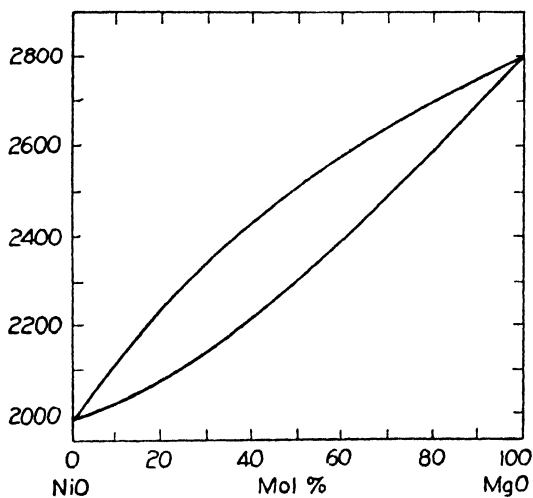

FIG. 209. System MgO-NiO. (*H. v. Wartenberg and E. Prophet, Z. anorg. u. allgem. Chem.*, **208**, 379, 1932.)

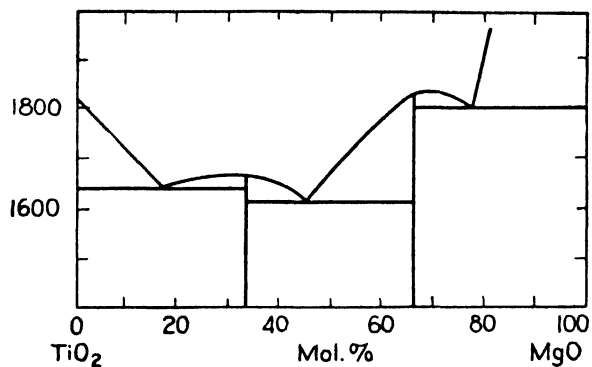

FIG. 210. System MgO-TiO₂. (H. v. Wartenberg and E. Prophet, *Z. anorg. u. allgem. Chem.*, **208**, 373, 1932.)

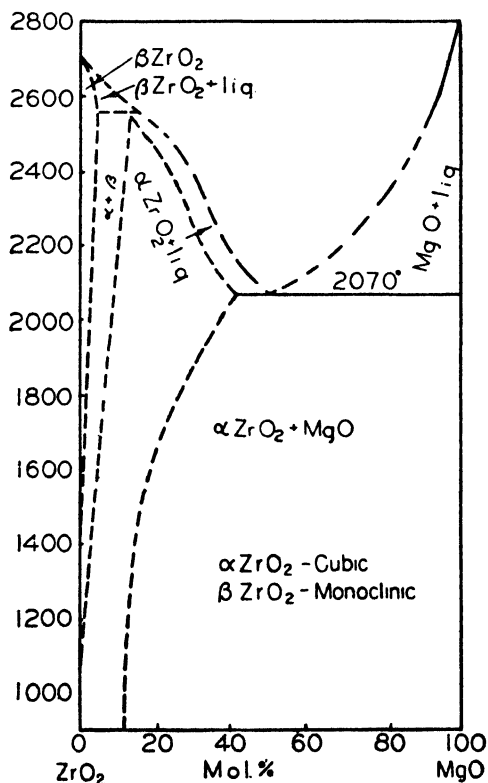

FIG. 211. System MgO-ZrO₂. (N. A. Zhirnova, *J. Applied Chem. (U.S.S.R.)*, **12**, 1279, 1939.)

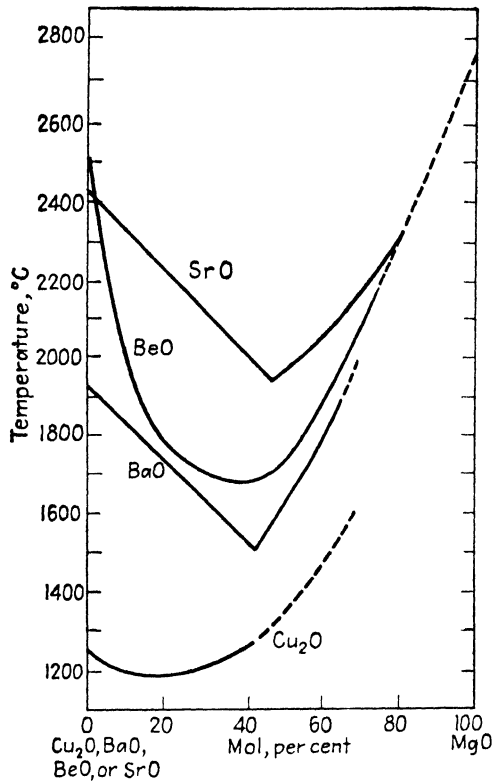

FIG. 212. Liquidus curves of systems $\text{Cu}_2\text{O}-\text{MgO}$, $\text{BaO}-\text{MgO}$, $\text{BeO}-\text{MgO}$, and $\text{MgO}-\text{SrO}$. Note: The $\text{MgO}-\text{BeO}$ curve has been corrected as shown in FIG. 214. (H. von Wartenberg and E. Prophet, Part V, *Z. anorg. u. allgem. Chem.*, **208**, 378, 1932.)

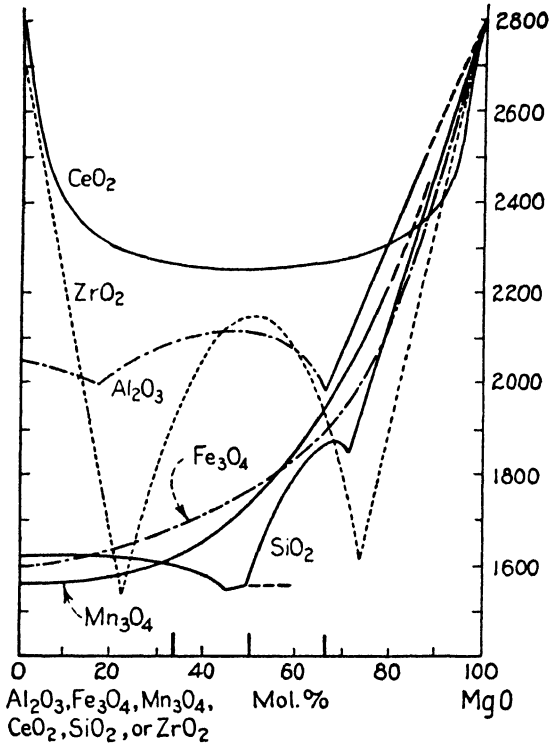

FIG. 213. Liquidus curves of systems MgO-Al₂O₃, MgO-Fe₃O₄, MgO-Mn₃O₄, MgO-CeO₂, MgO-SiO₂, and MgO-ZrO₂. (H. von Wartenberg and E. Prophet, *Z. anorg. u. allgem. Chem.*, **208**, 379, 1932; the CeO₂ curve from Wartenberg and K. Eckhardt, *Part VIII, ibid.*, **232**, 184, 1937.)

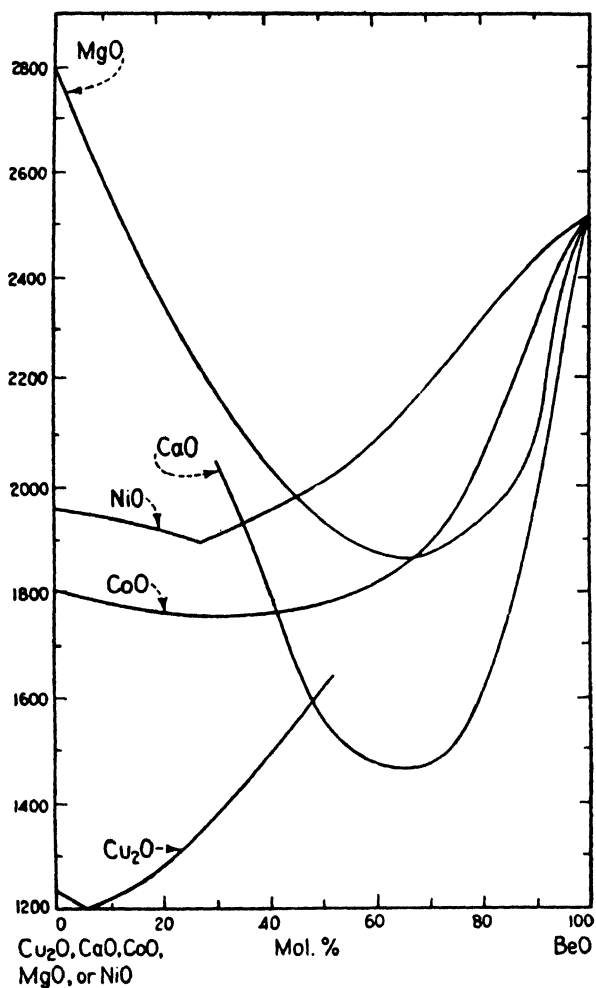

FIG. 214. Liquidus curves of systems BeO-Cu₂O, BeO-CaO, BeO-CoO, BeO-MgO, and BeO-NiO. (H. v. Wartenberg, H. J. Reusch, and E. Saran, Part VII, *Z. anorg. u. allgem. Chem.*, **230**, 275, 1937.)

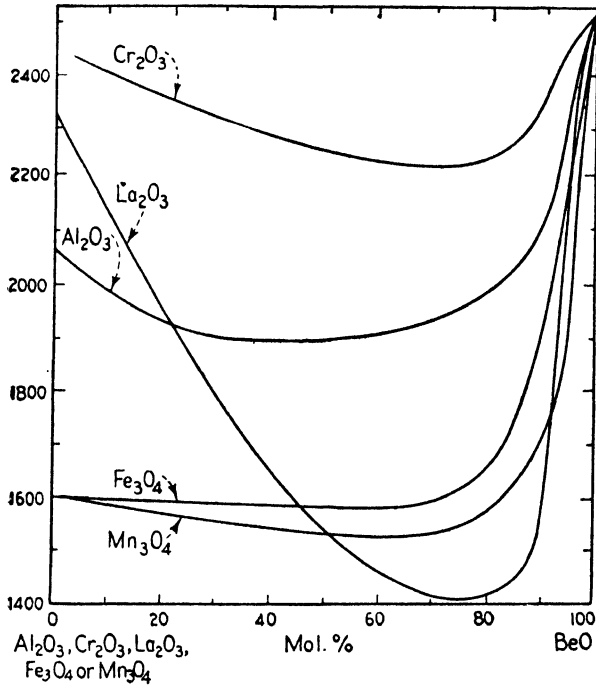

FIG. 215. Liquidus curves of systems BeO-Al₂O₃, BeO-Cr₂O₃, BeO-La₂O₃, BeO-Fe₃O₄, and BeO-Mn₃O₄. (*M. Dukelski, Z. anorg. Chem.*, **50**, 47, 1906.)

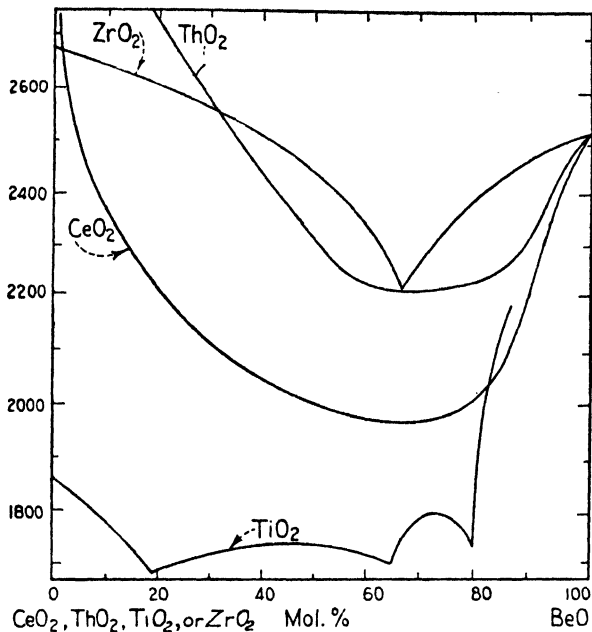

FIG. 216. Liquidus curves of systems BeO-CeO₂, BeO-ThO₂, BeO-TiO₂, and BeO-ZrO₂. (M. Dukelski, *Z. anorg. Chem.*, **50**, 47, 1906.)

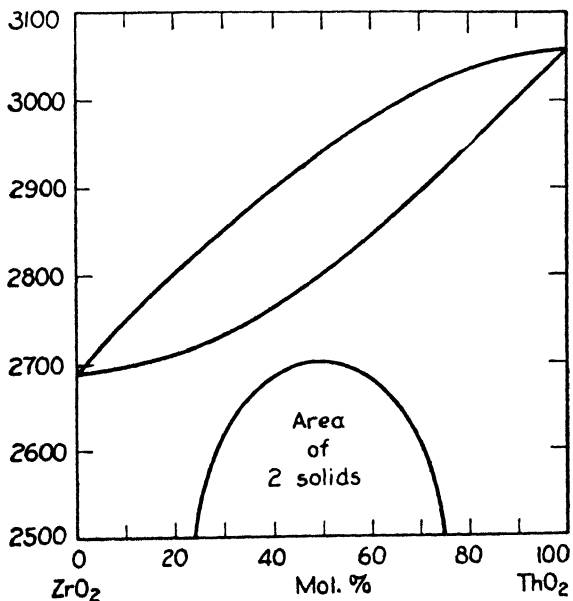

FIG. 217. System ThO₂-ZrO₂; probable diagram. (O. Ruff, F. Ebert, and H. Wöitinek, *Z. anorg. u. allgem. Chem.*, **180**, 255, 1929.)

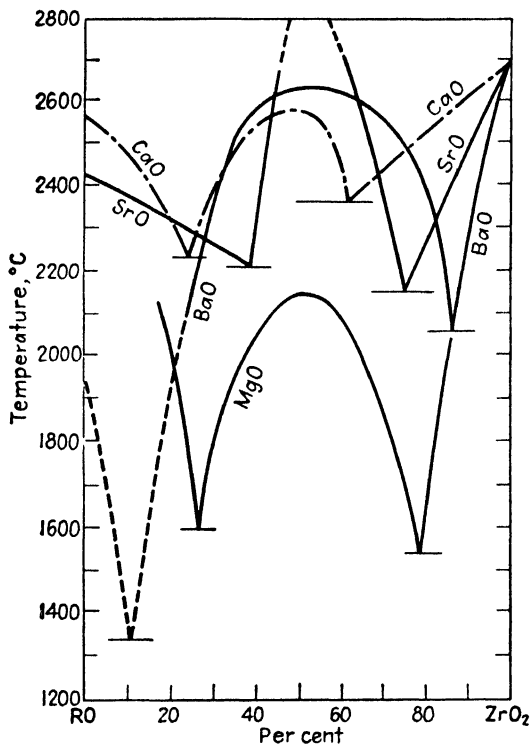

FIG. 218. Melting curves of BaO-ZrO₂, CaO-ZrO₂, MgO-ZrO₂, and SrO-ZrO₂. (H. von Wartenberg and W. Gurr, *Z. anorg. u. allgem. Chem.*, **196**, 381, 1931.)

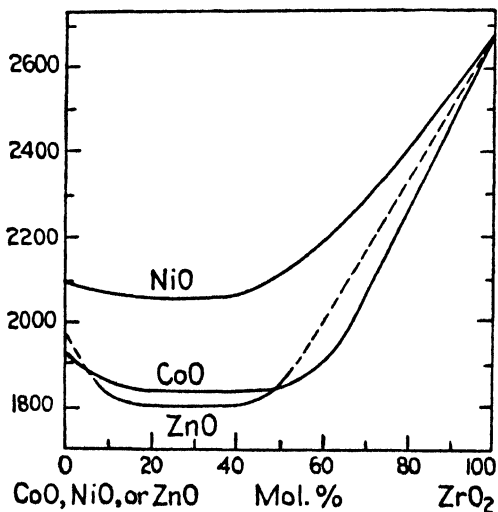

FIG. 219. Liquidus curves of systems CoO-ZrO₂, NiO-ZrO₂, and ZnO-ZrO₂. (H. von Wartenberg and W. Gurr, *Z. anorg. u. allgem. Chem.*, **196**, 381, 1931.)

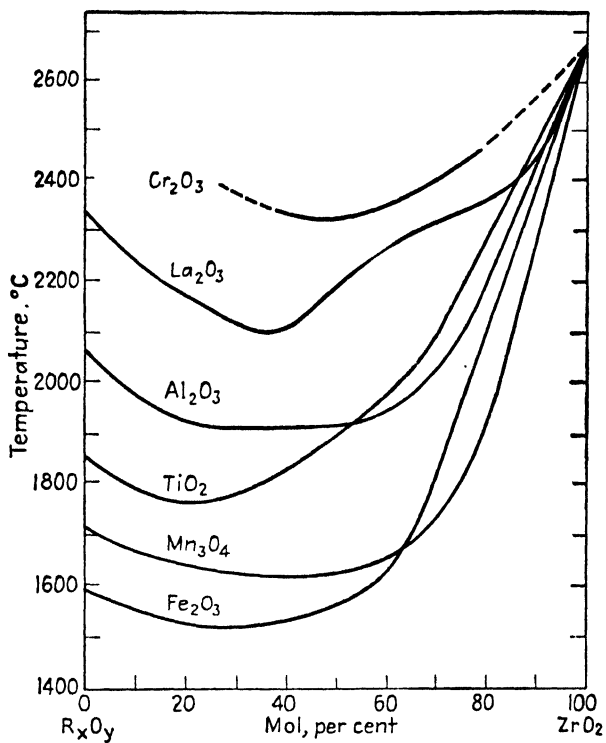

FIG. 220. Liquidus curves of systems $\text{Al}_2\text{O}_3\text{-ZrO}_2$, $\text{Cr}_2\text{O}_3\text{-ZrO}_2$, $\text{Fe}_2\text{O}_3\text{-ZrO}_2$, $\text{La}_2\text{O}_3\text{-ZrO}_2$, $\text{Mn}_3\text{O}_4\text{-ZrO}_2$, and $\text{TiO}_2\text{-ZrO}_2$. (H. von Wartenberg and W. Gurr, *Z. anorg. u. allgem. Chem.*, **196**, 381, 1931; the La_2O_3 curve from Wartenberg and K. Eckhardt, Part VIII, *ibid.*, **232**, 186, 1937.)

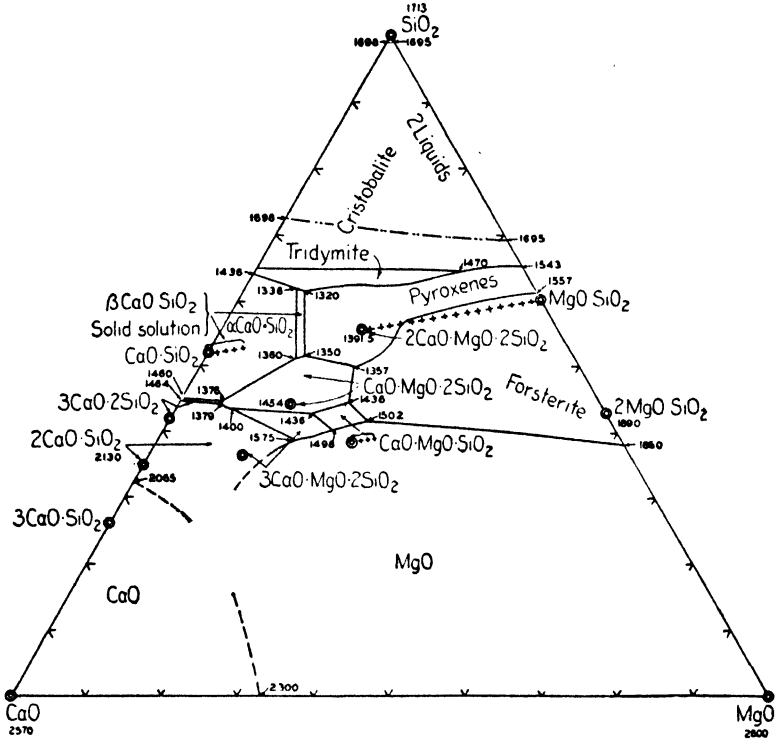

FIG. 221. System CaO-MgO-SiO₂. (E. F. Osborn, *J. Am. Ceram. Soc.*, **26** (10) 322, 1943.)

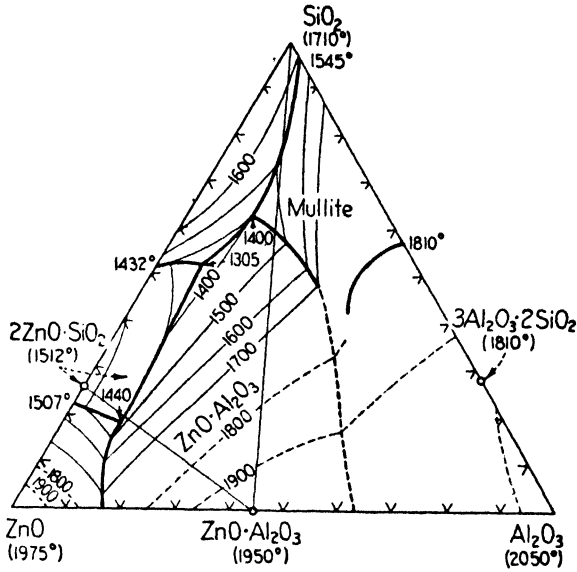

FIG. 222. System ZnO-Al₂O₃-SiO₂. (E. N. Bunting, *Bur. Standards J. Research*, **8** (2) 286, 1932; R. P. 413.)

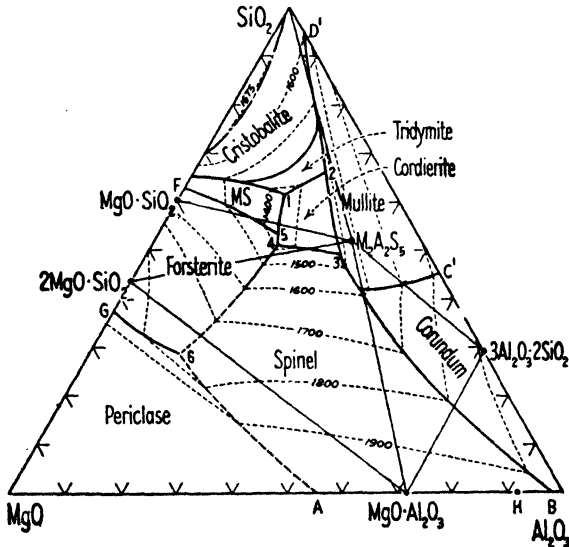

FIG. 223. System MgO-Al₂O₃-SiO₂. (G. A. Rankin and H. E. Merwin, *Am. J. Sci.*, 4th Ser., **45**, 322, 1918; modified according to J. W. Greig, *ibid.*, 5th Ser., **13**, 1-44, 1927.)

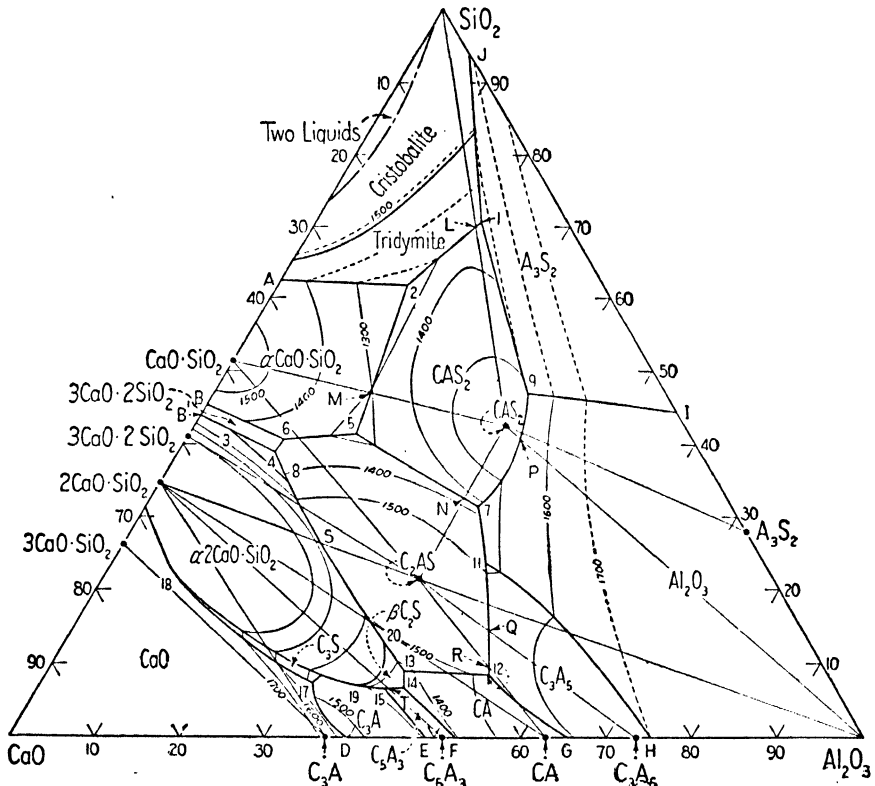

FIG. 224. System CaO-Al₂O₃-SiO₂; C = CaO, A = Al₂O₃, and S = SiO₂. (J. W. Greig, *Am. J. Sci.*, 5th Ser., 13, 41, 1927; G. A. Rankin and F. E. Wright, *Am. J. Sci.*, 4th Ser., 39, 52, 1915.)

| Pt | Crystal phases | CaO | Al ₂ O ₃ | SiO ₂ | Temp | Pt | Crystal phases | CaO | Al ₂ O ₃ | SiO ₂ | Temp |
|----|---|-------|--------------------------------|------------------|------|---|----------------|------|--------------------------------|------------------|------|
| A | S, CS | 37.0 | 63.0 | 1436 | 1 | CAS ₂ , AS ₂ , S | 9.8 | 19.8 | 70.4 | 1345 | |
| B | CS, C ₂ S | 54.5 | 45.4 | 1455 | 2 | CAS ₂ , S, α-CS | 23.3 | 14.7 | 62.2 | 1170 | |
| B' | C ₂ S, C ₂ S | 55.5 | 44.5 | 1475 | 3 | C ₂ S, C ₂ S, β-C ₂ S | 53.0 | 4.2 | 42.8 | 1415 | |
| C | C ₂ S, C | 67.5 | 32.5 | 2065 | 4 | β-C ₂ S, C ₂ S, C ₂ AS | 48.2 | 11.9 | 39.2 | 1335 | |
| D | C, C ₂ A | 59.0 | 41.0 | 1535 | 5 | CAS ₂ , C ₂ AS, α-CS | 38.0 | 20.0 | 42.0 | 1265 | |
| E | C ₂ A, C ₂ AS | 50.0 | 50.0 | 1395 | 6 | C ₂ AS, C ₂ AS, α-CS | 47.2 | 11.8 | 41.0 | 1310 | |
| F | C ₂ A, CA | 47.0 | 53.0 | 1400 | 7 | CAS ₂ , C ₂ AS, A | 29.2 | 39.0 | 31.8 | 1380 | |
| G | CA, C ₂ AS | 33.5 | 66.5 | 1590 | 8 | α-C ₂ S, β-C ₂ S, C ₂ AS | 49.0 | 14.4 | 36.6 | 1415 | |
| H | C ₂ AS, A | 24.0 | 76.0 | 1700 | 9 | CAS ₂ , A, AS ₂ | 15.6 | 36.5 | 47.9 | 1512 | |
| I | A, AS ₂ | 55.0 | 45.0 | 1800 | 11 | C ₂ AS, C ₂ AS, A | 31.2 | 44.5 | 24.3 | 1475 | |
| J | AS ₂ , S | 5.5 | 94.5 | 1545 | 12 | C ₂ AS, CA, C ₂ AS | 37.5 | 53.2 | 9.3 | 1505 | |
| L | CAS ₂ , S | 10.5 | 19.5 | 70.0 | 13 | C ₂ AS, β-C ₂ S, CA | 48.3 | 42.0 | 9.7 | 1512 | |
| M | CAS ₂ , CS | 34.1 | 18.6 | 47.7 | 14 | β-C ₂ S, C ₂ A, C ₂ AS | 49.5 | 43.7 | 6.8 | 1335 | |
| N | CAS ₂ , C ₂ AS | 30.2 | 36.8 | 33.0 | 15 | β-C ₂ S, C ₂ A, C ₂ AS | 52.0 | 41.2 | 6.8 | 1335 | |
| O | C ₂ AS, CS | 45.7 | 13.2 | 41.1 | 16 | C ₂ S, α-C ₂ S, C ₂ A | 58.3 | 33.0 | 8.7 | 1455 | |
| P | CAS ₂ , A | 19.3 | 39.3 | 41.4 | 17 | C, CS, C ₂ A | 59.7 | 32.8 | 7.5 | 1470 | |
| Q | C ₂ AS, C ₂ AS | 35.0 | 50.8 | 14.2 | 18 | C, α-C ₂ S, C ₂ S | 68.4 | 9.2 | 22.4 | 1900 | |
| R | C ₂ AS, CA | 37.8 | 52.9 | 9.3 | | | | | | | |
| S | C ₂ AS, C ₂ AS | 49.6 | 23.7 | 26.7 | 1545 | | | | | | |
| T | C ₂ S, C ₂ AS | 51.3 | 41.8 | 6.9 | 1350 | | | | | | |
| | CaO | 100.0 | | | 2570 | | | | | | |
| | Al ₂ O ₃ | | 100.0 | | 2050 | | | | | | |
| | SiO ₂ | | | 100.0 | 1713 | | | | | | |
| | 3CaO·5Al ₂ O ₃ | 24.8 | 75.2 | | 1720 | | | | | | |
| | CaO·Al ₂ O ₃ | 35.4 | 64.6 | | 1600 | | | | | | |
| | 5CaO·3Al ₂ O ₃ | 47.8 | 52.5 | | 1455 | | | | | | |
| | 3CaO·Al ₂ O ₃ | 62.2 | 37.8 | | 1535 | | | | | | |
| | CaO·SiO ₂ | 48.2 | | | 1540 | | | | | | |
| | 3CaO·2SiO ₂ | 58.2 | | | 1475 | | | | | | |
| | α-2CaO·SiO ₂ | 65.0 | | | 2130 | | | | | | |
| | 3CaO·SiO ₂ | 73.6 | | | 1900 | | | | | | |
| | 3Al ₂ O ₃ ·2SiO ₂ | | 71.8 | | 1810 | | | | | | |
| | CaO·Al ₂ O ₃ ·2SiO ₂ | 20.1 | 36.6 | 43.3 | 1550 | | | | | | |
| | 2CaO·Al ₂ O ₃ ·SiO ₂ | 40.8 | 37.2 | 22.0 | 1590 | | | | | | |

C = CaO; A = Al₂O₃; S = SiO₂.

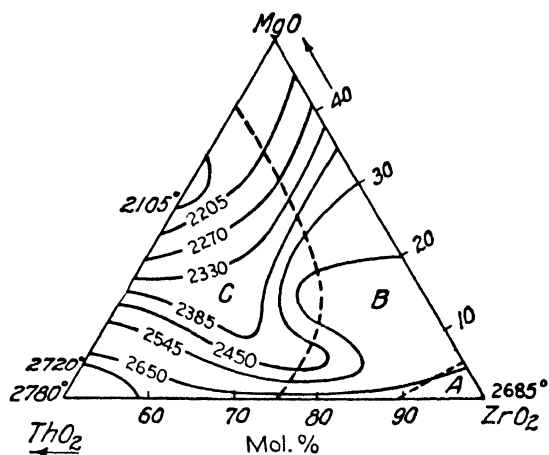

FIG. 225. Melting isotherms of system $\text{MgO}-\text{ThO}_2-\text{ZrO}_2$; A = monoclinic ZrO_2 , B = cubic mix crystal, C = two cubic mix crystals. (Otto Ruff, F. Ebert, and W. Loerpabel, *Z. anorg. u. allgem. Chem.*, **207**, 309, 1932.)

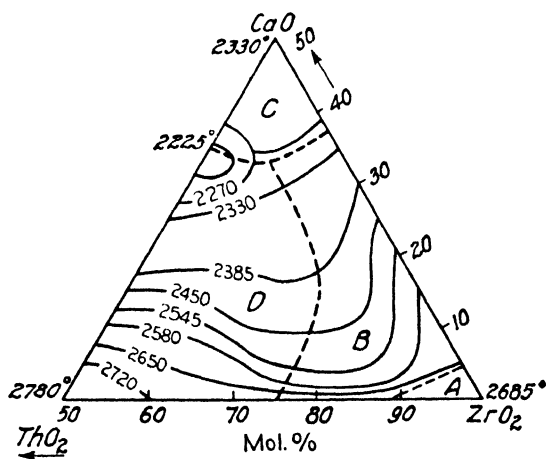

FIG. 226. Melting isotherms of system $\text{CaO}-\text{ThO}_2-\text{ZrO}_2$; A = monoclinic ZrO_2 , B = cubic mix crystal, C = cubic mix crystal + CaZrO_3 , D = two cubic mix crystals (miscibility gap). (Otto Ruff, F. Ebert, and W. Loerpabel, *Z. anorg. u. allgem. Chem.*, **207**, 309, 1932.)

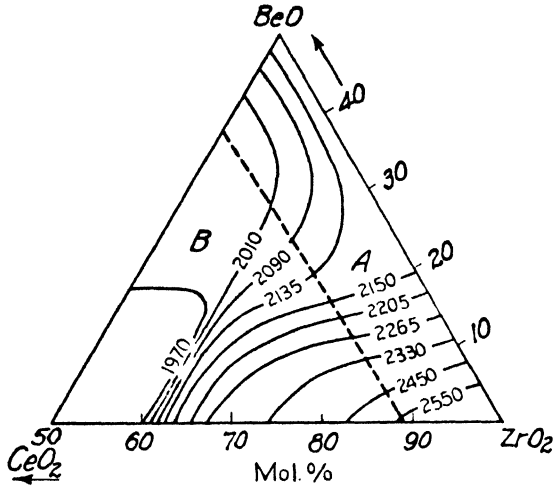

FIG. 227. Melting isotherms of system BeO-CeO₂-ZrO₂; A = monoclinic ZrO₂, B = cubic mix crystal. (Otto Ruff, F. Ebert and W. Loerpabel, *Z. anorg. u. allgem. Chem.*, **207**, 310, 1932.)

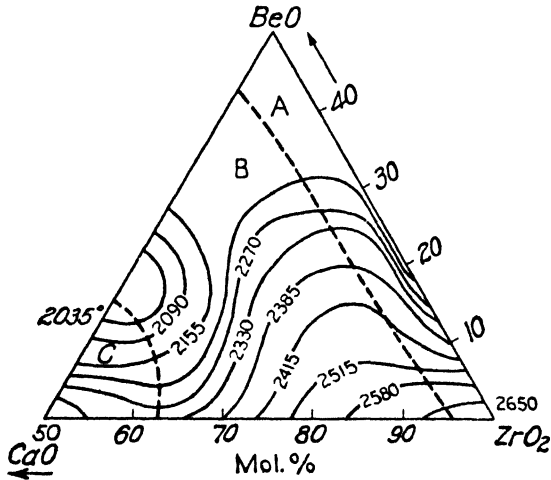

FIG. 228. Melting isotherms of system BeO-CaO-ZrO₂; A = monoclinic ZrO₂, B = cubic mix crystal, C = cubic mix crystal + CaZrO₂. (Otto Ruff, F. Ebert, and W. Loerpabel, *Z. anorg. u. allgem. Chem.*, **207**, 310, 1932.)

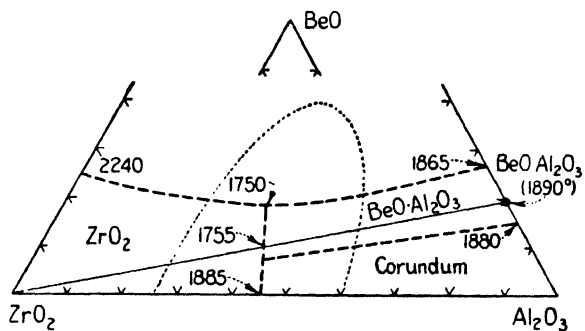

FIG. 229. System BeO-Al₂O₃-ZrO₂. (Geller, et al., see p. 303 of reference of Fig. 231.)

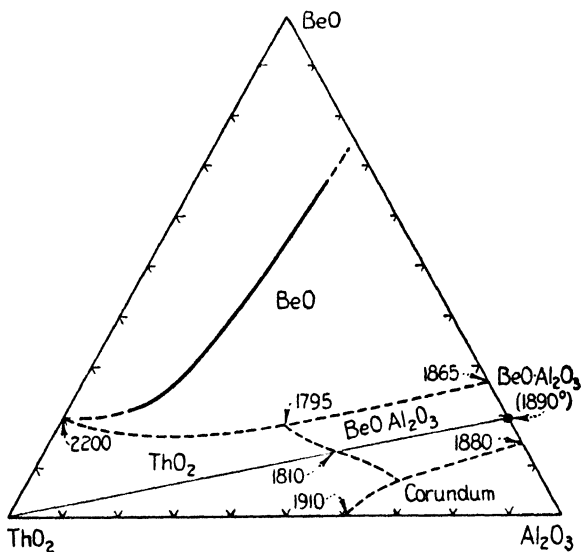

FIG. 230. System BeO-Al₂O₃-ThO₂. (Geller, et al., see p. 298 of reference of Fig. 231.)

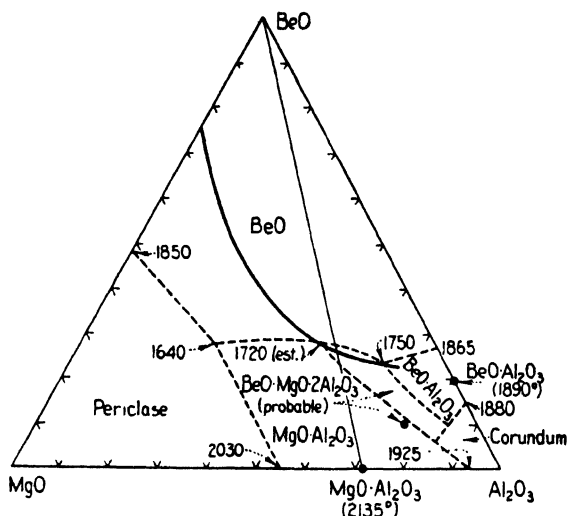

FIG. 231. System BeO-MgO-Al₂O₃. (R. F. Geller, P. J. Yavorsky, B. L. Steierman, and A. S. Creamer, *J. Research Nat. Bur. Standards*, **36**, (3) 289, 1946; R. P. 1703.)

| Pt | Crystal phases | CaO | MgO | Al ₂ O ₃ | Temp |
|----|--|-------|-------|--------------------------------|------|
| A | C, M..... | 67.0 | 33.0 | | 2300 |
| B | M, MA..... | | 45.0 | 55.0 | 2030 |
| C | MA, A..... | | 2.0 | 98.0 | 1925 |
| D | C, C ₃ A..... | 59.0 | | 41.0 | 1535 |
| E | C ₂ A, C ₅ A ₃ | 50.0 | | 50.0 | 1395 |
| F | C ₂ A, CA..... | 47.0 | | 53.0 | 1400 |
| G | CA, C ₂ A ₅ | 33.5 | | 66.5 | 1590 |
| H | C ₂ A ₅ , A..... | 24.0 | | 76.0 | 1700 |
| 1 | M, C, C ₂ A..... | 51.5 | 6.2 | 42.3 | 1450 |
| 2* | M, C ₂ A, C ₅ A ₃ | 46.0 | 6.3 | 47.7 | 1345 |
| 3* | M, C ₂ A, CA..... | 41.5 | 6.7 | 51.8 | 1345 |
| 4 | M, MA, CA..... | 45.7 | 6.9 | 52.4 | 1370 |
| 5 | MA, CA, C ₂ A ₅ | 33.3 | 3.5 | 63.2 | 1550 |
| 6 | C ₂ A ₅ , MA, A..... | 21.0 | 5.0 | 74.0 | 1680 |
| | 5CaO·3Al ₂ O ₃ | 47.8 | | 52.2 | 1455 |
| | CaO·3Al ₂ O ₃ | 35.4 | | 64.6 | 1600 |
| | 3CaO·5Al ₂ O ₃ | 24.8 | | 75.2 | 1720 |
| | MgO·Al ₂ O ₃ | | 28.4 | 71.6 | 2135 |
| | 3CaO·Al ₂ O ₃ | 62.2 | | 37.8 | 1535 |
| | Periclase..... | 100.0 | | | 2800 |
| | Lime..... | 100.0 | | | 2570 |
| | Corundum..... | | | 100.0 | 2050 |

* Eutectic.

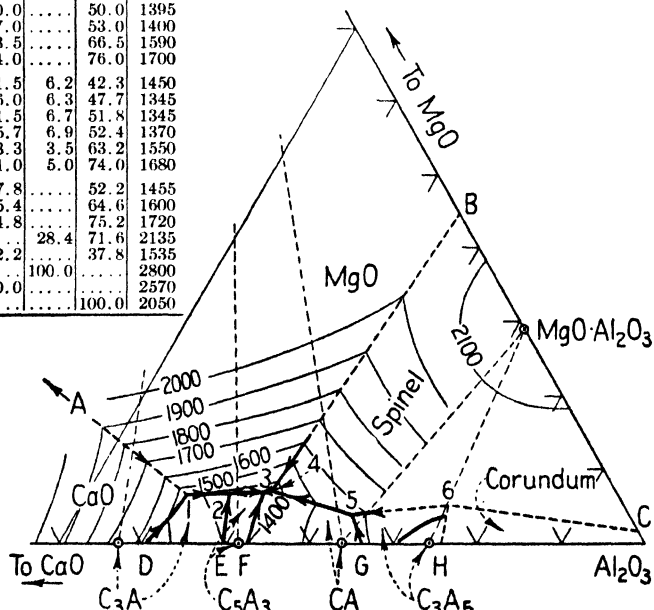

FIG. 232. System CaO-MgO-Al₂O₃; C = CaO, M = MgO, A = Al₂O₃. (G. A. Rankin and H. E. Merwin, *Z. anorg. u. allgem. Chem.*, **96**, 309, 1916.)

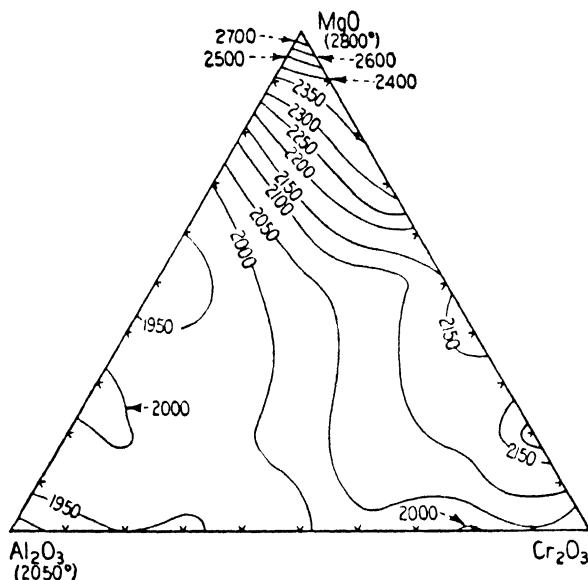

FIG. 233. Melting isotherms of system $\text{MgO}-\text{Al}_2\text{O}_3-\text{Cr}_2\text{O}_3$. (W. T. Wilde and W. J. Rees, *Trans. Brit. Ceram. Soc.*, **42**, 127, 1943.)

7. Bibliography

Methods of Measuring Fusion Points:

1. FIELDNER, A.C., A.E. HALL, and A.I. FEILD: The Fusibility of Coal Ash and the Determination of the Softening Temperature, *U.S. Bur. Mines, Bull.* 129, 1918.
2. FOOTE, FAIRCHILD, and HARRISON: Pyrometric Practice, *Natl. Bur. Standards, Tech. Paper* 170, 1921.
3. GORTON, A.F., and W.H. GROVES: New Type of Oxy-acetylene Fusion Furnace with Notes on the Behavior of Refractories at Cone 40, *J. Am. Ceram. Soc.*, **8**, 768, 1925.
4. MITCHELL, J., and W.B. MITCHELL: Laboratory Furnace for High Temperatures, *Trans. Ceram. Soc. (Engl.)*, **25**, 39, 1925.
5. BARTSCH, O.: The Determination of the Softening Temperature of Refractory Material, *Ber. deut. keram. Ges.*, **7**, 121, 1926.
6. ORTON, E., JR., and J.F. KREHBIEL: A Convenient Platinum-wound Resistance Furnace, *J. Am. Ceram. Soc.*, **10**, 373, 1927.
7. PHELPS, S.M.: An Elementary Account of the P.C.E. or the Softening of Refractories by Heat, *Am. Refractories Inst., Bull.* 17, 1927.
8. CARTRIGHT, V., and S.M. PHELPS: A Portable Pyrometric Cone Equivalent Furnace, *J. Am. Ceram. Soc.*, **14**, 1, 1931.
9. REMMEY, G.B.: The Remmey Fusion Test Furnace, *J. Am. Ceram. Soc.*, **14**, 358, 1931.
10. PENDERGAST, W.L.: An Electric Furnace for Determination of Pyrometric Cone Equivalents, *Bull. Am. Ceram. Soc.*, **18**, 1, 1939.

Theory of Fusion:

11. LUDWIG: Ueber Beziehungen zwischen der Schmelzbarkeit und der chemischen Zusammensetzung der Tone, *Tonind.-Ztg.*, **28**, 773, 1904.
12. SCHUEN, W.: Fusibility and Chemical Composition of Clays, *Keram. Rundschau*, **33**, 565, 1925; *J. Soc. Glass Technol.*, **9A**, 318, 1925.
13. KEPPELER, G.: The Softening of Clay by Heat, *Ber. deut. keram. Ges.*, **7**, 88, 1926.
14. SALMANG, H.: The Influence of Grain Size of Flux and Materials Used to Decrease the Plasticity of Clays on the Cone Deformation Point of Clays, *Ber. deut. keram. Ges.*, **7**, 100, 1926.
15. SCHUEN, W.: Die Schmelzbarkeit der Tone und die van't Hoff'sche Formel, *Tonind.-Ztg.*, **50**, 1643, 1926.
16. SCHUEN, W.: Feuerfestigkeit und chemische Zusammensetzung der Tone. *Tonind.-Ztg.*, **50**, 794, 1926.
17. HOHLER: Refractories at High Temperatures, *Russ. Ceram. Research Inst. Pub.* 12, 1928.
18. CHESTERS, J.H.: The Relation of Melting-point to Crystal Structure and to Compressibility, *Trans. Ceram. Soc. (Engl.)*, **29**, 169, May-June, 1930 (Memorial Section).
19. FRENKEL, J.: Continuity of the Solid and the Liquid States, *Nature*, **136**, 167, 1935.
20. HILL, E.L.: Virial Theorem and the Theory of Fusion, *Physik Z. Sowjetunion*, **8**, 401, 1935.
21. ZHDANOV, V.: Theory of Melting and of Plastic Deformation of Solids, *Verhandl. sibirisch. physik.-tech. Kujbyschew Staats-Univ. Tomsk.*, **4**, 163 (in English, p. 177), 1936.
22. HARTMANN, F.: Melting and Softening of Refractory Bricks as a Viscosity Problem, *Ber. deut. keram. Ges.*, **19**, 381, 1938.
23. LENNARD-JONES, J.E., and A.F. DEVONSHIRE: Critical and Cooperative Phenomena: III, Theory of Melting and Structure of Liquids, *Proc. Roy. Soc. (London)*, **A169**, 317, 1939.

Fusion-point Data:

24. KANOLT, C.W.: Melting Points of Fire Bricks, *Natl. Bur. Standards, Tech. Paper* 10, 1912.
25. RANKIN, G.A., and F.E. WRIGHT: The Ternary System CaO-Al₂O₃-SiO₂, *Am. J. Sci.*, 4th Ser. **39**, 1, 1915.
26. BOWEN, N.L.: The Sodium-potassium Nephelites, *Am. J. Sci.*, 4th Ser., **43**, 115, 1917.
27. LE CHATELIER, H., and B. BOGITCH: Sur les propriétés refractaires de la silice, *Trans. Ceram. Soc. (Engl.)*, **17**, 1, 1917.
28. WASHBURN, E.W., and E.E. LIBMAN: Diagram of System ZrO₂-SiO₂, *J. Am. Ceram. Soc.*, **3**, 634, 1920.
29. ESKOLA, P.: Silicates of Strontium and Barium, *Am. J. Sci.*, 5th Ser., **4**, 331, 1922.
30. MOREY, G.W., and N.L. BOWEN: The Melting of Potash Feldspars, *Am. J. Sci.*, 5th Ser., **4**, 1, 1922.
31. MATIGNON, C.: Action des températures élevées sur quelques substances réfractaires, *Compt. rend.*, **177**, 1290, 1923.
32. WILSON, H.: High Temperature Load and Fusion Tests of Fire Brick from the Pacific Northwest in Comparison with Other Well-known Fire Brick, *J. Am. Ceram. Soc.*, **7**, 34, 1924.

33. BOWEN, N.L., and J.W. GREIG: The System: $\text{Al}_2\text{O}_3\text{-SiO}_2$, *J. Am. Ceram. Soc.*, **7**, 238, 1924.
34. RYSCHKEWITSCH, E.: Über den Schmelzpunkt und über die Verdampfung des Graphits, *Z. Elektrochem.*, **31**, 54, 1925.
35. BROWN, J.: Refractory Properties of Commonly Used Oxides, *Feuerfest*, **2**, 105, 1926.
36. SCHUMACHER, E.E.: Melting Point of Barium, Strontium, and Calcium Oxides, *J. Am. Chem. Soc.*, **48**, 396, 1926.
37. GREIG, J.W.: Immiscibility in Silicate-melts, *Am. J. Sci.*, 5th Ser., **13**, 1, 133, 1927.
38. COLE, S.S.: Variations in Pyrometric Cone Equivalents of Silica Cements and Fire Clays, *J. Am. Ceram. Soc.*, **11**, 854, 1928.
39. VON WARTENBERG, H., H. LUIDE, and R. JUNG: Schmelzdiagramm höchstfeuerfester Oxyde, *Z. anorg. allgem. Chem.*, **176**, 349, 1928.
40. HANSEN, W.C., L.T. BROWNMILLER, and R.H. BOGUE: Studies on the System $\text{CaO-Al}_2\text{O}_3\text{-Fe}_2\text{O}_3$, *J. Am. Soc.*, **50**, 396, 1928.
41. RUFF, O., F. EBERT, and E. STEPHAN: The System $\text{ZrO}_2\text{-CaO}$, *Z. anorg. allgem. Chem.*, **180**, 215, 1929.
42. MOREY, G.W., F.C. KRACEK, and N.L. BOWEN: The Ternary System $\text{K}_2\text{O-CaO-SiO}_2$, *J. Soc. Glass Technol.*, **14**, 149, 1930.
43. VON WARTENBERG, H., and W. GURR: Melting Diagrams of Highly Refractory Oxides, III, *Z. anorg. allgem. Chem.*, **196**, 374, 1931.
44. BROWNMILLER, L.T., and R.H. BOGUE: System $\text{CaO-Na}_2\text{O-Al}_2\text{O}_3$, *Natl. Bur. Standards, J. Research*, **8**, 289, 1932.
45. CARLSON, E.T.: The System $\text{CaO-B}_2\text{O}_3$, *Natl. Bur. Standards, J. Research*, **9**, 825, 1932.
46. VON WARTENBERG, H., and H.J. REUSCH: Melting Diagrams of Highly Refractory Oxides, IV, Aluminum Oxide, *Z. anorg. allgem. Chem.*, **207**, 1, 1932.
47. VON WARTENBERG, H., and E. PROPHET: Melting Diagrams of Highly Refractory Oxides, V, Systems with MgO , *Z. anorg. allgem. Chem.*, **208**, 369, 1932.
48. BUNTING, E.N.: The System $\text{ZnO-Al}_2\text{O}_3$, *Natl. Bur. Standards, J. Research*, **8**, 279, 1932.
49. PARMELEE, C.W.: A Study of a Group of Spinels, *Univ. Illinois Eng. Expt. Sta., Bull.* 248, June, 1932.
50. National Research Council: "International Critical Tables," McGraw-Hill Book Company, Inc., New York, 1933.
51. BUNTING, E.N.: $\text{TiO}_2\text{-Al}_2\text{O}_3$, unpublished data.
52. REUSCH, H.J., and H. VON WARTENBERG: Heraeus-Vacuumschmelze Anniv. Vol., *Hanau*, **350**, 1933; *Ceram. Abstract*, **13**, 263, 1934.
53. IWASE, K., and U. NISIOKA: The Equilibrium Diagram of the System $\text{CaO-TiO}_2\text{-SiO}_2\text{-MnO-TiO}_2$, *Tôhoku Imp. Univ., Science Repts.*, Ser. I, **25**, 504, 1936; *Ceram. Abstract*, **16**, 161, 1937.
54. VON WARTENBERG, H., H.J. REUSCH, and E. SARAN: Melting Diagrams of Highly Refractory Oxides, VII, Systems with CaO and BeO_3 , *Z. anorg. allgem. Chem.*, **230**, 267, 1937.
55. SAUERMANN, G.: Super-refractory Materials, *Ber. deut. keram. Ges.*, **18**, 74, 1937.
56. LAX, E., and M. SCHON: Production of High Temperatures, *Chem. App.*, **24**, 361; **24**, 393, 1937.
57. MATVEEV, R.: Use of Barium Compounds in the Production of Refractories, *Ogneupory*, **5**, 684, 1937.

58. "Handbook of Chemistry and Physics," 23d ed., Chemical Rubber Publishing Co., 1939.
59. Titanium Alloy Mfg. Co.: Technical literature.
60. GELLER, R.F., and P.J. YAVORSKY: Melting Point of Alpha-alumina, *Natl. Bur. Standards, J. Research*, **34**, 395, 1945.

Equilibrium Diagrams:

61. HALL, F.P., and H. INSLEY: Phase Diagrams for Ceramists, *J. Am. Ceram. Soc.*, **30** (Part II, Nov. 1, 1947).

General:

62. BRADSHAW, L., and W. EMERY: The Influence of Oxidizing and Reducing Atmospheres on Refractory Materials, *Trans. Ceram. Soc. (Engl.)*, **21**, 117, 1921.
63. VICKERS, A.E.J., and L.S. THEOBALD: The Influence of Oxidizing and Reducing Atmospheres on Refractory Materials, *Trans. Ceram. Soc. (Engl.)*, **24**, 86, 1924.
64. VICKERS, A.E.J.: The Influence of Oxidizing and Reducing Atmospheres on Refractory Materials (II), *Trans. Ceram. Soc. (Engl.)*, **26**, 177, 1926.
65. COLE, S.S.: Variations in Softening Points of Refractory Materials Due to Rate of Heating, *J. Am. Ceram. Soc.*, **10**, 180, 1927.
66. COHN, W.M.: Crystal Modification of Zirconia: A Clear, Fused Zirconia Produced in the Sun Furnaces, *Trans. Electrochem. Soc.*, **68**, 65, 1935.
67. FOSTER, W. R., and H. F. ROYAL: An Intermediate Compound on the System $\text{BeO} \cdot \text{Al}_2\text{O}_3$ (Chrysoberyl)- Al_2O_3 (Corundum), *J. Am. Ceram. Soc.*, **32**, 26, 1949.
68. WHITTEMORE, O. J., JR.: Properties and Uses of Pure Oxide Heavy Refractories, *J. Am. Ceram. Soc.*, **32**, 48, 1949.
69. LEVIN, E. M., and H. F. McNARDIE: The System $\text{BaO} \cdot \text{B}_2\text{O}_3$, *J. Am. Ceram. Soc.*, **32**, 99, 1949.

CHAPTER XIV

LOAD-BEARING CAPACITY OF REFRACTORIES

1. Mechanism of Load Failure. *Flow Characteristics of Glass.* The flow properties of a heated glass fiber are shown in Fig. 234, in which the elongation is plotted against time for a single load. It will be noted that the flow starts in rapidly but soon decreases until it reaches a constant rate. If the straight portion of the curve is projected back to the zero time axis, the value S_1 is obtained, which represents the elastic strain. If, at time t_1 , the load is removed, the glass will contract rapidly at first and

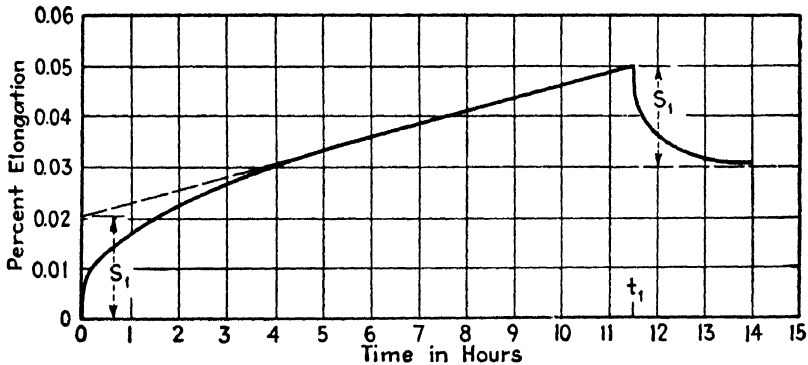

FIG. 234. Flow of heated glass.

then more slowly until it reaches a fixed length. The amount of contraction is equal to S_1 , or the original elastic effect. The heated glass is a truly viscous material; for if the steady rate of flow is plotted against stress as shown in *A* of Fig. 235, a straight line passing through the origin results.

The mechanism of flow in glass can perhaps be made clearer by considering a mechanical model, the motion of which reproduces the glass flow with considerable exactness. This model, shown in Fig. 236, consists of the spring *A*, which represents the elastic effect in the glass but is restrained from reaching instant equilibrium by the dashpots *B*, representing the restraining force or internal friction of the glass. The steady flow of the glass is represented by the motion of the dashpot *C*; the weight *W* provides the extension force.

Flow of Crystals. The flow of single crystals of nonmetals at elevated temperatures has not been studied with any great care. It is believed that

the single crystal has a definite yield point but deforms plastically below the melting temperature. Research on single crystals is complicated by the fact that some distortion occurs, probably along the slip planes, until there is no longer a single crystal and we must consider the system as many similarly oriented small crystals.

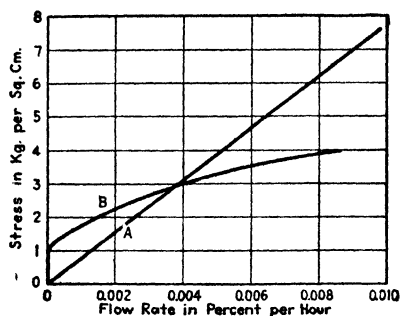

FIG. 235. Flow characteristics of a viscous material (A) and an elasto-plastic material (B).

A still greater departure from a single crystal is a system of small crystals with random orientation, which gives, in effect, the conditions of an isotropic medium. Here again, we have little information on the flow properties.

Flow of a Mixture of Crystals and Glass. This mixture, which is a normal characteristic of most refractory materials, has been studied to a considerable extent. Such mixtures are elasto-plastic materials, similar in flow characteristics to plastic metals; *i.e.*, if the steady rate of flow is plotted against stress, a line results that does not pass through the origin but indicates a certain minimum stress necessary to initiate flow, as shown in curve B of Fig. 235, a characteristic typical of all plastic materials. The time-elongation curve, however, is very similar to that for a glass, as indicated in Fig. 237 for a porcelain. This shows the initial portion of rapid flow and later the gradual conformity to a uniform rate. It is characteristic of almost all refractory materials that the rate of flow soon after the load is applied is much greater than after a uniform condition has been reached. Also it should be remembered that in plastic flow, the rate of flow is roughly proportional to the fourth power of the stress and not the first power as in viscous flow.

In Fig. 238 is shown a more or less idealized type of flow diagram for a refractory material at various temperatures.

The flow relations in an elasticoviscous material may be clarified by a mathematical discussion.

Let S_t = the total flow of the specimen

S_e = the elastic portion of the flow

S_1 = the total elastic flow under the external force F

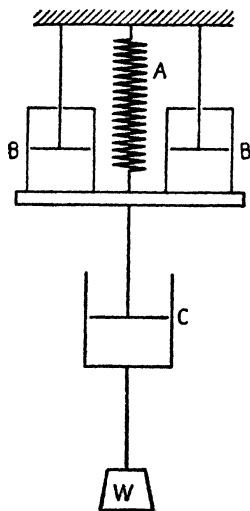

FIG. 236. Model simulating the flow in glass.

Now the force acting at any instant to cause elastic flow is

$$F_1 = F(S_1 - S_c)$$

That is, at the start of flow, $F_1 = F$, whereas at the condition of equilibrium flow $F_1 = 0$.

The retarding force restraining the elastic flow is given by

$$F_2 = k \frac{dS_1}{dt}$$

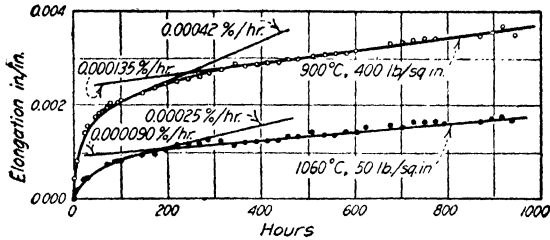

FIG. 237. Plastic flow of heated porcelain.

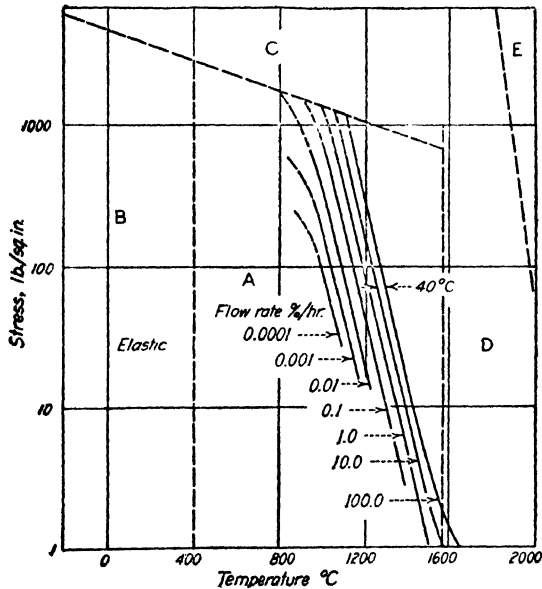

FIG. 238. The flow field of a porcelain.

- A = field of plastic flow
- B = field of elastic flow
- C = field of instant breaking
- D = field of viscous flow
- E = field of turbulent flow

But any time

$$F_1 = F_2$$

or

$$F(S_1 - S_e) = k \frac{dS_e}{dt}$$

Solving for S_e we obtain

$$S_e = S_1(1 - e^{Ft/k})$$

The viscous flow is

$$S_v = k_1 t$$

Then

$$\begin{aligned} S_t &= S_v + S_e \\ S_t &= k_1 t + S_1(1 - e^{Ft/k}) \end{aligned}$$

This expression represents the flow relation of Fig. 234 and the motion of the model of Fig. 236. After a period of time, the second term becomes zero and the flow is steady.

In the case of elasto-plastic flow, we can set up the expression for the elastic flow as

$$F(S_1 - S_e) = k_2(dS_e/dt)^n$$

and for the plastic flow as

$$S_p = k_3 t$$

where S_p = the plastic flow

$$n = \frac{1}{4} \text{ (approximately)}$$

The solution of these equations gives an expression for the total flow of

$$S_t = k_3 t + S_1 \left(1 - \sqrt[3]{\frac{1}{3F^4 S_1^3 + 1}} \right)$$

Reference should be made to the excellent series of papers on the flow of refractories by Clews and his coworkers.^(48,49,52)

2. Method of Measurement. *ASTM Load Test.* The load resistances of refractories are almost invariably measured with a compression specimen, which is heated under a definite schedule and the amount of deformation determined at the end of the test. However, tension^(30,33,42,47) and torsion^(31,32,41) tests have been made. A typical example of the compression tests is the ASTM standard test, which may be quoted as follows:

STANDARD METHOD OF TEST FOR REFRACTORY MATERIALS UNDER LOAD AT HIGH TEMPERATURES

ASTM Designation: C 16-41¹

ISSUED AS TENTATIVE, 1939; ADOPTED, 1941

This Standard of the American Society for Testing Materials is issued under the fixed designation C 16; the final number indicates the year of original adoption as standard or, in the case of revision, the year of last revision.

1. **Scope.** This method of test covers the procedure for determining the resistance to deformation of fireclay refractories, when subjected to a specified compressive load at a specified temperature for a specified time.

2. **Apparatus.** *a.* The apparatus shall consist essentially of a furnace and a loading service. It may be constructed in accordance with Fig. 239 or its equivalent.²

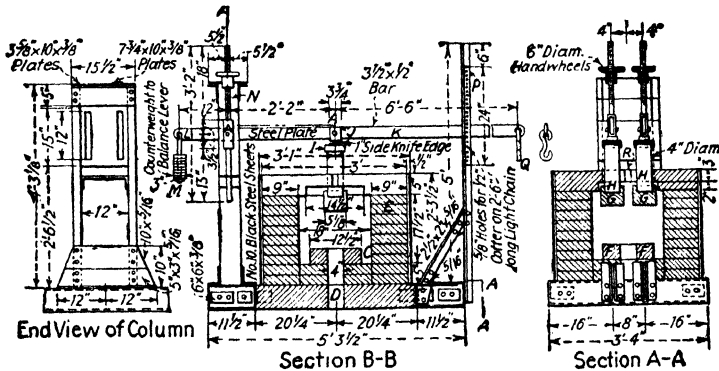

FIG. 239. Standard load-test furnace.

When gas or oil fuel is used, the furnace shall be of such form that the temperature is substantially uniform in all parts of the furnace. Two burners shall be used. These shall be capable of individual control and located to produce a tangential flame that will not impinge on the specimens or on the thermocouple protecting tubes.

b. The temperature shall be measured either with calibrated platinum-platinum-rhodium thermocouples, each encased in a protection tube with the junction not more than 1 in. (25 mm) from the center of the side or edge of each specimen farthest from the center of the furnace, or with some form of pyrometer that has been calibrated against a thermocouple in the furnace. A recording form of temperature indicator is recommended. If the optical pyrometer is used, obser-

¹ ASTM Standards are subject to revision. The Society's headquarters, in Philadelphia, may be consulted for the latest information.

² This standard, as adopted in 1941, recommends furnaces of three types, viz., the direct-load-type, gas- or oil-fired; the direct-load-type, electrically heated; and the lever-type load test furnace. Only the last is here illustrated.

variations shall be made by sighting into refractory tubes having closed ends and in the same relative positions to the test specimens as those specified for the thermocouples.

3. Test Specimen. *a.* The test specimen shall consist of a minimum of two 9 by 4½ by 2½ in. straight refractory brick, or specimens of this size cut from larger shapes, utilizing as far as possible existing plane surfaces.

b. If necessary, the ends of the specimen shall be ground so that they are approximately perpendicular to the vertical axis.

TABLE 72. TIME-TEMPERATURE SCHEDULES FOR HEATING THE TEST FURNACE

NOTE: All temperatures shall be maintained within $\pm 10^{\circ}\text{C}$ of those prescribed in this table, and the averages of the temperatures attained shall equal those specified.

| Time | | Temperatures for various heating schedules, $^{\circ}\text{C}$, fireclay brick | | | Tentative schedule of temperatures, $^{\circ}\text{C}$ | |
|---------|---------|---|--------------------------------|--|--|---|
| Hours | Minutes | Schedule No. 3, super duty | Schedule No. 2, high heat duty | Schedule No. 1, intermediate heat duty | Schedule No. 4, silica brick | Schedule No. 5, basic and neutral brick |
| After 1 | 0 | 560 | 500 | 500 | 119 | 500 |
| | 15 | 680 | 620 | 595 | 154 | 620 |
| | 30 | 800 | 720 | 685 | 193 | 720 |
| | 45 | 900 | 815 | 770 | 232 | 815 |
| After 2 | 0 | 990 | 900 | 850 | 280 | 900 |
| | 15 | 1070 | 980 | 920 | 335 | 980 |
| | 30 | 1140 | 1045 | 990 | 413 | 1045 |
| | 45 | 1200 | 1100 | 1050 | 552 | 1100 |
| After 3 | 0 | 1250 | 1150 | 1100 | 690 | 1150 |
| | 15 | 1290 | 1195 | 1145 | 830 | 1195 |
| | 30 | 1330 | 1235 | 1185 | 955 | 1235 |
| | 45 | 1370 | 1270 | 1220 | 1090 | 1270 |
| After 4 | 0 | 1400 | 1300 | 1250 | 1205 | 1300 |
| | 15 | 1430 | 1330 | 1275 | 1315 | 1330 |
| | 30 | 1450 | 1350 | 1300 | 1400 | 1350 |
| | 45 | 1450 | 1350 | 1300 | 1455 | |
| After 5 | 0 | 1450 | 1350 | 1300 | 1480 | To failure at 56°C per hr |
| | 15 | 1450 | 1350 | 1300 | To failure at 56°C per hr | |
| | 30 | 1450 | 1350 | 1300 | | |
| | 45 | 1450 | 1350 | 1300 | | |
| After 6 | 0 | 1450(end) | 1350(end) | 1300(end) | | |

c. The test specimen shall be measured before testing, four observations being made on each dimension (length, width, and thickness) at the center of the faces to within or minus 0.02 in. (0.5 mm). The average dimensions shall be recorded, and the cross section calculated.

4. Setting the Test Specimen. The test specimen, set on end, shall occupy a position in the furnace so that the center line of the applied load coincides with the vertical axis of the specimen as indicated in Fig. 239 and shall rest on a block of some highly refractory material, neutral to the specimen, having a minimum expansion or contraction. (Recrystallized silicon carbide brick have been found satisfactory for this purpose.) There shall be placed between the specimen and the refractory blocks a thin layer of highly refractory material such as fused alumina or silicon carbide, which has been ground to pass a No. 20 (840 μ) ASTM sieve (equivalent to mesh No. 20 of the Tyler standard series). At the top of the test specimen a block of similar highly refractory material should be placed, extending through the furnace top to receive the load.

NOTE: Gross errors which may more than double the deformation will result if the specimen is not set perpendicular to the base of the support or if the load is applied eccentrically.

5. Procedure. a. *Loading.* The gross load to be applied shall be calculated from the average cross section of the original specimen as determined in Sec. 3c. A load of 25 lb per sq ft (1.765 kg per sq cm) shall be used.

b. *Heating.* The rate of heating shall be in accordance with the requirements of Table 72 and the time-temperature curves shown in Fig. 240 which give the rate and time of heating required for different classes of refractory materials. The temperature shall not vary more than $\pm 10^{\circ}\text{C}$ from the specified temperature.

c. *Furnace Atmosphere.* The furnace shall be operated with an oxidizing atmosphere above 800 $^{\circ}\text{C}$.

d. *Completion of Test.* At the expiration of the time of heating, the supply of heat shall be stopped and the furnace allowed to cool by radiation to 1000 $^{\circ}\text{C}$, or lower, before the load is removed and the specimens examined. When the test specimens have cooled to room temperature, they shall be remeasured for length in accordance with Sec. 3c, and the average deformation shall be recorded and reported to the nearest 0.5 per cent of the original length.

NOTE: It is recommended that a photograph be made of the specimen before and after testing, since these will yield useful information.

The ASTM load test has been developed over a long period to fit best the needs of the manufacturer and the user of refractories and is particularly useful in control testing. As discussed later, it does not give information particularly suited to the need of the designer.

European Load Tests. In Europe, the load test is generally carried out on smaller specimens, *i.e.*, cylinders approximately 1 in. in diameter and 1 in. high. This method is preferred because the temperature can be made more uniform over the specimen and the furnace is smaller and more easily

controlled. An excellent furnace of this type is described by Swallow.⁽⁶⁰⁾ On the other hand, such a small specimen may not represent accurately the structure of a coarse-grained brick, and the specimens are so short that the precision of measuring the elongation is somewhat less than with the larger specimens. However, there are certain advantages with each type of specimen; and with carefully made tests, either should give reliable results. An excellent discussion of the load test is given in the references.^(34,39)

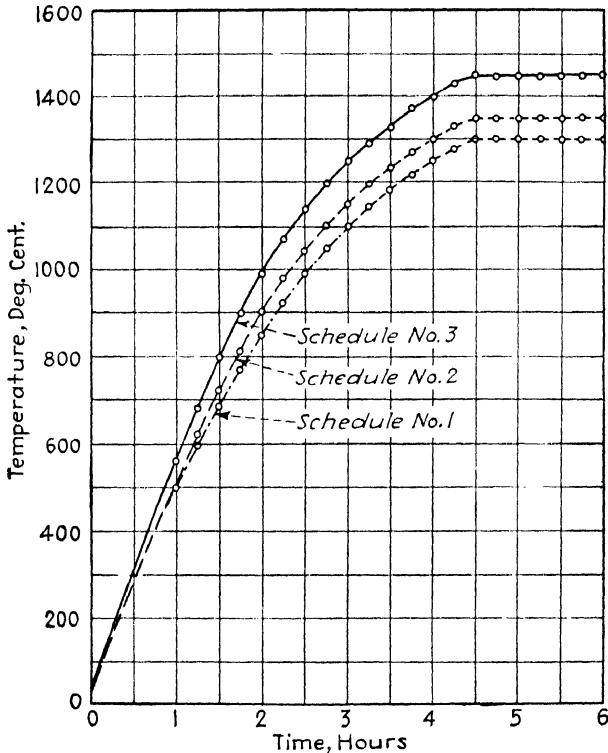

FIG. 240. Time-temperature curve for load test.

Long-time Creep Tests. Recently, some work has been carried out on the load testing of refractories in the same way that creep tests are made with metals;⁽⁴⁶⁾ *i.e.*, the refractory is heated to a uniform temperature and then loaded for a sufficient length of time to establish a uniform rate of flow. A furnace that is heated by electric globars to the necessary temperature for carrying out this test is shown in Fig. 241. The length of the specimen not only is measured at the end of the run but is measured every day with a pair of telescopes sighting on the ends of the specimen in order to determine a time-elongation curve. Figure 242 shows such a series of

curves for a firebrick run in this way; and in Fig. 243, the flow rates are plotted against load on logarithmic paper. It is felt that for design purposes, the long-time tests are much preferred to the short-time tests previously described. Whether or not the shorter tests give accurate com-

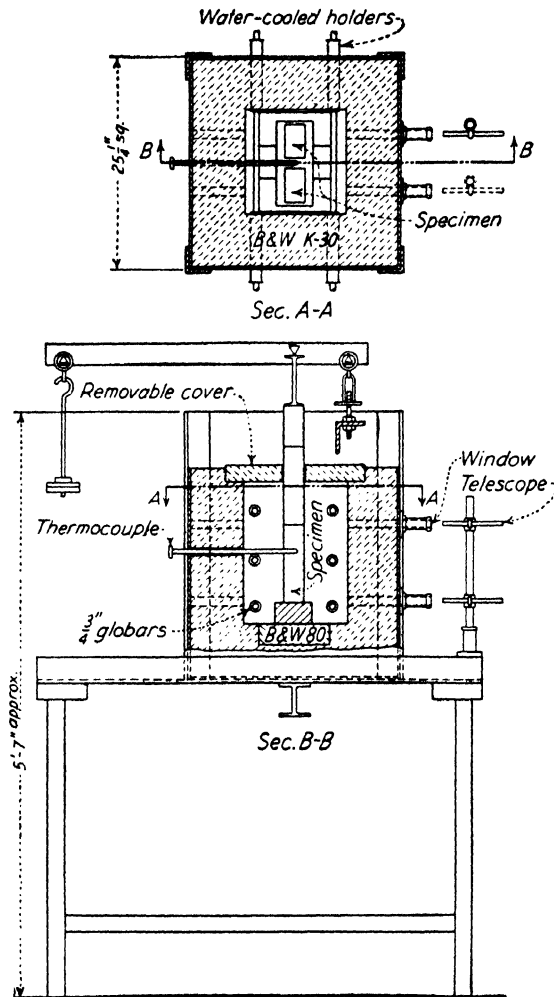

FIG. 241. Electrically heated load test furnace. (*J. Am. Ceram. Soc.*)

parisons between various bricks cannot be determined until more long-time tests have been made to reproduce more nearly actual conditions.

Considerable interest has been shown in the use of pure, sintered refractories for high-temperature structural parts such as described in Chap. XII. Both hot tensile strengths and tensile creep values have been

obtained on a number of materials. Most of the tests have been made on special specimens mounted in refractory holders with provisions for axial loading, which is of the utmost importance when dealing with brittle materials. While most of the testing has been done in a standard tensile machine, Towers⁽⁵⁶⁾ has developed a pneumatic type that seems to give

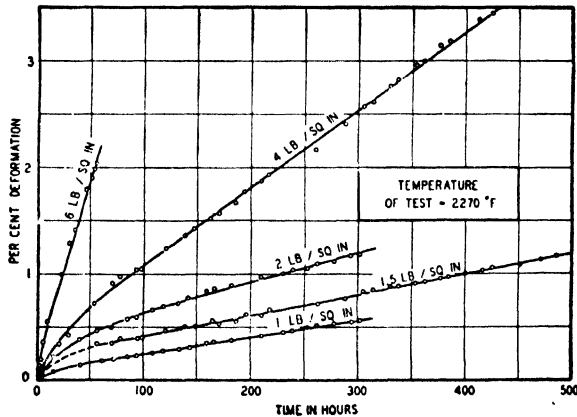

FIG. 242. Time-elongation curve for a firebrick. (*J. Am. Ceram. Soc.*)

unusually consistent results. The series of papers by Clews and his collaborators^(48,49,52) gives an excellent discussion of the flow of refractories, while the best data on tensile creep at high temperatures are those reported by Burdick, Moreland, and Geller.⁽⁶¹⁾

Recently, there has been developed in the Ceramic Laboratory of the Massachusetts Institute of Technology a torsion creep test for refractories of a unique character,⁽⁶⁰⁾ as the optical system is in the furnace. The

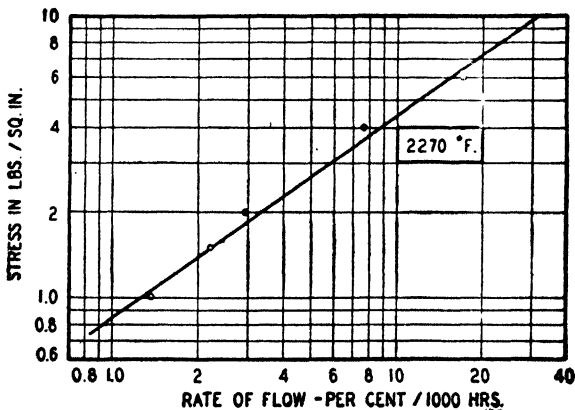

FIG. 243. Flow rate vs. load. (*J. Am. Ceram. Soc.*)

general plan is shown in Fig. 244. The specimen *a* is put under a steady torsional stress by the torque wheel *f* and the weight *g* through the refractory holders *e*. At the end of the gage length of the specimen are cemented two concave sapphire mirrors, *b*, $\frac{1}{8}$ in. in diameter. Light from lamps *c* are focused by these mirrors on the ground-glass scale *d*, so that any twist in the gage length shows up as a separation of the light spots. The screw *i* in the nut *j* moves the arm *h* by the micrometer dial *k* to calibrate the scale *d*. This method can be used up to at least 1300°C (about 2370°F)

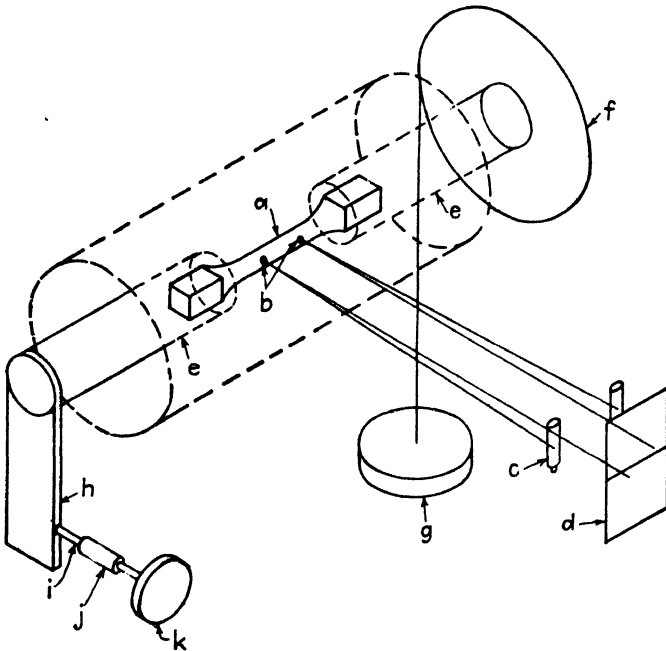

FIG. 244. A torsion creep furnace with a sapphire optical system.

with a precision of ± 0.001 deg. It should be noted that the holders do not have to be rigidly attached to the specimen, as slippage does not affect the optical readings. This method has many advantages over the tensile test because of its much greater precision in determining low flow rates.

3. Load Values for a Number of Refractories. In Table 73 will be found the comparative load values for a number of fireclay brick that have been tested in the ASTM type load test as published by the Refractories Institute.

Table 74 shows load values for a number of special refractories run in the ASTM furnace but at the schedule shown in Fig. 245 in order to bring all of them down to give a direct comparison.

Only recently⁽⁴⁶⁾ have any values been available on the load values of insulating firebrick. The bricks shown in Table 75 are representative of those on the market at present. Their load value together with those of two second-quality fireclay brick are given in Table 76 when heated on the schedule shown in Fig. 246. It is interesting to notice that some of the insulating firebrick, even though they have a porosity of around 80 per

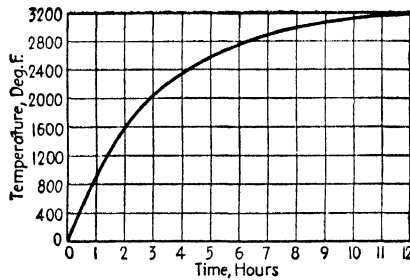

FIG. 245. Load-test schedule for special bricks.

TABLE 73. LOAD-BEARING CAPACITY OF FIRECLAY BRICK

| Method of manufacture | Brand No. | Pyrometric cone equivalent | Subsidence, per cent, at 1350°C. (2462°F.) load test 25 lb. per sq. in. | Chemical composition | | | | | |
|-----------------------|-----------|----------------------------|---|----------------------|---------|------------|---------|-------------------|------------------|
| | | | | Silica | Alumina | Iron oxide | Titania | Lime and magnesia | Combined alkalis |
| Dry press... | A | 19 | Failed | 68.88 | 24.03 | 2.57 | 1.24 | 0.92 | 2.01 |
| | B | 31 | 12.70 | 55.20 | 40.00 | 2.40 | 2.00 | 0.80 | 1.60 |
| | C | 32 | 3.40 | 61.18 | 35.05 | 1.91 | 1.04 | 0.61 | 0.71 |
| | D | 32 | 10.50 | 54.22 | 38.58 | 1.86 | 2.26 | 0.87 | 2.34 |
| | E | 32-33 | 3.60 | 54.08 | 40.97 | 2.34 | 1.89 | 0.40 | 1.42 |
| | F | 33 | 6.90 | 53.00 | 42.70 | 1.70 | 2.04 | 0.70 | 0.80 |
| | G | 33 | 2.60 | 52.47 | 42.70 | 1.56 | 1.97 | 0.48 | 0.62 |
| | H | 35-36 | 0.90 | 33.54 | 59.64 | 1.76 | 2.34 | 0.54 | 1.55 |
| Stiff-mud... | I | 31-32 | 1.30 | 73.81 | 21.69 | 1.85 | 0.90 | 0.40 | 0.66 |
| | J | 30-31 | 4.00 | 68.24 | 28.29 | 1.55 | 0.66 | 0.94 | 0.32 |
| | K | 30-31 | 5.60 | 60.04 | 33.22 | 1.83 | 0.99 | 1.20 | 2.32 |
| | L | 32-33 | 5.60 | 57.44 | 36.88 | 2.14 | 1.80 | 0.75 | 0.72 |
| | M | 32-33 | 3.90 | 52.66 | 38.57 | 2.28 | 2.53 | 0.96 | 2.64 |
| | N | 32-33 | 1.85 | 52.73 | 43.20 | 2.29 | 1.02 | 0.44 | 0.37 |
| | P | 29-30 | 4.95 | 75.96 | 21.46 | 1.12 | 1.10 | 0.54 | 0.70 |
| | Q | 27-28 | 2.62 | 70.00 | 25.00 | 1.20 | 1.00 | 0.50 | 2.30 |
| Hand-made.. | R | 30-31 | 9.86 | 65.28 | 28.47 | 1.77 | 0.56 | 0.83 | 1.79 |
| | S | 31-32 | 3.30 | 60.08 | 34.04 | 1.40 | 2.16 | 0.63 | 1.84 |
| | T | 32 | 8.43 | 48.42 | 44.33 | 3.58 | 1.70 | 0.90 | 1.52 |
| | U | 32 | 5.95 | 51.30 | 42.30 | 2.23 | 2.28 | 0.47 | 1.55 |
| | V | 33-34 | 10.90 | 42.20 | 49.98 | 3.18 | 2.40 | 0.85 | 1.47 |

TABLE 74. SPECIAL REFRACTORIES

| Type | Temperature for 10 per cent deformation | | Test† |
|---|---|-------|----------------------|
| | °C | °F | |
| Commercial fused alumina | 1716 | 3121 | |
| Fused alumina, Norton RA 1190 35 (99 per cent + Al ₂ O ₃) | 1925 ⁽⁵⁵⁾ | 3497 | 10 psi: 10°C per min |
| Chrome, commercial | 1404 | 2559 | |
| Chrome-magnesite (German, av fig.) . . | 1640 ⁽⁵¹⁾ | 2980 | 28 psi |
| Kaolin (B & W K-80) | 1593 | 2899 | |
| Magnesite (sintered Grecian) | 1400* | 2552 | |
| Magnesite, fused (Norton LM 171-35) . | 2240 ⁽⁵⁵⁾ | 4064 | 10 psi: 10°C per min |
| Mullite, dense | 1727 | 3140 | |
| Silica, commercial | 1646* | 2985* | |
| Spinel | 1510* | 2750* | |
| Zirconia (clay-bonded baddeleyite) . . . | 1376 | 2509 | |
| Zirconia, fused, lime stabilized, Norton LZO 172-35 | 2200 ⁽⁵⁵⁾ | 3992 | 10 psi: 10°C per min |

* Sheared.

† Unless noted tested under 25 psi at temperature rise shown in Fig. 245.

TABLE 75. TEST DATA ON COMMERCIAL INSULATING FIREBRICK

| Brand No. | Use limit, °F | Weight, lb per 9 in. straight | Modulus of rupture, psi | Cold crushing strength, psi |
|-----------|---------------|-------------------------------|-------------------------|-----------------------------|
| A | 2000 | 1.72-1.82 | 95 | 120 |
| B | 2000 | 2.21-2.75 | 197 | 172 |
| C | 2000 | 1.64 | 71 | 104 |
| D | 2000 | 2.27-2.32 | 107 | 559 |
| O | 2000 | 1.88 | 106 | 176 |
| E | 2200 | 1.87-1.96 | 165 | 193 |
| F | 2200 | 2.71-3.07 | 224 | 377 |
| G | 2200 | 2.27 | 129 | 208 |
| N | 2200 | 2.44 | 66 | 235 |
| I | 2500 | 2.40-2.63 | 196 | 248 |
| J | 2500 | 2.76 | 251 | 408 |
| K | 2600 | 2.30-2.50 | 133 | 128 |
| L | 2600 | 2.68-2.80 | 203 | 372 |
| S | 2600 | 2.40 | 127 | 196 |
| M | 2800 | 2.42-2.48 | 140 | 150 |
| T | 2900 | 2.90 | 235 | 220 |

TABLE 76. LOAD-TEST RESULTS

| Brand No. | Percentage at 1900°F. | | | Percentage at 2000°F. | | | Percentage at 2100°F. | | | Percentage at 2200°F. | | | Percentage at 2300°F. | | |
|-----------|-----------------------|--------|--------|-----------------------|--------|--------|-----------------------|--------|--------|-----------------------|--------|--------|-----------------------|--------|--------|
| | 10 lb. | 25 lb. | 40 lb. | 10 lb. | 25 lb. | 40 lb. | 10 lb. | 25 lb. | 40 lb. | 10 lb. | 25 lb. | 40 lb. | 10 lb. | 25 lb. | 40 lb. |
| A | 0.1 | 0.1 | 0.1 | 0.0 | 0.2 | 0.3 | 0.4 | 0.7 | 1.1 | 1.1 | 1.1 | 1.1 | 1.1 | 2.7 | Failed |
| B | 0.1 | 1.6 | 8.3 | 0.0 | 0.2 | 0.3 | 0.4 | 0.7 | 1.1 | 1.1 | 1.1 | 1.1 | 1.1 | 2.7 | Failed |
| C | 0.1 | Failed | Failed | 2.5 | 2.9 | 4.9 | 3.8 | Failed | Failed | Failed | Failed | Failed | Failed | Failed | Failed |
| D | 0.9 | 1.3 | 2.5 | 2.5 | 2.9 | 4.9 | 3.8 | Failed | Failed | Failed | Failed | Failed | Failed | Failed | Failed |
| O | Failed | Failed | Failed | 0.0 | 0.1 | 0.2 | 0.1 | 0.1 | 0.1 | 0.4 | 0.4 | 0.4 | 0.4 | 2.6 | Failed |
| E | 0.1 | 0.0 | 0.1 | 0.0 | 0.1 | 0.2 | 0.1 | 0.1 | 0.1 | 0.1 | 0.1 | 0.1 | 0.1 | 2.6 | Failed |
| F | 0.1 | 0.4 | 1.8 | 0.2 | 2.5 | 7.6 | 2.5 | Failed | Failed | Failed | Failed | Failed | Failed | Failed | Failed |
| G | 0.1 | 1.8 | 7.6 | 1.5 | Failed | Failed | Failed | Failed | Failed | Failed | Failed | Failed | Failed | Failed | Failed |
| N | Failed | Failed | Failed | 0.2 | 2.0 | Failed | 1.9 | Failed | Failed | Failed | Failed | Failed | Failed | Failed | Failed |
| I | 0.1 | 0.8 | 1.2 | 0.2 | 2.0 | Failed | 1.9 | Failed | Failed | Failed | Failed | Failed | Failed | Failed | Failed |
| J | 0.2 | 0.2 | 0.2 | 0.0 | 0.2 | 0.7 | 0.1 | 1.7 | Failed | Failed | Failed | Failed | Failed | Failed | Failed |
| K | 0.2 | 0.2 | 0.2 | 0.3 | 0.4 | 0.6 | 0.3 | 1.0 | 2.9 | 2.9 | 2.9 | 2.9 | 2.9 | Failed | Failed |
| L | 0.0 | 0.2 | 0.4 | 0.1 | 0.9 | 1.6 | 0.9 | 1.2 | 5.5 | 5.5 | 5.5 | 5.5 | 5.5 | Failed | Failed |
| S | 0.1 | 0.1 | 0.2 | 0.2 | 0.3 | 0.8 | 0.4 | 2.9 | 8.2 | 8.2 | 8.2 | 8.2 | 8.2 | Failed | Failed |
| M | 0.1 | 0.1 | 0.2 | 0.0 | 0.4 | 0.9 | 0.1 | 1.0 | 3.9 | 3.9 | 3.9 | 3.9 | 3.9 | Failed | Failed |
| T | 0.1 | 0.1 | 0.2 | 0.2 | 0.1 | 0.4 | 0.2 | 0.4 | 0.6 | 0.6 | 0.6 | 0.6 | 0.6 | 0.8 | Failed |
| 1 | | | | | | | | | 0.4 | 0.4 | 0.4 | 0.4 | 0.4 | 1.3 | Failed |
| 2 | | | | | | | | | 0.2 | 0.2 | 0.2 | 0.2 | 0.2 | 0.8 | Failed |
| | | | | | | | | | 0.2 | 0.2 | 0.2 | 0.2 | 0.2 | 0.8 | Failed |

cent, give a resistance to load superior to the second-grade fireclay brick with a porosity of around 25 per cent.

4. Factors Influencing the Load-bearing Capacity of Refractories. In general, it may be said that the load-bearing capacity of a refractory is directly influenced by the amount and viscosity of the glassy phase. Anything that can be done to diminish the amount of glass or raise its viscosity will increase the resistance to flow. This can be accomplished by adding

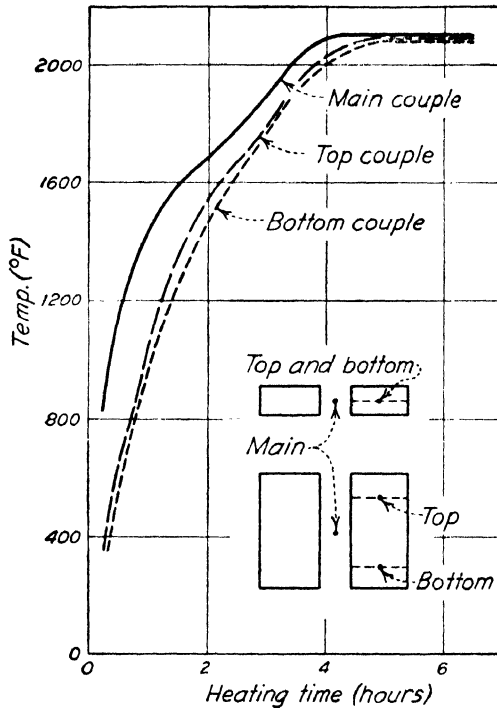

FIG. 246. Temperature vs. heating time during load testing of insulating firebrick. (*J. Am. Ceram. Soc.*)

to the refractory a material that will form from the glass a more viscous material or a material containing more crystals. For example, a chrome brick containing silica as an impurity may have a comparatively low load value; whereas if the proper amount of magnesite is added to the brick, it will form the crystalline magnesium ortho-silicate, forsterite, which will greatly increase the load-bearing value of the brick. Also, an increase in firing temperature will generally increase the load-bearing capacity because it distributes the glassy phase more thoroughly and permits it to absorb crystallizing elements. This is shown in Table 77, which lists a number of commercial firebricks that were tested as they came from the kiln and then after refiring at a higher temperature.

TABLE 77. EFFECT OF RETURNING ON THE LOAD-BEARING PROPERTIES OF REFRACTORIES

| Brand No. | As received | | | | After returning to 1620°C.* | | | |
|-----------|------------------|------|-----------------------|------|-----------------------------|------|-----------------------|--------|
| | Shrinkage starts | | 10 per cent shrinkage | | Shrinkage starts | | 10 per cent shrinkage | |
| | °C. | °F. | °C. | °F. | °C. | °F. | °C. | °F. |
| A | 1200 | 2192 | 1510 | 2750 | 1480 | 2696 | 1590 | 2894 S |
| B | 1260 | 2300 | 1440 | 2624 | 1460 | 2660 | 1550 | 2822 |
| C | 1200 | 2192 | 1490 | 2714 | 1460 | 2660 | 1570 | 2858 |
| D | 1170 | 2138 | 1460 | 2660 | 1490 | 2714 | 1620 | 2948 |
| E | 1090 | 1994 | 1460 | 2660 | 1430 | 2606 | 1580 | 2876 |
| F | 1250 | 2282 | 1500 | 2732 | 1450 | 2642 | 1580 | 2876 S |
| G | 1200 | 2192 | 1500 | 2732 | 1490 | 2714 | 1590 | 2894 S |
| H | 1260 | 2300 | 1520 | 2768 | 1490 | 2714 | 1650 | 3002 |

* S indicates failure by shear. Load, 25 lb. per sq. in.

The structure of the brick also has some influence on the load-bearing capacity. For example, a brick of high porosity will have less load-bearing capacity than one of the same material with a lower porosity, as there is less material in the brick to carry the load in the latter case. It must be remembered, however, that the porous bricks are lighter and therefore do not need to carry a heavy load.

5. Application of Load-test Results to Design. It will be clear from the preceding discussion that the results of the usual short-time load test are of little value to the designer of furnaces. Only with the long-time test that has come to equilibrium flow are values available for the designer to use in computing allowable stresses in the structure. From the curve in Fig. 243, the data may be utilized in the following example: A pier under the hearth of a heat-treating furnace has an allowable deformation of 10 per cent in its estimated working life of 4,000 hr, which amounts to a rate of 2.5 per cent in 1,000 hr. On the curve this corresponds to a loading of 1.7 psi.

It is probably safe to say that very few load failures occur in actual furnace construction and then only in cases where the refractory part is heated all the way through, such as in piers, partition walls, and highly insulated crowns. Nearly all other parts of furnaces have a considerable temperature gradient from the hot to the cool side, and therefore the load is supported by a relatively cool portion of the refractory, which is well able to carry the load. It is difficult with the data at hand at the present time to compute the load-bearing capacity of a wall with a variable temperature gradient, but an approximation can be made by dividing the wall into a

number of sections parallel to the face and considering the mean temperature of each section as a temperature for obtaining the load-bearing value. If these sections are all summed up, the load-bearing value of the whole wall can be roughly computed. It will be found, however, that in most cases, the cooler section will be responsible for supporting almost the whole load.

The possible use of the refractories to replace metals in highly stressed parts at elevated temperatures, as discussed in Chap. XXV, will require a much more extensive background than we have at present on the creep of pure refractories at temperatures above 1500°F (about 820°C).

6. Bibliography

1. BLEININGER, A.V., and G.H. BROWN: The Testing of Fireclay Refractories with Special Reference to Their Load Carrying Capacity at Furnace Temperatures, *Natl. Bur. Standards, Tech. Paper 7*, 1911.
2. MELLOR, J.W., and W. EMERY: Effect of Load on the Refractories of Firebricks, etc., *Trans. Ceram. Soc. (Engl.)*, **17**, 360, 1917-1918.
3. SIEURIN, E., E. CARLSSON, and B. KJELIGREN: Load Tests in Refractory Bodies, at High Temperatures, *Ber. deut. keram. Ges.*, **3**, 53, 1921.
4. BODIN, V.: Resistance Tests on Refractory Products under Load at Different Temperatures, *Trans. Ceram. Soc. (Engl.)*, **21**, 56, 1921-1922.
5. DALE, A.J.: The Relation between Ordinary Refractoriness, Underload Refractoriness and Composition, Physical and Chemical, of Refractory Material, (I), *Trans. Ceram. Soc. (Engl.)*, **23**, 217, 1923-1924; (II); **170**, 24, 1924-1925.
6. WILSON, H.: High Temperature Load and Fusion Tests of Fire Brick from the Pacific Northwest in Comparison with Other Well-known Fire Brick, *J. Am. Ceram. Soc.*, **7**, 34, 1924.
7. DALE, A.J.: An Investigation of the Effects of Load, Temperature and Time on the Deformation of Firebrick Material at High Temperatures, *Trans. Ceram. Soc. (Engl.)*, **24**, 199, 1924-1925.
8. DALE, A.J.: Some Fallacies to Be Avoided in the Standardization of a Method of Testing the Load-bearing Capacities of Refractories at High Temperatures; and a Suggested Method for Standardization, *Trans. Ceram. Soc. (Engl.)*, **24**, 216, 1924-1925.
9. HELSER, P.D.: A Laboratory Load Furnace, *J. Am. Ceram. Soc.*, **8**, 822, 1925.
10. HIRSCH, H.: The Softening of Raw Materials Used in the Refractory Industry at High Temperatures, *Keram. Rundschau*, **33**, 279, 1925.
11. GELLER, R.F., and W.L. PENDERGAST: Comparative Tests of Some American and German Fireclay Brick, *J. Am. Ceram. Soc.*, **9**, 370, 1926.
12. HIRSCH, H.: Investigation of the Load Test for and the Expansion of Silica Brick, *Stahl u. Eisen*, **47**, 1717, 1926.
13. BOOZE, M.C.: The Load Test for Fire Clay Refractories, *Am. Refractories Inst., Tech. Paper 2*, 1926.
14. SHEERAR, L.F.: The Effect of Atmospheric Conditions on the Load Test for Refractories, *J. Am. Ceram. Soc.*, **9**, 279, 1926.
15. DALE, A.J.: The Control of Silica Brick Making Based on Load-test Indications, (I, II, III, IV), *Trans. Ceram. Soc. (Engl.)*, **26**, 203, 210, 217, 225, 1926-1927.
16. DALE, A.J.: The Testing and Behavior of Refractory Material under Stress at High Temperatures, *Trans. Ceram. Soc. (Engl.)*, **26**, 138, 1926-1927.

17. BARTSCH, O.: Beitrage zur Methodik der Druckerweichungsversuches, *Sprechsaal*, **60**, 571; 592, 1927.
18. MIEHR, W., et al.: Vorschläge für Methodik der Druckerweichungsversuches an feuerfesten Baustoffen, *Tonind.-Ztg.*, **51**, 1618, 1927.
19. SALMANG, H.: Ueber die Erweichungsprüfung feuerfeste Stoffe, *Sprechsaal*, **60**, 477, 1927.
20. KANHAUSER, F., and J. ROBITSCHKEK: Beitrag für Kenntnis der Druckerweichungsprobe feuerfeste Stein, *Sprechsaal*, **60**, 685, 1927.
21. TADOKORO, Y.: Load Test of Clay Refractories as a Means of Estimating Their Qualities, *J. Japan. Ceram. Assoc.*, **35**, 149, 1927.
22. DALE, A.J.: The Effects of Temperature on the Mechanical Properties of Silica Products, *Trans. Ceram. Soc. (Engl.)*, **27**, 23, 1927-1928.
23. ILLGEN, F.: Contribution to the Load Test, *Ber. deut. keram. Ges.*, **9**, 454, 1928.
24. HIRSCH, H.: Strength of Refractory Materials at Elevated Temperatures, *Ber. deut. keram. Ges.*, **9**, 577, 1928.
25. KOHLER, E.: Deformation of Refractory Materials under Load at High Temperatures, *Trans. Ceram. Research Inst. (U.S.S.R.)*, **12**, 1, 1928.
26. WIDERMANN, R.V.: Load Tests at High Temperatures, *Céramique*, **31**, 214, 1928.
27. HIRSCH, H.: Beziehungen zwischen Festigkeit und Temperatur bei feuerfesten Baustoffen, *Tonind.-Ztg.*, **53**, 2, 1929.
28. LONG, B.: Testing Refractory Materials under Load at High Temperatures, *Science et ind.*, **181**, 75, 1929.
29. SWALLOW, H.T.S.: The Influence of Atmosphere on the Load-bearing Capacities of Firebricks, *Trans. Ceram. Soc. (Engl.)*, **29**, 339, 1930.
30. CHESTERS, J.H., and W.J. REES: The Application of Tensile Tests to the Study of the Bonding of Refractory Materials, *Trans. Ceram. Soc. (Engl.)*, **30**, 258, 1931.
31. ROBERTS, A.L., and J.W. COBB: The Behavior of Refractory Materials under Torsion at Different Temperatures, *Trans. Ceram. Soc. (Engl.)*, **32**, 22, 1933.
32. ROBERTS, A.L., and J.W. COBB: The Behavior of Refractory Materials under Torsion at Different Temperatures, Part II, *Trans. Ceram. Soc. (Engl.)*, **35**, 182, 1936.
33. NORTON, F.H.: The Flow of Ceramic Bodies at Elevated Temperatures, *J. Am. Ceram. Soc.*, **19**, 129, 1936.
34. CLEWS, F.H., and A.T. GREEN: Refractoriness-under-load Test, V, Experiments on the Behavior of Fire Brick at High Temperatures under Increasing Load, Refractory Materials Joint Committee, *Inst. Gas. Engrs., Twenty-eighth Rept.*, p. 61, 1937.
35. BREMOND, P.: Deformation of Refractories under Load at High Temperatures, Theoretical and Experimental Researches, *Céramique*, **40**, 1, 21, 41, 61, 1937.
36. BIGGS, H.C.: Refractoriness under Load Test, *J. Glass Technol.*, **21**, 264, 1937.
37. HEINDL, R.A., and W.L. PENDERGAST: Deformation and Young's Modulus of Fire-clay Brick in Flexure at 1,220°C., *Natl. Bur. Standards, Research Paper* 1030, 1937.
38. ROBERTS, A.L.: Notes on the Mechanical Properties of Refractory Materials, *Trans. Ceram. Soc. (Engl.)*, **36**, 326, 1937.
39. CLEWS, F.H., W.F. FORD, and A.T. GREEN: Refractoriness-under-load Test, VI, Refractory Materials Joint Committee, Twenty-ninth Report, *Inst. Gas Engrs., Commun.* 193, p. 33, 1938.
40. HYSLOP, J.F., and J. McNAB: Effect of Fluxes on the Underload Strength of a Fire Clay, *Trans. Ceram. Soc. (Engl.)*, **37**, 168, 1938.

41. ROBERTS, A.L., and J.W. COBB: The Behavior of Refractory Materials under Torsion at Different Temperatures, Part III, *Trans. Ceram. Soc. (Engl.)*, **37**, 296, 1938.
42. LONGCHAMON, L., and LIU-PING-KUN: The Resistance of Refractories to Tension at High Temperatures, *Arts du feu*, **1**, 81, 1938.
43. PARTRIDGE, J.H., and G.F. ADAMS: The Creep of Refractory Materials at High Temperature and Its Bearing on the Performance of Glasshouse Pots, *Trans. Soc. Glass Technol.*, **23**, 141, 1939.
44. PETIT, D.: A New Method of Assessing the Stability of Refractory Structures, *Trans. Ceram. Soc. (Engl.)*, **38**, 313, 1939.
45. NORTON, F.H.: A Critical Examination of the Load Test for Refractories, *J. Am. Ceram. Soc.*, **22**, 334, 1939.
46. NORTON, C.L., JR., and V.J. DUPLIN: Deformation of Insulating Firebrick under Load, *J. Am. Ceram. Soc.*, **23**, 22, 1940.
47. ILLGEN, F.: The Effect of the Quantity and Grain Size of Grog and of the Firing Temperature on the Physical Properties of Refractories, with Special Regard to the Tensile Strength at High Temperatures, *Ber. deut. keram. Ges.*, **11**, 649, 1940.
48. CLEWS, F.H., H.H. MACEY, and A.T. GREEN: Behavior of Refractory Materials under Stress at High Temperatures: I, Introductory Experiments with Porcelains under Torsion, *Bull. Brit. Refractories Research Assoc.*, **60**, 31, 1941.
49. CLEWS, F.H., H.M. RICHARDSON, and A.T. GREEN: Behavior of Refractory Materials under Stress at High Temperatures: II, Compression Experiments on a Refractory Insulating Product. *Bull. Brit. Refractory Research Assoc.*, **61**, 51, 1941.
50. SWALLOW, H.T.S.: Furnace and Apparatus for Carrying out Refractoriness-under-load Tests on Firebricks, *Trans. Brit. Ceram. Soc.*, **44**, 93, 1945.
51. SEIL, G.E., *et al.*: The Manufacture of Refractories and Information Concerning Their Use in the Iron and Steel Industry of Western Germany, P.B. 37804, 1946.
52. CLEWS, F.W., H.M. RICHARDSON, and A.T. GREEN: The Behavior of Refractory Materials under Stress at High Temperatures, Parts III and IV, *Trans. Brit. Ceram. Soc.*, **45**, 161, 1946.
53. KELER, E.K.: Testing Refractory Materials in Torsion, *Ogneupory*, **11**, 31, 1946.
54. BOOW, J., and G.A. WALKER: The Rate of Creep at Elevated Temperatures of Four Sillimanite Tank Blocks, *J. Soc. Glass Technol.*, **30**, 5, 1946.
55. WHITTEMORE, O.J., JR.: Pure Oxide, Heavy Refractories, Paper at Atlantic City Meeting of the American Ceramic Society, 1947.
56. TOWERS, H.R.: A Tensile Test Machine for Brittle Material, *Ohio State Univ., Proj.* 252, *Ret.* 36, 1947.
57. COOPER, W.G., W.L. STAFFORD, and G.A. BOLE: Subsidence of Insulating Refractories under Load. Presented at meeting of the American Ceramic Society, *Am. Ceram. Soc. Bull.* 26, p. 122, 1947.
58. MONG, LEWIS E.: Elastic Behavior and Creep of Refractory Brick under Tensile and Compressive Loads, *J. Am. Ceram. Soc.*, **30**, 69, 1947.
59. BRESSMAN, JOSEPH R.: Method for Determining Tensile Properties of Refractory Materials at Elevated Temperature, *J. Am. Ceram. Soc.*, **30**, 145, 1947.
60. STAVROLAKIS, J.A.: Thesis, Massachusetts Institute of Technology, 1948.
61. BURDICK, M.P., R.E. MORELAND, and R.F. GELLER: Creep Strength Characteristics of Refractory Porcelains, *NACA Tech. Note* 1561, 1948.

CHAPTER XV

SPALLING

1. Introduction. Spalling is usually defined as a fracture of the refractory brick or block resulting from any of the following causes:

1. A temperature gradient in the brick, due to uneven heating or cooling, that is sufficient to set up stresses of such magnitude as to cause failure.
2. Compression in a structure of refractories, due to expansion of the whole from a rise of temperature, sufficient to cause shear failures.
3. Variation in coefficient of thermal expansion between the surface layer and the body of the brick, due to surface slag penetration or to a structural change in service, great enough to shear off the surface layer.

Many consider only the first type as true spalling. It is undoubtedly the predominating effect in refractories such as silica, magnesite, and chrome. As this type is caused by the inherent properties of the refractory, it offers a good opportunity for careful analysis. The second type of spalling is almost always due to poor furnace design, and the refractory itself can seldom be blamed. The third type can be minimized by using bricks burned higher than their subsequent operating temperature and by preventing slag penetration in so far as is possible.

The spalling properties of refractories cannot be consistently improved until we know the true mechanism of spalling. Although the study of stresses and fractures in brittle material is by no means well understood, light has been thrown on the matter in recent years. This work has been extended by Booze⁽¹¹⁾ and Phelps,⁽¹⁶⁾ Green,⁽¹⁷⁾ Preston,⁽¹⁵⁾ numerous researches at the National Bureau of Standards, and by Endell in Germany.

2. Temperature Stresses in Solids. It may be of interest to examine first the distribution of stress in an elastic solid when its surface is heated or cooled. It is rather surprising that there has been so little recognition of the difference in stresses resulting from heating as differentiated from cooling. As will be shown later, the stresses as well as the fracture are quite different in the two cases. An investigation, therefore, has been carried out by the photoelastic method to determine the stresses occurring in various objects when suddenly heated and cooled at the surface.

Photoelastic Method. The method of studying stresses in various structures by photoelasticity has recently been used to a considerable extent in determining the distribution of stress in objects where a direct computa-

tion is impossible. For example, valuable studies have been made of the stresses in hooks, eyebolts, ships' hulls, and gear teeth, although it is believed that very little work has been previously carried out on the measurement of temperature stresses by this method.

Photoelastic models must be made from a transparent isotropic medium. In this case, clear bakelite was selected because of its high stress-optical coefficient.

Polarized light is passed through a plane specimen, which becomes double refracting under stress and retards the two wave systems according to the values of the principal stresses p and q . The two wave systems interfere when passed through an analyzer and give isochromatic bands proportional to the difference $p - q$. The isochromatic lines are also lines of principal shear, for the principal shear stress at any point is equal to one-half the difference of the two principal stresses. The separate values of p and q can be determined by repeating the observations with circularly polarized light, which shows the isoclinic lines, or lines of equal direction of principal stresses. The values of p and q can be calculated from the isoclinic and isochromatic lines, the boundary conditions, and the constants of the material. It should be emphasized that this method applies only to a plane object.

Temperature Stress Tests. The first model to be studied was a disk. This disk was carefully maintained at 50°C (122°F); then the circumference was suddenly heated to 100°C (212°F) by steam, and the resulting development of stresses watched until they had reached a maximum value, which required about 45 sec. The experiment was then repeated by suddenly chilling the circumference from 50°C (122°F) to 0°C (32°F) by means of ice water, and the stresses were similarly studied. In Fig. 247 are given the magnitudes and directions of the shear and resultant stresses under these conditions.

It will be observed that when the circumference is suddenly heated, tangential compression of considerable magnitude is developed near the surface but the center of the disk is under a slight tension having an equal magnitude in all directions. The radial stresses are zero at the circumference but increase slowly toward the center. On the other hand, when the circumference is cooled, the surface is under considerable tension and the center of the disk is under light compression. In both cases, the shear stresses are the same and reach a maximum at the circumference. Their direction is everywhere at 45 deg to the radii.

The next model tested was a brick heated on the end. The stresses are shown in Fig. 248 in the same way as for the disk. On heating, a compression maximum occurred at the center of the end; but on cooling, this was changed to a tension. It will be noted that the directions of the shear

stresses are approximately 45 deg to the surface everywhere and are a maximum at the center of the end.

In the case shown in Fig. 249, the model brick was heated at the end and about one-third of the way up the side. A somewhat different type of stress distribution resulted, for the increase in stresses at the sides causes

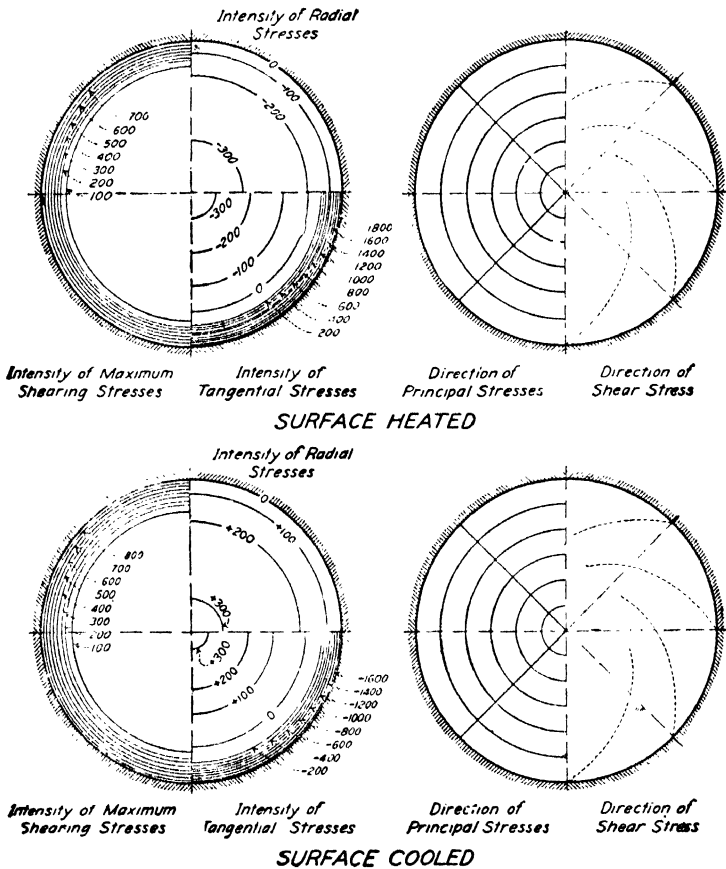

FIG. 247. Stresses in a disk. (J. Amer. Ceram. Soc.)

the stresses at the end to decrease. It will be noted that at the corners, the shear lines are curved and follow the isothermals closely.

Figure 250 shows a model representing a brick in a wall when this wall is heated and cooled at the surface. The isothermals will then be parallel to the heated surface. It will be noted that the resultant normal stresses are nearly parallel and perpendicular to the surface of the wall and that the shear stresses are at 45 deg to them.

Conclusions. We may conclude from the preceding results that

1. The stresses set up in a solid by suddenly heating the surface through a certain temperature interval are of the same order but of opposite sign from those set up by cooling the surface through the same temperature range.
2. No high tensile stresses are developed on sudden heating.
3. The maximum shearing stresses are equal to one-half the maximum resultant stresses.
4. The stresses are generally low at the corners and interior of the specimen but reach their highest value along the heated sides at a distance from the corners.

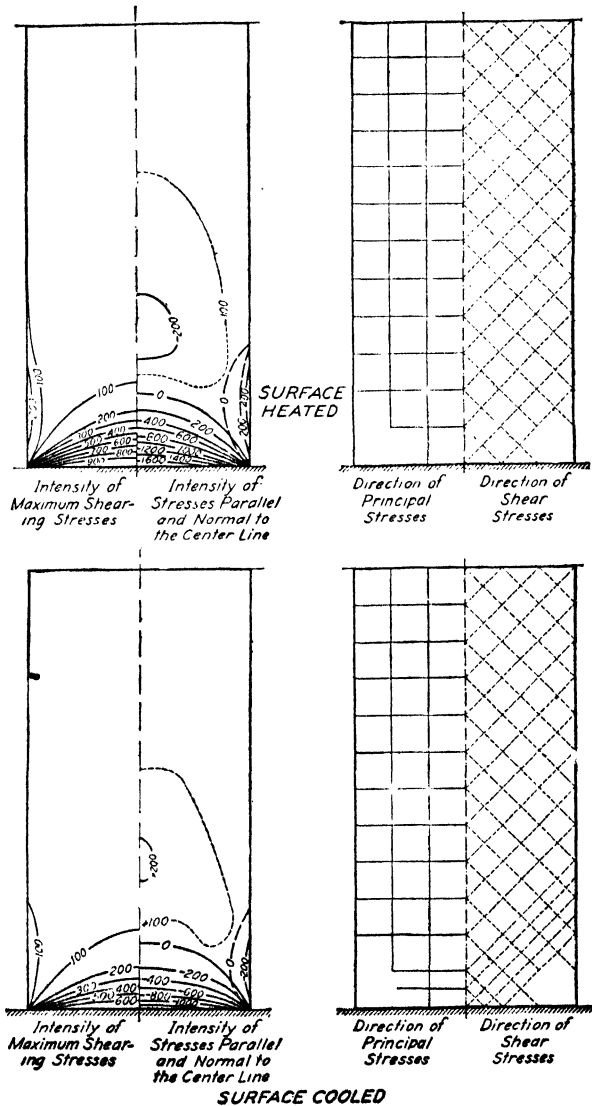

FIG. 248. Stresses in a brick heated at one end. (J. Amer. Ceram. Soc.)

3. Study of Cracks Developed in Spalling. In order to correlate the types of cracks formed in the material when heated and cooled, with the stress distribution previously determined, a number of spheres and bricks were made up with a fine-grained, porcelain-like structure in order to make spalling occur readily. These objects were gradually heated to 900°C

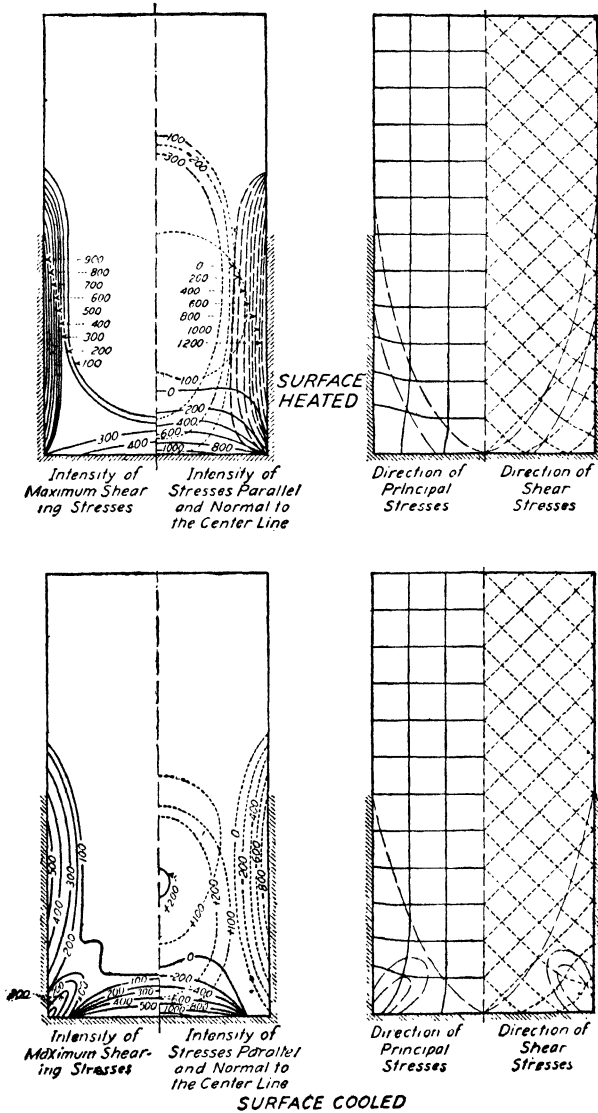

FIG. 249. Stresses in a brick heated on one end and one-third of the distance up the side. (J. Am. Ceram. Soc.)

(about 1650°F) for the first condition and were placed in still air to cool. Under the second condition, the objects were heated by placing suddenly in a furnace that had a temperature of 900°C (about 1650°F).

Spheres. Let us first consider the sphere that was suddenly cooled (Fig. 251). It will be noted that in general, the fractures follow great circles. When the portions of the sphere were separated, it was noted that

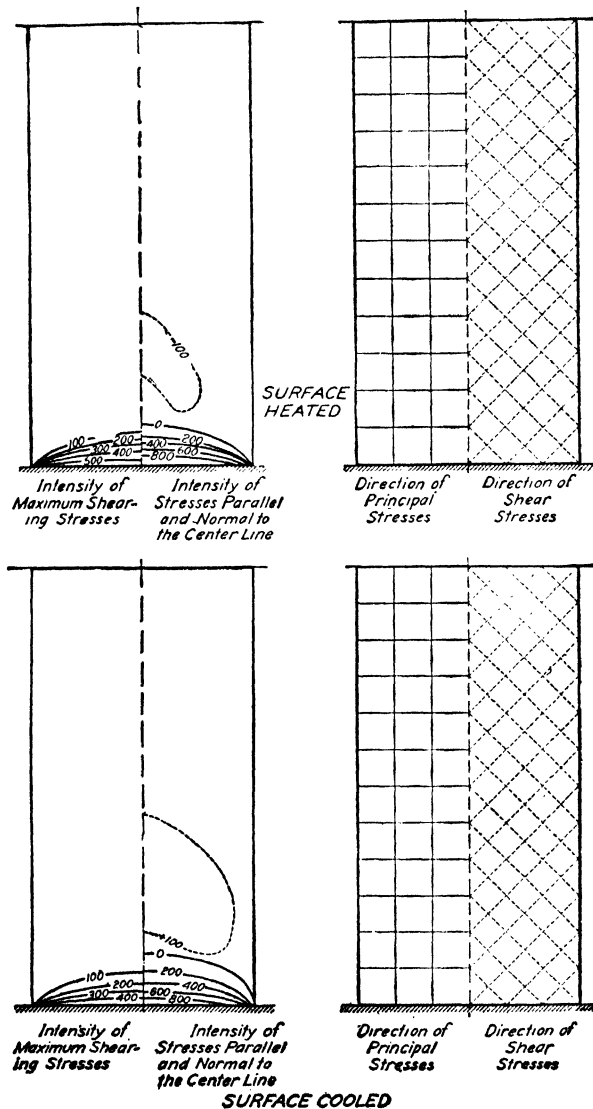

FIG. 250. Stresses in a wall. (J. Am. Ceram. Soc.)

the cracks entered the surface in every case at approximately 90 deg. On the other hand, when the sphere is suddenly heated, a quite different type of fracture is obtained, as shown in Fig. 252. In this case, the fractures entered the surface at 45 deg and tended to split off circular segments of the sphere having a height of approximately one-quarter the diameter.

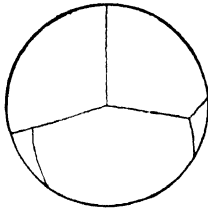

FIG. 251. Cracks in a sphere suddenly cooled. (*J. Am. Ceram. Soc.*)

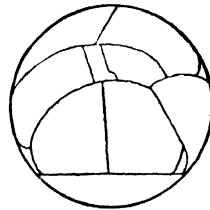

FIG. 252. Cracks in a sphere suddenly heated. (*J. Am. Ceram. Soc.*)

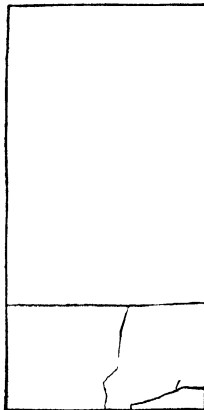

FIG. 253. Cracks in a brick suddenly cooled. (*J. Am. Ceram. Soc.*)

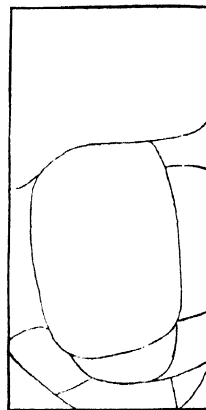

FIG. 254. Cracks in a brick suddenly heated. (*J. Am. Ceram. Soc.*)

Bricks. Standard-size bricks were made up of the same material as the spheres. They were also heated and cooled in the same way. In Fig. 253 are shown the fractures resulting from rapid cooling. It will be noted that the fractures enter, in nearly every case, at right angles to the surface and tend to break the brick into cubes. Figure 254 shows the same brick when heated suddenly. The typical spalling failure is shown at the edges and corners; and in every case, cracks enter the surface at approximately 45 deg.

As a brick does not consist of a homogeneous material, it is possible to have a weakening or disintegration of the structure aside from actual fractures. This effect is usually due to a difference between the coefficient of

thermal expansion of the bond and that of the grog particles. This may be due to the use of different materials for the grog and bond or to a low-burned bond when the material is the same throughout. Goodrich⁽¹⁹⁾ has examined the loss in strength due to repeated heatings and finds a distinct weakening of the brick structure.

Conclusions. We may conclude from the preceding studies that spalling is due to both shear and tension failures. On sudden heating, spalling is due almost entirely to shear stresses and, on sudden cooling, to tension stresses except at the corners and edges, where shear stresses may still cause failure. The shear values are about equal on heating and cooling, but there are no large tension stresses on rapid heating.

Shear failure occurs suddenly; *i.e.*, complete pieces are split off at each cycle of heating, and they begin to split at the edges and corners, so that a brick tends to approach a spherical shape on the end. The shear cracks follow in the lines of shear determined by the photoelastic method very closely, as is indicated by the slight curvature of the shear fractures at the corners.

Tension cracks seldom occur near the corners but usually first appear halfway up the brick where the tensile stresses are a maximum. The tension cracks enter the surface at 90 deg. They do not occur as suddenly as do shear fractures but penetrate deeper and deeper at each cycle until finally the cracks meet at the center. In every case, the tension failures follow approximately the lines of principal stress, although the deviation was considerably more than for the shear stress, owing undoubtedly to the length of the cracks and the greater influence of discontinuities.

It should be noted at this time that the stress distribution is much altered after a crack starts, as was pointed out by Preston.⁽¹⁵⁾ Generally, however, the tension cracks enter and leave at 90 deg and shear cracks at 45 deg to the surface. The fracture need not follow the direction of stress everywhere but will travel in such a way as to release the maximum strain energy. A great deal of confusion has been caused in the past by failure to differentiate between the effects of heating and cooling.

4. Theory of Spalling Due to Shear Stresses. As shown in the preceding pages, a spalling failure may occur either by a shear or by a tension fracture. If we first assume a shear failure, which appears to be the most common type, it is possible to analyze the mechanism of spalling in terms of the physical properties of the material.

Temperature Distribution. It is necessary at first to consider the distribution of temperature in a homogeneous solid. We shall first make the assumption that this solid has one infinite plane surface. Originally this solid is at a uniform temperature of t_0 , but at time τ_0 the surface is suddenly cooled to a temperature of t_2 . The problem is to find the temperature

distribution in the solid for different values of τ . For the solution, it will be necessary to apply Fourier's equation of heat flow. As the surface is infinite, the isothermal planes will be everywhere parallel to the surface of the solid. Putting $t_0 = t_1 - t_2$ or simply shifting the temperature scale, the temperature t at any distance below the surface x and at any time τ will be given by

$$t = \frac{2t_0}{\sqrt{\pi}} \int_0^{x/2h\sqrt{\tau}} e^{-\beta^2} d\beta \quad (1)$$

where h = a constant of the material.

The diffusivity of a material, or the rate at which a point in a hot body will cool under definite surface conditions, is known as h^2 and is equivalent

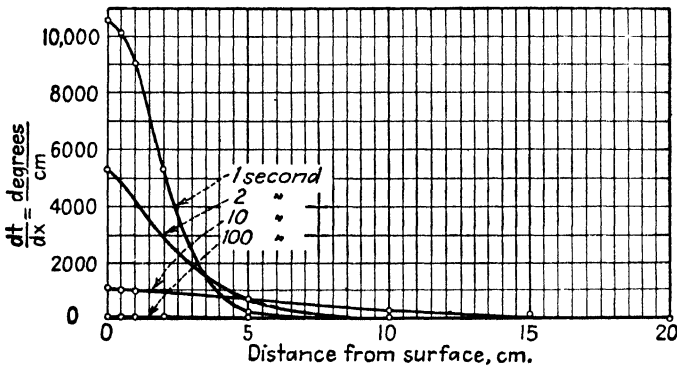

FIG. 255. Temperature gradients at different levels below the surface of a cooling body. (*J. Am. Ceram. Soc.*)

to $k/\rho c_p$, where k is the conductivity, ρ the density, and c_p the specific heat. It should be noted that the preceding equation is in the form of the probability integral and can therefore be readily evaluated from tables.

As will be shown later, the stress set up in a homogeneous material as a result of a change in temperature is proportional to the temperature gradient at any point. It will therefore be necessary to differentiate the preceding equation with respect to x .

We have

$$\begin{aligned} \frac{\partial t}{\partial x} &= \frac{2t_0}{\sqrt{\pi}} e^{-x^2/4h^2\tau} \frac{1}{(-2h\sqrt{\tau})} \\ &= \frac{-t_0}{h\sqrt{\pi\tau}} e^{-x^2/4h^2\tau} = \frac{dt}{dx} \end{aligned} \quad (2)$$

To show the practical application of this equation, curves have been plotted in Fig. 255 to give the temperature gradient $h = 0.080$ when a body is cooled suddenly from 850°C (about 1560°F) to room temperature.

The gradient is, of course, highest at the surface but falls rapidly toward the interior. Near the surface, the gradient falls rapidly with increasing time; but at a certain depth, the gradient increases with the time. This is one of the reasons why spalling does not usually take place immediately after the specimen is chilled.

In an actual case, the surface is not instantaneously cooled (1) because a cooling medium cannot be instantaneously introduced and (2) because perfect thermal contact cannot be made between the cooling medium and the surface of the brick. The equations can be modified to take care of this effect, as suggested by Ingersoll and Zobel,⁽²⁾ by adding a fictitious distance beyond the true surface. In this instance, however, as we are not interested in the region very close to the surface, it will be more convenient to use a constant k to modify h .

Only the case of an infinite plane surface has been considered. At the edge of a solid, the isothermal planes will not be parallel to the surface but will be rounded off as in Fig. 256. This can be explained by considering that point A is cooled by the area abc in addition to the cooling received from an infinite surface such as a point at B . As the isothermals recede further from the surface, the area abc increases and corresponding departures from parallel conditions exist at corners.

It is important to notice that the temperature gradient is slightly less at the edges and the corners than at the faces of a cooling brick; hence, corners spall off because of mechanical weakness rather than because of greater temperature gradients.

Temperature Stresses. Now that we have the temperature distribution in a solid, it is possible to study the distribution of stresses. We shall first assume that the material is an elastic, homogeneous medium. It will be shown later that in the temperature range at which spalling occurs, the brick is perfectly elastic. The homogeneity will depend upon the structure of the brick and upon the process of manufacture.

The exact evaluation of the stresses in a brick under a given temperature distribution cannot be solved mathematically except in a few simple cases; however, it is required to find the tendency to spall only in terms of the physical properties of the material; *i.e.*, comparative but quantitative results are desired among various types of brick tested in the same manner.

Let us consider an isothermal plane ab in a portion of a heating or cooling brick at a given instant of time (Fig. 257). Let the temperature of the plane ab be t and that of another isothermal plane dx distant be $t + dt$, which gives the temperature gradient dt/dx . Let the plane cd cut the isothermal surfaces at a neutral point of shear. Now measure along ab a

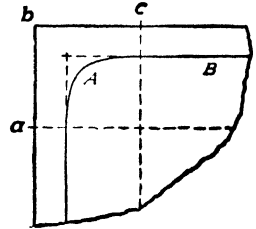

FIG. 256. The rounding of isothermal planes at the edge of a solid. (*J. Amer. Ceram. Soc.*)

distance s , and erect the plane ef . If the temperature throughout the brick were t , this plane would be normal to ab ; but under the existing conditions, it will cut the $t + dt$ isothermal at a distance $s + s\alpha dt$ from cd . The coefficient of expansion is α .

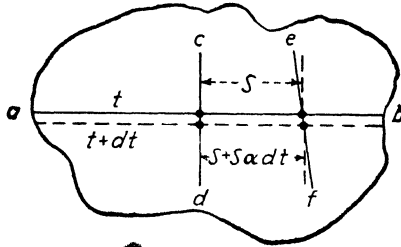

FIG. 257. A portion of a heating or cooling brick. (*J. Am. Ceram. Soc.*)

The shear strain is measured by the deflection of one plane with respect to another divided by the distance between them. In this case,

$$\phi = \frac{s\alpha dt}{dx} = s\alpha \frac{dt}{dx} \quad (3)$$

This means that the strain set up in a heating or cooling body is proportional to the size, the coefficient of thermal expansion, and the temperature gradient. This explains why large glassware cracks on cooling or heating more readily than small ware. In large pieces of refractory ware, the temperature distribution may be so uneven that strict proportionality to s may well be doubted. This does not greatly concern us, for we shall compare specimens of the same shape and size and with the same temperature gradient. The shear fracture theoretically should occur at 45 deg to the isothermal but often is parallel to it. However, the direction of fracture does not affect the reasoning. As pointed out by Clark,⁽⁵¹⁾ the maximum stress or strain is not strictly a constant of the material at a given temperature but varies to some extent with the duration of stress.

From Eq. (2)

$$\frac{dt}{dx} = \frac{k_1}{h} \quad (4)$$

where $k_1 =$ a constant

This follows, for dt/dx is closely proportional to $1/h$ because small changes of h in the term $e^{-x^2/4h^2\tau}$ have little effect when τ is reasonably large.

Then the tendency to spall S_s is

$$\frac{\phi}{\phi_b} = \frac{s\alpha (dt/dx)}{\phi_b} = \frac{s\alpha (k_1/h)}{\phi_b} = k_1 \frac{s\alpha}{h\phi_b} = k_2 \frac{\alpha}{h\phi_b} \quad (5)$$

where $\phi_b =$ the maximum shearing strain or flexibility

This shows that the spalling tendency of a brick is proportional to the

coefficient of thermal expansion divided by the square root of the diffusivity and maximum shearing strain.

5. Theory of Spalling Due to Tensile Stresses. The preceding theory has been based entirely on the shear failure of a material under shear stresses. It was seen that this failure would occur on sudden heating of the brick. The sudden heating produces local compressive stresses in the material, since the portion at a higher temperature tends to try to expand, but this being prevented by the cooler portions places the hotter portion of the brick in compression. It is known that brittle materials fail in shear when subjected to compressive stresses; hence, we get a shear failure under these conditions.

If the brick is suddenly cooled, a different phenomenon is involved. When one portion of the brick is suddenly cooled below the temperature of the adjacent material, the part of the brick at the lower temperature tends to contract, but this contraction is prevented by the adjacent portions, which are at a higher temperature.

In this case, tensile stresses are set up in the cooler portion; and since the shearing strength of a brittle material is usually considerably greater than the tensile strength, the brick will fail in tension, provided sufficiently rapid local cooling is present.

Let us then visualize a portion of the brick as shown in Fig. 258, which we will assume to be at the uniform temperature t_0 . This means that at the start, the isothermal planes ab and cd , which are initially separated by the distance dx , are at the same temperature t_0 . The surface of the brick is now cooled to a temperature t_2 ; and at a later time τ , the planes ab and cd possess temperatures t and $t + dt$, respectively, where the temperature is given by Eq. (1). Let us consider a gage length s between points M and N on plane cd . As a result of the lower temperature on plane ab , the material on this plane tends to contract by an amount ΔS . This contraction is, however, prevented by the adjacent material, and a tensile strain is set up in plane ab of amount

$$\Sigma = \frac{\Delta S}{S} = \alpha \cdot dt \tag{6}$$

where α = the coefficient of thermal expansion

Now, from Eq. (4)

$$\frac{dt}{dx} = \frac{k_1}{h}$$

and

$$\sigma = E \cdot \Sigma \tag{7}$$

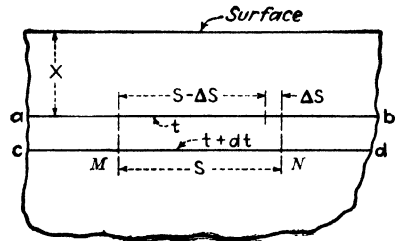

FIG. 258. Illustration of tensile stresses in a heating or cooling brick.

It follows from the preceding equations, then, that

$$\sigma = E \cdot \alpha \cdot dt = E \cdot \alpha \cdot \frac{k_1}{h} \cdot dx \quad (8)$$

If σ_b is the breaking stress of the material or the so-called "tensile strength,"

$$\sigma_b = E \cdot \Sigma_b \quad (9)$$

where Σ_b = the tensile breaking strain

The tendency to spall then becomes

$$S_t = \frac{\sigma}{\sigma_b} = \frac{E \cdot \alpha \cdot k_1 \cdot dx}{Eh\Sigma_b} = k_1 \cdot dx \frac{\alpha}{h\Sigma_b} \quad (10)$$

It will be noted that Eq. (10) has the same units and is in the same form as Eq. (5) of the preceding section. Instead of the shear strain σ_b at fracture, we have the tensile strain Σ_b ; and in place of the distance S from the neutral place of shear, we have the distance dx over which the temperature drop dt exists.

Let us now compare this equation temperature with the Winkelmann-Schott⁽¹⁾ equation, which is as follows:

$$\sigma = -\frac{A'A''}{A} \frac{t_0 \cdot E \cdot \alpha x}{2h\sqrt{\tau}} \quad (11)$$

where A' , A'' , A = constants

t_0 = the temperature of the outer layer

The tendency to spall is

$$S'_t = \frac{\sigma}{\sigma_b} = -\frac{A' \cdot A'' \cdot t_0 \cdot \alpha \cdot x}{2Ah\sqrt{\tau}(\sigma_b/E)} \quad (12)$$

or

$$S_t = k_3 \cdot x \cdot \left(\frac{\alpha}{h\Sigma_b} \right) \quad (13)$$

where

$$k_3 = -\frac{A'A''t_0}{2A\sqrt{\tau}} \quad (14)$$

It is thus seen that the Winkelmann-Schott equation can be put in the same form as given by Eq. (5) or (10). In the derivation given in the original article by Winkelmann and Schott, the size factor x was absorbed in another constant B , where B is essentially Kx . This, of course, can be done, since the purpose was to compare the spalling properties of various glasses for the same values of τ and x .

6. Experimental Confirmation of Theory. In order to determine the validity of the equation for tendency to spall, the physical characteristics of a number of different bricks shown in Table 78 were tested and the tendency to spall, as computed from the preceding formula, was compared with the actual spalling characteristics of the brick in Table 79.

TABLE 78. CHARACTERISTICS OF BRICK TESTED FOR SPALLING

| Material | Grog | Bond | Hardness | Approximate burning temperature | | Remarks |
|-----------------------------------|-------------|-------------|-----------|---------------------------------|------|-----------------------|
| | | | | °C | °F | |
| A. Fireclay | Very coarse | Soft | Soft | 1200 | 2300 | Commercial brick |
| B. Sillimanite | Medium | Little | Hard | 1680 | 3050 | Special brick |
| C. Fireclay | Very coarse | Soft | Medium | 1430 | 2600 | Same as A (hard burn) |
| D. SiC | 20-mesh | Molasses | Hard | 1540 | 2800 | Special brick |
| E. Fireclay | Coarse | Soft | Soft | 1316 | 2400 | Commercial brick |
| F. Bauxite | Fine | Little | Hard | 1704 | 3100 | Special brick |
| G. Fireclay | Medium | Soft | Soft | 1316 | 2400 | Commercial brick |
| H. Kaolin | Medium | Little hard | Very hard | 1650 | 3000 | Commercial brick |
| I. Fireclay | Fine | Soft | Soft | 1200 | 2300 | Commercial brick |
| J. Fireclay | Medium | Hard | Hard | 1200 | 2300 | Commercial brick |
| K. Fireclay | Fine | Soft | Soft | 1200 | 2300 | Commercial brick |
| L. Spinel | Medium | Hard | Hard | 1370 | 2500 | Commercial brick |
| M. Silica | Fine | None | Hard | 1480 | 2700 | Commercial brick |
| N. Same as C pre-heated to 2900°F | | | | | | |

Flexibility in Shear. In order to measure the characteristics of the bricks as listed above, a number of $1 \times 1 \times 9$ -in. bars were sawed out of each specimen. These bars were then cemented into holders, and the angle and torque measured up to the breaking point at a temperature of 500°C (about 930°F).

Such a low temperature is justified because it has been noticed that spalling nearly always occurs at about red heat. In all cases where the specimen was carefully held, there was no permanent set after removing the torque until a point was reached just before failure; *i.e.*, the specimens all acted as if perfectly elastic. The bricks tested are described in the table above and represent a wide range. Some are experimental bricks; others are of extensively used commercial brands.

The Coefficient of Expansion. The coefficient of thermal expansion of each type of brick was measured at 500°C (about 930°F). In general, the brick having the greatest coefficient of thermal expansion had the highest

TABLE 79. CONSTANTS FOR THE BRICKS TESTED

| Brand | ϕ_b | α | h | $(\alpha/\phi_b h)$ | Number of quenches |
|--------|----------|-----------|-----|---------------------|--------------------|
| A..... | 0.114 | 0.0000051 | 6.2 | 72×10^{-7} | 26.5 |
| B..... | 0.052 | 0.0000039 | 6.5 | 115 | 8.0 |
| B..... | 0.052 | 0.0000039 | 6.5 | 115 | 24.0 |
| C..... | 0.050 | 0.0000050 | 6.3 | 157 | 23.0 |
| D..... | 0.072 | 0.0000031 | 9.9 | 44 | * |
| E..... | 0.057 | 0.0000053 | 6.5 | 143 | 15.6 |
| F..... | 0.032 | 0.0000037 | 6.2 | 110 | 2.0 |
| F..... | 0.032 | 0.0000037 | 6.2 | 110 | 15.0 |
| G..... | 0.090 | 0.0000104 | 6.2 | 187 | 12.2 |
| H..... | 0.050 | 0.0000063 | 6.4 | 197 | 10.6 |
| I..... | 0.107 | 0.0000133 | 6.3 | 197 | 8.4 |
| J..... | 0.050 | 0.0000071 | 6.0 | 237 | 5.2 |
| K..... | 0.089 | 0.0000126 | 6.2 | 229 | 2.7 |
| L..... | 0.032 | 0.0000116 | 6.4 | 567 | 2.4 |
| M..... | 0.094 | 0.0000405 | 6.7 | 644 | 0.3 |
| N..... | 0.060 | 0.0000072 | 6.1 | 197 | |

* No exactly comparable spalling value was available for this brick; but it is undoubtedly lower than should be expected, as an oxidizing atmosphere tends to convert the SiC into SiO₂ and thereby to raise the coefficient of thermal expansion.

content of silica, but we are by no means justified in using the silica content of a brick as an index of its coefficient.

Diffusivity. The value of the diffusivity can, of course, be obtained by measurements of thermal conductivity and specific heat. These measurements, however, are laborious and slow, so a simple method of measuring the relative diffusivity was devised. A 2-in. cube of the material was cemented from four 1 × 1 × 2-in. blocks with a thermal junction at the center, was suspended by the junction wires in an electric furnace until it had reached a constant temperature of about 550°C (about 1020°F), and then was taken out and suspended in a room free from drafts. The temperature of the center was recorded, and the slope of the cooling curve at 500°C (about 930°F) taken as the value for the diffusivity. This method is rapid and accurate where only relative values are desired.

The values of the diffusivity given are entirely arbitrary, and the results are comparable only among themselves, but it will be noted that with the exception of the silicon carbide specimen, the values of h vary only a few per cent and cannot be an important factor in spalling.

Comparison with Actual Spalling Tests. The results from laboratory air-spalling tests are also given. A comparison between this test and actual service results has been made, and the agreement is generally good. From five to ten bricks of each kind were spalled, and the average taken.

Attention should be called to the two values given for bricks *B* and *F*. These two bricks showed the common type of shear spalling at the corners for several quenches, then suddenly broke across the center with a tension failure. The first value in the table gives the quenches actually obtained, and the second is estimated from the amount lost by shear. The first values have been disregarded in drawing the curves.

If the value of $\alpha/h\phi_b$ is an index of the spalling tendency of a brick as indicated by the theory, then these values plotted against the number of quenches for each specimen should fall along a curve rather than be widely

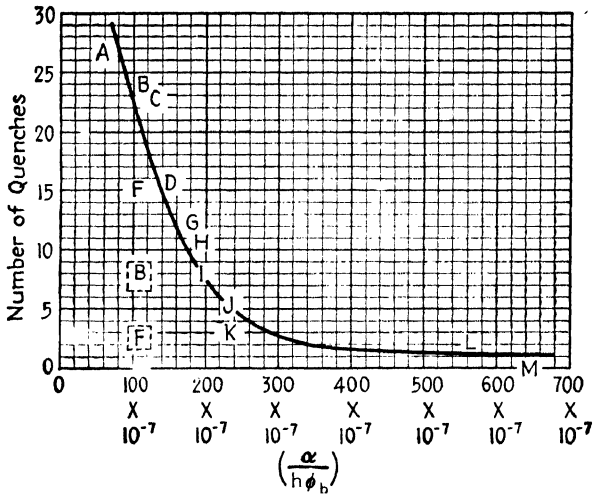

FIG. 259. A plot showing correlation between theoretical and experimental values of spalling. (*J. Amer. Ceram. Soc.*)

scattered. Such a plot has been made in Fig. 259, and it is quite clear that the points group themselves into a definite band. The deviations that occur can be explained by the fact that some of the bricks were altered from their original characteristics in heating.

Specimen *K*, which is considerably below the mean *K* curve, was noticeably laminated in structure. The higher values for bricks *B* and *F* were only estimates.

The form of the curve is of interest, for it approaches a rectangular hyperbola asymptotic to the two axes. When the value of $\alpha/\phi_b h$ is high, the bricks show little difference in spalling resistance, as they are almost completely shattered at the first temperature change. On the other hand, the bricks having a low value of $\alpha/\phi_b h$ increase rapidly in spalling resistance as $\alpha/\phi_b h$ is decreased. This behavior is not unexpected, as it is simply an approach to a classification of bricks into two sets: those which spall on the first quench and those which do not spall under an infinite number of quenches.

The best spalling brick of those tested withstood 26 quenches and had a value for $\alpha/\phi_s h$ of 72×10^{-7} . Suppose that by slightly increasing the flexibility or by decreasing the coefficient of thermal expansion, a value of 50×10^{-7} were obtained; the brick should then withstand about 50 quenches. This illustrates the possibilities of making remarkable non-spalling brick.

On the whole, it would seem that the theoretical work agrees with practice as closely as the nature of the tests allows. Although this method cannot be recommended to replace the usual spalling tests without a more thorough trial, it is felt that more information is obtained by it as to the causes of spalling in a certain brick than by other methods.

It is interesting to note that Booze⁽¹¹⁾ and Phelps⁽¹⁶⁾ independently came to the same conclusions after testing a number of experimental bricks for coefficient of thermal expansion, diffusivity, and flexibility. They found that the best spalling bricks had the greatest flexibility and that the diffusivity had no appreciable effect. Endell's⁽²⁶⁾ work on magnesite brick checks this theory.

7. Laboratory Spalling Test. The expense and the time required to determine the spalling characteristics of bricks in service are so great that a laboratory spalling test is highly desirable.

A number of spalling tests have been suggested and used. In most cases, they consist in subjecting the brick to a severe thermal shock in order that the test may produce definite results in a reasonably short time. Tests on single bricks as formerly used have now been almost abandoned, as they do not in all cases correspond to service conditions. Therefore the present ASTM test on a panel will be described. It is quite satisfactory but requires expensive equipment.

PANEL TEST FOR RESISTANCE TO THERMAL AND STRUCTURAL SPALLINGS OF REFRACTORY BRICK

ASTM Designation: C 38-42¹

ADOPTED, 1936; REVISED, 1942, 1945, 1947

This standard of the American Society for Testing Materials is issued under the fixed designation C 38; the final number indicates the year of adoption as standard or, in the case of revision, the year of last revision.

1. Scope. This method of test is intended to show the resistance of refractory brick to the separate and combined effects of structural and thermal spalling. The test is believed to give a sufficient simulation of service conditions to suggest

¹ ASTM Standards are subject to revision. The Society's headquarters, in Philadelphia, may be consulted for the latest information. Only minor changes from the 1942 revision given here have been made in the 1947 revision.

its use as a suitability test for certain classes of service that have been correlated with the test data (see NOTE).

NOTE: Such correlation is now available in the case of high-heat-duty clay brick for stationary boilers, malleable iron furnace bungs, and incinerator furnaces.

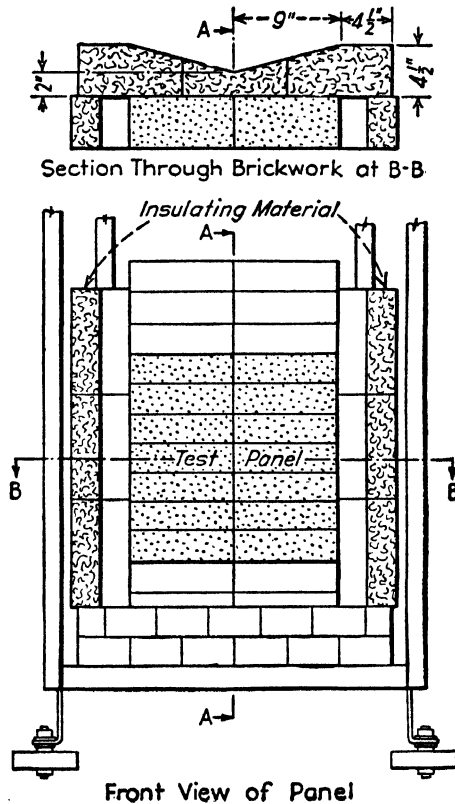

FIG. 260. Panel frame and brickwork. The brick around the test panel are dummy brick which are used to help maintain uniform conditions within the panel.

2. Apparatus. The following apparatus and equipment¹ are needed:

a. Panel Frame. A panel framework shall be used which is essentially the same as that shown in Fig. 260.

b. Preheating Furnace. A preheating furnace shall be used, constructed essentially like the design shown in Fig. 261.

c. Spalling Furnace. A spalling furnace shall be used, constructed in a manner as shown in Fig. 262.

¹ The complete set of drawings necessary for the construction of the panel spalling equipment would require too much space to be included with the procedure, but these are available at a nominal charge from the Refractories Fellowship, Mellon Institute of Industrial Research, Pittsburgh, Pa.

d. Temperature-measuring Instruments. The temperature of the test panel (during the preheating shall be measured by means of an optical pyrometer. The spalling furnace temperature shall be determined by means of a platinum, platinum-rhodium thermocouple.

e. Air Supply. Means shall be provided for delivering air through each cooling unit at a specified rate.

f. Transfer Facilities. A suitable means, such as a track or trolley, shall be provided for transferring the test panels.

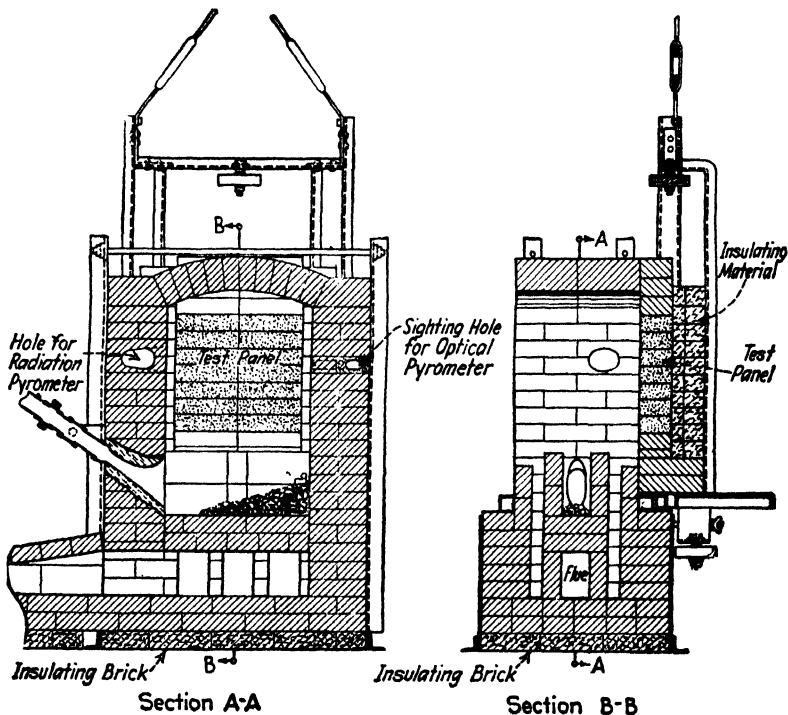

FIG. 261. Design of preheating furnace. In section *BB* there is shown in position one of the two panels used during the preheating.

3. Test Specimen. Whenever possible, the panel test specimen shall consist of 9-in. straight brick. When shapes of other sizes are to be tested, these shall be cut so as to be not more than 3 in. in thickness by 9 in. in length by $4\frac{1}{2}$ in. in width.

4. Panel Construction. The test brick shall be laid up so as to form a panel not less than 18 in. square, so that a 9- by $2\frac{1}{2}$ -in. surface of each brick will be exposed to the heat-treatment. Each test brick shall be labeled with ceramic paint on the face opposite that to be tested and then weighed to the nearest 0.05 lb. There shall be placed about the panel test specimen a suitable grade of refractory dummy brick, in the manner shown in Fig. 260. The dummy brick shall extend $\frac{1}{2}$ in. beyond the surface of the test panel. All brick in the test panel shall be

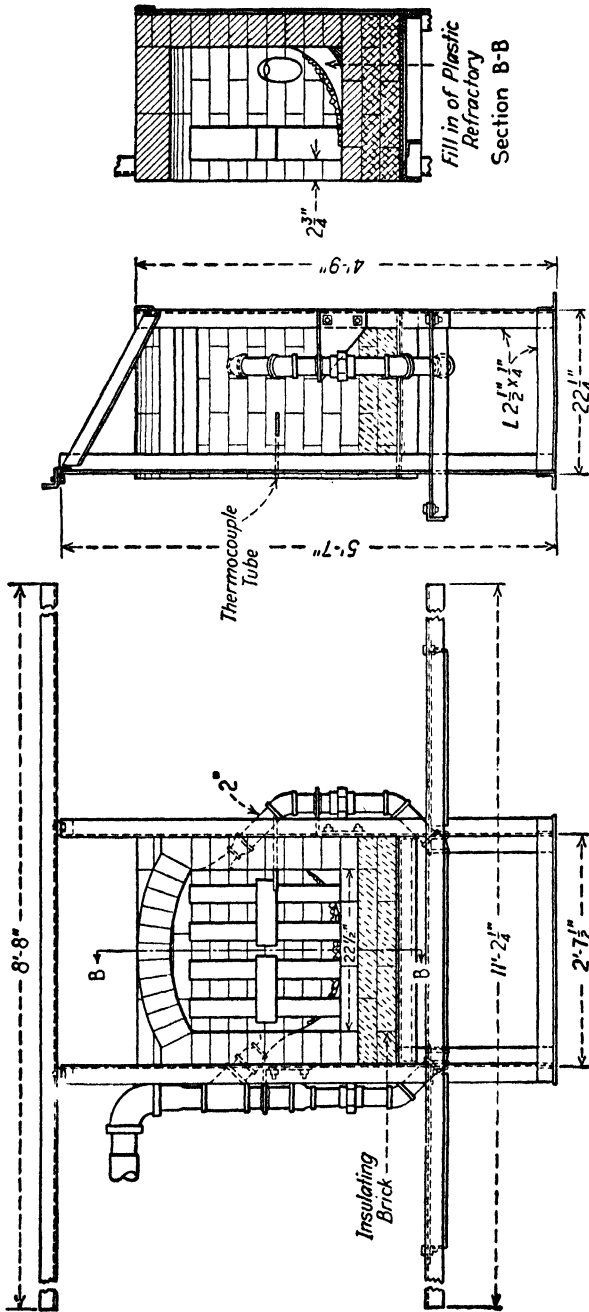

FIG. 262. Furnace of the spalling equipment.

laid up with refractory kaolin unless otherwise specified. The joints shall not be thicker than $\frac{1}{8}$ in. The insulation shall consist of a material suitable for service at 1300°C and of a specified insulating value.

5. Preheating Test Panels. The prepared test panels shall be placed in position on either side of the preheating furnace. When only one lot of brick is to be tested, a dummy panel should be used. The joint between the ends of the panel dummy brick and the preheating furnace shall be sealed with plastic kaolin. During the heating of the panels, the surface of the test brick opposite that being heated shall be insulated in the specified manner so as to maintain a suitable temperature gradient in the test brick. The furnace is to be operated so that the temperature specified for preheating shall be reached in not less than 5 hr nor more than 8 hr and maintained 24 hr. The permissible variation in temperature may be $\pm 20^{\circ}\text{F}$ or $\pm 10^{\circ}\text{C}$, but the average of the temperature during the run shall be that specified. After completing the preheating, the test panel shall be left in position for not less than 8 hr before being removed. As a result of this heat-treatment, any tendency toward fusion, vitrification, swelling, or shrinkage will be evident and any development of structural spalling will be apparent. A record shall be made of the condition of the brick, indicating the extent of the fusion, vitrification, swelling, or shrinkage. If shrinkage takes place, a record shall be made of its nature, *i.e.*, whether this occurs as a shrinkage of each brick as a unit or as the development of cracks on the surface of each brick. The surface of the test panels may be photographed.

6. Spalling. The panels shall then be subjected to thermal spalling by heating them in a specified time to a specified temperature and rapidly cooling by means of a prescribed blast. The panels shall be placed in position in front of the spalling furnace in the manner shown in Fig. 262. The temperature of the spalling furnace shall be raised within 3 hr to the specified temperature. During the heating period, the panels shall be alternately placed in position in front of the furnace so that each may be heated to about the same temperature. The position of the panels shall be changed at temperatures of 400, 200 and 100°C below the final furnace temperature. During this period, the panels shall not be cooled by means of the cooling blast. After the final temperature of spalling is obtained, the panels shall be held in position for a specified time and then shifted so as to expose the heated panel for cooling. After each panel has been subjected to the required number of cycles, the furnace shall be allowed to cool, but the cooling procedure for the panels shall be conducted so that each panel receives two additional periods.

7. Dismantling the Panels. When the panels have cooled sufficiently so that the brick can be handled, the test panel shall be carefully dismantled. The test brick shall be reweighed to the closest 0.05 lb, and the loss in weight recorded as percentage of the original weight.

8. Report. The report may include a photograph of the panel after preheating and shall include comments as to its condition. The average spalling loss for the whole panel shall be given, as well as a photograph of the spalled brick arranged in the manner shown in Fig. 263.

STANDARD METHOD OF PANEL TEST FOR RESISTANCE TO
THERMAL AND STRUCTURAL SPALLING OF HIGH HEAT
DUTY FIRECLAY BRICK

ASTM Designation: C 107-42¹

ADOPTED, 1936; REVISED, 1940, 1942, 1945, 1947

This Standard of the American Society for Testing Materials is issued under the fixed designation C 107; the final number indicates the year of original adoption as standard or, in the case of revision, the year of last revision.

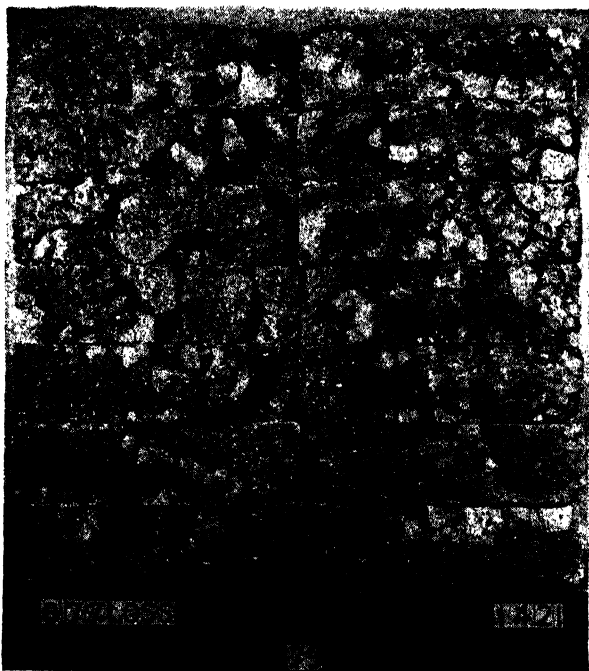

FIG. 263. A typical panel after the spalling test. (Courtesy of the American Refractories Institute.)

1. Scope. This method of test covers the procedure for determining the resistance of fireclay brick used for stationary boilers, malleable-iron furnace bungs, and incinerator furnaces to the separate and combined effects of structural and thermal spalling. This method makes use of the general requirements and procedure prescribed in the Method of Panel Test for Resistance to Thermal and Structural Spalling of Refractory Brick (ASTM Designation C 38) of the American Society for Testing Materials and supplements that method by giving the detailed requirements of the procedure to be followed in testing refractories for use in stationary boilers, malleable-iron furnace bungs, and incinerator furnaces.

¹ ASTM Standards are subject to revision. The Society's headquarters, in Philadelphia, may be consulted for the latest information.

2. Apparatus and Test Specimens. The apparatus and test specimens shall be in general as described in the Method of Panel Test for Resistance to Thermal and Structural Spalling of Refractory Brick (ASTM Designation C 38) of the American Society for Testing Materials.

3. Procedure. The procedure shall be in general as outlined in the Method C 38, supplemented by the procedure for preheating and spalling as prescribed in the following Secs. 4 and 5.

4. Preheating Test Panels. *a.* The test brick shall be laid up with kaolin having a pyrometric cone equivalent not below cone No. 34.

b. The test panels and dummy brick shall be insulated with group 26 insulating firebrick weighing 46 ± 2 lb per cu ft.

c. The temperature of the panel faces shall be maintained so as to average 2910°F (1600°C) by means of a gas-fired furnace for a period of 24 hr.

d. The furnace gas pressure during the 24-hr preheating period shall be within the limits of 0.4 to 0.5 in. of water for gas-fired furnaces.

5. Spalling. *a.* The panel insulation shall be removed.

b. The gas-fired furnace shall be operated so as to obtain a temperature of 2550°F (1400°C) before the panels are cooled by means of the blast.

c. The period for heating shall be 10 min and for cooling 10 min making a 20-min cycle.

d. The cooling shall be accomplished by means of an air-water mist blast, which shall be delivered through a vertical manifold with an opening measuring $3\frac{1}{2}$ by 24 in. as shown in the Method C 38. Air shall be delivered through each cooling unit at the rate of 1,400 cu ft per min. The water used in the four spray units shall be filtered and measured by means of a meter. The spray nozzles shall be regulated so as to deliver water at the rate of $2\frac{1}{2}$ gal during the first 8 min of the cycle. No water shall be used during the last 2 min. The cooling units shall be operated with a reciprocating motion so as to pass back and forth across the surface of the entire panel, including the dummy guard brick, 125 times in 10 min.

e. The spalling treatment shall consist of 12 cycles, after which the furnace shall be shut off and the panels given 2 additional cooling cycles without the water mist.

f. After carefully dismantling the panel, the kaolin shall be scraped off with a trowel, removing such pieces of the brick that separate easily. No attempt shall be made to separate pieces that might be removed by prying or tapping.

STANDARD METHOD OF PANEL TEST FOR RESISTANCE TO
THERMAL AND STRUCTURAL SPALLING OF SUPER DUTY
FIRECLAY BRICK

ASTM Designation: C 122-42

ADOPTED, 1937; REVISED, 1940, 1942, 1945, 1947

This Standard of the American Society for Testing Materials is issued under the fixed designation C 122; the final number indicates the year of original adoption as standard or, in the case of revision, the year of last revision.

1. Scope. This method of test covers the procedure for determining the resistance of super-duty fireclay brick to the separate and combined effects of structural and thermal spalling. This method makes use of the general requirements and procedure prescribed in the Method of Panel Test for Resistance to Thermal and Structural Spalling of Refractory Brick (ASTM Designation C 38) of the American Society for Testing Materials, and supplements that method by giving the detailed requirements of the procedure to be followed in testing super-duty fireclay brick.

2. Apparatus and Test Specimens. The apparatus and test specimens shall be in general as described in the Method of Panel Test for Resistance to Thermal and Structural Spalling of Refractory Brick (ASTM Designation C 38) of the American Society for Testing Materials.

3. Procedure. The procedure shall be in general as outlined in Method C 38, supplemented by the procedure for preheating and spalling as prescribed in the following Secs. 4 and 5.

4. Preheating Test Panels. *a.* The test brick shall be laid up with kaolin having a pyrometric cone equivalent not below cone No. 34.

b. The test panels and dummy brick shall be insulated with group 26 insulating fire brick weighing 46 ± 2 lb per cu ft.

c. The temperature of the panel faces shall be maintained so as to average 3000°F (1650°C) by means of a gas-fired furnace for a period of 24 hr.

d. The furnace gas pressure during the 24-hr preheating period shall be within the limits of 0.4 to 0.5 in. of water for gas-fired furnaces.

5. Spalling. *a.* The panel insulation shall be removed.

b. The gas-fired furnace shall be operated so as to obtain a temperature of 2550°F (1400°C) before the panels are cooled by means of the blast.

c. The period for heating shall be 10 min and for cooling 10 min making a 20-min cycle.

d. The cooling shall be accomplished by means of an air-water mist blast, which shall be delivered through a vertical manifold with an opening measuring $3\frac{1}{2}$ by 24 in. as shown in the Method C 38. Air shall be delivered through each cooling unit at the rate of 1,400 cu ft per min. The water used in the four spray units shall be filtered and measured by means of a meter. The spray nozzles shall be regulated so as to deliver water at the rate of $2\frac{1}{2}$ gal during the first 8 min of the cycle. No water shall be used during the last 2 min. The cooling units shall be operated with a reciprocating motion so as to pass back and forth across the surface of the entire panel, including the dummy guard brick, 125 times in 10 min.

e. The spalling treatment shall consist of 12 cycles, after which the furnace shall be shut off and the panels given 2 additional cooling cycles without the water mist.

f. After carefully dismantling the panel, the kaolin shall be scraped off with a trowel, removing such pieces of the brick that separate easily. No attempt shall be made to separate pieces that might be removed by prying or tapping.

In using the ASTM panel test for spalling, the following losses are generally used as limits.

| Conditions | Average Weight Loss, Per Cent |
|--|----------------------------------|
| Average spalling..... | 15 |
| Moderately severe..... | 10 |
| Severe (malleable furnace bungs)..... | 5-7.5 |
| Extremely severe (super duty class)..... | 4 |

The ASTM panel spalling test equipment has been installed in a number of laboratories and, in spite of the considerable cost of operation and large floor space required, has been well worth while when reliable spalling results are required. This test is valuable to the producer of refractories for a control test of his product and for the development of improved refractories. It also is of aid to the consumer in assuring that the standard of quality of the refractories purchased is adhered to. Those who do not have enough testing to justify the cost of this equipment may have their product tested at a commercial testing laboratory.

The U.S. Navy simulative service furnace, as described in Chap. XVII, can be used for a spalling test with results agreeing well with those obtained in service.

8. Spalling Characteristics of Various Bricks. In Table 80 are given the spalling resistance of a number of fireclay brick as measured by the ASTM panel spalling test.

Silica brick are not at all resistant to spalling in the low-temperature range; but once they are above the inversion temperature, they are very resistant to wide changes in temperature because of the flatness of the expansion curve in this region. This is the reason that they give such good service in regenerative furnaces.

Chrome and magnesite brick, because of their rather high coefficient of thermal expansion, are not so resistant to spalling as fireclay brick, but great improvements have been made in the last few years in providing a more flexible structure⁽²⁶⁾ and thus increased resistance.

Silicon carbide brick have an excellent resistance to spalling.

9. Effect of the Brick Structure on Spalling. The structure of the brick and the method of manufacture have a considerable influence on spalling. Data given below illustrate the effect of various factors. These data are for one particular clay and will not be exactly the same for others, but the trend should be general.

Effect of Grog Size. A number of bricks were made up with various sizes of grog, other conditions being the same. The spalling resistance for each grog size is given in Table 81. The spalling resistance increases

TABLE 80. SPALLING RESISTANCE OF FIRECLAY BRICK BY THE ASTM PANEL SPALLING TEST*
(Courtesy of the American Refractories Institute)

| Method of manufacture | Brand No. | Loss in panel spalling test, per cent | Porosity, per cent |
|-----------------------|-----------|---------------------------------------|--------------------|
| Hand-made..... | A | 12.8 | 17.8 |
| | B | 8.0 | 25.0 |
| | C | 6.3 | 24.0 |
| | D | 21.0 | 22.4 |
| | E | 25.0 | 15.7 |
| Stiff-mud..... | F | 28.0 | 13.7 |
| | G | 20.5 | 20.1 |
| | H | 2.5 | 24.4 |
| | I | 0.5 | 30.0 |
| | J | 14.8 | 20.9 |
| Dry-press..... | K | 5.5 | 16.7 |
| | L | 13.0 | 17.5 |
| | M | 2.0 | 23.0 |
| | N | 1.0 | 14.0 |

* These panels were preheated 1600°C according to specifications C-107.

steadily with the grog size for a given burning temperature. These results were obtained on single bricks, and somewhat different values might be obtained by panel spalling methods.

TABLE 81. EFFECT OF GROG SIZE ON SPALLING RESISTANCE

| Burned at | 1649°C. (3000°F.) | 1677°C. (3051°F.) | 1704°C. (3099°F.) |
|--------------|-------------------|-------------------|-------------------|
| 2 mesh..... | 20 cycles | 12 cycles | 5 cycles |
| 3½ mesh..... | 11 cycles | 6 cycles | 3 cycles |
| 4 mesh..... | 6 cycles | 3 cycles | 1 cycle |
| 20 mesh..... | 1 cycle | 1 cycle | 1 cycle |

Effect of Amount of Grog. In Fig. 264 is plotted a curve of spalling resistance against percentage of grog. It is interesting to note that the maximum spalling resistance occurs at 40 per cent of bond, or at the condition where the pores are just filled up. Above or below this point, the spalling resistance falls off rapidly, probably owing to loss of flexibility.

Effect of Burning Temperature. Figure 265 shows a curve of spalling resistance plotted against burning temperature. There is a minimum value at 1620°C (about 2950°F) and a maximum at 1650°C (about 3000°F). This type of curve has been observed a number of times for this particular

brick, but it may not apply to all others. The minimum point is probably due to the decreasing flexibility of the structure with increased temperature. Beyond 1600°C (about 2950°F), the free silica is dissolved and the coefficient of thermal expansion is lowered, which increases the spalling resistance up to 1635°C (about 3000°F). After this, the structure gets

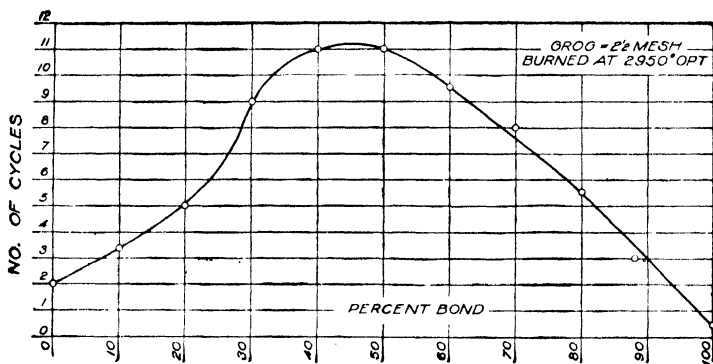

Fig. 264. The influence of the amount of bond on spalling resistance.

more rigid and the spalling resistance falls off. In general, it may be said that increasing the burning temperature decreases the resistance to spalling. This is shown in Table 82, where the spalling resistance is given for a number of bricks before and after preheating. Again it is probable that the hard-burned bricks would have shown up comparatively better if the spalling had been made with the panel test or in service.

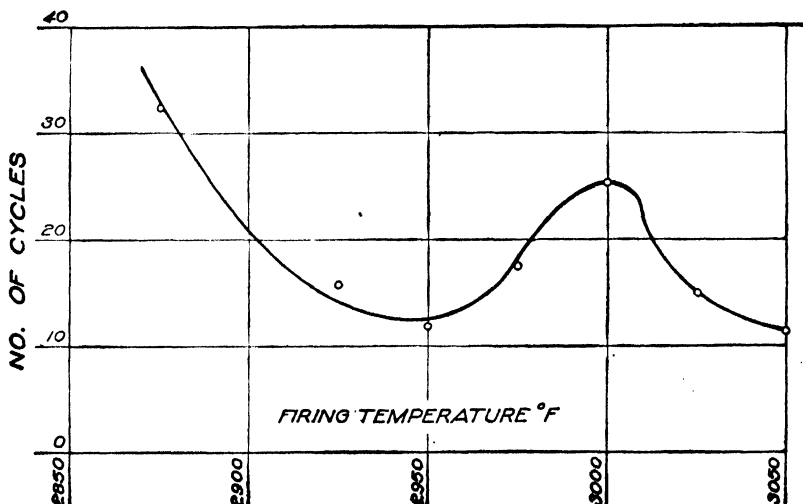

Fig. 265. Influence of burning temperature on spalling resistance.

Characteristics of a Good Spall-resisting Brick. We usually have a specified material from which to make a brick. With this material, it is impossible to alter the diffusivity appreciably, and only small changes can be made in the coefficient of thermal expansion. Therefore, if we desire to make the best spall-resistant brick from a given material, we must do two things: (1) make a structure having the greatest possible flexibility and (2) eliminate all possible flaws and laminations.

TABLE 82. EFFECT OF PREHEATING ON SPALLING RESISTANCE

| Brick | As burned, cycles | Preheated to 1670°C (3038°F) cycles |
|--------------------------|-------------------|--|
| Missouri..... | 45 | 4 |
| Missouri (diaspore)..... | 29 | 13 |
| Pennsylvania..... | 12 | 1 |
| | 18 | 4 |
| | 15 | 1 |
| | 22 | 2 |
| | 11 | 1 |
| Kaolin..... | 4 | 1 |
| | 12 | 12 |

Flexibility can best be obtained by using a large size of grog, a high degree of porosity, and a low degree of vitrification. These characteristics cannot be obtained to a high degree without sacrificing others of considerable importance. For example, bricks could easily be made to withstand 50 cycles in the air-spalling test; yet they would be mechanically weak and would probably have a high residual shrinkage. It has often been noticed that when a series of bricks are tested for spalling, there will be a great variation between the best and the worst out of the same lot. Where it is known that these bricks were made by identically the same process and that they all were burned at the same temperature, we can conclude only that the difference in spalling resistance is due to some lack of homogeneity in the structure of the brick. It is impossible to state definitely that any one method of making bricks gives the best or the worst spalling results, although it is generally found that re-pressed bricks, when properly tempered, give greater uniformity in the spalling test. We are greatly in need of a simple test to determine which bricks in a given lot will give a poor resistance to spalling. Some investigations have been made to test each brick by noting the sound emitted when struck with a hammer; but as yet, no very definite results have been obtained along this line. The recent work of Ford and Rees⁽⁵³⁾ on magnesite bricks is very valuable in correlating structure and spalling resistance.

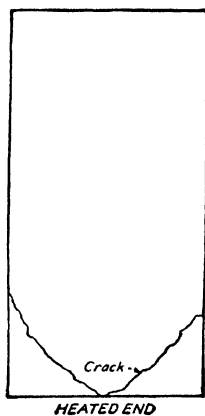
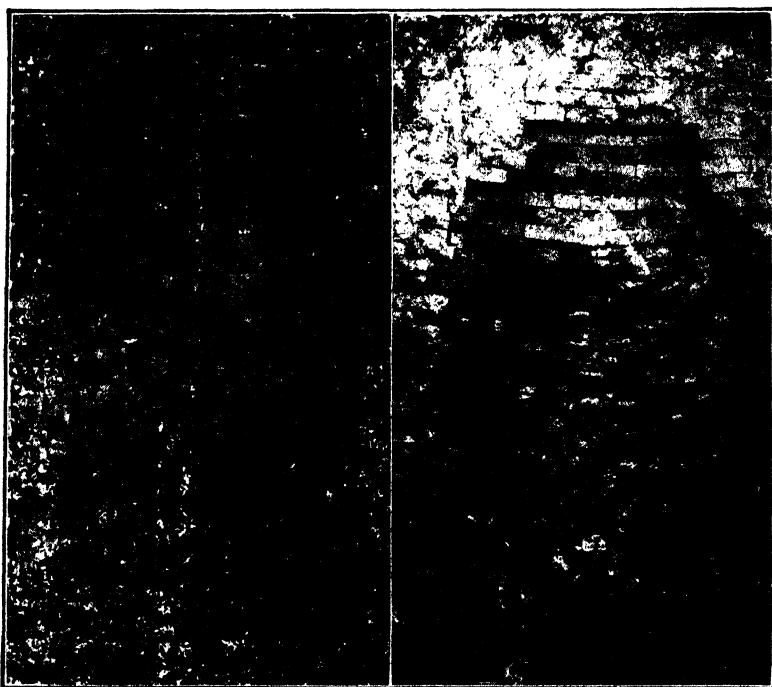

FIG. 266. A type of spalling fracture often occurring in service. (*J. Am. Ceram. Soc.*)



FIG. 267. Tension crack in end of a brick due to spalling. (*J. Am. Ceram. Soc.*)



FIGS. 268 and 269. Boiler furnace wall showing spalling under oil-fired conditions. (*Stone and Webster Company.*)

10. Spalling Fractures in Service. The types of spalling fracture in service walls are quite varied. Perhaps the most typical is that shown in Fig. 266, which consists of two shear cracks coming together at the center of the brick. There is often a small tension crack in the end of the brick, as shown in Fig. 267. The fracture corresponds well with the determined stresses for this condition. This type of failure is not often serious, because the fragments are so large that they stay in place. In other cases, the wall is pretty well shattered, as shown in Figs. 268 and 269.

Another type of spalling failure is the separation of a thin layer of material from the face of the brick, as shown in Fig. 270. This usually occurs with bricks of low vitrifying points or with slagged surfaces, and the fracture runs between the vitrified material and the body of the brick. Often layer after layer will peel off, giving a considerable length of service before the wall becomes too thin.

Exposed corners in a furnace are quite subject to spalling and should be avoided in design where possible. This type of failure by shear is shown in Fig. 271.

Spalling in a wall is greatly augmented by compression loads due to expansion. Expansion joints should be left at least every 15 ft and should amount to $\frac{1}{2}$ to 1 in. Another method is to place a slip of thin cardboard between bricks in each vertical joint (or thicker pieces in alternate joints). These will burn out and allow each brick to expand freely, and yet there will be no general movement of the wall. Thin pieces of steel, which are pulled out as the wall progresses, have sometimes been used instead of the cardboard.

In the case of arches, there is often a pinching off of the tips due to temperature strains. Care, however, should be taken to see that there is clearance between the inner ends when temperature or load conditions are severe.

Failure due to heating wet brickwork rapidly is sometimes considered spalling. The remedy is obvious. Mechanical breakage when slicing off slag deposits is also classed as spalling by some people. The brick manufacturer can do little to help this failure except to supply the hardest bricks that will stand the temperature changes.

There has perhaps been too great a tendency for manufacturers and users of refractories to specify brick with a good spall-resisting quality, as judged by the laboratory test. Many cases have come up where a hard,

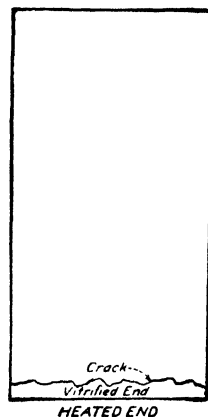

FIG. 270. Separation of a thin layer due to vitrification. (*J. Am. Ceram. Soc.*)

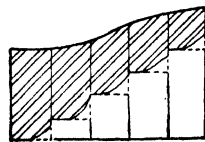

FIG. 271. Spalling of exposed corners of a furnace.

dense brick has stood up in service far better than one with a good spall-test record. This is probably due not to any fault in the test but to conditions of mechanical loads in service not encountered in the laboratory.

11. Bibliography

1. WINKELMANN, A., and O. SCHOTT: Ueber thermische Widerstandscoefficienten, verschiedener Glaser in ihrer Abhangigkeit von der chemischen Zusammensetzung, *Ann. Physik und Chem.*, **51**, 730, 1894.
2. INGERSOLL, L.R., and ZOBEL, O.J.: "The Mathematical Theory of Heat Conduction," Ginn & Company, Boston, 1913.
3. HOWE, R.M., and S.M. PHELPS: The Use of Plastic Clay Grog in Preventing Spalling, *J. Am. Ceram. Soc.*, **4**, 119, 1921.
4. HOWE, R.M., and R.F. FERGUSON: A Study of Spalling, *J. Am. Ceram. Soc.*, **4**, 32, 1921.
5. STEGER, W.: Investigations Leading to the Discovery of the Cause of Excessive Sagger Breakage, *Ber. deut. keram. Ges.*, **5**, 3, 1924.
6. BOOZE, M.C., and S.M. PHELPS: A Study of the Factors Involved in the Spalling of Fire Clay Refractories with Some Notes on the Load and Reheating Tests and the Effect of Grind on Shrinkage, *J. Am. Ceram. Soc.*, **8**, 361, 1925.
7. ENDELL, K.: The Resistance to Temperature of Refractory Brick in the Glass Industry, *Diamant*, **47**, 712, 1925.
8. STEGER, W.: Die Widerstandsfähigkeit feuerfester Baustoffe gegen Temperaturwechsel, *Stahl u. Eisen*, **45**, 249, 1925.
9. STEGER, W.: Present State of Knowledge Concerning the Resistance of Smelting Industry Refractories towards Changes in Temperature, *Ceramist*, **6**, 374, 452, 1925.
10. GREEN, A.T., and A.J. DALE: The Spalling of Refractory Materials, *Trans. Ceram. Soc. (Engl.)*, **25**, 428, 1925-1926; *Bull. Brit. Refractories Research Assoc.*, **12**, 127, 1926; Report of Committee C-8 (Appendix V).
11. BOOZE, M.C.: A Study of the Spalling Test for Fireclay Brick, *Proc. Am. Soc. Testing Materials*, **26**, 277, 1926.
12. ENDELL, K., and STEGER, W.: Temperature-sensitiveness of Refractory Materials in the Glass Industry, *Glastech. Ber.*, **4**, 43, 1926.
13. GILARD, P.: Note on the Flaking of Refractory Bricks, *Rev. universelle mines*, **9**, 81, 1926.
14. NORTON, F.H.: The Mechanism of Spalling, *J. Am. Ceram. Soc.*, **9**, 446, 1926.
15. PRESTON, E.W.: The Spalling of Bricks, *J. Am. Ceram. Soc.*, **9**, 654, 1926.
16. PHELPS, S.M.: A Study of Tests for Refractories with Special Reference to Spalling Tests, *Am. Refractories Inst., Tech. Paper 1*, 1926.
17. GREEN, A.T., and H. EDWARDS: The Spalling of Silica Refractory Material at Low Temperatures, *Trans. Ceram. Soc. (Engl.)*, **26**, 185, 1926-1927.
18. GELLER, R.F.: The Significance of Elasticity and Thermal Expansion of Fire Clays with Reference to the Spalling of the Fired Product, *Am. Refractories Inst., Tech. Paper 4*, 1927.
19. GOODRICH, H.R.: Spalling and Loss of Compressive Strength of Fire Brick, *J. Am. Ceram. Soc.*, **10**, 784, 1927.
20. PHELPS, S.M.: A Non-technical Description of Spalling Action, *Am. Refractories Inst., Bull.* **24**, 1928.

21. MIEHR, W., J. KRATZERT, and H. IMMKE: Der Einfluss des Brennes auf die chemischen und physikalischen Eigenschaften feuerfeste Tone, *Tonind.-Ztg.*, **52**, 280; (17), 298; (18), 323, 1928.
22. PARMALÉE, C.W., and A.E.R. WESTMAN: The Effect of Thermal Shock on the Transverse Strength of Fireclay Brick, *J. Am. Ceram. Soc.*, **11**, 884, 1928.
23. HEINDL, R.A., and W.L. PENDERGAST: Progress Report on Investigation of Fireclay Brick and the Clays Used in Their Preparation, *J. Am. Ceram. Soc.*, **12**, 640, 1929.
24. PHELPS, S.M., S.M. SWAIN, and R.F. FERGUSON: A Service Spalling Test for Refractories, *J. Am. Ceram. Soc.*, **14**, 389, 1931.
25. HYSLOP, J.F., and H.C. BIGGS: Slag and Spalling Tests on Firebricks, *Trans. Ceram. Soc. (Engl.)* **30**, 288, 1931.
26. ENDELL, K.: Gegen Temperaturänderungen unempfindliche Magnesitsteine, *Stahl u. Eisen*, **52**, 759, 1932.
27. ANON.: Spalling of Bricks, *Blast Furnace Steel Plant*, **20**, 736, 1932.
28. PRESTON, F.W.: Theory of Spalling, *J. Am. Ceram. Soc.*, **16**, 131, 1933.
29. HARVEY, F.A.: Notes on Spalling Tests, *Am. Refractories Inst., Tech. Bull.* **42**, 1933.
30. KELER, E.K., and A.I. ZAKHAROV: Determination of Resistance to Spalling of Refractory Materials, *Ogneupory*, **2**, 34, 1934.
31. MAMUIKIN, P.S.: Spalling Resistance of Refractory Materials, *Ogneupory*, **3**, 199, 1935.
32. Silika-und Schamotte-Fabriken Martin & Pagenstecher A.-G.: Increasing Spalling Resistance, Brit. Patent, 464,240, July 7, 1935.
33. BUDNIKOFF, P.P., and B.J. PINES: Constituents and Properties of "Radex" Magnesite Brick, *J. Am. Ceram. Soc.*, **18**, 125, 1935.
34. HEINDL, R.A.: Thermal Spalling of Fireclay Brick in Relation to Young's Modulus of Elasticity, Thermal Expansion, and Strength, *Am. Refractories Inst., Tech. Bull.* **58**, May, 1935.
35. Ceramic Products: Magnesital G.M.B.H., French Patent 791,916, Dec. 19, 1935.
36. Ceramic Products: Magnesital G.M.B.H., French Patent 802,518, Sept. 7, 1936.
37. KERR, W.R.: Panel Spalling Tests on Insulating Brick and Insulating Fire Brick, *Bull. Am. Ceram. Soc.*, **16**, 322, 1937.
38. KONDO, S., and H. YOSHIDA: Modulus of Elasticity of Magnesite Refractories, I, Importance of the Modulus of Elasticity of Refractories and Apparatus for Its Measurement, *J. Japan. Ceram. Assoc.*, **44**, 611, 1936; *Trans. Ceram. Soc. (Engl.)*, **36**, 24A, 1937.
39. HEINDL, R.A., and W.L. PENDERGAST: Deformation and Young's Modulus of Fireclay Brick in Flexure at 1220°C., *Nat. Bur. Standards, J. Research*, **19**, 353, 1937.
40. BARTSCH, O.: On the Impact-bending Strength of Ceramic Bodies and Glasses and Its Relation to the Resistance to Temperature Changes of Fireclay Bodies, *Ber. deut. keram. Ges.*, **18**, 465, 1937.
41. ELLIOTT, A.C., and R.J. MONTGOMERY: New Type of Thermal Shock, *J. Can. Ceram. Soc.*, **6**, 44, 1937.
42. PINES, B.Y.: Thermal Stability of Firebrick, I, *Zhur. Tekh. Fiz.*, **8**, 2126, 1938.
43. HYSLOP, J.F.: Refractories and Thermal Shock, *Brit. Clayworker*, **47**, (560), 282, 1938.
44. ENDELL, E., and F. ANGELERI: Torsion Properties of Itakolumite (Flexible Brazilian Sandstone), Crummendorf Quartz-schist, and Some Sandstones, *Ber. deut. keram. Ges.*, **19**, 359, 1938.
45. MCKINLEY, J.M., and S.M. PHELPS: Spalling of Silica Brick during Heating and Cooling of Furnaces, *J. Am. Ceram. Soc.*, **22**, 83, 1939.

46. KONDO, S., and H. YOSHIDA: The Modulus of Elasticity of Magnesite Refractories, XIV, Chemical Composition and Spalling Character, *J. Japan. Ceram. Assoc.*, **47**, 135, 1939.
47. KONDO, S., and H. YOSHIDA: The Modulus of Elasticity of Magnesite Refractories, XIII, Method of Improving the Mechanical Strength of Unburnt Magnesite Refractories at Ordinary and Higher Temperatures, *J. Japan. Ceram. Assoc.*, **47**, 17, 1939.
48. KONDO, S., and H. YOSHIDA: The Modulus of Elasticity of Magnesite Refractories, XII, Influence of the Amount of Fine Powder and Forming Pressure on the Resistance to Thermal Shock, *J. Japan. Ceram. Assoc.*, **47**, 15, 1939.
49. HYSLOP, J.F.: Refractories and Thermal Shock, *Trans. Ceram. Soc. (Engl.)*, **38**, 304, 1939.
50. HEINDL, R.A., and W.L. PENDERGAST: Panel Tests for Thermal Spalling of Fireclay Brick used at High Temperatures, *Natl. Bur. Standards, J. Research*, **34**, 73, 1945.
51. CLARK, O.H.: Resistance of Glass to Thermal Stress, *J. Am. Ceram. Soc.*, **29**, 133, 1946.
52. HOWIE, T.W.: Spalling of Silica Bricks, *Trans. Brit. Ceram. Soc.*, **45**, 45, 1946.
53. FORD, W.F., and W.J. REES: The Spalling Resistance of Magnesite Products, *Trans. Brit. Ceram. Soc.*, Part I, **46**, 290, 1947; Part II, **46**, 297, 1947.
54. FORD, W. F., and W. J. REES: The Spalling Resistance of Magnesite Products. Part III. The Effect of Iron Oxide Additions, *J. Brit. Ceram. Soc.*, **49**, 375, 1950.

CHAPTER XVI
 THE REACTION BETWEEN REFRACTORIES AND
 SLAGS OR GLASSES

1. Chemical Effect of Slag Action. In general, slag action can be divided into chemical effects and physical effects, the first of which will now be considered.

Equilibrium Conditions. It is very important to make a distinction between equilibrium conditions and the rate of reaction. For example, if an intimate mixture of magnesia and silica is maintained at a definite temperature, it will, after a certain length of time, be converted into mag-

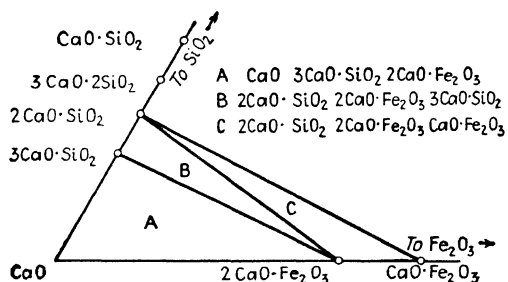

FIG. 272. Composition triangles in system $\text{CaO}-\text{SiO}_2-\text{Fe}_2\text{O}_3$. (W. C. Hansen and R. H. Bogue, *J. Am. Chem. Soc.*)

nesium silicate with a relatively low melting point. When the conversion is as complete as the proportion of the substances permits, equilibrium is attained and no further change will occur at that temperature. If the temperature is low, this reaction will progress with extreme slowness; but on the other hand, if the temperature is high, the reaction will take place rapidly; however, in each case, a state of equilibrium will be reached. It will first be advisable to investigate the equilibrium conditions for the combinations of various slags and refractories; for if the equilibrium conditions produce no material melting at a temperature lower than that at which the refractory is maintained, there can be no serious slag reaction. In such a case, the rate of reaction would not concern us. Usually, however, the slag or the material produced by the reaction of the slag with the refractory melts at a lower temperature than that maintained in the furnace.

Owing to the great complexity of the materials entering into slag and glass reactions, we do not have very complete information on the equilibrium diagrams concerned in these reactions. More data of this type are greatly needed. However, it can be stated in general that the slag reaction depends upon the formation of a low-melting compound or mixture.

Composition of Slags and Glasses. Table 83 shows typical analyses of commercial slags and glasses. In general, each one has so many elements present that it is difficult to tie them in with any simple system; and when the elements in the refractory are added, the complexity is still further increased.

Equilibrium Diagrams. It will be seen from Table 83 that the systems particularly applicable to slag-refractory reactions are

$\text{SiO}_2\text{—Al}_2\text{O}_3\text{—CaO}$ (Fig. 224, Chap. XIII)

$\text{SiO}_2\text{—Fe}_2\text{O}_3\text{—CaO}$ (Fig. 272)

$\text{SiO}_2\text{—CaO—Na}_2\text{O}$ (Fig. 273)

It should not be forgotten that small amounts of some other materials such as PbO or F may greatly influence the slag action.

Rate of Reactions. The second factor in slag reactions is the rate at which reactions occur. Suppose that a refractory is washed by a slag capable of combining with the refractory to form a low-melting compound. If the reaction occurs rapidly, these low-melting compounds will be formed in considerable quantities and will run off the face of the wall, thereby exposing fresh surfaces for the attack of the slag; therefore the slag resistance of the refractory will be poor. On the other hand, let us suppose that the same low-melting-point compounds are formed but that the rate of reaction is slow. Then the compounds will be formed in small quantities, and the resistance of the refractory to the slag may be good. This is the reason why the prevalent idea that basic refractories must be used with basic slags and acid refractories with acid slags is not necessarily true. Although the acidic and basic qualities determine the formation products, they do not necessarily determine the rates of reaction. For example, magnesite will stand up well under the action of certain highly siliceous slags, and silica bricks are known to give good service in lime kilns under highly basic conditions.

The rate of reaction is greatly influenced by the temperature. In many instances, an increase of 10°C (18°F) will double the rate of reaction. This is the principal reason why certain refractories will resist slag very well at the usual working temperatures but will be rapidly eaten away if the furnace temperature is increased by 50°C (about 90°F). Unfortunately, practically no information is available, owing mainly to the experimental difficulties, on the rate of reaction of the materials in which we are

TABLE 83. ANALYSES OF TYPICAL SLAGS AND GLASSES

| | Portland cement clinker | Lead blast furnace | Copper reverberatory | Coal ash, Ind. | Coal ash, Ill. | Acid, open hearth | Basic, open hearth | Blast furnace | Heating furnace | Window glass | Opal glass | Boro-silicate glass | Fuel oil |
|--------------------------------|-------------------------|--------------------|----------------------|----------------|----------------|-------------------|--------------------|---------------|-----------------|--------------|------------|---------------------|----------|
| SiO ₂ | 21.9 | 32.6 | 47.4 | 42 | 43 | 50.1 | 23.3 | 36.8 | 17.0 | 72.10 | 65.8 | 80.6 | 44.0 |
| Al ₂ O ₃ | 5.6 | 3.1 | 29.0 | 15 | 17 | 3.0 | 0.3 | 11.7 | 3.9 | 0.80 | 6.6 | 2.0 | 1.3 |
| Fe ₂ O ₃ | 4.6 | 30.4* | 34.5* | 33 | 27 | 30.3* | 26.6* | 3.4* | 75.3 | 0.08 | | 0.2 | |
| TiO ₂ | | | | | 1 | 1.5 | 1.0 | 0.5 | 0.7 | | | | 27.7 |
| CaO | 65.8 | 19.1 | 9.4 | 3 | 7 | 2.3 | 38.0 | 43.4 | 0.8 | 9.10 | 10.1 | 0.2 | 22.5 |
| MgO | 1.4 | 1.8 | 1.4 | Trace | 1 | 0.9 | 7.0 | 2.5 | 0.1 | 1.30 | | 0.3 | |
| MnO | | 0.9 | 0.4 | | | 11.7 | 4.2 | 0.9 | 1.9 | | | | |
| Na ₂ O | | | | 7 | 4 | Trace | 0.1 | 0.6 | 0.1 | 16.20 | 3.8 | 3.8 | 3.3 |
| K ₂ O | | | | | | | | | | | 9.6 | 0.6 | 1.0 |
| V ₂ O ₅ | | | | | | | | | | | | | |
| ZnO | | 8.3 | 1.5 | | | | | | | | | | |
| CuO | | 0.2 | 0.5 | | | | | | | | | | |
| PbO | | 1.2 | 0.3 | | | | | | | | | | |
| SO ₂ | 0.2 | | | | | | | | | 0.5 | | | |
| As ₂ O ₅ | | | | | | | | | | Trace | | | |
| F | | | | | | | | | | | 5.3 | 0.7 | |

* Chiefly FeO.

interested at high temperatures. However, the reaction rate may be approximately expressed by the following equation of Arrhenius:

$$\log \frac{K_{t_2}}{K_{t_1}} = A \left(\frac{1}{T_1} - \frac{1}{T_2} \right)$$

where K_{t_1} = the reaction velocity at temperature T_1 , deg abs
 K_{t_2} = the reaction velocity at temperature T_2 , deg abs
 A = a constant of the reaction

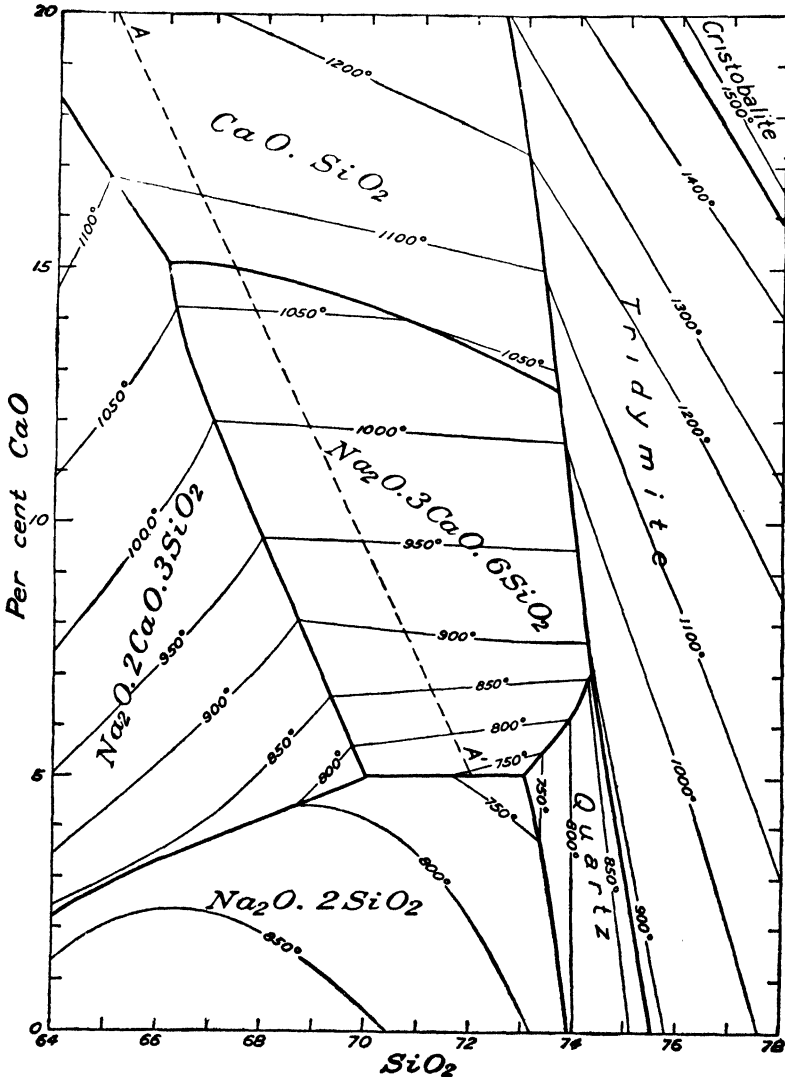

FIG. 273. Part of the ternary system Na₂O-CaO-SiO₂. (Hall and Insley.)

The value of A varies but is in the neighborhood of 10,000 for clays and fluxes.

2. Physical Effects of Slag Action. *Velocity of Flow.* As the rate of reaction is dependent upon the concentration of the slagging material on the surface of the refractory, it is evident that the more rapid the movement of the liquid slag over the refractory surface the more rapidly the fresh slag will be presented to the surface. It is well known that a liquid may flow in two ways. The first is a streamline flow, where the direction of the flow is parallel to the surface over which it is flowing; and the second, a turbulent flow, where the particles of the liquid are undergoing motion in various directions. The transition from streamline flow to turbulent flow depends upon the size, velocity, and viscosity of the melt. It is evident that turbulent flow is much more effective in bringing fresh slag to the surface than is streamline flow; so it is desirable to keep the velocity of flow low and the viscosity high. As the viscosity is dependent upon the temperature, we have another reason why high temperatures promote more rapid slag reaction. It may be said that in general, all slag flows are of the streamline type where the slag is flowing in thin layers over the refractory but, in the cases where the slag is in large quantities, as in glass tanks, the flow may be of the turbulent type for the more fluid glasses.

Diffusion in the Melt. Another physical effect that has an influence on the rate of slag attack is diffusion through the molten slag. Very little is known about the rate of diffusion of substances at high temperatures, but it is possible that this effect is quite important in bringing the reacting substances together. Bowen has shown that the rate of diffusion of silicates of the type of diopside in each other at 1500°C (about 2730°F) is comparatively rapid. The rate of diffusion is proportional to the viscosity and therefore depends largely upon the temperature of the melt.

Gas Diffusion through Melt. Sosman has suggested that another type of diffusion may have considerable influence on slag action. This is the phenomenon of the diffusion of gases through the melt. It has been shown that hydrogen and helium will pass through vitreous quartz glass at high temperatures so rapidly as to assume the character of an actual flow of gas.

Slag Penetration. In the previous discussion, we have considered the reaction occurring between the surface of the refractory and the molten slag. If the refractory is a dense material, this surface will be smooth; but on the other hand, if the refractory is porous, the surface may be considerably increased owing to penetration of the slag into the pores. A number of refractories are made from a hard grog and a softer bond, in which case the slag will react with the bond more rapidly than with the grog particles and will allow the latter to project from the surface. It often happens that these grog particles are carried away in the melt before they have

become dissolved. This has been noticed in glass melts and, of course, is harmful to the glass. Other types of refractories, even though composed of homogeneous material, will allow the rapid penetration of the slag into the interior.

Recent results on glass-tank blocks have shown that a high porosity may not cause susceptibility to slag action, provided the pores are all below a size that will allow the slag to be drawn in by capillary forces. On the other hand, flaws, laminations, or cracks are very harmful and allow rapid slag penetration.

Wetting of the Surface by Slag. There is another side to slag reactions which has not, it is believed, been generally discussed, *i.e.*, the wetting of the refractory surface by the molten slag. It has been noticed that when certain slags are applied to some refractories, they will melt on the surface and form in drops without wetting the surface. A refractory, under such conditions, is practically unaffected by the slag. This condition is just the opposite of many other cases, where the slag is drawn by capillary attraction deep into the pores. It seems quite reasonable to believe that the wetting by the molten slag in contact with the refractory may have a very important influence on the slag resistance of that refractory, and data on the surface tension under these conditions would be of considerable value.

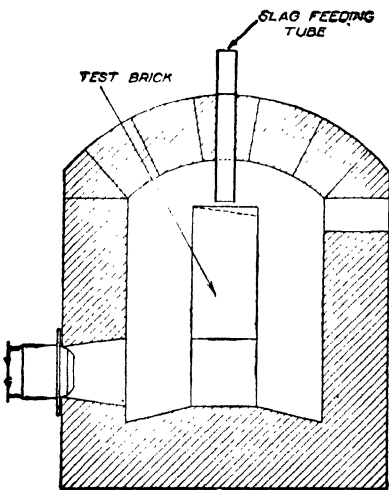

FIG. 274. Slag-test burner.

It seems quite reasonable to believe that the wetting by the molten slag in contact with the refractory may have a very important influence on the slag resistance of that refractory, and data on the surface tension under these conditions would be of considerable value.

3. Laboratory Slag Tests. Of all laboratory tests for refractories, the least satisfactory is the slag test, for it is difficult in a reasonably short time to evaluate the resistance of a refractory. To accelerate the action by higher temperatures or by a greater flow of slag may materially alter the conditions of reaction.

Early Methods of Test. Some of the proposed methods of slag testing consisted in measuring the penetration of slag into the refractory, the fusion point of powdered slag and refractory when mixed together, and the petrographic study of mixtures of slag and refractory after definite heat-treatments. These methods measure some factors of slag reaction but not by any means all of them.

Refractory in Slag Baths. A number of experimenters have measured the resistance of a refractory to slags by suspending them in a bath of molten slag, with motion to bring new slag to the surface. The test of

Endell, Fehling, and Kley⁽¹⁰⁾ used this method with considerable success.

Running Slag Test. Another method suggested by Prof. G. B. Wilkes consists of heating a single brick or a column of bricks to a uniform temperature and regularly dropping powdered slag on top, allowing it to run down the face in a groove, as shown in Fig. 274. The depth to which this groove has been cut at the end of the test gives a very good indication of

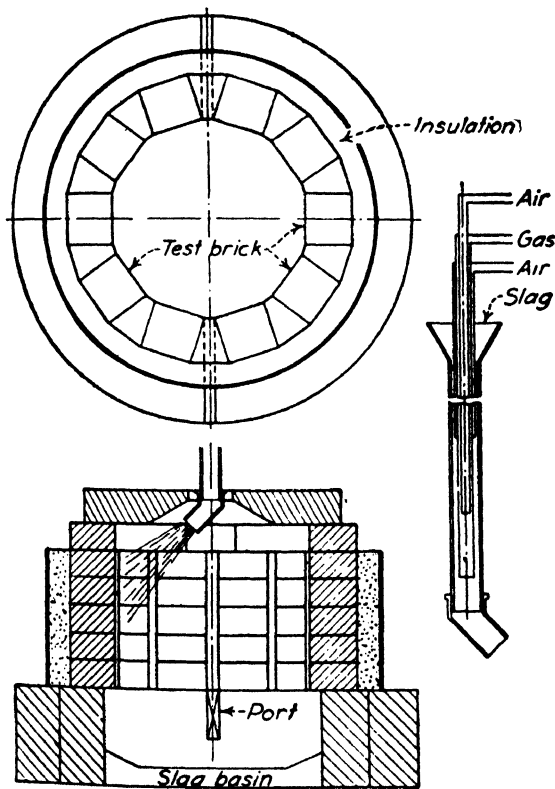

FIG. 275. Slag-test furnace and burner.

the slag resistance of the brick, because the test is carried on under conditions closely approximating those of service. Although this test gives excellent relative values, it is not a quantitative test and does not maintain a proper temperature gradient from the slag surface to the other face. Hartmann⁽¹⁸⁾ used a similar method with a small specimen in an electric furnace.

Spray Slag Tests. Perhaps one of the most satisfactory tests consists in spraying powdered slag against the heated refractory. A number of experimenters have used this method, but the most practical furnace is that used by Hursh^(21,22) as shown in Fig. 275. Here the powdered slag is

fed through a revolving burner impinging on the test bricks set on the inside of the cylindrical furnace. Thus, all the bricks get the same treatment and the temperature gradient through the bricks is similar to that found in service. If the test is run for several days, truly quantitative values can be obtained.

Tanks for Testing Glass Refractories. The only really satisfactory way to test glass-tank blocks is to use them in a small tank that is fed and drawn at regular intervals. A satisfactory tank for this purpose, shown in Fig. 276, is about the minimum size that can be used successfully. A 2-weeks'

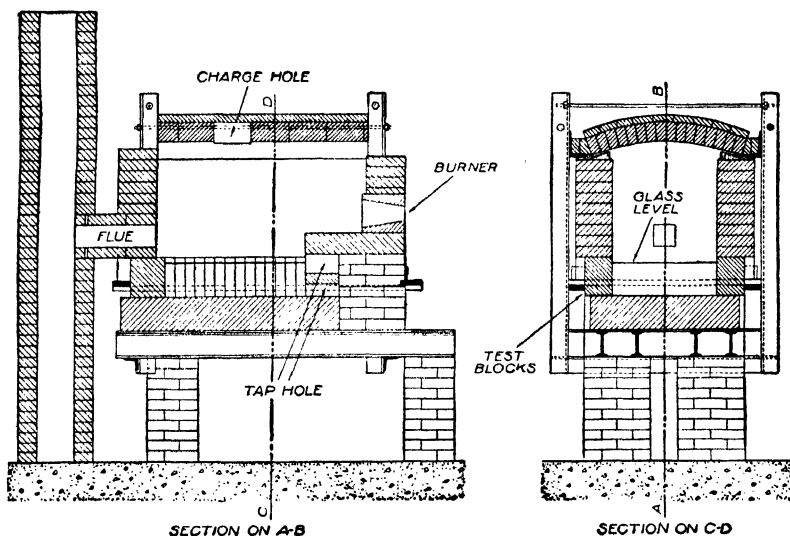

Fig. 276. Small tank with a 3 × 5 ft melting chamber. (Courtesy of the Babcock and Wilcox Company.)

run will give a fair indication of the resistance to the glass, but a longer run is sometimes desirable. McMullen⁽¹¹¹⁾ describes a small test tank for glass tank blocks that is heated by globars.

4. The Slag Resistance of Refractories. There are so few really quantitative data on the resistance of refractories to slags that it would seem impossible at the present time to give a table of values that would mean very much. However, from our experience in the use of refractories, certain conclusions can be drawn, which will be discussed in Part IV.

5. The Products Formed in Slag Reactions. *Fireclay Refractories and Coal-ash Slag.* The microscopic examination of the boundary layer between the slag and refractory indicates several definite zones that are generally present in all slagging of this nature. A study of these conditions has been made by McDowell and Lee,⁽¹¹⁷⁾ McVay and Hursh,⁽¹¹⁸⁾ and others. On the furnace side, there is a layer of slag that at high tem-

peratures may be very thin, perhaps 1 mm, but at lower temperatures may build up to a coating of several centimeters. This layer of slag usually contains anorthite, $\text{CaO}\cdot\text{Al}_2\text{O}_3\cdot 2\text{SiO}_2$, associated with iron oxide, which may be in any of several forms, depending upon the atmosphere of the furnace as shown in Fig. 277. Mullite crystals are also present, but they usually contain iron oxide in solid solution.

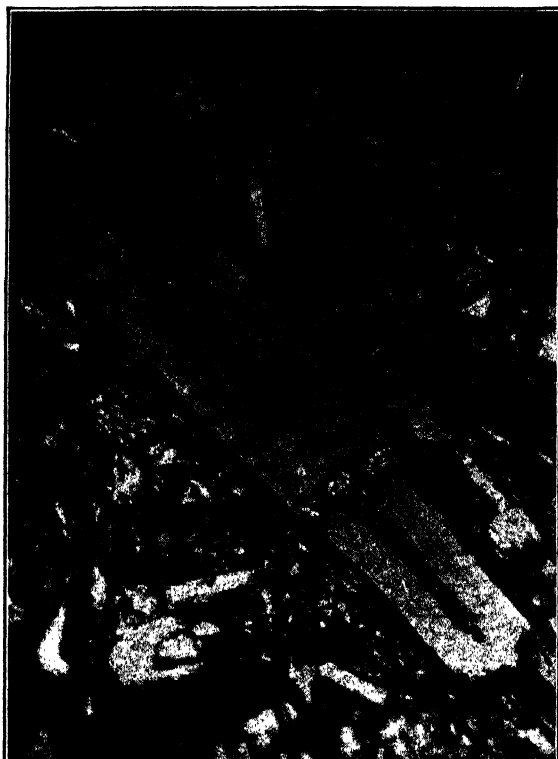

Fig. 277. Thin section of Illinois coal-ash slag which was slowly cooled. The large crystals shown is feldspar; 250 diameters, with crossed Nicol prisms and a gypsum plate.

The next zone, which is the transition zone between the slag and refractory, contains mainly large and well-developed mullite crystals. As in nearly every case of slagging between firebrick and slag or glass, the development of mullite crystals is accelerated in this intermediate zone.

The next zone is in the body of the refractory itself and generally shows some penetration of the slag into the pores of the brick and, in many cases, the initial solution of particles of the refractory.

In the case of a firebrick crown that is swept by powdered slag, stalactites form and drip off the roof. Here the composition may be somewhat different from the slag on the side walls because more time is available for

equilibrium to be established before the slag runs off. An examination of the stalactites shows magnetite and anorthite crystals well developed; and in a few instances, mullite crystals have been observed.

High-alumina Refractories and Coal-ash Slag. Refractories containing a high percentage of mullite, which have been made from kyanite and diaspore, show somewhat different characteristics under the action of slag.



FIG. 278. A thin section of a sample of opal glass which was near the refractory, showing dendritic crystals of cristobalite; 1,200 diameters, with ordinary transmitted light.

The first characteristic that will be noticed is that the slag penetrates deeply into the refractory and leaves little on the surface. On the surface of the refractory, which is only lightly covered with slag, mullite crystals predominate; but as we penetrate farther into the body of the refractory, corundum crystals increase in number until they may be equal in volume to the mullite. The zone of corundum crystals seems to give a weaker structure than the zone of interlocking mullite crystals and may present a zone of weakness that will cause spalling. The formation of the corundum crystals indicates a more rapid solution of the silica than of the other constituents, leaving excess alumina behind.

Siliceous Fireclay Refractories and Soda-lime Glass. The constituents formed between refractories and glass have been examined by Insley,⁽⁸⁹⁾ Wilson,⁽⁸⁷⁾ and Kai-Ching-Lu.⁽¹⁰²⁾ The hottest zone between the glass and the refractory is generally milky white or brownish and contains cristobalite crystals in glass. Corundum plates and nephelite crystals are sometimes observed here. The next zone as we approach the refractory is a white



FIG. 279. Thin section of opal glass taken at a point very close to the refractory. A large number of dendritic cristobalite crystals and a few corundum crystals are seen. A few unidentified crystals of high index are present in this slide; 80 diameters, with ordinary transmitted light.

layer containing mainly mullite crystals. The refractory itself shows penetration of the glass into the pores, but this is not evident at any distance from the surface. Thin sections shown in Figs. 278 to 281 give a clear picture of the crystal formation in glass.

Aluminous Fireclay and Soda-lime Glass. In this case, the hottest zone is a brown layer containing soda-lime feldspars imbedded in glass. The next layer is white and consists of mullite crystals imbedded in alumina glass with corundum crystals. The latter are formed from the alumina-saturated glass in this zone.

Silica Brick and Iron. A careful examination of silica roof brick by Scott⁽¹²⁹⁾ shows the following characteristics: The hot end of the brick is a gray zone of cristobalite crystals and magnetite, with perhaps a few tridymite crystals at the cooler end; the next cooler zone is black and consists of tridymite, magnetite, and a small percentage of cristobalite; the cooler

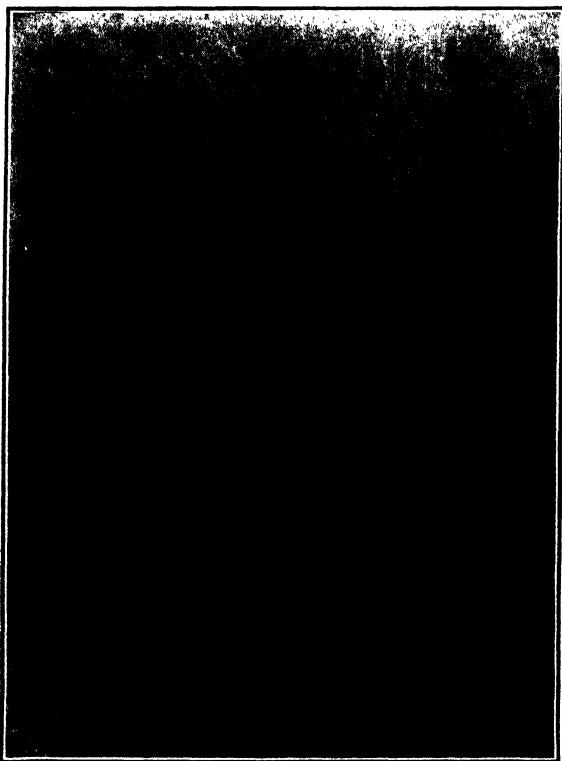

FIG. 280. Thin section of a glass stone, composed of nephelite which was formed by materials dropping from the crown into the melt. The material at the lower left-hand corner, containing inclusions, is the nephelite. The long slender needles appearing at the edge of the stone are of feldspar; 265 diameters, with crossed Nicol prisms and gypsum plate.

end of the brick consists of cristobalite, tridymite, and quartz, the last increasing toward the outer end of the brick.

In the hearth, fayalite, Fe_2SiO_4 , and tridymite were found in a brown glass. In the hotter portions, some cristobalite was found and about 20 per cent ferrous oxide was generally present. Iron silicates do not usually form in large quantities but were present only where the conditions were reducing.

Magnesite and Iron. In general, magnesite in contact with iron or its oxides gives periclase crystals with iron in solid solution, together with

some crystals of magnesioferrite. When lime is present, calcium oxide crystals are formed, sometimes of large size. Crystals of tricalcium silicate have been observed.

Zerfoss and Davis⁽¹³⁴⁾ give an excellent discussion of the theories of bursting when chrome-magnesite brick comes in contact with iron oxide.

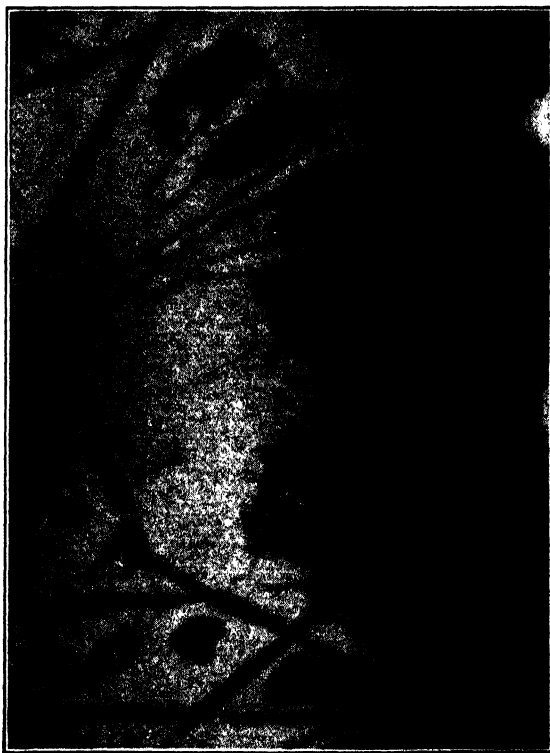

FIG. 281. Thin section of a stone in a glass melt. This stone was caused by a particle of the refractory being eroded from the side of the glass tank; 500 diameters, with crossed Nicol prism and gypsum plate.

They conclude on the basis of their work that the chromite grains act as nuclei for the growth of Fe_3O_4 and that this growth causes the bursting.

Fireclay Refractories and Iron. The main constituents formed by this reaction are iron silicates and mullite, with iron in solid solution.

Alkali Vapors and Refractories. Alkali vapors or dust are encountered in many industrial furnaces such as glass tanks, boiler furnaces, and blast furnaces. Much work has been done in the last few years on this subject as shown by the references.⁽⁶⁷⁻⁸⁶⁾ Siliceous-type bricks are not so resistant to alkali vapors as fireclay or aluminous types of brick, owing to the formation of a liquid slag in the first case. According to Hartmann,⁽⁷⁶⁾ magne-

site brick are very resistant. Hard firing and low porosity increase the slag resistance of any brick.

Other Slags. The reaction between refractories and other slags has not been studied to any great extent. Audley⁽¹³⁵⁾ examined the zinc-fireclay reaction and found the occurrence of a zinc spinel. Turner⁽⁹⁵⁾ and McSwiney⁽¹³⁷⁾ have discussed the action of arsenic in glass on refractories, but no definite conclusions have been reached.

We need information on the products formed by copper, lead, and tin when in contact with various refractories. Little is known of the slag reactions with chromite, zirconia, and zircon.

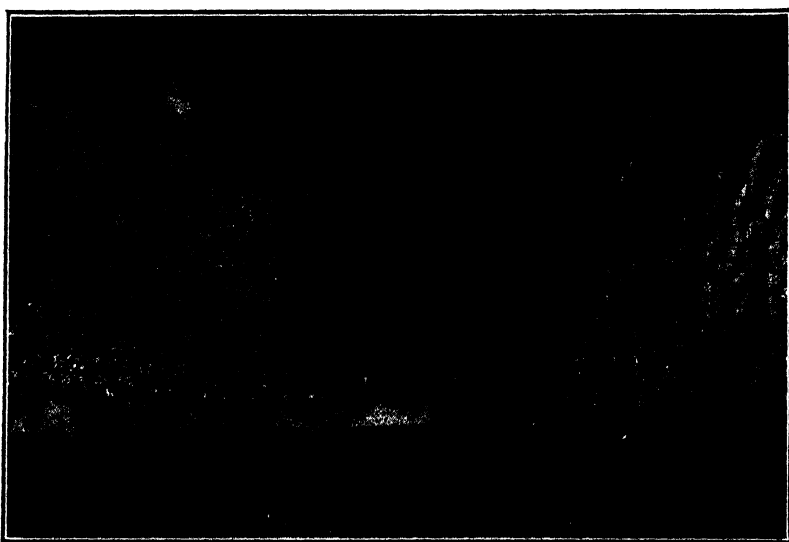

FIG. 282. Slag erosion of a boiler furnace wall. (Courtesy of Commonwealth Edison Company.)

6. Gases and Refractories. Carbon Monoxide. It has been known for a number of years that CO gas at certain temperatures weakens the structure of a firebrick. This effect is particularly noticeable in blast-furnace linings and zinc retorts. A number of investigators have studied the problem, such as Mitra and Silverman,⁽³⁹⁾ Hubbard and Rees,⁽⁴⁰⁾ and many others listed in the references. In general, it is believed that the starting point of the disintegration is the ferric oxide spots in the refractory. The ferric oxide is reduced to ferrous oxide, which acts as a catalyst to break up the CO to CO₂ and C, forming a deposit that causes the disintegration. This reaction takes place only between 420 and 470°C (788 to 878°F). It is believed by Mitra and Silverman that the magnetic oxide of iron Fe₃O₄ is not susceptible to this action.

A brick to resist CO must be either very low in iron or fired at a temperature high enough to allow the iron to combine with the silica and alumina in the brick.

Hydrocarbon Gases. A number of investigators have studied the embrittling effect of hydrocarbon gases on fireclay brick in the cracking



FIG. 283. Detail of typical slag erosion. (Courtesy of Commonwealth Edison Company.)

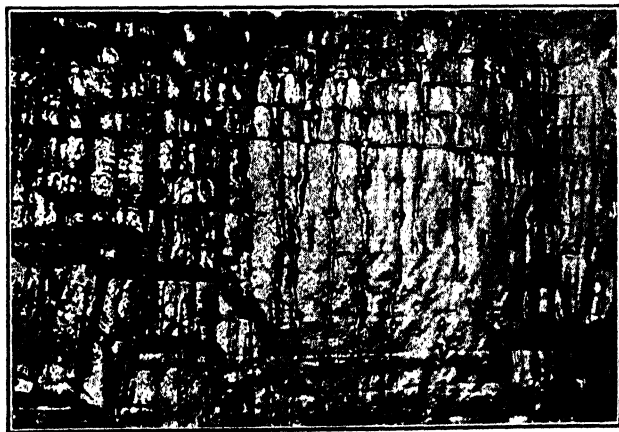

FIG. 284. Detail of slag erosion. Note the grooving effect. (Courtesy of Commonwealth Edison Company.)

range of temperature.^(50,52,56,57) The action seems to be similar to that of CO, *i.e.*, a deposition of carbon.

Steam. In some cases as in water-gas generators, steam has shown a weakening influence on refractories.

Oxygen. Silicon carbide refractories have a tendency to oxidize slowly. Many efforts have been made to prevent this by glazing the sur-

face as described by Walton⁽⁴⁵⁾ or by removing catalytic agents as described by Hartmann.⁽⁴³⁾

Chlorine. Richardson⁽⁶⁴⁾ shows that chlorine forms volatile ferric chloride, which tends to purify and in some cases weaken the refractory. Owing to the iron removal, their resistance to CO increased.

7. Reaction between Different Refractories in Contact. It is often desirable to know the maximum safe temperature at which one refractory can be heated when set on another. Our available data are not very extensive, and many factors, such as purity and atmosphere, have not been under complete control. However, Table 84 gives some data on commercial refractories, and Table 49, in Chap. X, gives data on pure materials.

TABLE 84. INITIAL REACTION TEMPERATURES, °F

| Material | Zircon | Zirconia | Magnesite | Silicon carbide | Chrome | Forsterite | Fused alumina | Kaolin | Super-duty |
|--------------------------------------|--------|----------|-----------|-----------------|--------|------------|---------------|-----------|------------|
| Zircon ⁽¹⁴⁶⁾ | | 3300 | | | | | | | |
| Magnesite ⁽¹⁴⁶⁾ | 2800 | | None | 2800 | >2800 | >2800 | >2800 | 2500-2600 | 2500-2600 |
| Zirconia | | | | | | | 3300 | | |

Remmey⁽¹⁴⁵⁾ points out that in some specimens, such as a 91 per cent alumina brick, the glassy phase may become sufficiently fluid at high temperatures to drain out of the brick and leave nearly pure alumina behind.

8. Slag Erosion in Service. The deterioration of refractories by slag is very serious in many types of installation. The action is particularly severe in boiler furnaces where low-grade coal is burned, as the slag formed is a very active flux. In many cases, the only solution to the problem is to use air or water cooling. Although it might be possible to find a more resistant refractory than fireclay brick, such as magnesite or spinel, the rapid heating and cooling of the boiler furnace make the use of these easily spalled materials impossible. Efforts should be made in the design to minimize the flow of slag over the hotter surfaces.

In Figs. 282 to 286 are shown typical boiler-furnace walls that have been eroded by slag. The vertical grooves formed by the running slag are representative. Where the melting point of the ash is high or the temperature of the furnace is low, the ash will not flow but will form a protective coating on the wall. If this coating does not build up so thickly that it tears off the face of the wall, it serves as a protection to the refractory.

The slag erosion in forging and heating furnaces by the molten mill scale is serious in the bottoms. Magnesite and chrome bottoms have been tried with considerable success under these conditions (Fig. 287).

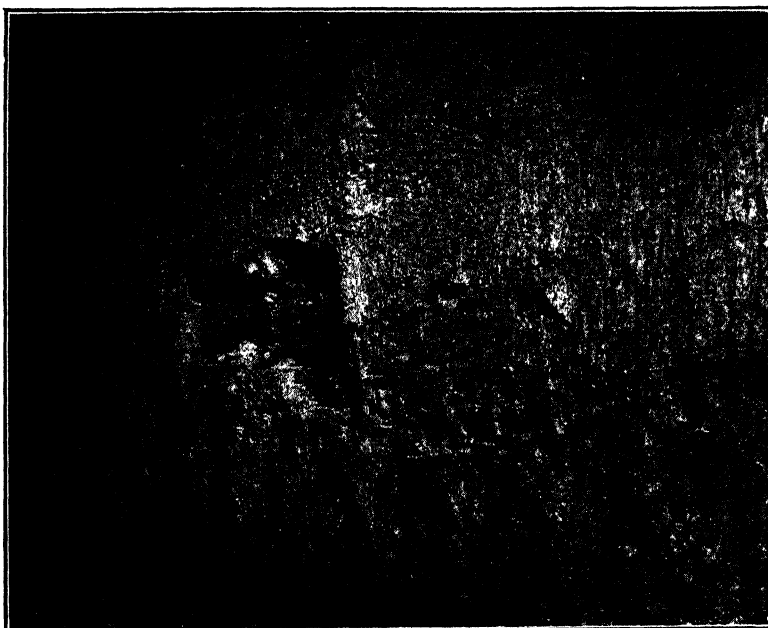

FIG. 285. A wall coated with a high-fusion-point slag. (Courtesy of Stone and Webster.)



FIG. 286. Bad grooving by slag on an inclined wall. (Courtesy of L. E. Hankison.)

In steel- and iron-melting operations, the high temperatures and activeness of the slag make the conditions for the refractory very severe. In the open hearth, the continued high temperature allows the use of magnesite or silica bottoms. Where fireclay refractories are used, as in the cupola, frequent patchings are necessary. High-alumina refractories seem to show good service in cement kilns (Fig. 288).

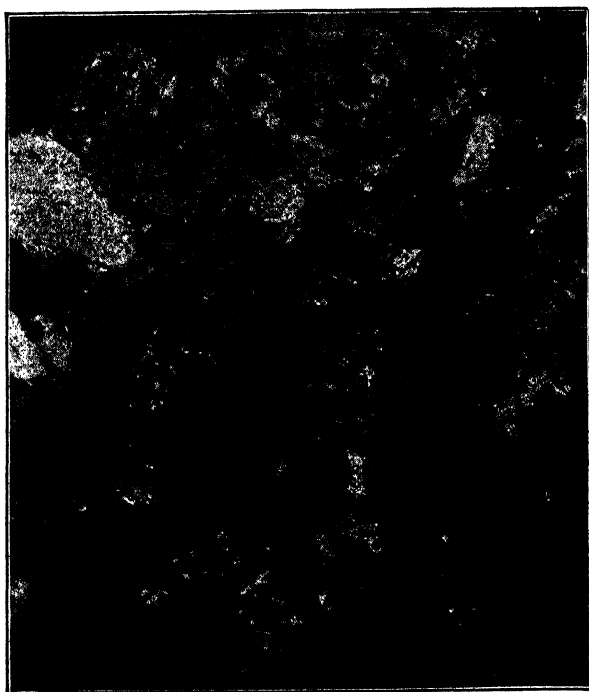

FIG. 287. Thin section of magnesite refractory which was used in a high-temperature furnace. The dark material in this section is magnesite which contains a considerable amount of iron rendering it fairly opaque. The light-colored crystals which can be seen are the result of the action of the slag on the magnesite; 60 diameters, with crossed Nicol prisms and gypsum plate.

Glass tanks are maintained at an even temperature, and rather large blocks of fireclay refractory are generally used. However, the blocks are eaten away fairly rapidly at the metal line. The action of some glasses is much more severe than others. Not only is it important to have a long life for the blocks, but it is necessary to have a material that will not form seeds or stones in the glass. The erosion of a typical glass tank is shown in Fig. 289 where the grooving of the blocks is evident. Recently, good results have been obtained with fusion-cast blocks having a high-mullite content and low porosity. The physical characteristics of the block may perhaps be more important than the chemical composition.

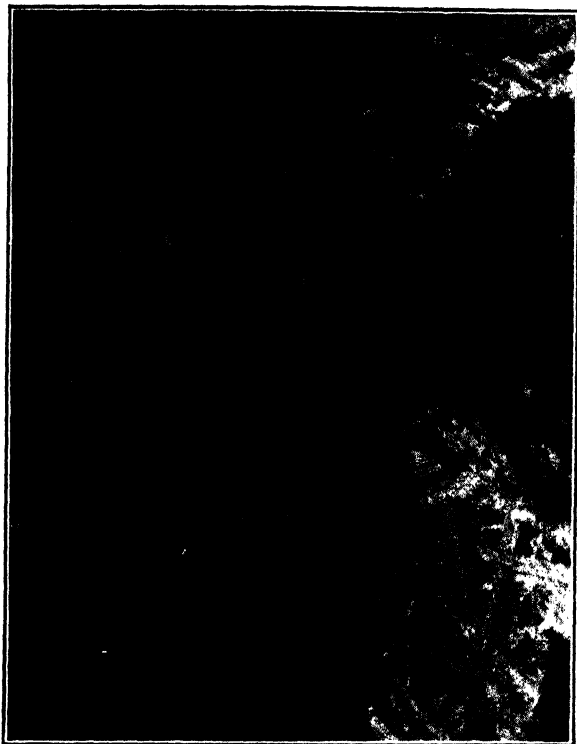

FIG. 288. Thin section of a refractory used in a rotary cement kiln. The charge has reacted to some extent with the refractory and partially eroded it, with the formation of lime feldspar. These are the light-colored crystals which appear between the grains; 250 diameters with crossed Nicol prisms and gypsum plate.

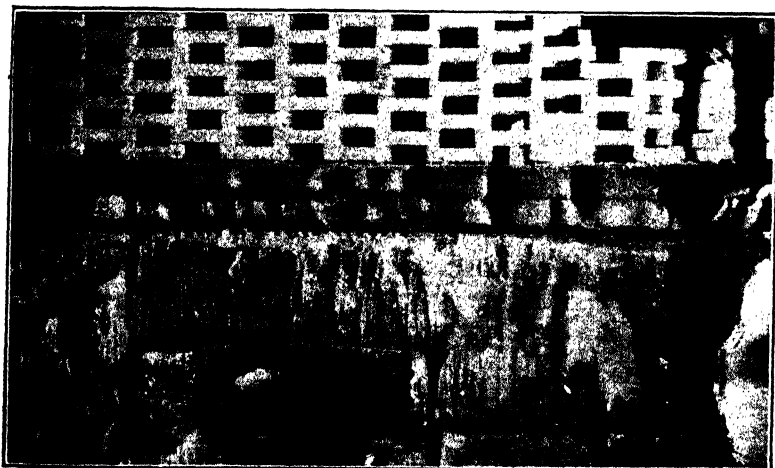

FIG. 289. Erosion of a typical glass tank.

9. Bibliography

Fundamentals of Slag Action:

1. SOSMAN, R.B.: Some Fundamental Principles Governing the Corrosion of a Fire Clay Refractory by a Glass, *J. Am. Ceram. Soc.*, **8**, 191, 1925.
2. SALMANG, H., and O. HEBESTREIT: Investigations of the Slag Resistance of Refractories, V, Relation between Slagging of Grog Bricks and Flux Content and Porosity, *Feuerfest*, **7**, 1, 1931.
3. McMULLEN, C., A.A. TURNER, and G.J. EASTER: Effect of Variations in the Alumina-Silica Ratio in Fused Refractory Materials upon Resistance to Metal Oxides, *J. Am. Ceram. Soc.*, **14**, 30, 1935.
4. FURNAS, C.C.: Kinetics of Some Reactions of Interest to Ceramists, *J. Am. Ceram. Soc.*, **19**, 177, 1936.
5. HUGILL, W., and A.T. GREEN: Action of Slags on Refractory Materials, I, Application of Tests to the Study of the Action of CaO-Al₂O₃-SiO₂ Slags on Refractory Materials, Refractory Materials Joint Committee, *Inst. Gas Engrs.*, *Twenty-eighth Rept.*, p. 44, 1937.
6. HUGILL, W., R.L. AINSWORTH, and A.T. GREEN: Action of Slags on Refractory Materials, II, Report of Refractory Materials Joint Committee, Twenty-ninth Report, *Inst. Gas Engrs. Commun.* 193, 1938.
7. ENDELL, K.: The Slagging Process of Refractory Bricks, *Ber. deut. keram. Ges.*, **19**, 491, 1938.
8. FRANKLIN, F.F.: Recent Investigations on Slags, *Blast Furnace Steel Plant*, **26**, 366; (5), 493, 1938.
9. SCHURECHT, H.G.: Reactions of Slag with Refractories, I, Surface Reactions, *J. Am. Ceram. Soc.*, **22**, 116, 1939.
10. ENDELL, K., R. FEHLING, and R. KLEY: Influence of Fluidity, Hydrodynamic Characteristics, and Solvent Action of Slag on the Destruction of Refractories at High Temperature, *J. Am. Ceram. Soc.*, **22**, 105, 1939.
11. CROOK, W.J.: The Series Iron Oxides-Silica, *J. Am. Ceram. Soc.*, **22**, 322, 1939.
12. CROOK, W.J.: The Series Iron Oxides-Lime, *J. Am. Ceram. Soc.*, **22**, 313, 1939.
13. HUGILL, W., R.L. AINSWORTH, and A.T. GREEN: Some Observations on the Corrosive Action of Lime on Aluminous, Fireclay and Silica Bricks, *Iron & Steel Inst.*, *Special Rept.* 26, p. 351, 1939.

Methods of Slag Testing:

14. HOWE, R.M.: A Study of the Slag Test, *J. Am. Ceram. Soc.*, **6**, 466, 1923.
15. HOWE, R.M.: Testing of Refractories, *Am. Soc. Testing Materials*, **6**, 269, 1923.
16. NORTON, F.H.: A Quantitative Laboratory Slag Test, *J. Am. Ceram. Soc.*, **7**, 599, 1924.
17. DALE, A.J.: The Testing of Refractory Materials for Resistance to Slag Corrosion, and Erosion, *Trans. Ceram. Soc. (Engl.)*, **25**, 326, 1925-1926.
18. HARTMANN, F.: Ein Prüfverfahren zur quantitativen Bestimmung des angriffs von Schlacke und Flugstaue auf feuerfeste Steine, *Stahl u. Eisen*, **47**, 182, 1927.
19. McDOWELL, S.J.: A Laboratory Study of Slag Erosion, *Blast Furnace Steel Plant*, **15**, 286, 1927.
20. FERGUSON, R.F.: A Review of the Literature on Laboratory Slag Tests for Refractories, *J. Am. Ceram. Soc.*, **11**, 90, 1928.
21. HURSH, R.K., and C.E. GRIGSBY: A Laboratory Furnace for Testing Resistance of Firebrick to Slag Erosion, *Univ. Illinois Bull. Circ.* 17, 1928.

22. GRIGSBY, C.E.: Effect of Typical Slags on Fire Brick with a Method of Determination Correlated to Service, *J. Am. Ceram. Soc.*, **12**, 241, 1929.
23. LECHER, O.: Method of Testing Fireclay and Silica Bricks for Resistance to Molten Slags and Glasses, *Sprechsall*, **62**, 390, 1929.
24. STROMBERG, B.W.: Furnace-testing Refractories for Slag Erosion, *Chem. Met. Eng.*, **37**, 685, 1930.
25. SCHAEFER, JOSEPH, and F. BAUMHAUER: Influence of Slag on Refractory Blocks, *Feuerfest*, **7**, 33, 1931.
26. HYSLOP, J.F., and H.C. BIGGS: Slag and Spalling Tests on Firebricks, *Trans. Ceram. Soc. (Engl.)*, **30**, 288, 1931.
27. HYSLOP, J.F., and H.C. BIGGS: The Corrosion of Refractories: A Quantitative Durability Test, *Trans. Ceram. Soc. (Engl.)*, **31**, 173, 1932.
28. VICKERS, A.F.J., and R.A. BELL: Apparatus for Investigating the Corrosive Action of Slags upon Refractory Materials, *J. Soc. Glass Technol.*, **19**, 151, 1935.
29. PATTERSON, W.E.: Practical Tests on Refractory Mixes, *J. Can. Ceram. Soc.*, **6**, 38, 1937.
30. DODD, A.E.: Notes on the Action of Slags on Refractories, and Some Methods of Testing, *Trans. Ceram. Soc. (Engl.)*, **36**, 63, 1937.
31. KRANER, H.M.: Development of a Slagging Test for Refractories, *Metals & Alloys*, **9**, 79, 1938.
32. HUGHES, R.K.: Laboratory Slagging-test Furnace with a Rotating Burner, *J. Am. Ceram. Soc.*, **22**, 354, 1939.
33. HYSLOP, J.F.: Quantitative Corrosion Test for Refractories, *Trans. Brit. Ceram. Soc.*, **41**, 165, 1942.

Action of Gases:

34. NESBIT, C.E., and M.L. BELL: Fire Brick Disintegration, *Brick & Clay Record*, **62**, 1942, 1923.
35. ANON.: Effect of Carbon Monoxide on Refractories, *Metal Ind. (London)*, **23**, 472, 1923.
36. PHELPS, S.M.: Studies of the Effect of Chlorine, Sulphur Dioxide and Carbon Monoxide upon Various Refractories, *Am. Refractories Inst., Bull.* 9, 1927.
37. DIEPSCHLAG, E., and K. FEIST: Disintegration of Blast-furnace Refractories by Carbon Monoxide, *Feuerfest*, **4**, 133, 1928.
38. KLAR, H.: Action of Reducing Gas Mixtures on Fire Brick at 1200° to 1400°C., *Keramos*, **7**, T2, 1928.
39. MITRA, H.K., and A. SILVERMAN: The Prevention of Disintegration of Blast Furnace Linings, *J. Am. Ceram. Soc.*, **11**, 278, 1928.
40. HUBBARD, D.W., and W.J. REES: The Dissociation of Carbon Monoxide in Contact with Refractory Material, *Trans. Ceram. Soc. (Engl.)*, **28**, 277, 1928-1929.
41. HUGILL, W., H. ELLERTON, and A.T. GREEN: Action of Carbon Monoxide on Refractory Materials, I, Experiments on the Disintegration of Fireclay Products by Carbon Monoxide, Refractory Materials Joint Committee, Twenty-second Report, *Inst. Gas Engrs., Commun.* 39, p. 26, 1931.
42. MARTIN, R.H.: Silicon Carbide Refractory Article: U.S. Patent 1,818,904, 1931.
43. HARTMANN, M.L.: Making Silicon Carbide Refractory Articles, U.S. Patent 1,790,474, 1931.
44. ANON.: Carbon Monoxide and Refractory Materials, *Feuerungstechn.*, **20**, 29, 1932.

45. WALTON, S.F. (Exolon Co.): Method of Applying Protective Refractory Glaze to Refractory Bodies Containing Silicon Carbide, U.S. Patent 1,868,451, 1932.
46. HIBBOTT, H.W., and W.J. REES: Influence of Cyanogen on the Reduction of Carbon Monoxide in Contact with Refractory Materials, *Trans. Ceram. Soc. (Engl.)*, **32**, 253, 1933.
47. HUGILL, W., H. ELLERTON, and A. T. GREEN: The Action of Carbon Monoxide on Refractory Materials, Part I, *Trans. Ceram. Soc. (Engl.)* **32**, 533, 1933.
48. HUGILL, W., H. ELLERTON, and A. T. GREEN: The Action of Carbon Monoxide on Refractory Materials, Part II, *Trans. Ceram. Soc. (Engl.)* **32**, 543, 1933.
49. HUGILL, W., H. ELLERTON, and A.T. GREEN: Action of Carbon Monoxide on Refractory Materials, III, Experiments with Laboratory-prepared Specimens, reprinted in *Trans. Ceram. Soc. (Engl.)*, **37**, (1) 6-11, 1938; IV, Deposition of Carbon on Certain Ferruginous Substances, *Bull. Brit. Refractory Research Assoc.*, **31**, 1933.
50. RUPRECHT, B.C., R.H.H. PIERCE, and F.A. HARVEY: A Study of the Effect of Natural Gas and of Hydrogen upon Various Refractories, *J. Am. Ceram. Soc.*, **17**, 185, 1934.
51. DODD, A.E.: The Action of Water Vapor on Silica Bricks at High Temperatures, and Its Possible Industrial Significance, *Trans. Ceram. Soc. (Engl.)*, **35**, 223, 1936.
52. ROWDEN, E.: Effect of Hydrocarbon Gases on Refractory Materials, IV, Effect of Ethylene on Refractory Materials, Refractory Materials Joint Committee, *Inst. Gas Engrs., Twenty-eighth Rept.*, p. 11, 1937.
53. HUGILL, W., H. ELLERTON, and A.T. GREEN: The Action of Carbon Monoxide on Refractory Materials, Part IV, *Trans. Ceram. Soc. (Engl.)*, **37**, 12, 1938.
54. HUGILL, W., H. ELLERTON, and A.T. GREEN: The Action of Carbon Monoxide on Refractory Materials, *Trans. Ceram. Soc. (Engl.)*, **37**, 6, 1938.
55. PUKALL, K.: Rapid Method of Testing the Resistance of Refractory Materials to Carbon Monoxide Attack, *Sprechsaal*, **71**, 321, 1938.
56. ROWDEN, E., and A.T. GREEN: The Effect of Hydrocarbon Gases on Refractory Materials, Part I, *Trans. Ceram. Soc. (Engl.)*, **37**, 75, 1938.
57. ROWDEN, E.: Effect of Hydrocarbon Gases on Refractory Materials, VI, Refractory Materials Joint Committee, Twenty-ninth Report, *Inst. Gas. Engrs., Commun.* 193, p. 20, November, 1938.
58. HARTMANN, FRITZ (Kohle- und Eisenforschung G.M.B.H.): Preventing or Lowering the Disintegration of Refractory Brick at High Temperatures by Gases, Ger. Patent 659,722, 1938.
59. BARRETT, L.R., N.E. DOBBINS, and A.T. GREEN: Action of Steam and Sulfur Dioxide on Refractory Materials: I, Action on Fire Clay at 1200°C. *Bull. Brit. Refractories Research Assoc.* **52**, p. 57, 1939; II, Action on Fire Clay at 600°C. by F. H. Clews, N. E. Dobbins, and A. T. Green, *ibid.*, p. 170.
60. LYNAM, T.R., T.W. HOWIE, and J.H. CHESTERS: Behavior of Chrome Ores and Chrome-magnesite Brick in Reducing Atmospheres, *Bull. Brit. Refractories Research Assoc.* **56**, 1940.
61. CLEWS, F.H., L.R. BARRETT, and A.T. GREEN: Action of Chlorine on Refractory Materials; IV, Effect of Chlorine Treatment on Some Properties of Fire-clay and Diatomite Products, *Bull. Brit. Refractories Research Assoc.* **61**, p. 59, 1941.
62. RIGBY, G.R., H. BOOTH, and A.T. GREEN: Disintegration of Fire-clay Products

- by Mixtures of Carbon Monoxide and Carbon Dioxide, *Bull. Brit. Refractories Research Assoc.* 59, p. 90, 1941.
63. RIGBY, G.R., H. BOOTH, and A.T. GREEN: Disintegration of Fire-clay Products by Mixtures of Carbon Monoxide and Carbon Dioxide, *Trans. Brit. Ceram. Soc.*, **43**, (4), 73, 1944.
64. RICHARDSON, H.M., F.H. CLEWS, L.R. BARRETT, and A.T. GREEN: Action of Chlorine on Refractory Materials: III, Effect of Chlorine Treatment on the Physical and Chemical Properties of Some Commercial Products, *Trans. Brit. Ceram. Soc.*, **43**, 179, 1944.
65. CLEWS, F.H., F. BALL, and A.T. GREEN: Action of Carbon Monoxide on Refractory Materials: VII, Some Aspects of the Catalytic Action of the Ferruginous Glass of Iron Spots, *Bull. Brit. Refractories Research Assoc.* 68, 1945.
66. HOWIE, T.W., and J. MACKENZIE: The Stability of Carbon Bricks in Carbon Monoxide, *Trans. Brit. Ceram. Soc.*, **46**, 161, 1947.

Action of Alkalies:

67. TURNER, D., and W.E.S. TURNER: Some Observations on the Corrosion of Fire-clay Materials, by Alkali Salts, *J. Soc. Glass Technol.*, **7**, 207, 1923.
68. WILSON, L.M.: The Effect of Salty Coal upon Refractory Materials, *Trans. Ceram. Soc. (Engl.)*, **23**, 39, 1923-1924.
69. BOOZE, M.C. and F.C. FLINT: Checker Brick for Resisting Alkaline Slags, *J. Am. Ceram. Soc.*, **7**, 594, 1924.
70. EVANS, G.S.: Effect on Refractories of Alkalies Used in Refining of Metals, *Fuels and Furnaces*, **5**, 767, 1927.
71. BARTSCH, O.: On the Action of Sodium Sulphate on Refractory Materials, *Glastech. Ber.*, **11**, 285, 1933.
72. CLEWS, F.H., A. GREEN, and A.T. GREEN: The Action of Alkalies on Refractory Materials, *Trans. Ceram. Soc. (Engl.)*, **34**, 436, 1935.
73. CLEWS, F.H., and A.T. GREEN: The Action of Alkalies on Refractory Materials, Part III, *Trans. Ceram. Soc. (Engl.)*, **36**, 225, 1937.
74. CLEWS, F.H., A. GREEN, and A.T. GREEN: The Action of Alkalies on Refractory Materials, Part II, *Trans. Ceram. Soc. (Engl.)*, **36**, 217, 1937.
75. CLEWS, F.H., M. RICHARDSON, and A.T. GREEN: Action of Alkalies on Refractory Materials, VIII, Aspects of the Action of Alkali Chlorine Vapor on Refractory Materials at 1000°C., Refractory Materials Joint Committee, *Inst. Gas Engrs., Twenty-eighth Rept.*, p. 32, 1937.
76. HARTMANN, F.: Action of Alkalies on Refractory Brick, *Stahl u. Eisen*, **57**, 1017, 1937.
77. CLEWS, F.H., W. HUGILL, and A.T. GREEN: Examination of Pronounced Alkali Attack on Silica Brickwork from a Vertical Retort, Report of Refractory Materials Joint Committee, Twenty-ninth Report, *Inst. Gas Engrs. Commun.* 193, p. 65, 1938.
78. CLEWS, F.H., H.M. RICHARDSON, and A.T. GREEN: Action of Alkalies on Refractory Materials, X-XI, Report of Refractory Materials Joint Committee, Twenty-ninth Report, *Inst. Gas Engrs. Commun.* 193, p. 9, 1938.
79. DEAR, P.S.: Study of Soda-Ash Foundry-slag Attack on the Refractory Lining of a Teapot-type, Reservoir Ladle, *Bull. Am. Ceram. Soc.*, **18**, 4, 1939.
80. CLEWS, F.H., H.M. RICHARDSON, and A.T. GREEN: Experiments on the Alterations in Strength When Refractory Materials Are Exposed to Potassium Chloride Vapour at 1000°C., *Iron & Steel Inst., Special Rept.* 26, p. 397, 1939.

81. CLEWS, F.H., H.M. RICHARDSON, and A.T. GREEN: An Examination of the Reactions of Sodium Chloride Vapour with Refractory Materials at 1000°C., and the Conditions Leading to the Volatilization of the Brick Constituents, *Iron & Steel Inst., Special Rept.* 26, p. 385, 1939.
82. CLEWS, F.H., and A.T. GREEN: The Action of Alkalies on Refractory Materials, Summary of Parts I-IX, *Iron & Steel Inst., Special Rept.* 26, p. 359, 1939.
83. GARDNER, W.T.: Attack on Refractory Materials by Alkali Chlorides, Refractories Materials Joint Committee, thirty-second Report, *Gas Research Board Commun.* 5, p. 88, 1941.
84. CLEWS, F.H., H.M. RICHARDSON, and A.T. GREEN: Action of Alkalies on Refractory Materials: XVI, Experiments on the Expansile Effect of Alkalies at 1000° to 1400°C., *Bull. Brit. Refractories Research Assoc.*, No. 61, p. 67, 1941.
85. CLEWS, F.H., H.M. RICHARDSON, and A.T. GREEN: Action of Alkalies on Refractory Materials: XVII, Cone-deformation Study of Certain Alkali-silica-alumina and Alkali-silica-alumina-ferrie Oxide Mixtures, *Bull. Brit. Refractories Research Assoc.*, No. 63, p. 1, 1942.
86. CLEWS, F.H., H.M. RICHARDSON, and A.T. GREEN: Action of Alkalies on Refractory Materials: XVI, Cone-deformation Study of Certain Alkali-silica-alumina and Alkali-silica-alumina-ferrie Oxide Mixtures, *Trans. Brit. Ceram. Soc.*, **44**, (2), 21, 1945.

Glass Attack on Refractories:

87. WILSON, G.V.: Notes on the Formation of Certain Rock-forming Minerals in and about Glass Furnaces, *J. Soc. Glass Technol.*, **2**, 197, 1918.
88. ROSE, C.I.: A Proposed Method for Studying the Attack of Molten Slags and Glasses upon Refractory Materials, *J. Am. Ceram. Soc.*, **6**, 1242, 1923.
89. INSLEY, H.: Notes on the Behavior of Refractories in Glass Melting Furnaces, *J. Am. Ceram. Soc.*, **7**, 583, 1924.
90. BARTSCH, O.: The Influence of Molten Glass on Refractory Materials, *Glustech. Ber.*, **3**, 249, 1925.
91. BARTSCH, O.: Studies of Pot Solution, *Glustech. Ber.*, **4**, 260, 286, 1926.
92. FLINT, F.C., and A.R. PAYNE: Tank Block Corrosion by Shelving, *J. Am. Ceram. Soc.*, **9**, 613, September, 1926.
93. McINTYRE, W.A.: Some Experiments on the Development of Sillimanite Refractories for Glass Making, *J. Soc. Glass Tech.*, **10**, 73, 1926.
94. ROSS, D.W.: Wearing Away of Tank Blocks, *J. Am. Ceram. Soc.*, **9**, 641, September, 1926.
95. TURNER, W.E.S.: The Attack of Arsenic Compounds on Fireclay Refractory Materials, *J. Am. Ceram. Soc.*, **9**, 412, 1926.
96. ANON.: Refractory Materials in Glass Furnaces, *Pottery Gaz.*, **51**, 1406, 1926.
97. JAESCHKE, A.: The Influence of Molten Glass on Refractory Materials, *Feuerfest*, **3**, 19, 1927.
98. REES, W.J.: Refractories for the Glass Industry, *Glass*, **4**, 468, 1927.
99. ROYER, C.: Glass Pots, *Ceram. verrerie*, **47**, 1105, 1927.
100. ANON.: Results of Tests on Tank Blocks, *Am. Glass Rev.*, **47**, 16, 1927.
101. BARTSCH, O.: Tank Block Testing, *Glustech. Ber.*, **15**, 353, 1927.
102. KAI-CHING-LU: Glass Tank Refractories and Their Chemical Relationship with the Molten Glass, *Ohio State Univ. Eng. Expt. Sta. Bull.* **44**, 1928.
103. PENDERGAST, W.L., and H. INSLEY: The Service of Refractory Blocks in a

- Small Experimental Glass Tank, *Bur. Standards, J. Research, Paper 44*, **2**, 453, 1929.
104. UHRMANN, C.J., and S.M. SLATER: The Corrosion of Tank Blocks by Opal Glasses, *J. Am. Ceram. Soc.*, **13**, 931, 1930.
105. ADAMS, G.F., and J.R. LAIT: Studies on Clay Mixtures of Glass Melting Pots. IV, the Corrosion-resisting Properties, *J. Soc. Glass Technol.*, **16**, 129, 1932.
106. BARTSCH, O.: Glass Attack on Refractory Materials, and a Method of Testing, *Ber. deut. keram. Ges.*, **15**, 281, 1934.
107. BAUDEWYNS, J.: Attack of Refractory Materials Used in Glassmaking, *Ing. chim.*, **22**, 131, 211, 1938.
108. THOMPSON, C.L., and E.P. REXFORD: Study of an Alumina-silica Checker Brick from the Regenerator of a Glass Tank, *J. Am. Ceram. Soc.*, **21**, 55, 1938.
109. REES, W.J.: Glass Tank Refractories, *Trans. Ceram. Soc. (Engl.)*, **38**, 522, 1939.
110. PARSONS, W.H., and H. INSLEY: Attack on Refractory Clay Pots by Optical Glasses, *Natl. Bur. Standards, J. Research, Research Paper RP 1689*, **36**, 31, 1946.
111. McMULLEN, J.C.: A Miniature Glass Test Tank, *Bull. Am. Ceram. Soc.*, **26**, 365, 1947.
112. HYSLOP, J.F., J. STEWART, and N. BURNS: Corrosion and Fluxing of Refractory Glass Mixtures, *Trans. Brit. Ceram. Soc.*, **46**, 377, 1947.

Coal-ash Slags:

113. WASHBURN, E.W.: The Latent Heats of Fusion of Lime and Magnesia, *Trans. Am. Ceram. Soc.*, **19**, 195, 1917.
114. WILSON, G.V.: Notes on the Formation of Certain Rock-forming Minerals in and about Glass Furnaces, *J. Soc. Glass Technol.*, **2**, 197, 1918.
115. HEWITT, L.C.: Fusion Points of Firebrick-coal-ash Mixtures, *J. Am. Ceram. Soc.*, **9**, 575, 1926.
116. SHERMAN, R.A., and E. TAYLOR: Service Factors Governing the Slagging of Boiler-furnace Refractories, *J. Am. Ceram. Soc.*, **10**, 629, 1927.
117. McDOWELL, S.J., and H.C. LEE: A Petrographic Study of Some Slags from Boiler Furnaces, *J. Am. Ceram. Soc.*, **11**, 35, 1928.
118. McVAY, T.N., and R.K. HURSH: Some Effects of Coal Ash on Refractories, *J. Am. Ceram. Soc.*, **11**, 224, 1928.
119. KLINEFELTER, T.A., and E.P. REXFORD: Action of Slags on Firebrick and Boiler-furnace Settings, *Trans. Am. Soc. Mech. Eng.*, **53**, 301, 1931.
120. SIMPSON, H.E.: An Investigation of the Action of Coal-ash Slags on Fire Brick by Microscopic Methods, *J. Am. Ceram. Soc.*, **15**, 520, 1932.
121. ENDELL, K., and C. WENS: Temperature-viscosity Relationships of Coal Slags, I, Methods of Investigation and Results, *Z. Ver. deut. Chem. (Beihelft)*, No. 12, *Angew. Chem.*, **48**, 76, 1935.
122. FETTKE, C.R., and W.E. STEWART: Slagging Action of Western Pennsylvania Coals on Different Types of Refractories in a Small Pulverized Coal Installation, *Carnegie Inst. Technol., Cooperative Bull. Mining and Met. Invest.*, **73**, 1936.
123. BAILEY, E.G.: The Action of Slag from Fuel in Boiler Furnaces, *Bull. Am. Ceram. Soc.*, **17**, 55, 1938.
124. FEHLING, R.: The Attack of Coal Slag on Refractory Bricks, *Feuerungstech.*, **26**, 33, 1938.

125. REID, W.T.: The Flow of Coal-ash on Furnace Walls, *U.S. Bur. Mines, Tech. Paper* 663, 1944.

Iron and Steel Slags:

126. ROSS, L.P.: Failure of Blast Furnace Stock Line Brick, *Iron Age*, **105**, 117, 1920.
127. MENKE, P.O.: Disintegration of Blast-furnace Linings, *Blast Furnace Steel Plant*, **10**, 116, 1922.
128. PRELLER, J., and V. KORBER: Action of Blast-furnace and Open-hearth Slags on Fire Brick and on Silica and Magnesite Bricks, *Chem. Listy*, **18**, 383, 1924.
129. SCOTT, A.: Corrosion of Steel Furnace Refractories, *Trans. Ceram. Soc. (Engl.)*, **25**, 339, 1925-1926.
130. SALMANG, H., and F. SCHICK: Investigations on the Slagging of Refractories, IV, The Corrosive Power and the Constitution of Iron-works Slags, *Stahl u. Eisen*, **50**, 1814, 1930.
131. DONOHO, C.K., and J.T. MACKENZIE: Effect of Fluxes on Cupola Linings, *Bull. Am. Ceram. Soc.*, **17**, 317, 1938.
132. KITTO, W.C.: Refractories for Bottom Cast Pouring, *Bull. Am. Ceram. Soc.*, **18**, 79, 1939.
133. HUGILL, W., and A.T. GREEN: The Application of Certain Tests to the Study of the Action of Blast-furnace Slags on Refractory Materials, *Iron & Steel Inst., Special Rept.* 26, p. 295, 1939.
134. Iron and Steel Institute: *Special Rept.* 32, 1946.

General:

135. AUDLEY, J.A.: Further Notes on Zinc Furnace Refractories, *Trans. Ceram. Soc. (Engl.)*, **18**, 468, 1918-1919.
136. HOWE, PHELPS, and FERGUSON: The Action of Slag upon Silica, Magnesite, Chrome, Diaspore and Fireclay Refractories, *J. Am. Ceram. Soc.*, **6**, 589, 1923.
137. McSWINEY, D.J.: The Action of Arsenic Compounds on Tank Blocks, *J. Am. Ceram. Soc.*, **8**, 307, 1925.
138. HARTMANN, F.: Action of Slags on Refractory Materials, *Ber. deut. keram. Ges.*, **9**, 1, 1928.
139. ANON.: Decomposition of Refractory Brick in a Copper Reverberatory Furnace, *Eng. Mining J.*, **125**, 244, 1928.
140. RIEKE, R., and W. PASCH: The Effect of Zinc Oxide on Kaolin at Different Temperatures, *Ber. deut. keram. Ges.*, **16**, 49, 1935.
141. POLE, G.R., and D.G. MOORE: Testing Refractories Against the Corrosive Action of Electric Furnace Phosphate Slags, *J. Am. Ceram. Soc.*, **19**, 259, 1936.
142. POLE, GORDON R., and W. BEINLICH, JR.: New Refractory Compositions Resistant to Molten Rock Phosphate, *J. Am. Ceram. Soc.*, **26**, 21, 1943.
143. MACHIN, J.S., and O.L. HANNA: Viscosity Studies of System CaO-MgO-Al₂O₃-SiO₂, *J. Am. Ceram. Soc.*, **28**, 310, 1945.
144. NORTON, C.L., JR., and BRADFORD HOOPER: Notes on Reaction between MgO and Various Types of Refractories, *J. Am. Ceram. Soc.*, **29**, 36, 1946.
145. REMMEY, G.H.: Mullite and High Alumina Brick, Lecture, New Jersey Ceramic Association, Dec. 12, 1947.
146. WHITE, J.: The Durability of Refractories with Special Reference to the Problem of Slag Attack, *Inst. Fuel Preprint*, February, 1947.

CHAPTER XVII

EXPANSION AND SHRINKAGE

1. Methods of Measurement. A number of different methods have been employed to determine the coefficient of thermal expansion of materials up to high temperatures. A few of the more satisfactory ones will be described.

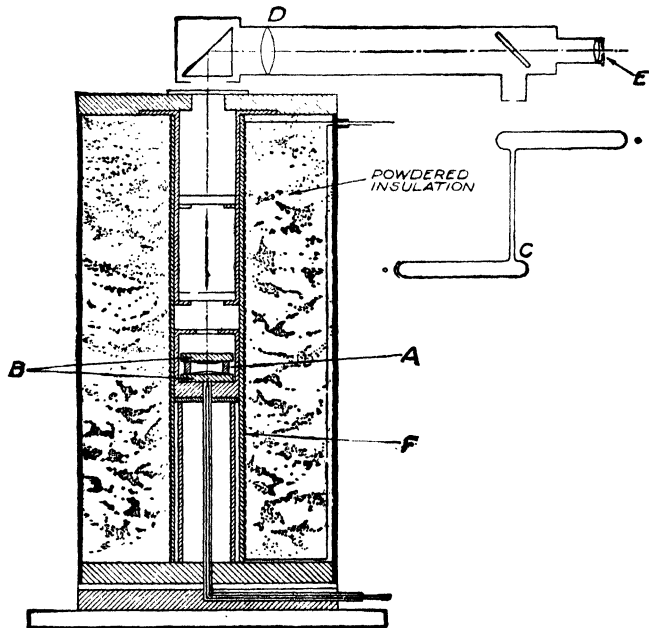

FIG. 290. Measurement of expansion with the Fizeau interferometer.

Interferometer Method. Where it is necessary to use a very small specimen, such as a section of glaze or enamel, the interference method, best illustrated by the Fizeau interferometer,^(9,45,62) is perhaps the most accurate. A cross section of this instrument is shown in Fig. 290. The specimen *A* can be in the form of a short cylinder or in three struts of equal length separating two fused quartz disks *B*, which have been polished with optically plane surfaces. Light from the vacuum tube *C* is passed through the optical system *D* and down through the quartz-disk assembly. Light is reflected from the surfaces in contact with the specimen, and the resulting

beam is passed back through the optical system to the eyepiece *E*. A series of alternating dark and light bands are produced by interference. The position of these bands is dependent upon the relative distance between the two quartz disks, and each band represents a distance of one-half wavelength of the particular light used. Of course, the more nearly parallel the plates the broader will be the bands.

When a test is made, the specimen is put in place and the instrument carefully lined up until the bands appear in the field. The heater *F* is turned on, and the temperature slowly raised to any desired value while the number of bands passing a vertical cross hair in the eyepiece are counted. From the number of bands and the wavelength of the light, the coefficient of thermal expansion of the specimen can be readily computed. The upper temperature is limited by this method to about 1000°C (about 1830°F). Disks of sapphire would permit going to temperatures of 1700°C (about 3090°F).

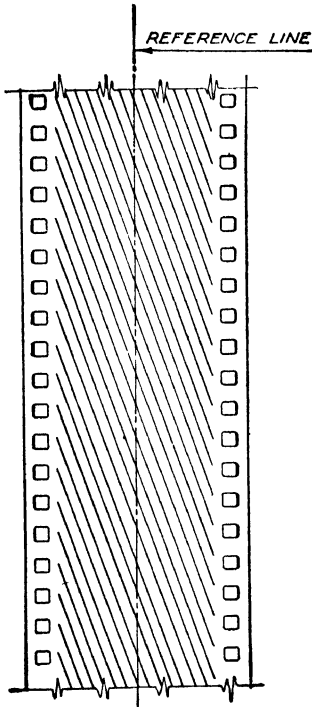

FIG. 291. Interference bands taken on a moving-picture film.

Counting the passage of the bands visually is a tedious process. Also there is the danger of missing one or more bands. Recently, several devices have been used to simplify the observation. In one case, an image of the bands and crossline is thrown on a moving strip of film, giving a set of lines as shown in Fig. 291. The number of lines and fractions crossing the reference line can readily be counted. Another method consists of using several band systems from sources having different wavelengths. By an initial and final reading on three sets of bands, the expansion can be computed without a continuous count. Since considerable manipulative skill is required to obtain good results with this instrument, it is not adapted to general plant use.

Fused-quartz-tube Method. Another method, which will permit tests to be made at slightly higher temperatures, consists of forming the specimen into a small cylinder and placing it in a quartz tube surrounded by a heater. The expansion of the cylinder is transferred outside the furnace by a fused quartz rod, the movement of which is measured by a micrometer telescope or dial.⁽³³⁾ Expansions can be measured in this way to temperatures as high as 1100°C (about 2010°F).⁽³⁾ Other experimenters have used fused-

quartz distance pieces to convey the movement to a dial micrometer. Such a device was used by Geller and Heindl.⁽¹⁹⁾

A similar method is used by Heindl⁽⁴⁶⁾ in a reducing atmosphere, where graphite can replace the fused quartz and thus allow the attainment of much higher temperatures. Distance pieces of whiteware body were used by Geller and Bunting.⁽⁶⁶⁾ Sapphire rods as distance pieces have permitted this method to be used to much higher temperatures.

High-temperature Measurements. When it is desired to obtain the coefficient of thermal expansion of a specimen at higher temperatures, a somewhat different procedure must be followed. A method developed at

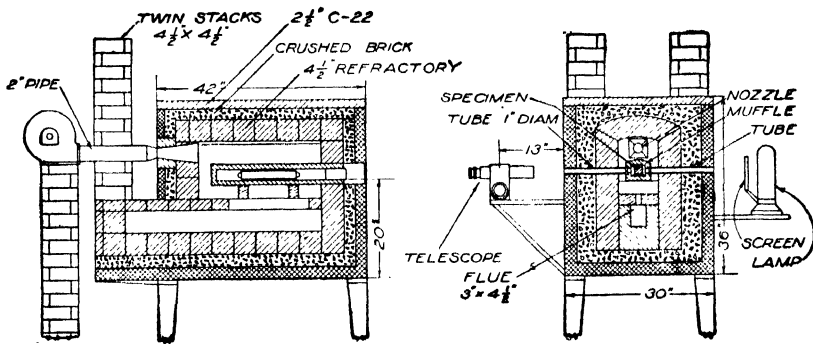

Fig. 292. Furnace used to measure the coefficient of expansion of refractories.

the Babcock & Wilcox laboratory⁽⁴⁶⁾ has proved quite satisfactory up to a temperature of 1700°C (about 3095°F). A specimen 9 in. long and 1 in. square is evenly heated, and its length measured directly with micrometer telescopes.

A drawing of the furnace is shown in Fig. 292. The specimen is placed on a level bed of loose sand composed of some refractory material, such as fused alumina. Around the specimen is a silicon carbide muffle, which ensures an even heating of the specimen. The heat is supplied to the furnace by a gas burner, the flame passing over the muffle and down around it to the exit flue and then out through the two stacks. Sight tubes pass through the furnace at the ends of the specimens and are cemented tightly to the walls of the muffle. The telescopes are sighted through these tubes across the ends of the specimen. Because of the excellent black-body conditions in the muffle, it would be quite impossible to distinguish the end of the specimen from the wall, so the sight tube is continued through on the other side of the furnace, and a powerful electric light with a ground-glass screen is placed at the end of the tube in order to provide a background brighter at all temperatures than the end of the specimen. The background must have an effective temperature higher than the highest

reached by the specimen in order to give contrast. The light should be used for all readings, for there is an apparent shift in the image when a dark background is used.

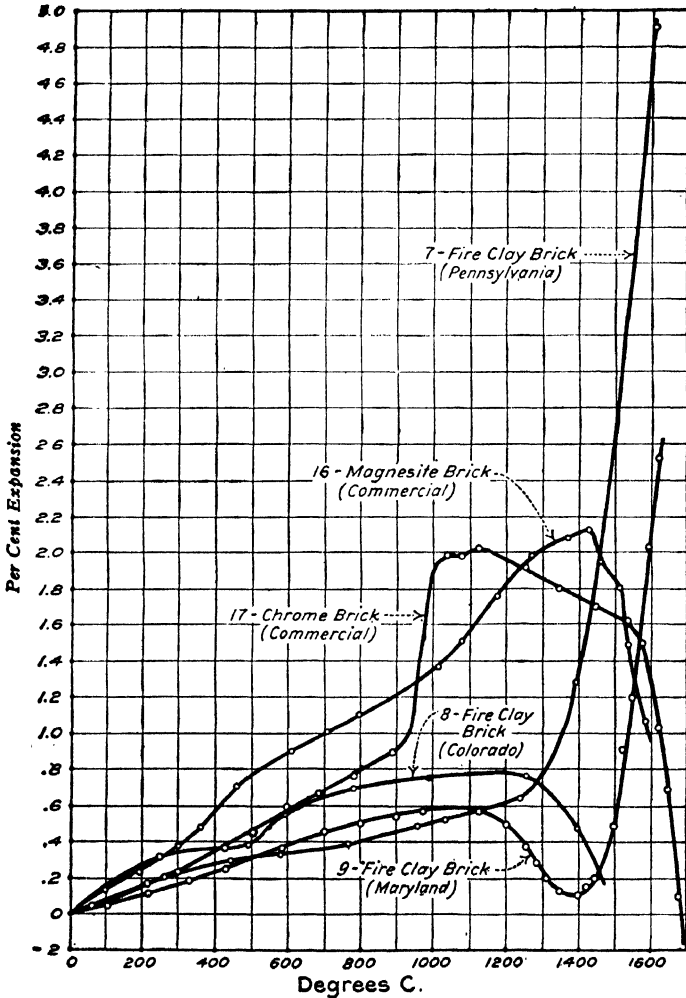

Fig. 293. Expansion curves for a number of refractories. (*J. Am. Ceram. Soc.*)

A specimen can be cut out of a standard brick with a carborundum saw; or where a brick is not available, it can be molded and burned.

To obtain an accurate reading on the end of the specimen, it is necessary to grind and polish it accurately. The telescopes contain vertical cross hairs which can be adjusted to correspond to the image of the specimen. The temperature of the specimen for the lower range is measured

with a thermocouple laid against the specimen. At high temperatures, this couple is pulled out and the temperature measured by an optical pyrometer through the sight tube. When making a test, it has been found most satisfactory to increase the temperature at a regular rate of 100°C per hr and to make measurements of the length as often as seems desirable.

This method will give a precision of measurement within ± 0.01 per cent of the length of a specimen, and the temperature can be read to $\pm 10^{\circ}\text{C}$ ($\pm 18^{\circ}\text{F}$) up to the highest temperatures. The maximum temperature of this test is limited mainly by the reaction of the specimen with its support. If the expense of building a complete furnace of the test material is justified, this reaction could be prevented and temperatures as high as 1800°C (about 3270°F) could undoubtedly be reached.

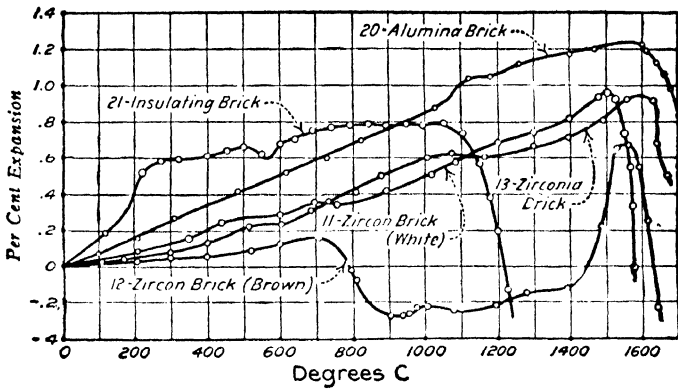

FIG. 294. Expansion curves for a number of refractories. (*J. Am. Ceram. Soc.*)

A similar type of furnace heated by globars is more convenient to operate and control than the preceding setup but is limited in maximum temperature to about 1600°C (about 2900°F).

The results from expansion tests are most conveniently plotted with the temperatures as abscissas and the percentage expansions as ordinates. From the slope of this curve, the coefficient of thermal expansion can be readily found at any temperature.

2. Expansion Characteristics of a Number of Refractory Bricks. In Figs. 293 to 297 are shown the expansion curves for a number of refractory materials. It should be kept in mind that the burning temperature markedly influences the curves, especially the temperature at which permanent shrinkage begins.

In Table 85 are summarized the main characteristics of many of these materials.

The data from expansion curves are of considerable value in determining the characteristics of a brick produced from a given material. It has

been shown that the tendency of a brick to spall, other conditions being invariable, is proportional to the coefficient of thermal expansion at the temperature where spalling occurs. This temperature range lies between 300°C (about 570°F) and 700°C (about 1290°F) in most cases; hence, the maximum coefficient of expansion in this range is a direct indicator of the spall-resisting properties of the material.

The expansion curves indicate in most cases where an allotropic change takes place in the crystal structure; *e.g.*, the curve for the silica brick shows

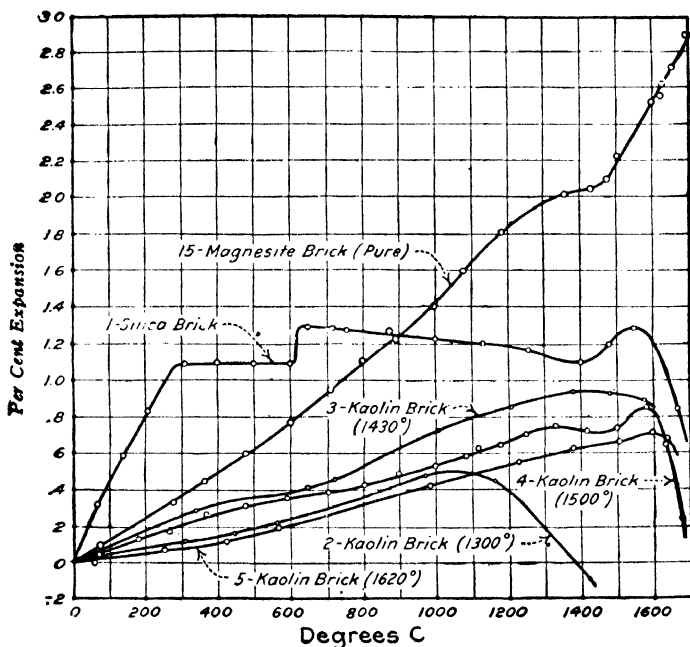

Fig. 295. Expansion curves for a number of refractories. (*J. Am. Ceram. Soc.*)

distinctly the inversion of low- to high-cristobalite around 260°C (500°F). The quartz inversion point is also sharply defined at 573°C (1062°F). The expansion of the specimen above 1470°C (about 2680°F) shows the gradual change of tridymite to cristobalite. The inversion point of quartz is shown to some extent in nearly all the fireclay bricks, indicating the presence of some free quartz in all these materials.

The temperature at which the specimen begins to shrink or expand irreversibly is of considerable importance, for it shows the approximate temperature at which the specimen is burned and also the maximum temperature at which it can be used satisfactorily in service.

The total reversible expansion of a material is of interest for the computation of the necessary expansion joints in the design of furnaces and kilns.

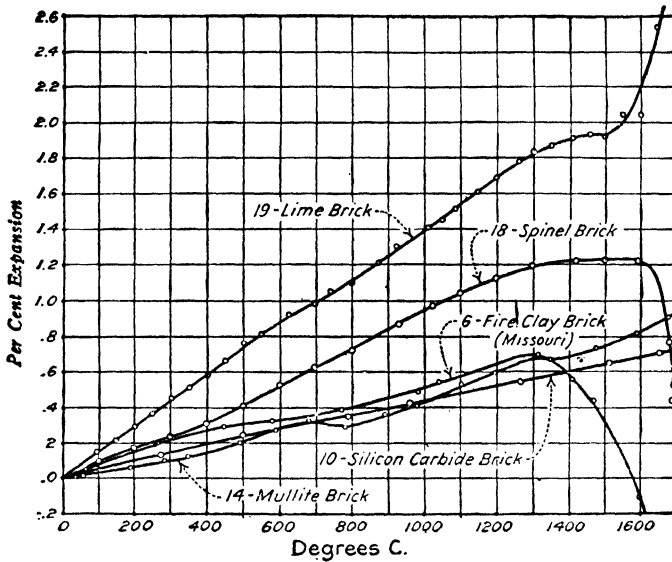

FIG. 296. Expansion curves for a number of refractories. (J. Am. Ceram. Soc.)

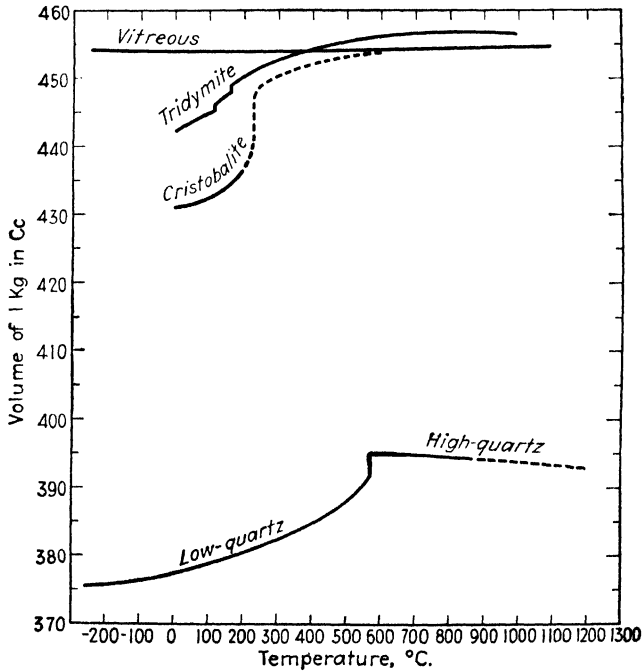

FIG. 297. Temperature-volume curves for the principal forms of silica. (R. B. Sosman, "The Properties of Silica," Chemical Catalog Company, Inc., Reinhold Publishing Corporation, New York, 1927.)

TABLE 85. THERMAL EXPANSION

| Specimen No. | Brick type | Burning temperature | | Mean coefficient of expansion between 0°C (32°F) and shrinkage temperature (per 1°C) | Maximum coefficient of expansion between 300°C (572°F) and 700°C (1292°F) (per 1°C) | Maximum irreversible contraction or expansion up to 1700°C (3092°F), per cent (- is expansion) | Inversion points | | Temperature at which shrinkage or expansion begins | |
|--------------|--------------------------------|---------------------|------|--|---|--|------------------|--------------|--|-------|
| | | °C | °F | | | | °C | °F | °C | °F |
| 1 | Silica | | | 0.0000083 | 0.0001000 | 1 | 260 to 610 | 500 to 1130 | 1550 | 2822 |
| 2 | Kaolin | 1300 | 2372 | 0.0000047 | 0.0000079 | 1 | 260 to 600 | 500 to 1112 | 1050 | 1922 |
| 3 | Kaolin | 1430 | 2606 | 0.0000068 | 0.0000087 | 1 | 260 to 600 | 500 to 1112 | 1380 | 2516 |
| 4 | Kaolin | 1500 | 2732 | 0.0000053 | 0.0000070 | 1 | 260 to 600 | 500 to 1112 | 1580 | 2876 |
| 5 | Kaolin | 1620 | 2948 | 0.0000043 | 0.0000067 | 1 | | | 1610 | 2930 |
| 6 | Fireclay (Missouri) | | | 0.0000054 | 0.0000080 | Large | 600 | 1112 | 1300 | 2372 |
| 7 | Fireclay (Pennsylvania) | | | 0.0000051 | 0.0000064 | -5 | 600 | 1112 | 1250 | 2282 |
| 8 | Fireclay (Colorado) | | | 0.0000054 | 0.0000174 | Large | 260 to 600 | 500 to 1112 | 1220 | 2228 |
| 9 | Fireclay (Maryland) | | | 0.0000045 | 0.0000080 | -3 | | | 1100 | 2012 |
| 10 | Silicon carbide | | | 0.0000043 | 0.0000048 | 0 | | | 1700+ | 3092+ |
| 11 | Zircon (white) | 1650 | 3002 | 0.0000064 | 0.0000092 | Large | 800 | 1472 | 1510 | 2750 |
| 12 | Zircon (brown) | 1390 | 2894 | 0.0000042 | 0.0000048 | 2 | 600 to 1400 | 1112 to 2552 | 1550 | 2822 |
| 13 | Zirconia | 1675 | 3047 | 0.0000059 | 0.0000087 | 1 | 800 to 1150 | 1472 to 2102 | 1600 | 2912 |
| 14 | Mullite | 1785 | 3245 | 0.0000053 | 0.0000082 | 0 | 700 to 1350 | 1436 to 2462 | 1700+ | 3092+ |
| 15 | Magnesite (pure) | 1680 | 3056 | 0.0000142 | 0.0000151 | 0 | 1430 | 2606 | 1700+ | 3092+ |
| 16 | Magnesite (Com'l) | | | 0.0000147 | 0.0000210 | 2 | | | 1440 | 2624 |
| 17 | Chromite (Com'l) | | | 0.0000104 | 0.0000124 | 2 | 1000 | 1832 | 1540 | 2804 |
| 18 | Spinel | 1690 | 3074 | 0.0000076 | 0.0000110 | 1 | | | 1600 | 2912 |
| 19 | Lime | 1740 | 3164 | 0.0000138 | 0.0000145 | 0 | 1300 | 2732 | 1700+ | 3092+ |
| 20 | Alumina | 1650 | 3002 | 0.0000077 | 0.0000082 | 1 | 1180 | 2156 | 1580 | 2876 |
| 21 | Insulating | | | 0.0000074 | 0.0000480 | Large | 200 to 570 | 500 to 1058 | 1050 | 1922 |
| 22 | Zircon (electrically fused) | | | 0.0000042 | 0.0000140 | | | | | |
| 23 | Magnesite (electrically fused) | | | 0.0000102 | 0.0000120 | | | | | |
| 24 | Topas | 1675 | 3047 | 0.0000043 | 0.0000151 | | | | | |
| 25 | Zircon (purified) | | | 0.0000038 | 0.0000151 | | | | | |

The effect of burning temperature on the coefficient of thermal expansion of clays is illustrated by the curves for kaolins. At the lowest temperature, the coefficient is low owing to the small amount of mullite development and corresponding small silica formation. Only a slight trace of the silica inversion points is present. At a burning temperature of 1430°C (about 2600°F), the thermal-expansion coefficient is much higher and the inversion points are quite prominent as a result of the breaking down of the silicates to form mullite and some free silica. At 1500°C (about 2730°F), the coefficient is reduced because of the initial combination of the free silica into glass. At 1620°C (about 2950°F), the free silica has almost entirely changed to glass, giving a low coefficient.

It may be concluded that magnesite, chrome, and lime have high mean coefficients of thermal expansion. Silica, alumina, and spinel have intermediate values, whereas clays, zirconia minerals, mullite, and silicon carbide generally have low values. In regard to the coefficient of expansion in the spalling range, silica shows much the highest value. Magnesite, chrome, lime, and spinel also have high values, as their sensitiveness to spalling would lead us to believe. Clays, alumina, mullite, zirconia minerals, and silicon carbide have lower values.

The more recent results of Heindl⁽⁴⁶⁾ made in a reducing atmosphere are substantially the same as those given here, except in the case of chromite where a difference was noted.

3. Expansion of Silica Minerals. The thermal-expansion characteristics of the various forms of silica are of interest, because the inversion points are clearly shown. An expansion curve of a silica refractory will indicate roughly the constituents present. In Fig. 297 are shown expansion curves of the four forms of silica. The low expansion of the quartz glass and the sudden changes at the inversion points are noteworthy. All the high-temperature forms of silica have a low coefficient of expansion.

The volume of all forms of silica is comparatively constant above 600°C (about 1100°F); therefore no spalling troubles will be encountered if the furnace is never allowed to fall below this temperature. Open-hearth steel furnaces, for example, which are constructed to a considerable extent of silica brick, experience large and sudden temperature changes. The temperature, however, is never allowed to fall below 600°C (about 1100°F) or 800°C (about 1470°F) even for repairs.

Unfortunately, quartz glass is not stable above about 1200°C (about 2190°F). If it were, a refractory extremely resistant to temperature changes could be made of it.

4. Expansion of Other Refractory Materials. In Table 86 are given the coefficients of thermal expansion of a number of other refractory materials. It should be remembered that zirconia has a transformation at 1000°C

TABLE 86. COEFFICIENT OF THERMAL EXPANSION OF HIGH-FUSING CRYSTALS

| Material | Temperature range | | Coefficient of thermal expansion per °C | Authority |
|---|-------------------|---------|---|---------------------------------------|
| | °C | °F | | |
| Alumina, fused, recrystallized... | 25-800 | 77-1472 | 7.9×10^{-6} | Merritt ⁽⁹⁾ |
| Sapphire, principal axis..... | 20-1000 | 68-1832 | 9.0 | Austin ⁽⁴⁰⁾ |
| Sapphire, ⊥ principal axis..... | 20-1000 | 68-1832 | 8.3 | Austin ⁽⁴⁰⁾ |
| Magnesium oxide, fused..... | 25-800 | 77-1472 | 13.4 | Merritt ⁽⁹⁾ |
| Magnesium oxide, single crystal. | 25-1000 | 77-1832 | 13.8 | Austin ⁽⁴⁰⁾ |
| Mullite, aggregate..... | 20-1430 | 68-2552 | 5.3 | Heindl ⁽⁴⁰⁾ |
| Mullite, principal axis..... | 20-1000 | 68-1832 | 5.7 | Austin ⁽⁴⁰⁾ |
| Mullite, ⊥ principal axis..... | 20-1000 | 68-1832 | 4.5 | Austin ⁽⁴⁰⁾ |
| Zircon, principal axis..... | 20-800 | 68-1472 | 6.2 | Austin ⁽⁴⁰⁾ |
| Zircon, ⊥ principal axis..... | 20-800 | 68-1472 | 3.7 | Austin ⁽⁴⁰⁾ |
| Zirconia, principal axis..... | 25-800 | 77-1472 | 8.1 | Merritt ⁽⁹⁾ |
| Zirconia, ⊥ principal axis..... | 25-800 | 77-1472 | 7.3 | Merritt ⁽⁹⁾ |
| Zirconia, aggregate..... | 25-800 | 77-1472 | 6.2 | Merritt ⁽⁹⁾ |
| Zirconia, principal axis..... | 20-900 | 68-1652 | 5.7 | Austin ⁽⁴⁰⁾ |
| Zirconia, ⊥ principal axis..... | 20-900 | 68-1652 | 8.9 | Austin ⁽⁴⁰⁾ |
| Chromite, single crystal..... | 20-1000 | 68-1832 | 8.1 | Austin ⁽⁴⁰⁾ |
| Thoria, aggregate..... | 25-800 | 77-1472 | 9.3 | Merritt ⁽⁹⁾ |
| ZnO·Al ₂ O ₃ , aggregate..... | 25-800 | 77-1472 | 8.9 | Chesters and Parmelee ⁽⁶⁰⁾ |
| MgO·Al ₂ O ₃ , aggregate..... | 25-800 | 77-1472 | 8.0 | Chesters and Parmelee ⁽⁶⁰⁾ |
| FeO·Al ₂ O ₃ , aggregate..... | 25-800 | 77-1472 | 8.6 | Chesters and Parmelee ⁽⁶⁰⁾ |
| MnO·Al ₂ O ₃ , aggregate..... | 25-800 | 77-1472 | 7.1 | Chesters and Parmelee ⁽⁶⁰⁾ |
| ZnO·Cr ₂ O ₃ , aggregate..... | 25-800 | 77-1472 | 10.1 | Chesters and Parmelee ⁽⁶⁰⁾ |
| MgO·Cr ₂ O ₃ , aggregate..... | 25-800 | 77-1472 | 9.3 | Chesters and Parmelee ⁽⁶⁰⁾ |
| FeO·Cr ₂ O ₃ , aggregate..... | 25-800 | 77-1472 | 8.5 | Chesters and Parmelee ⁽⁶⁰⁾ |
| BaO·Al ₂ O ₃ , aggregate..... | 25-1000 | 77-1832 | 7.5×10^{-6} | Henry ⁽⁷⁸⁾ |
| 2BeO·SiO ₂ , aggregate..... | 25-1000 | 77-1832 | 6.4×10^{-6} | Henry ⁽⁷⁸⁾ |
| CoO·Al ₂ O ₃ , aggregate..... | 25-1000 | 77-1832 | 8.5×10^{-6} | Henry ⁽⁷⁸⁾ |
| MnO·Cr ₂ O ₃ , aggregate..... | 25-800 | 77-1472 | 9.2 | Chesters and Parmelee ⁽⁶⁰⁾ |
| ZnO·Fe ₂ O ₃ , aggregate..... | 25-800 | 77-1472 | 9.7 | Chesters and Parmelee ⁽⁶⁰⁾ |
| MgO·Fe ₂ O ₃ , aggregate..... | 25-800 | 77-1472 | 12.7 | Chesters and Parmelee ⁽⁶⁰⁾ |
| FeO·Fe ₂ O ₃ , aggregate..... | 25-800 | 77-1472 | 15.5 | Chesters and Parmelee ⁽⁶⁰⁾ |
| MnO·Fe ₂ O ₃ , aggregate..... | 25-800 | 77-1472 | 11.0 | Chesters and Parmelee ⁽⁶⁰⁾ |
| 90 per cent cordierite, aggregate. | 20-308 | 68-586 | 1.0 | Geller and Insley ⁽⁴⁴⁾ |
| 80 per cent forsterite, aggregate. | 20-304 | 68-579 | 8.3 | Geller and Insley ⁽⁴⁴⁾ |
| Beryl, principal axis..... | 20-300 | 68-572 | 2.2 | Geller and Insley ⁽⁴⁴⁾ |
| Beryl, ⊥ principal axis..... | 20-265 | 68-509 | 1.0 | Geller and Insley ⁽⁴⁴⁾ |
| 95 per cent zinc orthosilicate... | 20-350 | 68-662 | 1.6 | Geller and Insley ⁽⁴⁴⁾ |
| Zinc aluminate..... | 20-525 | 68-977 | 7.7 | Geller and Insley ⁽⁴⁴⁾ |
| Celsian, 90 per cent..... | 20-400 | 68-752 | 3.4 | Geller and Insley ⁽⁴⁴⁾ |
| Anorthite, 96 per cent..... | 20-300 | 68-572 | 4.3 | Geller and Insley ⁽⁴⁴⁾ |
| Ceria, aggregate..... | 800 | 1472 | 8.6 | Henry ⁽⁷⁸⁾ |
| ZrO ₂ ·Cr ₂ O ₃ , aggregate..... | 800 | 1472 | 5.4 | Henry ⁽⁷⁸⁾ |
| SnO ₂ , aggregate..... | 800 | 1472 | 3.3 | Henry ⁽⁷⁸⁾ |
| ZrO ₂ ·P ₂ O ₅ , aggregate..... | 800 | 1472 | 0.5 | Henry ⁽⁷⁸⁾ |
| Thoria, aggregate..... | 100-500 | 212-932 | 9.0 | Geller ⁽⁷⁴⁾ |
| Beryllia, aggregate..... | 20-1400 | 60-2562 | 9.3 | Norton |
| Beryllia, aggregate..... | 800 | 1472 | 8.3 | White and Shremp ⁽⁶⁶⁾ |
| Titania, aggregate..... | 100-500 | 212-932 | 7.0 | Geller ⁽⁷⁴⁾ |
| Chromic oxide, aggregate..... | 100-500 | 212-932 | 7.0 | Pole <i>et al.</i> ⁽⁷⁶⁾ |
| Chromic oxide, aggregate..... | 100-500 | 212-932 | 12.0 | Henry ⁽⁷⁸⁾ |

(about 1800°F) accompanied by a large volume change. However, this transformation may be partially or wholly prevented by stabilizers added to the lattice as discussed in Chap. XII.

5. Reheat Shrinkage of Refractories. To determine the fitness of a particular brick for service, it is often tested for shrinkage under temperature conditions equivalent to those which it would receive in use. This after-shrinkage may be determined by the bar method, as described earlier in this chapter, which has the advantage of giving a continuous record of the shrinkage throughout the range of temperatures, but often it is desirable to make a test on a whole brick.

This is done by first determining the length or volume of the brick by measurement and then subjecting it to a prolonged heating at the desired temperature. After the brick has cooled, it is again measured and the length, volume, and shrinkage determined.

The standard ASTM test for reheat shrinkage is as follows:

STANDARD METHOD OF TEST FOR PERMANENT LINEAR
CHANGE AFTER REHEATING OF REFRACTORY BRICK

ASTM Designation: C 113-36¹

ADOPTED, 1936; REVISED, 1946

This standard of the American Society for Testing Materials is issued under the fixed designation C 113; the final number indicates the year of original adoption or, in the case of revision, the year of last revision.

1. Scope. This method of test covers a procedure for determining the permanent linear change of certain types of refractory materials when heated under prescribed conditions.

2. Apparatus. The apparatus shall consist of a kiln of the down-draft type and of such design as not to permit the flame to impinge directly from the burner upon the test specimens. The kiln atmosphere during the test shall be kept as oxidizing as is practicable.

3. Test Specimens. *a.* The test specimens shall consist of three standard 9-in. brick ($9 \times 4\frac{1}{2} \times 2\frac{1}{2}$ in.) or three pieces of these dimensions cut out of larger shapes.

b. Each test specimen shall be labeled with ceramic paint and carefully measured for length before and after reheating. The measurements shall be made by the use of a firm joint caliper and a steel rule. The calipering shall be done at the center of each end, and the dimension shall be measured to the nearest 0.02 in., or 0.5 mm.

4. Location of Test Specimens in Kiln. The test specimen shall be placed in the kiln so that each will rest on a 9 by $2\frac{1}{2}$ -in. face and only one course high. Each specimen shall be placed upon the 9 by $2\frac{1}{2}$ -in. face of a supporting brick

¹ ASTM Standards are subject to revision. The Society's headquarters, in Philadelphia, may be consulted for the latest information.

TABLE 87. CHANGE IN LINEAR DIMENSIONS ON REHEATING*

| Brick | Per cent of change after heating | |
|-------------------|----------------------------------|-------------------------------|
| | 5 hr. at 1400°C. (2557°F.)† | 5 hr. at 1500°C. (2732°F.) |
| Pennsylvania..... | 0.7 | 2.1 |
| | -0.6 | |
| | 0.1 | |
| | 0.3 | |
| | 1.3 | |
| | 0.1 | |
| | -1.6 | |
| | 0.8 | |
| | 0.3 | |
| | 0.2 | |
| | 0.1 | |
| | -1.8 | |
| | -0.2 | |
| | 1.1 | |
| 1.4 | 2.6 | |
| Missouri..... | -0.3 | -0.4 |
| | -0.8 | -0.7 |
| | 0.3 | |
| | 0.8 | |
| | -0.2 | |
| | 0.1 | |
| | -0.1 | |
| | -0.2 | |
| | -0.2 | |
| | -0.1 | |
| -0.4 | | |
| Kentucky..... | 1.7 | 4.5 |
| California..... | 0.0 | |
| | -0.2 | |
| Maryland..... | 0.0 | |
| | 0.2 | |
| | 0.3 | |
| | 0.3 | |
| | 0.0 | |
| Colorado..... | 0.3 | |
| Colorado..... | -0.7 | -1.2 |
| New Jersey..... | 0.1 | -0.8 |
| New Jersey..... | 0.2 | -1.7 |

* Heat Measurements Laboratory, Massachusetts Institute of Technology.

† Negative sign indicates shrinkage.

which shall be from the same lot as the test specimen or at least of equal refractoriness. There shall be placed between the test specimen and the supporting brick a layer of calcined diaspore, kyanite, or fused alumina ground to pass a No. 20 (840 μ) ASTM sieve (equivalent to mesh No. 20 of the Tyler standard series). Each specimen shall be placed so as to be not closer than $1\frac{1}{2}$ in. from other test specimens or the furnace wall.

5. Temperature Measurement. *a.* The temperature within the kiln shall be measured by means of a platinum-platinum-rhodium thermocouple and a potentiometer, preferably a recording potentiometer. The hot junction of the couple shall be placed so as to register the temperature of the test specimens. The kiln shall be of uniform temperature over the hearth and shall be checked from time to time by means of cones and they shall not show a difference of more than one cone. At 2560°F (1405°C), the thermocouple should be withdrawn and an optical pyrometer shall be used. The sighting shall be directed upon one of the test specimens.

b. During the constant temperature period of the test, the temperature as measured by the thermocouple shall not be allowed to vary by more than $\pm 10^\circ\text{C}$ and, in the case of the optical pyrometer, $\pm 15^\circ\text{C}$. Temperature readings shall be made at intervals not greater than 15 min.

6. Test Temperature Schedules. The kiln shall be operated so as to conform to the temperature schedule specified for the particular test to be conducted. Heating schedules for various classes of refractories are shown in the following table:

HEATING SCHEDULE FOR REHEAT TEST OF VARIOUS TYPES OF REFRACTORIES

| Elapsed time from start of heating, hr. | Temperature of test specimen, °C. | | | |
|---|------------------------------------|------------------------------------|------------------------------------|------------------------------------|
| | Schedule A | Schedule B | Schedule C | Schedule D |
| 1 | Between 700–800 | Between 900–1000 | Between 900–1000 | Between 825 and 925 |
| 2 | Between 1075–1125 | Between 1275–1325 | Between 1275–1325 | Between 1225 and 1275 |
| 3 | 1200 \pm 10 maintained for 5 hr. | 1400 \pm 10 maintained for 5 hr. | Between 1450–1500 | 1350 \pm 10 maintained for 5 hr. |
| 4 | | | Between 1550–1575 | |
| 5 | | | 1600 \pm 15 maintained for 5 hr. | |

7. Cooling. After completion of the heating period the test specimens shall be allowed to cool in the closed kiln for a period of at least 10 hr.

8. Calculation. The test specimens shall be remeasured after rubbing the ends with an abrasive block to remove small blisters. The percentage linear change based upon the original length shall be calculated and reported as the average value of the three test specimens.

In Table 87 are given some values for typical fireclay bricks under the standard test conditions. A few values are also given at 1500°C (2732°F).

It is interesting to notice that this test indicates an expansion as often as a shrinkage. This reheat volume increase is known both as "secondary expansion" and "afterexpansion." At the higher temperature, the shrinkage or expansion is usually increased; but in some cases, there is little change; and in others, an actual reversal in sign occurs.

Another test that determines the aftershrinkage of a brick is the simulative service test used by the U.S. Navy. According to the description by Rogers,⁽³¹⁾ it consists in building up two walls of a furnace, one of the brick to be tested and the other of a standard brick. The furnace is then run for 24 hr at a temperature of 1590°C (about 2900°F) and again at 1650°C (about 3000°F), with an examination of the walls between the tests. An examination of the wall after it is cooled will indicate by the width of the open joints the approximate shrinkage of the bricks. The photographs in Figs. 298 and 299 show typical walls. This test is, of course, not quantitative, but it does more or less correspond to actual service conditions. It is believed that a wall which shrinks a small amount at each joint is better than a wall which concentrates its shrinkage into a few large cracks. It should also be realized that a wall may have a considerable amount of open joints when cool and yet be substantially tight when at a high temperature.

As previously mentioned, bricks may show either an expansion or a shrinkage when heated to the temperatures of service. In general, bricks are not burned so high in the process of manufacture as the temperature of service; consequently, with the usual type of clay, the brick will decrease in volume at service temperatures. This is undesirable, especially in crowns and arches, because the open joints resulting give corners for spalling and slag erosion to start. The open cracks also concentrate the load in the arch on a relatively small area of the block, which greatly decreases the stability of the structure. A slight expansion is not particularly harmful if the wall or arch is properly designed.

Theory of Secondary Expansion. There are three phenomena that may produce an increase in volume of ware subjected to the reheat test. They are

1. Overfiring, *i.e.*, development of a vesicular structure, or bloating.
2. Opening of the laminations of the clay.
3. Transformations or reactions in the crystalline phases during the firing, yielding products of lower true density than the reactants.

In general, these phenomena take place in certain definite temperature ranges. When the temperature at which a brick is first fired is below this range, the brick may expand if subjected to a reheat temperature in the expansion range. When the temperature of the initial firing is in the expansion range, the ware may shrink, expand, or stay constant in volume in the reheat test, depending upon the time and the atmosphere of firing.

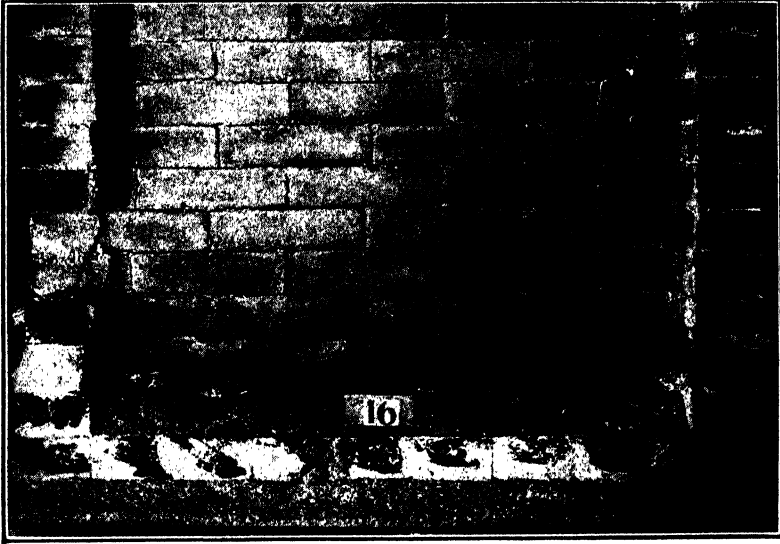

FIG. 298. Simulative service test, after a 1650°C (3000°F) heat. Bricks in fair condition.

The reactions that take place to cause overfiring have been discussed in Chap. VIII. Overfiring occurs in certain clays, especially plastic clays, and it is probable that the decomposition of some materials, perhaps sulfides and sulfates, is inhibited so gases are not given off until a temperature

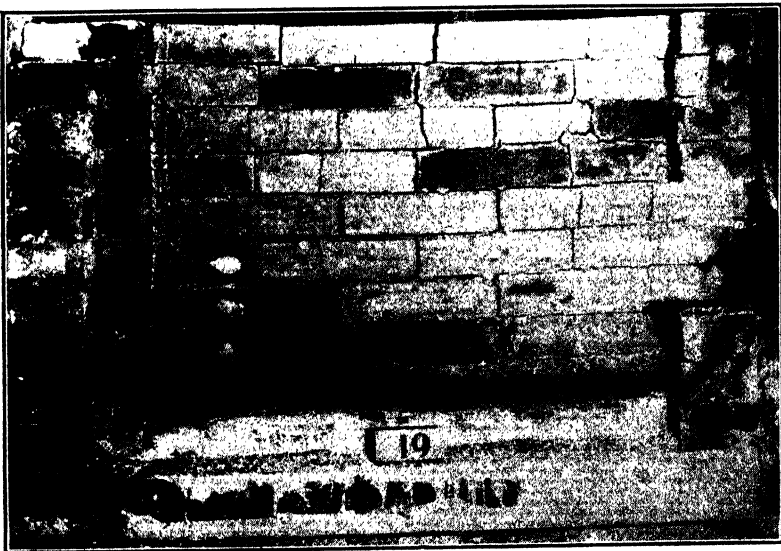

FIG. 299. Simulative service test, after a 1650°C (3000°F) heat. Bricks in poor condition.

near the fusion point is reached. These gases form bubbles in the glassy portion of the clay, and an expansion may result.

True secondary expansion may be caused by either 2 or 3 above. The former was investigated by Everhart,⁽⁶⁰⁾ who concluded that the increase in bulk volume was due to the opening of natural laminations or bedding planes in the clay grains. Fine grinding, blending of expanding and shrinking clays, slow firing, oxidizing atmosphere, and high forming pressure are suggested as means to decrease or eliminate the tendency to expand. This secondary expansion is characteristic of many clay deposits. The secondary expansion of the fireclay bricks given in Table 87 is undoubtedly due to the opening of the laminations in the clay grains. Reference should also be made to the paper on this subject by Heindl and Mong.⁽⁶³⁾

The discussion of the changes in kyanite during heating and the firing properties of clay-kyanite bodies in Chap. VIII is an excellent example of secondary expansion due to 3 above. Referring to curve *D* in Fig. 118 of Chap. VIII, it is clear that a brick of that composition fired first at 2400°F (about 1320°C) would show considerable expansion if reheated at 2700°F (about 1480°C). However, if the reheat temperature were above 2950°F (about 1620°C), shrinkage would result.

The expansion of refractories having high-alumina grog (corundum and mullite) bonded with fireclay or kaolin is due to transfer of silica into the grog grains by diffusion, which converts some of the corundum to the more bulky mullite, as clearly shown by Hall.⁽⁶⁸⁾

The role of sulfur in controlling the volume changes in reheat tests is discussed by Lesar⁽⁷⁶⁾ and his associates. They show that soluble sulfur compounds added to the clay can be made to compensate for the shrinkage of the normal clay or can be made to produce considerable expansion.

6. Bibliography

1. GOODWIN, H.M., and R.D. MAILEY: On the Physical Properties of Fused Magnesium Oxide, *Trans. Am. Electrochem. Soc.*, **9**, 89, 1906.
2. HODSMAN, H.J., and J.W. COBB: The Reversible Expansion of Refractory Material, *J. Soc. Glass Technol.*, **3**, 201, 1919.
3. ROSS, D.W.: Silica Refractories: Factors Affecting Their Quality and Methods of Testing the Raw Materials and Finished Ware, *Natl. Bur. Standards, Tech. Paper* 116, 1919.
4. McDOWELL, J.S., and R.M. HOWE: Magnesite Refractories, *J. Am. Ceram. Soc.*, **3**, 185, 1920.
5. LOOMIS, G.A.: Porosity and Volume Changes of Clay Fire Bricks at Furnace Temperatures, *Natl. Bur. Standards, Tech. Paper* 159, 1920.
6. HOULDSWORTH, H.S., and J.W. COBB: The Reversible Thermal Expansion of Silica, *Trans. Ceram. Soc. (Engl.)*, **21**, 227, 1921-1922.
7. HOULDSWORTH, H.S., and J.W. COBB: The Reversible Thermal Expansion of Refractory Materials, *J. Am. Ceram. Soc.*, **6**, 645, 1923.

8. HOULDSWORTH, H.S.: Note on the Influence of Rapid Cooling on the Reversible Expansion of Fire Clay, *J. Soc. Glass Technol.*, **8**, 30, 1924.
9. MERRITT, G.E.: Application of the Interferometer to Measurements of the Thermal Dilation of Ceramic Materials, *Natl. Bur. Standards, Sci. Paper* 19, p. 357, 1924.
10. STEGER, W.: The Significance of the Thermal Expansion Coefficients for the Stability of Ceramic Bodies and Their Raw Material toward Temperature Change, *Sprechsaal*, **57**, 26, 1924.
11. HARVEY, F.A.: Note on Secondary Expansion of Flint Clay, *J. Am. Ceram. Soc.*, **7**, 455, 1924.
12. HIRSCH, H., and M. PULFRICH: Neues Verfahren zur Ermittlung der Ausdehnung in höherer Temperatur, *Tonind.-Ztg.*, **49**, 452, 1925.
13. REES, W.J.: The True Specific Gravity and After-expansion of Lime-bonded Silica Bricks, *Trans. Ceram. Soc. (Engl.)*, Vol. 24, 1924-1925.
14. RHEAD, T.F.E., and R.E. JEFFERSON: Notes on: (1) Testing for Refractoriness and After-contraction; (2) A Few Experiences with Refractories in Vertical Retorts, *Gas J.*, **171**, 31, 1925.
15. STEGER, W.: An Apparatus for the Indication of the Thermal Expansion of Ceramic Materials, *Sprechsaal*, **58**, 48, 1925.
16. NORTON, F.H.: The Thermal Expansion of Refractories, *J. Am. Ceram. Soc.*, **8**, 799, 1925; Discussion in *Bull. Am. Ceram. Soc.*, **5**, 215, 1926.
17. WOOD, J.F.L., H.S. HOULDSWORTH, and J.W. COBB: The Influence of Foreign Matter on the Thermal Expansion and Transformation of Silica, *Trans. Ceram. Soc. (Engl.)*, **25**, 289, 1925-1926.
18. BECKER, K.: Eine röntgenographische Methode zur Bestimmung des Wärmeausdehnungs-koeffizienten bei hohen Temperaturen, *Z. Physik*, **40**, 37, 1926.
19. GELLER, R.F., and R.A. HEINDL: Progress Report on the Investigation of Sagger Clays—Some Observations as to the Significance of Their Thermal Expansions, (II), *J. Am. Ceram. Soc.*, **9**, 555, 1926.
20. MERRITT, G.E.: The Thermal Expansion of Some Fused Oxides Used as Refractories, *Trans. Am. Electrochem. Soc.*, **50**, 165, 1926.
21. PHELPS, S.M.: A Study of the Shrinkage of Diaspore Clays, (I), *J. Am. Ceram. Soc.*, **9**, 659, 1926.
22. ENDELL, K., and E. PFEIFFER: The Structure of Silica Brick Used in Coke Ovens, *Stahl u. Eisen*, **47**, 100, 1927.
23. KIEFFER, E.: Concerning the Expansion Behavior of Raw Sagger Materials Containing Quartz, *Ber. deut. keram. Ges.*, **8**, 73, 1927.
24. HIDNERT, P., and W.T. SWEENEY: Thermal Expansion of Graphite, *Natl. Bur. Standards, Tech. Paper* 335, 1927.
25. MIEHR, W., J. KRATZERT, and H. IMMKE: Die Bedeutung der thermischen Ausdehnung für die Beurteilung feuerfester Baustoffe, *Tonind.-Ztg.*, **51**, 417, 1927.
26. SCHONERT, K.: Die Wermeausdehnung von Feuerfesten Baustoffe, *Arch. Eisenhüttenw.*, **1**, 379, 1927.
27. BOOZE, M.C.: Shrinkage of Fireclay Refractories, *Refractories J.*, **3**, 687, 1928.
28. COHN, W.M.: Coefficient of Expansion of Zirconium Oxide, *Ber. deut. keram. Ges.*, **9**, 16, 1928.
29. ENDELL, K., and W. STEGER: Ueber Messungen der Wermeausdehnung feuerfester Baustoffe bis 1600°C., *Stahl u. Eisen*, **48**, 722, 1928.
30. PHELPS, S.M.: The Brick Meter, *Am. Refractories Inst., Tech. Bull.* 27, 1928.
31. ROGERS, G.L.: Use of the Simulative Test Furnace as a Means of Making Comparative Tests of Fire Brick, *J. Am. Ceram. Soc.*, **11**, 323, 1928.

32. WESTMAN, A.E.R.: Thermal Expansion of Fireclay Bricks, *Univ. Ill. Eng. Expt. Sta. Bull.* 181, p. 26, 1928.
33. HIDNERT, P., and W.T. SWEENEY: Thermal Expansion of Magnesium and Some of Its Alloys, *Natl. Bur. Standards, J. Research*, **1**, 771, 1928.
34. SINGER, F.: Ceramic Materials, Brit. Patent 282,403, 1928.
35. ENDELL, K.: Measuring Thermal Expansion of Refractory Materials up to 1600°C., *Feuerfest*, **5**, 3, 1929.
36. HEINDL, R.A., and W.L. PENDERGAST: Progress Report on Investigation of Fireclay Brick and the Clays Used in Their Preparation, *J. Am. Ceram. Soc.*, **12**, 640, 1929.
37. RICHARDSON, G.B.: The Causes and Prevention of Bulging in Handmolded Refractory Shapes, *J. Am. Ceram. Soc.*, **13**, 256, 1930.
38. THILENIUS, R., and H. HOLZMANN: New Method for Determination of Small Changes in Length and Its Application in Measuring Coefficient of Expansion of Glasses and Ceramic Materials, *Z. anorg. allgem. Chem.*, **189**, 367, 1930.
39. SALMANG, H., and A. RITTGEN: The Thermal Expansion of Raw and Fired Clays, *Sprechsaal*, **64**, 447, 465, 481, 501, 517, 1931.
40. AUSTIN, J.B.: The Thermal Expansion of Some Refractory Oxides, *J. Am. Ceram. Soc.*, **14**, 795, 1931.
41. STEGER, W.: Source of Error When Measuring Thermal Expansions of Ceramic Materials by Means of the Tube Method, *Sprechsaal*, **64**, 351, 1931.
42. REICH, H.: New Apparatus for Measuring the Thermal Expansion of Refractory Materials between 0° and 1,700°, *Ber. deut. keram. Ges.*, **13**, 157, 1932.
43. PARMELEE, C.W., and A. ALLY: Some Properties of Chrome Spinel, *J. Am. Ceram. Soc.*, **15**, 213, 1932.
44. GELLER, R.F., and H. INSLEY: Thermal Expansion of Some Silicates of Elements in Group II of the Periodic System, *Natl. Bur. Standards, J. Research*, **9**, 35, 1932.
45. MERRITT, G.E.: Interference Method of Measuring Thermal Expansion, *Natl. Bur. Standards, J. Research*, **10**, 59, 1933.
46. HEINDL, R.A.: The Thermal Expansion of Refractories to 1,800°C., *Natl. Bur. Standards, J. Research*, **10**, 715, 1933.
47. FROMM, F.: Thermal Expansion of Silica Brick, *Stahl u. Eisen*, **54**, 84, 1934.
48. KRAUSE, O., and E. JAKEL: The Thermal Expansion of Some Ceramic Bodies Containing Steatite in the Ternary System MgO-Al₂O₃-SiO₂, *Sprechsaal*, **67**, 509, 525, 543, 1934.
49. SALMANG, H., and F. GAREIS: Measurement of the Thermal Expansion of Refractory and Super-refractory Materials and of Quartz Glass: Density Determinations on Quartz Glass, *Sprechsaal*, **68**, 439, 455, 467, 479, 1935.
50. CHESTERS, J.H., and C.W. PARMELEE: Reaction-expansion Measurements on Chromite and Allied Spinel, *J. Am. Ceram. Soc.*, **18**, 94, 1935.
51. DURAND, M.A.: Coefficient of Thermal Expansion of Magnesium Oxide, *Physics*, **7**, 297, 1936.
52. GREAVES-WALKER, A.F., and C.W. OWENS, JR.: The Expansion of Pyrophyllite, *Bull. Am. Ceram. Soc.*, **15**, 303, 1936.
53. EBERT, H., and C. TINGWALDT: Expansion of Refractories at Temperatures up to 2,000°C., *Z. Physik*, **37**, 471, 1936.
54. MCGEARY, F.M.: Navy Department Method of Testing Refractory Linings for Naval Boilers, *Bull. Am. Ceram. Soc.*, **16**, 335, 1937.
55. THURNAUER, H.: Cordierite Gives Low Expansion in Ceramic Bodies, *Ceram. Ind.*, **29**, 362, 1937.

56. POLE, G.R., and D.G. MOORE: The Expansion Characteristics of Kyanite and Kyanite-clay Mixtures When Heated, *Bull. Am. Ceram. Soc.*, **17**, 355, 1938.
57. RIGBY, G.R., and A.T. GREEN: The Reversible Thermal Expansion of Refractory Materials, *Trans. Ceram. Soc. (Engl.)*, **37**, 355, 1938.
58. STEGER, W.: Expansion and Contraction Measurements on Unfired Ceramic Bodies, *Ber. deut. keram. Ges.*, **19**, 2, 1938.
59. AUSTIN, J.B.: Linear Thermal Expansion of Beta-alumina, *J. Am. Ceram. Soc.*, **21**, 351, 1938.
60. EVERHART, J.O.: Secondary Expansion in Refractory Clays, *Ohio State Univ. Expt. Sta. Bull.* **98**, p. 23, 1938.
61. HYSLOP, J.F., and A. McMURDO: The Thermal Expansion of Some Clay Minerals, *Trans. Ceram. Soc. (Engl.)*, **37**, 180, 1938.
62. SAUNDERS, J.B.: Improved Interferometer Procedure with Application to Expansion Measurements, *Natl. Bur. Standards, J. Research*, **23**, 179, 1939.
63. HEINDL, R.A., and L.E. MONG: Length Changes and Endothermic and Exothermic Effects during Heating of Flint and Aluminous Clays, *Natl. Bur. Standards, J. Research*, **23**, 427, 1939.
64. WHITE, H.E.: Electrically Fused Magnesia, *J. Am. Ceram. Soc.*, **21**, 216, 1939.
65. WHITE, H.E., and R.M. SHREMP: Beryllium Oxide, I, *J. Am. Ceram. Soc.*, **22**, 185, 1939.
66. GELLER, R.F., and E.N. BUNTING: Length Changes of Whiteware Clays and Bodies during Initial Heating with Supplementary Data on Mica, *Natl. Bur. Standards, J. Research*, **25**, 15, 1940.
67. NIX, F.C., and D. MACNAIR: An Interferometric-dilatometer with Photographic Recording, *Rev. Sci. Instruments*, **12**, 66, 1941.
68. HALL, J.L.: Secondary Expansion of High-alumina Refractories, *J. Am. Ceram. Soc.*, **24**, 349, 1941.
69. RIGBY, G.R., and A.T. GREEN: The Thermal Expansion Characteristics of the Calcium Aluminates and Calcium Ferrites, *Trans. Brit. Ceram. Soc.*, September, 1941.
70. RIGBY, G.R., G.H.B. LOVELL, and H.T. GREEN: The Reversible Thermal Expansion and Other Properties of Some Calcium Ferrous Silicates, *Trans. Brit. Ceram. Soc.*, **44**, 37, 1945.
71. NELSON, J.B., and D.P. RILEY: The Thermal Expansion of Graphite from 15°C. to 800°C., I, Experimental, *Proc. Phys. Soc.*, **57**, 477, 1945.
72. RILEY, D.P.: The Thermal Expansion of Graphite II, Theoretical, *Proc. Phys. Soc.*, **57**, 486, 1945.
73. HENRY, E.C.: Report on the Physical Properties of Several Refractory Materials, P.B. 60660, 1946.
74. GELLER, R.F., P.J. YAVORSKY, B.L. STEINMAN, and A.S. CREAMER: Structure of Binary and Ternary Combinations of Magnesia, Calcium, Baria, Beryllia, Alumina, Thoria, and Zirconia, *Natl. Bur. Standards, J. Research*, **36**, 277, 1946.
75. POLE, C.R., A.W. BERNBACH, JR., and N. GILBERT: Physical Properties of Some High Temperature Refractory Compositions, *J. Am. Ceram. Soc.*, **29**, 208, 1946.
76. LESAR, A.R., C.A. KRINBILL, JR., W.D. KELLER, and R.S. BRADLEY: Effect of Compounds of Sulphur on Reheat Volume Change of Fireclay and High Alumina Refractories, *J. Am. Ceram. Soc.*, **29**, 70, 1946.
77. TREDENNICK, W.T., J.F. KELLEY, and R.C. BURT: Comparison of Repeated Reheat Tests of Various Grades of Firebricks with Service Results, *J. Am. Ceram. Soc.*, **29**, 75, 1946.
78. HENRY, E.C., *et al.*: Quarterly Progress Report on the Investigation of Refractory Materials, *School of Mineral Ind.*, Penn. State College, 1948.

CHAPTER XVIII

HEAT TRANSMISSION BY REFRACTORIES

1. Introduction. In certain parts of a furnace, such as the walls or roof, a minimum transmission of heat to the outside is desired; hence, a refractory with a low thermal conductivity would be necessary for these conditions. On the other hand, such parts as muffles or underfired hearths require a refractory with a high conductivity value. It will therefore be seen that the furnace designer must have accurate data on the thermal conductivity of his refractories before he can intelligently select his materials or predict the performance of his furnace.

2. Laws of Heat Conduction. *Definitions and Units.* The following symbols have been generally adopted in reference to heat flow:

q = the quantity of heat conducted in Btu per hr

t_0 = the initial temperature in variable flow

t_1 = the temperature of the hotter surface, °F

t_n = the temperature of the cooler surface, °F

L = the thickness of the wall, in. (or length of heat path)

k = the conductivity of the material, Btu/(hr)(ft²)(in.)(°F)

A = the area of the section normal to the flow, sq ft

x = the distance from the hotter surface, in.

h^2 = the diffusivity = $k/\rho c$

ρ = bulk density, lb per cu ft

c = specific heat

τ = time, hr

Table 88⁽⁷⁰⁾ gives factors to convert the common units of heat flow into others. Throughout the chapter, engineering units will be used, except for the values of single crystals and glasses.

Steady Flow. For conditions of steady flow, the amount of heat passing through a wall is expressed by

$$q = \frac{kA(t_1 - t_n)}{L}$$

or if we consider a unit area of 1 sq ft, then

$$q = \frac{t_1 - t_n}{L/k} \quad (1)$$

for a simple wall.

TABLE 88. CONVERSION FACTORS*
Units of Conductance of Energy: Thermal and Electrical

| | G-cal. sec. ⁻¹ . cm. ⁻² . °C ⁻¹ | Kg-cal. hr. ⁻¹ . cm. ⁻² . cm. ⁻¹ . °C ⁻¹ | Watt-cm. ⁻² . cm. ⁻¹ . °C ⁻¹ | Watt. in. ⁻² . in. ⁻¹ . °C ⁻¹ | Kw.ft. ⁻² . in. ⁻¹ . °C ⁻¹ | Kw.ft. ⁻² . in. ⁻¹ . °F ⁻¹ | B.t.u. hr. ⁻¹ . in. ⁻² . in. ⁻¹ . °F ⁻¹ | B.t.u. hr. ⁻¹ . ft. ⁻² . ft. ⁻¹ . °F ⁻¹ | B.t.u. hr. ⁻¹ . ft. ⁻² . in. ⁻¹ . °C ⁻¹ |
|--|---|--|---|---|---|---|---|---|---|
| 1 g-cal. sec. ⁻¹ . cm. ⁻² . cm. ⁻¹ . °C ⁻¹ | 1 | 3.600 | 4.186 | 10.63 | 1.531 | 0.8506 | 20.16 | 2903 | 5225.8 |
| 1 kg-cal. hr. ⁻¹ . cm. ⁻² . cm. ⁻¹ . °C ⁻¹ | 0.2778 | 1 | 1.163 | 2.953 | 0.4253 | 0.2363 | 5.600 | 806.4 | 1462 |
| 1 watt-cm. ⁻² . cm. ⁻¹ . °C ⁻¹ | 0.2389 | 0.8600 | 1 | 2.540 | 0.3658 | 0.2032 | 4.816 | 693.5 | 1248 |
| 1 watt-in. ⁻² . in. ⁻¹ . °C ⁻¹ | 0.09405 | 0.3386 | 0.3937 | 1 | 0.1440 | 0.08000 | 1.896 | 273.0 | 491.5 |
| 1 kw.ft. ⁻² . in. ⁻¹ . °C ⁻¹ | 0.6531 | 2.351 | 2.734 | 6.944 | 1 | 0.5556 | 13.17 | 1896 | 3413 |
| 1 kw.ft. ⁻² . in. ⁻¹ . °F ⁻¹ | 1.176 | 4.232 | 4.921 | 12.50 | 1.800 | 1 | 23.70 | 3413 | 6143 |
| 1 B.t.u. hr. ⁻¹ . in. ⁻² . in. ⁻¹ . °F ⁻¹ | 0.04960 | 0.1786 | 0.2076 | 0.5274 | 0.07595 | 0.04219 | 1 | 144.0 | 259.2 |
| 1 B.t.u. hr. ⁻¹ . ft. ⁻² . in. ⁻¹ . °F ⁻¹ | 3.445 × 10 ⁻⁴ | 0.001240 | 0.001442 | 0.003663 | 5.274 × 10 ⁻⁴ | 2.930 × 10 ⁻⁴ | 0.006944 | 1 | 0.08333 |
| 1 B.t.u. hr. ⁻¹ . ft. ⁻² . ft. ⁻¹ . °F ⁻¹ | 0.004134 | 0.01488 | 0.01730 | 0.04395 | 0.006329 | 0.003516 | 0.08333 | 12.00 | 21.60 |
| 1 B.t.u. hr. ⁻¹ . ft. ⁻² . in. ⁻¹ . °C ⁻¹ | 1.914 × 10 ⁻⁴ | 6.889 × 10 ⁻⁴ | 8.011 × 10 ⁻⁴ | 0.002035 | 2.930 × 10 ⁻⁴ | 1.628 | 0.003858 | 0.5556 | 0.04630 |

* Based on International Critical Tables; mean values used for kg-cal. and B.t.u.; from White, American Ceramic Society.⁽¹⁰⁾

In a composite wall made up of several layers, the value of q is obviously the same for each layer under steady conditions; therefore

$$q = \frac{t_1 - t_n}{(L_1/k_1) + (L_2/k_2) + \dots + (L_n/k_n)} \quad (2)$$

where L_1, L_2, \dots, L_n and k_1, k_2, \dots, k_n refer to the properties of each layer, respectively.

Since the temperature drop across each layer is equal to the heat flow times the actual resistance of the respective layers, we may say

$$t_1 - t_2 = q \frac{L_1}{k_1} \quad (3)$$

$$t_2 - t_3 = q \frac{L_2}{k_2} \dots \quad (4)$$

From these temperature drops, the interface temperatures can be computed. It should also be remembered that the value of q entering the hot face and leaving the cool face is equal to the q of each layer.

Variable Flow. In practice, many cases of unsteady heat flow occur, as in batch-type furnaces. In a simple case, suppose that a wall is suddenly heated from t_0 to t_1 on one face. The temperature at a point x distant from the face is given by Fourier's equation.

$$t = \frac{2t_0}{\sqrt{\pi}} \int_0^\infty \frac{x}{2h\sqrt{\tau}} e^{-\beta^2} d\beta \quad (5)$$

where $\beta =$ a variable of integration.

It will be seen that the penetration of heat will depend on time and the value of diffusivity. An infinite time is required theoretically to reach equilibrium, and practical equilibrium requires many hours in thick walls. In Fig. 300 are shown curves of temperature rise of the cool face in refractory walls of various thicknesses that have suddenly been heated on one face. When the hot face is not brought up suddenly but at a definite schedule, the calculations are difficult. They may be approximated, however, by adding an imaginary layer to the hot face of the wall, as suggested by Ingersoll and Zobel,⁽²⁾ or the Schmidt method may be used as illustrated by Trinks.⁽¹⁶⁾

3. Theory of Heat Transfer through a Porous Body. Since most refractories are more or less porous, it is of interest to see how this porosity influences the transfer rate.

Conduction. Some of the heat is conducted through the body by virtue of the close contact of the particles making up the structure. This conduction will be decreased as the porosity increases.

Convection. If the pores are filled with air or combustion gases, as would usually be the case, some heat is transferred by convection currents in the pore itself. This transfer is so small as to be negligible for the usual size of pores.

Radiation. A considerable portion of the heat flow at high temperatures may be due to direct radiation across the pores. For a given amount of porosity, the large pores will transfer more heat by radiation.

The radiant heat transferred is also proportional to the emissivity of the refractory surface. These total emission coefficients are not accurately

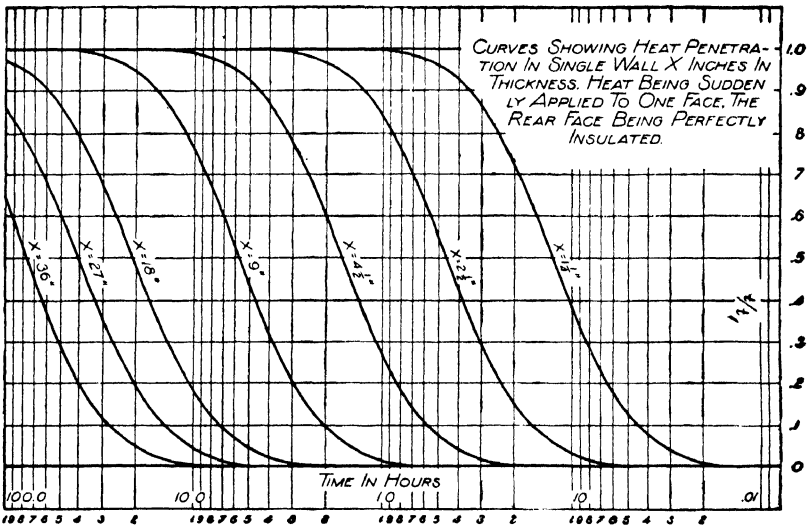

FIG. 300. Heat-penetration curves; t_1 = temperature of heated face, t_2 = temperature of rear face, x = wall thickness.

known at high temperatures, but some figures by Heilman⁽⁶²⁾ indicate that a black brick such as chrome has a value of 0.97 whereas a white refractory like a kaolin brick has a value as low as 0.3. During 1948, J. M. Brownlow, working under Professor Wilkes in the Heat Measurements Laboratory of the Massachusetts Institute of Technology, developed an ingenious method of measuring total emission coefficients. This consisted of revolving a cylinder of refractory in a global-heated furnace, with a narrow portion of the cylinder exposed to the open. The true temperature of the cylinder, kept uniform by rapid turning, was measured by a platinum thermocouple on the axis, and the apparent surface temperature at the exposed point, with a radiation pyrometer. From these two readings the coefficient could be computed readily.

The results on a few materials are shown in Fig. 301. The fused magnesia, alumina, and zirconia specimens were made by the Norton Company

of their regular material. The kaolin insulating brick was a Babcock and Wilcox K-28, and the dense kaolin was this same specimen coated with a kaolin cement. Most of the specimens have values quite close together except for the silicon carbide, which averages 0.9. The influence of surface roughness is very evident in the kaolin materials, as the porous structure

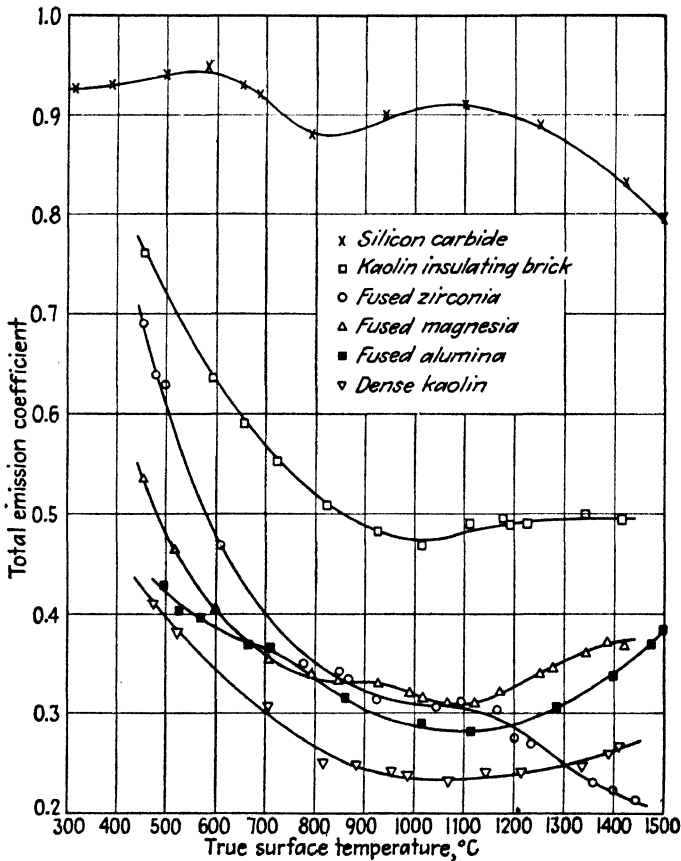

Fig. 301. Emission coefficients of refractories.

has twice the value of the dense one. Further work should be carried out in this field.

There is an excellent opportunity for anyone interested in the field of high-temperature insulators to do some valuable work by correlating the theoretical and measured values of k for materials with various types of porosity and emissivity. The work of Waddams⁽⁷⁶⁾ gives some interesting results at medium temperatures.

4. Measurement of Thermal Conductivity. *The High-temperature Calorimeter Method.* Most of the high-temperature tests on refractories

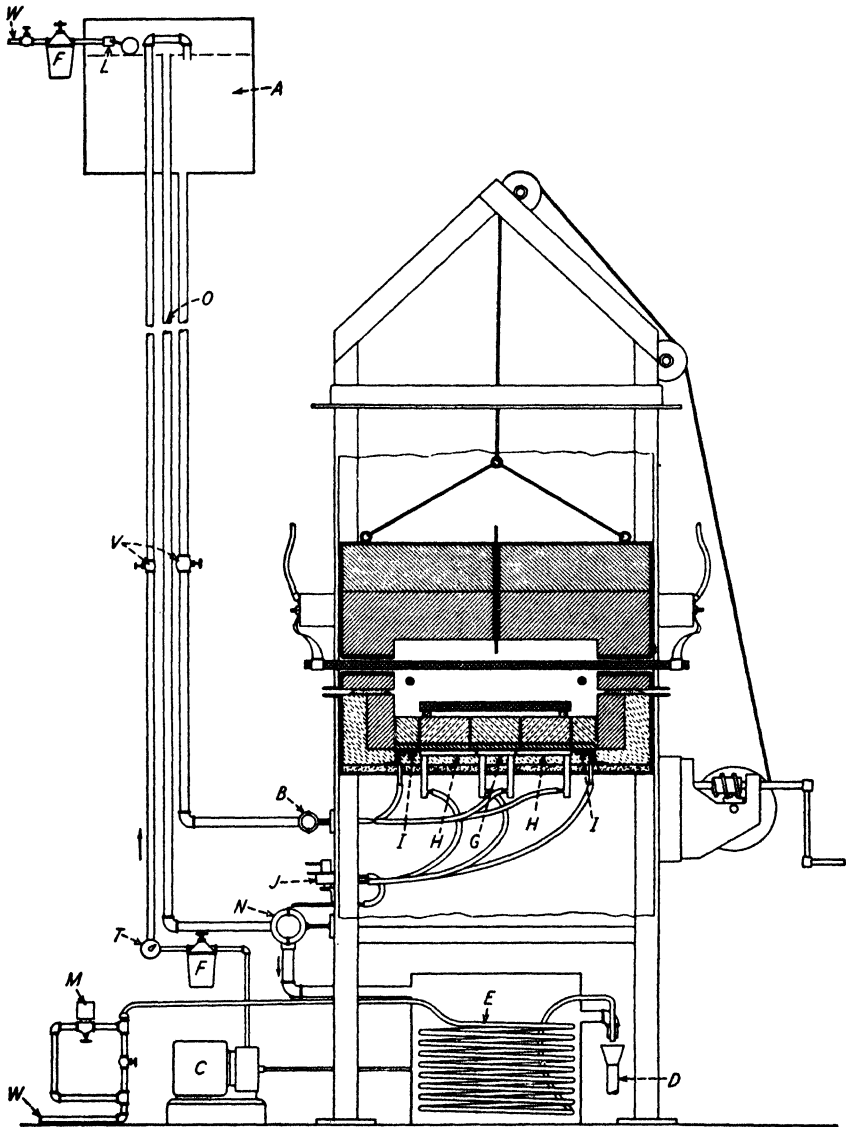

FIG. 302. Diagram showing essential parts of thermal conductivity apparatus.

- | | |
|-----------------------------------|----------------------------|
| A—Constant head water supply. | J—Microregulating valves. |
| B—Inlet manifold and thermometer. | L—Water level valve. |
| C—Circulating pump. | M—Magnetic control valve. |
| D—To drain. | N—Outlet manifold. |
| E—Cooling coil. | O—Overflow pipe. |
| F—Water filter. | T—Thermostat (Controls M). |
| G—Center calorimeter. | V—Valves. |
| H—Inner guard calorimeters. | W—Water inlet. |
| I—Outer guard calorimeters. | |

for thermal conductivity have been made by setting up a uniform parallel flow of heat normal to the faces of a slab. The quantity of heat flowing is measured by a water calorimeter on the cold face of the specimen, and the temperature gradient by the thickness and hot- and cold-face temperatures.

The establishment of a uniform flow is by no means easy, and only by careful guarding can this be accomplished. Also the temperatures on the isothermal planes must be read with great care. At the same time, an equilibrium flow must be established by a constant hot-face temperature

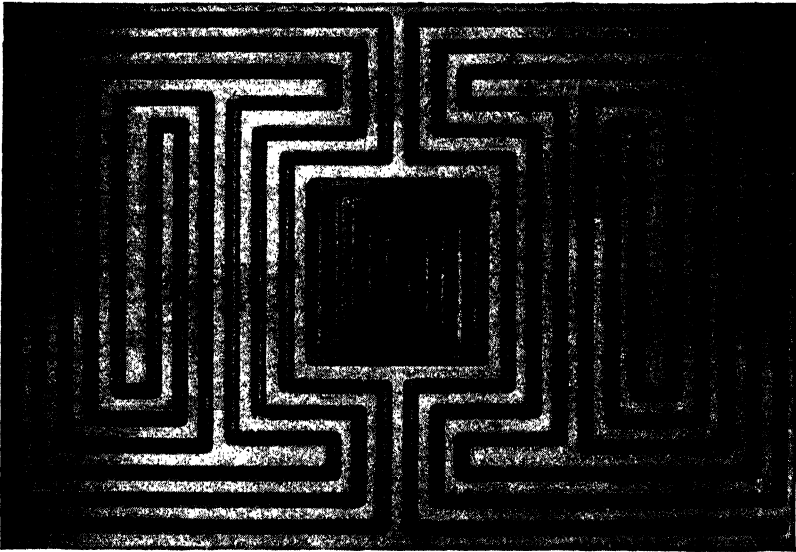

Fig. 303. Water passages in the calorimeter and guard ring.

for a long time interval. Perhaps no other physical measurement is beset with so many pitfalls. The papers by Norton⁽⁷³⁾ and Patton and Norton⁽⁷⁴⁾ give an excellent discussion of these errors and their correction.

This method can best be explained by an example of a high-temperature plate tester originally suggested by Wilkes but later constructed in many laboratories with minor changes. The following description applies to an apparatus recently constructed in the refractories laboratory of the Babcock and Wilcox Company⁽⁷³⁾ and later made ASTM Standard Method C 201-47.

A drawing of this apparatus is shown in Fig. 302. In Fig. 303 is shown the arrangement of water passages in the calorimeter and guard ring.

Special features are the constant-temperature water source, the temperature control of the furnace to maintain the temperature for the 24-hr run within $\pm 2^\circ\text{F}$ (about 1°C), and the flow passages in the calorimeter.

The method of making a test will be made clear by the following example in Table 89 of a run made on an insulating firebrick.

TABLE 89. TYPICAL THERMAL-CONDUCTIVITY RUN

| Time | Difference between guard and calorimeter, M.V. | Difference between inlet and outlet of calorimeter, M.V. | Hot face, M.V. | Center, M.V. | Cold face, M.V. | Water flow, per cc. min. |
|-------|--|--|----------------|--------------|-----------------|--------------------------|
| 9:00 | 0.002 | 0.030 | 4.62 | 13.73 | 1.70 | |
| 10:00 | 0.000 | 0.028 | 4.83 | 13.93 | 1.79 | 360 |
| 10:40 | 0.000 | 0.030 | 4.72 | 13.77 | 1.70 | 358 |
| 11:00 | 0.000 | 0.029 | 4.76 | 13.79 | 1.72 | 361 |
| 11:30 | 0.000 | 0.029 | 4.65 | 13.76 | 1.68 | 370 |
| 12:34 | 0.000 | 0.029 | 4.62 | 13.67 | 1.68 | 367 |
| 1:45 | 0.000 | 0.027 | 4.63 | 13.64 | 1.67 | 360 |
| 2:15 | 0.000 | 0.028 | 4.63 | 13.65 | 1.68 | |
| 3:15 | 0.000 | 0.027 | 4.63 | 13.66 | 1.67 | 360 |
| | = 0°F. | = 0.24°C. | = 995°F. | = 630°F. | = 105°F. | |

$$q = 0.24 \times 3.83 \times 360 = 332 \text{ B.t.u. per hr.}$$

$$\frac{332 \times 1.25}{630 - 105} = \frac{414}{525} = 0.79 = k \text{ at } 368^\circ\text{F.}$$

$$\frac{332 \times 2.5}{995 - 105} = \frac{830}{890} = 0.93 = k \text{ at } 550^\circ\text{F.}$$

$$\frac{332 \times 1.25}{995 - 630} = \frac{414}{365} = 1.13 = k \text{ at } 812^\circ\text{F.}$$

Thermal conductivity is measured in other ways; *e.g.*, a cylindrical specimen is sometimes convenient as shown in Fig. 304, which represents a pipe cover tester. In this way, edge losses are minimized, because the area of

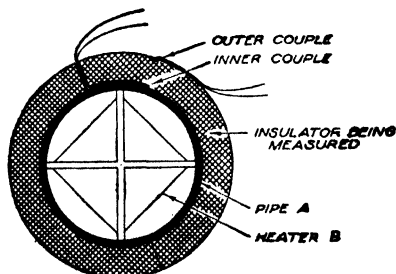

FIG. 304. Pipe tester for measuring thermal conductivity.

the ends is small compared with the outside area, but it is often difficult to obtain standard refractories of the proper shape. The cylindrical method, however, has been used by Holler⁽⁵⁹⁾ and others for high-temperature tests.

The Northrup method consists in passing a uniform, linear flow of heat through two layers of refractory in contact. If the temperature drop is known through each layer and the value of k known for one material, the conductivity of the other layer can be readily determined, as the value of q must be the same for both. The following relation holds:

$$\frac{\text{Temperature drop in specimen } A}{\text{Temperature drop in specimen } B} = \frac{k_B}{k_A}$$

Harmonic-flow Method. A somewhat different method has been used to determine the thermal conductivity by making use of Fourier's equation for nonuniform heat flow. If we consider Eq. (5) in this chapter, it will be noticed that the value of h^2 , the diffusivity, can be determined by studying the temperature changes in a given material. From the value of h , the thermal conductivity can be computed if the density and specific heat are known, properties that are not difficult to measure. This method has been carried out practically by applying to one surface of the test material a temperature varying harmonically. The temperature is then recorded inside the solid at several distances from the surface; and from these values, h can be computed. It will be noticed that this method does not necessitate a measurement of the quantity of heat flowing. On the other hand, the same difficulties are encountered in ensuring a linear flow of heat as in the other methods, and the problem of providing a sinusoidal heat supply at high temperatures is a serious one. Another method of measurement of this type consists in computing the diffusivity by measuring the temperature change on the axis of a cylinder, the outside temperature of which is suddenly changed by quenching. This may be found quite convenient and precise for small specimens such as pure oxides.

5. Thermal-conductivity Values for Refractories and Insulators. *Crystals and Glasses.* The available data for crystals and glasses are very meager at low temperatures and nonexistent at high temperatures. A few values are shown in Table 90 to bring out three important facts: (1) The thermal conductivity for some crystals decreases with increasing temperature, probably reaching a minimum and then increasing again, whereas for glasses it always increases. (2) The k value for a crystal with an orderly arrangement of atoms is greater than that for a corresponding glass as shown for the case of silica. (3) The conductivity of nonisotropic crystals varies with the direction of heat flow, being a maximum along one principal axis and a minimum along another. The ratio of the maximum and minimum k for a number of crystals is shown in the last column of Table 90.

At present, there are insufficient data to formulate a relation between atomic structure and thermal conductivity with any certainty. However,

TABLE 90. THERMAL CONDUCTIVITY OF SINGLE CRYSTALS AND GLASS

| Material | Mean thermal conductivity, cgs units, at a mean temperature of | | | | | | | Ratio of minimum to maxi- mum k at 200°C | Reference |
|---|---|-------|-------|-------|-------|-------|-------|--|---------------------------------|
| | 0°C | 100°C | 200°C | 300°C | 400°C | 500°C | 600°C | | |
| Quartz, <i>C</i> -axis | 0.027 | 0.021 | 0.016 | 0.014 | 0.013 | 0.012 | | 0.57 | Knapp ⁽⁷⁶⁾ |
| Quartz, ⊥ <i>C</i> -axis | | 0.019 | 0.015 | 0.012 | 0.010 | | | | Birch and Clark ⁽⁷²⁾ |
| Quartz, <i>C</i> -axis | | 0.009 | 0.009 | 0.009 | 0.010 | 0.011 | | | Knapp ⁽⁷⁶⁾ |
| Quartz, ⊥ <i>C</i> -axis | 0.016 | 0.012 | 0.010 | 0.008 | 0.007 | | | Birch and Clark ⁽⁷²⁾ | |
| Quartz, <i>C</i> -axis | 0.032 | 0.021 | | | | | | Eucken ⁽⁴²⁾ | |
| Quartz, ⊥ <i>C</i> -axis | 0.017 | 0.010 | | | | | | Eucken ⁽⁴²⁾ | |
| Fused silica | | 0.004 | 0.004 | 0.005 | 0.006 | 0.008 | 0.011 | | Knapp ⁽⁷⁶⁾ |
| Soda-lime glass | | 0.003 | 0.004 | 0.005 | 0.006 | | | | Knapp ⁽⁷⁶⁾ |
| Pyrex glass | | 0.003 | 0.004 | 0.005 | 0.006 | 0.007 | | | Knapp ⁽⁷⁶⁾ |
| Corundum, <i>C</i> -axis | | 0.014 | 0.015 | 0.016 | 0.016 | 0.017 | | | Knapp ⁽⁷⁶⁾ |
| Corundum, ⊥ <i>C</i> -axis | | 0.009 | 0.010 | 0.010 | 0.012 | 0.015 | | 0.67 | Knapp ⁽⁷⁶⁾ |
| Synth. sapphire, <i>C</i> -axis | | 0.008 | 0.009 | 0.010 | 0.012 | 0.015 | | | Knapp ⁽⁷⁶⁾ |
| Beryl, <i>C</i> -axis | | 0.007 | 0.008 | 0.009 | 0.011 | 0.012 | | | Knapp ⁽⁷⁶⁾ |
| Beryl, ⊥ <i>C</i> -axis | | 0.006 | 0.007 | 0.008 | 0.010 | 0.011 | | 0.88 | Knapp ⁽⁷⁶⁾ |
| Tourmaline, <i>C</i> -axis | | 0.004 | 0.005 | 0.006 | 0.007 | 0.008 | | | Knapp ⁽⁷⁶⁾ |
| Tourmaline, ⊥ <i>C</i> -axis | | 0.005 | 0.006 | 0.007 | 0.008 | 0.009 | | 0.83 | Knapp ⁽⁷⁶⁾ |
| Lithium fluoride | | 0.006 | 0.008 | 0.100 | 0.012 | 0.014 | | | Knapp ⁽⁷⁵⁾ |
| Topaz, <i>C</i> -axis | | 0.012 | 0.012 | 0.012 | 0.013 | 0.017 | | | Knapp ⁽⁷⁶⁾ |
| Topaz, <i>B</i> -axis | | 0.011 | 0.011 | 0.011 | 0.012 | 0.015 | | 0.92 | Knapp ⁽⁷⁶⁾ |
| Topaz, <i>A</i> -axis | | 0.010 | 0.010 | 0.010 | 0.011 | 0.014 | | 0.83 | Knapp ⁽⁷⁴⁾ |
| Topaz, average | 0.056 | | | | | | | | Eucken ⁽⁴²⁾ |
| Zircon, ⊥ <i>C</i> -axis | | 0.006 | 0.009 | 0.010 | 0.012 | 0.013 | | | Knapp ⁽⁷⁶⁾ |
| Periclase | | 0.013 | 0.016 | 0.018 | 0.021 | 0.022 | | | Knapp ⁽⁷⁶⁾ |
| Dense SiC (not a single crystal) | | 0.024 | 0.023 | 0.022 | 0.022 | 0.021 | | | Knapp ⁽⁷⁶⁾ |
| Mullite fibers, <i>C</i> -axis | | 0.009 | 0.009 | 0.010 | 0.011 | 0.013 | | | Knapp ⁽⁷⁶⁾ |
| Mullite fibers, ⊥ <i>C</i> -axis | | 0.006 | 0.006 | 0.007 | 0.008 | 0.009 | | 0.67 | Knapp ⁽⁷⁶⁾ |

the following equation proposed by Compton⁽³⁾ seems best to fit the experimental results.

$$k = bn^2 dRv \cdot \frac{2 - cT^{1/2} \cdot e^{-Bv/2T}}{c^2T}$$

where $b = 1$

n^2 = the number of atoms per unit area of the plane normal to the heat flow

d = the distance between neighboring atoms

v = the natural frequency of the atoms

c = determined by the conductivity at a given temperature

B = a universal constant

The field of research connecting thermal conductivity with atomic structure is almost virgin territory and offers excellent opportunity for further work, especially in developing a precise method of measuring k up to high temperatures on very small specimens.

Heavy Refractories. The commercial refractory consists of crystalline material alone or with a glass bond. Usually the crystals are small and randomly oriented. We should expect, from the preceding data, that the value of k would be higher for those refractories consisting of well-bonded crystals with the glass phase eliminated. For example, the recrystallized silicon carbide contains very little glass and has a high conductivity value. A great deal more research is needed on the conductivity of refractories made of crystals, glass, and air in varying proportions. Some values of thermal conductivity for heavy refractories are shown in Table 91. Owing to experimental difficulties, the values for heavy refractories cannot be depended on so closely as those for insulators.

Insulators. Insulators are composed of a more or less refractory skeleton having a large proportion of pores. The basic material may be mag-

TABLE 91. HEAVY REFRACTORY BRICK
Mean Thermal Conductivity* at a Mean Temperature, °F

| Type of Brick | Apparent porosity, per cent | 400 | 800 | 1200 | 1600 | 2000 | 2400 | Reference |
|--|-----------------------------|------|------|------|------|------|------|--------------------------------------|
| Alumina, fused | 21.3 | 18.5 | 21.7 | 24.2 | 26.7 | 28.4 | 30.0 | Norton ⁽⁸⁰⁾ |
| Carbon | | | | | 18.5 | 22.0 | | Powell and Schofield ⁽¹⁰⁾ |
| Chrome | 30.5 | 10.0 | 10.8 | 11.3 | 11.6 | 11.8 | 12.0 | Norton ⁽⁸⁰⁾ |
| Fireclay | 15.2 | 8.1 | 8.4 | 10.1 | 10.8 | 11.4 | 12.0 | Wilkes ⁽⁴⁹⁾ |
| | 18.4 | 7.3 | 8.7 | 9.8 | 10.6 | 11.6 | 11.8 | Norton ⁽⁸⁰⁾ |
| | 26.7 | 7.0 | 7.8 | 8.7 | 9.3 | 10.2 | 10.5 | Norton ⁽⁸⁰⁾ |
| Super-duty fireclay | | 7.5 | 8.4 | 9.0 | 9.5 | 9.8 | | Putton and Norton ⁽⁷⁴⁾ |
| Graphite | | 730 | 500 | 400 | 310 | 220 | | Powell and Schofield ⁽¹⁰⁾ |
| Kaolin | 10.8 | 13.5 | 15.0 | 16.3 | 18.0 | 18.8 | 19.7 | Norton ⁽⁸⁰⁾ |
| | 23.2 | 10.0 | 10.9 | 11.9 | 12.8 | 13.4 | 13.8 | Norton ⁽⁸⁰⁾ |
| | 49.1 | 3.0 | 4.4 | 5.2 | 6.1 | 6.7 | 7.1 | Norton ⁽⁸⁰⁾ |
| Magnesite | 29 | 25.8 | 22.0 | 18.2 | 15.7 | 13.7 | 12.6 | Wilkes ⁽⁴⁹⁾ |
| | 31.6 | 39.2 | 35.2 | 29.0 | 26.7 | 25.6 | 25.0 | Norton ⁽⁸⁰⁾ |
| Silicon carbide clay | 28.3 | 26 | 26 | 29 | 34 | 38 | 50 | Wilkes ⁽⁴⁹⁾ |
| Silicon carbide clay 5 per cent | 16.2 | | 175 | 155 | 135 | 118 | | Holler ⁽⁵⁹⁾ |
| Silicon carbide clay 20 per cent | 21.0 | | 70 | 61 | 58 | 57 | | Holler ⁽⁵⁹⁾ |
| Silicon carbide, recrystallized | 34.4 | 210 | 175 | 150 | 115 | 95 | 81 | Wilkes ⁽⁴⁹⁾ |
| | 35.3 | | 143 | 126 | 105 | 93 | 80 | Norton ⁽⁸⁰⁾ |
| | 28.0 | 6.5 | 8.5 | 10.5 | 12.4 | 14.0 | 15.7 | Austin and Pierce ⁽⁵⁶⁾ |
| Silica | | 7.5 | 8.0 | 9.0 | 10.0 | 10.9 | | Putton and Norton ⁽⁷⁴⁾ |
| | 30.4 | 8.1 | 10.0 | 11.8 | 13.0 | 14.2 | 15.3 | Norton ⁽⁸⁰⁾ |
| Spinel | 36.3 | 10.4 | 11.6 | 12.5 | 13.3 | 14.0 | 14.6 | Norton ⁽⁸⁰⁾ |
| 99 + per cent, fused alumina | 21 | | 27 | 20 | 18 | 17 | | Whittemore ⁽⁸⁰⁾ |
| | 36 | | 19 | 16 | 14 | 12 | | Whittemore ⁽⁸⁰⁾ |
| | 47 | | 13 | 11 | 9 | 8 | | Whittemore ⁽⁸⁰⁾ |
| | 57 | | 7 | 6 | 6 | 6 | | Whittemore ⁽⁸⁰⁾ |
| 96-99 per cent fused MgO | 19 | | 28 | 23 | 20 | 17 | | Whittemore ⁽⁸⁰⁾ |
| 98-99 per cent ZrO ₂ fused + CaO stabilized | 26 | | 5 | 5 | 5 | 6 | | Whittemore ⁽⁸⁰⁾ |
| | 44 | | 3 | 3 | 4 | 5 | | Whittemore ⁽⁸⁰⁾ |
| Zirconia (Baddeleyite) | 29.5 | 10.4 | 11.3 | 12.2 | 13.0 | 13.7 | 14.3 | Norton ⁽⁸⁰⁾ |

* k expressed as Btu per hr per sq ft per in. per °F.

TABLE 92. THERMAL CONDUCTIVITY OF INSULATING MATERIALS

| Type of insulation | Linear shrinkage—5-hr. reheat, per cent at °F. | Density, lb. per cu. ft. | Mean thermal conductivity* at a mean temperature of | | | | | |
|---|--|--------------------------|---|--------|--------|---------|---------|---------|
| | | | 200°F. | 400°F. | 800°F. | 1200°F. | 1600°F. | 2000°F. |
| Insulating firebrick: | | | | | | | | |
| Kaolin base..... | 1.00 at 2900 | 55 | | 2.9 | 3.3 | 3.9 | 4.5 | 5.2 |
| Kaolin base..... | 1.00 at 2800 | 44 | | 2.1 | 2.8 | 3.3 | 3.8 | 4.4 |
| Fireclay base..... | 3.10 at 2600 | 48 | | 2.5 | 2.8 | 3.2 | 3.7 | |
| Kaolin base..... | 0.10 at 2300 | 26 | | 0.8 | 1.0 | 1.3 | 1.5 | |
| Insulating brick: | | | | | | | | |
| Raw diatomaceous earth base..... | 1.00 at 1400 | 33 | 0.7 | 0.8 | 0.9 | 1.0 | | |
| Calcined diatomaceous earth base..... | 2.80 at 2300 | 43 | | 1.4 | 1.6 | 2.0 | | |
| High-temperature block insulation: | | | | | | | | |
| Diatomaceous earth base..... | 3.10 at 1900 | 23 | 0.58 | 0.62 | 0.70 | 0.80 | | |
| Vermiculite base..... | 0.75 at 1600 | 18.5 | 0.55 | 0.67 | 0.80 | 0.95 | | |
| Mineral wool base..... | 1.69 at 1600 | 22 | 0.42 | 0.56 | 0.84 | | | |
| Kaolin base..... | | 19 | 0.58 | 0.67 | 0.91 | 1.21 | | |
| Insulating blankets: | | | | | | | | |
| Mineral-wool base..... | 1000 | 8-12 | 0.38 | 0.52 | 0.78 | | | |
| Mineral-wool base..... | 800 | 8-12 | 0.35 | 0.51 | | | | |
| Glass-wool base..... | 1000 | 3 | 0.31 | 0.36 | 0.57 | | | |
| Plastic insulating cements: | | | | | | | | |
| Diatomaceous base..... | 1900 | 40 | 0.65 | 0.72 | 0.82 | 1.00 | | |
| Mineral-wool base..... | 1200 | 24 | 0.67 | 0.75 | 0.93 | | | |
| Vermiculite base..... | 1500 | 15 | 0.75 | 0.83 | 1.10 | | | |
| Asbestos base..... | 1200 | 17 | 0.80 | 0.93 | 1.25 | | | |
| 85 per cent magnesia..... | 600 | 15 | 0.49 | 0.55 | | | | |

* k expressed as Btu per hr per ft per in per °F.

nesium carbonate, asbestos, silica, clay, or glass fibers. The values of k for a number of typical materials are shown in Table 92. For data on any specific product, it is necessary to get in touch with the manufacturer or make an individual test of the material.

It will be noted that in general, the lighter the insulator the lower will be the value of k at low temperatures. There is a lower limit, however, as mineral wool, for example, below 5 lb per cu ft density shows an increasing value of k . In general, material with the smallest pores has the slowest increase in conductivity with increasing temperature; but here again, much research is needed to develop a general theory of heat conduction in porous materials, although this has been considered by some writers.⁽⁴²⁾

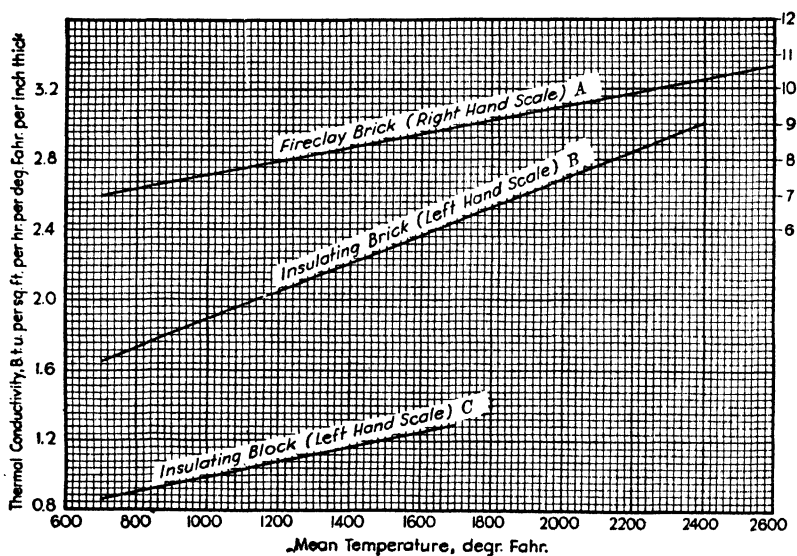

FIG. 305. Average curves of thermal conductivity used in calculations. (From R. H. Heilman, ASTM Committee C-8 on Refractories.)

6. Flow of Heat through Walls under Steady Conditions. *Computation of Heat Flow in a Simple Wall.* The flow of heat through simple walls is dependent on the thermal conductivity at the mean wall temperature and the temperature difference between the hot and cold face. Also it should be remembered that the quantity of heat passing through the wall must be equal to the heat leaving the wall. The latter is also dependent on the cold-face temperature and the velocity of the air outside the wall.

The calculation of the heat flow will be made clearer by a specific example. Assume a 9-in. refractory wall heated on the hot side to 2200°F. The outside air is 80°F and not moving. The values of k for this particular refractory are given by curve A in Fig. 305. The quantity

of heat lost from the outside of the wall, q_{rc} , is given by Heilman's curve in Fig. 306. We may write from Eq. (1)

$$q = \frac{t_1 - t_n}{L/k} = \frac{2200 - t_n}{9/k} = q_{rc}$$

but as k varies with $(t_1 - t_n)/2$ and q_{rc} varies with t_n , the equation cannot be solved directly. Therefore, we must assume a mean temperature and an

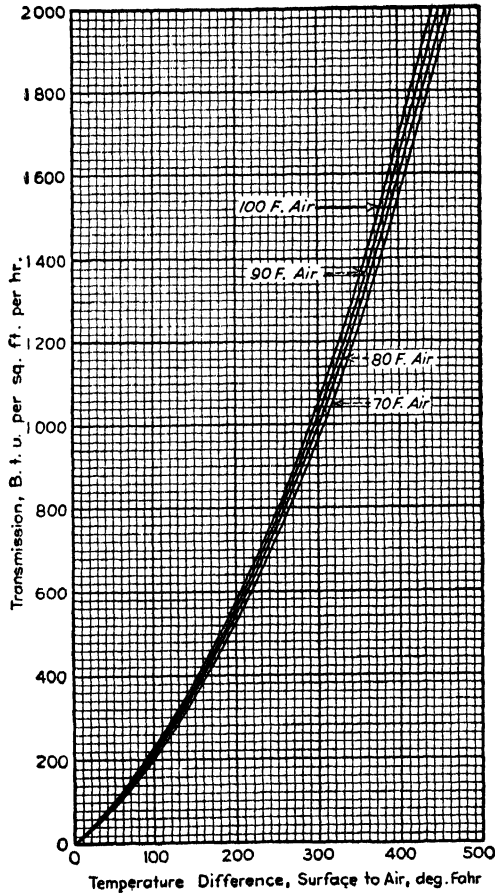

FIG. 306. Heat transmission from a vertical surface. (From R. H. Heilman, *ASTM Committee C-8 Refractories.*)

outside temperature. If q and q_{rc} are not equal, another and closer assumption of values is made until the required precision is reached. Assume $t_n = 300^\circ\text{F}$ and $k = 8.1$, then

$$q = \frac{2200 - 300}{9/8.1} = 1710 \quad q_{rc} = 620 \text{ from curve}$$

The cold face has been taken too low, so 500 will be taken for the next trial.

$$q = \frac{2200 - 500}{9/8.1} = 1720 \quad q_{rc} = 1530 \text{ from curve}$$

This gives a mean temperature of 1350°F; hence, a more precise value of k from the curve is 8.2. Choosing a lower cold-face temperature of 480°F gives

$$q = \frac{2200 - 480}{9/8.2} = 1570 \quad q_{rc} = 1590$$

which is sufficiently close.

Computation of Heat Flow in a Compound Wall. In this case, the value of q is the same for each layer of the wall of unit area and equal to the heat leaving the cold face. As another example, a 9-in. firebrick wall with a 2400°F hot face is backed up with 4.5 in. of insulating brick and 2 in. of insulating block. The air conditions are the same as before. From Eq. (2)

$$q = \frac{2400 - t_n}{(9/k_1) + (4.5/k_2) + 2/k_3} = q_{rc}$$

As a first trial, assume $t_n = 280^\circ\text{F}$ and k_1 , k_2 , and k_3 as 9.5, 2.0, and 0.9, respectively, from Fig. 305. Then

$$q = \frac{2400 - 280}{(9/9.5) + (4.5/2.0) + (2/0.9)} = \frac{2120}{0.95 + 2.25 + 2.23} = 390$$

$$q_{rc} = 545 \text{ from curve}$$

Next assume $t_n = 245$, then

$$q = 398 \quad q_{rc} = 417$$

which is sufficiently close for a first approximation.

Now from Eq. (3)

$$\begin{aligned} t_1 - t_2 &= 398 \times 0.95 = 375 \\ t_2 - t_3 &= 398 \times 2.25 = 895 \\ t_3 - t_n &= 398 \times 2.23 = 890 \\ t_1 - t_n &= \frac{2160}{} \end{aligned}$$

The interface temperatures will be 2025 and 1130°F; the mean temperatures of each layer will be 2212, 1577, and 685°F. Now go back to the conductivity curves and select more precise values of k , which will be, respectively, 9.90, 2.35, and 0.85. The heat flow is now worked out again, with $t_n = 245$.

$$q = \frac{2400 - 245}{(9/9.9) + (4.5/2.35) + (2/0.85)} = \frac{2155}{0.91 + 1.91 + 2.35} = \frac{2155}{5.17} = 417$$

which is the same as q_{rc} . Now the temperature drops are recalculated:

$$\begin{aligned}
 t_1 - t_2 &= 417 \times 0.91 = 379 \\
 t_2 - t_3 &= 417 \times 1.91 = 795 \\
 t_3 - t_n &= 417 \times 2.35 = 981 \\
 t_1 - t_n &= \underline{2155}
 \end{aligned}$$

The interface temperatures will then be 2021 and 1226°F.

The mean temperatures will be 2210, 1623, and 612°F. Taking new values for k and t_n of 242°F,

$$q = \frac{2400 - 242}{(9/9.9) + (4.5/2.39) + (2/0.81)} = \frac{2158}{0.91 + 1.88 + 2.47} = \frac{2158}{5.26} = 410$$

and $q_{rc} = 410$ as closely as can be read.

The values of temperature drops are

$$\begin{aligned}
 t_1 - t_2 &= 410 \times 0.91 = 373 \\
 t_2 - t_3 &= 410 \times 1.88 = 772 \\
 t_3 - t_n &= 410 \times 2.47 = \underline{1013} \\
 t_1 - t_n &= \underline{2158}
 \end{aligned}$$

Therefore the interface temperatures are 2027 and 1256°F, and the mean temperatures are 2213, 1641, and 627°F. By further trial, any degree of precision can be obtained, but the fourth trial here is sufficiently exact for ordinary purposes, as we do not know the conductivity values very accurately. Computing walls is a tedious process; but with experience, the initial selection of temperature will be fairly close to the final values. The heat flow and heat storage in a number of standard wall constructions are shown in Table 93.

7. Computation of Heat Flow in Cylinders. *Through Circular Structures.* Although the same general method is used for determining heat flow through circular structures, the equation for heat flow through a plane wall cannot be applied to flow through a cylinder if an accurate result is desired. The reason for this may readily be understood when it is considered that the inside circumference of a cylinder is smaller than the outside circumference. Consequently, heat spreads out as it travels from the inside to the outside, and conversely, it converges when the direction of flow is from the outside toward the inside.

Heat flow outward through a cylinder may be calculated by the following formulas:

1. For a wall of one material:

$$q = \frac{2\pi(t - t_n)}{(12/k_n) \ln (D_n/D)} \text{ Btu}/(\text{lin ft})(\text{hr})$$

or

$$q = \frac{t - t_n}{(12D_n/2k_n) \ln (D_n/D)} \text{ Btu}/(\text{sq ft})(\text{hr})$$

TABLE 93. HEAT LOSSES AND HEAT STORAGE CAPACITIES OF WALL STRUCTURES UNDER EQUILIBRIUM CONDITIONS*
(From Bull. R-2-H, Babcock and Wilcox Co.)

| Thick-ness of wall, in. | Thick-ness of B & W insulating and fireclay brick (FB), in. | Hot-face temperature, °F | | | | | | | | | | | | | | | |
|-------------------------|---|--------------------------|-------|-------|--------|--------|--------|--------|--------|--------|--------|--------|--------|--------|--------|--------|--------|
| | | 600 | | 800 | | 1000 | | 1200 | | 1400 | | 1600 | | 1800 | | 2000 | |
| | | HL | HS | HL | HS | HL | HS | HL | HS | HL | HS | HL | HS | HL | HS | HL | HS |
| 4½ | 4½K-16 | 67 | 398 | 100 | 564 | 138 | 742 | 180 | 928 | 226 | 1,130 | 278 | 1,320 | 420 | 2,040 | 468 | 2,320 |
| | 4½K-20 | 81 | 538 | 128 | 760 | 175 | 1,000 | 230 | 1,250 | 300 | 1,503 | 350 | 1,775 | 381 | 2,230 | 447 | 2,525 |
| | 4½K-23 | 89 | 574 | 117 | 820 | 160 | 1,085 | 211 | 1,350 | 262 | 1,645 | 320 | 1,930 | 426 | 2,320 | 476 | 2,620 |
| | 4½K-26 | 137 | 867 | 202 | 1,230 | 273 | 1,620 | 350 | 2,010 | 434 | 2,430 | 528 | 2,850 | 626 | 3,280 | 736 | 3,720 |
| 7 | 4½K-28 | 136 | 905 | 198 | 1,280 | 266 | 1,680 | 341 | 2,100 | 420 | 2,530 | 508 | 2,960 | 569 | 3,410 | 701 | 3,878 |
| | 4½K-30 | 176 | 1,170 | 261 | 1,660 | 356 | 2,170 | 460 | 2,700 | 574 | 3,270 | 697 | 3,830 | 835 | 4,420 | 985 | 5,000 |
| | 4½FB | 547 | 3,970 | 809 | 5,610 | 1,065 | 7,260 | 1,400 | 9,000 | 1,727 | 10,720 | 2,082 | 12,450 | 2,442 | 14,240 | 2,820 | 16,080 |
| | 7K-16 | 44 | 603 | 66 | 858 | 90 | 1,130 | 118 | 1,410 | 148 | 1,700 | 182 | 2,000 | 245 | 3,515 | 286 | 4,000 |
| 9 | 4½K-20 + 2½K-16 | 47 | 894 | 75 | 1,255 | 105 | 1,665 | 144 | 2,128 | 172 | 2,587 | 208 | 3,045 | 235 | 3,669 | 286 | 4,165 |
| | 4½K-23 + 2½K-16 | 51 | 945 | 67 | 1,378 | 94 | 1,780 | 126 | 2,235 | 163 | 2,710 | 185 | 3,195 | 235 | 3,669 | 286 | 4,165 |
| | 4½K-26 + 2½K-16 | 64 | 1,410 | 95 | 2,030 | 129 | 2,680 | 166 | 3,350 | 207 | 4,070 | 251 | 4,780 | 299 | 5,510 | 350 | 6,280 |
| | 4½K-28 + 2½K-16 | 65 | 1,470 | 96 | 2,120 | 130 | 2,800 | 169 | 3,510 | 212 | 4,260 | 260 | 5,040 | 313 | 5,860 | 372 | 6,690 |
| | 4½K-30 + 2½K-16 | 73 | 1,900 | 108 | 2,730 | 148 | 3,620 | 192 | 4,540 | 241 | 5,500 | 295 | 6,510 | 355 | 7,540 | 421 | 8,600 |
| | 4½K-30 + 2½K-23 | 80 | 1,920 | 125 | 2,750 | 167 | 3,620 | 209 | 4,580 | 267 | 5,580 | 322 | 6,620 | 385 | 7,650 | 437 | 8,750 |
| | 4½FB + 2½K-16 | 100 | 5,820 | 150 | 8,360 | 204 | 11,030 | 264 | 13,790 | 328 | 16,590 | 399 | 19,490 | 475 | 22,430 | 555 | 25,350 |
| | 4½K-23 + 2½K-23 | 114 | 6,062 | 170 | 8,500 | 230 | 11,100 | 293 | 13,890 | 366 | 16,625 | 442 | 19,550 | 522 | 22,485 | 608 | 25,500 |
| | 4½FB + 2½K-26 | 179 | 5,730 | 261 | 8,210 | 350 | 10,850 | 445 | 13,570 | 545 | 16,390 | 632 | 19,150 | 768 | 22,070 | 888 | 24,930 |
| | 4½K-20 + 4½K-16 | 39 | 1,085 | 56 | 1,560 | 78 | 2,075 | 102 | 2,637 | 127 | 3,210 | 157 | 3,805 | 190 | 4,415 | 220 | 5,050 |
| | 4½K-23 + 4½K-16 | 37 | 1,140 | 54 | 1,625 | 73 | 2,155 | 99 | 2,735 | 122 | 3,320 | 150 | 3,935 | 178 | 4,565 | 210 | 5,210 |
| | 4½K-26 + 4½K-16 | 46 | 1,590 | 68 | 2,370 | 93 | 3,160 | 121 | 3,970 | 151 | 4,810 | 186 | 5,690 | 223 | 6,500 | 260 | 7,360 |
| 4½K-28 + 4½K-16 | 46 | 1,730 | 67 | 2,470 | 92 | 3,250 | 119 | 4,080 | 148 | 4,930 | 180 | 5,810 | 215 | 6,720 | 253 | 7,650 | |
| 4½K-28 + 4½K-23 | 51 | 1,780 | 75 | 2,515 | 103 | 3,360 | 132 | 4,228 | 165 | 5,140 | 201 | 6,200 | 236 | 6,990 | 273 | 7,990 | |
| 4½K-30 + 4½K-16 | 50 | 2,160 | 74 | 3,120 | 102 | 4,130 | 132 | 5,190 | 166 | 6,270 | 203 | 7,400 | 244 | 8,570 | 290 | 9,790 | |
| 4½K-30 + 4½K-23 | 57 | 2,245 | 86 | 3,220 | 117 | 4,260 | 148 | 5,400 | 183 | 6,570 | 224 | 7,790 | 267 | 9,000 | 313 | 10,230 | |
| 4½FB + 4½K-16 | 61 | 6,100 | 91 | 8,810 | 126 | 11,610 | 163 | 14,540 | 203 | 17,530 | 248 | 20,580 | 294 | 23,680 | 344 | 26,860 | |
| 4½FB + 4½K-23 | 72 | 6,218 | 107 | 9,000 | 144 | 12,000 | 190 | 15,030 | 235 | 18,100 | 282 | 21,200 | 350 | 24,220 | 385 | 27,400 | |
| 4½FB + 4½K-26 | 118 | 6,280 | 172 | 9,010 | 231 | 11,930 | 294 | 14,920 | 362 | 18,000 | 433 | 21,170 | 510 | 24,350 | 592 | 27,560 | |
| 9 | 9K-16 | 34 | 768 | 51 | 1,090 | 70 | 1,440 | 92 | 1,790 | 116 | 2,170 | 142 | 2,530 | 210 | 3,985 | 248 | 4,510 |
| | 9K-20 | 46 | 1,050 | 67 | 1,505 | 86 | 1,995 | 117 | 2,470 | 147 | 2,955 | 177 | 3,450 | 210 | 3,985 | 248 | 4,510 |
| | 9K-23 | 41 | 1,085 | 58 | 1,550 | 80 | 2,080 | 108 | 2,640 | 135 | 3,170 | 163 | 3,665 | 192 | 4,280 | 225 | 4,880 |
| | 9K-26 | 72 | 1,650 | 106 | 2,340 | 142 | 3,060 | 182 | 3,810 | 225 | 4,600 | 274 | 5,400 | 324 | 6,230 | 385 | 7,080 |
| 9 | 9K-28 | 71 | 1,710 | 104 | 2,440 | 140 | 3,160 | 178 | 3,970 | 220 | 4,800 | 264 | 5,630 | 312 | 6,480 | 362 | 7,360 |
| | 9K-30 | 94 | 2,190 | 138 | 3,110 | 188 | 4,090 | 242 | 5,070 | 302 | 6,140 | 366 | 7,230 | 436 | 8,330 | 513 | 9,450 |
| | 9FB | 325 | 7,180 | 473 | 10,120 | 634 | 13,260 | 801 | 16,450 | 977 | 19,690 | 1,166 | 22,980 | 1,345 | 26,250 | 1,536 | 29,600 |

| | | | | | | | | | | | | | | | | | |
|-----|----------------|-----|--------|-----|--------|-----|--------|-----|--------|-----|--------|-----|--------|-------|--------|--------|--------|
| 11½ | 11½K-16 | 27 | 977 | 40 | 1,390 | 55 | 1,830 | 72 | 2,240 | 91 | 2,740 | 111 | 3,230 | 5,420 | 180 | 6,137 | |
| | 9K-20 + 2½K-16 | 33 | 1,417 | 46 | 2,020 | 67 | 2,660 | 86 | 3,331 | 107 | 4,000 | 129 | 4,718 | 5,420 | 172 | 6,960 | |
| | 9K-23 + 4½K-16 | 31 | 1,527 | 44 | 2,190 | 62 | 2,880 | 81 | 3,616 | 100 | 4,110 | 122 | 4,813 | 6,090 | 252 | 10,780 | |
| | 9K-26 + 2½K-16 | 45 | 2,340 | 67 | 3,410 | 91 | 4,300 | 117 | 5,660 | 145 | 6,860 | 177 | 8,115 | 9,410 | | | |
| 13¼ | 9K-28 + 2½K-16 | 45 | 2,450 | 66 | 3,520 | 89 | 4,680 | 114 | 5,940 | 141 | 7,070 | 171 | 8,340 | 203 | 9,640 | 237 | 11,010 |
| | 9K-30 + 4½K-16 | 53 | 3,220 | 79 | 4,660 | 108 | 6,200 | 140 | 7,770 | 174 | 9,430 | 213 | 11,130 | 256 | 12,940 | 303 | 14,730 |
| | 9K-28 + 4½K-16 | 89 | 10,810 | 131 | 15,400 | 177 | 20,420 | 227 | 25,310 | 282 | 30,790 | 340 | 36,080 | 402 | 41,460 | 468 | 46,900 |
| | 9FB + 2½K-23 | 102 | 10,702 | 146 | 15,400 | 198 | 20,350 | 256 | 25,350 | 316 | 30,400 | 378 | 35,600 | 441 | 41,140 | 510 | 46,450 |
| 16 | 9K-20 + 4½K-16 | 27 | 1,700 | 40 | 2,410 | 54 | 3,210 | 71 | 4,060 | 90 | 4,860 | 109 | 5,830 | 130 | 6,840 | 154 | 7,710 |
| | 9K-23 + 4½K-16 | 26 | 1,764 | 38 | 2,520 | 51 | 3,350 | 68 | 4,235 | 85 | 5,330 | 103 | 6,067 | 122 | 7,043 | 143 | 8,040 |
| | 9K-26 + 4½K-16 | 35 | 2,820 | 52 | 3,910 | 70 | 5,170 | 91 | 6,300 | 114 | 7,890 | 140 | 9,320 | 168 | 10,840 | 200 | 12,360 |
| | 9K-28 + 4½K-16 | 35 | 2,920 | 51 | 4,030 | 69 | 5,360 | 89 | 6,710 | 111 | 8,110 | 134 | 9,550 | 160 | 11,050 | 188 | 12,560 |
| 18 | 9K-30 + 4½K-16 | 40 | 3,650 | 59 | 5,290 | 81 | 7,000 | 105 | 8,790 | 131 | 10,640 | 160 | 12,600 | 192 | 14,630 | 228 | 16,640 |
| | 9FB + 4½K-16 | 57 | 11,450 | 84 | 16,460 | 115 | 21,720 | 149 | 27,090 | 185 | 32,650 | 224 | 38,390 | 265 | 44,370 | 309 | 49,930 |
| | 9K-20 + 4½K-23 | 67 | 11,692 | 100 | 16,800 | 132 | 22,250 | 168 | 27,770 | 209 | 33,100 | 251 | 38,450 | 296 | 43,930 | 341 | 49,350 |
| | 9FB + 4½K-26 | 103 | 11,100 | 150 | 15,990 | 199 | 21,010 | 252 | 26,300 | 309 | 31,660 | 368 | 37,200 | 431 | 42,810 | 496 | 48,410 |
| 18 | 9K-16 + 4½FB | 33 | 1,040 | 49 | 1,570 | 68 | 2,080 | 89 | 2,650 | 112 | 3,260 | 137 | 3,760 | 159 | 4,300 | 186 | 4,840 |
| | 9K-20 + 4½FB | 43 | 1,466 | 64 | 2,050 | 88 | 2,725 | 113 | 3,422 | 140 | 4,200 | 168 | 5,070 | 198 | 6,020 | 231 | 7,010 |
| | 9K-23 + 4½FB | 40 | 1,770 | 59 | 2,320 | 80 | 2,960 | 102 | 3,650 | 127 | 4,440 | 153 | 5,270 | 182 | 6,130 | 213 | 7,045 |
| | 9K-26 + 4½FB | 67 | 2,350 | 98 | 3,410 | 132 | 4,480 | 169 | 5,610 | 209 | 6,790 | 253 | 8,000 | 300 | 9,240 | 353 | 10,570 |
| 20½ | 9K-28 + 4½FB | 66 | 2,420 | 96 | 3,450 | 129 | 4,530 | 165 | 5,750 | 204 | 6,870 | 243 | 8,070 | 287 | 9,410 | 334 | 10,720 |
| | 9K-30 + 4½FB | 85 | 3,160 | 125 | 4,500 | 169 | 5,930 | 218 | 7,420 | 271 | 9,030 | 330 | 10,750 | 393 | 12,360 | 462 | 14,270 |
| | 13½FB | 283 | 10,230 | 338 | 14,520 | 448 | 18,950 | 363 | 23,310 | 684 | 28,180 | 869 | 33,000 | 934 | 37,800 | 1,067 | 42,700 |
| | 13½FB + 2½K-16 | 80 | 15,390 | 118 | 22,160 | 159 | 29,200 | 202 | 36,410 | 250 | 43,850 | 300 | 51,420 | 352 | 58,990 | 407 | 66,770 |
| 22½ | 9K-16 + 9FB | 32 | 1,580 | 48 | 2,350 | 65 | 3,130 | 85 | 4,100 | 108 | 5,000 | 132 | 5,920 | 177 | 8,860 | 227 | 10,050 |
| | 9K-20 + 9FB | 42 | 2,283 | 63 | 3,215 | 84 | 4,270 | 106 | 5,325 | 131 | 6,500 | 158 | 7,800 | 190 | 9,000 | 205 | 10,250 |
| | 9K-23 + 9FB | 38 | 2,527 | 50 | 3,420 | 73 | 4,403 | 99 | 5,505 | 124 | 6,470 | 149 | 7,800 | 177 | 9,000 | 205 | 10,250 |
| | 9K-26 + 9FB | 62 | 3,390 | 90 | 4,850 | 122 | 6,410 | 156 | 8,100 | 193 | 9,900 | 235 | 11,760 | 286 | 13,710 | 329 | 15,780 |
| 22½ | 9K-28 + 9FB | 61 | 3,470 | 89 | 4,940 | 120 | 6,540 | 153 | 8,210 | 188 | 9,960 | 226 | 11,750 | 286 | 13,720 | 310 | 15,690 |
| | 9K-30 + 9FB | 77 | 4,480 | 114 | 6,420 | 154 | 8,530 | 198 | 10,700 | 246 | 13,120 | 300 | 15,600 | 326 | 18,150 | 419 | 20,940 |
| | 13½FB + 4½K-16 | 53 | 16,470 | 79 | 23,690 | 106 | 31,520 | 136 | 38,980 | 169 | 46,930 | 204 | 55,150 | 271 | 63,380 | 280 | 71,630 |
| | 13½FB + 4½K-23 | 62 | 16,432 | 91 | 23,290 | 123 | 31,000 | 156 | 39,222 | 192 | 47,200 | 230 | 55,500 | 241 | 64,150 | 315 | 72,700 |
| 20½ | 18FB | 182 | 13,160 | 263 | 18,700 | 350 | 24,500 | 439 | 30,390 | 532 | 36,600 | 628 | 42,700 | 726 | 49,100 | 828 | 55,500 |
| | 18FB + 2½K-16 | 73 | 19,800 | 106 | 28,310 | 143 | 37,380 | 182 | 46,540 | 224 | 55,900 | 268 | 65,770 | 314 | 75,540 | 362 | 85,400 |
| 22½ | 18FB + 4½K-16 | 50 | 21,200 | 73 | 30,530 | 99 | 40,260 | 127 | 50,140 | 156 | 60,430 | 188 | 70,960 | 222 | 81,500 | 237 | 92,040 |
| | 18FB + 4½K-23 | 57 | 20,908 | 85 | 29,450 | 114 | 39,000 | 142 | 48,895 | 175 | 58,750 | 208 | 69,250 | 244 | 79,935 | 280 | 90,800 |
| 22½ | 22½FB | 150 | 16,180 | 216 | 22,850 | 286 | 29,800 | 358 | 37,100 | 434 | 44,700 | 512 | 52,400 | 591 | 60,200 | 674 | 68,100 |

* HL = heat loss in Btu per sq ft per hr. HS = heat storage capacity in Btu per sq ft. Based on still air temperature of 80°F.

TABLE 93. HEAT LOSSES AND HEAT STORAGE CAPACITIES OF WALL STRUCTURES UNDER EQUILIBRIUM CONDITIONS* (Continued)

| Thick- ness of wall, in. | Thickness of B & W insulating and fireclay brick (FB), in. | Hot-face temperature, °F | | | | | | | | | | | | | | | |
|--------------------------------|--|--------------------------|--------|-------|--------|-------|--------|-------|--------|-------|--------|-------|--------|-------|--------|-------|--------|
| | | 2200 | | 2300 | | 2400 | | 2500 | | 2600 | | 2700 | | 2800 | | 2900 | |
| | | HL | HS | HL | HS | HL | HS | HL | HS | HL | HS | HL | HS | HL | HS | HL | HS |
| 4½ | 4½K-16 | 510 | 2,830 | 545 | 2,985 | 987 | 4,630 | 1,062 | 4,870 | 1,135 | 5,180 | | | | | | |
| | 4½K-20 | 865 | 4,170 | 921 | 4,400 | | | | | | | | | | | | |
| | 4½K-23 | | | 864 | 4,350 | 921 | 4,770 | 980 | 5,050 | 1,042 | 5,290 | 1,173 | 5,780 | | | | |
| | 4½K-26 | | | 1,235 | 5,020 | 3,380 | 19,600 | 3,780 | 20,500 | 3,960 | 21,400 | 4,350 | 23,150 | 4,550 | 24,100 | 1,857 | 7,790 |
| 7 | 4½K-28 | 1,146 | 5,610 | 1,235 | 5,920 | 3,380 | 19,600 | 3,780 | 20,500 | 3,960 | 21,400 | 4,350 | 23,150 | 4,550 | 24,100 | 1,857 | 7,790 |
| | 4½K-30 | 3,210 | 17,770 | 3,410 | 18,750 | | | | | | | | | | | | |
| | 4½FB | | | | | | | | | | | | | | | | |
| | 7K-16 | 330 | 4,670 | 357 | 4,940 | 468 | 7,840 | 502 | 8,240 | 533 | 8,640 | 642 | 9,840 | 694 | 10,370 | | |
| 9 | 4½K-20 + 2½K-16 | 407 | 7,050 | 436 | 7,350 | 468 | 7,840 | 502 | 8,240 | 533 | 8,640 | 642 | 9,840 | 694 | 10,370 | | |
| | 4½K-23 + 2½K-16 | 436 | 7,540 | 473 | 7,980 | 511 | 8,420 | 553 | 8,890 | 596 | 9,360 | | | | | | |
| | 4½K-26 + 2½K-16 | 495 | 9,690 | 535 | 10,250 | 576 | 10,790 | 620 | 11,360 | 663 | 11,940 | 712 | 12,520 | 769 | 13,190 | 897 | 14,240 |
| | 4½K-30 + 2½K-16 | 507 | 9,860 | 552 | 10,430 | 604 | 10,985 | 652 | 11,600 | 709 | 12,200 | | | | | | |
| 9 | 4½FB + 2½K-16 | 639 | 28,260 | 682 | 29,790 | 797 | 31,670 | 845 | 32,200 | 895 | 33,700 | 1,372 | 35,200 | 1,448 | 36,560 | 1,525 | 38,050 |
| | 4½FB + 2½K-23 | 701 | 28,550 | 747 | 29,100 | | | | | | | | | | | | |
| | 4½FB + 2½K-26 | 1,020 | 27,870 | 1,084 | 29,280 | 1,155 | 30,740 | 1,223 | 32,220 | 1,295 | 33,700 | | | | | | |
| | 4½K-20 + 4½K-16 | 249 | 5,865 | 274 | 6,195 | 366 | 9,500 | 396 | 10,020 | 427 | 10,550 | | | | | | |
| 9 | 4½K-23 + 4½K-16 | 313 | 8,510 | 339 | 8,990 | 366 | 9,500 | 396 | 10,020 | 427 | 10,550 | | | | | | |
| | 4½K-26 + 4½K-16 | 294 | 8,600 | 316 | 9,050 | 339 | 9,550 | 364 | 10,050 | 396 | 10,480 | 422 | 10,960 | 450 | 11,480 | 478 | 11,930 |
| | 4½K-28 + 4½K-16 | 316 | 8,960 | 340 | 9,430 | 368 | 9,960 | 395 | 10,480 | 422 | 10,960 | | | | | | |
| | 4½K-30 + 4½K-16 | 340 | 11,010 | 367 | 11,640 | 396 | 12,280 | 429 | 12,930 | 482 | 14,200 | 518 | 14,880 | 558 | 15,580 | | |
| 9 | 4½K-20 + 4½K-23 | 362 | 11,560 | 388 | 12,200 | 418 | 13,000 | 450 | 13,490 | 482 | 14,200 | | | | | | |
| | 4½K-23 + 4½K-23 | 399 | 20,940 | 427 | 21,750 | 467 | 22,600 | 503 | 23,490 | 540 | 24,420 | 578 | 25,390 | 615 | 26,390 | 646 | 27,420 |
| | 4½FB + 4½K-16 | 440 | 30,450 | 467 | 32,200 | 496 | 33,820 | 523 | 35,730 | 560 | 37,700 | 597 | 39,750 | 625 | 41,880 | 656 | 44,100 |
| | 4½FB + 4½K-26 | 678 | 30,780 | 721 | 32,400 | 766 | 33,970 | 812 | 35,600 | 860 | 37,170 | 907 | 38,750 | 958 | 40,380 | 1,010 | 42,020 |
| 9 | 9K-16 | 358 | 5,475 | 375 | 5,770 | 510 | 8,820 | 546 | 9,260 | 586 | 9,710 | | | | | | |
| | 9K-20 | 442 | 7,930 | 474 | 8,370 | 471 | 8,820 | 504 | 9,260 | 535 | 9,710 | | | | | | |
| | 9K-26 | 516 | 8,230 | 544 | 8,700 | 674 | 11,160 | 734 | 12,400 | 785 | 13,800 | 840 | 15,080 | 899 | 16,480 | 946 | 18,000 |
| | 9K-30 | 1,740 | 33,050 | 1,835 | 34,800 | 1,935 | 36,450 | 2,042 | 38,200 | 2,155 | 39,950 | 2,260 | 41,700 | 2,345 | 43,400 | 2,450 | 45,200 |

HEAT TRANSMISSION BY REFRACTORIES

517

| | | | | | | | | | | | | | | | | | |
|------------|--|-------|---------|-------|---------|-------|---------|-------|---------|-------|---------|-------|---------|-------|---------|-------|---------|
| 11½ | 11½K-16 9K-20 + 2½K-16 9K-23 + 2½K-16 9K-26 + 2½K-16 | 200 | 7,850 | 214 | 8,310 | 347 | 13,590 | 375 | 14,370 | 404 | 15,110 | 385 | 15,980 | 408 | 16,700 | 589 | 23,680 |
| | | 297 | 12,170 | 321 | 12,870 | 347 | 13,790 | 375 | 14,370 | 404 | 15,110 | 385 | 15,980 | 408 | 16,700 | 589 | 23,680 |
| | | 275 | 12,380 | 294 | 13,070 | 314 | 13,790 | 347 | 14,490 | 358 | 15,220 | 385 | 15,980 | 408 | 16,700 | 589 | 23,680 |
| 13½ | 9K-20 + 4½K-16 9K-23 + 4½K-16 9K-26 + 4½K-16 9K-28 + 4½K-16 9K-30 + 4½K-16 9FB + 2½K-23 | 218 | 13,180 | 234 | 14,970 | 251 | 15,780 | 269 | 16,580 | 286 | 17,420 | 306 | 18,260 | 327 | 19,120 | 451 | 26,810 |
| | | 268 | 18,790 | 290 | 19,890 | 312 | 21,000 | 337 | 22,140 | 363 | 23,290 | 390 | 24,400 | 420 | 25,610 | 451 | 26,810 |
| | | 357 | 55,900 | 382 | 58,800 | 447 | 61,920 | 480 | 65,200 | 503 | 68,500 | 532 | 71,750 | 562 | 75,050 | 784 | 73,850 |
| 13½ | 9K-16 + 4½FB 9K-20 + 4½FB 9K-23 + 4½FB 9K-26 + 4½FB | 252 | 7,960 | 275 | 8,440 | 474 | 13,440 | 508 | 14,150 | 543 | 14,940 | | | | | | |
| | | 410 | 11,960 | 440 | 12,770 | 474 | 13,440 | 508 | 14,150 | 543 | 14,940 | | | | | | |
| | | 384 | 12,080 | 411 | 12,790 | 439 | 13,520 | 466 | 14,220 | 495 | 14,930 | 526 | 15,610 | 557 | 16,400 | 862 | 23,150 |
| 16 | 9K-28 + 4½FB 9K-30 + 4½FB 13½FB | 1,213 | 47,700 | 1,276 | 50,200 | 1,349 | 52,700 | 1,425 | 55,200 | 1,500 | 57,800 | 1,580 | 60,400 | 1,650 | 63,000 | 1,720 | 65,600 |
| | | 463 | 74,340 | 491 | 78,170 | 522 | 81,900 | 552 | 85,940 | 584 | 89,680 | 615 | 93,710 | 645 | 97,370 | 678 | 101,390 |
| | | | | | | | | | | | | | | | | | |
| 18 | 9K-16 + 9FB 9K-20 + 9FB 9K-23 + 9FB 9K-26 + 9FB | 236 | 11,450 | 255 | 12,130 | 443 | 20,340 | 475 | 21,580 | 507 | 22,900 | | | | | | |
| | | 383 | 18,040 | 412 | 19,220 | 443 | 20,340 | 475 | 21,580 | 507 | 22,900 | | | | | | |
| | | 356 | 17,650 | 380 | 18,820 | 406 | 19,800 | 432 | 21,010 | 459 | 22,160 | 487 | 23,300 | 515 | 24,430 | 782 | 35,120 |
| 20½ | 9K-30 + 9FB 13½FB + 4½K-16 18FB + 2½K-23 | 320 | 79,870 | 342 | 83,950 | 364 | 88,220 | 385 | 92,300 | 406 | 96,550 | 441 | 100,300 | 485 | 110,200 | 541 | 130,100 |
| | | 930 | 62,100 | 982 | 65,300 | 1,036 | 68,600 | 1,090 | 72,000 | 1,145 | 75,500 | 1,197 | 78,700 | 1,255 | 82,000 | 1,313 | 85,400 |
| | | 412 | 95,270 | 438 | 100,400 | 464 | 105,340 | 490 | 110,270 | 518 | 115,400 | 546 | 120,340 | 578 | 125,370 | 600 | 130,200 |
| 22½ | 18FB + 4½K-16 18FB + 4½K-23 | 294 | 102,880 | 313 | 108,250 | 333 | 113,710 | 352 | 119,290 | 372 | 124,160 | | | | | | |
| | | 317 | 102,250 | 341 | 108,200 | 362 | 114,165 | 384 | 120,300 | 407 | 126,500 | 431 | 132,700 | 456 | 139,000 | 482 | 145,350 |
| | | 757 | 76,200 | 802 | 80,200 | 844 | 84,200 | 886 | 88,400 | 930 | 92,400 | 971 | 96,500 | 1,015 | 100,700 | 1,060 | 105,000 |
| 22½ | 22½FB | | | | | | | | | | | | | | | | |
| | | | | | | | | | | | | | | | | | |
| | | | | | | | | | | | | | | | | | |

* HL = heat loss in Btu per sq ft per hr. Based on still air temperature of 80°F. HS = heat storage capacity in Btu per sq ft.

2. For a composite wall:

$$q = \frac{2\pi(t - t_n)}{\frac{12}{k_1} \ln \frac{D_1}{D} + \frac{12}{k_2} \ln \frac{D_2}{D_1} + \cdots + \frac{12}{k_n} \ln \frac{D_n}{D_{(n-1)}}} \text{ Btu}/(\text{lin ft})(\text{hr})$$

or

$$q = \frac{t - t_n}{\frac{12D_n}{2k_1} \ln \frac{D_1}{D} + \frac{12D_n}{2k_2} \ln \frac{D_2}{D_1} + \cdots + \frac{12D_n}{2k_n} \ln \frac{D_n}{D_{(n-1)}}} \text{ Btu}/(\text{sq ft})(\text{hr})$$

where q = the quantity of heat, Btu hr

t_1 = the hot-face temperature

t_n = the cold-face or casing temperature

D = the inside diameter of cylinder, in.

D_1 = the outside diameter of inside lining material, in.

D_2 = the outside diameter of secondary lining material, in.

$D_{(n-1)}$ = the outside diameter of next to last lining material, in.

D_n = the outside diameter of outside lining material, in.

k_1 = the thermal conductivity of inside lining material

k_2 = the thermal conductivity of secondary lining material

k_n = the thermal conductivity of outside lining material

k_1 , k_2 , and k_n are expressed in Btu/(hr)(sq ft)(in.)($^{\circ}$ F)

Interface temperatures between various layers are expressed as

t_1 = the temperature at D_1 , $^{\circ}$ F

t_2 = the temperature at D_2 , $^{\circ}$ F

$T_{(n-1)}$ = the temperature at $D_{(n-1)}$, $^{\circ}$ F

For a case in which the flow of heat is from the outside of the cylinder toward the center, D would become the outside or largest diameter and D_n the inside or smallest diameter.

8. Flow of Heat through Furnace Walls under Variable Conditions.

The temperature distribution in a simple or composite wall can be computed approximately for conditions of unsteady heat flow mathematically or graphically by the method of Schmidt. Such calculations require values of diffusivity for each material over the whole temperature range and, at best, are only approximate. For a discussion of this method, which requires too much space to treat here, reference should be made to Trinks⁽¹⁶⁾ or Schack.⁽⁴⁶⁾ Composite walls require a very complicated set of calculations.

Practically, the problem can be solved quite readily by constructing a small section of the wall as the side or door of a furnace. Couples on the faces and between the layers will give the temperature distribution accurately. The value of q passing out from the wall can be estimated fairly closely from the outside temperature. Recently electrical analogues of heat-flow systems have been made up for solving unsteady-state problems.

The case of dynamic heat flow in cylinders has been treated by Gurney and Lurie,⁽⁶⁾ and convenient monographic charts have been made up by Davis.⁽⁷⁹⁾

9. Bibliography

1. EUCKEN, A.: Über die temperatur abhängigkeit der wärmeleitfähigkeit fester nichtmetalle, *Ann. Physik*, **34**, 35, 1911.
2. INGERSOLL, L.R., and O.J. ZOBEL: "An Introduction to the Mathematical Theory of Heat Conduction," Ginn & Company, Boston, 1913.
3. COMPTON, A.H.: A Physical Study of the Thermal Conductivity of Solids, *Phys. Rev.*, **7**, 341, 1916.
4. GROBER, H.: "The Basic Laws of Thermal Conductivity and Thermal Transition," Verlag Julius Springer, Berlin, 1921.
5. TADOKORO, Y.: On the Determinations of the Thermal Conductivity, Specific Heat, Density and Thermal Expansion of Different Rocks and Refractory Materials, *Tôhoku Imp. Univ., Sci. Rept.*, **10**, 339, 1921.
6. GREEN, A.T.: The Thermal Conductivity of Refractory Materials at High Temperatures, *Trans. Ceram. Soc. (Engl.)*, **21**, 394, 1921.
7. MAKOB, M.: Messung des Wärmeleitvermögens von Flüssigkeiten, Isolierstoffen, und Metallen, *Z. Ver. deut. Ing.*, **66**, 688, 1922.
8. GURNEY, H.P., and J. LURIE: Charts and Estimated Temperature Distributions in Heating or Cooling Solid Shapes, *J. Ind. Eng. Chem.* **15**, 1170, 1923.
9. JAKOB, M.: Gefüge und Wärmeleitvermögen feuerfester Steine, *Z. Ver. deut. Ing.*, **67**, 126, 1923.
10. GREEN, A.T.: The Thermal Conductivity and Some Other Properties of Two Commercial, Heat-insulating Bricks Used in Kiln Construction, *Trans. Ceram. Soc. (Engl.)*, **23**, 271, 1923.
11. GREEN, A.T.: The Influence of Texture on the Transmission of Heat through Firebricks, *Trans. Ceram. Soc. (Engl.)*, **23**, 253, 1923.
12. HERSEY, M.D., and E.W. BUTZLER: Determination of Thermal Conductivity of Refractories, *J. Wash. Acad. Sci.*, **14**, 147, 1924.
13. SCHMIDT, E.: The Thermal Conductivity Values of Substances on the Basis of Measured Results, *Mitt. Forsch., Wärmeschutz*, **5**, 1924.
14. SCHULZE, K.: Die Wärmeleitung in Mineralien, Gesteinen, und den künstlich hergestellten Stoffen von entsprechender Zusammensetzung, *Fortschr. Mineral., Krist. Petrog.*, **9**, 221, 1924.
15. GREEN, A.T., and H. EDWARDS: The Heat-insulating Efficiencies of Some Diatomaceous Earth Products and Slag Wool, *Trans. Ceram. Soc. (Engl.)*, **24**, 228, 1924.
16. TRINKS, W.: "Industrial Furnaces," John Wiley & Sons, Inc., New York, Vol. I, 1923; Vol. II, 1925.
17. BARRATT, T., and R.M. WINTER: Some New Methods for the Measurement of Thermal Conductivity, *Phil. Mag.*, **49**, 313, 1925.
18. GROBER, H.: "Introduction to the Study of Heat Transfer," Verlag Julius Springer, Berlin, 1926.
19. HEILMAN, R.H.: Apparatus for the Determination of Thermal Conductivities of High-temperature Insulation. *Trans. Am. Inst. Chem. Engrs.*, **18**, 283, 1926.
20. JAKOB, M.: Heat Conduction, *Handb. Phy. Geiger-Scheel*, **11**, 42, 1926.
21. KAYE, G.W.C., and W.F. HIGGENS: The Thermal Conductivity of Vitreous Silica, with a Note on Crystalline Quartz, *Proc. Roy. Soc. (London)*, **113**, 335, 1926.

22. RAISCH, E.: On the Calculation of the Thermal Conductivity Values of Porous Bodies, *Mitt. Forsch., Wärmeschutz*, **7**, 1926.
23. SCHLUTER, A.: Heat Flow in Walls for Periodically Variable Temperature of One Surface, *Mitt. Wärmestell Fachausschussber*, **82**, 1926.
24. TADOKORO, Y.: On the Effect of Porosity upon Thermal Conductivity, Diffusivity, and Heat Capacity at High Temperatures, *Tōhoku Imp. Univ., Sci. Rept.*, **15**, 567, 1926.
25. HIND, S.R., and R.S. TROOP: A Note on the Calculation of Mean Temperatures in Flat Furnace Walls, *Trans. Ceram. Soc. (Engl.)*, **26**, 249, 1926.
26. GREEN, A.T.: The Temperature Diffusivity and Thermal Conductivity of Silica Refractory Material at High Temperatures, *Trans. Ceram. Soc. (Engl.)*, **26**, 159, 1926.
27. GREEN, A.T.: A Comparison of the Temperature Diffusivities and Thermal Conductivities of Silica and Fireclay Refractories, *Trans. Ceram. Soc. (Engl.)*, **26**, 168, 1926.
28. CAMMERER, J.S.: Apparatus for Measuring Heat Conductivity of Dry Insulating and Building Materials, *Messtech.*, **3**, 253, 1927.
29. KORNFELD, H.: Zur Frage des Temperaturverlaufs und des Wärmeflusses in periodisch beheizten Wänden mit veränderlicher Wärmeleitfähigkeit, *Z. tech. Physik*, **8**, 178, 1927.
30. NORTON, F.H.: The Thermal Conductivity of Some Refractories, *J. Am. Ceram. Soc.*, **10**, 30, 1927.
31. MEKER, G.: Determining Conductivity (Thermal) of Refractory Materials, *Céramique*, **30**, 445, 1927.
32. RAISCH, E.: Critical Survey of the Process of Testing for Thermal Conductivity Values, *Arch. Wärmewirt.*, **8**, 133, 1927.
33. WISHEVSKY, A.: Thermal Conductivities of Refractories, *Blast Furnace Steel Plant*, **15**, 309, 1927.
34. BOOZE, M.C.: Heat Penetration in Refractories, *Am. Refractories Inst., Bull.* **19**, January, 1928.
35. HARTMANN, M.L., O.B. WESTMONT, and C.E. WEINLAND: Methods of Measuring the Thermal Conductivity of Insulating and Refractory Materials, American Society for Testing Materials, Annual Meeting, **28**, 820, 1928.
36. JAKOB, M.: Wärmeübertragung, *Z. Ver. deut. Ing.*, **72**, 341, 1928.
37. JAKOB, MAX: Heat Transfer through Ceramic Materials (III), *Die Keramik im Dienste von Industrie und Volkswirtschaft*, trans. in *Ceram. Age*, **11**, 121, 1928.
38. REPKY, H.: Ermittlung günstigster Wanddicken von Industrieöfen, *Arch. Wärmewirt.*, **9**, 145, 1928.
39. EUCKEN, A., and H. LAUBE: Thermal Conductivity Measurements on Refractory Materials at High Temperatures, *Tonind.-Ztg.*, **53**, 1599, 1929.
40. MAASE, E.: The Calculation of Heat Losses through the Walls of Industrial Furnaces, *Feuerfest*, **7**, 97, 1931.
41. MAASE, E.: Structure and Thermal Conductivity of Refractory Bricks, *Stahl u. Eisen*, **51**, 860, 1931.
42. EUCKEN, A.: Thermal Conductivity of Ceramic Refractory Materials: Its Calculation from the Thermal Conductivity of Constituents, *V.D.I.*, 1932.
43. KANZ, A.: Investigations on the Thermal Conductivity of Refractory Bricks, *Mitt. deut. Forsch.-Inst. Verein. Stahlwerke*, Dortmund, **2**, 223, 1932.
44. SARJANT, R.J.: Fluctuating Flow of Heat in Furnaces, *Trans. Ceram. Soc. (Engl.)*, **31**, 83, 1932.

45. SCHACK, A.: "Industrial Heat Transfer," John Wiley & Sons, Inc., New York, 1933.
46. WILKES, G.B.: Thermal Conductivity of Magnesite Brick, *J. Am. Ceram. Soc.*, **16**, 125, 1933.
47. CRARY, A.P.: Thermal Conductivity of Acheson Graphite, *Physics*, **4**, 332, 1933.
48. ANON.: Thermal Conductivity of Refractories at High Temperatures, *Rept. Nat. Phys. Lab. (London)*, p. 26, 1933.
49. WILKES, G.B.: The Thermal Conductivity of Refractories, *J. Am. Ceram. Soc.*, **17**, 173, 1934.
50. GRANGER, A.: Twelve Years of Research on the Thermal Conductivity of Refractory Materials at High Temperatures, *Ceram. verrierie email.*, **2**, 341, 1934.
51. WEINLAND, C.E.: A Method of Measuring Thermal Conductivity at Furnace Temperatures, *J. Am. Ceram. Soc.*, **17**, 194, 1934.
52. HEILMAN, R.H.: Heat Transmission through Bare and Insulated Furnace Walls, *Am. Inst. Chem. Engrs.*, **31**, 1, 1934.
53. HEILMAN, R.H., and R.S. BRADLEY: Thermal Conductivity of Refractories under Operating Conditions, *J. Am. Ceram. Soc.*, **18**, 43, 1935.
54. SALMANG, H., and H. FRANK: The Thermal Conductivity of Refractory Materials up to Temperatures of 1400°, *Keram. Rundschau*, **43**, 197, 1935.
55. SALMANG, H., and H. FRANK: Measuring the Thermal Conductivity of Refractory Materials at High Temperatures, *Sprechsaal*, **68**, 225, 1935.
56. AUSTIN, J.B., and R.H.H. PIERCE, JR.: The Reliability of Measurements of the Thermal Conductivity of Refractory Brick, *J. Am. Ceram. Soc.*, **18**, 48, 1935.
57. AWBERY, J.H.: Temperature Rise in Material of Which the Thermal Properties Vary with Temperatures, *Proc. Phys. Soc. (London)*, **48**, 118, 1936.
58. NICHOLLS, P.: Determination of Thermal Conductivity of Refractories, *Bull. Am. Ceram. Soc.*, **15**, 37, 1936.
59. HOLLER, F.: The Thermal Conductivity of Technical Silicon Carbide Bricks, *Sprechsaal*, **69**, 735, 747, 761, 1936.
60. HOLLER, F.: Thermal Conductivity of Technical Silicon Carbide Brick, *Sprechsaal*, **69**, 733, 745, 761, 1936.
61. AUBERT, A.: Thermal-conductivity Coefficients of Heat-insulating and Refractory Materials, *Chaleur & Ind.*, **18**, 87, 1937.
62. CAMMERER, I.S.: Measurement of Thermal Conductivity of Insulating Materials Encased in Sheet Metal, *Wärme*, **60**, 765, 1937.
63. LONG, B.: On the Thermal Conductivity of Ceramic Materials, *Chaleur & Ind.*, **18**, 328, 1937.
64. POWELL, R.W.: Thermal and Electrical Conductivities of a Sample of Acheson Graphite from 0° to 800°C., *Proc. Phys. Soc. (London)*, **49**, 419, 1937.
65. BAUMANN, H.N., JR., and J.P. SWENTZEL: Physical Properties of Silicon-carbide Refractories, *Bull. Am. Ceram. Soc.*, **16**, 419, 1937.
66. BARITEL, A.: Radiation Properties of Several Silicoalumina Refractories, *Chaleur & Ind.*, No. 215, p. 237, 1938.
67. BARITEL, A.: Radiation Properties of Several Silicoalumina Refractories, II, *Chaleur & Ind.*, No. 216, p. 299, 1938.
68. JAY, A.H., and L. LEE: The Testing and Properties of Heat Insulating Materials. *Trans. Ceram. Soc. (Engl.)*, **37**, 151, 1938.
69. OLIVER, H.: A Note on the Reliability of Thermal Conductivity of Measurements for Insulating Materials, *Trans. Ceram. Soc. (Engl.)*, **37**, 49, 1938.
70. WHITE, H.E.: Conversion Tables for Thermal Units, *Bull. Am. Ceram. Soc.*, **21**, 17, 1938.

71. POWELL, R.W., and R.H. SCHOFIELD: Thermal and Electrical Conductivities of Carbon and Graphite at High Temperatures, *Proc. Phys. Soc. (London)*, **51**, 153, 1939.
72. BIRCH, F., and H. CLARK: The Thermal Conductivity of Rocks and Its Dependence upon Temperature and Composition, *Am. J. Sci.*, **238**, 529, 613, 1940.
73. NORTON, C.L., JR.: Apparatus for Measuring Thermal Conductivity of Refractories, *J. Am. Ceram. Soc.*, **25**, 451, 1942.
74. PATTON, T.C., and C.L. NORTON, JR.: Measurement of Thermal Conductivity of Fireclay Refractories, *J. Am. Ceram. Soc.*, **26**, 350, 1943.
75. KNAPP, W.J.: Thermal Conductivity of Non Metallic Single Crystals, *J. Am. Ceram. Soc.*, **26**, 48, 1943.
76. WADDAMS, A.L.: Flow of Heat through Granular Material, *J. Soc. Chem. Ind. (London)*, **63**, 337, 1944.
77. DUSENBERRE, G.M.: Numerical Methods for Transient Heat Flow, *Trans. Am. Soc. Mech. Engrs.*, **67**, 703, 1945.
78. EYRES, N.R., *et al.*: The Calculation of Variable Heat Flow in Solids, *Phil. Trans.*, **240**, 1, 1946.
79. DAVIS, D.S.: Nomographs for Heat Transmission by Conduction in the Unsteady State, *Chem. Ind.*, **60**, 466, 1947.
80. WHITTEMORE, O.J., JR.: Properties and Uses of Pure Oxide Heavy Refractories, *J. Am. Ceram. Soc.*, **32**, 48, 1949.

CHAPTER XIX

SIZES AND TOLERANCES

1. Standard Shapes. A standard shape is a refractory brick other than a straight $9 \times 4\frac{1}{2} \times 2\frac{1}{2}$ -in. size that is generally stocked by all refractory manufacturers in the United States and England. The German⁽¹⁶⁾ standard brick is $250 \times 123 \times 65$ cm. Although all manufacturers do not agree as to what constitutes a standard shape, there are many universally accepted ones that may safely be specified in any design work.

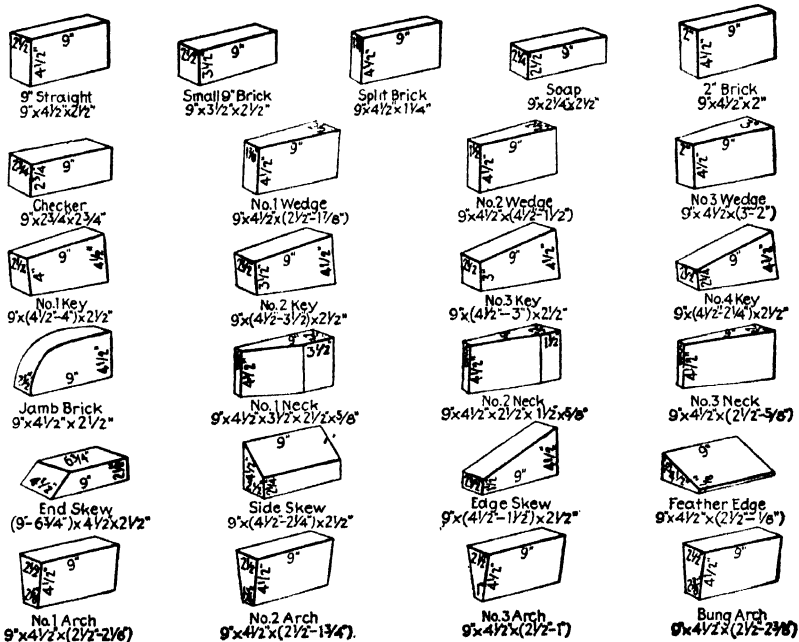

Fig. 307. Standard shapes (9-in. series).

Standard shapes are used in all types of construction to save cutting straight brick, as illustrated in Chap. XXVII.

In Figs. 307 and 308 are given the sizes of the generally accepted standard firebrick shapes. Of course, many others are stocked as standard by individual companies, and these will be treated separately as special shapes.

The size tolerance on standard shapes and straight brick is given by the American Society for Testing Materials as ± 2 per cent, which covers both

shrinkage and warpage on all dimensions over 4 in. On dimensions less than this, a tolerance of 3 per cent is specified. ASTM Method C 134-41 is used in measuring. Warpage is measured by laying a straightedge along a concave diagonal and inserting a calibrated wedge under the straightedge at the center of the tile. The American Refractories Institute recommends that warpage should not exceed 1 per cent of the diagonal,⁽¹³⁾ according to Method C 154-41.

Silica standard shapes are approximately the same as firebrick shapes. Magnesite and chrome refractories can be called standard only in the sim-

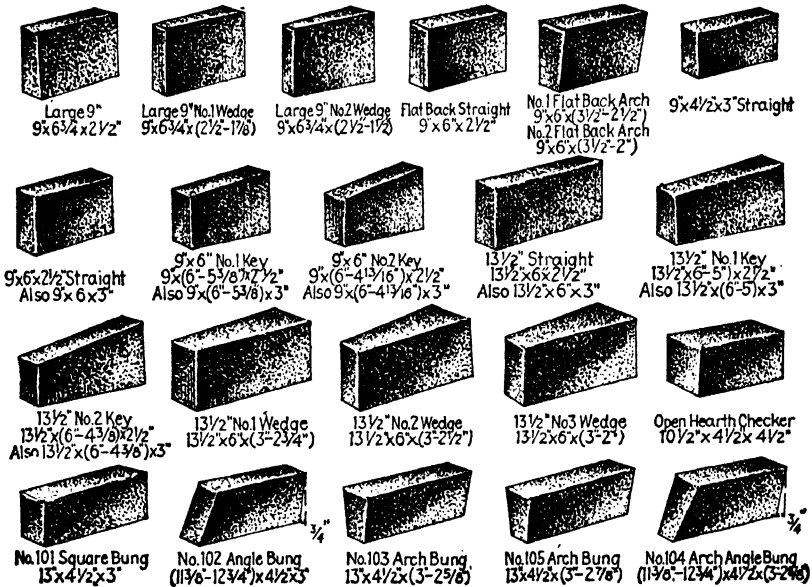

FIG. 308. Standard shapes of firebrick (larger than 9 in.).

pler shapes of the 9-in. series. The manufacturer's catalogue should always be consulted, as shapes stocked by one company might not be stocked by another.

2. Special Shapes. Glass-tank Blocks. Shapes that are used only for certain particular types of construction can be obtained from stock at times but are not generally available without ordering ahead. This class includes glass-tank blocks. Unfortunately there is little standardization of these blocks, but a few of the favorite sizes are listed in Table 94.

Glass-tank blocks, or flux blocks as they are usually termed, are generally made with more care than other large shapes. The clays are carefully blended and aged; the molding is carried out in such a way as to give a homogeneous structure; and the faces of the block are often ground accu-

rately to dimensions. Besides the rectangular blocks, there are many special blocks used in tanks, such as the throat blocks.

TABLE 94

Common Sizes of Flux Blocks for Continuous Tanks

| | | |
|------------------|------------------|------------------|
| 12 × 18 × 24 in. | 12 × 18 × 42 in. | 12 × 24 × 36 in. |
| 12 × 18 × 30 in. | 12 × 18 × 48 in. | 12 × 24 × 42 in. |
| 12 × 18 × 36 in. | 12 × 24 × 30 in. | 12 × 24 × 48 in. |

Common Sizes of Flux Blocks for Day Tanks

| | | |
|-----------------|-----------------|-----------------|
| 8 × 12 × 24 in. | 8 × 18 × 24 in. | 8 × 24 × 30 in. |
| 8 × 12 × 30 in. | 8 × 18 × 30 in. | 8 × 24 × 36 in. |
| 8 × 12 × 36 in. | 8 × 18 × 36 in. | 8 × 24 × 42 in. |
| | 8 × 18 × 42 in. | |

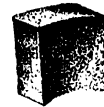

6" Cupola and Rotary Kiln Blocks

| No. of Block | Dimensions | Diameter Ins. Outs. | No. of Brick to Circle |
|--------------|-------------------------|---------------------|------------------------|
| 6-30 | 9" x 6 21/32" x 6" x 4" | 30" 42" | 15 |
| 6-36 | 9" x 6 3/4" x 6" x 4" | 36" 46" | 17 |
| 6-42 | 9" x 7" x 6" x 4" | 42" 54" | 19 |
| 6-48 | 9" x 7 1/8" x 6" x 4" | 48" 60" | 21 |
| 6-54 | 9" x 7 1/2" x 6" x 4" | 54" 66" | 23 |
| 6-60 | 9" x 7 7/8" x 6" x 4" | 60" 72" | 25 |
| 6-66 | 9" x 7 9/16" x 6" x 4" | 66" 78" | 27 |
| 6-72 | 9" x 7 11/16" x 6" x 4" | 72" 84" | 29 |
| 6-78 | 9" x 7 13/16" x 6" x 4" | 78" 90" | 31 |
| 6-84 | 9" x 7 7/8" x 6" x 4" | 84" 96" | 33 |
| 6-90 | 9" x 7 15/16" x 6" x 4" | 90" 102" | 35 |
| 6-96 | 9" x 8" x 6" x 4" | 96" 108" | 37 |
| 6-102 | 9" x 8 1/8" x 6" x 4" | 102" 114" | 39 |
| 6-108 | 9" x 8 1/4" x 6" x 4" | 108" 120" | 41 |

9" Cupola Blocks

| No. of Block | Dimensions | Diameter Ins. Outs. | No. of Brick to Circle |
|--------------|----------------------------|---------------------|------------------------|
| A | 9" x 5 3/4" x 4 1/2" x 9" | 16" 25" | 9 |
| B | 9" x 6 5/16" x 4 1/2" x 9" | 21" 30" | 11 |
| C | 9" x 6 3/4" x 4 1/2" x 9" | 27" 36" | 13 |
| D | 9" x 6 9/16" x 4 1/2" x 9" | 30" 39" | 14 |
| E | 9" x 7 1/2" x 4 1/2" x 9" | 40" 49" | 17 |
| F | 9" x 7 7/32" x 4 1/2" x 9" | 51" 60" | 21 |
| G | 9" x 7 9/16" x 4 1/2" x 9" | 60" 69" | 24 |
| H | 9" x 8" x 4 1/2" x 9" | 73" 82" | 29 |

9" Rotary Kiln Blocks

| No. of Block | Dimensions | Diameter Ins. Outs. | No. of Brick to Circle |
|--------------|-------------------------|---------------------|------------------------|
| 9-48 | 9" x 6 1/32" x 9" x 4" | 48" 60" | 23 |
| 9-54 | 9" x 6 3/4" x 9" x 4" | 54" 72" | 25 |
| 9-60 | 9" x 6 9/16" x 9" x 4" | 60" 78" | 27 |
| 9-66 | 9" x 7 1/16" x 9" x 4" | 66" 84" | 29 |
| 9-72 | 9" x 7 1/8" x 9" x 4" | 72" 90" | 31 |
| 9-78 | 9" x 7 1/4" x 9" x 4" | 78" 96" | 33 |
| 9-84 | 9" x 7 1/2" x 9" x 4" | 84" 102" | 35 |
| 9-90 | 9" x 7 5/8" x 9" x 4" | 90" 108" | 37 |
| 9-96 | 9" x 7 7/8" x 9" x 4" | 96" 114" | 39 |
| 9-102 | 9" x 7 31/32" x 9" x 4" | 102" 120" | 41 |

Rectangular Regenerator Tile

| Dimensions |
|--------------------|
| 18" x 6" x 3" |
| 18" x 9" x 3" |
| 22 1/2" x 12" x 4" |
| 18" x 9" x 4" |
| 27" x 9" x 3" |
| 18" x 12" x 4" |
| 27" x 9" x 4" |
| 22 1/2" x 6" x 3" |
| 27" x 12" x 4" |
| 22 1/2" x 9" x 3" |
| 31 1/2" x 12" x 4" |
| 22 1/2" x 9" x 4" |
| 36" x 12" x 4" |

| | |
|--|--|
| Rectangular Stock Hole Tile 16" x 9" x 4 1/2" | Rectangular Square Edge Tile 12" x 12" x 3" |
|--|--|

| |
|---|
| Rectangular Bridge Block 13 1/2" x 6" x 3" |
|---|

24" Circle Brick
24" Inside Diameter
12 to a Circle
(9"-) x 4 1/2" x 2 1/2"



60" Circle Brick
60" Inside Diameter
25 to a Circle
(9"-) x 4 1/2" x 2 1/2"

36" Circle Brick
36" Inside Diameter
15 to a Circle
(9"-) x 4 1/2" x 2 1/2"

48" Circle Brick
48" Inside Diameter
20 to a Circle
(9"-) x 4 1/2" x 2 1/2"

72" Circle Brick
72" Inside Diameter
28 to a Circle
(9"-) x 4 1/2" x 2 1/2"

84" Circle Brick
84" Inside Diameter
32 to a Circle
(9"-) x 4 1/2" x 2 1/2"

FIG. 309. Shapes and sizes of radial blocks.

Cupola and Rotary-kiln Blocks. These blocks are segments of a ring and are used to form a cylindrical lining. The common sizes are given in Fig. 309. Many manufacturers carry these blocks as standard shapes.

Cupola blocks are generally made of a dense fireclay, but rotary-kiln blocks are usually made of a high-alumina clay or magnesite, as these materials seem to resist the slag action well and hold a good coating of clinker.

Tile. Rectangular tile of fireclay may usually be obtained in the sizes shown in Table 95.

Checker Brick. These generally are available in the following size:

$$10\frac{1}{2} \times 4\frac{1}{2} \times 4\frac{1}{2} \text{ in.}$$

TABLE 95. COMMON SIZES OF FIRECLAY TILE

| | | |
|-----------------|-----------------|------------------|
| 2 × 9 × 12 in. | 3 × 6 × 18 in. | 4 × 9 × 18 in. |
| 2 × 12 × 12 in. | 3 × 6 × 22½ in. | 4 × 9 × 22½ in. |
| 2 × 12 × 15 in. | 3 × 9 × 18 in. | 4 × 9 × 27 in. |
| 2 × 12 × 18 in. | 3 × 12 × 12 in. | 4 × 12 × 18 in. |
| 2 × 12 × 24 in. | | 4 × 12 × 22½ in. |
| | | 4 × 12 × 27 in. |
| | | 4 × 12 × 36 in. |
| 6 × 12 × 36 in. | 8 × 18 × 42 in. | |
| 6 × 12 × 42 in. | 8 × 18 × 48 in. | |
| 6 × 12 × 48 in. | 8 × 18 × 54 in. | |
| 6 × 18 × 36 in. | 8 × 24 × 42 in. | |
| 6 × 18 × 42 in. | 8 × 24 × 48 in. | |
| 6 × 18 × 48 in. | 8 × 24 × 54 in. | |
| 6 × 24 × 42 in. | | |
| 6 × 24 × 48 in. | | |

Malleable Furnace Shapes. Certain shapes are made especially for malleable-iron furnaces. They include

| | | | | | |
|----------------|--------------|---|----|---|----------------|
| Bung arch, | 9 | × | 4½ | × | (2½ to 2¾) in. |
| | 13½ | × | 4½ | × | (3 to 2⅝) in. |
| | 13½ | × | 4½ | × | (3 to 2⅞) in. |
| Square bung, | 13½ | × | 4½ | × | 3 in. |
| Angle bung, | (13½ to 12½) | × | 4½ | × | 3 in. |
| Tap-out block, | 9 | × | 7½ | × | 7½ in. |

Lime-kiln Brick. Some special lime-kiln brick are made by a few manufacturers, usually of silica or high-alumina material.

Hot-blast Stove Checker Brick. A number of stove-brick shapes are made for particular types of structure. They are stocked by several manufacturers.

Coke-oven Shapes. Shapes for making up rectangular and beehive ovens are more or less standardized by a number of manufacturers. Shapes for by-product ovens are also stocked, but the number of shapes is so large that they cannot well be listed here.

Blocks for Suspended Arches. There are a number of patented constructions for suspended arches requiring rather complicated blocks. One type of arch block is shown in Fig. 310. More details are given in Chap. XXVII.

Boiler Shapes. There are a number of shapes used in stationary and locomotive boilers that are stocked by some manufacturers.

Other Special Shapes. In addition to these, many special shapes are made for a particular installation, such as burner tile, impeller disks, hollow blocks, and feed-hole bricks. A special shape is shown in Fig. 311.

The Design of Special Shapes. When designing a new furnace, it is often necessary to have special shapes made up. It should be remembered that

special shapes, particularly when in small quantities, are relatively expensive and should be used only where they are necessary. A special shape should be made as simple as possible because complications increase the mold cost and do not permit as careful molding. Undercutting or thin projections should be avoided. It is also undesirable to specify thin slabs or bars because the loss by warping is apt to be large. In general, the shape should be as compact as possible and not exceed 24 in. in length. However, shapes can be made 48 in. long if necessary. A small shape generally has a better structure than a large one and is burned more evenly. Therefore

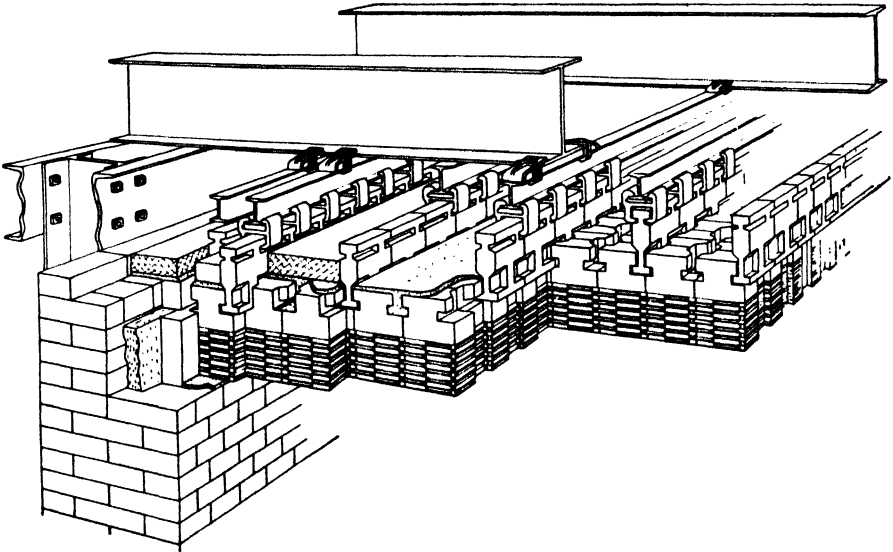

FIG. 310. Special shapes used in a detrick suspended-arch construction. (Courtesy of the M. H. Detrick Company.)

the size of shapes should always be kept as small as practical. In designing special shapes to be used in conjunction with straight brick, a good rule to follow is to make the vertical dimensions a multiple of $2\frac{9}{16}$ in. and the horizontal a multiple of $4\frac{9}{16}$ in. (the thickness and width of a straight brick plus one joint).

3. Kiln Furniture. A considerable volume of refractories is used as kiln furniture, *i.e.*, supports and containers for ceramic ware while it is being fired. As the furniture must be heated and cooled with the ware, it is desirable to keep its mass down to a minimum in order to permit a more rapid heating and cooling cycle and increase the kiln efficiency. Because of the frequent temperature changes, the furniture must be able to resist spalling fairly well; and in many cases, it must be able to support a heavy load at high temperatures.

Saggers. Saggers are refractory boxes for holding whiteware. They serve partly as a support and partly as muffles to protect the ware from the kiln gases. The saggers are generally piled one on top of the other in bungs as shown in Fig. 312. A wadding of soft clay is placed between the saggers to make a tight joint. The ware is supported in the saggers in a variety of ways, which we need not consider here.

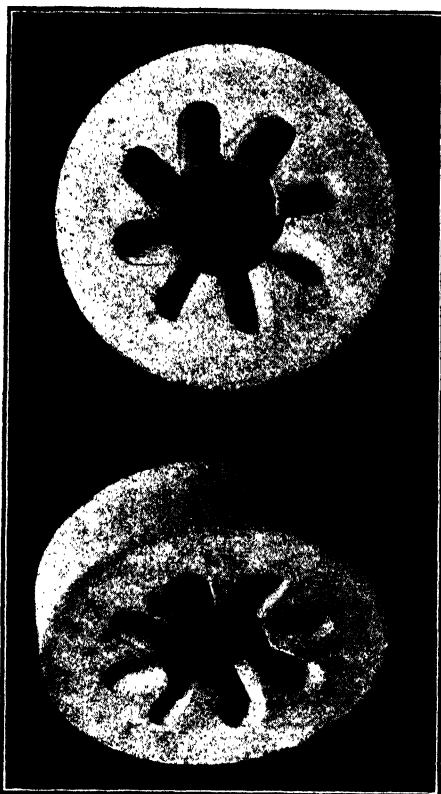

FIG. 311. Burner tiles. (Courtesy of Babcock & Wilcox Company.)

Saggers are made in a number of shapes and sizes, a few of which are shown in Fig. 313. However, there is no generally accepted standard. The wall thickness varies between $\frac{3}{8}$ and $\frac{7}{8}$ in. with an average of about $\frac{5}{8}$ in. The composition varies but generally consists of a grog (usually crushed saggers with the fines removed), a plastic clay to give strength, and a fireclay to prevent too much vitrification. A good body should have a low coefficient of thermal expansion and an elastic structure, as explained in Chap. XV. Talc is often used as an ingredient in modern sagger bodies.

The average life of a sagger was often no more than 25 cycles ten or fifteen years ago due to a poor body, nonhomogeneous molding, rough han-

ding, and, perhaps most important, lack of thorough preburning. As the sagger expense in the whiteware industry is a large item, a really superior sagger is well worth while. Many manufacturers have experimented to some extent on saggings, and the National Bureau of Standards has carried on a considerable investigation of this subject. Now the sagger life is often 50 to 100 cycles.

Another trouble with saggings is the separation of particles from the interior of the sagger, which may fall on the glazed ware and form serious

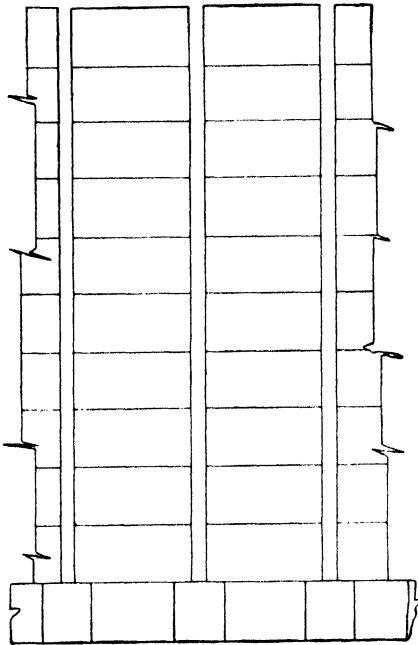

FIG. 312. Saggings piled in bungs.

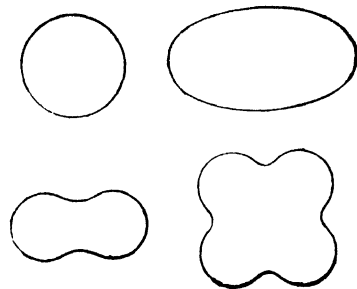

FIG. 313. Common shapes of saggings.

defects. A sagger therefore must have a firm, smooth surface, and it is the usual practice to paint over the inside of the sagger with a wash of some low-vitrifying compound to form a sort of glaze.

Saggings are made in a number of ways. Formerly they were all made by hand on a wooden form. This method requires considerable labor, but it was traditionally believed that first-class saggings could be made only by this method. Later they were made on a machine press, of which there are many kinds. Recently a large proportion of saggings have been made by casting a slip into a plaster mold.

Other materials have been used for saggings, such as silicon carbide, mullite, and zircon, but as yet they have not shown enough superiority over fireclay at moderate temperatures to warrant their increased cost.

Slabs and Posts. In many cases, ware does not have to be protected from the kiln gases, so that supports as shown in Fig. 314 can be used. Generally the slabs are made of fireclay, fused alumina, silicon carbide, or zircon from $\frac{5}{8}$ to $2\frac{1}{2}$ in. thick, depending on the size and load. Important advances have been made in open-setting kiln furniture in the last few years. Open settings permit 25 to 100 per cent more ware⁽¹⁷⁾ to be fired in a given volume and so have replaced the sagger largely in the whiteware industry for bisque firing.

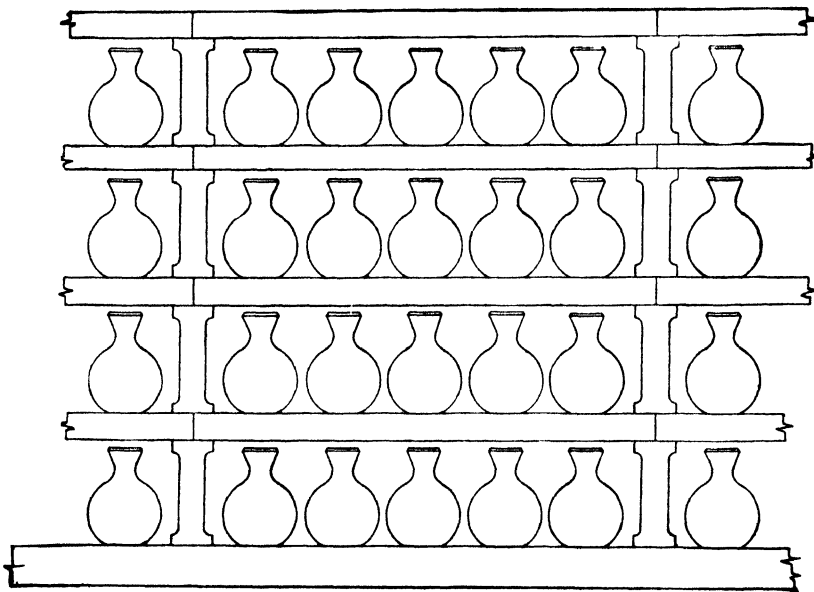

FIG. 314. Setting tile where ware needs no protection from the atmosphere.

TABLE 96. REFRACTORARY SLABS FOR OPEN-KILN SETTING

| | Inches |
|---|---|
| Sanitary ware for straight T.K. | $24 \times 36 \times 1\frac{1}{4}$ |
| | $24 \times 36 \times 2\frac{1}{4}$ |
| | $32 \times 25 \times 1\frac{1}{4}$ |
| | $17 \times 25 \times 1\frac{1}{4}$ |
| | $18 \times 24 \times \frac{3}{4}$ |
| General ware and electrical porcelain for straight T.K. | $25\frac{1}{2} \times 21\frac{1}{2} \times 1$ |
| | $20\frac{1}{2} \times 22\frac{1}{2} \times \frac{7}{8}$ |
| Circular T.K. | $32 \times 16\frac{1}{2} \times 18\frac{1}{2} \times 1$ |
| | $32 \times 16\frac{1}{2} \times 18\frac{1}{2} \times \frac{3}{4}$ |
| | $28 \times 16\frac{1}{2} \times 18\frac{1}{2} \times \frac{3}{4}$ |
| | $28 \times 16\frac{1}{2} \times 18\frac{1}{2} \times \frac{1}{2}$ |
| | $32 \times 16\frac{1}{2} \times 18\frac{1}{2} \times \frac{3}{4}$ |
| | $32 \times 16\frac{1}{2} \times 18\frac{1}{2} \times \frac{1}{2}$ |

4. Muffles. Muffles are generally used for enameled ware and for other articles when it is desired to keep them free from the furnace gases. Large muffles are constructed of sections of thin tile as shown in Fig. 315. The thickness is kept as low as possible, from $\frac{3}{4}$ to $1\frac{1}{4}$ in., in order to obtain the maximum rate of heat transfer. Sometimes each tile has its center recessed to an even thinner wall. The materials used for the muffle are fireclay, fused alumina, and silicon carbide. The high conductivity of the last two materials is of great advantage in this construction.

Small muffles are used in many laboratory types of furnace. Fireclay, fused-alumina, and silicon-carbide types can be obtained in many sizes. Small muffles of fused silica are available but cannot be used at high temperatures. A few of the common sizes of fireclay muffles are listed in Table 97.

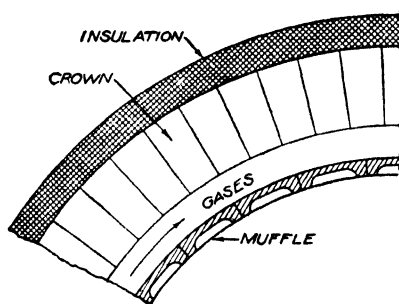

FIG. 315. A large muffle.

TABLE 97. COMMON SIZES OF FIRECLAY MUFFLES

| Length, in. | Width, in. | Height, in. |
|-----------------|-----------------|----------------|
| 7 | 3 | $2\frac{1}{4}$ |
| 8 | $4\frac{3}{4}$ | 3 |
| $10\frac{1}{2}$ | $5\frac{1}{4}$ | $3\frac{7}{8}$ |
| 12 | 6 | 4 |
| 12 | 8 | 5 |
| 15 | 9 | $5\frac{3}{4}$ |
| 16 | 10 | $5\frac{1}{2}$ |
| 18 | $12\frac{1}{4}$ | $7\frac{3}{4}$ |
| 19 | $10\frac{1}{2}$ | $6\frac{1}{2}$ |

5. Retorts. Fireclay retorts for gas manufacture are from 7 to 10 ft long and about 18 in. wide. The wall thickness is $2\frac{1}{2}$ to 3 in. in order to withstand the load. Since carbon closes up the pores when it is in use, the structure need not be dense but should be able to resist spalling.

The body is usually made of about equal parts of plastic clay and grog. As in the case of saggars, the fine particles of the grog are removed. The retorts are usually hand-molded onto a form, but pressed retorts have been used. The finished retorts are burned in a vertical position in a firebrick kiln, and sometimes they are glazed. The more modern continuous retorts are vertical with a height of 40 to 50 ft. They are made up from silica

shapes as shown in Fig. 316. A strong, dense structure is desired to prevent the lining from coming off as a result of carbon deposited in the pores.

6. Crucibles. Crucibles are made of a great variety of refractory materials and in many shapes and sizes. It is, of course, impossible to list all of them here, but a few common sizes will be described.

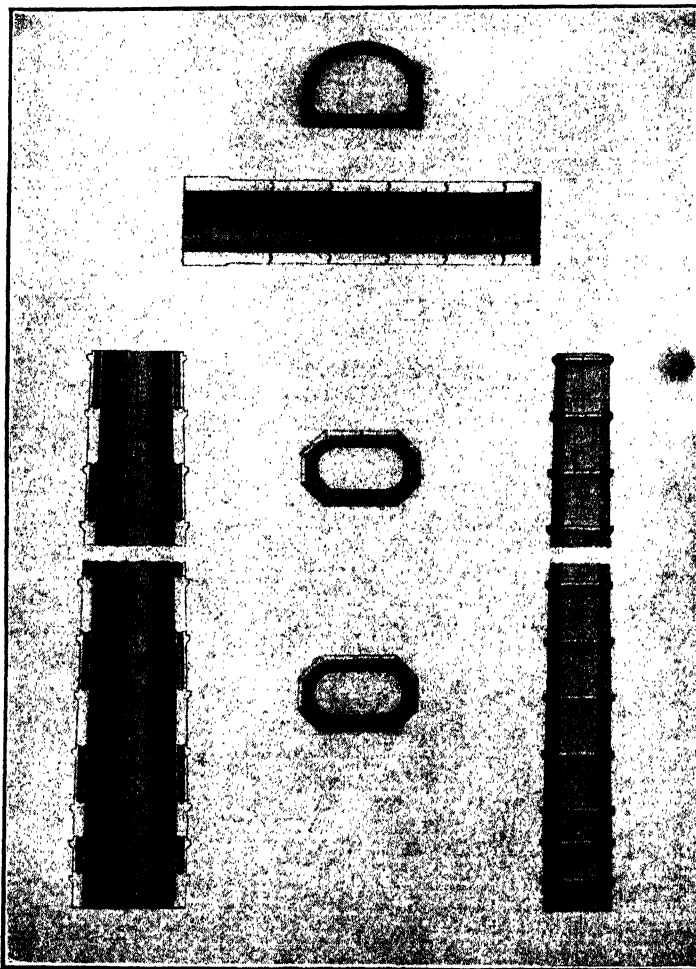

FIG. 316. Silica retorts for gas production. (Courtesy of Harbison-Walker Refractories Company.)

Clay Crucibles. Clay crucibles are made from fireclay and grog. The small ones are pressed, and the large ones made on a jigger or flower-pot machine. The clay crucibles are generally used in small sizes for assaying, roasting, and low-temperature melting. Common shapes are shown in Fig. 317.

The usual sizes of this clay crucible (Denver Fire Clay Company) are shown in Table 98.

TABLE 98. COMMON SIZES OF CLAY CRUCIBLES

| Size | Height, in. | Diameter at top, in. |
|------|----------------|----------------------|
| G | $5\frac{5}{8}$ | $3\frac{5}{8}$ |
| H | $5\frac{7}{8}$ | $3\frac{3}{4}$ |
| I | 6 | 4 |
| J | $6\frac{5}{8}$ | $4\frac{3}{8}$ |
| K | $7\frac{1}{4}$ | $4\frac{3}{4}$ |
| L | 8 | $5\frac{1}{4}$ |
| M | $8\frac{1}{4}$ | $5\frac{3}{4}$ |
| N | $9\frac{3}{8}$ | $6\frac{1}{2}$ |
| O | 10 | 7 |
| P | 11 | $7\frac{3}{4}$ |
| Q | 12 | $8\frac{1}{4}$ |
| R | 13 | $9\frac{3}{8}$ |

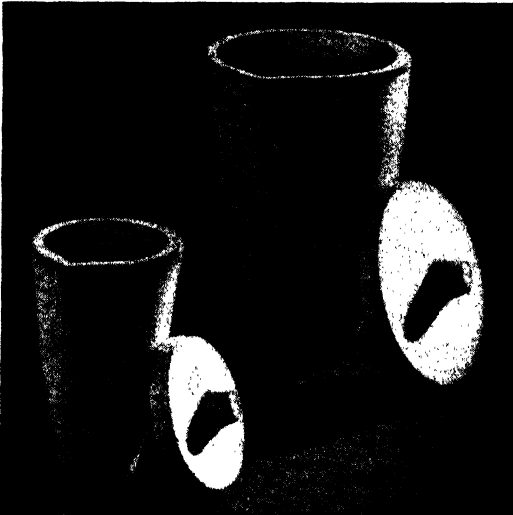

FIG. 317. Clay crucibles. (Courtesy of the Joseph Dixon Company.)



FIG. 318. A clay-graphite crucible. (Courtesy of the Joseph Dixon Company.)

Graphite Crucibles. Graphite crucibles are extensively used for metal melting. The graphite increases the thermal conductivity and gives a strong body at high temperatures. These crucibles are made of a mixture of plastic fireclay and flake graphite. The amount of graphite varies between 6 and 50 per cent. The clay and graphite are thoroughly mixed

in a wet pan or pug mill and aged. The crucibles are formed on a jigger in the same manner as fireclay crucibles. The shape found most suitable for this type of crucible is shown in Fig. 318. A large number of standard sizes are available as given in Table 99 (Dixon).

TABLE 99. COMMON SIZES OF GRAPHITE CRUCIBLES

| Number (Dixon) | Outside diameter, in. | Outside height, in. |
|----------------|-----------------------|---------------------|
| 0 | 1½ | 2 |
| 00 | 1⅞ | 2⅝ |
| 000 | 1⅞ | 2½ |
| 0000 | 2⅝ | 3 |
| 1 | 3⅞ | 3⅝ |
| 2 | 3¾ | 4½ |
| 3 | 4¼ | 5¼ |
| 4 | 4⅞ | 5⅝ |
| 5 | 4⅞ | 6 |
| 6 | 5¼ | 6¼ |
| 7 | 5½ | 6¾ |
| 8 | 5¾ | 7¼ |
| 10 | 6 | 8 |
| 14 | 6¾ | 8½ |
| 18 | 7⅞ | 9¼ |
| 20 | 7¾ | 10¼ |
| | up to | up to |
| 400 | 19⅛ | 24⅝ |

In Chap. XII some special crucibles are described, but no size standards have been evolved.

7. Glass Pots. Glass pots are made of a suitable mixture of clays and grog. Before the First World War, most of the American manufacturers imported their glass-pot clays. Since then, domestic clays have been used successfully in nearly all cases. As a result of the work of the National Bureau of Standards,^(1,15) the old hand-molded pots have been largely superseded by cast pots.

Apparently there are no generally accepted standards of size for pots, but covered pots are often 45 × 58 × 52 or 46 × 60 × 52 in. in width, length, and height, respectively. A typical covered pot is shown in Fig. 319.

8. Refractory Porcelain. Refractory porcelain is used mainly for laboratory ware, spark plugs, and pyrometer protection tubes. It must have a high softening point, a dense structure, and a resistance to spalling as high as possible.

The high-mullite porcelains, sometimes made from calcined sillimanite

or kyanite, are much used. However, they require high firing, preferably up to 1650°C (about 3000°F). Lately sintered alumina fired at 1800°C (about 3270°F) has been used for severe conditions.

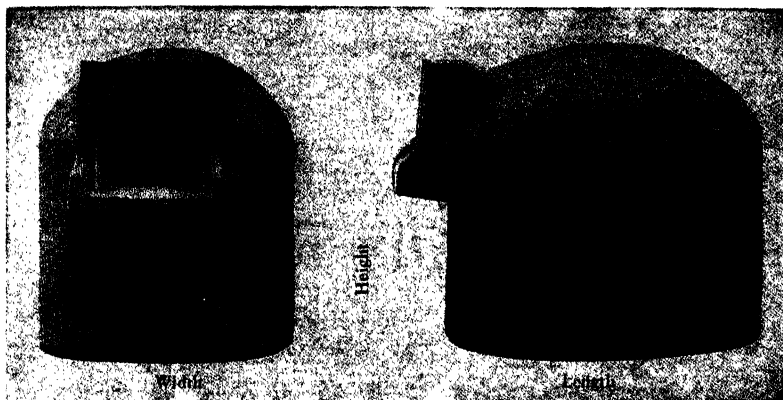

FIG. 319. Covered glass melting pot. (Courtesy of Findlay Clay Products Company.)

TABLE 100. COMMON SIZES OF REFRACTORY PORCELAIN TUBING

| Type | Outside diameter, in. | Hole diameter, in. | Length, in. |
|--|-----------------------|--------------------|-------------|
| Insulating tubing, 2-hole | $\frac{1}{8}$ | $\frac{1}{32}$ | 1-18 |
| | $\frac{1}{4}$ | $\frac{5}{64}$ | 1-48 |
| | $\frac{3}{8}$ | $\frac{7}{64}$ | 1-60 |
| Insulating tubing, 1-hole | $\frac{3}{32}$ | $\frac{1}{16}$ | 1-12 |
| | $\frac{5}{32}$ | $\frac{1}{16}$ | 1-18 |
| | $\frac{1}{4}$ | $\frac{1}{8}$ | 1-48 |
| Insulating tubing, 4-hole | $\frac{3}{16}$ | $\frac{3}{64}$ | 1-36 |
| | $\frac{5}{16}$ | $\frac{1}{16}$ | 1-48 |
| Protection tubes, closed end | $\frac{1}{4}$ | $\frac{1}{8}$ | 6-18 |
| | $\frac{3}{4}$ | $\frac{9}{16}$ | 6-48 |

The forming and firing of high-temperature porcelains are discussed in Chap. XII.

It is necessary to glaze some high-temperature porcelains to prevent passage of gases. Perhaps the most complete study of high-temperature glazes is that by Sortwell.⁽³⁾

Refractory porcelain can be obtained in a large variety of sizes, glazed or unglazed. In Table 100 are shown some common sizes.

9. Bibliography

1. RIDDLE, F.H.: The Equipment of a Casting Plant for the Manufacture of Glass Pots, *J. Am. Ceram. Soc.*, **2**, 647, 1919.
2. MOORE, B.J.: Some Notes on Saggars, *Trans. Ceram. Soc. (Engl.)*, **20**, 93, 1920-1921.
3. SORTWELL, H.H.: High Fire Porcelain Glazes, *Natl. Bur. Standards, Tech. Paper* 196, 1921.
4. EMERY, W.: Refractories for the Pottery Industry, *Trans. Ceram. Soc. (Engl.)*, **25**, 111, 1925-1926.
5. KONARZEWSKI, J.: The Influence of Wet Grog on the Properties of Saggars and Other Refractory Goods, *Trans. Ceram. Soc. (Engl.)*, **25**, 386, 1925-1926.
- 5a. PHELPS, S.M.: The Variation in Size Occurring in Clay and Silica Refractories, *Am. Refractories Inst. Bull.*, 1926.
6. THOMPSON, F.S., and H.I. VORMELKER: The Mullite Content of Some American Tank Blocks, *J. Am. Ceram. Soc.*, **9**, 639, 1926.
- 6a. TRINKS, W.: Simplified Practice Applied to Refractories, *Fuels and Furnaces*, **4**, 1177, 1926.
7. ROSS, D.W.: Design and Service of Tank Blocks, *J. Am. Ceram. Soc.*, **10** (10), 774, 1927.
8. VAN SCHOICK, E.H.: Notes on the Design of Fire Clay Shapes, *Am. Refractories Inst., Tech. Bull.* **16**, 1927.
9. EMERY, W.: Refractories for the Pottery Industry, (II), Saggars, *Trans. Ceram. Soc. (Engl.)*, **27**, 169, 1927-1928.
10. MACGEE, A.E.: Some Physical Properties of Glass Tank Block Refractories, *J. Am. Ceram. Soc.*, **11**, 858, 1928.
11. SWANGER, W.H., and F.R. CALDWELL: Special Refractories for Use at High Temperature, *Natl. Bur. Standards, J. Research*, **6**, 327, 1931.
12. ANON.: Cupola Refractories, *Natl. Bur. Standards, Simplified Practice Recommendation*, R154-38.
13. PHELPS, S.M.: Methods for Obtaining the Size and Warpage of Refractory Brick and Shapes, *Am. Refractories Inst., Tech. Bull.* **74**, 1940.
14. DESMOND, J.: Graphite Crucibles in Wartime, *Coal Trades Rev.*, **145**, 353, 1942.
15. HEINDL, R.A., G.B. MASSENGOLE, and L.G. COSSETTI: The Slip Casting of Clay Pots for the Manufacture of Optical Glass at the National Bureau of Standards, *Glass Ind.*, **27**, 177, 1946.
16. SEIL, G.E., *et al.*: The Manufacture of Refractories and Information Concerning Their Use in the Iron and Steel Industry of Western Germany, P.B. 37804, 1946.
17. HARRIS, R.G.: Saggars and Kiln Furniture in the Pottery Industry, *Trans. Brit. Ceram. Soc.*, **46**, 247, 1947.

CHAPTER XX

MISCELLANEOUS PROPERTIES OF REFRACTORIES

1. Measurement of Particle Size. *Screen Analysis.* The determination of the particle-size distribution in a granular material is of considerable importance in ceramic work. For materials coarser than 150 to 300 mesh,

TABLE 101. UNITED STATES STANDARD SIEVE SERIES

| Meshes per lineal inch | Sieve number | Sieve open- ing, inches | Sieve opening, millimeters | Wire diameter, inches | Wire diameter, millimeters |
|---------------------------|-----------------|----------------------------|----------------------------------|-----------------------------|----------------------------------|
| 2.58 | 2½ | 0.315 | 8.00 | 0.073 | 1.85 |
| 3.03 | 3 | 0.265 | 6.73 | 0.065 | 1.65 |
| 3.57 | 3½ | 0.223 | 5.66 | 0.057 | 1.45 |
| 4.22 | 4 | 0.187 | 4.76 | 0.050 | 1.27 |
| 4.98 | 5 | 0.157 | 4.00 | 0.044 | 1.12 |
| 5.81 | 6 | 0.132 | 3.36 | 0.040 | 1.02 |
| 6.80 | 7 | 0.111 | 2.83 | 0.036 | 0.92 |
| 7.89 | 8 | 0.0937 | 2.38 | 0.0331 | 0.84 |
| 9.21 | 10 | 0.0787 | 2.00 | 0.0299 | 0.76 |
| 10.72 | 12 | 0.0661 | 1.68 | 0.0272 | 0.69 |
| 12.58 | 14 | 0.0555 | 1.41 | 0.0240 | 0.61 |
| 14.66 | 16 | 0.0469 | 1.19 | 0.0213 | 0.54 |
| 17.15 | 18 | 0.0394 | 1.00 | 0.0189 | 0.48 |
| 20.16 | 20 | 0.0331 | 0.84 | 0.0165 | 0.42 |
| 23.47 | 25 | 0.0280 | 0.71 | 0.0146 | 0.37 |
| 27.62 | 30 | 0.0232 | 0.59 | 0.0130 | 0.33 |
| 32.15 | 35 | 0.0197 | 0.50 | 0.0114 | 0.29 |
| 38.02 | 40 | 0.0165 | 0.42 | 0.0098 | 0.25 |
| 44.44 | 45 | 0.0138 | 0.35 | 0.0087 | 0.22 |
| 52.36 | 50 | 0.0117 | 0.297 | 0.0074 | 0.188 |
| 61.93 | 60 | 0.0098 | 0.250 | 0.0064 | 0.162 |
| 72.46 | 70 | 0.0083 | 0.210 | 0.0055 | 0.140 |
| 85.47 | 80 | 0.0070 | 0.177 | 0.0047 | 0.119 |
| 101.01 | 100 | 0.0059 | 0.149 | 0.0040 | 0.102 |
| 120.48 | 120 | 0.0049 | 0.125 | 0.0034 | 0.086 |
| 142.86 | 140 | 0.0041 | 0.105 | 0.0029 | 0.074 |
| 166.67 | 170 | 0.0035 | 0.088 | 0.0025 | 0.063 |
| 200.00 | 200 | 0.0029 | 0.074 | 0.0021 | 0.053 |
| 238.10 | 230 | 0.0024 | 0.062 | 0.0018 | 0.046 |
| 270.26 | 270 | 0.0021 | 0.053 | 0.0016 | 0.041 |
| 323.00 | 325 | 0.0017 | 0.044 | 0.0014 | 0.036 |

screens are used to separate the material into any desired number of grades; but for the finer materials, air- or water-separation methods are most satisfactory.

The United States standard series of sieves is based upon a 1-mm opening, the larger and smaller screens varying as $\sqrt{2}$, or 1.414. The characteristics of this series of screens are given in Table 101.

The Tyler screens are more commonly used. They have as a basis a 200-mesh screen with an opening of 0.0029 in., and the sizes of openings also

TABLE 102. TYLER SCREEN SERIES

| Openings, inches | Openings, millimeters | Mesh per lineal inch | Diameter of wire, inches |
|---------------------|--------------------------|-------------------------|-----------------------------|
| 1.050 | 26.67 | | 0.148 |
| 0.883 | 22.43 | | 0.135 |
| 0.742 | 18.85 | | 0.135 |
| 0.624 | 15.85 | | 0.120 |
| 0.525 | 13.33 | | 0.105 |
| 0.441 | 11.20 | | 0.105 |
| 0.371 | 9.423 | | 0.092 |
| 0.312 | 7.925 | 2½ | 0.088 |
| 0.263 | 6.680 | 3 | 0.070 |
| 0.221 | 5.613 | 3½ | 0.065 |
| 0.185 | 4.699 | 4 | 0.065 |
| 0.156 | 3.962 | 5 | 0.044 |
| 0.131 | 3.327 | 6 | 0.036 |
| 0.110 | 2.794 | 7 | 0.0328 |
| 0.093 | 2.362 | 8 | 0.0320 |
| 0.078 | 1.981 | 9 | 0.0330 |
| 0.065 | 1.651 | 10 | 0.0350 |
| 0.055 | 1.397 | 12 | 0.0280 |
| 0.046 | 1.168 | 14 | 0.0250 |
| 0.0390 | 0.991 | 16 | 0.0235 |
| 0.0328 | 0.833 | 20 | 0.0172 |
| 0.0276 | 0.701 | 24 | 0.0141 |
| 0.0232 | 0.589 | 28 | 0.0125 |
| 0.0195 | 0.495 | 32 | 0.0118 |
| 0.0164 | 0.417 | 35 | 0.0122 |
| 0.0138 | 0.351 | 42 | 0.0100 |
| 0.0116 | 0.295 | 48 | 0.0092 |
| 0.0097 | 0.246 | 60 | 0.0070 |
| 0.0082 | 0.208 | 65 | 0.0072 |
| 0.0069 | 0.175 | 80 | 0.0056 |
| 0.0058 | 0.147 | 100 | 0.0042 |
| 0.0049 | 0.124 | 115 | 0.0038 |
| 0.0041 | 0.104 | 150 | 0.0026 |
| 0.0035 | 0.088 | 170 | 0.0024 |
| 0.0029 | 0.074 | 200 | 0.0021 |

vary as the $\sqrt{2}$. The intermediate sizes are available to give closer spacing. In Table 102 are given the characteristics of this series.

A sample to be screened should be completely dry, and the lumps broken up. It can then be passed through any required number of screens in series. Care must be taken, however, to shake the screens long enough to pass all undersized material through. A convenient piece of apparatus for making screen analyses is shown in Fig. 320. In some cases, wet screening is used, for example, to separate clay from grog.

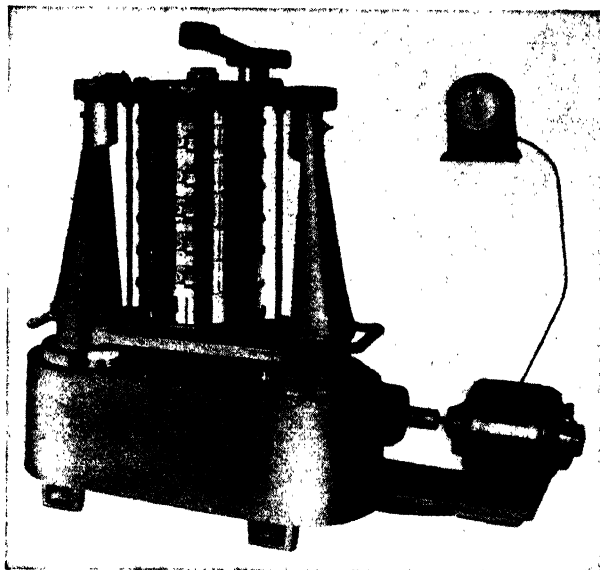

FIG. 320. A shaking apparatus for making screen analyses. (Courtesy of the W. S. Tyler Company.)

TABLE 103. EXAMPLE OF SCREEN DATA

| Screen | Weight, grams | Per cent | Cumulative per cent |
|-------------|---------------|----------|---------------------|
| On 4 | 0.5 | 0.5 | 0.5 |
| On 6 | 1.5 | 1.5 | 2.0 |
| On 8 | 3.0 | 3.0 | 5.0 |
| On 10 | 6.5 | 6.5 | 11.5 |
| On 14 | 10.0 | 10.0 | 21.5 |
| On 20 | 15.5 | 15.5 | 37.0 |
| On 28 | 20.0 | 20.0 | 57.0 |
| On 35 | 21.5 | 21.5 | 78.5 |
| On 48 | 14.0 | 14.0 | 92.5 |
| On 65 | 5.5 | 5.5 | 98.0 |
| On 100 | 1.0 | 1.0 | 99.0 |
| Through 100 | 1.5 | 1.5 | 100.5 |

A convenient method to make an analysis is to weigh out a sample of, say, 100 g. In obtaining this sample, the greatest care is necessary to ensure that it is representative. The sample is then passed through the desired screens, and the amount remaining on each screen is weighed. This weight in grams will give the percentage directly. A typical analysis is shown in Table 103.

There are a number of methods of plotting the results of a screen analysis. The fraction of each particular size of particle may be plotted on a frequency curve, as in Fig. 321, or the cumulative percentage may be plotted

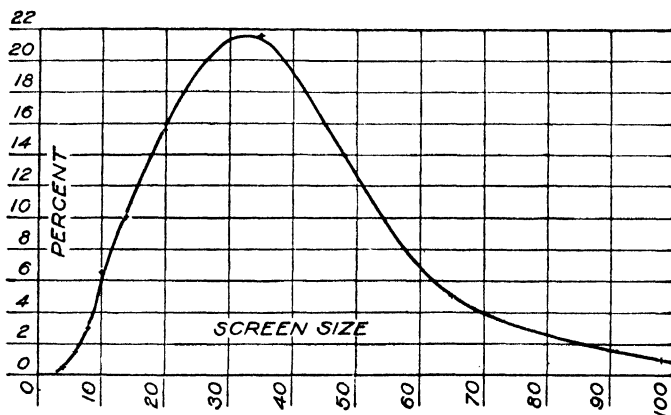

Fig. 321. The result of a screen analysis. The fraction of each particle size plotted as a frequency curve.

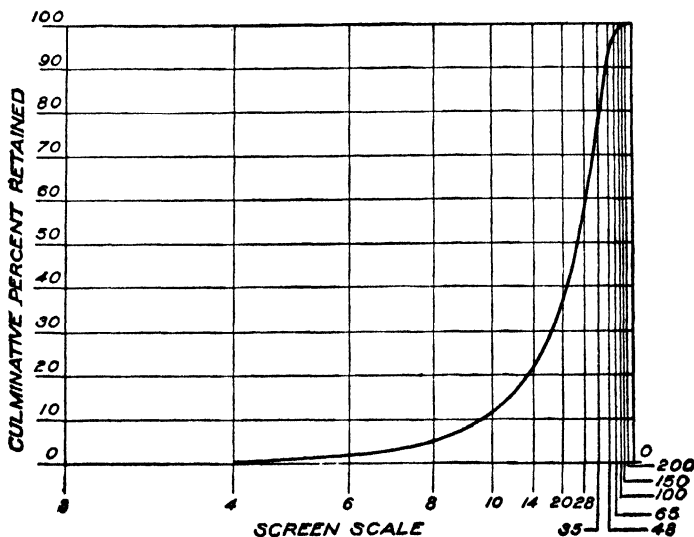

Fig. 322. Result of a screen analysis.

on logarithmic paper as is often done when using the Tyler screens (Fig. 322). Many attempts have been made to express the size distribution by means of a single factor. The work of Hatch and Choate⁽¹⁷⁾ gives, perhaps, the best representation. They found that if logarithms of the sizes were plotted against the percentages of each size, a very close approach to a probability curve resulted in all cases. This curve can be expressed by two parameters, M_g and σ_g . M_g and σ_g can be determined graphically by plotting experimental data on log-probability paper. The references at the end of the chapter will give many other viewpoints of this problem. The extensive work on fine grinding by Martin⁽⁹⁾ and others deserves careful study.

Settling Methods. In order to determine the particle-size distribution in a finely divided material such as a clay, the settling rate of the particles in water is found to be their most useful property. Using Stokes' law, which states that a sphere of diameter D will fall at a velocity V in a liquid of viscosity η when the density of the particle is S_1 and of the liquid S_2 , the diameter is found by

$$D = \sqrt{\frac{18\eta V}{(S_1 - S_2)g}}$$

in cgs units.

It might be thought that the irregular or platelike particles would settle at a different rate from equivalent spheres; but with the exception of extreme plates such as are found in mica, Stokes' law is found to hold down to 1μ diameter and probably lower. The work of Wadell⁽²¹⁾ and Norton and Speil⁽²³⁾ confirms this.

One of the most important factors in this measurement is the complete dispersion of the particles in water. If they are flocculated to any extent, the results will be greatly in error. In the case of clays, considerable agitation is needed to break up clumps in addition to a deflocculating agent such as silicate of soda, sodium pyrophosphate, sodium carbonate, or Daxad. The state of dispersion should be checked with the microscope before the settling test.

When the particles are below 1μ in diameter, the settling rate becomes so slow that it must be accelerated by centrifugal force. As most of the particles in a clay are within this region, a special centrifuge (Fig. 323) has been developed recently for measurements down to 0.05μ . The amount of suspended material at any one time is determined by the specific gravity of the suspension as measured by a special hydrometer bulb. The pipette method⁽²⁴⁾ of drawing off a small volume of suspension and drying down to find the suspended matter is slightly more precise than the hydrometer but more time-consuming.

The standard test method used in the Ceramic Laboratory at the Massachusetts Institute of Technology is given below as taken from the *Journal of the American Ceramic Society*⁽²⁸⁾ and is based on the work of Casagrande.⁽¹⁹⁾

A 13-g sample of the clay is shaken in 300 cc of distilled water to which has been added 0.13 g (1 per cent) of Daxad No. 23 (Dewey & Almy Chemical Co.). This is put through a hand homogenizer (Central Scientific Co., No. 70180) and transferred to a quart fruit jar. The jar is attached to a ball-mill frame and tumbled end over end at 60 rpm for 5 days.

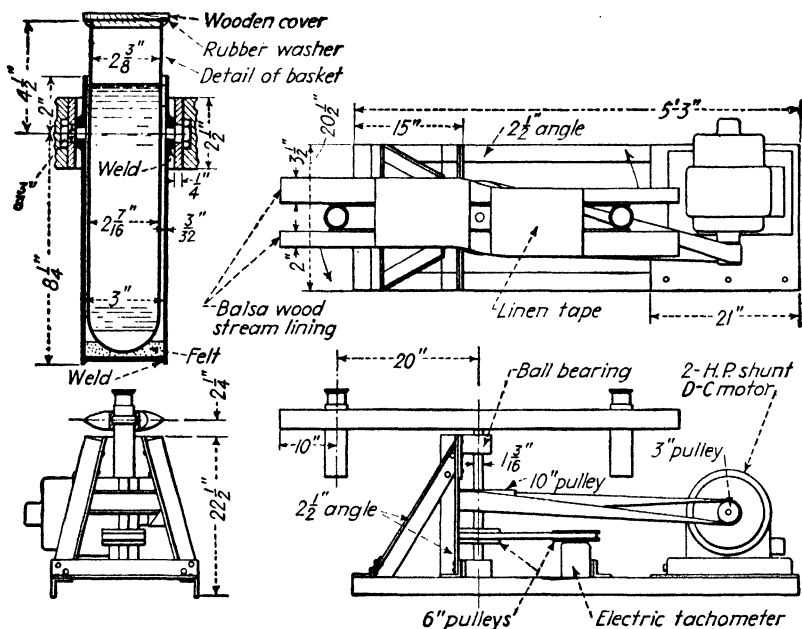

FIG. 323. Long-arm centrifuge. (*J. Am. Ceram. Soc.*)

The sample is then transferred to the glass container, used in the centrifuge, and diluted to exactly 650 cc. A 1,000-cc graduate is filled with a solution of 0.2-g Daxad No. 23 in 1,000 cc of distilled water to be used as a standard in checking the hydrometer. Just before starting a run, the sample is shaken end over end to form a homogeneous suspension; sheet rubber is tied over the top to prevent spilling. The time is taken from the instant the container is placed in the metal basket of the centrifuge. After $\frac{1}{2}$ min, the hydrometer bulb is carefully inserted into the suspension, and the specific gravity is read at the top of the meniscus exactly 1 min from the start of the test. The bulb is first immersed slightly deeper than the equilibrium position to assure a good meniscus. About 20 sec is allowed for the insertion or removal of the hydrometer to prevent eddy currents. The stem of the bulb must always be kept clean to obtain a good meniscus.

Two different samples are run concurrently in the present centrifuge; the second is started 12 min after the first sample to prevent any necessity of hurrying the early readings. After the first 10 min of the test, every specific gravity reading in the suspension is accompanied by a corresponding reading taken in the standard solution also at the top of the meniscus. The temperatures of these two are adjusted to be equal within 0.3°C at the start of the test, and they

TABLE 104

| Time interval | Speed, r.p.m. | Total equivalent time of gravity settling |
|---------------|---------------|---|
| Minutes: | | Minutes: |
| 1 | Stationary | 1 |
| 2 | Stationary | 3 |
| 2 | Stationary | 5 |
| 5 | Stationary | 10 |
| 10 | Stationary | 20 |
| 10 | Stationary | 30 |
| 30 | Stationary | 60 |
| Hours: | | Hours: |
| 1 | Stationary | 2 |
| 1.5 | Stationary | 3.5 |
| 2.5 | Stationary | 6 |
| Minutes: | | |
| 30 | 125 | 10.3 |
| 15 | 200 | 15.8 |
| 30 | 200 | 27 |
| 30 | 300 | 52 |
| 30 | 400 | 95 |
| 30 | 500 | 164 |
| 30 | 550 | 247 |
| Hours: | | |
| 1.25 | 600 | 493 |
| 1.75 | 600 | 835 |
| 3 | 600 | 1,420 |
| 3.5 | 600 | 2,110 |
| 4.5 | 600 | 2,980 |
| 8 | 600 | 4,550 |

are kept equal throughout the run. In this way, temperature corrections for the hydrometer are eliminated, because the value sought is the difference in specific gravity between the two and not the actual value of the specific gravity of the suspension. Temperature readings, precise to within $\pm 0.2^\circ\text{C}$, are taken in each container for every test point, and the temperature is kept as constant as possible during a run. The hydrometer, when not in actual use, is wiped off and placed in the graduate containing the clear Daxad solution. The times at which the

specific gravity should be read were determined arbitrarily to divide the region between 50 and 0.1μ into 20 approximately equal divisions when the data are plotted on semilogarithmic paper. Table 104 gives these time intervals, speed of rotation, and the total elapsed time of equivalent gravity settling, based on an effective centrifuge radius of 49 cm.

In using the centrifuge, the elapsed time was taken between starting the centrifuge and shutting off the current to the motor. The acceleration and deceleration were rapid enough so that this approximate procedure was justified. The starting and stopping, however, must not be so sudden as to cause swirling of the suspension. In the tests carried out, the first day's run extended through 493 hr so that any short interval of gravity settling after that time was practically negligible.

To change the data obtained from the sedimentation run into a distribution curve, the particle size or equivalent spherical diameter corresponding to each reading must be determined, as well as the percentage of material finer than this size. Using Stokes' law, the size which has settled to the center of the hydrometer bulb is easily obtained from the Casagrande nomographic chart.* It is necessary to calibrate only the distance-settled scale of the chart against the specific-gravity scale of the particular hydrometer used. Directions for this and also a key to the chart are given on the chart itself.

In using this distance-settled scale, a small meniscus correction (about 0.0003) must be added to the hydrometer reading, inasmuch as the actual distance settled is from the surface of the suspension (not the top of the meniscus) to the center of volume of the bulb. The value used on the temperature scale of the chart, which corrects for the temperature effect on the viscosity of water, should be the average over the test period up to the time of that reading.

For effective settling periods of more than 50 hr, better accuracy can be obtained with the chart by taking advantage of the fact that the size is given by the equation

$$D = kt^{-1/2}$$

where D = the diameter

t = the time

Thus the equivalent time is divided by a factor of 100; and using this new time value, the size obtained from the chart is divided by 10 to give the correct value. The reason for this step is to avoid large slopes between corresponding points on adjacent scales, a condition which decreases the accuracy of values obtained from the chart.

To determine the percentage of material finer than any given size, the following equation is used:

$$W \text{ per cent} = \frac{S}{S-1} \times \frac{100}{C} (R-d) \times 10^3$$

* These charts can be obtained from Julius Springer in Berlin, or from the Soil Mechanics Laboratory, Massachusetts Institute of Technology, Cambridge, Mass.

where S = the specific gravity of suspended material

C = the concentration of suspended matter, g/liter

$R - d$ = the difference in specific gravity between suspension and corresponding standard reading at same temperature

The specific gravity of the clay can be obtained in a pycnometer bottle but runs close to 2.58 for kaolinite types of clays. To make this method clearer, an actual example is worked out in Table 105.

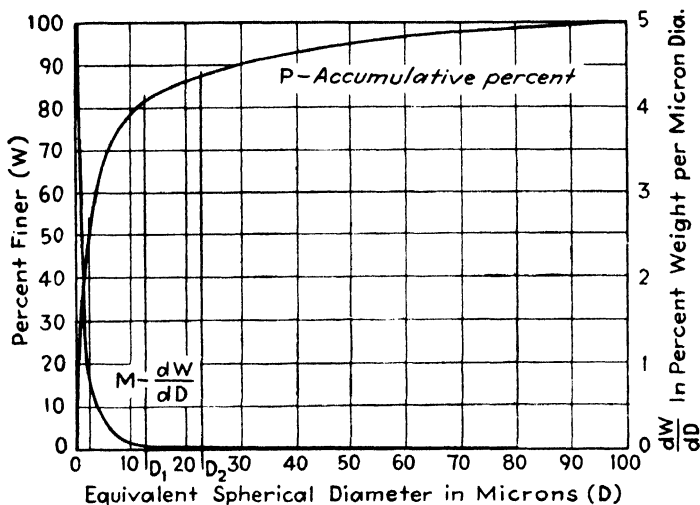

FIG. 324. Size distribution for a typical clay plotted with linear coordinates. (*J. Am. Ceram. Soc.*)

The graphical representation of the results of a size analysis is generally carried out by plotting the weight per cent, W , finer than a given size as ordinates against that size, D , as abscissas. This method is shown in curve P of Fig. 324. A better picture of the distribution, however, can be obtained by plotting the function dW/dD against D as in curve M . This curve represents the slope of P and the area under it between any sizes D_1 and D_2 will be

$$\int y \, dx = \int_{D_2}^{D_1} \frac{dW}{dD} \, dD = \int_{W_{D_2}}^{W_{D_1}} dW = W_{D_1} - W_{D_2}$$

Therefore the weight of particles between D_1 and D_2 in Fig. 324 is equal to

$$\text{Total weight of sample} \times \frac{\text{area between } D_1 \text{ and } D_2}{\text{total area under } M}$$

For example, the line at 50 per cent W cuts the P curve at 2.3μ , through which a vertical line divides the area under M into two equal parts.

The distribution curve in Fig. 324 brings out strikingly the fact that clays have a large proportion of the particles in a very narrow range of sizes. The curve, however, is so crowded into the fine end that little precision is possible in reading the plot in this range. For this reason, it has been found better to plot

TABLE 105

| Time | Centrifuge speed, r.p.m. | Acceleration \times gravity | Equivalent settling time | Temperature, °C. | Reading R | Blank d | $R + C$ | Size, microns | $(R - d) \times 10^3$ | Per cent |
|-------------|--------------------------|-------------------------------|--------------------------|------------------|-------------|-----------|---------|---------------|-----------------------|----------|
| 9.12 | 0 | 1.0 | Minutes | 24.2 | 1.0106 | 0.9996 | 1.0109 | 29.0 | 11.0 | 91.7 |
| 9.13 | 0 | 1.0 | 1 | | 1.0103 | | 1.0106 | 17.2 | 10.7 | 88.8 |
| 9.15 | 0 | 1.0 | 3 | | 1.0097 | 0.9996 | 1.0100 | 13.8 | 10.1 | 84.2 |
| 9.17 | 0 | 1.0 | 5 | | 1.0092 | | 1.0095 | 10.0 | 9.6 | 80.0 |
| 9.22 | 0 | 1.0 | 10 | 24.2 | 1.0084 | 0.9995 | 1.0087 | 7.4 | 8.8 | 73.0 |
| 9.32 | 0 | 1.0 | 20 | | 1.0078 | 0.9995 | 1.0081 | 6.15 | 8.2 | 68.5 |
| 9.42 | 0 | 1.0 | 30 | | | | | | | |
| | | | Hours | | | | | | | |
| 10.12 | 0 | 1.0 | 1 | 24.5 | 1.0070 | 0.9995 | 1.0073 | 4.5 | 7.5 | 62.5 |
| 11.12 | 0 | 1.0 | 2 | 24.4 | 1.0060 | 0.9995 | 1.0063 | 3.3 | 6.5 | 54.4 |
| 12.42 | 0 | 1.0 | 3.5 | 23.9 | 1.0054 | 0.9997 | 1.0057 | 2.5 | 5.7 | 47.5 |
| 3.42 | 0 | 1.0 | 6.5 | 23.7 | 1.0048 | 0.9998 | 1.0051 | 1.92 | 5.0 | 41.9 |
| 3.49-4.16 | 125 | 8.6 | 10.3 | 24.2 | 1.0043 | 0.9997 | 1.0046 | 1.54 | 4.6 | 38.6 |
| 4.29-4.44 | 209 | 22.0 | 15.8 | 24.5 | 1.0039 | 0.9995 | 1.0042 | 1.25 | 4.4 | 36.6 |
| 5.00-5.30 | 200 | 22.0 | 26.8 | 24.1 | 1.0030 | 0.9996 | 1.0033 | 1.00 | 3.3 | 27.8 |
| 5.40-6.10 | 300 | 49.5 | 51.5 | 23.8 | 1.0023 | 0.9997 | 1.0026 | 0.73 | 2.6 | 21.6 |
| 6.19-6.49 | 400 | 88.0 | 95.5 | 24.9 | 1.0015 | 0.9993 | 1.0018 | 0.56 | 1.9 | 15.8 |
| 6.58-7.28 | 500 | 137.0 | 164 | 25.7 | 1.0003 | 0.9991 | 1.0006 | 0.42 | 1.2 | 10.4 |
| 7.39-8.09 | 550 | 166.0 | 247 | 25.7 | 1.0000 | 0.9991 | 1.0003 | 0.35 | 0.9 | 7.6 |
| 11.16-12.31 | 600 | 196.0 | 492 | 26.3 | 0.9994 | 0.9990 | 0.9997 | 0.25 | 0.4 | 3.6 |
| 1.00-2.45 | 600 | 196.0 | 834 | 27.1 | 0.9990 | 0.9988 | 0.9993 | 0.19 | 0.2 | 1.7 |
| 3.00-6.00 | 600 | 196.0 | 1422 | 28.0 | 0.9986 | 0.9985 | 0.9989 | 0.145 | 0.1 | 0.8 |
| 9.00-12.30 | 600 | 196.0 | 2107 | 28.1 | 0.9986 | 0.9986 | 0.9989 | 0.12 | 0.0 | 0.0 |
| 1.00-5.00 | 600 | 196.0 | 2990 | 27.7 | 0.9988 | 0.9988 | 0.9991 | 0.10 | 0.0 | 0.0 |

the same data on semilog paper as in Fig. 325. Here the characteristics of the distribution in the fine fractions are brought out clearly, but the areas under the distribution curve have to be corrected for the scale if they are used quantitatively. As in Fig. 324, the line passing through 50 per cent of W cuts the P curve at 2.3μ and divides the plotted area under M into two equal parts. The actual area on the diagram, however, is quite different on the two sides of the line. The experimental points on the P curve show the consistency of the observations.

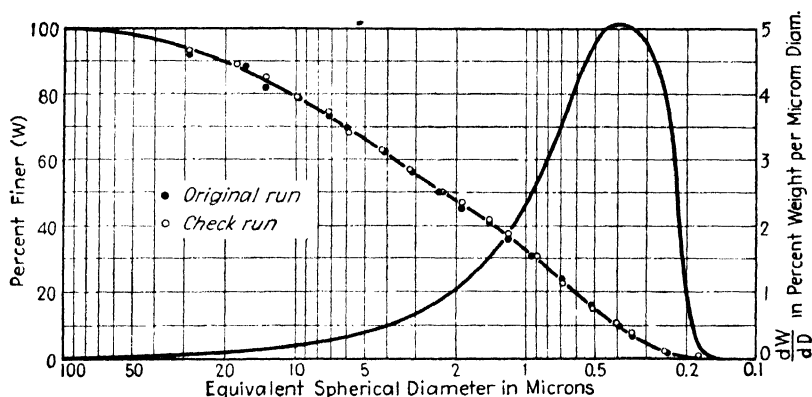

FIG. 325. Size distribution for a typical clay plotted on semilogarithmic paper. (*J. Am. Ceram. Soc.*)

The diver method of measuring particle size as developed by Berg⁽²⁶⁾ is most ingenious and consists of adding to the suspension tiny glass floats of known density which will always maintain a level consistent with the density of the suspension at that point. Therefore by plotting the settling rate of these floats, the density changes in the suspension can be followed with no disturbance.

Gaudin and Hukki⁽²⁹⁾ suggest plotting the logarithm of the cumulative per cent finer against the logarithm of the size. This has the great advantage of producing a straight line in most cases.

Other Methods. Elutriation⁽²²⁾ with either water or air as a medium can be used for the measurement of particle size, but this method is more useful for producing definite-size fractions.

The microscope allows direct measurement of the particle sizes with a calibrated eyepiece.⁽²⁷⁾ The lower limit, however, is about 1μ , but certain problems can well be handled by this method.

For finer sizes, the electron microscope gives us the only direct means of particle size measurement down to less than 0.1μ .

The X-ray diffraction pattern allows the calculation of particle sizes from 0.05μ and less by the line broadening that occurs with small particles. This method may also be used to measure the size of crystals in a lump of refractory.

A number of other methods have been used but are of minor importance in ceramics.

Interpretation of Particle Size. The mean diameter of a single particle is clear when considering a sphere or cube where the diameter or edge respectively are definite measures. In the case of a parallelepiped with sides a , b , and c , we can express four mean diameters as follows:

$$dm = \frac{a + b + c}{3} \quad (\text{Statistical})$$

$$dm = \sqrt{\frac{2ab + 2ac + 2bc}{6}} \quad (\text{Side of a cube of equal area})$$

$$dm = \sqrt[3]{abc} \quad (\text{Side of a cube of equal volume})$$

$$dm = \frac{3abc}{ab + ac + bc} \quad (\text{Harmonic mean relating surface to volume})$$

For platelike particles the various dm 's vary a great deal, so the type of mean diameter should always be specified. The spherical mean diameter is usually taken as the diameter of a sphere settling at the same rate as the given particle.

When considering an evenly graded series of particles, the following mean diameters for the series may be written

$$d_{ms} = \frac{\sum nd}{\sum n} = \frac{1}{2} \frac{d_1^2 - d_2^2}{d_1 - d_2} = \frac{1}{2} (d_1 + d_2) \quad (\text{Statistical mean})$$

$$d_{me} = \frac{\sum nd^2}{\sum nd} = \frac{2}{3} \frac{d_1^3 - d_2^3}{d_1^2 - d_2^2} \quad (\text{Length mean})$$

$$d_{ma} = \frac{\sum nd^3}{\sum nd^2} = \frac{3}{4} \frac{d_1^4 - d_2^4}{d_1^3 - d_2^3} \quad (\text{Area mean})$$

$$d_{mv} = \frac{\sum nd^4}{\sum nd^3} = \frac{4}{5} \frac{d_1^5 - d_2^5}{d_1^4 - d_2^4} \quad (\text{Volume mean})$$

where n = the total number of particles

d_1 = the smallest diameter in the series

d_2 = the largest diameter in the series

The so-called "Mellor mean" is often used

$$dm = \sqrt[3]{\frac{(d_1 + d_2)(d_1^2 + d_2^2)}{4}}$$

but does not seem to be based on any experimental evidence.

To illustrate the use of the various mean diameters, the following example based on an actual microscopic count by Perrott⁽⁷⁾ on an evenly graded series of particles is given in Table 106.

TABLE 106

| Fraction diameter, microns..... | 60 | 50 | 40 | 30 | 20 | 10 | 6 | 2 |
|---|------|------|------|------|-------|-------|--------|---------|
| No. of particles..... | 87 | 100 | 156 | 660 | 1,750 | 6,200 | 25,600 | 155,000 |
| Percentage of total based on: | | | | | | | | |
| Number $\frac{n}{\Sigma n}$ | 0.05 | 0.05 | 0.1 | 0.3 | 0.9 | 3.3 | 13.5 | 81.8 |
| Length $\frac{nd}{\Sigma nd}$ | 0.9 | 0.9 | 1.1 | 3.5 | 6.1 | 10.9 | 22.4 | 54.3 |
| Area $\frac{nd^2}{\Sigma nd^2}$ | 7.8 | 6.3 | 6.3 | 14.9 | 17.6 | 15.5 | 16.1 | 15.6 |
| Volume $\frac{nd^3}{\Sigma nd^3}$ | 22.5 | 14.9 | 11.9 | 21.3 | 16.7 | 7.4 | 3.8 | 1.5 |

Calculating the mean diameter for the whole series gives

$$d_{ms} = \sum \left(\frac{n}{\Sigma n} \cdot d \right) = \frac{\Sigma nd}{\Sigma n} = 3.0 \mu$$

$$d_{me} = \sum \left(\frac{nd}{\Sigma nd} \cdot d \right) = \frac{\Sigma nd^2}{\Sigma nd} = 7.0 \mu$$

$$d_{ma} = \sum \left(\frac{nd^2}{\Sigma nd^2} \cdot d \right) = \frac{\Sigma nd^3}{\Sigma nd^2} = 21.0 \mu$$

$$d_{mv} = \sum \left(\frac{nd^3}{\Sigma nd^3} \cdot d \right) = \frac{\Sigma nd^4}{\Sigma nd^3} = 36.4 \mu$$

The physical significance of these values can be visualized by assuming that all the particles in the sample were laid out in a line, each particle touching the next and each being smaller than the one preceding it. If the particle in this line was selected that had equal numbers of particles above and below it, its diameter would be 3.0 μ . On the other hand, if a particle were selected exactly in the center of the line, it would have a diameter of 7.0 μ . A particle selected so that the total area or volume of all the particles above or below it were equal would have a diameter respectively of 21.0 and 36.4 μ . This brings out the fact that a mean particle size has no significance unless the type of mean is specified.

2. Structure. The macrostructure of refractories is of importance because a homogeneous material is seldom encountered. The size and shape of the pores, the shape of the grog particles, and the extent of the bonding are of interest. By a study of the structure, the manufacturing methods may be improved to produce a better product.

A cross section of a brick can be ground to a flat surface on a cast-iron wheel with coarse carborundum and water. The brick is then dried and

heated enough to flow red sealing wax over the surface and into the pores. This surface can now be polished with a fine abrasive. The contrast between the light refractory and the dark sealing wax should bring out the structure very clearly. The structure of a kaolin brick prepared in this way is shown in Fig. 326.



FIG. 326. Structure of a kaolin refractory. The surface of this refractory was ground to a rough surface and then the pores were filled with sealing wax. The surface was then given a finer polish.

3. Permeability. *Importance in Refractories.* The flow of gases through refractory walls is important in many furnaces, especially where large pressure differences exist, as in recirculating types. Also the permeability of such parts as thermocouple tubes, muffles, and recuperators is of interest in efficient design.

Permeability is also of value as a check on the manufacture, as laminations, voids, and soft spots are shown up in the permeability test. In the case of heat insulators, this property is useful in indicating the extent of interconnecting pores.

Measurement of Permeability. Absolute permeability is the property of the refractory and does not in any way depend on the fluid. It may be expressed as

$$\lambda = \eta \frac{Q}{A} \cdot \frac{l}{(P_1 - P_2)} \cdot \frac{1}{t}$$

where λ = the absolute permeability

η = the viscosity of the fluid, poises

Q = the volume of gas flowing at mean pressure $(P_1 + P_2)/2$, cc

A = the area, sq cm

l = the length of path, cm

P_1 = the exit pressure, dynes/sq cm

P_2 = the entrance pressure, dynes/sq cm

t = the time, sec

The dimensions of this equation are $L^2 = \text{area}$. However, our usual meas-

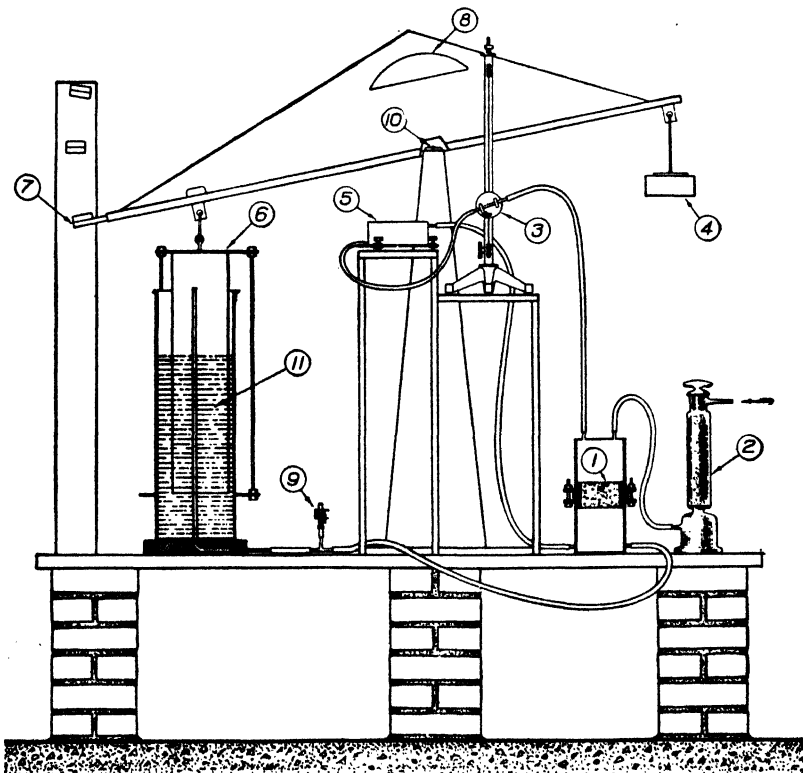

FIG. 327. Permeability apparatus.

urements of permeability are with a particular fluid such as air at room temperature, so that the measured permeability k is expressed by

$$\frac{\text{Volume of gas} \times \text{length of path}}{\text{Area} \times \text{time} \times \text{pressure difference}}$$

which has the dimension

$$\frac{L^2}{ML^{-1}T^{-1}} = \frac{\text{area}}{\text{viscosity}}$$

k is usually expressed as cc/(cm)(sq cm)(sec)(cm of water) or as cu ft/(in.)(sq ft)(min)(in. of water pressure).

Permeability can be measured on small cylindrical or cubical specimens, but a more representative value is obtained on a whole brick with air passing through as it does in the wall. Permeability tests of whole wall sections give data in regard to the joints and bricks together, but little work has been reported along these lines.

A precise and convenient apparatus for the measurement of permeability is shown in Fig. 327 as developed in the Ceramic Laboratory of the Massachusetts Institute of Technology. The specimen 1 is cemented tightly into the holder with beeswax. Air is drawn through the drying

TABLE 107

| Run No..... | 1 | 2 | 3 | 4 | 5 | 6 |
|---|--------|--------|--------|--------|--------|--------|
| Weight on end of beam, g. | 200 | 200 | 400 | 400 | 1,000 | 1,000 |
| Mercury below atmospheric pressure, mm.... | 0.85 | 0.85 | 1.70 | 1.70 | 4.24 | 4.24 |
| Atmospheric pressure, mm. mercury..... | 757.40 | 757.40 | 757.40 | 757.40 | 757.40 | 757.40 |
| Pressure in gasometer, mm. mercury..... | 756.55 | 756.55 | 755.70 | 755.70 | 753.16 | 753.16 |
| Temperature, °C..... | 29.0 | 29.1 | 28.4 | 28.3 | 28.0 | 28.1 |
| V (from chart), volume of air at standard conditions passed through specimen, cc. | 1,604 | 1,604 | 1,595 | 1,595 | 1,592 | 1,592 |
| P_0 , zero reading of manometer..... | 1.16 | 1.16 | 1.06 | 1.05 | 1.06 | 1.06 |
| P_1 , final reading of manometer..... | 1.41 | 1.40 | 1.52 | 1.51 | 1.94 | 1.94 |
| $P_1 - P_0$, pressure difference, cm. alcohol..... | 0.25 | 0.24 | 0.46 | 0.46 | 0.88 | 0.88 |
| Specific gravity of alcohol | 0.801 | 0.801 | 0.801 | 0.801 | 0.801 | 0.801 |
| P , pressure difference, cm. water..... | 0.20 | 0.19 | 0.37 | 0.37 | 0.71 | 0.71 |
| t , time, sec..... | 119 | 120 | 68 | 69 | 34 | 34 |
| K , permeability..... | 5.6 | 5.7 | 5.3 | 5.3 | 5.5 | 5.5 |

Area of specimen = 78.5 sq. cm. Thickness = 6.5 cm.

power 2 and the specimen by the suction of the gasometer 6 filled with oil 11 and counterweight 4 using a beam pivoted at 10. The latter is calibrated so that as it moves through a definite distance by the pointer 7, which can be timed with a stop watch to pull a known volume of air through the specimen. The balance weight 8 compensates for the buoyancy of the gasometer cylinder. The difference in pressure between the two sides of the

TABLE 108. PERMEABILITY OF FIREBRICKS (BURNED)

| Type of clays | Manufacturing method | Permeability, cc per sec per cm cube per cm head of water |
|---|----------------------|---|
| Flint, semiflint, and plastic..... | Semidry press | 0.0066 |
| New Jersey plastic..... | Hand molded | 0.0092 |
| Semiflint..... | Soft mud | 0.011 |
| Flint and semiflint and plastic..... | Soft mud | 0.012 |
| Second grade semiflint and plastic..... | Soft mud | 0.016 |
| Plastic..... | Soft mud | 0.017 |
| Semiflint..... | Soft mud | 0.033 |
| Cheltenham plastic..... | Dry press | 0.049 |
| Flint and semiflint..... | Hand molded | 0.069 |
| Flint and plastic..... | Hand molded | 0.11 |
| Flint and plastic..... | Soft mud | 0.13 |
| Grog, flint, and plastic..... | Soft mud | 0.14 |
| Pennsylvania clay..... | Dry press | 0.15 |
| Second grade semiflint and plastic..... | Dry press | 0.19 |
| Sillimanite and clay..... | Hand molded | 0.45 |
| Silicon carbide, recrystallized..... | Dry press | 0.80 |
| Clay and carbon, insulating..... | Dry press | 1.20 |
| Insulating firebrick, 3.5 lb..... | | 2.6 |
| Insulating firebrick, 3 lb..... | | 3.1 |
| Insulating firebrick, 2 lb..... | | 5.5 |

specimen is measured by the alcohol manometer 3 with its reservoir 5. The method of testing will be made clear by Table 107 for a typical run.

Permeability values for several refractories are shown in Table 108, and additional values are given in the references.^(40,41,42,48)

4. Strength of Refractories. The cold strength of fired refractories is not generally of importance in itself; however, it often serves as a guide to other characteristics such as vitrification, burning temperature, or purity of material. In the case of heat insulators, the strength is of value in determining the ability to withstand handling and shipping. The ASTM Standard method for cold crushing strength is given in C 133-39, a method that should be followed to obtain consistent results. For insulating brick,

C 93-46 should be used. In Table 109 are given values of crushing strength. The strength of many pure materials is given in the tables of Chap. XII.

TABLE 109. CRUSHING STRENGTH OF REFRACTORIES

| Material | Crushing Strength, lb per sq in. |
|------------------|----------------------------------|
| Fireclay brick | 2,000-12,000 |
| Bauxite brick | 6,000 |
| Silica brick | 3,000-5,000 |
| Zirconia | 7,000 |
| Magnesite | 5,000-8,000 |
| Chrome | 6,000 |
| Insulating brick | 50-500 |

5. True Density. The following method has been found satisfactory for the determination of true density: The material is powdered through at least 100 mesh, dried at 105°C until thoroughly dry, and placed over CaCl_2 until at room temperature. About 1 g is weighed into the previously calibrated and weighed pycnometer bottle. The bottle is filled about one-half full of freshly boiled distilled water and is kept at 60°C for about $\frac{1}{2}$ hr, and the contents agitated to wet the particles thoroughly and remove entrapped air. The bottle is next placed under a vacuum to make certain that all air has escaped. The reduced pressure should not be strong enough to boil the water violently, since loss is likely to occur. About 20 min of treatment using an ordinary aspirator pump is sufficient.

The bottle is then filled to the mark with distilled water and placed in a constant-temperature bath for 1 hr, whereupon the bottle is carefully capped; the capillary and the outside of the bottle wiped clean; and the whole weighed.

The specific gravity is calculated from

$$\text{Specific gravity} = \frac{W - P}{(W_1 - P) - (W_2 - W)}$$

where P = the weight of pycnometer and stopper

W = the weight of pycnometer and stopper and sample

W_1 = the weight of pycnometer and stopper full of water

W_2 = the weight of pycnometer and stopper and sample and water

Tetrahychonaphthalene or tetrachlorethane, because of their low viscosity and high wetting properties, are useful in the case of nonplastics in place of water, as the boiling and deairing steps are eliminated. Values on the same sample should check to ± 0.005 .

6. Abrasion Resistance. Refractories used in the hearths of furnaces or other places where objects are slid along them must have a good resistance to abrasion. Furthermore, refractories are often worn away by particles in a rapidly moving gas. Abrasion tests at room temperature, such as

are regularly used for paving brick and tiles, mean little for refractories because the conditions are far different at high temperatures. In the first place, the refractory must have a strong, well-bonded structure, and second, it must not become plastic at the working temperature. In general, it has been found that a brick which shows good resistance to load will also resist abrasion.

Abrasion has been measured at room temperature by the Bauschinger disk grinder, the sand blast of Bradshaw and Emery,⁽¹⁾ and the rattler test of the National Paving Brick Manufacturers' Association. None of these tests, however, is used at the working temperature of the refractory. Perhaps the most logical tests are those proposed by Hancock and King.⁽²⁾ Here samples of the refractory are rubbed together inside a furnace, and the loss in weight determined for a certain time of test. To show the effect of temperature, a specimen was tested as follows:

| Temperature of Test | Loss in Weight, g |
|---------------------|-------------------|
| 20°C (68°F) | 0.115 |
| 1050°C (1922°F) | 0.255 |

This shows that the abrasion resistance decreases with the temperature. It was also concluded that a fine-grained structure and a high-burning temperature increase the abrasion resistance.

The abrasion resistance of an insulating firebrick is naturally less than for a heavy refractory, although hard coatings are helpful. Abrasion tests have been made on this material by circulating fine particles by means of a high-velocity air stream through a duct lined with a particular brick.

7. Electrical Resistivity. In electric-furnace work, the electrical resistance of refractories is of considerable importance, and there are many other cases where a high-temperature electrical insulator is desirable.

The method of measuring the resistivity is theoretically simple but at high temperatures is beset by numerous practical troubles; however, at temperatures up to 1000°C (1832°F), the apparatus is comparatively simple. The methods used by the National Bureau of Standards,⁽⁵⁴⁾ King,⁽⁵⁷⁾ Northrup,⁽⁵⁰⁾ and Brace⁽⁵²⁾ are substantially the same. A comparatively high voltage is placed across the specimen, and the current flow measured with a sensitive ammeter or similar device. The greatest difficulty is to reduce the contact resistance, and a number of methods have been used to prevent this error. Henry⁽⁵⁵⁾ and a few others used alternating current of 1,000 cycles to prevent electrolytic effects.

In Table 110 are given some values of electrical resistivity obtained by different experimenters.

It will be noticed that the values given in the following table are rather discordant in some instances. This may be due in part to the variation in specimens and in part to errors in experimentation.

TABLE 110. ELECTRICAL RESISTIVITY, OHMS PER CENTIMETER CUBED

| Material | Firing temperature | Temperature of test | | | | |
|---|--------------------|---------------------|-----------------|-----------------|-----------------|-----------------|
| | | 700°C (1297°F) | 1000°C (1832°F) | 1200°C (2192°F) | 1400°C (2557°F) | 1500°C (2732°F) |
| Chemical porcelain ¹ | 1400°C (2550°F) | 84,000 | 20,000 | | | |
| Bureau Standards porcelain #152 ² | 1450°C (2640°F) | 550,000 | 251,000 | | | |
| Beryl ³ | 1355°C (2470°F) | 51,000 | High | | | |
| Spinel ⁴ | 1485°C (2700°F) | Infinite | | | | |
| Sillimanite ⁵ | 1485°C (2700°F) | Infinite | | | | |
| Kyanite ⁶ | 1485°C (2700°F) | Infinite | 95,000 | | | |
| Andalusite ⁷ | 1485°C (2700°F) | 570,000 | 130,000 | | | |
| Periclase ⁸ | 1485°C (2700°F) | Infinite | Infinite | | | |
| Ohio flint clay ⁹ | 1500°C (2732°F) | 15,800 | 2,120 | 1,050 | 721 | 582 |
| Kaolin ¹⁰ | 1500°C (2732°F) | 30,200 | 3,910 | 1,460 | 846 | 681 |
| Sillimanite ¹¹ | 1500°C (2732°F) | 46,700 | 36,300 | 11,500 | 4,290 | 3,150 |
| Silica ¹² | 1500°C (2732°F) | 77,500 | 49,000 | 15,700 | 8,050 | 5,660 |
| Magnesite ¹³ | 1500°C (2732°F) | 35,000 | 4,780,000 | 94,700 | 2,790 | 615 |
| Diaspore ¹⁴ | 1500°C (2732°F) | | 2,920 | 886 | | |
| Bauxite brick ¹⁵ | | | 17,200 | 6,100 | 2,200 | 1,100 |
| Carborundum brick ¹⁶ (recrystallized)..... | | | 197,000 | 29,500 | 10,000 | 8,580 |
| Carborundum brick ¹⁷ (10 per cent clay bond) | | | 171 | 63 | 85 | 41 |
| Chrome brick ¹⁸ | | | 10,800 | 4,160 | 1,420 | 880 |
| Fireclay brick ¹⁹ | | | | 480,000 | 180,000 | 80,000 |
| Fireclay brick ²⁰ | | | | 2,300 | 690 | 280 |
| Fireclay brick ²¹ | | | | 50,000 | 15,000 | 3,000 |
| Magnesite brick ²² | | | 708,000 | 193,000 | 22,400 | 2,500 |
| Magnesite brick ²³ | | | | 100,000 | 40,000 | 3,000 |
| Magnesite brick ²⁴ | | | | 12,000 | 400 | |
| Kaolin brick ²⁵ | | | | 50,000 | 15,000 | 3,000 |
| Silica brick ²⁶ | | | | 62,000 | 16,500 | 8,420 |
| Silica brick ²⁷ | | | | 300,000 | 125,000 | 63,000 |
| Silica brick ²⁸ | | | | 131,300 | 2,400 | 710 |
| Zirconia brick ²⁹ | | | | 1,230 | 300 | |
| Zirconia brick ³⁰ | | | | 1,250 | 968 | |
| Zirconia brick ³¹ | | | | 7,710 | | 412 |

¹ King.² Henry.³ Hartman.⁴ Wilkes.⁵ Stansfield, *et al.*⁶ Babcock & Wilcox Laboratory.⁷ Northrup.⁸ Nemst and Reynolds.⁹ Arnold.

At low temperatures, refractories conduct very slightly. As the temperature is raised, the conductivity increases rapidly until the melting point is reached, where electrolytic conduction occurs. With a pure material, the conduction would be low up to the melting point; but with the average refractory, liquid phases are formed by the impurities at relatively low temperatures, so that we get an early falling off of the resistance. In general, a pure, high-melting-point material will give the best high-temperature, electrical resistivity.

8. Bibliography

Abrasion:

1. BRADSHAW, L., and W. EMERY: Some Comparative Tests of Machine-made and Hand-made Silica Bricks (I), *Trans. Ceram. Soc. (Engl.)*, **19**, 73, 1919-1920.
2. HANCOCK, W.C., and W.E. KING: Note on the Abrasion of Fireclay Materials, *Trans. Ceram. Soc. (Engl.)*, **22**, 317, 1922-1923.

Strength:

3. WESTMAN, A.E.R., and W.H. PFEIFFER: A Comparison of the Uniformity of Strength and Texture of Fire Brick Made by Different Processes, *J. Am. Ceram. Soc.*, **9**, 626, 887, 1926.
4. HANCOCK, W.C., and J.G. COWAN: The Crushing Strength of Unfired Fireclay Bodies, *Trans. Ceram. Soc. (Engl.)*, **27**, 243, 1927-1928.
5. JOURDAIN, A.: A Simple Method for Determining the Cohesion of Refractory Products at Room Temperature, *Céramique*, **31**, 230, 1928.
6. LEHMANN, H., and M.T. SCHULZE: Improved Apparatus for Determining the Dry Strength of Ceramic Raw Materials and Bodies, *Sprechsaal*, **71**, 207, 1938.

Particle Size:

7. PERROTT, G.ST.J., and S.P. KINNEY: The Meaning and Microscopic Measurement of Average Particle Size, *J. Am. Ceram. Soc.*, **6**, 417, 1923.
8. SCHRAMM, E., and E.W. SCRIPTURE, JR.: The Particle Analysis of Clays by Sedimentation, *J. Am. Ceram. Soc.*, **8**, 243, 1925.
9. MARTIN, G., *et al.*: Researches on the Theory of Fine Grinding (V), On the Existence and Preparation of Statistically Homogeneous Grades of Crushed Sand, *Trans. Ceram. Soc. (Engl.)*, **25**, 240, 1925-1926; Small Particles, *Phys. Rev.*, **27**, 499, 1926.
10. GREEN, H.: The Effect of Non-uniformity and Particle Shape on "Average Particle Size," *J. Franklin Inst.*, **204**, 712, 1927.
11. LOVELAND, R.P., and A.P.H. TRIVELLI: Mathematical Methods of Frequency Analysis of Size of Particles, *J. Franklin Inst.*, **204**, 193, 377, 1927.
12. RIEKE, R., and L. MAUVE: Elutriation Velocity and Grain Size, *Ber. deut. keram. Ges.*, **8**, 209, 1927.
13. ANDREASEN, A.H.M.: Zur Kenntnis des Mahlgutes, *Kolloidchem. Beihefte*, **27**, 349, 1928. (References.)
14. BULE, B., and A. BENEDETTI-PICHLER: Zur Probenchine aus körnigen Materialien, *Z. anal. Chem.*, **74**, 442, 1928.

15. READ, T.T.: Pertinent and Practical Observations on the Theory of Sampling, *Eng. Mining J.*, **125**, 574, 1928.
16. WORK, L.T.: Methods of Particle Size Determination, *Proc. Am. Soc. Testing Materials*, **28**, 11, 771, 1928.
17. HATCH, T., and S.P. CHOATE: Statistical Description of the Size Properties of Non-uniform Particulate Substances, *J. Franklin Inst.*, **207**, 369, 1929.
18. VAN NIEUWENBURG, C.J., and WA. SCHOUTENS: Apparatus for Rapid Sedimentation Analysis, *Ber. deut. keram. Ges.*, **10**, 2, 1929.
19. CASAGRANDE, A.: The Hydrometer Method for Mechanical Analysis of Soils and Other Granular Materials, Soil Mechanics Laboratory, Massachusetts Institute of Technology, 1931.
20. WAGNER, L.A.: A Rapid Method for the Determination of the Specific Surface of Portland Cement, *Proc. Am. Soc. Testing Materials*, **33**, Pt. II, 553, 1933.
21. WADELL, H.: The Coefficient of Resistance as a Function of Reynolds Number for Solids of Various Shapes, *J. Franklin Inst.*, **217**, 459, 1934.
22. COOKE, S.R.B.: Short-column Elutriator for Subsieve Sizes, *U.S. Bur. Mines. Rept. Invest.*, **3333**, 39, 1937.
23. NORTON, F.H., and S. SPEIL: The Measurement of Particle Sizes in Clays, *J. Am. Ceram. Soc.*, **21**, 89, 1938.
24. ANDREASEN, A.H.M.: The Fineness of Solids, *Ingeniørvidenskab. Skrifter*, No. 3, 1939.
25. BERG, S.: Studies on Particle-size Distribution, *Pub. 2, Lab. Mortar, Glass and Ceramics, Royal Tech. Univ.*, Copenhagen.
26. AUSTIN, J.B.: Methods of Representing Distribution of Particle Size, *Ind. Eng. Chem., Anal. Ed.*, **11**, 334, 1939.
27. DUNN, E.J., JR.: Microscopic Measurements for the Determination of Particle Size of Pigments and Powders, *Ind. Eng. Chem., Anal. Ed.* **2**, 59, 1939.
28. SCHUHMAN, R., JR.: Laboratory Sizing, "Powder Metallurgy," American Society for Metals, 1942.
29. GAUDIN, A.M., and R.T. HUKKI: Principles of Comminution—Size and Surface Distribution, *Mining Technol.*, November, 1944.
30. BIRKS, L.S., and H. FRIEDMAN: Particle Size Determination from X-ray Broadening, *J. Applied Phys.*, **17**, 687, 1946.
31. CROSS, A.H.B.: The Determination of Powder Density Using the Rees-Hugill Flask, *Trans. Brit. Ceram. Soc.*, **47**, 38, 1948.

Permeability:

32. KETCHUM, P.W., A.E.R. WESTMAN, and R.K. HURSH: The Measurement of the Permeability of Ceramic Bodies, *Univ. Illinois Eng. Expt. Sta. Circ.*, **23**, 50, 1926.
33. ROBINSON, P.B.: Note on a New Method for the Determination of Porosity, *J. Soc. Chem. Ind. (Trans.)*, **45**, 33, 1926.
34. HOWE, W.L., and C.J. HUDSON: Studies in Porosity and Permeability Characteristics of Porous Bodies, *J. Am. Ceram. Soc.*, **10**, 443, 1927.
35. WICKERSHAM, F.A.: The Gas Permeability of Refractory Brick, *Blast Furnace Steel Plant*, **15**, 339, 1927.
36. WICKERSHAM, F.A.: The Gas Permeability of Refractory Brick Used in Metallurgical Furnaces, *J. Am. Iron Steel Inst.*, **116**, 481A, 1927.
37. BANSEN, H.: Gas durchlässigkeit von Silikasteinen, Mörtelfugen und Mauerwerk in Siemens-Martin Ofen, *Stahl u. Eisen*, **48**, 973, 1928.

38. BARTSCH, O.: Determination of the Water Permeability of Fireclay Bodies as a Means of Structure Characterization, *Ber. deut. keram. Ges.*, **12**, 619, 1931.
39. BREMOND, P.: Experimental Research on the Gas Permeability of Ceramic Products at High Temperatures, *Céramique*, **34**, 3, 1931.
40. CLEWS, F.H., and A.T. GREEN: The Permeability of Refractory Materials to Gases, Part I, *Trans. Ceram. Soc. (Engl.)*, **32**, 295, 1933.
41. CLEWS, F.H., and A.T. GREEN: The Permeability of Refractory Materials to Gases, Part II, *Trans. Ceram. Soc. (Engl.)*, **32**, 319, 1933.
42. CLEWS, F.H., and A.T. GREEN: The Permeability of Refractory Materials to Gases, Part III, *Trans. Ceram. Soc. (Engl.)*, **33**, 21, 1934.
43. CLEWS, F.H., and A.T. GREEN: The Significance of Permeability to Gases in Relation to the Texture and Industrial Usage of Refractory Materials, *Trans. Ceram. Soc. (Engl.)*, **33**, 56, 1934.
44. CLEWS, F.H., and A.T. GREEN: The Permeability of Refractory Materials to Gases, *Trans. Ceram. Soc. (Engl.)*, **33**, 479, 1934.
45. PRESTON, E.: A Critical Survey and Report on the Permeability of Refractory Materials to Gases, *Univ. Sheffield, Experimental Researches and Repts.*, **17**, 329, 1934.
46. BREMOND, P.: The Permeability of Ceramic Bodies to Gases at High Temperature, *Trans. Ceram. Soc. (Engl.)*, **34**, 287, 1935.
47. KANZ, A.: Effect of Firing Temperature and Grain Size on the Gas Permeability of Refractory Bricks, *Arch. Eisenhüttenw.*, **12**, 247, 1938-1939.
48. McCREIGHT, D.O.: Permeability Data on American Refractories, *Ind. Heating*, **14**, 1734, 1947.

Electrical Conductivity:

49. STANSFIELD, A., D.L. MACLEOD, and J.W. McMAHON: The Electrical Resistivity of Fire-bricks at High Temperatures, *Trans. Am. Electrochem. Soc.*, **22**, 89, 1912.
50. NORTHRUP, E.F.: High-temperature Resistivity of Refractories: A New Method of Measuring with Results for Alundum, *Met. Chem. Eng.*, **12**, 125, 1914.
51. EARHART, E.F.: Notes on the Electrical Behavior of Porcelain and Glass at Moderately High Temperatures, *Ohio J. Sci.*, **16**, 81, 1916.
52. BRACE, P.H.: The Electrical Resistivity of Porcelain and Magnesia at High Temperatures, *Trans. Am. Electrochem. Soc.*, **33**, 205, 1918.
53. HARTMAN, M.L., A.P. SULLIVAN, and D.E. ALLEN: Physical Characteristics of Specialized Refractories, *Trans. Am. Electrochem. Soc.*, **38**, 279, 1920.
54. HONEMAN, R.K., and E.L. FONESCA: Electrical Resistance of Various Insulating Materials at High Temperatures, *Natl. Advisory Comm. Aeronaut., Rept.* **53**, 15; *5th Annual Rept.*, 91, 1919.
55. HENRY, A.V.: The Electrical Resistivity of Refractories, *J. Am. Ceram. Soc.*, **7**, 764, 1924.
56. FERGUSON, J.B.: The Electrical Resistance of Refractory Materials, *Can. Chem. Met.*, **10**, 131, 1926.
57. KING, R.M.: The Electrical Resistivity of Some Ceramic Materials at Elevated Temperatures and a Simple Commercial Method for Its Determination, *J. Am. Ceram. Soc.*, **9**, 343, 1926.
58. RICHARDS, E.: The Electrical Resistance of Refractory Materials, *Keram. Rundschau*, **34**, 475, 1926.

59. ANON.: Electrical Resistance of Fire-resistance Material, *Metallbörse*, **16**, 2216, 2270, 1926.
60. KRANER, H.M.: Electrical Resistivity of Refractory Materials at Elevated Temperatures, *Ind. Eng. Chem.*, **23**, 1098, 1931.
61. WHITE, H.E.: Electrical Resistivity of Specialized Refractories, *J. Am. Ceram. Soc.*, **15**, 598, 1932.
62. KRATZERT, J., and F. KAEMPFE: The Electrical Conductivity of Refractory Bricks in Relation to the Iron Oxide Content, *Ber. deut. keram. Ges.*, **16**, 296, 1935.
63. BACKHAUS, K.: Investigations of the Electrical Conductivity of Some Basic Elements, Binders, and Their Mixtures for the Manufacture of Insulating Substances for Electrical Heating Elements, *Elektrowärme*, **8**, 261, 1938.

Part IV
USE

CHAPTER XXI

REFRACTORIES IN THE IRON AND STEEL INDUSTRY

1. Introduction. *Dependence of the Industry on Refractories.* The iron and steel industry is so dependent on refractories for efficient production that all the larger steel companies are themselves conducting research on refractories or are cooperating with the refractory manufacturers to obtain the best product for each position in the furnace. Unquestionably, in many cases, refractories capable of withstanding higher temperatures would permit more efficient production of steel and often a better quality of steel. For that reason, a great deal of effort is being expended on the study of high-temperature refractories, particularly for the open-hearth furnace.

Future Development. A problem that requires solution in the future is the production for the open-hearth furnace of a roof brick capable of operating at 100 or 200° higher than the silica roof and still giving a satisfactory life. The economy of insulation is now being thoroughly appreciated in the iron and steel industry, and to accompany insulation we must have a better quality lining brick to stand the greater mean temperature imposed. The super-duty silica brick is a step in this direction, and the experiments on the basic roof are watched with interest. In the heat-treating field, the development of lightweight refractories has been advancing rapidly, and now the insulating firebrick is almost exclusively used. The possibility of making sectional furnaces of portable panels that can be built around the completely fabricated structure for heat treating is being rapidly developed. Carbon refractories will undoubtedly receive increased study, particularly in the blast furnaces.

The disintegration of refractories under reducing conditions must receive more study, and bricks capable of withstanding this deteriorating influence more successfully will undoubtedly be developed.

2. Blast Furnace. *Principles of Operation.* The blast furnace is the primary unit for reducing iron ore to iron. The charge, which is a mixture of iron ore, limestone and coke, is blasted with preheated air in the correct amount to generate heat and form carbon monoxide, which reduces the ore to melted iron and slag. The composition of the iron depends a great deal on the type of ore used, but control of the final composition is possible in the blast furnace itself, except for manganese and phosphorus which cannot be greatly varied.

A Typical Furnace. In Fig. 328 is shown the cross section of a modern blast furnace with the various parts labeled. It takes the form of a vertical shaft from 50 to 100 ft high, with a hearth diameter of 18 to 27 ft. The refractories are completely surrounded by a steel shell. The charge

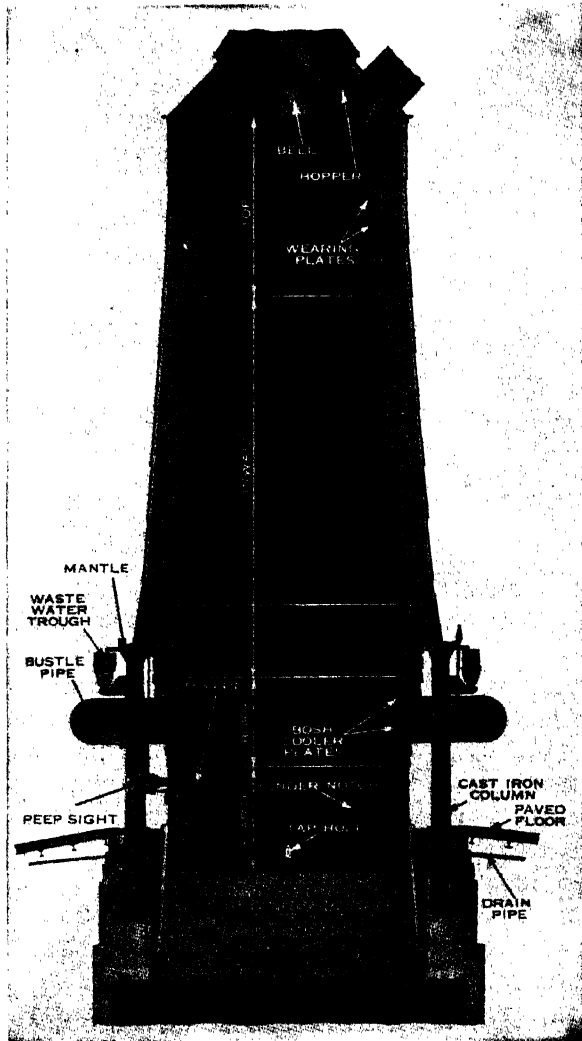

FIG. 328. Typical modern blast furnace. (From "Modern Refractory Practice," courtesy of the Harbison-Walker Refractories Company.)

is fed into the top of the furnace from a skip hoist through the double bell at the top and gradually passes down through the furnace as the reactions take place forming the iron and slag which collect in the crucible

at the bottom. Periodically, the iron and slag are tapped off through separate notches.

It will be noted that the refractories in hotter parts of the furnace and sometimes in the lower portion of the inwall are heavily water-cooled by hollow metal castings extending well into the wall around the bosh and a water jacket extends down around the bottom, which is found necessary to give the long life needed for a satisfactory campaign, often lasting 2 to 5 years with a production of 1 to 2 million tons of iron. Water cooling has made feasible the use of a thinner wall than previously thought possible.

The gas from the top of the blast furnace, which is mainly carbon monoxide and nitrogen, is cleaned, and part is burned in the stoves, which consist of vertical, brick-lined steel cylinders partially filled with checker brick. These checkers are first heated up by burning the blast-furnace gas at the bottom, and then air is drawn through them in the opposite direction to be fed to the tuyères, producing an average preheat temperature of 1100 to 1500°F (about 560 to 816°C). As soon as the temperature of the stove reaches a certain minimum value, the flow is switched over to another stove that has previously been heated so that the cycle can be continued. Usually three stoves are used with one modern blast furnace. Modern design calls for taller stoves with insulation inside the shell.

The blast furnace and its stoves are large users of refractories, as approximately one million bricks would be employed in the construction of a modern unit.

Types of Refractories Used. Practically all the refractories used in the blast furnace and stoves are fireclay brick. In the hearth and bosh are used high-flint clay bricks, which are generally vacuum extruded, dry pressed or air rammed, and high fired, to give a dense structure and low reheat shrinkage that will be resistant to slag and load under the severe conditions encountered in this part of the furnace. Accurate sizing of the blocks is desirable. The hearth bottoms are 9 to 12 ft thick and are usually constructed of blocks larger than the standard 9-in. brick in order to reduce the number of joints. In spite of this construction, however, the bottom bricks are gradually eaten away or floated out during a long campaign and are replaced by iron, which solidifies and forms the salamander. A good description of the action on the hearth refractories is given by McLain.⁽⁹⁾

For a number of years, machined carbon blocks⁽¹⁰⁾ and rammed carbon plastics have been used for bosh and hearth linings in a number of German blast furnaces; and in the last few years, about 20 installations have been

put into operation in this country. Although it is too early to evaluate these refractories completely, they certainly look promising. It is stated that in England a furnace is being tried with the carbon blocks above the slag line, where it is expected that the reducing atmosphere will protect them. Russia, also, seems to be using carbon linings. We have, as yet, no answer as to the relative merits of the block lining and the rammed lining; but in a few years, enough experience should be had with both to give a positive indication. The details of a German carbon-block-lined furnace are given by Seil.⁽⁹³⁾

The bricks in the shaft of the furnace need not be so refractory as those in the lower part because the temperature decreases to approximately 400° at the exit. However, the bricks should be hard and resistant to the abrasion of the moving charge; and most important of all, they should be stable under the disintegrating effect of carbon monoxide, which was discussed more fully in Chap. XVI. It is generally believed that if the iron in the bricks has been converted to iron silicate by high firing, little disintegration will occur. The shaft bricks also are subject to disintegration in the upper portions from metallic zinc, which is sometimes reduced from the ore and, volatilizing, settles in the cooler portions of the lining, causing swelling and disintegration. Alkalies that are vaporized in the lower sections of the furnace also condense in the cooler parts and decrease the life of the lining.

Life of Refractories. The nature of the blast furnace is such that little or no repairing can be done on the structure during a campaign, and therefore the life of the weakest part of the structure determines the total life. Usually the furnace must be shut down because of wearing away of the wall somewhere in the shaft due to slag erosion and abrasion. When the wall becomes so thin that the temperature on the outside casing cannot be held down even by extra cooling, it is impossible to continue the furnace in operation. The modern furnace with thorough water cooling gives excellent life, and campaigns of 3 to 5 years are commonly reported. In general, it would seem that the refractories available for the blast furnace are satisfactory for their purpose, but perhaps higher densities for the brick in the lower part of the furnace can still be achieved by more careful sizing of the raw materials, vacuum treatment, and higher pressures. Higher firing of the brick in the shaft will make them more stable in regard to disintegrating influences, but many problems still need study as far as these factors are concerned.

In Fig. 329 are shown⁽⁹⁾ the wear lines in a blast furnace at the end of a campaign. The first zone of wear is at the top under the stock-line wear plates and is due mainly to abrasion. The second zone is above the mantle and is caused by disintegrating influences of carbon monoxide, alkalies, and zinc, as well as slag erosion.

The checkers in the stoves show gradual deterioration due to slumping and shifting, but accurate pyrometer control to prevent overheating will minimize this condition. The use of super-duty fireclay brick in the upper portions of the checkers is generally recommended.

Table 111 gives an idea of the conditions encountered in the blast furnace.

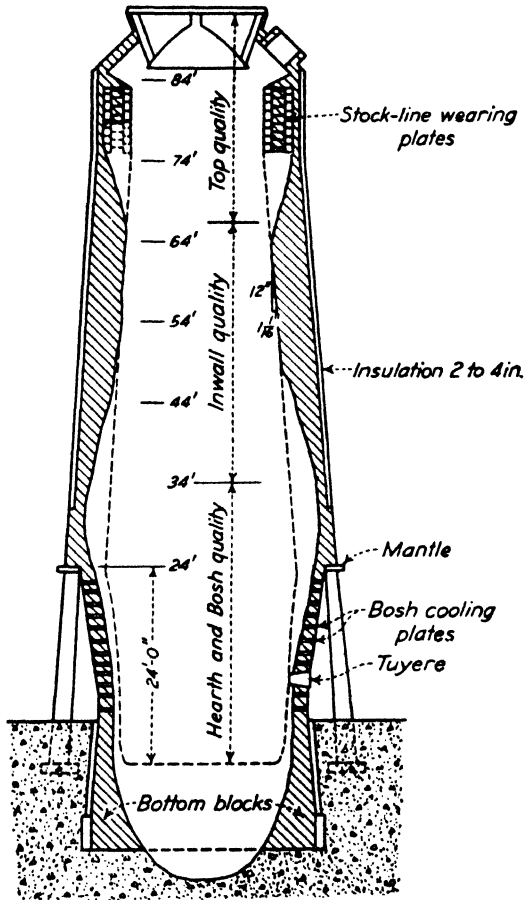

FIG. 329. Burn-out lines of furnace. (Courtesy of W. R. McLain, Bull. Am. Ceram. Soc.)

Two new developments in blast-furnace operation may have an important influence on the life of the lining. One of these is the use of oxygen-enriched air,^(104,105) and the other, high pressure in the shaft. The latter method seems economically sound at present and should materially increase the capacity of a given furnace.

3. Cupola. *Principle of Operation.* The cupola is strictly a melting furnace using as a charge cast iron in the form of pigs, stove plate, and other

TABLE 111. ANALYSIS OF SERVICE CONDITIONS IN THE BLAST FURNACE

| Furnace Part | Material | Temperature, °F. | Slagging action | Abrasion | Load, lb. per sq. in. | Spalling | Life, years | Remarks |
|-------------------|---|------------------|-----------------|----------|-----------------------|-------------|-------------|--|
| Top..... | Dense low-heat-duty fire-clay brick | 400-600 | None | Severe | Unimportant | Unimportant | 3-5 | |
| Upper inwall..... | Dense intermediate-duty fireclay brick | 600-1000 | Slight | Medium | Unimportant | Unimportant | 3-5 | |
| Lower inwall..... | Dense high-heat-duty fire-clay brick | 1000-2000 | Considerable | Slight | 10-15 | Unimportant | 3-5 | Disintegration by CO, Zn, and alkalis |
| Bosh..... | Dense high-heat-duty fire-clay brick | 2000-3300 | Severe | Slight | 20-30 | Unimportant | 3-5 | Water-cooling plates to protect refractory from slagging |
| Hearth..... | Dense high-heat-duty fire-clay blocks. Also carbon blocks | 2500-2900 | Severe | None | May be high | Unimportant | 3-5 | Water-cooled jacket |

scrap cast iron and in some cases scrap steel. The charge is alternately metal, coke, and some limestone as a flux. In a well-operated cupola, roughly 8 to 12 tons of iron can be melted to 1 ton of coke. The cupola

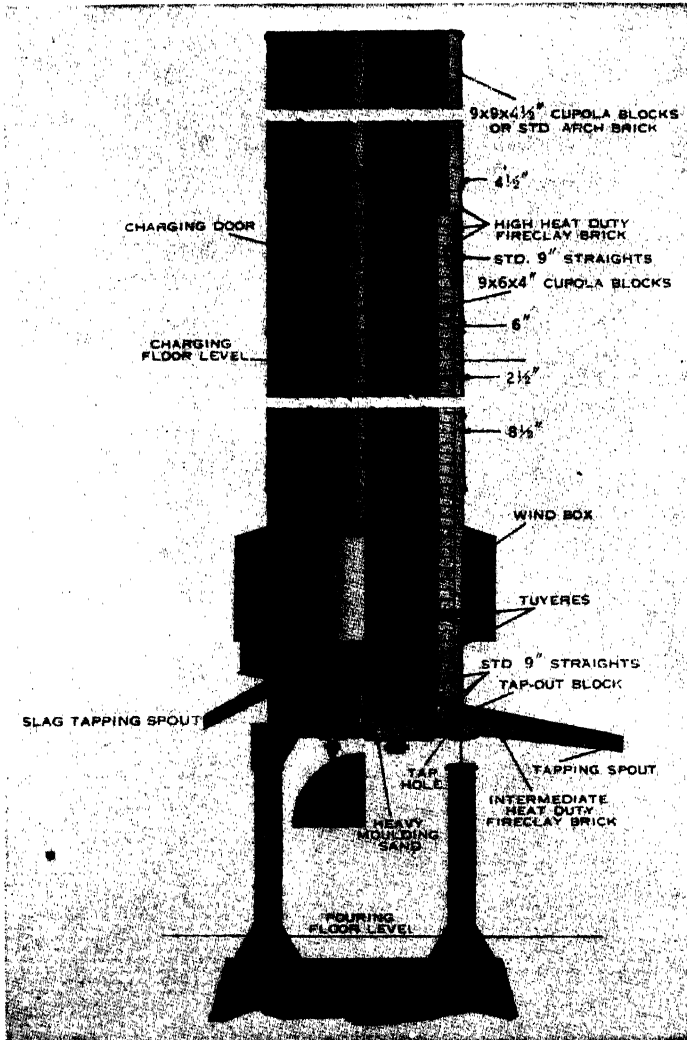

FIG. 330. Section of typical cupola. (From "Modern Refractory Practice," courtesy of the Harbison-Walker Refractories Company.)

itself is quite similar to the blast furnace in shape, consisting of a hollow shaft with a charge entering through a door near the top and the molten iron being tapped out periodically or constantly at the bottom. Air for combustion enters the lower part of the shaft through tuyères in the same

way as for the blast furnace, but seldom is preheated air used in cupola melting. Unlike the blast furnace, the cupola is not used on continuous operation but is dumped each evening, repaired by patching, and started up the next day.

Typical Furnace. In Fig. 330 is shown a cross section of a typical cupola for melting away gray iron for foundry use. The shaft is completely lined with fireclay blocks molded to fit the curvature of the cupola. The door for charging is near the top of the shaft, and no attempt is made to collect the hot gases from the top. In the bottom of the shaft is a crucible for collecting molten iron, as clearly shown, together with the tap hole for draining off the melted iron. The bottom of the cupola can be dropped down at the end of a run for quicker cooling and easier repairs.

Types of Refractory Used. The refractories used in the cupola are fireclay blocks made with a dense structure by hard pressing or by deairing. Considerable improvement has been made in the cupola refractory in the last few years in the way of a more uniform and denser structure. Such a structure is more capable of withstanding the abrasion and slagging; but on the other hand, because of the sudden temperature changes, the block must also have considerable resistance to spalling. Although the complete lining of the cupola lasts for a considerable length of time, perhaps for a year or more, it is necessary to make rather extensive repairs to the portion of the shaft around the tuyères every day by the addition of new blocks or simply by patching with a plastic material, which is usually made of crushed ganister and plastic fireclay.

• Attempts have been made to line cupolas with a castable refractory consisting of grog, ganister, and high-alumina cement. Although this mixture has been used for patching in this country, the use of complete linings of this material has been confined in the past to European practice. Rammed linings are also used abroad because of their low cost. In Table 112 are given some of the conditions encountered by the refractory.

4. Open-hearth Furnace. *Principles of Operation.* The open-hearth furnace is a reverberatory type with a flame playing over a relatively shallow layer of metal. The charge may be pig iron, either solid or in the molten state directly from the blast furnace; most generally pig iron and scrap; or scrap and carbon. The reactions occurring in this furnace are mainly an oxidation of the carbon, elimination of the phosphorus in the basic process, and a decrease in the silicon, manganese, and sulfur. In the acid process (siliceous slag), it is impossible to eliminate the phosphorus; accordingly, only low-phosphorus materials can be used, which in this country limits the production of acid open-hearth steel to about 5 per cent of the total. For this reason, only the basic process will be considered here.

TABLE 112. ANALYSIS OF SERVICE CONDITIONS IN THE CUPOLA

| Furnace part | Material | Temperature, °F | Slagging action | Abrasion | Load | Spalling | Life | Remarks |
|------------------------|---|-----------------|-----------------|------------------|------------------|-----------|-------------|------------------------------|
| Shaft lining, upper... | High-heat-duty fireclay blocks, 9 × 6 × 4 in. | 500-2000 | None | Severe | Light | Important | 1 year | |
| Shaft lining, lower... | High-heat-duty fireclay blocks 9 × 6 × 4 in. | 2000-3000 | Severe | | Medium | Slight | 1 year | Patching required every heat |
| Bottom..... | Rammed sand and clay | 2900 | Severe | | May be important | None | 1 heat | |
| Tapping-spout lining. | Intermediate-heat-duty bricks | 2600-2800 | Slight | Cutting by metal | None | Severe | 20-30 heats | |

The output of the open-hearth furnace is mostly used for casting steel ingots, which are later rolled, hammered, or pressed into the desired shapes.

The fuel used in the open hearth is most commonly producer gas, but furnaces are fired by natural gas, fuel oil, tar, coke-oven gas, and even pulverized coal. The type of fuel governs the design of ports in the furnace and has a considerable influence on the life of the refractories. For example, producer gas gives a long flame that has a tendency to heat the end walls and downtakes, whereas the coke oven gas has a hot flame that tends to heat the roof near the burner end of the furnace. All open-hearth furnaces are of the regenerative type, in which the outgoing gases heat checker chambers. After a period of time, the flow is reversed and the incoming air and gas are preheated by passing through these hot chambers and then combined at the ports to form the combustion flame. Neither coke-oven nor natural gas can be preheated because of the tendency to crack.

Typical Furnace. In Fig. 331 is shown a cross section of a typical stationary 100-ton basic furnace, which is an average size. Most of the furnaces are of the stationary type, but a few tilt on a horizontal axis for pouring and to make up the back wall. The tilting makes the operation of the furnace somewhat simpler, but the initial cost is much greater, and there is some difficulty in making the air and gas connections tight. If anyone is interested in more detailed construction of the open-hearth furnace, he should refer to the excellent book by Buell.⁽³⁸⁾

The hearth of the furnace is built up on steel plates, as shown in Fig. 331, with a layer of insulating brick, magnesite or chrome bricks, or a rammed mixture and then a fritted magnesite bottom, which is constantly being repaired during the campaign to maintain its normal thickness. The front and back walls of the furnace are usually made of silica brick with burned magnesite brick in the lower courses; but recently, chemically bonded brick of magnesite and metal-cased magnesite brick have been successfully used. A layer of chrome brick is usually introduced between the silica and magnesite brick.

Recently a considerable saving in time has been achieved by using rammed bottoms rather than fritting in a bottom in layers.⁽⁹⁰⁾

The end walls and bulkheads are built up of silica, magnesite, or chrome brick; but here again, the metal-case brick have proved quite satisfactory in many installations. The ports are usually constructed of silica brick, but chrome and magnesite brick are used to withstand the slag and cutting action of the high-velocity dust-laden gases. Chromite ramming mixtures are sometimes used over the silica brick.

The doors of the furnace usually have water-cooled frames, which protect the brickwork from the mechanical abuse of the charging machine and give sufficient cooling to prevent deterioration of the front wall—a difficult portion of the furnace to repair.

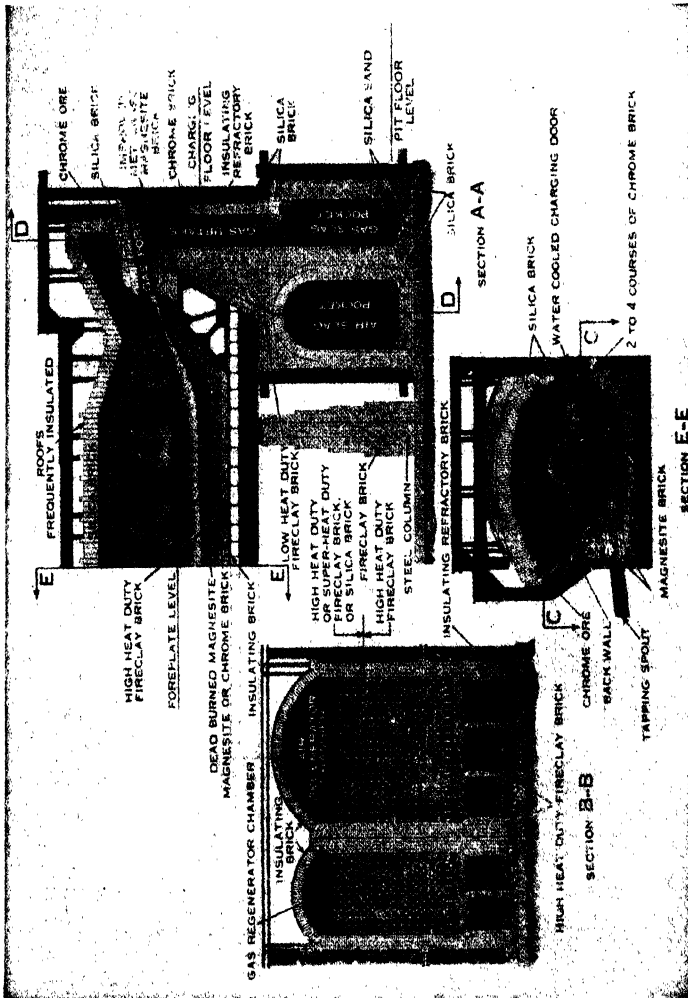

FIG. 331. Sections of typical basic open-hearth furnace. (Courtesy of Harbison-Walker Refractories Company.)

The roof of the open-hearth furnace is one of the most important portions of the structure, because the life of the furnace as a whole is more or less determined by the life of the roof. Generally, the refractories used in the sprung arch of the roof are silica brick of $13\frac{1}{2}$ or 18 in. thick-

ness. As the temperature required to maintain a low-carbon steel for pouring is 1585°C (about 2880°F) and the temperature at which the silica brick in contact with iron oxide begins to soften is 1650°C (about 3000°F),⁽⁵⁹⁾ it will be seen that only a small operating interval is available and that for this reason, the temperature control must be carefully maintained. In the modern plants, the roof temperature is read with optical pyrometers; and in some cases, temperature controllers operating on a radiation-pyrometer principle are permanently installed to cut off the fuel whenever the temperature exceeds the upper limit.

It might be thought that the silica brick, because of its tendency to spall, would be unsatisfactory in a regenerative furnace where a periodic change in temperature occurs at each reversal. However, if one would examine the expansion curve of a silica brick as shown in Fig. 297 of Chap. XVII, it will be noticed that above the red-heat range, the volume of the brick is substantially constant and changes in temperature in the higher zones will cause no appreciable volume change. In other words, the silica brick is unexcelled for these particular conditions, and this constant volume at high temperatures explains why such good results are obtained with them.

Steel manufacturers have long desired a roof brick with a higher temperature range than silica, because it is obvious that if the open hearth could run at 200 or 300°F higher temperature, production from a given unit could be greatly increased and, at the same time, qualities of steel that now can be produced only in the electric furnace could be turned out more cheaply in the open hearth. For this reason, a great deal of experimentation has been taking place both in this country and abroad on the use of more refractory materials. In Germany, specially made magnesite brick⁽⁵⁸⁾ have been used with greater resistance to spalling than the usual type, accomplished by special treatment to give a maximum flexibility to the structure.⁽³⁵⁾ Specially treated chrome brick have been used in the roof of the open hearth; and more recently, bricks made of mixtures of chrome and magnesite have seen extensive trials, particularly in England. The results from these refractories, when analyzed, do not give us as yet any clear picture of the possibilities in this direction because even though a number of successful trials have been reported, this construction has not been adopted at all extensively, since the much greater cost of the roof as compared with silica does not seem to be justified.

In spite of this, several basic roofs have been put in operation in this country and Canada, but further improvement of the brick is needed before they will compete seriously with silica brick in our type of operation. The recent German success with the basic roof depends, as

explained by Seil,⁽⁹³⁾ largely on their practice of using a high percentage of hot metal (about 70 per cent), so the heat shock is not great in charging.

The super-duty silica brick of more than usually pure ganister has shown considerable promise in permitting somewhat higher roof temperatures, but not all melters agree on its superiority over the standard silica brick.

The downtakes to the checker chambers are usually lined with silica brick, as is the upper part of the checker chamber itself. The checkers usually consist of hard-burned fireclay blocks such as $9 \times 6 \times 3$ or $10\frac{1}{2} \times 4\frac{1}{2} \times 4\frac{1}{2}$ in. in size. Often, however, the upper courses are made of silica because of the higher temperature conditions. A great many different types of checker block have been suggested and tried, and much theoretical work has been given over to the consideration of the checker efficiency. Many of these are noted in the references.^(52, 53, 60) The fact remains, however, that most of the furnaces now built use the simple, rectangular checker block. The life of the furnace, in some cases, depends on the checkers, because as the campaign continues, the checker passages decrease as a result of building up of slag on the checkers, collection of dust in the passages, and spalling off of fragments of the checker bricks themselves, which fall down and tend to plug the passages. It is usual to design the checkers to give a life equal to or considerably longer than that of the furnace roof without too great loss in regenerative efficiency. Anyone interested in more detailed construction of the checker design should again refer to Buell.

The cost of commercial oxygen has been so reduced by modern methods (\$20 to \$40 per ton) that enrichment of the combustion air is feasible with more rapid melting.^(102, 104, 105) Griffith⁽⁷³⁾ gives some figure to show a saving of about 2 hr in total heat time and, in addition, a real saving in fuel. It is believed that oxygen may be generally used in the future, and this will impose more problems on the refractories manufacturers.

Life of the Refractories. In Table 113 is given a résumé of the service conditions and life of the refractories in various parts of the basic open-hearth furnace. It should be realized that the figures given in this table are more or less average figures and that many exceptions will be found under particular conditions. All that it is hoped to do is to give a general picture that will explain why certain types of refractory are used and what the possibilities are of finding an improved material for that particular service.

5. Pouring-pit Refractories. *Ladles.* The steel ladle is used to receive the molten steel from the open-hearth furnace. In the ladle, the steel may receive some treatment such as the addition of deoxidizers or alloying elements, after which it is teemed into the ingot molds through a

TABLE 113. ANALYSIS OF SERVICE CONDITIONS IN PRODUCER-GAS-FIRED STATIONARY OPEN-HEARTH FURNACE
(Adapted from Industrial Survey of Conditions Surrounding Refractory Service in Open Hearth Practice, "Manual of
ASTM Standards on Refractory Materials")

| Furnace part | Material | Temperature | Slagging action | Abrasion | Load, lb. persq. in. | Spalling | Life | Remarks |
|--------------------------------------|---|--|-----------------|----------------------------|----------------------|---------------------------------------|------------------|--|
| Hearth: Bottom..... Banks..... | Magnesite Dead-burned mag- nesite and dol- omite | Up to 3000°F. (1650°C.) | Severe | Severe | Unimportant | None | 20 years | Development of cracks allows infiltration of metal, causing disrup- tion of bottom |
| | | Up to 3000°F. (1650°C.) | Moderate | Severe | 10 max. | None | | |
| Front wall..... | Silica brick Chrome brick | Up to 3000°F. (1650°C.) | Severe | Unimportant | 10 max. | Important | 250-500 heats | There may be consider- able spalling in roof and walls if furnace is heated too rapidly |
| | | Down to 1200°F. (650°C.) | Severe | Severe in some furnaces | 10 max. | Usually slight | | |
| Back wall..... | Chrome brick Magnesite brick Silica brick* | Down to 1200°F. (650°C.) | Severe | Unimportant | Arch stresses | Important | 100-300 heats | |
| | | Up to 3000°F. (1650°C.) | Severe | Important | Unimportant | Usually slight | | |
| Roof..... | Silica brick* | Down to 1200°F. (650°C.) | Severe | Important | 10 to 15 | Slight usually ex- cept on repairs | 250-500 heats | |
| | | Up to 3000°F. (1650°C.) | Severe | Severe | Unimportant | Usually slight | | |
| Ports..... | Silica brick | Down to 2000°F. (1095°C.) | Severe | Severe | 10 to 15 | Slight usually ex- cept on repairs | 100-300 heats | |
| | | 2900°F. (1595°C.), max. 2000°F. (1095°C.), min. | Severe | Severe | 15 to 20 | Slight | | |
| Bulkhead(endwall) | Silica brick Chrome brick Magnesite brick† | 2900°F. (1595°C.), max. | Severe | Moderate | 15 to 20 | Slight | 250-500 heats | |
| | | 2000°F. (1095°C.), min. | Severe | Unimportant | 5 to 10 | Unimportant | | |
| Downstake..... | Silica brick | 2900°F. (1595°C.), max. | Severe | Unimportant | 5 to 10 | Unimportant | 250-500 heats | |
| | | 2000°F. (1095°C.), min. | Severe | Unimportant | 5 to 10 | Unimportant | | |
| Slag pocket..... | Silica brick | 2900°F. (1595°C.), max. | Severe | Unimportant | 5 to 10 | Unimportant | 250-500 heats | |
| | | 2000°F. (1095°C.), min. | Severe | Unimportant | 5 to 10 | Unimportant | | |

* Magnesite and chrome-magnesite brick have been used.

† Metal-case brick often used.

TABLE 113. ANALYSIS OF SERVICE CONDITIONS IN PRODUCER-GAS-FIRED STATIONARY OPEN-HEARTH FURNACE (Continued)

| Furnace part | Material | Temperature | Slagging action | Abrasion | Load, lb. per sq. in. | Spalling | Life | Remarks |
|------------------|---|---|---|--------------------------------|--|----------------|------|---|
| Upper checkers | High-heat-duty fireclay brick | Gas { 2400°F. (1315°C.), max. 1100°F. (595°C.), min. Air { 2600°F. (1425°C.), max. 250°F. (120°C.), min. | Important at top; not important at bottom | Slight except in upper portion | 5 to 15 | Usually slight | | Gas checkers: Top varies from 2400 to 2000°F. (1315 to 1095°C.); bottom from 1100 to 1400°F. (595 to 760°C.) Air checkers: Top varies from 2600 to 2000°F. (1425 to 1095°C.); bottom from 250 to 1400°F. (120 to 760°C.) |
| | Silica brick | | | | | | | |
| Lower checkers | High-heat-duty fireclay brick | Same as for "Upper checkers" | Same as for "Upper checkers" | Same as for "Upper checkers" | 10 to 20 | Usually slight | | |
| Checker chambers | High-heat-duty fireclay brick | | | | | | | |
| Flue to stack | Intermediate-heat-duty fireclay brick | Up to 1350°F. (730°C.) | Unimportant | Unimportant | Unimportant | None | | |
| Stack | Intermediate- and moderate-heat-duty fireclay brick | Up to 1200°F. (650°C.) at bottom stack | Unimportant | Unimportant | Unimportant because of low temperature | None | | |

nozzle and stopper in the bottom of the ladle. The refractories used to line the ladle present a real problem because they must fulfill the following requirements:

1. Good resistance to temperature shock due to the sudden heating when the molten steel is poured into the ladle.
2. Good resistance to the slag layer on top of the steel.
3. Resistance to abrasion of the molten steel.
4. Freedom from particles of the refractory mixing in the molten steel and forming inclusions.
5. Low thermal conductivity to prevent the formation of sculls.
6. Tight joints to prevent adhesion of the sculls to the bottom and sides of the ladle.

As the steel is generally made in a basic furnace, it would seem reasonable that the lining of the ladle should also be basic; but unfortunately, a basic material cannot be found that would stand the sudden temperature change of pouring without serious failure. Therefore, it has been thought necessary to make the ladle lining out of fireclay brick with a fine-grained, fairly dense structure yet sufficiently porous to give good spalling resistance. There have been two schools of thought on ladle bricks: one advocating a high-silica brick of comparatively low fusion point which actually glazes over slightly on the surface and provides a smooth inner lining. The other type of brick recommended is the high-alumina brick of flint clay or diaspore having high refractoriness. Both types of brick are used in ladles; but as yet, no definite conclusion can be drawn as to the best type. When it is realized that perhaps 15 or 20 heats is the average for the ladle lining, possibilities of real improvement in the refractories are evident.

It is obvious that if care is taken to preheat the ladle to a high temperature and then use it continuously, the basic lining should be very satisfactory. This is shown by some results in France, where a basic ladle was used for 30,000 heats. Not only does the basic lining give a long life, but it is so resistant that the steel is not contaminated with nonmetallic inclusions. The basic lining should receive more serious thought in this country.

In lining a ladle, the common practice is to use a thickness of $2\frac{1}{2}$ to 9 in., depending on the size of the ladle, and modern usage seems to tend toward the use of 1 or $1\frac{1}{2}$ in. of insulation between the refractory lining and the steel shell. The ladle bricks, usually in two layers, should be uniform in size so that the thinnest possible dipped joints can be made. Care is necessary in drying out the ladle before use, which is usually done by building a fire of wood or coke in the bottom of the ladle or introducing gas burners. Practice varies in the time required for drying, some ladles being dried out in as short as 8 hr, and some in 48 hr. The life of the

ladle lining depends to some extent on the type of steel, certain alloys being much more severe on the lining than carbon steel. Fluorspar, which is often used to increase the fluidity of the flux, has a severe action on the ladle lining and will often materially decrease its life. Smaller ladles for cast iron are often lined with a fireclay plastic that must vitrify and give a hard surface.

Nozzles, Stoppers, and Sleeves. The nozzle used in teeming steel from the ladle is a very important part of the ladle. A cross section of a typical nozzle and stopper assembly is shown in Fig. 332. A good stopper and nozzle should give a clean flow of steel without spattering at a substantially constant rate throughout the pouring operation, should be able to shut off the stream between ingot molds cleanly without dribbling, and it should be possible to open the nozzle on the first ingot without sticking.

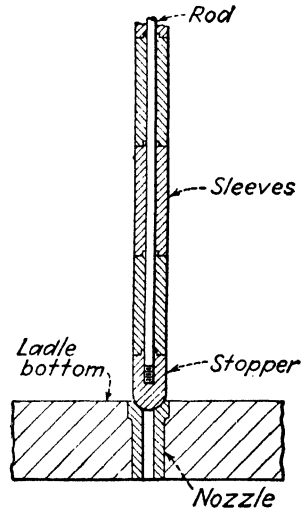

FIG. 332. Nozzle and stopper assembly.

In order to get a uniform rate of flow from the ladle, a material that will slowly erode and increase the diameter during the pouring operation must be used in the nozzle. It has been found that fireclay nozzles will have this property of giving a comparatively uniform flow rate from the beginning to the end of the pouring.

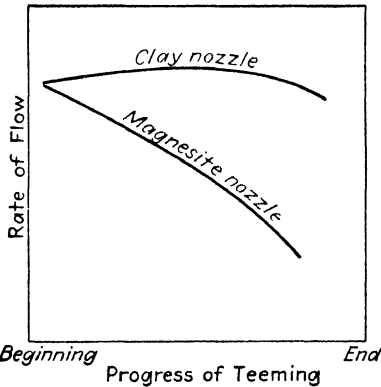

FIG. 333. Flow of steel through nozzles.

On the other hand, a nozzle of magnesite is so resistant to erosion that it maintains substantially a constant diameter and therefore the rate of flow decreases, as shown in Fig. 333.

In order to get a tight fit between the nozzle and stopper, it is usually desirable to have one of them slightly plastic, but not both, or sticking is certain to result. For this reason, either the nozzle or the stopper will generally be made of a more refractory clay than the other; or in many cases, the stopper would be made of graphite and clay, which are more rigid at the pouring temperature than the clay alone.

The steel rod attached to the stopper must pass down through the molten steel in the ladle and therefore must be protected with refractory sleeves. They are made of a fireclay, and it is particularly important

that they resist cracking under the sudden heat shock. It is also important that the joints between the sleeves be carefully fitted so that the molten steel cannot force them apart.

In recent years, a great deal of interest has been shown in steel inclusions. It is beginning to be realized that many of these are due to particles of refractory from the ladle lining or from the nozzle and that the ability to produce really clean steel would seem to depend largely on finding a refractory that would be more stable than the fireclay refractory now used.

Tap Holes. The tap hole in the open-hearth furnace must consist of a material strong enough to hold the pressure of the molten steel without breaking out and, at the same time, sufficiently soft to be knocked out with the tapping bar. It is general practice to make up a mixture of raw and burned dolomite for this purpose, although in some cases chrome-base cements have been used.

Hot Tops and Plugs. The plugs are used at the bottom of certain ingot molds to receive the direct impact of the stream of molten steel from the ladle. They must, therefore, be resistant to spalling and at the same time sufficiently dense to prevent erosion. They are usually made of a fireclay of comparatively low refractoriness and generally give little trouble.

The hot tops are placed on top of the ingot mold to prevent too rapid solidification of the top of the ingot and consequently a deep pipe. The hot tops must have a sufficiently close structure so that the steel will not penetrate them, and yet it is desirable to have them of light weight for low specific heat and low thermal conductivity with, at the same time, good spalling resistance. As they are generally used only once, the cost must be low. Usually, a comparatively low-burned fireclay mix is used, but some success has been had with lightweight refractories coated with a material to prevent penetration of the steel into the pores.

6. Air Furnace. *Principles of Operation.* The production of malleable iron is generally carried out in the air furnace. The malleable iron is produced from mixtures of pig iron, steel, and malleable foundry scrap, which is refined in the furnace to produce the proper percentages of carbon, silicon, sulfur, manganese, and phosphorus. When the malleable iron is first cast, it has practically all the carbon in the form of carbide of iron, which gives a comparatively brittle structure. The cast objects are then subjected to a heat-treating process while packed in iron boxes, perhaps seven or eight deep, for a considerable length of time, after which the carbon is precipitated and gathers into regular nodules known as "temper carbon." Sometimes the castings are simply annealed without packing. In the final condition, the metal is ductile and malleable and shows considerable elongation.

Typical Air Furnace. Figure 334 shows a section of a typical air furnace, which consists of a shallow hearth made of silica sand and a firebrick wall and crown to cover it. An average-size hearth is 6 by 20 ft

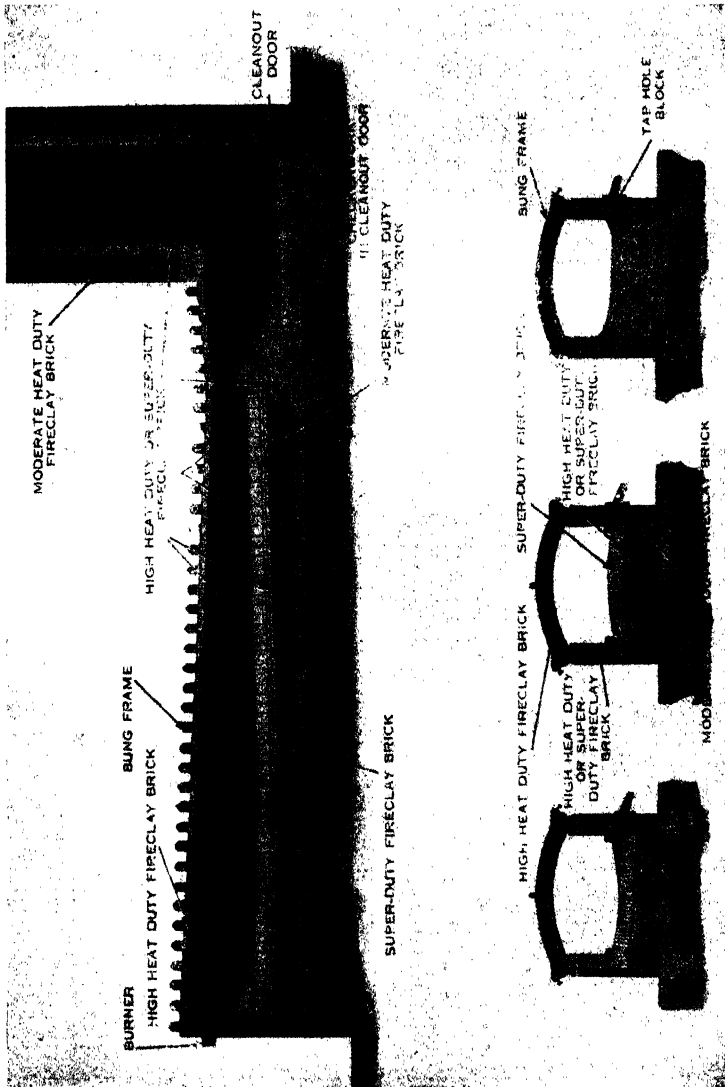

FIG. 334. Pulverized coal-fired reverberatory furnace for malleable iron. (Courtesy of Harbison-Walker Refractories Company.)

with a capacity of 15 tons, but furnaces up to 50-ton capacity have been made. Unlike most reverberatory furnaces, the crown is not fixed but is composed of separate bungs in which a ring of bricks comprising a section of the arch is clamped in an iron framework. In this way, one

TABLE 114. CLASSIFICATION OF REFRACTORIES FOR MALLEABLE-IRON INDUSTRY
 (Adapted from Industrial Survey of Conditions Surrounding Refractory Service in the Malleable-iron Industry, "Manual of ASTM Standards on Refractory Materials")

| Part (see Fig. 334) | Material | Temperature | Spalling | Slagging | Load | Abrasion | Life | Remarks |
|---------------------|-------------------------------|--|---|---|--------------------------|---------------------------------|-------------|--|
| Air furnace | | | | | | | | |
| Bungs | Fireclay brick | Up to 3000°F. (1650°C.) | Very important where bungs removed for charging immediately after tapping | Minor importance | See note under "Remarks" | Important near back bridge wall | 20-30 heats | The brick in the bungs are subjected to pressure that may be as high as 1000 lb. per sq. in. owing to setting up the clamps too tightly. This would be increased considerably as a result of thermal expansion when the bungs were heated up |
| Side walls | Fireclay brick | From 3000°F. (1650°C.) at front to 2400°F. (4315°C.) at back | Important above the slag line | Important from the hearth up to the slag line | 10 lb. per sq. in. max. | Unimportant | | |
| Bottom | Fireclay brick or silica sand | Varies from plant to plant and stage of melting operation. Approximately that of the metal | Minor importance | Important especially in "Duplexing" | Minor importance | Important | | |

| Part (see Fig. 324) | Material | Temperature | Spalling | Slagging | Load | Abrasion | Life | Remarks |
|---------------------|---|---|-------------|-------------|--|-------------|------|--|
| Stack lining | Fireclay brick | 2400°F. (1315°C.) max. | Unimportant | Unimportant | Depends upon construction. 50 lb. per sq. in. max. Usually an inner lining is built to a height of 15 to 20 ft. The load here is not in excess of 15 lb. per sq. in. | Unimportant | | |
| Waste heat boilers | Fireclay brick | 2400 to 2600°F. (1315 to 1425°C.) | Moderate | Unimportant | Unimportant | Unimportant | | |
| Air preheaters | Fireclay brick | 2400 to 2600°F. (1315 to 1425°C.) | Moderate | Unimportant | Unimportant | Unimportant | | |
| Combustion chamber | Fireclay brick | 2100°F. (1150°C.) See note under "Remarks" | Moderate | Moderate | Unimportant | Unimportant | | Some continuous ovens are oil-fired and higher temperatures prevail particularly in the bridge wall. Super-duty fireclay brick, high-alumina brick, and silica brick are then used |
| Annealing oven | | | | | | | | |
| Doors | Fireclay brick or insulating refractories | 1600 to 1800°F. (870 to 980°C.) | Unimportant | Unimportant | Unimportant | Unimportant | | |
| Walls | Fireclay brick or insulating refractories | 1600 to 1800°F. (870 to 980°C.) | Unimportant | Unimportant | 15 lb. per sq. in. max. | Unimportant | | |

or more bungs can be lifted from the furnace at any time with a crane and the furnace charged through the opening thus produced. The fuel used for heating this type of furnace may be coal, oil, or gas, but powdered fuel is, perhaps, most used. This produces rapid heating and comparatively high temperatures; consequently the crown of the furnace receives considerable abuse. A furnace is brought up to heat in $1\frac{1}{2}$ hr and held 5 to 8 hr. The bungs have a comparatively short life of 20 to 30 heats as a result of the rapid heating and cooling, but the side and end walls give generally good service. In Table 114 is given a summary of the service conditions in the air furnace.

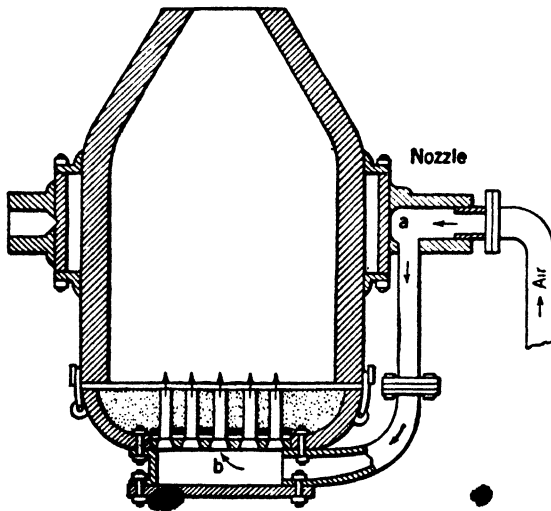

FIG. 335. Bessemer converter. (From "Iron and Steel," by H. M. Boylston.)

7. Bessemer Converter. Construction and Operation. The Bessemer converter is a pear-shaped, refractory-lined vessel on trunnions, which permit it to be tilted from the horizontal to the vertical position. The bottom consists of a refractory containing a large number of holes through which air can be blown under considerable pressure. A typical converter is shown in Fig. 335.

In operation, the converter while on its side is charged with molten iron from the mixer or blast furnace. It is then rocked into an upright position after the air blast has been applied, thus forcing air up through the molten metal and oxidizing the carbon and silicon to bring it down to the right composition. Experiments are being made on the use of oxygen-enriched air for the blast, which may well alter the conditions for the refractory.

Type of Refractory Used. Most of the converters are acid lined with silica brick or natural furnace stone such as sandstone or mica schist. The bottoms of the converter are usually made of fireclay and must be frequently replaced, as 10 to 30 heats is the average life. The walls of the converter, however, may give a life of 200 or 300 heats before extensive replacements are necessary.

8. Electric-arc Furnaces. *Principle of Operation.* Furnaces of this type are used to melt iron and steel by the heat of an arc formed between the slag layer and the overhead electrodes, usually three in number, which can be raised and lowered to accommodate the changes in metal height and loss in electrode length. There are many variations in types of furnace, but most of them consist of a cylindrical, refractory-lined shell with a domed roof and a charging door in the side. Nearly all of them are on trunnions so that they are poured by tilting.

The acid-type furnace is used mainly for steel castings and iron, whereas the basic furnace is most commonly used for production of steel ingots.

Construction. In Fig. 336 is shown a cross section of two typical electric basic furnaces. The bottom is composed of about 10 in. of rammed, dead-burned magnesite or electrically sintered magnesite, bonded with organic material or silica of soda. Such a bottom will probably be patched every heat but, under these conditions, will give good service.

The lower side walls are constructed of magnesite brick; and for this purpose, a low-iron magnesite is often preferred because of its better resistance to spalling. The upper side walls are usually made of silica brick.

The roof, which is in the form of a dome, is generally made of silica brick, using specially made shapes to fit around the electrodes. Good success has been obtained, however, with roof bricks of other materials such as super-duty fireclay, kaolin, and mullite, all of which are more resistant to spalling during the week-end shutdowns than the silica. An average roof will have a life of 100 to 150 heats, although a longer life is sometimes obtained.

9. High-frequency Induction Melting Furnaces. *Principle of Operation.* This type of furnace melts metal by inducing high currents in the charge by means of an external coil surrounding the crucible. This furnace differs from all others in that the heat is generated directly in the metal itself and the crucible is not subjected to any other heating. High-frequency induction furnaces are made in small units for experimental melts of a few pounds up to 5-ton steel-melting furnaces. This kind of melting has certain advantages, particularly for alloy steels, in that a thorough stirring of the melt takes place and the analysis of the resultant steel can be accurately controlled.

Refractories. In Fig. 337 is shown a cross section of a large high-frequency induction furnace for melting alloy steels. The high-frequency current is carried by the water-cooled coil, inside which is a formed mica sleeve or troweled on sillimanite mix for coil protection. On the inner

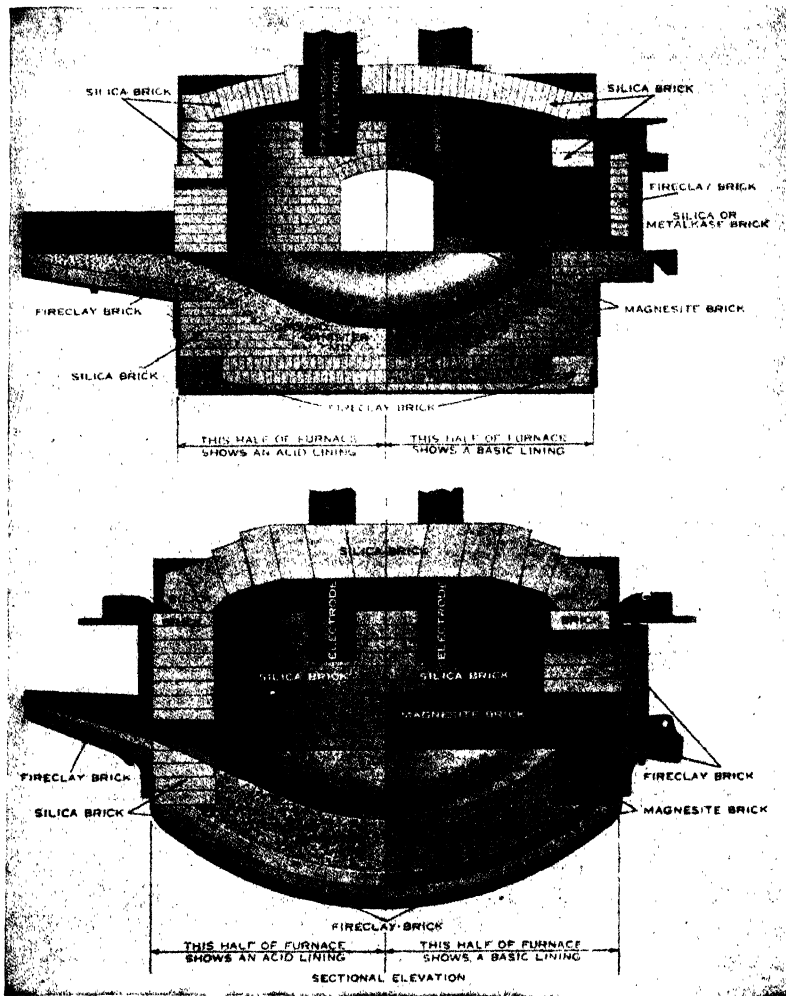

FIG. 336. Typical electric steel-melting furnaces. (From "Modern Refractory Practice," courtesy of the Harbison-Walker Refractories Company.)

side of this is rammed a thin layer of refractory to form the melting chamber. For the highest efficiency, this refractory must be thin, and yet it must not crack during the melting operation. The preferred method of putting in this refractory is to ram it by hand inside a core made in the form of a steel or asbestos cylinder. The core can be withdrawn or

melted out while, at the same time, fritting the surface of the refractory together into a strong mass.

A satisfactory refractory may be a rammed ganister bonded with a little clay or silicate of soda for acid furnaces. Electrically sintered magnesite with an organic binder is used for basic furnaces, although linings are fritted in place with no bond by melting out an asbestos sleeve. With patching, 100 to 200 heats can be obtained with a single lining. Fused alumina and zircon have also been tried with good success in special cases.

For the smaller furnaces, prefired crucibles are generally used, magnesite being usually preferred.

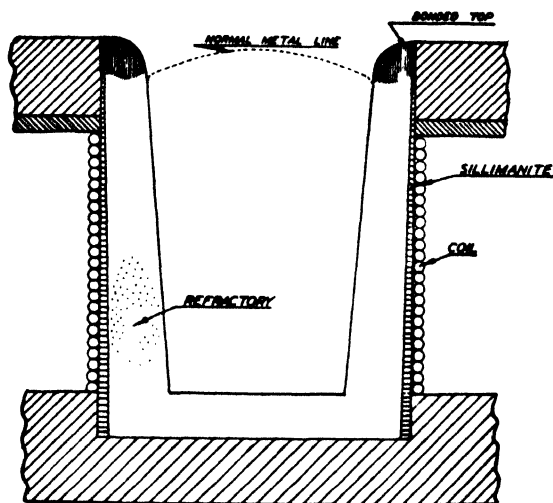

FIG. 337. General arrangement of coreless induction furnace. (Courtesy of B. W. Magalis, Babcock & Wilcox Company.)

10. Furnaces for Forming Operations. Soaking Pits. The soaking pit as shown in Fig. 338 consists of a rectangular or cylindrical furnace generally heated by tangential burners using either gas or oil as fuel. Regeneration is often employed. The removable cover, automatically operated, allows the heavy ingots to be placed or removed with an overhead crane.

The bottoms of these furnaces are made of rammed coke and molasses or rammed chrome plastic to withstand the action of mill scale, which forms in comparatively large quantities in furnaces of this type. The side walls are usually made of fireclay or silica brick, but unburned magnesite or chrome brick have been tried with success.

The cover is one of the most important parts of the furnace, as it must withstand considerable mechanical shock due to the frequent

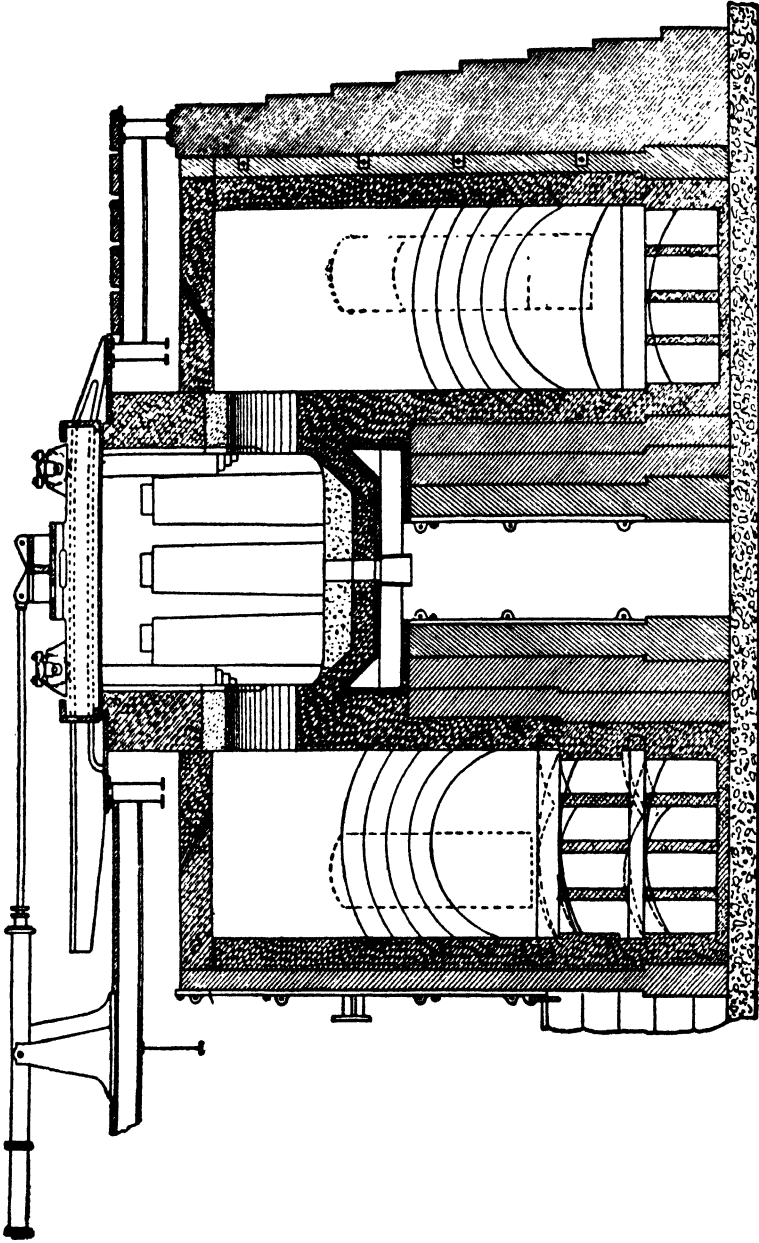

Fig. 338. Soaking pit. (From "The Making, Shaping and Treating of Steel," Carnegie Steel Company.)

opening and closing; and at the same time, it should be as light as possible for the quick operation necessary for efficiency. For this reason, covers have recently been made almost entirely from insulating firebrick, because it not only reduces the weight of the refractory in the cover but also permits much lighter steelwork to be employed. These refractories must be carefully selected so that they will stand the spalling conditions of frequent opening and closing of the cover, have a light weight and a good insulation value.

Billet-heating Furnaces. Billet-heating furnaces may be of the continuous type, a typical example of which is shown in Fig. 339. Here the billets pass through the furnace in a continuous layer on water-cooled rails and are heated mainly by convection of the hot combustion gases

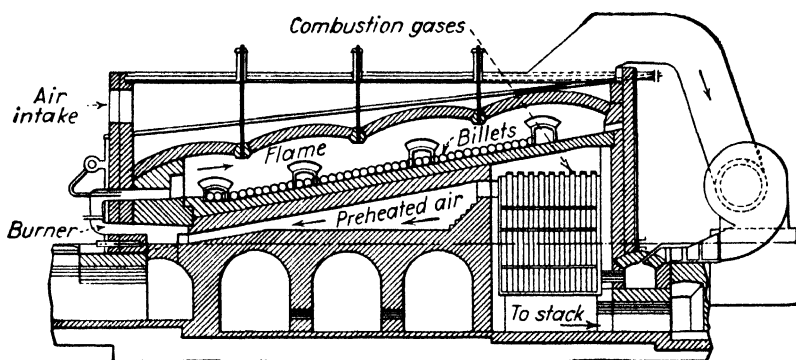

FIG. 339. Continuous billet-heating furnace.

passing over and under them. This type of furnace is a true recuperative type, due to the counterflow action, so that the efficiency is comparatively high. The hotter parts of the furnace are made of high-quality fireclay brick or kaolin brick, but the upper structure of the cooler portions is generally made from low-heat-duty brick with good insulation. The bottom of the furnace, which must resist the action of mill scale, is usually constructed of rammed chrome plastic at the hotter end.

Rotary-hearth billet-heating furnaces have many advantages, such as small floor space, ready handling of the billets, and good fuel consumption. They are replacing the horizontal type in many modern mills.

Batch-type billet-heating furnaces are constructed in a large number of designs, but here the bottom is usually made of chrome and the upper structure of insulating firebrick. The value of insulating firebrick is particularly evident in the doors, which are decreased in weight so that they can be operated more rapidly and with less discomfort to the workman.

Forging Furnaces. Forging furnaces are made in many types. The refractory used is generally of fireclay, but the use of lightweight refractories is becoming quite prevalent in modern construction. The floor of the furnace may be of dense fireclay brick or rammed chrome plastic.

11. Heat-treating and Stress-relieving Furnaces. Furnaces of this type are required to withstand only moderate temperatures. Heat-treating furnaces for high-speed steel might require a maximum temperature of 2400°F (about 1300°C), whereas stress-relieving furnaces would reach only 1400°F (about 760°C). For this reason, it has been found

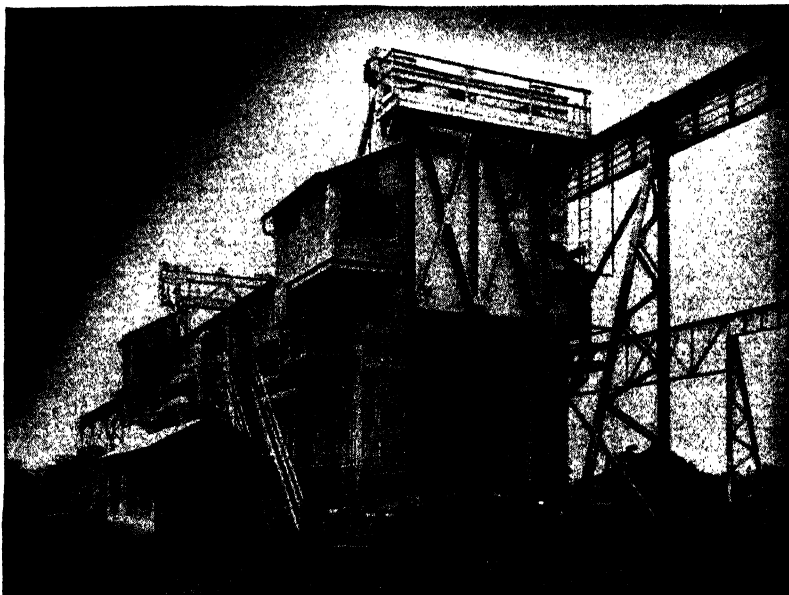

FIG. 340. Large car bottom stress-relieving furnace. (Courtesy of Babcock and Wilcox Company.)

that the insulating firebrick can be used very successfully in many constructions. It has the advantage of giving a material saving in fuel, lower cost of burner equipment, and, in many cases, increased life.

In Fig. 340 is shown an illustration of a large car bottom stress-relieving furnace fired by natural gas which will take drums to 100 tons in weight. It is lined with insulating firebrick, thus giving a very uniform distribution of temperature as well as excellent fuel economy.

12. Bright Annealing Furnaces. Furnaces of this type operate with a controlled atmosphere, usually with hydrogen. The temperatures are low; and for this reason, the insulating firebrick has seen extensive use both in the continuous and in the intermittent types. Because of the strong reducing action of the hydrogen, it is necessary to employ a refrac-

tory that will be stable under these operating conditions. For that reason, bricks low in iron oxide content are desirable.

13. Bibliography

Blast Furnace:

1. ANON.: "A Study of the Blast Furnace," Harbison-Walker Refractories Co., Pittsburgh, Pa., 1911.
2. MENKE, P.O.: Lining Failures Caused by Zinc, *Iron Trade Rev.*, **70**, 1409, 1922.
3. BOOZE, M.C.: Refractories in Blast Furnaces and Coke Ovens, *Blast Furnace Steel Plant*, **14**, 86, 1926; *Ceram. Abstracts*, **5**, 124, 1926.
4. LINDGREN, R.A.: Refractories for Iron-blast Furnaces, *Am. Inst. Mining Met. Eng. Tech. Pub.* 752, 1936; *Mining Tech.*, **1**, 1, 1937.
5. SEARLE, A.B.: Selection of Brick for Blast Furnaces, *Iron Steel Ind.*, **11**, 7, 55, 1937.
6. STOECKER, J., and A. REIN: Developments in a Blast-furnace Lining, *Stahl u. Eisen*, **58**, 965, 1938.
7. SINGER, F.: Carbon Linings for Blast Furnaces, *Metals & Alloys*, **10**, 104, 1939.
8. WOODHOUSE, W., W. HUGILL, and A.T. GREEN: An Investigation of the Linings of Three Blown-out Furnaces, *Iron and Steel Institute, Special Rept.* 26, p. 233, 1939.
9. McLAIN, W.R.: Present Application and Possible Future Development of Blast-furnace Refractories, *Bull. Am. Ceram. Soc.*, **19**, 62, 1940.
10. VOSBURGH, F.J.: Carbon Linings, *Iron Steel Eng.*, **17**, 68, 1940.
11. McLAIN, W.R.: Present Application and Possible Future Development of Blast-furnace Refractories, *Bull. Am. Ceram. Soc.*, **19**, 62, 1940.
12. FREEMAN, C.A.: Use of Missouri Refractories in Blast-furnace Service, *Blast Furnace Steel Plant*, **29**, 1119, 1941.
13. RIGBY, G.R., H. BOOTH, and A.T. GREEN: Manufacture of Carbon Blocks for Blast-furnace Hearths, *Bull. Brit. Refractories Research Assoc.*, No. 59, 1941.
14. BIRCH, R.E.: Modern Blast Furnace Refractories, *Blast Furnace Steel Plant*, **30**, 345; (4), 437, 1942.
15. KLESFER, R.: Destruction of the Refractory Lining of Blast Furnaces and the Lining with Tamped Carbon Masses, *Stahl u. Eisen*, **64**, 774, 1944.
16. FAY, M.A.: Refractories for the Iron Blast Furnace, *Brick & Clay Record*, **105**, 44, 1944.
17. FAY, M.A.: Refractories for Hot Blast Stoves of Iron Blast Furnaces, *Brick & Clay Record*, **105**, 52, 1944.
18. ANON.: Carbon Brick for Hearth Lining, *Brick & Clay Record*, **107**, 50, 1945.
19. PIROGOV, A.A., and I.A. TSETTLIN: Carbonaceous Lining for Blast Furnaces, *Ogneupory*, **45**, 27, 1945.
20. ESS, T.J.: Modern Blast Furnaces, *Iron Steel Eng.*, **23**, BF16, 1946.
21. ANON.: Blast Furnaces: Notes on German Practice, *B.I.O.S. Final Rept.* 819, Item 31, 1946.
22. CAREY, M.T., and F.B. HEACHER: Carbon—A Blast Furnace Refractory, *Blast Furnace Steel Plant*, **35**, 1483, 1947.
23. STAYMAN, T.H.: Some Notes on Recent American Blast Furnaces, *J. Iron Steel Inst.*, **155**, 136, 1947.
24. MACKENZIE, J.: Changes Occurring in Blast Furnace Stove Refractories during Service, *Trans. Brit. Ceram. Soc.*, **47**, 9, 1948.

Cupola:

25. MOLDENKE, R.: Refractory Requirements in the Gray Iron Foundry, *J. Am. Ceram. Soc.*, **8**, 712, 1925.
26. HURST, J.E.: "Melting Iron in the Cupola," Penton Publishing Company, Cleveland, 1929.
27. MARRAKER, E.E.: Cupola Refractories, *Trans. Am. Foundrymen's Assoc.*, **5**, 491, 1934.
28. SULLIVAN, J.D.: Foundry Refractories, *J. Am. Ceram. Soc.*, **19**, 213, 1936.
29. KELLY, H.W.: Operating a Cupola, *Foundry*, **65**, 37, 86, 1937.
30. REES, W.J.: Foundry Refractories, *Foundry Trade J.*, **59**, 239, 1938.
31. DONOHO, C.K., and J.T. MACKENZIE: Effect of Fluxes on Cupola Linings, *Bull. Am. Ceram. Soc.*, **17**, 317, 1938.
32. KOON, S.G.: Lining the Cupola with Firestone, *Foundry*, **70**, 128, 1942.

Open Hearth:

33. ANON.: "A Study of the Open Hearth," Harbison-Walker Refractories Co., Pittsburgh, Pa., 1909.
34. HANSEN, H.: Theory of Heat Exchange in Regenerators, *Z. angew. Mat. Mech.*, **9**, 173, 1929; *Sprechsaal*, **63**, 918, 1930.
35. ENDELL, V.K.: Gegen temperaturänderungen un empfindliche Magnesitsteine, *Stahl u. Eisen*, **52**, 759, 1932.
36. McDOWELL, J.S.: Sprung Arch Roofs of High Temperature Furnaces, *Refractories J.*, **15**, 395, 1935.
37. ANON.: Open-hearth Insulation Advances, *Steel*, **98**, 240, 336, 337, 1936.
38. BUELL, W.C.: "Open Hearth Furnaces," Penton Publishing Company, Cleveland, 1936.
39. KORT, E., and A. DRASHNIKOVA: Tests with Unfired Brick M-50 of the Magnesite Plant in Siemens-Martin Furnaces, *Ogneupory*, **4**, 797, 1936.
40. LAMORT, J.: Selection of Checker Brick from the Thermal Viewpoint, *Glashütte*, **66**, 32, 51, 94, 109, 132, 1936; trans. in *Glass*, **13**, 114, 1936.
41. LAPIN, V.V.: Chemical-mineralogical Changes in Dinas Brick from the Roof of an Electrical Steelmelting Furnace, *Trav. inst. Petrograf. acad. sci. U.R.S.S.*, Nos. 7-8, p. 235, 1936.
42. REES, W.J.: Mottled Silica Brick, *Trans. Ceram. Soc. (Engl.)*, **35**, 284, 1936.
43. ROLL, F.: Zone Formation in Silica Bricks, *Ber. deut. keram. Ges.*, **17**, 437, 1936.
44. SWINDEN, T., and J.H. CHESTERS: The Properties of Open-hearth Furnace Checker Bricks, *Trans. Ceram. Soc. (Engl.)*, **35**, 469, 1936.
45. TABAKOV, Z.YA., V.V. BELOVODSKII, and G. TAZITDINOV: Magnesite Brick Resistant to Spalling, *Ogneupory*, **4**, 102, 1936.
46. TAZITDINOV, G., and A. SCHAVOROSTOV: Tests with Thermally Stable Brick of the Magnesite Plant in Crowns of Siemens-Martin Furnaces, *Ogneupory*, **4**, 807, 1936; abstracted in *Chem. Zentr.*, ii, 1065, 1937.
47. ANON.: Industrial Survey of Conditions Surrounding Refractory Service in Open-hearth Practice, "Manual of ASTM Standards on Refractory Materials," 1937.
48. CHESTERS, J.H., and L. LEE: Properties of Magnesite and Chrome-Magnesite Brick, *Trans. Ceram. Soc. (Engl.)*, **36**, 294, 1937.
49. DODD, A.E.: Selection of Chrome Ores for Use in Steel Furnaces, *Iron Steel Ind.*, **10**, 497, 1937.

50. ROBERTSON, H.S.: Steel-plant Experience with Metal Encased Basic Brick, *Steel*, **101**, 99, 1937.
51. McCAUGHEY, W.J., and H.C. LEE: Hearth Refractories for Steel Making, *Metals & Alloys*, **8**, 153, 1937.
52. KIRICHENKO, N.: Spherical Checker Brick for Hot Stoves, *Teoriya i Prakt. Met.*, **9**, 5, 1937; *Metals & Alloys*, **9**, MA282, 1938.
53. ANON.: Tieknor Columnar Checker, *Glass Ind.*, **19**, 335, 1938.
54. DODD, A.E.: Some Results Obtained with Chrome-Magnesite Bricks in Open-hearth Steel Furnaces, *Trans. Ceram. Soc. (Engl.)*, **37**, 339, 1938.
55. HARVEY, F.A., and R.E. BIRCH: Olivine & Forsterite Refractories in America, *Ind. Eng. Chem.*, **30**, 27, 1938.
56. HUGILL, W., and A.T. GREEN: Factors Influencing the Durability of Chrome-Magnesite Brick in Basic Open-hearth Steelmaking Furnaces, *Trans. Ceram. Soc. (Engl.)*, **37**, 279, 1938.
57. LYNAM, T.R., and W.J. REES: Chrome Refractories for Use in the Neutral Course of the Basic Open-hearth Furnace, *Trans. Ceram. Soc. (Engl.)*, **37**, 481, 1938.
58. SINGER, F.: Refractory Problems in the Iron and Steel Industry, *Iron Steel Ind.*, **11**, 316, 479, 575, 1938.
59. SOSMAN, R.B.: Pyrometer and the Steel-maker's Refractories, *J. Am. Ceram. Soc.*, **21**, 37, 1938.
60. DAWIDOWSKI, R.: Results of Application of Streamlined Form of Brick in Regenerators of Steel-mill Furnaces, *Hutnické Listy*, **10**, 507, 1938; *Metals & Alloys*, **10**, MA212, 1939.
61. DODD, A.E., and A.T. GREEN: Refractories Used in the Production of Steel by the Basic Open-hearth Process: A Review, *Iron & Steel Inst., Special Rept.* 26, p. 21, 1939.
62. GREEN, A.T., W. HUGILL, and H. ELLERTON: Preliminary Results of the Examination of Bricks Taken from Furnaces, off for Relining, *Iron & Steel Inst., Special Rept.* 26, p. 217, 1939.
63. HITE, E.C., and G. SOLER: Refractories for Open Hearth Furnaces, *Brick & Clay Record*, **95** (2), 54 (3), 59 (4), 54, 1939.
64. LARSON, B.M., and A. GRODNER: Certain Relations between Refractories Service, Insulation, and the Flow of Heat in the Open Hearth Furnace, *Carnegie Inst. Bull.* 32.
65. ANON.: Smalley Checker System for Regenerative-type Furnaces, *Ind. Heating*, **9**, 930, 1942.
66. ARTHUR, J.E., et al.: Roof Design and Maintenance, *Proc. Elec. Furnace Steel Conf. Am. Inst. Mining Met. Engrs.*, **2**, 72, 1944.
67. BURKE, T.H.: Construction and Maintenance of Acid Bottoms, *Proc. Elec. Furnace Steel Conf. Am. Inst. Mining Met. Engrs.*, **2**, 90, 1944.
68. Committee on Physical Chemistry of Steel Making, Iron and Steel Division, American Institute of Mining Engineers: Basic Open Hearth Steelmaking, American Institute of Mining and Metal Engineers, New York, 1944, *Mech. Eng.*, **66**, 548, 1944.
69. BOWERS, J.A.: Acid Side Walls and Bottom, *Proc. Elec. Furnace Steel Conf. Am. Inst. Mining Met. Engrs.*, **2**, 88, 1944.
70. BIGGE, H.C.: Basic Furnace Bottoms and Construction, *Proc. Elec. Furnace Steel Conf. Am. Inst. Mining Met. Engrs.*, **2**, 83, 1944.

71. ARTHUR, J.E., *et al.*: Basic Side Walls and Bottom, *Proc. Elec. Furnace Steel Conf. Am. Inst. Mining Met. Engrs.*, **2**, 81, 1944.
72. KRANER, H.M.: Open Hearth Roof Kiln + Al_2O_3 of SiO_2 Bricks, *Proc. Natl. Open Hearth Conf. Am. Inst. Mining Engrs.*, **27**, 303, 1944.
73. GRIFFITH, H.M.: Progress Report on Basic Roofs and Port Ends, *Proc. Natl. Open-hearth Conf. Am. Inst. Mining Met. Engrs.*, **28**, 37, 1945.
74. KRANER, H.M., *et al.*: Bonded versus Ringed Roofs, *Proc. Natl. Open Hearth Conf. Am. Inst. Mining Met. Engrs.*, **28**, 85, 1945.
75. FONDERSMITH, C.R.: Basic Open Hearth at American Rolling Mill Co., *Proc. Natl. Open Hearth Conf. Am. Inst. Mining Met. Engrs.*, **28**, 47, 1945.
76. REINHARD, A.E.: Basic Open Hearth Furnace at Great Lakes Steel Co., *Proc. Natl. Open Hearth Conf. Am. Inst. Mining Met. Engrs.*, **28**, 51, 1945.
77. FONDERSMITH, C.R.: Mullite Refractories., *Proc. Natl. Open Hearth Conf. Am. Inst. Mining Met. Engrs.*, **28**, 87, 1945.
78. DEBENHAM, W.S., *et al.*: Silica Roofs, *Proc. Natl. Open Hearth Conf. Am. Inst. Mining Met. Engrs.*, **28**, 1, 1945.
79. DEBENHAM, W.S.: Analysis of Questionnaire on Open-hearth Bottom Construction and Materials, *Proc. Natl. Open Hearth Conf. Am. Inst. Mining Met. Engrs.*, **28**, 89, 1945.
80. FRANK, H.S.: Basic Open-hearth Installations at Ford Motor Co., *Proc. Natl. Open Hearth Conf. Am. Inst. Mining Met. Engrs.*, **28**, 45, 1945.
81. SNOW, R.B.: Density of Open-hearth Bottoms, *Blast Furnace Steel Plant*, **33**, 1394, 1945.
82. LAWTON, G.C.: Suspended Silica Steel Furnace Roofs, *Am. Inst. Mining Engrs.*, **28**, 73, 1945.
83. ANON.: Bonded versus Ringed Roofs, *Am. Inst. Mining Engrs.*, **28**, 85, 1945.
85. EKHOLM, L.G., and L.D. HOWER: Nozzle and Stopper Head Properties, *Blast Furnace Steel Plant*, **33**, 1160, 1945.
86. GREGOR, V.: Open Hearth Basic, Silica and Bottom Refractories, *Ind. Heating*, **12**, 1564, 1945.
87. PEVZNER, R.L.: Refractories for Processes Using Oxygen, *Ogneupory*, No. 4/5, p. 40, 1945.
88. CHESTERS, J.H.: Refractories, the Limiting Factor in Open-hearth Furnace Design, *Trans. Brit. Ceram. Soc.*, **8**, 289, 1946.
89. RIGBY, G.R., R.P. WHITE, H. BOOTH, and A.T. GREEN: Investigation into the Properties of Silica Brick, *Trans. Brit. Ceram. Soc.*, **45**, 69, 1946.
90. SOSMAN, R.B.: Outlook for all-basic Open-hearth Furnace, *Blast Furnace Steel Plant*, **34**, 251, 1946.
91. SNOW, R.B.: Behavior of Different Types of Open-hearth Bottoms in Service, *Brick & Clay Record*, **109**, 73, 1946.
92. CHESTERS, J.H.: Refractories, the Limiting Factor in Open Hearth Design, *Trans. Brit. Ceram. Soc.*, **45**, 289, 1946.
93. SEIL, G.E.: Basic Refractories in German Open-hearth Furnaces, *Proc. Natl. Open Hearth Conf. Am. Inst. Mining Met. Engrs.*, **29**, 269, 1946.
94. LAWTON, G.N.: Life of Basic Rammed Doors, *Proc. Natl. Open Hearth Conf. Am. Inst. Mining Met. Engrs.*, **29**, 281, 1946.
95. LILLY, A.: Super Duty Silica on Roofs, *Proc. Natl. Open Hearth Conf. Am. Inst. of Mining Met. Engrs.*, **29**, 283, 1946.
96. SEIL, G.E.: The Manufacture of Refractories and Information concerning Their Use in the Iron and Steel Industry of Western Germany, P. B. 37804, 1946.

97. KRANER, H.N.: Relation of Insulation to Refractory Consumption, *Proc. Natl. Open Hearth Conf. Am. Inst. Mining Met. Engrs.*, **29**, 287, 1946.
98. ANON.: Steel Making: Notes on German Practices, *B.I.O.S. Final Rept.* 825. Item 21, 1946.
99. SNOW, R.B.: Behavior of Various Types of Open Hearth Bottoms in Service, *Proc. Natl. Open Hearth Conf. Am. Inst. Mining Met. Engrs.*, **29**, 87, 1946.
100. HORNAK, J.N.: Plastic Lined O. H. Doors Give Longer Life and Reduce Surface Cooling, *Brick & Clay Record*, **110**, 76, 1947.
101. FAYLES, R.R.: Refractory Applications for Acid Open Hearth Furnaces, *Blast Furnace Steel Plant*, **35**, 217, 1947.
102. ANON.: To Test Basic Refractories and Oxygen in Open Hearth At Higher Heat, *Brick & Clay Record*, **111** (4), 55, 1947.
103. ANON.: Silica Versus Basic Brick, *Brick & Clay Record*, **111** (1), 68, 1947.
104. ANON.: Oxygen Firing Furnaces of Industry is Placing New Demands on Refractories, *Brick & Clay Record*, **112** (1), 56, 1948.
105. MANN, W.: Oxygen in Steelmaking, *Sci. American*, **53**, 1948.

Ladles, Nozzles, etc.:

106. BALES, C.E., and A.R. BLACKBURN: Refractories for Foundry Ladles, *Trans. Am. Foundrymen's Assoc.*, **46**, 163, 1938.
107. HEINDL, R.A., and A.J. COOKE: Fire-clay Ladle Sleeves, *Natl. Bur. Standards, Research Paper* 1084, 1938.
108. ZILBERFARB, L.: Technological Production of Refractory Floating Mold Tops, *Stal*, **3**, 21, 1938.
109. ANON.: Improved Method for Drying and Preheating Ladles, *Iron and Steel*, **15**, 272, 1942.
110. NOLAN, V.N.: Carbon and Graphite Mold Plugs and Stove Insert, *Steel*, **115**, 94, 1944.
111. PRICE, R.: Pouring-pit Practice and Refractories for Pouring, *Proc. Natl. Open Hearth Conf. Am. Inst. Mining Met. Engrs.*, **28**, 116, 1945.
112. EKHOLM, L.G., and L.D. HOWER, JR.: Nozzle and Stopper Head Properties, Pouring Techniques, and Their Effect on Casting-pit Performance, *Proc. Natl. Open Hearth Conf. Am. Inst. Mining Met. Engrs.*, **28**, 121, 1945.
113. RAIT, J.R.: Casting-pit Refractories as a Source of Nonmetallic Inclusions in Open-hearth Steel, *Iron and Steel*, **18**, 652, 1945.
114. BROWN, E.S.: Sulfur in Cast Iron and Steel, *Iron and Steel*, **19**, 2, 74, 1946.
115. MERCER, G.R.: Manufacture of Sleeves and Nozzles and Their Application, *J. Can. Ceram. Soc.*, **15**, 42, 1946.

Air Furnace:

116. Preliminary Report of the Sub-committee on the Survey of Conditions in the Malleable Industry, *Trans. Am. Foundrymen's Assoc.*, **34**, 88, 1926.
117. ANON.: Industrial Survey of Conditions Surrounding Refractory Service in the Malleable Iron Industry, "Manual of ASTM Standards on Refractory Materials," 1937.
118. WITCHEY, R.H.: Refractory Practice in Malleable Air-furnaces, *Brick & Clay Record*, **105**, 29, 1944.

Bessemer Converter:

119. WEISS, H., and P. ROLLER: Durability of Rammed and Jolted Converter Bottoms, *Stahl u. Eisen*, **48**, 1737, 1928.

120. CHESTERS, J.H., and R.J. McLEAN: Acid Bessemer Refractories, *J. Am. Ceram. Soc.*, **20**, 373, 1937.
121. CHESTERS, J.H.: Acid and Basic Bessemer Refractories. *Iron Age*, **150**, 43, 59, 1942.
122. ANON.: The Basic Bessemer Plant and Steel Making Practice at Reichswerke, A. A. Braunschweig. *B.I.O.S. Final Rept.* 1199, 1946.
123. ANON.: First Report of the Converter Refractories Subcommittee, *J. Iron Steel Inst.*, **155**, 235, 1947.

Induction Melting Furnaces:

124. CHESTERS, J.H.: Refractory Materials for the Induction Furnace. *Refractories J.*, **7**, 222, 1931.
125. NORTHRUP, E.F.: Larger Coreless Induction Furnace: Lining Improved, *Steel*, **88**, 39, 1931.
126. FRIESTLEY, J.E., and W.J. REES: High-frequency Furnace Linings and the Results of the Investigation of Several Lining Failures, *Trans. Ceram. Soc. (Engl.)*, **33**, 177, 1934.
127. BOOTH, C., and W.J. REES: Basic Refractories, Their Use in the Lining of Induction Furnaces, *Iron Steel Inst. (London), Carnegie Schol. Mem.*, **26**, 57, 1937; *Brit. Chem. Physiol. Abstracts—B*, **57**, 514, 1938.
128. STALHANE, J.B., and V. ANDERSON: Lining High-frequency Furnaces, *Jernkontorets Ann.*, **123**, 386, 1939.
129. ANON.: Basic Linings for High-frequency Induction Furnaces, *Brit. Steel-maker*, **5**, 180, 1939.
130. MAGALIS, B.W.: Refractories Used in High-frequency Electric Melting of Steel and Alloys, *Bull. Am. Ceram. Soc.*, **19**, 298, 1940.

Arc Steel Furnaces:

131. JORDAN, L.: Bonding Magnesite Linings for Steel-melting Furnaces without Use of Iron Oxide, *Metals & Alloys*, **3**, 22, 1932.
132. FREAR, C.L.: Gray Iron Production in the Direct-arc Acid-lined Electric Furnace, *Trans. Am. Foundrymen's Assoc.*, **41**, 289, 1933.
133. HEWITT, L.C.: Notes on Refractories for Electric Furnaces Producing Special Irons, *Trans. Am. Foundrymen's Assoc.*, **6**, 577, 1935.
134. SOLER, G.: Refractory Problems in Basic Alloy Steel Production, *Bull. Am. Ceram. Soc.*, **14**, 383, 1935.
135. FARNSWORTH, W.M., and E.R. JOHNSON: American Electric Furnace Practice, *J. Iron Steel Inst.*, **138**, 289, 1938.
136. ANON.: Sillimanite as a Refractory for Electric Furnace Roofs, *Iron Steel Ind.*, **12**, 205, 1939.
137. HITE, E.C., and G. SOLER: Refractories for Electric Furnaces, *Brick*, **94**, 48; **95**, 52, 1939.
138. DUFTY, N.F.: Arc-furnace Refractories. *Iron and Steel*, **15**, 224, 1942.
139. ARTHUR, J.E., et al.: Roof Life, *Proc. Elec. Furnace Steel Conf. Am. Inst. Mining Met. Engrs.*, **2**, 76, 1944.
140. WEAK, E.H.: Roof Life in Small Furnaces, *Proc. Elec. Furnace Steel Conf. Am. Inst. Mining Met. Engrs.*, **2**, 80, 1944.
141. GLADDING, S.D.: Sillimanite Roofs, *Proc. Elec. Furnace Steel Conf. Am. Inst. Mining Met. Engrs.*, **2**, 66, 1944.

142. ANON.: Refractories in Metallurgical and Electrometallurgical Furnaces, *Argile*, No. 204, p. 12, 1946.
143. FIEMAN, E.M.: Silica Hazard in Arc-furnace Construction, *Ind. Med.*, **15**, 14, 1946.

Forging and Heat-treating Furnaces:

144. BROWNLIE, D.: Air-jacketed Heat Treatment and Forging Furnaces, *Iron Steel Ind.*, 10, 587, 1937.
145. ANON.: Silicon Carbide Tube Recuperators, *Engineering*, **148**, 319, 1939.
146. HITE, E.C., and G. SOLER: Soaking Pit Refractories, *Brick & Clay Record*, **96**, 62, 1940.
147. HITE, E.C., and G. SOLER: Heating Furnace Refractories, *Brick & Clay Record*, **96**, 57, 1940.
148. PEARSON, T.S.: Hot-face Insulation, *Brit. Steelmaker*, **8**, 348, 1942.
149. SENFTER, E.: Refractory Insulating Brick as Structural Materials for Modern Annealing Furnaces, *Iron Steel Inst., Translation Series* 187, 1944.
150. SARGANT, R.J.: Insulation of Heat Treatment Furnaces, *Inst. Fuel (London), Wartime Bull.* 189, 1945.

General:

151. SULLIVAN, J.D.: Refractories in Metallurgical Industries, *J. Am. Ceram. Soc.*, **19**, 213, 1936.
152. ANON.: "Modern Refractory Practice," Harbison-Walker Refractories Co., Pittsburgh, Pa., 1937.
153. SULLIVAN, J.D.: Refractory Trends and Developments during 1936, *Blast Furnace Steel Plant*, 25, 88, 1937.
154. TROSTEL, L.J.: Refractories for the Steel Industry, *Iron Steel Eng.*, **14**, 24, 1937.
155. ANON.: Refractories in Steel Manufacture, *Iron Steel Ind.*, **11**, 351, 1938.
156. McDOWELL, J.S.: Refractories in the Steel Plant, *Blast Furnace Steel Plant*, **26**, 72, 1938.
157. SULLIVAN, J.D.: Uses, Trends, and Developments of Refractories in the United States, *Ind. Heating*, 5, 257, 1938.
158. CHESTERS, J.H., and T.W. HOWIE: Fireclay Bricks for Use in Iron and Steelworks, *Trans. Brit. Ceram. Soc.*, **38**, 131, 1939.
159. HAYMAN, J.C.: Steelworks Refractories in Service, Part I, *Trans. Brit. Ceram. Soc.*, **38**, 529, 1939.
160. HAYMAN, J.C.: Steelworks Refractories in Service, Part II, *Trans. Brit. Ceram. Soc.*, **38**, 536, 1939.
161. SJOSTROM, I.: Refractory Material for the Iron Industry, *Jernkontorets Ann.*, **123**, 165, 1939.
162. GLEBOV, S.V.: The Refractories Problem in Connection with the Use of Oxygen in the Steel Industry, *Kislород*, **3**, 18, 1946.

CHAPTER XXII

REFRACTORIES IN THE NONFERROUS-METAL INDUSTRY

1. Copper Production. *Outline of the Process.* The common copper ores contain between 1 and 2 per cent copper and must be concentrated by ore-dressing methods, which bring the percentage of copper up to between 20 and 30 per cent. If this concentrated ore contains free sulfur or a too high quantity of iron sulfide, it must be roasted to drive off a portion of the sulfur as SO_2 . This roasting takes place at a low temperature in a multiple-hearth furnace (Fig. 341); and although no serious refractory problems are encountered here, the hearths of fireclay brick must be abrasion resistant. The roasted ore is then smelted, which is carried out at the present time in a reverberatory type of furnace, as the blast furnace is seldom used. In this operation, the copper sulfide is separated from the gangue and some of the iron as a matte, which is a mixture of copper and iron sulfide. This matte is then treated in a converter where air is blown through the melted sulfides, thus oxidizing the sulfur and the iron, the latter being taken up in the slag and the former passing out of the furnace as SO_2 . The crude copper, called "blister copper," is then treated in an anode furnace where it is further oxidized, and the base metal oxides formed are taken up in the slag and removed. The copper is then reduced by covering with coke and introducing green poles which give off CO and water vapor, thus reducing all but a very small amount of the copper oxide to metallic copper. The copper from this process is cast in anodes and treated in a cell to form electrolytic copper cathodes; at the same time, the gold and silver can be recovered in the slimes. The electrolytic copper cathodes are then melted in a fining furnace and cast into commercial shapes.

Reverberatory Smelters. This type of furnace, as shown in Fig. 342, very much like a long open-hearth furnace, is fired at one end, usually with gas, oil, or powdered coal. The charge, which in the earlier furnaces was fed through openings in the center of the roof, is now fed through openings in the roof near the skewbacks. As the charge melts, it flows down to the cooler end of the furnace where the matte and slag can be tapped off separately. The size of these furnaces is usually 20 to 25 ft in width and 120 ft in length, capable of handling 500 to 1,000 tons of charge per day, although a few furnaces even larger than this have been constructed.

The bottom of the furnace is made of silica rammed in and fritted in place much in the same way as the acid bottom is put in an open hearth. The bottom must be sufficiently dense to prevent the penetration of the liquid matte and requires frequent repairs.

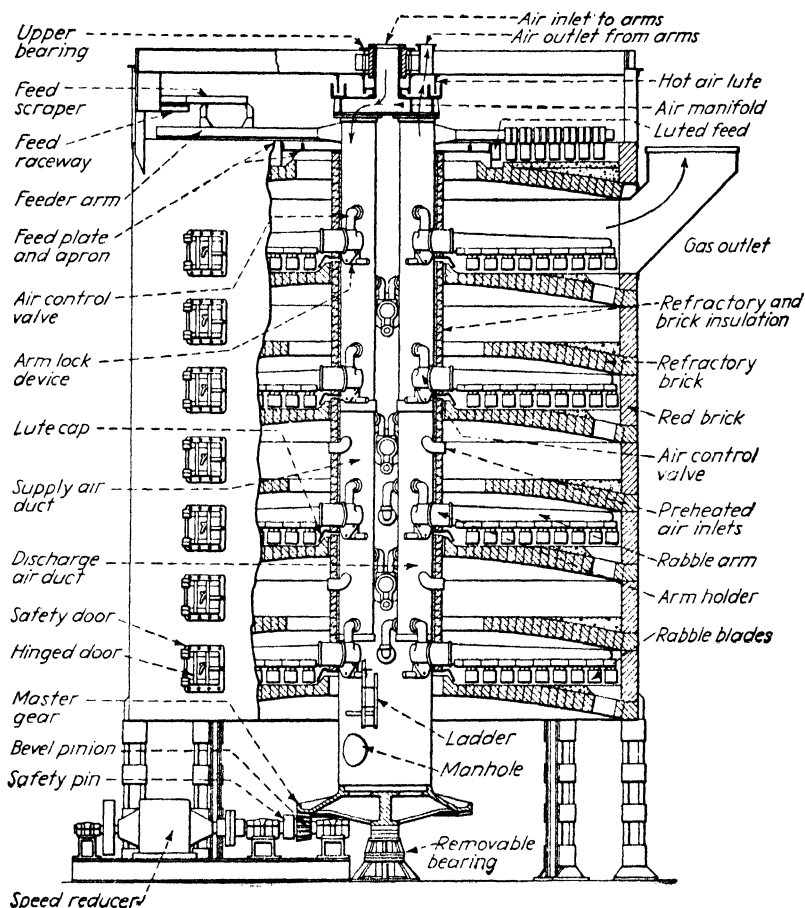

FIG. 341. Wedge roaster. (Courtesy of Bethlehem Foundry and Machine Company, G. Thorpe.)

The side walls of the furnace are generally silica brick, although magnesite brick have been used in the lower side walls. Water cooling at the burner end has been used in some furnaces; but at present, it is not common. Silica brick are also used in the end walls, but high-alumina brick have also been successful in some cases.

The roof of the reverberatory furnace is exposed to a great deal of dust, which fuses and produces a severe slag attack. Silica brick are generally used in the roof in spite of the fluxing effect. Within the last fifteen years,

magnesite brick either of the hard-fired, low-iron type or chemically bonded brick have been used quite extensively in the portion of the arch near the skewbacks, especially around the charging holes. Suspended roofs of chemically bonded magnesite have been tried with very good success in Canada. The life of the silica roof runs about 100 days; but with the use of magnesite, a somewhat longer life has been reported. Insulation of

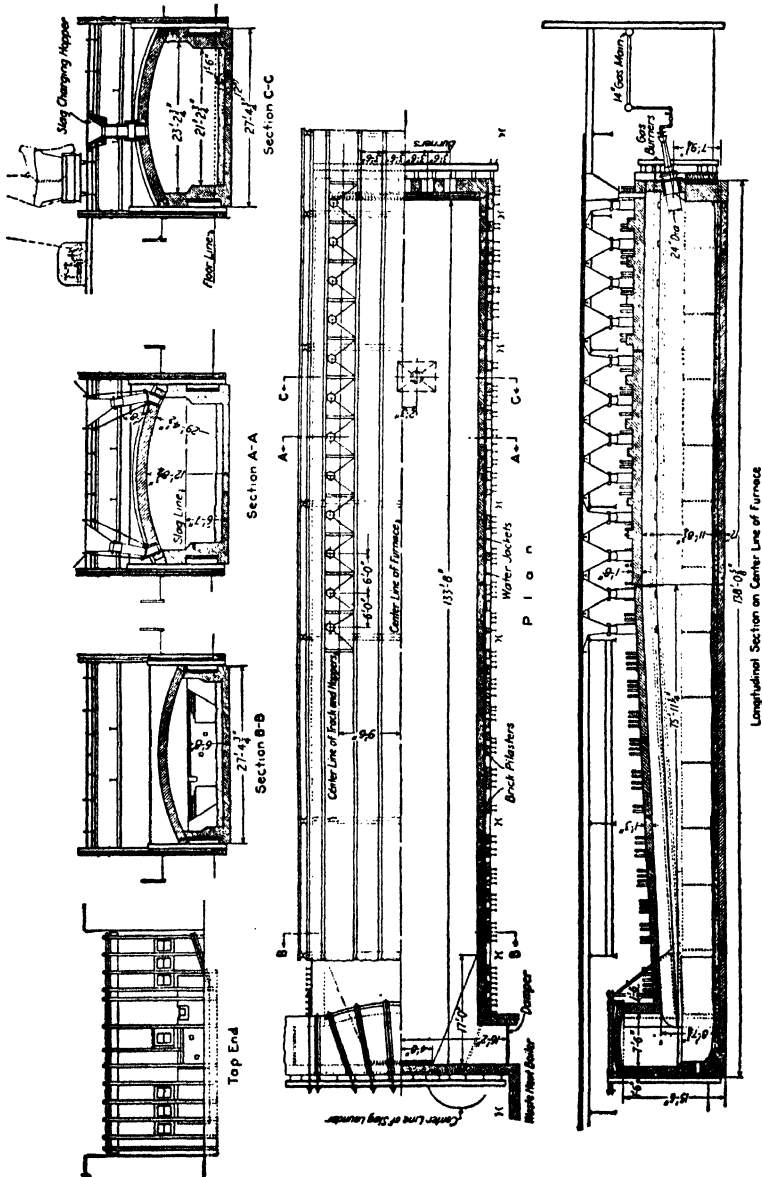

Fig. 342. Reverberatory copper-matting furnace. (Courtesy of American Institute of Mining and Metallurgical Engineers, Paper by Frederick Laist.)

these furnaces is beginning to be recognized as good practice, and probably all furnaces of this type will be insulated to some extent in the near future.

Copper Converters. Two types of converter are generally used at present known as the "Great Falls" (Fig. 343) and the "Peirce-Smith"

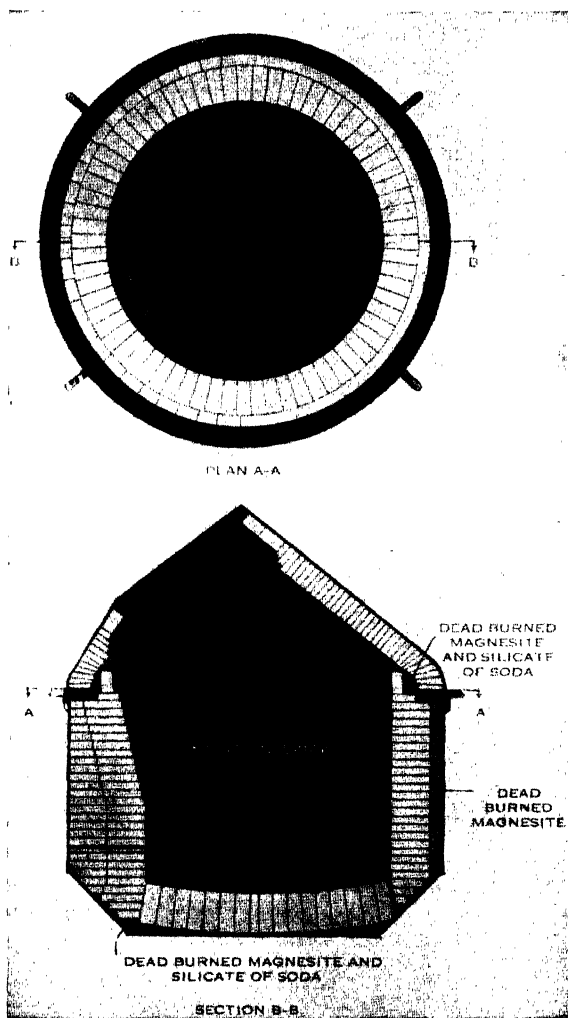

FIG. 343. Copper converter, Great Falls type. (From "Modern Refractory Practice," courtesy of the Harbison-Walker Refractories Company.)

(Fig. 344). In the Great Falls type, the horizontal section is circular; whereas in the Peirce-Smith type, it is rectangular. The converters are mounted on trunnions for pouring the slag and metal, and the capacity runs from 100 to 300 tons per day. Converters are almost always lined

with magnesite brick backed up with some magnesite grain between the lining and shell. Some unburned magnesite brick have been tried in converters, apparently with considerable success. The life of these linings is quite long, averaging 5 to 10 years, as a layer of magnesite is built up on

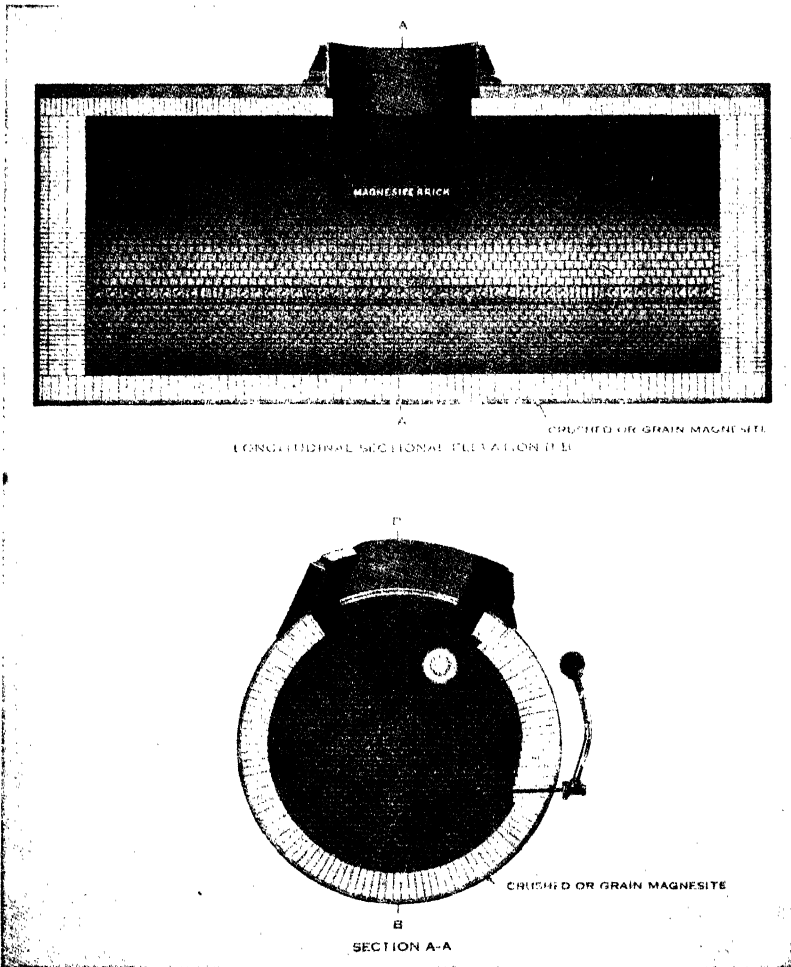

FIG. 344. Copper converter, Peirce-Smith type. (From "Modern Refractory Practice," courtesy of the Harbison-Walker Refractories Company.)

the inner surface and protects the lining. Around the tuyères, however, the cutting action may be quite severe, and repairs have to be made in this zone after about 6 months or less.

Copper Anode Refining Furnace. Most of these furnaces are of the reverberatory type, perhaps 35 ft long and 15 ft wide, with a capacity of

250 to 400 tons of copper. The fuel is oil, pulverized coal, or gas, firing being from one end. After melting, air is blown into the bath to saturate with Cu_2O , while a small amount of siliceous flux is sometimes added to slag the base metals. The slag is then skimmed off; the charge covered with coke and poled to reduce the Cu_2O . The refining cycle takes somewhere around 24 hr. The bottoms of these furnaces are quite similar to the bottoms of the smelting furnaces, *i.e.*, ganister rammed on top of clay brick. In the melting operation, at the surface of the ganister is formed copper silicate, which acts as a cementing material to give a strong, firm body. Often bottoms are kept cool by air circulating through pipes running under the bottom. Though requiring occasional patching, bottoms may last from 3 to 5 years. In the side walls, magnesite brick are used to slightly above the slag line, beyond which silica brick are generally used. Above the slag line, chemically bonded and metal-cased magnesite brick have been successfully tried, giving a life of 200 heats.

The roof of the refining furnace is generally of silica brick, but it is actively attacked by the copper oxide slag thrown against it during the poling operation. Thus the roof has a life of only 100 to 125 heats. Magnesite and forsterite bricks have been tried in the roofs to some extent, with somewhat increased life.

Wire-bar Furnaces. The operations producing wire bars and other commercial shapes from copper cathodes are practically the same as those for producing anodes. The furnaces are very similar to the anode furnaces previously discussed, except the bottom is made of silica brick instead of silica sand. Side walls are made of magnesite to slightly above the slag line, and either silica or magnesite brick are used up to the arch. In the upper parts of the side wall, both unburned and metal-case brick have been successfully tried. The roofs are usually made of silica, although magnesite brick have been used with a somewhat greater life.

2. Melting Copper Alloys. *Types of Furnace.* The melting of brass and other copper alloys is carried out in gas- or oil-fired furnaces with a shallow hearth and an open flame; but for smaller lots or high-zinc alloys, plumbago crucibles are used. The indirect-arc furnace in a rotating cylindrical shell is much used, but recently, however, the induction-type melting furnace of the Ajax-Wyatt type is favored.

Open-flame Melting Furnaces. In Fig. 345 is shown a tilting furnace of this type in which the oil burner is introduced through one end and the

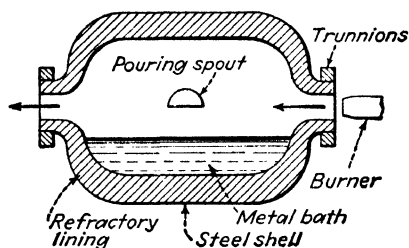

FIG. 345. Open-flame brass-melting furnace.

TABLE 115. CLASSIFICATION OF REFRACTORIES FOR THE COPPER INDUSTRY
 (Adapted from Industrial Survey of the Conditions Surrounding Refractory Service in the Copper Industry, "Manual of ASTM Standards on Refractory Materials.")

| Furnace part | Material | Temperature | Load | Spalling | Slagging action | Abrasion | Life | Remarks |
|---------------------------------|--------------------|--|-----------------------------------|--------------------------------------|---|-----------|------|----------------------------------|
| Roasting Process | | | | | | | | |
| Roasting furnace | Lining | High-heat-duty fireclay brick; insulating brick between lining and shell | 1500°F. (815°C.), max. | Moderate | Slight | None | | Important |
| | Hearths | High-heat-duty fireclay brick | 1500°F. (815°C.), max. | Moderate arch stresses | Slight | None | | Important |
| Smelting Process | | | | | | | | |
| Smelting furnace, reverberatory | Side walls | Silica brick, magnesite brick | Approximately 2800°F. (1540°C.) | 15 lb. per sq. in., max. | Slight | Severe | | Moderate |
| | Bottom | Silica sand, silica brick, magnesite brick, chrome brick, silica sand largely used | 2500 to 2800°F. (1370 to 1540°C.) | Unimportant | Unimportant | Severe | | Moderate |
| | Roof | Silica brick, magnesite brick, suspended, unburned magnesite brick, forsterite brick (in certain portions) | 2800°F. (1540°C.), max. | Arch stresses in sprung construction | Usually slight, although may be cause for premature failure | Important | | Moderate |
| | Firewall | Fireclay brick, silica brick, magnesite brick | 2850°F. (1565°C.) | 10 lb. per sq. in., max. | Moderate | Important | | Moderate |
| | Front wall | Silica brick, magnesite brick, fireclay brick, high-alumina brick | 2400°F. (1315°C.), max. | 10 to 15 lb. sq. in. | Slight | Severe | | Moderate |
| | Waste heat boilers | Fireclay brick, silica brick | 2300°F. (1260°C.), max. | 15 to 20 lb. per sq. in. | Slight | Important | | Moderate |
| | | | | | | | | |
| | | | | | | | | Waste heat boilers commonly used |

| Furnace part | Material | Temperature | Load | Spalling | Slagging action | Abrasion | Life | Remarks |
|--------------------|---|--|-----------------------------------|--|--|------------------------|---------------|---------|
| Converting Process | | | | | | | | |
| Converter | Lining | Magnesite brick | Unimportant | Temperature drops to 1200° F. during charging. Spalling unimportant for bottom half of lining; moderate for upper half | Moderate on basic lining | Erosion severe | 5-10 years | |
| Refining Process | | | | | | | | |
| Refining furnaces | Furnace roof | Silica brick | High | Moderate to severe | Severe | Slight | 100-125 heats | |
| | Furnace bottom | Silica brick, magnesite brick | High | Slight | Severe on silica brick at junction of bottom and side wall Severe | Severe | 3-5 years | |
| Holding furnaces | Furnace side walls | Front walls and from bottom to just above metal line in back wall, magnesite brick | Moderate | Severe in front wall piers or jambs | Severe at intake | High at charging doors | | |
| | | Back walls { magnesite brick silica brick fireclay brick } | Moderate | Severe on magnesite brick Moderate to severe | Severe on silica or fireclay brick Varies with fuel | Slight | | |
| | Combustion chamber | High-heat-duty fireclay brick | Moderate | Moderate | Moderate | Varies with fuel | | |
| | Upstacks | Magnesite brick, high-alumina brick, silica brick, high-heat-duty fireclay brick | Moderate | Moderate | Moderate | Severe at intake | | |
| | Waste heat boilers | High-heat-duty fireclay brick | Moderate | Moderate | Moderate | Moderate | | |
| | Bottom and side walls | Usually magnesite brick | 2700 to 2800°F. (1480 to 1540°C.) | Moderate | Moderate | Moderate | Slight | |
| Roof | Silica brick, magnesite brick, forsterite brick | Approximately 2300 to 2400°F. (1260 to 1315°C.) | Roof high; remainder moderate | Moderate to severe | Moderate to severe | Slight | | |

charge is put through a door in the side of the shell. The shell itself can be rotated on trunnions for pouring.

The linings of these furnaces are usually made from dense fireclay brick. For the hearth is used a rammed-in plastic material containing ganister, silicon carbide, or fused alumina with a clay bond. The refractories must

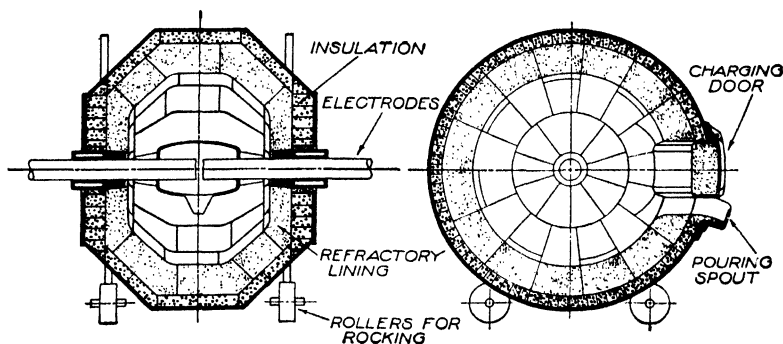

FIG. 346. Detroit rocking indirect-arc furnace. (Redrawn from illustration by Huhlman Electric Company.)

withstand spalling, and slag attack occurs occasionally. Five hundred to one thousand tons of brass can usually be melted in one lining.

Indirect-arc Melting Furnace. This furnace, as shown in Fig. 346, consists of a rotating, refractory-lining shell with an arc placed at the center of the axis so that the radiant heat falls directly on the metal bath and on the refractory walls. By rocking the furnaces, the hot refractory walls can be made to give up their heat to the metal bath and at the same time prevent the walls from being overheated. The lining is of high-alumina shapes or bricks, often with insulation. The furnace capacity runs from 250 to 2,000 lb, and as much as 1,000 tons of brass can be taken from a lining. Failures usually occur as a result of metal penetration in the lining and disintegration due to zinc dust.

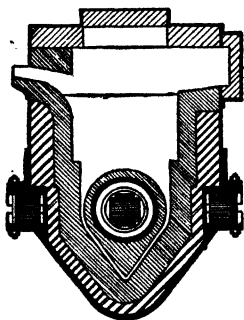

FIG. 347. Section of Ajax-Wyatt furnace. (J. Am. Ceram. Soc.)

The Induction Melting Furnace. This type of furnace, as shown in Fig. 347, consists of a crucible for holding the metal, and extending from the bottom of it is a U-shaped channel, which forms a one-turn secondary of a transformer by passing around its core. By means of the induced currents, the molten metal circulates through this U-shaped channel and heats the charge in the crucible. Of course, furnaces of this type must be started by a small amount of melted metal, after which pigs can be added.

From the refractory point of view, the greatest difficulty with these furnaces is the U-shaped passage or slot, which has a cross section of only a few square inches and must have thin walls to give a high efficiency. If any cracking occurs and molten metal runs down on to the transformer coil, the furnace is, of course, put out of commission and has to be rebuilt. It ceases to operate after a time because of gradual plugging of the slot by sludge. The refractory that has been found quite successful for these furnaces melting yellow brass is a plastic mixture of asbestos and fireclay, Adams⁽¹⁹⁾ reporting an 8-year life in one case. Booth⁽²⁶⁾ reports 12 million pound heats in a fused-alumina rammed lining for yellow brass. For higher temperature alloys, electrically fused magnesite and silicate of soda, carefully rammed into the furnace shell, have been used. Fused alumina with clay and magnesia-alumina ramming mixtures have also been used. In some cases, pre-fired shapes of flint clay have proved successful. A life of 600 heats for copper and 50 to 250 heats for nickel and its alloys has been reported.^(18,20)

3. Zinc. Outline of the Process. Zinc ores, which usually contain sulfides but occasionally consist of carbonates or silicates, are generally concentrated by ore-dressing methods to produce a concentrate high in zinc. This concentrate is then desulfurized by roasting or sintering and reduced by carbon at a temperature of 1100 to 1300°C (about 2010 to 2370°F). Because of the fact, however, that metallic zinc is volatile below the temperature at which ZnO is reduced, the process must be carried out in closed vessels with enough excess carbon to prevent oxidation of the vapor. The zinc vapor coming from these closed vessels or retorts is condensed in the liquid form at temperatures around 425 to 500°C (about 800 to 930°F).

Most of the zinc is made in comparatively small retorts of only 2 or 3 cu ft capacity by the batch process. Recently, however, continuous smelters have been in operation.

Batch Zinc Distilling Furnaces. The zinc retort, a cross section of which is shown in Fig. 348, is about 8 to 9 in. in inside diameter and 4 to 5 ft long. At the open end is attached the condenser, which tapers down to a diameter of about 3 in. for the escape of the gas. Both the condenser and retort are made of fireclay mixtures, a Missouri fireclay generally being preferred in this country because of its good hot strength. Although the retorts used to be handmade, they are made, at present,

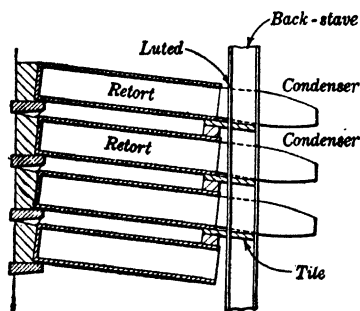

FIG. 348. Details of zinc retorts and condensers. (From J. L. Bray, "The Principles of Metallurgy.")

entirely by machine, such as a hydraulic press. A good density of structure is necessary to prevent loss of zinc vapor through the walls and also to prevent too much zinc from being lost in the pores of the retort when it is rejected at the end of the run. Some plants find that retorts containing 75 to 85 per cent silicon carbide give enough greater life to pay for this more expensive material.

These retorts with their condensers are set up in banks of 200 or 300 in a long gas-fired furnace, as shown in Fig. 349, usually of the Belgian

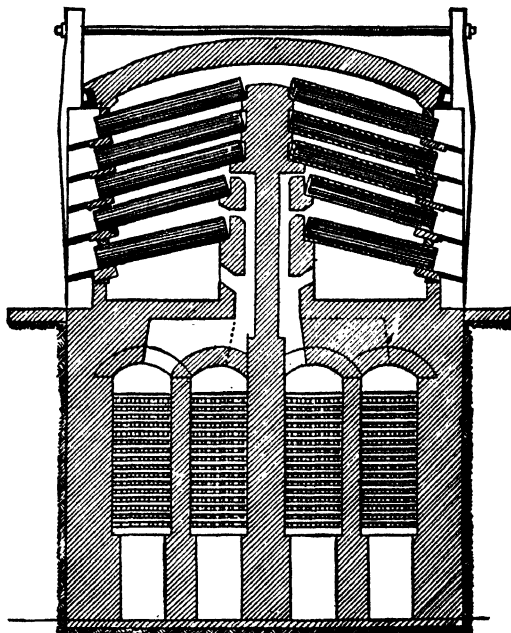

FIG. 349. A cross section of a Belgian zinc distillation furnace. (From "An Outline of Metallurgical Practice," by C. R. Hayward, courtesy of D. Van Nostrand Company, Inc.)

type. A center wall running down the middle of the furnace holds the back end of the retorts, whereas the front end is luted into the wall of the furnace. The firing is usually regenerative, and temperatures of 1250 to 1350°C (about 2280 to 2460°F) are reached inside the retorts, whereas outside temperatures as high as 1450°C (about 2640°F) are sometimes employed. This necessitates a rigid retort to carry the load at these temperatures, and it also means that the center wall of the furnace must be of a high-quality refractory. The side walls of the furnace are usually made of fireclay brick, whereas silica brick would be used for the center wall and roof. Hard-fired, high-alumina brick have been tried in the center walls and should give good results. The life of the retort runs from 30 to 40 days, but the furnace itself, being quite free from slagging

TABLE 116. ANALYSIS OF REFRACTORY SERVICE IN THE ZINC INDUSTRY

| Furnace part | Material | Temperature, °F. | Load | Spalling | Slagging | Abrasion | Life | Remarks |
|------------------------------|--|---------------------|---------------|-------------|----------|----------|---------------|--|
| Retorts | Flint fireclay. Dense structure | 2280-2460 | Important | Slight | Some | Slight | 30-40 days | Silicon carbide re- torts have been tried |
| Condensers | Flint fireclay. Dense structure | Low | Low | Slight | None | None | 2-3 years | |
| Smelting furnace side walls | High-heat-duty-fire- clay brick | 2500-2640 | Unimportant | Unimportant | None | None | 2-3 years | 50 per cent alumina brick have been tried here |
| Smelting furnace center wall | Silica or super-duty fireclay brick | 2500-2640 | Important | Unimportant | None | None | 2-3 years | |
| Smelting furnace roof | Silica | 2500-2640 | Arch stresses | Unimportant | None | None | 2-3 years | |

action, gives a life of several years without repairs. Table 116 gives the service conditions for this type of furnace.

The Continuous Zinc Distilled Furnaces. The continuous furnaces, as developed by the New Jersey Zinc Company, use a vertical retort constructed of silicon carbide with a section of about 1 by 5 ft and a height of 20 to 25 ft. The briquetted charge of coal and zinc ore is continuously fed in the top, and the distilled zinc is collected in condensers around the top of the shaft while residues are discharged at the bottom. A single retort has a capacity of about 6 tons of zinc per day, and the life of the continuous retorts is estimated at 3 years. The furnaces in which these retorts are placed are fired with gas.

The Electrothermic Zinc Furnace. This type of furnace has been described by MacBride.⁽³³⁾ It is a vertical shaft heated by electrical resistance of the charge itself. The refractories composing the shaft must have a low porosity to prevent zinc penetration, high softening point, and high electrical resistance.

4. Lead. *Outline of the Process.* Lead ores are usually sulfides, of which the mineral galena is most common. The ore is concentrated by selective flotation, and the lead concentrate is sintered to a firm mass, usually in the Dwight Lloyd type of continuous machine, which does not employ any refractory. In this process, most of the sulfur is driven off as SO_2 and the lead is converted to an oxide. The process also produces the ore in a lump form, which is more suitable for the smelting operation. The smelting generally takes place in a water-jacketed blast furnace in order to slag off the impurities contained in the ore and to reduce the lead oxide to molten lead. The larger part of the molten lead is removed from the furnace through a "siphon tap," which passes through the crucible wall to the bottom of the crucible. The slag with some occluded lead is tapped from the furnace and allowed to separate in a settler from which the slag overflows to a slag car. The lead is tapped out periodically.

The Lead Blast Furnace. The lead blast furnace, as shown in Fig. 350, indicates that very little is used in the way of refractories because of the almost complete water jacket. However, there are refractories, usually high-duty fireclay brick of good density, in the upper part above the water jacket. Abrasion is the most important factor here, as the temperature is comparatively low. Refractories are also used in a crucible below the tuyères, but here again the temperature is not very high, and therefore the refractory requirements are chiefly low porosity and hardness and resistance to the action of molten lead. Dense firebrick are used in the crucible, but it is important that the joints between them be very thin, and often a chrome-base mortar is used for a jointing material. In some cases, plastic refractories of fireclay grog, ash, and coke are rammed into the

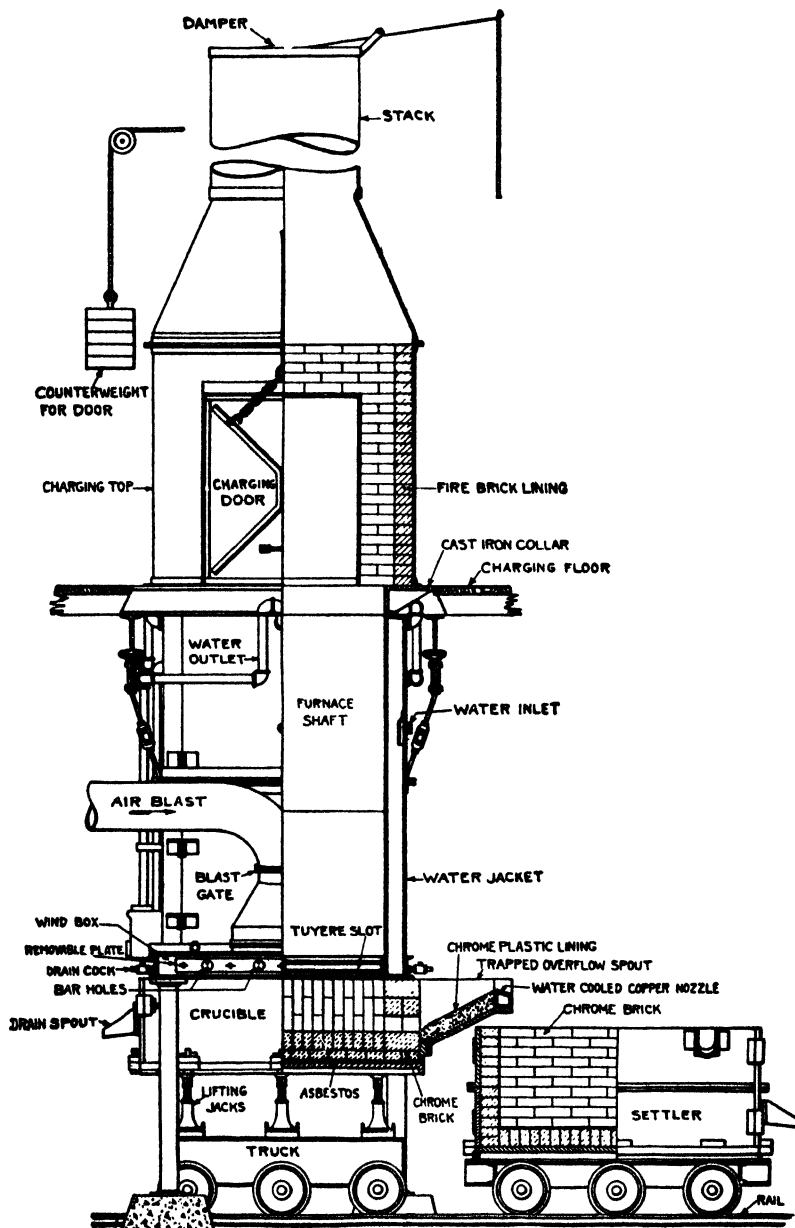

FIG. 350. Sectional view of lead-smelting furnace, matting type with outside settling. (Courtesy of Mr. C. H. Mace, The Mace Company, Denver, Colorado.)

crucible. Chrome plastics are also used to some extent, especially for the overflow spout.

Lead-refining Furnaces. Molten lead that comes directly from the blast furnace or from the desilvering kettles is treated in a reverberatory type of refining furnace somewhat as shown in Fig. 351. Air is blown into the bath to oxidize iron, arsenic, antimony, and tin to dross, and the latter is

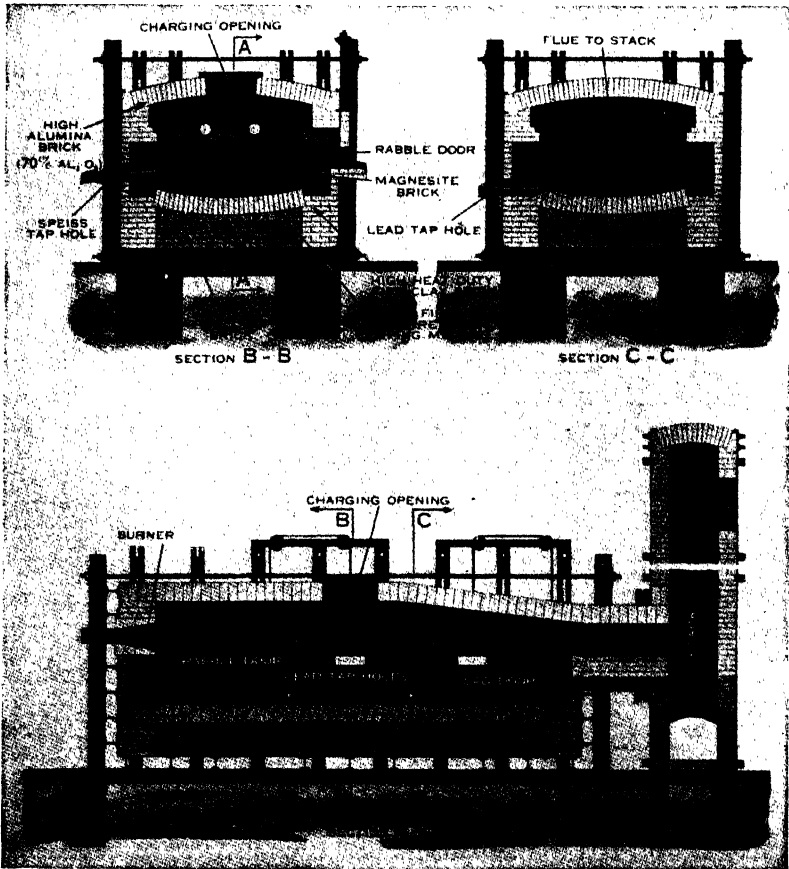

FIG. 351. Typical lead-drossing furnace. (From *Modern Refractory Practice*, courtesy of the Harbison-Walker Refractories Company.)

skimmed off and retreated. High refractoriness is not required, as the maximum temperature is around 1100°C (about 2000°F). Temperature changes are not particularly great; consequently, spalling is not a problem. Slag action is the most serious trouble, as the action of lead oxide is very severe in contact with most types of refractories. Magnesite brick are now generally used in the side walls to somewhat above the slag line, but

TABLE 117. CLASSIFICATION OF REFRACTORIES FOR THE LEAD INDUSTRY
 (Adapted from Industrial Survey of Conditions Surrounding Refractory Service in the Lead Industry, "Manual of ASTM Standards on Refractory Materials")

| Class | Furnace part | Material | Temperature | Load | Spalling | Slagging action | Abrasion | Remarks |
|------------------|--|--|-------------------|--------------------------|---|-----------------|-------------|--|
| Blasf furnace | Lining | High-heat-duty fireclay brick, chrome cement | 2200°F. (1205°C.) | 15 to 20 lb. per sq. in. | None | Not severe | Important | Bottom part of furnace where highest temperature prevails is made of water-cooled cast iron. Density is main requirement of refractories |
| | Bottom | High-heat-duty and intermediate-heat-duty fireclay brick | 2000°F. (1095°C.) | Unimportant | None | Important | Moderate | |
| | Side walls and end walls above metal line | High-heat-duty and intermediate-heat-duty fireclay brick | 2000°F. (1095°C.) | 10 lb. per sq. in., max. | Temperature change during charging, spalling slight | Important | Moderate | |
| | Side walls and end walls at and below metal line | Fireclay brick, magnesite brick, high-alumina brick | 2000°F. (1095°C.) | 10 lb. per sq. in., max. | Very slight | Very important | Moderate | |
| Drossing furnace | Roof | High-heat-duty and intermediate-heat-duty fireclay brick | 2000°F. (1095°C.) | Arch stresses only | Moderate | Important | Very slight | Conditions in firebox chamber vary depending upon whether oil, gas, or coal is used as fuel |
| | Refining fire furnace box | Fireclay brick, largely high-heat-duty brick | 2000°F. (1095°C.) | 10 to 15 lb. per sq. in. | Moderate | Moderate | Moderate | |
| | Bottom | High-heat-duty fireclay brick | | Unimportant | None | Important | None | |
| | Side walls | Magnesite brick or high-alumina brick | | Unimportant | Slight | Severe | None | |
| | Roof | Magnesite brick or high-alumina brick | | Unimportant | Moderate | Moderate | None | |

high-alumina brick have also been tried. The upper parts of the furnace may consist of a medium-duty firebrick with moderate resistance to spalling. The life of a brick in the upper wall depends a great deal on the type of operation and the amount of antimony in the lead.

5. Tin. There are, at the present time, very few tin smelters in the United States; but in other countries, this is a comparatively important operation. Many types of smelting are used, depending on the kind of ore. The metallurgist is fortunate in having, as his raw material, tin oxide, which can be readily reduced to the metal without great difficulty. The older types of furnace constructed are small blast furnaces much like the ones used for copper and lead. More recently, however, reverberatory furnaces have been used similar to those for copper ores, though on a much smaller scale. As the temperatures are comparatively low and the tin oxide is not an extremely active flux, dense fireclay brick have been found adequate as refractories.

6. Aluminum. Aluminum is produced by the electrolysis of fused salts, a process that calls for no particular amount of refractories. Aluminum is melted, however, in the larger scale operations in small open-hearth furnaces holding about 20,000 lb of metal. The temperatures are comparatively low, and the aluminum oxide is not very active but builds up on the walls and must be regularly sliced off. A good grade of dense fireclay brick accurately sized and giving thin joints has proved quite satisfactory, although in some cases the molten aluminum has a tendency to attack the brick, perhaps causing a thermite reaction with the iron oxide particles as suggested by Burrows.⁽³⁸⁾ Recently zircon⁽⁴⁰⁾ refractories have proved excellent for this purpose.

7. Nickel. Nickel is smelted in much the same way as copper, the detailed process depending a great deal on the type of ore available. The melting of nickel is often carried out in small open-hearth furnaces that are made almost completely of a dense fireclay brick, although super-duty fireclay and 50 per cent alumina bricks have been used with considerable success in some of the later furnaces.

8. Bibliography

Copper Production:

1. ANON.: Decomposition of Refractory Brick in a Copper Reverberatory Furnace, *Eng. Mining J.*, **125**, 244, 1928.
2. OLDRIGHT, G.L., and F.W. SCHROEDER: Suggested Improvements for Smelting Copper in the Reverberatory Furnace, *Trans. Am. Inst. Mining Met. Engrs.*, **76**, 442, 1928.
3. HEUER, R.P.: Refractories (in Copper Industry), *Trans. Am. Inst. Mining Met. Engrs.*, **106**, 278, 1933.

4. LAIST, F.: History of Copper Refining Practice, *Trans. Am. Inst. Mining Met. Engrs.*, **106**, 83, 1933.
5. ANON.: Linings for Tin Smelting Furnaces, *Brit. Clayworker*, **44**, 7, 1935.
6. ANON.: Industrial Survey of Conditions Surrounding Refractory Service in the Copper Industry, "Manual of ASTM Standards on Refractory Materials," 1937.
7. IVANOV, B.V.: Service of Dinas Brick in the Arch of a Reverberatory Copper-smelting Furnace, *Tsvetnye Metal.*, No. 9, p. 95, 1938.
8. HONEYMAN, P.D.I.: Reverberatory Smelting of Raw Concentrates at International Smelting, *Bull. Am. Inst. Mining Met. Engrs.*, 456.
9. ROBSON, H.C.: Copper Refinery Furnace Firing and Refract., *Bull. Inst. Mining Met.* **373**, 374, 376, p. 25.
10. HEUER, R.P., and A.E. FITZGERALD: Basic Refractories for the Copper Industry: I, *Metals & Alloys*, **19**, 133, 1944.
11. HEUER, R.P., and A.E. FITZGERALD: Basic Refractories for the Copper Industry: II, *Metals & Alloys*, **19**, 1405, 1944.
12. HEUER, R.P., and A.E. FITZGERALD: Basic Refractories for the Copper Industry: III, *Metals & Alloys*, **20**, 68, 1944.
13. DENNIS, W.H.: Modern Copper Smelting, *Metal Treatment*, Part II, **38**, 103, 1944.
14. KOCATOPCU, S.S.: Reaction between Copper Reverberatory Slag and Refractories, *J. Am. Ceram. Soc.*, **28**, 65, 1945.
15. DENNIS, W.H.: Refractories in the Extraction of Copper, *Metal Treatment*, **12**, 183, 1945.

Melting Copper Alloys:

16. GILLETT, H.W., and E.L. MACK: The Electric Brass Furnace Refractory Situation, *J. Am. Ceram. Soc.*, **7**, 288, 1924.
17. ST. JOHN, H.M.: Refractories for Brass Foundry Furnaces, *Trans. Am. Foundrymen's Assoc.*, **439**, 1926.
18. CAMPBELL, D.F.: Recent Developments in Electric Furnaces, *J. Inst. Metals*, **41**, 37, 1929.
19. ADAMS, W., JR.: The Ajax-Wyatt Induction Furnace, *Trans. Am. Electrochem. Soc.*, **57**, 462, 1930.
20. ROBIETTE, A.G.: The Low-frequency Induction Furnace and Its Scope, *Metalurgia*, **3**, 175, 1931.
21. KLYUTSCHAREV, J.A., and S.A. LOWENSTEIN: Acid Lining for Melting Nonferrous Metals in High Frequency Furnaces, *Feuerfest*, **9**, 157, 1933.
22. PATRICK, W.L.: Fused Magnesia in the Nonferrous Metal Industry, *Metal Ind. (London)*, **48**, 231, 1936.
23. LETORT, Y.: Refractory Furnace Linings for the Melting of Nonferrous Metals, *Bull. assoc. tech. fonderie*, **11**, 458, 1937.
24. PATCH, N.K.B.: Nonferrous Melting Requires Excellent Furnace Operation, *Foundry*, **65**, 25, 1937.
25. McDOWELL, J.S.: Refractories in Nonferrous Metallurgical Furnaces, *Mining Congr. J.*, **25**, 17, 1939.
26. BOOTH, S.H.: Use of Refractories in Melting Copper and Copper Alloys in an Ajax-Wyatt Induction Furnace, *Bull. Am. Ceram. Soc.*, **19**, 171, 1940.
27. DENNIS, W.H.: Refractories in the Extraction of Copper, *Metal Treatment*, **12**, 147, 1945.

Zinc Production:

28. ROSSMANN, W.F.: Refractory Material for Zinc Retorts, U.S. Patent 1,424,120, 1921.
29. VARIAN, J.P.: Retorts for Zinc Ores, *Eng. Mining J.*, **113**, 363, 1922.
30. ENDELL, K., and W. STEGER: Tests on Clays for Making Zinc Retorts, *Metall u. Erz.*, **20**, 321, 1923.
31. O'HARRA, B.M.: Bibliography on Zinc Retorts and Condensers, *Bull. Mo. School Mines Met.*, **8**, 15, 1925.
32. SPENCER, G.L., JR.: High-silica Retorts at the Rose Lake Smelter, *Trans. Am. Inst. Mining Met.*, **96**, 119, 1931.
33. MACBRIDE, W.B.: Notes on Refractories for the Electrothermic Zinc Industry, *Bull. Am. Ceram. Soc.*, **14**, 389, 1935.
34. WEISSMANN, L.: Use of Native Clays and Silicon Carbide in the Production of Zinc Muffles, *Hutnické Listy*, 1936, 353.
35. DENNIS, W.H.: Zinc Smelting and Refining, *Mine and Quarry Eng.*, **10**, 211, 1945.

Lead Production:

36. ANON.: Industrial Survey of Conditions Surrounding Refractory Service in the Lead Industry, "Manual of ASTM Standards on Refractory Materials," 1937.

General:

37. SEARLE, A.B.: Refractory Materials for Electric Furnaces, III, Melting Nickel and Its Alloys, *Metal Ind. (London)*, **38**, 569, 1931.
38. BURROWS, H.O.: Effect of Molten Aluminum on Various Refractory Brick, *J. Am. Ceram. Soc.*, **23**, 125, 1940.
39. HAYWARD, C.R.: "An Outline of Metallurgical Practice," D. Van Nostrand Company, Inc., New York, 1940.
40. KNAUFT, R.W.: Zircon Refractories for Aluminum Melting Furnaces, *Metals & Alloys*, **18**, 1326, 1943.
41. HANSON, W.H.: Special Refractories, Annual Meeting, American Foundrymen's Association, 1947.

CHAPTER XXIII

REFRACTORIES IN THE GENERATION OF STEAM POWER*

1. Development of Boiler Furnace Designs. The fuel used in early boilers was chiefly lump coal fired by hand or by stoker operating at a fairly low rate of heat input. In either case, solid firebrick walls formed an entirely satisfactory enclosure for the unit. In fact, the refractory gave very necessary aid to combustion by reradiating heat to the fuel-burning equipment. When oil and gas firing became popular, solid brick walls were also found to be satisfactory for these fuels at moderate furnace-heat inputs.

The introduction of pulverized coal firing greatly intensified the problem of slag attack of boiler furnace refractories. An accompanying and still continuing upward trend in the size of boiler unit (and consequently the height of wall) increased the structural load on the brickwork. An increase of furnace heat input, boiler rating, and steam temperature materially raised the furnace temperature to which the brickwork was subjected. These three factors made imperative the development of economical boiler furnace designs capable of withstanding far more severe conditions than can a solid firebrick setting.

Improvements in fuel-burning equipment, which paralleled the trends toward large, high-duty boiler units, now permit almost any type of fuel to be burned in a relatively low-temperature furnace. Therefore, most of the constructions that have evolved to take care of the previously described conditions of temperature, slagging, and load involve the use of partial or complete water cooling. For this reason, a large part of the present chapter deals with water-cooled furnace designs and the part played by refractories in supplementing them.

2. Modern Furnaces and Boiler Walls. The following types of wall constructions are often used on modern high-duty boiler units.

* This chapter was prepared by W. D. Stevens of the Babcock & Wilcox Company.

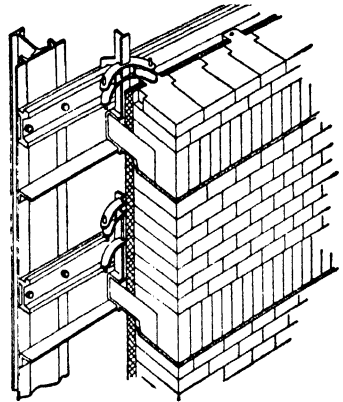

FIG. 352. Insulated, sectionally supported wall (American Arch).

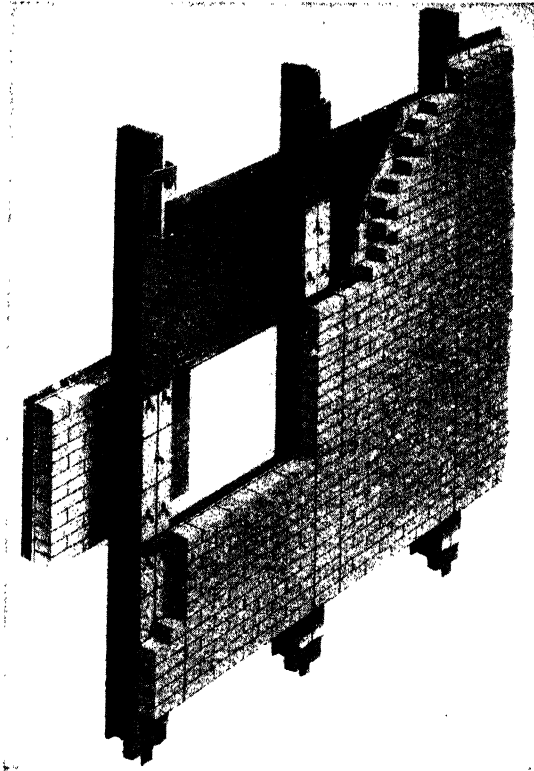

Fig. 353. Babcock and Wilcox insulating firebrick panel wall construction.

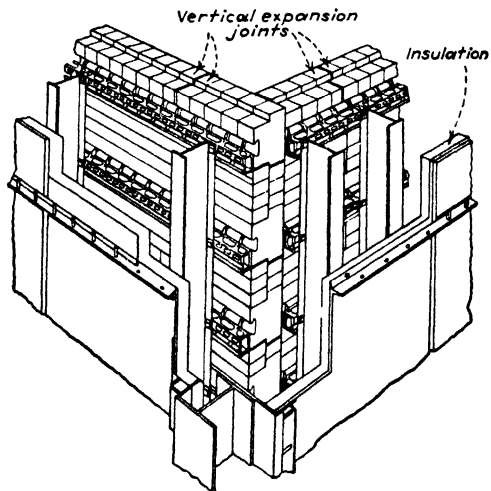

FIG. 354. Air-cooled, sectionally supported wall (Reintjes).

Sectionally supported walls divide the structural load and sectionalize the expansion of large walls by suspending the brickwork from castings that are, in turn, supported by external steelwork. There are many patented constructions of this type; among well-known ones are Detrick, Bigelow-Liptak, American Arch, and Reintjes.

Sectional walls may be made of tile only, of tile with insulation on the outside (see Fig. 352), or—in the absence of erosive conditions—of insulating firebrick (see Fig. 353). They are generally used for walls in the convection zone of the boiler or for low-duty furnace walls but can be

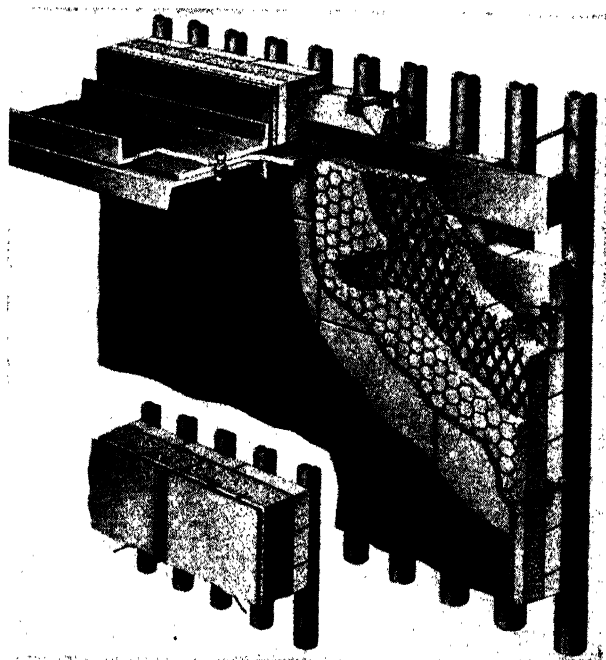

FIG. 355. Tube and brick wall. (Babcock & Wilcox Company.)

adapted to moderate-duty furnaces by facing with high-temperature brick or by air cooling (see Fig. 354). They have also been used for high-duty oil-, gas- or stoker-fired furnaces as a backing for waterwall tubes but in this application are more expensive than other types of water-cooled walls.

Tube and refractory walls (Fig. 355) are made up of waterwall tubes, which are part of the heat-absorbing surface of the boiler, spaced at intervals and backed with 2 to 3 in. of firebrick or tile. The brickwork is sufficiently cooled by the tubes to allow this type of wall to be used on the boiler convection zone for any type of firing, on high-duty furnaces fired by gas or stoker, and on low-duty pulverized-coal-fired furnaces. The

limiting factor with pulverized-coal furnaces is excessive slag accumulation rather than deterioration of the refractory.

Although temperature conditions do not dictate it, the refractory behind the tubes is usually of the high-duty type in order to obtain good slagging and fly ash erosion resistance and to take advantage of the closer sizing and warpage tolerances that may be expected from first-quality material. To prevent air leakage into the setting and to give structural strength, the brick or tile are normally laid in an air-setting mortar. In zones of high draft, further sealing can be accomplished by a backing of castable refractory reinforced by expanded metal lath. To give a reason-



Fig. 356. Outside view of tube and brick waterwall with insulation removed. (*Babcock & Wilcox Company.*)

able external surface temperature, the refractory is insulated with block insulation or insulating firebrick. For protection and appearance the external surface of the insulation is covered by a metal casing or a finish coat of plastic insulation.

The refractory and insulation are held in place by steel or alloy studs, which tend to sectionalize the structural loading of the walls. The wall tube spacing may be proportioned to give an operating refractory temperature about twice that of the boiler-pressure part temperature. Since the coefficient of expansion of firebrick is about half that of steel, this arrangement permits the refractory envelope to be continuous around the boiler setting without the provision of expansion joints. With expansion joints eliminated, the boiler setting will remain tight with a minimum

amount of maintenance. A tube and brick wall built without expansion joints is shown stripped of all insulation in Fig. 356. At the time of this photograph, the boiler had been in service for 7 months and during this period had undergone a heating and cooling cycle once each 24 hr.

Closely spaced tube walls (see Fig. 357) made of touching waterwall tubes can be used for any type of firing to form a continuous steel envelope

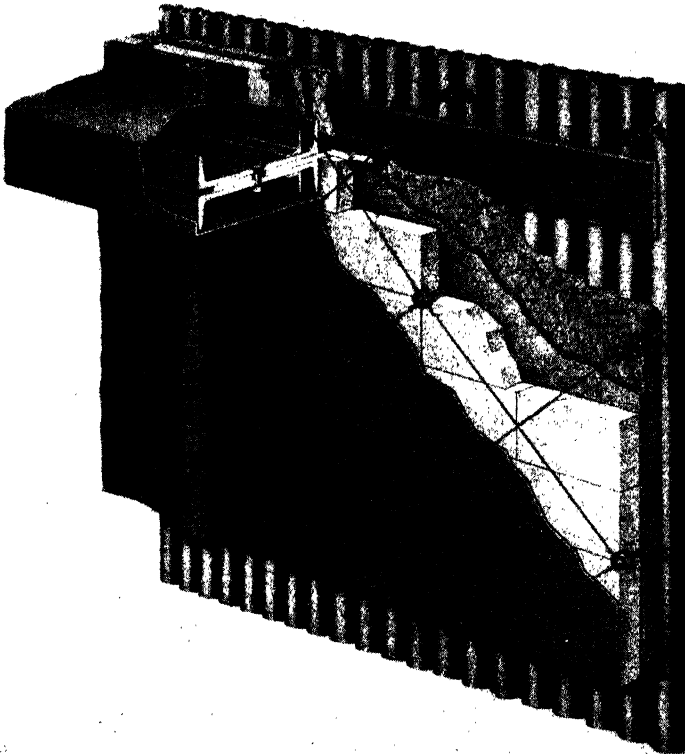

FIG. 357. Closely spaced tube waterwall. (Babcock & Wilcox Company.)

enclosing the furnace of a steam-generating unit. When its area is properly proportioned, such an enclosure will eliminate trouble from excessive accumulation of slag. It is usually sealed against air leakage with insulating concrete, insulated with block insulation or insulating firebrick, and covered with a metal casing or a plastic insulation finish.

The castable refractory backing is reinforced with expanded metal lath placed close to its outer surface, which makes the castable act as a reinforced concrete mat outside the tubes. Application of the concrete may be by hand or by cement gun. In either case, the metal lath is

installed on the wall first and the castable applied through it, so that the lath will act as a form.

This construction, like the tube and brick wall, can be made with no expansion joints. The drying shrinkage of the castable (about 0.5 per cent at 600°F) plus a small difference between the thermal expansion of the boiler steel and the castable (the castable coefficient of expansion is about two-thirds that of steel) results in a small theoretical difference between the width and height of the tube wall and that of the refractory



FIG. 358. Outside view of closely spaced tube waterwall showing castable refractory after use. (Babcock & Wilcox Company.)

backing after the unit has been brought up to operating pressure. The effect of this slight differential expansion is a series of hairline cracks very well distributed by the reinforcing metal lath. The resultant enclosure is tighter against air leakage than one with expansion joints and requires very little maintenance. Figure 358 shows the back of a closely spaced furnace tube wall after 12 months' service with a complete cooling and heating cycle once each week.

Flat stud tube walls are intended for use under similar conditions to those for which the closely spaced tube walls are used. They are somewhat more economical in their use of steel, since they are composed of tubes spaced at intervals. Each tube has a series of flat, rectangular steel plates welded along its entire length on both sides. The plates or studs on

two adjacent tubes close the space between them and present a practically continuous metal surface to the furnace. This type of wall is backed by the arrangement of castable refractory, insulation, and casing or plastic insulation finish previously described for closely spaced tube walls.

Partial or full stud walls are used where a higher furnace temperature than that obtainable from closely spaced tube or flat stud tube walls is desired. They are made up of waterwall tubes spaced at intervals. The space between the partial stud tubes is partially closed with two rows of round studs or rods welded to each side of the entire length of each tube. On the full stud walls, the entire furnace side of the tubes is covered with studs. The studs are packed with a chrome-base plastic pounded in place or a chrome-base castable gunnited or troweled in place to form a continuous wall. When in service, the chrome refractory is, in effect, water cooled because of the extended heat-transfer surface effect of the studs. The stud tube walls are sealed against air leakage and insulated in a manner similar to that used for closely spaced and flat stud walls.

One particular application of stud tube walls is the slag-tap furnace, where it is necessary to keep the coal ash above its fluid temperature in order to remove it as a liquid. This construction is very resistant to the fluid slag found in this type of furnace.

3. Slag-tap Furnace Floors. The floor of a furnace designed for liquid removal of coal ash must hold a pool of liquid slag that usually contains a high percentage of iron oxide. Therefore, it is a difficult refractory problem. This condition has been taken care of by making the floor of cast-iron Bailey blocks clamped tightly to tubes that are part of the boiler steam-generating surface as are the waterwall tubes. The blocks are covered with several inches of tightly packed chrome plastic or castable.

4. Boiler Baffles. Present-day refractory boiler baffles must be gas-tight enough to prevent leakage against high draft differentials. Although the cooling effect of the boiler tubes makes their service temperatures fairly low, the baffles are often made of high-duty firebrick or tile to assure high strength and erosion resistance. Gastightness is obtained by laying the brick or tile in an air-setting mortar.

Refractory baffles may also be made of a dense castable reinforced where necessary by alloy or steel rods.

5. Boiler Unit for Multi-fuel Firing. Figure 359 shows a steam-generating unit arranged for firing pulverized coal, oil, or gas either singly or in combination. The various wall constructions and refractory parts are labeled on the illustration.

The furnace cooling surface is proportioned to keep the temperature of the gases leaving the furnace below the ash initial deformation temperature (oxidizing basis) when pulverized coal is fired. This keeps most of the coal

ash in the furnace in a dry state and permits it to slide down the sloping hopper to the ashpit (not shown), which may be flooded with water or may be dry with a water sluice system. The ashpit lining is subjected to thermal shock due to the impingement of the water on the hot refractory. It may be of a castable refractory or of a high-duty firebrick selected for good spalling resistance.

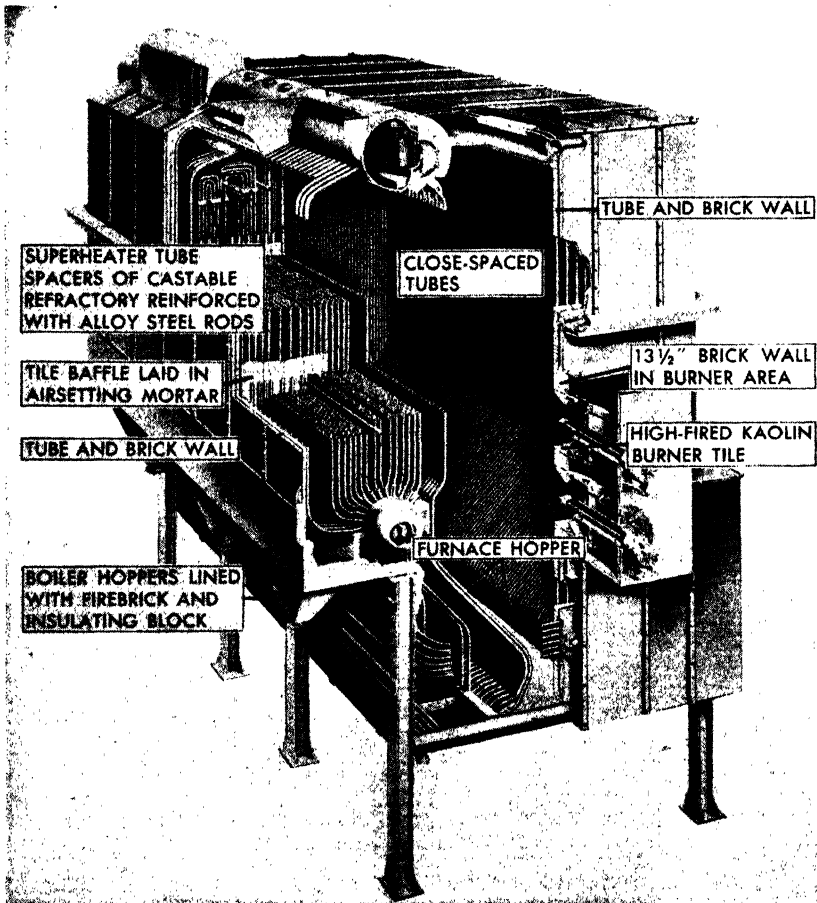

FIG. 359. Babcock and Wilcox integral furnace boiler with hopper-bottom furnace.

6. Pulverized Coal-fired Boiler (Slag-tap Type). The unit in Fig. 360 is primarily designed for pulverized coal firing but is capable of full steam output while using oil fuel. In order to avoid the accumulation of ash deposits on the tubes of the boiler banks when coal is burned, the total furnace-cooling surface of this boiler is sufficient to make the gases leave the furnace at a temperature below the initial deformation temperature of

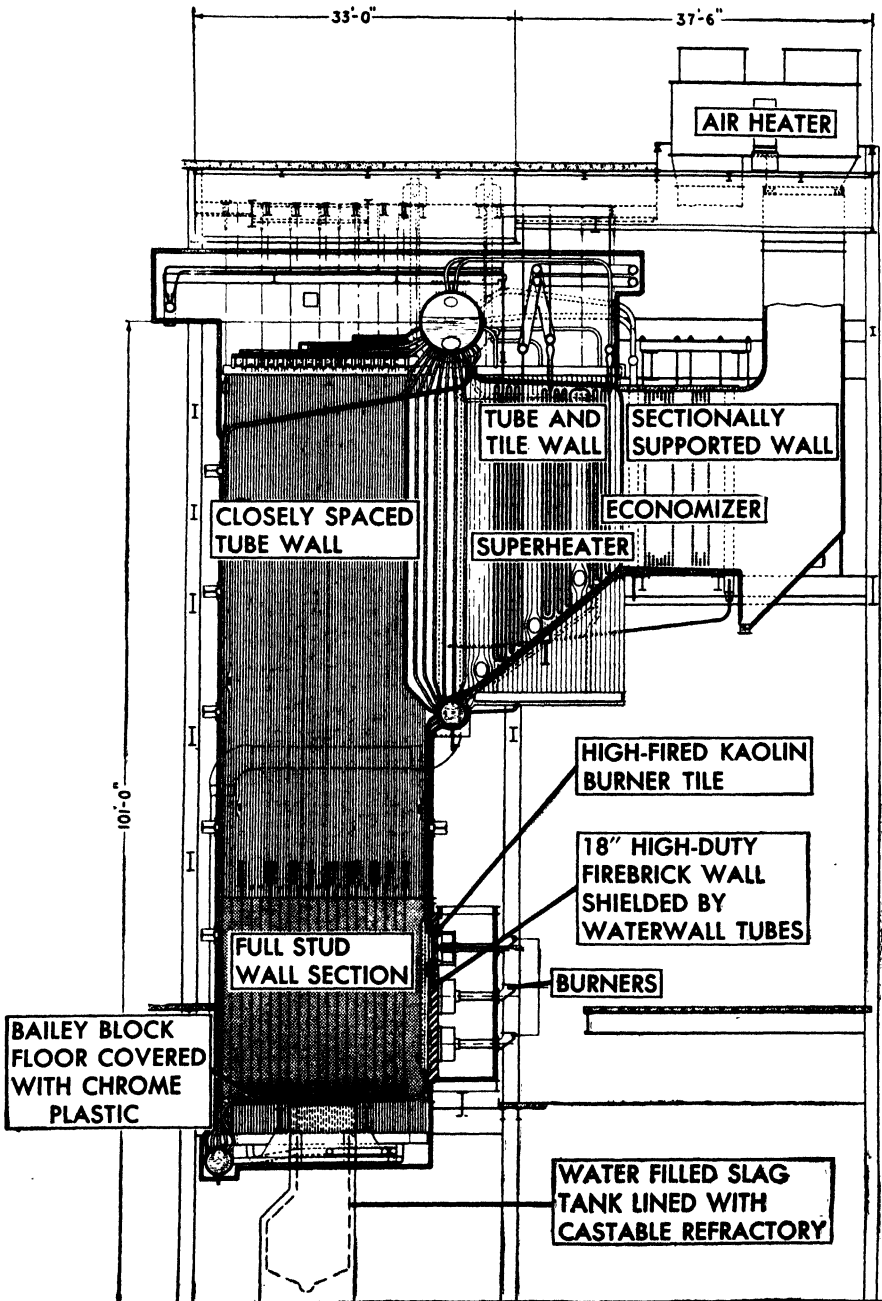

FIG. 360. Babcock and Wilcox radiant boiler with slag-tap furnace.

the coal ash. However, the location of burners and the use of fully studded tubes in the burner area make it possible to keep the temperature at the furnace floor high enough to melt the coal ash that collects there. The liquid slag thus formed drains continuously into a flooded slag tank. The

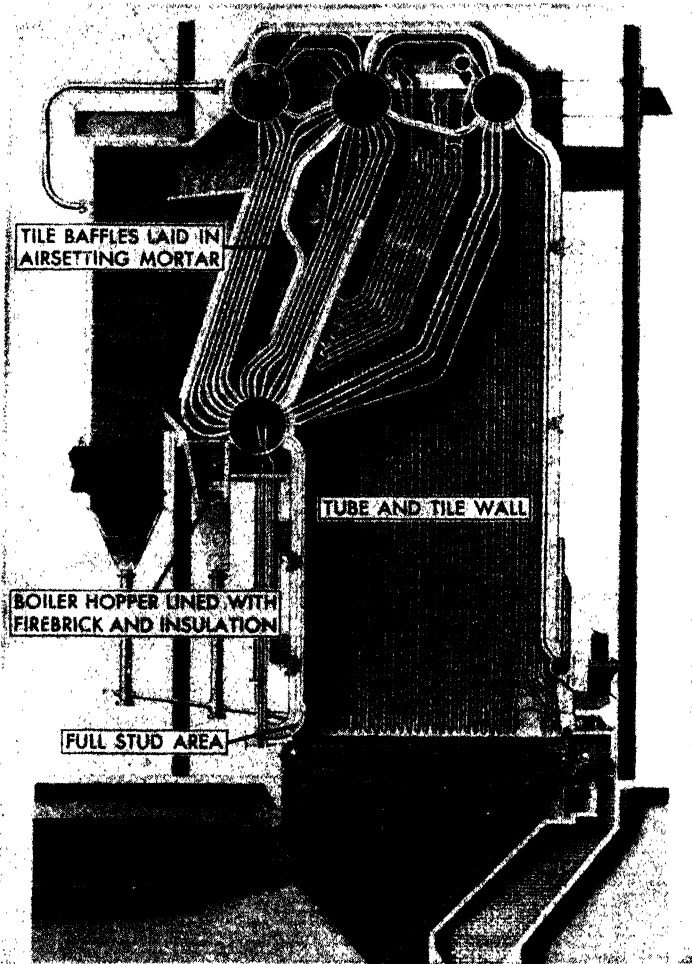

FIG. 361. Babcock and Wilcox sterling boiler fired by Detroit spreader stoker.

tank is lined with castable refractory, which must be highly resistant to spalling.

7. Cyclone Furnace. One interesting application of the full stud tube construction covered with chrome plastic or castable is the cyclone furnace, which burns crushed coal at a rate of heat input far exceeding that normally encountered with other types of firing. The cyclone is a cylinder about 8 ft

in diameter and 10 ft long constructed entirely of full stud tubes. Coal crushed to 0 to $\frac{1}{4}$ in. in an ordinary coal crusher is fed to one end of the cylinder, and the combustion air is admitted tangentially at high velocity. The coal burns rapidly while swirling around the cylinder walls in a film of fluid slag. The cyclonic action, in addition to promoting rapid combustion, permits a very high percentage of the ash to be removed from the furnace

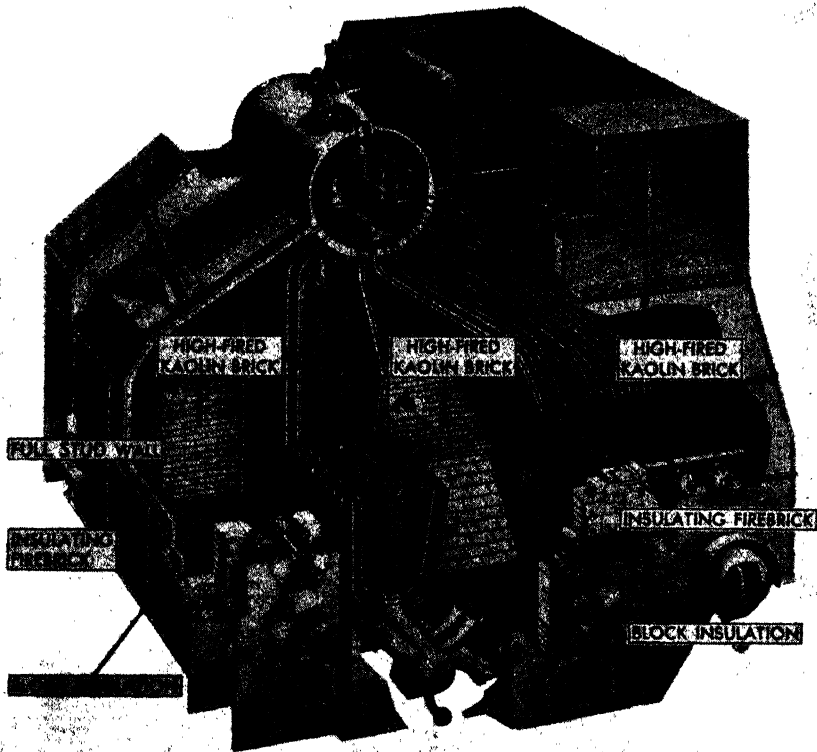

Fig. 362. Babcock and Wilcox single uptake controller super-heat boiler.

as slag. The products of combustion, which then enter a conventional water-cooled boiler furnace for further cooling, carry with them, entrained as fly ash, only about 10 per cent of the coal ash as compared with from 55 to 85 per cent for pulverized coal firing.

8. Spreader-stoker-fired Boiler. Figure 361 depicts a boiler fired by a spreader stoker. The bituminous coal is mechanically thrown into the grate from the front of the furnace. The grate moves slowly from rear to front and discharges the coal ash continuously.

The entire boiler and furnace enclosure is formed of tube and tile walls. The baffles are of tile laid in an air-setting mortar. On the rear wall just

above the stoker, the waterwall tubes are protected with full stud construction.

9. Oil-fired Marine Boiler. The marine boiler shown in Fig. 362 is a controlled superheat unit used to obtain high steam plant efficiency over a

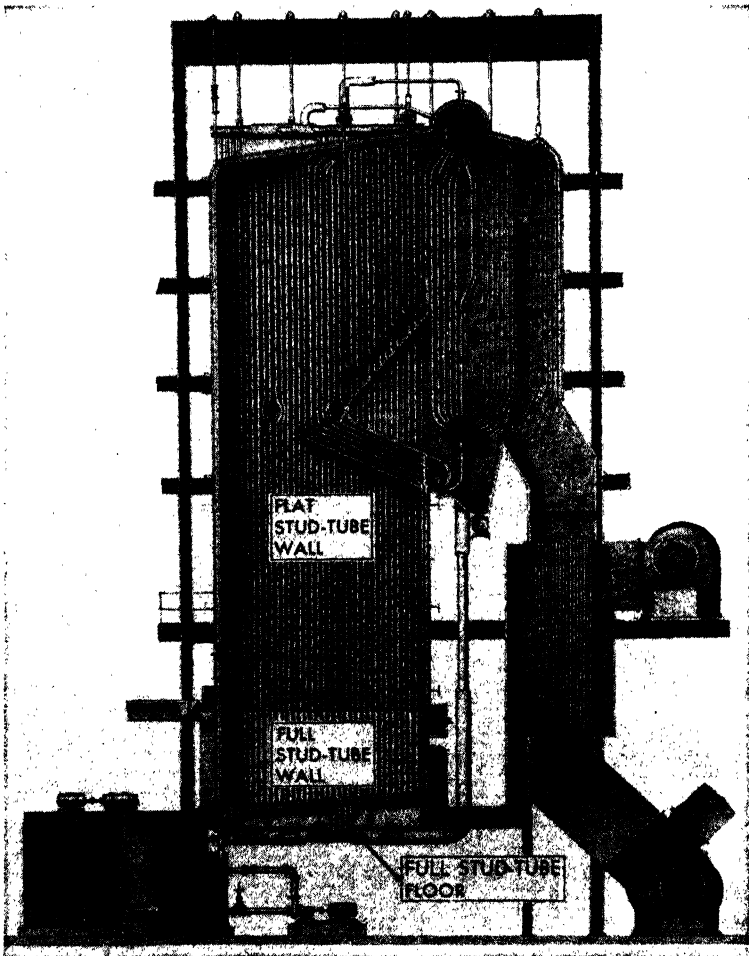

Fig. 363. Babcock and Wilcox two-drum recovery unit.

wide range of output. The furnace, which has an extremely high heat release, has one stud tube side wall. Owing to weight limitations, the front and rear walls are not water cooled. As shown, the uncooled refractory walls including the burner wall are built of high-fired kaolin brick held to the casing by anchor bolts and backed up by insulating firebrick and block insulation. However, on some of the more recent installations, the burner

wall has been made of a high-temperature kaolin-base castable refractory. The walls enclosing the boiler tube banks, where the temperature is too low for molten oil slag to exist, are made entirely of insulating firebrick to save weight.

10. Waste-heat Boilers. Waste-heat boilers are used in a great many industries for recovering heat in the flue gases from various types of industrial processes. Typical examples are the blast furnace and rotary cement kiln. The refractories used in the waste-heat boiler are always operated at comparatively low temperatures but, in general, are subjected to considerable abrasion, as most of the boilers operate under conditions where dust and ash are carried in the gases. For this reason, dense, high-duty firebrick are used for these conditions.

11. Black-liquor Recovery Furnaces. The economical operation of a modern pulp mill necessitates the recovery of chemical and heat values in the waste liquor. In the sulfate or kraft process, in which the recovery of chemicals is most generally employed, the wood chips are digested with a hot solution of sodium hydroxide, NaOH , and sodium sulfide, Na_2S , to remove the noncellulose portion of the wood. The spent cooking liquor (black liquor) is concentrated by evaporation until it contains from 55 to 65 per cent solids. It is then sprayed into a recovery furnace where it drops and falls to the floor as "char." On the floor, the carbonaceous material is burned with a deficiency of air. In the reducing atmosphere thus formed, the sodium salts are smelted out of the char. The resulting smelt containing mostly sodium carbonate, Na_2CO_3 ; sodium sulfide; a small percentage of sodium sulfate, Na_2SO_4 ; and traces of other sodium salts are discharged from a spout.

The conditions existing in this furnace are extremely severe as far as action on the refractories is concerned, primarily in view of the aggressive chemical activity of the fused sodium salts. In the earlier forms of recovery units, soapstone blocks were generally used as being the refractory best able to withstand the action of these molten sodium salts, but this material had a maximum life of only 10 to 12 months. In recent years, furnaces of this kind have been entirely water cooled with a high degree of success. Figure 363 shows a recovery unit having a water-cooled furnace. The upper walls are flat stud, while the lower walls and floor where a higher temperature is required are of full stud construction. The plastic chrome ore is quite resistant to the action of soda because it is inert chemically and is aided by the cooling action of the water tubes. This type of furnace requires little maintenance.

12. Bibliography

1. POWELL, E.B.: Boiler Furnace Refractories, American Society of Mechanical Engineers, Annual Meeting, 1925.

2. TERESHCHENKO, O.V., and S.I. PERKAL: Boiler Refractories, I, II, *Ukrain. Silikaty*, p. 101, 1929; p. 63, 1930.
3. CUNLIFFE, J.A., and H.E. CLEM: Refractories for Use in Sulphate-recovery Furnaces of the Pulp and Paper Industries, *J. Am. Ceram. Soc.*, **15**, 321, 1932.
4. FREISE, F.W.: Bagasse Fuel and Boiler Refractories, *Refractories J.*, **8**, (9), 360, 1932; see also *Ceram. Abstracts*, **11**, 494, 1932.
5. BUDNIKOFF, P.P., and S.A. JICHAREWITSCH: Choice of Chemically Resistant Refractory Materials for Sodium Sulphide Furnaces, *Trans. Ceram. Soc. (Engl.)*, **33**, 368, 1934.
6. FROMM, F.: Refractory Materials for Boiler Fire Boxes, *Glückauf*, **69**, 722, 1934.
7. LEPINGLE, M.: The Application of Mullite Refractories to Boiler Furnaces, *Chim. ind.*, **36**, 1087, 1936.
8. BAILEY, E.G.: The Action of Slag from Fuel in Boiler Furnaces, *Bull. Am. Ceram. Soc.*, **17**, 55, 1938.
9. SHERMAN, R.A.: Temperature Conditions in Boiler Furnaces, *Bull. Am. Ceram. Soc.*, **17**, 43, 1938.
10. ANON.: "Steam," The Babcock and Wilcox Co., New York, 1923.
11. FEHLING, H.R.: The Thermodynamic and Technical Principles of the Slag-tap Furnace, *Inst. Fuel, Conf. on Pul. Fuel Sup.* 769, 1947.

CHAPTER XXIV

REFRACTORIES FOR USE IN NUCLEAR POWER PRODUCTION

1. Introduction. In order to discuss the possible future role refractory materials may play in the components of nuclear power plants, it will be necessary first to review the mechanism by which power is obtained from the atom. The history of the developments in nuclear physics, almost all written in the last ten years, is simply and clearly stated in the Smyth report⁽²⁾ and therefore will not be discussed here.

2. The Nuclear Fission Process. *The Structure of the Atom.* The atom consists of a positively charged nucleus surrounded by negatively charged electrons. It is known that the chemical species is determined by the number of electrons about the nucleus and that this is represented in the case of neutral atoms by the atomic number. In chemistry we are concerned mainly with the electrons surrounding the atom, because it is these particles which enter into the various chemical reactions in forming compounds. Now it is necessary to go further and ascertain the structure of the nucleus itself, for this is the seat of nuclear power.

The atomic nucleus is now believed to be chiefly composed of a compact group of particles of two kinds; one the proton with a positive charge equal and opposite to the charge on the electron and the other the neutron with no charge at all. The number of particles in the nucleus is expressed by the mass number A . An element, therefore, can be written as ${}_{92}\text{U}^{238}$, where 238 is the mass number and 92 the atomic number, or number of protons Z . In a chemically neutral atom, the number of electrons equals the number of protons.

About 250 different nuclei exist in nature, ranging in charge and mass from ${}^1_1\text{H}^1$ to ${}_{92}\text{U}^{238}$. In all but two of these naturally occurring nuclei, the number of neutrons is equal to the number of protons or somewhat larger. As the number of protons increases, the excess number of neutrons tends also to increase as can be seen in the sequence of the nuclei of ${}^2_2\text{He}^4$, ${}^9_4\text{F}^{19}$, ${}_{83}\text{Bi}^{209}$, and ${}_{92}\text{U}^{238}$. In the case of most atoms, the ratio of the number of neutrons to the number of protons is not rigidly fixed. More usually the number of neutrons is variable within a small range and nuclei occur commonly with the same charge but with different masses. Such nuclei are called "isotopes" of one another (from the Greek, meaning "same place," applying to same place in the Periodic Table of elements). Since the num-

ber of orbital electrons is the same for all members of a set of isotopes, the chemical properties are identical. Most naturally occurring elements are a mixture of isotopes, which accounts for the fact that atomic weights are seldom integers.

Table 118 offers a brief summary of the properties of the nucleus and its components. It should be noted that in atomic and nuclear physics, the mass unit chosen is one-sixteenth of the mass of the predominant oxygen isotope, ${}_{8}\text{O}^{16}$, and is equal to 1.6603×10^{-24} g, which is greater than the value used by chemists by a factor of 1.00027.

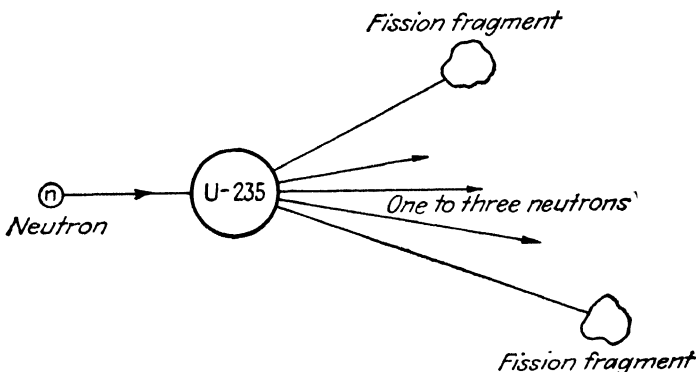

FIG. 364. Fission of ${}_{92}\text{U}^{235}$.

TABLE 118. SOME PROPERTIES OF THE NUCLEUS AND ITS COMPONENTS

| | Nucleus | Proton (${}_{1}\text{H}^1$) | Neutron (${}_{0}\text{n}^1$) |
|-------------------------|--------------------------------|-------------------------------|--------------------------------|
| Mass, units..... | About $A \times 1.0083$ | 1.00758 | 1.00893 |
| Diameter, cm..... | About 10^{-12} | 10^{-13} | 10^{-13} |
| Density, g per cc. | 10^{14} | 10^{14} | 10^{14} |
| Charge, coulombs..... | $Z \times 1.6 \times 10^{-19}$ | 1.6×10^{-19} | 0 |
| Number in nucleus..... | | Z | $A-Z$ |

More detailed information giving the nuclear properties of the various species of atoms can be obtained by referring to the Segre chart.⁽⁴⁾

The Fission Process. Physicists during the nineteen twenties had come to realize the fundamental concept that mass and energy are interchangeable. Einstein's relation $E = mc^2$ (where E is the amount of energy equivalent to a mass m and c is the velocity of light) is the basis for all considerations of nuclear power generation. It was not until 1932, however, that experimental proof of this relation was realized. At that time Rutherford's workers showed that by bombarding a target of lithium with protons (${}_{1}\text{H}^1$ nuclei) of 700 kv energy the following occurred:⁽²⁾

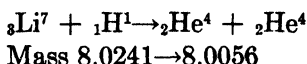

It was evident that 0.0185 units of mass had disappeared in the reaction. The energy of each α -particle (${}_2\text{He}^4$ nucleus) was found to be 8.5 million electron volts Mev* or a total energy release of 17 Mev. Since 0.0185 units of mass is 3.07×10^{-26} gm, 17 Mev is 27.2×10^{-6} erg and c is 3×10^{10} cm per sec, by substituting in the equation

$$E = mc^2$$

$$27.2 \times 10^{-6} = 3.07 \times 10^{-26} \times 9 \times 10^{20}$$

$$= 27.6 \times 10^{-6}$$

or substantial equivalence.

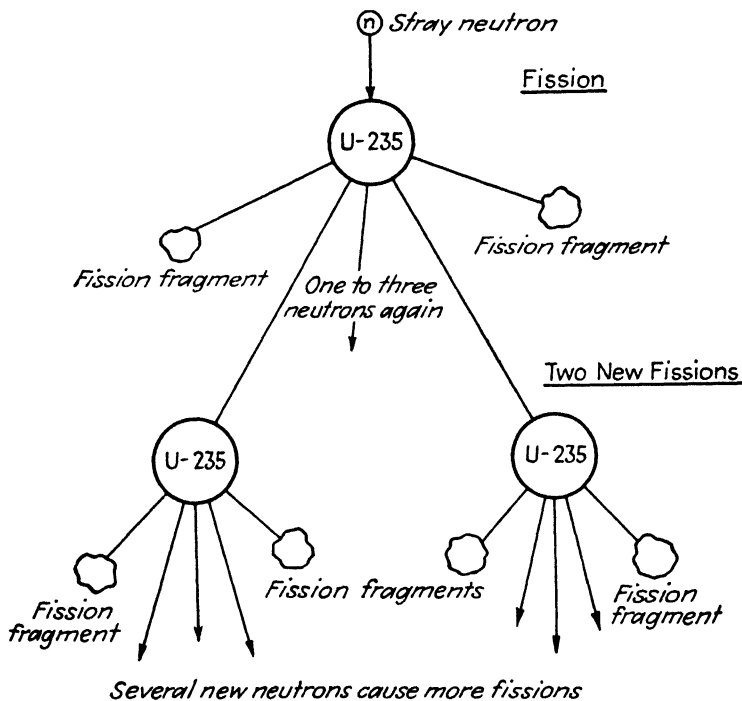

FIG. 365. Chain reaction of ${}_{92}\text{U}^{235}$ without moderator.

The heavy atoms have nuclei which approach instability and under certain conditions can be made to split into two fragments, with the loss of some neutrons so that in the process mass is lost and energy is released. For example if a neutron (${}_0\text{n}^1$) strikes a nucleus of ${}_{92}\text{U}^{235}$ two fragments will

* One electron volt (ev) is defined as being equal to the kinetic energy that a particle carrying one electronic charge acquires in falling freely between a potential drop of one volt. For convenience this value is multiplied by one million, hence Mev. Further to exemplify the energy unit Mev it can be shown that $1 \text{ Mev} = 1.6 \times 10^{-6} \text{ erg}$ and that $3.6 \times 10^{18} \text{ ergs} = 1 \text{ kw-hr}$.

be formed as shown in Fig. 364, together with from one to three neutrons, yielding a total energy release of about 200 Mev.

If only a small percentage of the released neutrons is captured before they can strike another nucleus of ${}_{92}\text{U}^{235}$, then the possibility is at hand to form a self-perpetuating cycle—the chain reaction (Fig. 365).

From the chain reaction it can be shown that, since each fission yields 200 Mev which is equal to 3.2×10^{-4} erg, or 3.1×10^{-14} Btu, or 8.9×10^{-18} kw-hr, and since a pound of ${}_{92}\text{U}^{235}$ contains 11.7×10^{23} atoms or nuclei, 1 lb of the isotope ${}_{92}\text{U}^{235}$ upon fission produces about 4×10^{10} Btu. Since

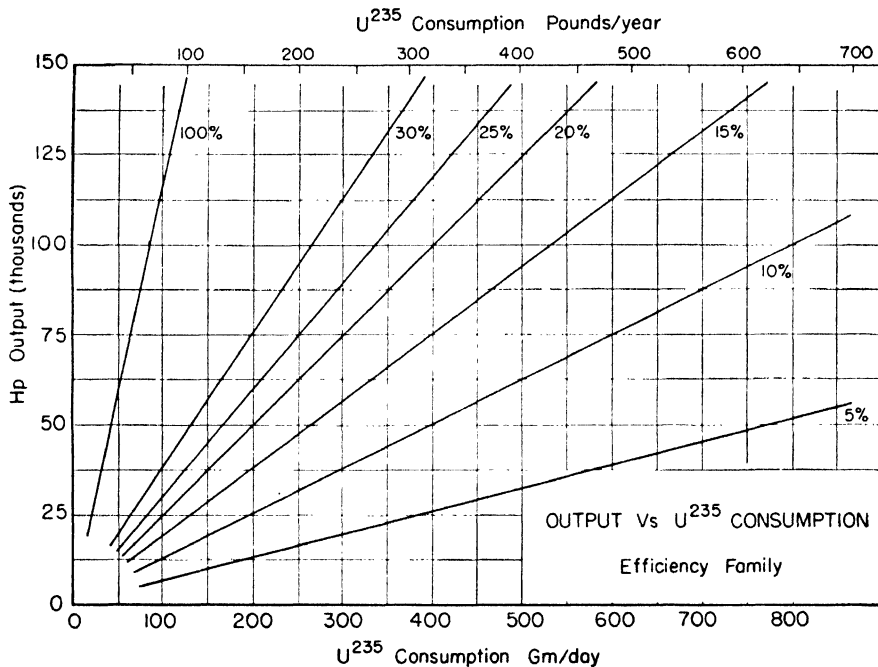

FIG. 366.(4) Power available from U^{235} .

1 lb of good coal yields only 14,000 Btu, 1 lb of fissionable ${}_{92}\text{U}^{235}$ is equivalent to approximately 1,500 tons of coal. Figure 366 shows graphically the horsepower outputs available with various rates of consumption from fission of ${}_{92}\text{U}^{235}$ under seven different operating efficiencies. Therefore, ${}_{92}\text{U}^{235}$ is potentially a highly concentrated fuel, which may in the future partly displace coal and oil now utilized in present-day power installations.

It should be noted that ${}_{92}\text{U}^{235}$ is not the only fissionable material which could be used as fuel. Plutonium (${}_{92}\text{U}^{239}$), which is made from natural uranium, and the isotope of uranium (${}_{92}\text{U}^{233}$), which is made from thorium, are also possible fuels.

Turning again to the energy release from the fission process, it can be shown to be proportioned roughly as follows:

| | Million Electron Volts |
|-------------------------|------------------------|
| Fission fragments..... | 160 |
| Neutrons (prompt)..... | 5 |
| Gammas (prompt)..... | 4 |
| Radioactive series..... | 20 |
| Absorbed neutrons..... | 9 |
| Total..... | 198 |

In fission induced by thermal neutrons, the nucleus seldom splits exactly in half, as one part is usually heavier than the other, giving an average distribution of new atoms as shown by the curve⁽⁴⁾ in Fig. 367.

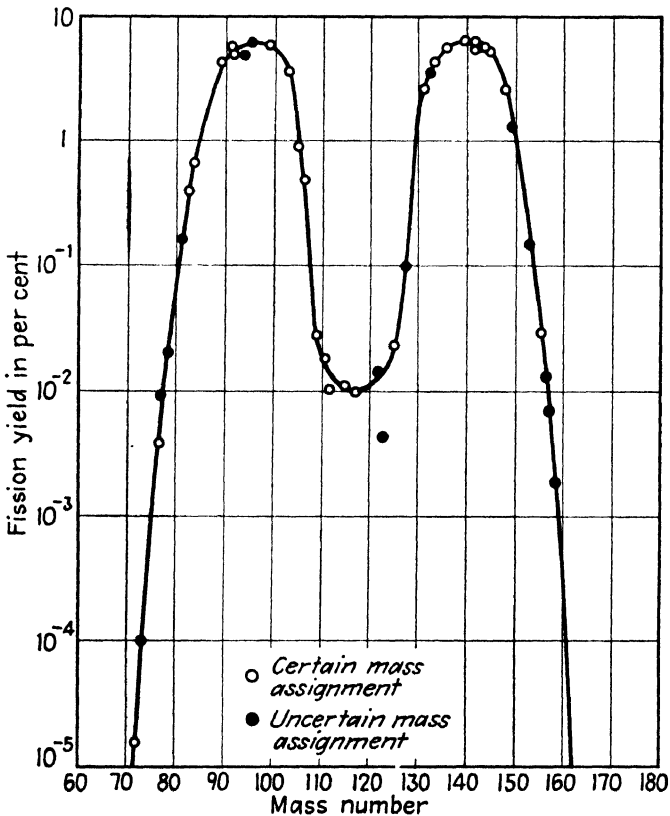

FIG. 367. Fission product curve⁽⁴⁾.

The interactions between bombarding neutrons and nuclei are expressed very simply in terms of nuclear cross sections. The meaning of the cross section of a given species of nucleus is best understood if we imagine a beam of neutrons of a given energy bombarding the nucleus; a certain fraction of

the neutrons will be removed from the beam by the nucleus. By definition, the fraction of neutrons contained in a 1 sq cm beam that is intercepted by a single nucleus is called the total cross section (σ) of the particular nucleus for such neutrons. Thus, in essence, the cross section is a measure of the probability that an incoming neutron will interact with the nucleus which is being bombarded. The atomic electrons play an insignificant role in these interactions.

The total cross section is composed of separate contributions from the various processes that may occur. For instance, the bombarding neutron may be absorbed into the nucleus in a certain fraction of the events. This cross section is usually denoted by σ_a . However, there is always a certain chance that the incoming neutron will be merely scattered off the nucleus without being absorbed. The probability for this process is represented by the scattering cross section σ_s . Consider, for instance, the collision of neutrons with hydrogenous material. In this case, only absorption and scattering can occur, and therefore the total cross section is expressed by $\sigma = \sigma_a + \sigma_s$.

The scattering process can be subdivided further, such as by considering whether or not the scattered neutron has lost a significant fraction of its original energy. If it has, we speak of inelastic scattering, otherwise, of elastic scattering. In this discussion, we shall not find it necessary to use special symbols for these cross sections.

In the case of fissionable nuclei, we may define σ_f , the cross section for fission which is a measure of the probability that an incident neutron will cause fission of the nucleus.

The probability that a certain process occurs varies with the energy of the incoming particle. Hence, the separate cross sections vary with energy, and therefore the total cross section is also a function of energy. For instance, it is found that if ${}_{92}\text{U}^{238}$ is bombarded with neutrons of varying energy, σ_a shows a very marked energy dependence. In particular, there are certain energies at which the absorption is extraordinarily high—we then speak of a resonance process. For ${}_{92}\text{U}^{238}$ this occurs at comparatively low energies.

Neutrons that are emitted in the fission process are emitted with an average energy in the Mev region. Thus, for this discussion we speak of such neutrons as fast neutrons. If these neutrons are slowed down by losing energy in collision, they eventually move with kinetic energy equivalent to the temperature of the surroundings. It is easily calculated that room temperature corresponds to $\frac{1}{40}$ ev. Thus we speak of neutrons that possess an energy of the order of 10^{-1} ev as “thermal neutrons.”

The energy of the bombarding neutrons should always be borne in mind when the values for cross sections of refractory or other material are quoted.

More specifically, in case a certain material has a high-absorption cross section, the total cross section is primarily due to absorption. Therefore $\sigma = \sigma_a$, such as is the case for boron. In other materials, such as bismuth, the total cross section is almost entirely due to scattering. Hence, $\sigma = \sigma_s$. Many materials, however, possess nuclear properties such that both absorption and scattering play an important role, and we must consider that $\sigma = \sigma_a + \sigma_s$. The dimensions for each of these cross sections, as the name implies, are area per nucleus, usually expressed as square centimeters per nucleus. Because most of these cross sections are in the order of 10^{-24} sq cm per nucleus in magnitude, this area has been nicknamed the "barn"; *i.e.*, 1 barn = 10^{-24} sq cm per nucleus. An example of the large differences that can exist between somewhat similar nuclei both bombarded with thermal neutrons is as follows:

$$\begin{aligned}\sigma_a({}_1\text{H}^1) &= 0.31 \text{ barn} \\ \sigma_a({}_1\text{H}^2) &= 0.00065 \text{ barn}\end{aligned}$$

For most elements, the sizes of nuclear cross sections cannot be accurately predicted from present theoretical knowledge but are obtained from a variety of experimental determinations.

Table 119 indicates the effect of various nuclei on the bombarding thermal neutrons. It must be emphasized that only a trace of some elements such as boron will so limit the production of neutrons that the chain reaction cannot be sustained. For this reason, extremely high purity is required in many components of nuclear power plants. Refractory materials considered for these applications not only must be examined beforehand for the effects of major chemical constituents on the bombarding neutrons but must also be analyzed spectrographically or otherwise for microquantities of elements that could, perhaps, seriously affect the desired nuclear reaction. Cross sections for nuclei-bombarded neutrons at higher energy levels may be found from curves.⁽⁴⁾

In order to produce a self-sustaining chain reaction, it is evident that the number of neutrons available in the fuel (or fissionable material) must be utilized in the most efficient way. In any nuclear power production reactor, there are essentially three processes competing for these neutrons. They are

1. The absorption of neutrons by the fissionable material, which results in fission and hence more neutrons, which sustain the chain reaction.
2. The nonfission absorption by the materials in the reactor, such as the moderator material, reflectors, impurities in these materials, etc.
3. The escape of neutrons from the system.

Therefore, the condition for obtaining such a chain reaction must be such that the number of neutrons produced by fission must be equal to or slightly

TABLE 119. SOME NUCLEAR PROPERTIES OF THE ELEMENTS⁽⁴⁾

| Atomic number Z | Element | Density | | Chemical at. wt | Nuclei per cc. $N \times 10^{24}$ | Nuclear cross sections, barns | | | Cross section, cm^{-1} | |
|--------------------|---------|----------|----------|--------------------|---|----------------------------------|------------|------------|------------------------------------|-------------|
| | | g per cc | At T, °C | | | σ | σ_c | σ_s | $N\sigma_c$ | $N\sigma_s$ |
| 1 | H | 0.0709 | -252.7 | 1.0078 | 0.0424 | 20 | 0.30 | 20 | 0.013 | 0.85 |
| 2 | He | 0.126 | -268.9 | 4.003 | 0.0190 | 1.5 | 0 | 1.5 | 0 | 0.029 |
| 3 | Li | 0.53 | 20 | 6.940 | 0.0459 | 66.3 | 64 | 2 | 2.9 | 0.092 |
| 4 | Be | 1.8 | 20 | 9.02 | 0.120 | 6.1 | 0.009 | 6.1 | 0.0011 | 0.73 |
| 5 | B | 2.3 | 20 | 10.82 | 0.139 | 703 | 700 | 3 | 97 | 0.42 |
| 6 | C | 1.62 | 20 | 12.01 | 0.0805 | 4.84 | 0.0045 | 4.8 | 0.00036 | 0.39 |
| 7 | N | 0.808 | -195.8 | 14.008 | 0.0347 | 11.75 | 1.75 | 10 | 0.061 | 0.35 |
| 8 | O | 1.14 | -183 | 16.000 | 0.0429 | 4.1 | 0.0016 | 4.1 | 0.000068 | 0.18 |
| 9 | F | 1.11 | -187 | 19.00 | 0.0351 | 4.1 | 0.065 | 4.1 | 0.0023 | 0.14 |
| 10 | Ne | 0.9002 | | 20.183 | 0.0268 | 2.8 | | ~2.5 | | 0.067 |
| 11 | Na | 0.93 | 97.5 | 22.997 | 0.0243 | 4 | 0.5 | 3.5 | 0.012 | 0.085 |
| 12 | Mg | 1.57 | 650 | 24.32 | 0.0389 | 4 | 0.4 | 3.6 | 0.016 | 0.14 |
| 13 | Al | 2.4 | 658 | 26.97 | 0.0536 | 1.7 | 0.23 | 1.5 | 0.012 | 0.080 |
| 14 | Si | 2.4 | 20 | 28.06 | 0.0515 | 1.95 | 0.25 | 1.7 | 0.013 | 0.088 |
| 15 | P | 1.745 | 44.5 | 30.98 | 0.0339 | 10.3 | 0.31 | 10 | 0.01 | 0.34 |
| 16 | S | 1.808 | 115 | 32.06 | 0.0339 | 2 | 0.53 | 1.5 | 0.018 | 0.051 |
| 17 | Cl | 1.557 | -33.6 | 35.457 | 0.0264 | <43 | 33 | ~10 | 0.87 | ~0.26 |
| 18 | A | 1.402 | -185.7 | 39.944 | 0.0211 | 2.53 | 0.62 | 1.9 | 0.013 | 0.040 |
| 19 | K | 0.83 | 62 | 39.096 | 0.0128 | 3.7 | 2.2 | 1.5 | 0.028 | 0.019 |
| 20 | Ca | 1.55 | 20 | 40.08 | 0.0233 | 9.93 | 0.43 | 9.5 | 0.01 | 0.22 |
| 21 | Sc | 2.5 | 20 | 45.10 | 0.0334 | | 2.8 | | 0.094 | |
| 22 | Ti | 4.5 | 20 | 47.90 | 0.0566 | 11.2 | 5.2 | 6 | 0.29 | 0.34 |
| 23 | V | 5.68 | 20 | 50.95 | 0.0704 | >13 | 6 | >7 | 0.42 | >0.49 |
| 24 | Cr | 7.14 | 20 | 52.01 | 0.0822 | 6.5 | 3 | 4 | 0.25 | 0.33 |
| 25 | Mn | 7.2 | 20 | 54.93 | 0.0789 | 15.2 | 12.8 | 2.4 | 1.01 | 0.19 |
| 26 | Fe | 6.9 | 1530 | 55.85 | 0.0744 | 12 | 2.5 | 11 | 0.19 | 0.82 |
| 27 | Co | 8.9 | 20 | 58.94 | 0.0909 | 38 | 33 | 5 | 3.0 | 0.45 |
| 28 | Ni | 8.90 | 20 | 58.69 | 0.0913 | 17.4 | 4.4 | 18 | 0.40 | 1.6 |
| 29 | Cu | 8.3 | 1083 | 63.57 | 0.0786 | 11.2 | 4 | 8 | 0.31 | 0.63 |
| 30 | Zn | 6.7 | 463 | 65.38 | 0.0617 | 4.85 | 1.25 | 4.2 | 0.077 | 0.26 |
| 31 | Ga | 5.91 | 20 | 69.72 | 0.0510 | 20 | 2.3 | 18 | 0.12 | 0.92 |
| 32 | Ge | 5.36 | 20 | 72.60 | 0.0444 | 25 | ~0.6 | 22 | ~0.03 | 0.98 |
| 33 | As | 2.0 | 20 | 74.91 | 0.0161 | 12.6 | 5.6 | 7 | 0.09 | 0.11 |
| 34 | Se | 4.50 | 25 | 78.96 | 0.0343 | 28 | 16 | 10 | 0.55 | 0.34 |
| 35 | Br | 3.119 | 20 | 79.916 | 0.0235 | 9.5 | 2.5 | 7 | 0.059 | 0.16 |
| 36 | Kr | (2) | | 83.7 | 0.0144 | 27 | 0.1 | 27 | 0.001 | 0.39 |
| 37 | Rb | 1.53 | 20 | 85.48 | 0.0104 | 12 | 0.5 | 11 | 0.005 | 0.11 |
| 38 | Sr | 2.6 | 20 | 87.63 | 0.0179 | 11 | 1.5 | 10 | 0.027 | 0.18 |
| 39 | Y | 5.51 | 20 | 88.92 | 0.0373 | | 1.1 | | 0.041 | |
| 40 | Zr | 6.4 | 20 | 91.22 | 0.0422 | 15 | >0.5 | 14 | >0.021 | 0.59 |
| 41 | Cb | 8.57 | 20 | 92.91 | 0.0555 | 6.9 | 1.4 | 5 | 0.078 | 0.28 |
| 42 | Mo | 10.2 | 20 | 95.95 | 0.0638 | 7.9 | 3.9 | 6.5 | 0.25 | 0.41 |
| 43 | Tc | | | 99 | | | | | | |
| 44 | Ru | 12.2 | 20 | 101.7 | 0.0502 | | | 6 | | 0.30 |
| 45 | Rh | 12.5 | 20 | 102.91 | 0.0496 | 155 | 150 | 5 | 7.4 | 0.25 |
| 46 | Pd | 11 | 1550 | 106.7 | 0.0639 | 13.5 | 9 | 4.5 | 0.58 | 0.29 |
| 47 | Ag | 10.5 | 20 | 107.880 | 0.0567 | 66.4 | 58.5 | 6.8 | 3.3 | 0.37 |
| 48 | Cd | 8.6 | 20 | 112.41 | 0.0461 | 2507.2 | 2500 | 5.3 | 115 | 0.24 |
| 49 | In | 7.3 | 20 | 114.76 | 0.0383 | 194 | 190 | 4 | 7.3 | 0.15 |
| 50 | Sn | 5.750 | 20 | 118.70 | 0.0292 | 4.89 | 0.69 | 5.0 | 0.020 | 0.15 |

TABLE 119. SOME NUCLEAR PROPERTIES OF THE ELEMENTS (Continued)

| Atomic number Z | Element | Density | | Chemical at. wt | Nuclei per cc. $N \times 10^{24}$ | Nuclear cross sections, barns | | | Cross section, cm^{-1} | |
|--------------------|---------|---------------------|----------|--------------------|---|----------------------------------|------------|------------|------------------------------------|-------------|
| | | g per cc | At T, °C | | | σ | σ_c | σ_a | $N\sigma_c$ | $N\sigma_a$ |
| 51 | Sb | 6.68 ^d | 25 | 121.76 | 0.0330 | 9 | 4.7 | 4.2 | 0.155 | 0.14 |
| 52 | Te | (\emptyset)6.00 | 20 | 127.61 | 0.0283 | 10 | 5 | 5 | 0.14 | 0.14 |
| 53 | I | 4.93 | 20 | 126.92 | 0.0234 | 9.4 | 6.8 | 3 | 0.16 | 0.07 |
| 54 | Xe | (2.7) | | 131.3 | 0.0124 | 35 | | | | |
| 55 | Cs | 1.90 | 20 | 132.91 | 0.0086 | 50 | 41 | 9 | 0.35 | 0.08 |
| 56 | Ba | 3.5 | 20 | 137.36 | 0.0153 | 9.25 | 1.25 | 8 | 0.019 | 0.12 |
| 57 | La | 6.15 | 20 | 138.92 | 0.0267 | 25 | 12 | 13 | 0.32 | 0.35 |
| 58 | Ce | 6.9 | 20 | 140.13 | 0.0296 | 29 | | | | |
| 59 | Pr | 6.50 | 20 | 140.92 | 0.0278 | >25 | | | | |
| 60 | Nd | 6.90 | 20 | 144.27 | 0.0288 | | 90 | | 2.6 | |
| 61 | Pm | | | 147 | | | | | | |
| 62 | Sm | 7.7 | 20 | 150.43 | 0.0308 | | 8,000 | | 246 | |
| 63 | Eu | | | 152.0 | | | 2,500 | | | |
| 64 | Gd | | | 156.9 | | | ~38,000 | | | |
| 65 | Tb | | | 159.2 | | 15 | | | | |
| 66 | Dy | | | 162.46 | | | 850 | | | |
| 67 | Ho | | | 164.94 | | | 65 | | | |
| 68 | Er | | | 167.2 | | | 260 | | | |
| 69 | Tm | | | 169.4 | | | 130 | | | |
| 70 | Yb | | | 173.04 | | 65 | | | | |
| 71 | Lu | | | 174.99 | | | 195 | | | |
| 72 | Hf | 11.4 | 20 | 178.6 | 0.0384 | 130 | 120 | 10 | 4.6 | 0.38 |
| 73 | Ta | 16.6 | 20 | 180.88 | 0.0552 | 24.5 | 35 | 7.2 | 1.93 | 0.40 |
| 74 | W | 19.3 | 20 | 183.92 | 0.0631 | 20.9 | 16 | 5.7 | 1.01 | 0.36 |
| 75 | Re | 20 | 20 | 186.31 | 0.0691 | | 130 | | 9.0 | |
| 76 | Os | 22.48 | 20 | 190.2 | 0.0707 | 30 | 20 | 10 | 1.41 | 0.71 |
| 77 | Ir | 22.4 | 20 | 193.1 | 0.0699 | | 400 | | 27.9 | |
| 78 | Pt | 19 | 1755 | 195.23 | 0.0586 | 21.5 | 10.8 | 12 | 0.63 | 0.70 |
| 79 | Au | 19.3 | 20 | 197.2 | 0.0589 | 101 | 94.5 | 5 | 5.57 | 0.29 |
| 80 | Hg | 14.19 | -38.9 | 200.61 | 0.0426 | 440 | 425 | 15 | 18.1 | 0.64 |
| 81 | Tl | 11.85 | 20 | 204.39 | 0.0349 | 16.9 | 2.9 | 9.7 | 0.101 | 0.34 |
| 82 | Pb | 11.34 | 20 | 207.21 | 0.0329 | 10.2 | 0.17 | 13 | 0.006 | 0.43 |
| 83 | Bi | 9.8 | 20 | 209.00 | 0.0282 | 8.9 | 0.016 | 9.2 | 0.0005 | 0.26 |
| 84 | Po | | | 210 | | | | | | |
| 85 | At | | | 211 | | | | | | |
| 86 | Rn | 4.40 | 20 | 222 | 0.0108 | | | | | |
| 87 | | | | 223 | | | | | | |
| 88 | Ra | 5.0 | 20 | 226.05 | 0.0133 | | | | | |
| 89 | Ac | | | 227 | | | | | | |
| 90 | Th | 11.5 | 20 | 232.12 | 0.0290 | 16 | 6 | ~10 | 0.17 | ~0.29 |
| 91 | Pa | | | 231 | | | | | | |
| 92 | U | 18.7 | 20 | 238.07 | 0.0473 | 10 | ~2 | 8.2 | 0.095 | 0.39 |
| 93 | Np | | | 237 | | | | | | |
| 94 | Pu | | | 239 | | | | | | |
| 95 | Am | | | 241 | | | | | | |
| 96 | Cm | | | 242 | | | | | | |

greater than the number consumed or lost in all the three above-mentioned processes. The smallest amount of fissionable material that can be used in any specific chemical or physical form in order to sustain a chain reaction is therefore defined by the effects of the three above-mentioned processes. This smallest amount of material is called the "critical size."

3. Nuclear Fuel. A primary nuclear fuel is defined, for purposes of this discussion, as a naturally occurring fissionable isotope. A secondary nuclear fuel is a fissionable isotope that is made synthetically by utilizing the nuclear properties of a primary fuel.

Uranium (${}_{92}\text{U}^{235}$) is the primary nuclear fuel. Of all the isotopes occurring in nature this one is unique in that it undergoes fission with thermal neutrons and, in the fission process, liberates from one to three neutrons. By virtue of this property, it is possible to have a chain-reacting system.

Plutonium (${}_{94}\text{Pu}^{239}$) is the most important of the secondary fuels. This synthetic element is made at Hanford from natural uranium in the following way: A large number of bars of pure natural uranium metal (containing approximately 139 parts of the isotope ${}_{92}\text{U}^{238}$ and 1 part of the fissionable isotope ${}_{92}\text{U}^{235}$) are surrounded by a matrix of very pure graphite. The graphite matrix, called a "moderator," is used to help slow down the neutrons as is shown in Fig. 368. The moderator can be made of other material such as heavy water (deuterium) or a beryllium compound. It should be mentioned that low-energy neutrons are preferable, since in the case of natural uranium, the lighter nucleus of the less abundant isotope ${}_{92}\text{U}^{235}$, although it can be made to fission by fast neutrons, is far more susceptible to fission by thermal neutrons. The requirements for a moderator nucleus, therefore, are that it should not possess a high-absorption cross section and that its mass should be as low as possible so that the neutron loses a high amount of energy per collision. Graphite was chosen at Hanford in favor of deuterium or beryllium. This assemblage of uranium and graphite is called a "pile."

The heavier nucleus of the more abundant isotope ${}_{92}\text{U}^{238}$ is not fissionable by thermal neutrons; but when a neutron of intermediate speed contacts this nucleus, it is very likely to be absorbed, as explained previously. Thus, when a fast neutron is born and encounters a ${}_{92}\text{U}^{238}$ nucleus, it is not likely to be absorbed but loses energy in bouncing about the carbon nuclei (inelastic collisions); and after it has been slowed down appreciably, there will be resonance absorption by a ${}_{92}\text{U}^{238}$ nucleus. Other neutrons will not undergo the resonance-absorption process in ${}_{92}\text{U}^{238}$, and these will be further slowed down all the way to thermal energies and help to sustain the reaction by causing fission of the ${}_{92}\text{U}^{235}$.

For purposes of plutonium production, we are interested in those neutrons which do get absorbed by the ${}_{92}\text{U}^{238}$. Upon absorption of a deener-

the plutonium can be extracted from the uranium by chemical methods, since the two elements are chemically dissimilar. Therefore, the possibility is at hand to use all the natural uranium as fuel and not be limited to the 0.7 per cent of ${}_{92}\text{U}^{235}$ in natural uranium, provided that the source of chain-reacting neutrons is replenished. However, the material in the pile must be periodically reprocessed to remove all the fission fragments that

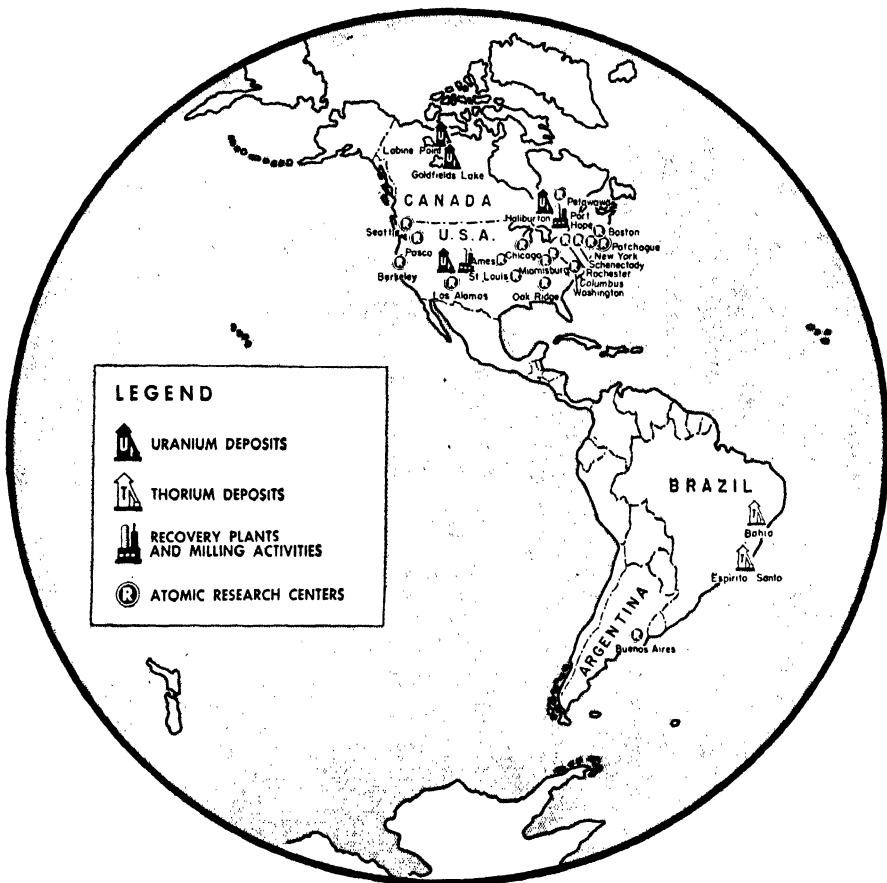
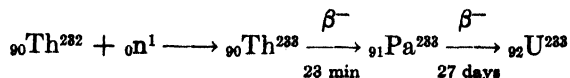

FIG 369. World sources of fissionable materials. (Courtesy of Fortune Magazine.)

tend to add further to the capturing nuclei present in the pile and therefore lower the reactivity.

The other secondary fuel is ${}_{92}\text{U}^{233}$. This isotope can be made synthetically if ${}_{90}\text{Th}^{232}$ is incorporated in the primary nuclear reactor as described for the production of plutonium. The reaction is as follows:



Although no technological details are available in regard to $^{92}\text{U}^{238}$, it is known that it undergoes fission with thermal neutrons and for this reason is also a potential nuclear fuel.

The maps (Figs. 369) offer some pertinent facts about the availability of fuels.

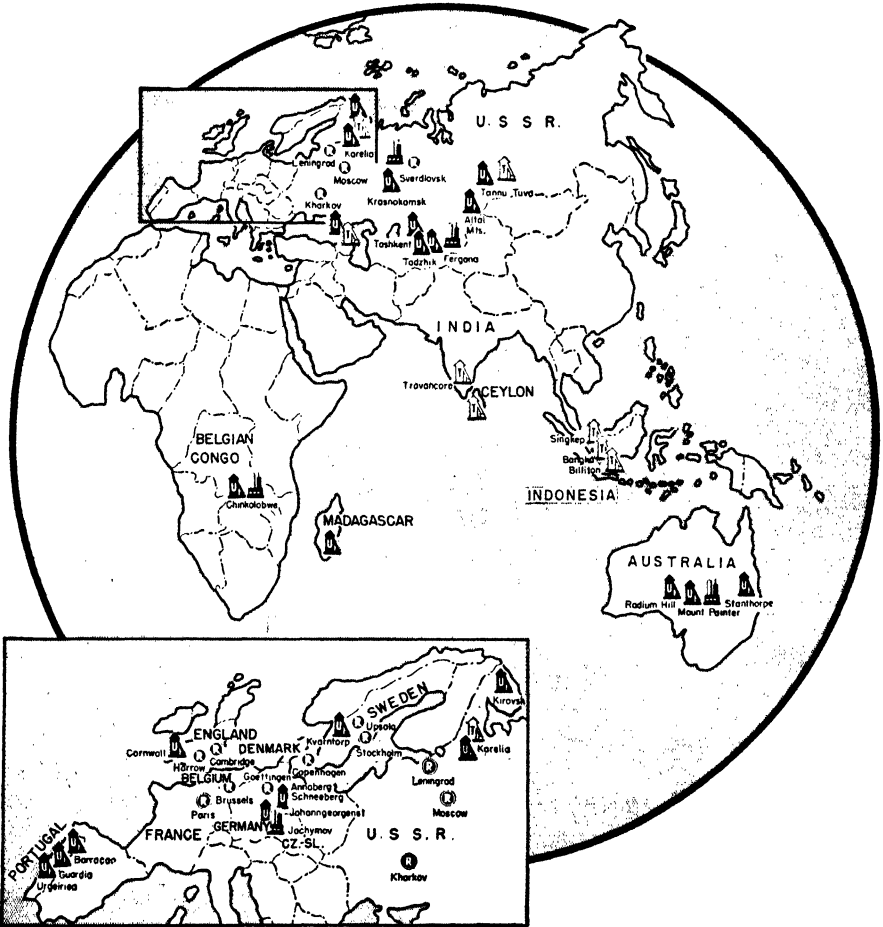

FIG. 369 (Continued)

4. Design of Power Piles or Reactors. The energy obtained from nuclear fission can be made available in the form of heat within the pile, or reactor. Before describing the actual designs of reactors that have been made and possible future designs of reactors for power purposes, it might be well to discuss how the heat from the pile, or reactor, can be utilized. Many impractical suggestions have been made, but apparently the only one that has a firm basis utilizes a circulating fluid, either liquid or gas,

which passes through the reactor operated at a finite temperature level. The hot fluid is then sent through a heat exchanger where water is converted to steam, which is used to run a turbine, or where the hot fluid in the form of a vapor or gas can be used to drive a high-temperature gas turbine. It is necessary to work at the highest temperature level for good efficiency. The failure of materials to stand up at high temperatures is the most important limiting factor. Refractory materials, such as high-melting-point oxides,

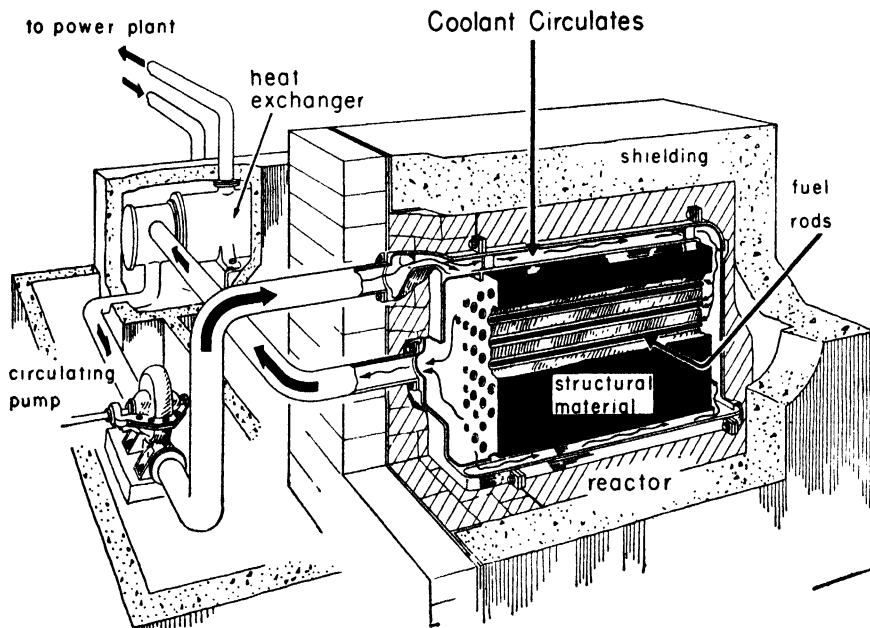

FIG. 370. Heterogeneous reactor with solid diluent and circulating coolant.⁽⁶⁾

seem to be most encouraging owing to their stability and strengths at elevated temperatures.

Reactors are considered to be of two classes: heterogeneous and homogeneous. In the heterogeneous reactor, the fissionable material is in rods or lumps such as was described for the pile used in the production of plutonium from natural uranium. In the homogeneous reactor, the fissionable material may be used in pure, metallic form, in metallic alloy form, or in the form of a solution or intimate mixture with a diluent.

Each of these two classes of reactors can be of three general types: fast, intermediate, or thermal—so named for the average energy of the neutrons that propagate the chain reaction.

The fluid or material used for the transferring of heat from the reactor

to the prime mover must possess the best over-all properties that satisfy the following conditions:

1. Must possess good nuclear properties; small absorption cross section and, in some cases, high moderating power.
2. Must be able to withstand high temperatures.
3. Must possess high heat transfer values.
4. Must not be made highly radioactive in the reactor.
5. Must not corrode or react with other materials in the reactor

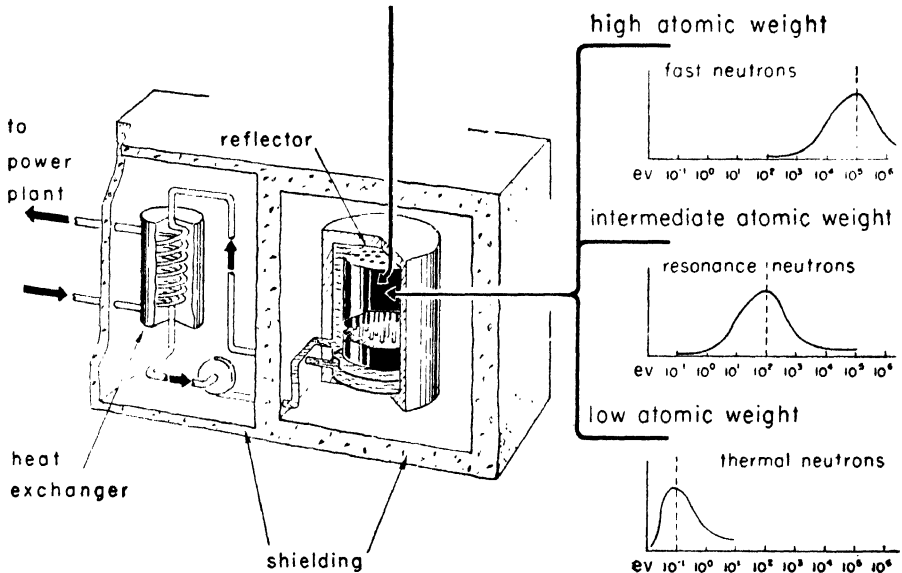

FIG. 371. Schematic diagram of a homogeneous reactor containing a solid fuel mixture. The cylindrical core or central section consists of a high-melting-point mixture of U or Pu.⁽⁴⁾

Materials that have been suggested are gases such as helium and air, liquids such as water and liquid metals, and homogeneous mixtures of the fuel itself dissolved or suspended in a liquid. The general heat-transfer problems are discussed by E. R. Gilliland.⁽⁴⁾

Table 120 is a summary of nuclear reactors that have been built thus far. None of the piles, or nuclear reactors, have been used for the production of useful, peacetime power. The Hanford-type pile as was mentioned previously is a primary reactor used to produce plutonium and is cooled by water, not to produce subsequent useful power, but to prevent the overheating of the pile. The Alamogordo, Hiroshima, Nagasaki, and Bikini fast reactors were military weapons, which liberated a vast amount of energy in extremely short intervals of time.

To form a reactor that can be used for the production of useful power, we have a number of possibilities, which are clearly discussed by Fermi.⁽⁵⁾

TABLE 120. SUMMARY OF NUCLEAR REACTORS⁽⁹⁾
Described in Open Literature

| Location | Initial dates | Class | Type | Fissionable material | Moderator | Coolant | Power developed or energy released | Reference |
|---|-------------------------------|--------|---------|----------------------|---------------------------|------------------|------------------------------------|-----------|
| University of Chicago. (West Stands) | Dec. 2, 1942 | Heter. | Thermal | U + U oxide (lumps) | Graphite | None | 200 watts | (1) |
| Oak Ridge | Nov. 4, 1943 | Heter. | Thermal | U (Al-clad rods) | Graphite | Air | > 2000 kw | (2) |
| Argonne | Spring, 1943 | Heter. | Thermal | U + U oxide (lumps) | Graphite | None | Few kw | (3) |
| Hanford (three) | Summer, 1944— Spring, 1945 | Heter. | Thermal | U (Al-clad rods) | Graphite | Water | >> 10 ⁵ kw | (4) |
| Argonne | May 15, 1944 | Heter. | Thermal | U (rods) | D ₂ O | D ₂ O | > 300 kw | (5) |
| Los Alamos | 1944 ? | Homo. | Thermal | Enriched U | H ₂ O | H ₂ O | 10 kw | (6) |
| Chalk River | Fall, 1945 | Heter. | Thermal | U (rods) | D ₂ O | D ₂ O | 3.5 watts | (7) |
| Alamogordo | July 16, 1945 | Homo. | Fast | U-235 or Pu-239 | None | None | > 10 ⁵ tons TNT | (8) |
| Hiroshima | Aug. 6, 1945 | Homo. | Fast | U-235 or Pu-239 | None | None | > 10 ⁵ tons TNT | (8) |
| Nagasaki | Aug. 9, 1945 | Homo. | Fast | U-235 or Pu-239 | None | None | > 10 ⁵ tons TNT | (8) |
| Bikini (two) | July 1 and July 25, 1946 | Homo. | Fast | U-235 or Pu-239 | None | None | > 10 ⁵ tons TNT | (8) |
| Haigerloch, Germany. | ? | Heter. | Thermal | U (2 tons) | D ₂ O (2 tons) | ? | ? | (9) |
| Los Alamos | Sept. 6, 1947 | Homo. | Fast | Pu-239 | C (10 tons) None | ? | ? | (10) |

References:

- Smyth report (1); Section 6.29 and Appendix 4; (2): Sections 6.44, 8.37, 8.43, 8.53; (3): 8.28; (4): Sections 7.19, 8.53; (5): 8.27, 8.32; (7): Appendix 6.
 (6): R. F. Christy, verbal report Chicago meetings, American Physical Society, July, 1946. *Abstract Bull. Am. Phys. Soc.*, December, 1946.
 (8): *Chem. Eng. News*, pp. 1782-1786, July 10, 1946; *Life*, pp. 25-29, July 15, 1946; *Power*, pp. 83-91, September, 1946.
 (9): Quotation from W. Heisenberg, *Boston Herald*, Feb. 24, 1947.
 (10): Science News Letter, Sept. 6, 1947.

Results indicate that natural uranium cannot be used for fuel in a self-sustaining *homogeneous* thermal reactor unless heavy water is used as a moderator. It can, however, be used as a fuel in a self-sustaining *heterogeneous* reactor using graphite as a moderator such as was mentioned for the production of plutonium in the Hanford piles. Figures 370 and 371 are proposed designs for a heterogeneous and homogeneous reactor, respectively.

In the case of the *homogeneous* reactor, the cylindrical core, or central section, could consist of a high-melting-point mixture of plutonium or uranium with a selected diluent. An alloy or a simple mechanical mixture of metal or compound with a diluent might be used. The core could be fabricated in sections or as a subcritical whole. It should be possible to obtain sufficient excess reactivity for operation from the introduction of the coolant and the addition of a reflector or material having a high scattering cross section. The coolant used could be either liquid or gas. Table 121 lists some possibilities for the components of a reactor when enriched uranium is considered as the fuel.

In the case of the *heterogeneous* reactor, the fuel rods, clad with a non-corrosive metallic coating, could be mounted horizontally in a structural

TABLE 121. SUMMARY OF MATERIALS OF CONSTRUCTION FOR HOMOGENEOUS NUCLEAR REACTORS THAT MIGHT OPERATE AT VERY HIGH TEMPERATURES⁽⁴⁾
Enriched Uranium Assumed in Each Case

| Type | Reactor materials | Mp, °C | Reflector | | Limitations |
|-----------|------------------------------------|--------|--------------------------------|-------------|------------------------------------|
| | | | Materials | Max. T., °C | |
| Fast* | U | 1150 | W | 3370 | Oxidation of W |
| Fast* | U + W | <3370 | W | 3370 | Oxidation of W and U |
| Fast* | U | 1150 | C | 3500 | Oxidation of C |
| Fast* | U + Th | <1150 | ThO ₂ | >3000 | |
| Resonance | U + Ta | ? | Ta | 2800 | Oxidation of Ta |
| Resonance | U + Re | <1150 | Re | 3400 | Scarcity of Re |
| Resonance | U + Cu | <1150 | MgO | 2800 | |
| Resonance | U + Cu | <1150 | ThO ₂ | >3000 | |
| Resonance | U + MgO | ? | MgO | 2800 | |
| Thermal | U + Be | <1150 | BeO | 2600 | |
| Thermal | U + BeO | ? | BeO | 2600 | Thermal stresses |
| Thermal | UC ₂ | 2260 | C | 3500 | Oxidation of C |
| Thermal | U + C | ? | MgO | 2800 | |
| Thermal | UO ₃ | 2500 | MgO | 2800 | |
| Thermal | U + Be ₂ C | ? | Be ₂ C | 2100 | Decomposition of Be ₂ C |
| Thermal | U + Al ₂ O ₃ | ? | Al ₂ O ₃ | 2500 | |

* Assumed to operate with molten core.

material that serves as a moderator in a thermal unit or as a diluent in a resonance or fast unit. A removable section of shielding allows the end manifold to be removed for replacement of fuel and other parts. Because of the intense radiations, this work would have to be accomplished by remote-controlled devices. The coolant would probably be a liquid; however, for special cases a gas coolant could probably be used whereby a

TABLE 122. SOME HIGH-MELTING-POINT COMPOUNDS OF URANIUM

| Material | Melting Point, °C |
|-------------------------------|-------------------|
| U | About 1150 |
| UO ₂ | 2180 |
| U ₂ C ₃ | 2400 |
| UN | ? |
| UB | ? |
| US | Above 2000 |
| U ₂ S ₃ | 1850 |
| US ₂ | 1850 |

TABLE 123. ELEMENTS HAVING LARGE ABSORPTION CROSS SECTIONS⁽⁴⁾
For Thermal Neutrons

| Materials | Atomic No. Z | Nuclear cross sections, barns | | |
|----------------------|-----------------|-------------------------------|------------|------------|
| | | σ | σ_a | σ_s |
| Lithium | 3 | 66.3 | 64 | 2 |
| Boron | 5 | 703 | 700 | 3 |
| Manganese | 25 | 15.2 | 12.8 | 2.4 |
| Cobalt | 27 | 38 | 33 | 5 |
| Rhodium | 45 | 155 | 150 | 5 |
| Silver | 47 | 66.4 | 58.5 | 6.6 |
| Cadmium | 48 | 2,507.2 | 2,500 | 5.3 |
| Indium | 49 | 194 | 190 | 4 |
| Cesium | 55 | 50 | 41 | 9 |
| Samarium | 62 | | 8,000 | |
| Europium | 63 | | 2,500 | |
| Gadolinium | 64 | | 38,000 | |
| Dysprosium | 66 | | 850 | |
| Holmium | 67 | | 65 | |
| Erbium | 68 | | 260 | |
| Thulium | 69 | | 130 | |
| Lutecium | 71 | | 195 | |
| Hafnium | 72 | 130 | 120 | 10 |
| Tantalum | 73 | 24.5 | 35 | 7.2 |
| Rhenium | 75 | | 130 | |
| Iridium | | | 400 | |
| Gold | 79 | 101 | 94.5 | 5 |
| Mercury | 80 | 440 | 425 | 15 |

substantially larger proportion of the reactor volume would be required for the coolant.

5. Survey of Refractories for Potential Use in Power Reactor Development. Refractory materials may find application in the following four major components of the pile:

1. Fuel
2. Control rods
3. Reflector
4. Moderator

Refractories for Fuel. In some types of homogeneous and heterogeneous reactors, it may be necessary to use pure metallic fissionable materials for fuel. As was mentioned before, at elevated temperatures these reactors would operate with a molten core. In some types of reactors, it may be desired to maintain the fuel in solid form at elevated temperatures. Table 122 suggests some of the possible high-melting-point compounds of uranium and its isotopes.

Refractories for Control Rods. Control rods are very important in that their function is to absorb the excess of neutrons in the chain reaction in the reactor. If the number of neutrons available for creating additional fis-

TABLE 124. SOME HIGH-MELTING-POINT COMPOUNDS*
OF LARGE-ABSORPTION CROSS-SECTION ELEMENTS
For Thermal Neutrons

| Material | Formula | Melting point, °C |
|-----------------------|--------------------------------|-------------------|
| Lithium oxide..... | Li ₂ O | 1700 |
| Boron..... | B | 2300 |
| Boron carbide..... | B ₄ C | 2350 |
| Boron nitride..... | BN | 2730 |
| Manganese oxide..... | MnO | 1790 |
| Cobalt oxide..... | CoO | 1800 |
| Rhodium..... | Rh | 1950 |
| Indium oxide..... | In ₂ O ₃ | 2000 |
| Hafnium..... | Hf | 1700 |
| Hafnium oxide..... | HfO ₂ | 2810 |
| Hafnium carbide..... | HfC | 3530 |
| Hafnium nitride..... | HfN | 3307 |
| Tantalum..... | Ta | 2850 |
| Tantalum oxide..... | Ta ₂ O ₅ | 1875 |
| Tantalum carbide..... | TaC | 3880 |
| Tantalum nitride..... | TaN | 3087 |
| Rhenium..... | Re | 3000 |
| Samarium sulfide..... | Sm ₂ S ₃ | 1900 |

* Most of the elements and/or compounds thereof except for the oxides could not be maintained at elevated temperatures in normal atmospheres.

sions was not controlled, the chain reaction would get out of hand and the reactor components would melt and contaminate a large area with highly radioactive material. Therefore, it may be said that the control rods govern the pile temperature. A control-rod should have a high absorption cross section as well as high chemical and physical stability at high temperatures. Table 123 lists the elements that possess large absorption cross sections. Table 124 lists some high-melting-point compounds of these elements which could perhaps be used as control rods. On the other hand,

TABLE 125. ELEMENTS POSSESSING LARGE SCATTERING CROSS SECTIONS⁽⁴⁾
For Thermal Neutrons

| Material | Atomic No. <i>Z</i> | Nuclear σ | Cross sections, barns | |
|-----------------|------------------------|---------------------|-----------------------|------------|
| | | | σ_a | σ_s |
| Hydrogen..... | 1 | 20 | 0.30 | 20 |
| Helium..... | 2 | 1.5 | 0 | 1.5 |
| Beryllium..... | 4 | 6.1 | 0.009 | 6.1 |
| Carbon..... | 6 | 4.84 | 0.0045 | 4.8 |
| Nitrogen..... | 7 | 11.75 | 1.75 | 10 |
| Oxygen..... | 8 | 4.1 | 0.0016 | 4.1 |
| Fluorine..... | 9 | 4.1 | 0.065 | 4.1 |
| Sodium..... | 11 | 4 | 0.5 | 3.5 |
| Magnesium..... | 12 | 4 | 0.4 | 3.6 |
| Phosphorus..... | 15 | 10.3 | 0.31 | 10 |
| Calcium..... | 20 | 9.93 | 0.43 | 9.5 |
| Iron..... | 26 | 12 | 2.5 | 11 |
| Nickel..... | 28 | 17.4 | 4.4 | 18 |
| Zinc..... | 30 | 4.85 | 1.25 | 4.2 |
| Gallium..... | 31 | 20 | 2.3 | 18 |
| Germanium..... | 32 | 25 | 0.6 | 22 |
| Bromine..... | 35 | 9.5 | 2.5 | 7 |
| Krypton..... | 36 | 27 | 0.1 | 27 |
| Rubidium..... | 37 | 12 | 0.5 | 11 |
| Strontium..... | 38 | 11 | 1.5 | 10 |
| Zirconium..... | 40 | 15 | 0.5 | 14 |
| Columbium..... | 41 | 6.9 | 1.4 | 5 |
| Ruthenium..... | 44 | | | 6 |
| Tin..... | 50 | 4.89 | 0.69 | 5.0 |
| Barium..... | 56 | 9.25 | 1.25 | 8 |
| Thallium..... | 81 | 16.9 | 2.9 | 9.7 |
| Lead..... | 82 | 10.2 | 0.17 | 13 |
| Bismuth..... | 83 | 8.9 | 0.016 | 9.2 |
| Thorium*..... | 90 | 16 | 6 | 10 |
| Uranium*..... | 92 | 10 | 2 | 8.2 |

* Thorium and uranium might be used as reflectors. There would be the possibility of forming secondary fuels in the process.

control rods may be cooled so that lower temperature materials may be used.

Refractories for Reflectors. The layer of material immediately surrounding the reactor is of great importance in preventing the escape of neutrons, for it is evident that the excessive escape of neutrons would reduce the efficiency of the reactor. Reflector materials should possess a large scattering cross section. Table 125 lists some of the elements possessing large

TABLE 126. SOME HIGH-MELTING-POINT COMPOUNDS OF LARGE SCATTERING CROSS-SECTION ELEMENTS For Thermal Neutrons

| Material | Formula | Melting point, °C |
|-------------------|--------------------------------|-------------------|
| Beryllium oxide | BeO | 2520 |
| Beryllium carbide | Be ₂ C | 2100 decomposes |
| Peryllium nitride | Be ₃ N ₂ | 2200 |
| Carbon | C | 3500 |
| Magnesium oxide | MgO | 2800 |
| Magnesium sulfide | MgS | 2000 |
| Calcium oxide | CaO | 2570 |
| Iron | Fe | |
| Iron oxide | Fe ₂ O ₃ | 1550 |
| Nickel | | |
| Nickel oxide | Ni | 1960 |
| Zinc oxide | ZnO | 1980 |
| Gallium oxide | Ga ₂ O ₃ | 1740 |
| Strontium oxide | SrO | 2430 |
| Strontium sulfide | SrS | 2000 |
| Zirconium | Zr | 1900 |
| Zirconium oxide | ZrO ₂ | 2720 |
| Zirconium carbide | ZrC | 2750 |
| Zirconium nitride | ZrN | 2982 |
| Columbium | Cb | 1955 |
| Columbium oxide | Cb ₂ O ₅ | 1520 |
| Columbium carbide | CbC | 3770 |
| Columbium nitride | CbN | 2050 decomposes |
| Ruthenium | Ru | 2450 |
| Tin oxide | SnO ₂ | 1900 |
| Barium oxide | BaO | 1920 |
| Thorium | Th | 1845 |
| Thorium oxide | ThO ₂ | 3050 |
| Thorium carbide | ThC ₂ | 2773 |
| Thorium sulfide | ThS | 1925 |
| Uranium carbide | UC ₂ | 2260 |
| | U ₂ C ₃ | 2400 |
| Uranium nitride | UN | |
| Uranium sulfide | US | |

scattering cross sections, while Table 126 lists some of the elements possessing large scattering cross sections and compounds thereof that have high melting points.

Refractories for Moderators. A moderator must be made of a material having light nuclei and a low-absorption cross section. Table 127 is a

TABLE 127. COMPARISON OF LIGHT ELEMENTS AS MODERATORS⁽⁴⁾
The Values Given Are for Thermal Energies

| Element | A | Cross section, cm | | § | Slowing-down power $N\sigma_s\text{§}$ | Moderating ratio $\frac{\sigma_s\text{§}}{\sigma_c}$ |
|---------|------|---------------------------|------------------------|-------|---|---|
| | | Scattering $N\sigma_s$ | Capture $N\sigma_c$ | | | |
| H | 1 | 0.85 | 0.013 | 1 | 0.85 | 65 |
| D | 2 | 0.10 | 0.0000015 | 0.72 | 0.072 | 47,500 |
| He | 4 | 0.029 | 0 | 0.425 | 0.0123 | ∞ |
| Li | 7 | 0.092 | 2.9 | 0.26 | 0.024 | 0.0083 |
| Be | 9 | 0.73 | 0.0011 | 0.2 | 0.146 | 133 |
| B | 11 | 0.42 | 97 | 0.17 | 0.071 | 0.00073 |
| C | 12 | 0.39 | 0.00036 | 0.15 | 0.058 | 162 |
| N | 14 | 0.35 | 0.061 | 0.13 | 0.045 | 0.74 |
| O | 16 | 0.18 | 0.000068 | 0.12 | 0.0215 | 316 |
| F | 19 | 0.14 | 0.0023 | 0.10 | 0.014 | 6.1 |
| Ne | 20 | 0.067 | | 0.095 | 0.0064 | |
| Na | 23 | 0.085 | 0.012 | 0.083 | 0.0071 | 0.59 |
| Mg | 24 | 0.14 | 0.016 | 0.080 | 0.0112 | 0.70 |
| Al | 27 | 0.080 | 0.012 | 0.070 | 0.0056 | 0.47 |
| Si | 28 | 0.088 | 0.013 | 0.070 | 0.0062 | 0.42 |
| P | 31 | 0.34 | 0.01 | 0.06 | 0.0204 | 2.04 |
| S | 32 | 0.051 | 0.018 | 0.06 | 0.00306 | 0.17 |
| Cl | 35.5 | 0.26 | 0.87 | 0.055 | 0.0143 | 0.0165 |
| A | 40 | 0.040 | 0.013 | 0.050 | 0.0020 | 0.154 |
| K | 39 | 0.019 | 0.028 | 0.050 | 0.00095 | 0.034 |
| Ca | 40 | 0.22 | 0.01 | 0.050 | 0.011 | 1.1 |

NOTE:

N = number of nuclei per sq cm = number of atoms per sq cm.

§ = fractional energy loss of neutron per collision with a nucleus.

TABLE 128. SOME HIGH-MELTING-POINT COMPOUNDS OF HIGH-MODERATING-RATIO ELEMENTS
For Thermal Neutrons

| Material | Formula | Melting point, °C |
|-----------------------------|-------------------|-------------------|
| Beryllium oxide | BeO | 2520 |
| Beryllium carbide | Be ₂ C | 2100 decomposes |
| Carbon | C | 3500 |

comparison of the light elements as moderators. Table 128 lists a few of the high-melting-point compounds of elements possessing light nuclei.

6. Summary and Conclusions. The Atomic Energy Commission⁽⁶⁾ has recently stated

. . . practical uses of atomic power will not be developed for at least ten years and it will be still another ten years before the influence of atomic energy is felt in the world. This does not mean that by September, 1949 electric power could not be actually developed by atomic energy. But what is definitely not near at hand are large-scale, commercial applications of power from atomic energy.

Materials used in an atomic power plant must be able to stand high temperatures. These construction materials must have another special property—they must not be too prone to consume neutrons. Proper coolants must be perfected. Methods must be perfected for removing radioactive by-products from the piles. Other problems are the development of quick-acting “throttles” (control rods) and methods of shielding the workers against radiation.

Still another problem is to have adequate stocks of uranium or plutonium to activate a sizable atomic power industry. The A.E.C. has undertaken research to try to “breed” new nuclear fuel in the very process of consuming the original fuel. A breeder is a nuclear chain reactor which over a period of time will actually create more fissionable material than is put into the reactor as fuel to sustain the reaction. If this regeneration of nuclear fuels can fully replace the original materials then all of the natural uranium and the world’s supply of thorium, which is more plentiful than uranium, constitute potential nuclear fuels.

In summation, it may be said that the great interest in nuclear power is based on the following attractive features.

1. The small weight of fuel for a given power release
2. No need for gaseous oxygen, permitting use in the stratosphere
3. Possibility of a large amount of power per unit weight

The eventual use of large-scale nuclear power plants is dependent upon developments in many scientific fields. The future developments in refractory research, development, and production will undoubtedly play an important role in this realization.

7. Bibliography

1. POLLARD, E., and W.L. DAVIDSON, JR.: “Applied Nuclear Physics,” John Wiley & Sons, Inc., New York, 1942.
2. SMYTH, H.E.: “Atomic Energy for Military Purposes,” Princeton University Press, Princeton, N.J., 1946.
3. FERMI, E.: Elementary Theory of the Pile, Department of Commerce, Washington, D.C., P.B. 40764, 1946.
4. GOODMAN, C.: “The Science and Engineering of Nuclear Power,” Addison-Wesley Press, Inc., Cambridge, Mass., 1947.
5. *New York Herald Tribune*, Mar. 21, 1948.

CHAPTER XXV

REFRACTORIES FOR GAS-TURBINE AND JET-PROPULSION ENGINES

1. Introduction. Since the previous edition of this book, great strides have been made in the development of gas-turbine and jet-propulsion devices for airplanes and guided missiles. During the Second World War the Germans were particularly active in this field, producing turbo-jet fighter planes of high performances and, later, liquid-rocket-propelled planes of high speed but very short flight times. They also produced the V-1 and the V-2 guided missiles, which would have been extremely destructive to the Allies if the war had lasted longer. All these developments were based on sound fundamental research carried out in a large number of high-speed wind tunnels; and therefore, in this field they were ahead of other nations. At the same time, an interesting development of the turbo-jet engine was carried through in England by Colonel Whittle, which in many ways was superior to the contemporary German engines. During the latter part of the war and since that time, we have been very active in this country in fundamental research and applications of jet propulsion devices and have made great advances in increasing the performance of these engines. In fact, it is generally believed that no high-speed aircraft of the future will use the reciprocating engine.

It is extremely difficult to say just how far refractories will enter into the future picture of this development. At present, very little refractory is used in any of these engines, but the desire for higher temperatures, less complicated cooling devices, and less use of strategic materials has developed a great interest in refractories, and much research is now being carried out in this particular field. The problem of satisfactorily adapting the refractory is a most difficult one because of the high temperatures, high rate of temperature change, and high gas velocity; but as the amount of refractory used would be comparatively small, the cost per pound enters into the picture only to a small degree, and this has stimulated research to extend out into fields of refractories that have not previously been explored. It is hoped in this section to give a very brief picture of the jet-propulsion engine and its operating conditions, together with the possibilities of improving its performance by the use of the proper refractory.

2. Types of Power Plants. Gas Turbines. The gas turbine to supply power for marine propulsion or locomotive use is quite similar to the well-known steam turbine except that the steam is replaced by combustion gases. In Fig. 372A is shown a diagram of such a turbine. *a* is a compressor that draws in air from the atmosphere and forces it into the combustion chamber *b*, where it is mixed with atomized fuel and the mixture burned to produce a temperature of 1200 to 1500°F (about 650 to 800°C) where it enters the turbine *c*. The power derived from the turbine is carried through the shaft *d* to drive the compressor, and useful power is taken from the shaft extension *e*. It should be realized that the actual power produced by the gas turbine is several times the amount of useful power output because of the large proportion of the turbine power taken by the compressor. In spite of this, the unit is relatively compact and light compared with a unit of similar power using either a diesel engine or a steam generator and turbine. With a compression ratio of 20, if such a figure can be attained in practice, a turbine without regeneration would have a maximum efficiency⁽¹⁰⁾ of 25 per cent at 1500°F (about 820°C) turbine entrance temperature and 36 per cent at 3000°F (about 1650°C). If regeneration is used with a compression ratio of 4, these efficiencies are increased to 39 and 50 per cent, respectively. Thus, it is seen that refractories would be highly desirable for a combustion chamber and turbine parts if they could be developed with high creep values, temperature shock resistance, and fatigue resistance. In general, the atmospheric conditions in the combustion chamber and turbines are oxidizing, but there would certainly be times when at least portions of the structure would have reducing gases in contact with them. A relatively long life, perhaps 10,000 hr, is desirable for the refractories in this application.

Propeller-turbo-jet. For aircraft and guided-missile propulsion, several novel power plants are now in use. The most conventional is the so-called propeller-turbo-engine as shown in Fig. 372B. The propeller *a* is driven by the gas turbine *b*, which is also connected to the axial compressor *c* in the same way as in the previous example. Because of the high velocity of the airplane, air is forced into the diffuser *d*, built up to higher pressures by the compressor, and forced into the combustion chamber *e*, where fuel is added and burned. From here it goes through the nozzle blades *f* into the turbine and then out through the tail pipe *g*. Thrust is provided both by the power supplied to the propeller and by the inertia of the gases leaving the tail pipe. In this case, with a combustion ratio of 4, efficiencies⁽¹⁰⁾ of 24 per cent are possible with 1500°F (about 820°C) turbine-entrance temperature and 30 per cent at 3000°F (about 1650°C), again showing the value of high-temperature materials.

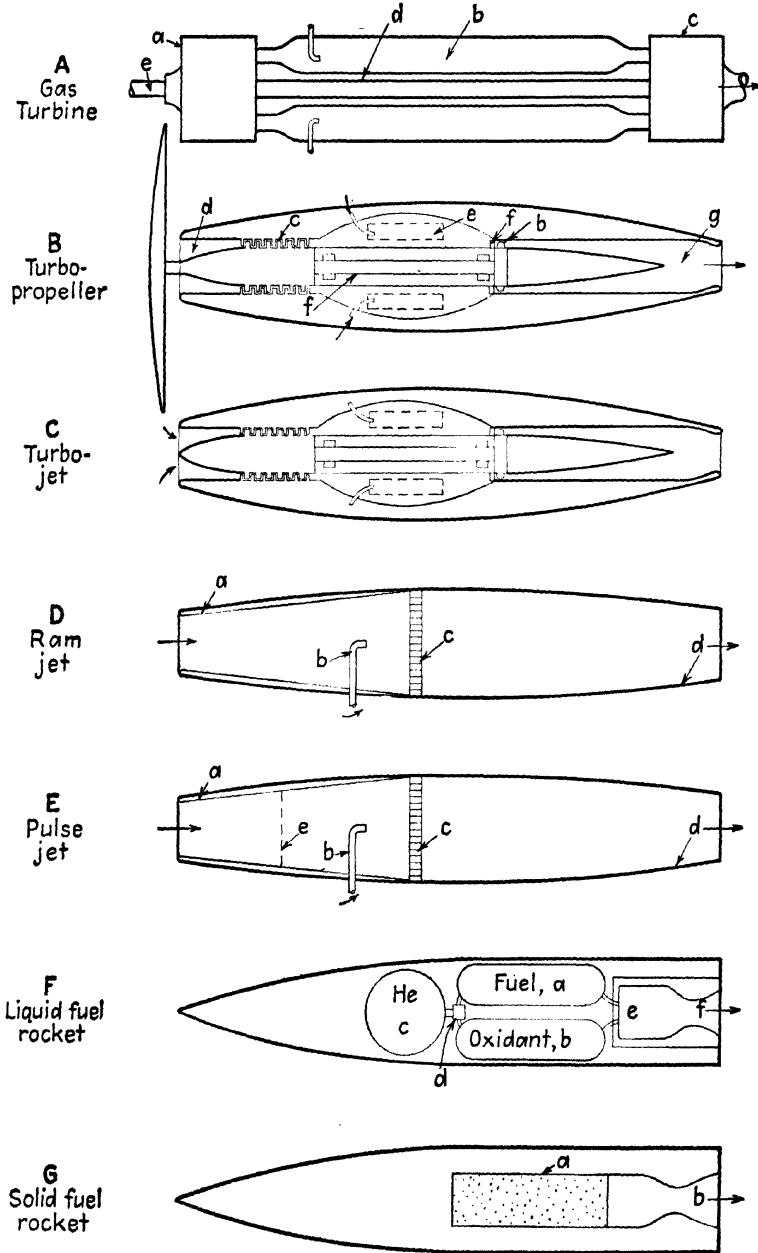

FIG. 372. Jet-propulsion engines.

Turbo-jet. The turbo-jet engine shown in *C* of Fig. 372 is the same as the previous example except that the propeller is omitted and the thrust comes entirely from the velocity of the gases passing out of the tail pipe. The effective power P delivered by such an engine is given by the following:⁽¹²⁾

$$P = \frac{W}{g} (V_1 - V_2)V_2$$

- where W = the weight of gas, lb/sec, from tail pipe
- g = the acceleration of gravity
- V_1 = the discharge velocity of the gas, ft/sec
- V_2 = the velocity of the aircraft, ft/sec

The propulsive efficiency η is given by

$$\eta = \frac{\text{output}}{\text{input}} = \frac{(W/g) (V_1 - V_2)V_2}{(W/g) (V_1^2 - V_2^2)}$$

The maximum output occurs when $V_1 = 2V_2$, and here $\eta =$ has a theoretical efficiency of 66.7 per cent.

This type of engine is relatively efficient compared with the reciprocating engine only at the higher speeds but has greater simplicity, low weight per horsepower, and, most important for high speeds, a small frontal area per horsepower. At speeds of 400 to 600 mph, the fuel consumption is now somewhat greater than for an equivalent reciprocating engine. The temperature now reached in production engines is somewhat as shown in Table 129.

TABLE 129. TEMPERATURE IN TURBO-JET ENGINES

| Part | Temperature | |
|---------------------------------------|-------------|----------|
| | °F | °C |
| Combustion chamber wall (metal)..... | 400-1200 | 200-650 |
| Gas exit from combustion chamber..... | 1500-2000 | 820-1100 |
| Turbine nozzle blades..... | 1000-1800 | 540-980 |
| Turbine buckets..... | 1000-1500 | 540-820 |
| Tail pipe..... | 500-1000 | 260-540 |
| Tail pipe gas temperature..... | 800-1500 | 430-820 |

In contradiction to other engines, this type does not show increased efficiencies⁽¹⁰⁾ with temperature above those generally used; *e.g.*, at 1500°F (about 820°C) it is only 12 per cent. However, it should be remembered that with this engine as well as the other types, higher temperature means increased thrust horsepower, so that even in this case higher temperatures

would be desirable for short periods of high output, even at the expense of greater fuel consumption.

Ram-jet. A quite different type of engine is the ram-jet shown in *D* of Fig. 372. This engine is of the most simple construction, as there are no moving parts and the structure is light. However, its efficiency is high only at supersonic speeds, and it has the disadvantage of not being self-starting, as it must be propelled up to a speed of somewhere around 400 mph before it will begin to deliver effective thrust. Air enters the diffuser *a* at the velocity of the engine and is compressed to a higher pressure at *b*, where fuel is injected and burned. A grid at *c* stabilizes the flame, and the hot gases are then forced out through the tail pipe *d* at a very high velocity, thus producing the effective thrust. With an exhaust temperature of 1500°F (about 820°C) an efficiency⁽¹⁰⁾ of 29 per cent is reached at 2,000 mph, while at 3000°F (about 1650°C) the efficiency reaches 40 per cent at somewhat over 3,000 mph. The pressure in the combustion chamber would run to 500 psi at 1,800 mph. The temperatures in the combustion chamber may run to 3000°F (about 1650°C), and the exit velocity from the tail pipe up to twice the air speed. In the latter part of 1947, it was announced that two models of ram-jet-driven missiles had exceeded 1,400 mph, or twice the speed of sound.

Pulse-jet. The pulse-jet as shown in Fig. 372*E* is similar to the preceding example except that a valve *e* permits the pressure in the combustion chamber to build up at each explosive cycle and force the hot gases through the tail pipe *d*. The pressure then drops in the combustion chamber below the dynamic pressure in the diffuser, which opens the valve *e*, fills the combustion chamber with fresh air, and the cycle is then repeated. This engine was used by the Germans on their V-1 guided missile at speeds of 400 to 500 mph. The efficiency at these speeds is not very high, but this is not important for short flights, and the simplicity of producing such a device compared with a reciprocating engine of the same power makes its use for expendable missiles quite advantageous. The atmosphere in the combustion chamber of both the ram-jet and the pulse-jet are close to neutral, but this does not mean that oxidation or reducing conditions are not occasionally obtained at various points of the structure.

Liquid-fuel Rocket. A brief history of the liquid-fuel rocket is given by Wyld.⁽¹⁶⁾ A motor of this type is shown in Fig. 372*F*. Unlike the previous engines, no air is required for combustion, so that the motor is adapted for flights at extremely high altitudes in the stratosphere. The fuel *a* and the oxidant *b* are carried in separate tanks. When the rocket is started, pressure from the helium reservoir *c* passes through the reducing and control valve *d* to force the fuel into the combustion chamber *e*, where it is immediately burned, and the exhaust gases pass out through the nozzle *f*. A rocket

motor is very light and may deliver as much as 100 thrust horsepower per pound of weight. The German V-2 rocket used liquid fuel and had the following characteristics:

TABLE 130. CHARACTERISTICS OF THE GERMAN V-2 ROCKET

| | |
|----------------------------------|-----------------------|
| Weight at start..... | 20,000 lb |
| Maximum thrust..... | 60,000 lb |
| Combustion chamber pressure..... | 225 psi |
| Flame temperature..... | 5000°F (about 2760°C) |
| Nozzle velocity..... | 8,000 ft per sec |
| Time of combustion..... | 200 sec |

A number of airplanes such as the German Me-163B and the Bell XS-1 have been flown with liquid-fuel-rocket engines. For control purposes several combustion chambers are used, as it is difficult to throttle down a single nozzle. The total time of combustion seldom exceeds 3 min. The extremely high temperatures produced in the combustion chamber and nozzles have made cooling of the walls necessary, which is generally done by recirculating some of the fuel around the wall before it enters the combustion chamber. Also fuel is sometimes injected through the wall itself to provide a film on the inner side, which gives evaporation cooling. Refractories have also been used in the nozzle section, but little information is available concerning them. Combustion conditions are usually reducing, and chamber pressures now do not exceed 300 psi, but higher pressure should be expected in the future. A few of the fuels suggested for use in rockets of this type are listed in Table 131.^(12,15)

TABLE 131. PROPERTIES OF SOME FUEL COMBINATIONS

| Fuel | Oxidant | Calculated combustion temperature | | Exhaust velocity at sea level ft per sec |
|--------------------------------|---------------------------------|-----------------------------------|------|--|
| | | °F | °C | |
| Nitromethane (monopropellant). | Red fuming nitric acid | 3950 | 2180 | 6,150 |
| Aniline..... | | 5070 | 2800 | 6,200 |
| Methyl alcohol..... | Hydrogen peroxide (76 per cent) | 4160 | 2290 | 6,300 |
| Liquid hydrogen..... | Liquid oxygen | 4390 | 2420 | 10,150 |
| Ethyl alcohol..... | Liquid oxygen | 5260 | 2910 | 6,870 |

Solid-fuel Rockets. The solid-fuel rocket is well known and is shown in G of Fig. 372. Here the fuel *a* burns in a metal combustion chamber and

passes at a high velocity through the nozzle *b*. Combustion chamber liners and nozzles of refractory would be valuable here, and much research is now being carried out on this development. The temperatures, pressures, and velocities are high but of short duration. These rockets are used as missiles such as the "bazooka" for antitank weapons and the "Jato" for assisting airplane take-offs. Chamber pressures of 500 to 4,000 psi are encountered with exit velocities up to 6,000 ft per sec. The duration, however, is seldom over 15 sec.

3. Combustion Chambers. Turbo-jets. In this engine the temperature in the combustion chamber is not particularly high, perhaps 2000°F (about 1090°C) at the most, and the pressure seldom exceeds 100 psi. However, the heat shock is severe in periods when the engine is started and stopped, and there is some erosion, which tends to carry any loosened particles into the turbine. In the conventional type of combustion chamber

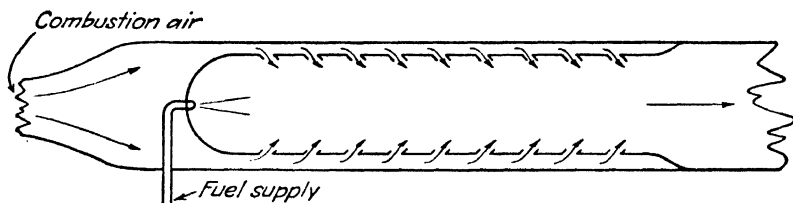

FIG. 373. Turbo-jet combustion chamber.

made of metal, as shown in Fig. 373, the cooling takes place by the surrounding air and infiltration of this air through holes in the walls of the combustion chamber. Up to the present time, the work on refractories has been mainly to attempt to produce a replica of the metal in a refractory material by the usual ceramic methods, but it would seem evident that a complete redesign to take advantage of the refractories will be necessary before a satisfactory solution is arrived at. Coatings have also been tried as a means to reduce scaling and to reduce heat flow through the combustion tube walls.

Ram-jets. As far as it is known, no refractory linings have been used in ram-jets, but a lining to permit higher flame temperatures would certainly be an advantage. Since the pressures may run up to 500 psi, the refractory would have to be rigidly supported, as breathing of the wall tends to crack the lining. The heat-shock resistance of the lining must also be good because the temperature builds up very rapidly at the start and would also drop rapidly immediately after the fuel is shut off. Coatings on the inside of the combustion chamber, however, have been tried.

There would be some advantage in producing a flame holder from refractory materials if it could be constructed to stand the heat shock and erosion of the rapidly moving gases.

Rockets. The heat release in the rocket is tremendous, amounting to as much as 20 million Btu per cu ft per min. At present it is necessary to cool the rocket walls by using the fuel regeneratively, and this works out satisfactorily only in the larger rockets because the amount of fuel is insufficient in the smaller sizes. A good refractory liner, even though thin, would materially reduce the amount of heat transferred to the fuel and might eliminate cooling entirely. However it would not, as some believe, appreciably increase the thermal efficiency, for only a very small proportion of the total heat passes through the most highly conducting wall. Here again the refractory would have to be well supported if pressures up to 300 psi were encountered, together with the severe temperature shock. Construction of the chamber lining would be a single cylinder in the smaller sizes as shown in Fig. 374A, or it might be made up in the larger sizes with

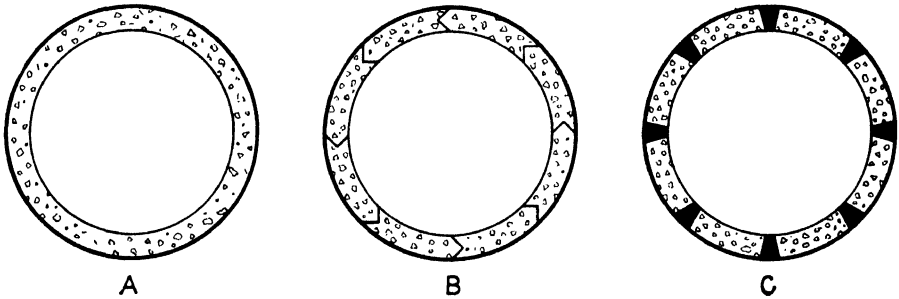

FIG. 374. Cross sections of refractory combustion-chamber liners.

a series of interlocking staves as shown in Fig. 374B with a rigid metal casing. These staves will permit a certain flexibility of the structure and give better heat-shock resistance. Another suggested method is a thin plastic refractory lining supported by pins welded to the inside of the combustion chamber much as the Bailey stud wall is used in steam boiler furnaces, as in Fig. 374C. This construction would seem to have considerable promise if its resistance to erosion could be made sufficiently great. Still another suggested method is to use a coating on the inside of the combustion chamber of a high-temperature enamel or refractory paint. Such an enamel as developed by the Bureau of Standards⁽¹⁴⁾ has proved quite interesting in tests, as it reduces corrosion and permits less heat flow into the metal. More recent work at the University of Illinois has produced some interesting coatings for metal and graphite.^(17,18)

4. Nozzles. *Liquid Rockets.* In this type of rocket, the nozzle is almost always cooled by regenerative circulation of the fuel, and then the heat flow through the wall amounts to as much as $2\frac{1}{2}$ to 4 Btu per sq in. per sec. The use of regenerative cooling at the higher temperatures means a considerable pumping loss; and as stated before, in the smaller units there

is not enough fuel to give a satisfactory amount of cooling. This regenerative cooling has been supplemented by film cooling, where a small amount of fuel passes through the wall in small holes and flows over the inner surface and by so-called sweat cooling where the fuel permeates the wall and cools by evaporation on the inner surface. An adequate refractory for the nozzle section would certainly lessen the necessity for cooling at higher temperatures, but it must be extremely resistant to erosion and heat shock. It would seem necessary, also, to have the inside of the nozzle smooth to reduce mechanical losses.

Solid-fuel Rocket. In this case, conditions at the nozzle are quite similar to that of the liquid-fuel rocket, but the duration is generally less; and as regenerative cooling is impossible, refractories are more generally used. The material must have high-temperature shock resistance and be able to withstand erosion under the very high velocity. While loosening of the particles from the refractory is not so serious in the rocket as in the turbo-jet where serious trouble may result in the turbine, it is found that when erosion loosens small pieces, they act as sand in a sandblast and wear out portions to the rear. Some of the material suggested for nozzles are

- Graphite with silicon carbide coating
- Silicon carbide
- Graphite and silicon carbide mixture
- Fused alumina and silicon carbide
- Graphite and metal mixtures
- Plaster of Paris and graphite mixtures
- High-temperature porcelains

5. Guide Vanes and Reactors. A rocket, such as the V-2, is guided by small vanes extending into the stream of gases from the nozzle. These vanes must withstand temperatures up to 5000°F (about 2750°C), but only for short periods. Dense graphite has been used for this purpose quite satisfactorily.

6. Turbine Buckets. Many attempts have been made to replace the metal buckets in the turbine with refractory materials. The earliest work was carried out by the Germans during the Second World War, perhaps not so much at that time to find materials superior to the metals, but to find materials as substitutes for the high-temperature alloys, which were very scarce in that country. A great deal of effort in this country was directed toward the production of metals of very high creep resistance, and a really amazing improvement was reached in creep strength for alloys containing Co, W, and Mo. However, these metals are not plentiful, and it would be difficult to find sufficient quantities in an emergency.

It might be interesting to try to make a comparison between metals and ceramic materials at the temperature of the gas turbine. Although we have

excellent creep data on the high-temperature alloys, the data on refractories are very meager indeed, and a great deal of work needs to be done in this field. However, in Fig. 375 are shown comparative creep values for several metals and refractories, indicating at least a possibility of producing high-creep-strength ceramic materials for the higher temperature ranges. It should be remembered that the density of the ceramic materials is roughly one-half that of metals, and therefore the stresses reached in the turbine blades will be that much less, giving the ceramic materials some advantage. In Fig. 376 is shown the hot breaking strength of some oxides and a high-temperature alloy. While the high breaking strength does not have so much significance as the creep values, it does indicate a possibility of producing strength in oxides greater than those in alloys, and at any rate we must realize that the oxidation of our best alloys is so great above 1800°F (about 980°C) that they would be useless except for very short periods of heating.

Some of the more promising refractories for buckets have been discussed in Chap. XII, such as glass-free porcelains developed by the Bureau of Standards from a beryllium oxide or zirconia base. In Germany, some research was carried out on fused quartz buckets, but they did not seem to have enough advantage in temperature limit over metals to make them particularly interesting. Also metal-bonded oxides⁽⁶⁾ and metal-bonded carbides have been suggested and tested with the idea of increasing the temperature-shock resistance, but little is known of their creep values. One German turbine had the buckets mounted on the inside of a rotating shell so that they would always be in compression.⁽⁶⁾

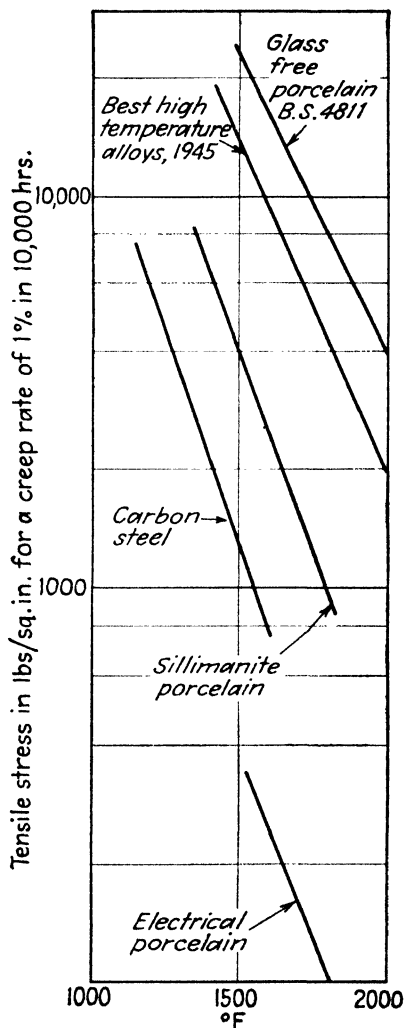

FIG. 375. Comparative creep values for metals and ceramics.

Also, some work has been done on the coating of metal buckets with a refractory enamel, mainly to reduce the oxidation.^(14,17,18) This step would certainly not appreciably raise the creep limit; however, for low-stressed parts and short time intervals, it would seem as if these coatings would permit replacement of alloys with carbon steel.

As most of the turbine buckets made from refractory materials must be very carefully dimensioned, it has been necessary in most cases to size them

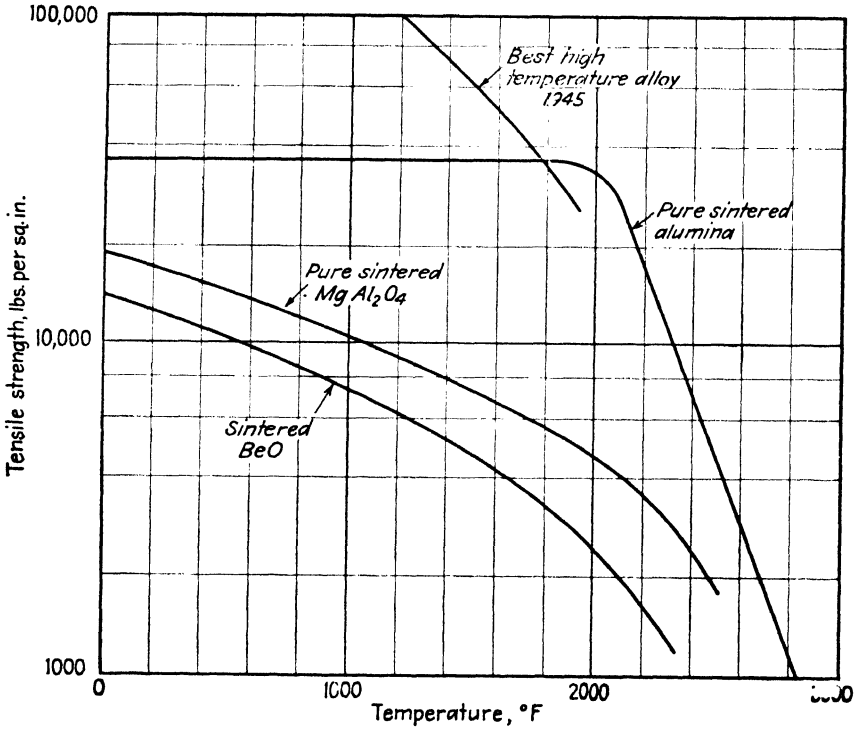

FIG. 376. Comparative hot tensile strengths for metals and ceramics.

with diamond wheels after firing, but this is a very costly operation. Then it would seem difficult to produce as thin a trailing edge on the bucket of a refractory as it is possible to obtain with metal, and therefore the over-all efficiency of the turbine is somewhat decreased when using the refractory. Also, it should be remembered that the refractory bucket at room temperature is brittle and handling difficulties will be experienced.

Another serious problem is the fastening of the ceramic bucket into the rotor. One method⁽⁶⁾ tried in Germany was to ram iron powder between the blade and the socket and then sinter it. Another method⁽⁸⁾ consisted in silvering the base of the blade and then heavily plating with copper, so that on clamping a yielding layer would distribute the stresses.

In regard to the future, it will certainly be necessary to carry on more fundamental work on glass-free oxide bodies with a minimum of impurity. These will have to be tested for creep rate, fatigue, impact, and heat-shock resistance. Also, the carbides, borides, and nitrides are quite promising, and work on these should be carried out simultaneously. Basic research should be stressed for the next few years to form a sound foundation on which to build future specific research.

7. Turbine Nozzle Blades. These blades have to encounter the same conditions as the turbine buckets, but the stresses are much lower and materials having higher creep rates could be used. On the other hand, if a material is satisfactorily developed for a turbine bucket, it would also be satisfactory for the nozzle blade.

8. Turbine Rotors. The turbine rotor has been experimentally produced in refractory materials, but the problems of attaching blades have not been entirely solved. At any rate, there is not such a great advantage in using refractories for this part, as the metal rotor can be cooled without too great a loss in the turbine efficiency.

9. Insulation. Portions of the jet engines must be insulated to prevent the interior of the airplane from becoming too hot. The long tail pipes in some of the jet fighters run down the fuselage and present considerable area. The insulation should be light, efficient, and stable under temperatures up to 1800°F (about 980°C) and severe mechanical vibration. Probably no thermal insulation is now available that exactly fits these specifications.

10. External Portions of the Rocket. When a rocket, after a high-altitude flight, returns to the earth's atmosphere at a speed of several thousand miles per hour, the surface of the war head and projecting vanes will heat by friction to 1200°F (about 650°C) or higher. To limit the rate of penetration of this heat to the explosive charge, an insulating coating on the metal would be very desirable.

11. Summary. It is still not clear how useful refractories will become in future jet-propulsion devices. However, the possibilities of increased performance by the use of refractories is so great that we should bend all efforts to develop them for this purpose. To this end a far larger proportion of research than at present should be directed toward fundamental studies such as the mechanism of sintering, long-time creep tests, high-temperature fatigue tests, and damping tests, as well as resistance to gas attack and thermal shock. Then again, we should not forget the fact that the materials going into the high-temperature alloys are rather limited, which may well mean that large-quantity production of engines using them will be impossible in a future emergency. The development of good coatings may permit the substitution of carbon steel for the high-priced alloys where the stresses are not high, as in tail pipes, but only high-grade refrac-

tories have the possibility of replacing the alloys where the stresses are considerable.

12. Bibliography

1. KIEFFER, R.: Metall keramische Bergestellte Kontak baustoffe, *Z. tech. Physik*, **21**, 25, 1940.
2. KIEFFER, R.: Pulver metallurgie und metall keramische, *Engineers metall u. Erg.*, **37**, 4, 1940.
3. ROELFINKE, F.: Metall keramische: Zusammenhange Zwirchen Metall keramische und Oxydseramik, *Z. Ver. deut. Ing.*, **84**, 681, 953, 1940.
4. KIEFFER and W. HOTOP: Sinter stoffe in der Natur und Sinter wekstoffe der Technik. *J. Brick der Metallic*, p. 172, 1943.
5. DEWITT, G.H.: Development of Ceramic Materials for Use in Turbine Engines, CIOS APO 413, 1945.
6. KEARN, D.J., and D.R. SHOULTZ: Jet Propulsion and Its Application to High Speed Aircraft, *J. Aeronaut. Sci.*, **13**, 411, 1946.
7. HAMLIN, B., and SPENCELEY: Comparison of Propeller and Reaction-propelled Airplane Performances, *J. Aeronaut. Sci.*, **13**, 425, 1946.
8. KISTLER, S.S.: Refractories in Turbine Blades and Miscellaneous Applications, CIOS APO 413, 1946.
9. FOSTER, S.W.G.: Note on the Use of Ceramics in Gas Turbine Design, *Roy. Aeronaut. Soc.*, **50**, 893, 1946.
10. KEENAN, J.H., and J. KAYE: A Survey of the Calculated Efficiencies of Jet Power Plants. *J. Aeronaut. Sci.*, **14**, 437, 1947.
11. HEALEY, R.: Rocket Engine Developments, *Aero Digest*, **55**, 38, 1947.
12. ANON.: Reaction-powdered Planes and Missiles, *Aero Digest*, **55**, 45, 1947.
13. BERGER, A.L.: High Temperature Ceramic and Cement Materials Paper, Ceramic Industry Annual Meeting, Columbus, Ohio, Nov. 7-8, 1947.
14. HARRISON, W.N., D.G. MORSE, and J.C. RICHMOND: Ceramic Coatings for High Temperature Protection of Steel, Natl. Bur. Standards, *J. Research*, 293, 1947, RP 1773.
15. MALINA, F.J., and M. SUMMERFIELD: The Problem of Escape from the Earth by Rocket, *J. Aeronaut. Sci.*, **14**, 471, 1947.
16. WYLD, J.H.: The Liquid Propelled Rocket Motor, Past, Present and Future, *J. Am. Rocket Soc.*, **70**, 2, 1947.
17. BENNETT, D.G.: Ceramic Coatings and Ceramic Bodies for Aircraft Power Systems, *Univ. Ill., Dept. Ceramic Eng., Rept.* 31, 1947.
18. PLANKERHORN, W.J., et al.: Specifications for the Preparation and Application of Certain High Temperature Ceramic Coatings for Aircraft Parts from Inconel Metal, University of Illinois Department of Ceramic Engineering, 1947.
19. DURHAM, F. P.: "Aircraft Jet Powerplants," Prentice-Hall, Inc., 1951.

CHAPTER XXVI

USE OF REFRACTORIES IN MISCELLANEOUS INDUSTRIES

1. Kilns. *Periodic Kilns.* The periodic kiln is used in the ceramic industry mainly for the firing of refractories and heavy clay products, with the use of coal as the principal fuel, although natural gas and oil are also used. A typical example of a round downdraft kiln of this type is shown in Fig. 134 of Chap. IX. The maximum temperatures obtained in these kilns run from 1800°F (about 980°C) for some building brick to 2800°F (about 1540°C) for silica brick.

The refractories used in the kiln are always fireclay brick, using low- or intermediate-duty brick for heavy-clay-products kilns and high-heat-duty or super-duty brick for the higher temperature kilns. Because of the fact that the kilns are heated and cooled fairly rapidly, silica brick would not be satisfactory.

Recently, a number of periodic kilns have been constructed with a lining of insulating firebrick. They have shown distinct advantages over those lined with heavy types of brick. Kilns of this type have been used for firing common brick and also for firing glass-tank blocks with temperatures of 2600 to 2700°F (1430 to 1480°C). The main advantage in using the insulating firebrick is the great reduction in the heat stored in the walls and crown of the kiln. In many cases, this heat storage has been cut down to 25 per cent of the value for heavy bricks. This means, of course, a substantial saving in the fuel required for heating the kiln, a quicker turnover so that a kiln can produce more ware, and, perhaps as important, a more even temperature distribution over the kiln itself.

The refractories in periodic kilns generally have a comparatively long life, many kilns in operation having had only minor repairs in the last 15 or 20 years. The main source of trouble is spalling of the crown brick over the fireboxes, shrinking and softening of the bag walls, and slagging from the coal ash around the furnaces. With the use of forced draft and forced cooling of the kilns, the spalling tendencies are increased but, even under these conditions, are not particularly severe. The use of insulating firebrick has not been studied for a sufficiently long period to give accurate information on the life; but from indications that we already have, it would seem that the life would compare favorably with the heavy brick.

The use of outer insulation on periodic kilns is increasing, especially on the crown. Although it is difficult to give any exact figures on fuel saving, the insulation does show a definite increase in economy and also enables a more uniform temperature to be maintained in the kiln. Of course, it may be necessary, when insulation is used on a high-temperature kiln, to employ a better grade of refractory to withstand the load at the higher mean temperature reached by the lining.

Continuous Kilns. The tunnel kiln has been described in Chap. IX. In general, the requirement for this type of kiln is a refractory lining that will give long, uninterrupted service at the required temperature level. There is little or no tendency to spall because the temperature at any one place is constant. Usually the wall bricks must have good strength and abrasion resistance in case ware rubs against them during an accident. Therefore, in the modern kiln construction, low-heat-duty fireclay brick is used in the heating and cooling zones and intermediate- or high-heat-duty brick in the hot zones, although for some types of kiln running at high temperatures, super-duty fireclay or kaolin bricks are found useful.

The tunnel kiln, of course, must be very thoroughly insulated throughout its length; otherwise, a large amount of heat would be lost from the great amount of surface exposed. This is accomplished with insulating brick or blocks on the sides and a loose insulation on the top.

Some tunnel kilns have been constructed with a lining of insulating firebrick; but in this case, a low heat storage is not so important as with the periodic kiln and therefore the insulating firebrick does not have so great an advantage. However, from one point of view, this type of construction shows real economy, *i.e.*, in the kiln that must make a change in temperature to accommodate various types of ware fired. It is found that with the kiln lined with the insulating firebrick, a change in schedule can be made in a few hours with a minimum loss in ware during the turn-over whereas with a heavy brick kiln, this change of schedule may take a day or more and the loss in unproductive firing is much greater. Also, the lighter weight construction can use lighter steelwork and foundations.

Some tunnel kilns are indirect fired and have a muffle lining. This muffle should, of course, have a high thermal conductivity, good hot strength, and stability over long periods of time. Such muffles are usually made of clay-bonded silicon carbide or clay-bonded fused alumina. There are, however, certain temperature ranges in which the silicon carbide tends to oxidize, and care should be taken to follow the recommendations of the manufacturer of the refractory in its use.

Perhaps the portions of the kiln giving the most trouble are the car bottoms, because they are alternately heated and cooled each time that they pass through the kiln and, for this reason, suffer from thermal shock.

There also is the difficulty that setting sand used in kilns firing refractories or heavy clay products will fall into the cracks between the car blocks when they are cool; then as the car heats, the blocks are forced apart and there is a gradual growth in the size of the car top until it eventually rubs on the kiln. For this reason, car bottoms are usually made of large shapes, and some manufacturers blow out the sand from the bottom of the car with compressed air each time that it comes out of the kiln. Considerable success has been had lately with car tops made of a lightweight castable mix, which can be put on the car very cheaply by unskilled labor, a construction that seems to give good life in many installations.

Kiln Furniture. In the last few years, a great deal of study has been made of the question of saggars, not only to increase their average life but also to reduce their wall thickness and weight for a higher efficiency. Many potteries are now purchasing saggars from refractory manufacturers rather than attempting to make their own. The old method of putting green saggars on top of the bungs filled with ware for the first firing has been largely superseded by prefiring the saggars at a somewhat higher temperature than would be used, with a consequent increase in strength. Although thirty years ago the average life of the sagger was only 15 burns in a kiln, a life of twice that is now obtained, and instances of even greater life are often found. The recently developed loose-bottom sagger does much to reduce the heating and cooling stresses.

In manufacturing the sagger, care is taken in sizing the grog to a definite screen analysis and a more uniform structure is obtained in forming, often by the casting method. Although most of the saggars are still made of fireclay, special talc bodies have been tried as well as bodies containing alumina and silicon carbide. For glost work, the question of dusting is a very important one and must be considered along with the other characteristics of the body used.

The open setting of ware has been making great strides in almost all types of whiteware firing. Electrical porcelains, sanitary ware, and semi-vitreous table ware are now fired in open settings with a considerable increase in kiln capacity and a lower fuel cost per unit ware. The open-setting method consists in supporting a series of slabs on corner posts until the car is built up to the required height, as shown in Fig. 314, Chap. XIX. Attempts are made, of course, to keep the thickness of the slab to a minimum and give the whole structure the greatest possible life. The furniture is usually made of clay-bonded silicon carbide, although clay-bonded fused alumina and zircon refractories have been used. Many ingenious methods have been developed for supporting the slabs to minimize expansion stresses and still give a stable structure. There is still some difficulty with the slabs made of silicon carbide, in that they tend to increase in size, or grow,

owing to gradual oxidation, each time that they go through the kiln. However, some of the more modern types of refractory have minimized this difficulty by surface coatings or other means to protect the silicon carbide from the air.

2. Glass Refractories. *General Types of Melting Furnace.* Glass is melted in a number of types of furnace, one of them being the pot furnace where the glass is melted in open or closed pots, similar to a crucible, with the heat applied to the outside. This type of melting would be used for small batches of glass or glass necessitating very careful control, such as colored or optical glass. For larger production, small reverberatory furnaces called "day tanks" are used, where the glass is melted in a hearth usually by producer gas using regenerators. The batch is melted down and worked out usually in a 24-hr period, a new batch put in, and the process continued. For larger quantities of glass, the continuous tank is universally used, where raw materials are fed in at a steady rate at one end and the glass drawn off continuously at the other end. These continuous tanks may be classified as bottle tanks for making containers and sheet-glass tanks for making window and plate glass by the continuous process.

Recently platinum crucibles of considerable size have been used for melting optical glass. Here there is no solution of refractory in the glass, and consequently a more transparent and homogeneous product results. It is understood that a small tank has been made from platinum by one of our large glass manufacturers.

A Typical Tank for Bottle Glass. It will, perhaps, be best to take as an example of a continuous tank for making bottle glass the furnace shown in Fig. 377. This furnace consists of a melting chamber fired by producer gas preheated by a series of regenerators and a refining section connected to the melting section by a throat below the surface of the glass. This refining section receives no direct heat but is kept hot by conduction and radiation from the melting section. The temperature in the melting section is around 2600 to 2800°F (about 1430 to 1540°C); whereas in the refining section, it is reduced to perhaps 2300°F (about 1260°C). From the refining section, the glass is drawn out into forehearth that have separate burners to maintain a uniform temperature.

The glass tank below the surface of the glass is composed of flux blocks that are generally a dense fireclay-grog-ganister mixture in comparatively large units in order to reduce the number of joints. A common size of these blocks would be 12 × 24 × 42 in., and they are usually ground accurately to size so that the joints are as thin as possible. No insulation is used around the bottom of the tank, as the higher mean temperature permits more rapid solution of the blocks in the glass and also tends to

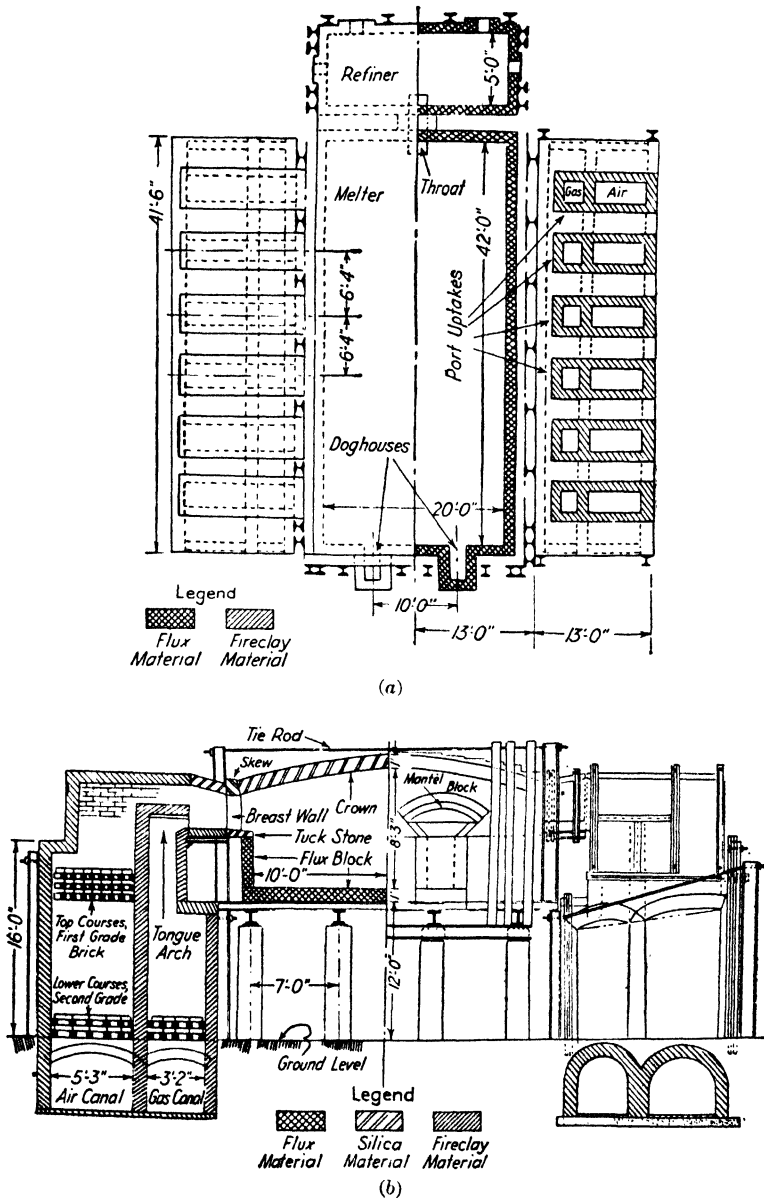

FIG. 377. (a) Plan view of producer-fired regenerative-type glass furnace. (b) Half section on center line of first port, producer-fired regenerative-type glass furnace. (Courtesy of Owens-Illinois Glass Co., Toledo, Ohio, from "Manual of ASTM Standard on Refractory Materials.")

TABLE 132. CLASSIFICATION OF REFRACTORIES FOR GLASS FURNACE
(From "Manual of ASTM Standards on Refractory Materials")

| Furnace part | Material | Temperature | Slagging action | Corrosion erosion | Abrasion | Spalling | Remarks |
|----------------------|---|-----------------------------------|-----------------|-------------------------|-------------------------|-----------|---|
| Melter: | Highly siliceous hand-made, machine-made, or slip-cast block Molten cast block of high-alumina content | 2500 to 2900°F. (1370 to 1595°C.) | Severe | Severe | Moderate | Slight | Spalling is of importance only during heating |
| Bottom..... | | | | | | | |
| Side..... | | | | | | | |
| Ends..... | | | | | | | |
| Refiner: | Same as melter | 2350°F. (1290°C.) | Moderate | Moderate | Moderate | None | Same as melter |
| Bottom..... | | | | | | | |
| Side..... | | | | | | | |
| Ends..... | | | | | | | |
| Tank crown..... | Silica brick | Up to 2900°F. (1595°C.) | Moderate | Moderate | Severe in some furnaces | Important | |
| End walls..... | Silica brick | Up to 2900°F. (1595°C.) | Moderate | Severe in some furnaces | Severe in some furnaces | Important | |
| Breast walls..... | Silica brick High-alumina brick | Up to 2900°F. (1595°C.) | Severe | Severe | Severe | | |
| Port jambs..... | Silica brick High-alumina brick | Up to 2900°F. (1595°C.) | Severe | Severe | Severe | | |
| Port sills..... | Silica-block High-alumina block | Up to 2900°F. (1595°C.) | Severe | Severe | Severe | | |
| Port wall sides..... | Silica brick Fireclay brick | Up to 2900°F. (1595°C.) | Severe | Severe | Severe | | |
| Port crowns..... | Silica brick Fireclay brick | Up to 2700°F. (1480°C.) | Moderate | Moderate | Severe in some furnaces | | |
| Port paving..... | Silica brick Fireclay brick | Up to 2700°F. (1480°C.) | Severe | Severe | Severe in some furnaces | | |
| Tongue arches..... | Silica brick | Up to 2900°F. (1595°C.) | Moderate | | Severe in some furnaces | Important | Spalling very important during heating |

TABLE 132. CLASSIFICATION OF REFRACTORIES FOR GLASS FURNACE (Continued)

| Furnace part | Material | Temperature | Slagging action | Corrosion erosion | Abrasion | Spalling | Remarks |
|-----------------------------|----------------------------|-------------------------|-----------------|-------------------|-------------------------|----------------|---|
| Mantle block..... | Fireclay block | 2500°F. (1370°C.) | | Severe | Moderate | Important | |
| Regenerator wall crown..... | High-alumina block | Up to 2000°F. (1090°C.) | Moderate | Moderate | Severe in some furnaces | | |
| | Fireclay brick | Up to 2000°F. (1090°C.) | Severe | Severe | Severe | Very important | Silica and magnesite are sometimes used |
| Checkers..... | Fireclay brick | Up to 2000°F. (1090°C.) | Severe | Severe | Severe | | |
| | High-alumina brick | Up to 2800°F. (1540°C.) | | | | | |
| Shadow wall..... | Silica brick | Up to 2900°F. (1595°C.) | Severe | Severe | Severe | | |
| | Silica block | Up to 2900°F. (1595°C.) | Severe | Severe | Severe | | |
| Tuckstones..... | Fireclay block | 2600°F. (1425°C.) | Severe | Severe | Severe | | |
| | High-alumina block | Up to 2900°F. (1595°C.) | Severe | Severe | Severe | | |
| Throat..... | Same as tank block | Up to 2500°F. (1370°C.) | Severe | Severe | Severe | | |
| Invert arches..... | Silica shapes | Up to 2500°F. (1370°C.) | Severe | Severe | Severe | Important | |
| Bridge-wall covers..... | Fireclay block | Up to 2700°F. (1480°C.) | Severe | Severe | Severe | Important | |
| | Silica | Up to 2700°F. (1480°C.) | Severe | Severe | Severe | Important | |
| Burner-block..... | Fireclay | Up to 2600°F. (1425°C.) | Moderate | Moderate | Moderate | | |
| | High alumina | Up to 2600°F. (1425°C.) | Moderate | Moderate | Moderate | | |
| Skimmers..... | Siliceous fireclay block | Up to 2600°F. (1425°C.) | Moderate | Moderate | Moderate | | |
| | High-alumina block | Up to 2600°F. (1425°C.) | Moderate | Moderate | Moderate | | |
| Feeder-tubes..... | Siliceous fireclay | Up to 2400°F. (1315°C.) | Severe | Severe | Severe | Important | Must have good transverse strength |
| | High alumina | Up to 2400°F. (1315°C.) | Severe | Severe | Severe | Important | Must have good tensile strength |
| Troughs..... | High alumina | Up to 2400°F. (1315°C.) | Severe | Severe | Severe | Important | Must have good shear strength |
| | Fireclay | Up to 2300°F. (1260°C.) | Moderate | Moderate | Moderate | Important | Must have good tensile strength |
| Plugs..... | High alumina | Up to 2300°F. (1260°C.) | Moderate | Moderate | Moderate | Important | Must have good shear strength |
| | High alumina | Up to 2300°F. (1260°C.) | Moderate | Moderate | Moderate | Important | Must have good tensile strength |
| Revolving tubes..... | Fireclay | Up to 2300°F. (1260°C.) | Moderate | Moderate | Moderate | Important | Must have good tensile strength |
| | Siliceous special material | Up to 2300°F. (1260°C.) | Moderate | Moderate | Moderate | Important | Must have good tensile strength |
| Plunger needles..... | Same as tubes | Up to 2300°F. (1260°C.) | Moderate | Moderate | Moderate | Important | Must have good tensile strength |

float the blocks out of the bottom. In fact, air cooling is regularly used on the outside of the blocks.

The upper side walls and roof of the glass tank are constructed of silica brick, which are often used for the ports. Kaolin forsterite and kyanite brick are finding increasing use in the upper parts of the tank.

In Table 132 is shown a classification of refractories used in the bottle-glass furnace together with their operating conditions. It is rather difficult to give any figures on the life of refractories in the glass-tank operation because it is so dependent on the type of glass, melting conditions, etc. It is usual, however, to run a continuous glass tank for 6 months to two years before the blocks wear so thin that a shutdown is necessary. The usual soda-lime glass of window or bottle composition is not so active in attacking the blocks as the borosilicate glass or the opal glass.

The tendency is to use more and more insulation in the upper parts of the modern glass tank. It is now standard practice to insulate the regenerator chambers and often the uptakes and side port walls as well. Quite a number of insulated crowns are in use at the present time, but this construction is still viewed with suspicion by many operators.

Tank Blocks. The demands on the flux blocks in the glass tank are particularly exacting, as the blocks are in contact continuously with the molten glass; and especially in portions where the movement of the glass is rapid, such as at the metal line and through the throat blocks, the attack is severe. Blocks for this service must have a low porosity, and particularly they must be free from flaws and laminations, which serve as an entering wedge for the glass erosion. Some believe that it is more important to have the pores all below a certain size than to have a minimum porosity, because apparently the surface tension of the glass will not permit it to enter pores below a critical size. Therefore, experience has shown that certain types of block, even with medium porosity, give good results if the pore size is very small. On the other hand, blocks with practically zero porosity made by casting the molten materials give good resistance to certain types of glass.

The chemical composition of the block does not seem to be so important as the physical characteristics. However, blocks made of mullite or alumina appear in general to have a resistance superior to those made of fireclay mixtures. Certain types of refractory, *e.g.*, chromite, that would be quite resistant to the glass cannot, of course, be used because of the color imparted to the glass, but chromite can be added in small amounts to fused Al_2O_3 blocks.

Glass Pots. The glass pot for melting glass is made of a carefully prepared fireclay-and-grog mixture with particular care to get a homogeneous structure. This is accomplished in modern practice by slip casting the

pot in one piece from a high-density slip carefully deflocculated to give sufficient fluidity for pouring. The pot must have sufficient mechanical strength and resistance not to creep at high temperatures so that the heavy load of glass will be supported without failure of the refractory. Here again it is difficult to give any definite figures on the life of the pot because it depends so much on the batch melted, the method of heating, and the type of fuel. However, pots often last for 10 to 20 melts before failure. In the manufacture of optical glass, the pot is used only once, because the batch and pot are cooled together and the pot is cracked away from the solidified glass.

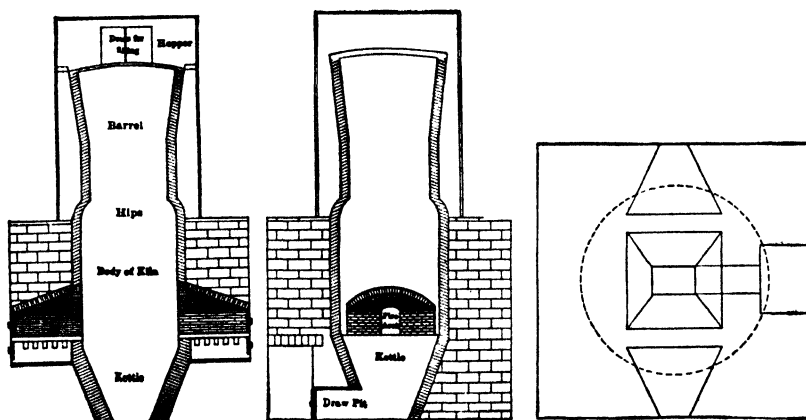

FIG. 378. A lime kiln. (Reprinted by permission from "Cements, Limes and Plasters" by Eckel, John Wiley & Sons, Inc.)

3. Refractories in the Cement and Lime Industry. *Shaft Kilns for Lime Burning.* All the lime was burned in shaft kilns in early days; and even now, the smaller plants use this type of kiln. As shown in Fig. 378, the kiln consists of a vertical shaft into which the raw material is fed at the top and the burned material pulled out at the bottom. Coal-fired grates supply the hot gases necessary for the burning operation.

These kilns are lined with a dense fireclay brick to stand the abrasion of the moving charge; but recently, super-duty fireclay brick have been used successfully for high-temperature parts. Success has often been obtained by using silica brick around the eyes of the kiln.

Rotary kilns are now used for burning lime in the larger plants and, in construction, are very similar to kilns for Portland cement manufacture. The lining of these kilns is usually made of super-duty fireclay block or high-alumina block. For the hot zone, magnesite blocks have been successfully used with steel-sheet inserts between the individual blocks.

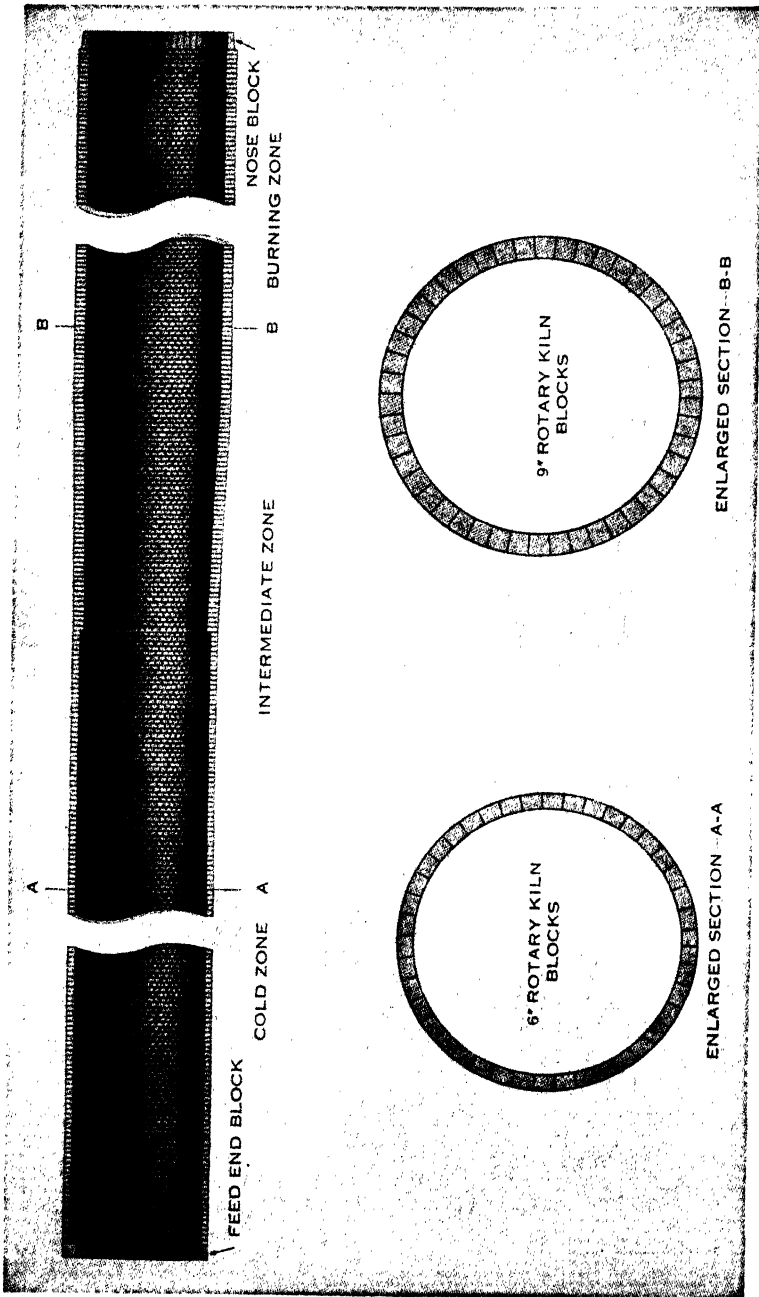

Fig. 379. Rotary cement-kiln lining. (From "Modern Refractory Practice," courtesy of the Harbison-Walker Refractories Company.)

Kilns for the Manufacture of Portland Cement Clinker. Portland cement is made from a mixture of limestone and clay, cement rock, or slag, which will give approximately the following composition:

| | Per Cent. |
|--------------------------------|-----------|
| SiO ₂ | 23 |
| Fe ₂ O ₃ | 3 |
| Al ₂ O ₃ | 8 |
| CaO | 63 |
| MgO | 2 |
| SO ₃ | 1 |

Two general processes are in use: In one, the raw materials are dried, ground, and fed into the kiln as a powder. In the other, the materials are wet ground and fed into the kiln as a slurry. Most of the Portland cement manufacture in this country is carried out with the dry process; whereas in Europe, the wet process is favored. As far as the refractories are concerned, there is no great difference between the two methods.

The rotary kiln lining, as shown in Fig. 379, is composed of special blocks usually of high-alumina material. In the hot end of the kiln, blocks are 9 in. thick; whereas in the cooler end, they are 6 in., and often insulation is used back of them in this portion. The temperature at the hot end of the kiln is rather high, reaching as much as 3000°F (about 1650°C), but there is little spalling. At the cool end of the kiln, the charge abrades the lining to some extent; and in the hot end, the clinker, which becomes soft, builds up a layer on the refractories and, under proper operating conditions, protects them from slag attack and abrasion; *i.e.*, the most satisfactory refractory is one that will best hold this layer of clinker. Recently, kiln linings of chemically bonded magnesite brick have proved very satisfactory, as might be expected from the basic character of the clinker. In Table 133 are given the common sizes of rotary kilns for cement manufacture.

4. Gas Production. *By-product Coke Ovens.* In this type of oven, the coking is carried out in a narrow chamber 16 to 22 in. wide, 10 to 12 ft high, and 30 to 36 ft long. The bituminous coal is fed in at the top until the chamber is full; then the coking takes place by heat applied to the outer walls of this chamber. After the coking has been finished, the charge is pushed out of the chamber laterally and at once quenched. The gases escaping during the coking period (12 to 30 hr) are collected in a large main and treated for removal of the by-products. A section of the Koppers type of by-product coke oven is shown in Fig. 380. It will be seen that the heating is regenerative, the gas usually being supplied by the coking process itself.

The walls of the coking chamber are comparatively thin to give low thermal resistance and therefore must have good mechanical strength. The refractory used is silica brick, the pores of which are more or less filled with coke after long operation. The bricks must, of course, be quite resistant to the abrasion of the entering and leaving charge, and

TABLE 133. USUAL SIZES OF ROTARY KILNS
(From "Portland Cement" by Meade)

| Inside diameter, ft. | Length, ft. | Capacity, bbl. per day |
|-------------------------|----------------|---------------------------|
| 6 | 60 | 200 |
| 7 | 100 | 430 |
| 8 | 125 | 625 |
| 9 | 150 | 1,100 |
| 9 | 175 | 1,430 |
| 9 | 200 | 1,775 |
| 10 | 175 | |
| 10 | 200 | 1,775 |
| 10 | 250 | |
| 11 | 250 | |

there is a very rapid temperature change when the coal is dropped into the red-hot oven chamber. Care must be taken not to allow the temperature to drop to the critical temperature for silica brick. Sometimes fire-clay brick are used at the end of the ovens where spalling may occur. Table 134 gives a survey of the conditions of the refractory in this type of oven.

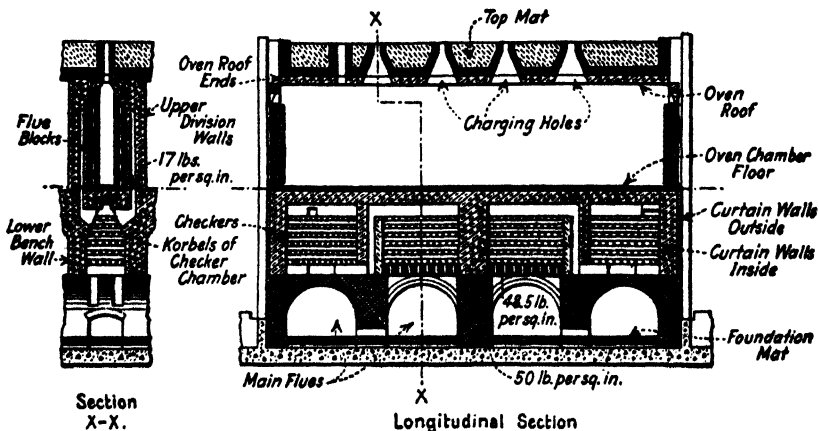

FIG. 380. By-product coke oven. (Courtesy of American Refractories Institute.)

TABLE 134. CLASSIFICATION OF REFRACTORIES FOR BY-PRODUCT COKE OVENS

(From "Manual of ASTM Standards for Refractory Materials")

| Part (See Fig. 380) | Material used | Temperature* | Slagging | Load as given for Koppers ovens lb. per sq. in. | Load conditions in Semet- Solvay ovens | Abra- sion | Spall- ing |
|--------------------------------|---------------------------------------|---|----------|--|--|-----------------|-----------------|
| Foundation mat | Fireclay brick | 1830°F. (1000°C.), max. | No | 25 to 30 | Important | No | No |
| Main flues | Silica brick and fireclay brick | 1000°F. (540°C.) extraordinary 1300 to 1400°F. (705 to 760°C.) | No | 16 to 20 | Important | No | No |
| Lower bench walls... | Silica brick | 1830°F. (1000°C.), max. | No | 18 to 20 | Important | No | No |
| Corbels of checker chambers | Silica brick | 1830 to 2550°F. (1000 to 1400°C.) | No | 20 to 25 | Important | No | No |
| Checkers | Fireclay brick and silica brick | 1830 to 2730°F. (1000 to 1500°C.) | No | 8 to 10 | No | No | No |
| Curtain walls inside... | Silica brick | 1830 to 2550°F. (1000 to 1400°C.) | No | | No | No | No |
| Curtain walls outside... | Fireclay brick | 390 to 1830°F. (200 to 1000°C.) | No | | No | No | No |
| Upper division walls... | Silica brick | 1830 to 2550°F. (1000 to 1400°C.) | No | 12 to 15 | Important | No | No |
| Flue blocks | Silica brick | 2190 to 2730°F. (1200 to 1500°C.) | No | | Important | Import- tant | No |
| Oven chamber floor... | Fireclay brick | 1830 to 2190°F. (1000 to 1200°C.) | No | 3 to 6 | No | Import- tant | No |
| Oven roof | Silica brick | 1830 to 2190°F. (1000 to 1200°C.) | No | 6 to 10 | Important | No | No |
| Oven roof ends | Fireclay brick | 1830 to 2190°F. (1000 to 1200°C.) | No | 5 to 10 | Important | No | No |
| Charging holes | Fireclay brick | 1470 to 2190°F. (800 to 1200°C.) | No | | No | Slight | No |
| Jamb blocks | Silica brick and fireclay brick | 1830 to 2730°F. (1000 to 1500°C.) | No | 15 to 20 | No | Import- tant | Import- tant |
| Top mat | Fireclay brick | 1110 to 1830°F. (600 to 1000°C.) | No | 5 to 10 | No | No | No |

* The equivalent centigrade temperatures given in parenthesis are to the nearest five degrees.

Water-gas Generation. Gas produced in this manner takes place by the following process: A chamber filled with a bed of hot coal has air blown through it to increase its temperature and produce a gas of nitrogen, carbon dioxide, and carbon monoxide, which is burned in a second chamber called a "carburetor" partially filled with checker bricks, thus raising their temperature. Sometimes a second checkerwork is used as a pre-heater. The second part of the cycle consists in shutting off the air

blast and passing steam through the hot coal, which gives off hydrogen and carbon monoxide. This passes through the carburetor, where it is preheated and enriched by the gas produced by spraying oil on to the hot checkers. As soon as the checkerwork is cooled to a predetermined value, the cycle is repeated. In Fig. 381 is shown a cross section of a typical water-gas generator operating on this principle. The refractories used are fireclay, as the temperature is not particularly high, but considerable resistance to spalling is necessary in the carburetor. Also, since

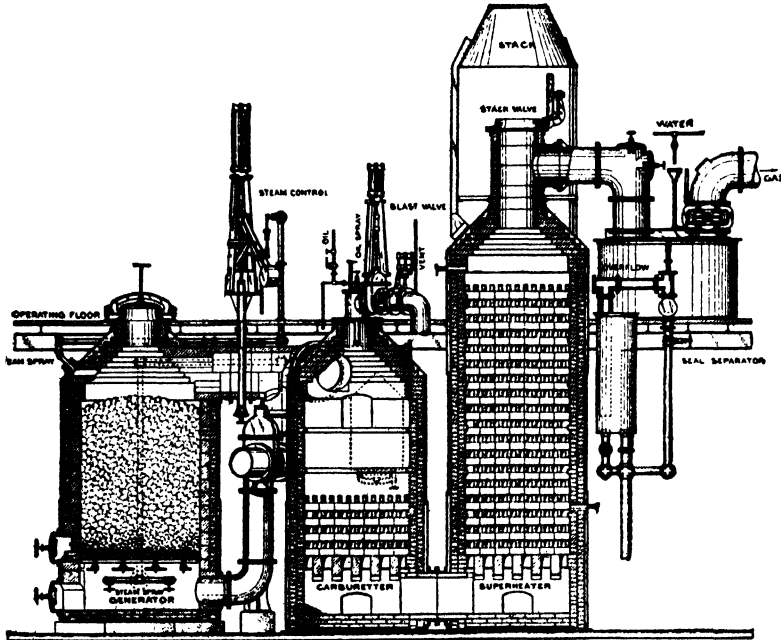

FIG. 381. Carbureted water-gas machine, Champaign. (From C. W. Parmelee, A. E. R. Westman, and W. H. Pfeiffer, University of Illinois, Engineering Experiment Station.)

the conditions for the most part are highly reducing, the bricks must be capable of withstanding the disintegrating effects of hydrogen and carbon monoxide.

5. Incinerators. Incinerators are used extensively for combustion of refuse and require refractories capable of standing sudden temperature changes, but they need never undergo very high temperatures. Therefore, a low-heat-duty brick with good spalling resistance is generally satisfactory.

6. Domestic Heating. The increasing use of oil burners for domestic heating has made a really large field for refractories, even though the number of bricks in any one unit amounts to only a few dozen. The temperatures in this service are low, but the bricks must be quite resistant

to spalling due to the intermittent action of the burner. In many types of installation, standard-size brick are used; but in a few cases, special shapes are assembled to reduce the labor cost.

The use of the insulating firebrick in this type of service has been increasing rapidly in the last few years because it permits a high temperature to be built up on the surface of the refractory immediately after the burner has started, so that efficient combustion takes place during the whole operation with less production of soot and lower consumption of oil. As the burner is in operation only for short periods of time, the immediate attainment of efficient combustion is very important. It has also been found that the sound-absorbing qualities of the porous insulating firebrick are very helpful in reducing the noise of the burner flame.

7. Paper-mill Refractories. *Sulfite Process.* For sulfur- and pyrite-burning furnaces, high-heat-duty or super-duty fireclay brick are generally employed.

Soda and Sulfate Processes. Refractories are required here for smelters, rotary incinerators, rotary and shaft kilns, and sludge recovery kilns. The slagging action is very severe in the smelting and recovery furnaces, as the soda salts are active fluxes. For the lower parts of these furnaces, soapstone or chrome brick are used, and dense high-heat fireclay brick are often employed in the upper portions. Black-liquor furnaces are discussed in Chap. XXIII.

8. Enameling. *Cast Iron.* Cast-iron enameling is generally carried out in recuperative-type muffle furnaces. The muffle, which is comparatively thin, is made of high-conductivity material, either silicon carbide or bonded alumina. The furnaces are generally underfired, and the refractory requirements of the piers holding up the hearth are rather severe, as the brick are heated all the way through and must carry a heavy load. For this purpose, high-burned kaolin or mullite brick have been found very satisfactory. The walls of the furnace itself are generally made of high-heat-duty firebrick, and insulation is often used outside this. Since the doors of these furnaces must be quick acting, they are often lined with a lightweight castable mixture or with insulating firebrick that are tied into the door casing. This not only permits a rapid operation of the door but makes conditions much more comfortable for the men working around the mouth of the furnace.

Sheet-steel Enameling. In this type of furnace, a muffle construction is used; but in many of the modern continuous furnaces, very little refractory is required, as the heat is supplied by radiant metal tubes inside which the combustion takes place. The walls of the furnace outside these tubes can readily be constructed of insulating firebrick, since the requirements in the way of temperature, load, and spalling are not at all severe.

Enamel Fritting. Enamel frit is made in rotary oil-fired furnaces or in small tanks. In the former case, the lining is made from circle blocks of fireclay material. It is desirable to have the blocks as free from iron specks as possible. In the tank, the conditions are about the same as for glass melting, and therefore dense flux blocks are generally used.

9. Bibliography

Kilns:

See Chap. IX.

Glass Tanks:

1. LAMORT, J.: "Glassmelzofen," O. Spamer, Leipzig, 1932.
2. PARTRIDGE, J.H.: "Refractory Blocks for Glass Furnaces," Society of Glass Technology, Sheffield, 1935.
3. ANON.: Industrial Survey of Conditions Surrounding Refractory Service in the Glass Industry as it Pertains to Continuous Bottle Furnaces, "Manual of ASTM Standards on Refractory Materials," 1937.
4. DEVILLERS, R.W.: "Glass Tank Furnaces" (in English), Ogden-Watney, New York, 1937.
5. THOMPSON, C.L., and E.P. REXFORD: A Study of an Alumina-Silica Checker Brick from the Regenerator of a Glass Tank, *J. Am. Ceram. Soc.*, **21**, 55, 1938.
6. PICK, HANS: Experience with Rotary Kilns, *Zement*, **31**, 193, 1942.
7. PARTRIDGE, J.H.: Refractory Materials for Glassmaking, *G.E.C. Journal*, **12**, 119, 1943.
8. LOOMIS, G.A.: Refractories in the Glass Industry, *Ohio State Univ. Eng. Expt. Sta. News*, **17**, 22, 1945.
9. HEINDL, R.A., G.B. MASSENGALE, and LOUIS G. COSETTE: Slip Casting of Clay Pots for the Manufacture of Optical Glass at the National Bureau of Standards, *Glass Ind.*, **27**, 177, 200, 202, 204, 208, 214, 1946.

Lime and Cement Kilns:

10. ENDELL, K.: Cement Kiln Refractory Linings, *Zement*, **18**, 38, 1929.
11. ANON.: Brick for Lining Cement Kilns, *Brit. Clayworker*, **40**, 323, 1931.
12. ANON.: Fire Brick for the Lime Kilns, *Brit. Clayworker*, **40**, 11, 1932.
13. ANON.: Lining Cement Kilns for Manufacturing High-quality Cements, *Tonind.-Zig.*, **57**, 75, 1933.
14. HEUER, R.P.: Rotary Kiln Studies on Magnesite, *Rock Products*, **37**, 42, 1934.
15. SONNTAG, C.H.: A Progress Report on a Magnesite Kiln Lining, *Rock Products*, **37**, 33, 1934.
16. SCHURECHT, H.G.: Types of Magnesite Refractories for Lining Cement Kilns, *Brick & Clay Record*, **90**, 174, 1937.
17. SONNTAG, C.H.: Selecting the Proper Refractory for Hot-zone Linings of Kilns, *Rock Products*, **41**, 52, 1938.
18. ROBITSCHKE, J., and BEDRICH HELAN: Insulation of Rotary Cement Kilns, *Starivo*, 289, 1938.
19. ROCHOW, W.F.: Refractory Linings for Rotary Cement Kilns: II, *Rock Products*, **48**, 126, 1945.

20. TSCHIRKY, L.: Developments in the Manufacture of Better Refractories for the Portland Cement Industry, *Pit and Quarry*, **37**, 135, 1945.
21. ROCHOW, W.F.: Refractory Lining for Rotary Cement Kilns: I, *Rock Products*, **48**, 188, 1945.
22. ROCHOW, W.F.: Refractory Linings for Rotary Cement Kilns, *Rock Products*, **48**, 53, 1945.
23. ANON.: Brick for Cement Kilns, *Brit. Clayworker*, **55**, 16, 1946.

Gas Production:

24. PULFRICH, M.: Destruction of Coke Oven Walls, *Tamind.-Ztg.*, **47**, 271, 1923.
25. PARMELEE, C.W., A.E.R. WESTMAN, and W.H. PFEIFFER: An Investigation of Checker Brick for Carburetors of Water Gas Machines, *Univ. Illinois Eng. Expt. Sta. Bull.* 179, 1928.
26. SEARLE, A.B.: Selecting Materials for Retort Design, *Gas Age-Record*, **66**, 874, 1930.
27. ANON.: Industrial Survey of Conditions Surrounding Refractory Service in By-product Coke Ovens, "Manual of ASTM Standards on Refractory Materials," 1937.
28. ANON.: Heat Insulation of Coke-oven Tops, *Coal Carbonisation*, **3**, 67, 1937.
29. EDWARDS, A.: Clay-bonded Silica Refractories in Segmental Horizontal Retorts, Refractory Materials Joint Committee, *Inst. Gas Engrs., Twenty-eighth Report*, p. 80, 1937.
30. ANON.: Refractories and the Coke Oven, *Coal Carbonisation*, **4**, 94, 1938.
31. RUECKEL, W.C.: Failure of Coke-oven Walls by Reaction with Coal Ash, *J. Am. Ceram. Soc.*, **21**, 354, 1938.
32. PENNEY, J.: Silicon Carbide Generator Linings, *Am. Gas J.*, **150**, 52, 1939.

Enameling Furnaces:

33. WALKER, J.: Refractories for Enameling Muffle Furnaces, *Foundry Trade J.*, **54**, 265, 1936.
34. WALKER, J.: Refractories for Enameling Furnaces, *Chem. Age (London)*, **34**, 290, 1936.

CHAPTER XXVII

BRICKWORK CONSTRUCTION

1. Foundations. The foundations for kilns or furnaces are usually made of reinforced concrete to carry the usual engineering loads. These loads include not only the weight of the furnace itself and its charge but the thrust of the buckstay foot. As concrete loses considerable strength at temperatures above 400°C (about 750°F), it will be found necessary

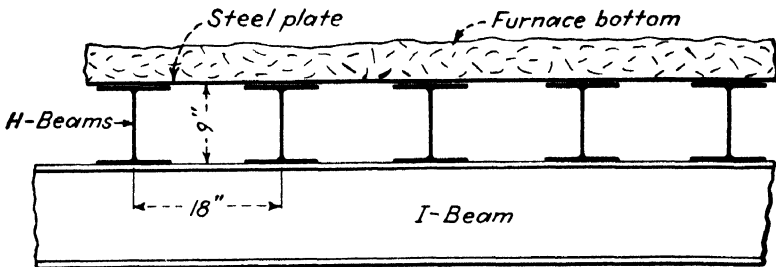

Fig. 382. Supports for an open-hearth bottom.

to protect the foundation from overheating if it is expected to maintain its full strength.

In some cases, the foundation is poured with a lightweight concrete containing a quartz-free aggregate. A mixture of crushed brickbats and high-alumina cement is generally preferred, a material that can be heated to elevated temperatures without cracking or entirely losing its strength, although it cannot be depended upon to support any concentrated loads. When reinforcing is used in foundations subjected to heat, the expansion characteristics of the high-temperature concrete and the reinforcing rods should be investigated to prevent a differential expansion from cracking the foundation.

In certain types of furnace, the bottom is supported directly on the steelwork. For example, the open-hearth furnace, a section of which is shown in Fig. 382, has the bottom on a steel plate which is supported by a series of H beams, thereby providing ventilation as well as a rigid support. The glass-tank bottom, as shown in Fig. 383, has the flux blocks supported directly on H beams, which permits the underside of the blocks to be air cooled.

2. Floors and Hearths. *Insulation.* The floor or hearth of a furnace is usually insulated from the concrete foundation, both to conserve fuel and to prevent overheating of the foundation. The insulation is often accomplished by putting down a layer of hollow tile on top of the concrete foundation. In other cases, discarded steel boiler tubes are set in the upper surface of the concrete foundation, a few inches apart, to allow ventilation. Another method uses a layer of cinders tamped over the concrete foundation, on top of which are laid several courses of firebrick. In the smaller furnaces, two or three courses of insulating brick may be laid on the concrete and then heavy brick placed on top of them. Many furnace designers do not appreciate the large amount of heat that may be lost through the foundations if the insulation is not well taken care of.

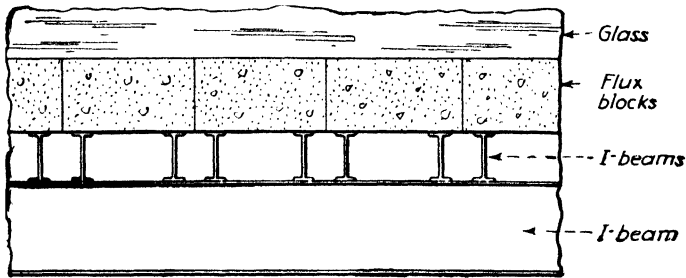

FIG. 383. Construction of the bottom of a glass tank.

Shapes and Bonds. Most of the hearth structures are laid with standard-size brick, a common type of construction being shown in Fig. 384. In some cases, however, larger blocks are used in the hearth to minimize the number of joints and to make larger units for reducing the tendency to float. In the case of the blast furnace, hearth blocks $18 \times 9 \times 4\frac{1}{2}$ in. are generally used. Sometimes these bottoms are keyed in to prevent floating. In the case of glass tanks, the bottom is made of large flux blocks often 24 by 48 in. across the face. Here again, the purpose is to minimize the joints and prevent the bottom from floating.

Expansion Joints. It is just as important to have expansion joints in the hearth as in the walls, because failure to take care of this expansion will force out the base of the furnace and bend the buckstays or cause buckling of the bottom. The expansion joints may be put in the hearth, as shown in Fig. 384, although expansion joints directly under the walls are not considered good practice by some designers. The amount of expansion to be left is considered more fully under the section on walls.

Monolithic Construction. Many types of furnace hearth are constructed of a monolithic slab. The material may be magnesite grain as

in the open-hearth furnace, chrome plastic as in the bottom of a powdered coal-fired boiler, or beach sand as in a malleable-iron furnace. There are two general methods of putting in the monolithic material. The first is to place it in dry, perhaps with a little slag, and sinter it down in layers until a firm hearth is produced. The other method is to ram in the plastic mix while it is wet to a homogeneous structure, then dry it out, and fire it in place. Refractory concrete, made with either ordinary or

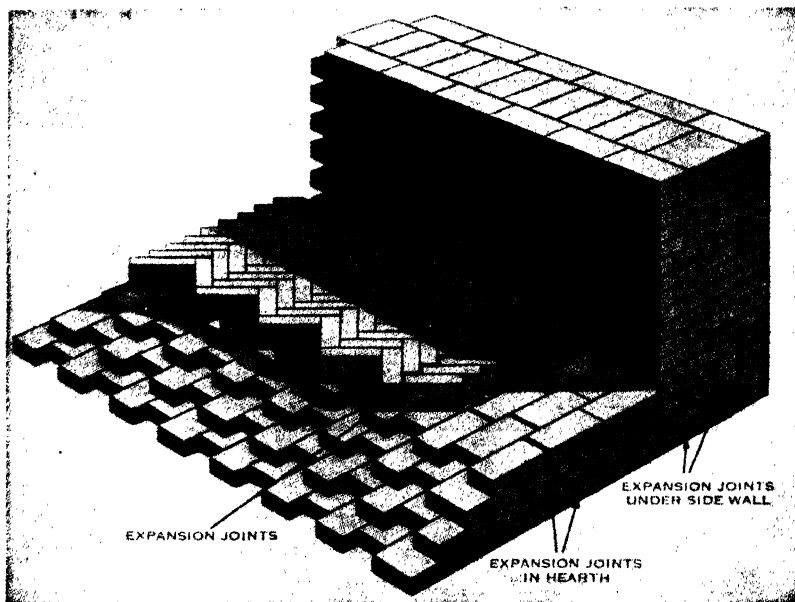

FIG. 384. Method of construction sometimes used in heating furnace bottoms. (From "Modern Refractory Practice," courtesy of the Harbison-Walker Refractories Company.)

lightweight aggregate, is used to form monolithic hearths, particularly for car-bottom furnaces and tunnel-kiln cars.

3. Walls. The walls of a furnace are primarily for the purpose of retaining the heat in the working chamber. To be satisfactory, however, they must be stable under the severe operating conditions encountered. Experience has shown that certain limiting factors must be understood before satisfactory construction of walls can be accomplished.

Thickness. The thickness of the wall depends a good deal on the conditions encountered. From the point of view of stability, the higher walls must be thicker, as shown in Table 135. On the other hand, if the wall is subjected to severe slag attack or spalling, extra thickness must be built into it to give it a reasonable amount of life. Table 136 gives the number of brick required for various thicknesses of wall, both solid

and composite, data that will be useful in brickwork estimating. Table 137 gives the weight of various types of refractory for computing wall weights.

TABLE 135. SAFE WALL HEIGHTS FOR UNANCHORED WALLS

| Wall Thickness, In. | Maximum Height* of Wall without Anchors but Arch Supported on Top of Wall, Ft. |
|---------------------|--|
| 4½ | 3 |
| 9 | 7 |
| 13½ | 12 |
| 18 | 15 |

* When wall does not support arch, the safe height is decreased 20 per cent.

Bonds. There are four ways of laying a standard brick, as indicated in Fig. 385. Nine-inch walls of one material are usually laid with all headers or with alternate header and stretcher courses. The rowlock courses are used for changing the height of the course, for sills, and for some floors but are not often used in wall construction with refractories. The soldier courses are not particularly stable and would not be used where they are expected to carry any amount of load. In building the thicker types of wall, it is necessary to bond the different layers together into a strong unit.

TABLE 136. WALLS MADE OF ONE KIND OF BRICK

| Wall Thickness, In. | Number of Straight Brick per Sq. Ft. |
|---------------------|--------------------------------------|
| 2½ | 3.6 |
| 4½ | 6.4 |
| 9 | 12.8 |
| 13½ | 19.2 |
| 18 | 25.6 |
| 22½ | 32.0 |
| 27 | 38.4 |
| 36 | 51.2 |

Refractory Lining of a Composite Wall

| | |
|---|------|
| 9, fifth course tie..... | 14 |
| 9, fourth course tie..... | 14.4 |
| 4½, fourth course tie..... | 8.0 |
| 4½, third course tie..... | 8.5 |
| 4½, alternate header and stretcher..... | 9.6 |
| Alternate 9" and 13½" courses..... | 16.0 |

Backing-up Insulation of a Compound Wall

| | |
|---|------|
| 9, fifth course tie..... | 11.5 |
| 9, fourth course tie..... | 11.2 |
| 4½, fourth course tie..... | 4.8 |
| 4½, third course tie..... | 4.26 |
| 4½, alternate header and stretcher..... | 9.6 |
| Alternate 9" and 13½" courses..... | 16.0 |

Typical methods of bonding are shown in Fig. 386 for walls of different thickness. It should be noted that at the end of a wall, it is better to break the joint with a $6\frac{3}{4}$ -in. brick, referred to as a large 9-in. straight, rather than with a soap, as this construction gives much greater stability.

TABLE 137. WEIGHT OF REFRACTORIES

| Material | Weight per Cubic Foot |
|---------------------------------------|---------------------------|
| Fireclay brick..... | 120-140 |
| Super-duty brick..... | 130-150 |
| High-alumina brick: | |
| 50..... | 125-135 |
| 60..... | 130-140 |
| 70..... | 140-150 |
| Fused Al_2O_3 | 153-196 |
| Kaolin brick..... | 130-135 |
| Silica brick..... | 100-110 |
| Magnesite brick: | |
| Burned..... | 160-175 |
| Chemical bonded..... | 180-185 |
| Chrome brick: | |
| Burned..... | 180-190 |
| Chemical bonded..... | 180-195 |
| Silicon carbide brick..... | 136-158 |
| Forsterite brick..... | 150-160 |
| Insulating firebrick: | |
| 1600°F..... | 19-30 |
| 2000°F..... | 28-40 |
| 2300°F..... | 30-45 |
| 2600°F..... | 39-55 |
| 2800°F..... | 40-60 |
| Insulating brick..... | 20-35 |
| Lightweight, castable..... | 55-80 (45-75 fired) |
| Fireclay plastic..... | 120-130 |
| Chrome plastic..... | 175-200 |
| Mortar, high temperature..... | 90-120 |
| Mortar, chrome..... | 125 |
| 1 cu. ft. of firebrick requires..... | seventeen 9-in. straights |
| 1 cu. ft. of red brick requires..... | 21 std. brick |
| 1,000 firebrick closely packed occupy | 60 cu. ft. |

With composite walls, *e.g.*, a combination of heavy brick and insulating firebrick, it is necessary to tie one layer into the other. The general rule is that the tie should be made of the stronger layer, as it is less apt to break off. A number of methods of tying composite walls are shown in Fig. 387. In many cases, the tie brick can be made with soaps rather than straights when using an insulating-firebrick lining, which reduces the heat conductivity of the whole.

Many types of furnace construction are carried out with bricks larger

than the 9-in. size for more rapid laying of the brick or for more solid structures. The 3-in. brick series is commonly used; and in some of the steel furnaces, still larger units are found useful. It should be noted that the dimensions of the standard brick are not ideal for the purpose of efficient laying. Strictly speaking, the thickness of the brick should be definitely related to the width and length, so that the brick could be tied into the structure no matter in what position it was used. For example, if we consider the length of the brick 9 in. and use a $\frac{1}{16}$ -in. joint, the dimensions would be $9 \times 4\frac{15}{32} \times 2\frac{15}{16}$. Under these conditions, a rowlock course would equal two stretcher courses and one soldier course would correspond

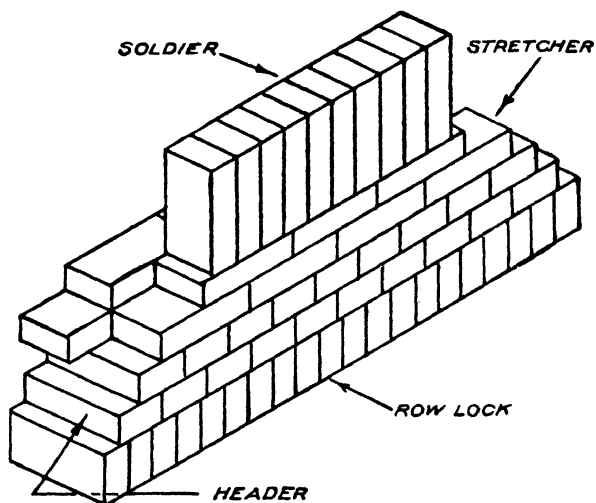

FIG. 385. Methods of laying brick.

exactly to three stretcher courses. It will be seen that the 3-in. brick closely fulfills these conditions.

Expansion Joints. All except the smallest refractory structures must have allowance made for expansion on heating. Considerable experience is necessary to know how many and what size expansion joints are to be used, but it is better to allow a little too much than not enough. An expansion joint in a wall can be a straight vertical joint, or it can be a broken joint, as shown in Fig. 388. In other types of construction, particularly when using silica and magnesite bricks, the expansion is taken care of by inserting a piece of cardboard in each vertical joint of the wall. This burns out and allows the individual bricks to expand freely.

When regular expansion joints are used, it is common in high-temperature furnaces to place them not more than 10 or 15 ft apart, usually at the corners of the furnace first and then in intermediate positions if

necessary. In Fig. 389 are shown typical expansion joints near a corner. Figure 390 shows an expansion joint used with insulating firebrick inside a steel casing. If it is necessary to keep the expansion joints gastight, loosely

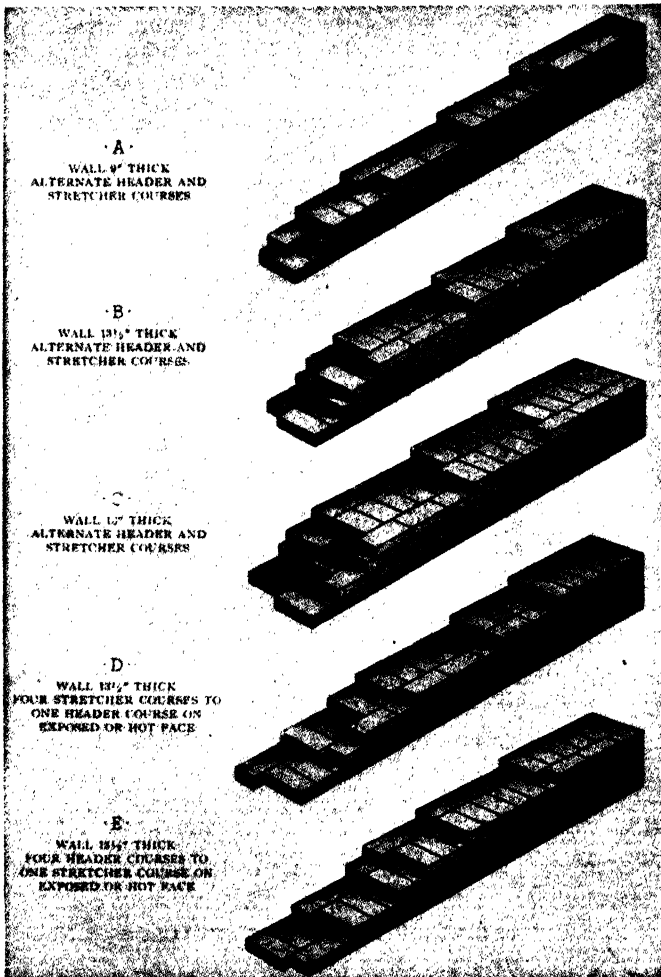
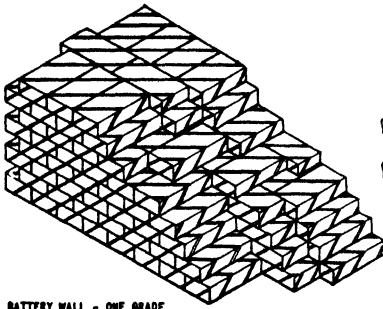

FIG. 386. Bonding of walls built with standard 9-in. brick. (From "Modern Refractory Practice," courtesy of the Harbison-Walker Refractories Company.)

packed asbestos rope or mineral wool can be used on the cooler face to seal them entirely.

Horizontal expansion joints to allow for vertical expansion are sometimes required, as in sectionally supported walls and where the arch is supported independently of the walls.



BATTERY WALL - ONE GRADE

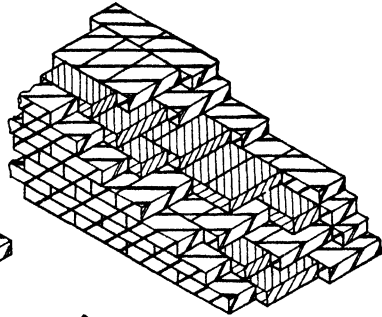

BATTERY WALL - TWO GRADES

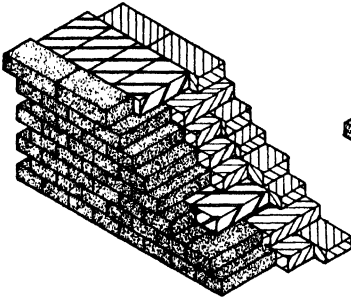

9" I.F.B. FACING TIED BY GRADE "A" FIREBRICK INTO GRADE "C" FIREBRICK BACKING

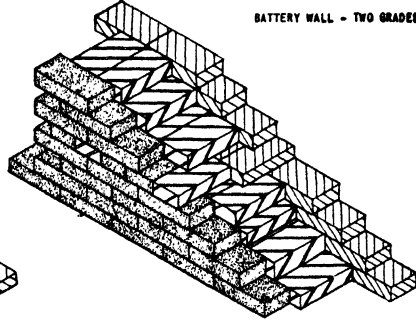

4 1/2" I.F.B. BACKED BY GRADE "A" FIREBRICK PLUS 1/2" GRADE "C" FIREBRICK

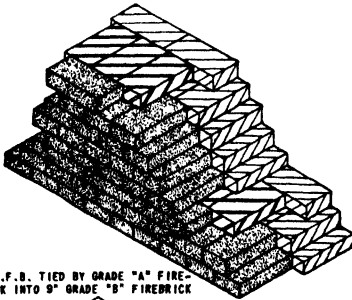

9" I.F.B. TIED BY GRADE "A" FIREBRICK INTO 9" GRADE "B" FIREBRICK

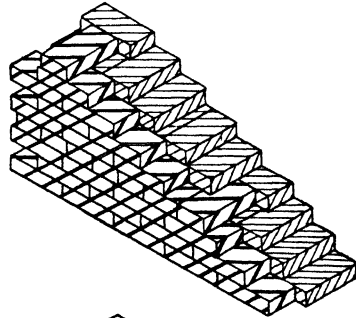

4 1/2" GRADE "A" FIREBRICK BACKED BY 9" GRADE "B" FIREBRICK

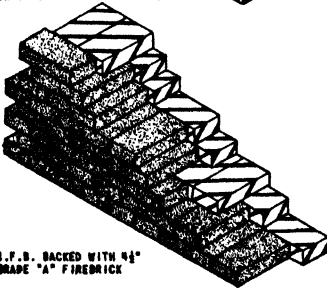

9" I.F.B. BACKED WITH 4 1/2" GRADE "A" FIREBRICK

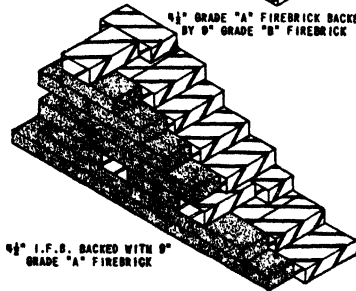

4 1/2" I.F.B. BACKED WITH 9" GRADE "A" FIREBRICK

FIG. 387. Method of bonding composite walls. (Courtesy of Babcock & Wilcox Company.)

In Table 138 is given the width of expansion joints in inches per foot of wall for various types of refractory and at various temperatures.

TABLE 138. WIDTH OF EXPANSION JOINTS IN INCHES PER FOOT OF WALL LENGTH

| Type of refractory | Maximum hot-face temperature | | | |
|----------------------|------------------------------|----------------|----------------|----------------|
| | 1500 | 2000 | 2500 | 3000 |
| Fireclay..... | $\frac{3}{64}$ | $\frac{1}{16}$ | $\frac{5}{64}$ | $\frac{3}{32}$ |
| Magnesite..... | $\frac{3}{32}$ | $\frac{1}{8}$ | $\frac{3}{16}$ | $\frac{1}{4}$ |
| Silica..... | $\frac{3}{16}$ | $\frac{5}{32}$ | $\frac{5}{32}$ | $\frac{5}{32}$ |
| Chrome..... | $\frac{1}{16}$ | $\frac{5}{64}$ | $\frac{3}{32}$ | $\frac{5}{32}$ |
| Silicon carbide..... | $\frac{1}{32}$ | $\frac{3}{64}$ | $\frac{1}{16}$ | $\frac{5}{64}$ |
| Kaolin..... | $\frac{1}{32}$ | $\frac{3}{64}$ | $\frac{1}{16}$ | $\frac{5}{64}$ |

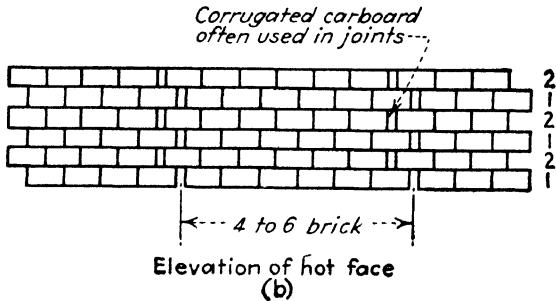
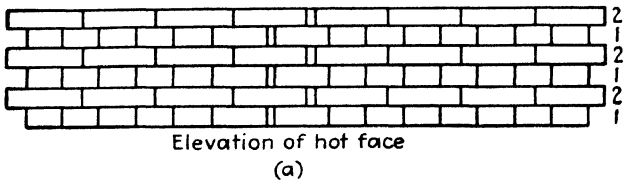

FIG. 388. Expansion joints in walls. (a) 13½-in. wall, alternate header and stretch construction. (b) Built of magnesite brick, 9-in. header construction. (From "Modern Refractory Practice," courtesy of the Harbison-Walker Refractories Company.)

Methods of Anchoring the Wall. When very thin or high walls are used they must be anchored at certain intervals to the casing or steelwork to prevent buckling. The design of anchors has been greatly improved in the last few years and has thereby permitted the use of much thinner walls in many types of furnace. This anchoring is usually accomplished by a bolt fitting into a special brick. In Fig. 391 is shown one method of anchoring an insulating firebrick wall with a heavy brick tile. Figure 392 illustrate

must be anchored. This can be carried out by the use of special anchor tile as furnished by the various manufacturers.

Insulation. When insulation is applied to the outside of the wall, it may be tied in as shown in Fig. 387 or it may be placed between the refractory and a steel casing in the form of a block. In some types of construction, the outer face of the wall is made of red brick to protect the insulating material. This construction is stable, but it increases the heat storage of

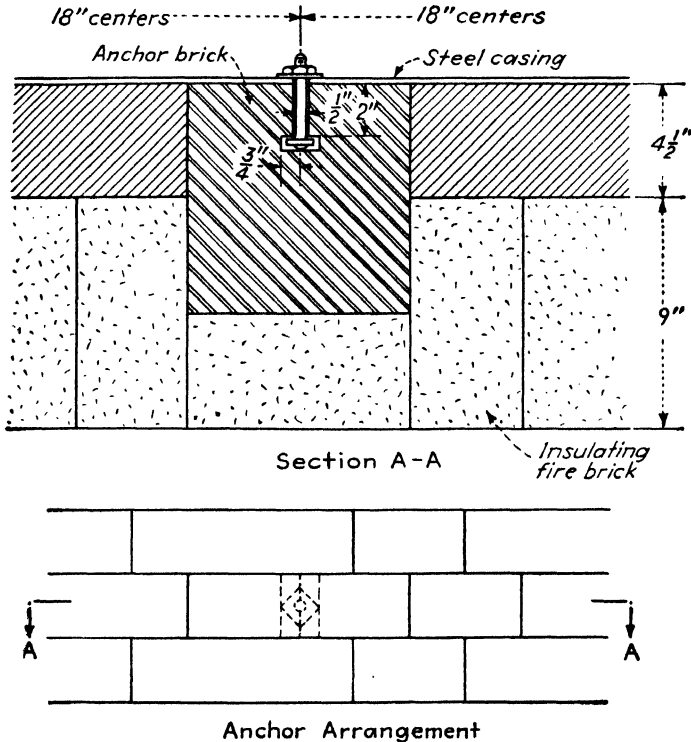

FIG. 391. Anchor arrangement. (Courtesy of Babcock & Wilcox Company.)

the wall, which is a disadvantage for intermittent operation, and also requires additional floor space. Many insulated furnaces simply have the corners protected with angle iron, and the face of the insulation is coated with a hard-face cement and possibly an asphalt coating for waterproofing. Another method of protecting the insulation is to use a casing of approximately 10-gage sheet steel or aluminum.

4. Doors, Ports, and Flues. *Door Openings.* The door openings in most furnaces are among the most troublesome points in the structure, both because they mechanically weaken the wall and because the door frame must take considerable abuse from charging and hot gases. One of the

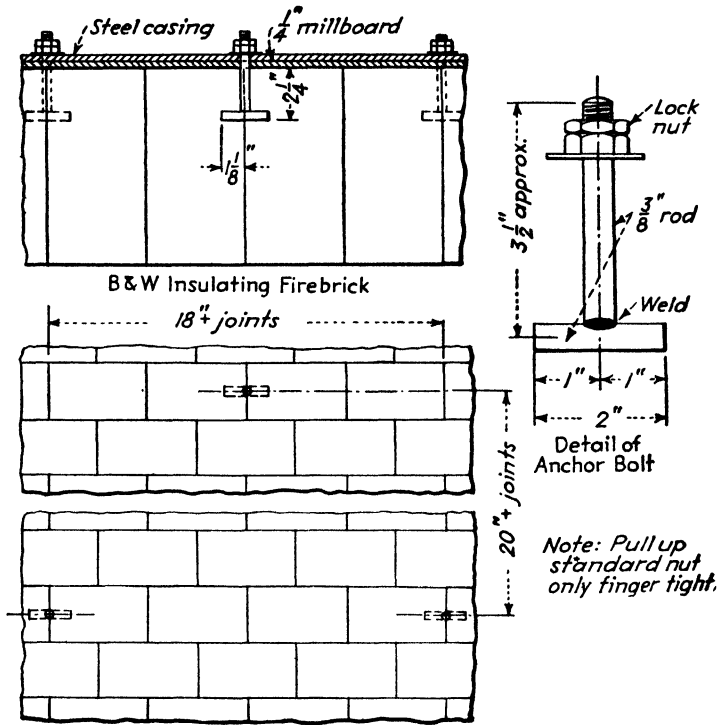

FIG. 392. Method of holding insulating firebrick to casing. (Courtesy of Babcock & Wilcox Company.)

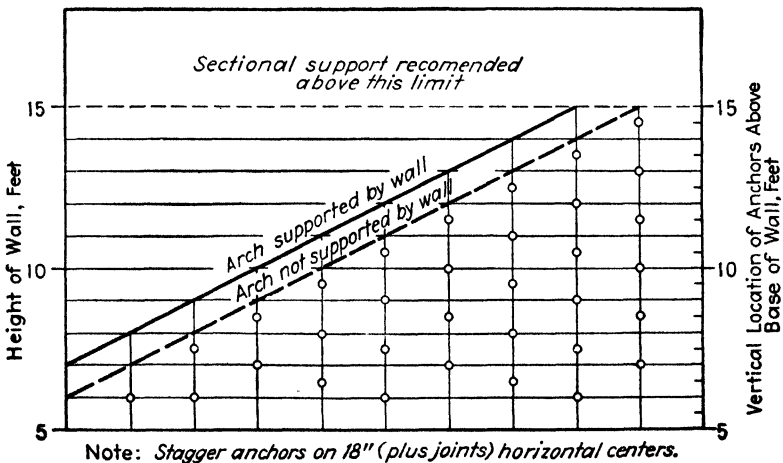

FIG. 393. Stagger anchors on 18-in. (plus joints) horizontal centers. (Courtesy of Babcock & Wilcox Company.)

first rules in door construction is to keep the width as small as possible compatible with access to the furnace. A typical door structure is shown in Fig. 394*a*, where a 4½-in. arch is thrown over the top of the opening and bonded into the wall. As the front 9-in. bricks are apt to be knocked loose, the sill of the door should be made of a solid construction. This may be accomplished by using a rowlock course bonded with air-setting mortar

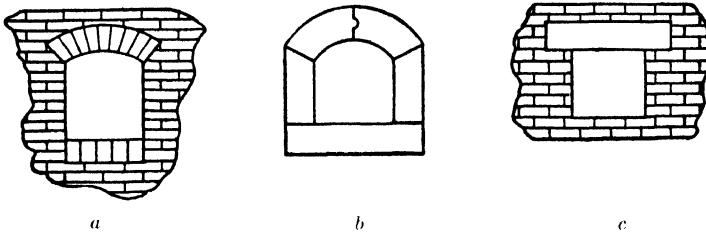

FIG. 394. Door openings.

or by using larger than 9-in. brick. Figure 394*b* shows a door opening, or port, of somewhat smaller size made up of special shapes, a construction that generally gives excellent service. In Fig. 394*c* is shown a wall opening with a heavy tile across the top. This construction, though satisfactory for low-temperature work, is to be avoided for high-temperature furnaces, as the tile usually cracks in the center and the broken ends sag.

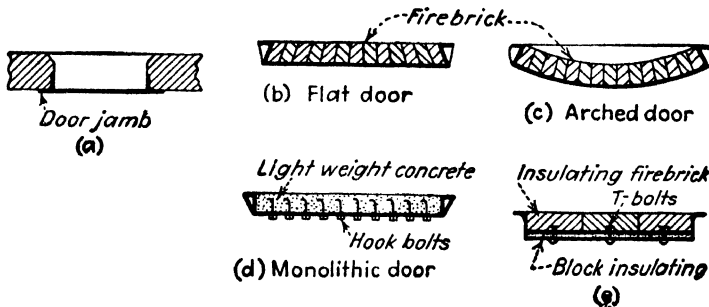

FIG. 395. Door construction.

In the low-temperature structures, a steel door jamb is often placed outside the wall to protect the brickwork. This is welded together from standard angle iron and makes a solid structure, as shown in Fig. 395*a*. For higher temperature furnaces, such as the open hearth, a water-cooled door jamb is generally used. It holds the brickwork in shape and resists to a considerable extent the abuse to which it is subjected from the charging machine.

Doors. Doors on furnaces almost always slide in vertical ways with a counterweight to balance them approximately. The weight of the door

should be kept as low as possible in order to reduce the cost of the supports and make the operation quicker. Two general types of door are the flat door and the arch door, as shown in Figs. 395*b* and 395*c*, where the shapes are locked into the door frame to prevent them from bowing in. Such a door will stand considerable mechanical abuse, but it is rather heavy and conducts much heat out of the furnace.

More recently, furnace doors have been lined with lightweight concrete held in place by hook bolts as shown in Fig. 395*d*. This construction is very simple to reline, gives a light door, and has a comparatively low heat conductivity. Another construction for higher temperature use is shown in Fig. 395*e*, where the door is lined with insulating firebrick held into the door frame. This gives a lightweight construction and one that is an excellent insulator; the latter is a factor of great importance to the comfort of the men working around the furnace.

Ports and Burner Openings. Ports or openings in the furnace walls, when large, are constructed in the same way as described for the door openings. When the ports are smaller, a special shape often is set into the wall with the proper opening molded into it or a number of shapes are fitted together to form the opening, as would be the case in burner tile as shown in Fig. 396. It is

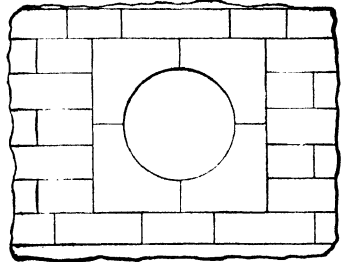

FIG. 396. Burner tile set in wall.

often found practical to form the port or opening out of plastic material, which is rammed into place around the form in a rectangular opening in the brickwork. When properly made, such a construction often works out very satisfactorily and avoids the necessity of purchasing special shapes. Such plastic structures, however, are generally not so abrasion resisting as fired shapes and are not so satisfactory for extreme temperature conditions as preburned tile.

When walls are constructed of insulating firebrick, the ports or openings, when small, can often be cut directly in the wall after it has been finished. For larger openings, specially cut shapes can be used to advantage.

Flues and Ducts. Flues and ducts for high-temperature use are lined with a refractory. The smaller sizes are usually rectangular, and the larger ones circular, in which case arch or circle brick are generally employed. Where the moving gases in the duct do not carry a large amount of suspended particles, the ducts can well be lined with insulating firebrick, as a much thinner layer can be used because of its better insulating value. This, in turn, will allow a very much lighter lining, which means lower cost of steelwork and supports. The cost of the duct can often be cut in half by the use of insulating firebrick.

Stacks. Stacks for low-temperature furnaces are often of steel with a brick lining up to a sufficient distance to protect the steelwork. Insulating firebrick and lightweight concrete reinforced with wide-mesh, light-gage, expanded metal lath are frequently used for linings. For really high-temperature work, however, an all-brick stack is desirable such as that used for periodic kilns. Such a stack should have a firebrick lining that is free to expand and contract inside a stable wall such as is shown in Fig. 397.

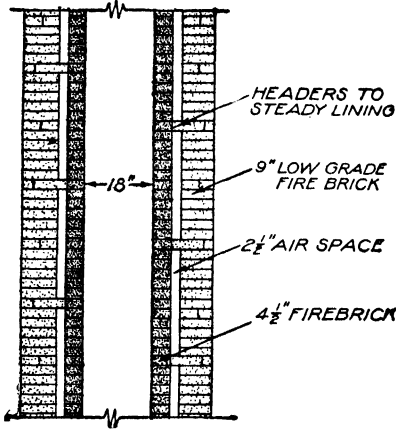

FIG. 397. High-temperature stack.

5. **Sprung Arches.** *Stresses and Shapes.* The circular arch, as generally employed, subtends an angle of 60 deg, which makes the radius of curvature equal to the span. However, there is no standardization in the ratio of span to rise of the arch, as in some cases a high arch is needed for combustion space and in others a very flat arch is desirable to force the

flame down on the work. It should be noted that the circular arch in the higher forms becomes relatively unstable because of the fact that the line of

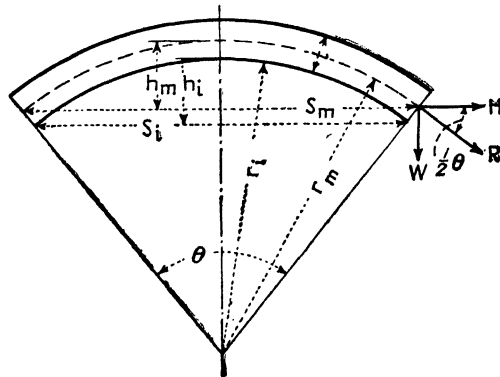

FIG. 398. Characteristics of the circular arch.

thrust of the arch takes the form of an inverted catenary which departs more and more from the circular form as the height of the arch increases. Therefore, it has been found desirable always to employ the catenary form of arch when the ratio of rise to span is large. The curvature of the circular arch is usually expressed in inches of rise per foot of span.

In Fig. 398 is shown a typical circular arch with the principal dimen-

sions given. From this diagram, it is easy to compute the various factors and stresses, which are given in the formulas below. It should be noted that for stress computations, the mean radius r_m must be used whereas for brickwork estimation, the inner radius r_i is more convenient. The rise, however, is the same in both cases, as $h_m/S_m = h_i/S_i$.

$$r_m = \frac{S_m^2}{8h_m} + \frac{h_m}{2}$$

$$h = r_m - \sqrt{r_m^2 - \left(\frac{S_m}{2}\right)^2}$$

$$\sin \frac{1}{2} \theta = \frac{S_m}{2r_m}$$

$$\tan \frac{1}{4} \theta = \frac{2h_m}{S_m}$$

$$W = \frac{1}{2} l t d$$

$$R = W \operatorname{cosec} \frac{1}{2} \theta$$

$$H = W \cot \frac{1}{2} \theta$$

$$l = 2\pi r_m \frac{\theta}{360}$$

where θ = the central angle

r_m = the radius at center of arch ring, ft

r_i = the inner radius of the arch ring

S = the span, ft

h = the rise, ft

t = the thickness, ft

W = one-half weight of 1-ft length of arch, lb

H = the horizontal thrust at skewback per foot of length, lb

R = the resultant thrust at skewback per foot of length, lb

l = the length of mean arc

$\pi = 3.1416$

d = the density of brick, lb/cu ft

In Table 139 are given the important factors applying to circular arches of various heights. This table will be found useful for the quick calculation of the characteristics of arches.

The temperature stresses in an arch are difficult to compute, but it may be said that they are greater in the flatter arches because a given expansion of the arch will produce a greater rise and more pinching of the tips of the bricks. To minimize this difficulty, especially with silica brick, tie bolts are often slacked off in a predetermined manner as the arch heats up in order to keep the curvature constant. There is also another temperature stress, due to the temperature gradient through the arch itself, thus causing the tips of the bricks to expand more than the outer face, which puts an

TABLE 139.

| Inches rise per foot span | Central angle | Fraction of a complete circle | Weight factor, W_1 | Horizontal-thrust factor, H_1 | Resultant-thrust factor, R_1 |
|---------------------------|---------------|-------------------------------|----------------------|---------------------------------|--------------------------------|
| 1.000 | 37°51' | 0.1051 | 1.02 | 2.90 | 3.07 |
| 1.250 | 47 04 | 0.1307 | 1.03 | 2.30 | 2.51 |
| 1.500 | 56 08 | 0.1560 | 1.04 | 1.87 | 2.13 |
| 1.608 | 60 00 | 0.1667 | 1.05 | 1.73 | 2.00 |
| 1.750 | 65 02 | 0.1807 | 1.06 | 1.57 | 1.86 |
| 2.000 | 73 44 | 0.2048 | 1.07 | 1.30 | 1.64 |
| 2.250 | 82 13 | 0.2284 | 1.09 | 1.15 | 1.52 |
| 2.500 | 90 29 | 0.2513 | 1.12 | 1.00 | 1.44 |
| 3.000 | 106 15 | 0.2952 | 1.16 | 0.76 | 1.25 |
| 6.000* | 180 00 | 0.5000 | 1.57 | 0.00 | 1.00 |

* Unstable.

To find the weight of the roof multiply together the mean span, length, thickness (in feet), weight per cubic foot, and the factor W_1 .

To find the horizontal thrust on one skewback multiply the factor H_1 by one-half the total weight.

To find the resultant thrust on one skewback multiply the factor R_1 by one-half the total weight.

additional compression force on the inner surface. This latter effect can be minimized by using insulation on the outside of the arch.

The catenary shape has been found particularly satisfactory for some of the higher arches, thus allowing the side walls and crown to be one con-



FIG. 399. Catenary. (Courtesy of Babcock & Wilcox Company.)

tinuous curve with almost complete elimination of ironwork, as shown in Fig. 399. The calculation of the catenary can be carried out as follows.

The equation of the catenary as illustrated in Fig. 400 is

$$y = \frac{m}{2} (e^{x/m} + e^{-x/m})$$

or in hyperbolic functions

$$y = m \cosh \frac{x}{m}$$

The latter form is the most convenient to work with.

The slope angle at any point on the curve is given by

$$\theta = \tan^{-1} \left(\sinh \frac{x}{m} \right)$$

The length of the curve between the apex and any point is

$$l = m \sinh \frac{x}{m}$$

The radius of curvature at any point is

$$r = \frac{y^2}{m}$$

The compression (or tension) at the apex is

$$H = wm$$

where w = the weight per unit length of the curve

Table 140 shows the calculation of a typical high-catenary arch.

TABLE 140.

| x | $\frac{x}{m}$ | $\cosh \frac{x}{m}$ | y | $y - m$ |
|-----|---------------|---------------------|------|---------|
| 0 | 0 | 1.000 | 19.0 | 0 |
| 5 | 0.263 | 1.035 | 19.7 | 7 |
| 10 | 0.527 | 1.142 | 21.7 | 2.6 |
| 15 | 0.789 | 1.328 | 25.2 | 6.2 |
| 20 | 1.054 | 1.609 | 30.6 | 11.6 |
| 25 | 1.317 | 2.000 | 38.0 | 19.0 |
| 30 | 1.579 | 2.528 | 48.1 | 29.1 |
| 35 | 1.841 | 3.231 | 61.4 | 42.4 |
| 40 | 2.108 | 4.177 | 79.5 | 60.5 |
| 42 | 2.210 | 4.613 | 88.0 | 69.0 |

$$m = 19$$

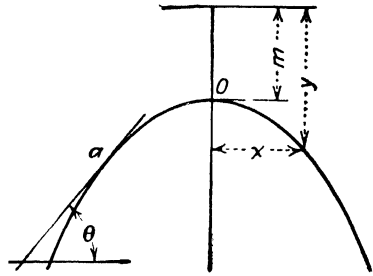

Fig. 400. Catenary.

It will be found, in general, more convenient to lay out the catenary by hanging a sash-weight chain along a vertical surface in such a way as to pass through the three points representing the skewbacks and the apex. The chain thus hanging will form a perfect catenary, and the shape can be traced from this directly on the surface.

Arch Spans and Thicknesses. It is a little difficult to give any hard-and-fast rules regarding the thickness and span of arches, as this ratio depends a great deal on the type of refractory, the temperature of the furnace, and the operating conditions. In general, for heavy brick construction, a $4\frac{1}{2}$ -in. thickness would not be used for more than a 5-ft span, a 9-in. arch would be used up to a 12-ft, a $13\frac{1}{2}$ -in. arch up to 16 ft, and an 18-in. arch up to 20 ft. However, there have been a number of successful operations at moderate temperatures with much wider arches than these. For example, a firebrick arch of 18-ft span and 9-in. thickness has given an excellent life.

In the case of the insulating-firebrick construction, the thickness is seldom over 9 in.; but in moderate-temperature construction, the span often is as great as 15 ft; and in one case, a 22-ft arch has given excellent service.

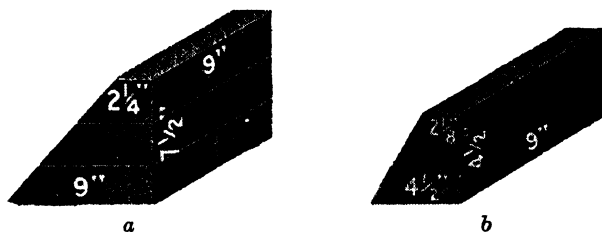

FIG. 401. (a) Skewback built with standard 9-in. featheredge brick of the $2\frac{1}{2}$ -in. series. (b) Skewback built with standard 9-in. sideskew and endskew brick of the $2\frac{1}{2}$ -in. series. (Courtesy of J. S. McDowell and L. L. Gill, "Steel.")

Skewbacks. The skewback must be made to give the proper angle for the ends of the arch, and it must have sufficient face to accommodate the thickness of the arch ring. Standard skewbacks are made with side skews and featheredge bricks as shown in Fig. 401, which accommodate $4\frac{1}{2}$ and $9\frac{1}{2}$ in. thick arches with rises of respectively $1\frac{1}{2}$ and $2\frac{5}{16}$ in. per ft. However, special skewbacks can be readily obtained from most of the refractory manufacturers, as shown in Figs. 402 to 404, for an arch of 60-deg central angle. In the case of insulating-firebrick, standard skewbacks can be made up as shown in Fig. 405 out of standard shapes for arches having a 60-deg central angle. In the case of the insulating firebrick, however, it is very easy to grind the skewbacks to any desired slope.

Methods of holding the skewback are shown in Fig. 406, but in all cases, the arch thrust should be well supported by the ironwork using either an

angle section or a channel. As explained previously, the arch can be supported on top of the wall or supported independently of the wall. The latter construction would be used where the life of the side walls is shorter than the arch, such as in a glass tank, in which case a replacement of the walls can be readily made without disturbing the arch. Also, in the case of

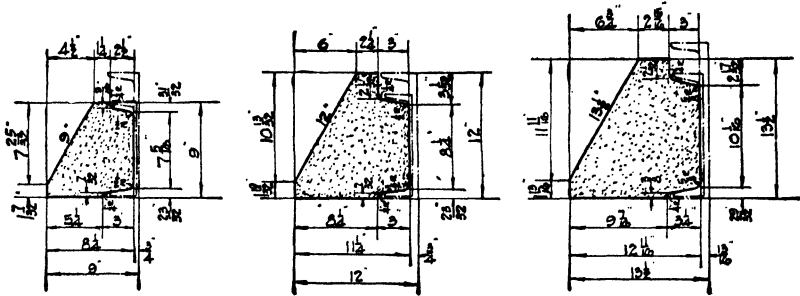

FIG. 402. Skewback brick with cutouts for steel channel framework. (Courtesy of J. S. McDowell and L. L. Gill, "Steel.")

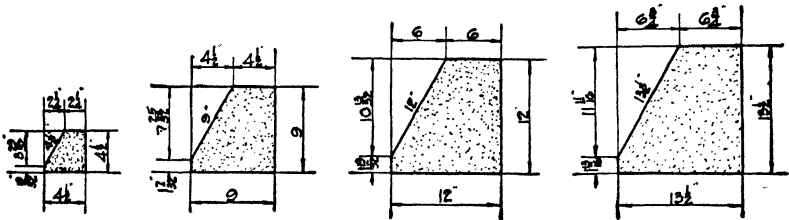

FIG. 403. Sixty-degree skewbacks. Shape 60-4½ is 9-in. thick; the others are 4½-in. thick. (Courtesy of J. S. McDowell and L. L. Gill, "Steel.")

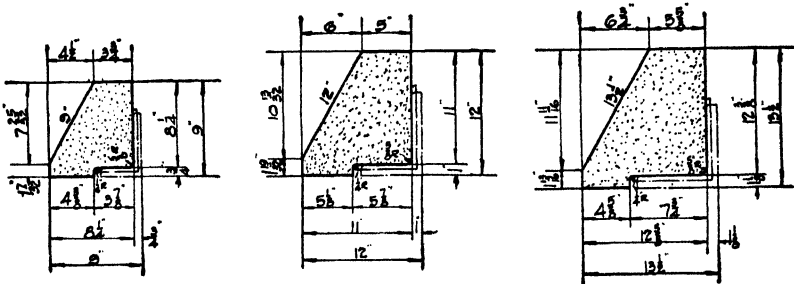

FIG. 404. Skewback brick with cutouts for steel angle supporting framework. (Courtesy of J. S. McDowell and L. L. Gill, "Steel.")

heavy arches, less load is put on the side walls if the arch is separately supported. On the other hand, wall-supported arches tend to hold the top of the wall from bowing in.

Steelwork. The steelwork for supporting the arch usually consists of an angle or channel running horizontally behind the skewback at the top of the wall; this is held in place by buckstays, the lower ends of which are held in

a socket in the concrete foundation and the upper ends tied together with a bolt. The section of iron used in the buckstays depends on the weight of the crown, a crown of insulating firebrick requiring much lighter sections than a heavy brick crown. The strength of these sections can be readily computed from the thrust of the arch, but a considerable factor of safety

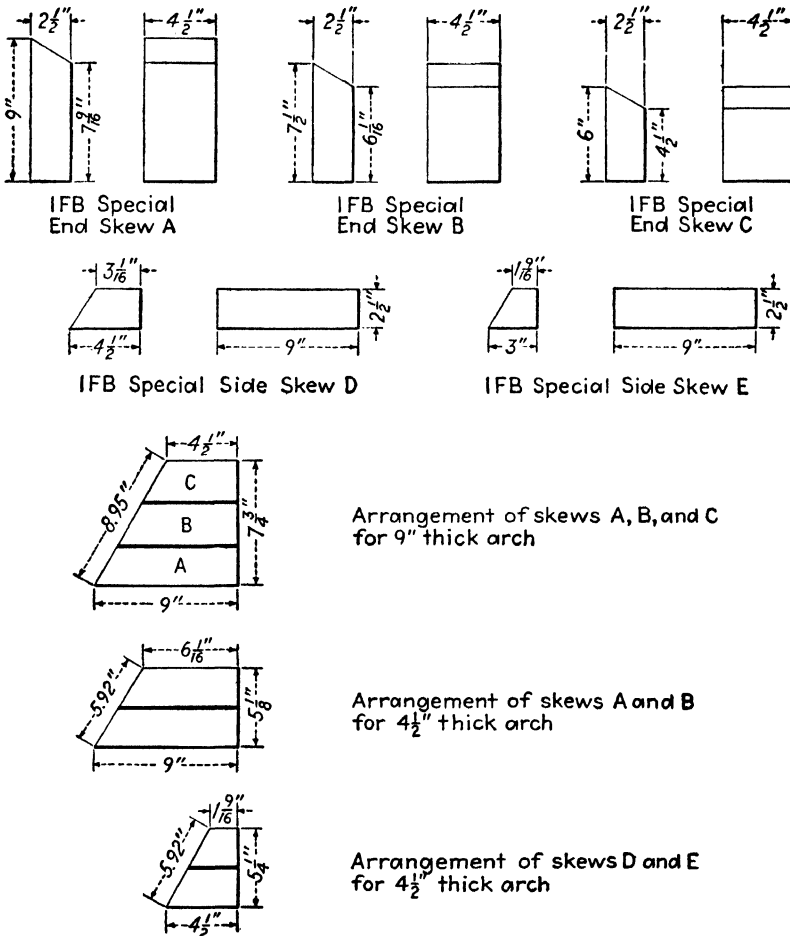

FIG. 405. Special IFB skewbacks for sprung arches in which the radius equals the span. Note: Mortar joints $\frac{1}{8}$ -in. thick. (Courtesy of Babcock & Wilcox Company.)

of at least 5 should be introduced because of the high temperature at which the buckstays go in certain types of construction.

The section of the buckstay has not received so much attention as it should. The I beam in (A) of Fig. 407 is the usual one because of its high mechanical efficiency. However, from the thermal point of view, it is most inefficient, as the inner flange is at a comparatively high temperature

whereas the outer flange is at a comparatively low temperature because of the small heat conductivity along the web. This condition produces a maximum of warping, which is often noticed in kiln construction, and thus

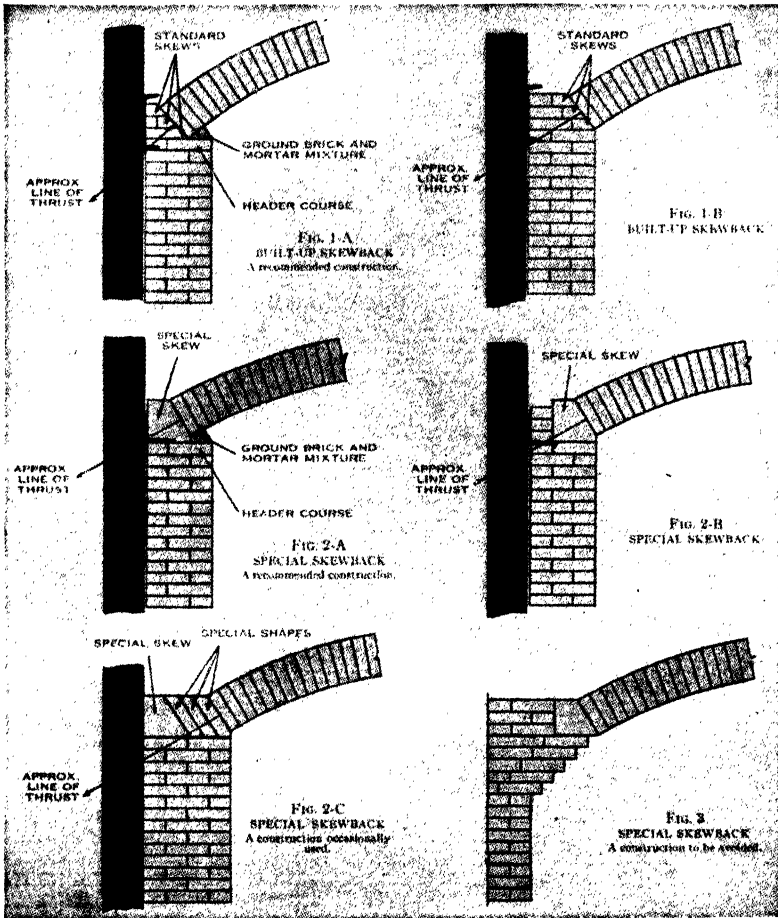

FIG. 406. Skewback construction. (From "Modern Refractory Practice," courtesy of the Harbison-Walker Refractories Company.)

allows a bowing of the walls. A simple section (B) or a H section (C) will be found thermally more efficient because it will maintain a much more uniform temperature over the section.

Bonding of the Arch. Arches can be built up in a bonded construction, such as shown in Fig. 408, or in a separate ring construction, such as shown in Fig. 409.

The bonded construction has the advantage of giving a more stable

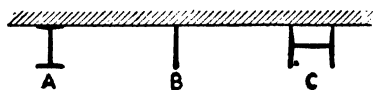

FIG. 407. Types of buckstay.

structure in case of failure of one or two individual units. On the other hand, it requires a little more skill in laying in order to get a uniform load on all the bricks. In the separate ring arch, any one ring can be repaired without disturbing the others, which in some cases is a real advantage.

Special Arches. There are many types of special arch, such as the rib arch in Fig. 410, often used in open-hearth-furnace crowns to give stability

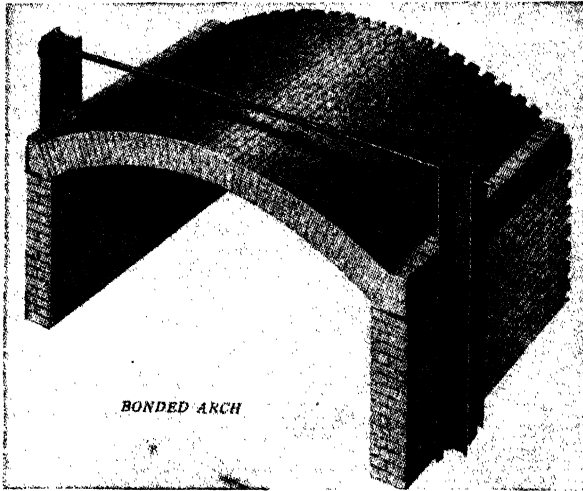

FIG. 408. (From "Modern Refractory Practice," courtesy of the Harbison-Walker Refractories Company.)

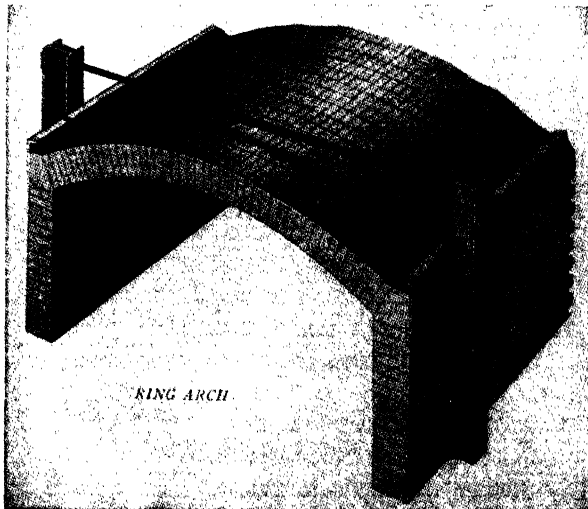

FIG. 409. (From "Modern Refractory Practice," courtesy of the Harbison-Walker Refractories Company.)

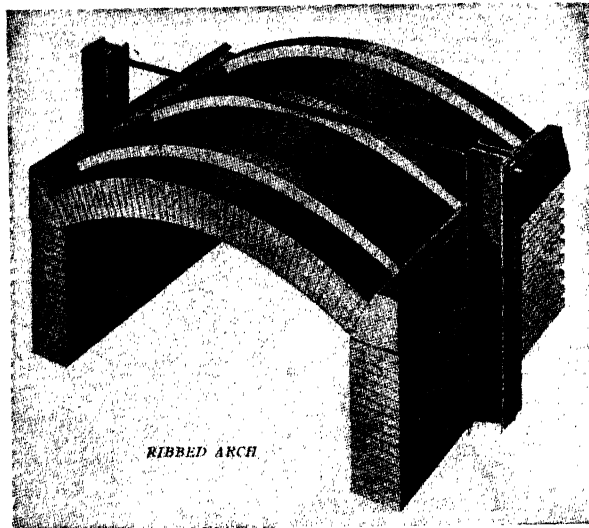

FIG. 410. (From "Modern Refractory Practice," courtesy of the Harbison-Walker Refractories Company.)

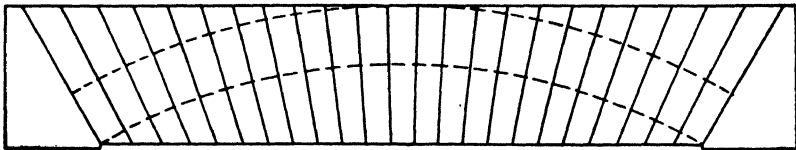

FIG. 411. Jack arch. This type of arch is formed by special wedge shapes, which may be designed by first laying out a radial sprung arch of proper rise and thickness for the given span, then extending all brick shapes upward to the level of the upper crown surface and downward to the spring line. This arch is designed on a basis of $1\frac{1}{2}$ -in. rise per foot of span. (From "Modern Refractory Practice," courtesy of the Harbison-Walker Refractories Co.)

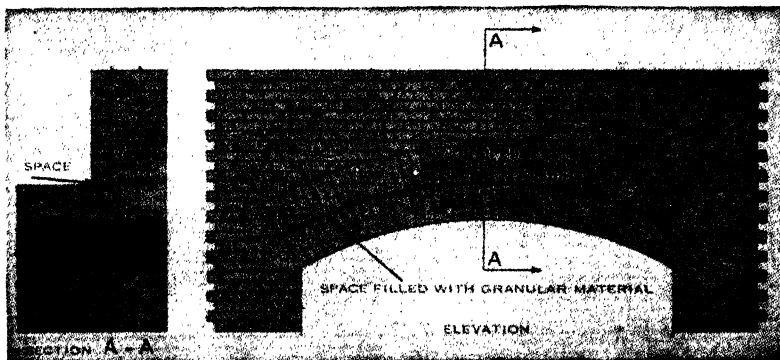

FIG. 412. Use of relieving arch to support wall. (From "Modern Refractory Practice," courtesy of the Harbison-Walker Refractories Co.)

TABLE 141. $9 \times 4\frac{1}{2} \times 2\frac{1}{2}$ -IN. KEY BRICK*

| Inside diameter | No. required to turn circle | | | | | Total |
|-----------------|-----------------------------|-----------|-----------|-----------|----------|-------|
| | No. 4 key | No. 3 key | No. 2 key | No. 1 key | Straight | |
| 1'6" | 26 | | | | | 26 |
| 2'0" | 17 | 13 | | | | 30 |
| 2'6" | 9 | 25 | | | | 34 |
| 3'0" | | 38 | | | | 38 |
| 3'6" | | 29 | 13 | | | 42 |
| 4'0" | | 21 | 25 | | | 46 |
| 4'6" | | 13 | 38 | | | 51 |
| 5'0" | | 4 | 51 | | | 55 |
| 5'3" | | | 57 | | | 57 |
| 5'6" | | | 55 | 4 | | 59 |
| 6'0" | | | 50 | 13 | | 63 |
| 6'6" | | | 46 | 21 | | 67 |
| 7'0" | | | 42 | 30 | | 72 |
| 7'6" | | | 38 | 38 | | 76 |
| 8'0" | | | 34 | 46 | | 80 |
| 8'6" | | | 29 | 55 | | 84 |
| 9'0" | | | 25 | 63 | | 88 |
| 9'6" | | | 21 | 72 | | 93 |
| 10'0" | | | 17 | 80 | | 97 |
| 10'6" | | | 13 | 88 | | 101 |
| 11'0" | | | 9 | 96 | | 105 |
| 11'6" | | | 4 | 105 | | 109 |
| 12'0" | | | | 113 | | 113 |
| 12'6" | | | | 113 | 5 | 118 |
| 13'0" | | | | 113 | 9 | 122 |
| 13'6" | | | | 113 | 13 | 126 |
| 14'0" | | | | 113 | 17 | 130 |
| 14'6" | | | | 113 | 21 | 134 |
| 15'0" | | | | 113 | 26 | 139 |
| 15'6" | | | | 113 | 30 | 143 |
| 16'0" | | | | 113 | 34 | 147 |
| 16'6" | | | | 113 | 38 | 151 |
| 17'0" | | | | 113 | 42 | 155 |
| 17'6" | | | | 113 | 47 | 160 |
| 18'0" | | | | 113 | 51 | 164 |
| 18'6" | | | | 113 | 55 | 168 |
| 19'0" | | | | 113 | 59 | 172 |
| 19'6" | | | | 113 | 63 | 176 |
| 20'0" | | | | 113 | 68 | 181 |
| 20'6" | | | | 113 | 72 | 185 |
| 21'0" | | | | 113 | 76 | 189 |
| 21'6" | | | | 113 | 80 | 193 |
| 22'0" | | | | 113 | 84 | 197 |

TABLE 141. $9 \times 4\frac{1}{2} \times 2\frac{1}{2}$ -IN. KEY BRICK* (Continued)

| Inside diameter | No. required to turn circle | | | | | |
|-----------------|-----------------------------|-----------|-----------|-----------|----------|-------|
| | No. 4 key | No. 3 key | No. 2 key | No. 1 key | Straight | Total |
| 22'6" | | | | 113 | 88 | 201 |
| 23'0" | | | | 113 | 93 | 206 |
| 23'6" | | | | 113 | 97 | 210 |
| 24'0" | | | | 113 | 101 | 214 |
| 24'6" | | | | 113 | 105 | 218 |
| 25'0" | | | | 113 | 109 | 222 |
| 25'6" | | | | 113 | 114 | 227 |
| 26'0" | | | | 113 | 118 | 231 |
| 26'6" | | | | 113 | 122 | 235 |
| 27'0" | | | | 113 | 126 | 239 |
| 27'6" | | | | 113 | 130 | 243 |
| 28'0" | | | | 113 | 135 | 248 |
| 28'6" | | | | 113 | 139 | 252 |
| 29'0" | | | | 113 | 143 | 256 |
| 29'6" | | | | 113 | 147 | 260 |
| 30'0" | | | | 113 | 151 | 264 |
| 30'6" | | | | 113 | 155 | 268 |
| 31'0" | | | | 113 | 160 | 273 |
| 31'6" | | | | 113 | 164 | 277 |
| 32'0" | | | | 113 | 168 | 281 |
| 32'6" | | | | 113 | 172 | 285 |
| 33'0" | | | | 113 | 176 | 289 |
| 33'6" | | | | 113 | 181 | 294 |
| 34'0" | | | | 113 | 185 | 298 |
| 34'6" | | | | 113 | 189 | 302 |
| 35'0" | | | | 113 | 193 | 306 |

* Applies also to $9 \times 4\frac{1}{2} \times 3$ -in. key brick.

NOTE: Fractional parts of one-tenth of a brick or more are counted as entire brick; smaller fractions are disregarded.

for long spans. The jack arch in Fig. 411 is made up of special shapes in order to give a flat lower surface. This type of arch is often used in certain portions of tunnel kilns to conform closely to the charge.

The relieving arch shown in Fig. 412 is sometimes used to support the weight of an end wall and to take the load off the main arch. Relieving arches in modern construction are not used very extensively.

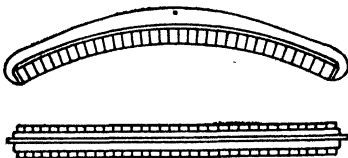

FIG. 413. Bung arch.

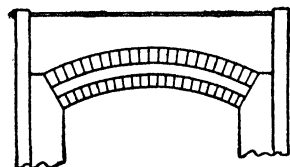

FIG. 414. Double arch.

REFRACTORIES

TABLE 142. $9 \times 4\frac{1}{2} \times 2\frac{1}{2}$ -IN. WEDGE BRICK*

| Inside diameter | No. required to turn circle | | | |
|-----------------|-----------------------------|-------------|----------|-------|
| | No. 2 wedge | No. 1 wedge | Straight | Total |
| 2'3" | 57 | | | 57 |
| 2'6" | 51 | 10 | | 61 |
| 3'0" | 38 | 30 | | 68 |
| 3'6" | 25 | 51 | | 76 |
| 4'0" | 13 | 71 | | 83 |
| 4'6" | | 91 | | 91 |
| 5'0" | | 91 | 7 | 98 |
| 5'6" | | 91 | 15 | 106 |
| 6'0" | | 91 | 22 | 113 |
| 6'6" | | 91 | 30 | 121 |
| 7'0" | | 91 | 38 | 129 |
| 7'6" | | 91 | 45 | 136 |
| 8'0" | | 91 | 53 | 144 |
| 8'6" | | 91 | 60 | 151 |
| 9'0" | | 91 | 68 | 159 |
| 9'6" | | 91 | 75 | 166 |
| 10'0" | | 91 | 83 | 174 |
| 10'6" | | 91 | 90 | 181 |
| 11'0" | | 91 | 98 | 189 |
| 11'6" | | 91 | 105 | 196 |
| 12'0" | | 91 | 113 | 204 |
| 12'6" | | 91 | 121 | 212 |
| 13'0" | | 91 | 128 | 219 |
| 13'6" | | 91 | 136 | 227 |
| 14'0" | | 91 | 143 | 234 |
| 14'6" | | 91 | 151 | 242 |
| 15'0" | | 91 | 158 | 249 |
| 15'6" | | 91 | 166 | 257 |
| 16'0" | | 91 | 173 | 264 |
| 16'6" | | 91 | 181 | 272 |
| 17'0" | | 91 | 188 | 279 |
| 17'6" | | 91 | 196 | 287 |
| 18'0" | | 91 | 203 | 294 |
| 18'6" | | 91 | 211 | 302 |
| 19'0" | | 91 | 219 | 310 |
| 19'6" | | 91 | 226 | 317 |
| 20'0" | | 91 | 234 | 325 |
| 20'6" | | 91 | 241 | 332 |
| 21'0" | | 91 | 249 | 340 |
| 21'6" | | 91 | 256 | 347 |
| 22'0" | | 91 | 264 | 355 |

TABLE 142. $9 \times 4\frac{1}{2} \times 2\frac{1}{2}$ -IN. WEDGE BRICK* (Continued)

| Inside diameter | No. required to turn circle | | | |
|-----------------|-----------------------------|-------------|----------|-------|
| | No. 2 wedge | No. 1 wedge | Straight | Total |
| 22'6" | | 91 | 271 | 362 |
| 23'0" | | 91 | 279 | 370 |
| 23'6" | | 91 | 286 | 377 |
| 24'0" | | 91 | 294 | 385 |
| 24'6" | | 91 | 301 | 392 |
| 25'0" | | 91 | 309 | 400 |
| 25'6" | | 91 | 317 | 408 |
| 26'0" | | 91 | 324 | 415 |
| 26'6" | | 91 | 332 | 423 |
| 27'0" | | 91 | 339 | 430 |
| 27'6" | | 91 | 347 | 438 |
| 28'0" | | 91 | 354 | 445 |
| 28'6" | | 91 | 362 | 453 |
| 29'0" | | 91 | 369 | 460 |
| 29'6" | | 91 | 377 | 468 |
| 30'0" | | 91 | 384 | 475 |
| 30'6" | | 91 | 392 | 483 |
| 31'0" | | 91 | 399 | 490 |
| 31'6" | | 91 | 407 | 498 |
| 32'0" | | 91 | 415 | 506 |
| 32'6" | | 91 | 422 | 513 |
| 33'0" | | 91 | 430 | 521 |
| 33'6" | | 91 | 437 | 528 |
| 34'0" | | 91 | 445 | 536 |
| 34'6" | | 91 | 452 | 543 |
| 35'0" | | 91 | 460 | 551 |
| 35'6" | | 91 | 467 | 558 |
| 36'0" | | 91 | 475 | 566 |
| 36'6" | | 91 | 482 | 573 |
| 37'0" | | 91 | 490 | 581 |
| 37'6" | | 91 | 498 | 589 |
| 38'0" | | 91 | 506 | 597 |
| 38'6" | | 91 | 513 | 604 |
| 39'0" | | 91 | 521 | 612 |
| 39'6" | | 91 | 528 | 619 |
| 40'0" | | 91 | 536 | 627 |
| 40'6" | | 91 | 543 | 634 |
| 41'0" | | 91 | 551 | 642 |
| 41'6" | | 91 | 558 | 649 |
| 42'0" | | 91 | 566 | 657 |
| 42'6" | | 91 | 573 | 664 |

TABLE 142. $9 \times 4\frac{1}{2} \times 2\frac{1}{2}$ -IN. WEDGE BRICK* (Continued)

| Inside diameter | No. required to turn circle | | | |
|-----------------|-----------------------------|-------------|----------|-------|
| | No. 2 wedge | No. 1 wedge | Straight | Total |
| 43'0" | | 91 | 581 | 672 |
| 43'6" | | 91 | 589 | 680 |
| 44'0" | | 91 | 598 | 689 |
| 44'6" | | 91 | 605 | 696 |
| 45'0" | | 91 | 612 | 703 |
| 45'6" | | 91 | 620 | 711 |
| 46'0" | | 91 | 627 | 718 |
| 46'6" | | 91 | 635 | 726 |
| 47'0" | | 91 | 642 | 733 |
| 47'6" | | 91 | 650 | 741 |
| 48'0" | | 91 | 657 | 748 |
| 48'6" | | 91 | 665 | 756 |
| 49'0" | | 91 | 672 | 763 |
| 49'6" | | 91 | 680 | 771 |
| 50'0" | | 91 | 687 | 778 |
| 50'6" | | 91 | 695 | 786 |

* Applies also to $9 \times 6\frac{3}{4} \times 2\frac{1}{2}$ -in. wedges and straights.

NOTE: Fractional parts of one-tenth of a brick or more are counted as entire brick; smaller fractions are disregarded.

In Fig. 413 is shown a bung arch used in the malleable-iron industry. These arch rings are wedged tightly into a heavy iron frame so that they can be lifted off as individual units. Brick with good strength and spalling resistance are essential in this type of construction. In Fig. 414 is shown a double arch sometimes used in tunnel-kiln construction for preheating of the combustion air. This type of arch should never be used for high-temperature work because of the difficulty in making repairs on the inner arch.

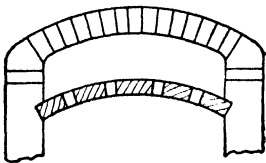

Fig. 415. Perforated arch.

Figure 415 shows a perforated arch used in some types of overfired furnace. As this arch is subjected to temperature on both sides, it must be made of material of high load-bearing capacity.

Expansion Joints. The longitudinal expansion joints in the crown should, in general, be aligned with the expansion joints in the wall. It is often desirable to recess the end of the crown into the end wall as shown in Fig. 416, giving a labyrinth joint. Expansion joints coming in the center of the crown should be covered with a row of splits cemented in place, also shown in Fig. 416.

TABLE 143. $9 \times 4\frac{1}{2} \times 2\frac{1}{2}$ -IN. ARCH BRICK

| Inside diameter | No. required to turn circle | | | | |
|-----------------|-----------------------------|------------|------------|----------|-------|
| | No. 3 arch | No. 2 arch | No. 1 arch | Straight | Total |
| 0'6" | 19 | | | | 19 |
| 1'0" | 12 | 15 | | | 27 |
| 1'6" | 4 | 30 | | | 34 |
| 1'9" | | 38 | | | 38 |
| 2'0" | | 34 | 8 | | 42 |
| 2'6" | | 26 | 23 | | 49 |
| 3'0" | | 19 | 38 | | 57 |
| 3'6" | | 11 | 53 | | 64 |
| 4'0" | | 4 | 68 | | 72 |
| 4'3" | | | 76 | | 76 |
| 4'6" | | | 76 | 4 | 80 |
| 5'0" | | | 76 | 11 | 87 |
| 5'6" | | | 76 | 19 | 95 |
| 6'0" | | | 76 | 26 | 102 |
| 6'6" | | | 76 | 34 | 110 |
| 7'0" | | | 76 | 41 | 117 |
| 7'6" | | | 76 | 49 | 125 |
| 8'0" | | | 76 | 56 | 132 |
| 8'6" | | | 76 | 64 | 140 |
| 9'0" | | | 76 | 71 | 147 |
| 9'6" | | | 76 | 79 | 155 |
| 10'0" | | | 76 | 87 | 163 |
| 10'6" | | | 76 | 94 | 170 |
| 11'0" | | | 76 | 102 | 178 |
| 11'6" | | | 76 | 109 | 185 |
| 12'0" | | | 76 | 117 | 193 |
| 12'6" | | | 76 | 124 | 200 |
| 13'0" | | | 76 | 132 | 208 |
| 13'6" | | | 76 | 139 | 215 |
| 14'0" | | | 76 | 147 | 223 |
| 14'6" | | | 76 | 154 | 230 |

TABLE 144. $9 \times 4\frac{1}{2} \times 3$ -IN. WEDGE BRICK*

| Inside diameter | No. required to turn circle | | | | |
|-----------------|-----------------------------|-------------|-------------|----------|-------|
| | No. 3 wedge | No. 2 wedge | No. 1 wedge | Straight | Total |
| 3'0" | 57 | | | | 57 |
| 3'6" | 50 | 13 | | | 63 |
| 4'0" | 44 | 26 | | | 70 |
| 4'6" | 38 | 38 | | | 76 |
| 5'0" | 32 | 50 | | | 82 |
| 5'6" | 25 | 63 | | | 88 |
| 6'0" | 19 | 76 | | | 95 |
| 6'6" | 13 | 88 | | | 101 |
| 7'0" | 6 | 101 | | | 107 |
| 7'6" | | 113 | | | 113 |
| 8'0" | | 107 | 13 | | 120 |
| 8'6" | | 101 | 25 | | 126 |
| 9'0" | | 94 | 38 | | 132 |
| 9'6" | | 88 | 51 | | 139 |
| 10'0" | | 82 | 63 | | 145 |
| 10'6" | | 76 | 75 | | 151 |
| 11'0" | | 69 | 88 | | 157 |
| 11'6" | | 63 | 101 | | 164 |
| 12'0" | | 57 | 113 | | 170 |
| 12'6" | | 50 | 126 | | 176 |
| 13'0" | | 44 | 139 | | 183 |
| 13'6" | | 38 | 151 | | 189 |
| 14'0" | | 32 | 163 | | 195 |
| 14'6" | | 25 | 176 | | 201 |
| 15'0" | | 19 | 189 | | 208 |
| 15'6" | | 13 | 201 | | 214 |
| 16'0" | | 6 | 214 | | 220 |
| 16'6" | | | 226 | | 226 |
| 17'0" | | | 226 | 7 | 233 |
| 17'6" | | | 226 | 13 | 239 |
| 18'0" | | | 226 | 19 | 245 |
| 18'6" | | | 226 | 26 | 252 |
| 19'0" | | | 226 | 32 | 258 |
| 19'6" | | | 226 | 38 | 264 |
| 20'0" | | | 226 | 45 | 271 |
| 20'6" | | | 226 | 51 | 277 |
| 21'0" | | | 226 | 57 | 283 |
| 21'6" | | | 226 | 63 | 289 |
| 22'0" | | | 226 | 70 | 296 |
| 22'6" | | | 226 | 76 | 302 |

TABLE 144. $9 \times 4\frac{1}{2} \times 3$ -IN. WEDGE BRICK* (Continued)

| Inside diameter | No. required to turn circle | | | | |
|-----------------|-----------------------------|-------------|-------------|----------|-------|
| | No. 3 wedge | No. 2 wedge | No. 1 wedge | Straight | Total |
| 23'0" | | | 226 | 82 | 308 |
| 23'6" | | | 226 | 89 | 315 |
| 24'0" | | | 226 | 95 | 321 |
| 24'6" | | | 226 | 101 | 327 |
| 25'0" | | | 226 | 107 | 333 |
| 25'6" | | | 226 | 114 | 340 |
| 26'0" | | | 226 | 120 | 346 |
| 26'6" | | | 226 | 126 | 352 |
| 27'0" | | | 226 | 133 | 359 |
| 27'6" | | | 226 | 139 | 365 |
| 28'0" | | | 226 | 145 | 371 |
| 28'6" | | | 226 | 152 | 378 |
| 29'0" | | | 226 | 158 | 384 |
| 29'6" | | | 226 | 164 | 390 |
| 30'0" | | | 226 | 170 | 396 |
| 30'6" | | | 226 | 176 | 402 |
| 31'0" | | | 226 | 182 | 408 |
| 31'6" | | | 226 | 189 | 415 |
| 32'0" | | | 226 | 195 | 421 |
| 32'6" | | | 226 | 201 | 427 |
| 33'0" | | | 226 | 208 | 434 |
| 33'6" | | | 226 | 214 | 440 |
| 34'0" | | | 226 | 220 | 446 |
| 34'6" | | | 226 | 227 | 453 |
| 35'0" | | | 226 | 233 | 459 |
| 35'6" | | | 226 | 239 | 465 |
| 36'0" | | | 226 | 246 | 472 |
| 36'6" | | | 226 | 252 | 478 |
| 37'0" | | | 226 | 258 | 484 |
| 37'6" | | | 226 | 264 | 490 |
| 38'0" | | | 226 | 271 | 497 |
| 38'6" | | | 226 | 277 | 503 |
| 39'0" | | | 226 | 283 | 509 |
| 39'6" | | | 226 | 289 | 515 |
| 40'0" | | | 226 | 296 | 522 |
| 40'6" | | | 226 | 302 | 528 |
| 41'0" | | | 226 | 308 | 534 |
| 41'6" | | | 226 | 315 | 541 |
| 42'0" | | | 226 | 321 | 547 |
| 42'6" | | | 226 | 327 | 553 |

TABLE 144. $9 \times 4\frac{1}{2} \times 3$ -IN. WEDGE BRICK* (Continued)

| Inside diameter | No. required to turn circle | | | | |
|-----------------|-----------------------------|-------------|-------------|----------|-------|
| | No. 3 wedge | No. 2 wedge | No. 1 wedge | Straight | Total |
| 43'0" | | | 226 | 334 | 560 |
| 43'6" | | | 226 | 340 | 566 |
| 44'0" | | | 226 | 346 | 572 |
| 44'6" | | | 226 | 353 | 579 |
| 45'0" | | | 226 | 359 | 585 |
| 45'6" | | | 226 | 365 | 591 |
| 46'0" | | | 226 | 372 | 598 |
| 46'6" | | | 226 | 378 | 604 |
| 47'0" | | | 226 | 384 | 610 |
| 47'6" | | | 226 | 390 | 616 |
| 48'0" | | | 226 | 397 | 623 |
| 48'6" | | | 226 | 403 | 629 |
| 49'0" | | | 226 | 409 | 635 |
| 49'6" | | | 226 | 415 | 641 |
| 50'0" | | | 226 | 421 | 647 |
| 50'6" | | | 226 | 428 | 654 |

* Applies also to $9 \times 6\frac{3}{4} \times 3$ -in. wedges and straights.

NOTE: Fractional parts of one-tenth of a brick or more are counted as entire brick; smaller fractions are disregarded.

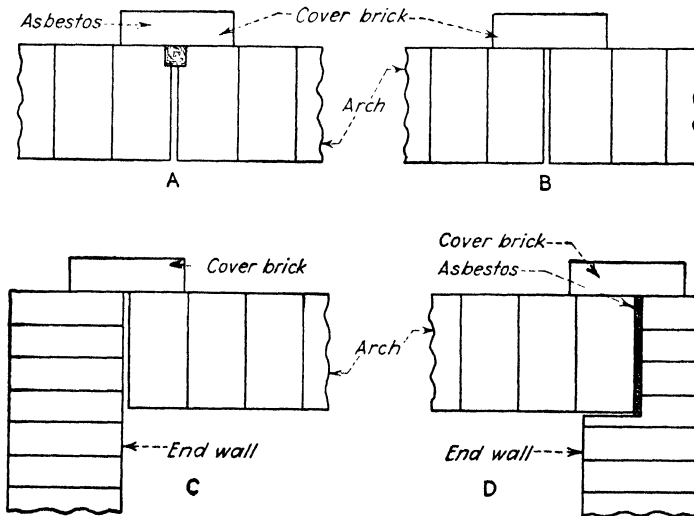

FIG. 416. Construction of expansion joints. (Courtesy of the Babcock and Wilcox Company.)

TABLE 145. 9 × 6 × 3-IN. KEY BRICK*

| Inside diameter | No. required to turn circle | | | |
|-----------------|-----------------------------|-----------|----------|-------|
| | No. 2 key | No. 1 key | Straight | Total |
| 6'0" | 48 | | | 48 |
| 6'6" | 45 | 6 | | 51 |
| 7'0" | 41 | 13 | | 54 |
| 7'6" | 38 | 19 | | 57 |
| 8'0" | 34 | 26 | | 60 |
| 8'6" | 31 | 32 | | 63 |
| 9'0" | 27 | 39 | | 66 |
| 9'6" | 24 | 46 | | 70 |
| 10'0" | 21 | 52 | | 73 |
| 10'6" | 17 | 59 | | 76 |
| 11'0" | 13 | 66 | | 79 |
| 11'6" | 10 | 72 | | 82 |
| 12'0" | 6 | 79 | | 85 |
| 12'6" | 3 | 85 | | 88 |
| 13'0" | | 91 | | 91 |
| 13'6" | | 91 | 4 | 95 |
| 14'0" | | 91 | 7 | 98 |
| 14'6" | | 91 | 10 | 101 |
| 15'0" | | 91 | 13 | 104 |
| 15'6" | | 91 | 16 | 107 |
| 16'0" | | 91 | 19 | 110 |
| 16'6" | | 91 | 22 | 113 |
| 17'0" | | 91 | 26 | 117 |
| 17'6" | | 91 | 29 | 120 |
| 18'0" | | 91 | 32 | 123 |
| 18'6" | | 91 | 35 | 126 |
| 19'0" | | 91 | 38 | 129 |
| 19'6" | | 91 | 41 | 132 |
| 20'0" | | 91 | 44 | 135 |
| 20'6" | | 91 | 48 | 139 |
| 21'0" | | 91 | 51 | 142 |
| 21'6" | | 91 | 54 | 145 |
| 22'0" | | 91 | 57 | 148 |
| 22'6" | | 91 | 60 | 151 |
| 23'0" | | 91 | 63 | 154 |
| 23'6" | | 91 | 66 | 157 |
| 24'0" | | 91 | 70 | 161 |
| 24'6" | | 91 | 73 | 164 |
| 25'0" | | 91 | 76 | 167 |
| 25'6" | | 91 | 79 | 170 |
| 26'0" | | 91 | 82 | 173 |
| 26'6" | | 91 | 85 | 176 |
| 27'0" | | 91 | 88 | 179 |
| 27'6" | | 91 | 92 | 183 |
| 28'0" | | 91 | 95 | 186 |
| 28'6" | | 91 | 98 | 189 |
| 29'0" | | 91 | 101 | 192 |
| 29'6" | | 91 | 104 | 195 |
| 30'0" | | 91 | 107 | 198 |

* Applies also to 9 × 6 × 2½-in. keys and straights.

NOTE: Fractional parts of one-tenth of a brick or more are counted as entire brick; smaller fractions are disregarded.

REFRACTORIES

TABLE 146. $9 \times 4\frac{1}{2} \times 3$ -IN. ARCH BRICK

| Inside diameter | No. required to turn circle | | | | |
|-----------------|-----------------------------|------------|------------|----------|-------|
| | No. 3 arch | No. 2 arch | No. 1 arch | Straight | Total |
| 1'6" | 29 | | | | 29 |
| 2'0" | 22 | 13 | | | 35 |
| 2'6" | 16 | 25 | | | 41 |
| 3'0" | 10 | 38 | | | 48 |
| 3'6" | 3 | 51 | | | 54 |
| 3'9" | | 57 | | | 57 |
| 4'0" | | 54 | 6 | | 60 |
| 4'6" | | 47 | 19 | | 66 |
| 5'0" | | 41 | 32 | | 73 |
| 5'6" | | 35 | 44 | | 79 |
| 6'0" | | 28 | 57 | | 85 |
| 6'6" | | 22 | 70 | | 92 |
| 7'0" | | 16 | 82 | | 98 |
| 7'6" | | 10 | 94 | | 104 |
| 8'0" | | 3 | 107 | | 110 |
| 8'3" | | | 113 | | 113 |
| 8'6" | | | 113 | 4 | 117 |
| 9'0" | | | 113 | 10 | 123 |
| 9'6" | | | 113 | 16 | 129 |
| 10'0" | | | 113 | 22 | 135 |
| 10'6" | | | 113 | 29 | 142 |
| 11'0" | | | 113 | 35 | 148 |
| 11'6" | | | 113 | 41 | 154 |
| 12'0" | | | 113 | 48 | 161 |
| 12'6" | | | 113 | 54 | 167 |
| 13'0" | | | 113 | 60 | 173 |
| 13'6" | | | 113 | 66 | 179 |
| 14'0" | | | 113 | 73 | 186 |
| 14'6" | | | 113 | 79 | 192 |

NOTE: Fractional parts of one-tenth of a brick or more are counted as entire brick, smaller fractions are disregarded.

TABLE 147. FLAT-BACK ARCH BRICK

| Inside diameter | No. required to turn circle | | | Total |
|-----------------|-----------------------------|----------------------|--------------------|-------|
| | No. 2 flat-back arch | No. 1 flat-back arch | Flat-back straight | |
| 1'4" | 26 | | | 26 |
| 1'6" | 22 | 5 | | 27 |
| 1'9" | 16 | 14 | | 30 |
| 2'0" | 11 | 22 | | 33 |
| 2'3" | 5 | 30 | | 35 |
| 2'6" | | 38 | | 38 |
| 3'0" | | 38 | 8 | 46 |
| 3'6" | | 38 | 15 | 53 |
| 4'0" | | 38 | 23 | 61 |
| 4'6" | | 38 | 30 | 68 |
| 5'0" | | 38 | 38 | 76 |
| 5'6" | | 38 | 45 | 83 |
| 6'0" | | 38 | 53 | 91 |
| 6'6" | | 38 | 60 | 98 |
| 7'0" | | 38 | 68 | 106 |
| 7'6" | | 38 | 75 | 113 |
| 8'0" | | 38 | 83 | 121 |
| 8'6" | | 38 | 91 | 129 |
| 9'0" | | 38 | 98 | 136 |
| 9'6" | | 38 | 106 | 144 |
| 10'0" | | 38 | 113 | 151 |
| 10'6" | | 38 | 121 | 159 |
| 11'0" | | 38 | 128 | 166 |
| 11'6" | | 38 | 136 | 174 |
| 12'0" | | 38 | 143 | 181 |
| 12'6" | | 38 | 151 | 189 |
| 13'0" | | 38 | 158 | 196 |

NOTE: Fractional parts of one-tenth of a brick or more are counted as entire brick; smaller fractions are disregarded.

TABLE 148. 12 × 6 × 3-IN. WEDGE BRICK

| Inside diameter | No. required to turn circle | | | | |
|-----------------|-----------------------------|-------------|-------------|----------|-------|
| | No. 3 wedge | No. 2 wedge | No. 1 wedge | Straight | Total |
| 4'0" | 76 | | | | 76 |
| 4'6" | 69 | 13 | | | 82 |
| 5'0" | 63 | 25 | | | 88 |
| 5'6" | 57 | 38 | | | 95 |
| 6'0" | 51 | 50 | | | 101 |
| 6'6" | 44 | 63 | | | 107 |
| 7'0" | 38 | 75 | | | 113 |
| 7'6" | 32 | 88 | | | 120 |
| 8'0" | 25 | 101 | | | 126 |
| 8'6" | 19 | 113 | | | 132 |
| 9'0" | 13 | 126 | | | 139 |
| 9'6" | 7 | 138 | | | 145 |
| 10'0" | | 151 | | | 151 |
| 10'6" | | 144 | 13 | | 157 |
| 11'0" | | 139 | 25 | | 164 |
| 11'6" | | 132 | 38 | | 170 |
| 12'0" | | 126 | 50 | | 176 |
| 12'6" | | 120 | 63 | | 183 |
| 13'0" | | 113 | 76 | | 189 |
| 13'6" | | 107 | 88 | | 195 |
| 14'0" | | 101 | 100 | | 201 |
| 14'6" | | 95 | 113 | | 208 |
| 15'0" | | 88 | 126 | | 214 |
| 15'6" | | 82 | 138 | | 220 |
| 16'0" | | 76 | 151 | | 227 |
| 16'6" | | 69 | 164 | | 233 |
| 17'0" | | 63 | 176 | | 239 |
| 17'6" | | 57 | 188 | | 245 |
| 18'0" | | 51 | 201 | | 252 |
| 18'6" | | 44 | 214 | | 258 |
| 19'0" | | 38 | 226 | | 264 |
| 19'6" | | 32 | 239 | | 271 |
| 20'0" | | 25 | 252 | | 277 |
| 20'6" | | 19 | 264 | | 283 |
| 21'0" | | 13 | 276 | | 289 |
| 21'6" | | 7 | 289 | | 296 |
| 22'0" | | | 302 | | 302 |
| 22'6" | | | 302 | 6 | 308 |
| 23'0" | | | 302 | 13 | 315 |
| 23'6" | | | 302 | 19 | 321 |
| 24'0" | | | 302 | 25 | 327 |
| 24'6" | | | 302 | 31 | 333 |
| 25'0" | | | 302 | 38 | 340 |
| 25'6" | | | 302 | 44 | 346 |
| 26'0" | | | 302 | 50 | 352 |
| 26'6" | | | 302 | 57 | 359 |
| 27'0" | | | 302 | 63 | 365 |
| 27'6" | | | 302 | 69 | 371 |
| 28'0" | | | 302 | 75 | 377 |

NOTE: Fractional parts of one-tenth of a brick or more are counted as entire brick; smaller fractions are disregarded.

TABLE 149. $13\frac{1}{2} \times 6 \times 3$ -IN. WEDGE BRICK

| Inside diameter | No. required to turn circle | | | | Total |
|-----------------|-----------------------------|-------------|-------------|----------|-------|
| | No. 3 wedge | No. 2 wedge | No. 1 wedge | Straight | |
| 4'6" | 85 | | | | 85 |
| 5'0" | 79 | 13 | | | 92 |
| 5'6" | 73 | 25 | | | 98 |
| 6'0" | 66 | 38 | | | 104 |
| 6'6" | 60 | 50 | | | 110 |
| 7'0" | 54 | 63 | | | 117 |
| 7'6" | 47 | 76 | | | 123 |
| 8'0" | 41 | 88 | | | 129 |
| 8'6" | 35 | 100 | | | 135 |
| 9'0" | 29 | 113 | | | 142 |
| 9'6" | 22 | 126 | | | 148 |
| 10'0" | 16 | 138 | | | 154 |
| 10'6" | 10 | 151 | | | 161 |
| 11'0" | 3 | 164 | | | 167 |
| 11'3" | | 170 | | | 170 |
| 11'6" | | 167 | 6 | | 173 |
| 12'0" | | 160 | 19 | | 179 |
| 12'6" | | 154 | 32 | | 186 |
| 13'0" | | 148 | 44 | | 192 |
| 13'6" | | 141 | 57 | | 198 |
| 14'0" | | 135 | 70 | | 205 |
| 14'6" | | 129 | 82 | | 211 |
| 15'0" | | 123 | 94 | | 217 |
| 15'6" | | 116 | 107 | | 223 |
| 16'0" | | 110 | 120 | | 230 |
| 16'6" | | 104 | 132 | | 236 |
| 17'0" | | 97 | 145 | | 242 |
| 17'6" | | 92 | 157 | | 249 |
| 18'0" | | 85 | 170 | | 255 |
| 18'6" | | 79 | 182 | | 261 |
| 19'0" | | 72 | 195 | | 267 |
| 19'6" | | 66 | 208 | | 274 |
| 20'0" | | 60 | 220 | | 280 |
| 20'6" | | 53 | 233 | | 286 |
| 21'0" | | 48 | 245 | | 293 |
| 21'6" | | 41 | 258 | | 299 |
| 22'0" | | 35 | 270 | | 305 |
| 22'6" | | 28 | 283 | | 311 |
| 23'0" | | 22 | 296 | | 318 |
| 23'6" | | 16 | 308 | | 324 |

TABLE 149. $13\frac{1}{2} \times 6 \times 3$ -IN. WEDGE BRICK (Continued)

| Inside diameter | No. required to turn circle | | | | Total |
|-----------------|-----------------------------|-------------|-------------|----------|-------|
| | No. 3 wedge | No. 2 wedge | No. 1 wedge | Straight | |
| 24'0" | | 9 | 321 | | 330 |
| 24'6" | | 4 | 333 | | 337 |
| 24'9" | | | 340 | | 340 |
| 25'0" | | | 340 | 3 | 343 |
| 25'6" | | | 340 | 9 | 349 |
| 26'0" | | | 340 | 15 | 355 |
| 26'6" | | | 340 | 22 | 362 |
| 27'0" | | | 340 | 28 | 368 |
| 27'6" | | | 340 | 34 | 374 |
| 28'0" | | | 340 | 41 | 381 |
| 28'6" | | | 340 | 47 | 387 |
| 29'0" | | | 340 | 53 | 393 |
| 29'6" | | | 340 | 59 | 399 |
| 30'0" | | | 340 | 66 | 406 |
| 30'6" | | | 340 | 72 | 412 |
| 31'0" | | | 340 | 78 | 418 |
| 31'6" | | | 340 | 85 | 425 |
| 32'0" | | | 340 | 91 | 431 |
| 32'6" | | | 340 | 97 | 437 |
| 33'0" | | | 340 | 103 | 443 |
| 33'6" | | | 340 | 110 | 450 |
| 34'0" | | | 340 | 116 | 456 |
| 34'6" | | | 340 | 122 | 462 |
| 35'0" | | | 340 | 128 | 468 |
| 35'6" | | | 340 | 135 | 475 |
| 36'0" | | | 340 | 141 | 481 |
| 36'6" | | | 340 | 147 | 487 |
| 37'0" | | | 340 | 154 | 494 |
| 37'6" | | | 340 | 160 | 500 |
| 38'0" | | | 340 | 166 | 506 |
| 38'6" | | | 340 | 172 | 512 |
| 39'0" | | | 340 | 179 | 519 |
| 39'6" | | | 340 | 185 | 525 |
| 40'0" | | | 340 | 191 | 531 |
| 40'6" | | | 340 | 198 | 538 |
| 41'0" | | | 340 | 204 | 544 |
| 41'6" | | | 340 | 210 | 550 |
| 42'0" | | | 340 | 216 | 556 |
| 42'6" | | | 340 | 223 | 563 |
| 43'0" | | | 340 | 229 | 569 |

TABLE 149. $13\frac{1}{2} \times 6 \times 3$ -IN. WEDGE BRICK (Continued)

| Inside diameter | No. required to turn circle | | | | |
|-----------------|-----------------------------|-------------|-------------|----------|-------|
| | No. 3 wedge | No. 2 wedge | No. 1 wedge | Straight | Total |
| 43'6" | | | 340 | 235 | 575 |
| 44'0" | | | 340 | 242 | 582 |
| 44'6" | | | 340 | 248 | 588 |
| 45'0" | | | 340 | 254 | 594 |
| 45'6" | | | 340 | 260 | 600 |
| 46'0" | | | 340 | 267 | 607 |
| 46'6" | | | 340 | 273 | 613 |
| 47'0" | | | 340 | 279 | 619 |
| 47'6" | | | 340 | 286 | 626 |
| 48'0" | | | 340 | 292 | 632 |
| 48'6" | | | 340 | 298 | 638 |
| 49'0" | | | 340 | 304 | 644 |
| 49'6" | | | 340 | 311 | 651 |
| 50'0" | | | 340 | 317 | 657 |
| 50'6" | | | 340 | 323 | 663 |
| 51'0" | | | 340 | 330 | 670 |
| 51'6" | | | 340 | 336 | 676 |
| 52'0" | | | 340 | 342 | 682 |
| 52'6" | | | 340 | 348 | 688 |
| 53'0" | | | 340 | 355 | 695 |
| 53'6" | | | 340 | 361 | 701 |
| 54'0" | | | 340 | 367 | 707 |
| 54'6" | | | 340 | 374 | 714 |
| 55'0" | | | 340 | 380 | 720 |
| 55'6" | | | 340 | 386 | 726 |
| 56'0" | | | 340 | 392 | 732 |
| 56'6" | | | 340 | 399 | 739 |
| 57'0" | | | 340 | 405 | 745 |
| 57'6" | | | 340 | 411 | 751 |
| 58'0" | | | 340 | 418 | 758 |
| 58'6" | | | 340 | 424 | 764 |
| 59'0" | | | 340 | 430 | 770 |
| 59'6" | | | 340 | 436 | 776 |
| 60'0" | | | 340 | 443 | 783 |

NOTE: Fractional parts of one-tenth of a brick or more are counted as entire brick; smaller fractions are disregarded.

TABLE 150. $13\frac{1}{2} \times 6 \times 3$ -IN. KEY BRICK*

| Inside diameter | No. required to turn circle | | | Total |
|-----------------|-----------------------------|-----------|----------|-------|
| | No. 2 key | No. 1 key | Straight | |
| 6'0" | 52 | | | 52 |
| 6'6" | 48 | 7 | | 55 |
| 7'0" | 43 | 16 | | 59 |
| 7'6" | 38 | 24 | | 62 |
| 8'0" | 33 | 32 | | 65 |
| 8'6" | 28 | 40 | | 68 |
| 9'0" | 23 | 48 | | 71 |
| 9'6" | 18 | 56 | | 74 |
| 10'0" | 13 | 64 | | 77 |
| 10'6" | 8 | 73 | | 81 |
| 11'0" | 3 | 81 | | 84 |
| 11'3" | | 85 | | 85 |
| 11'6" | | 85 | 2 | 87 |
| 12'0" | | 85 | 5 | 90 |
| 12'6" | | 85 | 8 | 93 |
| 13'0" | | 85 | 11 | 96 |
| 13'6" | | 85 | 14 | 99 |
| 14'0" | | 85 | 18 | 103 |
| 14'6" | | 85 | 21 | 106 |
| 15'0" | | 85 | 24 | 109 |
| 15'6" | | 85 | 27 | 112 |
| 16'0" | | 85 | 30 | 115 |
| 16'6" | | 85 | 33 | 118 |
| 17'0" | | 85 | 36 | 121 |
| 17'6" | | 85 | 39 | 124 |
| 18'0" | | 85 | 43 | 128 |
| 18'6" | | 85 | 46 | 131 |
| 19'0" | | 85 | 49 | 134 |
| 19'6" | | 85 | 52 | 137 |
| 20'0" | | 85 | 55 | 140 |
| 20'6" | | 85 | 58 | 143 |
| 21'0" | | 85 | 61 | 146 |
| 21'6" | | 85 | 65 | 150 |
| 22'0" | | 85 | 68 | 153 |
| 22'6" | | 85 | 71 | 156 |
| 23'0" | | 85 | 74 | 159 |
| 23'6" | | 85 | 77 | 162 |
| 24'0" | | 85 | 80 | 165 |
| 24'6" | | 85 | 83 | 168 |
| 25'0" | | 85 | 87 | 172 |
| 25'6" | | 85 | 90 | 175 |
| 26'0" | | 85 | 93 | 178 |
| 26'6" | | 85 | 96 | 181 |
| 27'0" | | 85 | 99 | 184 |
| 27'6" | | 85 | 102 | 187 |
| 28'0" | | 85 | 105 | 190 |
| 28'6" | | 85 | 109 | 194 |
| 29'0" | | 85 | 112 | 197 |
| 29'6" | | 85 | 115 | 200 |
| 30'0" | | 85 | 118 | 203 |
| 30'6" | | 85 | 121 | 206 |
| 31'0" | | 85 | 124 | 209 |
| 31'6" | | 85 | 127 | 212 |
| 32'0" | | 85 | 131 | 216 |
| 32'6" | | 85 | 134 | 219 |
| 33'0" | | 85 | 137 | 222 |
| 33'6" | | 85 | 140 | 225 |
| 34'0" | | 85 | 143 | 228 |
| 34'6" | | 85 | 146 | 231 |
| 35'0" | | 85 | 149 | 234 |

* Applies also to $13\frac{1}{2} \times 6 \times 2\frac{1}{2}$ -in. keys and straights.
 Norm: Fractional parts of one-tenth of a brick or more are counted as entire brick; smaller fractions are disregarded.

TABLE 151. 9-IN. CIRCLE BRICK

| Inside diameter | No. required to turn circle | | | | | |
|-----------------|-----------------------------|-------|--------|---------|---------|-------|
| | 24-33 | 36-45 | 48-57 | 60-69 | 72-81 | Total |
| 2'0" | 12 | | | | | 12 |
| 2'3" | 9 | 4 | | | | 13 |
| 2'6" | 6 | 8 | | | | 14 |
| 2'9" | 3 | 12 | | | | 15 |
| 3'0" | | 16 | | | | 16 |
| 3'3" | | 12 | 5 | | | 17 |
| 3'6" | | 8 | 10 | | | 18 |
| 3'9" | | 4 | 15 | | | 19 |
| 4'0" | | | 20 | | | 20 |
| 4'3" | | | 16 | 5 | | 21 |
| 4'6" | | | 10 | 12 | | 22 |
| 4'9" | | | 4 | 19 | | 23 |
| 5'0" | | | | 24 | | 24 |
| 5'3" | | | | 17 | 9 | 26 |
| 5'6" | | | | 12 | 15 | 27 |
| 5'9" | | | | 6 | 22 | 28 |
| 6'0" | | | | | 29 | 29 |
| | 72-81 | 84-93 | 96-105 | 108-117 | 120-129 | |
| 6'3" | 21 | 9 | | | | 30 |
| 6'6" | 14 | 17 | | | | 31 |
| 6'9" | 7 | 25 | | | | 32 |
| 7'0" | | 33 | | | | 33 |
| 7'3" | | 23 | 11 | | | 34 |
| 7'6" | | 14 | 21 | | | 35 |
| 7'9" | | 5 | 31 | | | 36 |
| 8'0" | | | 37 | | | 37 |
| 8'3" | | | 25 | 13 | | 38 |
| 8'6" | | | 18 | 21 | | 39 |
| 8'9" | | | 10 | 30 | | 40 |
| 9'0" | | | | 41 | | 41 |
| 9'3" | | | | 34 | 8 | 42 |
| 9'6" | | | | 23 | 20 | 43 |
| 9'9" | | | | 13 | 31 | 44 |
| 10'0" | | | | | 45 | 45 |

TABLE 152. 9-IN. CUPOLA BLOCKS

| Inside diameter | No. required to turn circle | | | | | | | |
|-----------------|-----------------------------|----|----|----|----|----|----|----|
| | A | B | C | D | E | F | G | H |
| 1'4'' | 9 | | | | | | | |
| 1'6'' | 6 | 4 | | | | | | |
| 1'9'' | | 11 | | | | | | |
| 2'0'' | | 6 | 6 | | | | | |
| 2'3'' | | | 13 | | | | | |
| 2'6'' | | | | 14 | | | | |
| 3'0'' | | | | 6 | 10 | | | |
| 3'4'' | | | | | 18 | | | |
| 3'6'' | | | | | 14 | 4 | | |
| 4'0'' | | | | | 5 | 15 | | |
| 4'3'' | | | | | | 21 | | |
| 4'6'' | | | | | | 14 | 8 | |
| 5'0'' | | | | | | | 24 | |
| 5'6'' | | | | | | | 12 | 15 |
| 6'0'' | | | | | | | | 29 |
| 6'1'' | | | | | | | | 29 |

NOTE: Fractional parts of one-tenth of a brick or more are counted as entire brick; smaller fractions are disregarded.

Brickwork Estimation for Sprung Arches. The sprung arch is made up of various combinations of straights, arches, wedges, or keys. The simplest method of finding the number of shapes in a given arch ring consists in determining the count needed for a complete circle in Tables 141 to 154 and then multiplying the number of each shape by the fraction of the circle covered by the arch as given in the third column of Table 139.

For example, let us find the number and kind of bricks in a 9-in. arch with an 11-ft span (*S*, of Fig. 398) and a rise of 1.608 in. per ft. Here the inner radius is equal to 11 ft; and from Table 142, it is seen that a circle of 22 ft inside diameter requires 91 No. 1 wedges and 264 straights. Multiplying these figures by the fraction of a circle 0.1667, the final count is 15 No. 1 wedges and 44 straights per ring. This calculation allows nothing for joints that may average $\frac{1}{32}$ to $\frac{1}{16}$ in. for the modern dipped joint.

The arch can be computed for any case without the tables by finding the total number of bricks in the ring, which is the outer arc in inches divided by 2.5 or 3.0 in. The number of tapered brick is found by dividing the difference between the inner and outer arcs in inches by the taper of a single brick in inches.

TABLE 153. 6-IN. CUPOLA BLOCKS AND 6-IN. ROTARY-KILN BLOCKS

| Inside diameter | No. required to turn circle | | | | | | |
|-----------------|-----------------------------|--------|---------|---------|---------|---------|---------|
| | 30-42 | 36-48 | 42-54 | 48-60 | 54-66 | 60-72 | 66-78 |
| 2'6" | 15 | | | | | | |
| 2'9" | 8 | 8 | | | | | |
| 3'0" | | 17 | | | | | |
| 3'3" | | 8 | 10 | | | | |
| 3'6" | | | 19 | | | | |
| 3'9" | | | 9 | 11 | | | |
| 4'0" | | | | 21 | | | |
| 4'3" | | | | 10 | 12 | | |
| 4'6" | | | | | 23 | | |
| 4'9" | | | | | 13 | 11 | |
| 5'0" | | | | | | 26 | |
| 5'3" | | | | | | 14 | 13 |
| 5'6" | | | | | | | 28 |
| | 60-72 | 66-78 | 72-84 | 78-90 | 84-96 | 90-102 | 96-108 |
| 5'9" | | 16 | 13 | | | | |
| 6'0" | | | 30 | | | | |
| 6'3" | | | 18 | 13 | | | |
| 6'6" | | | | 32 | | | |
| 6'9" | | | | 19 | 14 | | |
| 7'0" | | | | | 34 | | |
| 7'3" | | | | | 16 | 19 | |
| 7'6" | | | | | | 36 | |
| 7'9" | | | | | | 17 | 20 |
| 8'0" | | | | | | | 38 |
| | 90-102 | 96-108 | 102-114 | 108-120 | 114-126 | 120-132 | 123-135 |
| 8'3" | | 22 | 17 | | | | |
| 8'6" | | | 40 | | | | |
| 8'9" | | | 22 | 19 | | | |
| 9'0" | | | | 42 | | | |
| 9'3" | | | | 24 | 19 | | |
| 9'6" | | | | | 44 | | |
| 9'9" | | | | | 36 | 9 | |
| 10'0" | | | | | | 46 | |
| 10'3" | | | | | | | 48 |

NOTE: Fractional parts of one-tenth of a brick or more are counted as entire brick; smaller fractions are disregarded.

TABLE 154. 9-IN. ROTARY-KILN BLOCKS

| Inside diameter | No. required to turn circle | | | | | |
|-----------------|-----------------------------|---------|---------|---------|---------|---------|
| | 48-66 | 54-72 | 60-78 | 66-84 | 72-90 | 78-96 |
| 4'0" | 23 | | | | | |
| 4'3" | 11 | 13 | | | | |
| 4'6" | | 26 | | | | |
| 4'9" | | 14 | 13 | | | |
| 5'0" | | | 28 | | | |
| 5'3" | | | 15 | 14 | | |
| 5'6" | | | | 30 | | |
| 5'9" | | | | 12 | 19 | |
| 6'0" | | | | | 32 | |
| 6'3" | | | | | 14 | 19 |
| | 72-90 | 78-96 | 84-102 | 90-108 | 96-114 | 102-120 |
| 6'6" | | 34 | | | | |
| 6'9" | | 16 | 19 | | | |
| 7'0" | | | 36 | | | |
| 7'3" | | | 17 | 20 | | |
| 7'6" | | | | 38 | | |
| 7'9" | | | | 22 | 17 | |
| 8'0" | | | | | 40 | |
| 8'3" | | | | | 27 | 14 |
| 8'6" | | | | | | 42 |
| | 102-120 | 108-126 | 114-132 | 117-135 | 120-138 | 123-141 |
| 8'9" | 25 | 18 | | | | |
| 9'0" | | 44 | | | | |
| 9'3" | | 27 | 18 | | | |
| 9'6" | | | 46 | | | |
| 9'9" | | | | 48 | | |
| 10'0" | | | | | 49 | |
| 10'3" | | | | | | 50 |
| | 123-141 | 126-144 | 132-150 | 138-156 | 144-162 | 150-168 |
| 10'6" | | 51 | | | | |
| 10'9" | | 14 | 38 | | | |
| 11'0" | | | 53 | | | |
| 11'3" | | | 24 | 30 | | |
| 11'6" | | | | 55 | | |
| 11'9" | | | | 34 | 22 | |
| 12'0" | | | | | 57 | |
| 12'3" | | | | | 24 | 34 |
| 12'6" | | | | | | 59 |

NOTE: Fractional parts of one-tenth of a brick or more are counted as entire brick; smaller fractions are disregarded.

When using insulating firebrick, it is often advisable to have them all ground with such a taper that the joints will all be radial. This construction, of course, makes the best type of arch.

Forms. Steel forms are to be preferred for arch construction that is often rebuilt. On the other hand, wooden forms are less expensive and quite satisfactory for one job. The forms are usually lagged with 2- by 2-in. oak strips.

The form should be accurately placed, with wedges or jacks for lowering. The arch should be built up from both skewbacks simultaneously to meet at the apex. The keys should be carefully fitted and not driven in too hard; otherwise the crown will be strained and the key cracked. Insulating-firebrick keys should never be hammered into place.

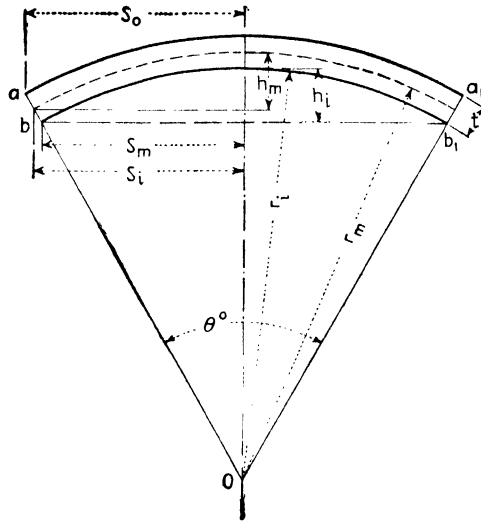

FIG. 417. Section of a dome.

6. Domes. Stresses in Domes. As the stresses in domes are redundant, it is difficult to obtain an exact evaluation. The band stress, however, is approximately given by

$$\frac{\text{Total weight of dome}}{\cos \frac{1}{2}\theta}$$

or

$$\frac{2\pi r_m h_m t d}{\cos \frac{1}{2}\theta}$$

in pounds

where d = the bulk density of the refractory, lb/cu in. The other symbols are shown in Fig. 417.

It should be noted that in the same way as for the cylindrical roof, the spherical dome is not the most stable form. Fellows⁽³⁾ and Goodier⁽⁴⁾ have shown that this limiting form approaches the surface of revolution formed by an ellipse. Any dome *inside* this surface is stable.

Brickwork Estimating. The dome can be constructed of radial blocks with a double taper to fit the particular radius used, or it can be made out of standard shapes such as straights, wedges, and keys, as is the usual practice in kiln construction. It will be seen, however, that perfect fitting cannot be obtained in either case and mortar must be used to make up the difference. The estimation of brick for the dome is a little complicated, but the following method will probably be found satisfactory for most cases.

With the Use of Special Blocks. The spherical dome can be best constructed of special shapes having a large end of $4\frac{1}{2}$ by $2\frac{1}{2}$ in. and a taper such that a projection of their corners will pass through the center of curvature of the dome. This allows strictly radial joints and either $2\frac{1}{2}$ - or $4\frac{1}{2}$ -in. rings. However, as the rings approach the top of the crown, even these blocks will not fit perfectly unless hand cut. In practice, such shapes can be economically made by grinding insulating firebrick, but with heavy bricks this is not generally feasible. Table 155 gives the dimensions of the small end of the bricks for 9 in. thick domes having various radii of curvature.

TABLE 155. RADIAL DOME BRICK

| Size of dome, radius of curvature (inside surface) | Size of inner ends | |
|--|--------------------|----------------|
| | Width, in. | Thickness, in. |
| 4 ft. = 48 in. | 3.79 | 2.11 |
| 6 ft. = 72 in. | 4.00 | 2.22 |
| 8 ft. = 96 in. | 4.12 | 2.29 |
| 10 ft. = 120 in. | 4.18 | 2.33 |
| 14 ft. = 168 in. | 4.28 | 2.37 |
| 18 ft. = 226 in. | 4.33 | 2.40 |
| 24 ft. = 288 in. | 4.36 | 2.42 |
| 30 ft. = 360 in. | 4.39 | 2.44 |
| 40 ft. = 480 in. | 4.42 | 2.45 |

With the Use of Standard Shapes. Most domes are built up in $2\frac{1}{2}$ -in. rings with combinations of straights and keys alternated with $4\frac{1}{2}$ -in. rings of straights and wedges to give the curvature in both directions. A by no means accurate fit can be obtained, and mortar must be used to fill the

joints. The estimation of the brickwork has been rather empirical, but the following method will give fairly close results.

Referring to Fig. 417, where a cross section of a typical dome is shown, the following relations are evident, all dimensions being in inches. It is assumed, as in the usual construction, that all the rings are $2\frac{1}{2}$ -in. wide.

The area of the outer surface of the dome

$$A = 2\pi(r_m + \frac{1}{2}t)h_m$$

Where h_m = the rise = $r_m - \sqrt{r_m^2 - s_m^2}$

The circumference of the segment at $a = 2\pi\left(r_m + \frac{1}{2}t\right) \cdot \sin \frac{1}{2}\theta$

The circumference of the segment at $b = 2\pi\left(r_m - \frac{1}{2}t\right) \cdot \sin \frac{1}{2}\theta$

$\frac{\text{Circumference at } a}{4.5} = \text{number of 9-in. equivalents in first ring}$

$\frac{\text{Circumference at } a - \text{circumference at } b}{4.5 - 4.0} = \text{number of No. 1 keys in first ring}$

$$\text{Arc } aa_1 = 2\pi\left(r_m + \frac{1}{2}t\right) \frac{\theta}{360}$$

$$\text{Arc } bb_1 = 2\pi\left(r_m - \frac{1}{2}t\right) \frac{\theta}{360}$$

$$\frac{aa_1}{2.5} = \text{number of rings}$$

$$\frac{aa_1 - bb_1}{2.50 - 1.88} = \text{number of No. 1 wedge rings}$$

The total number of 9-in. equivalents in the dome = $\frac{A}{4.5 \times 2.5} = \frac{A}{11.25}$

Of these $\frac{(aa_1 - bb_1)/(2.50 - 1.88)}{aa_1/2.5}$ are No. 1 wedges.

The remainder have $\frac{\frac{\text{circumference at } a - \text{circumference at } b}{4.50 - 4.0}}{\frac{\text{circumference } a}{4.5}}$

No. 1 keys and the rest are straights.

Example of Dome Calculations:

Assume $r_t = 120$ in.

$t = 9$ in.

$\theta = 60$ deg

Circumference of segment at $a = 2\pi(129) \cdot \frac{1}{2} = 406$ in.

Circumference of segment at $b = 2\pi(120) \cdot \frac{1}{2} = 377$ in.

$$\frac{406}{4.5} = 90 \text{ nine-inch equivalents in first ring}$$

$$\frac{406 - 377}{4.5 - 4.0} = \frac{29}{0.5} = 58 \text{ No. 1 Keys in first ring}$$

$$\frac{aa_1}{2.5} = \frac{129 \times 2\pi\frac{1}{6}}{2.5} = 54 \text{ rings}$$

$$\frac{aa_1 - bb_1}{2.50 - 1.88} = \frac{129 \times 2\pi\frac{1}{6} - 120 \times 2\pi\frac{1}{6}}{0.62} = \frac{135.2 - 125.9}{0.62}$$

$$= \frac{9.3}{0.62} = 15 \text{ No. 1 wedge rings}$$

$$\text{Total number of brick} = \frac{2\pi 129 \times 17}{2\frac{1}{2} \times 4\frac{1}{2}} = 1,230 \text{ nine-inch equivalents in whole dome}$$

$$1,230 \times \frac{15}{54} = 342 \text{ No. 1 wedges}$$

$$(1,230 - 242) \frac{58}{90} = 585 \text{ No. 1 keys}$$

$$1,230 - 880 = 303 \text{ straights}$$

Domes can be constructed with 4½-in. rings, which are sometimes favored for movable structures like covers. The calculation can be carried out in the same way. As each ring in the dome is self-supporting, a complete form is not needed.

Steelwork. The dome is particularly easy to brace because a simple tension band around the base will take care of the stresses completely. The section of this band can be easily computed from the formulas previously given, allowing a factor of safety of at least 5 to take care of the elevated temperatures, corrosion, and scaling.

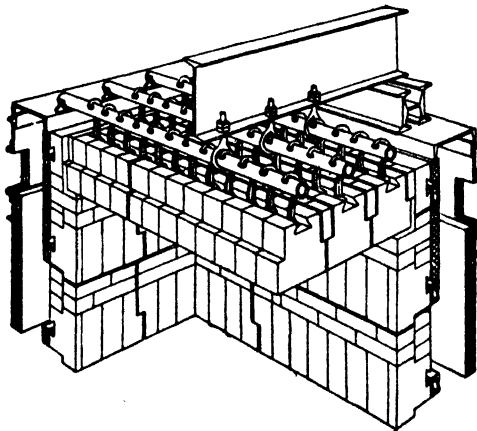

Fig. 418. Typical suspended-arch construction. Reintjes, each tile individually supported and removable. (Courtesy of Power Magazine.)

7. Suspended Arches. *Firebrick Suspended Arches.* Suspended arches consist of a type of construction where individual refractory units are held in place by a metal support tied to an overhead framework. In this type of arch, a single unit can be replaced without disturbing the whole crown.

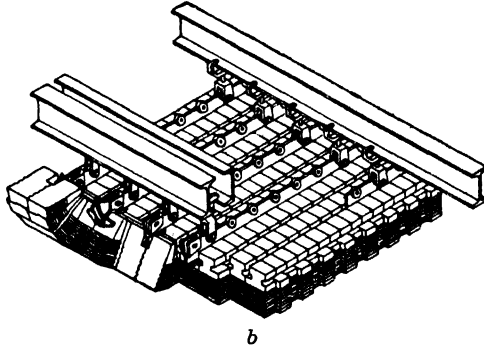

FIG. 418. Detrick tile corrugated on all sides prevent spalled refractory from falling into furnace.

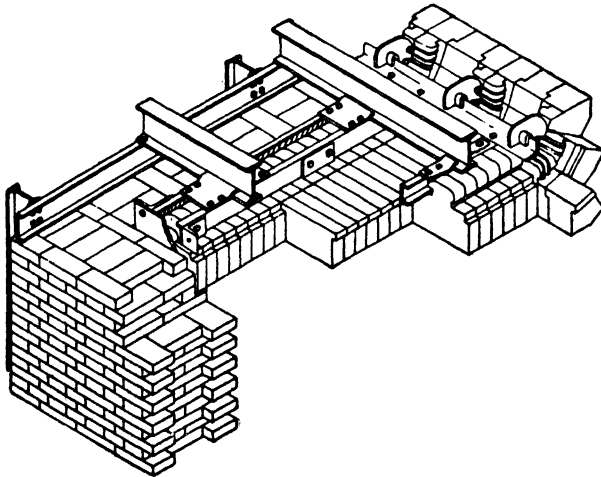

FIG. 418. American arch, alternate rows of tile removable without disturbing channel suspension.

A great many types of block are used for constructing these arches, some of the best known being shown in Figs. 418. This type of construction is useful for flat or special shaped roofs. It also allows an unlimited width. However, it cannot be insulated so completely as the sprung arch and is somewhat more costly.

Some of the basic roofs in German open-hearth furnaces make use of a

combination sprung and suspended arch that seems to have some advantages for this purpose.

Insulating-firebrick Suspended Arches. Insulating firebrick are particularly adapted to use in suspended arches because they are light in weight and thus permit an inexpensive supporting framework. Two typical types

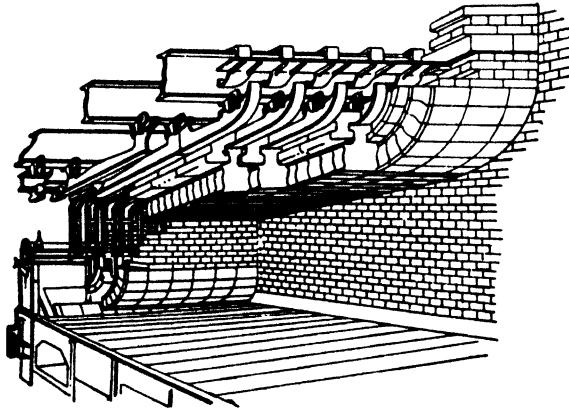

d

FIG. 418. Bigelow-Liptak, double suspensions increase refractory that can be eroded.

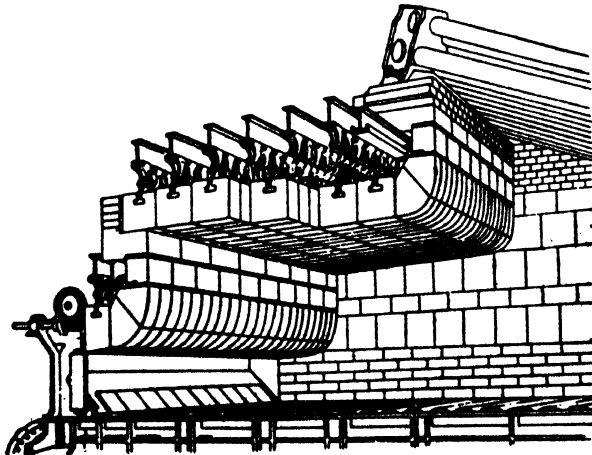

e

FIG. 418. McLeod & Henry, each tile individually supported and removable.

of suspended arch developed by the Babcock and Wilcox Company are shown in Fig. 419, where the brick units are threaded on light steel or alloy rods and supported on light steel hangers. Such a roof is comparatively inexpensive to set up and generally gives excellent service. This type of construction is used a great deal in the larger heat-treating furnaces and oil stills because there is no limit to the span that can be obtained. It also

finds application in soaking pit covers where the light weight allows rapid action.

In this type of roof, 9-in. straights can be used, which are easy to drill and assemble. The high insulating value of the insulating firebrick keeps the supporting steelwork comparatively cool. Usually the whole roof,

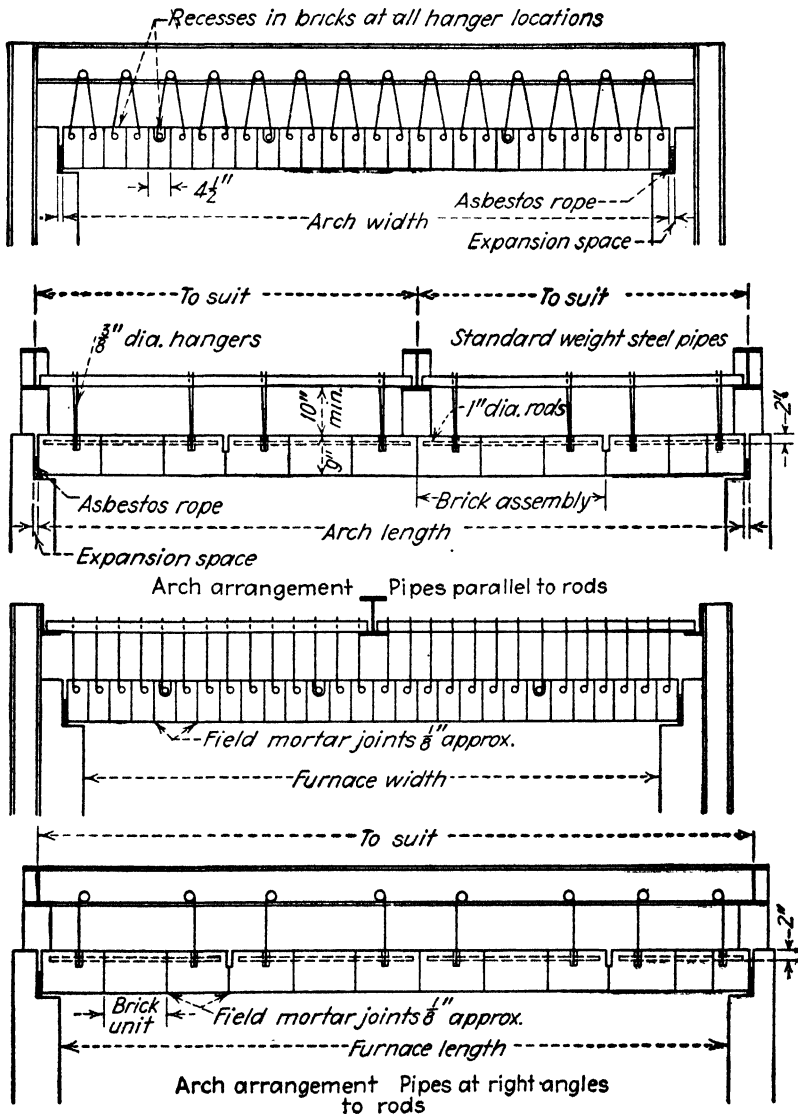

FIG. 419. Arrangement of Babcock & Wilcox insulating firebrick for 9-in. flat suspended arches. (Courtesy of Babcock and Wilcox Company.)

even when as large as 20 by 20 ft, is cemented together with air-set mortar into a monolithic structure with the only expansion joint around the edge. This joint should be sealed for gastightness.

8. Brick Laying. It is needless to say that good refractory construction requires the services of an experienced furnace-brick mason. Even under these conditions, complete drawings should be prepared for anything except the simplest structures. Joints should be kept thin, which is possible with modern refractories of uniform size.

As to the cost of brick laying, it is hard to give any definite figure because of the variation in wages. In a general way, the cost of labor may be \$75 per thousand on small jobs, depending, of course, on the amount of cutting. However, the brick contractor will have to add to the cost of labor, refractories, and mortar items such as hauling materials and tools, insurance, and old-age pensions, as well as overhead and profit. On small jobs, \$100 to \$200 per thousand should be allowed for laying costs in addition to the cost of the refractories; but on large jobs like an open-hearth furnace, \$60 to \$90 might cover the laying costs.

When ordering brick, a certain amount in addition to that estimated must be added for losses in cutting, broken bricks, etc. This is called "overage" and amounts to from 2 to 5 per cent on large jobs to 10 or 15 per cent on small ones. If there is much cutting, the overage must be increased. It also should be remembered that when bricks come in cartons, the number ordered must be an even multiple of the number in the carton, which may make it necessary to purchase more bricks than actually needed.

9. Bibliography

1. ANON.: "Modern Refractory Practice," Harbison-Walker Refractories Co.
2. NORTON, F.H.: The Design of Arches for Kilns and Furnaces, *J. Am. Ceram. Soc.*, **9**, (3), 144, 1926.
3. FELLOWS, J.A.: Domes for Circular Kilns, *J. Am. Ceram. Soc.*, **15**, (9), 508, 1932.
4. GOODIER, J.N.: Stresses in Domes and Crowns of Circular Kilns, *J. Am. Ceram. Soc.*, **16**, (5), 220, 1933.
5. McDOWELL, J.S., and L.L. GILL: Refractory Arches, Part I, *Steel*, **102**, 42, 1938.
6. McDOWELL, J.S., and L.L. GILL: Refractory Arches, Part II, *Steel*, **102**, 48, 1938.
7. McDOWELL, J.S.: Sprung-arch Roofs of High Temperature Furnaces, Part I, *Blast Furnace Steel Plant*, **27**, (6), 592, 1939.
8. McDOWELL, J.S.: Sprung-arch Roofs of High Temperature Furnaces, Part II, *Blast Furnace Steel Plant*, **27**, (9), 947, 1939.
9. McDOWELL, J.S.: Sprung-arch Roofs of High Temperature Furnaces, Part III, *Blast Furnace Steel Plant*, **28**, (2), 161, 1940.
10. ANON.: "Ceramic Data Book," Industrial Publications, Inc., Chicago, 1940.

APPENDIX

REFERENCE TABLES

TABLE 156. TEMPERATURE-CONVERSION TABLE
(Dr. L. Waldo, in *Metallurgical and Chemical Engineering*, March, 1910)

| C | 0 | 10 | 20 | 30 | 40 | 50 | 60 | 70 | 80 | 90 | | |
|------|------|------|------|------|------|------|------|------|-------|-------|-----|-------|
| | F | F | F | F | F | F | F | F | F | F | | |
| -200 | -328 | -346 | -364 | -382 | -400 | -418 | -436 | -454 | | | | |
| -100 | -148 | -166 | -184 | -202 | -220 | -238 | -256 | -274 | -292 | -310 | | |
| - 0 | + 32 | + 14 | - 4 | - 22 | - 40 | - 58 | - 76 | - 94 | -112 | -130 | | |
| 0 | 32 | 50 | 68 | 86 | 104 | 122 | 140 | 158 | 176 | 194 | °C. | °F. |
| 100 | 212 | 230 | 248 | 266 | 284 | 302 | 320 | 338 | 356 | 374 | 1 | 1.8 |
| 200 | 392 | 410 | 428 | 446 | 464 | 482 | 500 | 518 | 536 | 554 | 2 | 3.6 |
| 300 | 572 | 590 | 608 | 626 | 644 | 662 | 680 | 698 | 716 | 734 | 3 | 5.4 |
| 400 | 752 | 770 | 788 | 806 | 824 | 842 | 860 | 878 | 896 | 914 | 4 | 7.2 |
| 500 | 932 | 950 | 968 | 986 | 1004 | 1022 | 1040 | 1058 | 1076 | 1094 | 5 | 9.0 |
| 600 | 1112 | 1130 | 1148 | 1166 | 1184 | 1202 | 1220 | 1238 | 1256 | 1274 | 6 | 10.8 |
| 700 | 1292 | 1310 | 1328 | 1346 | 1364 | 1382 | 1400 | 1418 | 1436 | 1454 | 7 | 12.6 |
| 800 | 1472 | 1490 | 1508 | 1526 | 1544 | 1562 | 1580 | 1598 | 1616 | 1634 | 8 | 14.4 |
| 900 | 1652 | 1670 | 1688 | 1706 | 1724 | 1742 | 1760 | 1778 | 1796 | 1814 | 9 | 16.2 |
| 1000 | 1832 | 1850 | 1868 | 1886 | 1904 | 1922 | 1940 | 1958 | 1976 | 1994 | 10 | 18.0 |
| 1100 | 2012 | 2030 | 2048 | 2066 | 2084 | 2102 | 2120 | 2138 | 2156 | 2174 | | |
| 1200 | 2192 | 2210 | 2228 | 2246 | 2264 | 2282 | 2300 | 2318 | 2336 | 2354 | | |
| 1300 | 2372 | 2390 | 2408 | 2426 | 2444 | 2462 | 2480 | 2498 | 2516 | 2534 | °F. | °C. |
| 1400 | 2552 | 2570 | 2588 | 2606 | 2624 | 2642 | 2660 | 2678 | 2696 | 2714 | 1 | 0.56 |
| 1500 | 2732 | 2750 | 2768 | 2786 | 2804 | 2822 | 2840 | 2858 | 2876 | 2894 | 2 | 1.11 |
| 1600 | 2912 | 2930 | 2948 | 2966 | 2984 | 3002 | 3020 | 3038 | 3056 | 3074 | 3 | 1.67 |
| 1700 | 3092 | 3110 | 3128 | 3146 | 3164 | 3182 | 3200 | 3218 | 3236 | 3254 | 4 | 2.22 |
| 1800 | 3272 | 3290 | 3308 | 3326 | 3344 | 3362 | 3380 | 3398 | 3416 | 3434 | 5 | 2.78 |
| 1900 | 3452 | 3470 | 3488 | 3506 | 3524 | 3542 | 3560 | 3578 | 3596 | 3614 | 6 | 3.33 |
| 2000 | 3632 | 3650 | 3668 | 3686 | 3704 | 3722 | 3740 | 3758 | 3776 | 3794 | 7 | 3.89 |
| 2100 | 3812 | 3830 | 3848 | 3866 | 3884 | 3902 | 3920 | 3938 | 3956 | 3974 | 8 | 4.44 |
| 2200 | 3992 | 4010 | 4028 | 4046 | 4064 | 4082 | 4100 | 4118 | 4136 | 4154 | 9 | 5.00 |
| 2300 | 4172 | 4190 | 4208 | 4226 | 4244 | 4262 | 4280 | 4298 | 4316 | 4334 | 10 | 5.56 |
| 2400 | 4352 | 4370 | 4388 | 4406 | 4424 | 4442 | 4460 | 4478 | 4496 | 4514 | 11 | 6.11 |
| 2500 | 4532 | 4550 | 4568 | 4586 | 4604 | 4622 | 4640 | 4658 | 4676 | 4694 | 12 | 6.67 |
| 2600 | 4712 | 4730 | 4748 | 4766 | 4784 | 4802 | 4820 | 4838 | 4856 | 4874 | 13 | 7.22 |
| 2700 | 4892 | 4910 | 4928 | 4946 | 4964 | 4982 | 5000 | 5018 | 5036 | 5054 | 14 | 7.78 |
| 2800 | 5072 | 5090 | 5108 | 5126 | 5144 | 5162 | 5180 | 5198 | 5216 | 5234 | 15 | 8.33 |
| 2900 | 5252 | 5270 | 5288 | 5306 | 5324 | 5342 | 5360 | 5378 | 5396 | 5414 | 16 | 8.89 |
| 3000 | 5432 | 5450 | 5468 | 5486 | 5504 | 5522 | 5540 | 5558 | 5576 | 5594 | 17 | 9.44 |
| 3100 | 5612 | 5630 | 5648 | 5666 | 5684 | 5702 | 5720 | 5738 | 5756 | 5774 | 18 | 10.00 |
| 3200 | 5792 | 5810 | 5828 | 5846 | 5864 | 5882 | 5900 | 5918 | 5936 | 5954 | | |
| 3300 | 5972 | 5990 | 6008 | 6026 | 6044 | 6062 | 6080 | 6098 | 6116 | 6134 | | |
| 3400 | 6152 | 6170 | 6188 | 6206 | 6224 | 6242 | 6260 | 6278 | 6296 | 6314 | | |
| 3500 | 6332 | 6350 | 6368 | 6386 | 6404 | 6422 | 6440 | 6458 | 6476 | 6494 | | |
| 3600 | 6512 | 6530 | 6548 | 6566 | 6584 | 6602 | 6620 | 6638 | 6656 | 6674 | | |
| 3700 | 6692 | 6710 | 6728 | 6646 | 6764 | 6782 | 6800 | 6818 | 6836 | 6854 | | |
| 3800 | 6872 | 6890 | 6908 | 6926 | 6944 | 6962 | 6980 | 6998 | 7016 | 7034 | | |
| 3900 | 7052 | 7070 | 7088 | 7106 | 7124 | 7142 | 7160 | 7178 | 7196 | 7214 | | |

Examples. 1347°C. = 2444°F. + 12.6°F. = 2456.6°F.; 3387°F. = 1850°C. + 2.78°C.
= 1852.78°C.

TABLE 157. TEMPERATURE EQUIVALENTS OF ORTON PYROMETRIC CONES

| Cone No. | End point, 20°C. per hr. | | End point, 150°C. per hr. | |
|----------|--------------------------|------|---------------------------|-------|
| | °C. | °F. | °C. | °F. |
| 022 | 585 | 1090 | 605 | 1120 |
| 021 | 595 | 1100 | 615 | 1140 |
| 020 | 625 | 1160 | 650 | 1200 |
| 019 | 630 | 1170 | 660 | 1220 |
| 018 | 670 | 1240 | 720 | 1330 |
| 017 | 720 | 1330 | 770 | 1420 |
| 016 | 735 | 1360 | 795 | 1460 |
| 015 | 770 | 1420 | 805 | 1480 |
| 014 | 795 | 1460 | 830 | 1530 |
| 013 | 825 | 1520 | 860 | 1580 |
| 012 | 840 | 1540 | 875 | 1610 |
| 011 | 875 | 1610 | 905 | 1660 |
| 010 | 890 | 1630 | 895 | 1640 |
| 09 | 930 | 1710 | 930 | 1710 |
| 08 | 945 | 1730 | 950 | 1740 |
| 07 | 975 | 1790 | 990 | 1810 |
| 06 | 1005 | 1840 | 1015 | 1860 |
| 05 | 1030 | 1890 | 1040 | 1900 |
| 04 | 1050 | 1920 | 1060 | 1940 |
| 03 | 1080 | 1980 | 1115 | 2040 |
| 02 | 1095 | 2000 | 1125 | 2060 |
| 01 | 1110 | 2030 | 1145 | 2090 |
| 1 | 1125 | 2060 | 1160 | 2120 |
| 2 | 1135 | 2080 | 1165 | 2130 |
| 3 | 1145 | 2090 | 1170 | 2140 |
| 4 | 1165 | 2130 | 1190 | 2170 |
| 5 | 1180 | 2160 | 1205 | 2200 |
| 6 | 1190 | 2170 | 1230 | 2250 |
| 7 | 1210 | 2210 | 1250 | 2280 |
| 8 | 1225 | 2240 | 1260 | 2300 |
| 9 | 1250 | 2280 | 1285 | 2350 |
| 10 | 1260 | 2300 | 1305 | 2380 |
| 11 | 1285 | 2350 | 1325 | 2420 |
| 12 | 1310 | 2390 | 1335 | 2440 |
| 13 | 1350 | 2460 | 1350 | 2460 |
| 14 | 1390 | 2530 | 1400 | 2550 |
| 15 | 1410 | 2570 | 1435 | 2620 |
| 16 | 1450 | 2640 | 1465 | 2670 |
| 17 | 1465 | 2670 | 1475 | 2690 |
| 18 | 1485 | 2710 | 1490 | 2710 |
| 19 | 1515 | 2760 | 1520 | 2770 |
| 20 | 1520 | 2770 | 1530 | 2790 |
| 23 | | | 1580* | 2880* |
| 26 | | | 1595 | 2900 |
| 27 | | | 1605 | 2920 |
| 28 | | | 1615 | 2940 |
| 29 | | | 1640 | 2980 |
| 30 | | | 1650 | 3000 |
| 31 | | | 1680 | 3060 |
| 32 | | | 1700 | 3090 |
| 33 | | | 1745 | 3170 |
| 34 | 1755 | 3190 | 1760 | 3200 |
| 35 | 1775 | 3230 | 1785 | 3250 |
| 36 | 1810 | 3290 | 1810 | 3290 |
| 37 | 1830 | 3330 | 1820 | 3310 |
| 38 | 1850 | 3360 | 1835 | 3340 |
| 39 | 1865 | 3390 | | |
| 40 | 1885 | 3430 | | |
| 41 | 1970 | 3580 | | |
| 42 | 2015 | 3660 | | |

*Cones 23 to 38 heated at 100°C. per hr.

TABLE 158. STANDARD CALIBRATION DATA FOR CHROMEL-ALUMEL COUPLES

| E.m.f., millivolts | Reference junction at 0°C. | | | | | |
|-----------------------|----------------------------|-----|-----|-----|------|------|
| | 0 | 10 | 20 | 30 | 40 | 50 |
| | Temperature, 0°C. | | | | | |
| 0 | 0 | 246 | 485 | 720 | 966 | 1232 |
| 0.2 | 5 | 251 | 490 | 725 | 972 | 1237 |
| .4 | 10 | 256 | 494 | 730 | 977 | 1243 |
| .6 | 15 | 261 | 499 | 735 | 982 | 1249 |
| .8 | 20 | 266 | 504 | 740 | 987 | 1254 |
| 1.0 | 25 | 271 | 508 | 744 | 992 | 1260 |
| 1.2 | 30 | 276 | 513 | 749 | 997 | 1266 |
| 1.4 | 35 | 280 | 518 | 754 | 1002 | 1271 |
| 1.6 | 40 | 285 | 523 | 759 | 1007 | 1277 |
| 1.8 | 45 | 290 | 527 | 764 | 1013 | 1283 |
| 2.0 | 50 | 295 | 532 | 768 | 1018 | 1288 |
| 2.2 | 54 | 300 | 537 | 773 | 1023 | 1294 |
| 2.4 | 59 | 305 | 541 | 778 | 1028 | 1300 |
| 2.6 | 64 | 310 | 546 | 783 | 1033 | 1306 |
| 2.8 | 69 | 315 | 551 | 788 | 1038 | 1311 |
| 3.0 | 74 | 319 | 555 | 792 | 1044 | 1317 |
| 3.2 | 79 | 324 | 560 | 797 | 1049 | 1323 |
| 3.4 | 83 | 329 | 565 | 802 | 1054 | 1329 |
| 3.6 | 88 | 334 | 570 | 807 | 1059 | 1334 |
| 3.8 | 93 | 338 | 574 | 812 | 1065 | 1340 |
| 4.0 | 98 | 343 | 579 | 817 | 1070 | 1346 |
| 4.2 | 102 | 348 | 584 | 822 | 1075 | 1352 |
| 4.4 | 107 | 353 | 588 | 827 | 1081 | 1358 |
| 4.6 | 112 | 358 | 593 | 832 | 1086 | 1364 |
| 4.8 | 117 | 362 | 598 | 837 | 1091 | 1370 |
| 5.0 | 122 | 367 | 602 | 841 | 1096 | 1376 |
| 5.2 | 127 | 372 | 607 | 846 | 1102 | 1382 |
| 5.4 | 132 | 376 | 612 | 851 | 1107 | 1388 |
| 5.6 | 137 | 381 | 616 | 856 | 1112 | 1394 |
| 5.8 | 142 | 386 | 621 | 861 | 1118 | 1400 |
| 6.0 | 147 | 391 | 626 | 866 | 1123 | |
| 6.2 | 152 | 396 | 631 | 871 | 1128 | |
| 6.4 | 157 | 400 | 635 | 876 | 1134 | |
| 6.6 | 162 | 405 | 640 | 881 | 1139 | |
| 6.8 | 167 | 410 | 645 | 886 | 1144 | |
| 7.0 | 172 | 414 | 649 | 891 | 1150 | |
| 7.2 | 177 | 419 | 654 | 896 | 1155 | |
| 7.4 | 182 | 424 | 659 | 901 | 1161 | |
| 7.6 | 187 | 429 | 664 | 906 | 1166 | |
| 7.8 | 192 | 433 | 668 | 911 | 1171 | |
| 8.0 | 197 | 438 | 673 | 916 | 1177 | |
| 8.2 | 202 | 443 | 678 | 921 | 1182 | |
| 8.4 | 207 | 448 | 683 | 926 | 1188 | |
| 8.6 | 212 | 452 | 687 | 931 | 1193 | |
| 8.8 | 217 | 457 | 692 | 936 | 1199 | |
| 9.0 | 222 | 462 | 697 | 941 | 1204 | |
| 9.2 | 227 | 466 | 701 | 946 | 1210 | |
| 9.4 | 232 | 471 | 706 | 951 | 1215 | |
| 9.6 | 237 | 476 | 711 | 956 | 1221 | |
| 9.8 | 241 | 480 | 716 | 961 | 1226 | |
| 10.0 | 246 | 485 | 720 | 966 | 1232 | |

TABLE 159. STANDARD CALIBRATION DATA FOR CHROMEL-ALUMEL COUPLES

| E.m.f., millivolts | Reference junction at 32°F. | | | | | |
|-----------------------|-----------------------------|-----|------|------|------|------|
| | 0 | 10 | 20 | 30 | 40 | 50 |
| | Temperature, °F. | | | | | |
| 0 | 32 | 475 | 905 | 1329 | 1772 | 2250 |
| 0.2 | 41 | 484 | 913 | 1338 | 1781 | 2260 |
| 0.4 | 50 | 493 | 922 | 1346 | 1790 | 2270 |
| 0.6 | 59 | 502 | 930 | 1355 | 1799 | 2280 |
| 0.8 | 68 | 510 | 939 | 1363 | 1808 | 2290 |
| 1.0 | 77 | 519 | 947 | 1372 | 1818 | 2300 |
| 1.2 | 86 | 528 | 956 | 1380 | 1827 | 2310 |
| 1.4 | 95 | 537 | 964 | 1389 | 1836 | 2320 |
| 1.6 | 104 | 546 | 973 | 1398 | 1845 | 2331 |
| 1.8 | 113 | 554 | 981 | 1407 | 1855 | 2341 |
| 2.0 | 121 | 563 | 990 | 1415 | 1864 | 2351 |
| 2.2 | 130 | 572 | 998 | 1424 | 1873 | 2362 |
| 2.4 | 139 | 580 | 1006 | 1433 | 1882 | 2372 |
| 2.6 | 147 | 589 | 1015 | 1441 | 1892 | 2382 |
| 2.8 | 156 | 598 | 1023 | 1450 | 1901 | 2393 |
| 3.0 | 165 | 607 | 1032 | 1459 | 1911 | 2403 |
| 3.2 | 173 | 615 | 1040 | 1467 | 1920 | 2413 |
| 3.4 | 182 | 624 | 1049 | 1476 | 1930 | 2424 |
| 3.6 | 190 | 632 | 1057 | 1485 | 1939 | 2434 |
| 3.8 | 199 | 641 | 1065 | 1494 | 1949 | 2445 |
| 4.0 | 208 | 650 | 1074 | 1503 | 1958 | 2455 |
| 4.2 | 217 | 658 | 1083 | 1511 | 1967 | 2466 |
| 4.4 | 225 | 667 | 1091 | 1520 | 1977 | 2476 |
| 4.6 | 234 | 675 | 1099 | 1529 | 1986 | 2487 |
| 4.8 | 243 | 684 | 1108 | 1538 | 1996 | 2497 |
| 5.0 | 251 | 693 | 1116 | 1547 | 2005 | |
| 5.2 | 260 | 701 | 1125 | 1555 | 2015 | |
| 5.4 | 269 | 710 | 1133 | 1564 | 2024 | |
| 5.6 | 278 | 718 | 1142 | 1573 | 2034 | |
| 5.8 | 287 | 727 | 1150 | 1582 | 2044 | |
| 6.0 | 296 | 735 | 1158 | 1591 | 2053 | |
| 6.2 | 305 | 744 | 1167 | 1600 | 2063 | |
| 6.4 | 314 | 752 | 1175 | 1609 | 2072 | |
| 6.6 | 323 | 760 | 1184 | 1618 | 2082 | |
| 6.8 | 332 | 769 | 1193 | 1627 | 2092 | |
| 7.0 | 341 | 778 | 1201 | 1636 | 2101 | |
| 7.2 | 350 | 786 | 1210 | 1645 | 2111 | |
| 7.4 | 359 | 795 | 1218 | 1654 | 2121 | |
| 7.6 | 368 | 803 | 1227 | 1663 | 2130 | |
| 7.8 | 377 | 812 | 1235 | 1672 | 2140 | |
| 8.0 | 386 | 820 | 1243 | 1680 | 2150 | |
| 8.2 | 395 | 829 | 1252 | 1689 | 2160 | |
| 8.4 | 404 | 838 | 1260 | 1698 | 2170 | |
| 8.6 | 413 | 846 | 1269 | 1708 | 2180 | |
| 8.8 | 422 | 855 | 1278 | 1717 | 2190 | |
| 9.0 | 431 | 863 | 1286 | 1726 | 2200 | |
| 9.2 | 440 | 872 | 1295 | 1735 | 2210 | |
| 9.4 | 449 | 880 | 1303 | 1744 | 2220 | |
| 9.6 | 457 | 889 | 1312 | 1753 | 2230 | |
| 9.8 | 466 | 897 | 1320 | 1762 | 2240 | |
| 10.0 | 475 | 905 | 1329 | 1772 | 2250 | |

APPENDIX

TABLE 160. STANDARD CALIBRATION DATA FOR THERMOCOUPLES FROM PLATINUM AND PLATINUM ALLOYED WITH 10 PER CENT RHODIUM

| E.m.f., microvolts | 0 | 1,000 | 2,000 | 3,000 | 4,000 | 5,000 | 6,000 | 7,000 | 8,000 | 9,000 |
|-----------------------|------------------|-------|-------|-------|-------|-------|-------|-------|-------|--------|
| | Temperatures °C. | | | | | | | | | |
| 0 | 0.0 | 147.1 | 265.4 | 374.3 | 478.1 | 578.3 | 675.3 | 769.5 | 861.1 | 950.4 |
| 100 | 17.8 | 159.7 | 276.6 | 384.9 | 488.3 | 588.1 | 684.8 | 778.8 | 870.1 | 959.2 |
| 200 | 34.5 | 172.1 | 287.7 | 395.4 | 498.4 | 597.9 | 694.3 | 788.0 | 879.1 | 968.0 |
| 300 | 50.3 | 184.3 | 298.7 | 405.9 | 508.5 | 607.7 | 703.8 | 797.2 | 888.1 | 976.7 |
| 400 | 65.4 | 196.3 | 309.7 | 416.3 | 518.6 | 617.4 | 713.3 | 806.4 | 897.1 | 985.4 |
| 500 | 80.0 | 208.1 | 320.6 | 426.7 | 528.6 | 627.1 | 722.7 | 815.6 | 906.1 | 994.1 |
| 600 | 94.1 | 219.7 | 331.5 | 437.1 | 538.6 | 636.8 | 732.1 | 824.7 | 915.0 | 1002.8 |
| 700 | 107.8 | 231.2 | 342.3 | 447.4 | 548.6 | 646.5 | 741.5 | 833.8 | 923.9 | 1011.5 |
| 800 | 121.2 | 242.7 | 353.0 | 457.7 | 558.5 | 656.1 | 750.9 | 842.9 | 932.8 | 1020.1 |
| 900 | 134.3 | 254.1 | 363.7 | 467.9 | 568.4 | 665.7 | 760.2 | 852.0 | 941.6 | 1028.7 |
| 1,000 | 147.1 | 265.4 | 374.3 | 478.1 | 578.3 | 675.3 | 769.5 | 861.1 | 950.4 | 1037.3 |

| E.m.f., microvolts | 10,000 | 11,000 | 12,000 | 13,000 | 14,000 | 15,000 | 16,000 | 17,000 | 18,000 |
|-----------------------|------------------|--------|--------|--------|--------|--------|--------|--------|--------|
| | Temperatures °C. | | | | | | | | |
| 0 | 1037.3 | 1122.2 | 1205.9 | 1289.3 | 1372.4 | 1454.8 | 1537.5 | 1620.9 | 1704.3 |
| 100 | 1045.9 | 1130.6 | 1214.2 | 1297.7 | 1380.7 | 1463.0 | 1545.8 | 1629.2 | 1712.6 |
| 200 | 1054.4 | 1139.0 | 1222.6 | 1306.0 | 1389.0 | 1471.2 | 1554.1 | 1637.6 | 1721.0 |
| 300 | 1062.9 | 1147.4 | 1230.9 | 1314.3 | 1397.3 | 1479.4 | 1562.4 | 1645.9 | 1729.3 |
| 400 | 1071.4 | 1155.8 | 1239.3 | 1322.6 | 1405.6 | 1487.7 | 1570.8 | 1654.3 | 1737.7 |
| 500 | 1079.9 | 1164.2 | 1247.6 | 1330.9 | 1413.8 | 1496.0 | 1579.1 | 1662.6 | 1746.0 |
| 600 | 1088.4 | 1172.5 | 1255.9 | 1339.2 | 1422.0 | 1504.3 | 1587.5 | 1670.9 | 1754.3 |
| 700 | 1096.9 | 1180.9 | 1264.3 | 1347.5 | 1430.2 | 1512.6 | 1595.8 | 1679.3 | |
| 800 | 1105.4 | 1189.2 | 1272.6 | 1355.8 | 1438.4 | 1520.9 | 1604.2 | 1687.6 | |
| 900 | 1113.8 | 1197.6 | 1281.0 | 1364.1 | 1446.6 | 1529.2 | 1612.5 | 1696.0 | |
| 1,000 | 1122.2 | 1205.9 | 1289.3 | 1372.4 | 1454.8 | 1537.5 | 1620.9 | 1704.3 | |

TABLE 161. STANDARD CALIBRATION DATA FOR THERMOCOUPLES FROM PLATINUM AND PLATINUM ALLOYED WITH 10 PER CENT RHODIUM

| E.m.f., microvolts | 0 | 1,000 | 2,000 | 3,000 | 4,000 | 5,000 | 6,000 | 7,000 | 8,000 | 9,000 |
|-----------------------|------------------|-------|-------|-------|--------|--------|--------|--------|--------|--------|
| | Temperatures °F. | | | | | | | | | |
| 0 | 32.0 | 296.8 | 509.7 | 705.7 | 892.6 | 1072.9 | 1247.5 | 1417.1 | 1582.0 | 1742.7 |
| 100 | 42.0 | 319.5 | 529.9 | 724.8 | 910.9 | 1090.6 | 1264.6 | 1433.8 | 1598.2 | 1758.6 |
| 200 | 94.1 | 341.8 | 549.9 | 743.7 | 929.1 | 1108.2 | 1281.7 | 1450.4 | 1614.4 | 1774.4 |
| 300 | 122.5 | 363.7 | 569.7 | 762.6 | 947.3 | 1125.9 | 1298.8 | 1467.0 | 1630.6 | 1790.1 |
| 400 | 149.7 | 385.3 | 589.5 | 781.3 | 965.5 | 1143.3 | 1315.9 | 1483.5 | 1646.8 | 1805.7 |
| 500 | 176.0 | 406.6 | 609.1 | 800.1 | 983.5 | 1160.8 | 1332.9 | 1500.1 | 1663.0 | 1821.4 |
| 600 | 201.4 | 427.5 | 628.7 | 818.8 | 1001.5 | 1178.2 | 1349.8 | 1516.5 | 1679.0 | 1837.0 |
| 700 | 226.0 | 448.2 | 648.1 | 837.3 | 1019.5 | 1195.7 | 1366.7 | 1532.8 | 1694.8 | 1852.7 |
| 800 | 250.2 | 468.9 | 667.4 | 855.9 | 1037.3 | 1213.0 | 1383.6 | 1549.2 | 1711.0 | 1868.2 |
| 900 | 273.7 | 489.4 | 686.7 | 874.2 | 1055.1 | 1230.3 | 1400.4 | 1565.6 | 1726.9 | 1883.7 |
| 1,000 | 296.8 | 509.7 | 705.7 | 892.6 | 1072.9 | 1247.5 | 1417.1 | 1582.0 | 1742.7 | 1899.1 |

| E.m.f., microvolts | 10,000 | 11,000 | 12,000 | 13,000 | 14,000 | 15,000 | 16,000 | 17,000 | 18,000 |
|-----------------------|------------------|--------|--------|--------|--------|--------|--------|--------|--------|
| | Temperatures °F. | | | | | | | | |
| 0 | 1899.1 | 2052.0 | 2202.6 | 2352.7 | 2502.3 | 2650.6 | 2799.5 | 2949.6 | 3099.7 |
| 100 | 1914.6 | 2067.1 | 2217.6 | 2367.9 | 2517.3 | 2665.4 | 2814.4 | 2964.6 | 3114.7 |
| 200 | 1929.9 | 2082.2 | 2232.7 | 2382.8 | 2532.2 | 2680.2 | 2829.4 | 2979.7 | 3129.8 |
| 300 | 1945.2 | 2097.3 | 2247.6 | 2397.7 | 2547.1 | 2694.9 | 2844.3 | 2994.6 | 3144.7 |
| 400 | 1960.5 | 2112.4 | 2262.7 | 2412.7 | 2562.1 | 2709.9 | 2859.4 | 3009.7 | 3159.9 |
| 500 | 1975.8 | 2127.6 | 2277.7 | 2427.6 | 2576.8 | 2724.8 | 2874.4 | 3024.7 | 3174.8 |
| 600 | 1991.1 | 2142.5 | 2292.6 | 2442.6 | 2591.6 | 2739.7 | 2889.5 | 3039.6 | 3189.7 |
| 700 | 2006.4 | 2157.6 | 2307.7 | 2457.5 | 2606.4 | 2754.7 | 2904.4 | 3054.7 | |
| 800 | 2021.7 | 2172.6 | 2322.7 | 2472.4 | 2621.1 | 2769.6 | 2919.6 | 3069.7 | |
| 900 | 2036.8 | 2187.7 | 2337.8 | 2487.4 | 2635.9 | 2784.6 | 2934.5 | 3084.8 | |
| 1,000 | 2052.0 | 2202.6 | 2352.7 | 2502.3 | 2650.6 | 2799.5 | 2949.6 | 3099.7 | |

TABLE 162. STANDARD CALIBRATION DATA FOR COPPER-CONSTANTAN THERMOCOUPLE

| E.m.f., microvolts | 0 | 1,000 | 2,000 | 3,000 | 4,000 | 5,000 | 6,000 | 7,000 | 8,000 | 9,000 |
|-----------------------|------------------|-------|-------|-------|-------|-------|-------|-------|-------|-------|
| | Temperatures °C. | | | | | | | | | |
| 0 | 0.0 | 25.3 | 49.2 | 72.1 | 94.1 | 115.3 | 135.9 | 155.9 | 175.5 | 194.6 |
| 100 | 2.6 | 27.7 | 51.5 | 74.3 | 96.2 | 117.4 | 137.9 | 157.0 | 177.4 | 196.5 |
| 200 | 5.2 | 30.2 | 53.9 | 76.5 | 98.4 | 119.5 | 140.0 | 159.9 | 179.4 | 198.4 |
| 300 | 7.7 | 32.6 | 56.2 | 78.8 | 100.5 | 121.6 | 142.0 | 161.9 | 181.3 | 200.3 |
| 400 | 10.3 | 35.0 | 58.5 | 81.0 | 102.7 | 123.6 | 144.0 | 163.8 | 183.2 | 202.2 |
| 500 | 12.8 | 37.4 | 60.8 | 83.2 | 104.8 | 125.7 | 146.0 | 165.8 | 185.1 | 204.0 |
| 600 | 15.3 | 39.8 | 63.0 | 85.4 | 106.9 | 127.7 | 148.0 | 167.7 | 187.0 | 205.9 |
| 700 | 17.8 | 42.2 | 65.3 | 87.6 | 109.0 | 129.8 | 150.0 | 169.7 | 188.0 | 207.8 |
| 800 | 20.3 | 44.5 | 67.6 | 89.7 | 111.1 | 131.8 | 152.0 | 171.6 | 190.8 | 209.8 |
| 900 | 22.8 | 46.9 | 69.8 | 91.9 | 113.2 | 133.9 | 154.0 | 173.6 | 192.7 | 211.5 |
| 1,000 | 25.3 | 49.2 | 72.1 | 94.1 | 115.3 | 135.9 | 155.9 | 175.5 | 194.6 | 213.4 |

| E.m.f., microvolts | 10,000 | 11,000 | 12,000 | 13,000 | 14,000 | 15,000 | 16,000 | 17,000 | 18,000 |
|-----------------------|------------------|--------|--------|--------|--------|--------|--------|--------|--------|
| | Temperatures °C. | | | | | | | | |
| 0 | 213.4 | 231.7 | 249.8 | 267.6 | 285.1 | 302.4 | 319.5 | 336.4 | 353.1 |
| 100 | 215.2 | 233.6 | 251.6 | 269.4 | 286.9 | 304.1 | 321.2 | 338.0 | |
| 200 | 217.2 | 235.4 | 253.4 | 271.1 | 288.6 | 305.9 | 322.9 | 339.7 | |
| 300 | 218.9 | 237.2 | 255.2 | 272.9 | 290.3 | 307.6 | 324.6 | 341.4 | |
| 400 | 220.8 | 239.0 | 257.0 | 274.6 | 292.1 | 309.3 | 326.3 | 343.1 | |
| 500 | 222.6 | 240.8 | 258.7 | 276.4 | 293.8 | 311.0 | 327.9 | 344.7 | |
| 600 | 224.4 | 242.6 | 260.5 | 278.2 | 295.5 | 312.7 | 329.6 | 346.4 | |
| 700 | 226.3 | 244.4 | 262.3 | 279.9 | 297.3 | 314.4 | 331.3 | 348.1 | |
| 800 | 228.1 | 246.2 | 264.1 | 281.6 | 299.0 | 316.1 | 333.0 | 349.7 | |
| 900 | 229.9 | 248.0 | 265.8 | 283.4 | 300.7 | 317.8 | 334.7 | 351.4 | |
| 1,000 | 231.7 | 249.8 | 267.6 | 285.1 | 302.4 | 319.5 | 336.4 | 353.1 | |

REFRACTORIES

TABLE 163. STANDARD CALIBRATION DATA FOR COPPER-CONSTANTAN THERMOCOUPLE

| E.m.f., microvolts | 0 | 1,000 | 2,000 | 3,000 | 4,000 | 5,000 | 6,000 | 7,000 | 8,000 | 9,000 |
|-----------------------|------------------|-------|-------|-------|-------|-------|-------|-------|-------|-------|
| | Temperatures °F. | | | | | | | | | |
| 0 | 32.0 | 77.5 | 120.6 | 161.7 | 201.3 | 239.6 | 276.6 | 312.7 | 347.9 | 382.3 |
| 100 | 36.7 | 81.9 | 124.8 | 165.7 | 205.2 | 243.3 | 280.3 | 314.6 | 351.4 | 385.7 |
| 200 | 41.4 | 86.3 | 128.9 | 169.8 | 209.1 | 247.1 | 283.9 | 319.8 | 354.8 | 389.1 |
| 300 | 45.9 | 90.6 | 133.1 | 173.9 | 212.9 | 250.8 | 287.6 | 323.3 | 358.3 | 392.5 |
| 400 | 50.5 | 95.0 | 137.2 | 177.7 | 216.8 | 254.5 | 291.2 | 326.9 | 361.8 | 395.9 |
| 500 | 55.0 | 99.3 | 141.4 | 181.7 | 220.6 | 258.2 | 294.8 | 330.4 | 365.2 | 399.3 |
| 600 | 59.5 | 103.6 | 145.5 | 185.7 | 224.4 | 261.9 | 298.4 | 333.9 | 368.6 | 402.6 |
| 700 | 64.0 | 107.9 | 149.5 | 189.6 | 228.2 | 265.6 | 302.0 | 337.4 | 370.4 | 406.0 |
| 800 | 68.5 | 112.1 | 153.6 | 193.5 | 232.0 | 269.3 | 305.6 | 340.9 | 375.6 | 409.3 |
| 900 | 73.0 | 116.3 | 157.7 | 197.4 | 235.8 | 273.0 | 309.1 | 344.4 | 378.9 | 412.7 |
| 1,000 | 77.5 | 120.6 | 161.7 | 201.3 | 239.6 | 276.6 | 312.7 | 347.9 | 382.3 | 416.0 |

| E.m.f., microvolts | 10,000 | 11,000 | 12,000 | 13,000 | 14,000 | 15,000 | 16,000 | 17,000 | 18,000 | 19,000 |
|-----------------------|------------------|--------|--------|--------|--------|--------|--------|--------|--------|--------|
| | Temperatures °F. | | | | | | | | | |
| 0 | 416.0 | 449.1 | 481.7 | 513.7 | 545.2 | 576.4 | 607.1 | 637.4 | 667.6 | |
| 100 | 419.4 | 452.4 | 484.9 | 516.8 | 548.4 | 579.4 | 610.1 | 640.5 | | |
| 200 | 423.0 | 455.7 | 488.1 | 519.0 | 551.5 | 582.5 | 613.2 | 643.5 | | |
| 300 | 426.0 | 459.0 | 491.3 | 523.2 | 554.6 | 585.6 | 616.2 | 646.5 | | |
| 400 | 429.3 | 462.2 | 494.5 | 526.4 | 557.7 | 588.7 | 619.3 | 649.5 | | |
| 500 | 432.7 | 465.5 | 497.7 | 529.5 | 560.8 | 591.8 | 622.3 | 652.5 | | |
| 600 | 436.0 | 468.7 | 500.9 | 532.7 | 564.0 | 594.8 | 625.4 | 655.5 | | |
| 700 | 439.3 | 472.0 | 504.1 | 535.8 | 567.1 | 597.9 | 628.4 | 658.5 | | |
| 800 | 442.6 | 475.2 | 507.3 | 539.0 | 570.2 | 601.0 | 631.4 | 661.6 | | |
| 900 | 445.9 | 478.4 | 510.5 | 542.1 | 573.6 | 604.0 | 634.4 | 664.6 | | |
| 1,000 | 449.1 | 481.7 | 513.7 | 545.2 | 576.4 | 607.1 | 637.4 | 667.6 | | |

TABLE 164. FORMULAS USEFUL IN CALCULATIONS

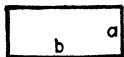

Rectangle:
Area = ab

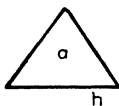

Triangle:
Area = $\frac{ah}{2}$

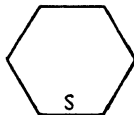

Regular Polygon:

| Sides | Area |
|-------|---------------------|
| 5 | $1.720 \times S^2$ |
| 6 | $2.598 \times S^2$ |
| 7 | $3.634 \times S^2$ |
| 8 | $4.828 \times S^2$ |
| 9 | $6.182 \times S^2$ |
| 10 | $7.694 \times S^2$ |
| 11 | $9.366 \times S^2$ |
| 12 | $11.196 \times S^2$ |

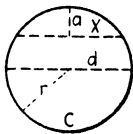

Circle:
Circumference = $\pi d = 2\pi r$
Diameter = $2r = \frac{C}{\pi} = 2 \sqrt{\frac{\text{area}}{\pi}}$
Radius = $\frac{d}{2} = \frac{C}{2\pi} = \sqrt{\frac{\text{area}}{\pi}}$
Area = $\frac{\pi d^2}{4} = \pi r^2 = 0.7854d^2$
Length of chord, $x = 2 \sqrt{a(d-a)^2} = 2r(\sin \frac{1}{2}\theta)$

Segment:
Area = $\frac{rl - x(r-a)}{2}$

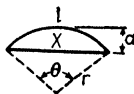

Height of arc above chord, $a = r - \sqrt{r^2 - (x/2)^2}$
Radius, when chord and height are known, $r = \frac{(x/2)^2 + h^2}{2h}$

Length of arc, $l = 2\pi r \frac{\theta}{360} = \pi r \frac{\theta}{180}$

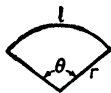

Sector:
Area = $\frac{1}{2} ir = \pi r^2 \frac{\theta}{360}$

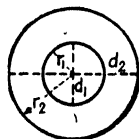

Annulus (Circular Ring):
Area = $\pi(r_2^2 - r_1^2)$
= $\pi(r_2 + r_1)(r_2 - r_1)$
= $0.7854(d_2^2 - d_1^2)$

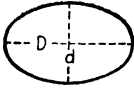

Ellipse:

$$\text{Area} = \frac{\pi}{4} Dd = 0.7854 Dd$$

$$\text{Perimeter (approx.)} = 2\pi \sqrt{\frac{D^2 + d^2}{8}}$$



Skewbacks:

To find a skew to fit a given arch:

1. Find subtended angle θ
2. Find sine and cosine of $\frac{1}{2}\theta$
3. $H = \text{thickness of arch} \times \sin \frac{1}{2}\theta$
4. $V = \text{thickness of arch} \times \cos \frac{1}{2}\theta$

Slope of the skewback from the horizontal = $90^\circ - \frac{1}{2}\theta$



Circle Brick:

$$\text{Radius of radial brick, } r = \frac{cT}{(C - c)}$$

Number of radial brick to make a circle:

$$n = \frac{\pi \times \text{diameter of circle}}{\text{thickness of large end}} = \frac{2\pi r}{C}$$

Number of straights to fill out a circle of given diameter using given number of radial brick:

$$n = \frac{\pi(\text{given outside diameter}) - (\text{possible diameter with radial brick})}{\text{thickness of straight}}$$

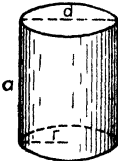

Cylinder:

$$\text{Volume} = \pi r^2 a = 0.7854 d^2 a$$

$$\text{Cylindrical surface area} = \pi da$$

$$\text{Total surface area} = 2\pi r(r + a)$$

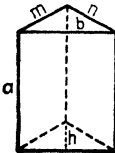

Regular Triangular Prisms:

$$\text{Volume} = \frac{1}{2} bha$$

$$\text{Lateral surface area} = (b + m + n)a$$

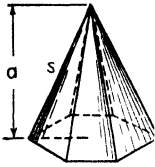

Pyramid:

$$\text{Volume} = \frac{\text{area of base} \times a}{3}$$

$$\text{Lateral surface area} = \frac{\text{perimeter of base} \times s}{2}$$

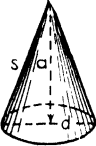

Cone:

$$\begin{aligned} \text{Volume} &= \frac{\pi r^2 a}{3} \\ &= 0.2618 d^2 a \end{aligned}$$

$$\text{Lateral surface area} = \pi r s$$

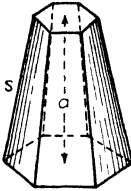

Frustum of Pyramid:

$$\text{Lateral surface area} = \frac{(P + p)s}{2}$$

$$\text{Volume} = \frac{a}{3} (b + B + \sqrt{Bb})$$

where P = perimeter of lower base
 p = perimeter of upper base
 B = area of lower base
 b = area of upper base

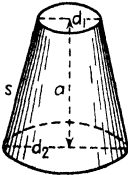

Frustum of Cone:

$$\begin{aligned} \text{Volume} &= \frac{a}{3} (b + B + \sqrt{Bb}), \text{ or} \\ &= \frac{\pi}{12} a (d_1^2 + d_1 d_2 + d_2^2) \end{aligned}$$

$$\text{Area of conic surface} = \frac{\pi S}{2} (d_1 + d_2)$$

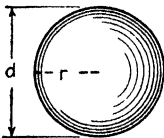

Sphere:

$$\text{Area of surface} = 4\pi r^2 = \pi d^2 = 12.566r^2$$

$$\text{Volume} = \frac{4\pi r^3}{3} = 4.1888r^3$$

$$= \frac{\pi d^3}{6} = 0.5236d^3$$

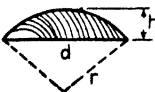

Segment of Sphere:

$$\text{Area of spherical surface} = 2\pi r h = \frac{\pi}{4} (d^2 + 4h^2)$$

$$\text{Volume} = \pi h^2 \left(r - \frac{h}{3} \right)$$

AUTHOR INDEX

A

Ackermann, H., 155
and H. Knuth, 153
Adams, C. B., 18
Adams, G. F., 335, 343
and J. R. Lait, 477
Adams, W., Jr., 615
Agte, C., 340
and H. Alterthum, 340
and K. Moers, 340
Alexander, J. P., 21, 22, 342
Allen, V. T., 72
Amberg, C. R., 339
Amdur, I., 282
Amelung, J. F., 17
American Society for Testing Materials,
150
Anderson, C. T., 226
Anderson, J. E., 300
Anderson, R. H., D. C. Gunn, and A. L.
Roberts, 256
Andreasen, A. H. M., 155, 557, 558
Andrews, M. R., 339
Andrieux, L., 340
Ao, T., 214
Arthur, J. E., *et al.*, 593, 594, 596
Ashley, G. H., 68
Aubert, A., 521
Audley, J. A., 11, 466, 478
Austenal Laboratories, Inc., 155
Austin, J. B., 488, 496, 497, 558
and R. H. H. Pierce, Jr., 508, 521
Awbery, J. H., 521

B

Backhaus, K., 560
Badger, E. H. M., W. Lewcock, and J. H.
Wylde, 218
Baeza, W. J., 224
Bailey, E. G., 477, 630

Baker, D. R., and D. P. Glick, 156
Bales, C. E., 92, 152, 213
and A. R. Blackburn, 595
and W. T. Christian, 258
Balke, C. W., 336
Ballentin, O., 256
Banco, R., 11
Bansen, H., 558
Bar, A. L. S., and H. J. C. Tendeloo, 152
Barber, E. A., 24
Barberot, G., 173
Baritel, A., 521
Barker, M. E., 68
Barlett, H. B., 218, 220
Barnes, M. H., 332, 333, 342
Barratt, T., and R. M. Winter, 519
Barrett, L. R., N. E. Dobbins, and A. T.
Green, 474
Barrett, W. E., 174
Bartell, F. E., and H. J. Osterhof, 152
Barth, H., 258
Bartsch, O., 397, 418, 451, 475-477, 559
Basic Refractories, Inc., 219
Baudewyns, J., 477
Baumann, H. N., Jr., 257
and J. P. Swentzel, 521
Bazilevich, A. S., 337
Beals, M. D., and S. Zerfoss, 218
Bechmann, O., 73
Becker, K., 325, 339-341, 495
and H. Ewest, 340
and R. Holbling, 339
Beevers, C. A., and M. A. S. Ross, 45, 72
Benner, R. C., and G. J. Easter, 225
Bennett, D. G., 666
Berg, S., 547, 558
Berger, A. L., 666
Berkelhamer, L. H., 73
Bernal, J. D., 223
Berns, M. H., 340
Betts, A. G., 148, 155
Bichowsky, F. R., and F. D. Rossini, 342

- Biggs, H. C., 418, 593
 Bigot, A., 149
 Bingham, E. C., 11, 149
 Birch, F., *et al.*, 343
 and H. Clark, 522
 Birch, R. E., 153, 221, 338, 591
 and F. A. Harvey, 73
 Birks, L. S., and H. Friedman, 313, 337,
 558
 Bischof, C., 11
 Blears, J., and R. W. Hill, 276, 289
 Bleining, A. V., 213
 and G. H. Brown, 417
 and M. R. Hornung, 151
 and C. A. Loomis, 68
 and E. T. Montgomery, 213
 and D. W. Ross, 149
 and H. G. Schurecht, 75, 213
 Bliss, L. G., 75
 Blood, H. A., 24
 Bloom, F. S., 258
 Bodin, V., 417
 Bole, G. A., 258
 Booth, C., and W. J. Rees, 596
 Booth, J. C., 16, 23
 Booth, S. H., 615
 Boow, J., and G. A. Walker, 419
 Booze, M. C., 69, 215, 417, 420, 436, 450,
 495, 520, 591
 and F. C. Flint, 475
 and S. M. Phelps, 450
 Bosazza, V. L., 73
 Bosch, C., 316
 and A. Mittasch, 341
 Bosch, R., 336
 Bosler, L. C., 258
 Bosworth, R. C. L., 151
 Bottomley, A. E., 154
 Bowen, N. L., 398
 and O. Anderson, 370
 and J. W. Greig, 315, 368, 399
 Bowers, J. A., 593
 Boyle, 279
 Boylston, H. M., 584
 Brace, P. H., 555, 559
 Bradley, R. S., W. D. Keller, and F. W.
 Schroeder, 73, 218
 Bradshaw, L., and W. Emery, 210, 211,
 225, 400, 555, 557
 Bragg, W. L., 218
 Bragg, W. R., 12
 Brand, F., 153, 174
 Branner, G. C., 68
 Branner, J. C., 12
 Bray, J. L., 607
 Bray, R. H., 70
 Bremond, P., 418, 559
 Bressman, J. R., 419
 Brewer, L., 327, 331
 et al., 327, 332, 343
 Brewer, R. C., 158
 Bridgeman, 139
 Bridgeway, R. R., and B. L. Bailey, 199
 Brindley, G. W., and K. Robinson, 71
 Broughton, G., and C. S., Windebank, 152
 Brown, D. P., and R. Hess, Jr., 93
 Brown, E. S., 595
 Brown, G. H., and E. T. Montgomery, 213
 and G. A. Murray, 213
 Brown, G. P., 289
 A. Dinaido, G. K. Cheng, and T. K.
 Sherwood, 278, 289
 Brown, J., 399
 Brown, L., and L. Coffin, 154
 Brownlie, D., 597
 Brownlow, J. M., 501
 Brownmiller, L. T., and R. H. Bogue, 399
 Brumell, H. P. H., 75
 Budnikov, P. P., 217, 218
 and S. A. Jicharewitsch, 630
 and B. J. Pines, 451
 Buell, W. C., 10, 572, 592
 Buerger, M. J., 198, 224
 Bule, B., and A. Benedetti-Pichler, 557
 Bunting, E. N., 370-373, 391, 399
 Burdick, M. P., R. E. Moreland, and R. F.
 Geller, 410, 419
 Burger, H., 342
 Burgess, G. K., and H. LeChatelier, 12
 Burke, T. H., 593
 Burr, E. A., 73
 Burrows, H. O., 614, 616
 Buss, E., 11
 Butler, W. A., 257
 Calhoun, F. H. H., 68
 Cammerer, J. S., 520, 521
 Campbell, D. F., 615

- Canneri, 341
 Cape, A. T., and K. B. Bowman, 221
 Carey, M. T., and F. B. Heacher, 591
 Carlson, E. T., 399
 Carruthers, J. L., 173
 Cartright, V., and S. M. Phelps, 397
 Cassagrande, A., 542, 558
 Cassan, H., and A. Jourdain, 150
 Casselman, E. J., 174
 Castell, H. C., S. Dilnot, and M. Warrington, 223
 Caven, T. M., 155
 Ceramic Products, 451
 Chadeyron, A. A., 220, 221
 and W. J. Rees, 218, 300
 Chapman, W. B., 258
 Charrin, V., 72
 Chelikowsky, J. R., 30, 69
 Chesters, J. H., 10, 398, 594, 596
 G. L. Clark, and K. C. Lyon, 219
 and T. W. Howie, 597
 and T. R. Lynnman, 144, 154
 and L. Lee, 155, 219, 592
 and T. R. Lynman, 220
 and R. J. McLean, 596
 and C. W. Parmelee, 219, 221, 337, 488, 496
 and W. J. Rees, 298, 418
 and W. Weyl, 173, 219
 Christman, H. M., 258
 Christy, R. F., 646
 Chudoba, K., and M. V. Stackelberg, 74
 Clark, F., 340
 Clark, G. L., and D. H. Reynolds, 195, 220
 Clark, H. N., 300
 Clark, O. H., 430, 452
 Claussen, G. E., and J. W. Skchan, 312, 336
 Clews, F. H., F. Ball, and A. T. Green, 475
 L. R. Barrett, and A. T. Green, 474
 H. Booth, and A. T. Green, 301
 W. F. Ford, and A. T. Green, 418
 A. Green, and A. T. Green, 475
 and A. T. Green, 153, 299, 418, 475, 476, 559
 W. Hugill, and A. T. Green, 475
 H. H. Macey, and A. T. Green, 404, 410, 419
 H. M. Richardson, and A. T. Green, 299, 404, 410, 419, 475, 476
 Coale, C. H., 92
 Coffin, Thomas, 17
 Coffyn, J. E., and G. W. Scott, 151
 Coghill, W. H., and F. D. DeVaney, 93
 Cohn, G., 223
 Cohn, W., and A. E. MacGee, 210, 211, 225
 Cohn, W. M., 14, 149, 150, 195, 196, 210, 212, 213, 220, 225, 226, 288, 343, 400, 495
 Colby, S. F., 74
 Cole, S. S., 217, 299, 399, 400
 and D. C. Lynn, 299
 Comber, A. W., 11
 Comeforo, J. E., 154
 et al., 177, 215
 Committee on Geological Surveys, 75
 Committee on Physical Chemistry of Steel Making, 593
 Compton, A. H., 507, 519
 Comstock, G. F., 220
 Conklin, J., and Ananias, 16
 Cook, G. H., 24
 Cooke, S. R. B., 558
 Cooper, W. G., W. L. Stafford, and G. A. Bole, 419
 Corkin, D. H., 343
 Corning Glass Works, 155
 Correns, C. W., and W. Mehmel, 71
 Coss, H. T., 299
 and N. J. Kent, 300
 Cox, 20
 Crary, A. P., 521
 Croatto, V., and A. Mayer, 338
 Cronshaw, H. B., 174
 Crook, W. J., 472
 Cross, A. H. B., 558
 and W. J. Rees, 219
 Cunliffe, J. A., and H. E. Clem, 630
 Curtis, C. E., 221, 313, 337
 Curtis, F. W., 289

D

 Dahlstrom, B. P., 258
 Dale, A. J., 223, 417, 418, 472
 Dana, E. S., 11, 190, 217
 Dana, J. D., 75
 Danehower, F. B., 148, 155
 Davey, W. P., 337

- David, L., 309, 336
 Davies, R. J. R. A. Green, and H. F. E. Donnelly, 70
 Davies, W., 73
 Davis, D. S., 519, 522
 Dawidowski, R., 593
 Dean, R. S., 92
 Dear, P. S., 475
 Debenham, W. S., 594
et al., 594
 DeLapparent, J., 72
 and E. Stempfel, 214
 Dennis, W. H., 615, 616
 Desch, C. H., 74, 222
 Desmond, J., 536
 Devillers, R. W., 682
 DeWitt, H., 256, 338, 666
 Diamond, G. S., 258
 Diepschlag, E., and K. Feist, 473
 Dietz, K., 300
 Dietzel, 333
 Dodd, A. E., 218, 473, 474, 592, 593
 and A. T. Green, 74, 593
 Dodd, C. M., 153
 and M. E. Holmes, 153
 Donoho, C. K., and J. T. MacKenzie, 478, 592
 Dressler, P., 256, 257
 Ducatil, J. T., and J. H. Alexander, 23
 Duckham, A., 257
 Dudley, B., 289
 Duffield, F. L., 149, 156
 Dufty, N. F., 596
 Dukelski, M., 386, 387
 Dunn, E. J., Jr., 558
 Durand, M. A., 496
 Durvey, P., and F. Odell, 337
 Dusenberre, G. M., 522
 Dusing and Huniger, 341
 Dyer, W. S., and A. R. Crozier, 69
- E
- Earhart, E. F., 559
 Easter, G. J., 225
 Eastman, E., *et al.*, 342
 Eastman, E. D., 327
 Ebert, H., and C. Tingwaldt, 496
 Eckel, 675
 Edwards, A., 683
- Eitel, W., 12, 223
 H. O. Muller, and O. E. Radczweski, 71, 177, 215
 Ekholm, L. G., and L. D. Hower, 594, 595
 Ellinger, F. H., 340
 Elliott, A. C., and R. J. Montgomery, 451
 Emery, W., 536
 Emory, L. T., 71, 72
 Endell, K., 28, 219, 420, 436, 450, 451, 472, 496, 682
 and F. Angeleri, 451
 R. Fehling, and R. Kley, 459
 and R. Harr, 217
 U. Hofmann, and D. Wilm, 69, 150
 and E. Pfeiffer, 217, 495
 and W. Steger, 450, 495, 616
 and C. Wens, 477
 Endell, V. K., 592
 Erdmann, K., 155
 Ericson, R., 144, 154
 Eriksson, J. A., 143, 154
 Erway, N. D., and R. L. Seifert, 337
 Eskola, P., 369, 370, 398
 Ess, T. J., 591
 Eucken, A., 519, 520
 and H. Laube, 520
 Evans, G. S., 475
 Evans, R. C., 12
 Everhardt, J. L., *et al.*, 343
 Everhart, J. O., 93, 153, 156, 216, 494, 497
 Ewell, R. H., E. N. Bunting, and R. F. Geller, 221
 Ewing, F. J., 72
 Eyres, N. R., *et al.*, 522
- F
- Faber, L., 299
 Fansteel Metallurgical Corporation, 289
 Fansteel Products Company, Inc., 336
 Faraday, Michael, 264
 Farkus, A., and H. W. Melville, 289
 Farnsworth, W. M., and E. R. Johnson, 596
 Fay, M. A., 591
 Fayles, R. R., 595
 Fehling, R., 477, 630
 Fehse, W., 288
 Fellows, J. A., 730, 736
 Felt, J. B., 16, 17, 23

- Fenner, C. N., 368
 Fenton, C. W., 18
 Ferguson, J. B., 559
 Ferguson, R. F., 14, 472
 Fermi, E., 645, 653
 Fessler, A. H., and W. J. McCaughey, 72
 and Schwartzwalder, 315, 316
 Fettke, C. R., and W. E. Stewart, 477
 Field, T. E., 225
 Fieldner, A. C., 258
 A. E. Hall, and A. L. Feild, 353, 397
 Fieman, E. M., 597
 Finzer, Charles, 256
 Fishenden, M., and O. A. Saunders, 12
 Fix, F. A., 153
 Fleischmann, M., 340
 Flint, F. C., and A. R. Payne, 476
 Foex, F. T. M., and C. H. Blanchetais, 288
 Fondersmith, C. R., 594
 Foord and Bichowsky, 341
 Foose, R. M., 69
 Foote, Fairchild, and Harrison, 397
 Forbes, C. R., 71
 Ford, W. F., and W. J. Reese, 447, 452
 Foster, H. D., 142, 154
 Foster, L. S., 281, 282
 Foster, S. W. G., 666
 Fowle, 343
 France, W. A., 148, 155
 Frank, H. S., 594
 Franklin, F. F., 472
 Frear, C. L., 596
 Freberg, A. K., 215
 Frederick, C. L., Jr., 73
 Frederick, R. E., and R. S. Spencer, 74
 Freeman, C. A., 591
 Freise, F. W., 630
 Frenkel, J., 398
 Freundlich, H., 150
 Friederich, E., 339
 and L. Sittig, 339
 Frohlich, K. W., 336
 Fromm, F., 496, 630
 Fulcher, G. S., and T. E. Field, 225
 Furnas, C. C., 258, 472
- G
- Gallagher, B. J., 257
 Gallup, J. L., 223
 Gambey, F., and G. Chaudron, 221
 Gamon, J. A., 72
 Gardner, W. E., 223
 Gardner, W. T., 476
 Gareis, F., 153
 Garner, W. E., 223
 Garve, T. W., 92, 174
 Gaudin, A. M., and R. T. Hukki, 547, 558
 Geller, R. F., 173, 289, 316, 338, 450, 488
 et al., 395
 and E. N. Bunting, 226, 481, 497
 and M. D. Burdick, 339
 and R. A. Heindle, 481, 495
 and H. Insley, 488, 496
 and W. L. Pendergast, 417
 and W. H. Wadleigh, 214
 and P. J. Yavorsky, 371, 400
 B. L. Steinman, and A. S. Creamer,
 339, 396, 497
 General Refractories Company, 154
 Gibson, G., and R. Ward, 223
 Gilard, P., 450
 Giles, R. T., 300
 Gillett, H. W., and E. L. Mack, 615
 Gilliland, E. R., 645
 and T. K. Sherwood, 160, 173
 Gladding, S. D., 596
 Glebov, S. V., 597
 Glick, D. P., 156
 Glover, J., 21
 Goldschmidt, V. M., 196, 197, 221
 Gombert, J., 68
 Goodeve, C. F., 151
 Goodier, J. N., 730, 736
 Goodman, C., 653
 Goodner, E. F., 215
 Goodrich, H. R., 427, 450
 Goodwin, H. M., and R. D. Mailey, 494
 Gorton, A. F., and W. H. Groves, 397
 Graafen, 258
 Graham, R. P., and J. D. Sullivan, 35, 70,
 151
 Granger, A., 521
 Greaves-Walker, A. F., 11, 24, 71
 and C. W. Owens, Jr., 496
 T. L. Hurst, and R. L. Stone, 72
 Green, A. T., 53, 210, 223-225, 519, 520
 and A. J. Dale, 450
 and H. Edwards, 420, 450, 519
 W. Hugill, and H. Ellerton, 593
 and L. S. Theobald, 223

- Green, H., 557
 Greger, H. H., and J. J. Reimer, 291, 300
 Gregor, V., 594
 Gregory, J., 154
 Greig, J. W., 193, 218, 368-370, 391, 392, 399
 Grewe, J., 256
 Griffith, H. M., 575, 594
 Griffiths, E., 12
 Grigsby, C. E., 473
 Grim, R. E., 69, 70
 and W. F. Bradley, 182, 215
 and J. S. Mackin, 93
 Grober, H., 519
 Grosse, W., and W. Dinkler, 226
 Groume-Grjmailo, 257
 Gruner, E., 28, 150
 Gruner, J. W., 70, 71
 Guntherschulze, A., and F. Keller, 341
 Gurney, H. P., and J. Lurie, 519
- H
- Hacks, K., and W. S. Sprow, 301
 Haddock, G. T., 301
 Hadlock, C., 158
 Hagar, E., and L. W. Flood, 153
 Hagg, G., 341
 Hall, A., 22
 Hall, F. P., 149, 151, 494
 and H. Insley, 363, 400, 456
 Hall, H. P., 107
 Hall, J. L., 497
 Hamlin, B., and Spenceley, 666
 Hancock, W. C., and J. G. Cowan, 557
 and W. E. King, 555, 557
 "Handbook of Chemistry and Physics,"
 343, 400
 Hankison, L. E., 469
 Hansen, H., 592
 Hansen, W. C., and R. H. Bogue, 453
 and L. T. Brownmiller, 399
 Hanson, H., 342
 Hanson, W. H., 616
 Harders, F., 75
 Harman, C. G., 151
 Harraeus, 300
 Harrassowitz, H., 71
 Harris, R. G., 536
 Harrison, H. C., 72, 218
 Harrison, W. N., D. G. Morse, and J. C.
 Richmond, 666
 Harrop, C. B., and H. S. Orth, 257
 Harter, I., and A. M. Kohler, 223
 Hartford-Empire Company, 224
 Hartmann, F., 398, 459, 465, 472, 474, 475,
 478
 Hartmann, M. L., 468, 473
 A. P. Sullivan, and D. E. Allen, 559
 O. B. Westmont, and S. F. Morgan,
 215 and C. E. Weinland, 520
 Harvey, F. A., 69, 451, 495
 and R. E. Birch, 218-221, 299, 593
 and J. S. McDowell, 220
 Harwood, H., 18
 Haslam, R. T., 258
 Hastings, E. S., 73
 Hatch, T., and S. P. Choate, 541, 558
 Hauser, E. A., 12, 31
 and S. Hirshon, 152, 194
 and C. E. Reed, 150
 Havard, F. T., 10
 Hayman J. C., 300, 597
 Hayward, C. R., 608, 616
 Healey, R., 666
 Heany, J. A., 336
 Hearing, R. H., and C. F. Tefft, 92
 Hedvall, J. A., 222, 223
 B. Lundin, and F. Sanford, 151
 and G. Schiller, 222
 Heilman, R. H., 501, 510, 511, 519, 521
 and R. S. Bradley, 521
 Heindl, R. A., 69, 451, 481, 487, 488, 496
 and A. J. Cooke, 595
 G. B. Massengale, and L. G. Cossette,
 109, 152, 536, 682
 and L. E. Mong, 216, 494, 497
 and W. A. Pendergast, 69, 297, 299, 300,
 418, 451, 452, 496
 Heisenberg, W., 646
 Helser, P. D., 417
 Helz, A. W., 151
 Henderson, C. H., 153
 Hendricks, S. B., 28, 71
 and M. E. Jefferson, 71
 Henry, A. V., 555, 559
 Henry, E. C., 315, 325, 338, 339, 488, 497
 et al., 340, 497
 and N. W. Taylor, 70
 Henzel, R. F., 342

- Jarves, D., 18
 Jay, A. H., and L. Lee, 521
 Jeffery, 315
 Jellinek, M. H., and I. Fankuchen, 73
 Jennings, H. W. K., 337
 Jillson, W. R., 68
 Jllgen, F., 224
 Johnson, A. L., and F. H. Norton, 98, 152
 Johnson, J. E., 10
 Johnson, P. D., 199, 266, 284, 304
 Jones, W. D., 75, 224
 Jordan, L., 596
 A. A. Peterson, and L. H. Phelps, 337
 Josi, S. E., and A. E. Hubbard, 257
 Jost, W., 223
 Jourdain, A., 557
- K
- Kai-Ching-Lu, 463, 476
 Kainarskii, I. S., and V. A. Brom, 299
 Kalbauder, O., 68
 Kamm, R., M. Steinberg, and J. Wulff, 156
 Kanhauser, F., and U. Robitschek, 418
 Kanolt, C. W., 398
 Kanz, A., 520, 559
 Kausch, O., 75
 Kay, H. N., 75
 Kaye, G. W. C., and W. F. Higgens, 519
 Kearn, D. J., and D. R. Shoultz, 666
 Kedesdy, H., 219
 Keenan, J. H., and J. Kaye, 666
 Keith, W. P., and O. Whittemore, Jr., 288
 Keler, E. K., 419
 and A. I. Zakharov, 451
 Kellogg, H. H., 89, 93
 Kelly, H. W., 592
 Kelly, K. K., 289, 344
 Kenyon, H. C., 258
 Keppeler, G., 71, 398
 and H. Schmidt, 152
 Kerr, P. F., 28, 71
 Kerr, W. R., 451
 Kestner, P. J. F., 300
 Ketchum, P. W., A. E. R. Westman, and
 R. K. Hursh, 558
 Kidnert, P., and W. T. Sweeney, 495
 Kieffer, E., 495
 Kieffer, R., 666
 and W. Hotop, 224, 342, 666
- King, R. M., 555, 559
 Kinzie, C. J., and D. S. Hake, 75
 Kirby, D., 312, 338
 Kirichenko, N., 592
 Kistler, S. S., 338, 666
 Kitto, W. C., 478
 Klar, H., 473
 Klesper, R., 591
 Klever, E., 214
 Klinefelter, T. A., and E. P. Rexford, 477
 Klyucharev, Ya., and S. A. Levenshtein,
 156, 615
 Knapp, W. J., 522
 Knauff, R. W., 616
 Knibbs, N. V. S., 11
 Knote, J. M., 300
 Kocatopcu, S. S., 615
 Koeppl, C., 10, 218
 Kohler, E., 69, 418
 Konarzewski, J., 536
 Kondo, S., and T. Yamauchi, 218
 and H. Yoshida, 451, 452
 Konopicky, K., 219
 and H. Kassell, 219
 Koon, S. G., 592
 Koppers, H., 218
 Korn, A. H., 93
 Kornfeld, H., 520
 Kort, E., and A. Drashnikova, 592
 Koster, W., and W. Mulfinger, 340
 Kozu, S., and M. Masuda, 214
 Kracek, F. C., 370
 Kraner, H. M., 217, 225, 473, 560, 594, 595
 et al., 594
 Kratzert, J., and F. Kaempfe, 560
 Kraus, L. P., Jr., 223
 Krause, H. F., and W. Weyle, 222
 Krause, O., and E. Jakel, 496
 and H. Wohner, 214
 Kreidl, N. J., 75, 337
 Kristler, S. S., 340
 Kukolev, G. V., A. T. Zelenskaya, and Z.
 P. Shalomcev, 154
 Kurtz, T. N., 24
 Kuzell, C. R., 301
- L
- Ladoo, R. B., 11, 343
 Laist, F., 600, 615
 Lake, W. O., 299

- Lambie, J. M., and D. W. Ross, 205, 215
 Lamort, J., 592, 682
 Landolt-Bornstein, 343
 Lane, F., 92
 Lane, R. O., 203, 218
 Langraeber, W., 75
 Lapin, V. V., 592
 Larin, G. B., 152
 Larsen, E. S., 12
 and H. Berman, 190, 217
 Larson, B. M., and A. Grodner, 593
 Lasch, H., 225
 Laschtchenko, P. N., 210
 Lawton, G. C., 594
 Lax, E., and M. Schon, 399
 Le Chatelier, H., 216
 and B. Bogitch, 398
 Lecher, O., 473
 Leduc, R., 152
 Lehmann, H., and M. T. Schulze, 557
 Lennard-Jones, J. E., and A. F. Devonshire, 398
 Lepingle, M., 630
 Lesar, A. R., 494
 C. A. Krinbill, Jr., W. D. Keller, and R. S. Bradley, 497
 Letort, Y., 11, 615
 Levy, S. I., 11
 Libman, E. E., 172
 Lilly, A., 594
 Linde Air Products Company, 332
 Lindgren, R. A., 591
 Lindsay, D. C., and W. H. Wadleigh, 174
 Link, A. E., 342
 Linton, R., 256
 Lipinski, F., 219
 Litinsky, L., 14, 299
 Litzow, J., 155, 224
 Lobaugh, F. E., 301
 Logan, W. N., 68
 Long, B., 72, 418, 521
 Longchambon, L., 300
 and Liu-Ping-Kun, 419
 and J. Zajtman, 70
 Longuit, J., and H. Forestier, 223
 Loomis, G. A., 494, 682
 Lorenz, R., 69
 and Woolcock, 341
 Lovejoy, E., 11, 92, 174
 and H. E. Covan, 153
 Loveland, R. P., and A. P. H. Trivelli, 557
 Lovell, G. H. B., G. R. Rigby, and A. T. Green, 337
 Ludwig, 355, 398
 Luks, D. W., 75
 Lundin, H., 336
 Lux, E., W. H. Daniels, and E. Kuhn, 155
 Lynman, T. R., 256
 T. W. Howie, and J. H. Chesters, 474
 and W. J. Rees, 74, 220, 593
 Lyon, J. B., 258
 Lyons, S. C., and A. L. Johnson, 93
- M
- Maase, E., 520
 MacBride, W. B., 616
 McCaughey, W. J., and H. C. Lee, 593
 McCraith, D. O., 559
 McDougal, Fessler, and Schwartzwalder, 315
 McDowell, J. S., 24, 70, 150, 367, 472, 592, 597, 615, 736
 and L. L. Gill, 702, 703, 736
 and R. M. Howe, 24, 73, 494
 and H. S. Robertson, 14, 24, 74, 220
 McDowell, S. J., and H. C. Lee, 460, 477
 Mace, C. H., 611
 Macey, H. H., 166, 173, 174
 and F. H. Clews, 216
 and S. R. Hind, 174
 McGeary, F. M., 496
 MacGee, A. E., 211-213, 215, 226, 536
 McGrue, W. M., 300
 Machin, J. S., and O. L. Hanna, 478
 McIntyre, W. A., 476
 Mack, J. R., 300
 McKenna, P. M., 340
 MacKenzie, J., 591
 McKinley, J. M., and W. K. Carter, 222, 224
 and S. M. Phelps, 451
 and R. R. Robinson, 174
 McLain, W. R., 565, 591
 McMahan, J. F., 299
 MacMichael, 100
 McMullen, C., A. A. Turner, and G. J. Easter, 472
 McMullen, J. C., 460, 477
 McNamara, E. P., and J. E. Comeforo, 154

- McQueen, H. S., 72
 McSwiney, D. J., 466, 478
 McVay, T. N., 14, 214
 W. W. Galbreath, Jr., and D. Allen, 218
 and R. K. Hursh, 460, 477
 Magalis, B. W., 587, 596
 Magnesia Refractory, 219
 Magnesit-industrie, 219
 Makob, M., 519
 Malina, F. J., and M. Summerfield, 666
 Mamuikin, P. S., 451
 Mandell, A. J., 154
 Mann, W., 595
 Mansur, H. H., 257
 Mantell, C. L., 11
 Marbaker, E. E., 592
 Marden, J. W., and M. N. Rich, 13
 Marshall, C. E., 28, 70, 150
 Martin, G., *et al.*, 541, 557
 Martin, J. L., 282
 Martin, R. H., 299, 473
 Matignon, C., 398
 Matveev, R., 399
 Matzen, H. B., and C. E. Parmelee, 174
 Mawhinney, M. H., 10
 Maynard, G. W., 24
 Mehmel, M., 70
 Meker, G., 520
 Melhase, J., 72
 Mellor, J. W., 12, 149, 173, 215, 216
 et al., 210
 and W. Emery, 417
 N. Sinclair, and P. S. Devereaux, 214
 Melnikov, F. I., 156
 Mendheim, A., and E. Reutlinger, 256
 Menke, P. O., 478, 591
 Mercer, G. R., 595
 Merritt, G. E., 488, 495, 496
 Merritt, L. M., 256
 Messervey, J. P., 73
 Metallges, Akt.-Ges., 221
 "Metals Handbook," 343
 Metz, G. F., 87
 Meyer, H. C., 74
 Meyer, O., 341
 Meyers, G. and M., 21
 Miehr, W., *et al.*, 418
 H. Immke, and J. Kratzert, 214, 226,
 451, 495
 Miller, W. T. W., and R. J. Sarjant, 92
 Milomi, G., 68
 Mingle, J. G., 257
 Mitchell, J., and W. B. Mitchell, 397
 Mitchell, L., and E. C. Henry, 69
 Mitra, H. K., and A. Silverman, 466, 473
 Moldenke, R., 592
 Molock, G. T., 93
 Mong, L. E., 419
 Moore, B. J., 536
 Moore, C. E., 173, 214
 Moore, E. S., and T. G. Taylor, 73
 Moore, R., 336
 Morey, G. W., 224
 and N. L. Bowen, 398
 and F. C. Kracek, 399
 Morgan, J. D., 75, 148, 155
 and R. E. Loew, 148, 156
 Morgan, W. R., and R. K. Hursh, 173
 W. I. Peskin, and S. J. Kronman, 299
 Moritz, W., 256
 Morse, R. S., 289
 Moser, A., 155, 300
 Motock, A. T., 55, 75
 Mott, W. R., 336
 Muller, G., 339
 Muller, R., 92
 Musgrave, J., 74

N

 Nacken, 332, 333
 Nagai, S., and J. Katayama, 299
 Nagelschmidt, 28
 National Research Council, 343, 399
 Navias, L., 153, 209, 225, 338
 Nelson, J. B., and D. P. Riley, 497
 Nernst, 234, 263
 Nesbit, C. E., and M. L. Bell, 473
 Neumann, B., C. Kroger, and H. Haebler,
 341
 Neumann, F., 218
New York Herald Tribune, 653
 Nicholas, I. A., 301
 Nicholls, P., 521
 Nix, F. C., and D. MacNair, 497
 Nolan, V. N., 595
 Nold, H. E., 92
 Noll, W., 71
 Northrup, E. F., 289, 555, 559, 596
 Norton, C. L., 152

- Norton, C. L., Jr., 222, 253, 258, 504, 522
 and V. J. Duplin, 419
 and B. Hopper, 478
 Norton Company, 224, 344
 Norton, F. H., 14, 68, 71, 104, 151, 173,
 174, 215, 258, 300, 332, 337, 342, 418,
 419, 450, 472, 488, 495, 508, 520, 736
 and V. J. Duplin, Jr., 288
 and F. B. Hogdon, 214
 and A. L. Johnson, 173
 and W. G. Lawrence, 151
 and S. Speil, 70, 541, 558
 Norton, J. L., 18
 Nutting, P. G., 150, 214, 215
- O
- Oberkauser, F., 341
 O'Brien, W. A., 73
 Ogden, E. P., 257
 O'Harra, B. M., 616
 Okaya, T., 225
 Oldright, G. L., and F. W. Schroeder, 614
 Olenew, K. F., 257
 Oliver, H., 174, 521
 and K. M. Roberts, 216
 Omundson, D. D., 256
 Orth, H. S., 258
 Orton, E., Jr., and J. F. Krehbiel, 397
 Osborn, E. F., 390
 Osborn, H. B., Jr., 289
 Ostroumov, 341
 Otstot, E. D., 92
- P
- Pannell, J. H., 54, 75
 Pardoe, H., 301
 Parmelee, C. W., 399
 and A. Ally, 496
 A. E. Badger, and G. A. Ballam, 211, 221
 and A. E. R. Westman, 451
 and W. H. Pfeiffer, 680, 683
 Parsons, J. R., 154
 Parsons, W. H., and H. Insley, 477
 Partridge, J. H., 10, 682
 and G. F. Adams, 419
 and J. R. Lait, 313, 338
 Patch, N. K. B., 615
 Patrick, W. L., 615
 Patterson, W. E., 473
 Patton, T. C., and C. L. Norton, Jr., 504,
 508, 522
 Pauling, L., 12, 327, 342
 Payne, H. M., 72
 Pearson, T. S., 597
 Peck, A. B., 71
 Pendergast, W. L., 397
 and H. Insley, 476
 Penney, J., 683
 Perevalov, V. I., 10, 11
 Perrott, G. St. J., and S. P. Kinney, 548,
 557
 Perry, J. H., 343
 Perry, J. S. C., and A. T. Prince, 156
 Peterson, W., 150
 Petit, D., 419
 Petrascheck, W., 75
 Petrie, Earl C., and D. W. Kocher, 299
 Pettersson, H., 223
 Pevzner, R. L., 594
 Pfefferkorn, K., 149
 Phelps, S. M., 113, 152, 216, 397, 420, 436,
 450, 473, 495, 536
 and C. G. Denney, 150
 S. M. Swain, and R. F. Ferguson, 451
 Philips, N. D., 343
 Phoenix, A. E., 257
 Pick, H., 682
 Pines, B. Y., 451
 Pinsker, Z. G., L. I. Tartarino, and V.
 A. Novihova, 71
 Pirogov, A. A., and L. A. Tseitlin, 591
 Pirumov, G., 74
 Plankerhorn, W. J., *et al.*, 666
 Plotnikov, W. A., and E. M. Natansson,
 152
 Podsezus, E., 341
 Pohl, H., 217
 Pohl, W., 256
 Pole, *et al.*, 488
 Pole, G. R., and W. Beinlich, Jr., 478
 and N. Gilbert, 221, 313, 315, 337, 497
 and D. G. Moore, 218, 297, 300, 478, 497
 and N. W. Taylor, 222
 Pollard, E., and W. L. Davidson, Jr., 653
 Poole, W. R., 75
 Potvin, R., 307, 337
 Powell, E. B., 629
 Powell, R. W., 521
 and R. H. Schofield, 508, 522

- Prager, W., 151
 Preliminary Report of the Sub-committee
 on the Survey of Conditions in the
 Malleable Industry, 595
 Preller, J., and V. Korber, 478
 Pressler, E. E., 215
 Preston, E. W., 420, 427, 450, 451, 559
 Price, G. W., 17
 Price, R., 595
 Priestley, J. E., and W. J. Rees, 596
 Produits réfractaires et céramiques du nord,
 222
 Pukall, K., 474
 Pukall, W., 172
 Pulfrich, M., 683
 Putnam, J., 18
- R
- Raisch, E., 520
 Rait, J. R., 337, 595
 Rampack, C., 73
 Rankin, G. A., and H. E. Merwin, 372,
 376, 391, 396
 and F. E. Wright, 369, 392, 398
 Rao, T. V. M., 72
 Rart, J. R., 74
 Rayner, H., 73
 Read, T. T., 558
 Rees, W. J., 72, 216, 476, 477, 495, 592
 and J. H. Chesters, 220
 and T. R. Lynam, 220
 Reich, H., 496
 Reid, W. T., 478
 Reinhard, A. E., 299, 594
 Remmey, G. B., 257, 397, 468, 478
 Repky, H., 520
 Reusch, H. J., and H. Von Wartenberg,
 399
 Rhead, T. F. E., and R. E. Jefferson, 495
 Rice, W. E., 258
 and H. C. Harrison, 256
 and R. A. Sherman, 257
 Richards, E., 559
 Richards, G. G., 75
 Richardson, G. B., 496
 Richardson, H. K., 152, 313, 338
 Richardson, H. M., F. H. Clews, L. R.
 Barrett, and A. T. Green, 468, 475
 Richardson, W. D., 256
 Richter, 354, 355
 Riddle, F. H., 218, 340, 536
 and A. B. Peck, 214, 224
 and R. Twells, 218
 Riddle, R. H., 72
 Ridgeway, R. R., 324, 340
 and B. L. Bailey, 224
 Rieke, R., and K. Blicke, 221
 and J. Gieth, 154, 174
 and W. Johne, 69
 and L. Mauve, 557
 and W. Pasch, 478
 and E. Semback, 149
 Ries, H., 11, 20, 24, 30, 69, 75
 and W. S. Bailey, 68
 H. B. Kummel, and G. N. Knapp, 24
 and H. Leighton, 12
 Rigby, G. R., H. Booth, and A. T. Green,
 474, 475, 591
 and A. T. Green, 497
 and G. H. B. Lovell, 337, 497
 H. M. Richardson, and F. Ball, 74, 219
 R. P. White, H. Booth, and A. T. Green,
 594
 Riley, D. P., 497
 Riley, H. L., 223
 Rinne, F., 342
 Roberts, A. L., 70, 418
 and J. W. Cobb, 418, 419
 Robertson, H. S., 593
 Robiette, A. G., 615
 Robinson, J. R., 152
 Robinson, P. B., 558
 Robinson, S., 16, 23
 Robitschek, J., 215
 and B. Helan, 682
 Robson, H. C., 615
 Robson, J. T., 174
 Rochow, W. F., 682, 683
 Roelfinke, F., 666
 Rogers, A. F., 190, 218
 Rogers, G. L., 495
 Rogers, Prof., 17, 20
 Rohde, W., 148, 156
 Roll, F., 592
 Roller, P. S., 103, 151
 and D. Rittenburg, 337
 and A. Gabriel, 338
 Rollfinke, F., 343
 Roos, C. K., 144, 154

- Rose, C. I., 476
- Ross, C. S., 28
and P. F. Kerr, 70
and E. V. Shannon, 70
- Ross, D. W., 68, 476, 494, 536
- Ross, L. P., 478
- Rossmann, W. F., 616
- Rowden, E., 258, 474
and A. T. Green, 474
- Royer, C., 476
- Rueckel, W. C., 153, 683
- Ruff, O., 340, 341
and F. Ebert, 195, 219
and W. Loerpabel, 393, 394
and E. Stephan, 376, 399
and H. Weitnick, 387
and F. Eisner, 341
and A. Riebeth, 152
and Wunsch, 339
- Ruprecht, B. C., R. H. H. Pierce, and F. A. Harvey, 474
- Russell, A., 20
- Russell, R., Jr., 93, 258
and W. C. Mohr, 316, 339
- Russell, R. N., 93, 336
- Rybnikoff, W. A., and P. P. Alimova, 224
- Ryncarson, G. A., and F. G. Wells, 74
- Ryschkewitsch, E., 11, 86, 221, 288, 327, 336, 338, 343, 399
- S
- St. John, H. M., 615
- Salmang, H., 10, 398, 418
and A. Becker, 149
and H. Frank, 521
and F. Gareis, 496
and F. Goeth, 156
and O. Hebestreit, 472
and Heinz Brothers, 288
and Hohler, 355
and J. Kind, 70
and P. Nemitz, 219
and A. Rittgen, 496
and F. Schick, 478
and K. Schnitzler, 219
and B. Wentz, 217, 218
- Sanderson, L., 74
- Sandlund, S., 216
- Sargant, R. J., 520, 597
- Sato, 342
- Sauermann, G., 399
- Saufrignon, R., 75
- Saunders, J. B., 497
- Sawyer, C. B., 342
- Schack, A., 521
- Schaefer, J., and F. Baumhauer, 473
- Schauer, T., 73
- Schleicher, H. S., and S. Kopin, 337
- Schlotterer, G. K., and R. H. Youngman, 155
- Schluter, A., 520
- Schmidt, E., 519
- Schoenlaub, R. A., 301
- Schonert, K., 495
- Schram, E., and F. P. Hall, 152
and E. W. Scripture, Jr., 557
- Schroeder, F. W., 225
- Schuen, W., 355, 398
- Schuhmann, R., Jr., 558
- Schulze, K., 519
- Schumacher, E. E., 399
- Schurecht, H. G., 472, 682
- Schwartzwalder, K., 148, 156
- Schwiersch, H., 214
- Scott, A., 478
- Scripture, E. W., Jr., and E. Schramm, 151
- Searle, A. B., 10-12, 24, 75, 256, 591, 616, 683
- Searson, T., 257
- Seil, G. E., 74, 130, 131, 156, 196, 220, 221, 299, 338, 566, 575, 594
et al., 226, 253, 256, 419, 536
- Senfter, E., 597
- Shaaf, D., 42
- Shaler, A. J., 198, 224
- Sharratt, E., and M. Francis, 36, 70
- Shaw, C., and C. Marsden, 156
- Shaw, J. B., 68
- Shearer, H. K., 24
- Shearer, W. L., 151
- Sheerar, L. F., 417
- Shepard, C. U., 23
- Shepherd, C. B., 158
- Sherman, R. A., 630
and E. Taylor, 477
- Sherwood, T. K., 158, 172, 173
- Shorter, A. J., 213, 226
- Siemens, 314
and Halske, 256, 307

- Sieurin, E., E. Carlsson, and B. Kjeligren, 417
- Silika-und Schamotte-Fabriken Martin & Pagenstecher, 451
- Silverman, A., 332, 342
et al., 343
- Simin, W. N., 174
- Simon, A., and W. Vetter, 150
- Simpson, H. E., 226, 477
- Singer, F., 343, 496, 591, 593
and F. Beken, 154
and H. Thurnauer, 343
- Sjostrom, I., 597
- Skinner, K. G., 257
- Skola, V., 154
- Skorski, R., 338
- Slyh, J. A., 338
- Smirnov, N. N., 217
- Smith, C. A., 73, 213, 226
- Smith, C. T., and A. B. Griggs, 74
- Smith, R. Percival, and A. McKendrick, 92
- Smith, R. W., 68, 72
- Smith, W. O., *et al.*, 156
- Smithells, 336
- Smithsonian Physical Tables, 289
- Smythe, H. E., 653
- Snow, R. B., 594, 595
- Société anonyme des hauts-fourneaux de la Chiers, 219
- Société anonyme des manufactures des glazes et produits chimiques de St. Gobtain, Chauny, et Cirey, 220
- Soler, G., 596
- Solon, M. L., 13
- Sonntag, C. H., 682
- Sortwell, H. H., 215, 535, 536
- Sosman, R. B., 12, 73, 188, 189, 217, 332, 342, 472, 485, 593, 594
- Spargo, J., 24
- Spence, H. S., 75
- Spencer, G. L., Jr., 616
- Springer, J., 544
- Stacey, A. E., Jr., 172
and H. B. Matzen, 174
- Stalhane, J. B., and V. Anderson, 596
- Stansfield, A., D. L. MacLeod, and J. W. McMahon, 559
- Stavrolakis, J. A., 419
- Stayman, T. H., 591
- Stedman, G. E., 74, 93
- Steger, W., 257, 258, 338, 450, 495-497
- Steigel, B., 17
- Steinhoff, E., 217
- Stettiner, C., 155
- Stevens, D. K., and R. E. Birch, 216
- Stevens, D. W., 617
- Stockbarger, D. C., 332, 342
- Stoecker, J., and A. Rein, 591
- Stone, R. H., 75
- Stone, R. L., 74, 154, 221
- Stott, V. M., 152
- Stout, W., 20, 24, 69
- Stover, E. C., 156
- Straight, H. R., 92
- Strelets, V. M., and V. V. Radin, 156
- Stromberg, B. W., 473
- Strong, J., 273, 289
- Stuckey, J. L., 68
- Stull, R. T., and P. V. Johnson, 103, 151
- Stumbke, H., 258
- Sturner, C., 68
- Sullivan, H. M., 275, 289
- Sullivan, J. D., 224, 592, 597
- Swain, S. M., and S. M. Phelps, 155
- Swallow, H. T. S., 408, 418, 419
- Swanger, W. H., and F. R. Caldwell, 312, 313, 338, 536
- Swentzel, J. P., 343
- Swinden, T., and J. H. Chesters, 592
- Sykes, C., 289
- Sykes, W. P., 340
- Sylvany, R., 257

T

- Tabakov, Z. Ya., V. V. Belovodskii, and G. Tazitdinov, 592
- Tadokoro, Y., 210, 225, 418, 519, 520
- Talwalkar, T. W., and C. W. Parmelee, 149
- Tammann, G., 197, 222
and W. Oelsen, 222
- Tanaka, Y., 223
- Tasitdinov, G., and A. Schavorostov, 592
- Taubin, G. B., and B. E. Pindrik, 72
- Taylor, N. W., 197, 222
and F. J. Williams, 222
- Taylor, W. A., 151

- Taylor, W. H., 72
 Tereshhtchenko, O. V., and S. I. Perkal, 630
 Terzaghi, C., 149
 Testut, R., 340
 Theiss, L. E., 339
 Theobald, L. S., and A. T. Green, 216
 Thilenius, R., and H. Holzmann, 496
 Thoenen, J. R., 73, 92
 and E. F. Burchard, 72
 Thomas, J. R., 21, 22
 Thomas, R., 21
 Thompson, C. L., and E. P. Rexford, 477, 682
 Thompson, F. S., and H. L. Vormelker, 536
 Thompson, J. A., and M. W. Mallet, 314, 338
 Thompson, M. deK., 344
 Thornberry, M. H., 68
 Thorne, P. C. L., and E. R. Roberts, 343
 Thornley, P. C., and W. H. Taylor, 72
 Thorpe, G., 599
 Thuret, A., 226
 Thurnauer, H., 496
 Titanium Alloy Manufacturing Company, 220, 400
 Titorchook, W. H., 282
 Tomkeieff, S. I., 72, 75
 Towers, H. R., 410, 419
 Travers and DeGoloubinoff, 217
 Traxler, R. N., H. E. Schwyer, and L. R. Moffatt, 152
 Tredennick, W. T., J. F. Kelley, and R. C. Burt, 497
 Treischel, C. C., and E. W. Emrich, 154
 Tribault, N. W., and H. L. Nyquist, 343
 Trinks, W., 10, 258, 500, 519, 536
 Troop, R. S., and F. Wheeler, 174
 Trostel, L. J., 215, 221, 597
 Tschaischwili, L., W. Bussem, and W. Weyl, 215
 Tschirky, L., 683
 Tupper, O. M., 92
 Turner, D., 339
 and W. E. S. Turner, 475
 Turner, W. E. S., 466, 476
 and J. T. Howarth, 222
 and W. Maskill, 222
- U
- Uhrmann, C. J., and S. M. Slater, 477
 Uneno, Z., 216
 U. S. Federal Specifications, 299
 United States Metals Refining Company, 155
- V
- Vachuska, E. J., and G. A. Bole, 72
 Van Arkel, 341
 and Bruijnes, 341
 Van Horn, H. T., 154
 Van Nieuvenburg, C. J., and H. J. Zijlstra, 217
 Van Nieuwenburg, C. J., and Wa. Schoutens, 558
 Van Praagh, G., 342
 Van Schoick, E. H., 122, 153, 536
 Varian, J. P., 616
 Vaughan, J. T., and J. W. Williamson, 267, 285, 289
 Veitscher Magnesitwerke, A.--G., 219
 Vernadsky, W., 214
 Vicart, 103
 Vickers, A. E. J., 216, 400
 and R. A. Bell, 473
 and L. S. Theobald, 354, 400
 Vinther, E. H., and M. L. Lasson, 70
 Von Baranoff, A., 149
 Von Gronow, H. E., and H. E. Schwiete, 214
 Von Wartenberg, H., 377
 and K. Eckhardt, 375, 384, 389
 and W. Gurr, 388, 389, 399
 H. Luide, and R. Jung, 399
 and E. Prophet, 381-384, 399
 and H. J. Reusch, 373-375, 380, 399
 and E. Saran, 378, 379, 385, 399
 Vosburgh, F. J., 591
- W
- Waddams, A. L., 502, 522
 Wadell, H., 541, 558
 Waggaman, W. H., and E. A. Gee, 336
 Wagner, C., 223
 and W. Schottky, 222

- Wagner, I. A., 558
 Wainer, E., 337-339
 Waldo, L., 737
 Walker, J., 224, 683
 Walker, N. U., 20
 Walter, G. W., 256
 Walton, S. F., 468, 474
 War Metallurgy Commission, 336
 Warren, B. E., 70
 Washburn, E. W., 12, 477
 and E. E. Libman, 398
 Washken, E., 198, 224
 Watson, J. R., 20
 Weak, E. H., 596
 Webb, H. W., 152
 Weber, R., 92
 Weigel, O., 211, 225
 Weigel, W. M., 68
 Weightman, H. E., 299
 Weil, R., 216
 Weinland, C. E., 521
 Weis, J. H., 89, 92
 Weiss, H., and P. Roller, 595
 Weissmann, L., 616
 West, F., 258
 Westgren, A., and G. Phragmen, 339
 Westman, A. E. R., 146, 153, 155, 163,
 164, 173, 215, 496
 and H. R. Hugill, 154
 and W. H. Pfeiffer, 156, 557
 Westman, H. E. R., 106, 150
 Wheeler, E. S., and A. H. Kuechler, 215
 White, H. E., 73, 298, 299, 497, 498, 521,
 560
 and R. M. Shremp, 75, 336, 488, 497
 and C. B. Sawyer, 336
 and S. F. Walton, 155
 White, J., 478
 White, W. P., 211, 225
 Whitewell, B. E., 257
 Whitlatch, G. L., 151
 Whittaker, H., 37, 70, 151, 173
 Whittlemore, J. W., and F. W. Bull, 150
 Whittlemore, O. J., Jr., 419, 508, 522
 Wickersham, F. A., 558
 Widermann, R. V., 418
 Wietzel, R., 210, 211, 225
 Wilde, W. T., and W. J. Rees, 397
 Wilkes, G. B., 209, 210, 226, 459, 501, 508,
 521
 Willetts, P. G., 215, 224
 Williamson, W. O., 151
 Wilson, D. L., 154
 Wilson, E. O., 107, 150
 Wilson, G. V., 463, 476, 477
 Wilson, H., 11, 38, 69, 398, 417
 and K. G. Skinner, 174
 Wilson, L. M., 475
 Wilson, S. T., A. D. Holderoft, and J. W.
 Mellor, 225
 Winchell, A. N., 12, 73
 Winchell, N. H., and A. N. Winchell, 12
 Windecker, R. E., 93
 Winkelmann, A., and O. Schott, 432, 450
 Winkler, H. G. F., 150
 Wisely, H. R., and H. H. Gobler, 316, 339
 Wishevsky, A., 520
 Witchey, R. H., 595
 Woloschtschuk, N. N., and A. C. Gelfgot,
 340
 Wood, A. R., 222
 Wood, J. F. L., H. S. Houldsworth, and J.
 W. Cobb, 217, 495
 Wood, W. P., and J. M. Cork, 12
 Woodhouse, W., W. Hugill, and A. T.
 Green, 591
 Work, L. T., 558
 Wright, J. W., and D. H. Fuller, 151
 Wulff, J., 224, 340, 342
 Wyld, J. H., 666
 Wysor, D. C., 71
- Y
- Yamaguchi, Y., *et al.*, 214
 Yarham, E. R., 336
- Z
- Zachariasen, 330
 Zapffe, C. A., 226
 Zerfoss, and Davis, 465
 Zhdanov, V., 398
 Zhirnova, N. A., 382
 Zilberfarb, L., 595
 Zvanut, F. J., 69
 and L. J. Wood, 215

SUBJECT INDEX

A

- Abrasion, 555
 in blast furnace, 556
Abrasion resistance, 554
Abstracts, bibliography of, 14
Abundance, relative, of refractory forming elements, 54
Accessory minerals in clay, 36
Adsorbed ions, 29
Adsorbed water, 178
Aftershrinkage (*see* Shrinkage, reheat)
Air-cooled walls for boiler furnaces, 618
Air furnace for malleable iron, 580
Air hammer for ramming shapes, 126, 140
Air locks for tunnel kilns, 250
Air preheaters, 254
Air ramming of shapes, 128
Air separators, 84
Air-water-clay system, 150
Airplane, rocket powered, 659
Akron, 21, 22
Alamogordo, 646
Alkali vapors, effect of, on refractories, 465
Allophane, 31, 32, 39, 40, 60
 analysis of, 39
Allotropic change, 484
 α -alumina, 44
 β -alumina, 56
 γ -alumina, 45
Alumina, forms of, 44
 properties of, 201, 318, 356, 488
 sintered, 304
 for tank blocks, 674
Aluminates, equilibrium diagrams of, 364
 melting point of, 358
Aluminum, formate, 148
 manufacture of, 614
Amanda furnace, 22
Amboy, 18
Anauxite, 32
Anchor bolts, for walls, 694
Andalusite, 43
 firing properties of, 204
 thin section of, 46
Annulus, properties of, 745
Anorthite, 462, 488
Apparatus, differential thermal, 33, 34
 for measuring drying shrinkage, 161
 for measuring particle size, 542
 for measuring viscosity of slips, 101
 for measuring workability of clay, 102
Arch, bonded, 705
 bung, 709
 catenary, 700
 circular, data on, 700
 expansion joints for, 712
 forms for, 729
 jack, 707
 perforated, 712
 relieving, 707
 ribbed, 707
 ring, 706
 spans for, 702
 special, 706
 sprung, 698
 steelwork for, 703
 stresses in, 698
 suspended, 733
 thickness of, 702
Arch brick, table of, 523, 524, 718
Area mean, 548
Argonne, 646
Arsenic, effect of, on refractories, 466
Asbestos, structure of, 631
Asbestos rope, 690
Ashland, 22
Atom, structure of, 631
Atomic nucleus, 631, 632
Auger, 123
 capacity of, 128
 deairing, 124
Autoclave, for growing crystals, 333
Axial compressor, 655

B

- Baddeleyite, 55, 60
 Baffle, boiler, 623
 Ball clay, 40, 42
 chemical analysis of, 42
 particle size of, 37
 Ball mills, 84
 capacity of, 87
 Baltimore, 20
 Barium oxide, 318, 356, 651
 Barn, 637
 Base-exchange capacity, 36
 Bases, exchangeable, 35
 Bauxite, 43
 production of, 59
 Bauxite deposits, Arkansas, 23
 Bauxitic clay, definition of, 27
 Beidellite, 32
 Bellport furnace, 22
 Bennington, 18
 Beryl, 55, 60, 333, 488
 Beryllia, 55, 307, 488, 651, 652
 analysis of, 307
 firing procedures for, 311
 forming procedures for, 309
 health hazard of, 312
 properties of, 201, 307, 312, 318, 356
 Beryllium, 640
 Beryllium carbide, 201, 322, 651, 652
 Beryllium nitride, 201, 326, 327, 651
 Beryllium sulphide, 328
 Bessemer converter, 584
 Bibliographies, list of, 13
 Bikini, 646
 Billet-heating furnace, 589
 Binders, inorganic, 135
 Black liquor, 629
 Black-liquor furnace, 629
 Blast furnace, iron, 563
 lead, 610
 service conditions in, 566
 type of refractories used in, 565
 Bloating, 205
 Blow pipe, 260
 Blunging, 112
 Boiler furnace, cyclone, 626
 development of, 617
 marine, 628
 oil fired, 628
 Boiler furnace, powdered-coal-fired, 624
 spreader-stoker-fired, 627
 walls for, 617
 waste heat, 629
 Boiling point, 306, 318, 322
 Bolivar, 21
 Bonding, of arch, 706
 chemical, 148
 composite walls, method of, 691
 melting point of, 359
 of walls, 687, 690
 Bonds, 331
 Books, list of, 10
 Boron, 356, 648, 649
 Boron carbide, 201, 322, 324, 649
 Boron nitride, 321, 326, 649
 Bosh, 564, 567
 Boston, 17
 Braintree, 16
 Brass, melting of, 603
 Brass-melting furnace, 606
 Brick, chrome, 196, 572
 chrome-magnesite, 196, 574
 forsterite, 196
 fracture of, 426
 handmade, flow diagram of, 113
 high-alumina, 193
 laying, cost of, 736
 magnesite, 193
 molding of, 94
 soft-mud, flow diagram of, 113
 stiff-mud, flow diagram of, 122
 structure, effect of spalling on, 444
 Brickwork construction, 684
 estimation of, for domes, 730
 for sprung arch, 726
 Bright annealing furnace, 590
 Bucite, 31
 Bubble structure, 144
 Buckstay, 704, 705
 Bulkheads, open-hearth furnace, 572
 Bulldozer, 76
 Bung arch, brick shapes for, 526
 Bungs, 529
 Burley clay, 27
 Burner, air-atomizing oil, 230
 gas, 232, 259, 260
 mechanical atomizing, 229
 oil, installation of, 231
 steam-atomizing oil, 230

- Burner, tiles, 528
Burning temperature, effect of, on spalling, 445
By-product coke ovens, 670, 678
- C
- Calcium oxide, 318, 331, 356, 651
Calorimeter, 504
Canon City, 22
Car speed, in tunnel kilns, 251
Carbides, 317
 forming of, 324
 melting point of, 359
 properties of, 322
Carbon, 651, 652
Carbon blocks, in blast furnace, 196
Carbon monoxide, action of, on refractories, 466
Carbon tube resistance furnace, 263
Carburetor, water gas, 679
Cast glass tank blocks, 674
Cast refractories, 207, 621
Casting, drain, 111
 of glass pots, 109
 of grog, 109
 methods of, 112
 slip, properties of, 107
 solid, 111
Casting process, 107
Catenary, 700, 701
Celsius, 488
Centrifuge, long-arm, 542
Ceria, 318, 356, 364, 365, 488
Cerium carbide, 322
Cerium nitride, 326
Cerium sulphide, 330
Cerium sulphide reaction, 634
Chalk River, 646
Chamber, hydrostatic, 138
Chamber kilns, 243
Checker brick, size of, 525
Checker chambers, open-hearth steel furnace, 575
Checkerwork, in tunnel kilns, 232, 249
Chemical bonding, 148
Chemical methods of ore treatment, 89
Chemically bonded refractories, 148
China clay, 39
Chlorine, attack of, on refractories, 468
Chrome bricks, size of, 524
Chrome ore, chemical analysis of, 54
Chrome oxide, 314
Chrome plastics, 294
Chrome refractories, early history of, 22
Chromite, 52, 61, 195, 488
 production of, 59
 thin section of, 53
Chromium oxide, 318, 356, 488
Chrysoberyl, 201
Circle, properties of, 745
Circle brick, 697
 sizes of, 525
 table of, 725
Circular arch, characteristics of, 698
Clay, ball (*see* Ball clay)
 burley, 27
 classification of, 30
 crucibles in, sizes of, 533
 definition of, 27
 diaspore, 27
 fire, 27, 41
 firing of, 175
 flint, 27
 high-alumina, 43
 analysis of, 44
 laboratory production of, 29
 nature of, 28
 origin of, 29
 particle size of, 37
 physical properties of, 37
 plasticity of, 37
 porosity of, 176, 183
 residual, 29
 shrinkage of, 38, 176, 183
 slip, 95
 storage system, 90
 transported, 29
 workability of, 104
Clay impurities, effect of heat on, 180
Clay minerals, 28, 30, 33
Clay refractories, production of, 4
Clay-water system, 95, 100, 106
Coal, 56
Coal-ash slag, 462
Cobalt, 648
Cobalt oxide, 649
Coefficient of thermal expansion (*see* Thermal expansion)
Coke, 56

- Coke-oven refractories, 526, 677
 Coking process, 678
 Colorado, early firebrick manufacturing
 in, 22
 Columbium, 356, 651
 Columbium carbide, 322, 651
 Columbium nitride, 326, 651
 Columbium ore, 57, 318
 Columbium oxide, 357, 651
 Combustion chambers, 660
 Combustion gas, properties of, 234
 Combustion zone, 246
 Components of a system, 362
 Composite walls, 691
 Compression test, 553
 Computation of heat flow, in compound
 wall, 512
 in cylinders, 513
 in simple wall, 510
 Concretes, refractory, 297
 Condenser in zinc manufacture, 607
 Conduction, heat, 500
 Conductivity (*see* Thermal conductivity)
 Cone, fusion point, 351
 properties of, 747
 pyrometric, table of, 738
 test, 350
 Connellsville, 22
 Constant-rate period of drying, 157
 Control, chemical, of raw materials, 89
 Control rods, 649
 Convection, heat, 501
 Conversion factors, heat units, 499
 Converters, copper, 601
 Cooling zone, tunnel kiln, 243
 Copper, alloys of, 603
 anode refining furnace for, 602
 converters, 601
 industry, classification of refractories
 for, 598
 melting of, 603
 reverberatory matting furnace, 600
 Corundum, occurrence of, 45, 61
 single crystals of, 332
 in slags, 463
 thermal expansion of, 488
 thin section of, 48
 Couples, chromel-alumel, table of, 729
 Coupling efficiency, 267
 Cracks developed, in brick, 449
 Cracks developed, in spalling, 424
 in sphere, 422
 Creep tests, long-time, 408
 values of, 663
 Cristobalite, 190, 191
 Critical point, in drying, 157, 162
 in plastic mixes, 99
 Crown, 700
 Crucibles, in blast furnace, 564
 clay, size of, 533
 early history of, 16
 graphite, size of, 534
 Crushers, gyratory, 84
 hammer-mill, 85
 jaw, 82
 ring-roll, 85
 roll, 82
 Crushing, 82
 Crushing strength of refractories, 553
 Crystal, flow of, 401
 single, 332
 Crystal forms of alumina, 45
 Cupola, 567
 Cupola blocks, table of, 525
 Cutter, wire, 125
 Cylinder, properties of, 746
 Cylindrical method of measuring thermal
 conductivity, 505
- D
- Daxad, 542
 Day tanks for glass, 670
 Deairing auger, 124
 Deairing dry press, 131
 Deflocculation, 107
 Deflocculents, 109
 Degrees of freedom, 362
 Delaware, early fire brick manufacturing
 in, 20
 Density, melting-point relation of, 355
 of refractories, 201, 318, 322
 Detrick suspended arch, 733
 Deuterium, 640
 Dialysis cell, 35
 Diamond, 61
 Diaspore, analysis of, 34, 44
 effect of heat on, 182
 Missouri, 43
 occurrence of, 61

- Diaspore, relation of, to other minerals, 32
 structure of, 182
 thermal curve of, 33
 Diaspore clay, definition of, 27
 Diatomaceous earth, 48
 analysis of, 49
 Dickite, 31, 32, 61
 Die, hot-pressing, 200
 steel, 311
 wear of, 144
 Diffusion pump, boiler fluids for, 277
 Diffusivity, thermal, 434
 Dilatency, 94
 Dolomite, 51, 59
 Dome, brick for, 731
 calculations of, 729
 stresses in, 729
 Domestic heating, 680
 Door construction, 694
 Dover, 21
 Downtakes, 575
 Drier, 157
 continuous, 170
 distribution of heat in, 168
 hot floor, 168
 humidity, 170
 temperatures in, 169
 tunnel, 169
 types of, 168
 Dry pan, 84
 Dry press, 130
 deairing, 131
 pressure distribution in, 134
 process for, 128
 Dry strength, 165
 Drying, constant rate period, 157
 efficiency of, 166
 falling rate period, 157
 mechanism of, 157
 moisture gradient in, 160
 Drying rate, maximum, 166
- E**
- East Liverpool, 20
 Elasticity, 94
 Elasticoplastic material, 94
 Elasticoviscous material, 94
 Electric-arc furnaces, 585
 Electrical resistivity, measurement of, 555
 values of, 20, 306, 320, 323, 556
 Electrolytes, as effecting viscosity of slips, 98
 Electron microscope, 177
 Electrostatic separation of minerals, 89
 Electrothermic zinc furnace, 610
 Elements, of high moderating ratio, 652
 melting point of, 356
 Ellipse, properties of, 746
 Elutriation, 547
 Emeralds, 333
 Emission coefficient, 502
 Enamel, high temperature, 661
 Enameling, 681
 End walls of open-hearth furnace, 572
 Equilibrium diagrams, 362
 interpretation of, 363
 list of, 364
 methods of obtaining, 363
 Erosion, of typical glass tank, 471
 Eutectic point, 364
 Eutectics, high melting, 317
 Evaporation chart, 158
 Excavators, 77, 78
 Exchangeable bases, 35
 Expanding minerals and shrinkage control, 203
 Expansion, thermal (*see* Thermal expansion)
 Expansion curves, 482-485
 Expansion joints, 622, 689
 in arches, 712
 in hearths, 685
 in walls, 692
 width of, 692
- F**
- Falling-rate period in drying, 157
 Fayalite, 464
 Filter-pressed, 112
 Fire travel in continuous kilns, 244
 Firebrick (*see* Brick; Insulating firebrick)
 Fireclay, 41
 analysis of, 42
 classification of, 30
 distribution of, 40, 41
 drying shrinkage of, 165
 firing shrinkage of, 186-189

- Fireclay, flint, 27**
 origin of, 29
 particle size of, 37
 plastic, 43
 porosity of, 186-189
 production of, 59
 thermal curve of, 176
- Fireclay bricks, early history of, 17**
 super-duty, 43, 675
- Fireclay muffles (see Muffles)**
- Firestone, 48**
- Firing properties of kyanite minerals, 192**
- Firing shrinkage, control of, 202**
- Fission, energy of, 635**
- Fission power available, 634**
- Fission process, 632**
- Fission products, 635**
- Fissionable material world sources, 642**
- Fizeau interferometer, 479**
- Flexibility, 433, 444**
- Flint clay, definition of, 17**
- Floor openings, in kilns, 237, 241**
- Florida, early firebrick manufacturing in, 20**
- Flotation, 89**
- Flow, of crystals, 401**
 of glass, 401
 of heat through walls, 510, 512
 of mixture of crystals and glass, 402
 of suspensions, 95
 types of, 94
- Flow field of porcelain, 403**
- Flow properties, of plastic body, 100**
- Flow rate, of refractory, 403**
- Flow relation, in kaolin suspension, 95**
- Flue, construction of, 697**
- Flue arrangements for kilns, 240**
- Fluid, definition of, 94**
- Flux blocks, 524, 670**
- Forge furnace, 590**
- Formulas, useful, in calculations, 745**
- Forsterite, 53, 62**
- Forsterite bricks, 196, 603**
- Foundations, 684**
- Fourier's equation of heat flow, 428**
- Frederick, 17**
- Fritting, enamel, 681**
- Frustum, of cone, properties of, 747**
 of pyramid, properties of, 747
- Fuel consumption, for compartment kilns, 244**
 expression of, 237
 for periodic kilns, 242
 for tunnel kilns, 252
- Furnace, Ajax-Wyatt, 606**
 black-liquor, 629
 boiler, 623, 625, 626, 628
 bright annealing, 590
 car bottom stress-relieving, 590
 carbon tube, 253
 continuous zinc distilling, 610
 copper alloy melting, 603
 copper anode refining, 602
 cyclone, 626
 electric arc, 264
 electrothermic zinc, 610
 floors for, 685
 forging, 590
 foundations for, 684
 for fusion point, 351
 globar, 264
 hearths for, 685
 heat-treating, 590
 high-frequency, atmospheric pressure, 268
 induction, 264
 vacuum, 239, 282
 quartz, 284
 (See also High-frequency induction melting furnaces)
- induction melting, 587, 606
- for kilns, 228
- laboratory, 259
 electric heated, 263
- lead dressing, 612
- for load test, 405, 409
- to measure coefficient of expansion, 481
- oxide resistor, 263
- propane-oxygen, 263
- rocking arc, 606
- for shrinkage test, 489, 492
- slag tap, 623
- for slag test, 459
- solar, 264
- for spalling test, 437-439
- stress-relieving, 590
- for thermal conductivity, 503
- walls of, 686

- Furnace, wire bar, 603
 zinc distillation, 607
- Furnace stone, history of, 15
- Fusion point, of bricks, 36
 determination of, 347
 effect of atmosphere on, 354
 effect of composition on, 354
 furnace for, 351
 specimens of, preparation of, 352
 standard method, 348
 value of, 361
 (See also Melting point; Softening point)
- Fusion process, 347
- G
- Gallium oxide, 357, 651
- Ganister, mining of, 81
 occurrence of, 46
 properties of, 46
 ramming mixes, 295
- Gas, bubbles of, 143
 natural, 232
 physical properties of, 274
 premixed, 260
 producer, 232
 in refractories, 466
 velocity of, 236
- Gas burners, 259-260
- Gas turbines, 655
 refractories for, 654
- Gauges, vacuum, 278
- Generators, high frequency, 269, 270
- Gibbsite, analysis of, 44
 effects of, on heating, 182
 occurrence of, 43, 62
 properties of, 43
 structure of, 31, 32
 thermal curve of, 34
- Glass, analysis of, 335, 455
 composition of, 455
 early history of, 16
 flow characteristics of, 401
 high alumina, 335
 metal sealing, 335
 refractory, 335
 soda-lime, 463
 viscosity of, 335
- Glass erosion of refractories, 471
- Glass furnace, 670-672
- Glass pots, 674
 early history of, 16
 sizes of, 534
- Glass refractories, 670
 testing tanks, 460
- Glass tank, 670
 action of glass on, 471
 continuous, 670
- Glass tank blocks, cast, 674
 sizes of, 524
- Glass tank bottom, construction of, 670
- Glaze, for high-temperature porcelains, 535
- Goethite, effect of heat on, 182
- Golden, 22
- Graphite, 56, 59, 62, 356, 508
- Great Falls copper converter, 601
- Grog, effect of, on spalling, 445
 size, control of, 91, 146
 sizing, 145
 use of, 202
- Gyratory crusher, 84
- H
- Hafnium, 356, 649
- Hafnium carbide, 322, 649
- Hafnium nitride, 326, 649
- Hafnium oxide, 357, 649
- Haigerlock, 646
- Halloysite, analysis of, 39
 occurrence of, 39, 62
 structure of, 31, 32
- Hammer mill, 85
- Hand molding, of shapes, 116-119
- Hand ramming, dry-press consistency, 123-127
- Hand repress, 120
- Handling methods, 255
- Hanford, 645
- Hardness, of clay, on heating, 178
 of refractories, 201, 318, 322
 relation of, to melting point, 355
- Harmonic-flow method of heat flow measurement, 506
- Headers, 689
- Hearth, 685
- Hearth blocks, 685

- Heat, absorption of, 209
 balance of, in kilns, 238
 changes in, methods of measuring, 175
 in cylinders, 513
 effect of, on hydrated minerals, 181
 evolution of, in minerals, 176
 quantity of, to fire ware, 209
 specific, 208
 transfer of, 234
 theory of, through porous body, 500
 transmission of, 498
 variable flow of, 500
- Heat conduction, laws of, 498
- Heat flow, computation of, 512
 unsteady, 518
- Heat losses through walls, 514
- Heat-penetration curves, 501
- Heat storage capacities of wall structures, 514
- Heat treating furnaces, 590
- Hematite, 63, 182
- High-alumina block, 667
- High-alumina brick, 23, 606, 608, 677
- High-alumina grog, 494
- High-alumina refractories, history of, 23
- High-alumina shapes, 606
- High-frequency induction melting furnaces, 587
 firing cycle for, 272
 generators for, 268-270
 vacuum firing system for, 272
- High-grog casting slip formula, 109
- High-temperature enamel, 661
- Hiroshima, 646
- Homestead, 23
- Horizontal expansion joints, 689-691
- Hot-blast stove checker brick, 565, 567
- Hot floor, 168
- Hot molding, 149
- Hot-pressed materials, physical properties of, 201
- Hot pressing, 198
- Hot tops, 580
- Hydrated materials, effect of heat on, 181
- Hydraulic pusher, 250
- Hydrocarbon gases, action of, on refractories, 467
- Hydrometer method of measuring particle size, 542
- I
- Illite, effect of heat on, 182
- Ilmenite, 55, 63
- Image shift, in reading telescope, 482
- Incinerators, 680
- Induction heating, principles of, 265
- Insulating firebrick, 734
 anchoring of, 693
 in boiler furnaces, 620
 in domes, 730
 as duct lining, 697
 load-bearing capacity, 142
 molding of, 413
 skewbacks of, 702
 sprung arches of, 702
 in suspended arches, 735
 value of, in tunnel kilns, 668
- Insulation, bonding of, 691
 of copper reverberatory furnace, 600
 of glass tanks, 674
 of hearths, 685
 of jet engines, 665
 of kilns, 668
 of ladles, 678
- Interferometer method for measurement of thermal expansion, 479
- Iridium, 356
- Iron, 651
- Iron and magnesite brick, 464
- Iron oxide, 651
- Iron and silica brick, 464
- Isochromatic bands, 421
- Isoclinic lines, 421
- Isothermals, 421
- Isotopes, 631
- J
- Jet-propulsion refractories, 654
- K
- Kaolin, 38
 analysis of, 39
 definition of, 27
 heat changes in, 178
 occurrence of, 38
 origin of, 29
 particle size of, 37, 38

- Kaolin, production of, 58
 properties of, 38
 residual, 27
 sedimentary, 28
 thin section of, 179
 Kaolin bricks, early history of, 19
 in glass tank construction, 674
 Kaolinite, crystals of, 28
 occurrence of, 63
 structure of, 31
 thermal curves for, 34
 Kentucky, early firebrick manufacturing
 in, 22
 Key brick, table of, 724
 Kiln, areas for, 241
 burners for, 229
 Chinese, 227
 continuous compartment, 243, 244
 fire travel in, rate of, 244
 fuel consumption of, 244
 early history of, 227
 efficiency of, 237
 electric, heating of, 233
 furnaces for, 228
 furniture for, 527, 669
 gas burners for, 232
 general principles of, 228
 globar, 263
 heat balance of, 238
 insulation of, 240
 oil burners for, 229
 oxygen-propane, 262
 periodic, 238
 dimensions of, 241
 down draft, 240
 flue systems for, 240
 fuel consumption of, 242
 heat balance of, 238
 refractories for, 667
 rotary, 253, 677
 setting of, 241
 shaft, 253
 Kiln laboratory, 259
 gas burners for, 260
 large, 261
 Kiln tunnel, 244
 capacity of, 251
 car seal, 249
 construction of, 247
 Kiln tunnel, cost of, 253
 dimensions of, 250
 fuel consumption of, 252
 Kittanning, 21
 Koppers oven, 677
 Kyanite, 44
 clay mixes of, 204
 effect of heating on, 192
 expansion of, 203
 occurrence of, 44
 in porcelains, 535
 production of, 58
 thin section of, 147
- L
- Ladle mixes, 294
 Ladles, 575
 Lanthanum carbide, 322
 Lanthanum nitride, 326
 Lanthanum oxide, 318, 357
 Lead, manufacture of, 610
 Lead blast furnace, 610, 611
 Lead industry, classification of refractories
 for, 613
 Lead-refining furnaces, 612
 Length mean of particles, 548
 Lepidocrocite, 182
 Lightweight concrete, 297
 Lime, burning of, 675
 changes of, on heating, 195
 early history of, 17
 occurrence of, 52
 Lime-kiln brick, 675
 Linear change, permanent, test for, 489
 Linseed oil, 148
 Lithium, 648
 Lithium oxide, 357, 649
 Load-bearing capacity, factors influencing,
 415
 test for, 405
 values of, for firebrick, 412
 for insulating firebrick, 413, 414
 for special refractories, 413
 Load failure, mechanism of, 401
 Load test, standard, schedule for, 408
 time-temperature curve, 412
 Load-test furnace, electrically heated, 409
 torsion, 412

- Load-test results, application of, to design, 416
 long time, 408
 Load tests, European, 407
 Los Alamos, 646
- M
- Magnesia, 148, 313
 properties of, 201, 318, 357, 488, 651
 Magnesia ramming mixtures, 295
 Magnesite, analysis of, 51
 blocks of, in lime kilns, 675
 bottom of, in open-hearth steel furnace, 572
 dense, 313
 firing properties of, 193
 occurrence of, 50, 63
 production of, 58
 Magnesite brick, burning of, 193
 in copper converters, 620
 in lead refining furnaces, 612
 Magnesite ramming mixtures, 549
 Magnesite refractories, early history of, 23
 Magnesium sulphide, 651
 Magnetic separation, 88
 Malleable furnace shapes, 526
 Malleable iron, manufacture of, 580
 reverberatory furnace for, 581
 Malleable iron industry, service of refractories in, 582
 Manganese, 648
 Manganese oxide, 649
 Marine boiler furnaces, 627
 Marion County, 22
 Maryland, early firebrick manufacturing in, 20
 Materials, for reactors at high temperature, 647
 refractory, location of deposits in U. S., 302
 Mechanical strength of clay on heating, 178
 Mellor mean, diameter of particles, 548
 Melted refractories, 207
 Melting point, of aluminates, 358
 of borides, 359
 of carbides, 322, 359
 definition of, 347
 effect of atmosphere on, 353
 Melting point, effect of composition on, 353
 of elements, 356
 of nitrides, 359
 of oxides, 356
 of phosphates, 360
 of pure materials, 360
 relation of, to atomic structure, 355
 of silicates, 357
 of spinels, 360
 standard method of determination, 348
 sulphides, 328
 of titanates, 359
 value of, 361
 of zirconates, 360
 (*See also* Fusion point; Softening point)
- Metals, abrasion-resisting, 144
 electrical conductivity of, 556
 melting point of, 356
 refractory, properties of, 306, 356
 Methyl silicate, as bond, 148
 Mica, 333
 Mica schist, 15, 585
 Microscope, measurement of particle sizes by, 547
 Mineral-dressing methods, 88
 Mineral wool, 690
 Mineralizers, 191
 Minerals, clay, 30, 32
 expanding, 192
 natural, table of, 60
 price of, 56
 production statistics of, 56
 silica, 46
 sillimanite types of, 43
 Mining, of clays, 76
 cost of, 81
 of ganister, 81
 open-pit methods of, 76
 underground methods of, 79
 Mirrors, sapphire, 411
 Missouri, early firebrick manufacturing in, 22
 Moderators, 640, 649, 652
 Moisture distribution, in plastic clay, 160
 Molding, hot, 149
 hydrostatic, 136, 143
 methods of, 94
 Molds, for handmade shapes, 115
 plaster, 110-112

Molds, rubber, 137, 142
 Molybdenum, melting point of, 356
 production of, 57
 Monkton, 19
 Monolithic construction of hearth, 685
 Montmorillonite, effect of heat on, 182
 Morin, 178
 Mortars, air-setting, 291
 application of, 292
 fireclay, 290
 heat-setting, 290
 production of, in U. S., 6
 refractory tests for, 293
 special, 292
 Mt. Savage, 20
 Mt. Union, 22
 Muffles, 531
 sizes of, 531
 Mullite crystals, 488
 in fired clay, 179, 487
 in glass, 463
 in slags, 461, 462, 465
 tank blocks, 674
 thin section of, 179
 Muscovite, 32, 36

N

Nacrite, 32, 64
 Nagasaki, 646
 Naphthalene as pure forming material, 142
 Natural furnace stone, 585
 Natural gas, 232
 Natural minerals, properties of, 60
 Neutron absorption, 636
 Neutrons, 636
 New Brunswick, 17
 New Castle, 16
 New England, early firebrick manufacturing in, 17
 New Jersey, early firebrick manufacturing in, 20
 New Milford, 17, 18
 New Orleans, 20
 New York, 17
 Nickel, 651
 melting of, 614
 Nickel oxide, 65
 Niles, 21
 Nitrides, forming of, 327

Nitrides, melting point of, 359
 use of, 327
 Nomographic chart, Casagrande, 544
 Nonclay refractories, production of, 5
 Nonferrous-metal industry, refractories for, 598
 Nontronite, 32
 Nozzle for jet propulsion, 661, 662
 for teeming steel, 579
 Nuclear cross section, 636, 648, 650
 Nuclear fission process, 631
 Nuclear fuel, 549, 640
 Nuclear properties of materials, 632, 638
 Nuclear reactors, summary of, 646
 Nucleus, properties of, 638

O

Oak Hill district, 21
 Oak Ridge, 646
 Ohio, early firebrick manufacturing in, 20
 Oil for fuel, 229, 230
 Oil burner, air-atomizing, 230
 installation of, 231
 mechanical atomizing, 229
 Olivine, 52, 64
 Opal glass, 462
 Open-hearth furnace bottom, 570, 572
 roof brick, 574
 service conditions in, 576
 use of oxygen in, 575
 Open setting, of ware, 530, 669
 Optical pyrometer, 351
 Ordvician clay, 32
 Organic matter in clay, 36
 Osmium, 350
 Overfiring, 493
 Oxides, melting point of, 356
 properties of, 318
 rarer, 314
 refractory, 304
 Oxygen-propane furnace, 263

P

Packing, of spherical particles, 145
 Packing diagrams, three components, 147
 two components, 146
 Panel spalling test, 436-444
 Panel wall construction, 618

- Paper-mill refractories, 681
- Particle size, distribution of, for beryllia, 309
 for clays, 37, 38
 interpretation of, 548
 method of measurement, 537
 for packing, 145, 146
- Pebble heater, 254
- Peirce-Smith copper converter, 602
- Pennsylvania, early firebrick manufacturing in, 21
- Periclase, 64, 193
- Periodic kilns, 238
- Periodicals, list of, 12
- Permeability, 550
 of firebricks, 553
 measurement of, 551
- Permeability apparatus, 551
- Perth Amboy, 20
- Phase, 362
- Phase diagrams, index to, 364
- Phase rule, 362
- Philadelphia, 21
- Phosphates, 315
- Phosphides, 331
- Phosphoric acid, 148
- Photoelastic method of stress determination, 420
- Physical properties, variation of, with particle size, 38
- Pipe tester for thermal conductivity, 505
- Pipette method of particle size measurements, 541
- Pittsburgh, 17
- Plaster of Paris, 110
- Plastic chrome ore, 629
- Plastic flow, 402
- Plastic masses, 98
- Plasticity, definition of, 94
- Plastics, 294
 application of, 295
 fireclay, 294
 ladle mix, 294
 packing of, 296
 special, 294
 testing of, 297
- Platinum, melting point of, 350
- Platinum crucibles, 670
- Platinum glass tank, 670
- Platinum metal, production of, 57
- Plugs, for steel teeming, 580
- Plutonium, 634, 640
- Polygon, regular, properties of, 745
- Porcelain, composition of, 316
 refractory, 315
 tubing, sizes of, 535
- Pore water, 161
- Pores, method of obtaining, 185
- Porosity, changes in, in heating clay, 183
 of clay on firing, 186-190
 control of, 206
 diagram of, 147
 measurement of, 183
 values of, 186
- Porosity determinations, precision of, 186
- Portland cement, 677
- Portland cement clinker, kilns for, 677
- Ports, 694, 697
- Posts, for kiln furniture, 530
- Pot furnace, 261
- Pouring-pit refractories, 575
- Power piles, design of, 643
- Power plants, aircraft, 655
- Preheaters, 254
- Preheating zone, of tunnel kiln, 247
- Pressures in toggle press, 131
- Prevention of segregation in storage, 90
- Producer gas, 232
- Propeller turbo jet, 655
- Providence, 16
- Pueblo, 22
- Pug mill, 115
- Pulse jet, 658
- Pulverized coal, boiler fired by, 626
- Pulverizer, 84
- Pycnometer, 554
- Pyramid, properties of, 747
- Pyrometric cones, for determination of fusion point, 348
 table of, 738
- Pyrophyllite, 31, 32, 44, 58
- Q
- Quartz, density of, 190
 expansion properties of, 507
 occurrence of, 65
 single crystal of, 322
 structure of, 190
 transformations in, 189

- Quartzites, 46
 chemical analysis of, 47
- R
- Radial blocks, size of, 525
Radial dome brick, table of, 730
Radiant-heat transfer, 501
Radiation coefficient, 502
Radiation pyrometer, 574
Ram jet engine, 658
Rammed linings, 570, 579
Rare earths, 55
Rattler test, 555
Reactions, rate of, 454
Reactors, heterogeneous, 644
 homogeneous, 645
 refractories in contact with, 199, 468
 temperatures of, 198, 266
Reburning, on load-bearing properties, 416
Recirculation, in kilns and furnaces, 238
Rectangle, properties of, 745
Recuperative action, 238
Reflectors, 649
Refractories, abstracts of, 14
 bibliographies of, 13
 books about, 10
 bubble structure in, 144
 cast, 107
 chemical control of, 207
 chrome alumina, 196
 chrome silica, 196
 clay, production of, 4
 dry-press, 128
 future trends in, 19
 for generation of steam power, 617
 history of, 15
 in iron and steel industry, 563
 load bearing capacity of, 401
 mining of, 76
 miscellaneous properties of, 537
 nonclay, production of, 5
 periodicals about, 12
 plastic, 294
 porosity of, 188
 recent developments in, 8
 relation of, to other industries, 3
 strength of (*see* Strength of refractories)
 structure of, 549
 in turbine buckets, 663
- Refractories, weight of, 688
Refractories industry, development of, 8
 growth of, 3
 scope of, 3
 statistics of, 4-7
Refractory bodies, coating of, 298
 firing of, 202
Refractory concretes, 297, 686
 lightweight, 297
Refractory elements, abundance of, 54
Refractory materials, deposits of, 40, 41,
 642, 643
Refractory metals, properties of, 305
Refractory mortars, 290
 application of, 292
 special, 292
 tests for, 293
Refractory nitrides, 325, 326
 properties of, 326
Refractory oxides, 318
Refractory porcelains, 315
 sizes of, 534
Refractory sulfides, 327
Refractory systems, heterogeneous, 334
Regenerative cooling, 661
Regular triangular prisms, properties of,
 746
Reheat shrinkage (*see* Shrinkage, reheat)
Re-press, 120, 125, 128
Resin bond, 148
Retorts, 531
Reverberatory copper-matting furnace,
 598
Reverberatory furnace, for malleable iron,
 581
Rhenium, 356, 649
Rheology, Society of, 94
Rheopepsy, 94
Rhodium, 356, 648, 649
Rhuthenium, 356, 651
Rise of arch, 500
Rocket, fuel combinations, 659
 guide vanes for, 662
 liquid fuel, 658
 solid fuel, 659
 V-2, 658
Rotary kiln, sizes of, 678
Rotary-kiln blocks, table of, 525
Rotary-kiln lining, sizes of, 678
Rowlock courses, 689

- Ruby, 332
Rutile, single crystals, 333
- S
- Saggers, 528
St. Louis, 22
Salem, 16
Sand, 48
Sand blast test, 555
Sand seal, 249
Sandstone, 16, 585
Saponite, 32
Sapphire, 488
Saturation point, 99
Saugus, 15
Scattering process, 636
Scheidhauer and Geissing process, 135
Scioto County, 21
Scraper, 77, 78
Screen, 87
 Tyler series, 538
 U. S. Standard series, 537
Screen analysis, plotting of, 537, 540
Screening, 87
Secondary expansion, theory of, 492
Sector, properties of, 745
Segment, properties of, 745
 of sphere, properties of, 747
Segregation in bins, 90
Selenides, 33
Service conditions, in blast furnace, 568
 in by-product coke oven, 679
 in copper industry, 604
 in cupola, 571
 in glass furnace, 672
 in lead industry, 613
 in malleable-iron industry, 582
 in open hearth, 576
 in zinc industry, 609
Setting in kilns, 241
 methods of, 242
Settling method of separation, 88
Shaft kilns, 253
Shaking apparatus, 539
Shapes, burning of, 240, 246
 molding of, 128, 135, 140
 special, 524
 standard, 523
Sharon conglomerate, 47
Shear, rate of, 96, 101
Shear failure, 427
Shear strain, 430
Shear stresses, 427
Shrinkage, conversion tables for, 163, 164
 drying, 160
 of clays, 165
 measurement of, 162
 mechanism of, 161
 firing, of clays, 186-190
 of kaolin, 177
 of kyanite, 192
 of magnesite, 193
 of silica, 187
 of mortar, 293
 of plastics, 294
 reheat, test for, 489, 490, 492
 test for, 183
 volume of, 183, 185
Shrinkage water, 161
Sieve (*see* Screen)
Silica, density of, 190
 expansion of, 487
 fused, 335
 polymorphous modifications of, 190
 properties of, 187, 319, 357
Silica brick, in coke ovens, 678
 in copper refining furnaces, 602
 in copper smelters, 572
 in glass tanks, 674
 history of, 22
 molding methods, 121
 in open-hearth furnaces, 533
 reaction of, with iron slag, 464
 super-duty, 575
 thin section of, 192
Silica inversions, 191
Silica minerals, 46
Silica models, atomic, 190
Silica refractories, early history of, 15
Silicate of soda, 148
Silicates, high temperature, 134
 melting point of, 357
Silicides, 331
Silicon carbide, 201, 322, 324
 nitride, 326
Sillimanite, 43, 66
 effect of heat on, 193
 simple liquid, definition of, 94
Simulative service tests, 492

- Size analysis, settling methods, 54
Size distribution, plotting of, 540
Sizes, of checker brick, 526
 of clay crucibles, 533
 of cupola blocks, 525
 of fire clay tile, 526
 of flux blocks, 525
 of graphite crucibles, 554
 of kiln furniture slabs, 530
 of malleable furnace shapes, 526
 of muffles, 531
 of porcelain tubing, 535
 of radial blocks, 525
 of standard shapes, 523, 524
Skewback, 702
 construction of, 704
 size of, 702-704
Slabs, size of, 530
Slag, analysis of, 455
 coal-ash, 460
 composition of, 455
Slag action, chemical effect of, 453
 physical effect of, 457
Slag erosion, 468
Slag penetration, 457
Slag reaction, products formed in, 460
Slag resistance of refractories, 400
Slag-tap type of furnace bottom, 623
Slag test, laboratory, 458
Slag wetting of surfaces, 458
Slake, 37
Sleeves, refractory, 579
Slip casting process, 107
Slug, 115
Smelters, reverberatory, 598
Soaking pits, 587
Soap, soft, 111
Soapstone blocks, 629
Society of Rheology, 94
Sodium hydroxide, 98, 108
Sodium sulfide, 629
Soft-mud process, 114
Softening point, 347
 test for, 348
 (See also Fusion point; Melting point)
Soldier courses, 689
Solid, definition of, 94
 deformation of, 402
 elasticoplastic, definition of, 94
Solid reactions, 196
Solubility, 306, 318, 320, 322, 328
Spalling, cracks developed in, 424
 definition of, 420
 test for, 436
 theory of, 427, 431
Spalling characteristics of various bricks, 445
Spalling fractures in service, 449
Spalling tendency, 430, 432
Spalling test, A.S.T.M. panel, 441
 furnace, 439
Special shapes, design of, 426
Specific gravity, determination of, 554
Specific heat, 208
 values of, 210, 306, 320
Specimens, fusion-point, 352
Spheres, fracture of, 425
Spinel, 66, 314
 melting point of, 360
 physical properties of, 201
 single crystals of, 333
Spray slag tests, 458
Sprung arches, 698
Stacks, 698
Standard shapes, 523
Standardized brick unit, 689
Statistical mean diameter, 548
Statistics, of refractories industry, 3-7
Steady flow of heat, 498
Steam as disintegrating agent, 467
Steam power, refractories for, 617
Steel inclusions, 580
Steelwork, for arches, 703
 for domes, 732
Stiff-mud process, 123
Stiff-mud shapes, air ramming of, 126, 140
Stokers for kilns, 228
Stokes' law, 541
Stone, furnace, 16
Stopper, for teeming steel, 579
Storage, of clay, 89
Storage bins, 255
Stourbridge, 17, 20
Stove linings, 18
Stoves for blast furnace, 565
Strength of refractories, 201, 318, 322, 553, 664
Stress relieving furnace, 590
Stress-strain diagrams, 103
Stresses, principal, 421

- Stretched membrane theory, 104
 Stretcher courses, 687, 689
 Stripping overburden, 77
 Strontium oxide, 357, 651
 Strontium sulfide, 651
 Sulfides, refractory, 327-331
 Sulfite process, 148
 Super-duty fireclay brick, 43, 675
 Susceptor materials, 266
 Suspended arch, firebrick, 733
 blocks for, 733
 insulating-firebrick, construction of, 734
 sizes of block for, 526
 Suspended roofs for copper reverberatory furnace, 600
 Suspension, thixotropy of, 97
 viscosity of, 96
 yield point of, 97
- T
- Tabling, 88
 Tale, 31, 32, 58
 Tamping, hot, 296
 Tank, for testing glass refractories, 460
 Tank blocks, 524
 Tantalum, 356, 649
 Tantalum carbide, 201, 322, 649
 Tantalum nitride, 326, 327, 649
 Tantalum ore, production of, 57
 Tantalum oxide, 318, 357, 649
 Tap holes, 580
 Tap-out block, 526
 Taunton, 20
 Temperature, equalization of, in kilns, 236
 Temperature breakdown, of clay impurities, 180
 Temperature-conversion table, 737
 Temperature distribution, 427
 Temperature equalization, 235
 Temperature gradients in spalling, 429
 Temperature schedule for load tests, 406, 408, 412
 Temperature stress tests, 421
 Temperature stresses, in arches, 699
 in solids, 420
 Temperature uniformity in kilns, 236
 Temple, 16
 Tensile strain, 431
 Tension failures, 426
 for abrasion, 555
- Test cones, mold for, 353
 Tetrachlorethane, 554
 Textures, 550
 Thermal analysis, 33
 Thermal conductivity, apparatus for, 503
 conversion factors for, 499
 of crystals, 507
 of glass, 507
 harmonic flow method of, 506
 of insulating materials, 509
 measurement of, 502
 of metals, 306
 Northrup method, 506
 of oxides, 320
 of refractory brick, 508
 of single crystals, 507
 test for, 402
 values of, 506
 Thermal expansion, 479
 of carbides, 323
 effect of, on spalling, 432, 433
 furnace for, 479, 481
 of high-fusing crystals, 488
 for hot pressed materials, 201
 measurement of, 479
 of oxides, 320
 of refractory metals, 306
 of silica minerals, 485, 487
 values of, for bricks, 482-486
 Thermocouple, chromel-alumel, table of, 739
 copper-constantan, table of, 743
 platinum, table of, 741
 Thickness, of arches, 702
 of wall, 686
 Thixotropy, 94
 Thoria, 55, 201, 312, 319
 ore production of, 57
 Thorium, 356, 642, 651
 Thorium carbide, 322, 651
 Thorium nitride, 326, 327, 651
 Thorium oxide, 351, 488, 651
 Thorium sulphide, 331, 651
 Ties, in compound walls, 691
 Tile, sizes of, 526
 Tin, manufacture of, 614
 Tin oxide, 357, 651
 Titanates, melting point of, 359
 Titania, 55, 319
 dense, 314

Titania, effect of heat on, 196
 Titanium, 356
 Titanium carbide, 201, 322
 Titanium nitride, 201, 325, 326
 Titanium oxide, 357, 488
 Tolerances in sizes, 523
 Topaz, 44, 66, 193
 Toronto, 21
 Torsion tests, 411
 Tractor loader, 80
 Triangle, properties of, 745
 Tridymite, density of, 190
 expansion properties of, 487
 structure of, 190
 Truck, lift, 255
 True density, measurement of, 554
 Tungsten, 356
 melting point of, 306
 Tungsten boride, 319
 Tungsten carbide, 201, 322
 Tungsten ore, production of, 59
 Tungsten oxide, 357
 Tunnel driers, 169
 Tunnel kiln, 244
 Turbine buckets, 662
 Turbine insulation, 665
 Turbine nozzle blades, 665
 Turbine rotors, 665
 Turbo jet, 657
 Turbo jet engines, temperature of, 657

U

U. S. Bureau of Standards, electrical resistivity measurements, 555
 University of Chicago, 646
 Unsteady heat flow, 518
 Uranium, 640, 651
 carbide, 322
 compounds of, 648
 nitride, 326, 651
 oxide, 55, 319, 357, 651
 production of, 57
 sulfide, 325, 651
 Uxbridge, 16

V

Vacuum attachment to dry press, 131
 Vacuum duct design, 277

Vacuum gauges, 278
 Vacuum method of measuring porosity, 184
 Vacuum principles, 273
 Vacuum pumps, 275
 Vanadium, 356
 Vanadium carbide, 201, 322
 Vanadium nitride, 326, 327
 Vanadium oxide, 319, 357
 Vapor pressure of elements, 303, 306
 Variance, 362
 Viscosimeter, 101
 Viscosity, 96
 definition of, 94
 of kaolin slips, 99
 of water, 166
 Voids, 144
 Volume flow, of gases, 236
 Volume shrinkage conversion, 162
 Vycor glass, 335

W

Walk, 115
 Wall, 686
 air-cooled, 617
 anchoring methods for, 692
 boiler, 617-623
 bonds for, 687, 691
 expansion joints for, 682
 flat stud tube, 622
 heat loss through, 514
 heat storage in, 514
 insulation of, 694
 number of brick in, 687
 safe heights of, 687
 sectionally supported, 617, 618
 stability of, 619
 thickness of, 686
 tube and brick, 619
 water, 621
 Water-cooled door frames, 696
 Water-film thickness, 165
 Water gas generation, 679
 Water-retention values, 293
 Wedge brick, table of, 710
 Wedge roaster, 599
 Weight of refractories, 688
 Weight loss, on heating clay, 175
 Weight loss curves, of minerals, 175

West Coast, early firebrick manufacturing on, 22

West Virginia, early firebrick manufacturing in, 22

Wet pans, 84

Wetting of surface by slag, 458

Willsboro, 19

Wire-bar furnaces, 603

Wire cutter, 128

Woodbridge, 20

Workability of clays, measurement of, 100, 101

mechanism of, 104

Y

Yield point, in plastic masses, 100, 103
in slips, 97

Yttrium carbide, 322

Yttrium oxide, 319, 357

Z

Zinc, manufacture of, 607
refractory service for, 609

Zinc distilling furnace, 668

Zinc oxide, 319, 357, 651

Zinc retort, 607

Zinc vapor in blast furnace, 566

Zircon, 55, 66, 195, 488

Zirconates, melting point of, 315

Zirconia, 55, 319, 357, 488, 651

dense, 313

effect of heat on, 195

forms of, 195

Zirconium, 356, 651

Zirconium carbide, 201, 322, 651

Zirconium minerals, chemical analysis of, 55

production of, 57

Zirconium nitride, 201, 325, 326, 651

