Birla Central Library

PILANI (Jaipur State)

Class No :- 796

Book No :- B94 B12

Accession No :- 32586

BUCK'S BOOK
of
RULES OF
GAMES AND SPORTS

Revised by

THE STAFF OF
THE Y.M.C.A. COLLEGE OF PHYSICAL EDUCATION,
SAIDAPET, MADRAS.

TWELFTH EDITION

1949-50

Published by N. Ghose from Y.M.C.A. Publishing House,
5, Russell Street, Calcutta.

Printed by S. N. Guha Ray, B.A., at Sree Saraswaty Press Ltd.
32, Upper Circular Road, Calcutta.

NOTE

The book 'Rules of Games and Sports' originally compiled by the late H. C. Buck was first published in 1929. It has gone through eleven editions during the space of twenty years showing its wide popularity. The book is titled 'Buck's Book of Rules of Games and Sports' in memory of its author.

The 1949 edition has certain new features. Rules of Swimming, Diving, Water Polo, and Cycling which are newly added are the latest International Rules for these activities. We hope the inclusion of these Rules will be appreciated by all those who promote and participate in these activities.

The Rules of Track and Field Sports included in this edition are the latest International Rules which were followed at the London Olympic Games. There are a few additions and minor changes in the Rules and these are printed in bolder type.

The Rules of Kho-Kho, Atya-Patya and Hu-tu-tu (Kabbadi or Chedugudu) as adopted by the Akhil Maharashtra Shikshana Mandal are included in this edition by the kind courtesy of the Mandal. The Kabbadi Rules as edited by the Indian Olympic Association are also included.

The Rules of Basketball for women are deleted from this edition because this game is not very popular with our girls.

We hope that the book will continue to serve all those who are interested in the promotion of games and sports in India and that the 1949 edition will be well received throughout the country.

CONTENTS

	PAGE
✓ CRICKET	I
✓ FOOTBALL	24
✓ HOCKEY	45
✓ BASKETBALL	63
✓ VOLLEYBALL	94
✓ SOFTBALL	110
✓ LAWN TENNIS	135
✓ BADMINTON	144
✓ TENI-KOIT	157
✓ HANDBALL	163
✓ WRESTLING	166
✓ BOXING	185
ATYA-PATYA	192
✓ KHO-KHO	203
✓ MUTU	211
✓ KABADDI (CHEDUGUDU)	221
✓ NETBALL	228
✓ THROWBALL	231
✓ SWIMMING (SWIMMING LAWS, DIVING, WATER POLO)	243
✓ CYCLE RACING	269
✓ TRACK AND FIELD SPORTS	295
METRIC AND BRITISH MEASURES	362



The Laws of Cricket

AS REVISED BY THE MARYLEBONE CRICKET CLUB
TOGETHER WITH
AUTHORIZED DECISIONS AND INTERPRETATIONS
THE GAME

1.—A match is played between two sides of eleven players each, unless otherwise agreed to ; each side has two innings, taken alternately, except in the case provided for in Law 53. The choice of innings shall be decided by tossing.

RUNS

2.—The score shall be reckoned by runs. A run is scored :—
1st—So often as the Batsmen, after a hit, or at any time while the ball is in play, shall have crossed, and made good their ground from end to end.

2nd—For penalties under Laws 16, 34, 41 and allowances under 44.

Any run or runs so scored shall be duly recorded by scorers appointed for the purpose.

The side which scores the greatest number of runs wins the match. No match is won unless played out or given up, except in the case provided in Laws 45.

(See also Law 13, Note (c)).

Note:—(a) A "tie" match is one in which the scores are equal when "time" has been reached, but only if the match has been played out or if the side to bat last has commenced that innings.

In one-day matches a "tie" can only apply to the first innings result if the match has not been carried to a further conclusion.

APPOINTMENT OF UMPIRES

3.—Before the commencement of the match two Umpires shall be appointed ; one for each end.

(See Law 43)

Notes.—(a) An Umpire should stand where he can clearly see the act upon which his decision may be required.

An Umpire wishing to stand on the off side of the wicket instead of the leg side should obtain the permission of the Captain of the fielding side.

MEASUREMENTS OF SOME CRICKET GROUNDS

LORD'S	OVAL	BRABOURNE STADIUM	MADRAS CRICKET CLUB
SCREEN	SCREEN	SCREEN	SCREEN
83 yds.	91 yds.	87½ yds.	80 yds.
77 yds....22 yds....75 III III yds.	60 yds....22 yds....80 III III yds.	82½ yds....22 yds....82½ III III yds.	80 yds....22 yds....80 yds. III III yds.
ROPE	ROPE	ROPE	
73 yds.	71 yds.	87½ yds.	80 yds.
PAVILLION RAILS 178 yds. by 152 yds. across	PAVILLION RAILS 187 yds. by 170 yds. across	SCREEN 197 yds. by 165 yds.	SCREEN 182 yds. by 160 yds.

N.B.—80 yds. from each wicket is a fair boundary.

tween them become unfit for play, and then only by consent of both sides.

(See also Law 3, Note (e)).

Notes.—(a) In all first-class cricket, each wicket shall be nine inches wide, the stumps twenty-eight inches out of the ground and the bails four inches and half in length.

(b) In a high wind, the Captains may agree, with the approval of the Umpires, to dispense with the use of bails, in which case Law 20 shall be modified.

THE BOWLING CREASE

7.—The Bowling crease shall be in a line with the stumps ; eight feet eight inches in length ; the stumps in the centre ; with a Return crease at each end, at right angles behind the wicket.

Note.—(a) The Return crease is shortened. It must be deemed unlimited in length.

THE POPPING CREASE

8.—The Popping crease shall be marked four feet from the wicket, parallel to it, and be deemed unlimited in length.

Note.—(a) The distance shall be four feet from the centre of the stumps to the inside edge of the popping crease.

THE GROUND

9.—The Ground shall not be rolled, watered, covered, mown, or beaten during a match, except before the commencement of each innings and of each day's play, when, unless the In-Side object, the ground shall be swept and rolled for not more than seven minutes. This shall not prevent the batsman from beating the ground with his bat, nor the batsman nor bowler from using sawdust in order to obtain a proper foot-hold.

Notes.—(a) The batting side has a right to have the ground swept and rolled for not more than seven minutes immediately before the commencement of each day's play. It is the duty of the Captain to see that his side obtain this advantage. The ground in this Law means the "pitch." The responsibility of supervising the rolling of the pitch before play will in the first place rest with the Umpires, who however, are not obliged to stand near the wicket in order to supervise the rolling, which must be completed so as to allow the play to commence at the stipulated time.

(b) Before and after the actual commencement of play the ground may be protected when necessary, and shall be protected every night during the continuation of a match, but the covering shall be removed each morning, if fine, at 7 o'clock. The covering must not protect more than 3 feet 6 ins. in front of the Popping crease.

**ADDITIONAL LAW FOR AUSTRALIA
NEW ZEALAND AND SOUTH AFRICA**

9*—In the event of rain falling on any day after the commencement of a Match prior to or during the currency of that day's play the groundman shall cause the wicket to be swept and rolled for not more than ten minutes after the close of that day's play, at any time before the commencement of the next day's play, whenever he is of the opinion that such rolling will improve the wicket, and he will use such roller, after consultation with the two Captains, as he thinks best calculated to produce that effect. This sweeping and rolling shall not affect the right to sweep and roll provided for in Law 9 of the Laws of Cricket.

Note.—(a) In all First-class matches, and whenever possible in other cases, the executive of the ground will appoint a responsible officer to supervise any rolling carried out under Law 9.*

The Bowlers

“NO BALL”

10.—The Ball must be bowled ; if thrown or jerked either Umpires shall call “No Ball.”

Note.—(a) It is a “No Ball” if, when about to deliver the ball, the bowler, seeing the striker out of his ground, throws the ball at the striker's wicket.

11.—The Bowler shall deliver the Ball, with one foot on the ground behind the Bowling crease, and within the Return crease, otherwise the Umpire shall call “No Ball.”

Notes.—(a) A bowler may bowl with both feet behind the Bowling crease provided that one foot is within the Return crease. When part of the bowler's back foot is grounded on or outside the Return crease the Umpire shall call “No Ball,” unless the other foot is behind the Bowling crease and within the Return crease. One foot must be grounded behind the Bowling and within the Return crease when the ball is delivered.

(b) If a bowler knock the wicket with his foot in delivering the ball and remove a bail or bails such act does not in itself justify an Umpire in calling “No Ball.”

(c) Many bowlers deliver the ball with the toe of the back foot pointing towards the near wicket, and with the heel towards and over the Return crease. If the bowler so delivers the ball with the heel on the ground, the Umpire shall “No Ball” him, the foot not being entirely within the Return crease. If he delivers with the heel raised off the ground and keeps that part of his foot which is on the ground within the Return crease the delivery is allowed as fair.

(d) If the bowler is running up to deliver the ball allows it to slip from his hand *before* delivery, the Umpire, at his discretion, may allow him to bowl again without penalty or interference.

(e) The Umpire in this Law refers to the Umpire at the bowler's wicket.

“WIDE BALL”

12.—If the Bowler shall bowl the ball so high over or so wide of the wicket, that in the opinion of the Umpire, it is not within reach of the Striker, the Umpire shall call “Wide Ball.”

Notes.—(a) The test for the Umpire to apply in deciding if the ball is wide is whether it is within reach of the striker.

When a ball has been delivered but remains stationary before reaching the striker no runs can be added to the score, unless it has been struck by the striker, the striker has a right to hit the ball without interference by the field. The Umpire must decide if the ball has been “delivered.”

(b) If the striker hit a ball which has been called “Wide” the call shall be ignored.

(c) When only one run has been made from a “Wide Ball” the batsman do not cross over to the positions they were in before the run was made.

(d) When a “Wide” is called the ball does not on that account become “dead” and the batsman may be out under Laws 23, 25, 28, 29, and 30.

“THE OVER”

13.—The Ball shall be bowled in Overs of six balls from each wicket alternately. When six balls have been bowled, and the ball is finally settled in the Bowler's or Wicket-keeper's hands, the Umpire shall call “Over.” Neither a “No Ball” nor “Wide Ball” shall be reckoned as one of the “Over.”

(For Australia and New Zealand only, in lines 1 and 2 for “six” substitute “eight”)

(Revised 1st May, 1889; 2nd May, 1900; 3rd May, 1922; 7th May, 1924.)

Notes.—(a) This Law should be read with Law 16, in which, though provision is made that the striker may obtain runs from a “No Ball,” the fact remains that neither a “No Ball” nor “Wide Ball” shall be reckoned as one of the over.

Although not counted in the over, “No Balls” and “Wides” shall be recorded in their proper place on the score sheet.

(b) A ball shall not count as one of the over nor shall any runs be scored in the following circumstances:—

(i) If both bails have been blown off the striker's wicket before he plays his stroke.

(ii) If the bowler in running up to deliver the ball allows it to slip from his hand before delivery.

At the end of an over the Umpire at the bowler's wicket shall distinctly call "Over" before leaving the wicket.

(c) (i) An over should always be begun if "time" has not been reached and the Umpires shall not call "Time" before the over is finished except as hereafter provided.

An over should always be finished, unless a wicket fall within two minute of "time" (*see* Law 45), or unless there is a local rule extending the time.

(ii) If a wicket fall within two minutes of "time" the Umpires shall call "Time" unless the incoming batsman claims his right to bat for the time remaining. If a wicket fall after "time" has been reached the Umpires shall call "Time."

(d) If a bowler is injured so that he cannot finish the over he has begun, the over shall be regarded as completed.

(e) A bowler can bowl round and over the wicket in the same over but he shall give the batsman an opportunity of taking a fresh guard. The same remarks apply to a change from over to underarm bowling *vice versa*.

The Umpire is justified in calling 'No Ball' in the event of contravention of this instruction.

CHANGING ENDS

14.—The Bowler shall be allowed to change ends as often as he pleases, provided only that he does not bowl two Overs consecutively in one innings.

(Revised 1st May, 1889)

15.—The Bowler may require the Batsman at the wicket from which he is bowling to stand on that side of it which he may direct.

SCORING OF "NO BALLS" AND "WIDES"

16.—The Striker may hit a "No Ball," and whatever runs result shall be added to his score ; but he shall not be out from a "No Ball" unless he be run out or break Laws 26, 27, 29, 30. All runs made from a "No Ball", otherwise than from the bat, shall be scored "No Balls," and if no runs be made, one run shall be added to that score. From a "Wide Ball," as many runs as are run shall be added to the score as "Wide Balls," and if no run be otherwise obtained one run shall be so added.

(See Laws 13 and 28 and Notes thereto)

Notes.—(a) A batsman cannot be stumped off a "No Ball" (Law 16). The Laws of Cricket clearly make a distinction between the wicket-keeper and the fieldsmen and between cases of "stumping" and "run out" (*see* Laws 23 and 28).

When a "No Ball" has been called it must be left to the Umpire to decide, on the facts before him, whether the case is one of "stumping" (under law 23) or "run out" (under Law 28).

(b) When a run is made by the bat off a "No Ball" only the run to the batsman should be scored and not the "No ball" as well. When a run has been made off a "No Ball" the run should be added to the score of the striker although the ball has been caught. If one run is attempted and the batsman is run out the "No Ball" alone counts. If runs are made off a "No Ball," although the runs are scored and not the "No Ball," the bowler is allowed another delivery.

(c) When "Byes" or "overthrows" are run from a "Wide" they are scored as "Wides."

"BYE" AND "LEG BYE"

17.—If the ball, not having been called "Wide" or "No Ball," pass the Striker without touching his bat, or person, and any runs be obtained, the Umpire shall call "Bye," but if the ball touch any part of the Striker's person (hand excepted) and any run be obtained, the Umpire shall call "Leg Bye," such runs to be scored "Byes" and "Leg Byes" respectively.

Note.—(a) If the striker kicks the ball wilfully, no runs shall be scored.

"PLAY"

18.—At the beginning of the match, and of each innings, the Umpire at the Bowler's wicket shall call "Play", from that time no trial ball shall be allowed to any bowler on the ground between the wickets, and when one of the batsmen is out, the use of the bat shall not be allowed to any person until the next batsman shall come in.

Note.—(a) Trial balls, if both batsmen are at the wickets, are not allowed.

The Batsmen

"OUT OF HIS GROUND"

19.—A batsman shall be held to be "out of his ground" unless his bat in hand, or some part of his person be grounded within the line of the Popping crease.

Note.—(a) It is sufficient if part of the batsman's foot is grounded *within* the line. If the foot is on the line, but no part is within, the batsman would be "out of his ground."

WICKET IS "DOWN"

20.—The wicket shall be held to be "down," when either of the bails is struck off, or if both bails be off when a stump is struck out of the ground.

Notes.—(a) The wicket is "down" under this Law if any part of either bail is "struck off" the top of the wicket.

An Umpire is justified in ruling that part of the bail has been "struck off," if as a result of the wicket being hit any part of either bail has been disturbed from its original position on the top of the stumps.

(b) If one bail is off, it is sufficient to remove the remaining one with the ball in order to stump or run a batsman out.

(c) Although the Law says nothing about the stumps being *pulled out*, it is customary to run a batsman out in this way when the bails are off; but the ball must be in the fieldsman's hand when he uses it for this purpose. (See also Law 28).

(d) If one bail has fallen from the stumps, and a ball, having been either bowled or thrown in, strikes a stump without displacing the remaining bail, the wicket is not "down" unless that stump is struck out of the ground.

(e) If owing to the strength of the wind, the Captains have agreed to dispense with the use of bails (*see* Law 6, Note (c)) the decision as to when a wicket is "down" is one for the Umpires to decide on the facts before them. (In such circumstances the wicket would be held to be "down" even though a stump has not been struck out of the ground.)

"BOWLED"

The Striker is Out—

21.—If the wicket be bowled down, even if the ball first touch the Striker's bat or person ;—"Bowled."

Notes.—(a) An Umpire is justified in giving the striker out "Bowled" when a stump is bowled down, even though the bails by some mischance remain in position.

(b) The striker having played the ball is out "Bowled" if he then kicks the ball on to his wicket.

"CAUGHT"

22.—Or, if the ball, from a stroke of the bat or hand, but not the wrist, be held before it touch the ground, although it be huggd to the body of the catcher—"Caught."

(See Note to Law 32)

Notes.—(a) The ball must not touch the ground before it is held ; but the hand holding the ball may touch the ground in effecting the catch.

(b) When a fieldsman catches a ball and falls and the ball touches the ground, it is a question of fact for the Umpire to decide whether or not the catch was completed before the ball touched the ground.

(c) When a batsman plays a ball on to the ground and in order to prevent it hitting the wicket, after touching the ground he strikes it again and the ball is caught, the batsman is not out. But if he hit the ball a second time before it touches the ground and is caught, he would be out under this Law.

(d) A batsman is out if caught off a ball which before striking the bat had hit his pad.

(e) If no boundaries have been arranged a striker can be caught off a tree, hedge or building.

(f) The striker is out if the ball is "hugged to the body of the catcher" even though he has not touched it with his hands. Should the ball lodge in the fieldsman's clothing, or in the top of the wicket-keeper's pads, this will amount to its being "hugged to the body of the catcher".

(g) The striker is out "Caught," although before the catch is held the ball after touching a fieldsman has removed a bail at the non-striker's end, the non-striker being out of his ground.

"STUMPED"

23.—Or, if in playing at the ball, provided it be not touched by the bat or hand, the Striker be out of his ground, and the wicket be put down by the wicket-keeper with the ball, or with hand or arm with ball in hand ;—"Stumped."

Notes.—(a) If the ball rebounds off the pad or person of the wicket-keeper, without having first touched the bat or hand of the striker, and the striker is out of his ground, the decision shall be "Stumped" and not "Run Out."

(b) It is sufficient for the wicket-keeper to remove one bail in order to stump a batsman.

It is not out if he knocks the bails off with his foot or with an arm or hand not holding the ball.

"L.B.W."

24.—Or, if with any part of his person (except his hand) which is between wicket and wicket he intercept a ball which, in opinion of the Umpire at the Bowler's wicket, shall have been pitched in a straight line from the Bowler's wicket to the Striker's wicket or shall have been pitched on the off side of the Striker's wicket and would have hit it:—"Leg before wicket."

(Revised 5th May, 1937)

Notes.—(a) There are four considerations which an Umpire must bear in mind ;

- (i) Would the ball have hit the wicket?
- (ii) Did it pitch on the offside of the striker's wicket or in a straight line between wicket and wicket?
- (iii) Was it part of the batsman's person other than the hand, which first intercepted the ball?
- (iv) Was the part of the batsman's person between wicket and wicket at the moment of impact?

If all these questions are answered in the affirmative the batsman is out.

(b) A batsman may be out L.B.W., although the bowler is bowling round the wicket, if the case comes within this Law.

(c) It is immaterial whether the ball breaks or not. It is sometimes only possible for a bowler round the wicket to obtain an L.B.W. with a breaking ball.

(d) The striker shall *not* be given out L.B.W. if the ball has touched his bat or hand before hitting his person. (See Law 27.)

(e) The Umpire is justified in giving the batsman out L.B.W. if in playing at the ball the striker's hat blew off and deflected the course of the ball which otherwise would have hit his wicket, all the requirements of Law 24 having been fulfilled.

(f) The word "person" in the Law includes the striker's dress.

"HIT WICKET"

25.—Or, if in playing at the ball he hit down his wicket with his bat or any part of his person or dress:—"Hit Wicket."

Notes.—(a) If, in making a second stroke to keep the ball out of his wicket, the striker hit down his wicket as above, he is out.

(b) If, while playing at the ball, but not otherwise, the striker's hat or cap falls on the wicket and dislodges a bail, he is out.

(c) If while playing at the ball, a part of the striker's bat breaks his wicket, he is out.

(d) A batsman is not out for breaking the wicket either with his bat or person when in the act of running.

"OBSTRUCTING THE FIELD"

26.—Or, if under pretence of running, or otherwise, either of the batsmen wilfully prevent a ball from being caught:—"Obstructing the field."

Notes.—(a) It should be noted that it is the striker who is out if this Law is infringed.

(b) The correct entry in the score book when the striker is given out under this Law is "Obstructing the field," and the bowler does not get credit for the wicket.

"HIT THE BALL TWICE"

27.—Or, if the ball be struck or be stopped by any part of his person, and he wilfully strike it again, except it be done for the purpose of guarding his wicket, which he may do with his bat or any part of his person, except his hands:—"Hit the ball twice."

Notes.—(a) It is for the Umpire to decide whether the ball has been struck "wilfully" for some purpose other than of guarding the wicket. The fact that a run is attempted may be evidenced of the batsman's intention to take advantage of the second stroke, and the Umpire is entitled to regard it as such, but is not conclusive.

(b) The spirit of this Law is infringed by the striker if playing the ball, he knocks it back to the bowler, although his wicket is in no danger.

(c) If the ball has been lawfully struck twice and an over throw is made, the striker is entitled to the runs which follow.

(d) A striker may be out for hitting the ball twice, although no run is attempted. (See also Law 22, Note (c).)

“RUNS OUT”**EITHER BATSMAN IS OUT**

28.—If in running, or at any other time, when the ball is in play he be out of his ground, and his wicket be struck down by the ball after touching any fieldsman, or by the hand or arm, with ball in hand, of any fieldsman ;—“Run out”. But the Striker may not be out thus, unless the ball has touched the bat or hand, when, in playing at a “No Ball” he be out of his ground and the wicket be put down by the wicket-keeper with the ball or with hand or arm with ball in hand.

(See Law 31, and Notes to Laws 20 and 35)

Notes.—(a) For a definition of “out of his ground” see Law 19 and note.

(b) At any time when the ball is in play either batsman can be “run out” by any fieldsman, including the bowler.

(c) It is not out if the striker hit the ball into the opposite wickets—the other batsman being out of his ground—unless the ball had been touched by a fieldsman after being hit and before striking the wickets.

(d) It is sufficient for a fieldsman, either by throwing, or with the ball in the hand used for the purpose, to remove one bail in order to “run out” a batsman.

“HANDLED THE BALL”

29.—Or, if he touch with his hands or take up the ball while in play unless at the request of the opposite side ;—“Handled the ball.”

Note.—(a) The correct entry in the score book when a batsman is given out under this Law as “Handled the ball” and the bowler does not get credit or the wicket.

“OBSTRUCTING THE FIELD”

30.—Or, if he wilfully obstruct any fieldsman ;—“Obstructing the field.”

(See Law 26, Note (b))

Note.—(a) The Umpire must decide on the facts before him if the obstruction was “wilful”.

“BATSMEN CROSSING”

31.—If the batsmen have crossed each other, he that runs for the wicket which is put down is out ; if they have not crossed, he that has left the wicket which is put down is out.

“RUNS”

32.—The Striker being caught no run shall be scored. A Batsman being run out, that run which was being attempted shall not be scored.

(See Notes to Law 22)

Note.—(a) Although that run which is being attempted shall not be scored, the remaining batsman does not resume his position at the wicket he has left, if he and his partner have crossed.

“DEAD BALL”

33-A.—A Batsman being out from any cause, the ball shall be “Dead.”

33-B.—If the Ball, whether struck with the bat or not, lodges in a Batsman’s clothing, the ball shall become “Dead.”

“LOST BALL”

34.—If a ball in play cannot be found or recovered, any fieldsman may call “Lost Ball,” when the ball shall be “Dead” six runs shall be added to the score; but if more than six runs have been run before “Lost Ball” has been called, as many runs as have been run shall be scored.

Note.—(a) A lost ball should be replaced by one in a similar condition.

“DEAD BALL ETC.”

35.—After the ball shall have been finally settled in the Wicket Keeper’s or Bowler’s hand, it shall be “Dead”; but when the Bowler is about to deliver the ball, if the Batsman at his wicket be out of his ground before actual delivery the said Bowler may run him out; but if the Bowler throw at that wicket and any run result, it shall be scored “No ball.”

Notes.—(a) Whether the ball is “finally settled” is a question of fact for the Umpire only to decide (See Law 13 Note (a)).

(b) A bowler may run a batsman out, without having delivered the ball, in any way authorized by the Laws. He may have passed the Bowling crease in his run or may change the ball from one hand to the other, before throwing at the wicket or knocking off the bails. The bails may be knocked off from either side of the wickets.

(c) If the bowler throws the ball at the wicket with object of running out the batsman at his end, such a throw does not constitute a “No ball,” and the ball not having been delivered does not count as one of the over. If, however, runs result from such action on part of the bowler, they are to be credited to “No ball” in the score book in accordance with Law 16.

General Notes on Law 33-A to 35 inclusive

(d) A ball can only become "dead" under Law 33-A, 33-B, 34, 35 including Note (f), 41 and 50, or on the call of a boundary.

(e) A ball does not become "dead," when the bails are off or the wickets struck down or because an unsuccessful appeal has been made to the Umpire.

(f) The ball does not become "dead" on merely hitting the Umpire unless it lodges in his pocket or clothing.

(g) Lodging in batsman's clothing includes practically all ways in which a ball can be said to lodge in or against his clothing.

(h) The ball ceases to be "dead" when the bowler begins his run or bowling action.

BATSMAN RETIRING FROM HIS WICKET

36.—A Batsman shall not retire from his wicket and return to it to complete his innings after another has been in, without the consent of the opposite side.

Note.—(a) When a batsman has retired owing to illness, injury, or some other unavoidable cause, his innings must be counted as "Not out."

SUBSTITUTES

37.—A substitute shall be allowed to field or run between wickets for any player, who may during the match be incapacitated from illness or injury, but for no other reason, except with the consent of the opposite side.

Notes.—(a) It is well to remember that a side which loses a player's services through illness or injury brought about during the match, is entitled to substitute, whereas in other circumstances consent is necessary, which must depend upon the courtesy of the opposing Captain.

(b) A side may bat with its full number, provided no disqualification rule applies, even though substitutes have been allowed to field. To prevent any abuse of this provision, and other disputes, the captains, before tossing, should exchange lists of the players.

The two Captains before tossing shall give each other a list of the eleven selected to play, together with the emergency fieldsman. Afterwards no alteration shall be made in either eleven or emergency player without the consent of the opposing Captain.

(c) There is no law prohibiting a player from howling because he has had a substitute to run for him.

(d) No substitute shall be allowed to bat or bowl.

38.—In all cases where a substitute shall be allowed, the consent of the opposite side shall be obtained to the person to act as substitute, and the place in the field which he shall take.

39.—In case any substitute shall be allowed to run between wickets, the Striker may be run out if either he or his substitute be out of his ground. If the Striker be out of his ground while the ball is in play that wicket which he has left may be put down and the Striker given out, although the other batsman may have made good the ground at that end, and the striker and his substitute at the other end.

Notes.—(a) The distinction between the words "Striker" and "Batsman" should be appreciated. When the injured batsman is not the striker he is subject only to such penalty under Law as is incurred by his runner.

(b) The intention of this Law is that the injured Striker's ground, when he has a substitute to run for him, is at the wicket-keeper's end. He himself can only be run out at that end as provided for in the latter part of the law.

40.—A Batsman is liable to be out for any infringement of the Laws by his substitute.

THE FIELDSMAN

41.—The Fieldsman may stop the ball with any part of his person, but if he wilfully stop it otherwise, the ball shall be "Dead" and five runs added to the run or runs already made ; if no runs have been made five shall be added.

Note.—(a) The five runs are a penalty and the batsman do not change ends.

WICKET-KEEPER

42.—The Wicket-keeper shall stand behind the wicket. If he shall take the ball for the purpose of stumping before it has passed the wicket, or, if he shall incommode the Striker by any noise, or motion, or if any part of his person be over or before the wicket, the Striker shall not be out, excepting under Laws 26, 27, 28, 29 and 30.

(a) A wicket keeper may run a batsman out by going in front of the wicket (Law 28). The Umpire must decide from the facts if the act is legal.

DUTIES OF UMPIRES

43.—The Umpires are the sole judges of fair or unfair play, of the fitness of the ground, the weather, and the light for play ; all disputes shall be determined by them, and if they disagree the actual state of things shall continue.

(See Law 3.)

(a) Fair and Unfair Play

Notes.—(i) Under this Law the Umpires are entitled to intervene without appeal in the case of unfair play, (See Law 3, Note (d)).

(ii) Umpires shall not allow themselves to be unduly influenced by appeals from such of the field who were not in a position to form a judgment on the point appealed upon, or by tricks—such as throwing up the ball, on an appeal for a catch at the wicket, without waiting for the decision. Umpires being the sole judges of fair or unfair play, must remember that such devices are obviously unfair, and are not in accordance with the spirit in which cricket should be played.

(iii) In the event of a player criticising on showing resentment on or off the field to the decision of an Umpire, the Umpire should in the first place request the Captains to take action, and if this proves ineffective, report the incident forthwith to the executives of the teams taking part in the match.

(iv) The special attention of Umpires is called to Law 48, which directs them to call "No ball," unless absolutely satisfied of the fairness of the delivery.

(v) It is illegal for the bowler to lift the seam of the ball in order to obtain a better hold. The ball, in such a case, should be shown to the Umpire who should call for another ball and warn the Captain that the practice is unfair. The use of rosin by bowlers is also unfair.

(vi) The persistent and systematic bowling of fast short-pitched balls at the batsman standing clear of his wicket is "unfair," and if, in the opinion of the Umpire at the bowler's end, unfair bowling of this type takes place he shall adopt the following procedure.

1. As soon as he decides that such bowling is becoming persistent he shall forthwith "caution" the bowler.

2. If this "caution" is ineffective, he shall inform the Captain of the fielding side and the other Umpire of what has occurred.

3. Should the above prove ineffective, the Umpire at the bowler's end shall:—

(i) At the first repetition call "dead ball" and the over shall be regarded as completed.

(ii) Request the Captain of the fielding side to take the bowler off forthwith.

(iii) Report the occurrence to the Captain of the batting side, as soon as an interval of play takes place.

A bowler who has been "taken off," as above shall not bowl again during the same innings.

(b) Ground, Weather and Light*General.*

(i) Only when the Captains (or their representatives) disagree or prefer to leave the decision to the Umpires does the responsibility of deciding as to the fitness of the ground, including the wicket, the weather and the light, for play rest with the Umpires.

(ii) The Umpires are not to be biased by the opinions of either side, still less are they to allow themselves to be influenced by the impatience

of the spectators for a resumption of the game and are not to be induced by the public interest in a particular match to declare the ground fit for play, unless they would consider the ground, weather, or light fit under any circumstances.

Ground.

(iii) At the commencement of a match the Umpires may be appealed to by either side as to the fitness of the ground for play.

Should they not agree, play will not commence until they are agreed.

The ground is unfit for play when water stands on the surface or when it is so wet, muddy, or slippery as to deprive the bowlers of a reasonable foothold, or the fieldsmen of the power of free movement.

Umpires are not justified in deciding the ground unfit for play merely because the grass is wet and the ball would, in consequence, be slippery.

(iv) In the case of interruption from rain, as soon as the rain has ceased, the Captains, or if the decision has been left to them, the Umpires, shall, immediately, without further instruction, inspect the wicket, unaccompanied by any of the players, and decide upon its fitness. Should it prove unfit, they shall continue to inspect at intervals until they decide that it is fit for play, they shall call upon the players to resume the game.

Weather and Light

(v) A batsman at the wickets and the Captain of the fielding side shall consult as to the fitness of weather and light for play, and if they are unable to agree, the question shall be determined by the Umpires. Should play be suspended, and the conditions later improve, the Umpires shall, without waiting for instructions, call upon the players to resume the game.

44.—They shall pitch fair wickets, arrange boundaries where necessary, and the allowances to be made for them, and change ends after each side has had one innings.

Notes.—(a) If a ball hit or pass over or through the boundary or is carried over it by the fieldsmen the Umpire shall call a boundary hit, but a fieldsmen, may lean against the boundary to catch or field a ball, and if a fieldsmen when standing within the playing ground, even though he be touching the boundary, catch a ball outside the boundary the batsman shall be given out.

If a fieldsmen grounds any part of his body on or over the boundary line while he has the ball in hand the Umpire shall signal boundary hit.

(b) When the ball touches the boundary it becomes "dead."

(c) The Umpire is not a boundary.

(d) It is for the Umpire to decide if a hit has reached the boundary.

(e) If a seat or other obstacle other than the sight screens is within the playing area, and such obstacle is struck by the ball, it cannot be regarded as a boundary unless so arranged by the Umpires.

(f) When four runs are allowed for a boundary hit it is the practice for Umpires to allow six runs for all hits that drop over and clear of the

boundary line or fence, even, though the ball has been touched by a fieldsman in an attempt to make a catch.

It is not the custom to allow six runs when a ball hits a sight screen full pitch, if the latter is positioned on or inside the boundary.

(g) When the batsman has actually made more runs for a boundary hit than have been arranged for the boundary, Law will prevail, and the runs completed shall be scored.

(h) The runs which have been arranged for a boundary hit are to be added to the runs already made should a fieldsman wilfully cause the ball to reach the boundary. If, however, the fieldsman involuntarily causes the ball to reach the boundary, only the value of the boundary shall be credited to the striker.

(i) In the case of a boundary overthrow, in addition to the ordinary boundary allowance, all runs completed and provided the batsmen had crossed at the moment the fieldsman threw the ball, the run in course of completion, count as runs.

INTERVALS

45.—They shall allow two minutes for each Striker to come in, and ten minutes between each innings. When they call "play" the side refusing to play shall lose the match.

Notes.—(a) The "in-going" batsman should meet the "out-coming" batsman before he enters the pavilion.

It is the duty of the Captains to see that this Law is strictly observed.

(b) The effect of this Law is that the Umpire shall decide whether the delay of the individual amounts to a refusal of the batting side to play. It provides a specific penalty in such a case but none for the individual.

(c) The interval for luncheon shall be 40 minutes. In the event of the last wicket falling within two minutes of the time arranged for luncheon, the game shall be resumed at the usual hour, no allowance being made for the 10 minutes between the innings.

APPEALS

46.—They shall not order a batsman out unless appealed to by other side.

Notes.—(a) An appeal, "How's that?" covers all ways of being out (within the jurisdiction of the Umpire appealed to), unless a specific way of getting out is stated by the person asking.

(b) The decision "Out" shall be signalled by raising the index finger above the head. Besides signalling, the Umpire shall call distinctly for the information of the players. If the batsman is not out, the Umpire shall call "Not out."

(c) If a batsman thinks he is out and walks away, the Umpire is not required to intervene save on appeal or should he consider a decision has been misconstrued.

On giving a decision the Umpire should make sure that the batsman understands what the decision is.

(d) An Umpire may alter his decision if, in the hurry of the moment or by a slip of the tongue he has given a wrong one provided that such alteration is made promptly.

JURISDICTION OF UMPIRES

47.—The Umpire at the bowler's wicket shall be appealed to before the other Umpire in all cases, except in those of stumping, hit wicket, run out at the Striker's wicket, or arising out of Law 42, but in any case in which an Umpire is unable to give decision, he shall appeal to the other Umpire whose decision shall be final.

Notes.—(a) When either Umpire has given a batsman "Not out" the other Umpire may answer any appeal within his jurisdiction, subject to an observance of Law 50.

(b) An Umpire is only justified in appealing to the other Umpire when he is unable to decide, owing to his having been prevented from seeing the occurrence on which the appeal is based. He is not to appeal to the other Umpire in cases on which he could give a decision, merely because he is unwilling to give that decision. If, after consultation, he is still in any doubt, the principle laid down in Law 43, that "the actual state of things shall continue," shall be followed and in consequence, the decision should be in favour of the batsman.

NO BALL

48.—If either Umpire be not satisfied of the absolute fairness of the delivery of any ball, he shall call "No Ball."

CALLING "NO BALL" AND "WIDE"

48 A.—The Umpire shall take especial care to call "No Ball" instantly upon delivery; "Wide Ball" as soon as it shall have passed the striker.

Notes on 48 and 48 A. If the Umpire has called "No Ball" when the ball has not been delivered he should revoke his decision.

SHORTS RUNS

49.—If either batsman run a short run, the Umpire shall call "One short" and the run shall not be scored.

Notes.—(a) When a batsman takes his guard in front of the Popping crease and run is made from the point, the Umpire does not call "One short."

(b) When a short run is called the batsmen do not cross over to the positions they would have been in if the run had not been attempted.

(c) If two or more runs are attempted, and the Umpire calls "One short," only one run is deducted, although the fact that the batsman failed to complete one run shortens the distance necessary to complete the subsequent run.

APPEALS

50.—After the Umpire has called "Over" the ball is "Dead," but an appeal may be made as to whether either batsman is out, such appeal however shall not be made after the delivery of the next ball, nor after any cessation of play.

Notes.—(a) No act on the part of the fielding side can cause a batsman to be out after the Umpire has called "Over," but an appeal may be made within the allotted time.

(b) An appeal may not be made after "Time" has been called and the bails have been removed by *both* Umpires. "Time" shall be called before the players leave the field for any interval of play, as well as at the close of play. (*See* Law 13. *Note* (e)).

51.—No Umpire shall be allowed to bet.

52.—No Umpire shall be changed during a match, unless with the consent of both sides, except in case of violation of Law 51; then either side may dismiss him.

FOLLOWING INNINGS

53.—The side which bats first and leads by 150 runs (in Australia 200 runs) in a match of three days or more, or by 100 runs in a two days' match, shall have the option of requiring the other side to follow their innings.

DECLARATIONS

54.—The In-side may declare their innings at an end in a match of three days or more, at any time on the second day; in a two days' match the Captain of the batting side has power to declare his innings at a close at any time; but such declaration may not be made on the first day later than 1 hour and 40 minutes before the hour agreed on for drawing stumps; in a one day match at any time.

32586

Notes.—(a) If a side declare its innings during the luncheon interval, it must do so within fifteen minutes after the commencement of such interval otherwise an extra seven minutes will be allowed for rolling.

(b) If a side declare its innings closed in the morning before play commences, it must do so in sufficient time to enable the other side to choose the roller it prefers, otherwise an extra seven minutes will be allowed for rolling.

(c) A declaration of a first innings does not preclude a second innings.

(d) For the purpose of stating the result of a match, an innings declared at an end is regarded as complete and the victory, if accomplished, is in runs and not by wickets.

55.—Where there is no play on the first day of a three day match Laws 53 and 54 shall apply as if the match were a two day match, and if in a three day match there is no play on the first two days, Law 54 and Law 1 "one day matches" shall apply as if the match were a one day match. Where there is no play on the first day of a two day match, Law 54 and Law 1 "one day matches" shall apply as if the match were a one day match.

ONE-DAY MATCHES

1.—The side which bats first and leads by 75 runs shall have the option of requiring the other side to follow their innings.

2.—The Match, unless played out, shall be decided by the First Innings. Prior to the commencement of a match it may be agreed:—that the Over consist 5 or 6 balls.

Notes.—(a) A tie is included in the words "play out."

(See also Law of Cricket No. 2. Note (b)).

(b) If the Captains are unable to agree, the Umpires shall decide if there is sufficient time left to carry the game to a further issue after each side has completed an innings.

(c) For "Declaration" in one day matches, see Law of Cricket No. 54.

NOTES FOR SCORERS AND UMPIRES

1. (a) The scorers must accept the Umpires' signals and instructions, and although it is no part of their duty to dictate to the Umpires, mutual consultation to clear up doubtful points is at all times permissible.

(b) During the progress of the game, if two scorers have been appointed, they should frequently check the total to ensure that the score sheets agree.

(c) The Umpires should wait until a signal has been answered by the scorer before allowing the game to proceed, and in addition to signalling the Umpire should call distinctly for the information of the players.

(d) The following method of entering "No Balls" and "Wides" (Law 16) in the score sheet is recommended:—

- (i) If no run is scored from the bat off a "No Ball," the latter should be entered as an "Extra," and a dot placed in the bowling analysis with circle round it to show that the ball does not count in the over.
- (ii) If runs are scored from the bat off a "No Ball," they should be credited to the striker, and entered in the bowling analysis with a circle round the figure. Such runs count against the bowler in his analysis even though the ball does not count in the over.
- (iii) Whatever runs are scored from "Wide Balls" are entered as "Extras" and inserted in the bowler's analysis with a cross to indicate that the ball does not count in the over.

2. The following code of signalling between the Umpires and the scorers has been approved:—

Boundaries shall be signalled by raising both arms side to side.

A boundary six shall be signalled by raising both arms above the head.

Byes shall be signalled by raising the open hand above the head.

Leg Byes shall be signalled by raising the leg and touching it with the hand.

Wides shall be signalled by extending both arms horizontally.

The decision "out" shall be signalled by raising the index finger above the head.

"One Short" shall be signalled by bending the arm upwards and by touching the top of the nearest shoulder with the tips of the fingers of one hand.

The decision L. B. W. according to the new L. B. W. Rule is given by raising the hand over the head palm facing the Batsman.

3. If the above instructions are properly carried out cases of disagreement as regards the scores and the result of matches should not occur.

It is, however, important that the Captains should satisfy themselves of the correctness of the scores on the conclusion of play, as error cannot subsequently be corrected.

It should be noted that, in general by accepting the result notified by the scorers, the Captain of the losing side has thereby acquiesced in the "playing out or giving up" of the match as stated in Law 2.

Football

Note.—Provided the principles of these Laws be maintained they may be modified in their application to player of school age, as follows: (a) size playing pitch; (b) size and weight of ball; (c) width between the goal-posts and height of the crossbar from the ground; (d) the duration of the periods of play.

LAW I.—THE FIELD OF PLAY

The Field of Play and appurtenances shall be as shown in the following plan:

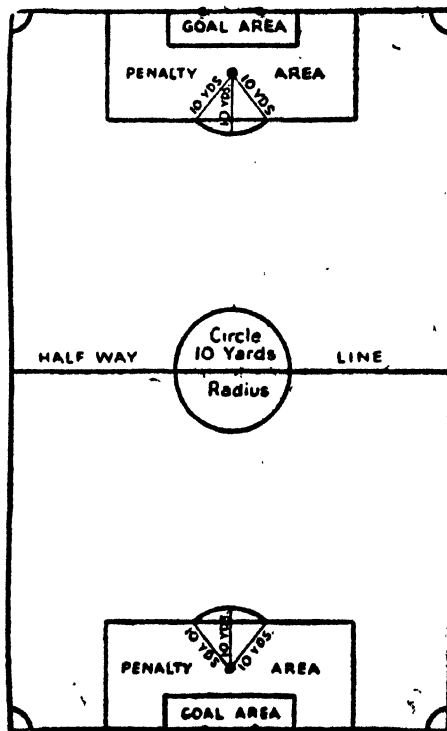

DIMENSIONS

(i) The field of play shall be rectangular, its length being not more than 130 yards nor less than 100 yards and its breadth not

more than 100 yards nor less than 50 yards. (In International Matches the length shall be not more than 120 yards nor less than 110 yards, and the breadth not more than 80 yards nor less than 70 yards.) The length shall in all cases exceed the breadth.

The most general size is 115 yards by 75 yards but the Rules of Competitions in which clubs take part should be studied.

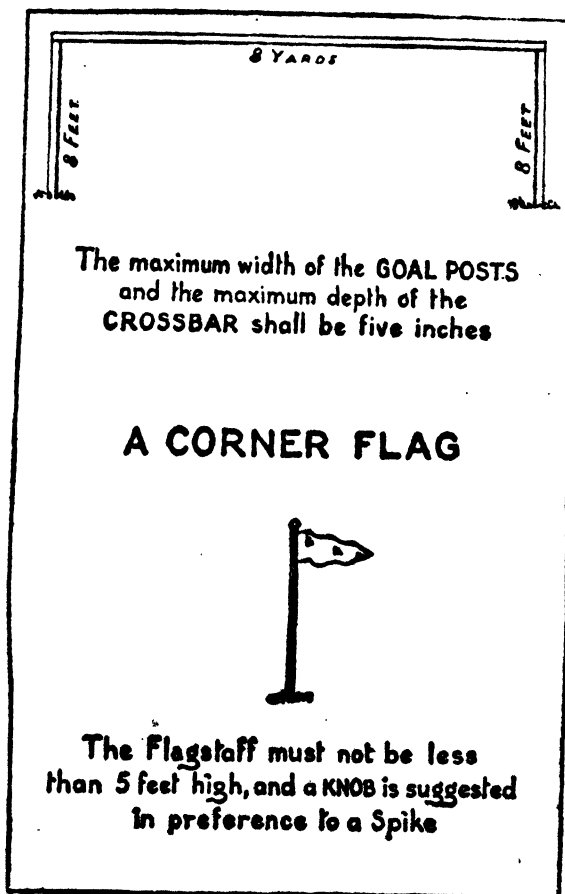

MARKING

(2) The field of play shall be marked with distinctive lines not more than 5 inches in width, not by a V-shaped rut, in accordance with the plan, the longer boundary lines being called the touch-lines and the shorter, the goal-lines. A flag on a post not less than 5 ft. high and having a non-pointed top, shall be placed at each corner; a similar flag-post may be placed opposite the half-way line on each side of the field of play, not less than 1 yard outside the touch line. A half-way line shall be marked out across the field of play. The centre of field of play shall be indicated by a suitable mark and a circle with a 10 yards radius shall be marked around it.

Visit the ground in good time before a match, to see that everything is in order. If through bad weather or negligence the state of the ground is such that it may endanger the players, refuse to sanction play. If the lines are not properly marked see that, if time allows, it is done before the match.

Be insistent that flag-posts are not less than 5 ft. high; shorter ones are dangerous.

Light-coloured flags should be used.

THE GOAL-AREA

(3) At each end of the field of play two lines shall be drawn at right angles to the goal-line, 6 yards from each goal-post. These shall extend into the field of play for a distance of 6 yards and shall be joined by a line drawn parallel with the goal-line. Each of the spaces enclosed by these lines and the goal-lines shall be called a goal-area.

THE PENALTY-AREA

(4) At each end of the field of play two lines shall be drawn at right angles to the goal-line, 18 yards from each goal-post. These shall extend into the field of play for a distance of 18 yards and shall be joined by a line drawn parallel with the goal-line. Each of the spaces enclosed by these lines and the goal-lines shall be called a penalty-area. A suitable mark shall be made within each penalty-area, 12 yards from the mid-point of the goal-line, measured along an undrawn line at right angles thereto. These shall be the penalty-kick marks. From each penalty-kick mark an arc of a circle having a radius of 10 yards, shall be drawn outside the penalty-area.

CORNER-AREA

(5) From each corner-flag post a quarter circle, having a radius of 1 yard, shall be drawn inside the field of play.

THE GOALS

(6) The goals shall be placed on the centre of each goal-line and shall consist of two upright posts, equidistant from the corner-flags and 8 yards apart (inside measurement) joined by a horizontal cross-bar the lower edge of which shall be 8 ft. from the ground. The width and depth of the goal-posts and the width and depth of the cross-bars shall not exceed 5 inches.

Nets may be attached to the posts, cross-bars and ground behind the goals. They should be appropriately supported and be so placed as to allow the goal-keeper ample room.

Never allow tape or any other substance not of a rigid nature to be used instead of a cross-bar.

Goal-post should be painted white.

Examine the goal-nets before every match, seeing that they are properly pegged down and that there are no holes in them.

LAW II. THE BALL

The ball shall be spherical ; the outer casing shall be of leather and no material shall be used in its construction which might prove dangerous to the players. The circumference of the ball shall not be more than 28 ins. nor less than 27 ins. The weight of the ball at the start of the game shall not be more than 16 oz. nor less than 14 oz.

The Home Club should supply the ball. See that it is fully inflated. Have reserve balls close at hand.

LAW III. NUMBER OF PLAYERS

The game shall be played by two teams, each consisting of not more than eleven players, one of whom shall be the goal-keeper. One of the other players may change places with the goalkeeper during the match provided notice be given to the Referee before such change is made. Except in a match played under the Rules of a Competition substitutes may be allowed to replace players receiving injuries during a game, subject to this arrangement being agreed upon by both teams before the start of a match. (An International Match in which one of the four British Associations is playing is deemed a match under the rules of a Competition).

PUNISHMENT

If, without notifying the referee, a player changes to goal-keeper during the game, and then handles the ball within the penalty-area, a penalty-kick shall be awarded.

Any player leaving the field during the progress of the game (except through accident) without the consent of the Referee shall be deemed guilty of ungentlemanly conduct,

Note which players are acting as goal keepers at the start of the game ; until informed of a change, allow no other player to take up or claim the privileges attached to the position.

A player who leaves the field during a match for any reason must not take part in another match until that in which he commenced has ended. (Council, 6th March, 1939).

LAW IV. PLAYERS' EQUIPMENT

A player shall not wear anything which is dangerous to another player. Boots must conform to the following standard ; all bars and studs must be made of leather or soft rubber ; nails shall be driven in flush with the leather or rubber ; bars shall be transverse and flat, not less than half-an-inch in width, and they shall extend for the total width of the boot and be round at the corner ; studs shall be round in plan, neither conical nor pointed, and not less than half-an-inch in diameter ; combined studs and bars may be worn provided the whole conforms to the general requirements of this Law ; bars and studs on the soles or heels shall not project more than half-an-inch and shall have all-fastening driven in flush with the leather or rubber. Metal plates, even though covered with leather or rubber shall not be worn.

(*N.B.*—The usual equipment of a player consists of a jersey or shirt, short trousers, stockings and boots. A goalkeeper should wear colours which distinguish him from the other players.)

PUNISHMENT

For any infringement of this Law, the player at fault shall be sent off the field of play temporarily. He shall not return without first reporting to the Referee, who shall satisfy himself that the player's equipment is in order ; the player shall only re-enter the game at a moment when the ball has ceased to be in play.

If a player wears* anything that the Referee considers liable to cause injury to another player, he must require the player to remove it, failing which the Referee must order the player off the field, and such player shall not play thereafter without the consent of The Football Association or Affiliated County Association concerned (Council, June 23, 1934).

**N.B.*—This refers to articles other than boots which are provided for in the Law, *e.g.*, artificial arm, and rings, belts etc.

LAW V. REFEREES

A Referee shall be appointed to officiate in each game. He shall:

(a) Enforce the Laws and decide any disputed point. His decision on points of fact connected with the play shall be final so far as the result of the game is concerned. His jurisdiction begins from the time he signals for the kick-off, and his power of penalising shall extend to offences committed when play has been temporarily suspended or when the ball is out of play. He shall, however, refrain from penalising in cases where he is satisfied that by doing so he would be giving an advantage to the offending team.

(b) Keep a record of the game ; act as time-keeper and allow the full or agreed time, adding thereto all lost through accident or other cause.

(c) Have discretionary power to stop the game for any infringement of the Laws and to suspend or terminate the game whenever, by reason of the elements, interference by spectators, or other cause, he deems such stoppage necessary. In such a case he shall report the matter to the National or Affiliated Association under whose jurisdiction the game was played, within two days, (Sundays not included). Reports will be deemed to be made when received in the ordinary course of post.

(d) Have discretionary power, from the time he enters the field of play, to caution any player guilty of misconduct or ungentlemanly behaviour and, if he persists, to suspend him from further participation in the game. In such cases the Referee shall send the name of the offender to the National or Affiliated Association concerned, within two days after the occurrence (Sundays not included). Reports will be deemed to be made when received in the ordinary course of post.

(e) Allow no person other than the players and linesmen to enter the field of play without his permission.

(f) Stop the game if, in his opinion, a player has been seriously injured, have the player removed as soon as possible from the field of play, and immediately resume the game. If a player is slightly injured, the game shall not be stopped until the ball has ceased to be in play. A player who is able to go to the touch or goal-line for attention of any kind, shall not be treated on the field of play.

(g) Have discretionary power to suspend from further participation in the game, without previous caution, a player guilty of violent conduct.

(h) Signal for recommencement of the game after all stoppages

To referee well, in such a way that will win the respect of players and spectators—

(a) Learn and understand every Law.

(b) Be absolutely fair and impartial in every decision.

(c) Keep physically fit and in good training.

Occasionally a player may deliberately waste time; he should be cautioned.

If a player is sent off the field before a game actually begins another player may take his place, but the kick-off must not be delayed.

Only suspend or terminate a match on account of the weather after very careful consideration.

When cautioning a player, call him by or require his name and plainly state that if he is again considered to be guilty of ungentlemanly behaviour he will be ordered off the field.

Note the procedure if a player is cautioned; a Referee who fails to report misconduct which came under the notice may be suspended, if it is proved to the satisfaction of the Council that the case of misconduct should have been further investigated.

Compare watches with the Linesmen, both before the game and at half-time.

Do not trust to memory alone in keeping a record of the game; note on paper the time of start, the time at which, if no extra time has to be allowed, half-time and the end of the game will fall due.

Note also the goals as they are scored.

In International Matches the Referees shall be neutral and the Linesmen shall be officials registered as Referees, with a National Association. (International Board, June 14, 1930.) This shall not apply to Amateur International Matches of the four British Associations. (International Board, June 1, 1932).

Referees in International Matches shall wear a Jacket or blazer the colour of which is distinctive from the colours worn by the contesting teams. (International Board, June 11, 1932).

It is misconduct for any Association or Club or any player, official or member of any Association or Club to offer, or attempt to offer, either directly or indirectly, any consideration whatever to another Club, player, or players of any other Club, with a view to influence the result of a match. It is misconduct for any Club player or players, to accept any such consideration.

It is the duty of the Referees to act upon the information of neutral Linesmen with regard to incidents that do not come under the personal notice of Referees. (Council, March, 1920).

While the game is in progress, trainers must not be allowed on the field of play unless called by the Referee; not must trainers or Club officials be allowed to coach players along the boundary lines.

The Laws of the Game are intended to provide that games should be played with as little interference as possible, and in this view it is the duty of Referees not to give penalties for technical or supposed breaches. Constant whistling for trifling and doubtful breaches produces bad feeling and loss of temper on the part of the players and spoils the pleasure of spectators. (Council, December 14, 1930).

LAW VI. LINESMEN

Two Linesmen shall be appointed, whose duty (subject to the decision of the Referee) shall be to indicate when the ball is out of play and which side is entitled to the corner-kick, goal-kick or throw-in. They shall also assist the Referee to control the game in accordance with the Laws. In the event of undue interference or improper conduct by a Linesman, the Referee shall dispense with his services and arrange for a substitute to be appointed. (The matter shall be reported by the Referee to the National or Affiliated Association having jurisdiction over the offending Linesman). The Linesmen should be equipped with flags by the Club on whose ground the match is played.

A Linesman who sees an incident on the field of play likely to bring disrepute on the game which the Referee has failed to notice, should immediately report it to him.

LAW VII. DURATION OF THE GAME

The duration of the game shall be two equal periods of 45 minutes, unless otherwise mutually agreed upon, subject to the following: (a) Allowance shall be made in either period for all time lost through accident or other cause, the amount of which shall be a matter for the discretion of the Referee; (b) Time shall be extended to permit of a penalty-kick being taken at or after the expiration of the normal period in either half.

At half-time the interval shall not exceed five minutes except by consent of the Referee.

A Referee has no power to set aside the Rules of Cup and other competitions where the time to be played is specified.

Normal period means 90 minutes, or if a shorter period is mutually agreed upon, and is permissible under the rules of the Competition, the period should be divided in equal halves.

Wherever it is possible, Linesmen should be neutral Linesmen where neutral must call the attention of the Referee to rough play or ungentlemanly conduct, and generally assist him to carry out the game in a proper manner.

Linesmen where neutral may be asked by the Referee to give an opinion on the ball crossing the goal-line between the posts.

A Linesman is justified by Law 6 in directing the Referee's attention to distinct breaches of the Law which have come under his notice and which he is satisfied the Referee could not see, and Referee should confer with the Linesmen in such a case, especially where the Linesmen are neutral. (Council, December 14, 1903).

Linesmen who observe incidents on the field of play likely to bring the game into disrepute, must, if such incidents have not come under the notice of Referee, immediately report them to him. Should a Referee fail to report misconduct which comes under his notice, and it is proved to the satisfaction of the Council that such misconduct was of a nature that required investigation, he shall be suspended, or otherwise dealt with. (Council, March, 1920).

LAW VIII. THE START OF PLAY

(a) **At the beginning of the game**, choice of ends and the kick-off shall be decided by the toss of coin. The team winning the toss shall have the option of choice of ends or the kick-off.

The Referee, having given a signal, the game shall be started by a player taking a place-kick (*i.e.*, a kick at the ball while it is stationary on the ground in the centre of the field of play) into his opponents' half of the field of play. Every player shall be in his own half of the field and every player of the team opposing that of the kicker shall remain not less than 10 yards from the ball until it is kicked-off; it shall not be deemed in play until it has travelled the distance of its own circumference. The kicker shall not play the ball a second time until it has been played or touched by another player.

(b) **After a goal has been scored**, the game shall be restarted in like manner by a player of the team losing the goal.

(c) **After half-time**: When restarting after half-time, ends shall be changed and the kick-off shall be taken by a player of the opposite team to that of the player who started the game.

(d) **Punishment**. For any infringement of this Law, the kick-off shall be retaken, except in the case of the kicker playing the ball again before it has been touched or played by another player: for this offence an indirect free-kick shall be taken by a player of the opposing team from the place where the infringement occurred. A goal shall not be scored direct from a kick-off.

(e) **After any other temporary suspension**: When restarting the game after a temporary suspension of play from any cause not mentioned elsewhere in these Laws, provided that immediately prior to the suspension the ball has not passed over the touch or

goal-lines, the Referee shall drop the ball at the place where it was when play was suspended and it shall be deemed in play when it has touched the ground: if, however, it goes over the touch or goal-lines after it has been dropped by the Referee, but before it is touched by player, the Referee shall again drop it. A player shall not play the ball until it has touched the ground. If this section of the Law is not complied with the Referee shall again drop the ball.

Note which side kicked off: The kick must be taken by a player competing in the match, except in the case of Charity Matches.

The practice of kicking-off by persons other than the players competing in a match is prohibited except in Charity matches. (Decision of Council, March 25, 1907).

Do not permit any encroachment until the ball is kicked off.

Limit the half-time interval to 5 minutes, unless in very exceptional circumstances.

When extra time is necessary, play shall be restarted according to (a). The interval between the end of the normal period of play and the start of the extra period shall be under the jurisdiction of the Referee.

Players have a right to an interval of five minutes at half-time (Decision of Council, January 15, 1906).

Many players, when the whistle sounds for the start, run inside the opponents' 10 yards' circle or across the half-way line. This is wrong as the game commences with kick off not with the Referee's signal.

In competitions where after a drawn game extra time is necessary, the Captains must toss again for choice of ends, and the extra time must be divided into two equal portions.

LAW IX. BALL IN AND OUT OF PLAY

The ball is out of play:

(a) When it has wholly crossed the goal-line or touch-line, whether on the ground or in the air.

(b) When the game has been stopped by the Referee.

The ball is in play at all other times from the start of the match to the finish, including:

(a) If it rebounds from a goal-post, cross-bar or corner flag post into the field of play.

(b) If it rebounds off either the Referee or Linesmen when they are in the field of play.

(c) In the event of supposed infringement of the Laws, until a decision is given.

To prevent being touched by the ball, or obstructing, Linesmen, should, as far as possible, keep out of the field of play, although close to the touch-line.

If the ball, while in the air, goes over the touch-line, even if it lands in the field of play, it is out of play.

A signal must be given immediately the ball goes out of play for, until this is done, the ball can be considered as in play. Decide and act quickly and if uncertain, consult the Linesman.

If an appeal is to be refused, shake the head or say "play on". Once given do not change the decision.

LAW X. METHOD OF SCORING

Except as otherwise provided by these Laws, a goal is scored when the whole of the ball has passed over the goal-line, between the goal-posts and under the cross-bar, provided it has not been thrown, propelled by hand or arm, or carried by a player of the attacking side. Should the cross-bar become displaced for any reason during the game, and the ball cross the goal-line at a point which, in the opinion of the Referee, is below where the cross-bar should have been, he shall award a goal.

The team scoring the greater number of goals during a game shall be the winner ; if no goals, or an equal number of goals are scored the game shall be termed a "draw."

To give an absolutely safe decision it is necessary to be close to the goal at the time of a shot, with a side view if possible.

If the ball be carried over the goal-line between the knees or ankles of an attacker, it can be a goal.

The player in these circumstances is not guilty of "carrying".

In catching the ball, or fishing out, a goal-keeper may sometimes let the ball, while in the air, pass into the goal ; if *certain* that the whole of the ball has passed the line, give a goal.

The words "not being thrown" cover a throw-in from touch.

The goal-line must be marked from corner to corner including the space between the goal-posts.

See that the cross-bars are securely fixed.

LAW XI. OFF-SIDE

A player is off-side if he is nearer his opponent's goal-line than the ball at the moment the ball is played unless ;

(a) He is in his own half of the field of play.

(b) There are two of his opponents nearer to their own goal-line than he is.

(c) The ball last touched an opponent or was last played by him.

(d) He receives the ball direct from a goal-kick, a corner-kick, a throw-in, or when it is dropped by the Referee.

Punishment. For an infringement of this Law, an indirect free-kick shall be taken by a player of the opposing team, from the place where the infringement occurred.

A player in an off-side position shall not be penalised unless in the opinion of the Referee, he is interfering with the play or with an opponent, or is seeking to gain advantage by being in an off-side position.

Note particularly the last paragraph.

The deciding-factor is where the player was at the moment the ball was played by a member of his own side; Not, as is often thought where he is when he himself plays the ball. It stands to reason that if a player is behind the ball when it is played, he cannot, even if he then runs forward, be off-side.

Remember that the Law applies also to times when a free or penalty-kick is taken.

If a player deliberately trips an opponent who is standing in an off-side position within the penalty area, and who does not attempt to play the ball or obstruct, a penalty kick should be awarded.

LAW XII. FOULS AND MISCONDUCT

A player shall be penalised if he intentionally:

- (a) Kicks, strikes, jumps at an opponent.
- (b) Trips, including throwing or attempting to throw an opponent by use of the legs or by stooping in front or behind him.
- (c) Handles the ball, *i.e.*, carries, strikes or propels it with the hand or arm. (This does not apply to the goal-keeper within his own penalty area).
- (d) Holds or pushes an opponent with his hand, or with his arms extended from his body.
- (e) Charges in a violent or dangerous manner; or charges an opponent from behind unless the latter be deliberately obstructing. (*N.B.*—This is not intended to penalise all charging; it is permissible as long as, in the opinion of the Referee, it is fair and is made when the ball is within playing distance of the players concerned and they are definitely attempting to play it.)
- (f) Also if he charges a goal-keeper, except when he is holding the ball or wilfully obstructing an opponent or when he has passed outside the goal area.
- (g) When playing as goal-keeper, carries the ball, *i.e.*, takes more than four steps while holding the ball, without bouncing it on the ground.

(*h*) Joins his team after the game has commenced or returning to the field of play while the game is in progress, without reporting to the Referee.

(*i*) Plays in a manner considered by the Referee to be dangerous.

(*j*) Is guilty of ungentlemanly conduct.

PUNISHMENT

(1) **Outside the penalty-area.**—For any infringement of (*a*), (*b*), (*c*), (*d*), (*e*), (*g*), a direct free-kick shall be taken by a player of the opposite team from the place where the infringement occurred.

(2) **Inside the penalty-area.**—(A) For infringement of (*a*), (*b*), (*c*), (*d*), (*e*), by the attacking team the punishment shall be a direct free-kick for the defending team from the place where the infringement occurred. For an infringement of (*g*), the punishment shall be an indirect free-kick. (B) For any infringement of (*a*), (*b*), (*c*), (*d*), (*e*), by the defending team, the punishment shall be a penalty-kick. A penalty-kick can be awarded, irrespective of the position of the ball if in play, at the time an offence within the penalty-area is committed. (C) For any infringement of (*f*) the punishment shall be an indirect free-kick.

(3) **Inside or Outside the penalty-area.**—For any infringement of (*f*) or (*i*), an indirect free-kick shall be taken by a player of the opposite team from the place where the infringement occurred, or where play was stopped:

(4) If a player liable to be penalised under (*h*) commits a more important offence he should be penalised according to that portion of the Law he infringes. A player shall be Cautioned if he:

(1) Joins his team after the kick-off or returns to the field of play while the game is in progress without reporting to the Referee.

(2) Persistently infringes any of the Laws of the Game.

(3) Shows by word or action, dissent from any decision given by the Referee.

(4) Commits ungentlemanly conduct.

In addition to the caution, if play has been stopped by reason of such misconduct it shall be resumed (*a*) if under paragraph (1), by the Referee dropping the ball at the place where the infringement occurred and (*b*) if under paragraphs (2) and (3) by an

indirect free-kick taken by a player of the opposite team from the place where the infringement occurred.

A player may be Ordered off if he:

- (1) Persists in misconduct after having received a caution.
- (2) Is guilty of violent conduct, *i.e.*, using foul or abusive language or if, in the opinion of the Referee, he is guilty of serious foul play.

If play be stopped by reason of a player being ordered off for an offence against an opponent without a separate breach of the Law having been committed, the game shall be resumed by an indirect free-kick to be taken by a player of the opposite team from the place where the infringement occurred.

A thorough knowledge of every clause of this Law is absolutely essential, but its correct application depends on the Referee's ability to make up his mind *immediately* whether or not an offence is INTENTIONAL.

Take particular note that in Clause (a) it is jumping at an opponent who is not playing the ball and not jumping for the ball that is a foul. There is no such thing as accidental jumping at an opponent.

In Clause (c) note that unless the hand or arm strikes at or propels the ball it is not a foul; far too often a player is penalised when the ball touches his arm through no intentional action of his own.

If the goal-keeper obstructs an opponent he may be charged even when in his goal-area. See that the goal-keeper is not unfairly charged, as he has so little chance of protecting himself when his attention is engaged with a coming shot.

If a player turns so as to face his own goal when he is tackled, or is obviously aware that he is about to be tackled by an opponent he is intentionally obstructing, and may be charged from behind. (International Board, June 8, 1907).

Where a defending player is ordered off the field for kicking or striking an opponent within the penalty-area, the Referee also has the power to order a penalty-kick. (Council, November 5, 1906).

The penalty-kick can only be awarded for the following nine offences, intentionally committed by a player of the defending side within the penalty area.

1. Tripping an opponent.
2. Kicking an opponent.
3. Striking an opponent.
4. Jumping at an opponent.
5. Handling the ball
6. Holding an opponent.
7. Pushing an opponent.
8. Charging an opponent violently or dangerously.
9. Charging an opponent from behind.

Although a player is entitled to charge the goalkeeper when the latter is in possession of the ball, i.e., holding the ball, it is not permissible for such a player to kick or attempt to kick the ball under such circumstances. The use of the foot amounts to ungentlemanly conduct and should be dealt with accordingly.

Do not allow players to crowd round you to question your decision or get you to change it.

Instruction to players:—This is one of the most important Laws and you are bound to offend against it unless you learn and understand *all* the Laws. Try not to be penalized or even cautioned; it is natural that if a player *has* been cautioned, his subsequent offences are considered as more serious. The following points may help you to keep within the spirit as well as the letter of the Law.

(a) Never retaliate when fouled, for you at once become liable to punishment yourself and if you *are* ordered off you may be suspended.

(b) Realise that there is no such thing as accidental jumping at an opponent.

(c) Refrain from claiming for 'hands'. A Referee will act on his own initiative in such a matter, moreover, if you claim and the Referee considers the offence 'accidental', you will have put yourself and your team at a disadvantage.

(d) Keep your temper and do not appear annoyed if you are charged.

(e) It is no disgrace to be bowled over by a fair charge; you will probably go over straight away if an opponent catches you standing on one foot. It will help you to learn a valuable lesson. Let your own charging, too, be fair and honest. Even if an opponent is intentionally obstructing you, you have no right to charge him in such a manner that you may do him injury.

(f) Accept the Referee's decision without question; it is an offence to show dissent by word or action.

(g) When playing as goalkeeper bear in mind that directly you leave the goal-area, any opponent may charge you. As long as you are within your goal-area, provided you do not hold the ball or obstruct an opponent, you are protected under the laws. The best advice possible to a goalkeeper is to get rid of the ball at once.

(h) Remember that no player may attempt to kick the ball when it is held by the goal-keeper. This may be considered by the Referee to be dangerous play and an indirect free-kick will result.

(i) Except through accident, no player may leave the field of play during the progress of the game without the Referee's permission. If, having had to leave the field of play, or when joining the game after play has begun, report to the Referee and only enter the field when the ball has ceased to be in play.

LAW XIII. FREE-KICK

Free-kicks shall be classified under two heads: "Direct" (from which a goal can be scored direct against the offending side), and "Indirect" (from which a goal cannot be scored unless the ball has been played or touched by a player other than the kicker before passing through the goal).

When a direct or indirect free kick is being taken a player of the opposite side shall not approach within 10 yards of the ball until it is in play, unless he be standing on his own goal-line, between the goal posts. If a player of the opposing team approaches within 10 yards before the kick is taken the Referee shall delay the taking of the kick until the Law is complied with. The ball shall not be deemed in play until it has travelled the distance of its own circumference. The ball must be stationary when the kick is taken, and after taking the kick, the kicker shall not play the ball a second time until it has been touched or played by another player. In a case of a free-kick being awarded to the defending side in the penalty-area, the goal-keeper shall not receive the ball into his hands in order that he may thereafter kick it into play; the ball must be kicked direct into play beyond the penalty-area and if this part of the Law is not complied with, the kick shall be retaken.

PUNISHMENT

If the kicker, after taking the free-kick, plays the ball a second time before it has been touched or played by another player, an indirect free-kick shall be taken by a player of the opposing team from the spot where the infringement occurred.

If in the opinion of the Referee the ball has not rolled completely over, or travelled the distance of its circumference, *i.e.*, about 27 inches, he must order it to be kicked off properly.

Note that the ball must be stationary before the kick is taken.

See that the kick is taken as quickly as possible; this is important not only so that the game shall not be slowed down, but because delay is unfair, particularly in the case of a kick from which a goal may be scored direct as it enables the offending side to re-arrange its defence.

The kick must not be taken until the Referee gives a signal, usually by whistle.

A player has been known to kick the ball directly into his own goal from a direct or indirect free-kick, in which case the Referee should award a corner-kick. If however, a player kicks the ball directly into the opponents' goal from an indirect free-kick, the Referee should award a goal-kick to the opponents.

Players who do not retire to the proper distance when a free-kick is taken must be cautioned, and any repetition be ordered off. It is particularly requested of Referees that attempts to delay the taking of a free-kick by encroaching should be treated as serious misconduct (Council, December, 1910).

LAW XIV. PENALTY-KICK

A penalty-kick shall be taken from the penalty-mark and when it is being taken, all players, with the exception of the player taking the kick; and the opposing goal-keeper, shall be within the field of play, but outside the penalty-area, and at least 10 yards from the penalty-mark. The opposing goal-keeper must stand (without moving his feet) on his own goal-line, between the goal-posts, until the ball is kicked. The player taking the kick must kick the ball forward; he shall not play the ball a second time until it has been touched or played by another player. The ball shall be deemed in play directly it is kicked, *i.e.*, travelled the distance of its circumference, and a goal may be scored direct from such a penalty-kick. If the ball touches the goal-keeper before passing between the posts, when a penalty-kick is being taken at or after the expiration of half-time or full-time, it does not nullify a goal. If necessary, time of play shall be extended at half-time or full time to allow a penalty-kick to be taken.

PUNISHMENT

(a) For any infringement by the defending team the kick shall be retaken, if a goal has not resulted.

(b) For any infringement by the attacking team, other than by the player taking the kick, the kick shall be retaken, if a goal has resulted.

(c) For any infringement by the player taking the penalty-kick, a player of the opposing team shall take an indirect free-kick from the spot where the infringement occurred.

This is an important law; therefore;

(a) Note carefully the last three lines of Law 5 (a).

(b) Study Law 12; it is clear that there are only nine offences for which a penalty-kick can be awarded and, even then, only if the offence was INTENTIONAL.

(c) Before giving the signal for the kick, make sure that the players and the ball are correctly positioned; *i.e.*, as stated in this Law. If a player wilfully encroaches, caution him and if he persists, order him off the field.

(d) Remember that if the original offence was sufficiently serious as to justify the player being ordered off the field, the awarding of a penalty-kick does not cancel this measure.

(e) Bear in mind that if the ball hits the goal-post or bar and rebounds into play, the player who took the penalty-kick must not play it again until it has been touched by another player.

Study this Law carefully; it is an important one. The following points may help you to interpret and apply it correctly:

(a) Players need not be "behind the ball." They may take up their position within the field of play, outside the penalty-area, but they must be at least 10 yards from the ball.

- (b) Always wait for the Referee's signal before taking a penalty-kick.
- (c) The goal-keeper may not move from the position he takes upon his goal-line between the posts, nor may a player rush in from his position outside the penalty-area, until the ball has been kicked. An offence here will mean a caution and, if repeated the player may be ordered off.
- (d) Remember that the kick must be forward.
- (e) If a penalty-kick is awarded and a goal is scored, the Referee will ignore any infringement by the defending team and will let the goal stand.

LAW XV. THROW-IN

When the whole of the ball passes over a touch-line, either on the ground or in the air, it shall be thrown in from the point where it crossed the line, in any direction, by a player of the team opposite to that of the player who last touched it. The thrower at the moment of delivering the ball must face the field of play and part of each foot shall be either on or outside the touch line. The thrower shall use both hands and shall deliver the ball from over his head. The ball shall be in play immediately it is thrown, but the thrower shall not again play the ball until it has been touched or played by another player. A goal shall not be scored direct from a throw-in.

PUNISHMENT

(a) If the ball is improperly thrown in, the throw-in shall be taken by a player of the opposing team.

(b) If the thrower plays the ball a second time before it has been touched or played by another player, an indirect free-kick shall be taken by a player of the opposing team from the place where the infringement occurred.

(a) The Linesman indicates clearly with his flag the point from where and by which team the throw-in is to be taken. He must be careful not to obstruct.

(b) The player taking the throw-in really uses both hands; some players are apt to throw with one hand only, using the other simply as a guide.

(c) The ball is thrown; it may not just be dropped even if from both hands.

(d) A part of both feet of the player taking the throw is on the ground when the throw-in is made.

Sometimes a ball is thrown by a player directly from a throw-in into his opponent's goal in which case the Referee should award a goal-kick. If, however, a player throws the ball directly into his own goal the Referee should award a corner kick.

Touch is that part of the ground on either side of the field of play.

If the ball has been kicked into touch, but before the ball is thrown in a player deliberately kicks an opponent, play should be resumed by a throw-in and the player dealt with by a caution or ordered off the field (Council, June 23, 1934).

LAW XVI. GOAL KICK

When the whole of the ball passes over the goal-line, excluding that portion between the goal-posts, either in the air or on the ground, having last been played by one of the attacking team, it shall be kicked direct into play beyond the penalty-area from a point within that half of the goal-area nearest to where it crossed the line, by a player of the defending team. A goal-keeper shall not receive the ball into his hands from a goal-kick in order that he may thereafter kick it into play. If the ball is not kicked beyond the penalty-area, *i.e.*, direct into play, the kick shall be re-taken. The kicker shall not play the ball a second time until it has touched or been played by another player. A goal shall not be scored direct from such a kick. Players of the team opposing that of the player taking the goal-kick shall not approach within 10 yards of the ball whilst the kick is being taken.

PUNISHMENT

If a player taking a goal-kick plays the ball a second time after it has passed beyond the penalty-area, but before it has touched or been played by another player, an indirect free kick shall be awarded to the opposing team, to be taken from the place where the infringement occurred.

Show *clearly* the side from which the kick is to be taken.

Before giving the signal for the kick, make sure that the player and the ball are correctly positioned, *i.e.*, as stated in this Law.

LAW XVII. CORNER-KICK

When the whole of ball passes over the goal-line, excluding that portion between the goal-posts either in the air or in the ground, having last been played by one of the defending team, a member of the attacking team shall take a kick from within the quarter-circle at the nearest corner flag-post, which must not be removed, *i.e.*, a corner-kick. A goal may be scored direct from such a kick. Players of the team opposing that of the player taking the corner kick shall not approach within 10 yards of the ball until it is in play, *i.e.*, it has travelled the distance of its own circumference nor shall the kicker play the ball a second time until it has been touched or played by another player.

PUNISHMENT

For any infringement of this Law, an indirect free-kick shall be awarded to the opposing team, to be taken from the place where the infringement occurred.

See notes applying to Law 16.

Occasionally the ball strikes a goal-post and rebounds to the player who took the kick. The stated Law holds—he must not play it again until it has been touched by another player.

**MEMORANDUM ON
CO-OPERATION BETWEEN REFEREES
AND LINESMEN—LAW 6**

In the Laws of the Game set out in the foregoing pages there are no instructions as to the relative positioning of Referee and Linesmen during a game. There are, however, instructions in Laws 5 and 6 with regard to powers and duties of Referees and Linesmen which rightly interpreted would mean co-operation. Law 6 stipulates that two Linesmen shall be appointed, whose duty (subject to the decision of the Referee) shall be:

- (a) To decide **WHEN** the ball is out of play.
- (b) To decide **WHICH** side is entitled to
 - (1) the corner-kick.
 - (2) the goal-kick.
 - (3) throw-in.
- (c) To assist the Referee in carrying out the game in accordance with the Laws. The assistance referred to in (c) is:
 - (1) Signalling when the **WHOLE** of the ball is out of play.
 - (2) Indicating **WHICH** side is entitled to the corner-kick, the goal-kick, or the throw-in.
 - (3) Calling the attention of the Referee to rough play, or ungentlemanly conduct.
 - (4) Giving an opinion on any point on which the Referee may consult him.

NEUTRAL LINESMEN

The assistance referred to above is best given by **NEUTRAL LINESMEN**. A limitation is placed upon **CLUB LINESMEN** because points (2), (3) and (4) are not usually referred to Linesmen who are not neutral. In cases of Neutral Linesmen they must be used as **ASSISTANT REFEREES**. It is appreciated that there must be a different attitude adopted by the Referee in this case, because in effect there are **THREE** officials supervising the play; the Referee remains as principal official but the Linesmen are there to assist him to control the game in a proper manner.

CLUB LINESMEN

To get the most effective co-operation from **CLUB LINESMEN** the following procedure should be adopted:

- (1) Referees should decide beforehand exactly **WHAT** they want their Club Linesmen to do and should be able to *tell* them distinctly how they can best help him.

- (2) BOTH Club Linesmen should report to the Referee BEFORE the start of the match, and receive his instructions, and be informed that no matter what may be their personal opinion the decision of the Referee is final, and must not be questioned.
- (3) The work allotted to them as CLUB Linesmen is to signal WHEN the ball is ENTIRELY over the touch-line, and to indicate WHICH side is entitled to the thrown-in, subject always to the decision of the Referee.

Keeping in mind their distinctive duties outlined above it is essential that there should be some conference between the three officials BEFORE any match. As the chief of this trio, the Referee must be able to indicate clearly to his assistants how they may best help him. His instructions must be specific, in order to avoid confusion. On their side, the LINESMEN must fully appreciate the Referee's prior authority, and accept his rulings without question, should there be any difference of opinion amongst them. The relationship to him MUST be one of assistance and neither undue intervention nor opposition.

The Referee will co-operate with his Linesmen on the following matters and indicate to them:

- (a) The time by his watch.
- (b) The side of the field which each Linesman will take in each half of the match.
- (c) Their duties prior to the commencement of the game, such as the examination of the appurtenances of the game.
- (d) Which shall be the senior Linesman in case of need.
- (e) The position to be taken for corner-kicks.
- (f) The sign that he has noticed his Linesman, but has overruled the indication therefrom.
- (g) Which action in the throw-in shall be the province of the Linesman, and which that of the Referee, e.g., many Referees ask their Linesman to watch for foot-faults whilst they look for the hand-faults.
- (h) The general procedure which he proposes to adopt as match officials, *viz.*, diagonal system of control, or which other method he prefers.

Other co-operative matters may be added, but it is important that each of these should be known to the three officials.

Hockey

I. TEAMS AND DURATION OF GAME

(a) A game shall be played by two teams of not more than eleven players each. The usual constitution of a team is five forwards, three half-backs, two backs and a goal-keeper.

(b) The duration of the game shall be two periods of thirty-five minutes each, unless otherwise agreed upon mutually by the respective Captains. At half-time the teams shall change ends, and the interval shall not exceed five minutes.

Extra time is provided for the completion of a Penalty Bully—where the goal-keeper is engaged in a Penalty Bully, extra time, not exceeding 3 minutes, is allowed for him to take off and put on his pads.

Extra time is allowed for accidents and for undue suspension of play from other causes. All time so deducted for accidents is to be added on again to the duration of the game and played in the half in which the accident occurred.

II. CAPTAINS

The Captain shall—

(a) Toss for the choice of ends ;

(b) Act as Umpires, if there be no Umpires, or delegate the duties of Umpire to a member of their respective team ; and

(c) Indicate the goal-keepers of their respective teams before starting the game and after any change of goal-keeper.

It has become now a practice for one of the Umpires to spin the coin though the rule says that it shall be done by one of the Captains.

In recognized Tournaments the Committee provides Referees.

Ordinarily, goal-keepers are distinguished by their pads, but in the interest of the game it is better if the goal-keeper is differently dressed ; a coloured shirt or sweater will be of great help.

If a captain, in the absence of a regular padded goal-keeper, fails to notify the umpire who is to be the goal-keeper, the umpire should penalize any player who kicks the ball in the circle while defending his goal.

RULES OF GAMES AND SPORTS

PLAN OF HOCKEY GROUND

The flag-posts at each of the centre line must be one yard outside the touch line

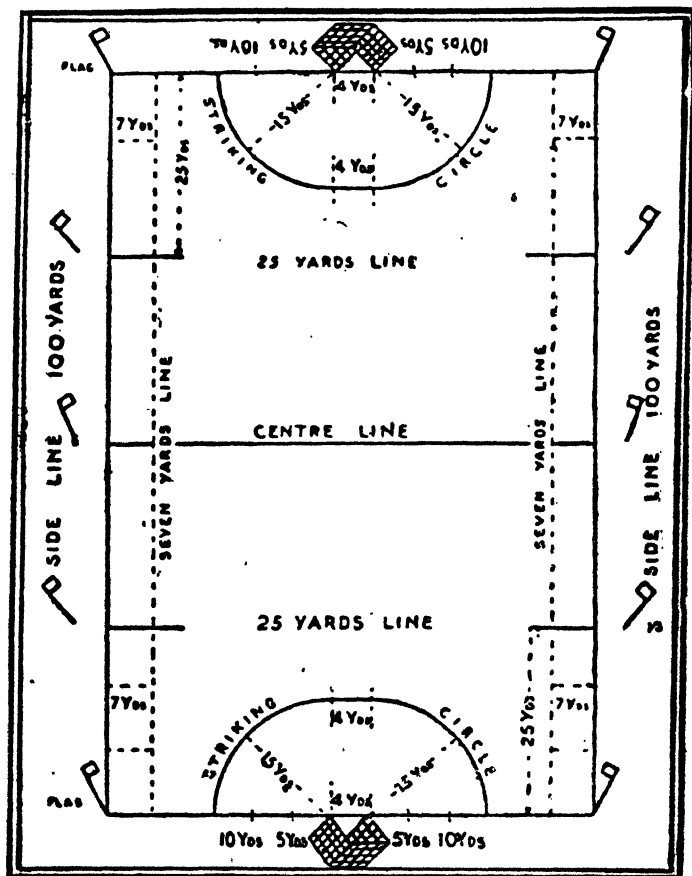

GOAL-LINE (55-60 YARDS)

N. B.—The 25 yds. line must not be fully drawn, but only its extremities (9 yds. only to be marked at each end). The 7 yards line to be dotted line, as shown in the above plan. The ground must also be marked for penalty corner hits, showing the 5 and 10 yards marks on the goal-line either side of the goal posts.

III. GROUND

(a) The ground shall be rectangular, 100 yards long and not more than sixty yards nor less than fifty-five yards wide. It shall be marked out with white lines, in accordance with the plan. The longer boundary lines shall be called the side-lines, and the shorter boundary lines shall be called the goal-lines.

(b) Flag-posts shall be placed at each corner of the ground, and also at the centre and twenty-five yards lines, but one yard outside the side-lines.

Umpire should satisfy himself before the game starts that grounds are properly marked out. The 7 yards line is not a continuous line but a succession of dashes. The 25 yards line with only nine yards at each end being marked by dashes.

IV. GOALS, POSTS, ETC.

(a) There shall be a goal at the centre of each goal-line and it shall consist of two perpendicular posts, four yards apart, joined together by a horizontal cross-bar seven feet from the ground (inside measurements). The goal posts shall not extend upwards above the cross-bar, nor the cross-bar sideways beyond the goal-posts. The goal-posts and cross-bar shall be two inches wide and not more than three inches deep and they shall have rectangular edges to the sides facing the field of play. Nets shall be attached firmly to the goal-posts, cross-bar and the ground behind the goal. at intervals of not more than six inches.

(b) Goal-boards, not exceeding eighteen inches high, shall be placed at the foot of the goal-nets, the shorter boards being at right angles to the goal-line.

(c) Flag-posts shall be not less than four feet high.

Goal post to be painted white or black and white. The goal board must be sufficiently deep not to interfere with the goal-keeper.

V. STRIKING CIRCLE

In front of each goal shall be drawn a white line, four yards long and three inches wide, parallel to, and fifteen yards from, the goal-line. This line shall be continued each way three inches wide, to meet the goal-line by quarter circles having the goal-posts as centres. The space enclosed by these lines and the goal-line, including the lines themselves, shall be called the striking circle (hereinafter referred to as the circle.)

Note:—It would be useful to mark on the goal-lines spots every 5 and 10 yards for the purpose of Penalty Corner.

It should be noted that the line itself whether on the goal-line or on the curved portions, forms part of the striking circle, hence it follows

that ball hit on the line may score a goal and an offence committed on the line by a defender may be penalized by a short-corner or penalty bully.

VI. BALL

(a) The cover of the regulation ball shall be of white leather, or of any other leather painted white. It shall be sewn in a manner similar to the cover of an ordinary cricket ball, or it may be seamless.

(b) The inner portion of the ball shall be composed of cork and twine, similar to that of an ordinary cricket ball.

(c) The weight of the ball shall be not more than five-and-three-quarter ounces and not less than five-and-a-half ounces.

(d) The circumference of the ball shall be not more than nine-and-a-quarter inches and not less than eight and thirteen-sixteenth inches.

(e) A ball of any other description may be used, as agreed upon mutually by the respective Captains.

The ball chosen under clause (e) must be a ball suitable for hockey.

VII. STICKS

(a) The stick shall have a flat face on its left-hand side only.

(b) The head, (*i.e.*, the part below the top of the splice) shall not be edged with, nor have any insets or fittings of hard wood or other substances, nor shall there be any sharp edges or dangerous splinters. The extremity shall not be cut square or pointed, but shall have rounded edges.

(c) The total weight of the stick shall not exceed twenty-eight ounces, and shall be of such a size (inclusive of any surgical binding) that it can be passed through a ring with an interior diameter of two inches.

PENALTY

Umpires shall forbid the use of any stick which does not comply with this Rule.

Stick broken during the game cannot be used. It is better for each Captain to test their sticks and examine their boots before players are on the ground.

VIII. BOOTS, ETC.

No player shall wear any dangerous material, such as spikes or nails, etc.

PENALTY

Umpires shall forbid the wearing of boots, etc., which do not comply with this Rule.

IX. BULLY

(a) To bully the ball, a player of each team shall stand squarely facing the side-lines, each with his own goal-line on his right. Each player shall tap first the ground between the ball and his own goal-line and then his opponent's stick over the ball three times alternately, after which one of these two players must play the ball with his stick before it is put into general play.

(b) All other players shall be nearer to their own goal-line than the ball until it is in play and none shall stand within five yards of the ball.

(c) To start the game, restart it after a goal is scored, and after half-time, a bully shall be played at the centre of the ground.

(d) Inside the circle, no bully shall be played within five yards of the goal-line.

PENALTY

For any breach of this Rule, the bully shall be played again.

Bully must be done with flat surface of the stick, for deliberate and repeated breaches of the bully rule, an Umpire is justified under the heading of misconduct in warning the offender and giving a free hit against him. If it happens during a penalty bully after a warning, the Umpire's power is still greater (See comments on rule 18) (a goal is awarded).

Particularly watch:—

(1) Players taking the bully not standing square and facing the side lines.

(2) Players breaking before the bully is completed.

(3) Players not standing 5 yards from the bully. (That is, 5 yards from the ball).

(4) Players using the back or edge of their sticks while taking part in the bully.

(5) That sticks meet face to face and over the ball 3 times.

(6) Obstruction. Passing the ball between one's own feet is nearly always obstruction. Preventing an opponent from hitting the ball by placing one's own stick in front of the ball is obstruction.

(7) The player who makes a habit of passing the ball from bully straight to his half. It is more than likely that he has not met his opponent's stick over the ball or that he has made the third tap with the back or edge of his stick.

Remember:—

(1) Any player can take a bully, the umpire merely indicates the spot where the bully is to be taken.

(2) Inside the circle no bully shall be taken within 5 yds. of the goal-line, but must be taken on a line at right angles to goal-line and

through the spot where the breach occurred. In some cases it may be necessary to take the bully more than 5 yds. from the goal-line, so as to allow players to stand 5 yds. from ball, and still remain within the field of play.

If there is any irregularity by any player, the bully must be taken again. But should one of the players deliberately and after being warned by the umpire, persist in not standing square, or in some other way, not bullying correctly, the umpire may deal with the offender under Rule 10 (k), Misconduct.

X. GENERAL DETAILS

(a) The flat face of the stick only may be used for playing the ball and for making contact with an opponent's stick at a bully. No player shall take part in, nor interfere with the game, unless he has own stick in his hand.

(b) When striking at the ball, no part of the stick shall be raised above the shoulder, either at the beginning, or at the end, of a stroke, nor may a ball above the height of a player's shoulder be stopped in the air by any part of the stick, nor may a player in the act of approaching the ball raise any part of this stick above his shoulder.

(c) The ball shall not be undercut. The scoop stroke, which raises the ball, is permissible except as specially provided for in Rule XIII (b), but the Umpire shall penalise this stroke if, in any particular instance, it be either dangerous in itself, or likely to lead to dangerous play. The ball may be hit whilst it is in the air, provided that the player does not contravene para (b) of this Rule.

(d) The ball shall not be stopped on the ground or in the air intentionally by any part of the body, except the hand. If the ball be caught, it shall be released into play immediately. The foot, or leg may not be used to support the stick in order to resist an opponent.

Note.—If the ball be caught it shall be released to drop perpendicularly. The foot cannot be used to stop a ball.

(e) The ball shall not be picked up, nor kicked, thrown, carried or propelled, in any manner or direction except with the stick.

(f) There shall be no hitting, hooking, holding, striking at or interference with the stick of an opponent.

(g) A player shall not obstruct by running in between an opponent and the ball, nor shall he interpose himself, or his stick, in any way as an obstruction, to an opponent nor attack from an opponent's left unless he touches the ball before he touches the stick or person of his opponent. There shall be no charging,

kicking, shoving, tripping, or striking at an opponent or his stick, nor holding an opponent or his stick by any means whatsoever.

(h) A goal-keeper shall be allowed to kick the ball but only whilst it is within his own circle. He shall not be penalised if, in stopping a shot at goal, the ball does not drop perpendicularly, having, in the opinion of the Umpire, merely rebounded off his open hand. In the event of his taking part in a penalty bully, these two privileges shall be denied him; but he may be permitted to remove his pads, and extra time shall be allowed, if necessary, for their resumption.

(i) If the ball becomes lodged in the pads of a goal-keeper, or in the wearing apparel of any player the Umpire shall suspend the game and shall restart it by a bully on the spot where the incident occurred [subject to Rule IX (d)].

(j) If the ball strikes an Umpire, it shall remain in play.

(k) Rough, or dangerous play shall not be permitted, nor any behaviour which, in the opinion of the Umpire, amounts to misconduct.

PENALTIES

1. For any breach of this Rule

(i) Outside the circle—

A free hit shall be awarded to the opposing team.

(ii) Inside the circle—

(a) *By the attackers.* A free hit shall be awarded to the opposing team.

(b) *By the defenders.* A penalty corner, or a penalty bully, shall be awarded to the opposing team.

2. For a simultaneous breach of this Rule by two opponents, inside or outside the circle. The Umpire shall order a bully to be played on the spot where the breach occurred [subject to Rule IX (d).]

3. For rough, or dangerous play, or misconduct. In addition to awarding the appropriate penalty, the Umpire may also warn the offending player, or suspend him from further participation in the game.

Note.—1 A player may be suspended without a previous warning.

Note.—2. Temporary exclusion is at times admissible.

Recommendations:—The Umpires and the Captains must see that a player does not cut the ball. (Cutting the ball is hitting it with the stick inclined from the bottom). This practice is very dangerous to both the teams.

Often the foot or leg is placed behind the stick as an additional help in stopping the ball but it is a foul if either is left there to support the stick in resisting an attacking opponent. A player must not use his body in any way whatever to aid himself or obstruct his opponent. If a player by driving the ball over to his left side places his right side however slightly between the ball and his opponent, he should be penalized.

Often goal-keepers and backs by running in between the attacker and the ball near the goal line, without attempting to play the ball, obstruct. If the attacker is hampered in any way when he was likely to play the ball this should always be penalised and there are circumstances when even a penalty bully would be justified.

Scoop is permissible but it should be penalized at once if dangerous in itself or likely to lead to dangerous play. Hence scoop made straight at a player within striking distance or if the ball is lifted to such a spot that dangerous play is likely to ensue specially in the circle, the Umpire must intervene.

If a goal-keeper deliberately pushes or throws the ball away in the circle, a penalty bully must be given against him.

Rough play should always be stamped out at once and vigorously penalized.

This is an important rule and has a wide application and should therefore be studied carefully.

A (1) No definition is given as to where the flat face of the stick terminates so that as long as the ball is played with the left-hand side of the stick (blade or handle), no breach occurs.

(2) A player must have his own stick in his hand. This means that should a player collide with another player and both players lose their sticks, neither player could continue with his opponent's stick.

B (1) Umpires should watch carefully for "sticks" from goal shot-out, corner hitting, clearances by goal-keepers, backs, and from centres by wing forwards. More particularly during any play in the circle.

(2) Remember that the offence of "sticks" is the one that often lends itself to the application of the advantage rule.

C (1) All undercutting must be penalized immediately.

(2) Every ball that is hit into the air is not necessarily from an undercut. The only way a ball can be cut is by making the stick move in a direction at the time of contact with the ball other than in a line at right angles or square to its face. In an undercut the stick slices or cuts across the ball. An umpire must watch the player's action and stroke carefully.

(3) The "scoop" stroke, or lifting stroke, is now under effective discretionary control of the umpire. Don't hesitate to penalize the "scoop" stroke when it is likely to, or results in dangerous play. Hence scoop made straight at a player within striking distance, or if the ball is lifted to such a spot that dangerous play is likely to ensue specially in the 'circle', the umpire must intervene.

(4) The "scoop" shot must be penalized if attempted from a free hit.

(5) The push or flick shot, which is permissible at all time, must not be confused with the scoop shot.

See also explanation under Rule 13, clause (b).

D If, in the opinion of the umpire, the ball is unintentionally stopped by the body of a player, or he is accidentally struck by the ball, paragraph (d) will not apply, and the player should not be penalized.

unless he infringes paragraph (e). The act of using the foot to support the stick is not in itself a breach of paragraph (d) or leg but it is a foul if either is left there to support the stick in resisting an attacking opponent.

E To cause a breach of this rule, there must be some movement by the player.

F This rule is most important and should be strictly enforced. Good hockey is often ruined and tempers frayed by illegal hooking and striking.

A player who, when he has lost the ball, makes a wild swing at his opponent's stick or person, is liable to be penalized under this sub-rule.

G (1) This is also an important rule and one that should be strictly enforced. There are so many ways of obstructing that it is almost impossible to describe them all. It is important to remember that a player can obstruct with his stick as well as with his person. As a general guide it can be laid down that, unless a player is some distance from the ball and well beyond reach of it, no other player nor his stick must cross the direct line from that player to the ball. If he does, he is obstructing and should be penalized. If a player by driving the ball over to his left side places his right side however slightly between the ball and his opponent, he should be penalized.

(2) A player can tackle from an opponent's left but he must be careful not to obstruct, that is, get in the direct line, nor touch his opponent before touching the ball.

(3) Watch the player in possession, particularly the outside left, to see that he does not so turn his body as to obstruct the tackler.

(4) It is an obstruction to keep the stick or the feet between the ball and the player hitting at it. This often happens at the termination of a bully.

(5) It is obstruction for a player to hit the ball between his legs when an opponent is within striking distance.

(6) It is obstruction for a goal-keeper to run out between an attacker and the ball and so prevent him reaching it before it crosses the goal-line. Some goal-keepers make this a habit.

H (1) Notice carefully that the ball has to be within the circle before a goal-keeper may kick it. (See Rule 5, Note 2).

(2) A goal-keeper may be standing in the circle and kick a ball that is just outside the circle. This is illegal and should be penalized.

(3) The goal-keeper shall be allowed to STOP the ball in any manner, provided he does not contravene any of these rules except Rule 10 (d), which does not apply to him with regard to stopping the ball with any part of his body.

(4) Penalize the goal-keeper who jumps to the ball and gives it more than the natural impetus of a rebound from any part of his body other than his legs or feet, there are circumstances when even a penalty bully would be justified.

I Umpires should, as far as possible, keep out of the line of the flight of the ball.

J (1) A player can be penalized, and, in addition, warned or suspended from the game.

(2) This is a type of "drag net" clause and can be enforced when no other penalty is specified in the rules, *e.g.*, if a player deliberately remains within the 7 yds. line at a roll after being warned not to do so or for refusing to bully correctly after due warning.

RULE XI. GOAL

(a) Except as specially provided for in Rule XVIII (d) a goal is scored if the ball pass wholly over the goal-line between the goal-posts and under the cross-bar, the ball, whilst inside the circle, having been hit by, or having glanced off, the stick of a player of the attacking team. It is immaterial if the ball subsequently touches, or be played by, one or more players of the defending team. If during the game, the goal-posts and/or the cross-bar become displaced and the ball passes wholly over the goal-line at a point which, in the opinion of the Umpire, is between where the goal-posts and/or under where the cross-bar, respectively, should have been, a goal is scored.

Note.—It must be noted that a goal is given only if the ball touches the stick of an attacking player inside the circle.

Also:—It is not necessary that the attacker must himself be in the circle whilst the ball is played by him.

The ball must be in the circle when it is played by the attacker.

If the ball is played by one of the attacking teams from outside the circle and touches the stick or person of a defending player and enters the goal then it shall not be a goal but a corner.

Whether to award an ordinary or a penalty corner depends upon the ball being put out by the defender intentionally or otherwise.

The ball in the circle as soon as it passes the line.

(b) The team scoring the greater number of goals shall be the winner.

It should be noted that the whole of the ball must be over the goal-line and the ball is still in play if any portion of it rests on the line.

A defender cannot put the ball through his own goal and have a goal registered against his side unless the ball when in the circle was first touched by the stick of an attacker or unless after the defender has hit, the ball subsequently touches the stick of an attacker who is in the circle. It is enough if the stick is in the circle.

RULE XII. OFF-SIDE

(a) No player can in any circumstances be off-side when in his own half of the ground.

(b) Subject to para (a) at the moment when the ball is hit or rolled in, any other player of the same side as the striker or roller-in, is in an off-side position unless

- (i) There be at least three opponents nearer to their own goal-line ; or,
- (ii) The striker, or roller-in, be nearer in the opponent's goal-line.

(c) A player who is in an off-side position shall not be penalized for off-side unless, in the opinion of the Umpire, he is, by his position, gaining some advantage or influencing the play of an opponent.

(d) A player who in an off-side position shall not be put on-side by reason of the ball having touched, or glanced off, the stick or person of an opponent.

(e) Subject to paras (c) and (d), a player in an off-side position shall be put on-side as soon as the ball has been definitely played by an opponent.

PENALTY

For any breach of this Rule: A free hit shall be awarded to the opposing team.

Note.—If the ball re-bound off a goal-post or the cross-bar, it shall be deemed to be a direct pass (and the offside Rule should be applied normally).

A player of the attacking team who is between the goal-post and the net shall be in the off-side position if he intervenes or even attempts to intervene or if in the opinion of the Umpire he impedes the goal-keeper.

It is not a breach of the Law for a player to be in an off-side position, but only when in that position he interferes with an opponent, or with the play. If a player who is in an off-side position advances towards and opponent, or the ball, and in so doing causes the play to be affected, he should be penalized.

A player, who is in an off-side position, is bound to keep out of the way of the play, and that he is liable to be penalized if in any manner his presence causes any interference with the play.

The point to notice is not where a player is when he plays the ball, but where he WAS at the moment it was played by a player of the same side. In the rush of a game a Referee is apt to lose sight of the positions of the field at every hit, yet he ought to fix each change on his mind, if a player is behind the ball when it is next played by one of his own side, he cannot possibly be off-side but if he is in front of it, he is liable to be so.

A player following up another of his own side who has the ball cannot be off-side. An opponent definitely playing the ball puts a player on-side at once.

A player who is in his own half of the field of play at the moment the ball is last played cannot be off-side.

A player once off-side cannot put himself on-side. This can only be done for him in three ways—(i) If an opponent definitely plays the ball; (ii) If he is behind the ball when it is next played by one of his own side; (iii) If he has THREE opponents between him and their goal-line when the ball is played by one of his own side further from his opponent's goal than himself.

The ball hitting the goal-post or bar and rebounding does not put a player who was off-side on side when the ball was last played.

This is, perhaps, the most important of the Rules of Hockey and is certainly one of the most difficult for an umpire to properly interpret. The proper position of an umpire will, and always must, play a most important part in giving proper and correct off-side rulings, and umpires are strongly urged to carefully study what has been written about the correct position for an umpire to take up on the field—Rule 19—Umpires.

There is nothing in the rules of the game to prevent a player from crossing the side- or goal-lines and returning to participate in the game. For umpires' guidance it is here laid down that a goal-keeper or any other player may still participate in the game from behind the goal or side-lines, and may clear a ball that has not crossed those lines, and such player can be penalized for any breaches of the rules.

RULE XIII. FREE HIT

(a) Except especially provided for in Rules XVI, *a*, and XVII a free hit shall be taken on the spot where the breach occurred, provided that no hit shall be taken within five yards of a goal-post.

(b) The ball shall be hit, or it may be pushed along the ground. The scoop stroke shall not be permissible in this instance.

(c) At the moment when a free hit is taken, the ball shall be motionless on the ground, and no other player of either team shall be within five yards of the ball. If the ball be not motionless, or if there be any other player within five yards of the ball, the free hit shall be taken again. If, however, in the opinion of the Umpire, any player remains within five yards of the ball in order to gain time, he should not cause the hit to be delayed.

(d) When taking a free hit, if the striker misses the ball, he shall take the hit again, provided that he has not contravened Rule X (b).

(e) After taking a free hit, the striker shall not approach within playing distance of the ball, nor in any way participate in the game, until the ball has touched, or been played by, another player of either team.

PENALTY

For any breach of the Rule:

(i) *Outside the circle.*

A free hit shall be awarded to the opposing team.

(ii) *Inside the circle.*

A penalty corner shall be awarded to the opposing team.

When there is undue congestion and encroachment specially near the edge of the circle, it is helpful to hold up the game and pace out 5 yards so that hit may be taken properly.

RULE XIV. ROLL-IN

(a) If the ball pass wholly over the side-line, it shall be rolled [and not bounced or thrown] in play by hand along the ground in any direction, from the point where it crossed the side-line, by a player of the team opposed to the player who last touched the ball.

(b) The ball may be rolled in at once, but the roller-in shall stand outside the field of play and have his hands, feet and stick behind the side-line, and he shall not approach within playing distance of the ball, nor in any way participate in the game, until the ball has touched, or been played by, another player of either team.

(c) All the other players of both teams shall be in the field of play and have their feet and sticks behind the seven yards line. If, however, in the opinion of the Umpire, any player of either team remain within the seven yards line, or outside the side-line, in order to gain time, he should not cause the roll-in to be delayed. Players may cross the seven yards line as soon as the ball leaves the hand of the roller-in.

PENALTY

For any breach of this Rule:

(i) *By the roller-in.* The roll-in shall be awarded to the opposing team.

(ii) *By any other player.* The roll-in shall be taken again (except as specially provided for in paragraph (c) of this Rule).

Persistent and deliberate breaches of this rule may be penalized by a free hit.

Umpire should watch for off-side when a roll-in takes place but a player is never off-side if it is rolled backward to him even though there are not three opponents between the receiver and the goal but the roller-in can be off-side when the ball is passed back to him by the player to whom he rolled it—a common tactics near the corner flag.

Obstruction at a roll-in is very common—and is often allowed to pass unpenalized. When a wing half places himself on the side of the opposing wing forward and nearer to his own goal-line, is one occasion on which you should carefully watch to see that the forward does not obstruct.

RULE XV. BEHIND

(a) If the ball be sent over the goal-line by a player of the attacking team, or, in the opinion of the Umpire be sent *unintentionally* over the goal-line by a player of the defending team from a distance of twenty-five yards or more from the goal-line, the game shall be restarted by a bully at the nearer twenty-five yards line, on a spot exactly opposite to where it crossed the goal-line.

(b) If, in the opinion of the Umpire the ball be sent *unintentionally* over the goal-line by a player of the defending team from a distance of less than twenty-five yards from the goal-line, a corner shall be awarded to the opposing team, unless a goal be scored.

(c) If, however, in the opinion of the Umpire, the ball be sent *intentionally* over the goal-line by a player of the defending team from any part of the ground, a penalty corner shall be awarded to the opposing team, unless a goal be scored.

25 Yards Bully is awarded, for the following:—

- (i) If the attacker sends the ball (intentionally or unintentionally) over the opponent's goal-line unless a goal is scored.
- (ii) If the defender sends the ball unintentionally over the goal-line from a distance of 25 yards or more from the goal-line.

Corner is awarded unless a goal is scored.

- (a) If a defender sends the ball over his goal-line from a distance of less than 25 yards from the goal-line. This includes the striking circles also.

Penalty Corner is awarded unless a goal is scored.

- (a) If the defender violates Rule X inside the striking circle.
- (b) If the defender sends the ball intentionally over his own goal-line from any part of the field.

If a defender kicks the ball through his own goal accidentally or deliberately provided that it has previously been touched by the stick of an attacker inside the circle, a goal should be awarded and not a penalty corner, (advantage rule).

RULE XVI. CORNER

(a) A player of the attacking team shall have a free hit from a spot on the defender's goal-line, or on the side-line, within three yards of the corner flag post—nearer to the point where the ball crossed the goal-line.

(b) At the moment when the hit is taken, the defending team shall be outside the field of play and shall have both feet and

sticks behind their own goal-line. The attacking team, except the player taking the hit, shall be in the field of play and have both feet and sticks outside the circle. If, before the ball be hit, a player of the defending team crosses the goal-line, or a player of the attacking team enters the circle, the Umpire may order the hit to be taken again.

(c) No shot at goal be made from a corner hit unless the ball first be stopped (not necessary motionless) on the ground by a player of the attacking team, or touch the stick or person of a player of the defending team.

PENALTY

For any breach of para (c) of this Rule: A free hit shall be awarded to the opposing team.

If the ball goes straight to an attacker he must make a definite attempt to stop it before shooting. The ball, if deflected from one attacker to another, it must be stopped before a shot at goal is attempted. Flying hit is not permissible and it must be penalized but not so if the ball has been played or have glanced off the stick of a defender. Watch for destruction during corner hit.

Para (c) is most important. It states how the ball shall be stopped before being hit into goal. Any player taking a flying hit at the ball, whether he hits it or not, must be penalized by a free hit against him. An umpire must also penalize any hit for goal if he thinks that the hit from the corner was not properly stopped. Also an attacker may not trap the ball on his stick in the air from such a hit, hit it forward a couple of feet from where he hits it goalwards. For the rule says that the ball shall be stopped (not necessary motionless) on the ground—The last three words are most important and are often forgotten by many umpires. Should, however, the defenders break over the line slightly too soon, but the attackers have sufficient time to get in a good clean shot at goals unobstructed—you should play the advantage rule and not cause the corner to be re-taken. A lot is left to the discretion of the umpire when he considers a ball to be sufficiently stopped. But for the sake of getting uniformity of ruling in this manner, we lay it down that a ball—after the attempt to stop it—which would only roll 6 inches should be considered to have been sufficiently stopped. If the hand is used the ball must be stopped dead. And should, from a corner hit, one forward not stop the ball, but pass it on, or deflect it to another forward, you as umpire, must see that this forward in his turn sufficiently stops the ball before shooting for goal. The striker of a corner hit should not be allowed to make pretence of hitting the ball and then hit it before the defenders get back behind the goal-line. This could be dealt with under Rule 10 (k)—Misconduct. And lastly, watch for off-side, especially by the striker taking the corner hit.

RULE XVII. PENALTY CORNER

Rule XVI shall also apply to a penalty corner, except that the free hit may be taken from any spot on the defender's goal-line on either side of the goal, but not within ten yards of a goal-post.

PENALTY

As for Rule XVI.

RULE XVIII. PENALTY BULLY

(a) A penalty bully shall be awarded to the opposing team if, in the opinion of the Umpire—

- (i) There has been an *intentional* breach of Rule X inside the circle, by a player of the defending team, to prevent a goal being scored ; or.
- (ii) A goal would probably have been scored had an *unintentional* breach of Rule X inside the circle not occurred.

Note 1.—A Penalty Bully ought therefore to be given for a STICK made intentionally with a view to prevent a goal being scored. It should be noted at the same time that in a case like this STICKS should have been made deliberately to prevent a goal being scored.

Note 2.—The two Rules or either are of equally great importance. The general opinion is that a Penalty Bully is not to be allowed except in case of an intentional breach to prevent a goal being scored. The Rule is very much more severe, since it is said that Penalty Bully ought to be allowed.

(a) For a breach clearly intentional.

(b) And also when it appears that without such a breach (even when unintentional) a goal would have been probably scored.

A player who falls on or behind the ball in the circle is almost certain to be impeding an attacker, in which case a penalty bully should be awarded.

If a goal-keeper is participating in a penalty bully he may, if he so desires, remove his pads, and extra time, not exceeding 3 minutes, shall be allowed, if necessary, for their removal and resumption. [See Rule 1, Note 7.]

(b) The bully shall be played on a spot five yards in front of the centre of the goal-line, by the offending player or any other player of the defending team if he has been incapacitated or suspended, and any player of the attacking team.

(c) Until the bully has been completed, all the other players of both teams shall remain outside the nearer twenty-five yards line.

(d) If, when the ball is in play from a penalty bully, it pass wholly ;

- (i) Over the goal-line between the goal-posts and under the cross-bar, off the stick of the attacker, or stick or person of the defender, a goal is scored ; or,
- (ii) Over any part of the goal-line which is within the circle, other than that between the goal-posts, off the stick or person of the defender, the bully shall be played again ; or,
- (iii) Outside the circle in all other cases, the game shall be restarted by a bully at the centre of the nearer twenty-five yards line.

(e) If, on the call of half-time or time, a penalty bully be not completed, extra time shall be allowed for its completion.

PENALTIES

1. *For any breach of any Rule (except Rule IX), and for an intentional breach of Rule IX, after a warning by the Umpire.*

- (i) *By the attacker.* The game shall be restarted by a bully at the centre of the nearer twenty-five yards line.
- (ii) *By the defenders.* A goal shall be awarded to the opposing team.

2. *For a simultaneous breach of Rules IX or X by both players.* The bully shall be played again.

Penalty Bully and How it is Played :—

- (a) The Bully is played on the Penalty Bully spot between the offender (unless he is suspended or incapacitated) and any other player of the attacking side: The rest of the players of both teams including the goal-keeper shall remain beyond the near 25 yards line till the bully is completed.

Penalty Bully is completed (unless a goal is scored) and the game is restarted by a bully at the *centre of the nearer 25 yards line*, when

- (a) the defender or the attacker plays the ball outside the striking circle over the curved portion, or played by the attacker over the goal-line other than that between the goal-posts.
- (b) the attacker violates any rule, this includes intentional breach of bully play after a warning by the Umpire.

Penalty Bully is completed and the game is started by a *centre bully* when a goal is awarded for the following:—

- (a) The attacker or the defender plays the ball wholly over the goal-line between the goal-posts and under the cross-bar.
- (b) When the defender violates any rule, this includes intentional breach of bully play after a warning by the Umpire.

Penalty *Bully* is played over again unless a goal is scored if,

- (a) The defender plays ball over the goal-line which is within the circle other than that between the goal-posts.
- (b) There is a simultaneous breach of rule 9 or 10 by both the players.

RULE XIX. UMPIRES

(a) There shall be two Umpires. Each Umpire shall take one half of the ground for the whole game. In addition, each shall take the whole of one side-line, but shall give corner decisions for his own half of the ground only.

(b) An Umpire shall give his decisions without waiting for an appeal.

(c) An Umpire shall only blow his whistle to

- (i) Start and end each half of the game.
- (ii) Enforce a penalty, or to suspend the game for any other reason.
- (iii) Indicate, when necessary, that the ball has passed wholly over the goal-line, or side-line.
- (iv) Signal a goal.

(d) An Umpire shall refrain from enforcing a penalty in cases where he is satisfied that, by enforcing it, he would be giving an advantage to the offending team.

(e) By mutual agreement, the time may be kept by one Umpire throughout, or by each Umpire for one half of the game. The full or agreed time shall be allowed after deducting all wastage for enforced stoppages, accidents, etc.

(f) If there be only one Umpire, there should be two linesmen to give side-line decisions.

(g) The Umpires and linesmen are debarred from coaching during a game.

(h) The Umpire shall keep a written record of the goals as scored.

RULE XX. ACCIDENTS

(a) If a player, or an Umpire, be temporarily incapacitated, the Umpire, or second Umpire, shall suspend the game. In either case, if a goal be scored before the game has been suspended, it shall be allowed if, in the opinion of the Umpire, it would have been scored had the accident not occurred.

(b) When game is resumed, it shall be restarted by a bully on a spot to be selected by the Umpire [subject to Rule IX (d).]

Official Basketball Rules

AS ADOPTED BY THE

INTERNATIONAL AMATEUR BASKETBALL FEDERATION

(These rules have been adopted by the Indian Olympic Association.)

THE GAME

The game of Basketball is played by two teams of five men each, the ball being passed from one player to another. The purpose of each team is to score as many points as possible by tossing the ball into its own basket, and at the same time prevent the other team from securing possession of the ball or scoring.

RULE 1

EQUIPMENT

Court—Dimensions

SECTION 1. The *Playing Court* shall be a rectangular surface free from obstructions and shall have maximum dimensions of 26 meters in length by 14 meters in width (85' 0" × 45' 0").

Note.—The following variations in the dimensions are admitted: plus or minus 2 meters (6' 8") on the length and plus or minus 1 meter (3' 4") on the width, these variations being proportional to each other.

Boundary Lines—Distance from Obstructions

SECTION 2. The *Playing Court* shall be marked by well defined lines, which shall be 5 cms (0' 2") in width and which shall be at every point at least 1 meter (3' 4") from any obstruction. The lines on the long sides of the court shall be termed the *Side Lines*, those on the short sides, the *End Lines*. The distance between these lines and the spectators should be at least 2 meters (6' 0").

Center Circle

SECTION 3. The *Center Circle* shall have a radius of 60 cms. (2' 0") and it shall be marked in the center of the court. A diameter parallel to the end lines shall be drawn in this circle and shall be prolonged on either side to the side lines.

Free Throw Lanes

SECTION 4. The free throw lanes shall be spaces marked in the court by lines perpendicular to the end lines at a distance of 90 cms. (3' 0") on either side from the middle points of the end lines. These perpendicular lines shall be terminated and the lanes

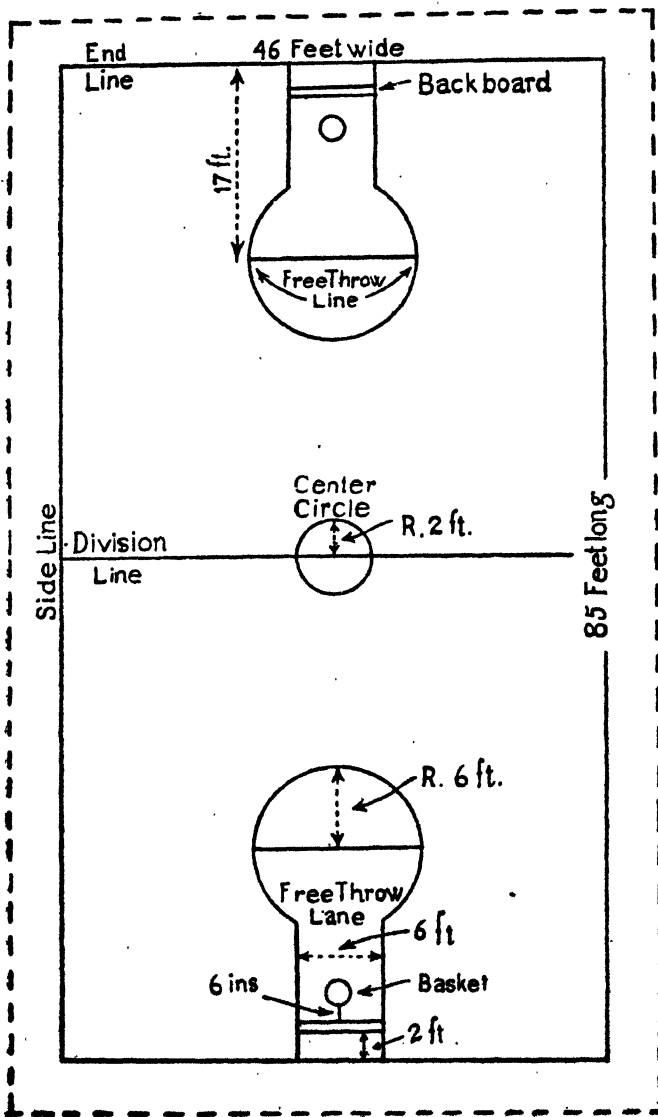

DIAGRAM OF A BASKETBALL COURT,

further marked by arcs of circles having 1.80 meter (6' 0") radius and centers at the middle points of the free throw lines.

Free Throw Lines

SECTION 5. A *Free Throw Line* shall be drawn across each of the circles described in Section 4. It shall be 5 cms. (0' 2") in width, and extend parallel to, and have its outer edges 5.20 meters (17' 0") from, the inner edge of the end line and shall be extended *ideally*, to the side lines. The area, enclosed between these lines and the corresponding end lines, shall be termed goal area.

Note.—All of these lines must be drawn in a perfectly visible manner.

RULE 2

Backboards—Size and Material

SECTION 1. Backboards must be provided, the dimensions of which shall be 1.80 m. (6' 0") horizontally and 1.20 m. (4' 0") vertically. These backboards shall be made of hard wood, 3 cms. (0' 1 $\frac{1}{4}$ ") thick, and shall present a smooth surface. The faces of the backboards shall be painted white.

Position of Backboards

SECTION 2. The backboards shall be located in a position at each end at right angles to the floor, parallel to the end lines, and with their lower edges 2.75 m. (9' 0") above the floor. Their centers shall lie in the perpendiculars erected at the points in the court 60 cms. (2' 0") from the midpoints of the end lines. The uprights supporting the backboards shall be at a distance of at least 40 cms. (1' 4") from the outer edge of the end lines in the out-of-bounds area and shall be of dark colour.

Baskets—Size and Material

SECTION 3. The baskets shall be nets of white cord, suspended from black iron rings 45 cms. (1' 6") in inside diameter. The nets shall be constructed so as to check the ball momentarily as it passes through the baskets, and be 60 cms. (2' 0") in length.

Note.—It is recommended that the cord used in the baskets be not less than 30-thread nor more than 60-thread seine twine, and the metal in the rings be 20 mms. (0' 6/8") in diameter.

Position of Rings

SECTION 4. The ring shall be rigidly attached to the backboard; it shall lie in a horizontal plane 3.05 m. (10' 0") above the floor and shall be equidistant from the two vertical edges of the backboard. The nearest point of the inside edge of the ring shall be 15 cms. (0' 6") from the face of the backboards.

Ball—Material, Size and Weight

SECTION 5. The *Ball* shall be round ; it shall be made of a rubber bladder covered with a leather case ; it shall be not less than 75 cms. (2' 6") nor more than 80 cms. (2' 8") in circumference ; it shall weigh not less than 600 gms. (21 ozs.) nor more than 650 gms. (23 ozs.) and it shall be tightly inflated (for tightly inflated it is meant that the ball shall have an air pressure of 13 pounds). The home team shall provide a new ball or two good used balls satisfactory to the Referee. If used balls are provided, the visiting team shall choose the one with which the game shall be played, and they shall have it as their practice ball. If a new ball is provided, neither team shall use it in practice. If the ball provided by the home team is unsatisfactory to the Referee he is hereby given authority to order the game played with the visiting team's ball if the latter is in better condition.

Note.—The referee has power to change balls during the course of the game if, on a rainy day, the ball becomes too heavy because of wetness.

RULE 3. OFFICIALS AND DUTIES OF OFFICIALS

SECTION 1. The Officials shall be a Referee and an Umpire, who shall be assisted by a Timekeeper and by a Scorer.

Note.—It cannot be too strongly emphasized that the Referee and Umpire of a given game should not be connected in any way with either of the organizations represented, and that they should be thoroughly competent and impartial. They should wear uniforms distinct from those of either team. The Officials have no authority to agree to changes in the rules. The Officials shall wear a uniform consisting of basketball or tennis shoes, long white trousers and half sleeved shirt, when possible, white.

Inspection of Equipment by Referee

SECTION 2. The Referee shall inspect and approve all equipment, including court, baskets, ball, backgrounds, Timekeeper's and Scorer's signals, and in particular, shall measure the ball. He shall not permit any player to wear braces, etc., which in his judgment are dangerous to other players ; this is in reference to rings, watches, braces, cleats on shoes, hard knee pads, etc.

Referee Announces Score

SECTION 3. The Referee shall check with the Scorers and then announce the score at the end of each half. The announcement at the end of the second half terminates the connection of the Officials with the game.

Referee Decides points not Covered in Rules

SECTION 4. The Referee shall have power to make decisions on any points not specifically covered in the rules.

Duties of Officials

SECTION 5. The Officials shall put the ball in play; shall decide when the ball is in play, when it is dead, to whom it belongs and when a goal has been made. They shall call violations and fouls, shall administer all penalties, shall recognize substitutes, and shall order time-out.

Note.—The game is most efficiently handled by the "Double Referee System," whereby each official covers one side and one end of the court, and is chiefly responsible for plays in his half of the court. They shall announce each goal as made, indicating with the fingers the point value of the goal. The game may however be handled by one Referee.

Officials Remove

SECTION 6. The Officials shall require to leave the game a player who has made four personal fouls, or a player who has committed a disqualifying foul.

Officials Call Time in Case of Injury

SECTION 7. The Officials may order time-out in case of injury to players or for other reasons, although not for trifles. If the ball is in play when an injury occurs, the Officials shall withhold their whistles until the play has been completed. By completed is meant that the team in possession of the ball has thrown for goal, lost possession of the ball, has withheld the ball from play, or that the ball has become a held ball or an out-of-bounds ball. If the injured player cannot resume his place 2 minutes after the interruption he shall be substituted, and his substitute alone can effect the free throw or throws that may have been awarded to him.

Officials Call Fouls for Unsportsmanlike Conduct

SECTION 8. The Officials shall have power to call foul for unsportsmanlike conduct on the part of players, coaches or spectators. They may disqualify players for flagrant unsportsmanlike conduct and they shall have power to call fouls on anybody officially connected with the teams. If a spectator becomes offensive so as to interfere with the normal course of the game, the home management shall be responsible for his removal.

Not to Question Each Other's Decisions

SECTION 9. Neither Official shall have authority to set aside or question decisions made by the other within the limits of his respective duties as outlined in these rules.

If the Officials make approximately simultaneous decisions on the same play and the infractions involve different penalties, the more severe penalty shall be imposed. This does not prevent double foul as defined in Rule 7, Sec. 15.

Time and Place for Decisions

SECTION 10. The Officials shall have power to make decisions for infractions of rules committed either within or outside the boundary lines ; also at any moment from the beginning of play to the call of time at the end of the game. This includes the period when the game may be momentarily stopped for any reason. Fouls may be called on any number of players at the same time.

Note.—When the ball is tossed up between two players the Officials shall see that the other players are in such positions that they do not interfere with the jumpers.

Designation of Fouls

SECTION 11. When an Official calls a foul he shall designate the offender. If it is a *personal* foul the Official shall signal with his fingers the number of free throws; he shall also designate the player who is to attempt the free throw or throws.

Duties of Scorers

SECTION 12. The Scorer shall record the goals made and the fouls committed ; shall distinguish in his records between personal and technical fouls, and shall notify immediately the Referee when the fourth personal foul has been called on any player.

Note.—The sounding of the Scorer's signal does not stop the game. He should be careful to blow his whistle when the balls is dead. The Scorer shall differentiate between personal and technical fouls by designating personal fouls P₁, P₂, P₃, P₄, and technical fouls T₁, T₂, T₃, T₄, and using capital letters when the foul involves more than one throw, and using small letters when the foul involves only one free throw.

Duties of Timekeepers

SECTION 13. The Timekeeper shall note when the game starts ; shall deduct time consumed by stoppages during the game as authorized by the Referee ; and shall indicate with gong, pistol or whistle the expiration of the actual playing time in each half time. At the beginning of a half time, or when play is resumed after time out, the Timekeeper shall start the watch at the instant the referee blows his whistle or when he tosses the ball. If the Timekeeper's signal fails to sound, or is not heard, the Timekeeper shall go on the court immediately to notify the Referee. If a goal

has been made in the meantime, the Referee shall consult the Timekeeper and Scorer. If they agree that the time was up before the ball was in the air the Referee shall rule that the goal does not count ; but if they disagree, the goal shall count unless the Referee has knowledge which would alter the ruling.

Note.—The Timekeeper shall use a stop watch placed on the table so that both he and the Scorer may see it.

Whistle Blown, When

SECTION 14. The Officials shall blow a whistle whenever necessary to make a decision.

Notes.—It is essential that the Scorer's signal be different from that of the Timekeeper or of the Officials.

RULE 4. PLAYERS AND SUBSTITUTES

Teams

SECTION 1. Each team shall consist of five players one of whom shall be captain. The game cannot begin if one of the teams is not on the court with five men ready to play. If 15 minutes after the starting time the faulty team is not present, the other team wins the game by forfeit.

Captain—Duties and Powers

SECTION 2. The captain shall be the representative of his team and shall direct and control its play, before the game is scheduled to begin furnish the Scorers with names, numbers and positions of players who are to play in the game. If a player changes his number during the game he shall report the change to the Scorers and Referee. The captain may address an Official on matters of interpretation or to obtain essential information when necessary, if it is done in a courteous manner. No other player may address any Official except provided in Section 3 of this Rule.

Note.—Substitutes arriving late but already inscribed on the score sheet may take part in the game.

Substitution, How Made—Scorers Shall Sound Horn When Ball is Dead

SECTION 3. Each team shall be allowed five substitutes. A substitute before going on to the court shall report to the Scorer, giving his name and number. The Scorer shall sound his horn as soon as the ball is dead. The substitute shall then report to the Referee, and shall not be withdrawn until after the play has been resumed. Substitutions shall not take more than 30 seconds. If more time is taken, it shall count as a time out, and shall be charged against the offending team.

Note.—In the absence of coach or other person entitled to make substitution, the Captain of the team will order the substitutions.

When Player may Re-Enter Game

SECTION 4. A player who has left the game, except for disqualification for four personal fouls or for other disqualification, may re-enter the game twice.

Player Leaving Court

SECTION 5. A player may not leave the playing court without permission of the Officials until time is called at the end of the half.

Players to be Numbered

SECTION 6. Each player shall be numbered on the front and back of his shirt with plain numbers contrasting with the colour of his shirt. The numbers on the back shall be 20 cms. (0' 8") high made of 2 cms. (0' $\frac{3}{4}$ ") wide material, and on the front 10 cms. (0' 4") high and 1 cm. (0' $\frac{3}{8}$ ") wide. Teams shall not use numbers one (1) and two (2) in numbering their players or any combination of digits which would be confusing to the officials. Players on the same team shall not wear duplicate numbers.

SECTION 7. There shall be two categories of teams, one of limited height, and another of unlimited height. In the limited height class only players of 1.90 meters (6' 2 $\frac{3}{4}$ ") of height or less may form the team.

RULE 5. PLAYING TEAMS**Goal, When Made**

SECTION 1. A *Goal* is made when the ball enters the basket from above and remains in or passes through. A goal scored from the field counts two points and a goal scored as a result of a free throw counts one point.

Players Out of Bounds

SECTION 2. *Out of Bounds*. A player is out of bounds when any part of his body touches the boundary line or the floor outside of the boundary line.

Ball Out of Bounds

The ball is out of bounds when any part of it touches the boundary line, the floor outside the boundary line, any object outside the boundary line, any balcony, the supports or back of the backboard, or when it is touched by a player who is out of bounds. If the ball strikes the edge of the backboard or rolls along the top of the backboard without touching the supports of the backboard, and then falls into the playing court, it is in play.

Who Causes Ball to Go Out of Bounds

The ball is caused to go out of bounds by the last player touched by it before it crosses the line.

Note.—Referees are not required to handle the balls on all out-of-bounds plays. They shall do so, however, every time there may be some misunderstanding as to whom the ball belongs.

Held Ball

SECTION 3. *Held Ball* is declared when two players of opposing teams have one or both hands firmly on the ball, or held ball may be called when one closely guarded player is withholding the ball from play in his front court and is making no apparent effort to put the ball into play.

Note.—Officials should not anticipate a held ball or declare it too quickly, thereby interrupting the continuity of the game, and unjustly taking the ball away from the players who has gained or is about to gain possession of it. Under the first clause of Section 3, held ball should not be called until both players have one or both hands so firmly on the ball that neither can gain sole possession without undue roughness. If the player holds the ball after an opponent has retained a position within three feet of him, and is making no attempt to put the ball into play (dribbling and pivoting with the ball are considered playing the ball) the Referee shall call held ball.

Jump Ball

SECTION 4. *A Jump Ball* takes place when the Official tosses the ball up between two opposing players.

Time-Out

SECTION 5. *Time-out* is declared whenever the game is legally stopped without the loss of playing time.

Own Goal

SECTION 6. *Own Goal* is the basket for which a team is throwing.

Dead Ball

SECTION 7. *The Ball is Dead* and play shall cease until the ball is put in play again in a manner indicated by one of the Officials:

- a. When the whistle of an Official sounds ;
- b. When a goal is made ;
- c. When held ball is declared ;
- d. When time-out is declared ;
- e. When either a foul or a violation is called ;
- f. When the ball goes out of bounds ;

- g. After each of the two free throws following a double foul ;
- h. At expiration of playing time ;
- i. When the ball lodges in the supports of the basket (jump ball at nearer free throw line, except that the ball goes to center if it would have been center ball had the free throw been unsuccessful) ;
- j. After each free throw except the last when a multiple throw is awarded.

If on a try for goal from the field the ball is in the air when the signal is sounded to indicate "dead ball," the goal counts if made, except as follows: If before the ball is in the air a foul or violation is made by a player of the team throwing for goal, the goal does not count. Of course, if an Official declares "held ball," the goal does not count even if the ball is in the air when the whistle sounds.

Note.—If the ball strikes an Official who is in bounds it is not dead but play continues as if the ball had not touched him.

Pivot

SECTION 8. A *Pivot* takes place when a player who is holding the ball steps once or more than once in any direction with the same foot, the other foot, called the pivot foot, being kept at its point of contact with the floor.

Running With Ball

SECTION 9. *Running with the ball (travelling)* is progressing in any direction in excess of prescribed limits while holding the ball. The limits follow:

Item 1. A player who receives the ball while standing still may pivot, using either foot as the pivot foot.

Item 2. A player who receives the ball while he is progressing or upon completion of a dribble may use a two-count rhythm in coming to a stop or in getting rid of the ball. The first count occurs:

- (a) As he receives the ball if either foot is touching the floor at the time he receives it ;
- (b) As the foot touches the floor or as both feet touch the floor simultaneously *after* he receives the ball if both feet are off the floor when he receives it.

The second count occurs when, after the count of one, either foot touches the floor or both feet touch the floor simultaneously.

When a player comes to a stop on the count of one he may pivot and may use either foot as the pivot foot.

When a player comes to a stop on the count of two, if one foot is in advance of the other he may pivot but the rear foot only may be used as the pivot ; however, if neither foot is in advance of the other he may not pivot but may lift either foot provided he gets rid of the ball before that foot again touches the floor.

Item 3. (a) A player who receives the ball while standing still, or who comes to a legal stop while holding the ball, may lift the pivot foot or jump when he throws for goal or passes, but the ball must leave his hands before one or both feet again touch the floor.

(b) In starting a dribble after receiving the ball while standing still, or after coming to a legal stop, a player may not jump before the ball leaves his hands, nor may he lift the pivot foot from the floor before the ball leaves his hands.

Dribbling

SECTION IO. A *Dribble* is made when a player, having gained control of the ball, gives impetus to it by throwing, batting, or bouncing it, and touches it again before it touches another player. In a dribble the ball must come in contact with the floor, except that one "air dribble" may be made ; that is, a player may begin a dribble by tossing the ball into the air, and may touch it again before it strikes the floor. After giving impetus to the ball as described in the foregoing, the player completes his dribble the instant he touches the ball simultaneously with both hands, or permits the ball to come to rest in one or both hands, the dribble ceases and the player must either pass the ball or throw for goal ; he may pivot after a legal dribble.

Note.—Referees are warned against illegal dribbling (pushing or rolling the ball). Successive tries for goal shall not be considered a dribble. Dribbling with two hands simultaneously is not allowed.

Holding

SECTION II. *Holding* is personal contact with an opponent that interferes with the opponent's freedom of movement.

Note.—"Guarding from the rear" which results in personal contact is a personal foul. Officials are requested to pay special attention to this style of play. The mere fact that the defensive player is attempting to play the ball does not justify him in placing one or both arms over his opponent's shoulder, if by so doing he causes personal contact.

Blocking

SECTION 12. *Blocking* is personal contact which impedes the progress of an opponent who has not the ball.

Note.—Blocking is a personal foul and therefore there is no such play as "legal block". Legally shutting off the approach of an opponent should be called "screening".

Foul—Technical, Personal

SECTION 13. A *Foul* is an infraction of the rules the penalty for which is one or more free throws. *Technical Fouls* are those listed in Rule 13, A and B; *Personal Fouls* are those listed in Rule 13, C.

Disqualifying Foul

SECTION 14. *Disqualifying Foul* is an infraction of the rules for which a player is removed from the game.

Double Foul

SECTION 15. A *Double Foul* takes place when fouls are called simultaneously upon both teams.

Multiple Throw

SECTION 16. A *Multiple Throw* takes place when two or more free throws are awarded the same team.

Violation

SECTION 17. A *Violation* is an infraction of the rules not involving a foul.

Free Throw

SECTION 18. A *Free Throw* for goal is the privilege given a team to throw for goal from a position directly behind the free throw-line.

Delaying Game

SECTION 19. *Delaying the Game* is unnecessarily interfering with the progress of the game by a player.

Extra Period

SECTION 20. *Extra Period* is the extension of playing time necessary to break a tie score.

Front Court, Back Court

SECTION 21. A team's *Front Court* is the half of the court which contains the basket for which this team is throwing. The other half of the court is this team's *Back Court*.

RULE 6. PLAYING REGULATIONS**Length of Game**

SECTION 1. The game shall be started by the Referee, who shall toss the ball up between two opponents, as provided in Sections 5 and 6 of this Rule.

Intermission

The game shall consist of two halves of 20 minutes each, with an intermission of 10 minutes between halves.

Captains Notified Before Each Half

SECTION 2. Captains shall be notified three minutes before the termination of intermission between halves. If either team is not on the floor ready to play within one minute after the Referee calls play, either at the beginning of the second half or after time has been taken out for any reason, the ball shall be put into play in the same manner as if both teams were on the floor ready to play, and the absent team shall lose the game.

Choice of Baskets

SECTION 3. The visiting team shall have choice of baskets in the first half. For the second half the teams shall change baskets.

Ball Thrown, etc., in any Direction

SECTION 4. The ball may be passed, thrown, batted, bounced, rolled or dribbled in any direction.

When Ball is Thrown up in Center

SECTION 5. The ball shall be put in play in the center circle (except as otherwise provided in these rules)

- a. At the beginning of each half, and of each extra period ;
- b. After a free throw following a technical foul, if one has been called ;
- c. After the last free throw following a double foul ; in the following manner ;

Positions of Center Players

Each center player shall stand with both feet on or inside his half of the center circle and facing his own basket. The Referee shall then toss the ball upward in a plane at right angles to the side lines between the center players, to a height greater than either of them can jump and so that it will drop between them. The ball must be tapped by one or both of the center players after it reaches its highest point. If it touches the floor without being tapped by at least one of the jumpers, the Officials shall

put it in play again in the same place. The Referee shall blow his whistle when the ball has reached its highest point.

Centers Must Tap Ball First

SECTION 6. The center players must not tap the ball before it reaches its highest point, and must not leave the circle until the ball has been tapped. Neither center may tap the ball more than twice, after which neither may touch the ball again until it has touched one of the other eight players, the floor, the basket, or the backboard. Under this provision four taps are possible, two by each center. The other players may take any position upon the court, provided they do not interfere in any way with the Referee or jumpers.

When Ball is Tossed Up Elsewhere Than in Center

SECTION 7. When the ball is tossed up between two players elsewhere than in the center, the players shall assume the same position in relation to each other as when jumping in the center.

Advancing The Ball

SECTION 8. (a) When a team gains possession of the ball in its back court, that team must advance the ball to its front court within a period of ten seconds unless the ball, while out of control of the team, touches or is touched by an opponent. In the latter event, a new play results and the ten-second period begins again when possession of the ball is regained in the back court. When a team has advanced the ball to its front court this team may not return the ball to its back court until:

- (1) a try for goal has been made ; or,
- (2) a jump ball at center or elsewhere has taken place ;
or,
- (3) an out-of-bounds award has been made ; or,
- (4) the ball has been recovered from the possession of the opponents.

(b) When the ball is in a team's front court following a jump ball, pass from out of bounds, throw for goal, or loss of possession of the ball by the opponents, only the player of that team who first touches the ball may cause it to go to his back court. As soon as the ball is touched thereafter in the front court by another player of either team, the right of the offensive team to cause the ball to go to the back court ceases until one of these four plays has recurred.

PENALTY

Failure to comply with the provisions of this section is a violation and the ball shall be awarded to the opponents at the nearest point out

of bounds; except that, if a team returns the ball to its back court illegally and the ball is first touched in the back court by an opponent, play shall continue. As in out-of-bounds plays, touching the division line is considered "over," and the last player who touches the ball before it goes over the division line is considered to have caused it to go over.

Note.—When a team has been awarded the ball out of bounds the ten-second count begins at the instant the ball is passed into the court. If the ball is lying on the court in possession of neither team and neither team makes an effort to gain possession, the ball must be played by the team in whose back court the ball lies. After allowing this team sufficient time to gain possession of the ball, the Referee (or Umpire) shall begin the ten-second count. The Referee (or Umpire) should count silently and it is suggested that the following method of counting seconds be used; "One-thousand-one, one-thousand-two," etc. If a player passes the ball from his back court to a team-mate who is touching the division line, the ball has been passed into the front court. If the latter then passes the ball to a team-mate who is touching the division line, the ball has been passed into the back court. In other words, the division line is in the front court or back court according to the position from which the ball is thrown.

When Game is Terminated

SECTION 9. After a field goal has been made and after a free throw or after the last free throw (if more than one has been awarded following a personal foul, if the free throw or the last free throw has been scored. *Note*—If not scored the ball remains in play), the ball shall be put in play in the following manner: As the goal is scored the Referee shall signal in the usual manner its point value and the number of the player who has scored it to the Scorer. He shall then gain possession of the ball and shall hand it to a player of the team that has suffered the goal, and this player shall put the ball into play, as if it were an out-of-bounds ball, from any point of the end line of his back court, as soon as the Referee by blowing his whistle has declared that the ball is in play. All provisions in those rules regarding out-of-bounds are also valid for this particular play.

SECTION 10. The game shall terminate by the blowing of the Referee's whistle, following immediately the sounding of the Timekeeper's signal indicating the end of the game. When a foul is committed simultaneously with or just previous to the sounding of the Timekeeper's signal, time shall be allowed for the free throw.

RULE 7. SCORING

Value of Goals

SECTION 1. A goal made from the field shall count 2 points; a goal from a free throw shall count 1 point. A goal from the field shall count for the team into whose basket the ball is thrown.

SECTION 2. A game shall be decided by the scoring of the greater number of points in the playing time.

Tie Score—Extra Period

SECTION 3. If the score is a tie at the expiration of the second half, play shall be continued with changes of baskets for an extra period of five minutes, or as many such periods of five minutes as be necessary to break the tie. One minute intermission shall be allowed before each extra period. Each extra period shall be considered a continuation of the second half, but at the beginning of each extra period the ball shall be put in play at the center and baskets shall be changed.

Refusal to Play

SECTION 4. Any team refusing to play after receiving instructions to do so from the Referee shall forfeit the game.

RULE 8. OUT OF BOUNDS

How Ball is Put in Play When Out of Bounds

SECTION 1. If at any time during the game the ball goes out of bounds, it shall be so declared by one of the Officials. He shall designate a nearby opponent of the player last touched by the ball before it went out of bounds to put it into play. This opponent shall stand out of bounds near the point where the ball left the court, and then shall throw, bounce or roll the ball to another payer within the court.

Note.—When the margin out of bounds free from obstructions is less than 3 feet, no player of either team shall be within 3 feet of the player who is putting the ball in play. On such courts a fine broken line should be drawn in the court 3 feet from the boundary line.

Note to Official

Officials should make their out-of-bounds decisions clearly evident to both teams. If there is any confusion or misunderstanding among the players as to the decision, the official should obtain possession of the ball and not permit the player entitled to it to play it until both teams have had a chance to recover their positions. Whenever the ball is awarded to a team out of bounds from its front court area, as provided in this rule or in Rule 12, the Official must hand the ball immediately to the player who is to put it into play. The purpose of this is to make the decision clear; the purpose is not to delay the game until the defensive team gets "set". The Officials are not required to designate the player who is to throw the ball in from out-of-bounds, if there is no obvious attempt to gain time by holding up play.

How Ball is Put in Play If Official is in Doubt as to Who Caused it to Go Out of Bounds

SECTION 2. If the Referee or Umpire is unable to determine which player touched the ball last before it went out of bounds,

he shall put the ball in play at a spot about 3 feet within the court, at right angles to the point where the ball crossed the boundary line, by selecting two opponents and tossing the ball up between them as for Held Ball. If, however on a jump ball at center, or elsewhere, the ball is tapped out of bounds by both players simultaneously, it shall be put in play again at the same point.

Note.—The two opponents referred to in this section shall be those involved in the out-of-bounds.

RULE 9. TIME-OUT

Time-Out on Order of Official Only

SECTION 1. Time shall be taken out only when ordered by an Official.

Time-out may be granted for a substitution whenever the ball is dead. This time-out is not charged unless the time consumed in making the substitution exceeds thirty seconds.

Time-out may be granted at the request of captain whenever the ball is dead or when the ball is in play and in the possession of the team requesting time-out. In this case a time-out shall be charged for each minute or fraction thereof consumed.

Time-out may be granted for injuries whenever the ball is dead, or when the injured player's team is in possession of the ball or upon the completion of a play by the opponents as explained to Rule 3, Section 7. In this case time-out shall be charged unless the injured player leaves the game within one minute, an additional allowance of thirty seconds may be made for substitution. A similar allowance may be made when a player is disqualified.

Time shall be taken out whenever a foul is called. (a) In case of a technical foul or of a double foul, time shall be resumed when the Official blows his whistle as he tosses the ball up at center; (b) in case of other fouls, if the free throw is successful, time shall be resumed when the ball crosses the boundary line as it is thrown into play; if the free throw is unsuccessful, time shall be resumed when the ball misses the basket.

Note.—The Officials shall determine upon a signal with the Time-keeper for "time out" and "time in," especially in connection with fouls and free throws.

Four Charged Time-Outs Per Game For Each Team

SECTION 2. Charged time-out shall be permitted only four times for each team during the game, but after a team has used its four time-out periods, it may be granted additional time-out

period at the expense of a technical foul in case of injury or other emergency.

After Time-out Ball is Thrown Up Unless a Violation in Foul has Taken Place, or Unless the Ball was in Play in Possession of a Player

SECTION 3. Whenever play is suspended (unless otherwise provided in the rules), play shall be resumed by tossing the ball up between the two players of opposing teams nearest to it, at that spot where it was when play ceased ; except that if a violation or a foul has taken place, play shall be resumed with the administering of the penalty ; or except that if the ball was in play and in the possession of a player when play ceased, that player shall be permitted to put the ball in play from out of bounds at the point nearest the spot where play ceased.

During a time-out period, the Officials shall not permit practice shooting.

RULE 10. HELD BALL

Held Ball Thrown Up

SECTION 1. When *Held Ball* is called, the Official shall put the ball in play as at center. The two players who were in contact with the ball shall assume positions similar to the centers at the start of the game, but in an imaginary circle at the spot where the ball was held, except as provided in Section 2.

When Called in Free Throw Lane

SECTION 2. When *Held Ball* is called in the free throw lane, the ball shall be put in play at the free throw line in the same manner as at center. See Rule 1, Section 5.

RULE 11. FREE THROW

Procedure When Foul is Called

SECTION 1. When a foul has been called an Official shall immediately secure possession of the ball and without delay place it upon the free throw line or in the hands of the player entitled to throw.

SECTION 2. When a personal foul has been called, the player upon whom the foul was committed shall be designated by the Official to attempt to free throw or throws ; if any other player attempts the throw it shall not count if made, and whether made or missed the ball shall be put in play at center. If the player designated is so injured that he must leave the game, his substitute must attempt the free throw or throws. If the player who has been fouled is to leave the game by reason of disqualification or for any other cause except injury, he shall attempt the free throw or throws before leaving.

SECTION 3. Free throws for goal after technical fouls may be made by any player of the offended team.

SECTION 4. The throw for goal shall be made within ten seconds after the ball has been placed either on the free throw line or in the hands of the player on the free throw line who is to attempt the free throw, and this shall apply to each free throw.

The Official shall blow his whistle to indicate that throw may be attempted. The player who is to attempt the free throw shall take a position immediately behind the free throw line, and shall be free to use any system in throwing the ball, but shall not touch the free throw line or the court beyond the line until the ball touches the basket or the backboard. If the ball misses the basket and the backboard and goes out of bounds it shall be put in play by the opposing team from that point. If the ball misses the basket and backboard and falls within bounds, it shall be put in play from the moment it touches the floor.

Note.—To avoid disconcerting the free-thrower, neither Official should stand in the free throw lane or behind the backboard.

Out-Of-Bounds Ball If Free Throw Successful

SECTION 5. If the goal is made the ball shall be put in play in the manner provided for these rules.

Ball in Play If Goal is Missed

SECTION 6. If the goal is missed the ball shall continue in play after a free throw following a personal foul, or if more than one such personal free throw has been awarded, the ball shall continue in play if the last free throw is missed.

Center Ball After Double or Technical Foul

After the last free throw following a double foul, or following one or more technical fouls, the ball shall go to center whether the last goal is made or missed, except as specified in the following section.

If successive free throws are awarded to one team and none to the other team, at least one free throw being for a personal foul the ball shall be in play if the last free throw is missed.

RULE 12. VIOLATIONS AND PENALTIES

A PLAYER SHALL NOT—

SECTION 1. Throw for goal when the ball is dead.

PENALTY

Goal If Made Does Not Count

SECTION 2. While making a free throw for goal, touch or cross the free throw line until the ball has touched the basket or backboard or consume more than ten seconds in making the free throw.

PENALTY**Goal If Made Does Not Count**

Note.—When one free throw has been awarded, jump ball at center whether goal is made or not. If Sec. 2 is violated on the last free throw of a multiple throw, jump ball at center whether goal is made or not.

SECTION 3. Cause the ball to go out of bounds.

Note.—If a player in possession of the ball near the boundary line is forced out of bounds, a negligible amount of contact being involved, the Officials are authorized to award the ball out of bounds to this player. If the Officials are in doubt as to which player is responsible for the out-of-bounds ball, jump ball should be declared.

SECTION 4. Carry the ball into the court from out of bounds.

SECTION 5. Touch the ball after putting it in play from out of bounds until it has touched another player.

SECTION 6. Consume more than five seconds in putting the ball in play from out of bounds.

(SECTIONS 3, 4, 5, 6)

PENALTY**Ball Goes to an Opponent Out of Bounds**

SECTION 7. Enter the free throw lane, or touch the free throw lines, or touch the ball while a free throw for goal is being made, until the ball has touched the basket or backboard, or attempt in any way to disconcert the player who has the free throw. If players contest for position along the free throw lanes, the Officials shall arrange the players so that the desirable positions are evenly divided.

(SECTION 7)

PENALTY

For violation by a player of the team throwing for goal, the goal if made shall not count, and if made or missed the ball be tossed up at center. If violated by a player of the opposite team, the goal if made shall count and if missed another free throw shall be allowed. This free throw is a throw substituted for the one originally awarded; if missed and it was originally a single free throw from personal foul, the ball is in play. If violated by players of both teams, the goal if made shall not count, and whether made or missed the ball shall be tossed up at center. A personal foul may be called for rough work on the free throw lines. On free throws following technical foul and double fouls, players shall not line up along the free throw lanes.

If the team has been awarded a multiple throw, the center ball and out-of-bounds ball provisions of the foregoing paragraph apply only to an infraction on the last free throw.

SECTION 8. Run with the ball, kick it, or strike it with the fists.

Note.—Kicking the ball is a violation only when it is a positive act; accidentally striking the ball with the foot or leg is not a violation.

SECTION 9. Pass the ball to another player while making a free trial for a goal, but must make an honest attempt to throw it into the basket.

(RULE II, SECTION 4)

SECTION 10. Make a second dribble after having completed a dribble, unless the ball when it was out of his possession has touched another player, or his own basket or backboard, or has been batted out of his control by an opponent.

Note.—If the offending player has the ball he shall pass it immediately to the nearer Official.

SECTION 11. When the ball is tossed up between two players at center or elsewhere, tap the ball before it reaches its highest point, catch the ball, or after tapping it a second time touch it again until it has touched the floor, one of the other eight players, the basket, or the backboard.

Note.—If an Official makes a defective toss, he should toss the ball again. If the players attempt to tap the ball but miss it, the ball may be tossed up again even though it is caught by one of the players as it falls.

(SECTIONS 8,9,10,11)

PENALTY

The ball shall go to an opponent out of bounds at the point nearest the spot where the violation was committed.

SECTION 12. Interfere with the ball or basket while the ball is on the edge of or within basket.

PENALTY

(a) If committed at opponents' basket, shall be declared a technical foul, and two free throws shall be awarded.

(b) If committed at player's OWN BASKET, shall be declared no goal whether made or not. (Jump ball on nearer free throw line.)

RULE 13. PENALTIES AND FOULS

A. Technical Foul

List of Technical Fouls

A PLAYER SHALL NOT—

SECTION I. Delay the game by:

- a. Touching the ball after it has been awarded to an opponent out of bounds.
- b. Interfering with a player who is returning the ball into the court from out of bounds; that is, no part of his person shall be outside of the court, and he shall not touch the ball until it has crossed the line.
- c. Taking time out when his team has used its four time out periods, or by taking time out when the ball is in play in possession of opponents.

- d. Acting in any manner which interferes with the progress of the game.
- e. Leaving the circle on any jump ball until the ball has been tapped.

Note.—If the player who remains in the circle legally taps the ball into his basket, the goal counts and the foul is not penalized.

SECTION 2. Go on the court as a substitute until he has reported to the *Scorers* and play has been suspended. He shall not participate in the game until he has reported to and been recognized by an Official, nor shall he communicate with any player except through the Referee until play has been resumed.

SECTION 3. Talk to the Official or spectators, or use any other unsportsmanlike tactics.

SECTION 4. Leave the court.

SECTION 5. Enter the game after leaving it three times.

(SECTIONS 1, 2, 3, 4, 5)

PENALTY

Free trial for goal and for infraction of Section 5, player disqualified. If two or more substitutes of the same team go on the court at the same time without reporting to the *Scorers*, or an Official, only one foul shall be called, this being charged to the captain.

SECTION 6. Change his number during the game without reporting the change to the Scorer and Referee.

(SECTION 6)

PENALTY

The players shall be disqualified for the rest of the game, and a free throw awarded.

B. Conduct of Coaches

SECTION 7. There shall be no coaching from outside the boundary lines during the progress of the game.

SECTION 8. A coach shall not address remarks to an Official during the progress of the game.

Note.—Sections 7 and 8 apply to time-out periods and one minute intermissions as well as to when the ball is in play. Anyone on the players' bench or officially connected with the team shall be considered a coach under Sections 7 and 8.

(SECTIONS 7, 8)

PENALTY

It shall be obligatory for the Officials to call a technical foul and charge it against the captain of the offending team for infraction of these sections. If the offence is repeated the officials shall order the offender from the vicinity of the court, and may forfeit the game to the opponents if the order is not obeyed.

C. Personal Foul

List of Personal Fouls

A PLAYER SHALL NOT—

SECTION 9. Hold, trip, charge or push an opponent, whether or not either player has possession of the ball. If a dribbler charges into an opponent, or makes personal contact with an opponent, without an apparent effort to avoid such contact, a personal foul shall be called on the dribbler. If, despite the dribbler's effort to avoid contact, personal contact ensues, either player, or both, may be guilty; but the greater responsibility is on the dribbler if he tries to dribble by an opponent who is in his path.

SECTION 10. Block an opponent.

SECTION 11. Use unnecessary roughness.

Note.—A disqualifying foul may be called when a player is fouled in the act of throwing for goal, if the offending player is exceptionally rough and makes no attempt to block the ball.

SECTION 12. Charge in and make bodily contact with an opponent who is one of two opposing players having one or both hands on the ball.

SECTION 13. Interfere in any way with his opponent when the ball is tossed up between them.

Note.—If two opposing players come in bodily contact in a well executed jump ball, there shall be no foul. (SECS. 9, 10, 11, 12, 13)

PENALTY

(a) Two free throws if committed on a player who is in the act of throwing for goal, provided the field goal is missed. If the field goal is made it counts, in which case only one free throw shall be awarded. In case of a double foul, only one free throw shall be awarded each team.

(b) One free throw for goal when foul is committed under conditions other than these specified in (a) and in addition a free throw may be awarded for unsportsmanlike conduct.

(c) In any of the foregoing cases the offender shall be charged with one personal foul. A player who has made four personal fouls is automatically disqualified and shall be required to leave the game. This provision for disqualification shall not be set aside under any consideration, but shall be strictly enforced.

(d) If two or more personal fouls are committed against a player, whether or not the player is in the act of throwing for goal, one free throw shall be awarded for each foul and a personal foul shall be charged to each offender.

(e) Official must disqualify a player for any flagrantly unsportsmanlike infraction of Sections 9, 10, 11, 12 or 13.

Note.—Whenever a foul is called on the opponent of a player who, as part of continuous motion which started before the foul occurred, succeeds in making a field goal, the goal shall count even if the ball leaves the players' hands after the whistle blows, provided the whistle did not affect the play. The player must be throwing for goal or starting an effort to throw for goal when the whistle blows; the goal does not count if he makes an entirely new effort after the whistle blows.

QUESTIONS AND ANSWERS IN BASKETBALL

Ques.— 1. How is the game started at the beginning of a game and at the beginning of the second half?

Ans.— As originally, with the centre jump.

Ques.— 2. How is the ball put into play after a goal is scored?

Ans.— Any player of the team scored on may take the ball to put it into play. If a player of the team scoring catches or handles the ball after a goal has been made and by so doing delays the game, the Referee may at his discretion call a technical foul against such a player.

Ques.— 3. What is the penalty if a team takes more than ten seconds to advance to its front court?

Ans.— Ball goes out of bounds to the opponents at the nearest point.

Ques.— 4. How does a Referee keep a record of ten seconds?

Ans.— By counting 1001, 1002, 1003, 1004, 1005, 1006, 1007, 1008, 1009, 1010. Also the court must have a division line dividing the court into two halves—Rule 6, Section 8.

Ques.— 5. What is the penalty for returning the ball to the back court after a team has advanced the ball to its front court?

Ans.— Ball is given out-of-bounds to the opponents on the centre line.

Ques.— 6. Is there any exception to the above rule?

Ans.— There are four exceptions. Refer Section 8, Rule 6.

Ques.— 7. Is it right for a player to put the ball in play from out of bounds on the end line or side line when one or more of his opponents are outside the court?

Ans.— It is unfair to do so. The Referee must check this by placing his hands over the ball in possession of the player who is ready to put it in play and let his hand go only when all players are in the court and ready to start.

Ques.— 8. What happens if both Referees make approximately simultaneous decisions?

Ans.— If the decisions are on the same play and the infractions involve different penalties, the more severe penalty shall be imposed. For example, one Referee calls a violation on a player for running with the ball, and on the same play the other Referee calls

a foul on an opponent for holding. In a case like this the foul is penalised and the violation is disregarded. If the Referees agree that both players were fouling on each other, then a double foul shall be ordered. (Rule 3, Section 9).

Ques.— 9. When does a substitute become a player?

Ans.— When he has reported to the Scorers, his name and number entered in the score book, and been finally recognised by either Referee. In the absence of a coach or other person authorized to make substitutions, the captain of the team will order the substitution. Rule 4, Section 4.

Ques.— 10. Shall a substitute go on to the court while the ball is in play?

Ans.— No. Substitution from outside must be controlled by the Scorer. The Scorer shall give the signal for time out for substitution only when the ball is dead. It is essential that the Scorer's signals be different from that of the Referee. The player to go in as substitute must have his name and number entered in the score book and ready to get on to the court to report himself to the Referee and the person for whom he is substituting. (Rule 4, Section 4).

Ques.— 11. How much time shall a substitution take?

Ans.— Not more than 30 seconds. If more than 30 seconds are taken, then it will be taken as a charged time out.

Ques.— 12. What is the penalty for a player for entering the court or leaving the court without the approval of the officials?

Ans.— A technical foul and the ball is dead after the throw for goal. The game shall be restarted in the centre. (Rule 13, Section 2).

Ques.— 13. How many substitutes are allowed in a game?

Ans.— Only five. (Rule 4, Section 3).

Ques.— 14. When is a player out of bounds?

Ans.— A player is out of bounds when any part of his body touches the boundary line or the floor outside of the boundary line. (Rule 5, Section 2).

Ques.— 15. When is the ball out of bounds?

Ans.— When any part of the ball touches the boundary line, or the floor outside the boundary line. (Rule 5, Section 2).

- Ques.*— 16. What is a double foul?
Ans.— When fouls are called simultaneously upon two players of both teams in the same play. One player may have blocked and the other pushed, all taking place simultaneously and in the same play.
- Ques.*— 17. What is the procedure when a double foul is ordered?
Ans.— One free throw for either players. The ball is dead after the second throw and the game restarted in the centre. (Rule 5, Section 15).
- Ques.*— 18. Should teams be notified between halves that three minutes remain for intermission?
Ans.— Yes.—The Referees shall be responsible for letting the captain know this through the Time-keeper or Scorer. (Rule 6, Section 2).
- Ques.*— 19. What should be the decision if the Time-keeper gives his signal for half time or time up and a goal is scored?
Ans.— If the ball had left the player's hands before the signal was given, the goal counts. If the ball left after the signal, the goal does not count. (Rule 3, Section 13).
- Ques.*— 20. What should be done if simultaneously with the Time-keeper's signal a foul is committed?
Ans.— Time shall be allowed for the free throw. (Rule 6, Section 10).
- Ques.*— 21. When may a team call time out and how many?
Ans.— Any time when the ball is dead or when a team is in possession of the ball. In the latter case the ball is put into play by the same team from out of bounds at the point opposite the location of the ball when time was called. A team is entitled to four charged time outs. The penalty for taking more than four charged time-outs is a technical foul against the team. (Rule 9, Sections 1 and 2).
- Ques.*— 22. Shall a coach or captain request time-out for rest?
Ans.— Yes. The period for such time-outs shall not exceed one minute. (Rule 9, Section 2).
- Ques.*— 23. Where should the ball be tossed up for a Held Ball inside the goal area?
Ans.— The goal area is enclosed between the free throw line extended ideally and the corresponding end lines. For Held Ball within the area, the toss up

shall be at the nearest spot on the free throw line or its extension. (Rule 10, Section 2).

Ques.— 24. What are the duties of the Referee when a foul is called on a player?

Ans.— The Referee shall immediately get possession of the ball and forthwith place it on the free throwline or in the hands of the player concerned. The free throw shall be taken within 10 seconds after this. A whistle should be given indicating that the throw may be attempted. (Rule 11, Sections 1, 2, 3, and 4).

Ques.— 25. What are the duties of the Time-keeper when a foul is called?

Ans.— He shall stop the watch whenever a foul is called. For when to restart the watch see Rule 9, Section 1.

Ques.— 26. How shall a tie be broken?

Ans.— If the score is a tie at the expiration of the second half, play shall be continued with change of baskets for an extra period of 5 minutes or as many periods of 5 minutes as may be necessary to break the tie. One minute intermission shall be allowed before each extra period. (Rule 7, Section 3).

Ques.— 27. How many free throws are given for personal foul on a player in the act of shooting for a basket?

Ans.— One free throw if a goal is scored in spite of the foul. Two throws if the goal is missed. (Rule 13, Penalty under Section 13).

Ques.— 28. What should be the procedure if a player is fouled by two or more opponents?

Ans.— If two or more personal fouls are committed against a player, whether or not in the act of throwing for goal, one free throw shall be awarded for each foul and a personal foul be charged to each offender. (Rule 13, Penalty under Section 13).

Ques.— 29. Under what circumstances could players leave the court?

Ans.— Only with the approval of the Referee as in a substitution or in case of an injury, and also during the intermission period between halves. At all other time-out period for rest, they should be on the court and should not in any manner communicate with the coach or players outside.

Ques.— 30. What is the penalty for coaching during play by coaches or players from outside the court?

Ans.— The Referee may be obliged to call a technical foul. If the offence is repeated, the Referee has the power to order the offender from the vicinity of the court and may even forfeit the game to the opponents if the order is not obeyed. (Rule 13. B., Conduct of Coaches).

Ques.— 31. Should Referee handle the ball when the ball goes out of bounds?

Ans.— Yes, the Referee should handle the ball when the ball goes out of bounds in the attacker's front court, but not in the back court.

Ques.— 32. What is the procedure if a free throw fails to strike any part of the basket or backboard and does not pass through the basket but goes out of bounds?

Ans.— The ball is taken out of bounds under the basket by the opponents. (Section 4, Rule 11).

Ques.— 33. What is the procedure if a free throw misses the basket and backboard and falls within bounds?

Ans.— The ball is in play the moment it touches the floor and any player may take possession of it. (Section 4, Rule 11).

Ques.— 34. What is the procedure in such a free throw if the ball is touched accidentally or intentionally by any player before it strikes the ground?

Ans.— Ball is given out of bounds to the opponents of the player who touched the ball.

Ques.— 35. What is a disqualifying foul?

Ans.— A disqualifying foul is one for which a player may be turned out of the game by the Referee. A player may be disqualified for dangerous play, unnecessary roughness, and unsportsmanlike conduct.

Ques.— 36. A free throw for goals is being made and a defending player steps in. What is the penalty?

Ans.— If the goal is made, the basket counts. If the goal is not made a substitute throw is ordered. (Section 7, Rule 12).

- Ques.*— 37. A free throw is being made and one of the attacking teams steps in. What is the penalty and how is the ball to be put into play?
Ans.— The goal if made shall not count and if made or missed the ball shall be tossed up at centre. (Section 7, Rule 12).
- Ques.*— 38. What is the procedure if players of both teams violate this rule?
Ans.— The goal if made shall not count and whether missed or made the ball shall be tossed up at the centre. (Section 7, Rule 12).
- Ques.*— 39. What is kicking the ball?
Ans.— Kicking the ball is advancing the ball with the foot or leg. Accidental touching of the ball by the foot or leg must be overlooked. Referee must use his discretion.
- Ques.*— 40. Is a player allowed to roll the ball on the court?
Ans.— The ball may be passed to a team mate by rolling it, but a player is not permitted to advance the ball by rolling it. This should be treated as an illegal dribble. (Section 10, Rule 5).
- Ques.*— 41. What is the penalty for interfering with the opponent's basket, backboard or net to prevent the ball from entering the basket?
Ans.— A technical foul for which two free throws are awarded. (Section 12, Rule 12).
- Ques.*— 42. How many players are allowed to take positions along the foul-lanes at the time of a free throw and what will be the arrangement of the players?
Ans.— There will be no more than three players on each side of the lane and they will take alternate positions by teams.
- Ques.*— 43. Is sliding on the court with the ball in possession allowed?
Ans.— Yes, provided the player concerned makes an honest attempt to stop.
- Ques.*— 44. In a jump-ball may one of the players not jump?
Ans.— Yes, but he is not permitted to leave the circle till the ball is tapped by the other player. For leaving the circle before the ball is tapped, the penalty is a technical foul.

SUGGESTIONS TO THE REFEREES

1. Be properly dressed for officiating the game. The Referee must wear some distinguishing costume from both teams.
2. Do not agree to officiate unless the teams distinguish uniforms and the players are numbered.
3. See that Scorer and Time-keeper have some method of signalling other than a whistle. The use of whistle by all the officials lead to confusion. The Scorer and Time-keeper may use the same signal. A small horn, or a bell may be used.
4. Check up with the Scorer and see that the names of the players of both teams are entered properly in the score book. Also check up on the equipment.
5. The Double-Referee system is recommended. If this system is being followed, confer with your colleague about sharing responsibilities.
6. Remember the first few minutes are very important. Get the game under your control from the very beginning. It will be difficult to recover lost steps later. Never let players run off with the game by your indifference in the beginning. From the very start, follow the ball closely and call all infractions of rules and fouls. Impress the players and the spectators that you mean business. Very soon you will see that things go on smoothly.
7. Call all the violations of rules and fouls so that the players and other officials hear and understand what you say. Also signal the number of points for each field goal or free throw for personal foul or technical foul.
8. Designate the team that is to put the ball into play when it goes out of bounds. This is very important, otherwise, players will fight for possession of the ball. Check the ball when it goes out of bounds to a team in its front court.
9. Designate the player and his number when he commits a personal foul. Get possession of the ball and either hand it over to the player who has been fouled or place the ball on the foul line. Before allowing the attempt for the free throw, insure that each team has sufficient time to take places along the free-throw lanes.
10. Watch all play closely especially under and around the basket.
11. Get possession of the ball that is to be used, and at the end of the first half. It shall not be used for practice by either teams. Between the halves, teams are allowed shooting practice.
12. Read up the rules before you go on to the court and clear your doubts. And remember a good Referee works harder on the court than the players.

BASKETBALL

Team.....
 Court.....Time.....Date.....
 Referee.....
 Umpire.....

BASKETBALL

First Half		Second Half		First Half		Second Half	
R.F.	Running Score	Running Score	R.F.	Running Score	Running Score	Running Score	Running Score
L.F.			L.F.				
C.			C.				
R.G.			R.G.				
L.G.			L.G.				

SCORE—1st Half.....2nd Half.....Final.....
 Field Goals.....Free Throws.....Fouls.....
 Field Goals.....Free Throws.....Fouls.....

Time Out, 1st Half and Half
 Time Out, 1st Half and Half

SCORING: Field Goal, 2 ; Free Throw, 1 ; Free Throw Missed, O. Indicate Personal Foul with letter P. and subscript numeral, Technical Foul with T. In Running Score column add points as they are made. When a substitute goes in, write his name in space under name of man whose position he fills.

.....
Officer's Signature.

FINAL SCORE.....
 FINAL SCORE.....

Volleyball

As Adopted By The Indian Olympic Association RULE I. GROUNDS

SECTION 1. The playing surface shall be a rectangular court 60 feet long and 30 feet wide, including outer edge of lines, free from obstructions and having a height of 15 feet or more which is free from apparatus or other obstructions or projections.

Note.—The size of the court may be modified for either indoor or outdoor informal games to accommodate larger or smaller groups to suit local requirements. It is urged that the standard size court be used in all match games, where possible.

SECTION 2.—The court shall be bounded by well defined lines two inches in width, and which shall be at every point at least three feet from walls or any obstructions. The lines on the short sides of the court shall be termed the "end lines," those on the long sides the "side lines."

SECTION 3.—A centre line, two inches in width, shall be drawn on the court immediately beneath and parallel to the net. It is assumed that the centre line is extended indefinitely beyond the side lines. (See Rule X, Sec. 13.)

SECTION 4.—To mark the service area, a line 6 inches long and 2 inches wide shall be drawn on the floor outside of the end line and parallel with and 10 feet from the right side line. The near end of this line shall begin 2 inches back of the end line. (See diagram).

RULE II. NET

The net shall be three feet wide over all and 32 feet in length when stretched. It shall be made of four-inch square mesh of black or dark brown No. 30 thread. The net shall be bound top, ends and bottom with one-quarter inch manila rope. A double thickness of white canvas, two inches wide, shall be sewed to the top and ends of the net, through which shall be run a flexible galvanized cable three eighths inch in diameter.

The net shall be tightly stretched by the four corners between walls or uprights which are entirely outside the court, and it shall cross the court midway between the end lines and parallel to them. The cable shall be drawn so as to permit as little sag as possible and

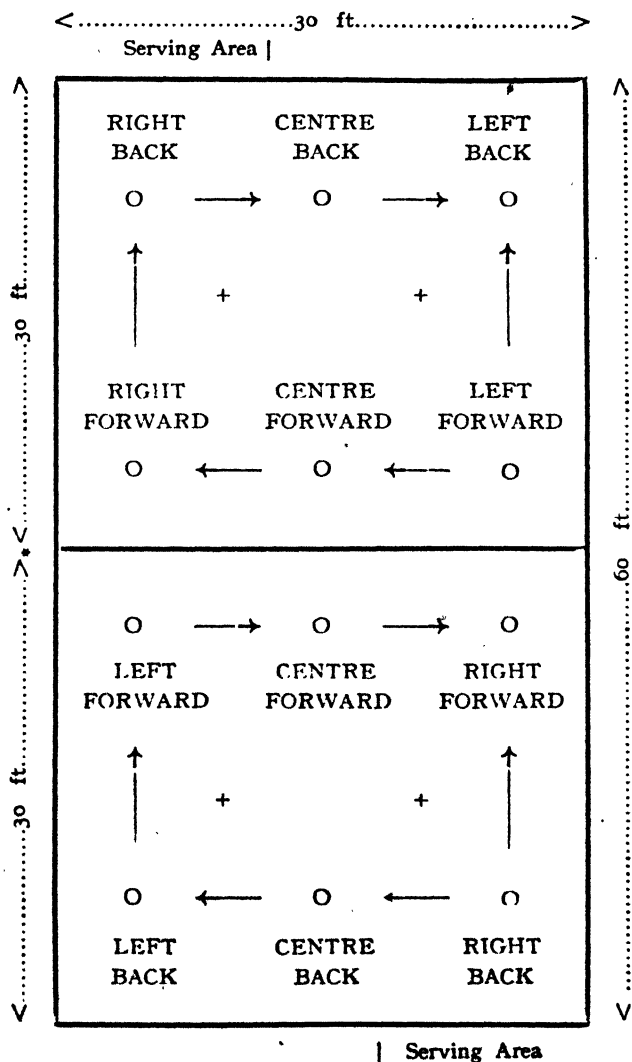

**DIAGRAM OF VOLLEYBALL COURT, SHOWING POSITION
OF PLAYERS AT START OF A GAME AND
THE METHOD OF ROTATION**

the top of the net shall be level and measure eight feet from the centre to the ground. The bottom of the net shall be drawn taut by ropes anchoring the lower corners to the side uprights or the floor, not less than 3 feet from the side lines.

A marker shall be placed on the tape on the top of the net directly above the side lines. A one-inch vertical marker of soft material should be placed the entire width of the net, vertical to the side lines.

RULE III. BALL

The ball shall be round and shall consist of a rubber bladder covered with a leather case. It shall be not less than 26 inches nor more than 27 inches in circumference, and shall weigh not less than nine ounces nor more than ten ounces. The air pressure of the ball shall be not less than $7\frac{1}{2}$ pounds and not more than 8 pounds.

Note 1.—When playing outdoors, by mutual consent a slightly heavier ball may be used, but it shall not exceed twelve ounces in weight.

Note 2.—The use of a balanced ball is recommended.

RULE IV. TEAMS

SECTION 1.—In all official matches teams shall be composed of no more or no less than six (6) players. When for any reason a team is reduced to less than six (6) players the game shall be forfeited to the opposing team.

Note.—Ordinary games could be played with nine (9) players on a side.

SECTION 2.—Substitutes and coaches shall be seated on the side of the court opposite the Referee.

SECTION 3.—A substitute may take the place of a player only when the ball has been declared "dead." The Captain or the incoming substitute shall first request "time out" for substitution from the Umpire, and when such substitution has been authorized, the substitute shall report to the Scorer. Substitute shall take the position of the player for whom he is substituting. He shall not converse with any other player until the ball has been served. No change shall be made in the position of players when a substitution is made.

SECTION 4.—A player taken out of the game may not re-enter the same game, but he may play in any subsequent game of the same match, except as provided for in Rule XIII.

SECTION 5.—In match games or tournaments a squad shall consist of not more than twelve different players.

SECTION 6.—Players shall be numbered with numerals placed conspicuously on the front and back of each player, not less than 6 inches, in size.

SECTION 7.—Players shall take their position as indicated in the diagram on page 95. The positions shall be known by the names indicated, viz., Left Forward, Centre Forward, Right Forward, Right Back, Centre Back, Left Back.

SECTION 8.—When the ball is served, each player shall be in his own area. After the ball is served, each player may cover any section of his own court (except as provided for in Rule X, Sec. 17).

Note.—The purpose and spirit of this rule must not be violated by deliberate and frequent interchange of positions. Such violations constitute a foul. This should not be interpreted to prevent a player from going outside his own area to play the ball, but it should prevent interchange of positions being maintained for any considerable period of play.

SECTION 9.—No player may leave the court in making a play unless the ball is on his side of the net. (“Side out” or “point.”)

SECTION 10.—Each court shall be marked with two crosses to indicate its division into six equal areas. Crosses shall be made of white lines—one (1) inch wide and six (6) inches long—parallel with the side and end lines. (See diagram).

RULE V. OFFICIALS

The officials shall be a Referee, Umpire, Scorer, and two linesmen.

RULE VI. DUTIES OF OFFICIALS

SECTION 1.—The Referee shall be the superior official of the game. He shall decide when the ball is in play, when it is dead, when a point has been made, when side is out, and shall impose penalties for all violations of the rules. (See Rules X and XIII.)

SECTION 2.—The Referee shall have the power to make decisions on any and all questions concerning the violations of the rules committed at any time from the beginning of play to the end of the match. This includes the periods when the game may be momentarily stopped for any reason. He shall have power to make decisions on any question not specifically covered in the rules. *He shall have the power to overrule the decisions*

of the other officials when in his opinion they have made an error.

SECTION 3.—The Referee shall station himself at one end of the net in a position that will give him an equally clear view of both courts.

Note.—The best position is one in which the eyes of the Referee arc from two to three feet above the net.

SECTION 4.—The Umpire shall take a position on the opposite side of the court from the Referee. He shall make decisions regarding crossing of the centre line below the net, shall keep official time of "Time-outs," control coaching from the sidelines by coaches and substitutes, authorize the substitution of players, *call contact at the net, call double contact in handling the ball, call attention of the Referee to violations involving unsportsmanlike conduct,* and assist the Referee in any manner which may be requested by the Referee.

SECTION 5.—The Scorer shall keep the official record and score of the game. He shall be seated beside the Umpire, opposite the Referee. Before the game the Scorer shall secure from each manager or captain names of players and substitutes and the serving order of the teams, and shall see that the players follow the serving order and rotate in position.

SECTION 6.—The Linesmen shall station themselves on the opposite corners of the court, so that each has one back and one side line in plain view, and whenever the ball strikes the ground near these lines the Linesmen shall assist the Scorer in seeing that the players follow the serving order and play in rotation.

Note.—Additional Linesmen may be added when deemed necessary.

SECTION 7.—Upon request, the Linesmen shall report to the Referee their views of any circumstance about which he may be uncertain. Linesmen shall watch every play and be ready to assist the Referee in making a decision, when requested.

RULE VII. DEFINITION OF TERMS

SECTION 1.—The court occupied by a team shall be called its own court; that occupied by the opponents, the opponents' court.

SECTION 2.—The order in which the teams are to serve shall be called the "serving order."

SECTION 3.—The shifting of the men in position shall be called "rotation."

SECTION 4.—A "service" is the putting of the ball in play by the player in the "Right Back" position, by batting it over the net into the opponents' court in any direction with one hand (open or closed) and while in a position with both feet wholly behind the right one-third of the back line of the court *before and until after the ball is struck.*

Note 1.—The back line of the court should be marked so as to indicate the serving area. (See diagram, page 95.)

Note 2.—Reference to the feet being back of the line applies also to the position of the feet while in the air.

SECTION 5.—"Point" shall be called when the team receiving fails to return the ball legally to the opponents' court.

SECTION 6.—"Side out" shall be called when the team serving fails to win its point or plays the ball illegally.

SECTION 7.—The ball is "dead" after "point," "side out," or any other decision temporarily suspending play.

SECTION 8.—A player who touches the ball, or is touched by the ball, when it is in play shall be considered as playing the ball.

SECTION 9.—The ball is out of bounds when it touches any surface or object, or the ground outside of the court. A ball touching a boundary line is good.

SECTION 10.—When the ball momentarily comes to rest in the hands or arms of a player he shall be considered as catching or holding the ball. The ball must be clearly batted. Scooping, lifting, shoving or following the ball shall be considered as holding.

SECTION 11.—A player touching the ball more than once with any part of his body when the ball meanwhile has not been touched by another player shall be considered as "dribbling." (See Rule IX, Sec. 2).

SECTION 12.—Any player committing any act which, in the opinion of the Referee, tends to slow down the game unnecessarily shall be considered as delaying the game.

RULE VIII. COURTS AND SERVICE

SECTION 1.—The captain shall toss for courts or service. The winner of the toss may choose either to take the first service or his choice of courts.

SECTION 2.—At the opening of the game the ball shall be put in play by the player in the "Right Back" position. (See Rule VII, Sec. 4).

SECTION 3.—Each server shall continue to serve until the Referee calls “side out.”

SECTION 4.—Service shall alternate as “side out” is called.

SECTION 5.—The team receiving the ball for service shall immediately rotate one position, clockwise.

SECTION 6.—The principle of rotation applies to the position of players when the ball is served.

SECTION 7.—A ball striking the net outside of the vertical side line marker on the net shall be considered a “*point*” or “*side out*.”

SECTION 8.—When a served ball touches the net, passes under the net or touches any player, surface or object before entering the opponents’ court, “side out” shall be called.

SECTION 9.—If a player serves out of turn, “side out” shall be called and any points made on his service before the error was discovered shall not be scored.

SECTION 10.—The team losing the previous game shall have the first service in the succeeding game.

SECTION 11.—Teams shall change courts at the end of each game.

SECTION 12.—At the beginning of a new game the players may be arranged in any position desired regardless of former positions in the preceding game. The Scorer shall be notified of change in positions of players.

SECTION 13.—*In matches where odd games are played in the final and deciding game*, the team with the lesser score may request change of court as soon as the opposing team has scored eight points, but the service continues with the player who has just scored the eighth point.

SECTION 14.—*There shall be no deliberate massed screening of the server.* (“*Point*” or “*side out*.”)

Note 1.—The Left Forward and Centre Forward move one position to the right. The Right Forward moves to the Right Back position; the Right Back and Centre Back move one position to the left, and the Left Back moves to the Left Forward position.

Note 2.—If teams consist of large numbers with more than two lines, the odd lines, beginning with the Forwards, move to the right, and the even lines move to the left.

Note 3.—At the beginning of the game, after the team first serving has lost the serve, their opponents shall rotate for their first serve, the same as at other items.

RULE IX. PLAYING THE BALL

SECTION 1.—The ball may be batted in any direction, and a player may use any part of his body above the hips in playing the ball.

SECTION 2.—*A ball may touch any number of parts from the hips up, and if all are simultaneous and the ball is not held, but is batted or deflected quickly it is legal.*

SECTION 3.—A ball other than a service touching the top of the net, and going over into the opponents' court, is still in play.

SECTION 4.—*In a legal return* the ball must pass over the net within OR OVER the marker on the tape on the top of the net directly above the side line.

SECTION 5.—A ball other than a service may be recovered from the net, provided the player avoids *contact with* the net.

SECTION 6.—The ball may be touched only three times by one team before being returned over the net.

Note.—This does not prevent a man from playing the ball twice, provided the rule against dribbling is not violated; that is, a man may be the first and third to play the ball. This means of course, that he is also eligible on his second play to return the ball over the net.

RULE X. POINTS AND SIDE OUT

If any player of the serving team shall commit any of the following acts, it shall be "side out"; if any player of the receiving team shall commit any of the following acts, one point shall be scored for the serving team.

- (1) Serve illegally. (See Rule VIII, Secs. 8 and 9).
- (2) Fail to return the ball legally to the opponents' court. (See Rule VII, Sec. 5 and Rule IX, Sec. 3).
- (3) Catch or hold the ball. (See Rule VII, Sec. 10).
- (4) Dribble (See Rule VII, Sec. 11).
- (5) Allow the ball to touch his person or clothing below the hips.
- (6) *Contact with* the net with any part of the body at any time except when the ball is "dead." However if two opponents *contact* the net simultaneously, neither "point" nor "side out" shall be called; *this constitutes a double foul.*

(7) Touch the ball when it already has been played three times before being returned over the net. *A ball striking the net outside of the marker shall be considered a "dead" ball.*

(8) Reach over the net under any circumstances whatsoever.

(9) *Serve out of turn.*

(10) Reach under the net and touch the ball or a player of the opposing team when the ball is in play on that side, or interfere with the play of the opposing team by entering their court.

(11) Illegal substitution. (See Rule IV, Sec. 4).

(12) Play out of position. (See Rule IV, Secs. 3 and 7).

Note.—If player touches opponents' court in completing a play, it shall be called a foul, even if he does not touch the floor until after the ball has hit the floor.

(13) Touch the floor on the opposite side of the centre line or an imaginary line extended indefinitely beyond the side lines. (See Rule I, Sec. 3).

(14) Enter opponent's court in an attempt to recover the ball. Reaching under the net with one or both hands but keeping the feet in own court is allowed.

(15) Receive deliberate coaching from outside the court. (See Rule XIII, Sec. 5).

(16) Persistently delay the game. (See Rule VII, Sec. 12).

(17) "Spike" or "kill" the ball when playing a back position.

Note.—This is to prevent one-man monopoly and to encourage team play. This rule should not be interpreted to prevent regular volleying by back players. In other words, a player who is in a back position, when the ball is put into play, cannot run forward to a net position and "kill" or "spike" the ball.

(18) *No player may leave the court in making a play unless the ball is on his side of the net.* (See Rule IV, Sec. 9).

(19) Leave the court *during "Time out"* without permission from the Referee. (See Rule VIII, Sec. 14).

(20) A Double Foul shall be called when players on opposing sides commit a foul simultaneously. In case of a Double Foul the ball shall be played over. A foul committed by a player in the same play at the net in which an opponent also commits a foul, shall be considered a Double Foul even if the fouls do not occur at the same instant.

Note.—In a play at the net the play of all players shall not be considered as completed until they have resumed their normal controlled position on the floor.

(21) *Deliberate stamping of the feet and jumping on the floor or vigorous waving of the arms immediately in front of an opponent about to play the ball, shall be ruled as unsportsmanlike conduct. ("Penalty," "Point" or "side out").*

(22) *There shall be no deliberate massed screening of the server. (See Rule VIII, Sec. 14).*

RULE XI. TIME OUT

SECTION 1.—"Time out" may be called by the Referee only, but the ball shall be in play until the whistle is blown by the REFEREE or UMPIRE. *When requesting "Time out" the Captain shall indicate whether it is "Time out" for rest or for substitutions. When neither is indicated, the REFEREE shall assume that it is "Time out" for rest. "Time out" for rest shall be allowed each team only twice during a game and may be requested only by the Captains. "Time out" for substitution of players or because of injury shall not be considered rest periods.*

SECTION 2.—During "Time out" for rest, either team may have a ball for practice, but only on its own respective court. During "Time out" for substitution, the in-coming substitutes may have a ball for practice for "warming up," which may involve the use of both courts.

SECTION 3.—The length of "Time out" for rest or for substitution shall not exceed one minute, and a maximum of five minutes in case of injury, provided the injured player is going back into the game.

RULE XII. SCORING

SECTION 1.—Failure of the receiving team to return the ball legally over the net into the opponent's court shall score one point for the team serving. (See Rule X).

SECTION 2.—A game is won when either team scores a two-point lead with fifteen (15) or more points.

Note.—Fifteen points always constitute a game unless the two contending teams arrive at "deuce" with a score of 14 points each. In this case play continues until one team obtains a two-point lead.

SECTION 3.—The number of games necessary for the winning of a match or Championship shall be determined by the Tourna-

ment Committee. If there is no Tournament Committee, the Managers of the contesting teams shall decide. The usual rule is that a match shall consist of three games.

RULE XIII. CONDUCT OF PLAYERS, SUBSTITUTES AND COACHES

The Referee shall have power to warn, declare "side out" or "point," or to disqualify for the game or match any player committing any of the following or other gross violations of sportsmanship.

- (1) Persistently address the officials in regard to decisions.
- (2) Make derogatory remarks about or to the officials.
- (3) Commit acts derogatory to the officials, or actions tending to influence their decisions.
- (4) Make personal or derogatory remarks about or to opponents.

This rule applies also to substitutes and coaches.

A substitute shall take the place of a disqualified player.

- (5) No deliberate coaching by coaches, officials, substitutes or spectators, shall be permitted from outside of the court. (See Rule X, Sec. 15).

RULE XIV. FORFEITED GAME

Any team refusing to play after receiving instructions to do so from the Referee shall forfeit the game or match.

RULE XV. DECISIONS

SECTION 1.—Decisions of the officials as to matters of fact are final.

SECTION 2.—Decisions pertaining to the interpretation of the rules must be called into question at once if a protest is to be filed later, but only by the captains of the contesting teams.

SECTION 3.—When a question pertaining to interpretation of the rules has not been settled conclusively by the Referee, but will be carried to higher authority for decision, the game shall proceed as directed by the REFEREE, who shall make proper note of the protest.

VOLLEYBALL

FOR BOYS, GIRLS AND WOMEN

The rules are the same as those for men except in the following instances:

1. The height of the net may be 7 ft. 6 inches or 7 ft. to suit conditions and players.
2. The ball must be light and may weight from 7 to 11 ounces.
3. The number of players may be from 6 to 9 on a side.
4. Rotation will be optional.
5. A player is given two trials in serving.
6. The server may receive one "assist." This means that a team mate may play a ball which has been served and thus assist in going over the net. This is optional.
7. The ball may be played by the same person twice in succession but no more than twice, before being played by another player.
8. The ball may be played any number of times before being returned over the net provided the same player does not touch it more than twice in succession.
9. A game consists of two halves of 10 or 15 minutes each, with a 5 minutes' rest between halves.
10. The team not having had service at the opening of the game is given service at the beginning of the second half.
11. A game is won by the team scoring the most points during the playing time.

QUESTIONS AND ANSWERS

No. 1. Rule 4, Section 4

Ques.—May a player re-enter the same game after he has been substituted by another player?

Ans.—No. He may play in subsequent games only.

No. 2. Rule 4, Section 6

Ques.—Is it necessary to have the players numbered?

Ans.—Yes; in fact, the rules now call for numbers on both the front and back of the player's uniform.

No. 3. Rule 4, Section 9, and Rule 10, Section 18

Ques.—When may a player leave the playing court and not be penalized?

Ans.—Only when the ball is on his side of the net, or when the ball is dead and he has received permission to do so from the Referee.

No. 4. Rule 4, Section 10

Ques.—How may a player know the area within which he is to stand when the ball is being served?

Ans.—Two crosses marked on the floor divide each court into six equal areas. These crosses serve as guides to players and officials.

No. 5. Rule 6, Section 2

Ques.—When may a Referee over-rule a decision by a minor official?

Ans.—When in his opinion a mistake has been made.

No. 6. Rule 6, Section 4

Ques.—Can the Umpire call a foul for contacting the net?

Ans.—Yes; he is not only given power to call this foul but also to call double contact.

No. 7. Rule 7, Section 4

Ques.—In serving the ball is it permissible to project one foot beyond the serving line, even though it does not touch the floor?

Ans.—No; both feet must remain entirely behind the serving line until after the ball has been hit.

No. 8. Rule 8, Section 12

Ques.—Is it permissible to rearrange players at the beginning of each game in a match?

Ans.—Yes; but scorer must be notified of changes in position.

No. 9. Rule 8, Section 13

Ques.—When may a change of courts be requested?

Ans.—Only in the deciding game of a series, and only by the side with the lesser score when the opponents have scored eight points.

No. 10. Rule 8, Section 14

Ques.—Must a player stay in the center of his playing area before the ball is served?

Ans.—It is not necessary to do so; he may stand in any location within his area, provided he does not gather with others of his own side to screen the server.

No. 11. Rule 9, Section 2

Ques.—If a hard driven ball is received by the defence in such a position that it touches several parts of the body at the same time, is this a multiple contact foul?

Ans.—No; provided the ball immediately leaves the body.

No. 12. Rule 9, Section 2

Ques.—When is a net ball in play?

Ans.—At all times except on the service. A net ball on the service is "side out."

No. 13. Rule 10, Section 8

Ques.—Is it a foul if a player is touched by the net by reason of a hard driven ball into the net by an opponent?

Ans.—Yes; it counts the same as if the player had deliberately touched the net himself.

No. 14. Rule 10, Section 17

Ques.—May any player "spike" or "kill" the ball?

Ans.—Yes; but only when he is playing a forward position. A back line player may return the ball over the net, but he cannot "kill" it from a forward position.

No. 15. Rule 10, Section 20

Ques.—If, in attempting to make a net play in which two players are involved, the one touches the net on the spike and the other comes to floor and then falls over the line or touches the net, are both penalized?

Ans.—Yes; it is a double foul. The play is not complete until all players concerned have assumed their normal controlled position on the floor.

No. 16. Rule 10, Section 21

Ques.—What is the penalty for stamping feet on the floor or yelling at an opponent to divert his attention?

Ans.—A foul, loss of serve or point.

No. 17. Rule 12, Section 2

Ques.—Does a team first scoring 15 points win the game?

Ans.—Not always. If the score is tied at 14—14 the game is won by the team first scoring a two-point lead.

HAND SIGNALS FOR REFEREES

1. **Point scored**..... Raise right hand pointing index finger toward team which has scored.
2. **Side out**..... Drop arm parallel to body, with index finger and hand pointing toward team about to take possession of the ball.
3. **Time out (for any reason)**..... Extend both arms at right angles to body, fingers extended, each hand pointing toward a team.
4. **Caught or held ball**..... Hold both arms upright and flex hands back and forth.
5. **Ball touching clothing below hips**..... Indicating by touching yourself on the spot where ball touched player.

6. **Contact with net by served ball or player.....** Strike top of net with hand.
7. **Double foul.....** Cross both arms, forming letter "X," fingers of both hands extended.
8. **Ball touched by team more than three times.....** Hold right hand vertically, with four fingers extended.
9. **Double contact by same player.....** Hold right hand vertically, with first two fingers extended.
10. **Play out of position.....** Point right index finger at player who is out of position and at the same time blow your whistle.
11. **Reach over the net.....** Place either hand over top of net, with fingers extended.
12. **Scooping or following the ball.....** Make a scooping motion with both hands, similar to player committing error.
13. **Stepping over center line.....** Point right index finger to center line, hold left hand over top of net.

These signals cover the most common fouls committed by teams in tournament play. For the less common errors as covered in the rules, such as serving illegally, interfering with opponent's play, coaching from side lines, etc., the Referee should blow his whistle at the time the foul is committed and announce the foul indicating who committed the error.

A SPECIMEN
SCORE SHEET FOR VOLLEYBALL

.....Tournament

Place.....

Date.....

..... vs.

No.	PLAYERS Serving Order	Substitute	No.	PLAYERS Serving Order	Substitute
1			1		
2			2		
3			3		
4			4		
5			5		
6			6		

FIRST GAME

1, 2, 3, 4, 5, 6, 7, 8, 9, 10, 11, 12, 13, 14, 15,

1, 2, 3, 4, 5, 6, 7, 8, 9, 10, 11, 12, 13, 14, 15,

SECOND GAME

1, 2, 3, 4, 5, 6, 7, 8, 9, 10, 11, 12, 13, 14, 15,

1, 2, 3, 4, 5, 6, 7, 8, 9, 10, 11, 12, 13, 14, 15,

THIRD GAME

1, 2, 3, 4, 5, 6, 7, 8, 9, 10, 11, 12, 13, 14, 15,

1, 2, 3, 4, 5, 6, 7, 8, 9, 10, 11, 12, 13, 14, 15,

Score.....Umpire.....Referee.....

Softball

RULE 1. THE "DIAMOND"

The official "Diamond" shall have 60 foot base-lines, with a pitching distance of 43 feet.

Note—When a 45-foot diamond is used the pitching distance shall be 37 feet 8½ inches and all other details shall be the same as for the 60-foot diamond.

Determine the position of the home plate. Draw a line in the direction it is desired to lay the diamond. Drive a stake at the corner of the home plate nearest the catcher. Fasten a cord to this stake and tie knots, or otherwise mark the cord, at 43 feet, 60 feet, 84 feet 9 inches, and at 120 feet.

Place the cord (without stretching) along the direction line and at the 43-foot mark place a stake—this will be the front line at the middle of the pitcher's plate. Along the same line drive a stake at the 84 feet 9 inches mark—this will be the center of second base.

Place the 120 feet marker at the center of second base and, taking hold of the cord at the 60-foot marker, walk to the right of the direction line until the cord is taut (but not stretched) and drive a stake at the 60-foot marker—this will be the outside corner of the first base, and the cord will now form the lines to first and second bases. Again holding the cord at the 60-foot marker—walk across the field and in like manner mark the outside corner of third base. Home plate, first and third bases are wholly inside the diamond.

To check the diamond, place the home plate end of the cord at the first base stake and the 120-foot marker at third base. The 60-foot marker should now check at home plate and second base.

Check all distances with a steel tape whenever possible.

The Batter's Box. The batter's box (one on each side of home plate) shall measure 3×6 feet. The inside line of the batter's box shall be 6 inches from home plate. The front line of the batter's box shall be 3 feet in front of a line drawn through the center of home plate, and the back line shall be 3 feet back of the center of home plate.

The Catcher's Box. The catcher's box shall be 10 feet in length from the rear outside corners of the batter's boxes and shall be 8 feet 5 inches in width.

DIAGRAM OF PLAYING FIELD FOR PLAYGROUND BALL

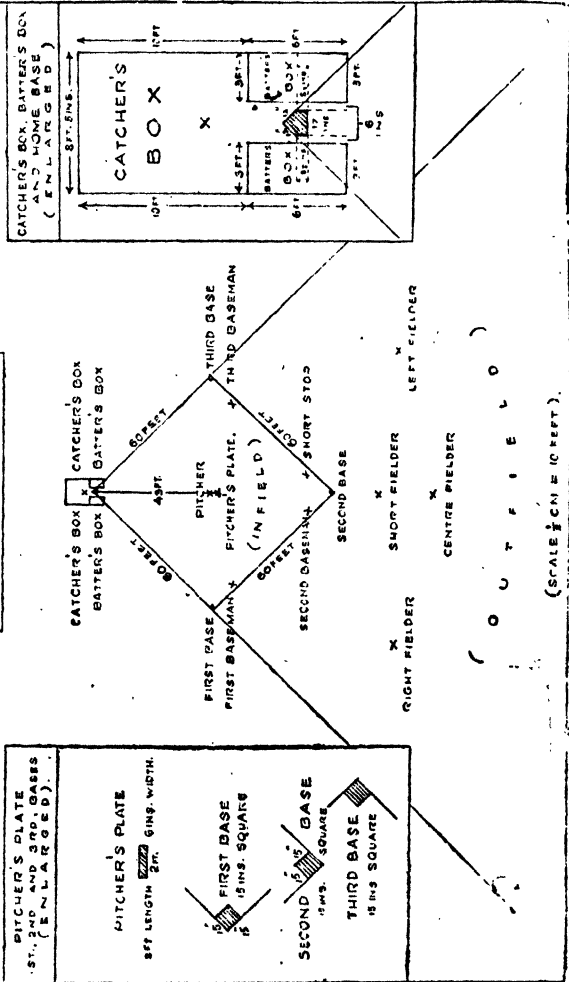

The Coacher's Box.—Starting at a point outside the diamond at first and third bases lines 15 feet in length shall be drawn toward the home plate, parallel to and 6 feet from the base-lines.

RULE III. EQUIPMENT

SECTION 1.—The bat shall be round, made of hard wood, and shall be of only one piece, not more than 34 inches in length and not more than $2\frac{1}{8}$ inches in diameter at its largest part. The bat shall have a safety grip of cork, tape or composition material. Such safety grip shall be not less than 10 inches in length and shall not extend more than 15 inches from the small end of the bat, and shall be marked "Official Softball Bat" to indicate that it conforms with the specifications of the rules regarding length and size.

Note.—A tolerance of $1/16$ inch is permitted to allow for expansion.

The bat shall have a safety grip of cork, tape or composition material. Such safety grip shall be not less than 10 inches in length and shall extend not more than 15 inches from the small end of the bat.

SECTION 2.—The official softball shall be a regular, smooth-seam, concealed stitch or flat-surfaced ball of any type.

Condensed specifications; Three to four ounces finest No. 1 quality Long Fibre Kapok compressed, hand or machine wrapped with fine quality twisted yarn, and covered with Latex or rubber cement. Cover of finest quality No. 1 Chrome Tanned Horse or Cow Hide with no imperfections, cemented to the ball by application of cement to underside of cover and sewed with Waxed Thread of Cotton or Linen.

The finished ball shall be not less than $11\frac{1}{4}$ inches nor more than $12\frac{1}{2}$ inches in circumference, and shall weigh not less than 6 ounces nor more than $6\frac{1}{2}$ ounces.

SECTION 3.—The home plate shall be made of rubber, or other suitable material, and shall be a five-sided figure 17 inches across the center and 17 inches across the edge facing the pitcher; the sides shall be parallel to the inside lines of the batters' boxes and shall be $8\frac{1}{2}$ inches in length; the sides of the point facing the catcher shall be 12 inches in length.

SECTION 4.—(a) The pitcher's plate shall be of wood or rubber, 24 inches long and 6 inches wide. The front line of the pitcher's plate shall be 43 feet from the outside corner of the home plate and the top of the pitcher's plate shall be level with the ground.

(b) For girl's play the official pitching distance shall be 35 feet.

SECTION 5.—The bases, other than home plate, shall be 15 inches square and shall be made of canvas or other suitable material.

SECTION 6.—Gloves may be worn by any player, but mitts may be used only by the catcher and first baseman.

Masks should be worn by catchers, and women catchers should wear both masks and body protections.

SECTION 7.—A shoe shall be considered official in Softball games if it is: (a) made with either canvas or leather uppers or similar material ; of rubber soles with or without soft rubber cleats ; (b) made with uppers of leather or similar material with hard-rubber cleats extending not over $\frac{3}{8}$ of an inch from the sole of the shoe ; (c) made with uppers of leather or similar material with metal spikes, provided the spike has blunt edges all around and does not extend more than $\frac{3}{8}$ of an inch from the sole of the shoe.

Track or any sharp spikes are illegal and will be barred.

RULE IV. TEAMS, PLAYERS AND SUSTITUTES

SECTION 1.—A team shall consist of 10 players, whose positions shall be designated as follows: Catcher, Pitcher, First Baseman, Second Baseman, Third Baseman, Shortstop, Short Fielder, Left Fielder, Central Fielder, and Right Fielder. Players of the team in the field may be stationed at any points on fair ground which their captain may elect, except that the pitcher, while in the act of delivering the ball to the batsman, must take his position as defined in Rule 8 and the catcher must be within the lines of his position.

SECTION 2.—No team shall be permitted to start or to continue a game with less than ten players and each side should have sufficient substitutes to carry out the provisions of this section.

SECTION 3.—A substitute may take the place of a player whose name is in his team's batting order, but the player for whom he is substituted shall not thereafter participate in the game, except as coacher.

SECTION 4.—A base-runner shall not have another player whose name appears in the batting order of his team run for him except by the consent of the captain of the other team.

SECTION 5.—In the event of the pitcher being taken from his position by either manager or captain, the new pitcher substituted for him shall continue to pitch until the batsman then at bat has

either been put out or has reached first base, or the side has been retired.

SECTION 6.—Whenever one player is substituted for another, whether as batsman, base-runner or fielder, the captain of the side making the change must immediately notify the umpire, who in turn must announce the same to the spectators. Play shall be suspended while the announcement is being made. Provided, however, that if through oversight such announcement has not been made, the substitute player will be considered as in the game, as follows:

If a pitcher, when he takes his place on the pitcher's plate.

If a batter, when he takes his place in the batter's box.

If a fielder, when he takes the place of the fielder substituted for.

If a runner, when the substitute replaces him on the base he is holding; and any play made by or on such unannounced substitute shall be legal under these rules.

RULE V. THE GAME

SECTION 1.—A regulation game shall consist of seven innings, unless the team second at bat scores more runs in six innings than the team first at bat has scored in seven innings.

SECTION 2.—It is a regulation game if the team last at bat in the seventh inning scores the winning run before the third man is out.

SECTION 3.—It is a regulation game if it be called by the umpire on account of darkness, rain, fire, panic or other cause which puts the patrons or players in peril, provided five or more equal innings have been played: or if the team second at bat shall have scored more runs at the end of its fourth inning than the team first at bat has made in five completed innings.

SECTION 4.—If the game be a tie at the end of seven innings for each team, play shall be continued until one side has scored more runs than the other in an equal number of innings; provided that if the side last at bat scores the winning run before the third man is out in any inning after the seventh, the game shall terminate and be a regulation game.

SECTION 5.—A regulation drawn game shall be declared by the umpire if the score is equal on the last even inning played, when he terminates play in accordance with Section 3 of this rule after each team has played five or more complete innings. If

the side that went second to bat is at bat when the game is terminated, and has scored in the incompleting inning the same number of runs as the other side, the umpire shall declare the game drawn without regard to the score of the last equal inning. If the side last at bat shall, before the completion of its fifth inning, equal the score made by the opposing side in five complete innings, the game shall be legally drawn.

Note.—A regulation drawn (tie) game is to be replayed from the beginning. However, if batting and fielding records are kept, players should be given credit for performance in regulation drawn games.

RULE VI. FORFEITED GAMES

A forfeited game shall be declared by the umpire in favour of the team not at fault, in the following cases.

SECTION 1.—If a team fails to appear upon the field, or being upon the field, refuses to begin a game for which it is scheduled or assigned at the time scheduled or within the time set for forfeitures by the organization in which the team is playing.

SECTION 2.—If, after the game has been begun, one side refuses to continue to play, unless the game has been suspended or terminated by the umpire.

SECTION 3.—If, after play has been suspended by the umpire, one side fails to resume playing within two minutes after the umpire has called "Play."

SECTION 4.—If a team employs tactics palpably designed to delay the game.

SECTION 5.—If, after warning by the umpire, any one of the rules of the game is wilfully violated.

SECTION 6.—If the order for the removal of a player is not obeyed within one minute.

SECTION 7.—If, because of the removal of players from the game by the umpire, or for any cause, there are less than ten players on either team.

RULE VII. CHOICE OF INNINGS—FITNESS OF FIELD FOR PLAY

The choice of innings shall be by toss of a coin, unless otherwise stated in the rules of the organization under which the schedule is being played.

Where a home team is designated, such team shall be the sole judge of the fitness of the ground for beginning a game. Where

no home team is designated, the umpire, or umpires, shall be the judge of the fitness of the ground for beginning a game.

After play has been called by the umpire he alone shall be the judge as to the fitness of the ground for resuming play after the game has been suspended.

RULE VIII. PITCHING RULE

(a) Preliminary to pitching, the pitcher shall come to a full stop, facing the batsman, with the ball held in both hands in front of the body, and with both feet squarely on the ground and in contact with the pitcher's plate, for not less than one second, before taking one hand off the ball at the start of the wind-up or backswing.

Note.—One second of time may be determined by repeating at ordinary conversational speed the words, "One Thousand and One."

(b) The pitcher shall not be considered in pitching position unless the catcher is in position to receive the pitch.

(c) In the act of delivering the ball to the batsman the pitcher shall not take more than one step which must be forward and toward the batsman. The step must be taken simultaneously with the delivery of the ball to the batsman.

(d) A legal delivery shall be a ball which is delivered to the batter underhand and with a follow through of the hand and wrist past the straight line of the body before the ball is released. The pitcher may use any wind-up he desires, providing that in the final delivery of the ball to the batter, the hand shall be below the hip and the wrist not farther from the body than the elbow.

(e) At no time during the progress of the game shall the pitcher be allowed to use tape, or other substance, upon the pitching hand or fingers; nor shall any foreign substance be applied to the ball, provided that, under the supervision and control of the umpire, powdered resin may be used to dry the hands.

No pitch shall be declared whenever the pitcher pitches during a suspension of play or when he attempts a quick return of the ball before the batsman has taken position or is off balance as the result of a previous pitch.

RULE IX. ILLEGAL PITCHES

An illegal pitch, entitling the base-runner or runners to advance one base, shall be called by the umpire as follows; and in each of the cases cited a ball shall also be called in favour of the batsman.

1. Any delivery of the ball to the batsman without previously taking position as defined in (a) and (b), Rule VIII.

2. If the pitcher takes more than one step before releasing the ball.

3. Final delivery of the ball to the batsman with the hand above the hip and the wrist of the pitching arm farther from the body than the elbow. (Rule VIII. d.)

4. Failure to follow through with the hand and wrist past the straight line of the body. (Rule VII. d.)

5. Rolling the ball along the ground, or dropping the ball, by the pitcher while the pitcher is in pitching position. (SECTION 3, Rule II.)

6. Holding the ball by the pitcher more than 20 seconds. (SECTION 5, Rule II.)

7. Making any motion to pitch without immediately delivering the ball to the batsman. (SECTION 6, Rule II.)

8. Delivery of the ball to the batsman when the catcher is outside the lines of the catcher's position as defined in Rule II. (See also SECTION 6, Rule XXVII.)

9. If the pitcher continues to wind-up after taking the step. (Rule VIII. c.)

10. If the pitcher takes pitching position on or near the pitcher's plate without having the ball in his possession.

In each of the foregoing cases the ball shall be dead and not in play until again put in play at the pitcher's box, provided, however, that if the batsman strikes at and hits the ball into fair territory any of the foregoing illegal pitches then there shall be no penalty for such illegal pitch and the ball shall remain in play, and base-runners may run bases or be put out as though the ball had been legally pitched.

RULE X. FAIRLY DELIVERED BALL

SECTION 1. A fairly delivered ball is one pitched by the pitcher, while standing in his position and facing the batsman, that passes over any portion of the home plate before touching the ground, nor lower than the batsman's knees nor higher than its shoulder. For every such fairly delivered ball the umpire shall call one strike.

Other cases in which the umpire shall call a strike are:

SECTION 2. A pitched ball struck at by the batsman without its touching his bat.

SECTION 3. A foul hit ball not caught on the fly unless the batsman has two strikes.

SECTION 4. A pitched ball at which the batsman strikes but misses and which touches any part of his person.

SECTION 5. A foul tip, held by the catcher, while standing within the lines of his position.

RULE XI. UNFAIRLY DELIVERED BALL

SECTION 1. An unfairly delivered ball is a ball delivered to the batsman by the pitcher while standing in his position and facing the batsman that does not pass over any portion of the home plate between the batsman's knees and shoulders, or that touches the ground before passing home plate, unless struck at by the batsman.

For every unfairly delivered ball the umpire shall call one ball.

Other cases in which the umpire shall call a ball are:

SECTION 2. An illegally pitched ball unless the batsman hits such a pitched ball fairly. (An illegally pitched ball struck at and missed, or fouled, and an illegally pitched ball at which the batsman does no strike, shall be called a ball under this rule.)

SECTION 3. A ball rolled along the ground, or dropped, by the pitcher while in the pitching position.

SECTION 4. A pitched ball, not struck at, which touches any part of the batsman's person or clothing while standing in his position provided the batter does not intentionally allow the ball to strike him. No base-runner shall advance on such ball unless he be compelled to do so by reason of its being the fourth ball and the batsman becomes a base-runner.

SECTION 5. A ball shall be called each time the pitcher delays the game by failing to deliver the ball to the batsman for a longer period than 20 seconds, except that at the commencement of each inning, or when a pitcher relieves another, the pitcher may occupy one minute in delivering not to exceed five balls to the catcher or an in-fielder, during which time play shall be suspended.

SECTION 6. A ball shall be called each time the pitcher makes any motion to pitch without immediately delivering the ball to the bat.

RULE XII. RULES FOR BATSMAN

Each player of the side at bat shall become a batsman and must take his position within the batsman's lines as defined in Rule II, in the order that his name appears in his team's batting order.

RULE XIII. ORDER OF BATTING

SECTION 1. The batting order of each team must be on the score card and must be delivered before the game by the manager or captain to the umpire at the home plate, who shall submit it to the inspection of the manager or captain of the other side. The batting order delivered to the umpire must be followed throughout the game unless a player be substituted for another, in which case the substitute must take the place in the batting order of the retired player.

SECTION 2. After the first inning the first batter in each inning shall be the batsman whose name follows that of the last man who completed his "time at bat" in the preceding inning.

Note.—When the third out in an inning may be the result of a base-runner leaving his base too soon on a pitched ball and a batsman is put out or becomes a base-runner on the same pitch, the player following such batsman in the batting order shall be the first batter in the next inning.

SECTION 3. A batsman has completed his "time at bat" when he has become a base-runner, as defined in Rule XXVI, or has been put out according to the provisions of Rule XX.

RULE XIV. A FAIR HIT BALL

A fair hit ball is a legally batted ball that settles on fair ground between home and first base, or between home and third base or that is on or over fair ground when bounding to the outfield, or that touches first or third base, or that first falls on fair ground on or beyond first or third base, or that while on or over fair ground touches the person of the umpire or a player. A fair fly must be judged according to the relative position of the ball and the foul line, and not as to whether the fielder is on fair or foul ground at the time he touches the ball.

Note.—A batted ball which first touches foul ground and then rolls or bounds into fair territory before having touched any object other than the playing field is a fair ball, provided it rolls or bounces into the diamond before reaching first or third bases. A batted ball which first touches fair ground and rolls foul and then again rolls into the diamond before reaching first or third bases is a fair ball provided that while the ball was on or over foul territory it did not touch any person or thing other than the playing field.

RULE XV. A FOUL HIT BALL

A foul hit ball is a legally batted ball that settles on foul territory between home and first base or home and third base, or that bounds past first or third base on or over foul territory or that

falls on foul territory beyond first or third base, or that while on or over foul ground touches the person of the umpire or a player.

Note.—A batted ball which touches any person, or object, such as a bat, glove, fence, bench or screen, or is handled by a fielder while on or over foul territory, is a foul ball regardless of where it may go thereafter.

RULE XVI. A FOUL TIP

A foul tip is a ball batted by the batsman while standing in the lines of his position, that goes sharp and direct to the hands of the catcher and is legally caught.

Any foul tip caught is a strike and the ball remains in play.

A foul hit ball which rises higher than the batsman's head shall not be a foul tip under this rule.

RULE XVII. A BUNT HIT BALL

A bunt is a batted ball, not swung at by the batsman, but met with the bat and which does not go out of the infield. A ball which touches the bat while the batsman is attempting to avoid being hit by a pitched ball shall not be considered a bunted ball under this rule.

RULE XVIII. BALLS BATTED OUTSIDE OF THE PLAYING FIELD

SECTION 1.—When a batted ball passes outside the playing field the umpire shall declare it fair or foul, according to where it leaves the playing field.

SECTION 2.—A fair batted fly ball that goes over the fence or into a stand shall entitle the batsman to a home run, unless it pass out of the grounds or into a stand at less distance than 200 feet from the home base, in which case the batsman shall be entitled to two bases only. In either event the batsman must touch the bases in regular order. The point at which the fence or stand is less than 200 feet from the home base shall be plainly indicated for the umpire's guidance.

SECTION 3.—A fair hit ball that bounds into a stand or over a fence shall be a two-base hit.

Note.—Whenever the location of obstructions, such as trees, wires, parked automobiles, or spectators, necessitates a modification of this rule a special ground rule should be established. Such special ground rule should be written upon the official score sheet and signed by both managers before the start of the game.

RULE XIX. AN ILLEGALLY BATTED BALL

An illegally batted ball is a ball batted in any way by the batsman when either or both of his feet are upon the ground outside the lines of the batsman's position.

RULE XX. WHEN BATSMAN IS OUT

The batsman is out—

SECTION 1.—If he fails to take his position at the bat in the turn in which his name appears in the batting order. But if the error is discovered the proper batsman may replace the man at bat before the latter becomes a base-runner, in which case the balls and strikes must be counted in the "time at bat" of the proper batsman.

Only the proper batsman shall be declared out, and no runs shall be scored or bases run because of any act of the improper batsman.

Note.—A player is not out for batting out of turn. The player who fails to bat in his proper place is the one to be called out.

This rule shall not be enforced unless the error is discovered and the out is declared before the ball is delivered to the batsman next facing the pitcher.

Should the batsman declared out under this section be the third out and his side thereby put out, the proper batsman in the next inning shall be the player who would have come to bat had the players been put out by ordinary play in the preceding inning.

SECTION 2.—If he fails to take his position within one minute after the umpire has called for the batsman.

SECTION 3.—If he makes a foul hit, other than a foul tip as defined in Rule XV, and the ball is caught by a fielder before touching the ground; provided it is not caught in a fielder's hat, cap, protector, pocket or other part of his uniform, or does not strike some object other than a fielder before being caught.

SECTION 4.—If he bats the ball illegally as defined in Rule XIX.

SECTION 5.—If he bunts foul after the second strike.

SECTION 6.—If he attempts to hinder the catcher from fielding or throwing the ball by stepping outside the lines of the batsman's position, or in any way obstructs or interferes with that player; except that if a base-runner attempting to steal is put out the batsman shall not be out; except, also, that the batsman shall not be out under this section if the base-runner is declared out according to Section 14 of Rule XXIX.

SECTION 7.—Immediately after he has three strikes if there are no outs or one out AND there is a runner on first base, or runners on first and second bases, or runners on first, second and third bases, or runners on first and third bases.

Note.—Under this section the batsman does not become a base-runner, even though the third strike is not caught, thereby preventing a trick force play set up by the intentional dropping of a third strike.

If first base is not occupied, regardless of the number of outs, the batsman becomes a base-runner on three strikes and the third strike must be caught or he must be thrown out.

If two are out, whether or not first or any other base is occupied, the batsman becomes a base-runner on three strikes and the third strike must be caught or he must be thrown out. Refer to Secs. 4, 5 and 6 of Rule XXIX.

SECTION 8.—If the third strike struck at and missed touch any part of the batsman's person.

SECTION 9.—If, before two are out, while first and second, or first, second and third bases are occupied, he hits a fair fly ball, other than a line drive, or a bunted fly ball, that is handled or in the opinion of the umpire would have landed within or near the base-lines.

SECTION 10.—If he steps from one batsman's box to the other while the pitcher is in his position ready to pitch.

Note.—No bases shall be run if the batter is declared out under Sections 4, 5, 6, 8 and 10 of this rule.

RULE XXI. DEFINITIONS

SECTION 1.—A block is a batted or thrown ball that is touched, stopped, or handled by a person not engaged in the game.

SECTION 2.—Whenever a block occurs the umpire shall declare it and base-runners may advance, without liability to be put out, one base in addition, to the one to which they were going at the start of the play in which the block occurs.

Note.—A wild pitch or passed ball shall not be a block under this rule.

SECTION 3.—A wild pitch is a legally delivered ball so high, low or wide of the plate that the catcher can not, or does not, stop and control it with ordinary effort.

SECTION 4.—A passed ball is a legally delivered ball that should have been held or controlled by the catcher with ordinary effort.

SECTION 5.—A force-out can be made only when a base-runner legally loses the right to the base he occupies by reason of the batsman becoming a base-runner and he is thereby forced to advance.

A force-out shall not be destroyed by the fact that a succeeding runner is called out for leaving his base too soon.

RULE XXII. BALL DEAD NOT IN PLAY

The ball is dead and not in play:

1.—If a pitched ball touches any part of the batsman's person or clothing while the batsman is standing in his position, whether the ball is struck at or not.

2.—In case of an illegally batted ball, or in case a batsman stepping from one box to the other when the pitcher is ready to pitch.

3.—In case of a foul hit ball not legally caught.

4.—In case of interference with the fielder or batsman.

5.—In case a fair hit ball strikes a base-runner or umpire before touching a fielder.

6.—In case an overthrown ball touches the person or clothing of a coacher.

7. In case a block ball is declared.

8. In case of an overthrow, if the ball touches any obstruction or person.

9. In case of an illegally pitched ball, or a ball dropped or rolled along the ground by the pitcher.

10.—In case "No Pitch" is declared.

In all the foregoing cases the ball shall not be considered in play until it is held by the pitcher standing in his position and the umpire shall have called "Play".

RULE XXIII. BALL IN PLAY

The ball remains in play and the base-runners may at their own risk run bases or be put out:

1.—After a fly ball, either fair or foul, or a foul tip, has been legally caught.

2.—After "four balls" has been called, provided that the batsman cannot be put out before he reaches first base.

3.—After an interference by a fielder with a base-runner provided that the runner interfered with cannot be put out before he reaches the base to which he is going (Sec. 5, Rule XXVII.)

4. After base-runners have reached the bases to which they are entitled under Sec. 7, Rule XXVII.

5.—If a fair hit ball strikes an umpire on fair ground after passing a fielder. (Sec. 1, Rule XXVII).

6.—If a fair hit ball strikes an umpire on foul ground. (Sec. 1, Rule XXVII).

7.—In case of any overthrown ball which remains inside the foul lines.

8.—In case of any throw or pitched ball which is not blocked or which does not touch an obstruction in foul territory. (Secs. 3 and 8, Rule XXVII).

9.—In cases a thrown or pitched ball strikes an umpire. (Sec. 4, Rule XXVII).

Note.—Sec. 4, Rule XXVII, does not put the ball out of play, but simply limits the advance of the runner.

10. When a base-runner is called out for leaving his base too soon.

11.—And in all other cases except as provided in Rule XXII.

RULE XXIV. AN OVERTHROW

An overthrow is a ball thrown from one fielder to another to retire a runner who has not reached or is off his base, and which goes into foul territory on a play at first, third, or home base. The advance of runners on an overthrow shall be determined by the base occupied by the runner at the time of pitch preceding the overthrow.

Note.—The difference between an overthrow and a passed ball: An overthrow is made only in making a play on a runner, while a passed ball is always a pitched ball. Also that in order to be an overthrow under this rule the ball must go into foul territory. A ball thrown past or over, a baseman, and which stays on fair ground, is not an overthrow. This rule applies only at first, third, and home. A ball overthrown in making a play at second base does not come under this rule, even though the ball may go into foul territory.

RULE XXV. LEGAL ORDER OF BASES

SECTION 1.—The base-runner must touch base in legal order, viz., first, second, third and home bases; and when obliged to return while the ball is in play must retouch the base or bases in reverse order. He can only acquire the right to a base by touching it, before having been put out, and then shall be entitled to hold such base until he has legally touched the next base in order, or has been legally forced to vacate it for a succeeding base-runner. However, no base-runner shall score a run to count in the game ahead of the base-runner preceding him in the batting order, if there be such preceding base-runner who has not been put out in that inning.

SECTION 2.—Having become a base-runner or having acquired legal title to a base, the base-runner cannot run bases in reverse order for the purpose either of confusing the fielders or making a travesty of the game. Runners are to be called out for violation of this rule.

SECTION 3.—In case a runner is being run down between bases, and the following runner occupies the same base the first runner has left, the second man cannot be out while holding the said base. If the first runner, however, returns safely to the base he left, and both runners are there occupying the same base, the second runner is the man out, if touched with the ball.

SECTION 4.—The failure of a preceding runner to touch a base (and who is declared out therefor) shall not affect the status of a succeeding runner who touches each base in proper order; except that, after two are out, a succeeding runner cannot score a run when a preceding runner is declared out for failing to touch a base as provided in Rule XXIX, Sec. 11. The exception also applies to a batsman who hits the ball out of the playing field for an apparent home run.

RULE XXVI. WHEN THE BATSMAN BECOMES A BASE-RUNNER

SECTION 1.—Instantly after he hits a fair ball.

SECTION 2.—Instantly after three strikes have been called, unless first base is occupied with less than two out.

SECTION 3.—Instantly after "four balls" has been called by the umpire.

SECTION 4.—If the catcher interferes with him in, or prevents him from, striking at a pitched ball.

SECTION 5.—If a fair hit ball strikes the person or clothing of the umpire or a base-runner on fair ground.

RULE XXVII. ENTITLED TO BASES

The base-runner shall be entitled without liability to be put out, to advance one base except where more are specified in the following cases:

SECTION 1.—If, while the batsman, he becomes a base-runner by reason of "four balls" or for being interfered with by the catcher in striking a pitchball, or if a fair hit ball strikes the person or clothing of the umpire or a base-runner on fair ground before touching a fielder; provided that, if a fair hit ball strikes the umpire after having passed a fielder other than the pitcher, or having been

touched by a fielder (including the pitcher), the ball shall be considered in play. Also, if a fair hit ball strikes the umpire on foul ground, the ball shall be in play.

SECTION 2.—If the umpire awards to a succeeding batsman a base on "four balls" or for being interfered with by the catcher in striking at a pitched ball; and the base-runner is thereby forced to vacate the base held by him.

SECTION 3.—If a ball delivered by the pitcher passes the catcher and touches any fence, building or backstop within 25 feet of home plate, all base-runners shall be entitled to advance on base.

SECTION 4.—If a thrown or pitched ball strikes the person or clothing of an umpire, the ball shall be considered in play, and the base-runner, or base-runners, shall be entitled to not more than one base.

Note.—This section states an exception to the opening paragraph of this rule in which runners are entitled to advance without liability to be put out. It limits the advance of runners to one base, but makes it necessary for them to make that base.

SECTION 5.—If he is prevented, from making a base by the obstruction of a fielder, except when a fielder is trying to field a batted ball, unless the fielder has the ball in his hand ready to touch the base-runner. The ball is still in play as far as other base-runners are concerned, affecting the runner interfered with after he has reached the base to which he is entitled because of the interference.

SECTION 6.—It shall be illegal for the catcher to leave his designated position immediately and directly back of the plate for the purpose of aiding the pitcher to give intentionally a base on balls to a batsman. If the catcher shall move out of position prior to the time of the ball leaving the pitcher's hand, all runners on bases shall be entitled to advance one base.

SECTION 7.—If the fielder stops or catches a batted ball or a thrown ball with his cap, glove, or any part of his uniform, while detached from its proper place on his person, the runner or runners shall be entitled to three bases if a batted ball, or two bases if a thrown ball, and in either case the runner may advance further at his own risk.

SECTION 8.—When, on any play which starts with a batted ball, the ball is overthrown into the foul territory at first, third, or home base, and the ball touches any obstruction or is blocked, the runner being played shall be entitled to advance one base

beyond that at which the overthrow was made, and all other runners shall be entitled to the same number of bases as the man on whom the play was made. (Rule XXIV). Number of bases to be determined by the base occupied by each runner at the time of the pitch preceding the overthrow.

Note.—If the ball is not blocked, or does not touch an obstruction, the ball remains in play and runners may advance at their own risk as far as they can make it.

SECTION 9.—If the pitcher drops or rolls the ball along the ground or if the pitcher makes an illegal delivery, provided the batsman does not hit an illegally pitched ball fairly.

Note.—When a runner is entitled to a base without liability to put out, while the ball is in play, under any rule in which the ball is in play after the runner reaches the base to which he is entitled, failure to touch the base to which the runner is entitled before attempting to make the next base shall forfeit his exemption from liability to be put out, and the runner may be put out by a play at the base or by tagging the runner before he returns to the base to which he was entitled.

Should the runner so put out be the batsman at first base or any runner compelled to advance to make room for the batsman, and such out should also be the third out in an inning, such out shall have the status of a force out.

This interception applies to all runners advancing as the results of the batsman being awarded a base on balls, runners advancing because of interference by a fielder, and runners advancing after a batted or thrown ball has been touched by any part of a fielder's equipment when detached from its proper place.

RULE XXVIII. RETURNING TO BASES

The base-runner shall return to his base without liability to be put out:

SECTION 1.—If the umpire declares any foul not legally caught.

SECTION 2.—If the umpire declares an illegally batted ball.

SECTION 3.—If a thrown ball touches the coacher.

SECTION 4.—If the umpire declares a dead ball, unless it is also the fourth ball and he is thereby forced to take the next base.

SECTION 5.—If the person or clothing of the umpire while stationed back of the bat, interferes with the catcher in attempt to throw.

SECTION 6.—If a pitched ball at which the batsman strikes but misses, touches any part of the batsman's person.

SECTION 7.—If the umpire is struck by a fair hit ball before touching a fielder ; in which case no base shall be run unless necessitated by the batsman becoming a base-runner, and no run shall be scored unless all bases are occupied.

SECTION 8.—If the umpire declares the batsman or base-runner out for interference in which case the base-runner shall return to the last base that was in the judgment of the umpire legally touched by him at the time of the interference.

In any and all the foregoing cases the base-runner is not required to touch the intervening bases in returning to the base to which he is legally entitled.

RULE XXIX. WHEN BASE-RUNNERS ARE OUT

The base-runner is out—

SECTION 1.—If, having made a fair hit ball while batsman, such fair hit ball is caught by a fielder before touching the ground or any object other than a fielder ; provided it be not caught in a fielder's hat, cap, protector, pocket or other part of his uniform.

SECTION 2.—If, after a fair hit ball, the ball is securely held by a fielder while touching first base with any part of his person before such base-runner touches first base.

SECTION 3.—If, after a fair hit ball, he is touched with the ball in the hand of a fielder before he shall have touched first base.

Note.—It is sufficient if the runner be touched with the hand or glove in which the ball is held.

SECTION 4.—If the third strike be legally caught by a fielder before touching the ground.

SECTION 5.—If after three strikes he be touched with the ball in the hand of a fielder before he shall have touched first base.

SECTION 6.—If after three strikes the ball be securely held by a fielder while touching first base with any part of his person before such runner touch first base.

SECTION 7.—If, in running the last half of the distance from home to first base, while the ball is being fielded to first base, he runs outside the three-foot line, as defined in Rule II, and in the opinion of the umpire, interferes with the fielder taking the throw at first base ; except that he may run outside the three-foot line to avoid a fielder attempting to field a batted ball.

Note.—If the runner runs on or inside the base-line and in any way interferes with the play being made at first base, he should be called out.

SECTION 8.—If, in running to any base, he runs more than three feet from a direct line between a base and the next one in regular or reverse order to avoid being touched by a ball in the hand of a fielder. But in case a fielder be occupying a base-runner's proper path in attempting to field a batted ball, then the base-runner shall run out of the direct line to the next base and behind such fielder and shall not be declared out for so doing.

Note.—It is not necessary for the runner to follow the direct line between the bases unless a fielder, in the direct line, actually has the ball in his possession. Read this section in connection with Section 5 of Rule XXVII. Notice that actual possession of the ball is the controlling factor.

SECTION 9.—If he fails to avoid a fielder attempting to field a batted ball in the manner described in this rule, or in any way obstructs a fielder in attempting to field a batted ball, or intentionally interferes with a thrown ball; provided that if two or more fielders attempt to field a batted ball, and the base-runner comes in contact with one or more of them, umpire shall determine which fielder is entitled to the benefit of this rule, and shall not decide the base-runner out for coming in contact with a fielder other than the one the umpire determines to be entitled to field such batted ball. If a fair hit ball goes through an infielder and hits a runner immediate back of him, the umpire must not declare the runner out for being hit by a batted ball. In making such decision the umpire must be convinced that the ball passed through the infield and that no other infielder had the chance to make a play on the ball. If, in the judgment of the umpire, the runner deliberately and intentionally kicks such a hit ball, on which the infielder has missed a play, then the runner must be called out for interference.

SECTION 10.—If at any time while the ball is in play he is touched by the ball in the hands of a fielder, unless some part of his person is touching the base he is entitled to occupy; provided, however, that the ball is held by the fielder after touching him, unless the base-runner deliberately knocks it out of his hand. The ball must be held firmly by the fielder after touching the runner. The ball cannot be juggled even though the fielder may retain possession of the ball and prevent same from dropping to the ground.

SECTION 11.—If when a fair or foul hit ball (other than a foul tip), is legally caught by a fielder, such ball is legally held by a fielder on the base occupied by the base runner when such ball is batted, or the base-runner is touched with the ball in the hand of a

fielder, before he retouches such base after such fair or foul hit ball is so caught ; provided that the base-runner shall not be out in such case, if after the ball is legally caught, it is delivered to the bat by the pitcher before the fielder holds it on said base, or touches the base-runner out with it ; but if the base-runner, in attempting to reach a base, detaches it from its fastening before being put out, he shall be declared safe. A base-runner who holds his base on a fly ball shall have the right to advance the moment the ball touches a fielder.

SECTION 12.—If, when the batsman becomes a base-runner the first base or the first and second bases, or the first, second and third bases are occupied, any base-runner so occupying a base shall cease to be entitled to hold it, and may be put out at the next base in the same manner as in running to first base, or by being touched with the ball in the hands of a fielder at any time before any base-runner following him in the batting order is put out, unless the umpire shall decide the hit of the batsman to be an infield fly.

SECTION 13.—If a fair hit ball strikes him while on or off a base before touching a fielder, and, in such case, no base shall be run unless necessitated by the batsman becoming a base-runner but no run shall be scored or any other base-runner be put out until the umpire puts the ball back into play.

SECTION 14.—If, when advancing bases, or being obliged to return to a base, he fails to touch the intervening base or bases, if any, in regular or reverse order, as the case may be, he may be put out by the ball being held by a fielder on any base he failed to touch, or by being touched with the ball in the hand of a fielder in the same manner as in running to first base ; provided that the base-runner shall not be out in such a case if the ball be delivered to the bat by the pitcher before the play is made on the runner or at the base. . . .

SECTION 15.—If he leaves or fails to keep contact with the base which he is entitled to occupy, while the pitcher has the ball in pitching position and until a legally pitched ball has left the hands of the pitcher.

SECTION 16.—If, when the umpire calls "Play", after the suspension of a game, he fails to return to and touch the base he occupied when "Time" was called before touching the next base ; provided that the base-runner shall not be out, in such case, if the ball is delivered to the bat by the pitcher before the fielder holds it on said base or touches the base-runner with it.

SECTION 17.—If, with one out, or none out, and a base-runner on third base, the batsman interferes with a play being made at home plate.

SECTION 18.—If he passes a preceding base-runner before such runner has been legally put out, he shall be declared out immediately.

SECTION 19.—If, in the judgment of the umpire, the coacher at third base by touching or holding the runner physically assists him in returning to or leaving third base. The runner, however, shall not be declared out if no play is being made on him.

SECTION 20.—The base runner in running to first base may overrun said base after touching it in passing without incurring liability to be put out for being off said base, regardless of which direction he turns, provided he returns at once and touches the base, after which he may be put out as at any other base. If, after over-running first base, he attempts to run to second base before returning to first base, he shall forfeit such exemption from liability to be put out.

SECTION 21.—If, while third base is occupied, the coacher stationed near that base shall run in the direction of home base on or near the base-line while a fielder is making or trying to make a play on a batted ball not caught on the fly, or on a thrown ball, or a fly ball, and thereby draws a throw to home base; the base-runner entitled to third base shall be declared out by the umpire for the coacher's interference.

SECTION 22.—If one or more members of the team at bat stand or collect at or around a base for which a base-runner is trying, thereby confusing the fielding side and adding to the difficulty of making such a play, or if a member of the team at bat obstructs or interferes with any play being made upon a base-runner, the base-runner shall be called out for the interference of his team-mate or team-mates.

SECTION 23.—If he runs bases in reverse order as defined in Rule XXV, SECTION 2.

RULE XXX. SCORING OF RUNS

SECTION 1.—One run shall be scored every time a base-runner, after having legally touched the first three bases, shall legally touch the home base before three men are put out; provided, however, that if he reaches home on or during a play in which the third man is forced out or is put before reaching first base, a run shall count;

also, if the third out is made by a preceding runner failing to touch a base a run shall not count.

Note 1.—No run shall be scored on any play in which the third man is called out for leaving his base before a pitched ball has left the pitcher's hand.

Note 2.—An out for leaving a base too soon on a caught fly ball is not a force-out and when such an out is the third out in an inning any run scored before the out was actually made will count.

Note 3.—In case of a runner failing to touch a base, if the base missed is the one to which a runner is forced to advance by reason of the batsman becoming a base-runner, and the out is the third out in an inning, no run scored in that series of plays will count, regardless of whether the runs were across the plate before the out was actually made.

RULE XXXI. UMPIRES

1. *Power and Duties.* The umpires are the representatives of the league or organization by which they have been assigned to a particular game, and as such are authorized and required to enforce each section of these rules. They shall have power to order a player, coach, captain or manager to do or omit to do any act which in their judgment is necessary to give force and effect to one or all of these rules and to inflict penalties as herein prescribed.

2. *Single Umpire.* If but one umpire be assigned, his duties and jurisdiction shall extend to all points, and he shall be permitted to take his stand in any part of the field that in his opinion will best enable him to discharge his duties.

3. *Plate Umpire.* The Plate Umpire shall take his position back of the catcher ; he shall have full charge of and be responsible for the proper conduct of the game. With the exception of the decisions to be made by the Base Umpire, as described in SECTION 4 of this rule, the Plate Umpire shall render all the decisions that ordinarily devolve upon a single umpire.

He shall call balls and strikes, he shall determine whether a batted ball is fair or foul, whether a fly ball has been caught, whether a batter bunts, whether a pitched ball touches the person or clothing of the batter, and whether or not a fly ball is an infield or an outfield fly.

He shall render base decisions in the following instances:

(a) If the ball is hit fair, with a runner on first, he must go third base to make a possible decision.

(b) With more than one base occupied, he shall, on appeal, decide whether or not a runner on third leaves that base before a fly ball is caught.

(c) In case of a runner being caught between third and home, when more than one base is occupied, he shall make the decision on the runner nearest home plate ; he shall have equal authority with the Base Umpire in calling a runner out for leaving his base too soon.

4. *Base Umpire.* The Base Umpire shall take such positions on the playing field as in his judgment are best suited for the rendering of base decisions. He shall render all decisions at first and second base and all decisions at third base except those to be made by the Plate Umpire in accordance with Section 3. He shall also have equal authority with the Plate Umpire in calling "illegal" pitches. He shall aid the Plate Umpire in every manner in enforcing the rules of the game and with the exception of declaring a forfeiture, shall have equal authority with the Plate Umpire in removing players from the game.

5. *No conflict of Authority.* Under no circumstances shall either umpire criticize or interfere with a decision unless asked to do so by his associate. In case the manager or captain of a team seeks a reversal of a decision, the umpire making the decision may, if he is in doubt, ask his associate for information before acting on the manager's or captain's appeal. However, the final decision shall rest with the umpire whose exclusive authority it was to make the decision and who requested an opinion of the other.

6. *Penalties for Violation.* In all cases of violation of these rules by a player, coach, or manager, the penalty shall be the prompt removal of the offender from the game and grounds. In the event of the removal of a player, coach or manager, he shall go direct to the club house and remain there during the progress of the game, or leave the grounds ; and a failure to do so will warrant a forfeiture of the game.

Umpires shall not permit any person connected with any team to continue to violate any rule, even though there is a penalty attached to the specific violation, and, after due warning, shall remove such person from the game.

7. *Cannot Change Umpire.* The umpire cannot be changed during a game by the consent of the contesting clubs unless the official is incapacitated from service by injury or illness.

Note.—There seems to be some confusion as to the authority of umpires when two or more are working.

The powers and duties of both the Plate and the Base umpire are clearly set forth in the rule, and, except where the rule provides that the authority is equal, each has exclusive jurisdiction in making the decisions assigned to him.

There is a mistaken idea that sometimes one umpire reverses a decision made by another. There is also a mistaken idea that an umpire, once having made a decision, cannot reverse that decision.

It must be remembered that it is the duty of an umpire to make correct decisions, and that the speed of action and the conditions surrounding a play may make this very difficult.

If, however, an umpire finds that he has mis-called a play, it is not only his right but his duty to call the play correctly.

In reaching his conclusion it is his privilege to consult his associate who, at the time, may have been in better position to see just what took place. The associate may, however, only express his opinion, the final decision must rest with the umpire whose business it was to make that decision.

Umpires should be very careful not to express their opinion on a play called by another umpire unless the umpire who made the decision, himself, requests an opinion.

When an umpire finds it necessary to reverse himself, this should be done before any succeeding play takes place.

Lawn Tennis

Rules of the Game as adopted by the Lawn Tennis Association
(Revised to Date)

THE SINGLES GAME

1. The court shall be a rectangle, 78 feet long and 27 feet wide. It shall be divided across the middle by a net, suspended from a cord or metal cable of a maximum diameter of $\frac{1}{8}$ of an inch, the ends of which shall be attached to, or pass over, the tops of two posts, 3 feet 6 inches high, which shall stand 3 feet outside the Court on each side. The height of the net shall be 3 feet at the Centre, where it shall be held down taut by a strap not more than 2 inches wide. There shall be a band covering the cord or metal cable and the top of the net for not less than 2 inches not more than $2\frac{1}{2}$ inches in depth on each side. The lines bounding the ends and sides of the Court shall respectively be called the base-lines and the side-lines. On each side of the net at a distance of 21 feet from it and parallel with it, shall be drawn the service-lines. The space on each side of the net between the service-line and the side-lines shall be divided into two equal parts called the service courts by the centre service-line, which must be 2 inches in width, drawn half-way between and parallel with, the side-lines. Each base-line shall be bisected by an imaginary continuation of the centre-service-line to a line 4 inches in length and 2 inches in width called the centre-mark drawn inside the Court, at rightangles to and in contact with such base-line. All other lines shall be not less than 1 inch or more than 2 inches in width, except the base-lines, which may be 4 inches in width, and all measurements shall be made to the outside of the lines.

Note.—In this case of International Lawn Tennis Championship (Davis Cup) or other official championships of the International Federation, there shall be a space behind each base line of not less than 21 feet, and at the sides of not less than 12 feet.

2. The permanent fixtures of the Court shall include not only the nets, posts, cords or metal cable, strap and band, but also, where there are any such, the back and side stops the stands, fixed or moveable seats and chairs round the Court, and their occupants, all other fixtures around and above the Court, and the Umpire, Footfault Judge and Linesmen when in their respective places.

THE SINGLES COURT

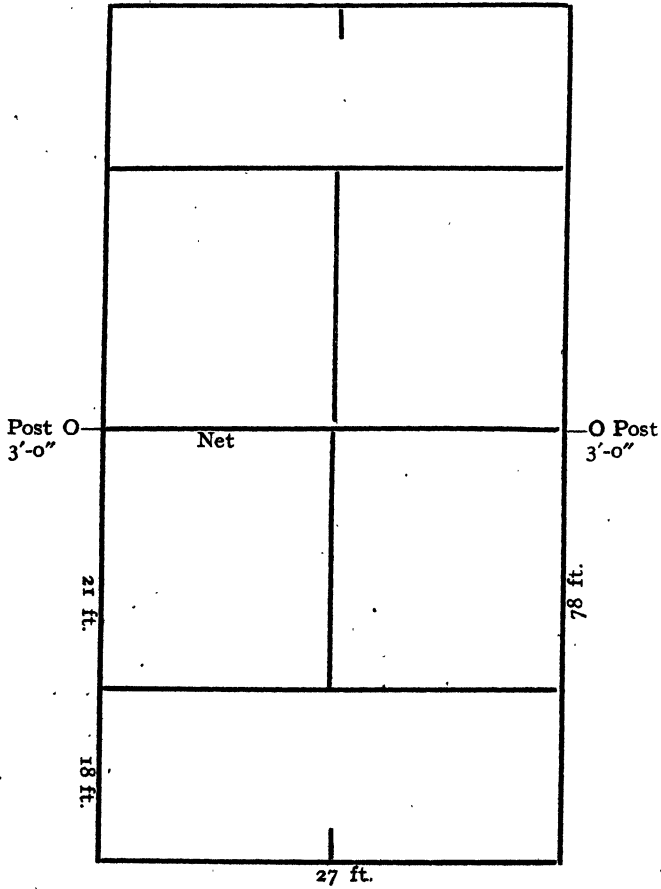

3. The outer surface of the ball shall be smooth and without stitches. The ball shall be not more than $2\frac{1}{2}$ inches and less than $2\frac{3}{8}$ inches in diameter, and not less than 2 oz., nor more than $2\frac{1}{16}$ oz. in weight. The ball shall have a minimum bound of 53 inches and a maximum bound of 58 inches, when dropped 100 inches at a temperature approximating to 68 degrees Fahrenheit, upon a concrete base and a deformation of not less than $\frac{2}{90}$ of an inch and not more than $\frac{3}{13}$ of an inch when subjected to pressure of 18 lbs. applied to each end of any diameter at a temperature approximating to 68 degrees Fahrenheit. All tests for deformation shall be carried out in accordance with the instruction as recommended by the Committee.

4. The players shall stand on opposite sides of the net ; the player who first delivers the ball shall be called the Server, and the other the Receiver.

5. The choice of sides and right to be Server or Receiver in the first game shall be decided by toss. If the winner of the toss choose the right to be Server or Receiver his opponent shall have the right to be Server or Receiver. The winner of the toss may, if he prefer it, require his opponent to make the first choice.

6. The service shall be delivered in the following manner :—Immediately before commencing to serve, the Server shall stand with both feet at rest behind (*i.e.* farther from the net than) the base-line, and within the imaginary continuation of the centre marks and side lines. The Server shall then project the ball by hand into the air *in any direction* and strike it with his racket and the delivery shall be deemed to have been completed at the moment of the impact of the racket and the ball. A player with the use of only one arm may utilise his racket for the projection.

7. The Server shall, throughout the delivery of the service—

- (a) Not change his position by walking or running ;
- (b) Maintain contact with the ground ;
- (c) Keep both feet behind (*i.e.*, farther from the net than) the base-line.

8. In delivering the service, the Server shall stand alternately behind the right and left courts, beginning from the right in every game. The ball served shall pass over the net and hit the ground within the service court, which is diagonally opposite or upon any line bounding such court, before the Receiver returns it.

9. The service is a fault (a) if the Server commits any breach of Rules 6, 7 or 8 ; (b) if he miss the ball in attempting to strike it ; (c) if the ball served touch a permanent fixture (other than the net, strap or band) before it hits the ground.

10. After a fault (if it be the first fault) the Server shall serve again from behind the same half of the court from which he served that fault unless it was a fault because he served from behind the wrong half, when he shall be entitled to deliver one service from behind the other half. A fault may not be claimed after the next service has been delivered.

11. The Server shall not serve until the Receiver is ready. If the latter attempt to return the service, he shall be deemed ready. If, however, the Receiver signify that he is not ready, he may not claim a fault because the ball does not hit the ground within the limits fixed for the service.

12. The service is a let (a) if the ball served touch the net, strap or band, provided the same be otherwise good ; (b) if a service of fault be delivered when the Receiver is not ready (see Rule 11.) In case of a let the service counts for nothing, and the Server shall serve again, but a let does not annul a previous fault.

13. At the end of the first game the Receiver shall become Server, and the Server Receiver ; and so on alternately in all the subsequent games of a match. If a player serves out of turn, the player who ought to have served shall serve as soon as the mistake is discovered, but all points scored before such discovery shall be reckoned. If a game shall have been completed before such discovery, the order of service remains as altered. A fault served before such discovery shall not be reckoned.

14. A ball is in play from the moment at which it is delivered in service (unless a fault or a let), and remains in play till the point is decided.

15. The Server wins the point (a) if the ball served touch the Receiver or anything which he wears or carries before it hits the ground : (b) if the Receiver otherwise lose the point as provided by Rule 17.

16. The Receiver wins the point (a) if the Server serve two consecutive faults ; (b) if the Server otherwise lose the point as provided by Rule 17.

17. A player loses the point if—

- (a) He fail, before the ball in play has hit the ground twice consecutively, to return it directly over the net [except as provided in Rule 20 (c)] ; or
- (b) He return the ball in play so that it hits the ground, a permanent fixture, or other objects, outside any of the lines which bound his opponent's court ; or
- (c) He volley the ball and fail to make a good return even when standing outside the court ; or
- (d) He touch or strike the ball in play with his racket more than once in making a stroke ; or
- (e) He or his racket (in his hand or otherwise) or anything which he wears or carries touch the net, posts, cord, or metal cable, strap or band of the ground within the opponent's court at any time while the ball is in play ; or
- (f) He volley the ball before it has passed the net ; or
- (g) The ball in play touch him or anything that he wears or carries, except his racket in his hand or hands ; or
- (h) He throws his racket at and hits the ball.

18. A ball falling on a line is regarded as falling in the court bounded by that line.

19. If the ball in play touches a permanent fixture (other than the net, posts, cord or metal cable, strap or band) after it has hit the ground, the player who struck it wins the point ; if before it hits the ground, his opponent wins the point.

20. It is a good return—

- (a) If the ball touches the net, posts, cord or metal cable, strap or band, provided that it passes over any of them and hits the ground within the court ;
- (b) If the ball, served or returned, hits the ground within the proper court and rebound or be blown back over the net, and the player whose turn it is to strike reaches over the net and plays the ball, provided that neither he nor any part of his clothes or racket touch the net, posts, cord or metal cable, strap or band, or the ground within his opponent's court, and that the stroke be otherwise good ;

- (c) If the ball be returned outside the post, either above or below the level of the top of the net, even though it touches the post, provided that it hits the ground within the proper court ;
- (d) If a player's racket passes over the net after he has returned the ball, provided the ball passes the net before being played and be properly returned ;
- (e) If a player succeeds in returning the ball, served on in play, which strikes a ball lying in the court.

21. In case a player is hindered in making a stroke by anything not within his control, except a permanent fixture of the court, the point shall be re-played.

22. If a player wins his first point, the score is called 15 for that player ; on winning his second point, the score is called 30 for that player, on winning his third point the score is called 40 for that player, and the fourth point won by a player is scored game for that player, except as below :—

If both players have won three points, the score is called deuce ; and the next point won by a player is scored advantage for that player. If the same player wins the next point, he wins the game : if the other player wins the next point, the score is again called deuce : and so on, until a player wins the two points immediately following the score at deuce. when the game is scored for that player.

23. The player who first wins six games wins a set except as below :

If both players have won five games, the score is called games-all and the next game won by a player is scored advantage game for that player. If the same player wins the next game, he wins the set ; if the other player wins the next game, the score is again called games-all ; and so on until a player wins two games more than his opponent, when the set is scored for that player.

24. The player shall change sides at the end of the first, third and every subsequent alternate game of each set, and at the end of each set, unless the total number of games in such set be even, in which case the change is not made until the end of the first game of the next set.

25. The maximum number of sets in a match shall be 5, or, where women take part, 3.

26. Except where otherwise stated, every reference in these Rules to the masculine includes the feminine gender.

27. In matches where an Umpire is appointed, his decision shall be final ; but where a Referee is appointed an appeal shall lie to him from the decision of an Umpire on a question of law, and in all such cases the decision of the Referee shall be final.

The Referee, in his discretion, may at any time postpone a match on account of darkness or the condition of the ground or the weather. In any case of postponement the previous score and previous occupancy of courts shall hold good, unless the Referee and the players unanimously agree otherwise.

28. Play shall be continuous from the first service till the match be concluded ; provided that after the third set, or when women take part, the second set, either player is entitled to a rest which shall not exceed 10 minutes, and provided further that when necessitated by circumstances within the control of the players, the Umpire may suspend play for such a period as he may consider necessary. These provisions shall be strictly construed, and play shall never be suspended for the purpose of allowing a player to recover his strength or his wind. The Umpire shall be the sole judge of intentional delay, and after giving due warning he may disqualify the offender.

Note.—Any Nation is at liberty to modify the first provisions in this Rule or omit it from its regulations governing tournaments, matches or competitions held in its own country, other than the International Lawn Tennis Championship (Davis Cup).

THE DOUBLES GAME

29. The above rules shall apply to the Doubles game except as below.

30. For the Doubles game, the Court shall be 36 feet in width, *i.e.*, $4\frac{1}{2}$ feet wider on each side than the Court for the Singles Game and those portions of the singles side-lines which lie between the two service-lines shall be called the service-side-lines. In other respects the Court shall be similar to that described in Rule I, but the portions of the Singles side-lines between the base-line and service-line on each side of the net may be omitted, if desired.

31. The pair who have the right to serve in the first game of each set may decide which partner shall do so, and the opposing pair may decide similarly for the second game. The partner of the player who served in the first game shall serve in the third ; the partner of the player who served in the second game shall serve in the fourth, and so on in the same order in all the subsequent game of a set.

The order of service having been arranged may not be altered during the set, but it may be changed at the beginning of each new set. Similarly, the Receivers may not change places with each other for the purpose of receiving the service before the end of a set, but they may do so at the beginning of a new set.

32. The service is a fault as provided for by Rule 9, or if the ball served touches the Server's partner or anything which he wears or carries, but if the ball served touches the partner of the Receiver or anything which he wears or carries, before it hits the ground, the Server wins the point.

3. If a partner serves out of his turn, the partner who ought to have served shall serve as soon as the mistake is discovered, but all points scored and any fault served before such discovery shall be reckoned. If a game shall have been completed before such discovery, the order of service remains as altered.

34. The players to receive the service shall receive it alternately throughout each game. The order thus established shall not be altered during the set.

35. The ball shall be struck alternately by one or other player of the opposing pairs, and if a player touches the ball in play with his racket in contravention of this Rule, his opponents win the point.

THE DOUBLE COURT

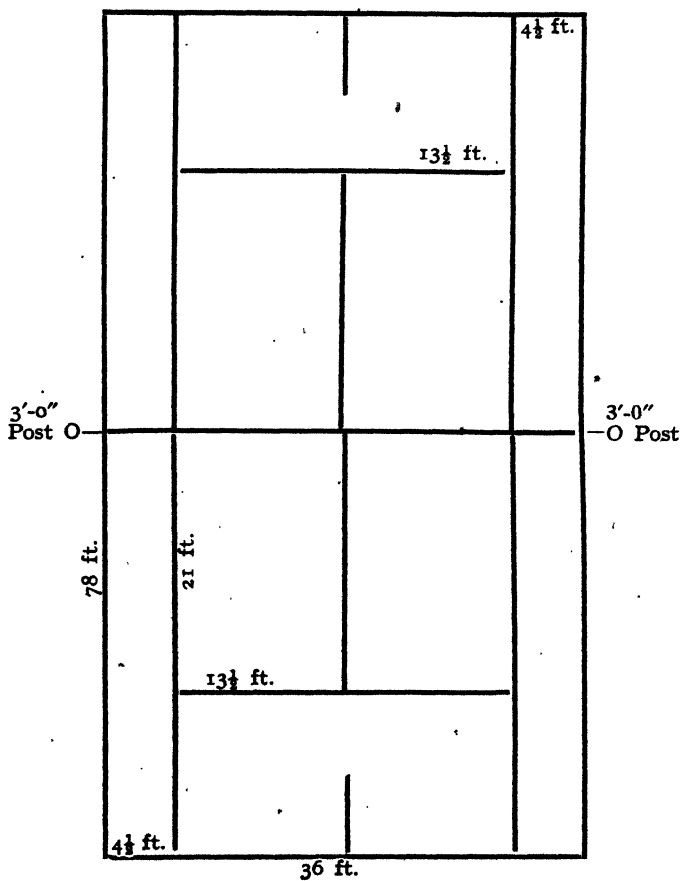

Badminton (Ball)

1.—The game is played by two sides of five players each with Badminton bats and woollen balls upon a court laid out as in the accompanying diagram. The game consists of 29 points.

Note.—The game could be played by sides of two on a side, using half the court. The same rules apply.

THE BALL

2.—The ball shall not be less than $1\frac{1}{8}$ tolas nor more than $1\frac{1}{4}$ tolas in weight, and not less than 2 in. nor more than $2\frac{1}{2}$ in. in diameter.

THE COURT

3.—The size of the court is 40 ft. in width and 80 ft. in length. It is divided across the middle by a net line, over which a net is suspended, the ends of which are attached to the tops of two posts, which stand at a distance not exceeding 3 ft. outside the court on each side. At each end of the court, parallel with the net line and at a distance of 40 ft. from it, are drawn the *Boundary-Lines*, the extremities of which are connected with the *Side-Lines*. Three feet away from each side of the net line and parallel with it are drawn the *Serving Crease-Line*. Half-way between the *Serving Crease-Lines* and parallel with the *Side-Lines* is drawn the *Centre-Line*, dividing the space on each side of the *Serving Crease-Line* into two equal parts, called the *Right* and the *Left* courts—see diagram.

4.—The top of the net shall be 6 ft. in height at the centre and 6 ft. 1 in. at the posts.

THE PLAY

5.—The act of serving shall consist in striking the ball from the right or left court of one to the diagonally opposite court of the other side. Each server shall commence from the right court and change over to the left court on making a point, and so on with each point made.

6.—The ball shall be served fairly underhand and below the waist; it shall go clear over the net and beyond the serving crease on the other side of the net.

DIAGRAM OF BADMINTON COURT

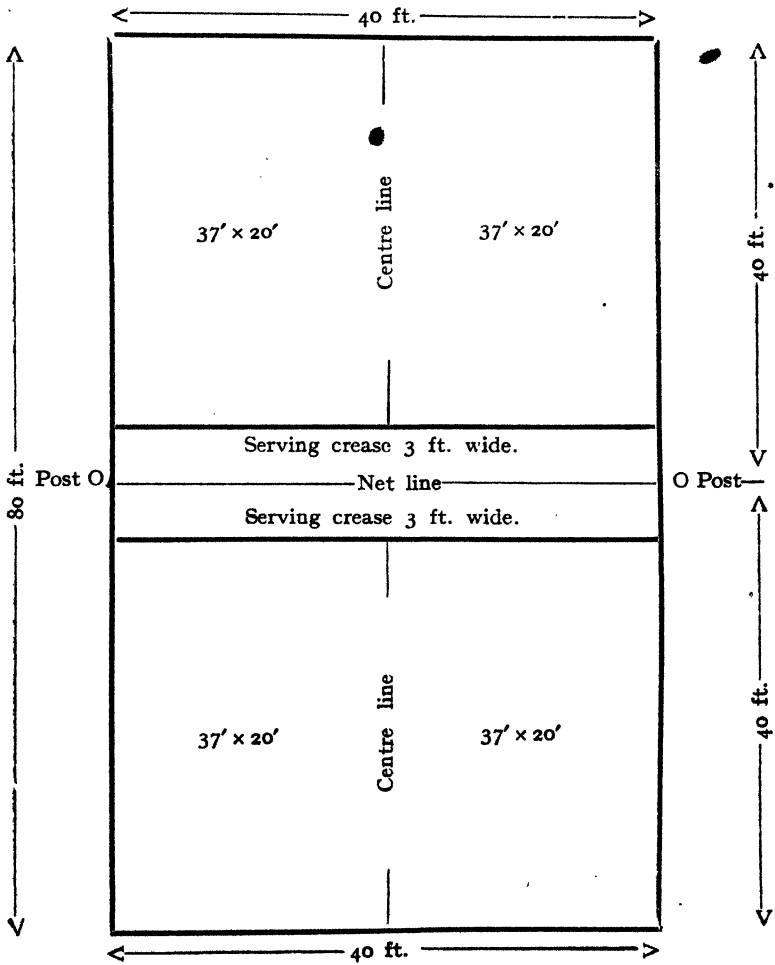

7.—The ball shall be returned before it touches the ground.

8.—No player shall strike the ball more than once consecutively.

9.—The server shall not serve until the other side is ready ; if the latter attempts to return the service, it shall be considered to be ready.

10.—Players shall not be allowed to cross the net line during play.

FAULTS

11.—A fault, made by any of the players of the serving side, shall put the server out ; if made by any of the players of the opposite side, it shall score a point to the side serving.

12.—It is a fault—

- (a) If the server misses his stroke in serving.
- (b) If the ball is served overhand. (A service is considered to be overhand if the ball at the moment of being struck be higher than the server's waist).
- (c) If the service is delivered from the wrong court.
- (d) If the ball served drops in the wrong court or on the centre line or on the serving crease line.
- (e) If a player serves out of his turn. (A player is said to serve out of his turn if he serves before the previous server is out).
- (f) If a player when serving crosses to centre line with his bat.
- (g) If the ball fails to clear the net either in serving or in returning ; and if in serving it clears the net and does not fall beyond the serving crease.
- (h) If the ball touches the top of the net.
- (i) It is a "Clash"—(*i.e.*) the touch of two bats in striking a ball.
- (j) If the players cross their bats over the net or touch the net line in the act of striking.
- (k) If the ball is touched by two bats of the same side successively—"Double touch."
- (l) If a player touches the net or its supports with his bat, person or dress, in the act of striking.
- (m) If the ball touches any player or his dress.

Rules of "Tenikoit"

1. Fig. 1 shows the Court for the Regulation Doubles or Four-Player Game, which shall be 40 ft. by 18 ft. The Singles or Two-Player Game shall be 40 ft. by 9 ft. The Neutral Ground each side of the net shall be 3 ft. wide (6 feet in all).

2. The net shall be of tanned or tarred cord and may be from 18 ft. to 20 ft. in length and 18 ins. deep. The top of the net shall be 5 ft. high and shall be edged at the top with a white tape doubled and supported by a cord run through the tape and attached to the top of the posts.

3. The posts shall be 5 ft. high, and shall be sufficiently firm to keep the net strained, the net being 4 ft. 9 ins. high in the centre.

Note.—The top of the net may be 5 ft. or 6 ft. high. (Some rules require 5 ft., others 6 ft. We recommend a 6 ft. high net).

4. The ring shall be about 7 ins. diameter, $1\frac{1}{4}$ ins. thick and shall weigh about 7 to 9 ozs.

5. The Game is played by either one or two players on each side.

Note.—In the game of one player a side (singles) only one half of the court is used, if the court is double.

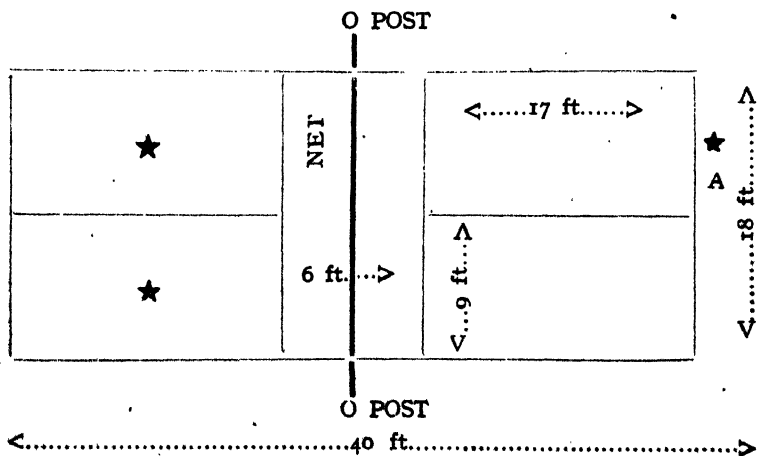

*Approximate position of four players at commencement of a game.
A serving.

6. The choice of courts or ends shall be decided by toss, the losers taking the first serve, or *vice versa*. The winners of a game commence the next game, but either player of that side may begin to serve.

7. The game with one player a side (singles) consists of 15 points, the game with two players a side (doubles) also consists of 15. Provided that if the score is 14 all, "Long sets," may be played, *i.e.*, the play is continued until one side is two points more than the other, such as 17, 15 or 24, 22.

Scoring may be done as in Tennis or as in Volley Ball.

Note.—Long sets are not permitted in American Tournaments or Handicap games.

8. A rubber is the best of three games. The players shall change ends at the commencement of each new game, and also in the third game when the leading score is 8.

Note.—In matches decided by a single game the players shall change ends as provided for the third game of a rubber.

9. In doubles the side taking the serve (called the side "in") starts the game by one player standing on (or behind, see Rule 14) the back line of the right hand court (see Fig 1) at any place on that line he may choose and serving the ring over the net to the opponent in the diagonally opposite court, his partner meanwhile occupying the left hand court wherever he may choose. Only the opponent to whom the ring is served may catch it, and provided he does so in accordance with Rule 10, he may return it over the net to any place within the boundaries of the opposite there to be caught by either of the players of the side, "in" who again returns the ring to either of the opponents, the game proceeding until the ring becomes "dead" under any of the following rules. If the first point is scored by the "in" side that side scores one point, but if the point is scored by their opponents (the side "out") then the "in" side merely lose their serve, the serve passing to the "out" side, no points being scored by either side, and the "out" side, taking the serve, thus become the "in" side and proceed as above. If the "in" side score the first point and thus become one point to none (or "one, love,") the player who served continues to serve, but this time from the back of the left hand court, his partner having changed over to the right hand court, the serve of course being confined as before, to the server's diagonally opposite opponent, which will now be the opponent other than the one to whom he last served, the "out" side always retaining their courts, and not changing their courts

until they become the "in" side. As long as the "in" side continue to win points so long do they retain the serve but on losing a point they lose the serve to their opponents, no point of course being counted to their opponents until they win a point after taking the serve. For instance, supposing the "in" side are "four, love," and lose the next point, then the "out" side through winning that point take the serve the score becomes "love, four," and the game proceeds. After losing the serve in playing "doubles," the player who has been serving occupies the right hand court, thus receiving the first serve from his opponents, his partner of course occupying the left hand court and receiving the second serve, if any.

The first player to serve of the "out" side, when they have won their serve, is the player occupying the left hand court, who will when they lose their serve, occupy the right hand court, the serve passing to the opponent in the left hand court, the serving being taken alternately.

In playing "singles" the serve merely passes from one player to the other, as, only one court per side being occupied, change is impossible.

After the serve is delivered, the server and the other players may take up any positions they choose on their side of the net, irrespective of any boundary lines. (See Rule 16).

10. The ring must only be caught with one hand, either hand being permissible. It is not permitted to catch with two hands, and to do so incurs the loss of a point. The ring may be caught by the hand against any part of the body of the player or his partner, or caught on any part of the body provided it does not touch the ground; but it must always be thrown by hand. In play, but not in receiving a service, it is permissible for one hand of each partner to catch the ring at the same time, only one player returning it, also if the ring is touched by one partner, it may be caught by the other, the one who catches, returning it.

11. Both in serving and in play the delivery of the ring must be made with an upward tendency, and the ring must rise for at least 6 inches after it has left the hand. Over-hand delivery in any form is not allowed and is a losing point if used, also in no circumstances must the hand be allowed to cross the net.

In serving, wabbling of the ring is not permitted.

12. The ring must be returned by the player from approximately the position in the court where he has caught it. Such things as catching the ring in mid court, walking to the net, and practically dropping the ring over, are not allowed and lose points.

13. Baulking in any form is not allowed, and if employed loses a point. Such things as feints at delivery are the commonest form of this.

14. In serving, the server may take a run if he choose, so long as the ring leaves his hand when he is either on or behind the back line of the court.

15. Only one serve is allowed, except in cases when the ring touches the net (called a "let") in passing over, but is otherwise a good serve, when it does not count and the serve is replayed. If the ring touches the net in passing over but lets untouched either in the wrong court or out of bounds, it is a foul stroke, and the serve passes to the opponents in the usual way. The ring touching the net in passing over during play other than the serve is not penalised.

16. No player, under penalty of losing a point, must stand within the neutral ground (3 ft. on either side of the net), nor must the ring be allowed to drop within this ground, even though the ring has crossed the net. If the ring does so fall, a point is lost by the side which has delivered the ring.

Note.—A foot on any line is counted in the court, and not penalised.

17. The ring must be played over the net and not allowed to pass round the side of the post.

18. A ring falling untouched (see Rule 21 if touched) in the proper court, if a serve, or "in bounds" in succeeding play, counts against the side failing to catch it. A ring falling untouched out of the proper court if a serve, or "out of bounds" in subsequent play, counts against the side delivering the ring.

19. The first point of contact with the ground is deemed to be the place where the ring has touched, and not that place where the ring eventually comes to rest. A ring striking any boundary line, no matter, where the ring eventually comes to rest, is deemed as in the court.

20. The server may not serve until both his opponents are ready.

21. If a player catch the ring or even touch it no matter where he is standing (except the neutral ground) the catch is deemed to be good if caught under Rule 10. If the ring is touched and dropped, even though the player and the ring are outside the court boundaries (other than the neutral ground) the player is deemed to have lost the point.

22. If in service the ring touches the top of the net in passing over, and is then caught by the player to whom it was served, it is assumed that the ring would have fallen into the proper court. It is thus a "Let" under Rule 15, and must be replayed as such.

23. The ring must be returned immediately and not retained in the hand. The holding of the ring is considered "baulking," under Rule 13.

24. A player serving from the wrong court, or out of turn, or to an opponent standing in the wrong court, shall not count any points won or lost unless the next succeeding service has been played when all points won or lost up to that service shall count. The error in serving will then be corrected and play resumed.

25. The ring must be returned by the same hand with which it is caught.

A FEW BRIEF POINTS ON THE GAME OF TENIKOIT

Single—Two players—15 points up. Best of Three Games.

Doubles—Four players—15 points up.

When serving do not screw the Ring up, hold and play it naturally.

Do not garb at a fast Ring, or a wobbler, let the Ring come into the hand on a retarding movement, as a cricketer fields a ball.

You must score off your own Service, not that of your opponents.

At 13 all, the first player reaching 13 may set the best of 5.

At 14 all, the first player reaching 14 may set the best of 3.

The Ring must not be thrown or served over-hand in any shape or form, nor is a flat thrown Ring allowed. The temptation to throw flat or over-hand Rings is very great when a fast rally is played close up to the net. Flat or over-hand played rings absolutely spoil the game, they stop all open play, and check the beneficial exercise the game provides.

The Ring must always be played or served with an upward tendency of at least six inches, and as much more as the players care to give, no matter whether the Ring be taken high or low. No baulking or hesitating is allowed, and the Ring must be returned immediately it is received no matter in what position you are. Your feet are not allowed in the neutral ground (*i.e.*, each

side of the Net). A Ring striking any line or falling on a line is "in" no matter where the Ring eventually comes to rest.

SPECIAL NOTES ON THE SERVICE

The back-hand service from the standing position, *i.e.*, (right foot forward) is without doubt the better, when open play and finesse is preferred, and all the finer points of the game exploited to obtain the beneficial exercise and pleasant pastime "Tenikoit" provides.

For faster and more aggressive play, use the forehead service (*i.e.*, left foot forward from the standing position, or with a run) Both feet in any service must be behind or on the back line at the time the Ring leaves the hand. Fore-hand play is indulged in from the back of the court. If played when close to the net, flat or over-hand Rings are apt to be played, these should be promptly faulted. There are many occasions when fore-hand play must be adopted, and if the Ring is played with a pronounced upward tendency no possible exception can be taken, and a lot of points are scored from this play on account of the Ring being returned so quickly and because it must be returned by the same hand by which it was caught. In taking a fast Ring, whether naturally played or a wobbler, do not grab at it, take it with arm receding slightly.

Handball

SINGLE WALL COURT

1.—Standard one-wall courts shall be approximately 20 feet in width by 34 feet in length and the wall 16 feet in height, the short line to be at least 13 feet from the board. There shall be a line parallel to the short line or markers on the floor marking an imaginary line 9 feet behind the short line. This line will be known as the service line.

2.—Ball to be standard rubber hand ball, Spalding No. 131, or similar thereto.

3.—Twenty-one points shall constitute a game.

4.—First service shall be determined by the toss of a coin or in any other manner agreed by the contestants.

5.—If the players cannot agree upon a ball, a new ball shall be selected by the Referee.

6.—In serving, the ball must be bounded on the floor within the square formed by the two side lines, the short and the rear line, and struck on the first bounce. Missing the ball puts the serve out. The server has the privilege of several attempts at bouncing the ball before serving.

7.—The server must stand between the short line and the service line before commencing his service with at least one foot between the side lines, and must not step over the short line while serving. Stepping over the short line while serving (or serving with both feet outside of the court) shall be counted a fault, the same as a short or long ball. Doing so twice in succession shall be counted a hand out.

Note.—For informal play an old tennis ball may be used instead of the standard ball.

8.—The server must serve the ball so that it will first strike the board and bounce from the board inside of the square formed by the two side lines, the short line and the service line.

9. Two short balls in succession or two long balls in succession or a short ball and a long ball in succession shall count as a hand out.

10.—One ball served outside of the side line shall count as a hand out.

11.—Hitting the ceiling, floor or any other part of the room before the front wall while serving counts as a hand out.

12.—If either side catches or stops the ball on the service or play before it hits the floor, it counts as a hand out or a point against the offending side.

13.—The receiver cannot play a short nor a long ball. The server or his partner may stop a short ball after it touches the floor and before it has been touched by the opposing side.

14.—While his partner is serving, the player must stand outside of the court and must not enter the court until the ball having hit the board has returned past the short line.

15.—The receiver may strike the ball in returning same on the fly or on the first bounce.

16.—After the receiver strikes the ball, it must return to the front wall before hitting the floor and bound back into the court between side lines, the bound and service line. If the receiver fails to hit the front wall first and return the ball so that it bounces within the limit of the court, it shall be counted as a point for the server.

17.—If the receiver fails to return the ball, it counts as a tally for the side serving. If the server fails to return the adversary's play, it counts as hand out and the side loses the server.

18.—If a player strikes the ball and it hits an adversary before striking the floor or the front wall, the ball is dead and the point must be played over.

19.—If a ball, before it is dead, touches a player on the way back from the front wall, it loses the point for the player touched and the ball is immediately out of play.

20.—Hitting a partner with the ball immediately puts the ball out of play and loses the point for that side.

21.—If a player is interfered with unintentionally by his opponent, he may claim a hinder and the point shall be played over.

22.—A player being interfered with in playing the ball by an opponent, may claim a hinder unless his opponent after having played the ball shall have stood still, in which case no hinder shall be allowed.

23.—In doubles both players on a side are entitled to a fair and unobstructed chance at the ball, and either one is entitled to a decision on a hinder even though it might be the partner's ball,

and notwithstanding that the partner may be attempting to play the ball or that he may have already missed it.

24.—When, in the opinion of the Referee, a player is hindered intentionally, he should decide that point against the offending player.

25.—It is the duty of the Referee to decide all hinders without being appealed to by the players, as it is often distasteful to a player to make claims especially in close cases, and failure to claim a hinder does not relieve the Referee from the duty of rendering a decision.

26.—During a play the ball may not be played by a player after it has been touched either by a partner or by himself.

27.—A player may not claim a hinder when interfered with by his partner.

28.—Kicking the ball is not allowed.

29.—In all match games there should be a Linesman, a Referee and a Score-keeper, who should sit next to the Referee.

30.—During tournament or match play, leaving the court without consent of an adversary forfeits the series unless excused by the Referee.

31.—After the completion of a rally, both players shall be allowed a reasonable time to get in position, after which the Referee may call play. If the server fails to serve the ball after play is called, the Referee may count ten as nearly as possible at the rate of one count per second, and if the ball is not served before the completion of the count, the server shall be declared out.

32.—The Referee's decision is final.

33.—Any player refusing to abide by the decision of the Referee forfeits the match.

34. Drawings may be made either 48 or 72 hours before the scheduled time of the contest, and the method of drawing shall be the same as prescribed in Boxing Rules.

35.—If a ball strikes the ceiling or other obstruction either in going or coming from the front wall, it shall be counted as a point against the player who struck the ball.

Note.—A Tennis ball serves very well as a Handball.

International Rules For Wrestling

GRECO-ROMAN AND FREE STYLES

WEIGHT CLASSIFICATION AND WEIGHING-IN

SECTION 1.—Participants of the Olympic and International Competitions shall wrestle in the following weight classes:—

- | | |
|----------------------|---------------------------|
| 1. Batamweight | up to 56 Kilos. (123 lb.) |
| 2. Featherweight | up to 61 Kilos. (134 „) |
| 3. Lightweight | up to 66 Kilos. (145 „) |
| 4. Welterweight | up to 72 Kilos. (158 „) |
| 5. Middleweight | up to 79 Kilos. (174 „) |
| 6. Light heavyweight | up to 87 Kilos. (194 „) |
| 7. Heavyweight | over 87 Kilos. (191 „) |

The contestants shall participate in the weight class corresponding to the natural weight of their body. Exception is to be made if they enter in the next higher weight class ; but such engagements must be submitted before weighing-in takes place.

The weighing-in shall take place on the day of the competition ; it shall be commenced three hours before and finished two hours before the beginning of the first bout. If the competition extend beyond one day, the competitors shall be weighed every day of the competition, when no allowance of weight shall be permitted. Reweighing to commence two hours and to be finished one hour before the first bout.—No automatic scale shall be used.

The competitors shall be weighed nude (netto) and be subjected to a medical examination, in order to avoid infection. The competitors shall have the right to appear on the scale as many times as they wish during the period of weighing and reweighing.

DRAWING THE LOT AND PAIRING

SECTION 2. The participants of the competition shall be paired for each round according to their numbers as drawn by lot. The numbers are to be drawn by the competitors or by their representatives.

SECTION 3. The time-table and the protocol of the competition shall be drawn up, also a list of the pairing of the contestants in each round for the information of the competitors.

The competitors drawn by the lot to follow each other, as on the register, will wrestle together in the first round. If the number of the competitors be uneven, the one drawing the highest number receives a bye and will proceed without any bad point into the following round, where he is to be put on the register as first to be paired. He shall retain his place, as first, until the competitor having the next higher number after him becomes a bye in the succeeding round and proceeds to the head of the list.

A bye is a right won by drawing the lot, and it cannot be withdrawn, except in the final bout if the two other competitors have already met each other in the preceding rounds.

The order of the contests shall be as follows: the first name on the list shall be paired with the competitor coming next after him, who, however, has not yet wrestled with him. For example in the second round, if there were no bye in the first round; 1—3, 2—4, 5—7, 6—8, and so on. If there were a bye: the bye—1, 2—3, 4—5, etc. And the same in the following rounds. Should two compatriots be paired together in the first round, one name must be passed over.

COSTUME

SECTION 4.—Competitors shall appear before the public in a decent dress with a belt or a suspensor worn beneath.

The dress must cover the body to at least the middle of the thigh, it may not be cut away at the shoulders or at the neck more than two palms breadth (20 cm.).

Shoes with heels or nailed soles shall not be worn, and it is also forbidden to rub the hands, the arms or any part of the body with grease or any kind of greasy material.

Bandages on the wrists or hands shall not be worn unless in case of an injury or on doctor's prescription.

The nails of the competitors shall be cut short, and they are forbidden to wear rings, bracelets, shoes with buckles, metal work or anything that would be liable to hurt their opponents.

MAT

SECTION 5. At every international competition a mat of at least six metres by six metres and 10 cm. thick is obligatory. At the Olympic competition and European Championships the mat shall be eight metres by eight metres. All round the mat there shall be left a free space for the security of the contestants; this

should not be less than $1\frac{1}{2}$ metres wide. The middle of the mat shall be marked by a circle of 1 metre diameter, on the circumference of which a stripe of 10 cm. width and of different colour from that of the mat (cover).

If a raised platform be used (without posts and ropes the use of which is forbidden) the height from the ground shall not be more than 110 cm. ($3\frac{1}{2}$ ft.), the sides sloping at an angle of not less than 45° and boarded in.

The floor close around the mat shall be covered with soft well fixed cover. The mat shall have a soft cover which, to avoid infection, shall be repeatedly cleaned. The buckles of the cover shall be protected and concealed.

The mat shall be placed in such manner that the bridge shall be feasible even if the legs get outside of the mat.

BEGINNING, PROGRESS AND END OF A BOUT

SECTION 6. If the competitor, after having been regularly called, refuses to commence wrestling or does not appear within 5 minutes, he is to be declared beaten and bad points given as though he had actually lost a fall. But on the first day of a meeting such delay may be extended to 15 minutes for the first bout only.

At the beginning of a bout, the opponents shall place themselves at the two opposite corners of the mat. From these points they go to meet each other and shake hands with the right hand, pass each other, turn around leftward and begin to wrestle. After the bout they shall again shake hands.

SECTION 7. A bout shall be begun, interrupted, and ended only by the whistle of the Referee. Competitors are not entitled to order their opponents from the edge to the middle of the mat.

At the commencement of the bout on the ground the wrestler below shall go on all fours—both his hands and knees to touch the mat at the same time—while his opponents shall touch him with a hand as the signal for the beginning of the bout.

A surprise attack upon the adversary below is forbidden, and the Referee shall caution the wrestler at fault; he is also entitled to order both the contestants to stand up.

SECTION 8. All bouts shall continue until the regular defeat of one of the contestants, provided the defeat takes place within the maximum time fixed for the bouts.

A fall shall end the bout instantaneously.

The maximum time for the bout shall be 20 minutes in the Greco-Roman Wrestling, and 15 minutes in the Free Style.

The official Time-keeper shall announce loudly the lapse of each minute.

THE JURY

SECTION 9. The Jury consists of a Referee and two Judges.

Should enough Judges be present at a competition, there may be employed also three Judges in a bout. The role of the Referee in this case shall be only the conduct of the bout, without giving his own decision or filling up a scoring paper.

Three Judges shall be employed only when it is assured that all bouts of the competition be arbitrated under the same circumstances. The number of the Judges shall not be permitted to be changed in a competition.

In order to avoid partiality, compatriots of the wrestlers can act neither as Referee nor as Judges for the bouts in which their countrymen are engaged.

It is also necessary no two members of the Jury shall be of the same nationality.

During the bout the Referee and the Judges are not allowed to speak to any person other than the members of the Jury.

The Representative of the I.A.W.F. shall appoint the Jury by the following method:

The list of the Referee and that of the Judges shall be drawn up, their names in the order determined by drawing the lot. One name be included on both the lists. The members of the Jury shall be appointed in the sequence of names as figuring on the lists, but the names of compatriots of the contestants of any bout should be passed over.

FALL

SECTION 10. Defeat shall be declared:

A—One Referee and two Judges being in the Jury—

1. If the Referee declare the fall and one of the two Judges agrees ;
2. If the Referee declare a fall and the two Judges do not protest ;
3. If the Referee has not seen the fall but the two Judges have seen it.

But if the Referee has clearly seen that it was not a fall his decision shall be accepted even if the two Judges are for the fall.

B.—One Referee and three Judges in the Jury—

1. If the Referee declare a fall and one of the Judges agrees ;
2. If the Referee declare a fall and two of the Judges do not protest ;
3. If the Referee has not seen the fall, but two of the Judges have seen it and declare it ;
4. If the three Judges declare the fall against the opinion of the Referee.

In the case of equality of votes, the vote of the Referee shall decide.

However short may be the touch of the two shoulders with the mat, it shall be considered as fall.

In the Free-Style wrestling, the Rolling Fall shall not count unless there is a definite cessation of movement which leaves no doubt that the two shoulders have been in simultaneous contact with the mat.

To decide a fall at the edge of the mat, it is sufficient if, at the moment of the throw, the head and both the shoulders have been in contact with the mat.

WINNING ON POINTS

SECTION 11. If no fall occurs within the time fixed for a bout (20 minutes in the Greco-Roman, and 15 minutes in the Free Style) the members of the Jury entitled to vote (if two Judges acting, the Referee shall vote also) must hand their scoring papers to the Representative of the I.A.W.F., who according to the majority of votes, must declare the winner.

It is obligatory for both Judges and Referee (if latter is voting) to appoint a winner.

BAD POINTS

SECTION 12. The results of the bouts shall be counted on bad points as follows:

The competitor winning by fall, will receive 0 bad points while his opponent will be given three bad points. If the bout be decided by the vote of the Jury, the winner receives one bad point, while his opponent receives three points.

If the vote of the Jury be two to one, the winner receives one bad point, his opponent receives two bad points.

The competitor having accumulated five bad points will be eliminated.

Competitors who have been eliminated at the same round are to be regarded as eliminated at the same time.

Should it happen that candidates for the third place have been eliminated with equal bad points in the same round they shall be paired, if they have not yet met each other, for the third place.

CLASSIFICATION FOR PLACE-WINNERS

SECTION 13. The winner of the competition of a weight class is the one who has accumulated the smallest number of bad points. When two contestants have an equal number of bad points, the victory shall be awarded to the one who was winner of the bout against the other. In the event of a triple tie, they must be weighed immediately, and the lightest contestant shall be declared the winner. The contestants having a chance to end in a triple tie, are entitled to demand their re-weighing immediately after their last bout.

ILLEGAL HOLDS

(A)—*Greco-Roman Wrestling*

SECTION 14. It is forbidden to take hold below the hips. In general a competitor should touch the body of his adversary with open hands—palms only, exceptions are the arms and the hands.

It is not allowed to touch the face of the opponent between the eyebrows and the mouthline.

Any hold of the throat is forbidden, likewise it is illegal to seize the clothing or the belt.

It is forbidden to strike, to kick, to push, to scratch, to pull opponent's hair or to trip him.

It is allowed to seize the wrist and the fist, but the fingers are in no circumstances whatever allowed to be seized.

The scissors (to squeeze the adversary between the locked legs) are forbidden. It is not allowed, when in front of the adversary, to get a hold on the head without the hands of the aggressor being placed against the chest of his opponent. When

using the Double Nelson the legs of the aggressor shall remain in passive and the pressure of the hold be directed sideways.

The attacker having a body hold from behind, and having raised his opponent upside down,—*i.e.*, a rebours hold—at the moment of the throw he must go down on the mat on one knee, before his opponent's trunk touches the mat. The throw must be carried through sideways, a violent throw down being expressly forbidden.

The bridge must be pressed down. It is forbidden that an opponent in a bridge should be lifted up and thrown down on the mat. Further it is forbidden, when defender is on the bridge, to force his head in such direction that it is bent backwards upon his neck.

The legs of the contestant shall be always passive. Butting, pushing or lifting up with the legs is forbidden.

When lifting the arm of the adversary in parterre, it is to be considered irregular to bring the forearm behind the back at an angle less than a right angle ; with the arm carried behind the back in such position, it shall not be pressed at the forearm or twisted outwards.

(B)—*Free Style Wrestling*

Any fair hold, grip, lock or trip is allowed.

The contestants may take hold how and where they please, subject to the following restrictions ;

The hair, flesh, ears, private parts or clothes may not be seized.

Twisting of fingers and toes is forbidden.

Striking, kicking, gouging, hair pulling and butting are forbidden ; and any grip that endangers life or limb, or has for its object the punishing of an opponent, or the infliction of such pain as to force him to give the fall, will not be allowed.

Forbidden holds are the Double Nelson, Strangle or Half Strangle, Flying Mare with the palm uppermost, the toe Hold with a twist, the Scissors on head or body, the Hammerlock, and an arm or foot up the back with a Bar. Interlacing of the fingers is prohibited.

To strike with the side or sole of the foot shall not be regarded as kicking.

When making use of standing throws from behind so that an opponent is turned upside down, the throw must be carried out sideways and not vertically. It is necessary for the attacker to

touch the mat with one of the knees before the upper part of the opponent's body touches the mat.

It is forbidden to break a bridge by raising an opponent and dashing him down bodily, by forcing him down vertically in the direction of the head, or by pressure of the elbow or knee on the abdomen or stomach.

Defender's arm having been carried behind his back, it is forbidden to push the forearm beyond a right angle with the upper arm, or, the arm being so placed, to force the forearm outwards.

PENALTIES

SECTION 15. If by using an irregular or a forbidden hold the attacker falls into a disadvantageous situation, wrestling shall be continued without interruption.

Any advantage resulting from an illegal hold shall be cancelled even if the irregular situation is already over.

The irregularity is to be eliminated, if possible, without disturbing the relative positions.

Against a competitor using irregular holds the Referee shall proceed as follows:—

- (a) Eliminate irregularity ;
- (b) Break the hold ;
- (c) Order the competitor to stand up ;
- (d) Declare the competitor loser, after having given him cautions according to Sec. 17 of the Rules for Wrestling.

In case of a very serious irregularity disqualification may be decided upon at once, without any previous caution, by a majority of the Jury of the bout. Such disqualification shall operate for the whole competition.

ACTIVITY—PASSIVENESS

SECTION 16. Superiority shall be judged in every situation by the activity of the competitors without regard to their actual position whether above or below.

An attempt to get a hold in order to throw the opponent is to be considered as activity.

Passiveness is the intention to avert holds without counteracting ; to run off the mat or to push the adversary from it ; to lie flat on the mat or to hold down the opponent without attempting a decisive attack.

It shall be regarded as passiveness also the continual holding of the opponent's wrist—and also to stand up repeatedly when underneath in the ground wrestling (3 plus 3 minutes), without attempting holds.

CAUTIONS

SECTION 17. After 1 minute of passiveness or for repeated taking of illegal holds, the contestant or both the contestants shall be given a caution.

For escaping from the mat—but only if he were not pushed off—the competitor must be given a caution, communicated in his own language if necessary by an interpreter. The Referee is also authorised to order the escaping contestant to parterre position.

If, in the Greco-Roman wrestling, a competitor, when lifted, touches the legs of his aggressor with his feet or hand in order to prevent him from carrying through the throw, he shall be given a caution and ordered to ground wrestling in the underneath position.

The throw out of the mat is forbidden. To avoid accidents caution must be given for the same, even if the act were not international.

The competitor having received three cautions in a bout shall be declared beaten.

It is prerogative of the Referee to give cautions without consulting the Judges.

If in the ground wrestling, the uppermost wrestler attempts no real holds for 1 minute, the Referee shall order the wrestling to be continued in standing position. This rule is not in operation during the 3 plus 3 minutes ground wrestling.

GROUND WRESTLING

SECTION 18. In the Greco-Roman style the bout shall be interrupted after 10 minutes, in the Free-style after 6 minutes wrestling and the scoring papers may be examined.

If before the expiration of the 10 or 6 minutes a situation exist that may result in a fall, the bout shall not be interrupted until the end of the said situation, but as the 20 or 15 minutes time limited for a bout cannot be exceeded, all overtime of the first 10 or 6 minutes will be deducted, from the second half-time.

If after 10 or 6 minutes wrestling chiefly in standing position neither of the wrestlers has a definite lead, the Referee, in agreement with a majority of the Judges, shall order the 3 plus 3 minutes ground wrestling. The wrestlers must go down on the mat one after the other in the order determined by drawing the lot. Each period of this ground wrestling shall last 3 minutes only. At the end of the time the Referee must stop the bout whatever the situation may be.

The ground wrestling is to be regarded as normal wrestling, with the exception that during the 3 minutes the contestant underneath must resume his position on the mat immediately he has succeeded in escaping from it.

If the wrestler underneath, by getting up quickly, tries to avoid or prevent ground wrestling, he shall be given a caution.

But if he succeeds in bringing his adversary underneath, such success shall be appreciated by the Jury. If the uppermost wrestler fall into a dangerous situation, the same shall be continued until the end of the 3 minutes period.

If the ground wrestling produces a series of attacks it should not be interrupted until it has come to a halt.

If, after 10 or 6 minutes duration of a bout, in the opinion of the Jury one of the opponents has obtained a definite lead, the bout shall be continued in the same position where it had been interrupted. The contestant having the lead shall be entitled to demand—at his own risk—the 3 plus 3 minutes ground wrestling, and this shall be allowed in the order determined by drawing the lot.

In the Greco-Roman wrestling the time of the contests shall be composed by 10 plus 3 plus 3 plus 4 minutes.

In the Free-style the time shall be 6 plus 3 plus 3 plus 3 minutes.

INTERRUPTION OF THE BOUT

SECTION 19. Should a contestant be prevented by any reason outside his powers as accident of costume, bleeding of his nose, falling on head outside of the mat, or by any acceptable cause from continuing the bout, the Referee shall be entitled to suspend the bout for 5 minutes. If the competitor cannot continue wrestling after the lapse of his time, he shall be declared the loser.

In any question not provided for by these Rules, the Hon. Secretary shall decide in the first place, and in the second the Jury d'Appel.—In the event of any divergence of opinion in the interpretation of these Rules, the German text only is official.

RULES FOR JUDGING THE BOUTS

SECTION I. Should a bout end without a fall, it shall be decided by the Jury, the decision of which is to be formed by judging the totality of the performances of each of the opponents.

To this purpose all and any positive actions that occurred during the bout, from the beginning until its end, shall be recorded on the scoring paper.

SCORING PAPER

SECTION 2. The scoring paper shall be used to note down the judgments of all and any actions occurring in the bout to the credit of the respective contestants, in the corresponding time-rubric of the official scoring paper, as to when the actions occurred.

These records shall be drawn up with the utmost possible care, for the scoring paper shall be regarded as the Minutes of the bout carrying the responsibility of the undersigned Judge.

SECTION 3. When judging the individual actions of a bout, the activity of the contestant shall be decisive without regard to the uppermost or underneath position of the same.

Any attempt to get a hold in order to throw the opponent on his shoulders is to be regarded as activity.

Should the wrestling produce a series of actions, both the contestants shall be recognized in the degree of their initiative as well as holds carried through. Pretended holds or feigned attacks shall receive no recognition.

GENERAL IMPRESSION

SECTION 4. It shall be the duty of the Judges to follow the bout with careful attention and to judge the single actions occurring therein such a manner that the records of the scoring papers will clearly and truly reflect the General Impression that shall be formed upon the activity, initiative and endurance, the open wrestling and physical superiority of the competitor—on the basis of which the winner shall be appointed.

INSTRUCTIONS FOR REFEREE AND JUDGES

REFEREES

SECTION I. The Referee shall be responsible that the rules as well as the spirit of sportsmanship shall be observed in the bout, that is to be begun, interrupted and ended only by his whistle. He alone is entitled to give cautions ; these he shall communicate at the same time to the speaker in order that the public may be informed. He alone shall order the contestants from the edge to the middle of the mat and also how they shall resume wrestling ; in standing position or parterre, in the uppermost or in the underneath situation.

A fall shall be judged according to Sec. 10 of the Wrestling Rules.

THE FALL

SECTION 2. The fall shall be signalled precisely. The Referee must be confident, before giving the signal with his whistle, that the Judges do not contradict.

BACKHAMMER

SECTION 3. When the Backhammer is used the Referee must distinguish between the holding of the opponent's arm and the forcing of his body to roll over by means of the hold. The simple holding of the forearm is permitted, but when carrying through the Backhammer, the upper arm only is permitted to be forced.

CAUTIONS

SECTION 4. Cautions for faults shall be counted together with the cautions given for illegal holds in the same bouts.

Distinction should be made between the expressions: "declared loser" and "disqualified." After 3 cautions, no matter for what reason they were given, the offender shall be declared loser. Only if all the 3 cautions were given for illegal holds, may disqualifications be decided upon. The same to remain in operation for the whole competition. (Sec. 15, Rules for Wrestling).

When giving a caution the bout shall be interrupted and the caution communicated in such manner that the cautioned contestant as well as the public shall clearly understand not only the caution itself but also the reason.

GROUND WRESTLING

SECTION 5. In the Greco-Roman wrestling, after the first 10 minutes, in the Free-style after 6 minutes period the bout shall be interrupted to announce the jury's opinion by the electric indicator, *i.e.*, either the lead of one of the contestants by the electric lamp of the respective colour (that of the anklet of the competitor having the lead) or the necessity for the ground wrestling—indicated by the white lamp.

Should ground wrestling be ordered, the Referee shall immediately proceed to draw the lot by the red-green painted disk of 15 cm. diameter.

The contestant who has been awarded the lead shall be consulted by the Referee: "You are leading—do you wish the 3 plus 3 minutes ground wrestling or do you prefer to continue the bout in the same situation where it has been interrupted?" If the contestant prefers the ground wrestling, the drawing of the lot shall follow immediately.

If ground wrestling be ordered, the underneath wrestler shall wait until he is touched by his opponent's arm or hands. The underneath wrestler shall not proceed to counterattack before his opponent attempts a hold on him *i.e.*, before he takes hold of his arm, or lays his own arm on his back.

If the underneath competitor avoids an attack by lying flat on the mat, he shall resume the position on all-fours immediately after the hold has been broken off.

The contestant given the uppermost position need not go on his knees, being entitled, if he wishes, to attempt holds from the standing position. The situation "on all fours" is obligatory only for the underneath wrestler.

Should the uppermost wrestler take a hold and the one underneath tries to avoid it by standing up, the aggressor shall be entitled to throw his opponent being in standing position, without however, changing the hold. Should the hold be broken off, ground wrestling must be resumed, and the underneath wrestler must be cautioned, according to Sec. 16 of the Rules for Wrestling, for having stood up.

If the man below gets the uppermost position with no holds taken, the bout shall be interrupted and the original situation resumed.

RETURN TO THE MAT

SECTION 6. When throwing his opponent the contestant must have both feet on the mat irrespective of the position of his adversary. Should the latter get off the mat, the attacker may take no new hold of him, even if he, himself, remains on the mat.

If the opponents leave the mat, the Referee shall order them to return, in a standing position or in ground wrestling, according to the situation as it was when crossing the edge of the mat. If, when leaving the edge of the mat, the uppermost wrestler does not dominate his opponent, wrestling shall be resumed in standing position.

AT THE EDGE OF THE MAT

SECTION 7. Should a throw be ended without a fall, yet the defender be thrown to the mat, his head and shoulders within the edge of same—no matter if he crawls out afterwards—if he were dominated by the aggressor all the time, wrestling shall be resumed in *parterre*. If a contestant be thrown down in such manner that his arms go beyond the mat, the bout shall be resumed in standing position. Should he get down with his hands upon the mat, the bout shall be resumed on the ground.

OPEN AND CLOSED WRESTLING

SECTION 8. It is very important to observe, especially in periods when no decisive actions occur, which of the opponents wrestles in an open way and which one tries to avoid wrestling.

It is also of great importance that the Referee enforce real wrestling in the last minutes of a bout wherein no actions have previously occurred or if both contestants were equal. If no holds have been carried through, a more active wrestling must be brought about by warning. An opinion can be thus formed in respect of the physical condition and superiority of the contestants that assists the Judges to give their decision upon a just basis and not by mere haphazard.

It shall be permitted that a contestant push his opponent off the mat in order to escape real wrestling.

Feigned attacks, especially at the edge of the mat, shall not only be prevented, but also punished by cautions.

When the contest be broken off at the edge of the mat by whistle signal, wrestling shall be stopped immediately. The contestant attempting a hold thereafter shall be given a caution.

The Referee being alone entitled to give cautions, he shall be at the same time responsible that the wrestling shall be genuine and that it be performed on that mat.

DUTIES OF REFEREES AND JUDGES

SECTION 9, 1. The Referee shall conduct the bout without unnecessary interference. If the contestants approach to the edge of the mat, he shall be ready to warn and also to prevent their going off the mat.

2. He must be able to judge the right moment for blowing the whistle to interrupt the contest neither too soon nor too late.

3. He must know exactly the principle when to send back the contestants to the middle of the mat also when in the standing position, and when in ground wrestling.

4. He shall not stand too near the wrestlers when in standing position ; he should be able to see their legs. When in parterre wrestling he can go nearer.

5. When sending back the contestants to the middle of the mat, the Referee shall order without any hesitation how to continue the bout ; standing or in parterre.

6. A fall being imminent, he should not lie too near to the contestants, in order not to prevent the view of the judges and the public. He should possibly avoid placing his hand underneath the contestants.

7. The Referee should be able to maintain his authority over the contestants so that they will respect and follow his instructions and commands.

8. The Referee shall be responsible that the contestants do not have a rest during the bout, *e.g.*, by leaving the mat to get dried, to wipe the nose, to bind bootlaces, to rinse the mouth or by pretending injuries.

9. The Referee shall control the time lost this way by a watch—possibly stop-watch. He shall intervene in the bout without serious reasons during the first 2 or 3 minutes, until the wrestling gets into its due course.

10. Cautions can be given, however, for illegal hold or for bad behaviour during the first minutes.

11. The Referee shall be ready to change his standpoint on the mat or around it instantaneously. He shall wear a practical sporting suit in order to be able to lie immediately flat on the mat to see an imminent fall.

12. The Referee shall order the contestants to remain on the mat while announcing the Jury's decision. In the case of a fall, the time and the decisive hold; in the case of the Jury's decision, the vote of the Judges, shall be announced.

13. The legs of contestants in the Greco-Roman wrestling when in the standing position shall be especially observed.

14. If during a bout the Judges observe anything that should be brought to the knowledge of the Referee, *e.g.*, fall, illegal hold, etc., which apparently he has not seen the same shall be communicated appropriately without disturbing him.

15. The Judges must be ready after each bout to give the reasons for their decisions if demanded by the Jury d'Appel and to give explanation of each period of the contest.

16. In order to save time at the end of the bouts the Judges should undersign their scoring papers as soon as received.

After the bout, the name of the loser shall be squarely cancelled.

17. In a bout, the opponents being nearly equal, the Judges must give the reasons for their decisions in a few words.

18. During the bout the Referee and the Judges are not allowed to speak to any person other than the members of the Jury.

* * * *

In the case of difference of opinion in the interpretation of these Rules, the German text only is accepted as official.

SAMPLE SCORE SHEET FOR WRESTLING (*Free Style*)

Y.M.C.A. COLLEGE TOURNAMENT

FEATHERWEIGHT CLASS,
DATE*Rounds & Score*

First Round	Second Round	Third Round	Fourth Round	Fifth Round	Sixth Round	Seventh Round
1, 2, 3, 4, 5, 6, 7,	7, 1, 2, 3, 4, 5, 6.	No. 2 and 4 are eliminat- ed, each hav- ing 5 b a d marks 6, 7, 1, 3, 5.	Nos. 6, 3 are eliminated 5, 7, 1.	No. 7 is eliminated 5, 1.		
1/0 vs. 2/3 3/1 vs. 4/2 5/1 vs. 6/3 7/0 vs. Bye	7/3 vs. 1/0 2/2 vs. 3/1 4/3 vs. 5/0 6/3 vs. Bye	6/2 vs. 7/1 1/1 vs. 3/3 5/0 vs. Bye	5/1 vs. 7/2 1/0 vs. Bye	5/2 vs. 1/1		

SAMPLE SCORE SHEET (CONSOLIDATED)

No.	Name	Rounds						Place
		1st	2nd	3rd	4th	5th	6th	
1	H. R. Ghai	0	0	1	0	1		First
2	D. Dass	3	2	2	2	2	2	
3	D. D. Nath	1	1	3	2	2	2	
4	B. J. Pereira	2	3	2	2	2	2	
5	Nambiar	1	0	0	1	2		Second
6	M. S. Sathe	3	0	2	2	2	2	
7	J. P. Verma	0	3	1	2			Third

Running Score Sheet

SAMPLE SCORE SHEET FOR WRESTLING (*Free Style*)
BANTAMWEIGHT CLASS.

MADRAS OLYMPICS TOURNAMENT

Rounds & Score.

First Round	Second Round	Third Round	Fourth Round	Fifth Round	Sixth Round
1, 2, 3, 4, 5, 6, 7, 8, 9, 10.	1, 2, 3, 4, 5, 6, 7, 8, 9, 10.	Nos. 1, 4, 6, 7, 10 are eliminat- ed, each getting 5 bad marks.	No. 5 is eliminated	3 and 8 are eliminated	Hence No. 2 is the winner
1/3 vs. 2/0	1/2 vs. 3/1	2, 3, 5, 8, 9.	9, 2, 3, 8.	9, 2.	
3/1 vs. 4/2	2/0 vs. 4/3				
5/1 vs. 6/2	5/1 vs. 7/3				
7/2 vs. 8/1	6/2 vs. 9/1	2/1 vs. 3/2		9 vs. 2	
9/1 vs. 10/3	8/0 vs. 10/3	5/3 vs. 8/1	9/3 vs. 2/1	2 has already defeated 9	
		9/0 vs. Bye	3/1 vs. 8/0		

SAMPLE SCORE SHEET (CONSOLIDATED)

No.	Runs	Rounds					Place
		1st	2nd	3rd	4th	5th	
1	Ashraf	3	2	3	3	3	First
2	Ghai	0	0	1	1	3	Third
3	Chaman	1	1	2	1	3	Fourth
4	Chelliah	2	3	3	3	3	Second
5	Mahajir	1	1	3	3	3	
6	Ganapathy	3	2	3	3	3	
7	Azim	2	3	3	3	3	
8	S. D. Gupte	1	0	1	2	3	
9	S. P. Samuel	0	1	0	3	3	
10	Kanabargi	3	3	3	3	3	

Running Score Sheet

Boxing Rules

I. THE RING

In all boxing competitions, the ring shall be not less than 12 nor more than 20 ft. square and shall be formed of posts and ropes, the latter to extend in triple lines, 2, 3 and 4 ft. from the floor of the ring.

The floor of the ring shall extend beyond the lower rope for a distance of not less than 2 ft.

The ring posts shall not be nearer to the ring ropes than 18 inches and must be properly padded.

The ring floors shall be padded over the entire platform of the ring, and covered with a top covering of canvas tightly stretched and lashed to the platform. (Material that tends to gather in lumps must not be used).

The ring must be provided with suitable steps for the use of the contestants, seconds and officials.

II. THE GONG

The gong that is used to indicate the beginning and the ending of each round must be sufficiently loud sound so that the officials and contestants can hear the same clearly.

III. OBSTRUCTIONS

The entire ring platform shall be cleared of all obstructions, including buckets, stools, etc., the instant the gong indicates the beginning of the round and none of these articles shall be placed on the ring floor till the gong has sounded the end of the round.

IV. WEIGHT CLASSIFICATION

The following weight classification shall apply except in such cases like School boy or Junior boxing where special weight classification is necessary. In such School boy or Junior boxing the general principle should be to permit not more than 5 lbs. difference between classes.

Championship Weights

Pinweight	100 lbs. and under.
Paperweight	106 ,, and under.
Flyweight	112 ,, and under.
Bantam weight	118 ,, and under.
Featherweight	126 ,, and under.
Lightweight	135 ,, and under.
Welterweight	147 ,, and under.
Middleweight	160 ,, and under.
Light Heavyweight	175 ,, and under.
Heavyweight	Any weight.

V. WEIGHING IN

All competitors in all weights must weigh in either naked or in costume, as they may desire, on the first day fixed for the competitions before any bouts are put on.

A competitor weighing more or less than the weight for which he is entered may compete at the weight he makes on the scales on the day of weighing in. A competitor may box in one weight class only, that which he makes on the day of weighing in.

VI. GLOVES

The gloves worn must be of a standard weight of 8 oz. each except in weight classes below the 100 lbs. class. In these lower weight classes the gloves shall weigh 6 oz. each.

The gloves shall be supplied by the Club conducting the competitions.

The clerk shall examine the gloves of both contestants before the bout to see that they comply with the rules. The Referee may also order new sets of gloves if he considers the ones worn by the contestants unsatisfactory.

VII. CLOTHING

Competitors shall box in light boots or shoes (without nails or studs), or barefooted, shorts or drawers, and a vest covering chest and back. No straps or support shall be worn outside the costume. Swimming costume is prohibited.

Competitors must wear distinguishing colours, such as red and blue sashes round their waists. The sashes shall be supplied by the Association conducting the boxing.

VIII. BANDAGES

No bandages of any sort may be worn on the hands or wrists except in cases where it is considered necessary by the physician in charge.

In case bandages are permitted by the doctor, they must be made of surgical gauze and must not exceed six feet in length and 2 inches in width.

IX. ROUNDS

The number of rounds to be contested shall be three.

The duration of each round shall be 2 minutes with an interval of one minute between each round. The third round, however, may be 3 minutes in duration if the Association in charge so decides. In Junior bouts the time may be reduced to $1\frac{1}{2}$ min. each round.

X. SECONDS

Each competitor may be attended by two seconds, but no advice or coaching shall be given to any competitor by either of his seconds, during the progress of any round.

A second shall not give in for a competitor.

Seconds must leave the ring enclosure ten seconds before the beginning of each round. They shall leave the ring platform and remove all obstructions, buckets, stools, etc., promptly when gong sounds for the beginning of each round.

Violations of the above provisions shall be followed by the ejection of the offenders from the ring corner and may result in the disqualification of their principal by the Referee.

XI. JUDGES AND JUDGING

Two Judges shall sit at opposite sides of the ring. Each official shall reach his decision without conferring in any manner with any other official or person.

The Judges and Referee shall award at the end of each round five points to the better competitor and a lesser number to the other according to his merits. But if the third round is longer in duration than the first and second, seven points shall be awarded to the better competitor in the third round. Thus, when the rounds are 2 min. — 2 min. and 2 min., the scoring shall be 5—5—5. But if the rounds are 2 min. — 2 min. — 3 min., the score shall be 5—5—7.

When in any round the competitors are equal, the maximum number of points must be given to each.

A competition cannot be a draw. Extra rounds are not permitted to decide a competition. The Judges and Referee must nominate a winner at the end of three rounds and must sign their scoring papers.

At the end of each bout Judges' and Referee's scoring papers, indicating the points awarded for each round to each competitor, shall be collected by the M. C. or official appointed for the purpose, and the winner shall be the competitor whom two of the three scoring papers, indicate as the winner. The three scoring papers shall then be compared in consultation with the Referee and the winner announced by the M.C. After announcing the winner the scoring papers shall be turned over to the Referee and placed by him in a box to be preserved until the termination of the competitions.

The decision of the Judges and Referee shall be final and without appeal.

Marks shall be awarded for "attack" as follows:—Direct clean hits with the knuckle part of the closed glove of either hand on any part of the front or sides of the head or body above the belt; and for "defence" guarding, slipping, ducking, counter-hitting, or getting away. Where competitors are otherwise equal, the majority of marks shall be given to the one who does most of the leading off or who displays the better style.

XII. FOULS

The Referee shall have power to disqualify a competitor for any of the following acts, ordinarily classified as fouls:—For hitting below the belt, for hitting with the open glove, the inside or "but" of the hand, or with the wrist or elbow; for striking a competitor when he is down or getting up; for using the kidney or rabbit punch for holding, butting, shouldering, leaning on opponent, intentionally falling without receiving a blow, wrestling or roughing, unfair use of ropes, or for any other act he may deem foul.

If a competitor claims a foul which the Referee shall not have seen, the Referee shall immediately consult the Judges and if either of them has seen it the Referee may disqualify the competitor committing it.

In the event of a competitor being down, his opponent shall retire to the further corner of the ring and shall not recommence boxing until told to do so by the Referee. A competitor is considered to be down even when he is on one foot or both feet, if at the same time any other part of his body is touching the ground. The Referee shall not allow a competitor to be down longer than ten seconds. When a competitor goes down, the time-keeper shall immediately count the seconds quietly to himself and on the expiration of ten seconds shall inform the Referee who shall stop the competition. The Referee shall be empowered to stop a round if in his opinion a competitor is out-classed or unfit to continue and that competitor shall be deemed to have lost the bout.

In all the competitions, any competitor failing to resume sparring immediately after the rest between the rounds or after an interval of 10 seconds, if he has been down, shall lose the bout.

The breaking of any of the rules by a competitor or his second shall render such competitor liable to disqualification.

The Judges and Referee shall decide (1) the interpretation of any of the rules, (2) any question not provided for in the rules.

XIII. METHOD OF "WARNING" THE BOXERS

When a Referee finds it necessary to warn boxers during a contest, he must first stop the fight, give his warning in as brief a manner as possible, and then order the contest to continue. For example, '*Stop! Red, you are holding; Box on!*'

If for any reason the Referee cannot make himself heard he must stop the contest by ordering the time-keeper to strike the gong, then, after giving his warning, order the contest to continue.

It is wise for a Referee to have a whistle with which to stop bouts if found necessary.

XIV. THE REFEREE

The Referee should ordinarily occupy a seat outside and on one side of the ring. He may, however, referee inside the ring if he finds it necessary.

The primary duty of the Referee is to see that the rules and fair-play are strictly observed, to judge on the merits of two contestants in a boxing contest, and to cast his vote on the winner.

XV. THE TIME-KEEPER

The time-keeper must be seated on the side of the ring beside the Referee and close to the gong. He shall indicate the beginning and ending of each round by striking the gong. He shall provide himself with a suitable stop watch for proper timing of rounds and intervals.

Ten seconds before the beginning of each round the timer shall order the seconds out of the ring by commanding audibly—"Seconds, out of the ring!" Then at the expiry of ten seconds he shall sound the gong, to commence boxing. But before sounding the gong he will announce the number of each round, as "First Round—Gong," "Second Round—Gong," "Last Round—Gong."

The bout commences when "Gong" is sounded.

XVI. SHAKING HANDS

The Referee must insist on all boxers shaking hands properly at the commencement of the first and last rounds, and after the decision has been announced. Boxers may be disqualified for attempting to box before properly finishing the formality of shaking hands.

XVII. FIXTURES

In competitions where there are more than four competitors, a sufficient number of byes shall be drawn in the first series so as to reduce the number of remaining competitors to four, eight, or sixteen, as the case may be, and the drawers of such byes shall not have to box then, and in the second series those who have received byes shall complete before those who have already boxed. Byes that may, for some reason, subsequently arise shall be boxed for the specified time with an opponent approved by the Judges and Referee.

In fine the universal method of arranging fixtures and drawing byes for tournaments shall be followed.

XVIII. MASTER OF CEREMONIES

The Master of Ceremonies shall announce the names of the Referee, Judges, and Time-Keeper when the competitions are about to begin, also all changes made in official or programme as the tournament progresses, as well as making other announcements of importance.

He shall announce the names of all contestants, the weight class in which they are competing, the Club they represent, and the decisions of the Judges and Referee.

He shall collect the score sheets from the Referee and the two Judges, compare them with the Referee and then make the announcements of the results.

XIX. PHYSICIANS

One or more physicians must be in attendance throughout boxing competitions to deal with any emergency which may arise.

The physician shall thoroughly examine each contestant immediately before the contests, and shall eliminate any who are not physically fit.

XX. CLERK OR OFFICIAL IN CHARGE OF BOXERS

The clerk shall attend to the drawing as specified in the rules. He shall examine the bandages (if bandages are permitted) of all contestants to see that they comply with the rules. He shall also examine the gloves put on by each contestant to see that they conform with the rules.

He shall notify the contestants when to get ready for their bouts, shall give the boxers all necessary information, and shall supervise the general conduct of the tournament.

Atya Patya

[DARIA BANDHA OR THE GAME OF FEINTS]

(as adopted by the Akhil Maharashtra Shareerika Shikshana Mandal)

THE PLAY FIELD

Dimensions in the following Diagram

1. Each of the nine breadthwise strips known as 'Trenches' (Patis) are 23 feet 1 inch long and 13 inches wide (e.g. AB, CD etc.).

2. The central lengthwise strip known as the 'Central Trench' (Sur-Pati) is 89 feet 1 inch long and 13 inches wide (EF).

3. The Central Trench (Sur-Pati) divides each of the nine trenches into equal halves.

4. (a) The distance between the front lines of two adjacent trenches is 11 feet (BD).

(b) Each of the squares of intersection has each side of 13 inches (small squares formed by the intersection of the central trench and the other trenches K, L etc.).

5. (a) There are in all nine trenches.

(b) Two lines are drawn, each parallel to and at a distance of 11 feet, one in front of the 'Front trench and other behind the 'Back trench'. These are the end lines (GH & IJ). The side lines are produced to meet these end lines. The two lines which mark each trench shall be extended to a distance of three feet outside the side lines.

(c) There should be a clear space of about 10 feet all round the play field.

6. Those who have not completed their fifteenth year of age and are not more than 5 feet in height shall be called 'Junior players'.

7. For Junior players the size of the play field shall be as follows:—

(a) Each trench shall be 12 inches \times 21 feet.

(b) The distance between the front lines of adjacent trenches shall be 10 feet.

(c) Central Trench shall be 12 inches \times 81 feet.

PLAY FIELD
ATYA PATYA

E F 89 ft. 1 in.
A M " "
B N " "
A B 23 ft. 1 in.
C D " "

The figures by the side of the trenches do not indicate their order. They are put in to facilitate counting at the end of an inning.

FOR JUNIORS

E F = 81' x 1'
A B = 21' x 1'
K = 1' x 1'
B D = 10'

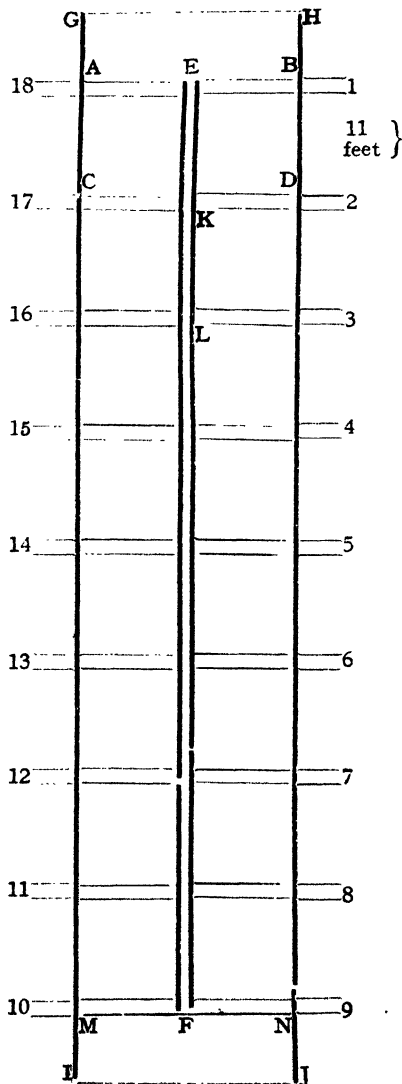

NOTE:—The lines in the diagram are cut for printing only. The lines on the field should be continuous.

DEFINITIONS

1. **SIDE-LINES, END LINES & BOUNDARY.** The long lines on the two sides of the play field are known as the side-lines (AM & BN). And the two lines, one in the front of the front trench and the other behind the back trench are known as the end lines (GH & IJ). These four lines form the boundary of the play field.

• 2. **TRENCH [PATI].** (a) Each of the breadthwise strips (rectangles) measuring 23 feet 1 inch in length and 13 inches in width is known as a 'Trench' (Pati).

(b) The two lines of each trench, which mark the trench and which cut the side-lines and the two lines of the central trench which cut each of the trenches are known as 'The lines of the trench.'

3. **FRONT TRENCH [Chambhar Pati or Kapal Pati].** The foremost trench is known as the 'Front Trench'.

4. **BACK TRENCH [Lona Pati].** The last trench is known as the 'Back Trench'.

5. **CENTRAL TRENCH [Sur-Pati].** The lengthwise rectangular strip which intersects the breadthwise strips—trenches—is known as the 'Central Trench'.

6. **'GOING DOWN', 'GOING UP'.** Playing to cross the trenches from the 'Front trench' to the 'Back trench' is known as 'Going down'. Playing to recross the trenches from the 'Back trench' to the 'Front trench' is known as 'Going up'.

7. **SQUARES OF INTERSECTION.** Each of the small squares formed by the intersection of the central trench and the other trenches is known as the 'Square of Intersection'.

8. **COURT OF A TRENCH.** The field between two adjacent trenches is known as the 'Court of a trench'. The court in front of the defender who holds (defends) the trench is known as the Court of that trench.

9. **SQUARE.** Each part of the court of a trench divided by the central trench is known as a 'Square'.

10. **DEFENDERS [Patiwale].** Those who stand on the trenches and hold them by moving along the trenches trying to prevent the players of the other side from crossing the trenches by touching them and thus putting them out are known as 'Defenders'.

11. **GRENADIER [Sur].** The defender who holds (defends) the front and the central trench is known as the 'Grenadier' (Sur).

12. **ASSAILANTS.** Those who try to cross the trenches are known as 'Assailants'.

13. **FOOT-FAULT.** If any part of the body of a defender and a grenadier touches any part of the ground outside the lines of his trench either in front of him or behind him, he is said to have committed a 'Foot-fault'.

14. **HAND-FAULT.** If any part of the body except the feet of a defender and a grenadier touch any part of the ground he is said to have committed a 'Hand-fault'.

15. **CUTTING THE SQUARES.** (a) A grenadier must at the beginning of an inning keep his foot or a part of the foot in the square of intersection of the front trench ; he must then on the start of the play touch the square of intersection of the first trench with the same foot or its part ; and again touch the square of intersection of the front trench with the same foot or its part. The whole of this action is known as 'Cutting the squares'.

(b) While thus cutting the squares, a grenadier may commit a foot fault and/or a hand fault.

16. **RAISED A FOOT.** If a defender lifts his foot above the ground and stands on the other foot, he is said to have 'Raised a foot'.

Note 1. As long as any part of a foot is touching the ground, a foot is not raised.

Note 2. If the defender is walking or running along a trench, a foot is not raised.

17. **TURNING THE FACE.** A defender is allowed to turn the shoulder line (the imaginary line supposed to be drawn to join the shoulders) upto a right angle to the lines of a trench. If he turns the shoulder line beyond it, he is said to have 'Turned the face'.

18. **FOOT OUT.** If the whole foot of an assailant touches the ground outside the boundary of the field he is said to have placed his 'Foot out'.

Note 1. Even if a point of the great toe is touching the ground inside the boundary, the foot is not out.

Note 2. Even if the whole body is in air, not touching the ground, outside the boundary, the foot is not out.

19. **PUTTING OUT.** If a defender or a grenadier touches an assailant by hand without committing the breach of any rules, the assailant is said to be 'Put out'.

20. **'TO CALL FOR' and 'GIVE' 'TOND'.** While going up to recross the trenches, when an assailant, standing behind a defender, utters loudly and clearly, addressing the defender the word 'Tond',

he is said to have 'Called for Tond'. Immediately on hearing the call, the defender must turn about and face the back trench. This action is known as 'Giving the Tond'.

21. OBTAINING, TAKING AND BRINGING 'TOND'. When an assailant who is going up—up player—and an assailant who is going down—down player—meet in one square, it is said that 'Tond' is 'obtained'. The up player is said to have taken it to the down player. The up player is said to have brought 'Tond'.

Note. An assailant who has obtained 'Tond' is known as an 'up player' and an assailant who has not obtained it, is known as a 'down player'.

22. LONA [Game]. When the foremost up player from amongst the assailants while recrossing the trenches crosses the front trench, it is said that 'Lona' (Game) is scored against the defendants.

23. FOULING. (a) If an up player crosses a trench in going up, without a down player obtaining Tond, the down player has fouled.

(b) If a down player, while going down, crosses a trench which has already been recrossed by an up player or if he goes up and crosses a trench without obtaining Tond he has fouled.

24. RING. When a defender and a grenadier enclose two or more assailants in a square it is known as a 'Ring'.

Note. If either the grenadier or defender stands with one foot on one side and the other foot on the other side of a square of intersection, a ring is not formed.

25. PREVIOUS TRENCH, REMNANT, AND HALF. (a) The trench in front of the defender of a Ring is known as the 'Previous Trench'.

(b) That part of the previous trench which is on the side of the ring is known as the 'Remnant' and the other part as the 'Half'.

RULES OF THE PLAY

1. The play field shall be marked as shown in diagram on page 193.

2. At the commencement of the play, the assailants shall stand in the area between the front trench and the end line in front of it. The defendants shall stand on the trenches—one on each trench—facing the front trench. The grenadier shall stand on the central trench ready to cut the squares. The defenders cannot change their trenches during an inning. (Each of the trenches excluding the front trench is consecutively termed as the 1st trench, 2nd trench, 3rd trench etc. and one defender stands on each).

3. After the signal for commencement of the inning is given, the grenadier shall cut the squares. He cannot put any assailant out unless he has cut the squares.

4. (a) While cutting the squares, a grenadier, must be on his central trench, but he may commit hand faults and/or foot faults.

(b) If a grenadier does not cut the squares correctly, the umpire shall call him to cut the squares again ; but the umpire cannot do so when the grenadier has once crossed three trenches including the front trench.

5. Other defenders can put an assailant out from the commencement of the inning.

6. A defender can put an assailant out on either side of his trench, while he is playing to cross that trench. A grenadier can put an assailant out on either side of the front trench, be he either an up player or a down player.

7. When an assailant has completely crossed a trench, no part of his foot shall touch the court of the trench which he has crossed.

8. (a) A defender, while he is putting an assailant out or immediately after it, shall not (i) raise his foot (ii) commit a hand fault (iii) commit a foot fault or (iv) turn his face. If he has committed a breach of any of these conditions, the assailant shall not be declared out ; but if the breach is committed as a result of a push from the assailant given before or after his crossing the trench. the assailant shall be declared out.

(b) A grenadier, in putting an assailant out, can raise his foot, commit a hand fault within the lines of his trench, go up and down and turn his face.

9. An assailant shall be out if, (i) he has fouled, (ii) he goes out of the boundary, (iii) he is put out by a defender or grenadier without committing any breach as mentioned in rule No. 8, (iv) he breaks the rules 7, 10 and 20.

10. An assailant shall not allow both of his feet to go out of the boundary simultaneously. It shall be permissible if one foot goes out. If both feet of the assailant have gone out of the boundary, while the rest of the body is inside the boundary, he shall be considered to have placed his feet out. [The rules of the ring in this regard are different, please refer to them].

11. While holding [defending] his trench, a defender may go beyond the sidelines, but he shall go through the lines of his trench if produced ; in doing so he shall not commit the breach of the conditions mentioned in rule 8.

12. The foremost assailant shall call for Tond on crossing the back trench, from the defender of that trench. The defender shall then turn about and give 'Tond'. All the assailants who may be in upper court of that trench shall then come down in the lower court of that trench. After all these assailants have crossed down and are out of the way of the defender, they shall again try to recross that trench. While the assailants are thus going down the trench, the defender shall not put them out. This procedure shall be repeated at every trench while going up to recross the trenches.

Note. The court on the front trench side of any trench is known as the upper court and the court on the back trench side of any trench is known as the lower court of that trench.

13. (a) A defender shall immediately turn about and give 'Tond' when an assailant calls for it ; when once he has turned about and given 'Tond' a defender shall not again turn about until the inning is over or a lona (game) is scored.

(b) If a grenadier is intervening and an assailant cannot go behind a defender to call for Tond, he shall call for Tond from the place where he is standing. The defender shall then, go to that side and turn about and give Tond. The assailant shall not cross the trench and go up until Tond is given.

14. If the up player and the down player are in different squares of a trench and if the grenadier is intervening, the down player shall go to the square where the up player is. The grenadier and the defender of the trench shall not put the down player out when he is thus going.

15. If there is no assailant remaining in the court of a trench upto which Tond has been brought, the down player who crosses that trench while going down, shall be considered as having obtained Tond when he has entered that court.

16. An assailant shall be entitled to take Tond to other assailants when once he has obtained it.

17. Immediately when a lona is scored, the referee shall announce that 'a lona has been scored' (or make a signal to that effect by blowing a whistle). On such an announcement (or signal) all the remaining assailants who are not out, shall go up and stand

between the front trench and the end line on that side ; all the defenders shall face the front trench, and the grenadier shall stand on his trench ready to cut the squares (i.e. all players excluding those assailants who are out, shall stand as they were at the beginning of the inning). The referee shall then signal to start the play again. The grenadier shall cut the squares and the play shall go on as at the beginning of the inning.

18. When an assailant is out, he shall immediately come out of the playfield, report to the scorer and sit down at the place indicated by the scorer.

RULES OF THE RING

DIAGRAM

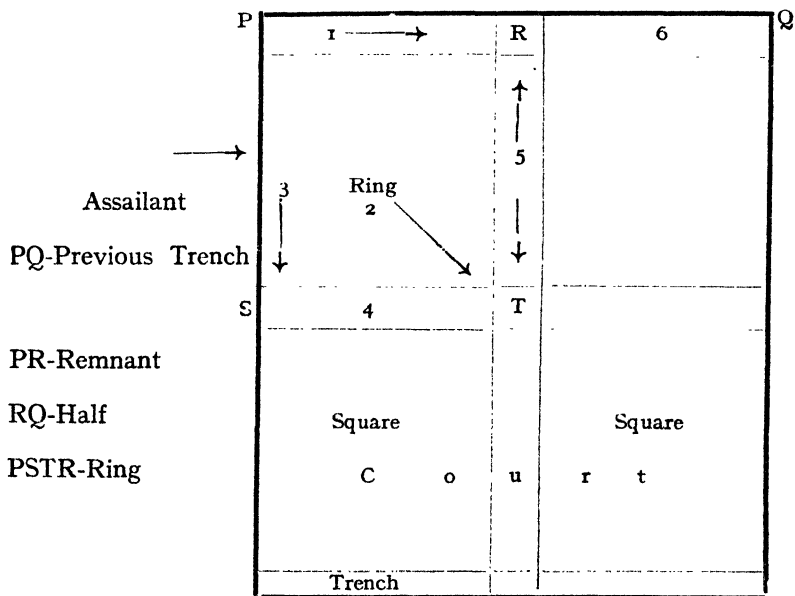

- 1 Assailant on the remnant trying to cross the central trench.
- 2 Central Assailant.
- 3 Assailant trying to cross the trench.
- 4 Defender of the trench of the Ring.
- 5 Grenadier.
- 6 Defender of the previous trench.

19. **THE BOUNDARIES OF THE RING.** The boundaries of the ring are the sideline of the square where the defender is defending the trench and the outer line of the trench opposite to that of the defender (previous trench).

Note. An assailant entering a ring shall cross the previous trench completely ; if he does not do so and stands on that trench, the defender of that trench shall have the right to put him out.

20. The assailants in the ring and in the previous trench shall have both their feet entirely within the boundaries of the ring and sidelines. They shall not place any foot out, in crossing the central trench, the trench of the ring and the previous trench.

21. If there is no assailant in the court of the previous trench, the defender of that trench shall remain in the half of that trench.

22. As long as there is an assailant in the ring on the remnant of the previous trench trying to cross the central trench, at least one of the assailants in the court of the previous trench shall remain in the square opposite the half of the previous trench ; he shall not go in the ring.

23. If an assailant in the court of the previous trench as described in rule 22, intends to try to cross that trench without observing the rules of the ring, he shall inform the defender of the trench and the umpire of the trench accordingly. He shall then be allowed to do so and the rules of the ring shall not be applied to the previous trench for the time being.

24. If there is only one assailant in the court of the previous trench he shall remain in the square opposite the half of the previous trench until the assailant in the ring trying to cross the central trench is out of the way of the previous trench. He shall not go in the ring.

25. If any assailant goes in the ring in contravention of the rules 22 and 24, he shall be brought back to the court of the previous trench by the umpire.

RULES ABOUT MATCHES

26. (a) Each side shall consist of nine players.

(b) The captain of the side winning the toss shall intimate to the referee as to whether they will be defenders or assailants.

27. Each inning shall be of 7 minutes duration ; but if the captain of the side of the assailants wishes to declare the inning over before that time, he shall intimate accordingly to the referee.

who shall then signal to stop the play. Until the referee has so stopped the play the inning shall not be taken as over.

28. At the end of each inning there shall be an interval not exceeding 5 minutes.

29. The side of the assailants shall score ten points for each trench crossed by them, the number of trenches including the front trench, being calculated on the basis of the trenches crossed by the foremost assailant.

Note. If a lona is scored, the side scores 180 points as each trench is crossed twice over.

30. Three innings shall be played by each side alternately playing as assailants and defenders. The side which scores more points in the three innings shall be the winners. If the scores are equal, an additional inning shall be played by each side as assailants. If the tie still remains, the whole match shall be replayed.

31. If a match is not completed for any reason, it shall be continued further on another occasion and the scores of completed innings of each side shall be counted for that side.

32. If the score of a side exceeds that of the other by 180 points or more, that side shall have the option of requiring the other side to follow their inning as assailants without losing their right to have their own inning as assailants afterwards, in case the other side exceeds their score.

OFFICIALS FOR THE MANAGEMENT OF A MATCH

33. The following officials shall be appointed for the management of a match:—

1 Referee, 9 Umpires, 1 Scorer, and 1 Marker.

34. **UMPIRES.** There shall be 9 umpires—one for each trench and one for the central and front trenches, thus in all making nine ; each umpire shall give all decisions promptly and distinctly about his trench and its area.

35. No appeal shall be necessary for any decision of any umpire. The umpires shall direct the assailants who are out in their jurisdiction to go and report themselves to the scorer from outside the field.

36. An umpire shall immediately report to the referee if any player wilfully obstructs the conduct of the play or intentionally breaks the rules or behaves in any ungentlemanly or mischievous manner.

37. **THE REFEREE.** (a) The referee shall decide in the presence of both the captains, as to how and when the play and the inning shall be commenced and finished. He shall start and finish the inning with proper signals. (b) He shall keep time and shall announce the score of the assailants at the end of each inning. (c) He shall at the end announce the scores of both the sides and the result of the match. (d) He shall have the authority and discretion to penalise any improper conduct mentioned in rule 36 ; the penalty at his discretion shall range according to the default from forbidding the defaulting player from participation in one inning upto forbidding the entire side of the defaulting player from participation in further play. (e) He shall decide any questions relating to the interpretation of the rules if they arise. (f) He shall assist the umpires in the discharge of their duties. In case of difference between the umpires over a decision, he shall give his final decision. (g) He shall be responsible for the general supervision of the conduct of the play and the match.

38. **SCORER.** He shall keep a record of assailants who are out. He shall consult the referee and announce the score at the end of each inning. He shall properly fill in the score sheet and get it signed by the referee.

39. **THE MARKER.** He shall station himself outside a sideline (with a suitable sign like a flag in his hand which can be easily seen by the players) and shall move along with the foremost leading assailant to mark the trenches crossed by him. He shall inform the referee and the scorer the number of trenches crossed by the assailants at the end of an inning.

40. The referee may appoint additional officials if he thinks them necessary for the proper conduct of the match. All the officials shall be appointed by the institution under whose auspices the match is organised. They shall work under the guidance of the referee.

Kho-Kho

(A GAME OF CHASE)

(as adopted by the Akhil Maharashtra Shareerika Shikshana Mandal)

THE PLAY FIELD

1. The Khokho field is rectangular and measures 111 feet by 51 feet.
2. X and Y are two rectangles. One side of the rectangle is 51 feet (breadth of the playfield) and the other side is 15 feet.
3. At M and N there shall be two wooden poles.
4. M N is a central lane 81 ft. long and 1 foot wide. There are eight small squares $1' \times 1'$ on the lane. The centre of each square is at a distance of 9 feet from the centre of its adjacent square.
5. There are eight cross lanes which lie across the small squares 51 ft. in length and 1 foot in breadth, at right angles to and divided equally into two parts by the central lane.

DEFINITIONS

1. **POSTS.** At M and N in the diagram two wooden posts shall be fixed. They shall be 4 feet above the ground and their circumference shall be from 13 to 16 inches.
2. **CENTRAL LANE.** The rectangle 81' long and 1' broad between the posts M and N is known as the central lane.
3. **CROSS LANE.** Each of the rectangles, 51' long and 1' broad, intersecting the central lane at regular intervals, is known as a cross lane.
4. **SQUARE.** Each of the rectangles, $1' \times 1'$ which is formed by the intersection of the central lane and the cross lanes, is known as a square.
5. **THE LINE OF THE POST.** The line, which goes through the centre of the post and is at right angles to the central lane, is known as the line of the post.
6. **THE RECTANGLE.** The field outside the line of the posts is known as the rectangle (X and Y).

7. THE LIMITS. The two side lines at a distance of 25 feet from the central lane and parallel to that lane and the lines forming the outer boundary of the two rectangles are known as the limits.

DIAGRAM OF PLAY-FIELD

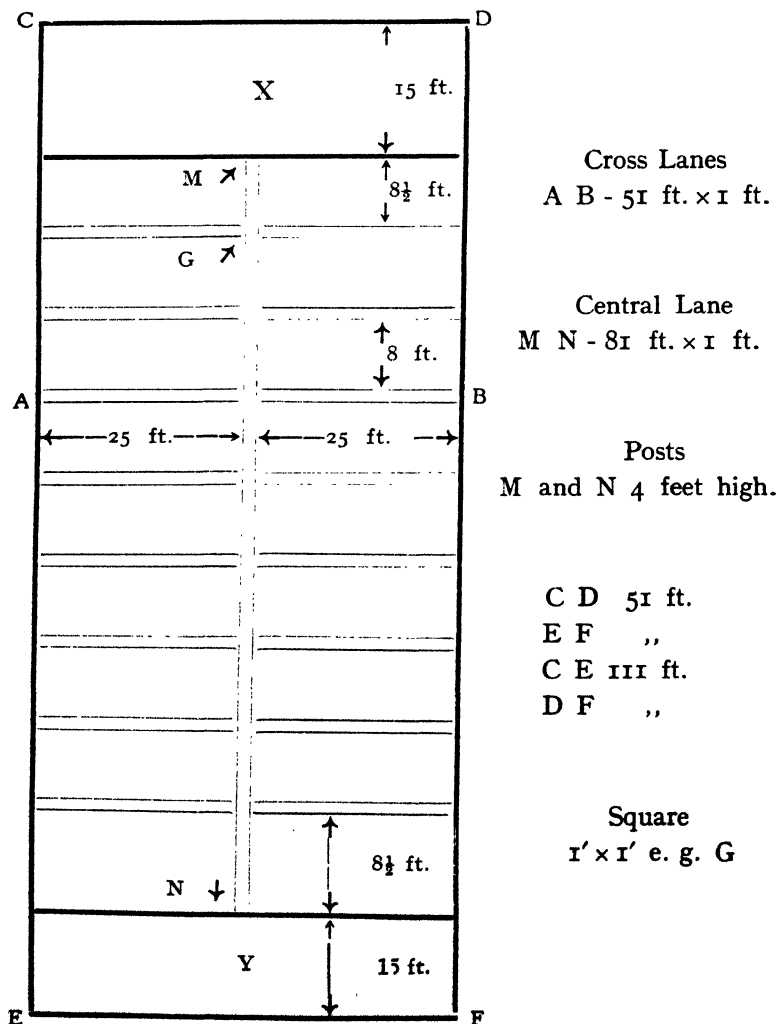

8. **CHASER, ACTIVE CHASER.** The players of the side, who sit on the squares and try to tag and touch the players of the other side, are known as chasers and the one of them, who is pursuing the players of the other side, is known as an active chaser.

9. **RUNNERS.** The players of the side other than the chasers are known as runners.

10. **TO GIVE 'KHO'.** When an active chaser utters loudly and distinctly the word 'Kho', after touching by hand a sitting chaser, it is known as 'giving kho'.

11. **FOUL.** If a sitting or an active chaser violates (commits the breach of) a rule, it is known as a foul.

12. **TO TAKE A DIRECTION.** To go from one post to another post is known as taking a direction.

13. **TO TURN THE FACE.** When an active chaser, while going in a particular direction, turns his shoulder line (the imaginary line joining his shoulders) through more than a right angle, he is said to have turned the face.

14. **TO RECEDE.** When an active chaser, while going in a particular direction, goes in the opposite direction, he is said to have receded.

15. **TO LEAVE THE POST.** When an active chaser lets go his hold or touch of a post and goes beyond and leaves the rectangle, both these actions are known as leaving the post.

Note. If any part of the body of an active chaser is in contact with the ground in the rectangle, he has not gone beyond or left the rectangle.

16. **FOOT OUT.** When the whole of a foot of a runner is touching the ground outside the limits, he is said to have placed his foot out.

Note. If any part of the foot is touching the ground inside the limits, the foot is not out. If the whole of the body is in the air outside the limits, the foot is not out.

17. **LONA (game).** When all the runners are out, a lona is said to be scored against the runners by the chasers.

RULES OF THE PLAY

1. The play field shall be marked as given in the diagram on page 204.

2. The side winning the toss shall inform the referee of their choice to be chasers or runners. Eight of the chasers shall sit on the eight squares on the central lane in such a way that no two

adjacent chasers face in the same direction. The ninth chaser stands at either of the posts to start the pursuit (active chaser).

3. No part of the body of an active chaser shall touch the ground of the central lane or beyond it. An active chaser shall not cross the central lane from inside the posts (from the side of the posts on which the central lane is marked).

4. If a 'Kho' has to be given, it shall be given from the back side of a seated chaser. It shall not be shouted from a distance. It shall be given in a sufficiently loud tone so that the runners can hear. The seated chaser shall not get up without getting kho or before getting kho. An active chaser shall not utter kho unless he touches by hand a seated chaser. An active chaser shall not give kho by touching the arm or leg extended by a seated chaser.

5. If an active chaser violates any of the rules 3, 4 and 6, the umpire shall declare a foul by blowing his whistle and raising, without any delay, both hands sideways, and shall compel immediately the active chaser (any one who is then actively chasing) to go in a direction opposite to that in which the runner is going. Immediately on hearing the signal, given by the umpire by his whistle, the active chaser shall stop and take the direction indicated by the umpire. If the active chaser does not stop or take the direction indicated by the umpire, and if the runner thereby becomes out, he shall be declared 'not out' and the active chaser shall have to follow the direction indicated by the umpire.

6. If an active chaser goes beyond the cross lane of the square on which a chaser is sitting and if he has let go his hold of that sitting chaser, the active chaser shall not give him kho. An active chaser shall not recede to give kho.

7. An active chaser shall sit down immediately after giving kho on the square of the chaser to whom kho is given.

8. On getting up after a kho, an active chaser shall go in the direction, which he has taken, by going beyond the cross lane of the square on which he was sitting. He shall not recede.

Note. As long any part of the foot of a player is touching the ground of a cross lane, he has not gone beyond the lane. An active chaser has receded if any part of his body touches the ground behind him (i.e. on the part of the ground beyond which he has gone) in the direction opposite to that which he has taken.

9. An active chaser shall take the direction to which he turns his face i.e. he turns his shoulder line (the imaginary line going across the shoulders). He shall not recede.

10. An active chaser shall take the direction according to one of the actions mentioned in rule 8 and 9 which he has performed first.

11. When an active chaser has once taken a direction of the post M or N, he shall go in that direction upto the line of that post unless he gives a *kho* before that. An active chaser shall not go to the other side of the central lane, unless he turns round the post from outside.

12. If an active chaser has left a post, he shall go in the direction of the other post, remaining on that side of the central lane where he was when he left the post.

Note. When at a post, an active chaser shall not cross the central lane.

13. The face (shoulder line) of an active chaser shall be in the direction which he has taken. He shall not turn his face. He shall be allowed to turn the shoulder line upto a position parallel to the central lane.

14. The chasers shall sit in a manner which shall not obstruct the runners. If a runner becomes out by such an obstruction, he shall not be declared out.

15. The rules about taking the direction and turning the face shall not be applicable in the area of the rectangles (rule Nos. 8 to 10 and 13).

16. During an inning an active chaser may go outside the limits but he shall observe all the rules about taking direction and turning face even when outside the limits.

17. A runner shall not intentionally touch a seated chaser. If he does so, he shall be out.

18. A runner shall be out, if both of his feet go outside the limits.

Note. If both of the feet of a runner are outside the limits, the rest of the body being inside, it shall be considered that the feet are out.

19. A runner shall be out if he is touched by hand by an active chaser.

20. The active chaser and the other chasers shall not violate any of the rules Nos. 3 to 13 both inclusive. It shall be a foul if any rule is violated. If a player is out as a result of such a foul or if a foul is committed immediately as a result of the action taken in putting a runner out, the runner shall be declared not out.

21. An umpire shall compel immediately, without any delay, an active chaser to take the proper direction or to do the proper action, if he commits a foul by violating any of the rules Nos. 7 to 13 both inclusive.

RULES ABOUT MATCHES

22. Each side shall consist of 9 players.

23. (a) Each side shall be chasers and runners alternately. There shall be two such turns.

(b) The runners shall fix and record with the scorer their names in their order of playing. At the beginning of an inning the first 3 players shall be inside the limits. Immediately on these three being out the next three shall enter. This shall continue till the end of the inning. The active chaser, who has put out the third runner (in each group of three who enter) shall not pursue a new entering runner. He shall give kho. Each side shall enter their runners in the field from one side of the field only.

24. Each inning shall continue for 7 minutes. The tournament committee shall have the option to vary the time from 5 to 7 minutes according to the age and skill of the players by previously fixing the same and announcing it. The chasers shall have the option to end the inning before the allotted time. The captain of the chasers shall inform the referee about the same and request him to stop the play and declare the inning closed. Immediately on this request, the referee shall stop the play and close the inning. Until the referee has signalled to stop the play, the inning is not closed. There shall be an interval upto 5 minutes between two innings.

25. The side of the chasers shall score 10 points for each runner who is out. If all the runners are out before the time, a lona is scored against them and they shall again send, in the same order, their runners to play as given in rule 23 (b). The play shall be continued in this manner until the time of the inning is over. The order of the runners shall not be changed during an inning.

26. The side, that scores more points at the end of the match, shall be declared the winners. If the points are equal, two more innings (one turn for each side as chasers and runners) shall be played and if again the points are equal, the whole match shall be replayed.

27. If a match is not completed for any reason, it shall be continued further at another time and the scores of the completed innings of each side, shall be counted for the sides.

28. If the points of a side exceed the points of the other side by 120 or more, the former side shall have the option of requiring the latter side to follow on their inning as chasers, without forfeiting their right to take their inning as chasers afterwards, in case the other side exceeds their score.

OFFICIALS FOR THE MANAGEMENT OF A MATCH

29. The following officials shall be appointed for the management of a match.

Two umpires. A referee (one of the umpires may be appointed as a referee), A Timer and a Scorer.

30. UMPIRES. A line may be drawn in the centre of the field parallel to the lines of the post, dividing the play-field into two halves. One umpire shall stand in each half of the field thus formed. He shall give all decisions in his half. No appeal shall be necessary for decision. The umpires shall declare a foul and compel an active chaser (whosoever is chasing) to act up to the rules. A foul is declared by an umpire by blowing a whistle and raising both hands sideways. An 'out' is declared by word of mouth and raising the right hand upwards. The umpires shall direct, the runners who are out, to go outside the field and report to the scorer and sit at the place indicated by him.

31. REFEREE. The referee shall perform the following duties:—(a) He shall help the umpires in the performance of their duties and shall give his final decision in case of any difference amongst them. (b) If a player intentionally obstructs the conduct of the play or behaves in an ungentlemanly or mischievous manner or intentionally violates the rules, the referee shall, at his discretion, penalise the defaulting player. The penalty, at his discretion, shall range according to the default from forbidding the defaulting player from participation in one inning upto debarring his entire side from participating in further play. (c) He shall give decisions about any questions regarding the interpretation of rules if they arise. (d) He shall announce the scores of the sides at the end of the match and also the result of the match. (e) He shall be responsible for the general supervision of the conduct of the play and the match.

32. TIMER. He shall give clear signals about the start and the finish of an inning and shall keep an account of the time and hand it over to the scorer at the end of each inning. The duties of a timer may be delegated to the referee or the scorer.

33. **SCORER.** He shall take the order of the runners from their captain and see that they enter the field in that order. He shall keep a record of the runners who are out and make them sit in a place kept for the purpose. At the end of an inning he shall write the score-sheet and shall prepare the score of the chasers in consultation with the referee. He shall at the end of the match complete the scoresheet and prepare the scores of the two sides and the result of the match in consultation with the referee. He shall get the score-sheet duly signed by the referee and the umpires.

34. The officials of the match shall be appointed by the institution under whose auspices the match is arranged and they shall function under the guidance of the referee.

Hututu

(KABBADI or DO-DO-DO)

(as adopted by the Akhil Maharashtra Shareerika Shikshana Mandal)

Note:—(1) There are 3 varieties of the game. One is known as 'Sanjeevani' game-(revival game), wherein a player, who is once out, can re-enter the play-during an inning. The second is known as 'Ganimi' Game (non-revival game) wherein, a player who is once out, cannot re-enter the play, unless an inning is over or a lona-a-game is scored by either party. The third is known as the 'Amar' game, (all in game) wherein, a player, who is out, does not go out of the field, but continues to play, a record of such players being only made for the purpose of scoring points for the sides.

(2) The several rules of play are the same for all these varieties. The play field is the same for the first two varieties, but some rules about matches differ (the time allowed for each inning, the number of innings played and the method of scoring) and some rules are also different and these only are given at the end.

THE PLAY-FIELD

1. A B C D is the play-field. It is divided into two equal rectangles (ABNM & CDMN). AB is 25 ft. BC is 40 ft. BN, NC, AM, MD are each 20 ft. in length. PN and NR are each 8 ft. in length. MN is a line dividing the play-field into two halves. OP and QR are two lines parallel to it on either side at a distance of 8 ft.

2. EF and GH are two lines drawn parallel to BC and DA respectively and at a distance of 3 feet from them. These strips 40 ft. in length and 3 ft. in breadth, on either side of the play-field, are the 'Lobbies'. The end-lines AB and CD are extended to meet these lines. The central line is also extended to meet these lines.

3. For junior players the dimensions of the play-field are as follows:—

AB, CD—20 ft. each. BC, AD—30 ft. each.

BN, NC—15 ft. each. PN, NR—6 ft. BE, AH—2½ ft.

DEFINITIONS

1. (a) THE BOUNDARY. The lines, on the four sides of the play-field, are known as the boundary (AB, BC etc.).

(b) THE LOBBIES. Each of the strips on the sides of the play-field is known as a lobby. When the lobbies are included in the play-field (when the lobbies come in play) the boundary of the play-field is extended upto the four lines which enclose the field including the lobbies EF, FG, GH and HE).

2. **THE MID LINE (MARCH).** The line that divides the play-field into two halves is known as the mid-line (MN).

3. **THE COURT.** Each half of the field, divided by the mid-line, is known as the Court.

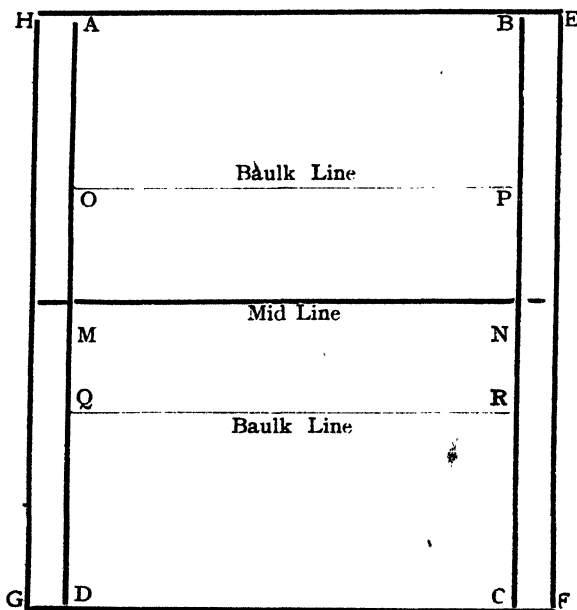

Diagram of the play-field

4. **THE BAULK LINE (BAULK).** Each of the lines in the Court parallel to the mid-line (8 ft. from it) is known as the baulk line (OP, QR).

5. **THE CANT ; TO KEEP THE CANT, TO GO WITH THE CANT.** The repeated and clear sounding aloud of the syllables Hu-tu-tu within the course of one respiration is known as the cant. Doing this in the court of an opponent is known as keeping the cant or going with the cant.

6. **RAIDER AND ANTI.** One, who goes in the court of the opponent with the cant, is known as a raider and those whom he raids are known as antis.

7. **LOSING THE CANT.** To stop the repeated and clear sounding aloud of the syllables Hu-tu-tu or to take in a breath

during a cant is known as losing the cant. Obviously, a cant must be started and continued within one and the same expiration.

8. **TO PUT OUT AN ANTI.** If a raider touches an anti without the breach of the rules, or if any part of the body of an anti touches any part of the body of a raider, the anti is said to be put out.

9. **TO HOLD A RAIDER.** If the antis hold and keep the raider in their court and do not allow him to go in his court until he loses his cant, it is known as 'holding the raider'.

10. **TO REACH HOME (SAFELY).** If a rider without losing the cant crosses the mid-line and touches the ground of his court with any part of his body, he is said to have 'reached home (safely)'.

RULES OF THE PLAY

1. The play-field shall be marked as shown in diagram. There should be a clear space of at least 15 feet all round the play-field.

2. The side that wins the toss shall have the choice of the court and shall send their first raider in the opponent's court. In the second inning, the courts shall be changed and the other side shall send their raider first.

3. (a) If any player goes out of the boundary during an inning he shall be out. A player shall not be out (i) if any part of his body is touching the ground inside the boundary and (ii) during a struggle if any part of his body is touching the ground inside the boundary or any part of any other player's body which is inside the boundary.

(b) When either a raider or an anti touches each other, a struggle begins. When a struggle begins the lobbies are included in the play-field during that struggle. (Refer to definition 1).

4. (a) A raider shall keep the cant with Hu-tu-tu as the syllables for sounding ; other syllables shall not be allowed.

(b) A raider must enter the opponent's court and start the cant simultaneously. If he starts the cant late, the umpire shall order him to go back, and declare the turn of raiding of his side as over. The opponents shall not pursue and put out such player.

(c) If any raider or his side is purposely violating the rule 4 (b), i.e., simultaneous entry and cant, for the purpose of losing their turn of raiding, the umpire shall not declare their turn over and order the side to send their raider.

5. As long as at least one foot of a player is touching the ground of his court, he has not entered the opponent's court.

6. After a raider has reached home or is put out in the opponent's court, the opponents shall immediately send their raider. Thus each side shall send raiders alternately until the end of an inning.

7. If a raider who is caught or is being caught by the antis, escapes from their attempt to hold him and reaches home safely, he shall not be pursued and put out.

8. (a) Only one raider shall go in the opponent's court at one time ; if more than one raider enter the opponent's court, the umpire shall order all of them to go back to their court and declare their turn of raiding as over, and shall declare those antis who are touched by these raiders as 'not out'. The opponents shall not pursue and put out these raiders.

(b) If any such raider—as given in (a) above—is caught by any anti and his side, the umpire shall wait until he loses his cant ; if the raider loses the cant, while so held, he shall be declared out ; but even if such a raider reaches home safely, escaping from the hold of the antis, the antis shall not be declared out.

(c) If an umpire finds out that a side is purposely sending more than one raider at a time, he shall warn that side not to do so. But if, in spite of such a warning, the side does the same thing again intentionally, the umpire shall declare their turn of raiding over and shall declare all the other raiders except the first according to his judgment, as out.

9. If a raider, while in the opponent's court, loses his cant and thereafter touches or is touched by an anti, he shall be out.

10. If a raider reaches home safely, all the antis, who have touched him or are touched by him in the opponents court, shall be out.

11. (a) When a raider is held, the antis shall not try to obstruct and stifle his cant by keeping their hands on his face or mouth ; they shall not also attempt to stop his cant by pulling his hair or by any other improper or injurious methods or means. If any antis do so and if the raider loses his cant thereby, the raider shall be declared to have reached home safely.

(b) No player shall intentionally push his opponent out of the boundary. If any one is so pushed, the one who pushes, shall be declared out and the one pushed 'not out'. If the player,

who is pushed out, is a raider, he shall be declared to have reached home safely.

12. If any anti is not put out, or if the baulk-line in the opponent's court is not crossed completely at least once by a raider, before he comes back to his court, he shall be declared out.

Note. As long as, any part of the body of a raider is touching the ground between the mid-line and the baulk-line, the baulk-line is not crossed by the raider.

13. (a) As long as a raider is in the court of the antis, no one of the antis shall touch the ground of the raider's court, beyond the mid-line with any part of his body. If any anti violates this rule, he shall be out.

(b) If any anti, who is out having violated the above rule 13(a), holds a raider or has helped in holding a raider, or has violated the said rule while holding or helping to hold the raider, the raider shall be declared to have reached home safely.

14. If a raider goes out of turn in the opponent's court, he shall not be out only for this action of his, but rule 13(a) shall be applicable to him.

15. If an anti pulls a raider across to his court, before the raider has crossed the mid-line, nobody shall be out; the umpire shall ask the raider to go for raiding.

16. When all the players of a side are out, the other side shall have scored a lona (game) against them; the play goes on, and all the players of both the sides enter their own courts as in the beginning and continue playing. The side against whom the lona is scored shall send their raider to begin the play. In an inning, if a lona is thus scored and the time of the inning is not over, the inning continues according to this rule with all the players reviving and entering the play. The play thus continues until the time of the inning is over.

17. During an inning, players shall not talk loudly amongst themselves, give hints, shout, make noise, and shall not do such other things, so as to obstruct the hearing of the cant by the umpire. If any player behaves in this manner, the referee shall warn him; if he continues to do so in spite of the warning, the referee shall debar him from further participation in that inning. Only the captain of the side shall have the right to give hints to the players of his side, and to talk to the umpires, referee and other officials.

RULES ABOUT MATCHES

18. Each side shall consist of 9 players.

19. Between the innings an interval upto 5 minutes shall be given. The courts shall be changed for each inning.

20. Each side shall score 10 points for each opponent who is out. The side, which scores a lona, shall score 20 points for the lona.

Note:—A player, who is out more than once in an inning, shall be counted as a separate player for each time he is out, for the purpose of scoring.

21. The side, which scores more points at the end of all the innings, shall be declared winners.

22. If there is a tie, 2 extra innings of 5 minutes each shall be played. If the tie still remains the whole match shall be played again.

23. If owing to any reason a match is not completed, the scores of each side, for the innings which are completed, shall be counted for the side and the match continued further at another time.

24. It is desirable to form the sides according to weights in Hu-tu-tu. The following groups are made according to the weights of the individual players. The sports committee should announce the groups they intend to select for their tournament. It is desirable to take the weights of all the players in a tournament in their sports clothing on the same weighing machine, and that too, every time just before the play starts. The sports committee should previously announce the time and the method etc. of recording weights along with the announcement of the tournament.

Group 1	Open	any weight is allowed,
" 2	110 lbs.	and under
" 3	90 lbs.	" "
" 4	75 lbs.	" "
" 5	60 lbs.	" "

Groups 4 and 5 shall be counted as juniors. If the tournaments are taken by age groups, the committee should announce as to which age groups are to be counted as juniors.

THE OFFICIALS OF THE MATCH

25. The following shall be the officials for the management of a match.

2 Umpires, 1 Referee (who shall be other than the umpires, 1 Scorer and 1 Timer.

26 (i) The Umpires shall station themselves along the side lines, one on each side and shall promptly declare all the decisions on their side. No appeal shall be necessary for a decision. They shall direct all the players who are out, to go out of the field, to report to the scorer and sit at a place indicated by him.

(ii) The Referee shall (a) supervise the duties of the umpires and shall give his final decision in case of any difference of opinion between the two umpires, (b) penalise a defaulting player who intentionally obstructs the play, or behaves in an ungentlemanly or mischievous manner, or violates the rules purposely. The extent of the penalty may range according to his discretion and nature of the default, from debarring the defaulting player from an inning up to debarring his whole side from further play, (c) decide the points about interpretation of the rules if they arise, (d) announce the scores of each side at the end of each inning, (e) announce the scores and the winners at the end of the match and (f) supervise in general the conduct of the whole match.

27. The Scorer shall (a) keep a record of those who are out in their order of becoming out and see that they are seated in a place indicated by him. In the revival game he shall indicate the player who revives and keep a record of the same, (b) fill in the score sheets in consultation with the referee and announce the scores at the end of each inning and the result at the end of the match and (c) complete the score sheet and get it duly signed by the referee and the umpires.

28. The Timer shall give clear signals to begin and end an inning and keep the record of the time. The referee may perform the duties of a timer.

29. More officials may be appointed if necessary. The institution under whose auspices the match is held, shall appoint the officials and they shall work under the direction of the referee.

Note:—It is desirable ordinarily to have an official at each of the lines bounding the play-field to facilitate the conduct of the play and the match. The referee may appoint some officials for this purpose as helpers and may give them specific duties. The referee should station himself near the scorer. Two helpers may be appointed for the two lines along which the umpires are not stationed. They can help the umpires to give their decisions when referred to and also help the scorer to record the players who are out [and also those who revive in the revival game]. The helpers shall not give any decisions unless questioned by or asked by the umpires

THREE VARIATIONS OF THE GAME

The above rules are applicable to all the three variations of the game. Additional rules for each variation and the rules which are not applicable to each variation are given below.

The Sanjeevani Game [The Revival Game]

1. (a) Players who are out shall be revived and enter play. One player shall be revived for each opponent who becomes out. Players shall be revived in the same order in which they become out.

(b) A player who is revived shall enter his court from the end-line parallel to the mid-line.

2. There shall be two innings of 20 minutes each in a match. The tournaments committee may at their discretion vary and previously announce the time from 15 to 20 minutes according to the age and skill of the players.

The Ganimi Game [The Non-Revival Game]

1. There shall be three innings of 12 minutes each in a match. The tournaments committee may at their discretion vary and previously announce the time from 10 to 12 minutes according to the age and skill of the players.

Amar Game [The All In Game]

THE PLAY-FIELD. The dimensions in the diagram on page 212 shall be as follows:—

AD = BC = 30 feet. BN = NC = 15 feet.

PN = NR = 7 feet.

For Juniors: AD = BC = 24 feet. BN = NC = 12 feet.

PN = NR = 5 feet.

1. The following rule shall be applicable instead of rule 16 above. A player shall not go out of the field after he is declared out; he shall continue playing. When an umpire declares a player out, the scorer shall promptly make a record of the same.

2. No lona is scored and hence no points for lona shall be scored.

3. There shall be two innings of 20 minutes each in a match. The tournaments committee may at their discretion vary and previously announce the time from 15 to 20 minutes according to the age and skill of the players.

A Rule to be observed in all Games

When a match is being played, players are forbidden to talk loudly amongst themselves, to shout, to make noise and to do such other things as will cause difficulty in the conduct of the play and the match. The referee shall warn a player if he behaves in such a manner. If, in spite of the warning, he continues to behave in such a manner, the referee shall disqualify him and forbid him to participate in that inning. The captain of a side shall be the only person who shall instruct his players, and talk with the referee, and other officials.

Rules about Substitution and Changes of Players in ATYAPATYA, KHO-KHO and HUTUTU

1. A side can start a match with one or two players less in their team ; but (a) in ATYAPATYA their trenches shall be counted as crossed when their side is defending. The central trench must be defended by a player ; (b) in KHO-KHO, they shall be counted as 'out', when all are out, in calculating the score of the other side as chasers. Substitutes shall be allowed when their side is playing as chasers and the substitutes shall be approved by the captain of the other side ; (c) in HUTUTU, when all the other players of their side are out, the absentees shall be counted as out and a lona shall be scored against the side ; (d) when the absentees come, they shall enter the play with the permission of the referee ; (e) substitutes can be taken in place of the absent players at any time, but when they are thus taken no change of players shall be allowed afterwards until the end of that match. (f) If a match is replayed, the players need not be the same again.

2. If a player is so seriously injured, that, in the opinion of the referee, he is unable to continue to play, the referee shall allow the side of the injured player, to choose another player to substitute him. The referee shall inform the captain of the other side about the same.

3. If a player suffers from a minor injury and does not play, his side may be allowed to take a substitute with the permission of the referee and the captain of the other side. In such a case the injured player shall not re-enter that match.

4. Whenever a substitute is allowed, he shall possess all the necessary qualifications to play for that side as required for the match. (Membership of the institution, age, weight etc. whatever the condition of inclusion in a team may be.)

5. If players are penalised for any default and are forbidden to participate in the play by the referee, no substitutes shall be allowed. In Kho-kho, however, substitutes shall be allowed only when the side is playing as chasers and then the substitutes shall be according to the choice of the captain of the other side. The substitutes shall not play as runners. In Atyapatya, their trenches shall not be defended, but they shall be counted as crossed when the opponents play as assailants. In Kho-kho and Hututu, the penalised players shall be counted as 'out' when all others are out. If more than two players are penalised and forbidden to play at one time, the whole side shall be taken as disqualified.

Rules of Chedugudu or Kabaddi

As adopted by the Indian Olympic Association (1944)

THE GAME

The game of Kabaddi, commonly known as Hu-tu-tu in Bombay and in the Central Provinces and as Chedugudu in Madras and Mysore, is played by two teams of seven players each. The purpose of each team is to score as many points as possible by putting out players of the opposite team.

The game does not require any equipment except a small space of 14 yards by 11 yards.

RULE I—GROUNDS

DIAGRAM OF KABADDI GROUND

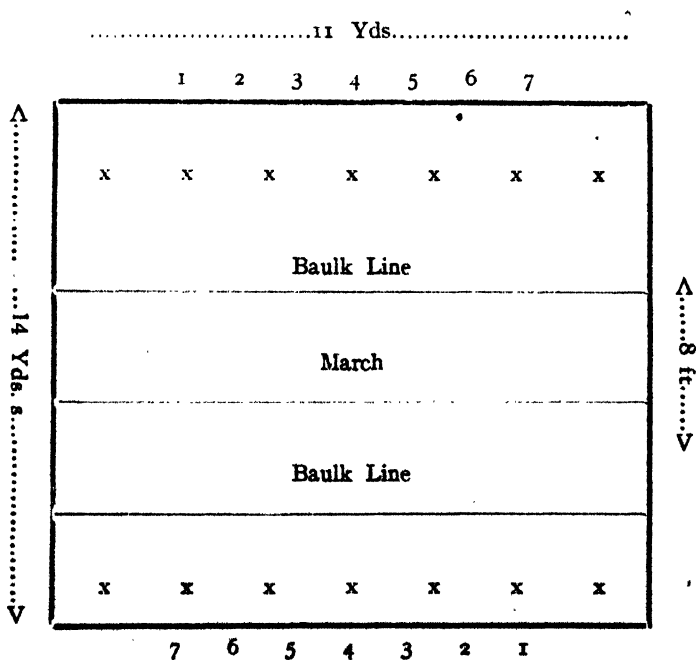

Players who are eliminated from the game take their places in the order in which they are eliminated and await for their revival.

1. The ground shall be level, measuring 14 yards by 11 yards, divided by a middle line into two halves, each being 11 yards wide and 7 yards deep.

2. It is necessary to have 6 ft. of clear space outside the side line and 12 ft. of clear space outside the end lines. Wherever this is not possible the Captains may agree to have their own ground rules.

3. The mid-line or the "March" dividing the homes of the two sides shall be distinctly drawn and shall not be more than six inches broad.

4. There shall be a Baulk line drawn through the entire width of each court parallel to, and eight feet away from, the March.

RULE II—DURATION

1. The game shall consist of two half hour periods with a five minutes rest in between.

2. For junior matches and women's matches the duration of the game shall be 20 minutes halves with a five minutes rest in between.

RULE III—TEAMS

1. The game shall begin with seven players on each team.

2. Substitutes shall be allowed only in the case of an injury making a player incapable to play further. Substitutions shall be made from among the players whose names are mentioned in the entry form.

3. The personnel of a team shall not be changed in the course of a match.

4. Each team shall alternately send a raider into the home of other team.

5. One or more players can be put out in the course of a raid.

6. A player who is out shall be revived, in the same order he is out, only when one opponent is put out.

7. A player when out shall leave the court and shall wait outside to be revived.

8. The whole side when put out during play shall automatically be revived and the opposite team shall score two more points in addition to the usual points scored for putting out the individual members of the opposing team.

9. The Captain of a team which has only one or two players left during play, may declare them out and bring in the whole team provided, however, he concedes to the opposing team one point per player left and an additional two points.

10. A raider or an anti who gives a point to the opponent shall be considered as dead or out of the game but shall await his turn to be revived.

11. The minimum dress of a player shall be a sleeveless banyan and shorts or junghyas with langote or jock strap underneath. No oiling of the body or limb shall be allowed. All must play bare feet. No metal should be worn and nails must be closely clipped.

12. All players shall be suitably numbered and all teams shall appear in distinct uniform. The numbers shall be six inches high and in bold type.

Note. In this connection it is desirable that sleeveless jerseys with distinct colours and six-inch high numbers printed or stitched on the back be used by all teams.

13. Any player entering or leaving the court while the game is in progress may do so with the permission of the Umpire only when a raid is complete failing which the opposite team will score one point.

RULE IV—OFFICIALS

1. The officials shall be a Referee, two Umpires, two Linesmen, a Scorer and a Time-Keeper. One of the Umpires may act as Referee.

2. The Umpires' decision on the field shall be final. When two Umpires disagree the Referee shall give his decision which shall be final and binding.

3. The Referee shall have the power to warn, declare point against, or to disqualify from the match any player or team committing any of the following or other gross violations of sportsmanship:—

- (a) Persistently address the officials in regard to decisions.
- (b) Make derogatory remarks about or to the officials.
- (c) Commit acts derogatory to the officials, or actions tending to influence their decisions.
- (d) Make personal or derogatory remarks about or to opponents. This Rule applies also to coaches and supporters.

4. The Referee's decisions are final and players shall not question his decisions while play is in progress. The Referee has the power to warn or disqualify a player or a whole team for such unsportsmanlike conduct.

5. The Referee shall have the power to stop a match for deliberate coaching by coaches, officials or spectators.

6. The Referee shall have the power to suspend a game temporarily in case of a serious accident.

RULE V—DEFINITION OF TERMS

1. The repeated sounding aloud of one or more approved syllable within the course of one respiration shall be called a "Cant".

2. One who goes from his home into that of the opponent party with the captain's order to put out one or more of his opponents shall be called a "Raider". Every player of the other party acting against the raider shall be called Anti-raider or "Anti".

Note. The "Raider" must begin his "Cant" as soon as he leaves the March. A player who violates this rule is not playing the game and he (the player) should receive a warning from the Umpire. The Referee has the power to disqualify a player who persistently violates this rule.

3. A Raider to reach Home when he touches any part of the March or after crossing the March, touches any part of the home.

4. By Touch is meant contact by or with any part of the body, clothing, or any other of one's personal belongings; and by a Struggle is meant the holding of the raider by one or more Antis to prevent the former from reaching home with Cant.

5. By an Intruder is meant (a) a player found on the March or in the opponent's home when a raid is on, (b) A raider who has left the March but is without a Cant or a Raider who has lost his Cant before reaching home.

Exception. No Anti in a struggling group will be deemed an Intruder while the struggle is on.

6. Each of two or more persons starting and acting as Raiders will be liable to be dealt with as an Intruder until only one is left to act as such.

7. By 'No Raid' is meant the failure on the part of the Raider to cross the Baulk Line of the defending team.

Note. Baulk Line is not crossed so long as both legs of a "Raider" have touched the ground between the March and the Baulk Line.

RULE VI—SCORE

1. If a Raider reaches home with Cant after touching one or more Antis he shall score as many points as the number of Antis touched. The Antis who were touched would automatically be out and wait their turn for revival.

2. Each Raider must cross the Baulk Line of the opposite Home, at least once during a raid. When a "Raider" fails to cross the opposite Baulk Line he shall be declared out and the opponents shall score one point.

3. But in case of pursuit the Raider pursuing and touching an Anti immediately following his raid need not cross the Baulk Line and the Anti so touched shall be out.

Note. Baulk Line need not be crossed where the "Raider" touches an Anti or Antis between the March and the Baulk Line or *vice versa*. In other cases the Baulk Line must be crossed.

4. If a Raider, who has been touched or held by one of the Antis, does not reach his home with Cant, the Raider shall be out and the defending team shall score one point.

5. Any player who goes out of bounds shall be considered out, and the opposing team shall score one point. If in a struggle the raider or the opponents move out-of-bounds wilfully the one that goes out of bounds first shall be out and the opponents shall score one point. But in a struggle the player or players who are thrown out-of-bounds by the opponent or opponents shall score one point but no one shall be out.

Note. A player goes out-of-bounds when any part of his body comes in contact with the ground outside the boundary lines.

6. An Intruder if he is touched by any one of his opponents with Cant shall be out and the opposite team shall score one point.

7. A Raider may be put out by an Anti taking Cant when there is one or more Intruders in the raiding field. The team that puts him out shall score one point.

8. If a Raider is warned against any danger by one of his own side the Anti will score one point.

9. A Raider is not to be held by any part of his body other than his trunk or limbs, and for any violation of this rule the opponents shall score one point.

10. If a Raider succeeds in touching the March with any part of his body in spite of a struggle by his Antis, all those of the Antis who came in touch with the Raider would be out and the raiding team shall score as many points as the number of players put out.

11. When a team manage to put out the entire opposing team they shall score two points in addition to the points scored by putting out individual players.

12. When only one or two players of a team are left during any game, and the Captain of the team "declares" them out in order to bring in the full team, the opponents shall score as many points as there were players left before declaring, as well as two points for putting out the whole team.

RULE VII—FOULS

1. A player shall not attempt to stifle a "Raider's Cant" by shutting his mouth, throttling or any other way. The Referee should act promptly when this rule is violated and he has the power to disqualify the player concerned from further participation in the game.

2. Violent tackling leading to injuries to the body are forbidden. The Referee shall exclude players inclined to do this from the game.

3. Players shall not unduly prolong the game. A team that takes more than five seconds to send a "Raider" when asked to do so by the Referee is delaying the game unnecessarily and shall concede one point to the opponents.

RULE VIII—MATCHES

1. The team which has won the toss shall have the right to choose its home, and the other side shall send the Raider.

2. When the match is resumed after half time, the teams shall change homes and the team which did not send the first Raider at the outset of the game, shall send their Raider now.

Notes. After half time the game shall continue with the same number of players of both teams as it was at the end of the first half.

3. If the score is a tie at the end of a game, it shall be continued for periods of 10 minutes each till the tie is broken.

4. Time out may be called by the Captain of the team in the event of an injury to a player. Such time out period shall not, however, exceed more than 2 minutes.

5. The team which scores the highest total score at the end of the full time shall be declared the winner of the Match.

6. In the Match between junior teams and Women's teams there is no change of rules except the duration of play.

KABADDI SCORE SHEET

Date..... Place..... Time.....
 Round Semifinal Final

..... vs.
 Name of players. Name of players.
 1..... 1.....
 2..... 2.....
 3..... 3.....
 4..... 4.....
 5..... 5.....
 6..... 6.....
 7..... 7.....
 8..... 8.....
 9..... 9.....
 10..... 10.....

RUNNING SCORE.

1 2 3 4 5 6 7 8 9 10
11 12 13 14 15 16 17 18 19 20
21 22 23 24 25 26 27 28 29 30
31 32 33 34 35 36 37 38 39 40
41 42 43 44 45 46 47 48 49 50
51 52 53 54 55 56 57 58 59 60
61 62 63 64 65 66 67 68 69 70
71 72 73 74 75 76 77 78 79 80
81 82 83 84 85 86 87 88 89 90
91 92 93 94 95 96 97 98 99 100

1 2 3 4 5 6 7 8 9 10
11 12 13 14 15 16 17 18 19 20
21 22 23 24 25 26 27 28 29 30
31 32 33 34 35 36 37 38 39 40
41 42 43 44 45 46 47 48 49 50
51 52 53 54 55 56 57 58 59 60
61 62 63 64 65 66 67 68 69 70
71 72 73 74 75 76 77 78 79 80
81 82 83 84 85 86 87 88 89 90
91 92 93 94 95 96 97 98 99 100

Out	Revived	Out	Revived

Points Scored..... Points Scored.....
 Won by..... Scorer..... Referee.....
 Umpires: (1)..... (2).....

Netball

(As played by the Women's Inter-Collegiate Athletic Association, Madras.)

I. Object Of The Game

Netball is a game played by two teams of seven players each, upon a court divided into three areas. At each end of the court a goal is fixed; one for each team. The field should run north and south. The goal at the north end belongs to one team, and the goal at the south end belongs to the other team. Teams change goals at half-time. The object of the game is to pass the ball to and fro, until it reaches one of the two players (shoot and help shoot) whom the rules permit to throw for goal. Each goal made scores one point. The team having the highest score at the end of the game, wins.

II. Equipment

The Court shall be 100' long and 50' wide. It shall be divided into three equal areas by transverse lines. A goal post shall be placed in the exact centre of each end line. A semicircle, with a radius of 16' shall be drawn around each goal post and shall be called the *shooting circle*.

In the centre of the field, parallel to the end-line, a line 9' long shall be marked. It shall have a return crease, projecting 6' long at each end of the line, and at right angles to it. This is called the *centre pass* is taken.

The goal shall consist of a post which measures exactly 10' from the surface of the ground to the top of the post. Fixed on the top of the post and projecting 6" from its inner edge there shall be an iron ring 15" in diameter. This is the goal. (See plan).

The ball shall be a No. 5 Association Football. When inflated it should be between 27" and 28" in circumference, and between 14 oz.

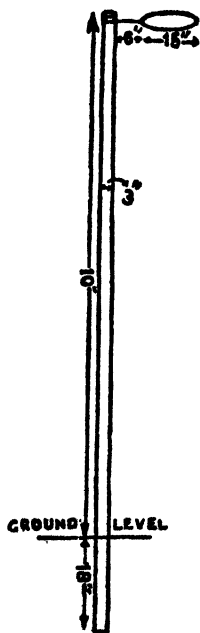

Plan of goal post and 15 oz. in weight.

THE NETBALL COURT

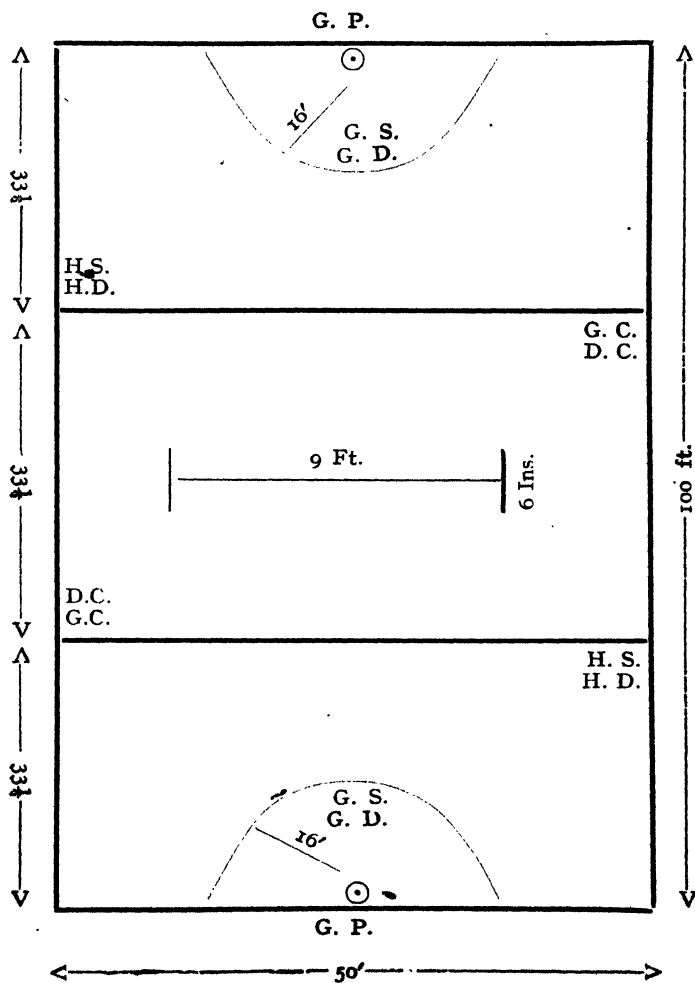

III. Length Of Play

The game consists of two halves of 15 minutes each. There shall be an interval of 10 minutes between halves. The team shall change goals after the interval. In no case may time be exceeded, except to complete a free throw for goal, which was awarded before time expired. But in case of a tie score, a further five minutes is played. If again the score is tied, another five minutes is played, and if necessary repeated, until, when time expires, one team has at least one point more than the other. In case rain interferes with the match, the entire match shall be re-played.

IV. Officials

(i) For the purpose of Umpiring, imagine a line drawn by prolonging the centre line to divide the field into two equal parts. Each Umpire keeps to one part, and thus has responsibility for one entire side-line. Which side-line this is to be shall be decided before the game starts. Umpires shall not change positions at half-time.

(ii) If both Captains agree, there may be one Umpire only.

(iii) There shall be two time-keepers, preferably one representing each team. They shall sit together, and one of them shall be provided with a whistle or gong with which loudly to announce completion of time.

(iv) There shall be a score-keeper. She shall be provided with a blackboard, on which the score shall be recorded, so that all may see it.

V. Umpires

The Umpire or Umpires shall: (i) be in complete control of the game; (ii) before the game begins, instruct the time-keepers and scorers in their duties, and shall be in control of them; (iii) penalize players as provided for by the rules; (iv) refrain from imposing penalties, if by so doing an advantage would be given to the team committing the fault; (v) in the case of continued rough play, or for any action which, in her opinion, deliberately delays or interferes with the game, have power to warn the offending player, and then if the offence is repeated, to suspend her from further participation in the game. If this is done a substitute player may take her place.

The decision of the Umpires, or Umpire, shall be final, and without appeal, either during or after the game.

VI. The Players

There shall be seven players on each team :—The goal-shooter ; the help-shooter ; the goal-centre ; the centre ; the defence-centre ; the help-defence ; the goal-defence.

Boundaries for players: (i) The three centres on each team may travel anywhere about the court except in the two shooting circles. (If they step on, or inside, the shooting circle they are offside. *Penalty:* A free pass). It is, however, unwise for the centres, except in an emergency, to race about the field. In an emergency, she may do more, but if each player takes the responsibility for a certain area, and may be *counted upon to be there*, netball becomes the *passing* game it is intended to be, and not just the wild chasing up and down the field into which it often degenerates.

(ii) The goal-shooter and help-shooter on each team may cover two-thirds of the court, *i.e.*, their goal area, and all of the centre area. They would, however, be very unwise if they tried to do so. The goal-shooter should, as a rule, stay fairly close to the goal, within the one-third of the court which is the goal area, and both she and her partner, the help-shooter, should play *across* their one-third of the court rather than up and down the field, thus playing chiefly a passing, *not* a running game.

(iii) The goal-defence and help-defence on each team may cover two-thirds of the court, *i.e.*, their own area and all of the centre area, as defenders. They should, however, attempt to stay close enough to their opponents, to prevent their securing the ball when the ball comes to their end of the field.

VII. How To Play

The ball may be caught or held in any manner, thrown or batted in any direction by one or both hands, or head. It may be bounced once, in order to gain possession of it *i.e.*, if the ball is in the air and the player cannot catch it, she may stop the ball with the hand, head, or body and allow it to touch the ground once. She must then pick it up, or allow some one else to pick it up. She may not bounce the ball *twice*. *Penalty:* A free pass.

VIII. The Centre Pass

The centre pass is taken (i) at the beginning of the game ; (ii) at the beginning of the second half, (iii) after each goal is made. Unless a foul is committed, it is taken in turn by the two centres.

IX. Offside

When the centre pass is to be taken, until the whistle is blown:—

(i) The goal-shooter and goal-defence in each team must stand inside their shooting circle. No part of either player's foot or body may touch the line, *or she is offside*. *Penalty*: A free pass is given to the other side.

(ii) The help-shooter and help-defence, goal-centre and defence-centre on both teams, must stand in their corners. No part of the players' feet or bodies may touch the line, *or they are offside*. *Penalty*: A free pass is given to the other side.

(iii) The centre taking the pass must remain with one foot in contact with the return crease until the ball has left her hand, *or she is offside*. *Penalty*: A free pass is given to the other side.

(iv) The centre pass may not be received directly by *any player of the same side*, with any part of her foot or body touching the shooting circles. *Penalty*: A free pass is given to the side.

Note. There is nothing against the goal-shooter receiving the ball direct from the centre's hands, *provided* that the goal-shooter runs *out* of the shooting circle after the whistle has blown, and is, actually, completely outside the circle at the moment she catches the ball.

(v) When the centre pass has been made and received without foul, play has actually begun. It continues without interruption until (a) a foul is committed; (b) a goal is made; (c) the ball goes out of bounds; (d) time is up; (e) a Captain calls for time out.

X. To Begin The Game

The Umpire or Umpires shall call the two Captains to the centre of the field, and toss a coin, leaf or pebble. The Captain winning the toss has the choice of goal or centre pass. The players then take their positions on the field.

If there are two Umpires, the Umpire in whose half of the court stands the centre taking the first pass, makes sure (i) that the scorers and time-keepers are ready and (ii) that no players are offside. She then blows the whistle for the game to begin.

Note. If there are two Umpires, one Umpire whistles for the centre pass to be taken during the entire first half, and the other during the entire second half. They decide the orders before the game begins.

XI. Held Ball

If two players, of opposite sides, secure possession of the ball at the same moment and hold it between them it is called 'held ball'. The Umpire blows her whistle and takes the ball. The two players who held the ball then stand 9' apart, on the spot where the ball was held, each with her left side toward her own goal, her feet together and arms at her sides. The Umpire then blows the whistle, and bounces the ball between the two players. Until it *touches the ground*, neither player may move. When it has touched the ground either player may catch it, or knock it away with her hand.

When the ball is thus bounced after a held ball, it shall not be in play until it has *touched* (it need not be caught) by one of the players *between whom it was bounced*. If neither touches it, it must again be bounced; if both players again secure it so that it is again a held ball the ball must again be bounced, and this is, if necessary, repeated until one of the two players secures the ball.

Note. If a held ball occurs within the shooting circle, a goal may not be attempted by the goal-shooter or help-shooter directly from the bounce. The ball must first be passed to another player.

XII. Penalties

For fouls committed, the Umpire or Umpires may inflict one of three penalties; (i) a free pass for *technical* fouls, *i.e.*, errors in handling the ball; (ii) a free throw for *personal* fouls, *i.e.*, rough or interfering play; (iii) suspension from the game for continued rough play.

XIII. The Free Pass: How It Is Made

The opponent of the player who committed the foul takes the ball, and stands on the spot where the foul was committed. No other player may stand within 9' of her until the ball has left her hand. The Umpire blows her whistle, and then the pass must be taken: that is, the ball must be thrown to another player within three seconds.

(i) If the player making the free pass, steps while in the act of throwing, or fails to throw within three seconds, she loses the pass. The Umpire then blows the whistle, her opponent takes the ball, stands on the spot, and makes the pass as soon as the whistle is blown.

(ii) No player may step within 9' of the player making the free pass, until the ball has left the passer's hand. If a player

on the *same* side does so, the Umpire blows her whistle, and the opposing player takes the pass. If a player on the *opposite* side does so, the Umpire blows the whistle and delays the pass until all players stand correctly.

Note. That the opponent of the player committing the foul must make the free pass.

XIV. Fouls For Which A Free Pass Is Given

(i) If the centre pass is received directly from the centre player, by any player of the *same* side, who has any part of her touching the ground in the shooting circle.

(ii) If a player scores a goal (a) directly from a pass received with any part of her foot, hand or body touching the ground *outside* the shooting circle ; (b) directly from a bounce within the shooting circle ; (c) from the second of two consecutive shots *unless* the ball has been touched by another player.

Note. For (ii) (a) and (b) the penalty is given *only* if the goal is made, and, if made, the score is not allowed.

(iii) If the ball is bounced more than once, in order to gain possession.

(iv) If the player in possession of the ball deliberately (a) throws it into the air and catches it again ; (b) rolls or places it on the ground ; and takes it up again ; (c) kicks it or strikes it with closed fist. . . (*Note* that 'to be in possession of the ball' means that a player must have control of the ball; she must be holding it with one or both hands.)

(v) If a player holds the ball for more than three seconds (a) after the whistle for making the centre pass (b) after taking her place for throwing the ball from out of bounds ; or (c) after the whistle for making a free throw or a free pass.

(vi) Travelling with the ball. A player may not walk or run with the ball. After receiving it, she may turn around, but she must not make a complete step in any direction after receiving the ball *i.e.*, she may move one foot in any direction, but if, while holding the ball she lifts *both* feet off the ground, together, or one after the other, she has travelled. Note that a player may leap or jump into the air, in order to make a better throw, but the ball must have left her hands before her feet again touch the ground.

(vii) If when the ball is being passed, there is not room for a third player between the one who passed and the one who received the ball.

(viii) If any player is offside (see Rule IX). In addition to Rule IX, all centres are offside if, during the play, any part of their feet, hands or bodies touch either shooting circle. The goal-shooter, help-shooter, goal-defence, and help-defence of north goal are *offside* if any part of their feet, hands or bodies touch the goal area line for south goal. Similarly the goal-shooter, goal-defence, help-shooter, and help-defence of south goal, are offside if any part of their feet, hands or bodies touch the goal area line for north goal. If two opposing players are offside at the same time, it cancels out, and play continues.

(ix) If any player puts one or both hands upon the ball after another player is in possession of it.

(x) If on a held ball, one of the players between whom the ball is to be bounded, moves *before* the ball touches the ground. If both players move it cancels, and the ball is bounded again.

(xi) If any opposing player touches the goal post when a try for goal is being made, either from the field or from a free throw, the penalty is awarded, even though the ball does not touch the goal ring.

(xii) If a player having tried for goal and missed, takes a second shot when the ball has not been *touched* by any other player.

(xiii) (a) If when a player is making a free throw for goal a player on the *same* side stands within 9' of her. (If the goal is made it is not allowed.) (b) If an opposing player stands within 9' of her, the free throw, even if made, is taken again. If the first free throw was made, it scores one point as usual. If the second free throw is made, it also scores one point as usual.

XV. The Free Throw: How It Is Made

A free throw is taken only after a personal foul has been committed. Play is stopped, and the team against whom the foul was committed is given the ball. The free throw is usually taken by either the goal-shooter or help-shooter. She takes the ball, *without delay*, and *stands just outside* the shooting circle. The Umpire blows the whistle, and within three seconds the player tries to throw the ball through the goal ring. If she *makes the goal* the Umpire blows the whistle, the players take their original position on the field and the ball is again put into play by a centre pass. If the goal is *not made* the ball may be caught by any player and the game continues.

A free throw, though usually made by the goal-shooter, may be made by any player who is allowed within the goal area (the shooter, help-shooter or any of the three centres). The free throw for goal may be taken from any point outside the shooting circle.

(i) The player who takes it must stand with both feet outside the shooting circle, and with no part of either foot touching the circle.

(ii) The ball must be aimed directly at the goal, and not thrown to any other player.

(iii) No player may stand behind the goal-line when a free throw is made, except those permitted within the shooting circle (shooter and defence, help-shooter and help-defence).

(iv) No player may touch, nor in any way interfere with the goal until the free throw has been completed, and either (a) the goal has been made or (b) the ball is clear of the goal.

(v) If the free throw for goal is *made* the players take their original position on the field, and the ball is again put into play by a centre pass.

(vi) If a free throw for goal is *missed*, any player may recover the ball, but the player who made the first free throw attempt may not make a second attempt at the goal until the ball has been touched (it need not be caught) by another player. Thus if the player who attempted the free throw and missed it, catches the ball as it comes down, and it has not been touched by any other player, she must pass the ball to another player, and receive it again, before she makes a second attempt at goal. For breach of these rules (a) by the side making the free throw a free pass is given to the opposing side, taken by the opponent of the player committing the foul; (b) for a breach by the opposing side a second free throw shall be taken. The second is taken even though the first goal was made.

Note. When a *free pass* is given, it must be taken by the opponent of the player committing the foul. When a *free throw for goal* is given it may be taken by any one who is permitted in the goal shooting area, i.e., the goal-shooter or help-shooter, or any one of the three centres.

XVI. Fouls For Which A Free Throw Is Given

(i) If a player in any way *removes* the ball from another player's hands, by knocking, slapping, or batting.

(ii) If a player *charges, pushes, holds,* or keeps her arms across a player to prevent her from moving, or from catching the ball.

(iii) If she puts her *arms over or around* a player in possession of the ball.

(iv) If any player *stands so close* in front of the player in possession of the ball that it is impossible to throw the ball.

(v) If any player stands in front of the player in possession of the ball, *with arms upraised*, making it impossible for the ball to be thrown to another player.

(vi) If any player *jumps to intercept* the ball after it has left the hands of a player *shooting for goal*. (The ball thrown to another player *not shooting for goal* may always be intercepted.)

(vii) If the goal-shooter or help-shooter is fouled within the shooting circle, she may, if she likes, take the free-throw for goal from the spot where she was fouled.

XVII. Out Of Bounds

If, during play, the ball is thrown, batted, rolled or for any other reason, goes out of bounds, it is thrown in again by the opponent of the player who touched it last.

(i) *The throw-in*: The player who is to throw-in recovers the ball, then stands *outside* the boundary line on the spot where the ball crossed the line, and at once throws the ball in without waiting for the whistle.

The ball must be thrown in, from out of bounds, within three seconds after it has been recovered, and the player has taken her position for the throw-in. If the ball has not left the player's hands within three seconds, the Umpire blows the whistle and the ball is given to the opposing player. Thus it would then be thrown in by the player who touched it out.

(ii) *Stepping*: If in the act of throwing in, the player takes a step, that step must be completed outside of the field. If in completing the step, the player steps across, or on to the line (even though the ball has left her hand), it is a foul, and she loses the pass. The Umpire blows the whistle and gives the ball to the opposing player, who then takes the throw-in. *Note.*—that when the player has completed the step (if she took one while throwing) she then steps into the court at once and continues playing.

Exceptions: The only exception to the rule that the ball is thrown in by the opponent of the player who touched it out is, if the ball goes out of bounds across the end-line within the shooting circle, and was last touched by a player who is not permitted,

by the rules, to enter the shooting circle. The ball must be thrown in by a player on the opposing team who is permitted within the shooting circle.

(iv) If a player, standing within the shooting circle, catches the ball on a throw-in, she may not attempt a goal until she has passed the ball to another player, and received it again.

XVIII. Time Out

The Captain of a team may call time out if for any reason a player (or players) is momentarily unable to continue because of accident to person or clothing. If time out is requested the Umpire instantly stops the play, until in her judgement it should be resumed. The Umpires are responsible for accurate observation of time out by the time-keepers. 'Time out' means that the time is not counted which elapses between the whistle which stops play, and the whistle which begins it again.

Note. If a player or a team repeatedly asks for time out to arrange or fasten clothing, warning may be given that further requests will be treated as fouls, and a free throw given to the opposing team.

XIX. Clothing

No player may wear brooches, glass bangles, ornaments in her hair, or on her person, which might in any way cause injury. Shoes, if worn, must have rubber soles and heels.

Throwball

Throwball is so called, because on a court 50' long and 30' wide, two teams of 12 players each, stand on either side of a net, and try to throw the ball back and forth across the net.

Note.

Court for girls	... 50' x 30'	—	net 6' high.
Court for college students	... 60' x 40'	—	net 7' high.

I.—EQUIPMENT

The court shall be 50' long and 30' wide. Across the exact centre of the court the net shall be stretched between two posts. The posts shall be fixed in the ground, exactly 25' from either end-line, and at a spot 12" outside the court. For beginners the net may temporarily be fixed at a height of 5'. For High School matches the net should be fixed at 6'. For inter-collegiate matches the net should be fixed at 7'. The height of the net is always measured at the centre of the court. The net may not be touched during measuring. The height is taken from the ground, exactly to the top of the net, at the centre of the court.

On both sides of the net, parallel to it, and 3' away from it, a line shall be drawn, across the court. This is called the box. The box is a neutral zone. If the ball lands in the box, it counts as out. No player may step into the box to recover a ball, but may reach forward into the box, catch the ball and return it, but while doing so, she must not step into the box.

The net must be provided with a rope, at the bottom as well as at the top of the net. The net must be tied at top and bottom so that its entire surface will be taut enough for the ball to rebound easily off it.

The ball shall be a No. 5 association football, and should measure when inflated between 27" and 29" in circumference.

II.—HOW TO PLAY

There shall be 12 players on each team. They stand in three lines of 4 players each. The same relative positions must be maintained throughout any one game, and the order of serving *must not* be altered. Positions may, however, be altered for any subsequent game.

The players are numbered 1 to 12 in this order, and may not change their order during a game.

1	2	3	4
5	6	7	8
9	10	11	12

No. 12 serves first for her side.

(i) Officials: One umpire, 2 linesmen (one for each end of the field).

(ii) Tournaments: In tournament play the best of three games decides the batch.

(iii) The game: It consists of throwing, not batting, the ball to and fro across the net. The ball may not be batted, but must be caught and thrown with one or both hands.

(iv) Penalty: The side batting the ball, if serving, loses the service to the opposite side. If receiving, the serving side gains a point.

(v) To begin the game: The umpire tosses a leaf or coin and the captains of the two teams choose side or service. Players take their positions which the umpire must carefully note. Linesmen take their places.

III.—HOW TO SERVE

(i) To serve, the player stands at any point *outside* the court and *behind* the line, with no part of her body touching the line, and throws the ball to *any part* of her opponent's court. Any one of her 12 opponents may catch the ball and attempt to throw it back across the net. The ball is thrown back and forth across the net until a player fails to return it. If the receiving side fails to return the ball, the serving side wins the point they score one, and continue serving. If the server fails to get the ball over the net, or if the serving side fails to return the ball, no score is made, but the serving side loses the service, and must then change places, zig-zag fashion. No. 12 moves up to position 1, and all other players then move up one, so that No. 11 is in serving position. After losing the service, players on the *serving* side must change places before the game may continue. But players on the receiving side do not change. Meanwhile the player due to serve for the opposing side, takes the ball and stands at the back of the line, ready to serve. Before serving, she must call the score and then say 'Play' ; for example 'One-love Play'. If she serves without thus warning the other side, it is a foul. Penalty: Her side loses the service.

Note. Many players have the bad habit of throwing the ball, while they say "Play". This is wrong. The server must pause for a second between the words.

(ii) If in serving the server takes one or more steps, that step must be completed outside the line, regardless of time elapsed between the service and the completed step. Penalty: Serving side loses the service.

IV.—SCORING

A game consists of 15 points. One point is scored by the serving side each time their opponents fail to throw the ball back over the net.

If a ball is out and the players call it "out" and do not attempt it, but it strikes a player standing inside the court or on the line, that ball is counted "good" *i.e.*, a ball is good if it touches or is touched by any player, voluntarily or involuntarily if she is *inside* the court or *on* the line.

(i) Deuce: 14 points all, constitutes deuce. It is played as in tennis or teniquoit, *i.e.*, at 14 all, the server calls 'Deuce—play'. To win the game the serving side must then win two consecutive points. 'Advantage all' is not permitted and each game must be played out. For example, the server calls 'Deuce—play'. If her side wins the point, she calls 'Advantage in—play'. If her side wins the next point, the game is won. But if she calls 'Deuce—play' and her side loses the point, the ball goes to the opposing side. The server of that team again calls 'Deuce—play', and so the game continues until one team succeeds in winning two consecutive points.

V.—HANDLING THE BALL

(i) When in possession of the ball, a player may step, if necessary, to maintain her balance, although it is not be encouraged. She may not *in order to make a better return*, step or travel forward with the ball. Penalty: If the serving side fouls, the service is lost. If the receiving side fouls, the serving side is awarded the point.

(ii) Double touch (juggling the ball in the hands) is not allowed. Penalty: If the serving side double touches, they lose the service. If the receiving side double touches, the serving side scores one point.

(iii) A ball that has been served, and is being *returned* may be caught, dropped, picked up by another player (not the same player) and returned, unless it has touched the ground. Any ball touching the ground is dead and that play is ended.

(iv) A ball served, or any ball in play may be touched or thrown into the air by any number of players, in order to get it back over the net, but it may not be touched twice in succession by any player. She may touch it, fail to stop it, then another player may catch it, throw it in the air and the first player may then catch it again. Thus in returning the ball, if there is difficulty in getting it over the net, it may be touched or caught repeatedly by a player, if meanwhile one or more players have touched it.

(v) When serving, the ball may not be assisted over the net by any other player.

(vi) A "net" ball, on serving, is a fault. Penalty: Ball goes to the other team. A "net" ball is a ball that touches the top of the net, *but* goes on over.

(vii) A net ball on a return is good, and may be played.

(viii) Line balls are good, both in serving and returning.

(ix) If a ball is going out but a player touches the ball, fails to stop it, and the ball then goes out, it has been played, and the side failing to return it has lost the point.

(x) Two or more players may reach for and touch the ball at the same time, but one of them must remove her hands from the ball before it is thrown back. Only one player may return the ball across the net. Penalty: The fouling side loses the point.

(xi) Players may not *intentionally* catch the ball with the assistance of the body or legs. The ball should be stopped and touched with the hands only. In returning hard balls, however, it is often impossible to avoid the ball striking the chest. But the Umpire will easily be able to tell if it is done purposely. If any player deliberately rests the ball against her body to assist in holding it, that play is stopped. If the serving side has fouled, it loses the service. If the receiving side has fouled, the serving side scores one point.

Swimming

I. SWIMMING LAWS

(As adopted by the Fédération Internationale,
de Natation Amateur, 1946-48)

The following Rules shall apply in all cases to Competitions held at Olympic Games and to all open International Events:

OFFICIALS

RULE 27.—For all Races there shall be a Starter, a Referee, and not less than Two Judges and Three Timekeepers.

(a) The Starter shall have full control of the competitors until the signal to start is given, and before starting the Race, the Starter must satisfy himself that all the other officials are in their places.

(b) The Judge shall have jurisdiction over the competitors immediately the signal to start has been given, and they shall decide the winner and the placings of those competing. For Swimming Events the judges shall be placed on elevated stands in line with the finish.

The filming of the finishes of all heats, semi-finals and finals of the swimming events at the Olympic Games and Championships of Continents shall be compulsory and such films shall be consulted whenever thought desirable by the majority of the judges and the Referee. Such films must be delivered to the F.I.N.A. and whether developed or not, shall be the sole property of the Federation.

(c) The Referee shall give a decision on any point where the opinions of the Judges may differ. He shall have authority to interfere in a competition at any stage to ensure that the racing conditions are observed.

(d) The Timekeepers shall take the time of the Race according to the regulations of Rule 37. (Records.)

RULE 28.—The start in all races shall be made with a dive (except in Back Stroke Races, which shall be as provided for in Rule 35, and the Starting Stations shall be determined according to the regulations of Rule 29. The Starter shall use the preparatory command "Take your marks," and there shall follow a sufficient length of time before the signal to start is given. The competitors shall remain stationary until the actual signal (shot, whistle or starting word) is given.

The Starter shall call back the competitors at the first or second false start, and remind them of not starting before the starting signal. Such false starts, if repeated in the same heat (no matter if by the same or another swimmer), shall disqualify.

DRAWING OF HEATS

RULE 29.—“In all International Swimming races, the starting stations for all scratch or championship swimming events shall be determined by draw in the heats and finals (if no heats are held), Number 1 starting from the right facing the course. All semi-finals and finals (other than mentioned) shall be seeded as follows: The swimmer or team having the fastest time in the trial heats is placed in the center lane in odd-laned pools or in Lane 3 or 4 respectively in pools with 6 or 8 lanes. The competitor having the next fastest time to be placed on his right, then alternating the other qualifiers left and right in accordance with their times established in the trial heats. If any qualifying competitors have the same time their respective lanes will be determined by draw.

THE STARTER

RULE 30.—The Starter must explain to each competitor before the Race:—

(a) The word of preparation and signal or word which will be given by him to start the Race.

(b) The distance to be covered and where the Race will terminate.

(c) If in open water, the objects to be rounded, and in what manner.

In relay races, the team of a competitor whose feet have lost touch with the ground before his preceding partner touches the wall shall be disqualified, unless the competitor in default returns to the original starting point at the wall, but it shall not be necessary to return to the starting platform.

When starting a race the starter must take up a position on the side of the bath or pool.

THE BATH

RULE 31.—The end walls of the bath must be built perpendicular to the surface of the water for at least 1.50 metres from the surface of the water, and so constructed that the competitors can push off with their hands or feet in turning.

The starting platform shall not exceed 75 centimetres (2 feet 6 inches) in height from the level of the water ; or, when in open water, not exceeding 1 metre 50 centimetres (5 feet), but in either case the height must not be less than 30 centimetres.

Starting grips, where possible, shall be provided for backstroke starts, such grips not to protrude into bath or pool, and must be removable.

THE COURSE

RULE 32.—For competition in still water, the course shall be marked off distinctly, and be easily visible at right angles, and if the finish is not at the end of the course, the same must be at a firmly fixed pole and marked so that it can be easily seen by the competitors. Lane lines shall be provided.

THE RACE

RULE 33.—(a) Obstructing another competitor by swimming across or otherwise, shall disqualify the offender, and should the foul be intentional, the Referee must report the matter to the Association promoting the race, and to the Association of the Swimmer so offending.

(b) Should a foul endanger the chance of success of a competitor, the Judges shall have power to allow him to compete in the next round, or, should the foul occur in a final, they may order it to be re-swum.

(c) When turning, swimmers must touch the end of the bath or course with one or both hands (or as described in Rule 34 Breast Stroke and Rule 35 Back Stroke). In case there is a rail at the finish, the competitors must touch the wall. The turn must be made from the wall, it is not permitted to take a stride or step from the bottom of the bath.

(d) Standing on the bottom during a race shall not disqualify a competitor, but he must not walk.

(e) A competitor swimming over the course alone must cover the whole distance to qualify as the winner.

BREAST STROKE SWIMMING

RULE 34.—(a) Both hands must be moved forward together and brought backward simultaneously.

(b) The body must be kept perfectly on the Breast, and both shoulders in line with the surface of the water.

(c) The feet shall be drawn up together, the knees bent and open. The movement shall be continued with a rounded and outward sweep of the feet, bringing the legs together. Up and down movements of the legs in the vertical plane are prohibited.

(d) When touching at the turn, or on finishing a race, the touch shall be made with both hands simultaneously, with shoulders in horizontal position.

(e) Any competitor introducing a sidestroke movement shall be disqualified.

(f) A swimmer must swim, when on the surface, either orthodox (conventional) breast-stroke or butterfly stroke throughout the race. **THESE STROKES MUST NOT BE ALTERNATED.** Heats and Finals are considered separate races.

BACK STROKE SWIMMING

RULE 35.—(a) Competitors shall line up in the water, facing the starting end, with both hands resting on the end or rail of the Bath or starting grips.

(b) At the signal for starting, they shall push off and swim upon their backs throughout the Race. The hands resting on the end or rail of the bath must not be lifted before the signal of starting. Any competitor leaving his normal position on the back before his foremost hand has touched the end of the course for the purpose of turning or finishing, shall be disqualified.

(c) At each end of the Bath, the competitors must touch the turn with one or two hands before pushing off.

PROTESTS

RULE 36.—Any protest or complaint shall be made in writing to the Referee within 30 minutes of the occurrence.

But if known before the Race, such protest must be lodged before the signal to start is given.

All protests and complaints shall be considered and decided by the Executive or Committee appointed by the Association of the Country in which the Race takes place, or, if occurring during the Olympic Games, by the F.I.N.A. Executive Committee.

When the officials are recognised or appointed by their Association, no protest or appeal shall be allowed from their decision on questions of fouling or placing. The decisions on these matters shall be final.

WORLD'S AMATEUR RECORDS

RULE 37.—(a) For world's records, the following distances and styles for both sexes shall be recognized:—

	Yards	Metres
Free Style	100	100
„	220	200
„	300	300
„	440	400
„	500	500
„	880	800
„	1,000	1,000
„	1,760	1,500
Back Stroke	100	100
„	150	200
„	—	400
Breast Stroke	100	100
„	200	200
„	—	400
„	—	500

RELAY (four competitors)—

„	Men	4 x 100	4 x 100
„	Men	4 x 200	4 x 200
Free Style	Ladies	4 x 100	4 x 100

MEDLEY RELAY (three competitors)—

Back Stroke	}	Men	3 x 100	3 x 100
Breast Stroke		Ladies	3 x 100	3 x 100
Free Style				

(b) All records must be made in fresh or salt still water *i.e.*, without current or tide) and in a scratch competition, or individual race against time, held in public and announced publicly by advertisement at least three clear days before the race or attempt is to be made. If the existing world's record for the corresponding yards distance is better, it shall also count for the shorter metric distance, only one medal and diploma (see clause *j*) however being awarded.

(c) The measurement of the course must be certified correct by a Surveyor or other qualified appointed or approved by the Governing body of the country in which it is situate. The course shall not be less than 25 yards in length for distances from 100 yards to 500 metres, and for longer distances, not less than 50 yards, except the 100 metres distance, when the minimum length must be 25 metres. For men's relay swimming records, 4 x 200 metres and 4 x 200

yards, the course shall be not less than 50 metres and 50 yards respectively. In open water there must be an even number of laps.

Performances which are regularly made at intermediate distances not marked by the end of the bath or a bar lying on the surface of the water, shall be recognized as world's records providing the watches of the timekeepers are stopped, when the head of the swimmer passes under a cord or cable previously fixed to indicate the particular distance.

(d) The height of the starting platform from the surface of the water shall not exceed 75 centimetres (2 feet 6 inches) in a bath, or 1.50 metres in open water. Enclosed baths in the sea or a river, provided the surrounding walls of the bath effectually prevent the ingress and egress of the water, are not considered as open water.

(e) The swimmer must wear the regulation costume as laid down in F.I.N.A. Law, No. 38.

(f) The start shall be made with a dive except in back stroke swimming, when the swimmer shall start in the water with both hands resting on the starting point.

(g) No pacemaking shall be permitted, nor may any device be used or plan adopted which has that effect. No instruction to the swimmer may be given after he has started.

(h) The time shall be taken by three timekeepers appointed or approved by the Governing Body of the country concerned and they shall start their watches when the starting signal is given. When the time recorded by two of the timekeepers agrees, that shall be the accepted time, but in cases where the time of all three differs, that recorded by the middle watch shall be accepted. The referee or some other responsible official shall inspect the watches used, record the times, and publicly announce them. All watches used shall be certified as accurate to the satisfaction of the Governing Body concerned. Times recorded by an approved electrical time-keeping apparatus shall be officially recognized, but the three individual timekeepers herein provided for shall continue to officiate.

(i) Applications for records must be made on the official form provided by the F.I.N.A. (k) and shall be sent to the Governing Body of the country concerned within 21 clear days of the performance, who, if satisfied that all the aforesaid regulations have been correctly observed, and particularly that the swimmer had no advantage from current or tide, shall in turn forward the application to the Hon. Secretary of the F.I.N.A. as soon as possible thereafter or **AT LATEST SO AS TO REACH HIM BY THE FOLLOWING**

FEDERATION INTERNATIONALE DE NATATION AMATEUR
INTERNATIONAL AMATEUR SWIMMING FEDERATION
World's Record Application Form

1. Style of Swimming (Free Style, Back or Breast stroke)	
2. Distance covered	
3. Length of Bath or course	
4. Name and nationality of Swimmer	
5. Date of Race	
6. Time	
7. City at which the race took place and name of pool	
8. Name of the Association who has passed this Record	
9. Was the Course measured by a qualified person (State his name)	
10. How many Timekeepers acted officially? State their names and the times returned by each.	
11. Have the watches been certified as accurate?	
12. Was the water <i>absolutely still</i> , that is, <i>without any tide or current</i> ?	
13. Salt or Fresh water?	
14. State if the course is enclosed? Indoor or outdoor pool?	
15. Have the Swimming Laws of the F.I.N.A. and the world record rule been complied with in your opinion?	

Date.....

(Signed) President

Hon. Secretary

Received Passed and diploma delivered on Not passed (state reasons)

Application for Any Record must be made to the Hon. Secretary of the F. I. N. A. by the 1st of June of the year following the performance.

FEDERATION INTERNATIONALE DE
NATATION AMATEUR

R. M. RITTER

Hon. Secretary

428 Vernon Road, Jenkintown, PA, U.S.A.

1ST OF JUNE. No application shall be entertained which does not comply with this regulation. A performance which apparently lowers the standing world's record, shall be provisionally reported, within fourteen days of the date of such performance, to the Hon. Secretary of the Federation by cablegram or by air-mail, and be subsequently confirmed as provided earlier in this rule by the National Association passing the record.

(j) If the record is accepted by the F.I.N.A., a diploma (signed both by the President and the Hon. Secretary) and a medal, shall be presented to the swimmer in recognition of the performance.

(k) F.I.N.A. standard world's record application form. (See page 249).

COSTUMES

RULE 38. Competitors in all International events and in world record performances shall wear the following:

Males:

- (a) Swimming costumes or suits with drawers or slips underneath.
- (b) Swimming trunks with drawers or slips underneath. Trunks must come to the top of the hip bone, fit snugly and be straight around the legs, not above the crotch and should fully cover the buttocks.

Females:

Swimming costumes of one piece devoid of open work excepting at the back. Leg is to reach within $7\frac{1}{2}$ centimetres (3 inches) of the crotch and should be cut in a straight line around the circumference of the leg. Costumes should be cut not more than 12 centimetres ($4\frac{1}{2}$ inches) from the pit of the neck in front and not more than 5 centimetres (2 inches) from the crease of the arm in front. Fastenings, if any, shall be on shoulders.

The texture of all swimming costumes and trunks shall be non-transparent and they shall be of dark colour.

The referee of a competition shall have the right to debar from starting any competitor whose costume does not comply with the aforesaid regulations.

Note. The measurements given are approximate: the object is to debar immodest costumes.

RULE 39. The interpretation of these laws or any of them, or any other question not provided for herein, shall be referred to the Congress of the F.I.N.A., whose decision is final.

II. DIVING

GENERAL RULES

1. All diving competitions organised at international games shall be subject to the regulations of the F.I.N.A.
2. The spring boards, the fixed boards and all diving installations shall be in accordance with the present regulations, and shall be examined and approved by the delegate of the F.I.N.A. previous to the competition.
3. All diving installations shall be available for use by entered competitors for not less than eight days before the competition.
4. The order of starting shall be decided by lot.
5. The drawing by lot shall be in public, and the place and time of such drawing shall be stated in the announcements of the competitions.
6. If the total number of dives to be executed in one diving competition is excessive the competition shall be divided into several groups of dives so that the number of dives to be executed in any one group shall be not more than 150. The dives of each group shall be executed by all the competitors consecutively and the different groups shall be executed in separate sessions. The results of all the dives shall be collated to find the final placings.
7. Before each dive the referee shall have announced in the language of the country the name of the competitor and the dive which he is about to execute.
8. The competitor shall be given sufficient time for the preparation and execution of the dive. The dive to be executed shall not be announced before the diver has assumed his position on the board or platform.
9. Only such dives as are mentioned in the tables may be executed.
10. Each competition shall comprise a certain number of compulsory and voluntary dives. The compulsory dives shall be determined, and the list of same made available, not later than January 1st of the year following the previous Olympic Games, by the F.I.N.A. International Diving Committee. The voluntary dives shall consist of those selected by the competitor, and of the number permitted by the competition.

11. Each competitor must deliver to the Diving Secretary not less than five clear days (not including the day of the competition) before the competition takes place on an official form written in ink or typewritten, and in triplicate, a complete statement of the voluntary dives selected. On this form must be stated:

- I. The group, the number and denomination of each dive according to the F.I.N.A. diving tables.
- II. The manner of the take-off (running or standing).
- III. The execution of the dive: (a) straight (b) with pike (c) with tuck.
- IV. Height of the board or platform.
- V. The degree of difficulty.

One copy, signed by the Diving Secretary, to be returned to the competitor, one remaining with the Diving Referee and one with the Diving Secretary.

12. None of the compulsory dives may be repeated as a voluntary dive. All dives of the same number are to be considered as the same dives.

13. The list of voluntary dives must be signed by the competitor and—the due time having passed—cannot be altered. Each competitor is entirely responsible for the correctness of the statements of the list.

14. Unless the list be presented in due time a competitor shall not be admitted to the competition.

15. The Referee shall inspect the list and should the statement on the list be not according to the rules, the referee shall decide, before the beginning of the competition, whether or how the statement can be corrected, or whether the competitor shall be excluded from the competition.

16. All dives must be executed by the competitors themselves without any assistance from any other person.

II. METHOD OF MARKING

17. The jury shall be composed of the referee and the judges. In addition, two secretaries shall be appointed.

18. For each competition of the Olympic Games and Continental Championships seven judges recognized by the F.I.N.A.

shall be appointed. For official inter-nation competition five judges are sufficient.

19. The referee shall manage the competition and ensure that the regulation are observed.

20. The minutes of the contest shall be kept by two secretaries.

21. The judges shall be placed by the referee separately and preferably on both sides of the diving board, if practicable.

22. After each dive, on a signal given by the referee, each of the judges, without communicating with one another, shall immediately and simultaneously and in a distinct manner announce the mark awarded by him.

23. The referee shall dictate and place the individual awards one by one in the same consecutive order on a score sheet cancel the highest and lowest awards and pass the score sheet to the first secretary. The second secretary shall enter on his score sheet the awards dictated by the Referee. If two or more awards of those which are to be cancelled are equal either of them can be cancelled.

24. The secretaries shall independently state the average value of the remaining awards, multiply it by the degree of difficulty and enter the points thus established as the result into the list of results. The result thus mutually checked shall then be announced.

25. The final result shall be obtained from the list of results and entered in the main minutes at the end of the contest.

26. At the end of the contest the referee shall supervise the score sheets and the list of results in collaboration with the two secretaries, and confirm the final result by his signature in the main minutes.

27. The winner of the contest shall be the competitor who obtained the greatest sum of points. If two or more competitors obtained the same sum of points the greater sum of points awarded for compulsory dives shall decide. If there still be any dead heats the award for the compulsory dive with the highest degree of difficulty shall decide.

28. Points shall be awarded from 0-10 with half points from 6-10, according to the opinion of the judges and the following table:

Completely Failed.....	0 points
Unsatisfactory	1—2 ,,
Deficient	3—4 ,,
Satisfactory	5—6 ,,
Good	7—8 ,,
Very Good.....	9—10 ,,

29. When judging a dive only the dive is to be considered without regard to the approach to the starting position. The points to be considered are:

The run.

The take-off.

The technique and grace of the dive during the passage through the air.

The entry into the water.

30. If a diver executes a dive other than that announced, the dive must be awarded 0, but dives of the same number are to be considered as the same dive. The diving referee is authorized to have a spoiled dive repeated, when in his opinion the execution of the dive was influenced by exceptional circumstances. The request for such repetition must be made immediately.

In the case of a dive being announced erroneously, the diving referee shall cancel it and have the correct dive performed immediately after the execution of the erroneously announced dive. The diver whose dive was erroneously announced should have it rectified at once, if possible before its execution.

III. EXECUTION OF THE DIVE

31. The diver must not start until the referee has given a signal.

32. Dives should be executed and judged on the following principles:

(a) The approach to the starting position shall not be taken into consideration ; the starting position shall be free and unaffected.

(b) The starting position in standing dives shall be assumed when the competitor stands on the front end of the board and shall

be straight, head erect, feet together, arms up or stretched straight forward level with and the width of the shoulders apart, the fingers together. The starting position of a running dive shall be assumed when the competitor is ready to take the first step of the run.

(c) The run shall be smooth, straight, without hesitation, and consist of not less than three steps before the jump to the end of the board.

(d) The take-off shall be bold, reasonably high and confident. In running dives the take-off from the spring-board must be from both feet simultaneously, but from fixed boards the take-off can be from one foot only. When executing a standing dive, the diver must not bounce on the board before the take-off.

When executing a running dive, the diver shall *not* be allowed to stop his run before the end of the board and to make more than one jump on the same spot, before the final take-off.

In either of these cases the referee shall declare it a failed dive and no points shall be awarded.

In arm-stand dives the diver must show a steady balance, with the body straight.

The diver who loses his balance and who makes a second attempt, provided his hands have remained on the board, shall receive 3 points less than if he had obtained his balance at the first attempt. This deduction shall be made by the referee, not by the judges, and shall be duly announced by him. If the second attempt to obtain a balance is unsuccessful, the referee shall declare it as a failed dive.

The same applies to a restart in a standing or running dive.

(e) During the passage through the air the body can be carried straight, with pike or with tuck. In the first case the body shall not be bent either at the knees, or at the hips, the arms must be straight, the feet together and toes pointed.

In the second case the body shall be bent at the hips, but the legs must be kept straight at the knees, toes pointed.

In the third case the whole body is bunched up with the knees together, toes pointed. The tuck should be as compact as possible.

The diving illustrations serve as guides only and it is to be noted that the position of the arms shall be at the choice of the diver, except in the case of the plain header forwards, where the arms must be stretched out sideways in line with the shoulders during the flight through the air. The arms must be kept still until

just before the entry into the water, when they must be brought together rapidly and extended beyond the head in a line with the body. (This refers to the execution (a) "straight" of the plain header forward *only*. With the executions (b) and (c) of the same dive the position of arms is left to the option of the diver.)

(f) In the plain dives with one half and full twist, the twisting must not be done directly from the board.

In all pike dives with twists, the twist must not be started until there has been a marked pike position, and in all half gainer dives with twist, the twist must not be started until there has been a marked descending header position.

(g) In somersaults with tuck (other than flying somersaults) the turn must commence as soon as the diver leaves the platform, or board, but in flying somersault dives there must be a well defined header before the somersault, with the somersault made as rapidly as possible.

(h) The entry into the water must in all cases be vertical, or nearly so, with the body straight, toes pointed. All head first entries shall be executed with the arms stretched beyond the head in a line with the body, with the hands close together; all feet first entries with the arms close to the body, and no bending at the elbows.

IV. PROTESTS

33. All protests, if any, shall be made to the referee in writing immediately after the end of the contest.

34. Protests, the reason of which is known beforehand, must be lodged before the start of the contest.

35. No protest can be made against the marking of the judges.

36. Decisions concerning protests shall be given by the jury of appeal.

37. Protests against incidents not covered by these regulations shall be referred to the International Diving Committee of the F.I.N.A., which shall consider them as quickly as possible.

V. SPECIAL REGULATIONS

A. Spring Board Diving

38. The spring boards shall be 1 and 3 m. above the water level, at least 4m. long and $\frac{1}{2}$ m. wide, and covered along the whole length with rough cocoanut matting. The spring boards for the

Olympic Games, Continental Championships and Inter-Nation contests shall be provided with movable fulcrums. Spring board events in the Olympic Games and Continental Championships shall be held from the 3m. board. For these latter events the spring boards shall be new.

39. The front of each board shall project at least 1 m. beyond the edge of the bath.

40. The depth of the water shall be at least 3 m., 1 m. back, 10 m. in front and 4 m. each side from a vertical dropped from the centre of the front end of the board. In Baths constructed after January 1st, 1947, these dimensions must be: depth 3.50 metres, 1 m. back, 7 m. in front and 3m. each side.

41. The men's competition shall comprise five compulsory and five voluntary dives.

The ladies' competition shall comprise four compulsory and four voluntary dives.

Compulsory Dives for the Period 1947-1948

A. <i>Spring Board Diving, Men :</i>	3 m.
1 (a) header forward running.....	1.3
9 (b) backward header.....	1.7
15 (a) Isander (half Gainer) reverse dive (running).....	1.9
22 (b) backward spring, forward dive.....	1.2
31 (a) 1 twist forward running.....	2.0
B. <i>Spring Board Diving, Ladies :</i>	
1 (b) header forward running.....	1.2
9 (a) backward header.....	1.6
15 (a) Isander (half Gainer) reverse dive (running).....	1.9
22 (b) backward spring, forward dive.....	1.2

42. The compulsory dives shall be stated by the International Diving Committee of the F.I.N.A. for each Olympic period, and must be chosen from different groups.

43. The voluntary dives shall be chosen according to Rules 11 to 15 of the present regulations from different groups.

III. WATER POLO

RULES OF THE GAME

Promotion

1. The club or organization promoting matches under these rules is responsible for the provision of all stated fixtures and requisites and for correct measurements and markings of the field of play. ("Yards" to read as "metres" in countries where the metric system is in force.)

Field of Play

2. The uniform distance between the respective goal-lines must not exceed 30 yards, or be less than 19 yards; the uniform width must not exceed 20 yards. Distinctive marks must be on both sides of the field of play to denote the goal-line, two yards and four yards from that line, and half-distance between the goal lines. These markings must be clearly visible throughout the game. The boundary of the field of play at the ends is one foot behind the goal line.

The dimensions shall be as extensive as possible subject to above measurements.

Space must be provided to enable the referee to have free way from end to end of the field of play, or, alternatively, an elevated platform of sufficient length to enable all parts of the playing space to be within his easy vision. Space must also be provided at the goal-lines for the goal-scorers.

Water depth must not be less than three feet and must be free from undergrowth, or articles likely to injure players.

Goals

3. The goal posts and cross bar must be of wood or metal, rectangular shape, 3 in. square sections, and painted a single distinctive colour. They must be fixed rigid at the ends of the playing space, even distances from the sides and at least one foot in front of any obstruction. Should any artificial standing or resting place exist (other than the floor of the bath) for the goalkeeper, such must be removed, or the goal posts moved to prevent its use. The goal posts must be 10 ft. apart, and the cross-bar must be 3 ft. above water surface, when the water is 5 ft. or more in depth; when less than 5 ft. the cross-bar must be 8 ft. from the floor of the playing

space, these measurements to be from the inner sides of the goal posts.

Limp nets must be attached to the goal fixtures to enclose the entire goal space securely, fastened from the goal posts and cross-bar to allow not less than one foot space clear behind the goal line everywhere within the goal area.

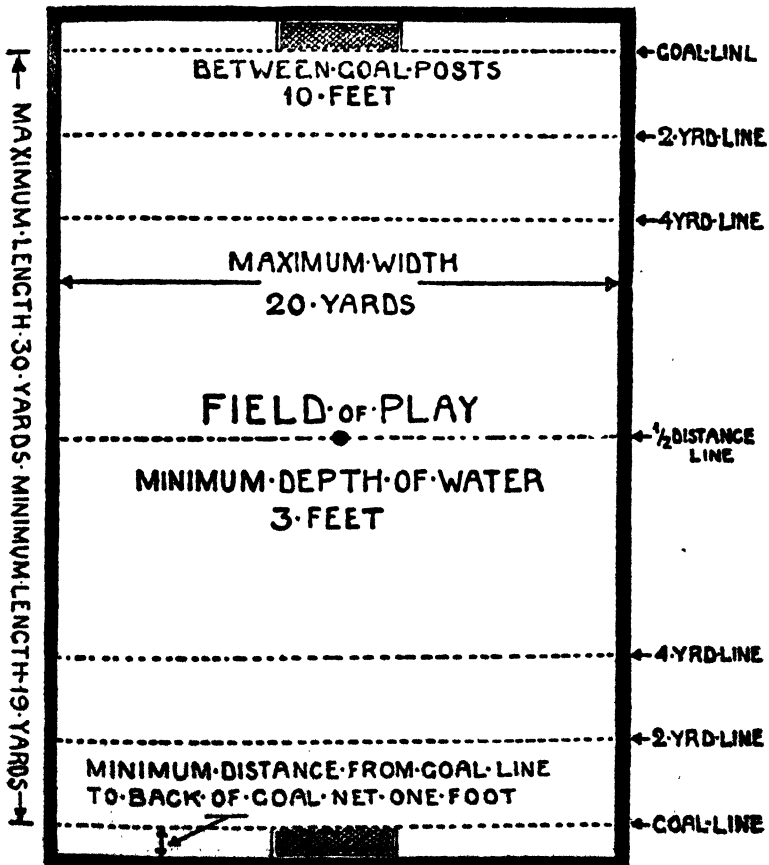

The Ball

4. The ball must be leather-covered, and waterproof, without grease or similar composition, and have no external strappings. It must be fully inflated, round, with an air-chamber supplied through a self-closing valve. Size: minimum/maximum, 27/28 ins. ; weight, 14/16 ounces.

Flags

5. The referee must be provided with two flags, one dark-blue, one white, and each goal-scorer with two flags, one red and one white.

Caps

6. One team must wear dark blue, and the other white caps, except goalkeepers, who must wear red caps, quartered with their sides colours. Caps must be tied with tapes under the chin; if a player loses his cap it must be replaced at the next stoppage of the game.

Officials

7. The officials consist of referee, timekeeper, and two goal-scorers, with specified duties and powers, as stated below:

(a) The referee is in absolute control of the game, and his authority extends until he leaves the precincts of the bath. He must have a shrill whistle, by which he must start the game ; he must declare all goals, goal-throws, corner-throws (whether signalled by the goal-scorer or not), and infringements of the rules, and he must be the sole judge of these points.

All signals to stop play must be by whistle, and from that signal until the ball has left the hand of the player taking the throw, the referee must require all players to remain in their respective positions.

THE REFEREE'S DECISION ON QUESTION OF FACT ARE FINAL. His interpretation of the rules must be obeyed during the game.

The referee may refrain from declaring a foul if, in his opinion, such action would be an advantage to the offending team ; he may alter any decision given by him, provided it is done before the ball is again in play. He has power to order from the water any player for misconduct or disobeying his authority, and should any player refuse to leave the water when so ordered, the game must be stopped, and the opposing side declared winners. He may stop the game at any period, if in his opinion, the behaviour of the players or spectators, or other circumstances prevent it being brought to a proper conclusion. In these circumstances the referee must report his actions to the competent authority.

(b) The timekeeper must be fully acquainted with the rules, and be provided with a water polo stop-watch and shrill whistle ; his duty is to record on the watch the exact period of actual play, as stated in Rule 8, and he must notify half-time, and time, by whistle, independently of the referee, the signal taking immediate effect.

(c) The goal-scorers must mutually agree upon ends, and take up position directly level with the goal lines on the opposite side to the referee for the whole match. Their duties are to signal with the white flag for the goal-throw (see Rule 13), with the red flag for a corner-throw (see Rule 14), and with both flags for a goal (see Rule 12). Goal-scorers are responsible to the referee for the correct score of each team at their own ends.

- (d) 1. For Olympic and Continental Water Polo Tournaments, a referee must be nominated by his National Governing Body, and included in the list of water polo referees published in the Official Bulletin of the F.I.N.A. and revised annually.
2. For important events such as the Olympic Games, Continental Water Polo Tournaments, etc., each affiliated country may nominate not more than 3 water polo referees. Such nominations shall be made only from the official list referred to in "1."
 3. Prior to the commencement of a Tournament the Bureau of the F.I.N.A. or the Committee controlling the Tournament shall select from the official list the water polo referees for the series of matches.
 4. The appointment of referees for the matches shall be by draw provided that, as far as possible, an equal number of matches shall be awarded to each referee.
 5. The referee appointed must be neutral.
 6. If for any reason of major force (illness, accident, etc.) a referee is prevented from officiating, a substitute shall be appointed by draw.
 7. No referee shall be appointed to more than four matches in any one Tournament, unless exceptional circumstances warrant this course.
 8. Where a Tournament is organized in several rounds the referees shall be appointed to each round separately, and not to all rounds at the commencement of the Tournament. The list of official referees shall be revised and if necessary altered prior to each new draw.

9. In order to enable the Executive Committee to compile a list of competent referees, it should be made possible, that prior to the Tournament, proper inter-nation training matches be arranged on the spot, so that referees, whose qualifications are not sufficiently well known to the members of such Committee, may have the opportunity of demonstrating their capabilities in the presence of the delegates of the Committee.

Time

8. The duration of a game shall be fourteen minutes actual play, in two periods of seven minutes, the teams changing ends at halftime ; three minutes' interval must be allowed at half-time. Time counts from the referee's starting signal ; at all signals for stoppage the recording watch must be stopped until play is resumed.

Teams

9. Teams must consist of seven players, each wearing drawers or costumes with drawers underneath, according to the local conditions prevailing. Prior to the start they must discard rings, straps or other articles likely to cause injuries, and players must not have oil, grease or similar composition on the body, under penalty of dismissal from the game. If the referee ascertains, before starting the game, that oil, grease or similar composition has been used by a player, he must order such player to remove same immediately. Should the offense not be detected until after the game has commenced, it must be treated as a major foul. The captain of each team must be a player, and before the game, in the presence of the referee, must toss for choice of ends ; the loser to have choice of colours. The captain must endeavour to maintain the good conduct of his team.

Goalkeeper

10. The goalkeeper may stand to defend his goal ; he is exempt from clauses (*d*) and (*f*) in Rule 15, and clauses (*a*) and (*c*) in Rule 17, but otherwise, when in possession of the ball, is treated as any other player. He must not go beyond the four-yards line, nor touch the ball outside that line ; breach of this rule is an ordinary foul (Rule 15, clause *j*). He must not throw the ball beyond the half-way line, the penalty for so doing being a free throw to the opposing side's nearest player, taken from where the ball crossed the line.

When a goalkeeper is awarded a free throw, other than a goal-throw, he may depute the nearest player of his team to take the throw from where the foul occurred. If a goalkeeper is awarded a

free throw, and deposes the nearest player of his team to take same, the goalkeeper himself must remain where he was when the whistle was blown, and can only return to his goal after the ball has left the hand of the player whom he so deposed. (Rule 16). When the goalkeeper is penalized for holding the bar or rail at the end of the bath, the free throw must be taken from where such foul occurred.

If a goalkeeper, taking a free-throw or goal-throw, releases the ball, and before any other player has touched it, regains possession, and allows it to pass through the goal, a corner-throw must be awarded.

Should a goalkeeper retire from a game through illness or injury, the referee must, on request of the captain, at once allow another player to act as goalkeeper ; otherwise the goalkeeper may only be changed at half-time or the beginning(s) or half-time(s) of extra time(s), by another player of the team, after reporting to the referee. In any other circumstance, any player defending the goal must not be subject to goalkeeper's limitations or allowed his privileges.

Starting

11. At the start or re-start of a game, the players must take up position about one yard apart on their respective goal-lines and at least one yard from either goal-post (only two players to be allowed between the goal-posts) and await the referee's signal after he has ascertained the teams are ready. The start is by one blast of the whistle and the referee must then release or throw the ball into the centre of the field of play.

Scoring

12. A goal is scored by the ball passing fully over the goal-line into the goal, and may be scored by any part of the body, provided, at the start or restart (1) the ball has been played by a player of each team, or (2) by two players of the same team, in which case the scorer must be within half distance of the goal attacked, or (3) by three or more players of the same team, provided always that the ball has been played by the second or subsequent player in the opponents' half. For all fouls, as per Rule 15, 16 and 17, the player taking the free throw may pass the ball to another member of his team, whether or not the latter is within half distance of the goal attacked, and such member may shoot the ball directly at the goal. If he scores, the goal is valid. An attempt by the goalkeeper to stop the ball before it has been played in this way does not constitute playing, and should the

ball cross the goal-line, hit the goal-post or goalkeeper a free throw must be awarded against the offending player.

PLAYING THE BALL MEANS TO HANDLE THE BALL WITH THE PALM SIDE OF THE HAND.

Should a foul occur before this rule has been complied with, Rules 15, 16 and 17 operate.

Goal-Throw

13. A player throwing, or off whom, the ball goes over his opponents' goal-line, concedes a goal throw to the defending goalkeeper, who from his normal position between the goal-posts must pass the ball to another player, or beyond the two yards line.

Corner-Throw

14. A player throwing, or off whom, the ball goes over his own goal-line, concedes a free throw from the two-yard mark to the opposing team's player nearest the mark on the side where the ball goes out. In the case of a goal-throw or corner-throw, the whistle must be blown immediately the ball crosses the goal-line, and from that time until the ball leaves the hand of the player taking the throw all players must remain in their respective positions.

Ordinary Fouls

15. It is a foul—

- (a) To start before the referee blows his whistle.
- (b) To assist a player at the start or re-start, or during the game.
- (c) To hold on to, or push off from, the goal-posts or their fixtures ; to hold on to the rails or fixtures except at the start or re-start ; to hold on to, or push off from, the sides during actual play.
- (d) To stand (except for resting) or walk, when the play is in progress.
- (e) To take or hold the ball under the water when tackled.
- (f) To strike at the ball with the clenched fist.
- (g) To splash in the face of an opponent.
- (h) To touch the ball before it reaches the water when thrown in by the referee.
- (i) When taking the free throw, to throw directly or after dribbling, at the opposing goalkeeper, or to a player of his own team within the opponents two yards area, except when behind the line of the ball.
- (j) For the goalkeeper to take a throw improperly ; or to go, or touch the ball, outside the four-yards line.

The penalty for an ordinary foul must be a free throw to the nearest opponent, to be taken where the foul occurred.

Note. If an attacking player commits an ordinary foul, e.g., five yards from the goal attacked, and his nearest opponent is the goalkeeper, who—as per Rule 15 (j)—is not permitted to touch the ball outside the four yards line, the goalkeeper should not be regarded as the “nearest opponent.” (Ruling of the Board, August 5th, 1936.)

Free-Throws

16. The referee must declare fouls by blowing his whistle, and exhibiting the flag corresponding in colour to caps worn by the team to which the free throw is awarded, and all players must remain in their respective positions until the ball has left the hand of the player taking the throw. The throw must be made to enable other players to observe the ball leaving the hand of the thrower, and no player is allowed to interfere with the taking of the throw.

In case of stoppage (1) through illness or accident, or other unforeseen reason, (2) when one or more players of each team commit a foul at the same moment, to make it impossible for the referee to distinguish which player offended first, he must himself take the ball, and throw it into the water as nearly as possible at the place where the incident took place, in such manner that one player of each team shall have equal opportunity to play it after it has touched the water.

In all cases of a free-throw or corner-throw, or throw-in by the referee, the ball must be played by more than one player before a goal can be scored. An attempt by the goalkeeper to stop the ball, before it has been played by two players, does not constitute handling, and should the ball cross the goal-line, hit the goal-post, or the goalkeeper, a free throw against the offender shall be awarded.

Major Fouls

17. It is a major foul—

(a) To jump from the floor of the bath to play the ball or tackle an opponent.

(b) To hold, sink, pull-back or retard the free limb movement of an opponent, or to impede him in any way, unless he is holding the ball; swimming on the shoulders, back or legs of an opponent, constitutes impeding. Dribbling or striking the ball is not “holding”, but lifting, carrying, pressing under water, or placing the hand under or over the ball when actually touching, is holding. Dribbling the ball up and through the posts is permissible.

(c) To touch the ball with both hands at the same time.

(d) To push off from, or to kick an opponent or make disproportionate movements with that intent.

(e) For the goalkeeper or any other player to hold or move the goal-posts in order to prevent a goal.

(f) To go within two yards of the opponents' goal-line, or to remain there, except (1) when in possession or control of the ball; (2) when behind the line of the ball. A player who has entered the two yards area to tackle an opponent or for any other legitimate purpose, must leave that area with all reasonable speed after the ball has left that area. If the ball is passed back to such player while in the two-yards area, he must, before playing the ball, first leave such area.

(g) To waste time by failing to assist the normal progress of the game, when in possession or control of the ball. (Example: It should be considered "wasting time" for a team to retain control of the ball with the aim of delaying the re-entry of a player, who has been ordered out.)

The penalties for a Major Foul are:

1. If in the opinion of the referee the offense was not premeditated—a free throw as for an ordinary foul.

2. If in the opinion of the referee the offense was premeditated.—A free throw and in addition the offending player must be ordered from the water.

3. An alternative, at the discretion of the referee, to ordering the offender from the water, in respect of Clause (b) and (d) Rule 17, a free throw at goal can be given.

Free Throw at Goal

To indicate the free throw at goal, the referee shall whistle and hold the appropriate colour flag in a perpendicular position above his head.

The player taking the Free Throw at Goal must await the referee's further signal by whistle before throwing, when he must immediately release the ball. (Feinting to throw not permitted).

A goal may be scored by a direct throw at goal, otherwise the rules applicable to a free throw will apply.

To dribble the ball and then throw at goal is not permitted.

The free throw at goal is awarded from where the foul occurred at any position in the field of play.

A player failing to take a Free Throw at Goal as prescribed shall concede a free throw to his nearest opponent.

Any player interfering with the taking of a free throw at goal must be ordered from the water and the throw retaken, but any player may regularly intercept the Throw.

Penal Fouls

18. It is a penal foul—

(a) To deliberately change position after the referee has blown his whistle for stoppage, and before the ball is again in play. (WHEN A PLAYER IS PENALISED UNDER THIS CLAUSE, THE PREVIOUS RULING OF THE REFEREE IS NOT SUPERSEDED.)

(b) To refuse obedience to the referee.

The penalty for a penal foul must be a free-throw as awarded for an ordinary or major foul, but, in addition, the player committing the offence must be ordered from the water.

IN ALL CASES WHERE A PLAYER IS ORDERED FROM THE WATER, THE NORMAL PERIOD IS UNTIL A GOAL IS SCORED, BUT THE REFEREE HAS POWER TO ORDER RETIREMENT FOR THE WHOLE GAME.

Penalty Throw

19. A player intentionally fouled when within four yards of his opponent's goal-line, must be awarded a penalty throw, and may elect to take it from any point on the four-yard line. The offender must be ordered from the water. It is not necessary for the ball to be played by any other player before a goal can be scored, but any player within the four-yard line may intercept the ball. The player throwing must await the signal of the referee by whistle, when he must immediately throw the ball at the goal ; should the ball rebound from the goal posts or crossbar it remains in play.

A player failing to take a penalty throw as prescribed above, shall concede a free-throw to his nearest opponent ; if a defending player irregularly intercepts a penalty throw, he must be ordered from the water and the throw retaken.

Out of Play

20. Should a player send the ball out of the field of play at either side, a free-throw from the same point must be awarded to the opposing side ; the player nearest to where the ball goes out must take the throw. Should the ball strike, or lodge in, an overhead obstruction, it must be considered out of play, and the referee must stop the game, and throw the ball into the water under the said obstruction, and the ball must not be played by any player until after it has touched the water. (See Rule 16, para-

graph 2.) Should the ball rebound from the goal posts or cross-bar or side of the field of play, it remains in play, except as provided for in Rule 12.

Leaving the Water

21. A player must not leave the water, or sit, or stand on the steps or sides of the bath during a game except:

- (a) at half-time,
- (b) in case of illness or accident,
- (c) by permission of the referee.

A player infringing this rule must be deemed guilty of misconduct and liable to suspension by the body governing the particular game in which he is competing. Any player having left the water legitimately may only re-enter at his own goal-line, and by permission of the referee. In cases of accident or illness, the referee may, at his discretion, suspend the game for not more than three minutes.

Extra Time

22. Should a game in which a definite result is required, end with equal scores at full time (Rule 8), any extra time played must be two periods of three minutes, with one minute interval for change of ends. This procedure may be repeated as required, giving ten minutes' interval between any full time and extra time(s).

If at full time or extra time(s) a player was out of the water, having been ordered out, but not for the rest of the game, he must not be permitted to resume with his team for extra time(s) until a goal has been scored.

Cycle Racing

AN AMATEUR

1. An amateur is one who (a) engages in sport solely for the pleasure and the physical, mental and social benefits, he derives therefrom, and to whom sport is nothing more than an avocation ; (b) has never competed for a money prize, or monetary consideration or for any wager or staked bet, who has never engaged in, assisted in, or taught any athletic exercise as a means of pecuniary gain ; and who has never taken part in any cycling competition with any one who is not an amateur.

An Amateur Cyclist shall not:—

(a) Knowingly compete with a professional, or person under sentence or suspension, in public or for a prize.

(b) While competing under B.P.O.A. Rules, knowingly pace or be paced by a professional, or suspended person, in public or for a prize.

(c) Sell or otherwise raise money on any prize won by him.

(d) Accept for a prize for events under the jurisdiction of B. P. C. A., a cycle, accessory, or an article of apparel.

(e) Accept directly or indirectly for cycle riding any remuneration, compensation or expenses except as permitted by Rule 2.

(f) Accept directly or indirectly for cycle riding any remuneration or consideration from any party or parties who may be financially interested in his performance.

(g) Permit his name, person, likeness, machine, accessory, performance or equipment to be used for advertisement for any commodity or maker, or vendor thereof ; nor shall he have the name of his machine or its maker so prominently displayed that it appears in photographs re-produced in the press or give a testimonial which can in any way be associated with his performance.

(h) Compete under an assumed name.

(i) Mis-represent facts regarding eligibility, ability or performance.

(j) Be a party to any attempt to induce an amateur dishonourably to violate his standing.

An amateur shall not lose his status by competing with or against professionals in games (e.g., cricket, football, golf, hockey) for which money prizes are not given, PROVIDED that such games form no part of, nor have any connection with, any cycling meeting.

2. Any organisation, person or persons desiring to pay an amateur rider's travelling and/or hotel expenses, or part thereof, in connection with a Sports Meeting, shall make application on the form prescribed to the Association. Permission may be granted, or refused, under the direction of the Committee who will determine the amount allowable. For a meeting in a foreign country such application must be supported by the governing body of that country. The Committee may require that a suitable amount be deposited, and that payment shall be made to the Association on behalf of the rider.

3. Individuals promoting or assisting to promote any athletic or sports meeting for personal remuneration, or pecuniary gain, shall not be entitled to compete as amateurs.

Junior Amateur

4. A junior shall be under 18 years of age, and will not be allowed to compete in events over 100 Kilometres or 62.137 miles in distance, nor in stage races over a period of a day. He shall abide by the Rules governing amateurism as formulated by the B. P. O. A.

Novice

5. A novice is one who, at the time of starting, has not previously placed first, second or third in any cycle race, other than a race confined to members of one club.

A novice, winning or placing in any novice event or events during a season, shall not be permitted to participate in novice events any more.

Senior Amateur

6. A senior shall be 18 years of age or over and eligible to compete in all events unless specifically stated to be for juniors only. He shall abide by the Rules governing amateurism as formulated by the B. P. O. A.

Women Cyclists

The qualifications in the junior, novice and senior amateur classes shall apply.

"First-Claim"

7. A cyclist is a "first-claim" member of that club in which he has the longest unbroken period of membership.

8. A rider shall represent only one club throughout the season except:

(a) on his resigning from that club and joining another.

(b) in a team event if the club of which he is a "first-claim" member has no team or he is not included in their team, he may ride for a club of which he is a second-claim member.

(c) when he is permitted by the Secretary of the club of which he is a "first-claim" member, to represent another club.

CYCLES

9. The following cycles are eligible for races held under the Association Rules:—

(a) *For Bicycle Races*:—Any two wheeled one-track cycle carrying one rider.

(b) *For Tandem Bicycle Races*:—Any two-wheeled one-track cycle carrying two riders seated one directly behind the other.

MACHINES AND EQUIPMENT

Road and Circuit Races

10. Competitors must present their machines to the Machine Examiner for the race before the start. All machines must conform to the following standards:—

(a) Machines must be presented for examination in a clean state ; an examiner can refuse to pass a cycle on the following grounds ;

(b) For Road Races and Circuit events, a free wheel and two independent brakes in full working order must be fitted. Coaster hubs, charge speed gears and wing nuts are permitted.

(c) All lamp bracket, bag supports, mud-guards and their fittings, and other impediments must be removed.

(d) Pumps must be securely attached to the frame.

(e) Wheels must be securely fastened, tubular tyres must adhere to sprint rims under Examiner's test ; Examiners must not permit a competitor to start if not satisfied upon this important point.

(f) Handle-bars must be plugged at the open ends.

(g) Brake levers must be securely attached to the handle-bars.

(h) Spare tyres must be securely fastened if carried on a machine.

TIME TRIALS AND TEAM TIME TRIALS

(i) For time trials competitors are allowed to use a fixed wheel, and one brake. Two brakes are, however, recommended.

TRACK RACES

- (j) For all open track events a fixed wheel must be fitted.
(k) Brakes, bell and wing nuts are not permitted.

11. No competitor will be allowed to start in a Road or Circuit Race without his appropriate starting number securely attached to the back of his jersey, and the corresponding number affixed to the frame of his machine visible from either side, and food satchels, if carried, must not hide the number of a competitor.

COSTUME

12. (a) Competitors must present a clean and tidy appearance at the start of all events. The Clerk of the Course will carefully inspect competitors and if not satisfied with a rider's appearance that rider will not be permitted to line up for the start.

(b) Competitor's attire for all events must consist of a sleeved jersey or vest and dark coloured knickers reaching at least half way to the knee, or an ensemble as near to this description as possible. All attire must be free from political signs or badges and trade advertisements.

FOOD AND DRINKS**Road and Circuit Races**

13. (a) Riding 'hands off' the handle-bars or competitors pouring the contents of drinking flasks or bottles over themselves or others during a race is forbidden.

(b) Competitors must not accept food or drinks during a race from non-competitors other than at a station, pit, or control determined by the Organiser/s and stated on the programme, or verbally instituted when giving starting instructions to competitors.

(c) No sponge, food, or drink shall be handed up during an event of 100 Kilometres (62.137 Miles) or less.

(d) Competitors may hand each other food or drink.

(e) The use of glass vessels of any kind is prohibited.

SPARE TYRES**Road and Circuit Races**

14. (a) Spare tyres may be handed to a competitor by a helper, but only at the pits determined by the Organiser/s.

(b) Competitors may hand each other tyres, pumps or other parts.

EXCHANGE OF MACHINES

15. Any competitor desirous of having a spare machine in readiness during a race, must submit same for Examiner's Test and it must be held at the pits, station, or control stated by the Organiser/s. Apart from interchange between themselves, competitors must obey this procedure. Competitors must not continue on a machine that is rendered unsafe, e.g., broken frame or handle-bars &c. A rider borrowing a machine from a co-competitor in a Road and Circuit Race must see that the original frame number is removed before proceeding. A competitor or competitors accepting the loan of a machine or equipment from the public, helpers or marshals will be disqualified and/or suspended.

STARTING RULES

Massed Start Races

16. (a) Competitors must line up for the start of an event in their programme order, and not less than 15 minutes before the start of such an event.

(b) Late starts are not permitted ; any competitor not ready by the advertised starting time will not be permitted to compete.

(c) For all events, only competitors whose names appear on the starting sheet shall be allowed to start.

Time Trials

(d) Teams and competitors must start at the time stated on the start sheet, or the time allotted to them, or lose the time they are late.

(e) If a team or competitor arrives late at the start of an event, the time of reporting to the Time-Keeper shall be noted and the time lost shall continue the penalty.

ARRANGEMENTS FOR ATTENDANT, ETC.

17. Each competitor is responsible for making his own arrangements for attendant, food, drink and spares, unless otherwise agreed to be provided by the Organiser/s.

COMPETITORS

Rules of Conduct

18. (a) Competitors acting improperly at the start or ignoring Event Organiser's starting instructions, will be withdrawn from the event immediately.

(b) Misconduct during a race, or at the finish of a race, will be dealt with by disqualification and/or suspension according to the severity of the offence. Competitors using obscene language will be withdrawn from the race and/or suspended.

(c) In all Road and Circuit events competitors must keep to the left half of the road (closed circuit races excepted). For Road Races, competitors passing through towns, villages or any narrow congested defile must ride single file. All hostilities must cease in such areas, and any rider attempting a "break-away" or riding more than single file will be withdrawn from the event, disqualified and/or suspended.

(d) Switching from side to side in a massed-start race is forbidden ; any rider causing an accident to his co-competitors through such action will be liable to the above penalties.

(e) Competitors must give audible warning to their fellow competitors if mechanical trouble, cramp or any other unforeseen eventuality overtakes them, care in slowing down to withdraw from race must be used.

(f) Competitors involved in any stoppage must draw in to the left hand side of the road.

(g) Competitors are urged to foster the spirit of comradeship between themselves ; any one guilty of fouling or interfering in any way with other competitors will be disqualified and/or suspended. The spirit of mutual assistance should prevail in all difficult situations.

(h) Competitors are at liberty to report any infringement of Rules by other competitors during an event. All reports must be substantiated in writing, and a clear view of the incident stated therein. Any competitor so reported will be notified that his actions are under examination by the Jury of Appeal. A competitor has the right to appeal which must be substantiated in writing, and presented to the Organising Secretary there and then. All reports of transgressions of the Rules must be made to the Event Organiser and substantiated in writing at the finish of the event. If a competitor's or competitors' guilt is ascertained in the foregoing respect, he will be disqualified from the event in question and/or suspended.

(i) An Organiser has the power to withdraw any competitor from an event for contrary action, either before, during or at the termination of a stage of a race, or at the finish of the race itself. A travelling Judge or Time-Keeper also has this authority. Competitors lapped in circuit races or too far behind in road races can be withdrawn by the afore-mentioned Officials.

(j) Competitors must use extreme care in contesting a prime or sprint for the finish of a road race. In both cases the Rules of the Road MUST be strictly adhered to.

(k) After the finish of a race competitors must not congregate in the road-way or cause any other obstruction. They are under the direct authority of the Marshal/s and must obey their instructions implicitly.

(l) Competitors will be warned that they are approaching the finish of an event by means of an Official flag to be described by the Organiser/s upon the programme, or verbally when giving starting and finishing instructions. This flag will be 200 yards from the finishing line.

(m) Other flags may be used during an event to caution competitors as to dangerous turnings, &c. also to notify a competitor to withdraw from a race, or any other eventuality arranged by the Organiser/s.

(n) Every competitor shall obtain and, during the race wear his programme number in a conspicuous place, to the satisfaction of the Chief Judge.

(o) Competitors shall not make use of any dope. (Doping is the use of any stimulant not normally employed to increase the power of action in Cycling competition above the average).

(p) Any infringement of Rules or misconduct not specifically dealt with in the foregoing, shall, after due investigation, warrant similar penalties as stated in the foregoing.

LAPPED RIDERS

19. Any rider being so far behind as to be lapped by the leaders must, when instructed by a Judge, retire from the race, report to the starter and hand in his number.

ENTRIES

20. Every entrant in open amateur races shall belong to a club affiliated to the Association.

21. No suspended rider may compete in any race, either open, invitation, closed or limited, until re-instated.

22. Every entrant for an open race shall give the full and correct information as required by the form, the last handicap performance under one Kilometre being shown in metres and under one Mile being shown in yards. Results of closed or limited events shall not be shown unless the entrant has no other performances to give. All entries shall be made and all races shall be ridden in

the real name of the competitor, who must himself sign the Official entry Form.

23. In tandem events each entrant shall show the name of his partner, and no alteration shall be allowed except by consent of the Chief Judge or Referee.

24. Entries must be sent to the Organising Secretary, and in no case shall they be accepted by the Committee or Handicappers.

25. The entry for each open event organised by the Association shall be not less than Re. 0-8-0 and not more than Rs. 2/- for each single event and not less than Rs. 2/- and not more than Rs. 8/- for team events for a team of four.

The above entry fees refer to races up to a distance of 100 Kilometres or 62.137 Miles. Entry fees for distances over a 100 Kilometres or 62.137 Miles shall not be more than Rs. 3/-. If, however, feeding arrangements for the competitors are made, a proportionately increased entry fee may be charged.

26. No rider accepting an invitation to ride in an open event shall enter elsewhere for the same date, unless his acceptance shall have been withdrawn in writing not less than seven days prior to the date of the invitation event.

No rider who has accepted an offer of expenses under B.P.O.A. Rules to ride in an invitation event, and has once reported present at the meeting, shall refrain from competing in such event, without the permission of the Referee, the event or events, to be clearly stated on invitation form and acceptance.

HANDICAPS

27. All open handicaps shall be handicapped by an officially appointed Committee of Handicappers.

28. All open handicaps, EXCEPT those for novices, shall be framed to a Time Standard, to be fixed under the direction of the Committee of Handicappers.

29. The limit in open handicaps (novices, closed and limited handicaps excepted) shall be:—

50 Metres in 400 Metre races.				55 yards in $\frac{1}{4}$ Mile Races.			
100	''	''	800	''	''	''	''
150	''	''	1,200	''	''	''	''
200	''	''	1,600	''	''	''	''
375	''	''	3,000	''	''	''	''
625	''	''	5,000	''	''	''	''

and proportionately at other distances.

30. A competitor winning a first prize in an open handicap, after entering for another handicap, shall be, unless already considered by the Committee of Handicappers, subject to a ten per cent penalty, fractions of metres and yards being ignored. He must report any such win immediately in writing to the Organising Secretary, who shall inform the Committee of Handicappers. The Committee shall notify the Organising Secretary, whether it has considered such win, or if a penalty shall be applied on the day. Prior to competing the competitor must also notify the Referee of such win or wins otherwise he may be disqualified and be liable to suspension.

Two or more wins on one day shall only incur one penalty. Wins on subsequent days shall carry additional ten per cent penalties calculated from the actual mark started from.

The Committee of Handicappers may impose penalties in subsequent events for wins at the same meeting, BUT only if so stated on the programme or by a notice in the Local Daily Newspaper.

When sports are postponed competitors who win open handicaps during the intervening period shall be subject to the above penalties.

The above Rule shall be printed in the programme of every sports meeting which includes open handicaps.

PRIZES

31. Not more than six prizes (time, record medals and lap prizes alone excepted) may be offered for any one event.

Lap prizes may be given for the leaders at stated distances at the discretion of the promoters, BUT the conditions must be clearly stated on the prospectus, entry form and programme.

32. In no case shall a value prize or order on a tradesman be offered or taken in any open event, nor shall an alternative of money or prize be offered or taken in any case.

A cycle, accessory or an article of apparel may not be offered or given as a prize. (Vide Ruling 1 (d)).

33. In the event of a dead-heat, the competitors shall not be allowed to divide the prize or points, or to toss for them, BUT must compete again for a distance decided by the Referee.

34. The award of any prize to a successful competitor shall be subject to his eligibility to compete, the award of the prize shall be subject to the statements on his entry form being accurate and complete. Should it be shown subsequently that he was not eligible or that such statements were inaccurate or incomplete, the award

of the prize shall give him no claim to it, and he must return it forthwith on request.

The Managing Committee may take such proceedings as are deemed advisable to secure the return of prizes obtained by misrepresentation or may prosecute the riders, or otherwise deal with them.

RACE MEETING OFFICIALS

35. Any Official at an open meet shall not be permitted to compete in any race during that meet.

36. The Organising Secretary of a meet shall submit to the Association within a week full results of the said Meeting.

37. The Officials shall consist of a Manager, a Referee, four or more Umpires, Clerks of the Course, a Chief Judge, six or more Judges at Finish, a Chief Scorer, Scorers, a Chief Time-Keeper, three or more Time-Keepers, a Starter, one or more Lap Recorders, an Announcer, one or more Marshals, a Press Steward, an Official Surveyor, a Medical Officer and a Machine Examiner.

DUTIES OF OFFICIALS

Manager

38. The Manager shall have control of the Meet and be responsible for the proper carrying out of the programme.

He shall attentively follow the events going on and decide when a new event shall begin.

Before the beginning of a new competition he shall, in good time, inform the Officials concerned and have the competitors who are entered in the event called out on the field.

After the finish of each event he shall, through his assistants, receive the results from the Scorers.

He shall control his assistants and assign to them such duties as he may deem proper.

Referee

39. The Referee shall see that the Rules are observed. He shall decide all questions relating to the Meet, the final settlement of which is not otherwise covered by these Rules.

In the case of a difference between the Judges he shall decide. In the event of improper conduct by a competitor he has the right of expelling the offender. Any protest or objection which has reference to the conduct by a competitor in the actual competition shall be decided by the Referee on the ground, and his decision shall be final.

When, in any BUT the final heat of a race, a claim for a foul or interference is made, he shall have the power to disqualify the competitor who was at fault, if he considered the foul intentional or due to culpable carelessness and shall also have the power to allow the hindered competitor to start in the next round of heats, as if he had been placed in his trial.

When, in a final heat, a claim for a foul or interference is made, he shall have the power to disqualify the competitor who was at fault, if he considered the foul intentional or due to culpable carelessness, and he shall also have the power to order a new race between such of the competitors as he thought entitled to such a privilege.

Umpires

40. It shall be the duty of an Umpire to stand at such point as the Referee may designate, to watch the competition closely, and in case of a foul or violation of the Rules by a competitor or other person to make a report to the Referee of the incident.

Such Umpires are merely assistants to the Referee, to whom they shall report, BUT they have no power to give decisions.

Clerk of the Course

41. Clerk of the Course shall call over the names of the competitors ; see that the competitors are on their appointed marks, are properly clothed, and their numbers properly exhibited.

In all track events he shall draw for the competitors' respective stations and assign those stations to each competitor and to each team.

He shall control his assistants and assign to them such duties as he may deem proper.

Chief Judge

42. There shall be one Chief at the finish. All other Judges at finish shall report to the Chief Judge.

The Chief Judge shall place himself free from picking places. He shall place as far as possible two Judges to pick first place, two Judges to pick second place, two Judges to pick third place and so on. Judges shall always take two places more than the number of places required for prizes.

Judges

43. Judges shall decide the order in which the competitors finish in the competition. In case of a disagreement, the majority of Judges concerned with the dispute place or places shall decide.

The Judges should be placed at least two metres from and in line with the finishing line, and it is recommended that an elevated stand be used for the Judges in order to allow them to have a good view of the finishing line.

Chief Scorer

44. The Chief Scorer shall be provided with the names and numbers of all entered in the events.

He shall record the order in which each competitor finished his event, together with the time finished by the Chief Time-Keeper and shall as soon as possible place the results at the disposal of the Manager.

Scorers

45. The Chief Scorer shall have Scorers as his assistants and shall control them and shall assign to them such duties as he may deem proper.

Chief Time-Keeper

46. There shall be one Chief Time-Keeper. All other Time-Keepers shall report to the Chief Time-Keeper.

Time-Keepers

47. At least three Time-Keepers shall time every event. In case two of their watches agree and the third disagrees, the time marked by the two shall be the Official time. If all the watches disagree, the time marked by the watch recording the middle time shall be the Official time.

If for any reason only two watches record the time of an event and they fail to agree, the longer time of the two shall be accepted as the Official time.

The time shall be taken from the flash of the pistol.

An electrical time-keeping device in addition, approved by the Association, may be used by the Time-Keepers.

Starter

48. The starter is the sole Judge of the validity of the start.

The Starter shall have entire control of the competitors on their marks, and shall be the sole Judge of the fact as to whether or not any man has gone over his mark.

The Starter, when it has been reported to him by the Chief Clerk of the Course that all the competitors are ready, shall sound a warning whistle and then effect the start by the report of a pistol.

If in the opinion of the Starter, the start has not been a fair one, he must re-call the competitors by a second shot.

Lap Recorders

49. Lap Recorders shall check the number of laps ridden by competitors and give the distances ridden when requested to do so by the Chief Time-Keeper or Judge.

One of them should be appointed to call to the various competitors the number of laps they have covered or have still to cover and shall announce by means of a bell, or otherwise, when the leading man enters the last lap.

Announcer

50. The Announcer shall have his seat next to the Manager. No other person shall have access to the microphone.

The Announcer shall be directly responsible for making all announcements to the spectators with the Manager's permission only. All notices to Officials and competitors shall be announced by the Announcer under the supervision of the Manager and with his permission.

Marshals

51. The Marshal shall have full police charge of the enclosure and shall prevent any BUT Officials and actual competitors from entering or remaining therein. He shall control his assistants and assign to them their duties.

Press Steward

52. The Press Steward shall obtain from the Manager of the meet the names of all Starters in each event, the names of all point winners, and the times or distances of each winning or record performance, and shall keep the press thoroughly informed of all occurrences at the meet.

53. The Official Surveyor shall survey the track and measure all the distances which are to be contested and make a report to the Organising Committee before the meet.

Medical Officer

54. There shall be a Medical Officer present on the grounds ready with his equipment.

If women's events are included in the programme, a Lady Doctor shall be present on the grounds too.

The Medical Officer shall have the Ambulance Squad and a car if available, under his charge.

Machine Examiner

55. The Machine Examiner shall see that the competitors' machines conform to the Rules 10 and 11.

TIME TRIALS AND TEAM TIME TRIALS

56. Competitors must ride absolutely unpaced, EXCEPT during Team Time Trials ; and must neither give nor take shelter, to, or from, another competitor. In all events competitors must maintain a sharp look-out ; any rider neglecting this principle in any way, for any period, is liable to disqualification and/or suspension.

57. Team Time Trials are limited to a maximum of four riders to a Team, and members of a team must belong to the same club EXCEPT in special cases of invitation events. Teams should endeavour to use the same racing colours for each competitor, or alternatively an identical marking or ribbon must be used.

58. Teams must never ride more than two abreast (EXCEPT on enclosed circuits), and in changing position for the lead the team must overtake on the offside. When a Team is being overtaken it must allow the faster Team to attain the leading position. Under no circumstances must competing Teams ride side by side any longer than it is necessary for one to overtake the other.

59. Teams may nominate a reserve or reserves, if they desire ; a person or persons nominated as such may have his name on the start sheet as a rider in a second or otherwise graded team.

60. The time of the last member of the team, unless otherwise stated on the start sheet for the event, to cross the finishing line, will constitute the time of the team.

61. Any infringement of the Rules by any member of a team may entail disqualification and/or suspension of the whole team.

62. Team Time Trials shall be held on Courses that dispense with dead end turns.

63. Intervals between competitors shall be not less than one minute EXCEPT in the case of Team Time Trials, and as provided in Rule 16 (e).

64. A competitor once started, shall not be allowed a second start.

65. All Rules of the road and instructions from any authorised persons must be adhered to.

- TRACKS**Grass Track**

66. Any enclosure on a levelled field with the grass cut as short as possible shall constitute a grass track.

It is essential that a grass track shall have a minimum of 30 Metres straights (Home straight and back straight) joined at the extremities by semi-circles of a diameter of not less than 60 Metres.

The track shall be measured 30 centimetres (12 inches) outward from the inner edge of the track.

67. The races shall be run left hand inside.

68. The finishing line shall be distinctly marked across the track at the winning post.

It is recommended that prior to the construction of any track for cycle racing, the plans and specifications should be submitted to the Association.

Heats

69. In all open track events heats shall be run if there are more than six competitors.

70. All competitors while racing on tracks, other than grass or road circuits, shall wear a crash helmet of an approved pattern.

71. Each competitor must start from his proper mark in all handicap events and in default may be disqualified, BUT, with the consent of the Referee he may start from a mark behind the one allotted him.

72. Where more than one competitor starts from the same mark lots may be drawn to decide their positions counting from the inside of the track.

73. In starting, the foremost part of the machine in contact with the ground must be placed on the competitor's mark, and on banked tracks near the base of the banking.

74. Each competitor may be allowed an attendant to push-off, BUT the latter must keep both feet behind the mark from which the competitor actually starts. Should the attendant cross such mark with either foot the competitor shall be liable to disqualification.

Subject to due notice being given in the prospectus entry form and programme, and to the Chief Judge being satisfied as to their stability, the Organiser/s may appoint Official Attendants.

75. A competitor overtaking another must pass on the outside unless the rider who is passed be dismounted or has retired, or is riding wide. Before taking ground in front of another rider there must be a clear length between his own and the other rider's machine. Riders must allow room for their opponents to pass on the outside. Any competitor infringing this rule or being otherwise

guilty of foul or unfair riding shall be liable to disqualification and/or suspension.

76. Any rider who fails to take up the chase, when another rider breaks away, may be deemed to be "not trying" and liable to disqualification and/or suspension.

77. Competitors may dismount during a race at their pleasure, and may run with their machines, BUT they must keep to the extreme outside of the track whenever dismounted.

78. Any objection respecting foul riding, starting of a wrong mark or other offence committed during a race, shall be made to the Referee as soon as possible, and before the distribution of prizes.

79. All objections, must be in writing, signed by the objecting competitor and in case of team events by the Captain of the objecting team.

80. In the event of an objection being lodged against a placed rider, his prize shall be withheld until the Referee shall have given his decision and confirmed or varied the placings.

TRACK RACES

81. Track races may be of the following types:—

Scratch Race ; Handicap Race ; Time Trial ; Lap Race ,
Scratch Race with Lap Prizes ; Pursuit Race ; Devil Take The
Hindmost ; Madison Race ; Sprint Race.

Scratch Race

82. (a) A Scratch Race is one in which all competitors start from the scratch line (Starting Line) and finish the whole distance. Timing for all Scratch Races shall be recorded over the full distance.

(b) A Scratch Race on grass track should not exceed a distance of 10,000 metres or 6.2137 miles.

(c) Preliminary rounds* or heats shall be held in every Scratch Race on grass track, in which the number of competitors is more than six.

(d) The heats shall be arranged by the Organising Committee and the representatives of different clubs shall be placed, as far as possible, in different heats.

(e) No subsequent round shall begin earlier than 30 minutes after the conclusion of the preceding round.

(f) In all Scratch Races at least the first and the second shall qualify for the next round.

(g) At least six competitors shall qualify for the final round.

(h) All heats shall be run as appearing in the Programme.

(i) In all Scratch Races a draw shall be made for inside position at the start.

(j) Time limits may be imposed in Scratch Races, BUT in no case shall it be less than 4 minutes per mile or 1.6093 Kilometres for open events and 5 minutes per mile for events for Juniors, Novices and Women.

In case of a lone rider for any particular heat, the Organisers may fix a time limit as above for that heat.

A notice that a time limit will be fixed must be inserted in the entry form and programme.

No time limit shall be imposed in handicap races.

Handicap Race

83. In a handicap event the competitor or competitors on scratch shall start from the starting line, the other competitors starting from marks as fixed by the Committee of Handicappers ahead of the competitors on scratch.

This event should be organised on a banked track or on a road and circuit.

Time Trial

84. Rule numbers 10 ; 16 (d) ; (e) ; 18 (a) ; (b) ; (e) ; (f) ; (g) ; (h) ; (i) ; (k) ; (l) ; (n) ; (o) ; and 56 to 65 apply.

At a time not more than one competitor shall be on the track.

85. Starts for the Time Trials may be one of the following types:—

Flying Start.

Standing Start.

Rolling Start.

FLYING START

86. A flying start is one in which a competitor gathers full speed over the starting line by riding any distance which shall be less than a lap, before the starting line.

STANDING START

87. Standing Start may be one of the following types:—

(a) Release Start, (b) Push Start.

(a) **RELEASE START.** In the standing release start competitors are held by attendants on the starting line and are released at the start of the race.

(b) **PUSH START.** In the standing push start competitors are held by attendants on the starting line and are pushed off at the start of the race.

ROLLING START

88. In the rolling start the competitors are held by attendants and are rocked to and fro behind the starting line and are pushed off at the start of the race.

Lap Race

89. In a Lap Race points shall be awarded to the first three at every lap. The points awarded for the first three places shall be 5, 3 and 1 respectively. Double the number of points shall be awarded for the last lap. Places shall be decided on the number of points gained by the riders.

Scratch Race with Lap Prizes

90. As in a lap race points are awarded to the first three at every lap. Places shall be decided as in a scratch race that is in the order of crossing the finishing line at the termination of the race. Lap winners shall be decided on the number of points gained by the riders.

Pursuit Race

91. This may either be one of the following classes:—

- (a) Team Pursuit, (b) Individual Pursuit.

The pursuit races shall be adjudged either by time or by distance.

Time Pursuit races shall not be organised over a period of more than ten minutes.

(a) TEAM PURSUIT

- (i) Team shall consist of 4 riders, who shall be members of the same club.
- (ii) The teams shall be equally spaced round the track. As far as possible there shall not be more than three teams in a heat and not more than two teams in the final.
- (iii) Teams shall start either in line or in a file.
- (iv) The event shall be decided by the time of the third man of each team over the line in a distant pursuit race and by the distance covered by the third man of each team over the line in a time pursuit race.
- (v) If the third rider of the either team draws level with the third rider of the other team, the match is finished when only two teams are riding and the overtaking team shall be the winners. When more than two teams are riding the team overtaken shall withdraw and the overtaking team shall complete the race.

- (vi) Any member of either team overtaken by three of the opposing team, shall retire from the contest, BUT any rider who is, in the opinion of the Referee, interfering with the opposing team, shall be called off and his team shall be liable to disqualification.
- (vii) Club colours shall be worn.
- (viii) Small "pace-following" wheels shall not be used.

Note: Promoters shall secure the services of three Time-Keepers for each team and the Time-Keepers shall time the actual finish of the third rider. The start shall be made in the usual manner by a pistol shot, the starter standing in the centre of the track enclosure.

(b) **INDIVIDUAL PURSUIT**

- (i) As far as possible there shall not be more than four riders in a heat and not more than two riders in the final.
- (ii) Riders shall be equally spaced round the track. At the pistol each individual rider has to go all out for the distance or the period of the race.
- (iii) Any rider overtaken by another rider shall retire from the race.
- (iv) The winners shall be judged by the time taken to cover the distance or by the distance they have covered during the stated period.

Devil Take The Hindmost

92. This is neither a time nor a distance event, the distance being fixed according to the number of riders and shall be one lap less than the number of competitors reporting at the start. At the completion of each lap the last competitor shall be eliminated, till three competitors are left in the race who will compete for the final positions. In case of any mishap which necessitates a competitor or competitors to retire before being eliminated, the elimination shall continue at the end of each lap from among the members riding till only three competitors are left who shall complete the number of laps specified at the start of the race and compete for the final positions.

Madison Race

93. This event shall only be organised on a road circuit or a banked track.

(a) It is an event in which teams of two participate, and during any part of the race EXCEPT at the change-over only one rider of the team shall compete at a time.

(b) Sprints may be fixed at any fixed number of laps, according to the distance of the circuit, which shall be announced on the Entry Form and Programme of the event.

(c) Riders shall only change over one clear lap before each sprint or in any other lap.

(d) Points shall be awarded for first, second and third places for the sprints, which shall be 5, 3 and 1 respectively. Double the number of points shall be awarded for the last sprint.

(e) One rider from each team shall line up at the start and continue in the race until relieved by his partner.

(f) A change is effected by a rider riding abreast of his partner when the relieved rider shall drop out, until he relieves in a like manner. The relieving rider need not touch his partner. Any teams relieving in other than the proper manner shall render themselves liable to disqualification.

(g) Handslinging in changes is definitely forbidden.

(h) A whistle shall be blown at two laps to go for each sprint and any change must be made before crossing the line at one lap to go for the sprint.

(i) For every team at least two change-overs shall be effected.

(j) In case of a puncture or fall or other unavoidable accident when with the leaders the rider or his partner will be allowed to join the race within one lap at the point of mishap without losing position EXCEPT that should he be ahead of the field BUT not a complete lap ahead when the mishap occurs, he shall be deemed to have lost his lead.

(k) The Race shall be decided:

- (i) If all the teams are together (that is to say, no team has gained a lap) by the addition of points gained at each sprint.
- (ii) If one team gains a lap then that team wins irrespective of points gained.
- (iii) If several teams gain a lap or laps, by the number of laps and points won by those teams.

If A	is	3	laps	ahead	with	10	points	—	1st.
„ B	„	2	„	„	„	0	„	—	2nd.
„ C	„	1	lap	„	„	15	„	—	3rd.
„ D	„	1	„	„	„	9	„	—	4th.
„ E	„	0	„	„	„	14	„	—	5th.
									i.e. 3 laps behind the winner.

(l) Irrespective of laps gained or lost by a team, points shall be awarded for the sprints to the first three riders over the line in each case PROVIDED they are with the main group. The Referee has power to disqualify any team, whose riders, in his opinion, allow themselves to be lapped.

1,000 Metres Sprint-Track

94. (a) This event shall only be organised on a banked track, road and circuit.

(b) A draw shall be made for inside position at the start, and the rider drawing inside position shall take the lead until the bell, unless the other rider voluntarily releases him of it. The Organiser may apply this Rule to scratch races other than match races, PROVIDED notice is given in the prospectus, entry form and programme of the event.

(c) Time shall be registered for the last 200 metres.

(d) The race shall be re-run in case of mechanical trouble to any rider before the last 200 metres. The rider experiencing mechanical trouble shall raise his hand as a signal, when the starter shall call the race off by the shot of pistol.

(e) The semi-final and final rounds shall be decided by best of three matches.

(f) The matches shall be grouped as follows:—

2 Competitors Final of 2.

3 „ 1 in bye.
1 match of 2.
1 „ between the loser and the bye.
Final of 2 winners.

4 „ 2 semi-finals.
1 final of 2 winners.
1 „ „ 2 losers to decide third place.

5 „ 1 in bye. 2 matches of 2. Winners qualifying for semi-finals. 1 match between 2 losers and the bye.
2 to qualify for semi-finals.

6 „ 3 matches of 2. 1 re-run of 3 losers.
Winners qualify for semi-final.

- 7 competitors 1 in bye. 3 matches of 2. 3 re-runs between 3 losers and the bye. Winners of the re-run matched again. Winners qualify for semi-final.
- 8 " 4 Quarter finals of 2 each. Winners qualify for semi-final.
- 9 " 3 matches of 3. 2 to qualify from each match.
1 re-run between 3 losers. 2 to qualify. Quarter finals.
- 10 " 5 matches of 2. 1 re-run between 5 losers. 3 to qualify. Quarter finals.
- 11 " 4 matches of 2. 1 match of 3.
3 re-runs of losers. Winners qualify for quarter finals.
- 12 " 6 matches of 2. 2 re-runs of 3. Winners qualify for quarter finals.
- 13 " 5 matches of 2. 1 match of 3.
1 re-run of 3. 2 re-runs of 2. Winners of the re-run matched again. 2 to qualify. Quarter finals.
- 14 " 7 matches of 2. 1 re-run of 3. 2 re-runs of 2. Winners of the re-run matched again. Quarter finals.
- 15 " 6 matches of 2. 1 match of 3. 4 re-runs of 2. 2 matches between the winners of the re-run. Winners to be matched again. Quarter finals.
- 16 " 4 matches of 3. 2 matches of 2.
5 re-runs of 2. Winners of the re-run matched again. Quarter finals.
- 17 " 5 matches of 3. 1 match of 2
4 re-runs of 2. 1 re-run of 3. Winners of the re-run matched again. 2 to qualify. Quarter finals.

18	competitors	6 matches of 3. 4 re-runs of 3. 2 to qualify.	Winners of the re-run matched again. Quarter finals.
19	„	5 matches of 3. 4 re-runs of 3.	2 matches of 2. Winners of the re-run matched again. Quarter finals.
20	„	10 matches of 2. 2 re-runs of 3. 2 re-runs of 2. 8 matches of 2.	2 to qualify. Quarter finals.
21	„	9 matches of 2. 4 re-run of 2 1 re-run of 3. 8 matches of 2.	1 match of 3. 2 to qualify. Quarter finals.
22	„	11 matches of 2. 4 re-runs of 2 8 matches of 2.	1 re-run of 3. Quarter finals.
23	„	10 matches of 2. 2 re-runs of 3. 8 matches of 2.	1 match of 3. 3 re-runs of 2. Quarter finals.
24	„	12 matches of 2. 4 re-runs of 3. 8 matches of 2.	Quarter finals.
25	„	7 matches of 3. 5 re-runs of 2 8 matches of 2	8 matches of 2. 2 re-runs of 3. Quarter finals.
26	„	8 matches of 3. 4 re-runs of 2. 8 matches of 2.	1 match of 2. 3 re-runs of 3. Quarter finals.
27	„	9 matches of 3. 3 re-runs of 2. 8 matches of 2.	4 re-runs of 3. Quarter finals.
28	„	8 matches of 3. 6 re-runs of 3. 8 matches of 2.	2 matches of 2. Quarter finals.

CHAMPIONSHIPS

95 The Bombay Provincial Cycling Championships shall be organised annually by the Association and shall comprise of the following events:—

FOR MEN**ROAD AND CIRCUIT**

- (i) 1,000 Metres Sprint.
- (ii) 100 Kilometres Road Race (Massed Start).
- (iii) 100 " " " (Time Trial).

GRASS TRACK

- (i) 1,000 Metres Scratch.
- (ii) 1,000 " Time Trial.
- (iii) 4,000 " Team Pursuit.
- (iv) 4,000 " Lap Race.

FOR LADIES**GRASS TRACK**

- (i) 500 Metres Scratch.
- (ii) 500 " Time Trial.
- (iii) 1,000 " Individual Pursuit.

96. A race styled a "Provincial Championship" or a meet styled a "Meeting of Champions" shall not be held by any sports promoting body.

RECORDS**Road Records**

97. The Association shall recognise the following classes of amateur records:—

- (a) Massed Start Records.
- (b) Time Trial Records.
- (c) Individual Records (Private Time Trials).

98. The Association will consider and adjudicate on rides by Members of an Affiliated Club, in the territory under the jurisdiction of the Association, in competitions registered with the Association, at distances of :

- (a) 10, 15, 25, 50 and 100 miles.
- (b) 15, 20, 25, 50 and 100 kilometres.
- (c) Place to Place (e.g. Bombay to Poona).
- (d) Place and Back (out and Home).

99. Distances must be certified by a Registered Surveyor.

100 Claim for massed start and time-trial records shall be considered only if the record has been created in a registered meet.

101 Notice of proposed attempt to lower any existing record must be received by the Hon. Secretary at least 15 clear days before the start. Such notice must specify the date, time and place of starting and must be accompanied by not less than 6 copies of the actual course proposed to be followed, showing the approximate time of arrival at the various places en route.

102 If a start is made and the attempt terminates sufficiently soon to enable the rider to make a fresh start, he may do so within half an hour of the time appointed for the original start.

103 At least 3 Registered Time-Keepers of the Association must record the time.

104. For Individual Records no pacing whatever will be allowed. A rider must ride entirely alone, and must not be preceded by any mounted helper within sight.

He may, however, be followed by mounted witnesses, who must not, whilst he is mounted, approach within 100 yards, or coach him by audible signals, EXCEPT that the Officials may approach or pass a rider from time to time.

105. It is essential that riders when dismounted, must wheel or carry their machines without assistance, or any portion of the route.

106. A record must be claimed within one month and proofs must be lodged with the Hon. Secretary in respect of which the claim is made.

107. Claims to records shall be made on prescribed form only by the man or men performing the ride and must state clearly the date, distance, time and class of machine used.

108. All evidence in respect of claims will be retained by the Association and will be dealt with by them as deemed fit.

109. The entire onus of proof shall rest with the man or men making the claim, BUT the Association may procure and use any evidence bearing upon the ride in question.

110. Certificates will be granted for all Records.

111. In the event of a claimant being dissatisfied with the decision of the Committee, he may apply for a re-hearing on depositing the sum of Rs. 10/- to be forfeited if the appeal is deemed frivolous.

112. The Association has full power to decide any question not provided for in these Rules, and its decision is final.

Path Records

113. The Association shall recognise the following classes of track records:—

(a) Massed Start and (b) Un-paced.

Un-paced records shall be one of the following classes:—

- (i) Flying Start Record.
- (ii) Standing Start Record.

114. In all attempts on records the rider shall start from a point not more than one yard from the inside edge of the track.

115. In all attempts on flying start records the rider during his preliminary "wind-up" shall remain all the time within one yard from the inside edge of the track.

116. In all attempts on standing start records the rider shall be allowed an attendant to push him off.

117. Where a "flat" is provided on the inside of the track such shall be rendered un-rideable during a record attempt.

118. Records on grass track shall be recognised over following distances:—

500, 1,000, 2,000, 3,000, 4,000, 5,000 and 10,000 metres.
 1, $\frac{1}{4}$, $\frac{1}{2}$, $\frac{3}{4}$, 1, 2, 3, 4 and 5 miles.

119. Besides the above on a banked track records over the following distances will also be recognised:—

10, 15, 50 and 100 kilometres.
 5, 10, 15, 25, 50 and 100 miles.

120. Any member of an Affiliated Club wishing to attempt to lower any existing un-paced path record in a registered meet, must notify the Organising Secretary of his intention at least 15 clear days before the meet. The Organising Committee may allow the individual to make an attempt if time permits, after duly notifying the Association.

121. Road Record Rules 101 to 112 hold good for path records also.

INTERPRETATION OF THE RULES

122. The interpretation of these rules and of their construction and effect, rest with the Association, and any ruling given by the Association shall be final and binding on all concerned.

Track and Field Sports

Athletic Rules For Men's International Competitions
As Adopted by the International Amateur Athletic Federation

I. MANAGEMENT OF THE MEETING

RULE I. OFFICIALS (OPTIONAL LIST)

One Manager,
One Referee,
4 or more Umpires,
One Clerk of the Course,
One Chief Field Judge,
3 or more Field Judges,
2 Scorers for Field Events,
6 or more Judges at the Finish,
One or more Judges of Walking,
3 or more Timekeepers,
One Starter,
One Scorer for Track Events,
One or more Lap Scorers,
One Official Surveyor,
One Marshal,
One Press Steward,
One Doctor.

If deemed necessary, assistants may be provided for the Manager of the Meeting, the Clerk of the Course, the Marshal and the Press Steward ; and Official Announcers may also be appointed.

RULE 2. THE MANAGER

1. The Manager shall have control of the Meeting and be responsible for the proper carrying out of the programme.
2. He shall attentively follow the events going on and decide when a new event shall begin.
3. Before the beginning of a new competition he shall in good time inform the officials concerned and have the competitors who are entered in the event called out on the field.
4. After the finish of each event he shall, through his assistants, receive the results from the scorers. All announcements to the public, press, etc., shall be given by the Manager through the Official Announcer, Press Steward, loud speaker, etc.

5. He shall have the right to take action against any competitor whose clothing does not conform to the regulations.

6. The Manager shall control his assistants and assign to them such duties as he may deem proper.

RULE 3. THE REFEREE

1. The Referee shall see that the Rules are observed. He shall decide all questions relating to the meeting, the final settlement of which is not otherwise covered by these rules.

2. In the case of a difference between the judges he shall decide. In case of improper conduct by a competitor he has the right of exclusion. Any protest or objection which has reference to the conduct of a competitor in the actual competition shall be decided by the Referee on the ground, and his decision shall be final.

3. When, in any but the final heat of a race, a claim for a foul or interference is made, he shall have the power to disqualify the competitor who was at fault, if he considers the foul intentional or due to culpable carelessness, and shall also have the power to allow the hindered competitor to start in the next round of heats, as if he had been placed in his trial.

4. When, in a final heat, a claim for a foul or interference is made, he shall have the power to disqualify the competitor who was at fault, if he considers the foul intentional or due to culpable carelessness, and he shall also have the power to order a new race between such of the competitors as he thinks entitled to such a privilege.

RULE 4. UMPIRES

1. It shall be the duty of an Umpire to stand at such point as the Referee may designate, to watch the competition closely, and in case of a foul or violation of the rules by a competitor or other person, to make a report to the Referee of the incident.

2. Such Umpires are merely assistants of the Referee, to whom they shall report; but they have no power to give any decisions.

RULE 5. THE CLERK OF THE COURSE

1. The Clerk of the Course shall be provided with the names and the numbers of all entered, and he shall warn them to appear at the starting line before the start of each event in which they are entered.

2. In all track events he shall draw for the competitors' respective stations and assign those stations to each competitor and to each national group.

3. He shall control his assistants and assign to them such duties as he may deem proper.

RULE 6. FIELD JUDGES

1. The Chief Field Judge shall see that all implements and equipment are in accordance with these rules and that the field events are conducted expeditiously.

2. The Field Judges shall judge, measure and record each trial of each competitor in all events, in which the results are determined by distance or height. The decision as to the performance of each man shall be final and without appeal.

RULE 7. SCORERS FOR FIELD EVENTS

1. The Scorers for Field Events, of whom one shall act in throwing events, the other in jumping events, shall be provided with the names and the numbers of all entered in their respective events.

2. They shall receive the competitors at the start of each event in which they act, and shall call over the names of the competitors.

3. They shall record the order in which each competitor finished his event, together with the height or distance furnished them by the Field Judges, and shall as soon as possible hand the results to the Manager.

RULE 8. JUDGES AT THE FINISH

1. The Judges at the Finish shall decide the order in which the competitors finish in the competition. In case of a disagreement, the majority of the judges concerned with the disputed place or places shall decide. Their decision as to the order in which the competitors finish shall be final or without appeal. It is recommended that one Judge selects the first man to finish, one the first and second, one the second and third, and so on.

2. The Judges should be placed at least two metres from and in line with the finishing line, and it is recommended that an elevated stand be used for the Judges in order to allow them to have a good view of the finishing line. (For apparatus, refer to Rule 69.)

RULE 9. JUDGES OF WALKING

The Judge or Judges of Walking shall determine the fairness or unfairness of walking in accordance with the walking rules (see Rule 51), and any of them may caution and, after one caution, disqualify a competitor; they shall, however, immediately disqualify any competitor when walking unfairly during the last 400 metres or 440 yards of a race and their decisions shall be final and without appeal.

RULE 10. TIMEKEEPERS

1. Three Timekeepers shall time every event. In case two of their watches agree, and the third disagrees, the time marked by the two shall be the official time. If all the watches disagree, the time marked by the watch recording the middle time shall be the official time.

2. If for any reason only two watches record the time of an event, and they fail to agree, the longer time of the two shall be accepted as the official time.

3. The time shall be taken from the flash of the pistol.

4. For races up to and including 1,000 metres the tenth of one second timing shall be accepted. For longer races the timing shall be in one-fifth of a second.

5. **An electrical timekeeping device in addition, approved by the National Association of the country where the competitions is held, may be used by the timekeepers.**

RULE 11. THE STARTER

1. All questions concerning the Start shall be decided by the Starter.

2. The Starter shall have entire control of the competitors on their marks, and shall be the sole judge of the fact whether or not any man has left his mark.

3. All races shall be started by the report of a pistol or any similar apparatus.

4. At all international meetings, the words of the Starter in his own mother tongue, shall be: "On your marks", "Set", and then when all competitors are "Set", i.e. steady on their marks, the pistol shall be fired.

5. If a competitor leaves his mark with hand or foot after the word "Set" but before the shot, it shall be considered a false start.

6. The Starter must warn the offender or offenders and shall, except in the Pentathlon or Decathlon, disqualify at the second false start.

7. If in the opinion of the Starter, the start has not been a fair one, he must recall the competitors with a second shot (a faulty start). In this case he may warn the competitors at his discretion.

8. If the Starter has to warn any competitor after the word "Set" because of unsteadiness or any other reason, he shall order all competitors to stand up.

9. Starting blocks or foot supports may be used, not as a material aid to the runner but to protect the track and to expedite carrying out the programme. Hand supports are not allowed. If starting blocks are used both feet must be in contact with the track while starting (For apparatus, refer to Rule 72).

10. At starts, where the competitors are not placed behind the same starting line (200—400 m. races on circular tracks) the Starter shall so place himself that the distance between him and the different competitors is approximately the same.

11. **On athletic fields where the Starter cannot place himself in such a position, the pistol should be placed there and discharged by an electric device.**

RULE 12. THE SCORER FOR TRACK EVENTS

1. The Scorer for Track events shall be provided with the names and the numbers of all entered in track events.

2. He shall receive the competitors at the starting line, and he shall there call over the names of the competitors.

3. He shall record the order in which each competitor finished his event, together with the time furnished him by the Timekeepers, and shall as soon as possible place the results at the disposal of the Manager.

RULE 13. LAP SCORERS

The Lap Scorers shall keep a tally of the laps covered by each competitor in races exceeding one lap, and shall announce by means of a bell, or otherwise, when the leading man enters the last lap.

RULE 14. THE OFFICIAL SURVEYOR

The Official Surveyor shall survey the track and measure all the distances which are to be contested and make a report to the organising Committee or to the Referee before the Meeting.

RULE 15. THE MARSHAL

The Marshal shall have full police charge of the enclosure and shall prevent any but officials and actual competitors from entering or remaining there. He shall control his assistants and assign to them their duties.

RULE 16. THE PRESS STEWARD

The Press Steward shall obtain from the Manager of the Meeting the names of all starters in each event, the names of all point winners, and the times or distances of each winning or record performance, and shall keep the Press thoroughly informed of all occurrences at the Meeting.

II. RULES FOR COMPETITIONS**RULE 17. ENTRIES**

1. The various competitions are confined exclusively to amateurs.

2. The amateur status of every competitor must be guaranteed by the Association that governs in the country from which the competitor has entered, according to the definition of the International Amateur Athletic Federation, and he shall not be permitted to compete in any foreign country unless he holds such guarantee and has permission to compete in any particular event.

3. This guarantee must accompany each entry. Entries must be made in duplicate properly typed or printed.

RULE 18. HEATS

1. Preliminary rounds shall be held in every event in which the number of competitors is too large to allow the competitions to be conducted satisfactorily in a single round.

2. The heats shall be arranged by the Committee conducting the Meeting and the representatives of each nation shall be placed as far as possible in different heats.

3. No subsequent round shall begin earlier than 40 minutes after the conclusion of the preceding round.

4. In all races at least the first and the second shall qualify for the next round.

5. At least six competitors shall qualify for the final round.

RULE 19. THE COMPETITION

1. Competitors shall be required to wear shorts or trunks reaching to within four inches of the knee, and the clothing must be clean and so designed and worn as not to make an indecent display of the competitor's person.

2. Every competitor shall be supplied with and must wear on the breast during competition a distinctive number corresponding to his number on the programme. In races not exceeding 300 metres duplicate numbers shall be provided and worn, one on the breast, and one on the back.

3. Any competitor wilfully jostling, or running across, or obstructing another competitor so as to impede his progress, or evidently competing to lose, shall forfeit his right to be in the competition, and shall not be awarded any position or prize that he would otherwise have been entitled to.

4. No competitor shall be allowed to rejoin a race after **voluntarily** leaving the track, either for the purpose of gaining a place or to pace or assist another competitor.

5. The officials shall have the power to change the place of the competition in any field event if in their opinion the conditions warrant the same.



RULE 20. DOPING

1. Doping is the use of any stimulant not normally employed to increase the power of action in athletic competition above the average.

2. Any person knowingly acting or assisting as explained above, shall be excluded from any place where these rules are in force or, if a competitor, be suspended for a time or otherwise, from further participation in amateur athletics under the jurisdiction of this Federation.

RULE 21. STARTING ORDER

1. The Authorities conducting the Meeting shall draw for the stations of the competitors in each event, and the names of the competitors shall be printed in the programme in this order, in heats and groups.

2. In all field events the competitors shall make their trials in the order of their names as printed in the programme.

3. In the event of a competitor being entered in both a field event and a track event which take place at one and the same time, the field event officials shall allow the competitor to make his trials in an order other than that of the programme.

4. In all track competitions up to and including 1,000 metres competitors shall draw for their respective stations immediately before the start. The competitor with number one shall take the inside station, with number two next, and so on.

5. **In track competitions of 3,000 metres and over, the best man of each nation shall be placed in the first row, the other competitors being stationed in the row corresponding with their effective worth.**

RULE 22. MEASUREMENTS

1. All measurements must be made with a steel tape, graduated in centimetres or in inches.

2. In all throwing events and broad jumps that portion of the tape showing the covered distance must be held by the Official at the take-off or at the circle.

RULE 23. ATTENDANTS

No attendant or competitor who is not actually taking part in the event shall accompany any competitor on the mark or in the race, nor shall any competitor be allowed, without the permission of the Referee or Judges, to receive assistance or refreshment from anyone during the progress of an event, and in no case can assistance or refreshments be given to any competitor in a race of less than 16 kilometres (10 miles).

RULE 24. TIES

1. In all contests where results are determined by measurements of height or distance, ties for first and other places shall be decided as follows:

2. If two or more competitors tie in the standing or the running high jump or in the pole vault.

(a) the competitor with a lesser number of trial jumps at the height at which the tie occurs, shall be declared the winner.

(b) if the tie still remains, the competitor with the lowest number of failures throughout the competition **up to and including the last height** cleared shall be declared the winner.

- (c) if the tie still remains, the competitor with the lowest number of attempts throughout the competition **up to and including the last height** cleared shall be declared the winner.

3. If the tie still remains, and if it concerns the first place, an additional trial at the height failed at should be allowed. If more than one tying athlete clears the bar at this fourth trial, the bar shall be raised 2 cm and the competitors shall be given one trial at the new height. If none of the tying athletes clears the bar at this fourth trial, the bar shall be lowered to the previous height cleared and one more trial allowed. Should the tie continue the bar shall be raised or lowered until it is decided with only one trial given at each height.

4. Ties for other than first place in the High Jump and in the Pole Vault shall be recognized and the tying competitors shall be given the same place in the competition.

5. In case of a tie in any field event for distance the second-best performance of the tying athletes shall decide the tie. If the tie still remains the third-best performance shall decide a. s. o.

6. In case of a dead heat in any track event, the competitors shall not be allowed to divide the prize or points, or to toss for them, but must compete again at a time and place appointed by the Referee.

Record Sheet for field events (height) and how to decide places when there is a tie.

Key: ✓/Success —Pass (Not attempted)

x Failure

I. (Lesser number of trial jumps)

No.	Name	5.2	5.3	5.4	5.5	5.6	Place
1.	M. Patel	... ✓	—	✓	✓	xxx	I.
2.	S. Francis	... —	—	—	x ✓	xxx	II.
3.	M. Ismail	... —	—	✓	xxx		III.
4.	Janakiraman	✓	✓	xxx			IV.

There is a tie for the 1st place at 5.5 between Nos. 1 & 2. Now *apply the first condition* for deciding the tie (a competitor with a lesser number of trial jumps at the height at which the tie occurs, shall be declared the winner). Between Nos. 1 & 2, Patel (No. 1) had the least trials, hence he is declared the winner,

II. (Lesser number of failures)

No.	Name	5.2	5.3	5.4	5.5	5.6	Place
1.	M. Patel ...	✓	✓	—	x ✓	xxx	I.
2.	S. Francis ...	✓	x ✓	x ✓	x ✓	xxx	II.
3.	M. Ismail ...	✓	✓	✓	xxx		III.
4.	Janakiraman	✓	✓	xxx			IV.

There is a tie for the 1st place at 5.5 between Nos. 1 and 2. Now as per the first condition the tie still remains both making two attempts at 5.5 hence the 2nd condition must be applied (the competitor having the least number of failures throughout the competition shall be declared the winner). Between Nos. 1 and 2, Patel (No. 1) had the least number of failures, hence he is declared the winner.

III. (Lesser number of attempts)

No.	Name	5.2	5.3	5.4	5.5	5.6	Place
1.	M. Patel ...	—	—	x ✓	✓ x	xxx	I.
2.	S. Francis ...	—	✓	x ✓	✓ x	xxx	II.
3.	M. Ismail ...	✓	—	✓	xxx		III.
4.	Janakiraman	✓	✓	xxx			IV.

There is a tie for the 1st place at 5.5 between Nos. 1 and 2. Now as per the first condition (competitor with a lesser number of trials at the height at which the tie occurs) and the 2nd condition (the competitor having the least number of failures throughout the competition) the tie still remains—hence apply the third condition (least number of attempts throughout the competition) now between Nos. 1 and 2, Patel (No. 1) had the least number of attempts, hence he is declared the winner.

IV. An Extra Jump (4th Jump)

No.	Name	5.2	5.3	5.4	5.5	5.6	Place
1.	M. Patel ...	—	—	x ✓	x ✓	xxx ✓	I.
2.	S. Francis ...	—	—	x ✓	x ✓	xxxx	II.
3.	M. Ismail ...	✓	—	✓	xxx		III.
4.	Janakiraman	✓	✓	xxx			IV.

There is a tie between Nos. 1 and 2 at 5.5 ; now the tie remains even though the 1st, the 2nd and 3rd conditions being applied in order. Hence, apply the other rule which allows an extra jump (the 4th jump) at the height at which the tie occurs and if the tie still remains, the bar should be raised or lowered as the case may be and only one jump at each height be allowed, till the tie is broken.

This method is to be followed only in the case of a tie for the 1st and 2nd place. Competitor trying for the 2nd and 3rd or 3rd and 4th shall be given the same place in the competition and the last condition need not be applied.



RULE 25. PROTESTS

1. Protests concerning the right of an athlete to participate in a meeting must be made before the meeting and shall be dealt with before the meeting is commenced. Protests concerning matters which develop during the carrying through of the meeting must be made during the meeting or within two hours after the meeting is finished.

2. Protests may be made orally but must be confirmed in writing and duly presented to the Referee or the Jury of Appeal accompanied by a **Deposit of One Pound Sterling or its equivalent before action is taken.** The deposit may be forfeited at the discretion of the body deciding the protest.

3. If the protest concerns questions of a physical nature, the organization responsible for the carrying through of the meeting shall arrange for a physical inspection to be made by a medical expert. The athlete must submit to the inspection as well as to the decision taken in consequence thereof.

RULE 26. WORLD'S RECORDS

1. No record shall be accepted unless made outdoors and timed by at least three official Timekeepers (accepted by the National Association as such) and, in field events, measured with a steel tape by at least three Field Judges.

2. The Rules and Records Committee of the I.A.A.F. shall investigate every performance to which their attention is called and shall be empowered, at their discretion, to reject any record which is not supported by the affidavits of at least six officials certifying as to the place, time of day, state of weather, condition of track or field, force and direction of wind, level or gradient of ground, weight, measurement and material of implements, and correctness of announced time or distance.

3. Each member of the Federation shall keep a list of the best records made in its particular country. The world's best records, however, can only be accepted by the Congress of the International Amateur Athletic Federation.

4. Records claimed for events made with implements which do not comply with the specifications adopted by the International Amateur Athletic Federation will not be allowed.

5. A record can only be made in a *bona fide* competition, either scratch or handicap, which has been duly fixed and advertised before the day, and is included in the printed programme, together with the names of the entrants for the events.

6. A result obtained in deciding a tie cannot be accepted as a world's record.

7. No record will be accepted in races on straight courses, in the Broad Jump, or in the Hop, Step and Jump, if the competitor obtains an assistance from a wind blowing at his back, either directly or in a slanting direction. For this purpose a following wind exceeding 2 m/sec. is considered to be of assistance to the competitor.

8. No walking record shall be recognised unless made on a track.

9. In a race of a certain distance, competitors who wish to attempt to make a record over a shorter distance shall be allowed to do so, on condition, however, that such an attempt is made in perfect accordance with the stipulations of this rule and that the attempt is controlled by special timekeepers and judges.

10. When the time taken for a longer distance is better than, or as good as, the time taken for a shorter distance, the time for the longer distance shall cover and be recognised as the record for the shorter distance.

11. It is not allowed to attempt a record for a longer distance than announced in the programme.

12. When a world's record is made by an athlete of a foreign country, the National Association of the country where the record is made, shall proceed to verify the record in the same way as it does for its own athletes. The record having been passed by the said National Association, the record blank adopted by the I.A.A.F. shall be filled out and forwarded to the I.A.A.F., Norrköping, Sweden. The Association shall also send a duplicate of this blank to the National Association of the athlete.

13. All applications for world's records must be made on the official form of the I.A.A.F.

RULE 27. OFFICIAL ATHLETIC IMPLEMENTS

1. In all international competitions and in all record attempts under the sanction of the International Amateur Athletic Federation, the implements used must comply with the specifications for official implements adopted by the International Amateur Athletic Federation. These specifications are set out in Rules 55—71.

2. All implements used at international competitions shall be provided by the organisers of the competitions, except in the Pole Vault where the competitors may use their own poles.

3. Each Member of the Federation may stamp the implements approved of with its own mark which may be registered in accordance with the laws of the country in question.

III. JUMPING EVENTS

RULE 28. JUMPING EVENTS IN GENERAL

1. In the Running and the Standing high jump and in the Pole Vault a competitor may commence at any height above the minimum height and may jump at his own discretion at any subsequent height. Three consecutive failures, regardless of height, disqualify from further jumping.

2. Before the beginning of the competition, the judge shall announce to the competitors the different heights to which the bar will be raised.

3. Dislodging the bar in the course of a jump or passing the plane of the uprights shall count as a trial.

4. In the Broad Jumps and in the Hop, Step and Jump each competitor shall be allowed three trials and the six best shall be allowed three more trials.

5. In all the Jumping Events and in the Pole Vault the length of the run is unlimited. On athletic fields used for international competitions, the minimum lengths provided for the runaways shall be as follows :

for High Jump	...	15 m or 50 feet.
for Broad Jump	...}	40 m or 126 feet.
for Hop, Step and Jump	...}	
for Pole Vault	...}	

6. In all jumping events each competitor shall be credited with the best of all his jumps, subject to conditions relating to ties.

7. The employment of weights or grips of any kind (grips of cork included) is forbidden.

8. The take-off ground about the jump must be level.

9. The maximum allowed inclination of the track for jumping events shall be one:one thousand.

10. A competitor may place marks for his take-off and a handkerchief on the cross-bar for sighting purpose.

RULE 29. RUNNING HIGH JUMP

1. The competition shall start at a height of 160 centimetres (5 feet 3 inches), and the bar shall be raised as the judges may decide.

2. The competitor must take off from one foot.

3. Neither diving nor somersaulting over the bar shall be permitted.

4. All measurements shall be made perpendicularly from the ground to the upper side of the bar where it is lowest.

5. The uprights shall not be moved during the competition unless the judges consider the take-off has become unsuitable. Such a change shall be made only after a round has been completed.

(For apparatus, refer to Rule 55.)

RULE 30. STANDING HIGH JUMP

1. The competition shall start with the bar at a height of 120 centimetres (3 feet 11 inches).

2. The feet of the competitor may be placed in any position, but shall leave the ground only once in making an attempt to jump. When the feet are lifted from the ground twice, or two springs are made in making the attempt, it shall count as one trial jump without result. A competitor may rock forward and backward, lifting heels and toes alternately from the ground, but he may not lift either foot clear from the ground or slide it along in any direction on the ground.

3. With these additions, the rules are similar to those for the Running High Jump.

(For apparatus, refer to Rule 55.)

RULE 31. POLE VAULT

1. **The competitions shall start at a height of 3 metres (9 feet 10 inches), and the bar shall be raised as the judges may decide.** The take-off for the Pole shall be from a wooden box as designed in the Specification of Implements (see Rule 55).

2. A competitor must not, at the moment that he makes a jump, or after leaving the ground, place his lower hand above the upper one or move the upper hand higher up on the pole. If a competitor clears the bar, but in doing so the pole should remove the same, it shall be considered as a failed try.

3. As soon as a competitor has left the ground for the purpose of making a jump, this shall be counted as a jump.

4. **It shall be considered a failure if the pole of the competitor touches the ground beyond the plane of the stop board of the wooden box.**

5. No attendant should be allowed to touch the pole unless it is falling away from the bar or uprights.

6. Competitors may use their own poles. These may have a binding, but must not have any further support for the hands. No competitors shall be allowed to use any of the private poles except with the consent of their owners.

7. All measurements shall be made perpendicularly from the ground to the upper side of the bar where it is lowest.

8. If the uprights are moved, they shall not be moved more than 60 centimetres (two feet) in any direction, and not more than one hole may be made.

9. If the uprights are moved, the Field Judges should make a remeasurement, because if there is any inequality in the ground

at all, changing the uprights may make a difference varying from a quarter of an inch to one inch, and a competitor should not be allowed to obtain an advantage in that way.

10. The uprights shall be at least 3.66 metres (12 feet) apart.

11. If in making a trial in the Pole Vault the competitor's pole is broken, it shall not count as a trial.

(For apparatus and implement, refer to Rules 55 and 56.)

RULE 32. RUNNING BROAD JUMP

1. The length of the run is unlimited.

2. If any competitor touches the ground beyond the take-off board or its front line extended, with any part of his body, such jump shall not be measured but it shall be counted against the competitor as one jump.

3. The take-off shall be from a board, the outer edge of which shall be called the scratch line. In front of the scratch line and across all the length of it over a width of 10 centimetres (4 inches), the ground shall be sprinkled with soft earth or sand to make it 12 millimetres ($\frac{1}{2}$ inch) higher than the take-off board. From the take-off board the earth shall be raised at an angle of 30° to the height of 12 millimetres ($\frac{1}{2}$ inch).

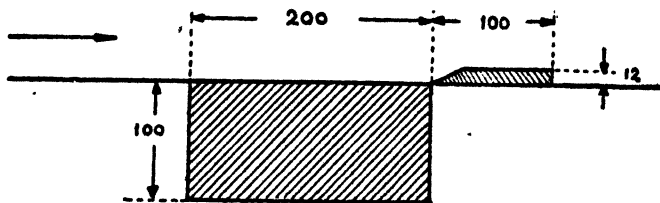

4. The measurement of the jumps shall be made at right angles to the nearest break in the ground made by any part of the body of the competitor.

5. The excavation (pit) shall have a minimum width of 2 metres 75 centimetres (9 feet).

6. The distance between the take-off and the end of the excavation (pit) shall be at least 9 metres ($29\frac{1}{2}$ feet).

(For apparatus, refer to Rule 57).

RULE 33. STANDING BROAD JUMP

See rules for the Standing High Jump, as well as, where applicable, for the Running Broad Jump.

RULE 34. HOP, STEP AND JUMP

1. The competitor shall first land upon the same foot with which he shall have taken off, the reverse foot shall be used for the second landing, and both feet shall be used for the third landing.

2. In all other respects, the rules for the Running Broad Jump shall apply.

(For apparatus, refer to Rule 57.)

IV. THROWING EVENTS**RULE 35. THROWING EVENTS IN GENERAL**

1. In all throwing events, each competitor shall have three trials, and the best six shall have three more. Each competitor shall be credited with the best of all his throws.

2. In all throwing events from a circle it shall be a foul throw if the competitor, after he has stepped into the circle and started to make the throw, touches with any part of his body the ground outside the circle or if he steps on the circle.

3. The competitor must not leave the circle until the implement has touched the ground, and he shall then from a standing position leave the circle from the rear half which shall be indicated by a chalk line extended outside the circle.

4. The circle shall be measured from the inside and shall be flush with the ground outside the circle. The earth or clay in the circle shall be packed hard and firm and 2 centimetres ($\frac{3}{4}$ inch) lower than outside the circle.

5. All throws from a circle, to be fair, must fall within a sector of 90 degrees.

6. In the javelin, discus and hammer competitions a distinctive flag shall be provided with which to mark the throws of each competitor, and a special flag to mark the existing world's record.

7. Only throwing implements provided by the organisers of the meeting can be used at international meetings.

8. No harness, instrument or device of any kind which can be used as a support when making the throw or the shot put shall be allowed.

9. When throwing the hammer ordinary gloves for the protection of the hands are permitted.

10. In javelin throwing the length of the run is unlimited. On athletic fields used for international competitions the minimum length provided for the runaway shall be 25 metres or 80 feet.

11. The maximum allowed inclination of the track for throwing events shall be one:one thousand.

RULE 36. JAVELIN THROWING

1. The throwing shall take place from behind a scratch line, properly marked, which shall be a board 7 centimetres ($2\frac{3}{4}$ inches) in width and at least 3.66 metres (12 feet) in length sunk flush with the ground.

2. The javelin must be held at the grip.

3. No throw shall be counted in which the point of the javelin does not strike the ground before any part of the shaft or where the competitor crosses the scratch line or its extension.

4. The thrower must not place his foot or feet upon the board.

5. The throw is measured from the nearest mark made by the point of the javelin perpendicularly to the inner line of the board or its extension.

6. In throwing the javelin, if the javelin breaks while in the air, it shall not count as a trial, provided the throw was performed in accordance with the rules.

(For implement, refer to Rule 58).

RULE 37. THROWING THE DISCUS

1. The discus shall be thrown from a circle 2.50 metres (8 feet $2\frac{1}{2}$ inches) in diameter.

2. Letting go the discus in making an attempt shall be counted as a trial.

3. The measurements of each throw shall be made from the nearest mark made by the fall of the discus to the inside of the circumference of the circle along a line from the mark made by the discus to the centre of the circle.

(For implement and apparatus, refer to Rules 59, 64 and 67—68.)

RULE 37a. THROWING THE DISCUS (HELLENIC STYLE)

1. The throw shall be made from a special rectangular stand (Balbis) 80 centimetres (2 feet $7\frac{1}{2}$ inches) long and 70 centimetres (2 feet $3\frac{1}{2}$ inches) wide, the surface of which shall slope in the direction in which the throw is made.

2. The discus thrower (right-handed) places himself on the stand with the right foot in front of the left. Neither foot must step over the outer surface of the sides. Starting from this position the competitor shall make the throw. It is forbidden during the throw to change the position of the feet or lift them from the stand. Turning on the ball of the foot, is, however, permitted. After the throw has been made, the competitor may leave the stand by making a jump forward.

3. The throw is measured from the middle of the outer surface of the front side of the throwing stand to the mark made by the discus nearest the stand.

(For implement and apparatus, refer to Rules 59 and 65.)

RULE 38. PUTTING THE SHOT

1. The put shall be made from a circle 2.135 metres (7 feet) in diameter. In the middle of the circumference, at the front half of the circle, shall be placed a stop-board firmly fastened in the ground.

2. The shot shall be put from the shoulder with one hand only and it must never be brought behind the shoulder.

3. Foul puts and letting go the shot in an attempt shall be counted as trial puts without result.

4. The measurement of each put shall be taken at the circle from the nearest mark made by the fall of the shot to the inside of the circumference of the circle along a line from the mark made by the shot to the centre of the circle.

(For implement and apparatus, refer to Rules 60, 64 and 66—68.)

RULE 39. THROWING THE HEAVY WEIGHT

1. All throws shall be made from a circle 2.135 metres (7 feet) in diameter.

2. In making his throw, the competitor may assume any position he chooses and use both hands.

3. Foul throws and letting go the weight in an attempt shall count as trial throws without result.

4. The measurement of each throw shall be taken at the circle from the nearest mark made by the fall of any part of the weight to the inside edge of the circumference of the circle along a line from the mark to the centre of the circle.

(For implement and apparatus, refer to Rules 61, 64 and 67—68.)

RULE 40. THROWING THE HAMMER

1. All throws shall be made from a circle 2.135 metres (7 feet) in diameter.

2. Foul throws and letting go of the hammer in an attempt shall count as a trial throw without result.

3. The measurement of the throw shall be from the nearest edge of the first mark made by the head of the hammer to the inside circumference of the circle along a line from such mark made by the hammer to the centre of circle.

4. In throwing the hammer, if the hammer breaks during the trial or while in the air, it shall not be considered a throw, provided the throw was performed in accordance with the rules. If the competitor thereby loses his equilibrium and commits a foul, it shall not count against him.

5. It shall not be considered a foul throw if the head of the hammer touches the ground when the competitor makes the preliminary swings. But if he after having so touched the ground stops throwing so as to begin the trial again, this shall count as a trial throw without result.

(For implement and apparatus, refer to Rules 62—64 and 67—68.)

RUNNING TRACK DIMENSIONS						
MILES	TOTAL LENGTH OF SIDE	CIRCUM OF END	B-END RADIUS	SAME IN FT+IN	C-CURB RADIUS	
1 "	1320.0'	2640.0'	420.169	420-2 $\frac{3}{4}$ "	419-2"	
$\frac{1}{2}$ "	660.0'	1320.0'	210.084	210-1 $\frac{1}{4}$ "	209-1 "	
$\frac{1}{4}$ "	330.0'	660.0'	105.042	105- $\frac{1}{2}$ "	104- $\frac{1}{2}$ "	
$\frac{3}{8}$ "	165.0'	330.0'	52.521	52-6 $\frac{1}{4}$ "	51-6 $\frac{1}{4}$ "	
$\frac{1}{8}$ "	82.5'	165.0'	26.260	26-3 $\frac{1}{8}$ "	25-3 $\frac{1}{8}$ "	
$\frac{1}{16}$ "	41.25'	82.5'	13.130	13- $\frac{1}{8}$ "	12- $\frac{1}{8}$ "	
$\frac{1}{32}$ "	20.625'	41.25'	6.565	6- $\frac{1}{16}$ "	6- $\frac{1}{16}$ "	

DIRECTION FOR LAYING OUT RUNNING TRACKS

LAYING OUT A 400 METRE OVAL RUNNING TRACK

With the growing interest in the World Olympics and in adopting the same code of rules as govern the World Olympic Sports, many requests come in to us for advice regarding laying out a running track in metres. As you are well aware all sports items in the Olympic programme are measured in metres. This being so we have changed our running track at the Y.M.C.A. College, Saidapet, Madras and gladly give here with the methods followed by us in laying out our 400 metre track, so that those requesting information may have it for their guidance.

We also give herewith the diagram and dimension of the running track of the 1936 World Olympic in Berlin.

The accompanying figure and diagram should enable any person who understands sports, to lay out a track on which the modern programme of sports can be efficiently and satisfactorily conducted:—

1 Metre	=	3.281 ft.
100 Metres	=	328 ft. 1-1/5 in.
110 Metres	=	360 ft. 10-9/10 in.
400 Metres	=	1312 ft. 4-4/5 in.

Now, if we make the length of each of the straights of the 400 Metre oval track to be 80.3 Metres, or 263.465 ft. (263 ft. 5-3/5 in.), then the running distance around each curve of the track will be 119.7 Metres or 392.735 ft. (392 ft. 8-4/5 in.).

You will thus find the total distance of the track to be:—

263 ft. 5-3/5 in. or 263.465 ft. or 80.3 Metres	= One side.
263 ft. 5-3/5 in. or 263.465 ft. or 80.3 Metres	= Other side.
392 ft. 8-4/5 in. or 392.735 ft. or 119.7 Metres	= Other curve.
392 ft. 8-4/5 in. or 392.735 ft. or 119.7 Metres	= One curve.

1,312 ft. 4-4/5 in. or 1,312.400 ft. or 400.0 Metres = Complete track.

Now since the Running Distance around one curve is 119.7 Metres or 392.735 ft. your knowledge of Mathematics will enable

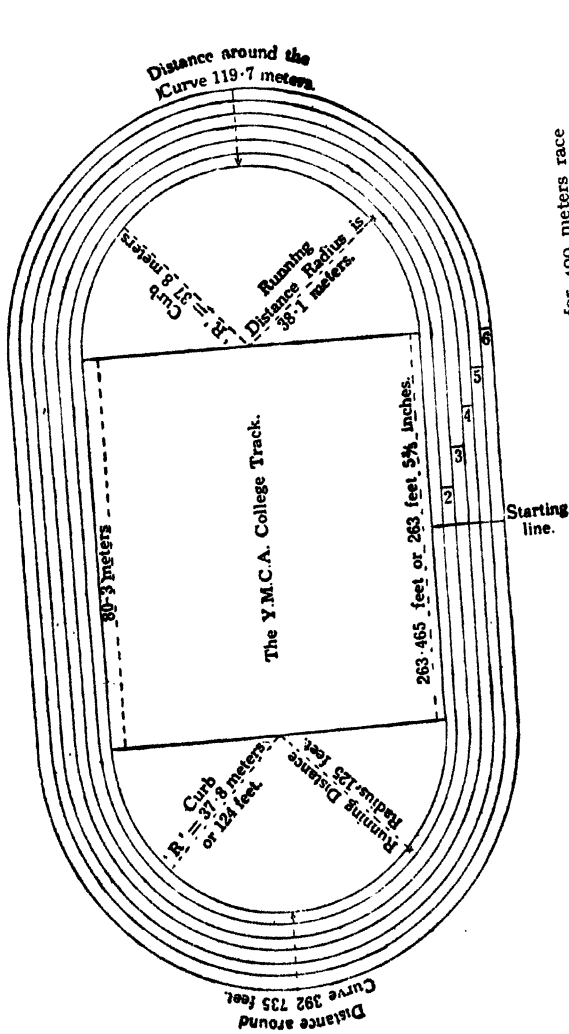

Diagrammatic Sketch of 400 meters Track
 = 26.8 Metres = 87.9 feet.
 = 37.8 metres = 124 feet.
 = 38.1 metres = 125 feet.
 = 80.3 metres = 263.465 feet.

Staggers for 400 meters race
 1st Lane starts Scratch.
 2nd " 23 ft. 1/4 inch from
 3rd and subsequent Lanes 25 ft. 1/4 inch from
 2nd, etc., respectively.

Scale 1" = 1.41"
 Curb Radius 1.41"
 Running Distance Radius = 38.1 metres = 125 feet.
 Length of straight 3" = 80.3 metres = 263.465 feet.

$= 20.093$ Meters. The Curb Radius $= 36.5$ meters
 Length of one straight $= 84.39$ meters

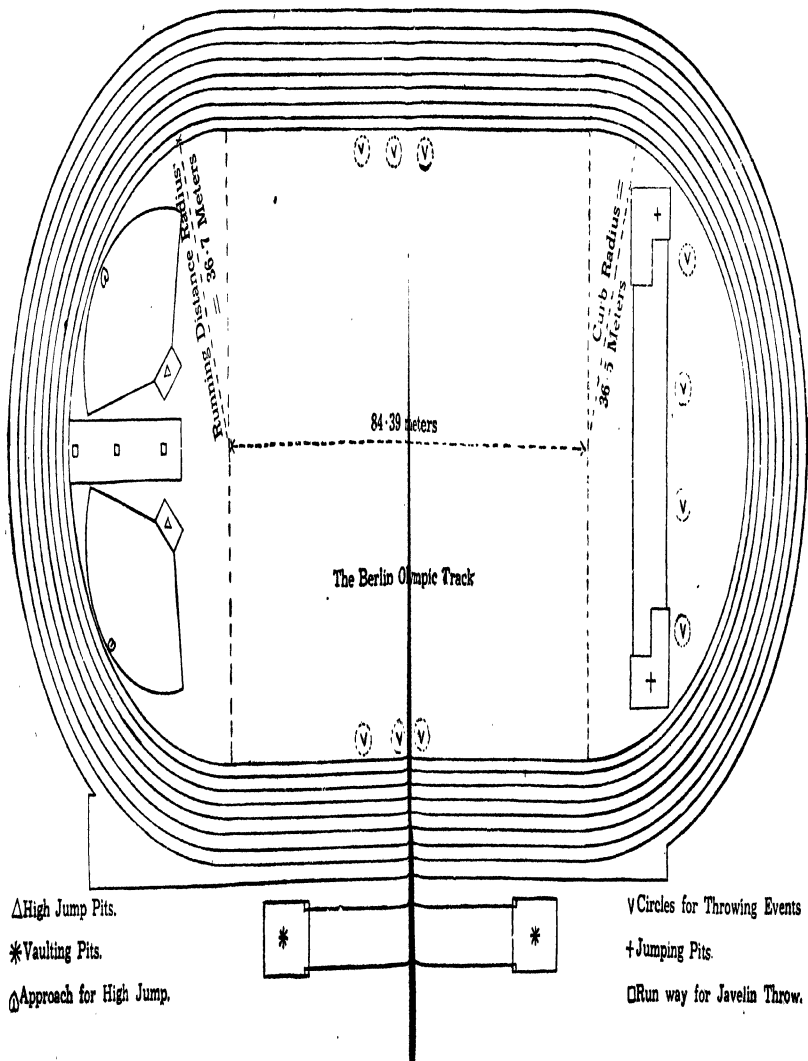

Δ High Jump Pits.

$*$ Vaulting Pits.

\odot Approach for High Jump.

\vee Circles for Throwing Events

$+$ Jumping Pits.

\square Run way for Javelin Throw.

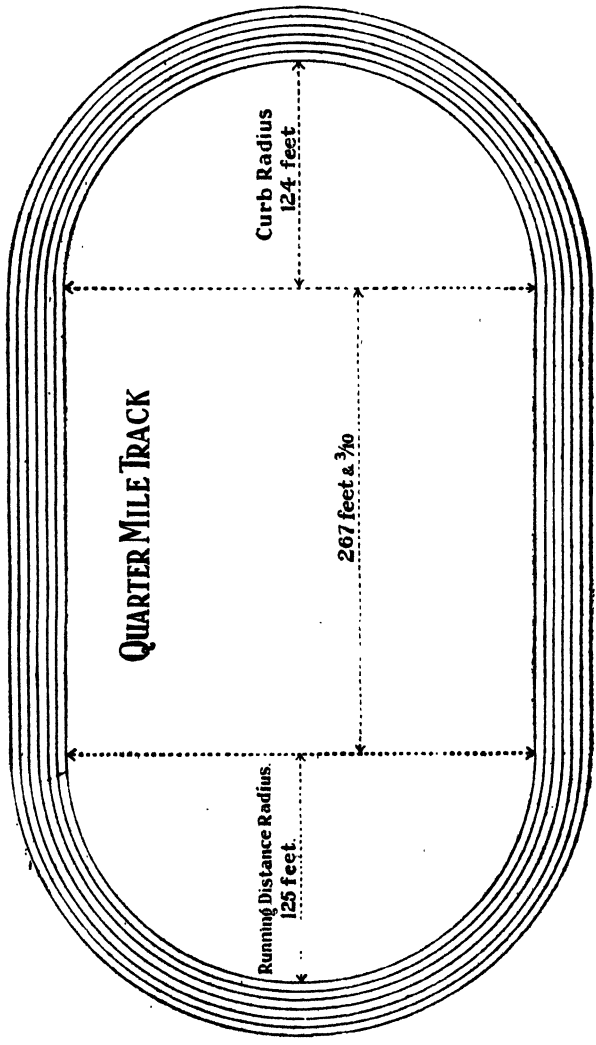

QUARTER MILE TRACK

you to figure out that the radius required for that is 38.1 Metres or 125 ft. This radius of 125 ft. is what is called the "Running Distance Radius." But the running distance on a track is measured not on the curb or chalk line of the track but one foot away from it. Therefore for actually marking out the track we deduct one foot from the running distance radius, and use that distance for our "Curb Radius" or for actually marking the running track on the ground. For the particular running track in question we have found that the "Running Distance Radius" is 38.1 Metres or 125 ft. Therefore for actually marking the track we use a "Curb Radius" of one foot less. In this case our "Curb Radius" is 37.8 Metres or 124 ft.

A careful study of the diagram will clearly indicate how you should proceed to lay out your 400 metre running track.

The rules of sports require that in every race up to and including the 40 Metres, each runner shall have a separate lane of at least 1.22 Metres or 4 ft. in width. In a straight away race this presents no problem because from the starting line to the finishing line all lanes are of equal length. But when running races around a curve if all runners started abreast the runners on the outer lanes would be running greater distance than those on the inside lanes. Therefore the method of "staggered starts" is used to give each runner the same actual distance. These staggered starts are indicated in the six lanes represented on the 400 Metre track in the diagram. According to the rules of sports the distance of the first lane is measured 12 in. away from the curb line. But succeeding lanes are measured 8 in. away from their inside line. The measuring radius is therefore different and your application of Mathematics will tell you to mark your starting lines for a 400 Metre race as follows:—

The man in the first lane starts scratch.

The man in the second lane starts at a mark which will be 23 ft. $\frac{1}{2}$ in. in advance of scratch.

The men in the third and subsequent lanes start at marks 25 ft. $1\frac{1}{2}$ in. in advance of the 2nd, 3rd, 4th, etc., respectively.

Then in making staggered starts for the 200 Metre race the distance between starting marks would be just half that for the 400 Metres, the starting would be on exactly the opposite side in the centre of the running course and the finish line would be where the 400 Metres begins.

V. RACES

RULE 41. TRACK AND LANES

1. The running track shall be measured 30 centimetres (12 inches) outward from the inner edge of the track. There must be a border of board, rope, cement, or any other material. The inner border shall be 5 centimetres (2 inches) in height.

2. In all races of a distance up to and including 400 metres or 440 yards, each competitor shall have a separate course of at least 1.22 metres (4 feet) properly measured, the entire course to be marked with 5 centimetres (2 inches) chalk lines. The inner lane shall be measured as stated above, the outer lanes 20 centimetres (8 inches) from their respective borders.

3. The direction of running shall be left hand inside.

4. Each competitor shall keep in his respective position from start to finish in all races run in lanes. In all races he shall not cross in front of a competitor until he is 2 metres in advance of his nearest competitor.

5. To conduct properly important International Meetings the track should permit of at least six lanes.

6. The maximum allowed inclination of the running track of the field shall be one: one thousand.

RULE 42. THE FINISH

1. The finishing line shall be a line on the ground drawn across the track from finish post to finish post and the competitors shall be placed in the order in which any part of their bodies (*i.e.* "torso", as distinguished from the head, arms, feet or hands) reaches such line. But a competitor falling at the finish is not considered to have completed the race unless his entire body shall have crossed the finishing line.

2. For the purpose of aiding the judges, but not as a finishing line, there shall be stretched across the track at the finish, 1.22 metres (4 feet) above the ground, worsted which shall be fastened to the post at each side of the finishing line, at right angles to the course and parallel to the finishing line.

3. The finish posts shall be of rigid construction of about 1.37 metres (4 feet 6 inches) height, 8 centimetres (3 inches) width and 2 centimetres ($\frac{3}{4}$ inch) thickness.

(For apparatus, refer to Rule 69.)

RULE 43. 110-METRE (120 YARDS) HURDLE RACE

1. On every course there shall be 10 hurdles, each hurdle 1.06 metres (3 feet 6 inches) high.

2. The distance from the scratch mark to the first hurdle shall be 13.72 metres (15 yards), the remaining hurdles shall be placed 9.14 metres (10 yards) apart, and the distance from the last hurdle to the winning post shall be 14.02 metres (15 yards).

Note. When the race is 110 metres, the metric measures shall be used, when the race is 120 yards, the English measures shall be used.

3. In making a record it shall be necessary for the competitor to jump over every hurdle in its proper position.

4. The knocking down of one or more hurdles does not disqualify the athlete, nor does it disentitle him from claiming a record.

5. A competitor who trails his legs or foot alongside any hurdle shall be disqualified.

6. Each competitor shall have his own lane of hurdles and shall keep to that lane throughout the race.

(For apparatus, refer to Rule 70.)

RULE 44. 200-METRE (220 YARDS) HURDLE RACE

1. In the 200-metre Hurdle Race there shall be 10 flights of hurdles, each hurdle to be 76.2 centimetres (2 feet, 6 inches) in height. The first hurdle shall be placed 18.29 metres (20 yards) distant from the scratch mark; the remaining hurdles shall be placed 18.29 metres (20 yards) apart, and the distance from the last hurdle to the winning post shall be 17.10 metres (2 yards).

Note. When the race is 200 metres, the metric measures shall be used, when the race is 220 yards, the English measures shall be used.

2. In all other respects the rules for the 110-metre (120 yards) Hurdle Race shall apply.

(For apparatus, refer to Rule 70.)

RULE 45. 400-METRE (440 YARDS) HURDLE RACE

1. In the 400-metre Hurdle Race there shall be 10 flights of hurdles, each hurdle to be 91.4 centimetres (3 feet) in height. The first hurdle shall be placed 45 metres (49.213 yards) from the scratch mark, the remaining hurdles shall be placed 35 metres (38.277 yards) apart, and the distance from the last hurdle to the winning post shall be 40 metres (43.745 yards).

Note. When the race is 400 metres, the metric measures shall be used, when the race is 440 yards, the English measures shall be used.

2. In all other respects the rules for the 110-metre (120 yards) Hurdle Race shall apply.

(For apparatus, refer to Rule 70.)

RULE 46. RELAY RACES

1. A line shall be drawn 10 metres (11 yards) on each side of the starting line of each relay to be known as the starting zone. Both runners must be within this zone when passing the baton. No member of a relay team, in order to relieve one of his team, can run outside of such zone.

2. The baton must be passed (not thrown or dropped) by a competitor and taken by the one succeeding him.

3. Violation of any of these rules by any competitor shall disqualify the team.

4. The baton must be carried throughout the entire distance of the race. No competitor can run two sections in any team.

5. The composition of the team must not be changed after a trial heat has been run, but the members of the team may change their order of running.

6. The position of the teams must be drawn for.

7. All teams entered in relay races shall be lettered, commencing with the letter A.

8. When relay races up to and including 400 metres or 440 yards are contested on a circular path, each competitor must have a separate lane and each lane shall be the full distance.

(For implement, refer to Rule 71.)

RULE 47. TEAM RACE

1. Track team races may be divided into trials heats and a final, if necessary.

2. In track team races the maximum number of starters of a team and the number of competitors whose positions are to count shall be stated on the entry blank. The team scoring the least number of points, according to the positions in which the members of the team finish whose positions are to count, shall be the winner. Positions of other members of the team and posi-

tions of members of a team which does not finish at least the number whose positions are to count, shall not be counted.

3. In case of a tie between two or more individual competitors finishing simultaneously, each of them shall score for his team a number of points obtained by dividing the total sum of their position numbers, reckoned as if they had, instead of being tied, finished regularly in a file, with the number of such competitors (thus, for instance, if two competitors finish tied for second place, each of them shall score two and a half points).

4. In case of a tie on points, the team whose last scoring individual member finished nearest to first place shall be the winner.

5. The composition of a team must not be changed after a trial heat has been run and only competitors finishing the full distance are eligible to compete in the final.

RULE 48. STEEPLE-CHASE

1. The hurdles shall be 91.4 centimetres (3 feet) high, and a water-jump shall be included. It is recommended that the hurdles be at least 3.66 metres (12 feet) wide and so heavy that they cannot be easily overturned. Each competitor must go over or through the water, and any one who steps to one side or the other of the jump shall be disqualified.

2. There shall be to each lap of 400 metres five jumps including a water jump. The hurdle at the water jump shall be firmly fixed; height 91.4 centimetres (3 feet). The water jump shall be 3.66 metres (12 feet) in width and length, the water being 76 centimetres (2 feet, 6 inches) in depth at the hurdle end and sloping to the level of field at the further end.

3. The competitor must clear each jump, but may vault each obstacle.

RULE 49. CROSS-COUNTRY RACE

1. The race shall be run on a *bona fide* cross-country course properly marked and surveyed. The start and finish may be within the athletic grounds.

2. The course must be marked preferably with red flags to the left and white flags to the right, which must be observable from a distance of 125 metres. In all other respects the rules governing track competitions shall prevail.

RULE 50. MARATHON RACE

(42,195 metres = 26 miles 385 yards)

1. The Marathon Race shall be run on high roads. The start and finish may be on the athletic grounds.
2. Each competitor must send with his entry a medical certificate, from a physician of standing, certifying his fitness to take part in a race of this kind.
3. No competitor, either at the start or during the progress of the race, may take any so-called drugs on pain of immediate disqualification.
4. A competitor must at once retire from the race if ordered to do so by a member of the medical staff, officially appointed.

VI. WALKING

RULE 51. DEFINITION AND RULES OF WALKING

1. *Definition.* Walking is progression by steps so taken that unbroken contact with the ground is maintained.
2. *Judging and Disqualifications.* A competitor whose mode of progression fails, in the opinion of two of the Judges of Walking, to comply with the definition during any part of the competition, shall be disqualified and informed of his disqualification by one of the Judges of Walking.
3. Effect may be given to any such disqualification immediately after the conclusion of the competition, if circumstances render impracticable an earlier notice to the competitor of his disqualification.
4. Judges may advise a competitor upon his mode of progression if it should appear that the competitor be in danger of ceasing to comply with the definition of walking.
5. In track races a competitor who is disqualified must immediately leave the track and in road races the disqualified competitor must, immediately after his disqualification, remove the distinguishing number or numbers which he is wearing.
6. *It is recommended* that a system of signalling "caution" by white flag, and "disqualification" by red flag during a walking race be used as far as possible for the information of the officials of the sports, competitors, and spectators, but this is not compulsory.

VII. COMBINED COMPETITIONS

RULE 52. PENTATHLON

1. The competition comprises the following events: Running Broad Jump, Throwing the Javelin (best hand), 200 metres Flat Race, Throwing the Discus (best hand), and 1,500 metres Flat Race. The events follow in the above mentioned order.

2. Three trials are allowed in both jumping and throwing.

3. In the 200 metres flat race, groups of three men are formed by lot. If the number of runners is such that after the groups have been arranged one man is over to run alone, one man shall be drawn by lot from among the other competitors to run against him. The order of the competitors in this event shall be decided on the basis of each contestant's time.

4. If false starts occur in the running competitions, the competitor will, after the second false start, be penalized by one hundredth of the distance of the race for each false start. After four false starts the competitor at fault shall be eliminated from the event in which the offence was committed.

5. In the flat races, the time for each competitor shall be taken with three watches.

6. The winner shall be the one who has obtained the highest number of points in the five divisions awarded on the basis of the new Scoring Table for field and track events adopted by the I.A.A.F. Congress in Stockholm, 1934.

RULE 53. DECATHLON

1. The competition comprises the following events: 100 metres Flat, Running Broad Jump, Putting the Shot, Running High Jump, and 400 metres Flat, on the first day. Hurdle Race (110 metres), Throwing the Discus (best hand), Pole Vault, Throwing the Javelin (best hand), and 1,500 metres Flat, on the following day. The events follow in the above-mentioned order.

2. Three trials only are allowed in both jumping and throwing.

3. Both in the 100 metres and 400 metres flat races, as well as in the hurdle race, three or four competitors start in each group. On the other hand, in the 1,500 metres race, five or six shall start. However, the Referee shall have the right, in case of necessity, to make alterations.

4. The composition of the groups is decided by lot.

5. The time for each competitor shall be taken with three watches.

6. If false starts occur in the running competitions, the competitor will, after the second false start, be penalized by one hundredth of the distance of the race for each false start.

7. After four false starts the competitor at fault shall be eliminated from the event in which the offence was committed.

8. The knocking down of one or more hurdles does not disqualify the athlete, nor does it disentitle him from claiming a record.

9. The winner shall be the one who has obtained the highest number of points in the ten divisions, awarded on the basis of the new Scoring Table for field and track events adopted by the I.A.A.F. Congress in Stockholm, 1934.

VIII. VARIOUS EVENTS

RULE 54. TUG-OF-WAR

This event is abolished from the I.A.A.F. programme.

IX. SPECIFICATIONS FOR OFFICIAL IMPLEMENTS AND APPARATUS

RULE 55. JUMPING OR VAULTING STANDARDS

1. *Uprights*. Any style or kind of uprights or posts may be used provided they are rigid.

2. *Cross Bar*. The cross bar shall be triangular in section, each side of which shall measure 30 millimetres ($1 \frac{3}{16}$ inch). Optionally the cross bar may be split in the middle and joined with a metal clip about 300 millimetres (1 foot) long.

3. The length of the cross bar shall not be less than 3.66 metres (12 feet) and not more than 4 metres (13 feet $1 \frac{1}{2}$ inches). The maximum weight of the cross bar shall be 2 kilogrammes (4 lbs. $6 \frac{2}{5}$ ozs.).

4. *Supports for High Jump*. The support of the cross bar shall be flat and rectangular, 40 millimetres ($1 \frac{1}{2}$ inches) wide and extending 60 millimetres ($2 \frac{3}{8}$ inches) in length. It shall face the opposite upright and the end of the cross bar shall rest on it in such a fashion that the cross bar easily falls to the ground both forwards and backwards, if touched by the competitor.

5. There shall be a space of 10 millimetres ($\frac{3}{8}$ inch) between the cross bar and the uprights.

6. The following drawing illustrates *one* way of constructing the uprights as per stipulations above:

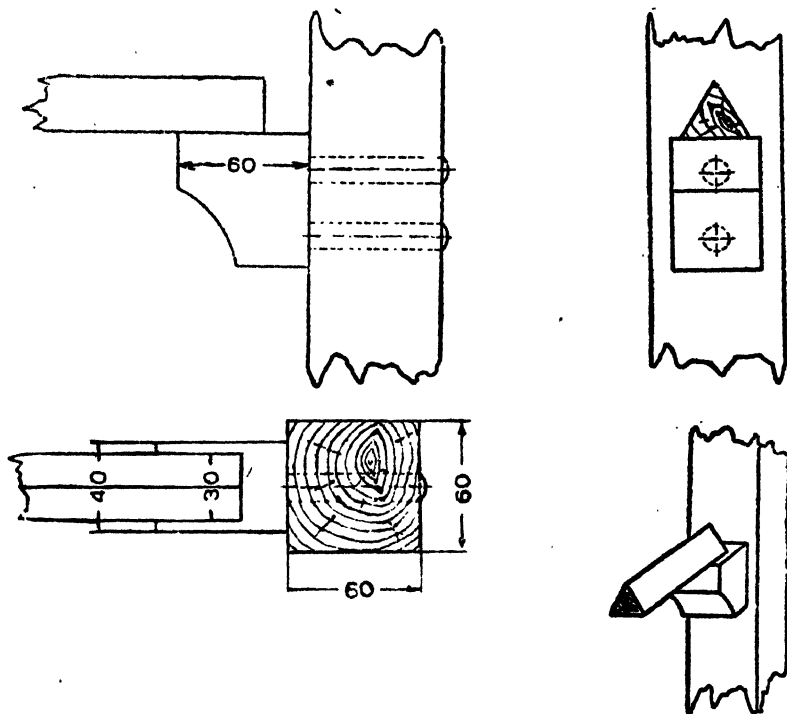

7. *Supports for the Pole Vault.* At competitions in the Pole Vault, pegs shall be used for the support of the cross bar. The pegs shall be without notches or indentations of any kind, of uniform thickness throughout and not more than 13 millimetres ($\frac{1}{2}$ inch) in diameter and must not extend more than 75 millimetres (3 inches) from the uprights.

8. *Wooden box of the take-off for the Pole Vault.* This shall measure 1000 millimetres (3 feet 4 inches) in length, 600 millimetres (2 feet) in width at front end and tapering to 150 millimetres (6 inches) in width at the stop-board, where it shall be 200 millimetres (8 inches) in depth. The bottom of the box shall be covered

on the inside to a length of 800 millimetres (2 feet 8 inches) with a piece of 0,6 millimetre sheet iron. See drawing below:

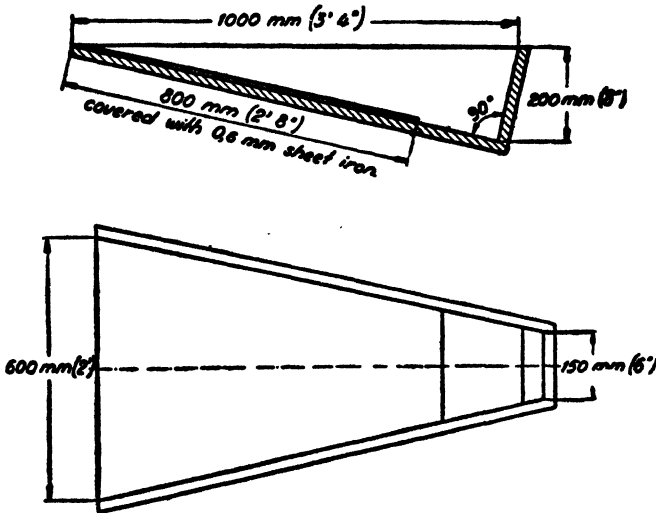

RULE 56. VAULTING POLE

Construction. The pole shall be of any material and of any length or diameter. It shall have no assisting devices except as provided for, but may be wound or wrapped with adhesive tape. The wrapping must be of uniform thickness. The lower end of the pole may terminate in a single metal spike or a wooden plug.

RULE 57. TAKE-OFF BOARD. (BROAD JUMPS)

1. *Construction.* The take-off board shall be made of wood.
2. *Measurements.* The board shall measure 1.22 metres (4 feet) long 200 millimetres (8 inches) wide, and 100 millimetres (4 inches) deep.
3. *Finish.* The Board shall be painted white.

RULE 58. JAVELIN

1. *Construction.* The javelin shall be of wood with a sharp iron or steel point. The javelin shall be constructed in such a way that the space between the foremost point and the centre of gravity is not longer than 110 centimetres (3 feet 7½ inches), or shorter than 90 centimetres (2 feet 11 inches).

2. *Grip.* It shall have, about the centre of gravity, a grip formed by a binding 16 centimetres ($6\frac{3}{10}$ inches) broad, of whipcord, without thongs or notches on the shaft, and shall have no other holding than the above-mentioned binding, whose circumference at either edge shall not exceed the circumference of the shaft by more than 25 millimetres (1 inch).

3. *Measurements.* The length shall be not less than 260 centimetres (8 feet 6 inches) complete as thrown.

4. *Weight.* The weight shall be not less than 800 grammes (1 lb. $12\frac{1}{2}$ ozs.) complete as thrown.

RULE 59. DISCUS

1. *Construction.* The discus shall be composed of a smooth metal rim, permanently attached to a wood body, brass plates set flush into the sides of the wood body, and, in the exact centre of the discus, a means for securing the correct weight. The brass plates shall be circular in form, having a diameter of not less than 51 millimetres (2 inches) nor more than 57 millimetres ($2\frac{1}{4}$ inches). Each side of the discus shall be a counter-part of the other side and shall have no indentations, projecting points, or sharp edges. The sides shall taper in a straight line from the beginning of the curve of the rim to a line a distance of 25 millimetres (1 inch) from the centre of the discus.

2. *Measurements.* The largest dimension shall be a circle not less than 219 millimetres ($8\frac{3}{8}$ inches) in diameter. The thickness through the exact centre, on a line perpendicular to the diameter, shall be not less than 44 millimetres ($1\frac{3}{4}$ inches). The thickness at 25 millimetres (1 inch) from the centre shall be exactly the same as at the centre. The thickness of the rim at a distance of 6 millimetres ($\frac{1}{4}$ inch) from the edge shall be not less than 13 millimetres ($\frac{1}{2}$ inch.) The edge shall be rounded on a true circle.

3. *Weight.* The weight of the discus shall be not less than 2 kilogrammes (4 lbs. $6\frac{2}{3}$ ozs.) complete as thrown.

4. A metal discus, complying with the official measurements, conditions and weight, may be used.

RULE 60. SHOT

1. *Construction.* The shot shall be of solid iron, brass or any metal not softer than brass, or a shell of such metal filled with lead or other material. It must be spherical in shape.

2. *Weight.* The shot shall weigh not less than 7.257 kilogrammes (16 pounds).

RULE 61. HEAVY WEIGHT

1. *Head.* The head shall be of moulded lead or a brass shell filled with lead, and spherical in shape, having imbedded a forged steel eye bolt as a means for attaching the handle.

2. *Handle.* The handle shall be made of round iron or steel measuring 13 millimetres ($\frac{1}{2}$ inch) in diameter, bent in a triangular form, no side of which shall be more than 184 millimetres ($7\frac{1}{4}$ inches) inside measurement.

3. *Connection.* The handle shall be connected to the head by means of a welded steel link measuring 10 millimetres ($\frac{3}{8}$ inch) in diameter.

4. *Weight.* The weight shall be not less than 25.401 kilogrammes (56 pounds) complete as thrown.

5. *Length.* The length shall be not more than 406 millimetres (16 inches) complete as thrown.

RULE 62. HAMMER

1. *Head.* The head shall be of solid iron, brass or any metal not softer than brass or a shell of such metal filled with lead or other material. It must be spherical in shape.

2. *Handle.* The handle shall be a single unbroken and straight length of spring steel wire not less than 3 millimetres ($\frac{1}{8}$ inch) in diameter, or No. 36 piano wire, 2.6 millimetres ($\frac{1}{10}$ inch) in diameter. The handle may be looped at one or both ends as a means of attachment.

3. *Grip.* The grip may be either of single or double loop construction, but must be rigid and without hinging joints of any kind.

4. *Connections.* The handle shall be connected to the head by means of a swivel, which may be either plain or ball bearing. The grip shall be connected to the handle by means of a loop. A swivel may not be used.

5. *Weight.* The weight shall be not less than 7.257 kilogrammes (16 pounds) complete as thrown.

6. *Length.* The length shall be not more than 1.219 metres (4 feet) complete as thrown.

7. *Construction.* The construction of the hammer shall be such that it can not elongate appreciably while it is being thrown.

RULE 63. HAMMER THROWING CAGE

1. It is strongly recommended that all hammer throws be from an enclosure or cage to ensure the safety of spectators. A cage of the following dimensions is suggested:

2. The cage should be circular in form, having an inside diameter of not less than 8.23 metres (27 feet), height should be not less than 2.13 metres (7 feet). There should be an opening, through which the throw is made, of approximately 7 metres (23 feet). The cage should be composed of 57×114 millimetres ($2\frac{1}{4} \times 4\frac{1}{2}$ inches) diamond mesh wire screen of 10 millimetres ($\frac{3}{8}$ inch) wire. The screen should be mounted upon pipe uprights, buried in the ground to a depth of 760 millimetres (30 inches), and space not more than 2.44 metres (8 feet) apart. The size of the pipe should be 63 millimetres ($2\frac{1}{2}$ inches).

3. It might be desirable, in some instances, to instal a dismountable cage, having sockets grouted permanently in the ground, into which the pipe uprights might be set when the cage is erected. The sockets could be provided with covers when the uprights are removed.

RULE 64. CIRCLES

1. *Construction.* The circle shall be made of band iron or steel, or wood.

2. *Measurements.* Metal—The circle shall measure not more than 2.135 metres (7 feet) in discus throwing not more than 2.50 metres (8 feet 2 inches), inside diameter. The sides shall be 6 millimetres ($\frac{1}{4}$ inch) thick by 76 millimetres (3 inches) high.

3. *Wood.* The circle shall measure not more than 2.135 metres (7 feet), in discus throwing not more than 2.50 metres (8 feet 2 inches), inside diameter. The sides shall be 76 millimetres (3 inches) thick by 51 millimetres (2 inches) high.

4. *Finish.* The circle shall be painted white.

RULE 65. STAND FOR DISCUS THROWING HELLENIC STYLE (BALBIS)

1. *Construction.* The sides of the stand may be either of wood or iron or any other similar material. The inside shall be filled with earth or coal ashes packed hard and firm. The surface shall be even and strictly follow the slope of the sides.

2. *Measurements.* The stand shall measure 80 centimetres (2 feet $7\frac{1}{2}$ inches) long and 70 centimetres (2 feet $3\frac{1}{2}$ inches) wide.

The front side of the stand (the one from which the throw is measured) shall be 5 centimetres high from the ground while the one parallel to it shall be 15 centimetres high. See drawing below:

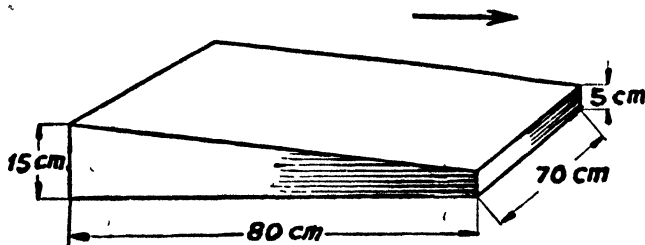

RULE 66. STOP-BOARD. (PUTTING THE SHOT)

1. *Construction.* The board shall be made of wood.
2. *Measurements.* The board shall measure 1.22 metres (4 feet) long, 114 millimetres ($4\frac{1}{2}$ inches) wide, and 102 millimetres (4 inches) high.
3. *Finish.* The board shall be painted white.

RULE 67. SECTOR FOR THROWS FROM CIRCLE

The ninety degree sector, within which all specified throws from the circle must fall, shall be clearly marked on the ground, the radii lines crossing at the centre of the circle. The outer ends of the radii lines shall be marked with flags.

RULE 68. SECTORS FLAGS

1. *Construction.* The sector flag shall be entirely of metal.
2. *Measurements.* The flag shall be rectangular in shape and shall measure 10×18 centimetres (4×7 inches). The standard shall be not less than 8 millimetres ($\frac{5}{16}$ inch) in diameter and not less than 91 centimetres (36 inches) in length.
3. The flag shall be painted red.

RULE 69. STAND FOR JUDGES AT FINISH (OPTIONAL)

1. *Construction.* The stand shall be made of wood or steel and be easy to move in all directions.
2. *Measurements.* The stand shall measure 2 metres (6 feet $6\frac{1}{2}$ inches) in height, 3 metres (9 feet 10 inches) in length and 1.1 metres (3 feet $7\frac{1}{2}$ inches) in width. It shall be divided in five steps 400 millimetres ($15\frac{1}{4}$ inches) high and 600 millimetres ($23\frac{1}{2}$ inches) deep. The steps may at the one end be divided in two, thus allow-

ing an easy access to the different steps of the stand. See drawing below:

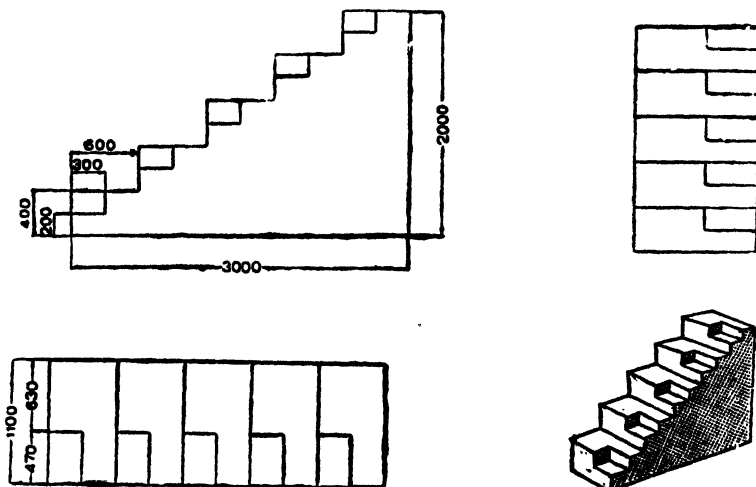

RULE 70. HURDLES

1. *Construction.* The hurdle shall be made of wood or metal and shall consist of two bases and two uprights supporting a rectangular frame reinforced by one or more crossbars, the uprights to be fixed at the extreme end of each base. The hurdle shall be of such a design that a force of at least 3.6 kilogrammes (8 pounds) applied to the centre of the top edge of the cross bar is required to overturn it. The hurdle may be adjustable in height but shall be rigidly fastened at the required height for each event. In case the counterweights of the bases are not adjustable, the adjustable hurdle shall be constructed in such a way that the force required to overturn the hurdle when adjusted in its highest position (1.06 metres or 3 feet, 6 inches) shall be at least 3.6 kilogrammes (8 pounds).

2. *Measurements.* The height of the hurdle shall be: in the 110 metres (120 yards) hurdle race 1.06 metres (3 feet 6 inches), in the 200 metres (220 yards) hurdle race 76.2 centimetres (2 feet 6 inches) and in the 400 metres (440 yards) hurdle race 91.4 centimetres (3 feet). The extreme width shall be 1.20 metres (3 feet 11 inches). The extreme length of base shall be 70 centimetres (27½ inches). The total weight of the hurdle shall be not less than 10 kilogrammes (22 lbs. 3½ ozs.).

3. The width of the top bar shall be 700 mm ($2\frac{3}{4}$ inches).
4. *Finish.* The top bar shall be striped in black and white. The hurdles shall be so placed on the track that the ends carrying the uprights shall be farthest from the starting line.
5. *Testing.* For the control of the resisting force of the new type of hurdle, use a simple spring-balance effecting a pulling force to the centre of the cross bar. Alternatively use a cord with a hook, applied to the centre of the cross bar, take the cord along over a

Patented Feb. 5, 1929

U S. No. 1,701,026

G. T. BRESNAHAN
 FOOT SUPPORT
 Filed April 29, 1927

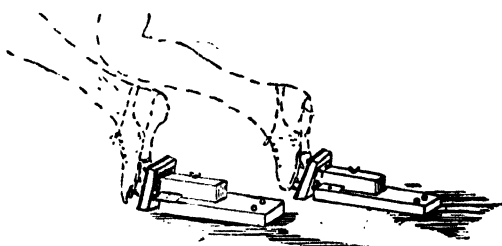

Fig. 4

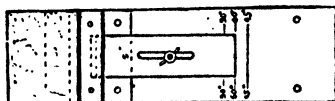

Fig. 5

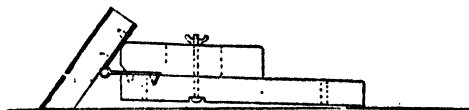

Fig. 6

Inventor - G. T. Bresnahan
 Attorney - Chas. R. Allen

pulley fixed conveniently and load the other end of the cord with weights.

RULE 71. RELAY BATON

1. *Construction.* The baton shall be a hollow wood tube.
2. *Measurements.* The length shall be not more than 300 millimetres (or 1 foot).
3. *Weight.* The weight shall be not less than 50 grammes (1 $\frac{3}{4}$ ozs.). The circumference shall be 120 millimetres (4 $\frac{3}{4}$ inches).

RULE 72. STARTING BLOCKS

Starting blocks or foot supports must be constructed entirely of rigid materials. They may be adjustable but must be without springs or other devices to give artificial impetus to the runner. Inasmuch as their purpose is to expedite carrying out the programme and to protect the track, they shall all be so constructed that they may be placed and removed quickly without damage to the track.

Athletic Rules For Women's International Competitions

For Women the rules for Men as decided by the I.A.A.F. will be in force with the following additions and modifications:

RULE 1. OFFICIALS

Addition:

In women's competitions there shall be a woman doctor and as great a number of women officials as is deemed proper in every special case.

RULE 21. STARTING ORDER

Last paragraph to be omitted.

RULE 25. PROTESTS

Modification:

The deposit to be £ 0 10 0 or its equivalent instead of £ 1.

RULE 27. OFFICIAL ATHLETIC IMPLEMENTS

1. In all international competitions and in all record attempts the implements used must comply with the specifications for official implements set out in these Rules.
2. All implements used at international competitions shall be provided by the organisers of the competitions.
3. In each country the implements approved of may be stamped with an agreed mark which may be registered in accordance with the laws of the country in question.

RULE 28. JUMPING EVENTS IN GENERAL

Modification of the third paragraph of the rule:

In the Broad Jumps each competitor shall be allowed three trials, and the four best, if the total number of competitors does not exceed twelve, or the six best, if the total number of competitors exceeds twelve, shall be allowed three more trials.

RULE 29. RUNNING HIGH JUMP

Modification of the first paragraph of the rule:

The competition shall start at a height of 120 centimetres, and the bar shall be raised as the judges may decide.

RULE 30. STANDING HIGH JUMP

Modification of the first paragraph of the rule:

The competition shall start at a height of 80 centimetres and the bar shall be raised as the judges may decide.

RULES 31, 34 to be omitted.

RULE 35. THROWING EVENTS IN GENERAL

Modification of the first paragraph of the rule:

1. In all throwing events, each competitor shall be allowed three trials, and the four best, if the total number of competitors does not exceed twelve, or the six best, if the total number of competitors exceeds twelve, shall have three more. Each competitor shall be credited with the best of all her attempts.

Addition to the rule:

2. At the Women's World Games there shall only be a best hand competition. In other international meetings throwing both sides may take place, if agreed upon by the Nations competing together. If such is the case, the order shall be the following: right hand (all competitors three attempts), then left hand similarly. For each competitor the best throw of each hand shall count and their addition form the total distance. The best competitors shall be allowed further attempts same as in the case of one hand.

RULES 39, 40 to be omitted.

RULE 43. 80-METRE HURDLE RACE

Modification of the first and second paragraphs of the rule:

1. On every course there shall be 8 hurdles, each hurdle to be 76.2 centimetres in height.

2. The distance from the scratch mark to the first hurdle shall be 12 metres, the remaining hurdles shall be placed 8 metres apart, and the distance from the last hurdle to the winning post shall be 12 metres.

RULE 44. 83-METRE HURDLE RACE

1. On every course there shall be 7 hurdles, each hurdle to be 76.2 centimetres in height.

2. The distance from the scratch mark to the first hurdle shall be 14 metres, the remaining hurdles shall be placed 9 metres apart, and the distance from the last hurdle to the winning post shall be 15 metres.

3. In all other respects the rule for the 80-metre hurdle shall apply.

(For apparatus, refer to Rule 79.)

RULE 49. CROSS-COUNTRY RACE

1. The distance shall not be greater than three kilometres. It shall be run on a bonafide cross-country course properly marked and surveyed. The start and finish may be within the athletic grounds. The track shall be level for the first 80 metres, and also for the last 80 metres minimum.

2. The course must be marked preferably with flags of a similar colour which must be observable from a distance of at least 100 metres. The arrangements can be completed by scattering the track with bands of paper of similar colour.

3. When laying out the route very high obstacles should be avoided, so should deep ditches, and dangerous ascents or descents, thick undergrowth and in general all that could constitute a difficulty beyond the aim of the competition.

4. When a cross-country race is run as a team race, competitors shall count the actual number of the order in which they finish. Individuals will not count in this classification, nor the competitors belonging to a club having already four finished.

5. The classification of each team shall depend on the total of the numbers representing the order of finishing of its first four members maximum; the winning team shall be the one which has obtained the smallest total.

6. If a team is incomplete at the finish, each missing individual shall count the total of competitors in the race by teams plus one.

7. In case of a tie on points, the team whose individual member finished nearest to first place shall be the winner.

RULE 58. JAVELIN

1. *Construction.* The javelin shall be of wood with a sharp iron or steel point. The javelin shall be constructed in such a way

that the space between the foremost point and the centre of gravity is not longer than 95 centimetres, or shorter than 80 centimetres.

2. *Grip.* It shall have, about the centre of gravity, a grip formed by a binding 15 centimetres broad, of whip-cord, without thongs or notches on the shaft, and shall have no other holding than the above-mentioned binding, whose circumference at either edge shall not exceed the circumference of the shaft by more than 25 millimetres.

3. *Measurements.* The length shall not be less than 220 centimetres complete as thrown.

4. *Weight.* The weight shall not be less than 600 grammes complete as thrown.

RULE 59. DISCUS

1. *Construction.* The discus shall be composed of a smooth metal rim, permanently attached to a wood body, brass plates set flush into the sides of the wood body, and, in the exact centre of the discus, a means for securing the correct weight. The brass plates shall be circular in form, having a diameter of not less than 50 millimetres nor more than 57 millimetres. The two sides of the discus shall be indetical and have no indentations, projecting points, or sharp edges. The sides shall taper in a straight line from the beginning of the curve of the rim to a line a distance of 25 millimetres from the centre of the discus.

2. *Measurements.* The largest dimension shall be a circle not less than 18 centimetres in diameter, the thickness through the exact centre, on a line perpendicular to the diameter, shall be not less than 3.7 centimetres. The thickness at 25 millimetres from the centre shall be exactly the same as at the centre. The thickness of the rim at a distance of 6 millimetres from the edge shall be not less than 12 millimetres. The edge shall be rounded on a true circle.

3. *Weight.* The weight of the discus shall be not less than one kilogramme complete as thrown.

4. A metal discus, complying with the official measurements, conditions and weight, may be used.

RULE 60. SHOT

1. *Construction.* The shot shall be of iron or a brass shell filled with lead and spherical in shape.

2. *Weight.* The shot shall not weigh less than 4 kilogrammes.

GENERAL RULES FOR OLYMPIC EVENTS

RULE 1. THE JURY

1. The Jury shall consist of five or eight members appointed by the International Amateur Athletic Federation and shall manage the field and track events at the Olympic Games.

2. All financial and technical arrangements of the Olympic Games shall be in the hands of the National Olympic Committee organising the Games, but the Jury mentioned above shall supervise the technical arrangements, appoint judges, etc., as stated hereafter. The organising Committee shall appoint one of its members as liaison officer to the Jury ; such liaison officer shall take care of and be responsible for good communication between the Jury and the organising Committee.

3. The organising Committee shall be responsible for part of the travelling expenses of the Jury, but not for those of the international Judges.

RULE 2. WORK OF THE JURY

1. The Jury shall be the highest authority on the track, and receive and decide any protests. (See Rule 25 of the Athletic Rules for International Competitions.)

2. The Jury shall not overrule the decisions of the Referees or Judges unless it shall find that a distinct mistake has been made.

3. The Jury shall decide all questions relating to the actual conduct of the Meeting, the final settlement of which is not otherwise covered by the rules.

4. The Jury shall, through special experts, investigate the track and field and the technical arrangements thereof, also that implements are in accordance with specifications, not less than 15 days before the opening of the Games. The report of such experts shall be forwarded by the Jury to the Olympic Committee organising the Games, as soon as possible, with the request that certain alterations be made if necessary.

5. The Jury shall meet at the place where the competitions are to be held not less than eight days before the beginning of the events. It shall see that field and track are in good order, courses properly laid out and measured to conform to all the requirements

as laid down by the Athletic Rules of International Competitions and that all implements and equipment necessary for satisfactory competitions are provided.

6. The organising Committee shall have all the implements ready for inspection at least five days before the opening of the games. Should the Jury not find the implements in accordance with specification, new implements shall be obtained as directed by the Jury.

7. The organising Committee shall hand over to the Jury final entries arranged for the different competitions not less than five days before the opening of the Games. The Jury shall accept or reject such entries, arrange the series and heats, and return the result to the organising Committee, which shall publish the entries with the competitors' numbers in sufficient time before the opening of the Games.

8. In the event of the track and field upon which the Olympic Games are to be held not being available for practice, the organising Committee shall provide a suitable place for this purpose.

RULE 3. THE ATHLETIC GROUND

1. The length of each lap should be 400 or 500 metres. The track for the 200 metres dash may be straight.

2. All tracks for running, jumping and throwing events must be of cinder or similar material. Grass is not permitted.

3. On the field inside the track there shall be arranged two platforms. One of these shall be near the tunnel through which the competitors enter the field, and from which the field and track events shall be managed, and which shall have telephone communication with the dressing rooms of the athletes, the Press Stand, the Band Stand, the loud speaker, the flag posts, etc., and from which bells may be operated in all dressing rooms, to call the competitors to the start.

4. The other platform shall serve as an office for the Jury in charge of the field and track events.

5. The loud speaker shall be governed by the Manager of the Games, and the speaker into the microphone placed near the Manager.

RULE 4. OFFICIALS

1. Besides the Jury there shall be the following officials:
 One Manager,
 3 or 4 Assistant Managers,
 One Keeper of the Implements,
 2 or more Announcers.
2. One Referee for track events,
 3 Starters,
 7 Judges at the finish,
 6 or more Umpires,
 9 Timekeepers,
3. One Referee for throwing events,
 6 or more Judges for throwing events,
4. One Referee for jumping events,
 6 or more Judges for jumping events.
5. One or more Press Stewards,
 One Official Surveyor,
 One Marshal,
 One or more Doctors.
6. Necessary number of Clerks and Scorers, including Lap-Scorers,
 Necessary number of Assistants.
7. For the running events in Decathlon, as well as in the Marathon race and the 50,000 metres Walking Race, the numbers of officials must be considerably increased.

RULE 5. THE MANAGER

The Manager shall have charge of the field and track events and be responsible for the proper carrying out of the Games. Ten minutes before the time of an event, he shall sound the bells in the dressing rooms, and Announcers shall announce on the field, to the competitors, the judges and the public, the start of the event. The Manager of the Games shall not leave his stand during the time a competition is going on. After the finish of an event he shall, through his assistants, receive the results from the scorer of such event. All announcements to the public, press, etc., shall be given by the Manager of the Games through the Announcers, Press Stewards, loud speakers, etc.

RULE 6. THE ASSISTANT MANAGERS

1. The Manager shall have three or four Assistant Managers, one for running events, one for jumping events and one for throwing events, etc. The Assistant Managers shall see that starts are carried out and shall follow the particular competitions. 15 minutes before the finish of any competition they shall notify the Manager thereof, in order that he may be prepared for the start of the next event.

2. The Assistant Managers shall at the end of each event collect and hand to the Manager the results given by the scorers.

RULE 7. THE KEEPER OF THE IMPLEMENTS

This official shall keep all implements under lock and key and shall be responsible for the implements being at hand in proper time for each event. The keeper of the implements acts directly under the Manager of the Games.

RULE 8. THE REFEREES

1. The Referees are responsible for the proper conduct of each event under their control and assign to the Judges their particular duties. In the case of a difference between the Judges, they shall decide and, if necessary, refer to the Jury.

2. When, in any but the final heat of a race, a claim for a foul or interference is made, the Referee shall have the power to disqualify the competitor who was at fault, if he considers the foul intentional or due to culpable carelessness, and shall also have the power to allow the hindered competitor to start in the next round of heats, just as if he had been placed in his trial.

3. When, in a final heat, a claim for a foul or interference is made, he shall have the power to disqualify the competitor who was at fault, if he considers the foul intentional or due to culpable carelessness, and he shall also have the power to order a new race between such of the competitors as he thinks entitled thereto.

RULE 9. TIMEKEEPERS

1. Timekeepers shall use only watches tested and certified at an astronomical or physical institute during the same year in which the Games take place, and the rules and conditions of the test be similar to those adopted by the National Physical Laboratory, Teddington, England (The said Rules are published in the 1931 edition of the Athletic Rules.)

2. The use of watches of the Splitsecond Type (Rattrapante) is strongly recommended, also that all watches to be used by the official timekeepers at the Games, shall be provided by the Organizing Committee of the Games.

3. One of the timekeepers acts by appointment of the Jury as head timekeeper and regulates the daily division and work of the other timekeepers.

4. The timekeepers shall act independently from one another, enter their time without discussing times and without showing their watches to each other, in the printed form specially made for this purpose, and after signing the form, hand it to the head timekeeper who is entitled to control the reported times on the watches.

5. The head timekeeper enters the reported time in a special blank (schedule) fixes the official time results according to Rule 10 and provides for publication.

6. The head timekeeper may entrust one of the time-keepers with taking intermediate times and may designate for taking the time of the winner a (fourth) reserve-timekeeper, the time taken by whom shall only be taken into account in case and for whatever reason only two watches have been acting.

7. The timekeepers take their place by gradation in extension to the finish line on the outer side of the track and in at least two metres from the finishing post.

8. In all races up to 200 metres the times of at least the first three, in all other running and walking races the times of at least the first six, shall be officially taken and published.

9. Out of the timekeepers 4 take the time of the first,
 3 " " " second,
 3 " " " third.

One of the four designated for the first place acts as a reserve-timekeeper (see under 4).

10. In races of 400 metres or more those timekeepers who take the time of the first place take also the time of the fourth place, those who take the time of the second place, take also the time of the fifth place, and those who take the time of the third place take also the time of the sixth place.

RULE 10. OTHER OFFICIALS

Regarding other officials, their duties are specified in the athletic Rules for International Competitions which apply for all other questions regarding the Olympic Games.

RULE 11. QUALIFICATION TRIALS

1. Where in any of the throwing or jumping events (hammer throwing, women's high jump and women's javelin throwing excepted) the number of entries exceeds 18, a qualifying round shall be held prior to the competition proper.

2. No athlete shall participate in the competition proper unless he has reached the prescribed standard in the qualifying round ; but if in any event less than 12 competitors reach the qualifying standard, then the first 12 athletes and any athlete tying for the 12th place shall take part in the competition proper.

3. In each qualifying round, each competitor shall be allowed three trials, but the performances accomplished shall not be considered part of the competition proper. Once a competitor has reached the qualifying standard, he shall not make any more trials.

Events for which World's records are Allowed

M E N

RUNNING

100 yards	1 mile	100 metres	5,000 metres
220 "	2 miles	200 "	10,000 "
440 "	3 "	400 "	20,000 "
880 "	6 "	800 "	25,000 "
	10 "	1,000 "	30,000 "
	15 "	1,500 "	
		2,000 "	
		1 hour	

RELAY RACES

4 × 110 yards	4 × 110 metres
4 × 220 "	4 × 200 "
4 × 440 "	4 × 400 "
4 × 880 "	4 × 800 "
4 × 1 mile	4 × 1500 "

HURDLES

120 yards	110 metres
220 yards	200 metres
440 yards	400 metres

WALKING

2 miles	10 miles	3,000 metres	20,000 metres
7 "	20 "	5,000 "	30,000 "
	30 "	10,000 "	50,000 "
			1 hour and 2 hours

JUMPING

High Jump
 Broad jump
 Running hop, step and jump
 Pole vault

THROWING

Shot put	} Best hand
Javelin throwing	
Discus "	
Hammer "	

DECATHLON**W O M E N****RUNNING**

60 metres	4 × 100 metres Relay
100 "	4 × 100 " "
200 "	3 × 800 " "
800 "	4 × 110 yards "
	4 × 220 " "
	3 × 880 " "

HURDLES

80 metres (8 hurdles)

JUMPING

High jump Broad jump

THROWING

Javelin throwing, best hand
 Discus throwing, best hand
 Shot put, best hand

PENTATHLON

BY-LAWS**RULE 1. TITLE**

1. The International Amateur Athletic Federation embraces the governing Athletic Associations of the various nations accepting the rules and regulations of the International Amateur Athletic Federation. Only one Association may represent a nation.

Note. In these rules such Athletic Association is termed "Member of the Federation".

2. The jurisdiction of Members of the International Amateur Athletic Federations is limited by the political boundaries of the country or nation they represent.

RULE 2. OBJECTS OF THE FEDERATION

The objects of the Federation shall be:—

(a) To establish friendly and loyal cooperation between all Members for the benefit of track and field athletics throughout the world.

(b) To compile and subscribe to the rules and regulations of the Federation governing international competitions for men and women in amateur field and track athletics.

(c) To establish rules and regulations for and to conduct field and track events at the Olympic Games.

(d) To pass and register World's amateur records in field and track athletics.

(e) To establish an Amateur definition, applicable to international competitions in field and track athletics.

RULE 3. CONGRESSES

1. Each Member of the Federation may be represented by not more than five (5) delegates. The Members included in Group A being allowed three (3) votes each, those included in Group B two (2) votes each and those in Group C one vote each. (See Rule 6).

2. A Member of the Federation can only be represented by its delegates. The same delegate may only represent one Member of the Federation. A delegate must be a citizen of the nation he represents and eligible to compete as an amateur.

3. The Congress shall convene biennially and the President of the Federation shall preside at all meetings.

4. The Congress only shall have power to amend and draft rules and regulations.

RULE 4. REPORTS AND FINANCES

The President, Hon. Secretary and Council shall submit a report and balance sheet to the Congress on the proceedings and finances of the Federation, and the Congress shall pass on and audit said report and balance sheet, and also devise ways and means for the adoption and passing of the budget.

RULE 5. COUNCIL

1. The Council, which shall be chosen by the Congress, shall consist of the President, the Honorary Secretary and six other members elected from different nations.

2. The President and the Honorary Secretary shall be elected for a term of four years ; they shall reside in the same country. The six members of the Council shall be elected for terms of two years.

3. The President, Hon. Secretary and members of the Council shall serve until their successors are elected and inducted to office.

4. In the absence of the President, the Hon. Secretary shall take his place.

5. In case of a vacancy occurring in the Council, such vacancy shall be filled by the Member of the Federation, with which the retiring member of Council was identified.

6. The Council shall administer the affairs of the Federation, inform the Members of all penalties imposed on any Member, shall register all records, settle all urgent affairs of general interest, and prepare and summon the Congress, the venue and time of which have been decided by the preceding Congress.

7. *English, French and German* are official languages of the Federation, and any of these languages may be used at the Congresses.

8. The By-Laws and Rules shall be printed in the three official languages, the Minutes, reports and other communications as the Council will decide. In the case of a difference in the interpretation of the text the English text shall have preference.

9. The Council may summon special Congresses, provided five Members give notice in writing to the Honorary Secretary that they desire such Congress, and state their reasons for same. On receiving such notice, the Honorary Secretary must summon the Congress to meet within three months after receipt of the said notice.

10. In cases of great importance, requiring immediate settlement, the Council shall have power to summon an Extraordinary Congress of the Federation.

RULE 6. MEMBERSHIP AND ELIGIBILITY

1. The governing Athletic Association of each country shall be eligible for membership of the Federation.

2. Applications for membership of the Federation shall be submitted to the Council, which after investigation, shall submit same to the Congress for election.

3. Any new Member may be admitted by a majority vote of the Members represented at the Congress.

4. Membership shall be divided into three groups and any Member joining the Federation after March 1st 1938 shall be placed in such group as the Congress may decide. The following grouping has been made at the Paris Congress in 1938 and shall remain as agreed until altered by a subsequent Congress:

Group A

Canada	Hungary
Finland	Italy
France	Japan
Germany	Sweden
Great Britain and Northern Ireland	United States

Group B

Argentina	India
Australia	Netherlands
Belgium	New Zealand
China	Norway
Czecko-Slovakia	Poland
Denmark	South Africa
Eire	Switzerland
Greece	Yugo-Slavia

Group C

All the other Members

5. During the interim between sessions of the Congress, the Council is empowered to elect provisionally such ruling bodies as they may deem fit.

RULE 7. RECOGNITION

1. Associations affiliated with the Federation shall acknowledge each other as the only, legislative authorities for athletics in the respective countries, and as the only organisations authorised to regulate international agreements in athletics.

2. All correspondence regarding international affairs shall pass through the Members of the Federation.

RULE 8. DISQUALIFICATION

1. A disqualification adjudged in proper form by a Member of the Federation of any of its athletes shall also be binding on all the other countries represented in the Federation, and shall be notified by the Member in question.

2. Every Member of the Federation has the right to suspend or disqualify, on its own territory, any foreign athlete for offences against the rules and regulations of the Federation. Report of such action shall be given to the Member of the Federation to which the athlete belongs.

3. The Council of the Federation is empowered to suspend temporarily or permanently from International Competition any Member of the Federation or any athlete violating the rules or regulations of the International Amateur Athletic Federation.

RULE 9. INTERNATIONAL FIELD AND TRACK MEETINGS

1. An international field and track meeting is either arranged between two or more Members of the Federation or may be held by one Member only or by a club belonging to a Member and with the sanction of the said Member provided other Members of the Federation or clubs belonging to such Members are invited to take part in the meeting.

2. A national championship open to all amateur athletes is not an international meeting.

3. At all international meetings the rules and regulations of the Federation shall apply.

4. The right to arrange or sanction international meetings is exclusively reserved to the Members of the Federation. If a Member of the Federation wishes to sanction an international meeting during the period of two months immediately before the Olympic Games, the permit of the Council of the I.A.A.F. must be obtained.

5. No athlete of any nation shall be permitted to represent his nation at any meetings, other than those sanctioned or arranged

by a Member of this Federation. Any athlete desirous of competing in any foreign country must make application to his governing body for a permit to compete, and no Member of this Federation shall allow any foreign athlete to compete unless he presents a letter signed by the proper official of the Association of his country, certifying that he is an amateur and permitted to compete. Such an athlete during his stay in a foreign country shall also be under the control of the Association of that country.

6. An athlete residing in a foreign country and wishing to take part in athletic competitions shall be under the athletic laws of such country.

7. At international competitions, however, a Member of this Federation may be represented only by a native born or naturalised subject of the nation which the Member in question represents.

RULE 10. CHAMPIONSHIPS OF THE WORLD

1. The competitions of the Olympic Games only shall be regarded as Championships of the World in the respective branches of field and track sports.

2. No other Championship of the World may be held in addition to these.

3. The Council shall have the right to organise or authorize World's, European, Far East, Latin American and other championships for field and track events.

4. Every Member of the Federation shall have the right to hold its national championships according to its own rules and regulations.

RULE 11. SUBSCRIPTION

1. The annual subscription shall be according to the grouping indicated in Rule 3, each Member in Group A shall subscribe £ 10, in Group B £ 6 and in Group C £ 2.

2. Subscriptions shall be paid in advance on the 1st January of each year. Any nation whose subscription is unpaid on the 30th June shall be liable to be struck off the list of members of the Federation or suspended at the discretion of the Council. No representative can be authorized to take part in any meeting of the Congress, the Council or Committees if the subscription of the nation he represents remains unpaid on the 31st December of the preceding year.

AMATEUR STATUS

1. An amateur is one who competes only for the love of sport.
2. Competing for money or any other pecuniary reward in any sport makes the competitor a professional in all sports.
3. In track and field athletic sports one who knowingly competes with, or against, a professional, thereby becomes a professional.
4. In the event of an amateur competing with, or against, a professional in sports other than track and field athletics, not for money and other pecuniary reward, then the Member of the Federation to which the athlete belongs shall be the judge of such competitor's status according to its own rules, and its certificate as to the competitor's status shall be accepted by all other Members of the Federation.
5. One who teaches, trains, or coaches in any sport for money or other pecuniary considerations is a professional, except, however, that so far as competition in his own country, and there only, is concerned, an employee or representative of the state or school or other educational institution, who teaches, trains, or coaches as an incident to his main vocation or employment, may, or may not be a professional, as the Association of the country of such a person shall decide.
6. Anyone who shall have knowingly become a professional shall not be reinstated as an amateur.

* * * *

As an interpretation of the above fundamental rules and to be considered as part thereof, the following regulations are set down, and any athlete who violates any thereof shall, thereby, become a professional:

- a.* An amateur cannot wager, or be interested in a wager, money bet, or stake made in connection with the athletic competition in which he is to participate.
- b.* An amateur must not compete for any prize or token which cannot be suitably inscribed with some words or letters commemorative of the competition. Prizes must not be of a character which cannot be possessed or retained for the period of the life of the recipient.

c. An amateur cannot compete for a prize or token of a value of more than ten pounds, except by consent of the Association of his country.

d. An amateur shall not sell, pawn or give away his prizes, and shall hold the same subject at all times to the inspection of the Association of his country.

e. An amateur cannot enter or compete in any contest under a name other than his own or one assumed permanently by him for purposes of competition and registered by him with the Association of his country.

f. An amateur cannot issue a challenge or in any manner evidence his intention of competing with, or against, a professional, or for money or its equivalent.

g. An amateur cannot accept or in any manner receive any money or other pecuniary gain in going to, attending, or returning from, an athletic meeting, other than his actual outlay for transportation, meals and lodging. Under no circumstances shall the amount paid for expense money exceed the cost of one first-class sleeping accommodation, and one pound or the equivalent per day for meals and lodging.

In the case of its being proved on the representation of a National Association that in that country the sum of one pound in gold currency per day be insufficient, the Council of the I.A.A.F. may increase the sum to the country in question.

*h.** An amateur cannot receive payment for his travelling and other expenses to enable him to take part in competitions abroad, for a longer sojourn than 21 days in all per calendar year spent in foreign countries. Accumulation of these 21 days in two consecutive years cannot be allowed. An extension can be given the athlete by the Association of his country, if he is selected by said Association to take part in Olympic Games or represent his country in matches against another country. The Council of the I.A.A.F. is entitled to make extensions also in other cases if it deems proper.

The national associations are responsible for the faithful observance of the above rule and shall keep a complete record of times spent abroad and expenses incurred by their athletes, the record to be laid before the I.A.A.F. if called for.

* Note to section *h*: Travelling days outside of the country of competition shall not be included in the 21 days.

i. Any expense money must be paid, not to the athlete, but to the Association of the athlete's country, provided, however, that in exceptional cases such payment of actual expenses may be made through the National Association of any country where the athlete is sojourning.

In all cases where an athlete receives payment through a foreign governing body notification of such payment shall be made by said body the governing body of the athlete's country.

j. An amateur cannot accept travelling expenses or payment of any kind for a trainer, rubber, masseur, friend or relative. (Note.—This rules does not mean the travelling expenses of trainer and the like cannot be paid, but that such expenses cannot be demanded by, or paid to, the athlete.)

*k.** An amateur cannot, directly or indirectly, accept payment for any loss of time or wages in attending, or training for, any athletic competition.

l. An amateur cannot, directly or indirectly, receive any reward for becoming, or continuing as, a member of any club or any other athletic organisation.

m. An amateur cannot compete for, or from, an athletic organisation in whose employ he is, or who, for compensation, renders personal services of any kind to such organisations.

n. An amateur cannot sign a contract agreeing to take a professional position in athletics, or to take part in any athletic sports for money.

o. An amateur cannot receive any compensation for using the goods or apparatus of any firm, manufacturer or agent, nor shall he allow his name to be used as a means of advertising or recommending the goods of any firm or manufacturer.

* * * * *

In all questions as to the athlete's amateur status other than those in which the Member of the Federation of the country of the athlete has been made the sole arbitrator, the statement of any

* Note to section *k*: It has been agreed with the International Olympic Committee that a holiday given under normal condition of a business or profession or a holiday accorded on occasion of the Olympic Games, provided that it does not lead to a reimbursement for lost salary direct or indirect, does not fall within section.

Member as to an athlete's status is subject to the review and decision of the Federation.

* * * * *

The Congress at Geneva, 1921, decided:

1. If it is proved that any of the National Associations do not follow the Amateur Status, the International Federation will, after investigation, make the necessary remonstrances with the Association at fault.

2. The nations are invited to accept the Amateur Status and to make it their own, with such restrictions, however, as may be judged necessary by the National Association.

3. As it is not appropriate for the amateur associations to occupy themselves with professional sports, it is desirable that none of their organisations be placed at the disposal of professional sports, and consequently it is decided that the arenas, grounds and organisations of the amateur associations should be closed to professional matches.

PENTATHLON AND DECATHLON SCORING TABLE

(Adopted by the I.A.A.F. Congress)

NO. 1.—100 METRES

Time Seconds	Points	Time Seconds	Points	Time Seconds	Points
9.7	1,320	12.2	556	14.7	195
9.8	1,275	12.3	536	14.8	185
9.9	1,231	12.4	517	14.9	175
10.0	1,189	12.5	499	15.0	165
10.1	1,148	12.6	481	15.1	155
10.2	1,109	12.7	464	15.2	146
10.3	1,071	12.8	447	15.3	136
10.4	1,035	12.9	430	15.4	127
10.5	1,000	13.0	414	15.5	118
10.6	966	13.1	399	15.6	110
10.7	934	13.2	383	15.7	101
10.8	902	13.3	369	15.8	93
10.9	872	13.4	354	15.9	84
11.0	843	13.5	340	16.0	77
11.1	814	13.6	326	16.1	69
11.2	787	13.7	313	16.2	61
11.3	760	13.8	300	16.3	53
11.4	735	13.9	287	16.4	46
11.5	710	14.0	275	16.5	39
11.6	686	14.1	262	16.6	31
11.7	662	14.2	251	16.7	24
11.8	640	14.3	239	16.8	17
11.9	618	14.4	228	16.9	11
12.0	597	14.5	217	17.0	4
12.1	576	14.6	206		

No. 2.—RUNNING BROAD JUMP

Distance Metres	Points	Distance Metres	Points	Distance Metres	Points	Distance Metres	Points
7.75	1,015	7.62	977	7.49	939	7.36	902
7.74	1,012	7.61	974	7.48	936	7.35	899
7.73	1,009	7.60	971	7.47	933	7.34	897
7.72	1,006	7.59	968	7.46	930	7.33	894
7.71	1,003	7.58	965	7.45	928	7.32	891
7.70	1,000	7.57	962	7.44	925	7.31	888
7.69	997	7.56	959	7.43	922	7.30	885
7.68	994	7.55	956	7.42	919	7.29	883
7.67	991	7.54	953	7.41	916	7.28	880
7.66	988	7.53	950	7.40	913	7.27	877
7.65	985	7.52	948	7.39	911	7.26	874
7.64	982	7.51	945	7.38	908	7.25	872
7.63	979	7.50	942	7.37	905	7.24	869

NO. 2.—RUNNING BROAD JUMP (Cont.)

Distance Metres	Points	Distance Metres	Points	Distance Metres	Points	Distance Metres	Points
7.23	866	7.07	823	6.10	580	4.50	248
7.22	863	7.06	820	6.00	556	4.40	229
7.21	861	7.05	817	5.90	534	4.30	211
7.20	858	7.04	815	5.80	511	4.20	194
7.19	855	7.03	812	5.70	489	4.10	176
7.18	852	7.02	809	5.60	467	4.00	158
7.17	850	7.01	806	5.50	446	3.90	142
7.16	847	7.00	804	5.40	425	3.80	125
7.15	844	6.90	777	5.30	404	3.70	109
7.14	841	6.80	751	5.20	383	3.60	93
7.13	839	6.70	726	5.10	363	3.50	77
7.12	836	6.60	700	5.00	343	3.40	61
7.11	833	6.50	676	4.90	323	3.30	45
7.10	831	6.40	651	4.80	304	3.20	30
7.09	828	6.30	627	4.70	285	3.10	15
7.08	825	6.20	603	4.60	266		

NO. 3.—PUTTING THE WEIGHT

16 Lbs. Shot

Distance	Points	Distance	Points	Distance	Points	Distance	Points
18.00	1,279	15.30	955	12.60	677	9.80	431
17.90	1,266	15.20	944	12.50	688	9.70	422
17.80	1,253	15.10	933	12.40	658	9.60	414
17.70	1,241	15.00	922	12.30	649	9.50	406
17.60	1,228	14.90	911	12.20	639	9.40	398
17.50	1,215	14.80	900	12.10	630	9.30	391
17.40	1,203	14.70	890	12.00	621	9.20	383
17.30	1,190	14.60	879	11.90	612	9.10	375
17.20	1,178	14.50	868	11.80	603	9.00	367
17.10	1,166	14.40	858	11.70	594	8.90	359
17.00	1,153	14.30	847	11.60	585	8.80	352
16.90	1,141	14.20	837	11.50	576	8.70	344
16.80	1,129	14.10	826	11.40	567	8.60	336
16.70	1,117	14.00	817	11.30	558	8.50	329
16.60	1,105	13.90	806	11.20	549	8.40	321
16.50	1,093	13.80	795	11.10	540	8.30	314
16.40	1,081	13.70	785	11.00	531	8.20	306
16.30	1,069	13.60	775	10.90	523	8.10	299
16.20	1,058	13.50	765	10.80	514	8.00	292
16.10	1,046	13.40	755	10.70	506	7.90	284
16.00	1,034	13.30	745	10.60	498	7.80	277
15.90	1,023	13.20	735	10.50	489	7.70	270
15.80	1,011	13.10	725	10.40	480	7.60	263
15.70	1,000	13.00	716	10.30	472	7.50	255
15.60	989	12.90	706	10.20	463	7.40	248
15.50	977	12.80	696	10.10	455	7.30	241
15.40	966	12.70	687	9.10	439	7.20	234

NO. 3.—PUTTING THE WEIGHT (Cont.)

Distance	Points	Distance	Points	Distance	Points	Distance	Points
7.10 ...	227	6.20 ...	166	5.30 ...	108	4.40 ...	53
7.00 ...	220	6.10 ...	160	5.20 ...	102	4.30 ...	46
6.90 ...	213	6.00 ...	153	5.10 ...	96	4.20 ...	41
6.80 ...	207	5.90 ...	146	5.00 ...	89	4.10 ...	35
6.70 ...	200	5.80 ...	140	4.90 ...	83	3.90 ...	23
6.60 ...	193	5.70 ...	133	4.80 ...	77	3.80 ...	18
6.50 ...	186	5.60 ...	127	4.70 ...	71	3.70 ...	12
6.40 ...	179	5.50 ...	121	4.60 ...	65	3.60 ...	6
6.30 ...	173	5.40 ...	114	4.50 ...	59	3.50 ...	1

NO. 4.—RUNNING HIGH JUMP

Height Metres	Points	Height Metres	Points	Height Metres	Points	Height Metres	Points
2.10 ...	1,181	1.75 ...	727	1.45 ...	414	1.15 ...	158
2.05 ...	1,110	1.70 ...	671	1.40 ...	368	1.10 ...	120
2.00 ...	1,040	1.65 ...	616	1.35 ...	323	1.05 ...	83
1.95 ...	974	1.60 ...	563	1.30 ...	280	1.00 ...	48
1.90 ...	909	1.55 ...	512	1.25 ...	238	.95 ...	13
1.85 ...	846	1.50 ...	462	1.20 ...	197	.90 ...	3
1.80 ...	786						

NO. 5.—400 METRES RUN

Time Seconds	Points	Time Seconds	Points	Time Seconds	Points
45.0 ...	1,229	47.2 ...	1,056	49.4 ...	910
45.1 ...	1,220	47.3 ...	1,049	49.5 ...	904
45.2 ...	1,212	47.4 ...	1,042	49.6 ...	898
45.3 ...	1,204	47.5 ...	1,035	49.7 ...	892
45.4 ...	1,195	47.6 ...	1,028	49.8 ...	886
45.5 ...	1,187	47.7 ...	1,025	49.9 ...	880
45.6 ...	1,179	47.8 ...	1,014	50.0 ...	874
45.7 ...	1,171	47.9 ...	1,007	50.1 ...	868
45.8 ...	1,162	48.0 ...	1,000	50.2 ...	862
45.9 ...	1,154	48.1 ...	993	50.3 ...	857
46.0 ...	1,147	48.2 ...	987	50.4 ...	851
46.1 ...	1,139	48.3 ...	980	50.5 ...	845
46.2 ...	1,131	48.4 ...	973	50.6 ...	840
46.3 ...	1,123	48.5 ...	967	50.7 ...	834
46.4 ...	1,115	48.6 ...	960	50.8 ...	829
46.5 ...	1,108	48.7 ...	954	50.9 ...	823
46.6 ...	1,100	48.8 ...	947	51.0 ...	818
46.7 ...	1,093	48.9 ...	941	51.1 ...	812
46.8 ...	1,085	49.0 ...	935	51.2 ...	807
46.9 ...	1,078	49.1 ...	928	51.3 ...	801
47.0 ...	1,070	49.2 ...	922	51.4 ...	796
47.1 ...	1,063	49.3 ...	916	51.5 ...	791

NO. 5.—400 METRES RUN (Cont.)

Time Seconds	Points	Time Seconds	Points	Time Min. Sec.	Points
51.6	785	56.6	563	I 1.7	394
51.7	780	56.7	559	I 1.8	391
51.8	775	56.8	555	I 1.9	388
51.9	770	56.9	551	I 2.0	385
52.0	765	57.0	547	I 2.1	383
52.1	760	57.1	543	I 2.2	380
52.2	755	57.2	540	I 2.3	377
52.3	750	57.3	536	I 2.4	374
52.4	745	57.4	533	I 2.5	371
52.5	740	57.5	529	I 2.6	369
52.6	735	57.6	525	I 2.7	366
52.7	730	57.7	522	I 2.8	363
52.8	725	57.8	518	I 2.9	361
52.9	720	57.9	515	I 3.0	358
53.0	716	58.0	511	I 3.1	355
53.1	711	58.1	508	I 3.2	353
53.2	706	58.2	504	I 3.3	350
53.3	701	58.3	501	I 3.4	347
53.4	697	58.4	497	I 3.5	345
53.5	692	58.5	494	I 3.6	342
53.6	688	58.6	491	I 3.7	340
53.7	683	58.7	487	I 3.8	337
53.8	678	58.8	484	I 3.9	334
53.9	674	58.9	481	I 4.0	332
54.0	669	59.0	477	I 4.1	329
54.1	665	59.1	474	I 4.2	327
54.2	661	59.2	471	I 4.3	324
54.3	656	59.3	467	I 4.4	322
54.4	652	59.4	464	I 4.5	319
54.5	648	59.5	461	I 4.6	317
54.6	643	59.6	458	I 4.7	314
54.7	639	59.7	454	I 4.8	312
54.8	635	59.8	451	I 4.9	310
54.9	630	59.9	448	I 5.0	307
55.0	626	I .1	442	I 5.1	305
55.1	622	I .2	438	I 5.2	302
55.2	618	I .3	435	I 5.3	300
55.3	614	I .4	432	I 5.4	298
55.4	610	I .5	429	I 5.5	295
55.5	606	I .6	426	I 5.6	293
55.6	602	I .7	423	I 5.7	290
55.7	598	I .8	420	I 5.8	288
55.8	594	I .9	417	I 5.9	286
55.9	590	I 1.0	414	I 6.0	284
56.0	586	I 1.1	411	I 6.1	281
56.1	581	I 1.2	408	I 6.2	279
56.2	578	I 1.3	405	I 6.3	277
56.3	574	I 1.4	402	I 6.4	274
56.4	570	I 1.5	400	I 6.5	272
56.5	566	I 1.6	397	I 6.6	270

NO. 5.—400 METRES RUN (Cont.)

Time Min. Sec.	Points	Time Min. Sec.	Points	Time Seconds	Points
I 6.7	... 268	I 7.5	... 250	I 8.3	... 233
I 6.8	... 265	I 7.6	... 248	I 8.4	... 231
I 6.9	... 263	I 7.7	... 246	I 8.5	... 229
I 7.0	... 261	I 7.8	... 244	I 8.6	... 227
I 7.1	... 259	I 7.9	... 242	I 8.7	... 225
I 7.2	... 257	I 8.0	... 240	I 8.8	... 223
I 7.3	... 255	I 8.1	... 238	I 8.9	... 221
I 7.4	... 252	I 8.2	... 236	I 9.0	... 219

NO. 6.—110 METRES HURDLES

Time Seconds	Points	Time Seconds	Points	Time Seconds	Points	Time Seconds	Points
14.0	... 1120	16.6	... 698	19.2	... 445	21.8	... 277
14.1	... 1099	16.7	... 686	19.3	... 437	21.9	... 272
14.2	... 1078	16.8	... 674	19.4	... 429	22.0	... 267
14.3	... 1058	16.9	... 662	19.5	... 422	22.1	... 262
14.4	... 1038	17.0	... 651	19.6	... 414	22.2	... 257
14.5	... 1019	17.1	... 640	19.7	... 407	22.3	... 252
14.6	... 1000	17.2	... 629	19.8	... 400	22.4	... 247
14.7	... 982	17.3	... 618	19.9	... 393	22.5	... 242
14.8	... 964	17.4	... 607	20.0	... 386	22.6	... 237
14.9	... 946	17.5	... 597	20.1	... 379	22.7	... 232
15.0	... 929	17.6	... 587	20.2	... 373	22.8	... 227
15.1	... 912	17.7	... 577	20.3	... 366	22.9	... 223
15.2	... 896	17.8	... 567	20.4	... 360	23.0	... 218
15.3	... 879	17.9	... 557	20.5	... 353	23.1	... 214
15.4	... 864	18.0	... 547	20.6	... 347	23.2	... 209
15.5	... 848	18.1	... 538	20.7	... 341	23.3	... 205
15.6	... 833	18.2	... 529	20.8	... 334	23.4	... 200
15.7	... 818	18.3	... 520	20.9	... 328	23.5	... 196
15.8	... 804	18.4	... 511	21.0	... 322	23.6	... 192
15.9	... 790	18.5	... 502	21.1	... 316	23.7	... 188
16.0	... 776	18.6	... 493	21.2	... 311	23.8	... 183
16.1	... 762	18.7	... 485	21.3	... 305	23.9	... 179
16.2	... 749	18.8	... 477	21.4	... 299	24.0	... 175
16.3	... 736	18.9	... 468	21.5	... 294		
16.4	... 723	19.0	... 460	21.6	... 288		
16.5	... 710	19.1	... 452	21.7	... 283		

NO. 7.—THROWING THE DISCUS

Distance Metres	Points	Distance Metres	Points	Distance Metres	Points
52.0	... 1107	51.6	... 1093	51.2	... 1078
51.9	... 1103	51.5	... 1089	52.1	... 1074
51.8	... 1100	51.4	... 1085	51.0	... 1071
51.7	... 1096	51.3	... 1082	50.9	... 1067

NO. 7.—THROWING THE DISCUS (Cont.)

Distance Metres	Points	Distance Metres	Points	Distance Metres	Points
50.8	1064	40.6	729	32.9	513
50.7	1060	40.5	726	32.8	511
50.6	1057	40.4	723	32.7	508
56.5	1053	40.3	720	32.5	503
50.4	1049	40.2	717	32.0	490
50.3	1046	40.1	715	31.9	487
50.2	1042	40.0	711	31.8	485
50.1	1039	39.9	709	31.5	477
50.0	1305	39.8	706	31.3	472
49.9	1032	39.7	703	31.1	467
49.8	1028	39.6	700	31.0	464
49.7	1025	39.5	697	30.5	452
49.6	1021	39.4	694	30.0	440
49.5	1018	39.3	691	29.5	427
49.4	1014	39.2	688	29.0	414
49.3	1011	39.1	685	28.5	402
49.2	1007	39.0	682	28.0	390
49.1	1004	38.9	679	27.5	378
49.0	1000	38.8	676	27.0	366
48.9	997	38.7	673	26.5	355
48.8	993	38.6	671	26.0	343
48.7	990	38.5	668	25.5	332
48.6	987	38.4	665	25.0	320
48.5	983	38.3	662	24.5	309
48.4	980	38.2	659	24.0	297
48.3	976	38.1	656	23.5	286
48.2	973	38.0	653	23.0	275
48.1	970	37.0	625	22.5	264
48.0	966	36.0	597	22.0	253
47.9	963	35.0	570	21.5	242
47.8	959	34.9	567	21.0	232
47.7	956	34.8	564	20.5	221
47.6	952	34.7	561	20.0	210
47.5	949	34.6	564	19.5	200
47.4	946	34.5	556	19.0	190
47.3	942	34.4	553	18.5	180
47.2	939	34.3	551	18.0	170
47.1	936	34.2	548	17.5	159
47.0	932	34.1	545	17.0	149
46.9	929	34.0	542	16.5	139
46.8	926	33.9	540	16.0	129
46.7	922	33.8	537	15.5	119
45.0	866	33.7	535	15.0	110
44.0	834	33.6	532	14.5	110
43.0	803	33.5	529	14.0	90
42.0	772	33.4	527	13.5	81
41.0	741	33.3	524	13.0	72
40.9	738	33.2	521	12.5	63
40.8	735	33.1	519	12.0	54
40.7	732	33.0	516		

NO. 8.—POLE VAULT

Height M.Cm.	Points	Height M.Cm.	Points	Height M.Cm.	Points
4.5	1149	3.4	652	2.3	270
4.4	1098	3.3	613	2.2	240
4.3	1048	3.2	575	2.1	211
4.2	1000	3.1	538	2.0	182
4.1	953	3.0	501	1.9	154
4.0	907	2.9	466	1.8	127
3.9	862	2.8	431	1.7	100
3.8	818	2.7	397	1.6	74
3.7	775	2.6	364	1.5	49
3.6	733	2.5	332	1.4	24
3.5	692	2.4	301		

NO. 9.—THROWING THE JAVELIN

Distance M.Cm.	Points	Distance M.Cm.	Points	Distance M.Cm.	Points	Distance M.Cm.	Points
78.2	1,199	73.1	1,074	57.5	732	43.0	465
78.0	1,194	73.0	1,071	57.0	722	42.5	456
77.8	1,189	72.0	1,047	56.5	712	42.0	448
77.6	1,184	71.0	1,025	56.0	702	41.5	440
77.4	1,179	70.0	1,000	55.5	692	41.0	431
77.2	1,174	69.5	989	55.0	682	40.5	431
77.0	1,169	69.0	977	54.5	672	40.5	423
76.9	1,166	68.5	966	54.0	662	40.0	415
76.7	1,161	68.0	955	53.5	653	39.5	407
76.6	1,159	67.5	944	53.0	644	39.0	399
76.5	1,156	67.0	932	52.5	635	38.5	391
76.4	1,154	66.5	921	52.0	625	38.0	383
76.2	1,149	66.0	910	51.5	616	37.5	375
76.0	1,144	65.5	899	51.0	606	37.0	367
75.8	1,139	65.0	888	50.5	597	36.5	359
75.6	1,134	64.5	877	50.0	588	36.0	351
75.4	1,129	64.0	867	49.5	579	35.5	343
75.2	1,124	63.5	856	49.0	570	35.0	343
75.0	1,177	63.0	845	48.5	561	35.0	335
74.5	1,107	62.5	835	48.0	552	34.5	328
74.0	1,095	62.0	824	47.5	543	34.0	320
73.9	1,092	61.5	814	47.0	534	33.5	312
73.8	1,090	61.0	803	46.5	525	33.0	305
73.7	1,088	60.5	793	46.0	516	32.5	297
73.6	1,085	60.0	782	45.5	507	32.0	290
73.5	1,083	59.5	772	45.0	498	31.5	283
73.4	1,080	59.0	762	44.5	490	31.0	275
73.3	1,078	58.5	752	44.0	482	30.5	268
73.2	1,076	58.0	742	43.5	473	30.0	260

RULES OF GAMES AND SPORTS

NO. 10.—1,500 METRES

Time		Points	Time		Points	Time		Points			
Min.	Sec.		Min.	Sec.		Min.	Sec.				
3	54.0	...	1000	4	0.0	...	923	4	16.0	...	747
3	54.5	...	993	4	0.5	...	916	4	17.0	...	737
3	55.0	...	987	4	5.0	...	863	4	18.0	...	727
3	55.5	...	980	4	10.0	...	808	4	18.5	...	723
3	56.0	...	973	4	10.5	...	803	4	19.0	...	718
3	56.5	...	967	4	11.0	...	798	4	20.0	...	709
3	57.0	...	961	4	12.0	...	787	4	21.0	...	699
3	57.5	...	954	4	13.0	...	777	4	22.0	...	690
3	58.0	...	948	4	13.5	...	772	4	23.0	...	681
3	58.5	...	941	4	14.0	...	767	4	24.0	...	672
3	59.0	...	935	4	15.0	...	757	4	25.0	...	663
3	59.5	...	929								

NO. 11.—200 METRES

Time		Points	Time		Points	Time		Points
Seconds.	Seconds.		Seconds.	Seconds.		Seconds.	Seconds.	
21.2	...	1,000	25.0	...	554	31.0	...	184
21.3	...	984	25.5	...	512	31.5	...	163
21.4	...	969	26.0	...	473	32.0	...	143
21.5	...	954	26.5	...	436	32.5	...	124
22.0	...	883	27.0	...	401	33.0	...	106
22.5	...	817	27.5	...	368	33.5	...	88
23.0	...	757	28.0	...	337	34.0	...	71
23.1	...	745	28.5	...	308	34.5	...	56
23.2	...	734	29.0	...	281	35.0	...	40
23.5	...	700	29.5	...	255	35.5	...	26
24.0	...	648	30.0	...	230	36.0	...	12
24.5	...	600	30.5	...	207			

SPECIMENS OF SCORE SHEET

Record Sheet for Athletic Events (Track Events)

.....*Sports.* *Date*.....

Qualify...in Trial Heats...in Semi-Finals, and...in Final Heat

First Heat		Second Heat		Third Heat		Fourth Heat	
No.	Name	No.	Name	No.	Name	No.	Name
	Time.....		Time.....		Time.....		Time.....

1st Semi-Final Heat		2nd Semi-Final Heat	
No.	Name	No.	Name
	Time——		Time——

Final Heat		Winners		Club	Points	Judges' Signature
No.	Name	No.	Name			
	Time——		Best Time. Made by No.....			

Record Sheet for Field-Events (Height)

.....Sports. Date.....

No.	NAME	Successive Heights of Cross Bar									

Result	No.	NAME	Club	Points	Height	Judges' Signature
First						
Second						
Third						
Fourth						

Key: — = Pass. \checkmark = Cleared. \times = Failed.

Record Sheet for Field Events. (Distance)

.....Sports. Date.....

No.	Name	Record of Preliminary Trials			Record of Final Trials		
		1st trial	2nd trial	3rd trial	1st trial	2nd trial	3rd trial

Result	No.	NAME	Club	Points	Distance	Judges' Signature
First						
Second						
Third						
Fourth						

Metric and British Measures

WEIGHT

1 gram	... 15,432 grains.	1 grain0648 gram
1 gram035274 oz.	1 oz. (av.)	... 28,350 grams
1 kilo	... 2.2046 lbs.	1 lb. (av.)	... 45,359 kilo
1 kilo019684 cwt.	1 cwt.	... 50,802 kilos
1 tonne98421 ton.	1 ton	... 1.016 tonne

LENGTH

1 mm.039371 in.	1 inch	... 25.400 mm.
1 metre	... 3.2808 feet	1 foot3048 metre
1 metre	... 1.0936 yards	1 yard9144 metre

CORRESPONDING DISTANCES

50 Metres	... 54 yards 2 ft. $\frac{1}{2}$ in.
75 "	... 82 yards 0 ft. $\frac{13}{16}$ in.
80 "	... 87 yards 1 ft. $\frac{5}{16}$ in.
83 "	... 90 yards 2 ft. $\frac{3}{16}$ in.
100 "	... 100 yards 1 ft. 1 in.
110 "	... 120 yards 0 ft. $\frac{10}{16}$ in.
200 "	... 218 yards 2 ft. 2 in.
400 "	... 437 yards 1 ft. 4 in.
800 "	... 874 yards 2 ft. 8 in.
1,500 "	... 1,640 yards 1 ft. 3 in.
5,000 "	... 3 miles 188 yards 0 ft. 2 in.
10,000 "	... 6 miles 376 yards 0 ft. 4 in.
Marathon Race (42,195 metres)	... 26 miles 385 yards.

THE Y.M.C.A. COLLEGE OF PHYSICAL EDUCATION

SAIDAPET, MADRAS,

IS

An All India Training Institution. It trains Leaders in Health and Physical Education. The Diploma and Certificates awarded by the College are recognised by the various Provincial Governments, Indian States, Universities, Colleges and Schools throughout India. Health Education is given special emphasis in the training given to students.

The College is situated in ideal surroundings, both healthy and beautiful. It has extensive play fields, swimming pool, outdoor gymnasia, and other facilities. The institution is residential, and co-educational. Attractive hostels and other separate facilities for women students.

For detailed information write for illustrated prospectus to

THE PRINCIPAL,
Y.M.C.A. COLLEGE OF PHYSICAL EDUCATION
SAIDAPET, MADRAS



Rigid control of Quality, the finest of modern manufacturing facilities, and ideal working conditions makes every piece of Sports equipment bearing SHARMANS' name worthy of your confidence.

We are official Suppliers to the Y. M. C. A. College and many other similar Institutions.

SHARMAN & CO.

SPORTS SPECIALISTS

Mount Road : : Madras
Vty. Hall Road : : Coimbatore

ALL KINDS OF PLAY-GROUND
APPARATUS ALSO AVAILABLE

