

BIRLA CENTRAL LIBRARY

PILANI (Rajasthan)

Class No. 2213

Book No. 1215

Accession No. 5757



SOILLESS GROWTH OF PLANTS

CARLETON ELLIS and M. W. SWANEY

Second Edition, Revised and Enlarged

by

TOM EASTWOOD

*Olericulturist, Lago Oil and Transport Co. Ltd.
Aruba, Curaçao, N. W. I.*

REINHOLD PUBLISHING CORPORATION
NEW YORK
CHAPMAN & HALL, LTD., LONDON

Copyright 1947 by
REINHOLD PUBLISHING CORPORATION

All rights reserved
Sixth Printing, 1960

Printed in the United States of America
George McKibbin and Son

Foreword to Second Edition

Considerable commercial experience with soilless culture of crops has been gained since the first edition of this book was published in 1938; in fact, the quantity of data available has necessitated complete revision of the text. The new edition widens the scope of the original book, and it is hoped that both the practical hobbyist and the professional grower will be able to utilize the information presented. Further, it is felt that the revised edition offers possibilities as a general textbook for the agricultural student, both high school and college, who is interested in the soilless culture aspects of horticulture. With these three general types of readers in mind, both semi-technical information and practical directions are included. Numerous tables are presented to simplify the practical data; to illustrate, some of the tables in Chapter 6 will enable the non-technical man to prepare a suitable nutrient solution even without studying the theoretical concepts discussed in this chapter.

The revision has been presented in chronological order, that is, it is based on the various operational sequences followed in a soilless culture unit. A brief discussion of plant physiology emphasizing the role of the essential mineral elements in plant life is naturally presented first.

The general types of soilless growing—water culture, sand culture, and gravel culture—are introduced, both in definition and practical applications, in the second chapter. The three chapters following deal briefly with these techniques. It will be noted that each of these chapters is subdivided into three categories. Because of the attempt to widen the scope of the text, it was felt necessary to prepare these three chapters in this manner. Each type of soilless culture possesses distinctive characteristics in respect to special physiological problems, unit construction and unit operation. The reader will readily observe the reasoning for this particular approach to the problem, even though it is slightly repetitious at some points. It is a sound idea to be acquainted with all the peculiarities of any new process. Next the plan of construction must be undertaken. Finally,

an outline of the operations required to run the unit is a helpful guide.

The above-mentioned five chapters are of general nature, except for the construction information included in Chapters 3, 4, and 5. The remaining chapters are concerned with the actual details of operation of a gravel sub-irrigation unit. The commercial applicability of the gravel culture method appears to be the greatest; hence the main emphasis is placed upon this method.

Chapter 6 discusses the theoretical and practical problems involved in preparing nutrient solutions. Contrary to popular opinion, this phase of soilless culture is not particularly difficult or complicated. The natural sequence of events dictates that after a nutrient solution is made, certain technical control procedures must be followed. Hence, a discussion of solution acidity or pH, among others, is given in Chapter 7.

Chapters 8, 9, and 10 are perhaps the most important in this book. Their chief purpose is to impress upon the soilless culture operator that the actual culture of the plant *per se* is still the most important phase of crop production, regardless of the culture method. Actually, the problems of plant culture with and without soil are quite similar, except that in the latter case the element of control is closer in respect to water and nutrient relationships. Because of the special nature of soilless culture, the plant growth problems may be readily discussed from three aspects: technical control, general plant culture, and control of common detriments. As mentioned previously, the handling of the plant, *i.e.*, planting, spraying, etc., is essentially the same in both soil and soilless crop production; but special problems exist in soilless culture, particularly in respect to spraying. Further, in spite of unfounded claims, disease and insect problems are quite prevalent in the soilless culture of plants, as will be mentioned in Chapter 10.

Chapter 11 deals with special means of plant culture which are particularly well adapted for soilless methods. They are not essential needs for crop production, but are useful aids capable of improving results. Some of the data presented are still of experimental nature, but the information contained is sufficiently advanced for commercial consideration.

The last chapter fills a need for the practical grower. Whether he uses gravel or soil culture, this chapter is of value to him. Although

the two general methods of nutrient ion analyses are by no means the ultimate procedure, they are practical and workable. If the extent of operations of the grower justifies finer methods of analyses, the means discussed will supply the basis for further improvement.

The basic plan of this revised edition is drawn from actual practices used in developing hydroponics on the island of Aruba, Curaçao, Netherlands West Indies, in the Caribbean Sea, by the Lago Oil and Transport Company, Limited, a subsidiary of the Standard Oil Company of New Jersey. At present an experimental unit and pilot unit are in operation in Aruba. Mr. L. G. Smith, former President and General Manager of Lago, deserves much credit for foreseeing the possibilities of hydroponics on barren oceanic islands. It was through the efforts of Mr. Smith, who was well advised by Mr. Ralph Watson, a Lago employee who was a successful hydroponics amateur, that the company decided to investigate the potentialities of hydroponics in Aruba.

As a result, the Shell Oil Company (C.P.I.M.) on the island of Curaçao, N.W.I., became interested in hydroponics. These companies initiated their respective gardens early in 1944 and operation started late in 1944. The purpose of the gardens is to supply the members of their foreign staff colonies with fresh vegetables.

Other localities are also developing hydroponics. The United States Army Air Force operates large gardens on Ascension Island, in British Guiana, and on Iwo Jima. Recent articles in newspapers indicate that other developments are under way, notably in Japan under the direction of the United States Army. Several commercial outdoor gardens are in operation in the neighborhood of Miami, Florida. Numerous greenhouses in the United States have been using this type of plant culture experimentally and semi-commercially for the past six to ten years.

Hydroponics has a definite place in agriculture. Its chief value lies in two applications: the first is in areas wherein suitable agricultural soil does not exist, but the climatic conditions are suitable for crop production. The second is its use as an improved type of forcing technique in greenhouses for growing crops which have a high return value.

Acknowledgment is due at this point to various people who kindly offered suggestions and data, both in the development of the present Aruba garden and in the preparation of this manuscript.

Thanks are extended to Dr. W. R. Mullison, formerly plant physiologist for C.P.I.M.; Dr. J. P. Biebel, formerly with U. S. Army Air Force Hydroponics Branch, Coral Gables, Florida; Drs. R. B. and A. P. Withrow, Purdue University, Lafayette, Indiana; Dr. V. A. Tiedjens, Virginia Truck Experiment station, Norfolk, Virginia; and Mr. K. W. Blodget, Terre Haute, Indiana. Several Lago employees at Aruba merit special reference, including Mr. Ralph Watson, Mr. H. M. Hatfield, Mr. C. C. Moyer, Mr. T. Johnson and Mr. George Asregadoo. Special thanks are expressed to Mr. R. W. Schlageter and Mr. J. R. Knoll for taking the photographs at Lago.

Many thanks are extended to the Lago Oil and Transport Company, Limited, for permission to use data and photographs secured by the writer in his present capacity as Olericulturist for the company. Similar thanks are accorded to the Shell Oil Company (C.P.I.M.) of Curaçao, N.W.I. Appreciation is expressed for the use of certain photographs and information kindly supplied by a number of greenhouses in the United States.

Finally the writer wishes to convey deep thanks to his wife who so ably assisted him in the development of the Aruba hydroponics garden and the preparation of the manuscript.

TOM EASTWOOD

Lago Oil and Transport Company, Limited
Aruba, Curaçao, Netherlands West Indies
June, 1946

Foreword to First Edition

One of the earliest interests of the senior author was that of experimenting with plants. He began producing cuttings by placing easily rooted stock, such as coleus and geranium slips or cuttings, in moist sand and allowing these to form roots. It seemed as though some good fairy had watched over the vegetation because later the rooted cuttings were potted and sold at the rate of ten cents per plant. At that time the character of the soil used for potting was the important question: a heavy, black earth was considered necessary. Imagine the author's surprise if at that time he had seen similar plants growing vigorously in cinders taken from some nearby stove or furnace!

In the past few years so great a degree of interest has been aroused in so-called soilless growth that a popular discussion of the subject seems in order. The present text was written after numerous laboratory tests and investigations had been carried out. It is hoped that this volume will prove useful to those who desire to grow plants by the methods described herein.

Comments on and photographs of novel set-ups covering methods of soilless growth would be appreciated by the authors. It is desired in subsequent editions to embrace this field in as wide a manner as possible.

CARLETON ELLIS
MILLER W. SWANEY

Ellis Laboratories, Inc.
Montclair, N. J.
April, 1938

Contents

	PAGE
FOREWORD TO SECOND EDITION	iii
FOREWORD TO FIRST EDITION	vii
CHAPTER	
1. GENERAL PLANT PHYSIOLOGY	1
<i>Plant Structure and Function • Physiological Functions • Role of Mineral Elements</i>	
2. GENERAL TYPES OF SOILLESS CULTURE	19
<i>General Aspects of Soilless Culture • Types of Soilless Culture</i>	
3. WATER CULTURE	45
<i>Cultural Problems • Unit Construction for Home and Commercial Use • Unit Operation</i>	
4. SAND CULTURE	61
<i>Cultural Problems • Unit Construction for Home and Commercial Use (Slop Culture, Drip Culture, Modified Slop Culture, Dry Salt Method) • Unit Operation</i>	
5. GRAVEL CULTURE	85
<i>Cultural Problems • Unit Construction for Home and Commercial Use (Bucket and Gravity, Pump and Motor, Compressed Air, Wick Devices, Direct-feed, Gravity Feed) • Construction Details (Bed, Tile, Flume, Cistern, Tank, Pumps, Motors, Time Clocks, Piping, Valves, Media) • Unit Operation</i>	
6. THE NUTRIENT SOLUTION	129
<i>Theory of Nutrient Solutions • Chemicals Required (Macro and Micro Elements, Acids, Alkalies) • Water • Typical Nutrient Solutions • Preparing the Nutrient Solution</i>	
7. TECHNICAL CONTROL OF NUTRIENT SOLUTION	155
<i>Solution Acidity or pH • Solution Volume • Nutrient Ion Concentration • Solution Changes</i>	
8. TECHNICAL CONTROL OF THE PLANT CULTURE	174
<i>Medium Environment (Pumping Cycle of Nutrient Solution, Gravel Temperature, Manipulation of Nutrient Solution to Alter Plant Growth) • Atmospheric Environment (Air Temperature, Sunlight, Carbon Dioxide, Relative Humidity, Wind, Rain)</i>	

CHAPTER	PAGE
9. GENERAL PLANT CULTURE	198
<i>General Aspects (Spacing of Plants, Plant Yield and Quality, Crops to Grow) • Seeding • Propagation of Cuttings • Transplanting • Training • Spraying • Sprinkling and Syringing • Flushing the Gravel • Harvesting • Removing Old Plants</i>	
10. COMMON DETRIMENTS	213
<i>Non-Parasitic Diseases (Mineral Deficiencies, Mineral Toxicities, Toxic Gases, Spray and Dust Injury, Chlorine in Water, Water Relations) • Parasitic Diseases (Diseases Caused by Bacteria and Fungi, Virus Diseases) • Control of Media-Borne Diseases (Seed Protectants and Sterilizing Agents, Gravel Sterilization) • Control of Pests</i>	
11. SPECIAL CHEMICALS	227
<i>Soil Blocks • Manure Extracts • Thiourca • Hormones • Vitamin B₁</i>	
12. ANALYSES OF THE NUTRIENT SOLUTION	237
<i>Measurement of pH • Analyses for Macro and Micro Nutrient Ions (Quick Tests, Laboratory Tests) • Water Titration • Analyses for Formaldehyde • Plant Tissue Test</i>	
SELECTED REFERENCE LIST	267
INDEX	269

Chapter 1

General Plant Physiology

The discussion of plant physiology in this book is necessarily brief. This text is chiefly concerned with applied plant physiology rather than with theoretical concepts. Thus the following sections, "Plant Structure and Function" and "Physiological Functions," are quite short and general in nature. They serve merely as a general guide to the study and appreciation of plant physiology in relation to practical plant culture. A knowledge of the rudiments of plant structure and life processes will help the plant culturist in adjusting the growth of his crops to the existing environmental conditions.

A little more detail will be presented in the last section of this chapter, "The Role of Mineral Elements." This phase of plant physiology will be purposely discussed more fully because soilless culture of plants is the practical application of the theories of mineral nutrition.

Plant Structure and Function

Plant structure will be briefly discussed in the relation of structure to function. The discussion will be broken down into a study of the (1) cell, (2) root, (3) stem, (4) leaf and (5) flower.

The Cell. A cell is the simplest and the elementary structural unit of the plant body. The combination of various kinds of cells forms different kinds of organs which in turn combine to make up the plant body. Each plant cell possesses a wall of cellulose, which is the basic structural unit. Contained within the cell wall is the protoplasm, the living portion of the plant. Protoplasm in a sense is life, and is a complex jelly-like colloidal material. Mineral substances, carbohydrates, fats, proteins and water are important and necessary constituents of protoplasm. All the life processes of the plant are initiated and controlled by the protoplasm. Reproduction is also centered within the protoplasm in the nucleus.

The Root. Roots serve as the means of anchoring or supporting the plant in its growing substrate. If the substrate is not dense enough, as in water culture, the roots are not in a position to supply support. Thus, from a strictly functional viewpoint, the job of plant support by the roots is secondary.

Certain physiological functions appear to be the primary work of the root system. It absorbs water by the process of osmosis through the root hairs. Likewise, necessary mineral elements diffuse through the root hairs. These two functions are dependent upon the rate of oxygen uptake by the roots and by the rate of respiration of the root cells.

Besides the function of water and mineral nutrient ion uptake, certain metabolic actions occur in the root tissue. In some plants practically all of the nitrate-nitrogen assimilation occurs in the young root cells; protein synthesis also goes on in the roots of some plants. Many roots serve as storage organs and this function is highly specialized in some crops, such as carrots, sweet potatoes and asparagus.

To permit the flow of water and nutrient ions from the absorptive tissues to the stem, specialized internal organs are present. The xylem vessels permit the flow of these substances to similar structures in the stem. The downward flow of elaborated food materials from the leaves and stems to the absorptive and growing regions of the root moves through the phloem tubes. Thus the root supplies water and mineral nutrients to the aerial portion of the plant and in turn receives necessary foods for its own life processes.

The Stem. The stem is chiefly a medium of support and conduction for the plant. It holds the leaves up to permit them to be exposed to the necessary sunlight. Phloem tubes transport food materials, manufactured in the leaves, to the roots and the growing points of the stems. Likewise, water and minerals travel from the roots to the leaves and apical meristems through the xylem vessels of the stem.

The location of these conducting tissues within the stem is dependent upon the type of plant. Seed-bearing plants may be divided into two groups, the monocots * and the dicots.* The monocots contain the phloem and xylem tissues in a compact strand called a fibrovascular bundle. Phloem faces toward the outside of the stem

* Convenient forms of the words "monocotyledon" and "dicotyledon."

and xylem toward the inside. These bundles are placed in concentric rings within the stem tissues. Corn is a typical monocot plant.

Dicot plants contain an internal sheath of xylem cells, which are bounded internally by the pith cells and externally by the cambium cells. The xylem tissue forms a continuous sheath around the stem. Next to the cambium tissue lie the phloem cells, which also form a continuous sheath around the stem. The cambium between these two conducting regions produces new xylem and phloem cells as the plant grows. Tomato is a representative type of dicot.

The Leaf. The leaf is the main manufacturing center for the plant food materials. Simple sugars are fabricated by the process of photosynthesis. The chloroplasts in the palisade cells of the leaf contain chlorophyll, the green pigment necessary for this reaction. Chlorophyll is a complex organic compound which contains nitrogen and magnesium in addition to carbon, hydrogen and oxygen. To permit the essential exchange of gases, the leaf has small pores on its surfaces, sometimes both upper and lower, sometimes only on the lower, depending upon the species. These pores are called *stomata*, and are capable of opening and closing. To provide space for gas within the leaf tissue various air sacs or "empty spaces" connect the stomata with the palisade cells.

Conducting bundles are contained in the leaf blade and in its petiole which is attached to the stem. These tissues are extensions of the vascular cells of the stem. They form the midrib and the veins of the leaf. These vascular units transport the manufactured foods from the leaf and carry water and minerals into it.

The Flower. The flower is the reproductive part of the plant. Seed production is dependent upon proper functioning of the various organs of the flower. Since floral production is closely related to the proper formation of the flower organs, a brief study of flower structure is of importance to the practical soilless culture operator.

At the base of the flower are green leaflets called sepals; these are collectively known as the calyx. The colored petals form the corolla, which is the decorative part of the flower. At the base of the calyx and the corolla is found the ovary. This female organ develops into the future seed pod or fruit. A slender tube arises from the ovary to form the pistil. At the upper end of the pistil is located the stigma, which is the female receptive organ. The surface of the stigma contains a sticky substance which retains the pollen grain when it

alights upon the stigma. Usually placed around the pistil are the stamens, the male portion of the flower. They produce pollen in the knob-shaped anthers at the tip. When pollen is "ripe" the anthers burst to release the pollen. Depending upon environmental conditions and the species of plant, the pollen is transferred to the stigmatic surfaces of the pistils by means of insects, wind, rain, initial propulsion from the anthers or pollen sacs, and by various other agencies.

Three general types of flowers are found in green plants. The perfect flower contains both female and male parts on the same flower. Thus, self-pollination as well as cross-pollination is possible; tomato and rose are typical examples. Imperfect flowers for the present purpose may be classified into two general sub-types. Monoecious plants contain separate female and male flowers in the same plant, such as cucumber. Dioecious plants contain separate female and male flowers on separate plants, as in asparagus.

Physiological Functions

The various physiological reactions of the plant will be presented in a necessarily short form. Essential functions are outlined under (1) growth, (2) respiration, (3) photosynthesis, (4) water and nutrient ion uptake, (5) plant food metabolism, (6) translocation of nutrients and food materials, (7) transpiration and (8) reproduction.

Growth. A plant grows by two distinct, but related processes, namely, cell division and cell elongation. Usually cell division occurs by the process termed *mitosis*. Young mature cells in apical meristems of the plant, root tips and stem tips, divide into two daughter cells. This separation is initiated by division of the nucleus. In dicot plants another type of tissue is also capable of cell division. This is the secondary meristem or the cambium, which divides in the same manner as the apical meristematic tissues. Monocot plants do not possess cambium. Thus dicot plants can increase in diameter by development of new cells, wherein monocots cannot. Monocot plants can grow to only a certain predetermined diameter by a definite enlargement of the existing stem cells.

After the plant cells divide and produce two new daughter cells, further growth is performed by cell elongation; that is, the small daughter cells increase to the size of the parent cells by enlargement.

This is permitted by stretching of the cell wall and laying down of new cell wall material until full cell size is achieved.

Respiration. Energy in the form of nutrients is needed by the plant to sustain its various responses and growth. The chief sources

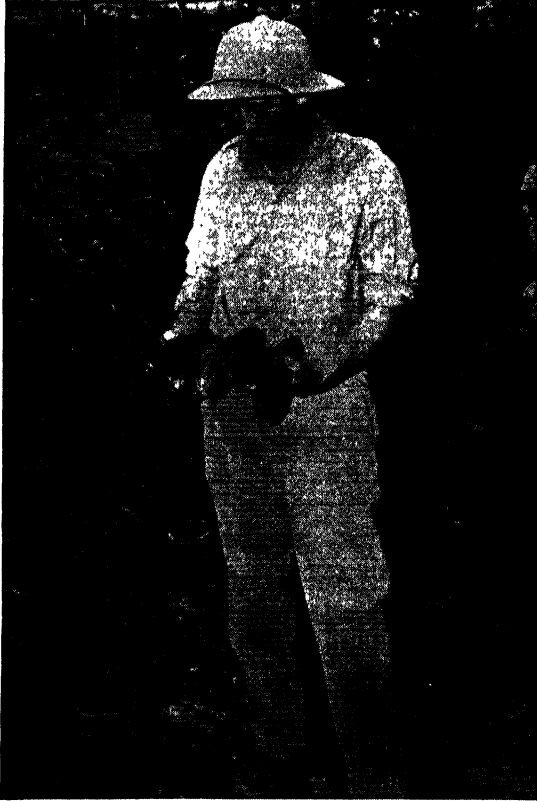

Figure 1-2. Cucumbers grown by gravel culture on Ascension Island. (Courtesy Science Service)

of such energy are carbohydrates and fats. Complex carbohydrates must be converted by the process of digestion to simple six-carbon sugars before they are usable for respiration. The same applies to fats and oils, which must be digested to simple fatty acids. Digestion requires adequate quantities of water, a suitable temperature and the proper hydrolytic enzymes which are specific for only certain substrates. The specificity of the enzyme, which acts as a catalytic agent, may be illustrated by the fact that sucrase digests only su-

crose, raffinose and gentianose, which are complex sugars possessing certain chemical linkages. Lipase is needed to digest fats into glycerol and fatty acids.

After digestion occurs respiration *per se* can progress. Of course these two processes go on simultaneously. The simple sugars and fatty acids are oxidized to energy, carbon dioxide and water in the presence of living protoplasm. The carbon dioxide and water may be considered as by-products or waste products of the reaction. Thus, it is noted that oxygen is necessary for this function, although under some conditions anaerobic respiration occurs. However, this is not the usual order of things in the growth of the higher type seed plants used for food and floral crops.

Photosynthesis. This important physiochemical reaction is performed only by green plants; in fact, this reaction may be considered as the basis for support for life upon the earth. The usual site of the reaction is in the green leaf, although some occurs in the green stem of the plant. The structure and chemical make-up of the leaf are adapted to carry out photosynthesis. Basically the reaction is the formation of simple sugars and oxygen by the interaction of carbon dioxide and water in the presence of chlorophyll which is activated by sunlight, which supplies the necessary energy. The chlorophyll acts as a catalyst in the reaction.

Water and Nutrient Ion Uptake. This physiological action is a function of the root system, particularly the root hairs; the response is dependent upon several internal and external factors. The roots must possess a sufficient respiration rate and have a satisfactory oxygen supply to permit adequate intake of water and minerals.

Two important external factors are the water supply and the mineral nutrient ion supply. Absorption of water depends upon the rate of osmosis * through the semi-permeable root membranes. If the water supply is low, less water passes into the roots. The same occurs with diffusion of nutrient ions when they reach a low concentration in the root substrate. However, these two factors are closely interrelated. A low moisture content or a high salt content in the root substrate will influence the plant in the same manner, because in both cases water intake will be limited.

* Osmosis is the diffusion of a liquid through a porous or "permeable" wall or membrane due to the attraction between the molecules of two solutions (such as water and sugar) of different strengths.

Plant Food Metabolism. The plant function of metabolism of food may be expressed more simply by the term *assimilation*. Thus, as noted in the previous section, absorption is the taking in of raw materials; assimilation is the utilization of these compounds



Figure 1-3. Tomatoes growing in sub-irrigation gravel culture at Purdue University. (Courtesy A. P. Withrow)

in the preparation of elaborated food materials. Both processes operate separately and are in a sense quite independent of each other. If growth conditions are not satisfactory, nitrate-nitrogen assimilation will cease, but absorption of nitrate-nitrogen will continue with subsequent accumulation. Of course, if absorption stops assimilation will eventually slow up.

The various metabolic activities of the plant apparently occur

chiefly in the leaf, but some proceed in the roots of some plants. The various processes of metabolism may be sub-divided into three major phases: carbohydrate metabolism, fat metabolism, and protein metabolism.

The elaboration of various sugar, starch and cellulose components in the plant is basically dependent upon a condensation reaction between simple sugars in the presence of suitable enzymes. Thus, two simple sugars, such as glucose and fructose, combine to form sucrose with the release of water. In the formation of more complex sugars, starch and cellulose, the reaction is the same, but a larger number of simple carbohydrates combine in various proportions and linkages.

Fat metabolism is dependent upon carbohydrate metabolism. Simple sugars are the bases of fat formation. Fatty acids and glycerol (glycerin), which are formed from simple sugars, may combine by a condensation reaction in the presence of the enzyme lipase to produce fats and oils (oils are liquid fats). The development of fats within the plants is not fully understood. This holds for the formation of the necessary building blocks, fatty acids and glycerol, as well as for the synthesis of the fats and oils.

Glycerol synthesis probably follows a complex path. One theory is that glucose undergoes a condensation and a cleavage reaction at the center of the six-carbon chain molecule to give two molecules of glyceric aldehyde. The glyceric aldehyde is reduced to produce glycerol.

A fatty acid synthesis theory propounds that simple carbohydrates decompose to produce acetaldehyde which contains one less carbon than glyceric aldehyde. Following rearrangement of the aldehyde molecule a simple fatty acid results. By the combination of aldehyde molecules it is postulated that longer-chain fatty acids may be built up.

Protein synthesis may be considered in three steps: (1) Plants absorb nitrate-nitrogen which must be reduced by enzymatic action to ammonia-nitrogen through a nitrite-nitrogen stage; (2) the ammonia-nitrogen reacts with simple four-carbon organic acids, which are derived from simple sugars, to form simple amino acids; (3) amino acids link together by a condensation reaction to form complex proteins.

It will be noted that carbohydrates and fats are composed of

carbon, hydrogen and oxygen. Proteins include nitrogen in addition to these three elements. Some proteins also contain sulfur and phosphorus by virtue of the constitution of several essential amino acids.

Translocation. The transport of organic and inorganic solutes and water within the plant tissues is not definitely understood. The channels of conduction are fairly well diagrammed, but how this motion occurs is incompletely figured out. It appears that the

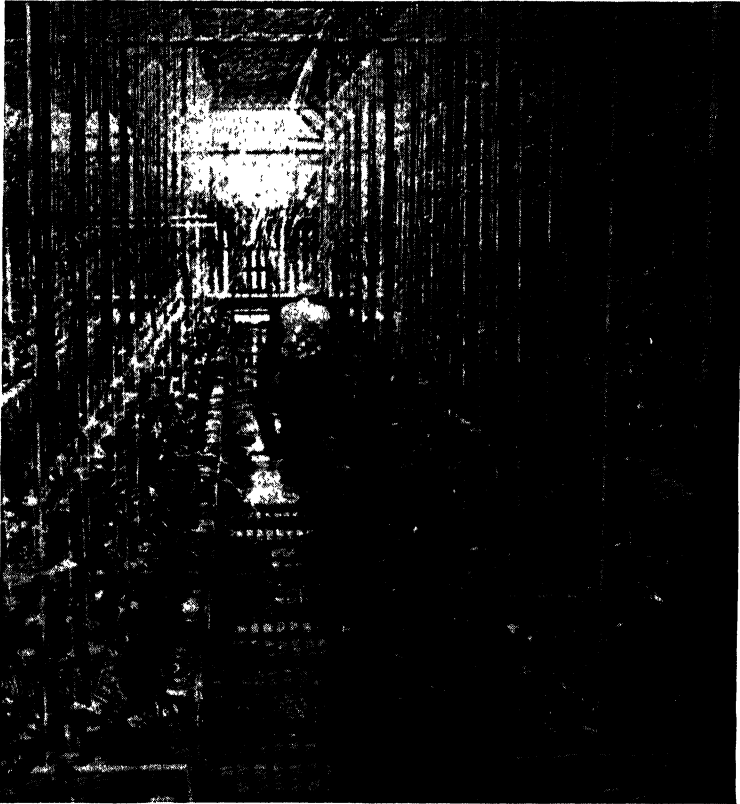

Figure 1-4. Peppers, beans and tomatoes growing in gravel culture on Aruba, N.W.I. (Courtesy W. R. Schlageter)

phloem handles the flow of organic solutes, while water and inorganic solutes (mineral nutrient ions) pass through the xylem.

Several theories have been developed in an attempt to explain the transport of solutes. One of these is the mass flow theory. Mate-

rial will diffuse from an area of high concentration to one of a low concentration within a given system by mass action. This theory does not fit all the conditions existing within the plant. Another theory is based upon protoplasmic streaming. Some botanists believe that as the protoplasm circulates around the cell and through the connecting strands of the phloem cells solutes are carried along. But this postulate does not fully explain the circumstances either. These two theories are mostly concerned with attempting to explain movement of the organic solutes (food materials). They could also partially explain movement of the inorganic solutes (raw materials) in the xylem vessels. Undoubtedly, several processes interact to cause the movement of solute within the plant.

Water transport in the xylem is likewise indefinitely known. One idea supports the root pressure theory. It is well known that the root develops a water pressure within it. Whether this pressure is sufficient to raise water to the top of a high tree is problematical. However, it does appear to be sufficient to supply the needs of small plants, like many of the commonly used vegetable and floral crops. Another contention is the water cohesion theory. A thin column of water develops considerable tension. This strong cohesive and tensile (stretching) force may enable the plant to maintain an unbroken water stream up to a considerable height. Transpiration does not appear to affect materially the conduction of water through the plant other than to initiate (related to cohesion theory) it and to alter its rate. It appears that a theory combining the root pressure and the water cohesion ideas will fairly well explain water movement through the plant.

Transpiration. Transpiration is often called a necessary evil. Plants lose water by transpiration, but as yet, no definite function is attributed to this plant response. The moisture is lost through the stomata of the leaves. Transpiration is directly and greatly affected by weather conditions. Under conditions of excessive evaporation in conjunction with inadequate moisture supply, wilting will occur. In fact control of the transpiration rate is an important cultural problem, particularly in the greenhouse. Transpiration is not directly associated with the uptake of the mineral nutrient ions.

Reproduction. As mentioned above, sexual reproduction of plants occurs in the flower. The ripe pollen is transferred to the stigmatic surface of the pistil by various means. This process is known as pol-

ination. The pollen grains develop long tubes which grow downward through the pistil to the ovary. This act of fertilization initiates the formation of the embryonic seed.

Apparently, the pollination starts a chain of hormone reactions which brings about fruit formation. Either the pollen supplies a hormone which reacts with other hormones in the ovary, or it is the source of the entire hormone supply. The development of the fruit is dependent upon these hormone reactions. This is well illustrated by the fact that the production of seedless fruit of many plant species is possible by the external application of hormone-like chemicals. Under natural fertilization conditions the development of the seed sustains the formation of the fruit.

Some plants are capable of asexual reproduction. The somatic tissue can produce new organs if it is supplied with proper conditions. Thus many species are propagated by vegetative cuttings. Leaf, stem or root cuttings are prepared and inserted in moist sand to grow new roots and leaves to develop another plant. This means of reproduction is of great importance in commercial horticulture.

Role of Mineral Elements

The role of mineral elements in the nutrition of green plants is of particular importance to the practical grower, whether he uses soil or soilless culture. Further, it is one of the cultural factors which the grower may control to a considerable extent.

To present a general picture of the influence of the mineral nutrient ions upon the physiological responses of the plant, the following outline is given:

- (a) Supply building material for the cell protoplasm.
- (b) Supply building material for the cell wall.
- (c) Influence the osmotic pressure of the cell sap.
- (d) Influence the acidity or alkalinity of the cell sap.
- (e) Influence the buffer action of the cell sap.
- (f) Influence the degree of hydration of the protoplasm.
- (g) Influence the permeability of the cell membranes.
- (h) Exert a toxic effect upon the cell if present in too great a concentration.
- (i) Exert an antagonistic action between some mineral elements to help counteract possible toxicities.
- (j) React as catalytic agents for certain physiological functions.

The individual effects of the various essential mineral nutrient ions will be described in the following paragraphs. Major or macro elements will be separated from minor or micro elements for the purpose of this discussion. The macro elements include nitrogen, potassium, magnesium, calcium, phosphorus and sulfur. Micro or "trace" elements are iron, manganese, boron, copper and zinc. Each element will be studied in respect to its occurrence in the plant, its form in the plant, its function in the plant and the internal effects, anatomical and chemical, of a deficiency. External deficiency symptoms are listed in Table 10-1, page 214.

Major or Macro Elements. Nitrogen. Nitrogen occurs throughout the entire plant because it is an essential constituent of the protoplasmic proteins. It is also found in storage proteins in the seed and in other storage organs.

Nitrogen is found in numerous compounds in the plant. These include both organic and inorganic substances. The inorganic forms and the soluble organic nitrogen fractions are water-soluble and mobile within the plant. Organic substances containing nitrogen include proteins, amides, amino acids, chlorophyll, alkaloids, flavins (yellow pigments), nucleic acids and other complex nitrogenous products. The usual inorganic forms are nitrate-nitrogen and ammonia-nitrogen.

The functions of nitrogen in plants are widespread. These include their essential part in the formation of proteins, protoplasm, chlorophyll and nucleic acids. Plant life is basically dependent upon nitrogen along with carbon, hydrogen and oxygen.

A deficiency of nitrogen causes both anatomical and chemical disturbances inside the plant. The plant cells become smaller with thicker cell walls. Increased lignification of the cell walls occurs and greater fiber development follows. Also, the cells contain less protoplasm. Chemical analyses indicate more carbohydrate accumulation and more anthocyanin pigmentation, while no nitrate-nitrogen is present.

Potassium. Potassium remains chiefly in the inorganic state in the highly mobile form of the potassium ion throughout the whole plant. However, this ion is localized mostly in areas of high physiological activity, such as the apical meristems, cambium, developing fruits and leaves. Potassium is found as a water-soluble inorganic salt in the plant. Possibly some potassium organic salts are also present.

The exact role of potassium in the plant metabolism is obscure. It appears to act mostly as an inorganic catalytic agent. The element does not enter into any plant compound or structure. Numerous physiological functions of the plant are apparently dependent upon an adequate potassium supply. The normal maintenance of the following processes is influenced by this essential nutrient ion:

- (a) Enzyme activities; potassium ions appear to directly affect the activity of diastase, invertase, catalase and reductase.
- (b) Synthesis of simple sugars, starch, fats and proteins.
- (c) Assimilation of nitrate-nitrogen.
- (d) Meristematic activity, both apical and cambial; influence cell division.
- (e) Neutralization of organic acids.
- (f) Osmosis of the cell sap.

Internal anatomical effects of a potassium deficiency take the form of smaller cells with thicker cell walls. Lignification of the cell walls is increased. Secondary meristematic tissue, or cambium, is reduced in amount and activity. Thus, potassium-deficient sweet potatoes and beets are thin and long rather than thick and short. Often larger stomata of the leaves are observed. Chemical analyses indicate accumulation of nitrate, amide, amino acid and other soluble nitrogen compounds. This is probably caused by restriction of nitrate-nitrogen reduction and protein synthesis during the early stages of a deficiency. Excessive proteolysis (hydrolytic protein break-down) probably accounts for the high soluble organic nitrogen content during the later stages of potassium shortage.

The carbohydrate content of the plant is influenced by the relative stage of the deficiency conditions. In the early stages carbohydrate accumulation develops mostly because protein, fat and nitrate-nitrogen metabolism is retarded. As the deficiency condition continues, carbohydrates decrease in amount as sugar and starch syntheses are interfered with.

Other mineral salts often increase in concentration, including phosphorus, calcium, magnesium and iron, because their assimilation is affected.

Magnesium. Occurrence of magnesium is evident in the leaves, seeds and meristematic tissue. It is found in both the organic and the inorganic state within the plant. Magnesium is a necessary component of chlorophyll. Inorganic salts exist in the cell sap.

The major function of magnesium in the plant is in the formation

of chlorophyll; thus it indirectly influences the photosynthetic activity. Magnesium appears to act as a transporting agent for phosphorus by forming a labile complex with this element. It seems to function in this capacity in connection with fat synthesis and nucleoprotein formation. Phospholipid (lecithin) formation is associated with fat and oil production. Nucleo-proteins contain nucleic acids which contain phosphorus.

Published data upon the internal symptoms of magnesium deficiency are incomplete. The dry weight of the leaf decreases as the water content increases. Magnesium deficiency develops in the older leaf tissue and the element is mobile to the extent of chlorophyll decomposition and the supply of inorganic salts.

Calcium. Calcium is usually found in the greatest amount in leaves and seed coats. It is relatively insoluble and immobile in the plant. Only a small proportion of the total calcium is water-soluble. Usually calcium is combined in the organic form as calcium pectate and as calcium salts of organic acids such as calcium oxalate. Some calcium is combined in protein complexes in the nucleus and in the plastids.

Calcium functions as a plant structure-building material. It is necessary for the middle lamella or the calcium pectate cementing layer of the cell walls. Meristematic activity, both stems and roots, is inhibited and actually stopped in acute cases of calcium deficiency. This retards nitrate-nitrogen absorption as well as the uptake of water and other essential nutrient ions. Protein synthesis also appears to be influenced by the calcium ion. Its effect upon translocation of carbohydrates and amino acids is open to question. Calcium influences the permeability of the cytoplasmic membranes and the degree of hydration of the cell colloids. An antagonistic value, particularly in respect to magnesium toxicity, is apparent. Calcium seems to function as a neutralizing agent for organic acids. Calcium salts of these acids, especially calcium oxalate, are commonly found in plant cells. Calcium soaps are also present.

Internal anatomy changes include break-down of the middle lamella when calcium is lacking. Granulation of the protoplasm, decrease in protoplasm content of the cell and a general decomposition of the meristematic tissues occur. Chemical tests indicate increased carbohydrate content and a lowered quantity of inorganic materials, including nitrate-nitrogen and calcium.

Phosphorus. Phosphorus is most abundant in seeds, fruits and meristematic tissues. It is combined in many protoplasmic proteins, particularly the nucleo-proteins. Nucleic acids and phospholipids are phosphate complexes. Hexose phosphates and phytin, a seed storage form of phosphate, are present. Of course inorganic phosphate is evident, and this element is relatively mobile within the plant.

Phosphorus functions as a constituent of certain protoplasmic proteins. Nitrate-nitrogen reduction is inhibited by a lack of phosphorus and it may alter carbon dioxide assimilation, particularly in later stages of deficiency. Hydrolysis of starch to simple sugars and synthesis of starch from sugars are influenced by phosphate. The starch grain contains some phosphorus in its nucleus. Respiration is also influenced by the action of phosphorus upon oxido-reducto enzymes. Another important function of phosphate is its buffering effect upon the acidity of the cell sap.

A lack of phosphorus in the plant causes the cells to become smaller, with thicker walls and greater lignification of the walls. Chemical changes are an increase of nitrate-nitrogen and lowering of phosphorus content in the plant cells. In the earlier stages carbohydrate accumulation occurs, with a resulting increase of anthocyanin pigment. During the later stages the carbohydrate content decreases.

Sulfur. Sulfur is well distributed throughout the entire plant. Organic forms of sulfur in the reduced state include proteins, the amino acids—cystine and methionine, the respiratory pigment—glutathione, and the glycoside mustard oils. Sulfur is present in the inorganic form in the oxidized state as the soluble sulfate.

The role of sulfur in the growth of the plant is important as a component of the essential sulfur-bearing amino acid cystine; it is also found in plant proteins. Thus sulfur influences protein formation. Nitrate-nitrogen reduction is also reported to be affected, as well as respiration. The sulfur-containing respiratory pigment glutathione appears to react as an oxidation-reduction enzyme in sugar oxidation. This pigment seems to act as a hydrogen acceptor in a reducing action. Then it is oxidized back to the original form, acting as a hydrogen donator. Cambium activity may be influenced by the sulfur content of the tissue, as a low level interferes with cell division and fruiting. Nodule formation on legume roots is also stimu-

lated by adequate sulfur supplies. Chlorophyll development may be affected by low sulfur content because chlorosis is a common symptom of sulfur shortage. Further, an organic storage compound develops in the form of mustard oil glycosides. These materials impart the distinctive odors and flavors to garlic, onions and mustards.

Internal anatomical symptoms of sulfur deficiency are similar to those manifested by a lack of nitrogen. Cells are smaller; walls become thicker and more lignified, and more fiber cells develop. Carbohydrates accumulate and nitrate-nitrogen increases. Organic sulfur becomes water-soluble and the cell loses some of its protoplasm.

Minor or Micro Elements. *Iron.* Iron is present in small quantities in the entire plant in both the inorganic and the organic form. Probably the greatest amount is in the organic state. Inorganic iron may be further classified into available and unavailable iron. Iron is one of the most immobile mineral elements utilized by plants. Practically no redistribution occurs.

The major function of iron appears to be as a catalytic agent, particularly for chlorophyll synthesis in the green plant. Iron is not a constituent of the chlorophyll molecule, but it must be present for its formation. Another function appears to be its behavior as an oxygen carrier in oxidation-reduction processes in cellular respiration (iron acts in a similar manner in the hemoglobin of the blood of animals and man). Iron also plays a role as an antagonistic agent in respect to manganese toxicity. It must also be considered in relation to other physiological conditions, both internal and external, in respect to its action upon plant development. A relationship exists between iron availability on one hand and iron solubility, phosphate concentration and the acidity of the cell sap on the other hand. These same relations also exist in the root substrate.

Published data do not present complete information upon internal effects of iron deficiency. The leaf cells lose their chlorophyll. In acute stages necrosis of the cell protoplasm follows.

Manganese. This essential micro element is generally present throughout the entire plant. However, the greatest concentrations are found in tissues of considerable physiological activity, such as meristems and leaves.

The exact form of manganese in the plant has not been ascertained. No doubt, it exists in both the organic and the inorganic

form. Probably it is in the ionic, but highly immobile, state in the inorganic form.

Manganese, like the other minor elements, acts as a catalytic agent. It affects chlorophyll formation and respiration. The plant becomes chlorotic if manganese is not available. The oxidation-reduction enzyme systems appear to depend upon manganese. Some believe that manganese may be a component of oxidases or that it may act as a coenzyme of oxidases. Further, some published work indicates that protein and carbohydrate synthesis are also influenced by this essential mineral element. Possibly calcium and magnesium assimilation are also affected. Antagonism is apparent between manganese and iron. Manganese also affects root aeration, that is, more efficient use of oxygen is possible in the presence of ample manganese supplies in the root substrate.

Internal symptoms of manganese deficiency in respect to anatomy and chemical composition are not well known. Of course chlorophyll is lacking and the protoplasm becomes necrotic.

Boron. Boron is widespread in all plant tissue, but the greatest quantities are found in the leaves. The concentration of this element in the plant cells is extremely low. Probably boron exists in the inorganic form in the plant. It appears to be mobile, except in the leaves.

Boron is an inorganic plant catalyst. It seems to be associated with calcium metabolism. Cell division is profoundly disturbed by a lack of boron. Both apical and cambial meristems are destroyed by a deficiency. The activity of vascular tissue, especially phloem, is dependent upon boron. Nodule formation on legume roots is also inhibited by a lack of this element, probably because the necessary connecting vascular system is practically non-existent.

Distinctive anatomical changes are caused by a lack of boron. Meristematic and vascular tissue decomposition is apparent. Gum formation often develops in vascular and cortical regions. Internal corky tissue forms in fruits, such as apples and oranges. Vegetable crops like potatoes and beets are affected in a similar manner. Chemical analyses show an increase of carbohydrates, sugars and starch in photosynthetic tissues, chiefly the leaves. Associated with this accumulation, greater quantities of anthocyanin pigments develop in the leaves of some plants. Carbohydrate reserves are di-

minished elsewhere in the plant. These effects are largely a result of damage to the phloem tissue.

Copper. Copper is considered to be an essential element for plant growth. However, no definite information is available as to its function. The symptoms of chlorosis and lack of turgor apparent in a deficiency suggest some possible functions, probably of a catalytic nature. Chlorophyll synthesis may depend upon copper. Internal water relations also may be associated with copper metabolism.

Zinc. Zinc is classified as an essential mineral element, but its exact functions in the plant are not known. Chlorophyll formation is influenced by its presence. Apparently meristem activity is controlled by zinc because break-down of this tissue occurs when zinc shortage develops.

Chapter 2

General Types of Soilless Culture

Three practical types of soilless culture exist, both for the home gardener and the commercial grower: these are the water culture, the sand culture and the gravel culture methods. Before considering the general principles applying to these, certain matters should be discussed regarding soil versus soilless culture.

General Aspects

This section deals with a brief discussion of the definition of soilless culture (from a purely practical viewpoint). The physiological functions of soilless culture in respect to the plant roots are similar to those of soil. Further, certain advantages of soilless over soil culture are apparent under some circumstances.

Definition. The title of this chapter may be subjected to criticism by many people; but the term "soilless culture" as used here implies the growth of plants in any material other than soil. Soil is a complex physicochemical unit containing various biologic agents; it has a definite structure, although in agricultural soils this structure is disturbed. Each layer or horizon of the soil has distinctive chemical and physical properties. Many of the artificial culture techniques employ media for a root substrate which do not have definite stratification of functional sections. The organic matter and action of the biologic entities all influence the reaction between the soil complex and the plant roots. These factors do not play a necessary part in soilless plant production.

Functions. The physiological functions of soilless culture may be considered from three major relationships. Such a culture substitutes other agencies for soil as a source of mineral nutrients, moisture and plant support.

Mineral Source. Soilless culture supplies the necessary inorganic nutrient elements which are normally obtained by the plant from the soil. These materials are supplied by the soil to the plant root

in two available forms. Most of the necessary minerals are dissolved in the soil water held upon the particle surfaces of the soil; when dissolved in water the minerals diffuse through the membranes of the roots. The nutrient ions in soilless culture are also in aqueous solution and are absorbed by the plant in a similar manner. Some of the elements may be available to the plant in a colloidal state (particle size greater than dissolved particles, but smaller than true suspension particles), both in soil and in artificial culture. Thus when the plant root comes into contact with a particle of the medium, the adsorbed colloidal particles may diffuse into the root tissue. This effect is most probable in the solid-media type of soilless culture.

It must be mentioned at this point that nutrient ions, not plant foods, are mentioned in this discussion. The essential minerals are not themselves food materials, but merely raw materials necessary for the building up of food substances.

Moisture Source. The soil also is a source of moisture for the plant. Soilless culture media also supply the necessary water requirements. Water culture supplies free liquid; solid media carry a moisture film on the particle surfaces. In the case of porous media, like cinders or Haydite, water is also held within the capillary interstices of the particles. Although the total moisture-holding capacity of solid media is less than that for soil, a greater percentage of the water present may be removed by the plant roots. The particle size in sand or gravel culture is greater than in soil culture. Since the affinity of the particle for the moisture film is less, more moisture may be taken from the system, but it also will have to be replenished more often.

Plant Support. The third major function of the soil is to afford mechanical support for the plant and its roots. Water culture does not supply this and provisions must be installed to make up this deficiency. Sand and gravel cultures are similar to soil in the mechanical respect.

Advantages. The advantages of soilless culture are primarily that of better nutrient control, less fertilizer waste, less operating labor required and adaptability in areas where suitable agricultural soils do not exist.

Nutrient Control. The relatively simple nature of soilless culture media, whether liquid or solid, facilitates control of the nutritional

requirements of the plant. No major complex interactions develop within the system, as in the case of soil. The only major reactions are simple chemical ones within the nutrient solution itself, except the interactions between the nutrient solutions and the plant roots. (In the case of alkaline media, such as crushed coral, precipitation of such minerals as phosphorus will naturally occur). Thus more complete analysis is possible with soilless culture than with soil. Soil culture analyses are only relative, whereas the absolute composition of the nutrient solution may be ascertained by simple chemical tests. This allows more accurate reproducibility of the nutritional conditions because closer control is possible.

Fertilizer and Labor Requirements. The comparison of cost data between soil and soilless culture must be based upon similar production conditions. Only under such circumstances can it be shown that production costs may be reduced by the use of soilless culture, for it is a forcing technique, not a field technique. It may be shown that in the greenhouse fertilizer and labor costs per crop may be lower than with soil. More economical use of fertilizer is possible because more exact proportioning of the nutrient requirements is obtained, with correspondingly less waste of fertilizer.

Labor economies include less time required for (1) weeding, (2) fertilizer applications, (3) watering, and (4) sterilization. Also no manure applications are necessary, and the time occasionally required to screen excess roots from the gravel is less than that needed for a complete change of soil.

Adaptability. Soilless culture may be used in the greenhouse, in the home garden, in the house, and in areas where suitable soil areas are not present. Its greatest advantages are for types of culture wherein ultimate cost is not important or the returns per unit are high. In non-soil areas the cost of production often is less than shipping charges for fresh(?) produce. Regardless of the cost, the nutritive qualities and the palatability of local grown perishable vegetables in barren places are far superior to those of produce shipped in.

Types of Soilless Culture

The discussions of water, sand, and gravel culture in this chapter will deal primarily with general principles of operation and practical applications. Succeeding chapters are devoted to a study of various

cultural and constructional considerations. Water culture is presented in Chapter 3, sand culture in Chapter 4, and gravel culture in Chapter 5. Chapters 6 to 12 inclusive are concerned with technical and cultural details of crop production by soilless culture, with the emphasis upon gravel culture.

Water Culture. All types of soilless culture may be discussed in the light of three items. These are (1) definition, (2) principle of operation, and (3) practical application. These points are discussed at this time in respect to water culture which was suggested for commercial use in 1929 by workers at the California Agricultural Experiment station.

Definition. Water culture in the purest sense involves growing flowers or vegetables by suspending the roots in a water solution of nutrients. The term "hydroponics" was coined by Dr. W. F. Gericke to apply solely to this type of crop production. Literally, the word means "water-working." Within the limitations of the term, it is herein suggested that it be applied only to unmodified water culture where no tray of litter is used to support the plants. In cultures which employ a litter tray, the term is not accurate in the strictest sense, because a large portion of the plant roots develop and function in the litter or bedding which is of organic nature. Such plants do not grow entirely in a liquid medium, but partly in an organic substrate (which undergoes decomposition and actually is often desired and recommended for some crops to secure best results).

Thus, since the term "hydroponics" is even used to describe a water culture system which also employs a solid medium, it is logical to permit use of the word for sand culture and gravel culture also. "Hydroponics" may then be used as a general term for soilless culture, whether water, sand or gravel.

Principle of Operation. The basic principle of water culture is that the plant roots develop and grow in a liquid medium which contains all the necessary nutrient minerals. Sufficient oxygen must be present in the immediate proximity of the roots to sustain proper plant growth. This may be supplied in three ways: (1) forced aeration, (2) maintenance of a moist air space around the upper roots, and (3) growing some of the roots in a loose supporting medium. The moist air space is usually employed even when either one or both of the other techniques is used with it. When the plant roots are small and short, only a one-half to one-inch air space is provided

between the solution level and the crown of the plant. Gradually the moist air space is increased to a thickness of two or three inches. The upper roots are capable of absorbing sufficient oxygen for the needs of the entire root system from this moisture-saturated atmosphere. A solution depth of three to six inches is carefully maintained to hold the proper air space.

The plants may be held in place by corks or cotton wads for experimental or household growth; but for commercial units, trays of loose litter are employed. Usually two to four inches of litter or bedding, such as excelsior or straw, is utilized as a plant support. The relative coarseness and moisture retention requirements of this litter are governed by the plant being grown.

Practical Applications. Applications of the water culture technique to practical crop production is considered from two standpoints. These are the possibilities for home use, either indoors or outside, and for commercial crop production. For home use, this type of culture is of special interest to the home gardener who enjoys gardening as a hobby. Much pleasure and plenty of fresh vegetables and flowers can be derived by diligent efforts. A backyard basin, a greenhouse bench or a house container may be utilized. House plants should be chosen from a list of those adaptable to the usual indoor growing conditions.

Before the hobbyist attempts to use the water culture method, he must be conversant with the necessary culture and constructional details (see Chapter 3). The greatest chances for failure in this method appear to lie in the improper construction of the litter bed and in the incorrect manipulation of the nutrient solution level and the air space around the upper roots.

Compared to the other types of soilless culture, water culture seems to be the most difficult for the average amateur to master; but once the necessary experience is acquired, certain crops possibly may be grown best in this type of soilless culture. This holds particularly for plants that possess large water requirements, such as cucumber; potatoes also appear to be well adapted.

The great opportunity for commercial exploitation of water culture lies in the greenhouse and in outdoor locations where soil areas of satisfactory agricultural value do not exist.

Just before the war the Pan American World Airways Company operated a small water culture installation on Wake Island in the

Pacific Ocean, the purpose of which was to develop a fresh-vegetable supply for the airport personnel and the plane passengers. Unfortunately this unit was not in operation long enough to secure complete information.

Several greenhouse concerns in California have worked with water culture under commercial conditions for several years. Figure 2-1



Figure 2-1. Tomatoes grown by water culture method in greenhouses of Ernest Brundin, Montebello, Calif.

is a photograph of one of these installations, using a bed of litter to hold the plants in place.

Dr. L. J. Alexander, of the Ohio Agricultural Experiment Station, Wooster, Ohio, has conducted a water culture demonstration, 750 square foot bed area, for six years in the greenhouses of Ruetenick Gardens, Vermillion, Ohio. Yields of nine to seventeen pounds of tomatoes per plant were realized with a winter-spring crop. Usually the water culture-grown tomatoes outyielded the soil-grown tomatoes by one to two pounds of fruit per plant. Figures 2-2 and 2-3 show tomatoes and cucumbers in production.

The J. W. Davis Company, of Terre Haute, Indiana, has operated both experimentally and semi-commercially since 1938 and 1940,

respectively. About one-sixth of an acre under glass is devoted to tomato and cucumber production. Apparently, results with tomato are better than with cucumber according to the latest report. Early

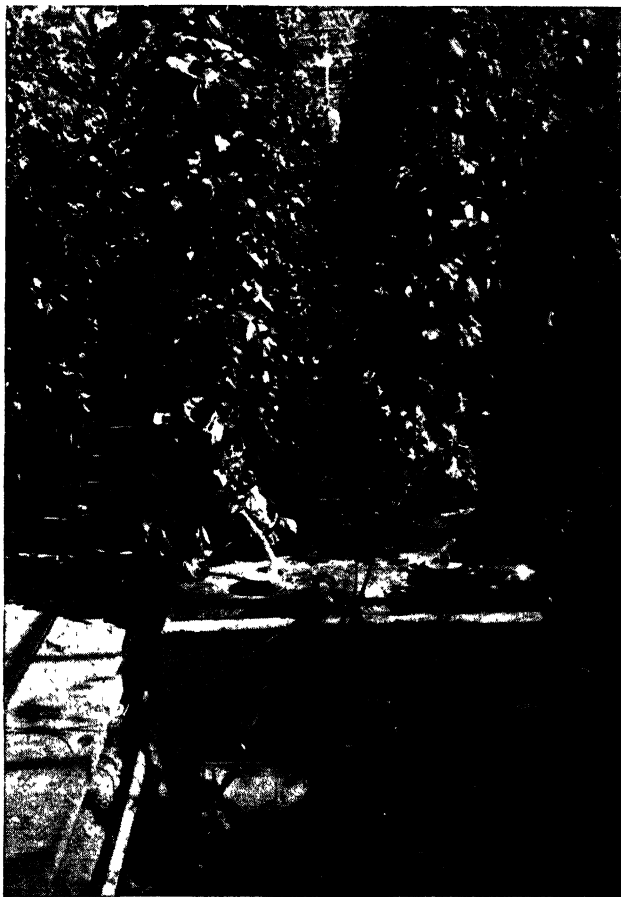

Figure 2-2. Tomatoes grown by water culture method in greenhouses of Ruetenick Gardens, Vermillion, Ohio. (Courtesy L. J. Alexander, Ohio Agricultural Experiment Station, Wooster, Ohio)

experimental work indicated that cucumber growth in water culture was better than in gravel culture, but the reverse was observed for tomato. This company has no plans for expansion as yet.

Data are not available to indicate the complete cost of commercial application of water culture. Contrary to some published

remarks, the cost of chemicals is not a determining factor in production figures. Actually, the charge for the chemicals is a relatively small part of the total cost. The initial costs of the physical instal-



Figure 2-3. Cucumbers grown by water culture method in greenhouses of Ruetenick Gardens, Vermillion, Ohio. (Courtesy L. J. Alexander, Ohio Agricultural Experiment Station, Wooster, Ohio)

lation, of the trained supervisory personnel, and of the operating labor are the major expense items.

At the present date the status of water culture for commercial exploitation appears to be less favorable than for gravel or sub-irrigation culture. However, in barren areas, wherein suitable gravel media do not exist or the shipping charges for transporting the media to the garden site are prohibitive, water culture may be well adapted.

Sand Culture. Sand culture became established as a practical possibility in 1929 when New Jersey Experiment Station workers suggested its commercial use. Rhode Island Station workers indicated its practical aspects in 1921.

Definition. Sand culture is usually synonymous with slop culture or drip culture. A fine medium, usually sand, supplies the plant support and a place for root development. The nutrient solution is applied at the surface of the medium, either by pouring or "sloping" or by the drip method. As long as the nutrient solution is applied at the surface and allowed to drain through the volume of the medium, the term "sand culture" holds even though fine gravel may be used.

Principle of Operation. Sand culture is the simplest procedure of soilless growth. The roots develop and grow in a relatively inert medium of fine size. The root substrate must be fine enough to hold an adequate moisture level for a reasonable length of time. Also, it must not be too fine to interfere with proper aeration. Air circulation takes place between the particles as in soil. Aeration is further effected by replacement of the air volume as the nutrient solution is poured upon the surface of the medium. The particles retain upon their surfaces sufficient moisture and nutrients for the plant roots. Proper drainage at the bottom of the container is important. The sand must be only moist, not waterlogged, or poor root development results.

Practical Applications. Sand culture is applicable for crop production in home gardens and in commercial establishments. In fact, it is the easiest method of soilless culture. It is highly recommended for the beginner, whether hobbyist or commercial grower. If a few simple instructions are followed properly, most plants do reasonably well with a minimum of experience and technical knowledge required by the grower. This technique is suggested as a basis for experience before a person attempts the water culture or gravel culture procedures.

This type of culture is of special interest to the home gardener who does not wish to invest too much cash; moreover, he does not have to be as "scientific" to secure satisfactory results, as with the other types of culture. It is the cheapest method to initiate because less expensive equipment and less installation is necessary.

Sand culture is adaptable to growing plants in the house, in the lean-to greenhouse or in the backyard garden. The choice of plants

should fit the climatic conditions for each environment. Probably the greatest difficulties to surmount are the proper choice of sand size and the frequency with which the nutrient solution should be applied. Chapter 4 presents necessary details of cultural operation.

The greenhouse grower can often put the sand culture method to good use. This applies particularly to the commercial propagator of flower cuttings. Quite often the sand or sand and peat propagation beds are empty for about one-half the year. Growing of cash crops in these sand beds during the off season, usually late summer, fall and early winter, by the slop culture method is suggested. This will be more suitable than leaving the beds empty or removing the sand to replace it with soil for a short time.

Another commercial application lies in the utilization of sand culture for seed germination and seedling development. Sand beds are easier to sterilize than soil beds. Usually damping-off is under better control in sand culture. Usually less weed growth occurs in sand. Further, better root development of young plants occurs. Greater control of the type of growth exists by manipulation of the nutrient solution applications. Stocky and healthy plants may be grown for sale which often are transplanted more readily in the field than are soil-grown plants.

Yoder Brothers, of Barberton, Ohio, utilize their chrysanthemum cutting benches to grow stock chrysanthemum plants during the late summer and into the early winter period. Ordinary slop culture is used with a medium-fine building sand. The New Jersey Agricultural Experiment Station in New Brunswick, New Jersey, has well demonstrated over a period of years the practicability of sand culture, particularly with carnations.

The F. E. McFarland greenhouse at Waukegan, Illinois, has its entire range in sand-peat culture. A 50-50 mixture of sand and peat is used as the growing medium. Commercial grades of fertilizer, usually a 4-12-4 formula, are applied in the dry state to the medium and watered in (similar to soil practices). This "dry salt" mixture is applied when the grower believes it is necessary. Approximately 2600 square feet of bench area are devoted to the production of cut flowers. Crops produced include carnation, chrysanthemum, tulip, iris, narcissus, larkspur, candy tuft, snapdragon, blue lace flower and vegetable plants such as cabbage and tomato seedlings. Results are sufficiently satisfactory that immediate plans call for

doubling the present area. This method of "dry salt" application has been tested fully and recommended by Ohio State University and the Central Experimental Farm, Ottawa, Canada.

Again, as noted above for the water culture method, commercial cost data for the sand or slop culture method are not available. Actually the cost of installation for a sand culture bench is comparable to that for a soil bench in the greenhouse. Over a period of years the sand cost is cheaper than for soil. Fertilizer and operating labor costs appear to be quite similar.

Gravel Culture. Gravel culture was proposed by the Purdue University Agricultural Experiment Station for practical consideration in 1936. Concurrently, the New Jersey Agricultural Experimental Station developed the method independently. In agreement



Figure 2-4. Rose stock just benched in Haydite in greenhouses of Yoder Brothers, Barberton, Ohio.

with the general outline of this chapter, gravel culture will be discussed in respect to definition, principle of operation and practical uses.

Definition. Gravel culture as a term is applied to that type of soilless culture which employs a relatively coarse medium, which is flooded with nutrient solution by sub-irrigation; *i.e.*, solution is applied at the bottom of the bed and circulates up into the medium.

Principle of Operation. Gravel sub-irrigation employs the use of waterproof beds. A relatively coarse medium is placed in the beds to serve as the root substrate. This medium, generally called "gravel," must be fine enough to hold sufficient moisture for the plant roots. Also, the particle size must be coarse enough to allow adequate aeration to occur about the plant roots. As the nutrient solution is pumped into the beds at the bottom, the "old" air in the

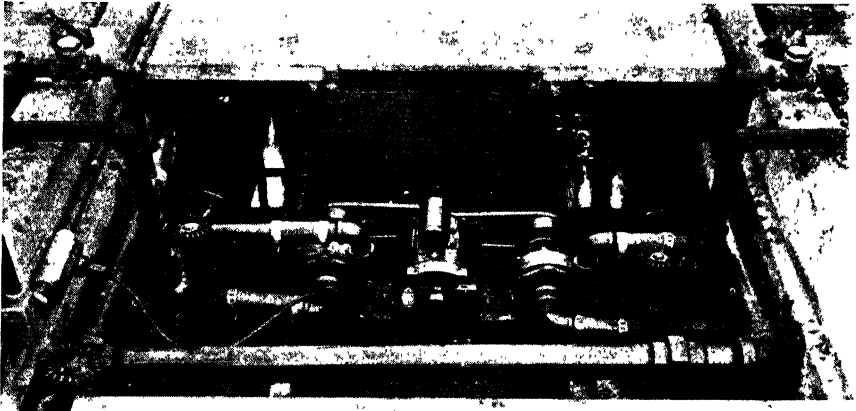

Figure 2-5. Pump and motor installation for experimental beds at Yoder Brothers greenhouses, Barberton, Ohio.

medium is pushed out. Then "fresh" air is sucked into the medium as the solution drains from the beds back into the reservoir. The particles retain sufficient water and nutrients upon their surfaces (also within the particles of porous media) to support satisfactory plant growth. Various cultural factors govern the frequency of pumping the nutrient solution into the "gravel" beds.

The nature of the bed affords convenient re-use of the nutrient solution for an indefinite period, thus reducing water and nutrient losses as compared to sand culture. A waterproof cistern holds the solution supply when it is not in the medium bed. This solution is transferred to the bed by means of gravity or pumps or both. As soon as the medium is flooded, the solution is immediately drained out. The tile, which fits loosely upon the bottom of the bed, facilitates even distribution of the solution throughout the bed.

Practical Applications. Gravel culture is recommended for home use by the hobbyist, rather than by the run-of-the-mine gardener.

In other words, the person who gardens by planting the seed and letting nature do the rest would have trouble in securing good



Figure 2-7 View of Hydroponics Garden at Modern Farms, Kendall, Florida. (Courtesy J. P. Biebel)



Figure 2-8 Hydroponics Garden producing tomatoes at Modern Farms, Kendall, Florida (Courtesy J. P. Biebel)

results by gravel sub-irrigation. He is referred to the sand slop culture method.

Gravel sub-irrigation appears to be the most practical type of soilless culture for commercial purposes. It enjoys the widest use in greenhouses in the United States. Also, several gardens are in operation in tropical areas in the world, including the South Atlantic, South America, the Caribbean and the Pacific areas. Upon this premise, the revision of this book was based mainly upon expounding the various cultural problems of gravel culture. Therefore, the

chapters following deal primarily with gravel culture. However, the technical and cultural problems discussed will apply to all types of soilless culture.

As mentioned above, gravel culture requires some attention to technical and cultural details for good results. This method is adaptable in the house, the home greenhouse and outdoors. Naturally to obtain good results, the proper selection of plants must be

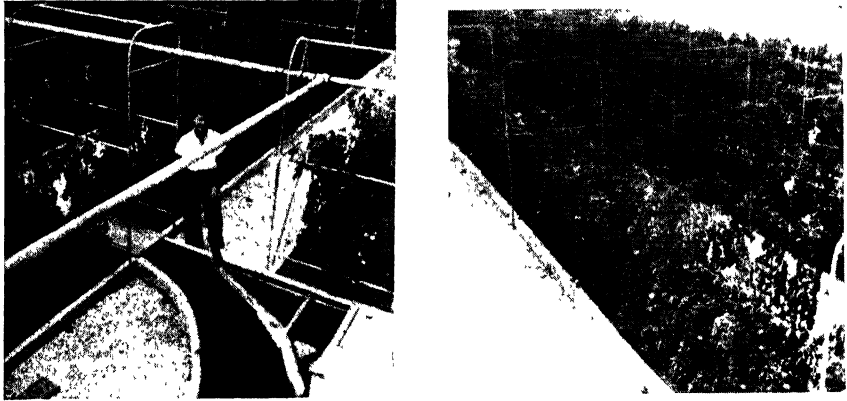

Figures 2-9, 2-10. Hydroponics Garden producing tomatoes at Flagler Farms, Kendall, Florida. (Courtesy J. P. Biebel)

considered; that is, the choice of the kind and the variety of plant for the particular conditions existing is quite important. This point cannot be repeated too often. The most experienced gravel culture operator using the best designed unit cannot produce a decent crop if the wrong kind or the wrong variety of plant is grown.

This type of soilless culture requires the greatest outlay of cash and equipment, but the actual operation is simpler than for the water culture method. Also, the operation costs are less than for sand culture.

As noted previously, gravel sub-irrigation culture appears to be the most practical type of soilless culture under commercial conditions. Although the initial cost is relatively high compared to the other methods of soilless culture and to soil culture, the operating costs are less under forcing culture conditions.

Better root aeration, easier control of the nutrient ion levels in the solution, greater ease of setting and supporting the plants and better control of the volume of the solution under rainy conditions

are possible than with water culture. Less waste of water and nutrient chemicals, less labor in chemical and water applications, and greater control of the nutrient level is possible than with sand cul-

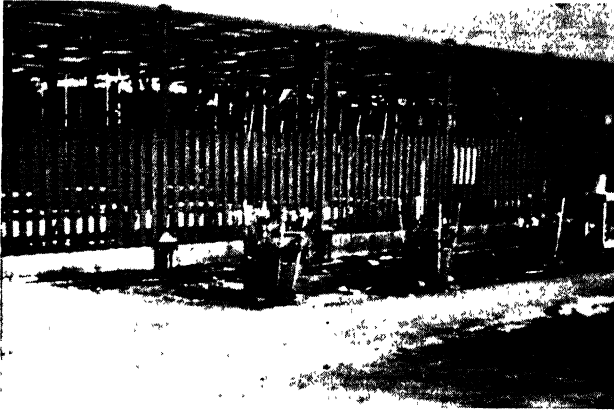

Figure 2-11. External view of Lago Hydroponics Garden, Aruba, N.W.I. (Courtesy J. R. Knoll)

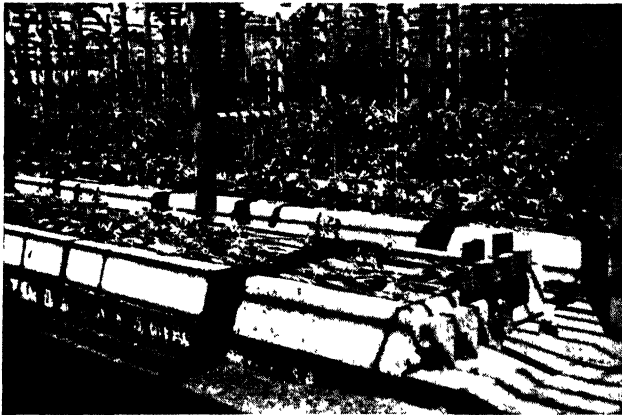

Figure 2-12. View of three separate crops of tomatoes growing in Lago Hydroponics Garden, Aruba, N.W.I. (Courtesy J. R. Knoll)

ture. Greater control of the nutrient level, less operating labor (includes watering, fertilizer and manure applications, weeding and cleaning gravel versus changing the soil) and greater ease of sterilizing are several operational advantages over soil culture.

The greatest advantage of gravel culture lies in the fact that it is

an improved forcing technique. Thus, the capital expenditure is justified in (1) the greenhouse, (2) the area wherein agricultural soil is practically nonexistent and (3) areas where, in spite of rea-



Figure 2-13. Showing bed construction in foreground and tomato crop in background at Lago Hydroponics Garden, Aruba, N.W I. (Courtesy J. R. Knoll)



Figure 2-14 Swiss chard growing in Lago Hydroponics Garden, Aruba, N W I (Courtesy J. R. Knoll)

sonably adequate soil, peculiar and special market conditions are present to supply high returns per unit of produce.

A number of greenhouses in the United States have accumulated considerable commercial experience with gravel culture during the past ten years. Results have varied somewhat, as can be expected with the practical application of a new method. Further, the recent war markedly interfered with the program of gravel culture development in the commercial greenhouse. Several representative greenhouses will be mentioned to illustrate the extent of this method. No attempt is made to include all known greenhouses that operate gravel culture units.

The Geo. J. Ball, Inc. greenhouse at West Chicago, Illinois, has

worked with gravel culture for at least eight years. Several floral crops have been grown in a total bench area of about 6000 square feet on a semi-commercial basis. Such crops as sweet peas, carnations, stocks, snapdragons, and chrysanthemums were produced. This company feels that more work is needed to fully evaluate gravel culture in the greenhouse. Several factors which they feel

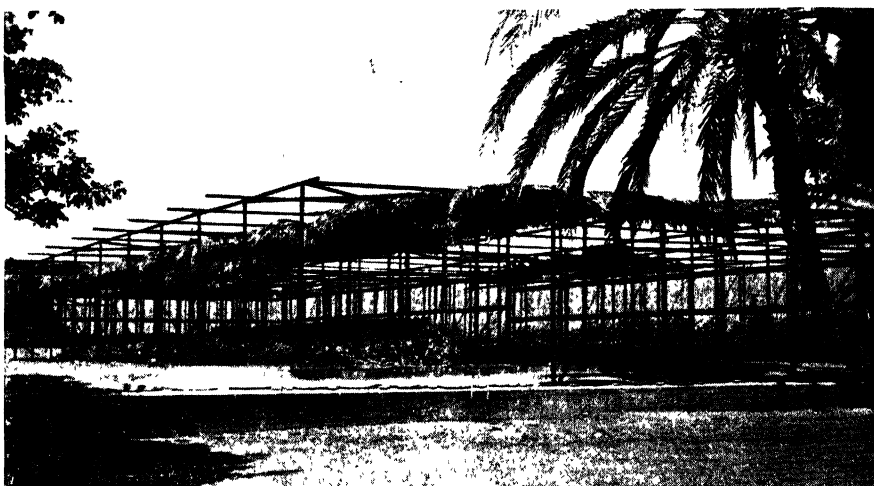

Figure 2-15. General view of C.P.I.M. Hydroponics Garden, Curacao, N.W.I. (Courtesy W. R. Mullison)

require more work include (1) improved bench construction, particularly benches that will withstand steam sterilization; (2) trained supervisory help; and (3) a satisfactory and reliable source of chemicals (this was a major point during the recent war).

The A. F. Amling Company, Maywood, Illinois, originally had promising success with gravel culture. This greenhouse maintained some gravel culture for the production of several floral crops until 1946. Several factors were noted to explain their recent decision to discontinue gravel culture in their ranges. These points included (1) difficulty of obtaining waterproofed beds; (2) bench failure when sterilizing with steam; (3) difficulty of obtaining the correct grade of chemicals during the war; (4) the bottle neck caused by concentration of responsibility in one trained operator; and (5) difficulty of starting plants, particularly when transplanted.

Proper construction will eliminate the waterproofing problem.

Also, the further development of metal, steel or aluminum benches will insure more sturdy beds, which, moreover, should withstand steam and hot water sterilization. The use of chemical sterilizing



Figure 2-16. Cutting celery, swiss chard, and tomatoes growing in the C.P.I.M. Hydroponics Garden, Curacao, N.W.I. (Courtesy W. R. Mullson)

agents instead of steam will solve this problem (see Chapter 10). Numerous nutrient solutions may be formulated from several substitute salts which will produce reasonable results. Proper training of regular greenhouse personnel by teaching the simplest rudiments of gravel culture will reduce the centralization of responsibility. Plants will start in gravel, whether direct-seeded or transplanted, just as readily as in soil. The chief difficulty reported appears to be in the

common, but incorrect, practice of excessive watering of the transplants when first set out.

The J. L. Dillon greenhouse, wholesale and retail florist, in Bloomsburg, Pennsylvania, reports commercially successful rose production in gravel culture. A start was made with two experi-

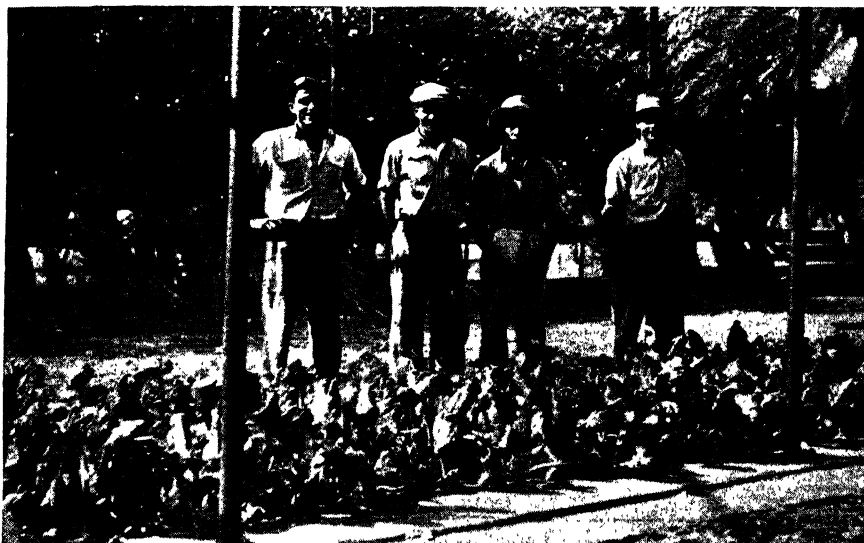

Figure 2-17. Excellent swiss chard growth in the C.P.I.M. Hydroponics Garden, Curacao, N.W.I. (Courtesy W. R. Mullison)

mental beds containing about 1500 plants five years ago. For the past three years 8000 rose plants have been in gravel culture production. Gravel production was similar to soil production, but quality appeared to be better, in that stem length was greater. Results have been so gratifying that this greenhouse plans to increase its gravel culture area in the near future.

Mr. Ross Churchward, Columbia Station, Ohio, has grown carnations by the sub-irrigation method for six years, besides several other miscellaneous floral crops, including chrysanthemums, calendulas, sweet peas and asters. Haydite is used as the medium. Installation costs of gravel beds were estimated to be double that of soil beds. Production labor costs were reported to be about 50 per cent of soil culture operation, while operating material costs were similar for both methods.

Ninety per cent, or 9000 square feet, of this greenhouse is devoted

to soilless culture crop production. Carnation yields in gravel were not superior to yields in soil, but the quality was better. However, the keeping quality of the blooms was the same. Sweet pea production was doubled in the Haydite beds. Flower quality and stem length were also increased. Stem length of 24 inches was obtained



Figure 2-18. Panorama view of army Hydroponics unit on Ascension Island.
(Courtesy Science Service)

and production of 325 blooms per foot of row was achieved. Calendula produced about as well in Haydite as in soil, except that soilless culture improved the stem length and bloom size. Chrysanthemum results were stated to be excellent. Quality was also excellent, sufficient to win a number of first premiums at the 1940 National Chrysanthemum Show. Pompom yields were somewhat increased. Stocks did well in gravel. Snapdragons were not successful, but satisfactory results have been reported elsewhere. Asters of high quality were also grown by Mr. Churchward, and he reported observing elsewhere good crops of lilies, daffodils and iris. He cau-

tioned that many problems develop in gravel culture, but stated that this method of greenhouse crop culture is here to stay.

Yoder Brothers, wholesale greenhouse at Barberton, Ohio, are one of the pioneers in the commercial development of soilless culture in the greenhouse. Practical research in gravel was initiated in 1936. Experimental work with sand slop culture was started several



Figure 2-19. Close-up view of Hydroponics Garden (plant bed section) on Ascension Island. (Courtesy U. S. Army, A.A F)

years previous to that date. Much experimental and semi-commercial work has been done by this company with numerous cut flower crops, including roses, gardenias, chrysanthemums and snapdragons. Other crops included snapdragon seed and tomatoes. The recent war greatly curtailed this company's development work with gravel culture. The present commercial area includes about 2200 square feet for chrysanthemums, 500 square feet for roses, and 1300 square feet for carnations. Yoder Brothers plan eventually to grow all their floral crops in gravel culture. Figures 2-4 and 2-5 are photographs taken in their range.

The J. W. Davis Company, Terre Haute, Indiana, has used the gravel culture method on both an experimental and semi-commer-

cial basis for about eight years. Quite satisfactory results were reported with tomato and cucumber grown in a local calcareous gravel. As with many other greenhouse concerns, the war retarded gravel culture development. Recent information supplied indicated



Figure 2-20. View of the main hydroponics beds at Ascension Island. Note the use of overhead netting to provide shade for the tender young plants. (Courtesy Science Service)

that present results are not sufficiently striking to warrant immediate expansion. Figure 2-6 shows an early experimental bed of cucumbers.

A. Rasmussen and Son, Florists, New Albany, Indiana, are producing roses in cinder culture. In 1941, 6600 square feet were devoted to soilless culture. Difficulty in securing chemicals during the war caused reduction of the bench area to 600 square feet by 1946. Results were reported to be variable, but still promising—at any rate sufficient to warrant continued experimentation. Labor production costs were estimated to be lowered about 25 per cent because no watering and fertilizer applications by hand were needed. Nutrient salt costs were considered to be similar to soil fertilizer and manure costs.

It was of interest to note Mr. Rasmussen's comment upon the best method of judging the water requirements of the soilless culture unit. Originally time-clock operation of the nutrient solution



Figure 2-21. Use of asphalt-lined beds and solution drainage trench (shown above) in hydroponics at Ascension Island. (Courtesy U. S. Army, A.A.F.)

pumping schedule was used. Experience soon indicated that "ordinary rose grower's common sense," developed with soil culture, was much more successful. That is, the pumping was done only when the cultural conditions dictated.

The application of hydroponics to outdoor culture of crops is chiefly centered in sub-tropical and tropical climates. Both commercial and governmental agencies operate these gardens.

During the last six years a commercial unit has grown tomatoes

for the so-called "ripe" market in the Miami, Florida, area. This garden, Modern Farms (Kendall, Florida), now comprises two acres. More recently several other outdoor installations from one-quarter to two acres in size have been set up in this area. Figures 2-7 and 2-8 are photographs taken at Modern Farms. Figures 2-9 and 2-10 were taken at Flagler Farms (Kendall, Florida).

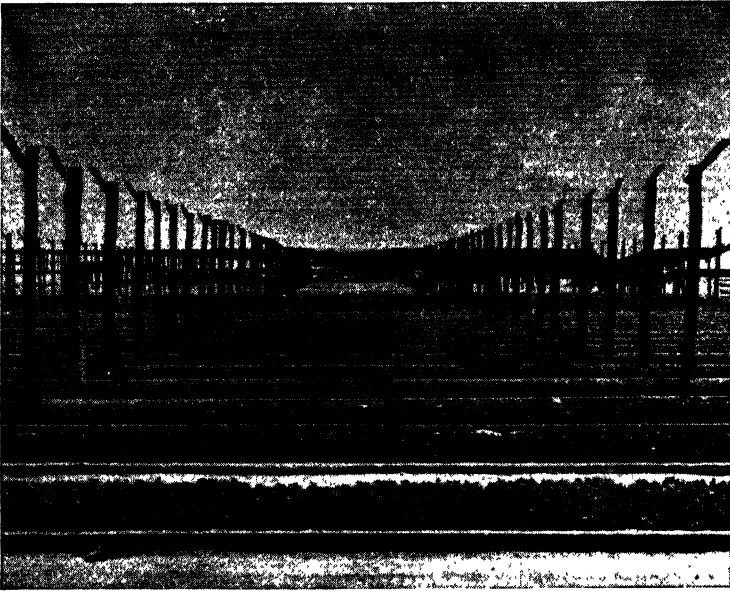

Figure 2-22. Looking across beds of lettuce in Atkinson Field Hydroponics Garden, British Guiana, South America. (Courtesy Science Service)

The Lago Oil and Transport Company, Limited, Aruba, Curaçao, N.W.I., operates a small hydroponic garden on this barren coral island in the Caribbean Sea. The Shell Oil Company (C.P.I.M.), Curaçao, N.W.I., likewise operates a similar sized garden (about one-quarter acre) on the neighboring island of Curaçao. The produce grown is for the company commissaries at the respective refineries. Tomatoes are the chief crop, but various salad and cooking vegetables are grown quite satisfactorily in these two gardens. By the choice of the proper variety of tomato, production is possible throughout the year. An average of ten pounds of fruit per plant during the winter season and six pounds during the summer season is commercially realized. These yields compare favorably with

average commercial production in the greenhouse in the United States. This means that a single 100-foot bed can produce a ton of tomatoes during one year (this requires two separate crops). Ex-



Figure 2-23. Army Hydroponics Garden on Iwo Jima (Courtesy Geo. J. Ball, Inc.)

perience obtained since 1944 fully indicates the possibilities of hydroponics in barren tropical islands. Figures 2-11, 2-12, 2-13 and 2-14 show scenes at the Lago garden. Photographs of the C.P.I.M. garden are given in Figures 2-15, 2-16 and 2-17.

The United States Army Air Force started a hydroponics branch about 1944. Two angles of approach were used, one for convalescent hospitals and the other for the actual production of fresh vegetables at barren Army outposts. A small unit has been in operation for some time in Coral Gables, Florida, at an Army convalescent hospital. Figure 2-24 was taken in Coral Gables.

Three larger units are in use for food production purposes. The first unit on Ascension Island (Figures 2-18 through 2-21) in the South Atlantic Ocean has a bed space of about 30,000 square feet. A larger unit at Atkinson Field, near Georgetown, British Guiana,

South America, covers an area of about four and one-half acres (Figure 2-22). Another unit was more recently set up in Iwo Jima (Figure 2-23) in the Pacific Ocean. Such crops as tomatoes, cucumbers, lettuce and radishes are produced in these gardens for Army personnel in the area.

Suitable data upon installation and operation costs of gravel culture gardens are not available; partial figures are on record, but no true overall cost picture can be presented. Local conditions govern the commercial unit construction and operation charges. It is beyond the scope of this book to attempt to give actual cost data. Consultation with successful growers appears to be the best means of obtaining preliminary figures.



Figure 2-24. Hydroponics garden of U. S. Army Air Force at Coral Gables, Florida.

Chapter 3

Water Culture

Certain considerations must be met and solved to operate a water culture unit properly. These matters may be divided for convenience into cultural, constructional and operational problems.

Special Cultural Problems

Cultural problems include three major factors. Several nutritional aspects of the actual nutrient solution, which are important in all types of culture, but are sometimes of special importance in water culture must be taken into account. Certain physical conditions in the nutrient solution must be properly met. Another cultural problem is the development of the plant support.

Nutritional Aspects of the Nutrient Solution. Numerous nutrient solutions may be used in this type of culture. Any one of the solutions listed in Table 6-6 (page 142) are adaptable. However, in water culture, because it is essentially a non-buffered system, more exact control of the nutrient solution is often necessary, particularly the acidity, phosphate, and iron relations.

Solution Acidity. Plants often appear to be more susceptible to adverse acidity conditions of the solution in water culture than in either sand or gravel culture. Probably one reason for this effect is that phosphate coatings may occur on the surfaces of the solid media and exert an acidity-stabilizing action. Thus any extreme changes occurring in the nutrient solution *per se* are not as readily reflected upon the plant roots in contact with the sand or gravel particles.

Phosphate Level. Nutrient solutions possessing high phosphate levels are usually not recommended for fluid culture. Excessive precipitation of the minor elements, particularly iron, occurs when the phosphate content is too high. This is particularly true in unbalanced nutrient solutions which tend to become alkaline quickly. However, if proper balance between alkaline and acidic ions is pres-

ent in conjunction with a phosphate level sufficiently high to exert a buffering action, the problem will not be as serious.

Iron Level. Iron is often difficult to maintain in an available state in the nutrient solution. Frequent additions in low concentrations are suggested to insure adequate supply without toxicity. Sometimes it is most practical to apply the iron solution to the litter in the plant support tray. Under the moist conditions of the litter the iron apparently remains in an available form for a longer time.

These nutritional factors are discussed more fully in Chapters 6 and 7. Although the discussion in these chapters bears mainly upon gravel culture, the manipulations directly concerned with the nutrient solution apply to all types of soilless culture.

Physical Aspects of the Nutrient Solution. Several physical conditions must be handled correctly to promote proper plant growth. These include (1) root darkness, (2) aeration, (3) circulation, (4) heating, (5) cooling, and (6) rainfall.



Figure 3-1. Effect of forced aeration on corn plants grown in nutrient solution. Good aeration. (Ohio Agricultural Experiment Station)

Root Darkness. The roots must be kept in darkness. Roots will grow in the light, but extraneous circumstances demand darkness. Various green algae—small, green water plants—will grow in the nutrient solution in the presence of light, and will interfere with

the proper growth of the crop. Algae compete for nutrients, reduce the solution acidity, and make the culture messy and odorous. During the daylight period the algae will produce plenty of oxygen, but during the night they will compete for the oxygen content of the nutrient solution. It may be possible to cause excessive oxygen conditions in the culture during the daylight period by the release of oxygen by the algae. Further, decomposition products effected by dead algae may be somewhat toxic to the roots, and thus interfere with their development and function.

Aeration. Proper aeration is the major key to success in the free liquid type of nutrient solution culture. Plant roots require an adequate oxygen supply to support satisfactory plant growth. Figures 3-1 and 3-2 well illustrate this necessity. However, some published work and practical observations indicate that over-aeration is entirely possible and should be avoided. About three to five parts per million of oxygen in the nutrient solution appear to suffice (at 60° F).

This may be accomplished by forcing air under pressure through an aerator. The aerator may be constructed with small iron pipe or

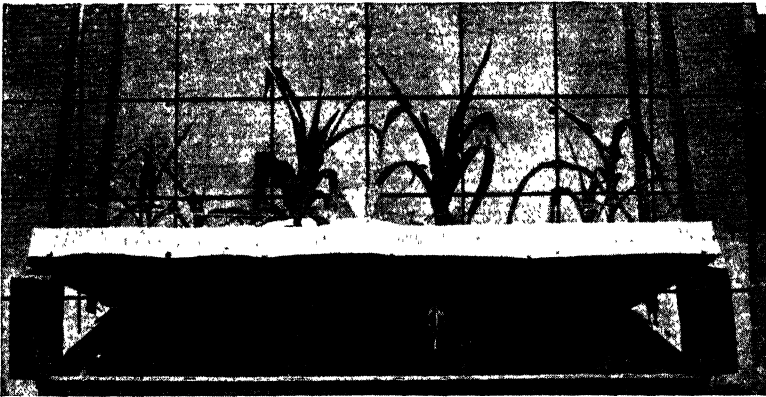

Figure 3-2. Effect of forced aeration on corn plants grown in nutrient solution. No aeration. (Ohio Agricultural Experiment Station)

glass tubing. One-half inch pipe with one-eighth inch holes bored along the sides a foot apart in a staggered fashion is serviceable. A similar set-up with glass tubing for orifices may be made. Experience will indicate the volume of air needed, which depends upon the solution volume, the temperature, and the kind of plant. Prob-

ably a rate of 5 to 10 bubbles per minute will suffice. Sometimes a more rapid rate, 10 to 20 per minute, for about 15 minutes every hour is effective.

Another technique, developed by the Ohio Agricultural Experiment Station, is to attach a small tube to the intake side of a circulating centrifugal pump. This pipe, about one-quarter inch in diameter, is attached to the intake side piping and rises to a level above the nutrient solution in the tank. A small gas type valve is put on top of the riser to adjust the air intake. As the pump circulates the nutrient solution air is sucked into the pump and mixed with the liquid.

The maintenance of a two- to three-inch air space between the liquid surface and the crown of the plant or the bottom of the tray is somewhat effective in supplying some air to the roots. It appears that the portion of the roots in this moisture-saturated atmosphere is capable of absorbing sufficient oxygen for respiration of the roots.

Further, when the roots grow in the litter or bedding, which is supplied with both nutrients and water, aeration is possible. These roots are well situated to obtain ample oxygen because of the porous nature of the environment.

When the culture maintains the litter tray with an air space beneath, forced aeration is apparently not absolutely needed in order to secure satisfactory plant growth. Forced aeration is definitely needed to secure the best results in non-litter water culture.

Circulation. Circulation of the nutrient solution is sometimes recommended. The chief reasons for this are better distribution of the nutrient ions and better aeration. The solution reactions are undergoing change at the root surface. It is felt that movement of the solution past the roots would help stabilize their environment. Of course, the motion must be reasonably slow or mechanical injury to the roots would result. Actually, practical conditions do not support these contentions.

The other factor, aeration, is not completely fulfilled merely by a slow movement of the solution. Either passage over a baffle, similar to those used at city water works, or injection of air into the fluid, as mentioned above, is necessary.

Heating. Some workers recommend heating the nutrient solution to improve plant growth. An increase of 10 to 20° F above average night temperature is usually suggested. Where circulating

systems are installed, the nutrient solution may be passed through an external heat source. In stationary units, electrical, hot water, or steamcoils may be placed in the tank. As mentioned in Chapter 8, the benefits of heating the nutrient solution depend to a large extent upon the specific circumstances.

Cooling. The opposite effect, that is, to prevent the nutrient solution from becoming too hot, is important under hot, bright climatic conditions. The solution basin must be protected from the direct rays of the sun. Constructing the tanks imbedded in the supporting fill or placing mulch around the tanks will help solve this problem; also, increasing the depth of the litter, which acts as a mulch, will tend to insulate the solution. The nutrient solution should not become warmer than the daytime air temperature and preferably not over 90 to 100° F. Chapter 8 deals with this problem in more detail, particularly in reference to gravel culture, but the principles involved are the same for water culture.

Rainfall. Another physical problem is rainfall. Since the litter on the tray is porous, water will enter the basin and overflow it in time. Usually an overflow is installed to prevent the solution level from being changed. The units may be covered with waterproof material, like roofing paper or rubberoid asbestos sheets, but must be painted white to prevent excessive temperature rise.

Plant Support. The following discussion refers entirely to the litter type of culture. The problems of bedding depth, porosity, and water retention are not present in non-litter culture. Either a cork or a wad of non-absorbent cotton suffices to hold the plant in place in the container. In the litter type a portion of the roots grow in the bedding; hence certain physical factors must be considered. These roots provide support, absorb moisture, and oxygen, and take up nutrient ions in the bedding medium.

Litter Depth. The depth of the bedding or litter is greatly influenced by the kind of plant grown, particularly by its type of root system. Plants possessing relatively weak, slow-growing roots should be placed in a shallow tray, not over two inches thick. Other plants require a four-inch thickness of litter (potatoes fall into this class).

Another factor influencing the depth of bedding is the insulation properties required for hot weather. Shallow beds allow the nutrient solution to become too warm. The bedding thickness must be increased to counteract this effect.



Figure 3-3. Begonia growing in water culture.

Rainfall also influences the bedding depth. In areas where rainfall is heavy, excessive wetness of the litter may result, especially if the litter is too thick and does not dry out readily. This problem is of importance from the disease standpoint.

Litter Porosity. The porosity of the litter is also related to disease incidence. Tightly packed trays, containing much fine material, stay wet much longer than coarser beddings.

But the type of root system is a factor in this respect, too. Plants like lettuce or carrots require a finer root medium than plants like rose or tomato. Thus the litter must be prepared by properly proportioning fine and coarse materials. This will afford proper support, moisture, and aeration conditions for the roots.

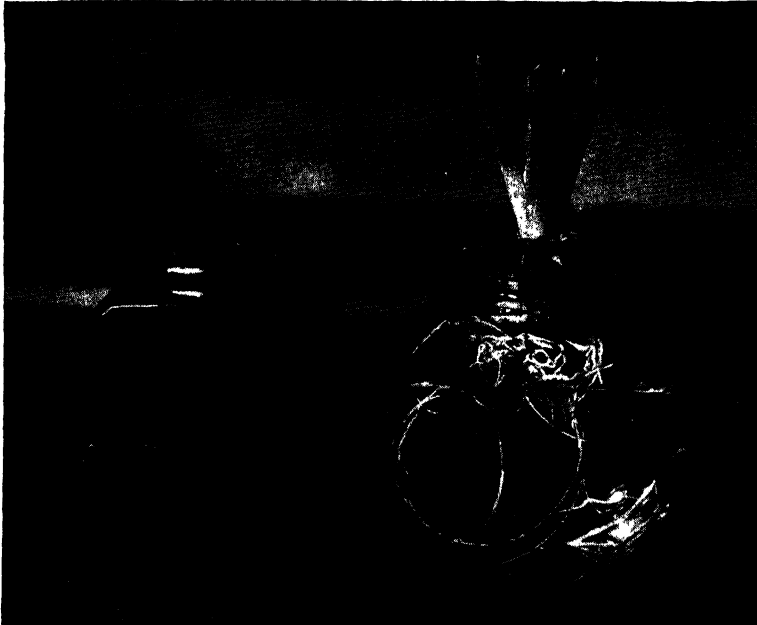

Figure 3-4. Water culture arrangement for bulbar or tuberous flowers such as hyacinth.

Moisture Retention of the Litter. Moisture retention of the litter materials is an important factor in their choice. Materials which dry out too easily are not satisfactory if root growth is desired in the bedding. However, for crops which are quite susceptible to root and crown rots, a non-absorbent material placed close to the plant crown is advisable. Substances which hold moisture too well must be utilized sparingly, especially in areas of heavy rainfall. The best litter should contain a mixture of these types of materials.

Unit Construction

The construction needs for a water culture installation first depend upon the type of unit desired. Home use requirements may be



Figure 3-5. Continuous-flow method of water culture. (New Jersey Agricultural Experiment Station)

the same as commercial needs; on the other hand they may be entirely different.

Home Use. Any kind of glass or porcelain container is suitable to grow plants in water culture around the house. Even metal pails are satisfactory if properly asphalted inside. As long as the roots are kept in the dark and adequate aeration and light are supplied, the plants should develop satisfactorily in agreeable surroundings. Aeration in these types of cultures is handled by maintaining a two-inch air space just above the solution level. Figures 3-3 and 3-4



Figure 3-6. Continuous-flow method of water culture. (New Jersey Agricultural Experiment Station)

indicate one type of set-up. Wads of non-absorbent cotton may be used to hold the plant in place. Also, soft muslin or cheese cloth may be utilized. In other cases, corks perforated with a hole of sufficient size are adequate.

Another technique developed by the New Jersey Agricultural Experiment Station is presented in Figures 3-5 and 3-6. This

method provides for continuous circulation of the nutrient solution. Aeration is obtained by forcing air under pressure into the culture. The "spent" solution may be collected and re-used for several days or a week if desired. The rate of flow is adjusted to approximately one quart per day and is increased to two to four quarts when the plant becomes quite large. The system is essentially a drip culture



Figure 3-7. Aeration device for water culture growth. Each drop of solution which falls from siphon tip (upper left corner) forces a slug of air down through tube, the air then bubbling through the solution in region of roots. Inset shows full view of set-up. Efficient aeration favors good root growth.

unit, using capillary tubing about 0.5 mm inside diameter. This method is particularly adaptable for the "scientifically bent" hobbyist (see Chapter 4 for sand drip culture).

A refinement of the above technique is seen in Figure 3-7. This procedure does not need an additional source of air. The inlet tubing outside the plant container is increased in length and height. Each drop of nutrient solution from the reservoir falls through an air space to develop sufficient velocity to trap a "slug" of air in the intake tube of the plant container. Thus, as the nutritive liquid flows into the root area, a bubble of air is carried along with it.

Of course, the home gardener may also use the same means of construction as outlined below for commercial purposes.

Commercial Use. The construction of the commercial unit should be considered in three steps. These include the basin or tank, the tray, and the bedding or litter material.



Figure 3-8. Two wooden troughs ($7 \times 1 \times 1$) for water culture unit.

Tank Construction. Concrete, metal or wood are the usual construction materials. Concrete is probably the cheapest permanent material. Redwood and cypress are probably the most durable woods. Regardless of the construction material, the tank should be made sturdy and should be waterproofed. It is recommended that a coat of asphalt be applied to the internal surfaces. Either hot-mopped asphalt or asphalt emulsion is satisfactory. Sometimes a good grade of asphalt paint is serviceable on metal surfaces. No



Figure 3-9. Wire basket ($\frac{1}{2}$ -inch mesh) partly filled with excelsior. Any convenient mesh can be employed. Wire should be painted with asphalt before use.

coal-tar asphalt should be used, but only petroleum asphalts; a grade of about 180° F softening point is suggested.

The dimensions of the culture unit depend upon the individual circumstances. Widths of 12 to 42 inches and 25 to 100 foot lengths are usual. Crops like sweet peas, cucumbers and tomatoes may be grown in a single row in 12-inch wide tanks. The tanks may be spaced 24 to 36 inches apart. A standard width for greenhouse benches is 30 to 42 inches. Lengths of 25 to 100 feet are common,

depending upon the size of the greenhouse. (Units 10 to 25 feet long may be more practical in the home garden.)

The depth of the tank should be at least six to nine inches. This will allow space for 4 to 6 inches of solution with two to three inches of air space underneath the tray. Most crops will do well with four inches of nutrient solution and with two inches of air space; thus a six-inch deep tank is suitable. Figure 3-8 is a typical illustration

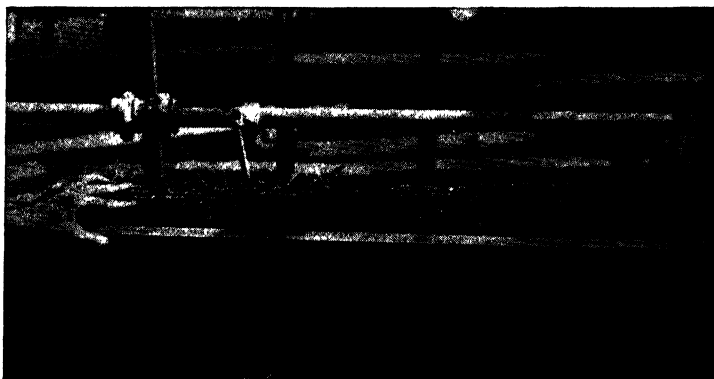

Figure 3-10. Plants grown in wire basket support. Note roots below. Basket is in raised position.

of a water culture basin. Figures 3-9 and 3-10 are photographs of two basket arrangements.

Tray Construction. The framework of the bedding or litter tray may be made of wood, concrete, metal strips, or all wire mesh. This tray may either fit on top of the tank or be fitted into a recess on the tank (in this case the tank must be at least two to four inches deeper than usual). The tray is usually two to four inches deep, depending upon the crop requirements. Across the bottom of the tray wire mesh is tightly stretched and supported to avoid sagging. Hardware cloth of one-quarter to one-half inch mesh or one-inch chicken wire is used, depending upon the type of crop and the litter. Usually one-inch mesh is the best and most adaptable. Proper choice of the bottom layer of bedding will prevent any fine materials from falling into the nutrient solution. The wire mesh must be coated with asphalt to prevent any possibility of zinc toxicity.

Bedding or Litter Material. Numerous materials may be used for the bedding or litter. Various mixtures of material appear to work

better than single items. The type of roots of the crop and whether direct seeding or transplanting is followed all govern the final decision in preparing the litter. Excelsior, straw, salt hay, wood shavings, coarse sawdust, chaff, peat moss, sphagnum moss, leaf mold, dried hay, rice hulls, sand, and even soil are used as components of the litter. Toxic materials should be avoided. If any doubt arises, germinate a few seeds in the material in a flower pot and grow the seedling for a week or two by applying nutrient solution. If no root damage or stunting of the plant develops, the material is safe to use.

Unit Operation

If the plant is to be grown in jars wherein no litter is used, it must be started elsewhere. These plants may be grown from seed in soil,

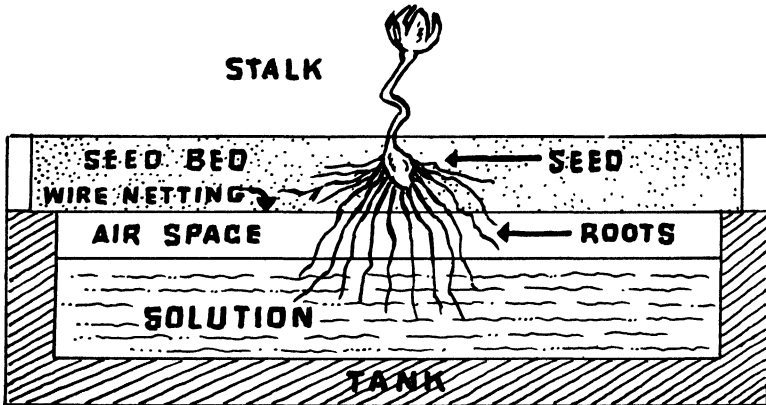

Figure 3-11. Diagram of litter type water culture unit. (After W. F. Gericke)

sand, or special seed beds as illustrated in Figure 3-12. The same procedures may also be used for preparing the plants for litter type cultures. When transplanting the young seedlings, the soil or sand adhering to the roots may be gently removed by washing in water.

With litter-type cultures, either direct seeding or transplanting may be practiced. After the plants are started, the solution level must be adjusted. Then the water supply, nutrient ion content and the solution acidity must be carefully followed.

Seeding. As mentioned above, the make-up of the litter depends upon whether direct seeding or transplanting is to be done. For direct seeding of small seeds, the upper one to two inches of litter

should be a fairly fine material like rice hulls, peat moss, sand, or even soil. The depth of the coarser layer beneath the fine layer is dependent upon the type of root and the rate of root elongation of the particular crop. Plants which produce rapidly growing roots will reach the solution quickly, hence will readily pass through a thicker and coarser layer of litter. Also, tap root and fibrous root systems which are vigorous can tolerate a coarse underlayer; but some types of tap-rooted plants, like carrots, are very delicate in the young stages and require a fairly fine germinating medium.

Transplanting. Transplants, like young tomato plants or carnation cuttings, may be set in a reasonably coarse litter. Enough fine



Figure 3-12. Germination net for use with nutrient solutions. Seeds are placed on paraffined cheesecloth stretched over pan of diluted stock nutrient solutions, the level of the latter being brought up to touch seeds. The seedlings may be easily removed and transferred. Sprouting by this method may be carried on in full sunlight provided solution level is not allowed to drop. Center, buckwheat seeds germinating; right, oat seedlings of convenient size for transplanting. (Courtesy J. W. Shive and W. R. Robbins, N. J. Agricultural Experiment Station)

material is mixed with it to insure adequate moisture conditions around the roots in this litter. The plants are placed in the bedding in such a manner that about one half the length of the roots dips into the nutrient solution while the other half remains in the litter. Any soil or sand attached to the roots may or may not be removed before transplanting (see Chapters 9 and 11).

When the plants are young, whether started from seed or transplants, both moisture and nutrients are applied to the litter to stimulate root growth. Either the nutrient solution or the dry mixture of chemicals can be used. When the dry mix is spread in the litter, it is watered in like fertilizer in soil. The same quantity of

dry chemicals is applied to the litter that would be used to prepare the full volume of the nutrient solution for the specific tank.

Usually the application of dry fertilizer to the litter occurs at the same time that the initial fresh solution is prepared. The frequency of later dry applications depends upon the growth responses. Often it is recommended that all subsequent additions of nutrients to the solution be made via the litter. When the fertilizer is watered in, some remains in the litter and the rest flushes through to the tank.

Solution Level. The nutrient solution level is maintained at a high level until the roots reach well into the liquid. The fluid must be within one-half to one inch of the bottom of the tray, but not close enough to wet the tray. As the roots elongate, the solution volume is reduced gradually until a two- to three-inch air space exists between the top of the liquid and the bottom of the tray. The overflow pipe of the tank is then adjusted to maintain this volume.

Water Additions. Water is usually added daily to maintain the proper volume in the unit. When the plants are young, the litter is kept moist. This holds true for many crops during their entire life in the plant bed. Of course, for some crops the litter should be dried down as the crop nears maturity.

Nutrient Ion Additions. The nutrient solution composition should be held within certain limits to support good crop production. See Chapter 7 for details.

Solution Acidity. The proper degree of solution acidity should be checked frequently, at least daily until experience dictates otherwise. See Chapter 7 for details.

Chapter 4

Sand Culture

Each type of soilless culture has certain special problems which must be given specific consideration. The sand culture technique will be discussed with this viewpoint in mind.

Special Cultural Problems

Several nutritional aspects of the nutrient solution may be briefly mentioned. Actually the nutritional problems of sand culture are relatively simple compared to those of water and gravel culture. But the physical considerations differ somewhat from water culture, but are quite similar to those of gravel culture.

Nutritional Aspects of the Nutrient Solution. Any of the nutrient solutions listed in Table 6-6 (page 142) are usable for sand culture crop production. In fact, the choice of suitable nutrient solution is less exacting for this method. As with all kinds of soilless culture, the solution acidity, the phosphate and the iron relations must be properly adjusted. Brief mention is made at this point upon these subjects, while a fuller discussion will be found in Chapters 6 and 7.

Solution Acidity. Fairly wide fluctuations in acidity of the root media are permissible in sand culture. At least under experimental conditions reasonably satisfactory plant growth is reported with a range of strongly acid to slightly alkaline solutions (see Chapter 7). However, best production for most crops occurs in the range of medium to slight acidity. Some lime-loving plants will do well even at neutrality (pH 7.0). The adjustment of the solution acidity is an external matter, in that the acidity of the solution applied is corrected. If the medium is not unduly acidic or alkaline and if the solution is well stabilized, the acidity will remain within correct limits.

Phosphate Level. Sand culture-grown plants appear to be able to tolerate high phosphate levels in the nutrient solution. This is

probably a physical problem in that the excess phosphate is precipitated to insoluble compounds within the sand. Thus the safety level for the upper limits of the phosphate content is quite high for sand culture compared to water or even gravel culture. However, there is no point in maintaining a level any higher than five millimoles (see Chapters 6 and 7). In fact, it is possible to treat the sand with a concentrated phosphate solution prior to planting and then omit subsequent phosphate applications for the entire crop or for a considerable portion of its life (see both Dry Salt Method (page 83) and Chapter 5).

Iron Level. Usually maintenance of an iron supply in sand culture offers no special problem. Addition of ample supplies to the nutrient solution before application to the sand appears to take care of the problem satisfactorily. Many sands contain sufficient iron for the plant needs. However, when silica and quartz sand are used iron must be added to the nutrient solution.

Some people recommend the addition of insoluble iron compounds to the sand before the plants are set. About one-tenth per cent by volume of magnetite, an iron oxide compound, is suggested.

Physical Aspects of the Nutrient Solution. The peculiar nutritional aspects of sand culture are primarily physical in nature. In other words, sand culture requires knowledge especially in the proper handling of media and the nutrient solution. The nutrient solution *per se* is of secondary consideration as long as a reasonably well-balanced solution is employed. But the following factors must be considered, namely, type of sand, aeration, drainage, moisture applications, solution applications, medium flushing, medium temperature and rainfall.

Type of Medium. Naturally the medium must not contain any toxic substances. Chemically inert media, like silica and quartz sand, are serviceable, but are too expensive for commercial use. Ordinary bank run building sand is satisfactory, but the calcareous content should not be above 20 per cent for best results. Sand with a 50 per cent calcareous content may be used if a pre-treatment with phosphate is used (see Chapter 5). Fine grades of cinders, Haydite, granite chips or other gravels used for gravel culture are usable.

Quite often 25 to 50 per cent by volume of peat moss is added to sand to improve moisture retention; it also helps reduce the alkalinity of alkaline media because peat moss is an acidic material.

Further, it will loosen up a very fine medium and improve aeration.

Other usable media, particularly for home use, include glass wool, rock wool, pumice and granulated mica.

Aeration. This factor is governed by the particle size of the sand and the frequency of moisture applications. Very fine sands do not dry out readily, but remain water-logged and interfere with proper root aeration. Too frequent moisture applications also keep the sand too wet. This results in poor growth because of insufficient oxygen for the roots. Practical experience indicates the importance of root aeration in respect to particle size of the medium. Much more rapid growth of chrysanthemum and petunia plants was noted in a coarse sand, about $\frac{1}{32}$ to $\frac{1}{16}$ inch diameter, than in a fairly fine sand, 40 to 100 mesh.

Another practical example of excessive watering of sand was observed with chrysanthemums grown in propagation beds for cut flowers in the fall. The sand was of about 40 to 100 mesh size and was mixed with about 50 per cent of peat moss. Daily watering was followed in spite of cool air temperatures and cloudy weather. The crop was not very successful. If this crop had been watered only two or three times a week, results would have been more satisfactory.

Drainage. Drainage is closely tied up with aeration. If drainage is not adequate, root aeration is impaired. The same factors which are associated with proper aeration apply here also. Still another physical factor must be properly approached, namely the provision for drainage at the bottom of the sand container or bench. Properly sized and spaced openings must be placed to allow the excess solution or water to run completely through the medium. Do not try to grow plants in sand culture wherein drainage holes are not present, unless you have had considerable experience with plant growing. Plants can be grown in both soil and sand in non-draining cultures for experimental purposes, but it is not recommended for amateur use.

An illustration of an actual case in a greenhouse will suffice to stress this point quite strongly. It was attempted to grow Euphorbia in rose cases after the grafting season was over. The glass superstructure was removed, but the practically watertight benches were retained. The building sand medium was also too fine for best sand culture results. The crop was practically a failure because too fre-

quent watering was done in conjunction with inadequate drainage. In fact, several of the benches became full of water on several occasions. Naturally the plant mortality was high. A much smaller planting made about the same time, but in a coarser sand in a well-drained bench, grew quite well.

Water Applications. The brief discussion here implies application of water to the medium, whether water or nutrient solution. Experience is the best guide in establishing when to add moisture. The sand particle size, the sand depth, the kind and size of plants, and the climatic conditions all influence the water requirements. More detailed instructions are given below (see page 78).

Nutrient Solution Application. Again experience with the particular conditions is the best judge for this problem. The kind and size of the plants and the climatic conditions are pertinent factors. Large plants require more nutrients than small ones. Cool, cloudy weather is conducive to reduced nutrient consumption, while hot, bright weather increases it.

Also, the type and concentration of the nutrient solution must be taken into account. Solutions containing low nitrate levels must be applied more often than those high in nitrate. Dilute nutrient solutions require more frequent additions than concentrated ones. Conversely, highly concentrated solutions must be used with caution as to frequency of application to eliminate the danger of excessive salt accumulation.

Several procedures are followed which will be discussed in more detail presently. They are:

- (1) alternation of water and nutrient solution application,
- (2) use of fresh nutrient solution for all moisture applications and
- (3) re-use of the nutrient solution for a definite period.

Flushing the Medium. This is an operation recommended in practically all literature upon sand culture. It is apparently an arbitrary safety feature. The idea is to prevent excessive accumulation of salts within the medium, upon its surface, and upon the base of the plant stems. Inspection of the nutrient solution recommended in some cases indicates that it is fairly concentrated. When such concentrated solutions are used for slop sand culture, intermittent water applications are in order. It is suggested that the sand be thoroughly flushed with water once a week or at least every two weeks.

It is obvious that this practice of flushing is wasteful of both water, chemicals and labor. Analyses of the sand with regular soil testing techniques is a better system of periodically checking up on salt accumulation.

Considerable work was done in the tropics in the development of sand slop culture for home garden use. Also much work was done for commercial purposes, using regular gravel culture media in slop culture units as a testing technique in nutritional studies. Some crops were grown for six months or more, in both fine and coarse media, without any flushing. Some cultures received nutrient solution two to three times a week and water the rest of the time. Moisture applications in these cases were made once or twice daily under the warm and bright tropical climatic conditions. Other cultures were given nutrient solution two to four times a day with no water application. Small plants under partial shade, like radish or lettuce, were fed twice a day, while six-foot tall tomato plants under no shade required four applications a day under the cultural conditions. Petunia, pine, cooking greens and New Zealand spinach were also grown. The quality and yield of these crops were satisfactory and no evidence of salt accumulation was present.

A "normal" concentration nutrient solution was used in this work. The osmotic concentration (see Chapter 7) was about 0.9 to 1.0 atmosphere. Sufficient solution was applied each time to cause some drippage. It is felt that these results can be secured under the cool, cloudy weather conditions prevalent in temperate zones. Continue the use of a "normal" concentration solution and modify the plant response by manipulation of the moisture supply, instead of using highly concentrated nutrient solutions. This will help reduce salt accumulation because fewer chemicals are used.*

The above discussion refers only to slop culture. Flushing in reference to drip culture is another problem. In units wherein the volume transferred is small, that is, where the rate of flow is slow, salt accumulation will occur on the sand surface and upon the base of the plant stems. Thus an occasional flushing with water is recommended, usually once a week. If "normal" concentration solutions are used, a weekly flushing with the "spent" solution should meet all flushing requirements under most circumstances.

* This discussion applies to year-round weather conditions, both winter and summer, in temperate zones.



Figure 4-1. Simplified sand culture experiment. Ordinary flower pot (with saucer) is filled with sand, and plant is inserted. Sand is first saturated with nutrient solution, and water sprinkled on as needed to keep sand moist. Coleus shown in photo was started as a small cutting in this sand pot.

Temperature of Medium. The same discussion given in Chapter 3 for the water culture method on heating and cooling the root medium applies to the sand culture method. Further details are given in Chapter 8 for gravel culture.

Rainfall. The only thing to do with sand culture units when it rains (in the case of outdoor cultures) is to let it rain. If the unit is properly constructed the excess water will be readily dispersed. Similar methods of nutrient solution application during prolonged rainy periods, as given for gravel culture in Chapter 8, apply to sand culture.



Figure 4-2. McGredy's yellow rose plant growing in sand slop culture pot.

Unit Construction

The basic principles of construction for sand culture units are the same for both home and commercial installations. Sand culture units require three phases of construction. These include the bed,

the medium, and the nutrient solution dispensing apparatus. This breakdown will be specified for commercial units, but only generalizations will be discussed for home unit construction. This is so because the number of types of containers suitable for home use is legion, and at least four methods of sand culture can be used.

Home Use. The four methods of sand culture applicable to both house use and back-yard garden purposes will be briefly discussed under the following headings: slop culture, drip culture, modified slop culture and dry salt culture.

Slop Culture. This type of "sand" culture is the simplest to set up. Practically anything may be used for a plant container, including flower pots, tin cans, barrels, drums, sewer pipes, metal and wooden boxes, etc. The major provision is that adequate drainage must be supplied. Usually the hole or holes at the bottom of the sand receptacle is covered with a wad of glass or rock wool to prevent the medium from flushing out of the container. Then the container is filled with the medium.

Figures 4-1 and 4-2 show coleus and rose respectively growing in a flower pot. Figure 4-3 is a picture of tomatoes growing in a hole-less glazed pot wherein an automatic siphon device provides the necessary drainage. Figure 4-4 illustrates another simple device for the home. Sewer pipes are also quite serviceable for use inside the house or on the porch. These illustrations noted in this paragraph are only suggestive of the list of containers which may be used for small, simple sand cultures. Even other media than sand may be utilized, as indicated in Figure 4-5.

Numerous kinds of containers may be used to store the nutrient solution. Glass carboys, porcelain-lined buckets, asphalted galvanized pails, asphalted 50-gallon steel drums, etc. are suitable. A measuring cup, tin can or a clothes sprinkler are satisfactory for pouring the nutrient solution upon the surface of the medium. Place a porcelain stew pan beneath the pot to collect the drippage. Larger units may be set up around the home as diagrammed in Figure 4-6 and illustrated in Figure 4-7.

Outdoors a convenient set-up is the use of wooden barrels or steel drums. The wooden barrels may be cut in half, crosswise. Two lengths of two-by-four lumber are nailed to the bottom to raise the unit off the ground. About four one-half inch holes are bored in the bottom of the barrel to supply drainage. Place a wad of glass



Figure 4-3. Simplified sand pot arrangement. Solution is sprayed by hand spray-bulb over the surface of the sand several times daily. Pot is equipped with automatic constant-level siphon tube which requires no priming after initial flow. Solution is used repeatedly for several days (depending on plant size) before replacing.

or rock wool over these holes and put the sand in the barrel. If the unit is much over 12 inches deep, place rocks in the bottom and cover with six to nine inches of sand.

An old steel drum may be cut either crosswise or lengthwise.

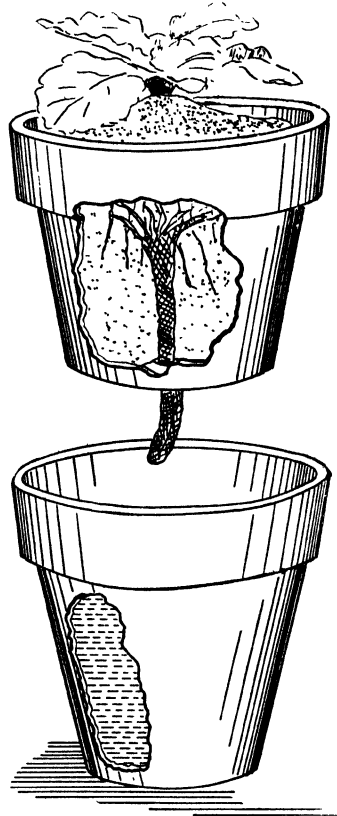

Figure 4-4. White gloxinnia. The picture was taken about a month before the blooming stage. Two years ago, a dark purple variety was grown successfully in the same pot and nine flowers were open at one time. The simple double-pot arrangement used is illustrated at the right. The lower receptacle is watertight and contains the nutrient solution. The upper one is an ordinary flower pot filled with coarse sand and fitted with a glass-wool wick that passes down through the bottom hole. When this pot is in position, the wick extends into the nutrient solution and draws it up. The wick is divided at the top and branches horizontally in opposite directions to distribute the fluid adequately. (Courtesy *Compressed Air Magazine*)

Drum halves, cut lengthwise, are suggested. They may be placed upon a suitable metal or wooden frame of any convenient height. Punch a one-inch hole in the center of the bottom for drainage. Cover the drainage hole and any holes in the ends of the drum with glass or rock wool prior to placing the medium.

Raised wooden or metal benches may be constructed. Ground beds are also in order if desired. For general suggestions on dimen-

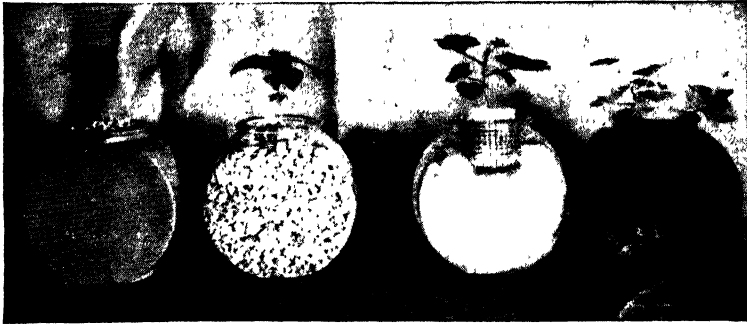

Figure 4-5. Two fuchsias (left) and ivy geraniums (right) in nutrient-solution bowls. The fuchsias are supported in lump pumice. Geraniums are growing in glass wool.

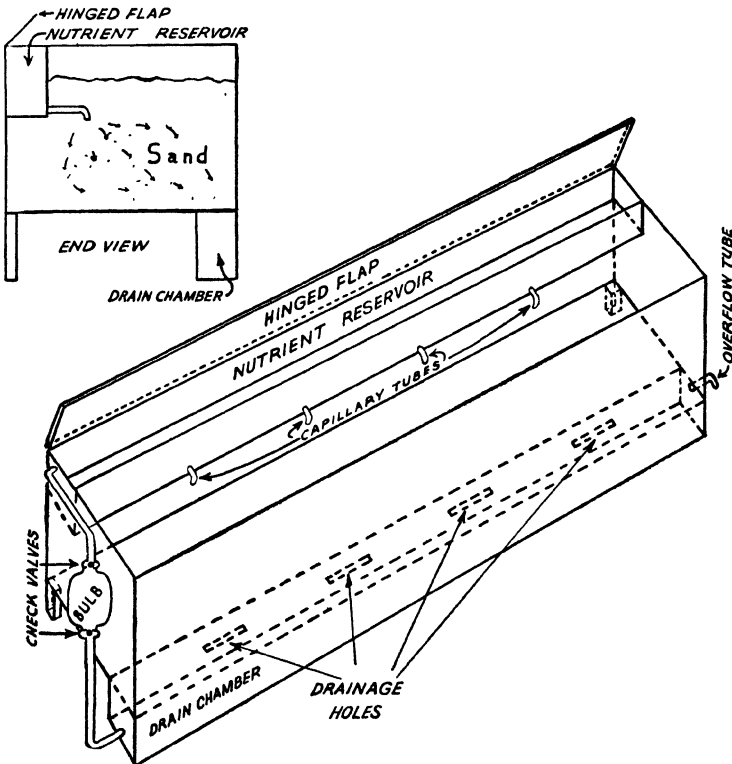

Figure 4-6. Diagram of window box equipped for continuous flow of nutrients through sand or other medium. Box may be constructed of wood or other non-toxic material. Galvanized containers and soldered seams should be avoided. Drainage holes are covered by wire screen to prevent sand from entering drain chamber.

sions refer to the section on commercial construction (page 76).

When metal or wooden containers are used, they may or may not be protected with a suitable coating. Internal surfaces may be covered with asphalt or paint. The asphalt may be applied as a hot mop, water emulsion or solvent paint. Contrary to popular opinion



Figure 4-7. Window box filled with young plants (geraniums, petunias, and German ivy). Reservoir has capacity of one-half gallon, and the solution is circulated once or twice daily. Seeds or cuttings may be germinated or rooted directly in this box. Rubber squeeze bulb (shown in photo) with oppositely faced check valves can be purchased as standard piece of equipment.

the use of ordinary house paint is safe to use on sand slop culture units; only moist sand is in contact with the painted surface and a year's experience in the tropics has shown no signs of toxicity. External surfaces are coated with regular grades of paint.

Drip Culture. The equipment needs for drip culture are similar to those for slop culture except that extra means must be provided to convey the solution to the culture automatically. If glass jars are used they should be painted black to exclude light and thus prevent algae growth.

Figure 4-8 well illustrates the usual drip culture employed for

experimental work; it is adaptable for home use. The necessary apparatus is indicated in general in the photograph. The quart mason jar rests in the saucer on the support. A 0.5-millimeter bore glass capillary tube is bent to fit over the edge of the saucer and under the mouth of the jar; that is, the tube is bent in a U shape. To regulate the dropping rate, the lower end of the tube is adjusted to be one to two inches lower than the solution level in the

Figure 4-8. Continuous flow set-up of rose bush growing in sand, nutrient solution dripping from glass jar which acts as reservoir. Small watch-glass or smooth-rimmed saucer should be inverted and placed over drain hole of pot to prevent sand from escaping. (Courtesy J. W. Shive and W. R. Robbins, N. J. Agricultural Experiment Station)

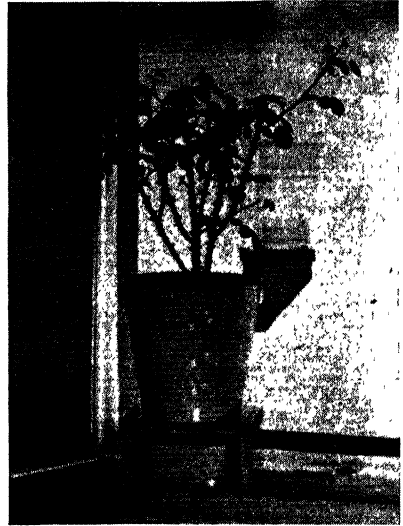

saucer. Figure 4-9 shows a rose plant thriving in a drip sand culture pot. A novel tandem arrangement of a series of drip cultures is shown in Figure 4-10.

The Ohio State Agricultural Experimental Station developed a large scale drip culture unit. A steel drum, asphalted inside, is a suitable solution reservoir. The secondary pressure-regulating tank may be of about three-gallon capacity. A bathroom toilet float and valve serves as the regulating device. The header arrangement is made with three-quarter-inch black iron pipe with one-eighth-inch nipples attached at convenient intervals to deposit solution at the base of each plant (every 18 inches apart for tomatoes). Drippers made of one-millimeter bore capillary glass tubing are connected to the iron nipples by three-sixteenth-inch rubber tubing.

The bed for the medium may be constructed either of wood or metal. Surfaces are protected by a good grade of petroleum asphalt.



Figure 4-9. Sand-cultured rosebush six weeks from dormancy. In center is remnant of blossom which opened several days earlier.

A tile is placed on the bottom to afford drainage to the lower end of the unit (see Chapter 5 for discussion of tile construction). It is recommended to raise the unit off the floor or ground and tilt it slightly to make the drain end the lowest point. The nutrient solution may be collected in a drum and re-used if desired. If the nutrient solution is not to be re-used, a water-tight bench is not necessary.

It may be constructed with holes or cracks in the bottom to provide ample drainage (see commercial construction details, page 76).

Modified Slop Culture. A technique developed by Dr. Frank M. Eaton of the United States Department of Agriculture may be

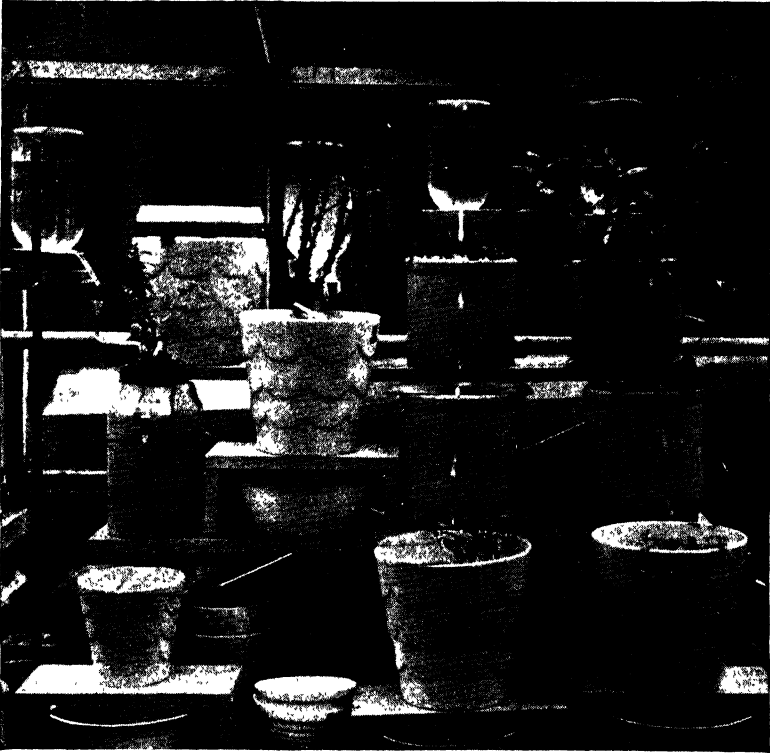

Figure 4-10. Corner of greenhouse showing experimental sand pots in tandem arrangement. Continuous constant-level siphons deliver the solutions from upper to lower pots.

termed a modified slop culture. It was originated for experimental purposes, but it appears to have possibilities for the amateur gardener for some types of crops. Essentially the unit construction is similar to that used for gravel sub-irrigation culture as described in detail in Chapter 5; but sand instead of gravel is used for the root substrate. Further, the solution is pumped through headers which floods the surface of the sand; the nutrient solution then percolates through the sand and eventually back into the solution reservoir.

It appears that this technique may be serviceable for plants of upright growth characteristics which have relatively long stems. Thus crops like roses and tomatoes may be adaptable, but lettuce cannot tolerate excessive quantities of free liquid around the crown, which occurs at the flooding stage; at least with slop culture wherein the nutrient solution was poured upon the plant lettuce did not do too well in Aruba.

Dry Salt Method. Some people may be interested in applying nutrient salts as a fertilizer in the dry form to the sand, as is often done in soil culture. The only physical needs are a suitable bench, which provides proper drainage facilitates.

Commercial Use. Regular unmodified slop sand culture is recommended for commercial work. The construction details given here are concerned with only this type of culture (use of the dry salt method still requires the same bench construction and media). Either raised or ground beds may be made, depending upon the particular conditions. Ground beds should be underlaid with at least four to six inches of coarse gravel or cinders to provide drainage. Raised beds are made with cracks about one-quarter to three-eighths inch wide between the bottom boards or tile. Coarse gravel, cinders, pieces of lath, glass or rock wool, etc. may be placed over the cracks to prevent the sand from falling through. Of course the raised bench should be properly braced, because sand is usually heavier than soil. Several means of construction are feasible, while variability is possible in selection of the media and the method of applying the nutrient solution.

Bed Construction. Concrete or wood are the usual greenhouse construction materials for benches. Sometimes flat tile, several feet long and about six to eight inches wide, is used for the bottom of the bed, instead of concrete or wood. Concrete beds should be coated with petroleum asphalt of 180° F softening point. It is not necessary to use asphalt for wooden benches, but it will improve their durability. Cypress and redwood are the woods commonly used in the greenhouse.

Any standard greenhouse bench is suitable for sand culture. The common width is 42 inches, but 30- to 48-inch benches are feasible. Of course the type of crop often will influence the bench width. The bench should be deep enough to hold at least four to six inches of sand, preferably six inches (in the tropics a six- to ten-inch depth of medium is recommended). It is to be noted that the usual propa-

gation bed is quite adaptable. A convenient height for the raised bench is 30 inches.

Media. The choice of the medium may be regarded from two aspects: the first is the kind; the second, the particle size. Item one has been discussed above (page 62); the size of medium particles will be considered here.

There is considerable difference of opinion among authorities as to the proper particle size. A range of 14 to 100 mesh is generally suggested. A particle diameter smaller than 40 mesh is not recommended, because such fine sizes do not give sufficient aeration for many crops. Sand with particle dimensions ranging from 10 to 40 mesh ($\frac{1}{10}$ to $\frac{1}{40}$ inch in diameter) is recommended. This range for practical purposes should include about 50 per cent of 10- to 20-mesh particles and the rest between 20 and 40 mesh.

More recent work under practical conditions indicates that even a larger particle diameter is permissible. Sand or fine gravel with a size one-sixteenth to one-eighth inch diameter supports excellent growth. Even in the tropics (Aruba) a local bank sand one-sixteenth to one-quarter inch in diameter produced good plant growth. However, more frequent watering was necessary during sunny weather, but during cloudy and rainy weather the coarse medium did not become too "wet."

To secure best results the sand or other media should be clean and free from silt and organic matter. When the sand is quite "dirty" it should be washed.

Solution Application Equipment. The equipment necessary for applying the nutrient solution to the sand beds is quite simple. Two techniques may be utilized. An overhead device may be set up, depending upon gravity to produce the necessary pressure. A cistern or a ground-supported tank may be constructed and the solution supplied with a centrifugal pump.

Many greenhouses install an overhead nutrient solution reservoir in the second floor of the headhouse. Wooden tanks or a series of steel drums can be manifolded together. The containers may be asphalted if desired. The solutions flow by gravity through a piping system throughout the range. Either a separate piping system may be installed or the regular water piping system may be used. The same arrangement of wooden tanks, steel drums or concrete tanks may be set up on the ground, either in one corner of the greenhouse or in the headhouse. A centrifugal pump with a head of 10 feet and

a capacity of 20 gallons per minute would handle a number of beds. If the expense is justified, a concrete cistern may be built. Concrete tanks should be asphalted.

The nutrient solution may be applied to the sand surface by an overhead irrigation system or by a hose. In many greenhouses the overhead water sprinkler system may be used to good advantage. When hosing is followed, the solution or water must be directed in such a manner as to prevent disturbance of the sand around the plant roots. Either a rose-type sprinkler head or a split hose attachment is suggested; the latter permits a solid stream of water or solution under reduced pressure to flow upon the sand between the plants.

Unit Operation

In the actual operation of a sand culture unit procedures similar to soil culture methods are followed; in fact, sand culture is the closest of the three soilless methods to soil culture. This is one of the reasons why this method is recommended for the beginner to gain experience. Operational practices which should be discussed in particular include, (1) seeding, (2) transplanting, (3) water application and (4) nutrient application.

Seeding. Seeds are sown in sand as in soil. Usually the same depths are used; sand is actually a more satisfactory seed bed than soil, as better control of moisture and nutrient conditions is possible, and sturdier plants with larger root systems are obtained. The adverse effect of damping-off is reduced somewhat by the moisture control, but is by no means eliminated. Sand is easier to sterilize (use steam, hot water or formaldehyde) than soil. See Chapter 10 for further details on sterilization of the media.

Usually the best method of seeding is to germinate seeds in sand with water. Some seeds germinate better when nutrient solution is used, while others do not do as well as when water is used to moisten the sand. However, many seeds respond similarly to both water and nutrient solution. Apply moisture when necessary. Under cool, cloudy weather conditions moisture applications every other day may suffice. During hot, bright weather one to two waterings a day may be required (see Chapter 9 for further details).

Figure 4-11 shows a convenient way to start young plants around the home. Tin cans are also serviceable substitutes for flower pots.

Wooden flats or boxes, a common greenhouse piece of equipment, which hold a two- to four-inch depth of sand, are good for germinating seeds. A regular propagation sand bench is another satisfactory seed bed.

The same grades of sand recommended for crop production are adaptable for seed bed function. In fact sand culture is well suited for direct seeding of the crop. Direct-seeded crops yield better than transplanted crops.

Transplanting. To clarify any question as to how plants are transplanted is the purpose of this brief section. Transplanting in sand and soil is done in the same manner. Plants usually transfer from sand to sand better than from soil to soil. Two reasons are

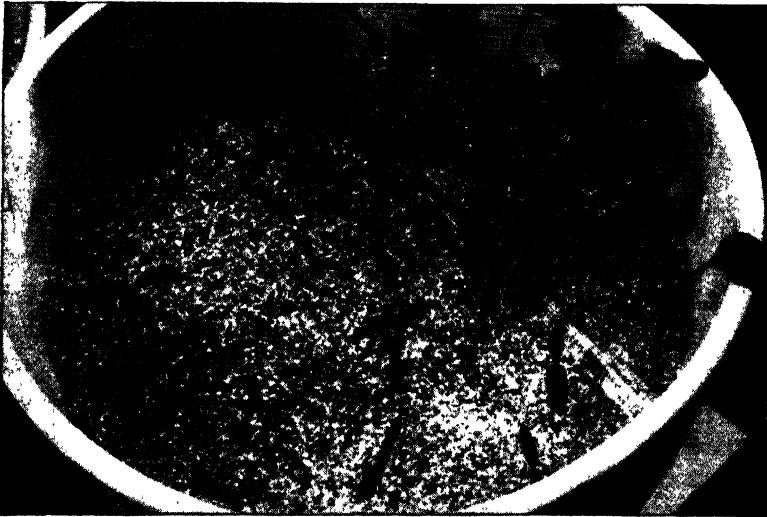

Figure 4-11. Tomato seedlings (left) and radish seedlings (right).
Produced in sand fed by nutrient solution. (One-third actual size)

chiefly responsible. One is that a greater portion of the root system is transferable on a sand-grown plant; thus there is less checking of growth. The other reason is that the roots are more readily brought into intimate contact with the particles of the medium. After the plants are set, the sand is lightly watered around the base to settle the medium quickly and firmly about the roots.

If plants are transferred from soil to sand the soil may or may not be carried along. However, this statement must be qualified.

Usually hardwood plants, particularly floral crops, are better if transferred with the soil block intact upon the roots; but hardwood plants as well as softwood plants may be readily transplanted after the soil is gently washed off the roots.

Another factor to consider in relation to the soil adherence to the roots is the particle size of the medium. It is not recommended that the soil be left on the roots of the plants if they are to be transplanted into very fine sand. The soil will further interfere with proper aeration, which is not too good in fine sand in any case.

Water Application. Water should be applied as frequently as seems necessary. With the coarser grades of sand, at least one-sixteenth to one-eighth inch particles, even daily application, regardless of weather conditions will not cause undue difficulty. Finer grades of sand mixed with peat moss will support plant growth in the winter in the greenhouse with only one to three waterings a week. In the summer, fine grades only need water daily or every other day, depending upon the shading conditions and the size of plants. Sometimes twice a day is necessary with very large plants in the coarser media.

Individual slop culture units, that is, one or two plants per unit, are supplied with sufficient water or nutrient solution to cause only slight drippage. This will require from a pint to a gallon of "water," depending upon the size of the container and the moisture content of the medium. Greenhouse benches may be given liquid at a rate of five to twenty-five gallons per 100 square feet.

Of course in drip cultures moisture is supplied continuously. Depending upon the volume of the sand and the size of the plant, a range of one quart to one gallon a day (sometimes this rate is adjusted for a 24-hour period, while at other times for the daylight period) per individual unit is suggested. The rate is regulated by raising or lowering the end of the drip tube over the culture or by varying the size of the tube. For large drip-culture installations, like the Ohio Experiment Station unit, the rate of flow may be regulated at one to two quarts per plant per day.

Nutrient Application. How often nutrients should be applied to sand culture units depends on numerous cultural factors. The reader is referred to Chapters 6, 7 and 8 for a fuller discussion of nutrient solutions and their maintenance. Also, the physical set-up of the unit must be considered. The discussion here will be sub-divided in

respect to the three types of sand culture, namely, slop culture, drip culture and dry salt culture.

Slop Culture. The problem resolves itself into a matter of how often the nutrient solution should be applied to obtain satisfactory plant growth. Experience is the best judge. Besides the usual plant and climatic factors the particle size of the medium is a factor. Usually three techniques are followed for slop culture. They are (1) alternate application of water and nutrient solution; (2) addition of fresh nutrient solution whenever "water" is needed; and (3) re-use of the nutrient solution for a certain period.

In greenhouses in the United States slop culture is developed upon the first method for commercial or practical use. In the winter the nutrient solution is applied to the sand once or twice a week; in the summer it is supplied two or three times per week. Water is furnished to the media between times to maintain adequate moisture conditions. The home gardener may follow the same procedure for his house plants or his outdoor garden.

In the tropics three solution applications a week or even daily additions with nutrient solution are in order. This is because nitrogen must be supplied in reasonably generous quantities, which necessitates more frequent additions of the nutrient solution.

A cultural factor which is important in deciding on the frequency of nutrient application is the concentration of the solution. Highly concentrated solutions, two or three times normal level, should be applied less often than "normal" or more diluted solutions. Often the application of a double concentration solution once a week is equivalent to two or three applications of a solution of "normal" or one-half "normal" concentration. Therefore, a highly concentrated solution should not be used too often, as salt accumulation may occur and cause trouble.

The particle size of the medium also affects the choice of the application schedule. When coarse sand or fine gravel is used, more frequent additions of "water" are needed. During hot, bright weather two to three waterings a day are often required with large plants. This frequency of watering causes excessive leaching of the nutrient chemicals when the water is added between intervals of nutrient supply. Further, if the water is not acidified the acidity of the root medium is often raised somewhat.

The use of nutrient solution every time watering is necessary has been tested under practical conditions in the tropics. Such a pro-

cedure was required in Aruba to secure maximum yields with several crops, notably tomatoes. In several home garden demonstration slop culture units, wherein a granite gravel of about one-sixteenth to one-quarter inch particle size was used, solution application twice a day produced the best tomato yields. Where the solution was applied several times a week, with intermittent water applications, yields were markedly inferior. This technique of using fresh solution of usual concentration every time moisture is needed is commendable for amateur use, regardless of the cultural conditions. The extra expense of chemicals is well justified by the satisfactory results secured. It is the most fool-proof type of soilless culture. The pH of the root medium is more stable, the nutrient level is more constant and practically no need arises for flushing the medium because of salt accumulation.

A refinement of this technique may be used by the more experienced plant grower. This is the collection and re-use of the nutrient solution for a definite period of time. Such a method naturally entails the need of a waterproofed bed. The Ohio Station drip culture type of box or the Eaton type of installation may be set up. Of course the simplest procedure for the home gardener is to place a pail under the drainage hole of a steel drum unit. If the commercial man is interested in this procedure, it will be more feasible to graduate to gravel sub-irrigation culture.

The solution may be re-used for a week, then replaced with a fresh one. During the period in which the old solution is being used, the full volume of the nutrient solution should be maintained by necessary water additions. This adds an extra technical problem; the acidity (pH) of the nutrient solution must be checked and adjusted because the water is usually alkaline (see Chapter 7 for more details).

Drip Culture. Drip culture is a continuous type, wherein only nutrient solution is continuously flowing through the medium. The nutrient solution may be replenished each day with fresh liquid or the solution may be used for a week; in the latter case, of course, the solution volume and acidity must be kept properly regulated. Periodic flushing of the culture is often recommended. Probably the best procedure is to flush the culture with the used solution at the end of each week. When rapid rates of flow are used, the flushing problem is diminished because accumulation of salts upon the surface of the medium is reduced.

Dry Salt Culture. In this type of culture the sand bed is handled exactly as a soil bed. The nutrient chemicals are applied in the dry form to the surface of the sand and are watered in just like a fertilizer used on soil. In fact, the usual commercial fertilizers may be used, because less soluble forms of the nutrient chemicals are required. This is necessitated by the fact that all moisture requirements are supplied by adding water. Very soluble chemicals would be easily leached out.

The dry salts should be added at least two weeks prior to planting. Keep the sand moist during this period to dissolve and disperse the chemicals within the sand. After the plants are started, fertilizer applications are made every two to four weeks, or whenever plant conditions warrant fertilization. These applications are made upon the sand surface and watered in. Sometimes it is suggested to flush the sand thoroughly with water before each addition of chemicals; this will help prevent excessive accumulation of some salts to toxic levels. Of course, if soil test methods are available, the sand may be analyzed and fertilizer treatments made accordingly.

The use of Vigoro at the rate of about 1.5 to 2.0 pounds per 100 square feet at each application is suggested. Concentrated fertilizers, like Nitrophoska, are satisfactory, but must be used in smaller quantities, 0.75 to 1.0 pounds per 100 square feet of sand surface. Sometimes a need for extra magnesium results when common soil fertilizers are used, because they do not usually contain magnesium except as an impurity. The first fertilizer should have enough of it for many purposes, but the latter one often requires the addition of three to four ounces of Epsom salts per pound of fertilizer.

The dry salt method has been advocated by Laurie of Ohio State University and by Hill and Davis of the Central Experimental Farm, Ottawa, Canada. However, it offers little advantage over soil culture in respect to labor requirements. But the use of a relatively inert medium simplifies the nutritional problems compared to growth in soil. The commercial propagator may be interested in this method under some conditions, rather than in the regular slop sand culture methods, to grow crops during the off season in the propagation beds. The amateur who wishes to grow plants in areas wherein good soil is hard to obtain may be interested. No special outlay of equipment is necessary. Just buy a load of building sand instead of some soil to use in the outdoor garden or in the flower pot in the house.



Figure 4-12. Chrysanthemums grown by the dry salt method. (Courtesy *Better Crops with Plant Food*)

Naturally the nutritional control is not as good as regular slop sand culture and the fertilizer costs are usually greater because of waste due to leaching. Figure 4-12 shows chrysanthemums grown by this method in Canada compared with the regular slop culture method pictured in Figure 4-13.



Figure 4-13. Chrysanthemums grown by the slope-culture method. (Courtesy *Better Crops with Plant Food*)

Chapter 5

Gravel Culture

This chapter may be considered as introductory in respect to gravel culture details. Several special cultural problems will be mentioned briefly in order to maintain continuity of form outlined in the previous two chapters on water and sand culture. Details are discussed in Chapters 6, 7, and 8. Construction materials and designs will be considered in full in this chapter (page 90). Operational considerations will be briefly outlined, while further details will be taken up in Chapters 7, 8, 9, and 10.

Special Cultural Problems

Special attention will be accorded to certain cultural problems which are important in gravel culture. Nutritional control approaches the technical needs of water culture. Physical conditions of the root substrate are more exact than the requirements of sand culture.

Nutritional Aspects of the Nutrient Solution. In line with other kinds of soilless culture, many types of nutrient solutions are feasible in gravel culture. The various solutions listed in Table 6-6 (page 142) are well adapted for gravel culture use. As with all nutrient solution installations, the acidity, phosphate level and iron concentration must be properly considered. These cultural factors will only be discussed briefly because details are to be found in Chapters 6 and 7.

Solution Acidity. The acidity of the nutrient solution should be maintained between medium and slight acidity to obtain best results. In respect to the need for acidity control, gravel culture lies between water culture and sand culture; that is, the solution acidity fluctuations are not as serious as in water culture, but should be less than in sand culture. Chapter 7 devotes a section in detail to the acidity (pH) control of nutrient solutions; the general theory of pH, its effect upon plant growth and adjustment are explained.

Phosphate Level. The phosphate level of the nutrient solution in a gravel culture installation must be properly regulated. Excessive quantities cause undue iron precipitation in the solution reservoir and within the medium. Not over four to six millimoles (see Chapter 6) of phosphate should be used in the regular nutrient solution. Proper manipulation of the phosphorus content will aid in regulation of the solution acidity because of its buffering action. A concentration range of two to four millimoles will bring about this buffering effect. These considerations are presented more fully in Chapters 6 and 7.

Also, as in sand culture, the gravel may be pretreated with a strong phosphate solution. Sufficient calcium phosphate coating may develop upon the particle surfaces to support plant growth for a reasonable length of time (see below, page 125).

Iron Level. The maintenance of an adequate iron supply is a major problem, almost as difficult as with water culture. Frequent additions in low concentrations are in order to keep ample supplies in the nutrient solution. Quite often sufficient iron is contained in the water and the commercial grade chemicals as impurities to supply the needs of the plants.

Sometimes iron solutions are poured upon the surface of the gravel, especially when alkaline media are used. Usually a five to ten part per million solution is utilized. This procedure is not too highly recommended because the element of control over the iron supply is reduced. Danger of toxicity is prevalent if caution and good judgment are not followed with this method. It is much better to make all iron additions at recommended concentrations directly to the nutrient solution in the reservoir at proper intervals. (See Chapters 5, 6, and 7 for more information.)

Physical Aspects of the Nutrient Solution. As will be noted later in this book, the requirements in gravel culture may be subdivided into three general categories. These are (1) technical control of the nutrient solution (the nutrient solution *per se*); (2) technical control of the plant culture (chiefly the media relationships); and (3) actual plant culture (handling the plant itself). This part of the chapter deals solely with the technical problems specific to the nutrient solution and the media in general terms. A more comprehensive study will be found in Chapters 7 and 8 respectively. The general plant culture is taken up in Chapter 9.

Specific technical problems in gravel culture include a study of media characteristics, pumping cycles, solution volume, drainage requirements, media flushing, media temperature, and rainfall.

Media Characteristics. The root substrate, or medium, must possess many desirable characteristics in order to support satisfactory plant growth. (1) It must not contain any toxic materials. Usually the problem is concerned mostly with excessive alkalinity or acidity. Some media, like cinders or calcareous gravel, are often quite alkaline. If the cause of this excessive alkalinity is not corrected, plant growth is retarded when such media are used. The root substrate should be held somewhat below neutrality if possible. Pretreatment of such media by water-leaching, acid-leaching or soaking in phosphate solution is suggested.

Other media either may contain acidic constituents or be acidic in nature. Cinders may fall into this class. Correction can be accomplished by water-leaching, alkali-leaching or phosphate-coating of the particles. Excessive quantities of boron and sulfur compounds may be present in some cinders. Leaching with water is suggested. Treatment of the media with water glass (sodium silicate) solution is also recommended to control possible boron toxicity.

(2) The media must possess the quality of good moisture retention. The particle size governs this to a great extent. However, the shape of the particles also influences moisture retention; irregular or flat particles have greater external surfaces to hold films of water and they also lie closer together than round particles. Thus the voids between the gravel particles are individually smaller and more water is held within the body of the media because capillary attractions are greater. The porosity is of importance also; materials like cinders and Haydite retain moisture better than granite or usual bank run gravel of comparable particle size. Thus it is often necessary to specify coarser media if it is of the porous type.

(3) The media must be capable of good drainage. Particle dimension and presence of fine foreign matter such as sand, silt or soil affect the drainage, particularly if porous materials are fine. All the free liquid must be removed from the voids within the media; only a film of moisture containing nutrients must be held to the surface of the particles.

(4) Aeration is closely associated with both moisture retention and drainage. If water retention is too good and if drainage is too

poor, inadequate aeration results. The roots of the plants require oxygen to carry on their various necessary physiological functions. If the system becomes "water-logged," the oxygen content of the root atmosphere is reduced while the carbon dioxide content becomes too great. Thus a satisfactory balance between moisture retention and drainage of free liquid from the medium must be set up to provide ample aeration.

(5) The media must be of sufficient hardness to be durable. Some media, like some coal cinders, some local gravel (caliche in Aruba) and lava cinders are soft and break down in time. This decreases the particle size which interferes with proper aeration and naturally retards plant growth. To eliminate poor crop production these soft media must be frequently renewed, thus nullifying one of the advantages of gravel culture over soil culture. Naturally changes of gravel are expensive. A durable gravel should be obtained which ought to last indefinitely.

(6) The nature of the surface of the particle must be considered. Some types of media possessing hard sharp edges often cause mechanical damage to the plants, particularly when they are young and quite succulent. In cases of excessive air motion, injury may be done to the stem and the lower leaves as the weeping plant suffers abrasion by the sharp edges of the media. Also, during heavy rain storms leaf vegetables, like lettuce, are beaten down upon the media and the leaves are shredded. Slightly rounded particles are not as injurious in these respects.

The influence of the above characteristics of the media are discussed at various points in Chapters 7, 8, and 9 in respect to the various cultural problems concerned. Since the medium is such an important part of the gravel culture unit, its influence is quite varied. The purpose of the above section is to present all the cultural functions of the medium in one place to stress the importance and interrelation of its various functions besides that of pure mechanical support for the plant and its roots.

Aeration. This function was stressed above in relation to media characteristics. As will be noted in Chapter 8, the pumping cycle also influences the aeration of the roots. Too frequent pumping, too slow filling, and too slow drainage all reduce the oxygen level about the roots. This happens because the voids in the medium are too often filled with free fluid instead of with moisture-saturated

air. To repeat again, plants need plenty of oxygen for proper root development.

Drainage. The characteristics of the media influence the drainage of the gravel culture unit, as mentioned above. However, another factor plays a prime role. This is the proper design and construction of the gravel bed. *All of the "free water" must be removed from the bed.* The reasons for this complete removal will be given in Chapters 8 and 10.

Pumping. How often the gravel bed should be pumped is dependent upon two factors. The first one is the moisture requirement of the given system; the second is the nutrient needs. Water is the prime limiting factor. Thus, the pumping cycle is primarily adjusted to supply an adequate moisture content in the gravel. Chapter 8 discusses the pumping cycle in detail in respect to frequency, time of day, speed of pumping, and rate of drainage. If the pumping schedule is properly regulated to meet water needs, nutrient supplies are automatically handled in a suitable manner.

Solution Volume. The problem to discuss here is the volume of solution to maintain. Of course sufficient solution must be present in the reservoir to flood the gravel bed to the proper depth. It is an advantage to operate with an excess volume; in this way better control of the total solution concentration and the content of the individual nutrient ions is possible. Greater quantities of chemicals and water are used; hence, the percentage change occurring from day to day in chemical and water losses is less. However, economic considerations must be met. A larger cistern greatly increases the installation cost, as well as the initial chemical and water costs. To counteract these extra expenses, an excess volume of nutrient solution helps reduce work in technical control (analyses, chemical additions and water additions) because it does not have to be done as often. Further, it is possible to secure better crop production under more exact control conditions. Twice the required volume of solution is recommended. However, a 50 per cent increase is feasible if the particular conditions do not fully justify the first suggestion. This problem will be noted again in respect to cistern dimensions (page 117).

Flushing the Media. There is no necessity of flushing the media if cultural conditions are in proper shape; but if undesirable developments occur, a thorough flushing of the gravel bed with fresh water

is recommended. A more complete discussion of this subject is found in Chapter 9.

Temperature of the Media. The same discussion given in Chapter 3 for the water culture method on heating and cooling the root media applies here; additional details for gravel culture are given in Chapter 8.

Rainfall. Rain affects both water culture and gravel culture units in a similar manner; that is, the nutrient solution volume is increased. During a heavy rain, considerable water may be collected in the bed which in turn increases the volume of solution in the reservoir. If adequate cistern capacity is provided, a reasonable amount of water may be accumulated; thus less loss of nutrients by excessive flushing of the media occurs than in a sand culture unit. Also, the total nutrient ion content in the reservoir is not depleted, but only diluted in concentration, whereas an actual reduction of chemical content results in a water culture unit. This is because the excess water flows out through the overflow and dilutes the solution, both relatively and actually. A more complete discussion of the effect of rainfall upon outdoor gravel culture units is given in Chapter 8.

Unit Construction

The basic principle of construction for a home garden unit and a commercial installation is identical; consequently all construction details listed for commercial units below apply for home garden units. The same applies for the media specifications. Thus, only general designs will be discussed in connection with home garden set-ups. Design, construction details and media will be considered under the commercial unit section.

Home Use. Usually four different methods of sub-irrigation are considered for home use. The easiest is the bucket and gravity technique. More advanced students of sub-irrigation will use pumps and motors or compressed air systems. Also, for use in the house, a wick device is of interest.

Bucket and Gravity Design. The bucket and gravity design is purely what the terminology implies. Plant growing beds are constructed identically the same as power-operated units. The only difference is that no pump and motor is supplied.

A one-quarter or a one-half inch black-iron nipple is installed in the end of the box. A similar nipple is soldered at the bottom of a

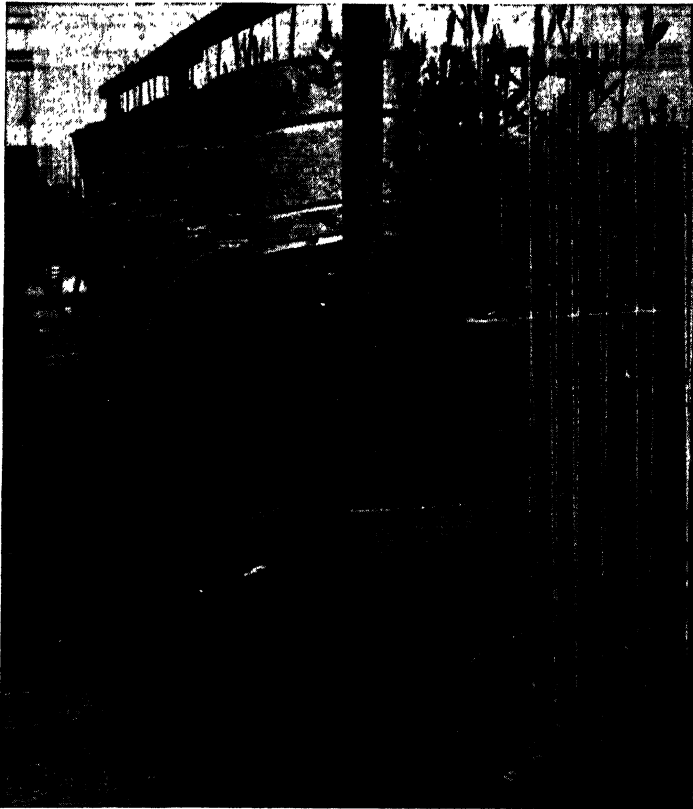

Figure 5-1. Experimental bucket and gravity units at the greenhouse of Geo. J. Ball, Inc.

Figure 5-2. Bucket and gravity units, W. A. Rogers Estate, Glen Ellyn, Illinois. (Courtesy Geo. J. Ball, Inc.)



12-quart pail which is coated with asphalt. The proper size of rubber tubing or an old garden hose (a three-quarter inch hose fits nicely over a one-half inch pipe nipple) connects the two nipples. Figure 5-1 shows a series of such units in the greenhouse used for experimental purposes, while Figure 5-2 is a picture of an amateur set-up.

For units using only one to three gallons of nutrient solution, no

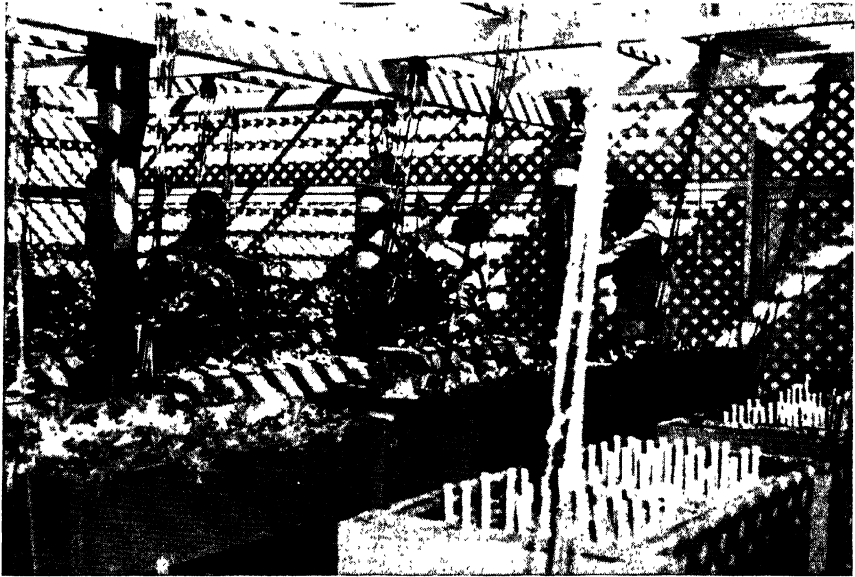

Figure 5-3. Lago experimental hydroponics unit, Aruba, N.W.I. (Courtesy *Esso Farm News*)

pulley arrangement is necessary to raise the pail. The pail is placed on any suitable overhead framework or hook. Raise the pail so that its bottom is about one foot above the bottom of the box.

Units of five to twenty gallons capacity or more require a pulley arrangement to conveniently hoist the solution container in order to flood the gravel bed. Figure 5-3 shows a unit in Aruba using this method. For this set-up 10-gallon containers were fabricated from sheet metal. Even steel oil drums or wooden barrels may be used for the solution reservoir.

Small wooden or metal boxes, asphalt-coated, may be utilized for the plant box. They should be at least six to eight inches deep, but four-inch deep greenhouse flats are adaptable for small experimental units. If wooden boxes 24 inches long, 18 inches wide and 6 inches

deep are used, a 12-quart pail will hold sufficient solution. Larger units of 10-gallon capacity, may be made $42 \times 18 \times 7$ inches.

Pump and Motor Design. With this method a centrifugal pump is operated by an electric or a gasoline motor. For small units one-

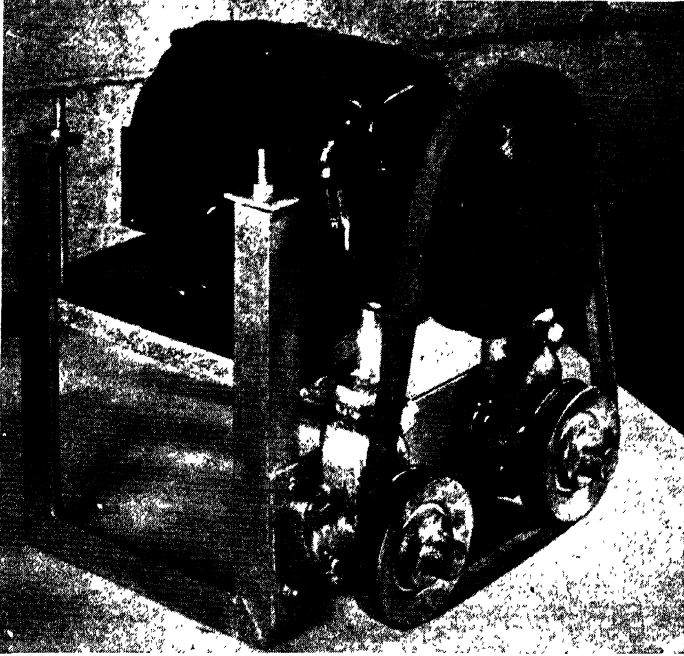

Figure 5-4. Ford pump installation. Note the $\frac{1}{3}$ h.p. electric motor mounted above; the large pulley on its shaft to increase pump speed—and the two small pumps side by side below. Pumps must always be kept below the tank levels so they will be primed. The belt is a standard fan belt from a Ford. Close examination will reveal that the motor is actually suspended by that long bolt from the top of the “L” beams. Any good welding shop should be able to duplicate this installation. (Courtesy Geo. J. Ball, Inc.)

half inch black-iron pipe is used to connect the pump to the solution reservoir and to the plant bed. The centrifugal pump may be from a washing machine or from an automobile motor. Figure 5-4 shows an interesting type of installation. Small all-iron centrifugal pumps which have a 10-foot head and a 10 to 20 gallon per minute capacity may be purchased. The centrifugal pump eliminates the absolute need of valves in the unit. Flow of fluid is possible in both directions through such pumps, so that when the pump stops, the fluid can

drain back through the pump into the reservoir from the plant bed.

Many things may be used to construct the plant beds. Metal, wood or concrete is suitable. The same means of construction are used as for commercial beds. Some people use half steel drums, cut lengthwise. A number of such drums may be manifolded together. They should be deep enough to accommodate six inches of gravel.

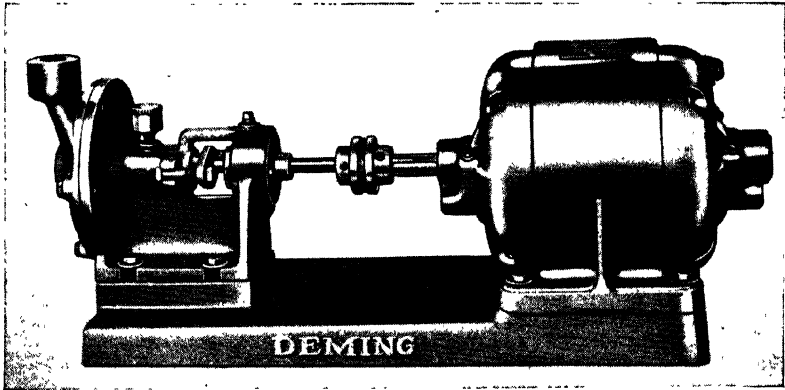
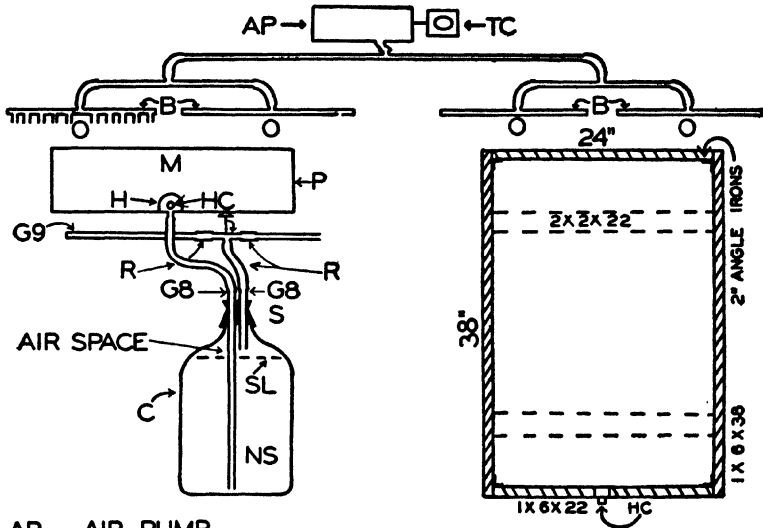

Figure 5-5. Typical centrifugal pump unit. (Courtesy Deming Pump Co.)

The pump may be direct-driven (see Figure 5-5) or belt-driven, depending upon the requirements of the garden unit. In any case, the bed should be pumped as fast as possible and it should not take longer than 20 to 30 minutes. In fact, a five to ten-minute pumping period is recommended. Often a one-sixth to a one-quarter horsepower electric motor is direct-connected to the centrifugal pump. A similar motor may be belt-driven to one or several pumps if desired. Relative pulley size will depend greatly upon the pump characteristics. The usual commercially designed centrifugal pump operates at 1750 r.p.m. Therefore, the speed of the motor and the number of pumps to be run must be determined. Often the pump will operate satisfactorily at two-thirds speed; thus a two-inch pulley on the motor V-belt driven to a three-inch pulley on the pump makes a convenient set-up for the small unit. A 100 to 150 square foot unit can be operated in this manner with a one-sixth horsepower motor and a 10-gallon per minute pump.

The sub-irrigation power-operated unit may be controlled manually or automatically. An electric time clock may be installed to regulate the pumping cycle.



- AP AIR PUMP
 TC TIME CLOCK
 B BLEEDER
 O OUTLETS FOR CARBOYS
 M MEDIUM
 P EXPERIMENTAL PLOT 2' X 3' X 6"
 H HALF TILE
 HC MALE HOSE CONNECTION
 T NINE MM. GLASS T
 G9 NINE MM. GLASS TUBING
 G8 EIGHT MM. GLASS TUBING
 R 1/4" X 5/8" RUBBER TUBING
 S NO. 6 TWO HOLED RUBBER STOPPER
 SL SOLUTION LEVEL
 C FIVE GALLON CARBOY
 NS NUTRIENT SOLUTION

Figure 5-6. Diagram of a small plot assembly. (Ohio Agricultural Experimental Station)

Compressed Air Design. This system was developed by the Ohio State University Floriculture Department for extensive gravel culture experimental units. As many as forty 2' x 3' x 6" wooden boxes may be operated at one time. Of course, the home gardener may wish to operate a smaller number of large boxes. A five-gallon glass carboy holds sufficient nutrient solution for the above-sized boxes; larger boxes could be operated by using 10 to 12 gallon acid

carboys. These carboys may be left in the wooden boxes to protect the bottle and to keep the solution in the dark and eliminate algae growth.

Glass tubing and rubber tubing are used for all piping between the solution bottle and the plant box and the air line. A two-hole

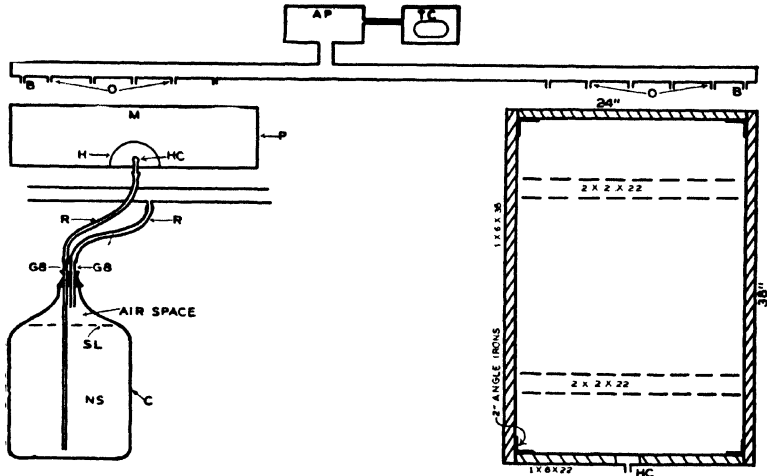

Figure 5-7. Diagram of a small plot assembly. (Ohio Agricultural Experiment Station)

stopper holds the glass tubes in place in the carboy. All tubing should be at least one-third to one-half inch inside diameter to facilitate rapid pumping and drainage.

The construction of the pressure-regulating air manifold is the critical point in this method. Several means may be used. A series of inter-connected manifolds of slightly larger glass tubing or iron pipe is sometimes set up. Thus, as indicated in Figure 5-6, a series of 10 boxes may be connected to a sub-header which in turn connects to a main header. Figure 5-7 shows a better plan, in which the main airline is a larger pipe which contains as many one-quarter inch pipe nipples as there are separate plant boxes. The area of the main air line must be slightly greater than the total area of the sum of the air outlets. This design affords even filling of the separate units.

To supply the air, either cylinders of compressed air or small portable air compressors are serviceable. If bottled air is used, a regulating valve is necessary, because 2,000 pounds per square inch is the usual pressure in a cylinder. Small portable compressed air paint-spraying outfits are suitable for small units. These compressors

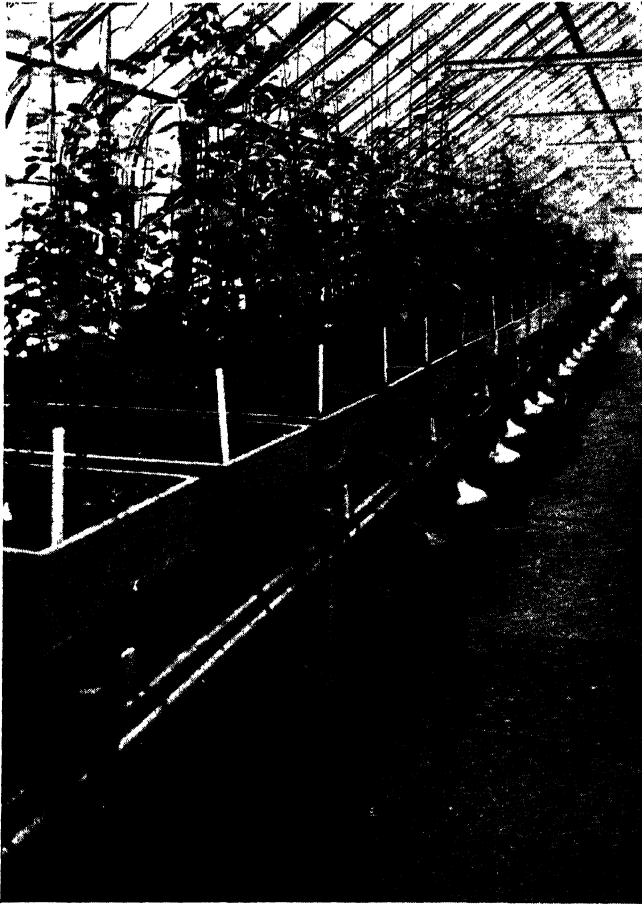

Figure 5-8. Compressed air unit growing experimental roses at Ohio State University. (Ohio Agricultural Experimental Station)

usually operate at a maximum pressure of 40 pounds per square inch. The electrically driven compressor may be operated manually or by a time clock. Automatic operation is feasible if the self-leaking type of compressor is used or if a manifold bleeder, which releases the pressure, is installed in the main airline. The operating pressure is regulated to pump the boxes up in 15 to 30 minutes, preferably the former.

Figure 5-8 shows an experimental setup for growing roses in the greenhouse. Figure 5-9 is a picture of an experimental unit growing tomatoes in Curaçao, N.W.I. This unit uses a locally designed

pressure-equalizing device for each steel drum solution container, which of course must be air-tight. A large service station type of compressor operates the twenty large experimental units.

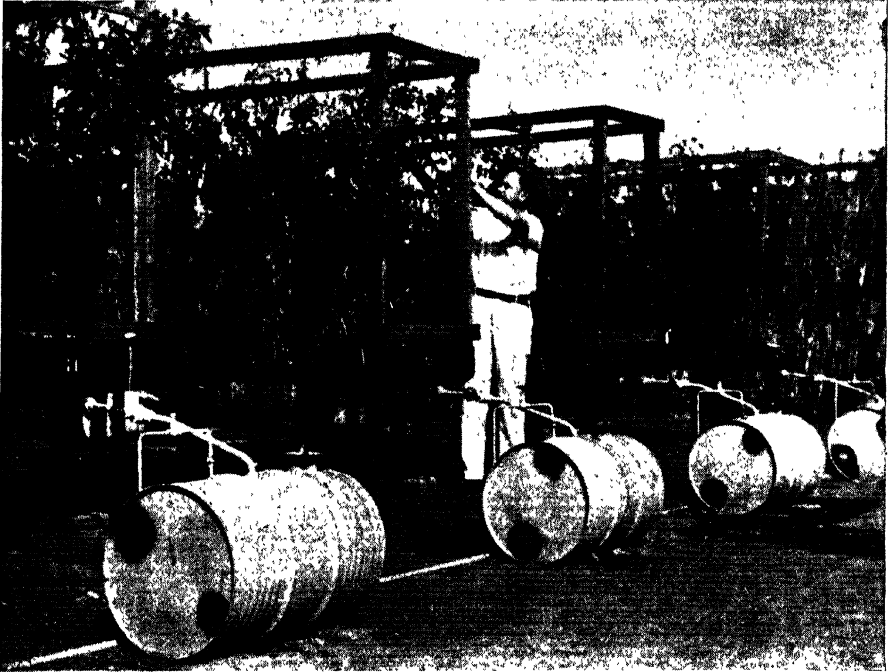

Figure 5-9. C.P.I.M. experimental hydroponics unit, Curaçao, N.W.I. (Courtesy W. R. Mullison)

Wick Devices. Although a discussion of wick devices does not really fit into the gravel culture chapter, it is a form of sub-irrigation. A fine medium, rather than a coarse one, is necessary to maintain the capillary action. The water is supplied from the bottom and the moisture passes up into the medium. Such a method is adaptable for the culture of pot plants in the house; suitable seed beds also may be prepared.

Some devices for pot culture utilize a glass wool wick * to draw the moisture from the reservoir up into the media. Figure 4-4 (p. 70) illustrates the technique. The photograph in Figure 5-10 shows the principle applied to soil culture pot plants. Figure 5-11 indicates the possibilities for seed flat use, either for soil or sand, in the green-

*The Atlas Asbestos Company, North Wales, Pennsylvania, manufactures wicking and reservoirs for this purpose.



Figure 5-10. Effect of glass wool "wick" watering on Kalanchoe; the plant to the right has been wick-watered, the one to the left, top watered. (Courtesy Geo. J. Ball, Inc.)

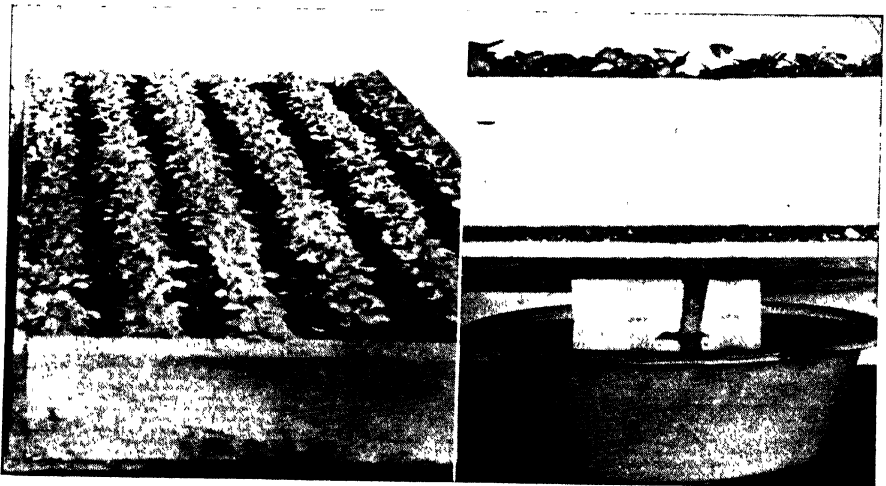

Figure 5-11. Wick watering of standard 16 × 24-inch greenhouse flat. (Courtesy Geo. J. Ball, Inc.)

house or in the home. If glass wool is not available, rock wool should suffice, but it is not durable.

Commercial Use. The instructions for building a commercial unit are divided into three phases. These include the general design, of which two general types are in use. Construction details then follow. Last, but not least, the media are considered.

General Designs. Two general designs are in commercial use. The first system is the direct-feed unit which is the original Purdue installation. For very large-scale operations, the gravity method is utilized. Although pumps are used in the gravity type unit, the actual flooding or "pumping" of the medium is performed by gravity. Two sub-types may be classified for the gravity method. These are the open system and the closed system.

Direct-feed Unit. The essential points are diagrammed in Figure 5-12. A reservoir is located at a level below the lowest point of the

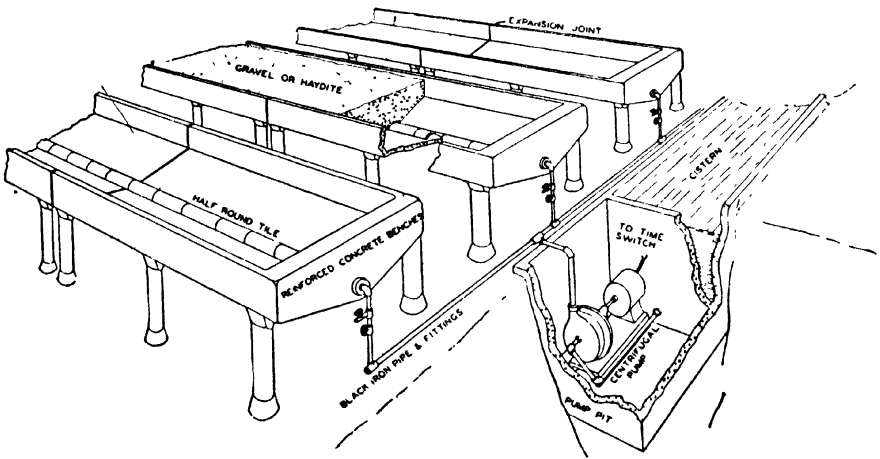

Figure 5-12. Diagrammatic presentation of the sub-irrigation system of nutrient solution culture. (Courtesy Purdue University Agricultural Experiment Station)

gravel beds. The top of the cistern should be at least six to twelve inches below the bottom of the beds. This cistern may be at the ends of the beds or beneath them. A centrifugal sump pump may be used to eliminate the pump pit. The nutrient solution is pumped into the beds through suitable piping. The nipples at the end of the bed fit into the tile which lies loosely upon the bottom of the water-tight bed. The plant-growing beds may be either above or on the ground.

When several beds are to be pumped together at one time, a manifold must be constructed to equalize the pressure. Often five to ten 5 by 100 foot beds may be operated as one unit in a greenhouse. Either one large central type is used or a step-type manifold is installed. If the large central type is used, the cross-sectional area of this pipe should be slightly greater than the sum of the areas of the nipples. With the step-type manifold, a 2 to 3-inch pipe forms the main manifold and is connected to the pump. Two to five beds may be attached to a sub-manifold of 1½ to 2½-inch pipe. The several sub-manifolds are connected to the main line at properly spaced intervals; 1 to 1½-inch pipe nipples are used for the bed connections. Valves may be installed at the bed on the sub-header and on the main manifold to be used for final pressure adjustment purposes.

Other piping accessories include a by-pass line on the discharge side of the pump to direct the solution back into the reservoir. This line may be used to regulate the pressure of the fluid to the beds, and also for mixing the chemicals in the tank. Another pipe is connected to pass discarded solution to the sewer. This line may be installed at the pump or the manifold near the beds. Of course, valves are placed at the proper points in these two pipe lines.

A large intake pipe should be used for the pump to insure proper efficiency of operation. Thus if a pump has a 2-inch intake port, use a 3 to 4-inch suction line, attached by appropriate reducers.

Usually an electric motor drives the pump through a direct flexible coupling. This motor may be operated manually or by an electric time clock.

Gravity Feed Unit. As mentioned above, this type of installation may be divided into the open system and the closed system. The open system is just what the term implies; the drain nipple of the bed is open at all times, except when the bed is being pumped. Two methods are in use, the gravity tank one and the flume system. Closed systems contain automatic siphons, which means that the bed is not free-draining unless special provisions are included.

Open System. Figure 5-13 shows the Lago Unit in Aruba, which is a gravity tank system. This unit is open at all times; that is, the growing bed drains are always open except when closed for the pumping operation. The unit is experimental in design and may be operated in two ways. All the solution required to flood nine beds may be pumped into the upper concrete tank, which is asphalt-

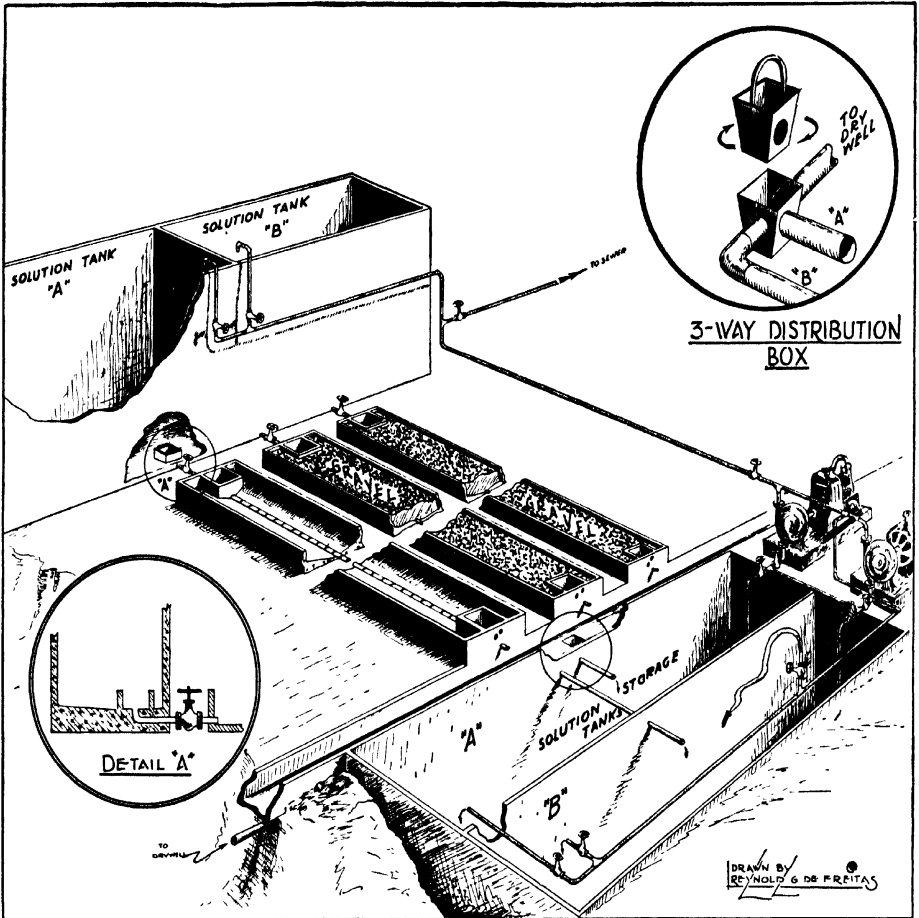

Figure 5-13. Lago unit diagram.

coated inside. This tank, which serves nine beds, is 45 feet long, 60 feet high and 2.5 feet wide and will hold as much as 5,000 gallons of nutrient solution. The beds are filled by properly opening the valves.

The second method, which is being used quite successfully, is to utilize the standpipes inside the tank. As the nutrient solution is pumped into the tank, it overflows the wooden standpipes which are 6 inches high and 5 inches square, and fills nine beds at one time. The top of the standpipe is approximately 12 inches above the bottom of the bed. Probably better operation will occur if this difference were only 6 to 9 inches. Final adjustment of the rate of flow

into the beds is accomplished by regulating the 2-inch valve. A well designed standpipe arrangement will not require valves. The end of the pipe nipple inside the standpipe can be stoppered with a wooden plug if a bed is taken out of service.

The concrete beds are 100 feet long, 2.5 feet wide and 7.5 inches deep. Walls are four inches wide because they support the uprights for an overhead shade framework. Two-inch reinforced walls are sufficient if no overhead load rests upon them. The beds are hot-mopped with asphalt.

When the beds are full of nutrient solution, the 2-inch drain nipples are opened by removing pipe caps or wooden plugs. This solution flows into a concrete drainage trench, also asphalted--which serves nine beds. The trench is 45 feet long, 12 inches wide and 6 inches deep at the ends, and 8 inches deep at the center, where a three-way valve is installed. The diagram illustrates a square valve, but it was not practical to construct. A round valve was fabricated locally and installed. Six-inch pipe may be machined with a slight taper to make the sleeve fit snugly into the box to make a water-tight fit. An occasional coating of graphite prevents sticking of the valve in operation. The valve is so designed to permit the solution to be diverted to either solution storage tank A or B or to the dry well. During heavy rain storms, the valve is turned to divert the excess water to the dry well to prevent overflowing the cistern. All piping connected to the three-way valve should be 6 to 8-inch soil pipe or black-iron pipe.

The solution storage tanks are constructed of concrete and are hot-mopped with asphalt on the bottom and the sides. Each one is 60 feet long, 5.5 feet wide and 6.0 feet deep and will hold enough solution for two nine-bed units. The extra cistern is constructed to handle an 18-bed extension in the future.

The pumping system of this unit is designed to pump from either cistern with the regular 10-horsepower electric motor-driven pump or with the 60 horsepower Ford motor-driven auxiliary pump. Leather foot valves are installed at the bottom of the 6-inch suction lines. A 6-inch pipe cross "T" connects the two suction lines. Six-inch valves are placed on the cistern side of the cross "T" to be used to cut out one cistern while the other is being pumped out. The suction pipes are reduced to 4 inches on the pump side of the cross "T." By means of a reducer, 3-inch valves are inserted in the intake

lines just before the pumps to be able to cut out one pump if the other one is being operated. These valves are attached to the centrifugal pump by another reducer to fit the 2-inch intake port.

On the discharge line of the 150-gallon per minute pumps, 3-inch valves are installed to cut out the pump when the other one is being run. Further, these valves are closed when the pump is being primed (see below). The two pumps tie into the 3-inch discharge line to the upper solution tanks. A 3-inch by-pass pipe or mixing line is attached to this solution line between the two pumps. The nutrient solution is run through the by-pass pipe to the head of the cisterns where it is diverted to the proper one by appropriate valves. These valves are also used to regulate the pressure to the solution tanks. Also, connected to the by-pass line is a 2-inch nipple to which a 2-inch valve is attached. A 2-inch fire hose is threaded to the valve and used to supply sufficient agitation when chemicals are being mixed with the solution. (See Chapter 6.)

Because of peculiar circumstances, these pumps are placed above the solution level in the reservoirs, and therefore must be primed in order to start pumping. However, if it is necessary to install centrifugal pumps above the solution level, certain fixtures are necessary to de-aerate the pump during the priming operation if self-priming centrifugal pumps are not available.

The priming plug on the top of the centrifugal pump is removed and replaced with a ½-inch "U"-shaped pipe. The top of the "U" is about 6 inches above the pump. Between the pump and the "U"-bend a valve is inserted. The end of the pipe terminates below the pump. This valve is opened to release air from the pump while priming and it is not closed until the pump is operating.

The water line is tapped into the suction line immediately next to the intake port of the pump. Of course a valve is placed in the water line. Further back in the suction line, close to the top of the pipe that goes into the cistern, air vent valves are installed. They are the petcock type and are opened to release air in the suction line. When water squirts out of the petcock, it is closed and the pump is turned on. After the pump is working, the water prime line is shut off.

Another type of open gravity feed system is used in the United States Army Air Force hydroponics installations. It is a modification of the Terre Haute unit (see page 113). A tier of three beds is

constructed of concrete or asphalt-sand mix at successively lower levels. Usually the first bed is 120 feet long (3 feet wide and 8 inches deep), the second is 100 feet long and the third 80 feet long. These beds are connected by 2- or 3-inch pipes which contain quick-opening valves. When the first bed is filled with nutrient solution the valve is opened to allow the solution to flow into the second bed. When the second bed is filled, the solution enters the third bed. It is then drained from the third bed into a trench or flume which carries it to a sump or cistern. This solution is pumped to an above ground tank at the head of the beds. This tank may be made of concrete or redwood. When the beds are to be flooded, the quick-opening valve at the head of each bed is opened to the proper setting. As each bed of the upper section of a 10 to 25 group of beds is flooded the valve is closed and the next bed is flooded, and so on.

The flume system * is another type of open system. It appears to be a reasonably economical unit to construct and to operate. All the solution is conveyed to and from the beds via the flume. Thus no piping or valves are needed, except at the pump. Two methods of nutrient solution storage are followed, depending upon the specific location. Either an above ground tank, along with a pump sump, or an excavated cistern is built. All construction is generally concrete. Figure 5-13A shows a diagrammatic sketch of this design.

The flume usually has a depth of 12 to 15 inches and a width of 12 to 18 inches. Depending upon the length, a slope from the upper end to the lower end (next to the sump or the cistern) is constructed. This slope varies from a two to six inch drop in the bottom of the flume. The holes along the flume sides, which enter into the ends of the beds, are four inches in diameter, but six-inch holes may be better. These bed drain holes are placed about three to six inches above the bottom of the flume. Sometimes the last bed has its drain hole level with the bottom of the flume. However, even this bed should have its drain hole at least two inches above the bottom of the flume. The flume may or may not be covered. It is advisable to cover it with wood or metal sections (pre-cast concrete slabs also could be utilized).

To divert the nutrient solution properly, sluice gates are installed

* Mr. Carroll Klotzbach of Kendall, Florida, is credited for the development of this type of installation. A number of hydroponic gardens in the Miami, Florida area are based upon this design. Future expansion plans by Lago also contemplate this design.

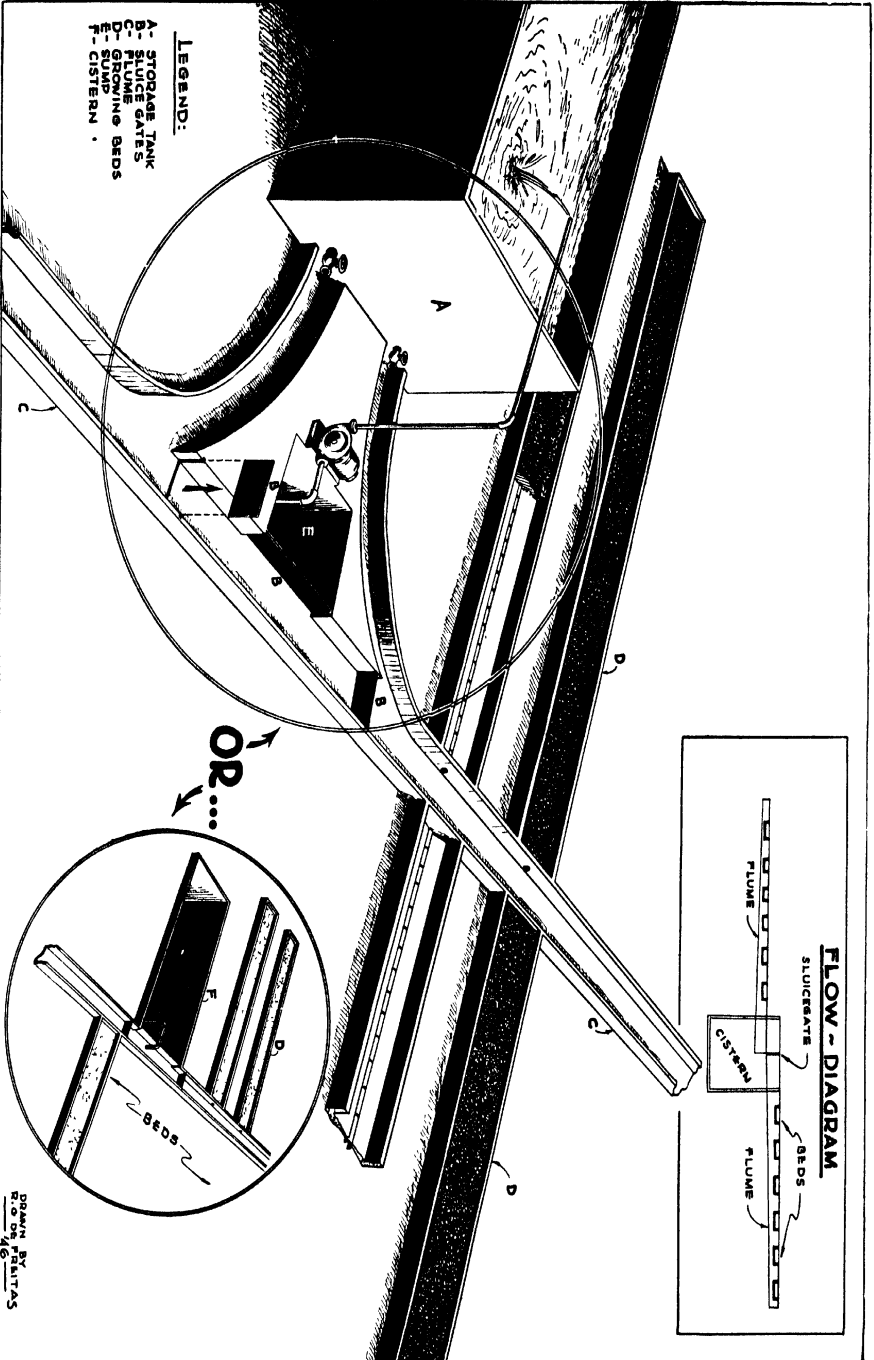

Figure 5-13A. Diagram of flume design

in the flume at certain points. Three gates are installed at the junction of the two flume sections and the solution reservoir. One gate, the middle one, diverts the solution into the sump or the cistern. The other gates control the solution flow into the respective flume sections. At the opposite ends of the flume sections sluice gates also are installed. These gates provide a means of external draining in case of heavy rains, as well as for disposal of old nutrient solution and sterilizing solution. Sometimes sluice gates are installed in the center of each flume section; this is handy for partial operation of that section of a unit.

The number of beds per unit governs the length and the elevation of the entire flume. Usually 50 to 100 beds are operated with one flume and solution reservoir, 25 to 50 beds in each half-section. It appears advisable to construct only 50 bed units with 25 beds in each sub-section. Thus a more rapid rate of filling and draining of the beds is possible. Such a unit will require each half-section of the flume to be about 90 feet long. One entire bed and flume section is on at least a 12 inch higher level than the other one as indicated in the diagram.

Beds are 100 feet long, 3 feet wide and 8 inches deep. A length-wise slope of two to four inches is formed in the bottom, with the side walls on the level. Thus, the beds become progressively deeper to the lower end at the flume. A cross-wise pitch of one to two inches to the center of the bed bottom is likewise formed to facilitate complete drainage. Sometimes, an additional depression is placed in the bottom of the bed, beneath the tile, to further improve solution transfer. A two-by-three inch triangular or square channel is formed. A one-third round tile of 6 to 8 inch radius or a one-half round tile of 6 inch radius is placed in the center of the bed. The 4 to 6-inch diameter drain hole, which is the lowest point of the bed, opens into the flume. Wooden plugs may be made to fit into the flume side of this hole if it is necessary to take certain beds out of service.

Besides the width of the beds, the width of the walks govern the area needed for a unit. Three foot walks are usually recommended. Thus, a 50-bed unit will require a space of about 180 feet by 212 feet or approximately an acre. The entire flume will then be about 180 feet long.

As mentioned above, the specific circumstances of the garden area

indicate the type of nutrient solution reservoir to be constructed. When an above ground reservoir or tank is built a pump sump is needed. This sump, which connects with the flume, is usually a five or six-foot cube, situated between the flume and the tank. The tank is large enough to hold from one to two times the volume of solution required for filling one-half the beds in a unit. If a cistern is made, no tank and sump are needed. Of course the cistern will have the same capacity as a tank. The flume opens directly into the cistern.

A pump is installed in either the sump or the cistern. Either a sump pump or a self-priming centrifugal pump is needed. Depending upon the size of the unit, a 500 to 1000 gpm pump is recommended. A 1000-gpm irrigation type pump also appears to be suitable. The pump capacity should be sufficient to allow a 15 to 30 minute filling and a 15 to 30 minute draining time.

A brief sketch of operation of the flume system unit follows. If a tank is used to store the solution, a valve is opened to allow the solution to flow into the flume. One-half of the beds are then filled at one time. The solution is then drained from this sub-section to the other one, which is on a lower level. The second half is drained into the sump. A float switch actuates the pump motor, wherein the solution is transferred to the tank. With the cistern unit, the pump transfers the solution to the flume. The solution then drains from the flume back into the cistern.

Closed Systems. Figure 5-14 is a diagrammatic plan of the Shell (C.P.I.M.) unit in Curaçao, N.W.I. This unit is closed at all times unless the individual bed drain pipe is opened. Water will not flow from the beds under normal circumstances until the level (full) is high enough to operate the automatic siphon. This unit is a modification of the Terre Haute unit (see page 113).

The beds in this unit are of asphalt-sand mix construction. They are 100 feet long, 36 inches wide and about 8 inches deep. The major modification from the Terre Haute unit is an improved type of siphon. Siphons are made of 2 to 4-inch pipe. The diagram exaggerates the length of the discharge side of the siphon, to illustrate the principle.

The centrifugal pump shown in the sketch is actually in a pit below the solution level. Nutrient solution is pumped into the head bed. When this bed is filled, the pump is shut off manually (it

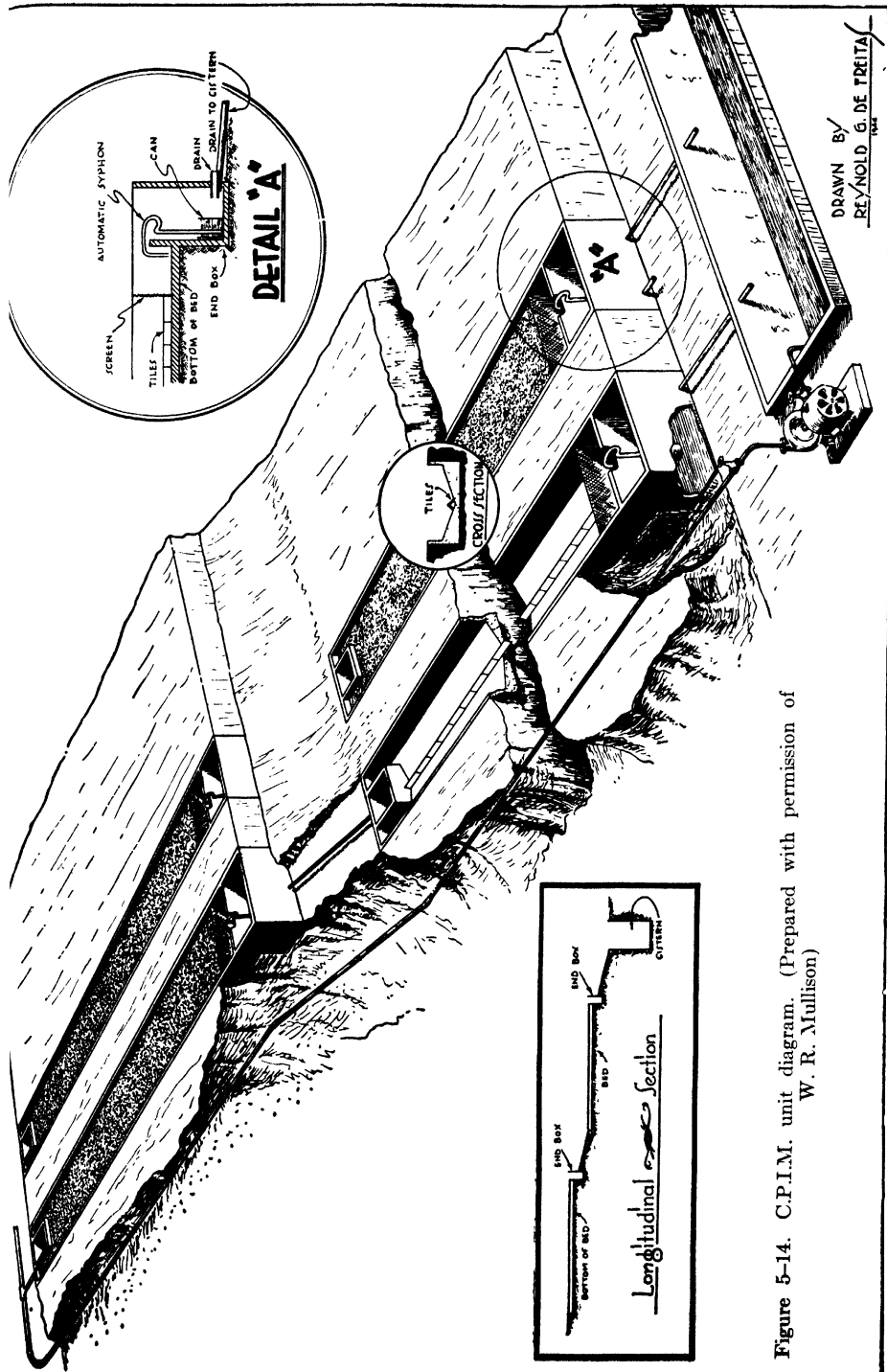

Figure 5-14. C.P.I.M. unit diagram. (Prepared with permission of W. R. Mullison)

(b) \pm 60 per cent of RC diluent.

(c) Viscosity 14 to 24 Saybolt Furol at 122° F.

A period of three days was allowed for drying before applying the hot asphalt coat. Adhesion was excellent.

The hot asphalt is applied to the prepared surface at a temperature of 350° to 400°F. Mops, old paint brushes, roofing brushes, etc., are used for the means of application. Two thin coats are suggested rather than one thick one. Depending upon the smoothness of the concrete, it will require from one to two drums per 100-foot bed.

Satisfactory results can be obtained by using a solvent paint rather than hot asphalt. A 50 per cent solution paint is made up, using naphtha or a non-leaded gasoline. This paint is brushed upon dry, well-cured and clean concrete. Two coats are recommended.

On green concrete, asphalt emulsions are suitable. Water-dispersible, quick-breaking types of emulsions are used.¹ The concrete must be still wet to secure adequate adhesion. Two coats are suggested at the rate of one gallon to about 75 square feet for each coat. Ordinary paint brushes are used for the application. Keep the brushes clean by occasionally dipping them in a can of gasoline.

Conventional wooden greenhouse benches, raised, may be readily converted for gravel culture. Strong legs and stringers must be employed because a gravel bed will have to support media which weigh about 100 pounds per cubic foot. Cinders and Haydite are much lighter than the usual gravels, and hence require lighter construction. One-inch lumber for the sides and bottom suffices, while 2 by 4 inch lumber serves as the stringers and cross-pieces; the latter are spaced 2 feet apart across the stringers. The stringers rest upon legs spaced about four feet apart. Legs may be made of poured concrete, concrete blocks, or wood. Outside-type bent angle irons are serviceable for side supports.

To supply sufficient cross-wise pitch in the bench, triangular shims may be placed upon the cross-ties. Thus the bottom will have a slight slope toward the center. (Sometimes a thin layer of concrete is poured upon the bottom of the bed to form a "V" bottom.) Any cracks between the lumber greater than $\frac{1}{4}$ inch must be covered with thin pieces of sheet metal; $\frac{1}{4}$ -inch round molding or triangular strips are placed along the edge of the sides. This strip reduces the

¹ Some asphalt emulsion sources: (a) Pure Asphalt Co., 3300 West 31st Street, Chicago, Illinois; (b) Elastic Asphalt Co., 404 North Wells Street, Chicago, Illinois (Elastex H.X. Quickbreak).

angle of bend for the asbestos roofing felt or paper, 15 to 20 pound weight, which is laid in the bench and shaped to fit. All laps are at least 4 to 6 inches wide. The paper is gently creased at the corners. A coat of hot asphalt is applied over the paper. (Note that this first paper layer is not asphalted to the bench.) Before it cools and hardens, another layer of paper is put in place. Any joints or laps in this second paper layer are placed away from the joints in the first layer. The second paper layer is also hot-mopped with asphalt. An asphalt emulsion may be used for this work, but hot asphalt usually is more satisfactory.

The solution intake nipple requires special attention. Its position in the bed is often dependent upon the length of the bed. For short benches, less than 75 feet long, the nipple may be inserted in the end board. To obtain adequate support, the best method is to weld a metal plate to the nipple. The plate is screwed firmly to the outside of the end board. The nipple is placed so that it reaches the lowest point in the bed to provide complete drainage. Special attention is paid to asphaltting around the nipples, which should be at least 8 to 12 inches long and placed so as to have 4 to 6 inches inside the bed.

On long beds the nipples may be placed in the bottom at the center of the bed. A pipe "T" is slightly countersunk in the bottom and a nipple connects it to the feed line. A metal plate may be welded to the lower part of the "T." This plate is firmly screwed to the outside of the bottom of the bed.

A recommendation offered by Ohio State University in connection with nipple arrangement for raised beds is commendable. They suggest the use of several intakes into the bed, rather than one. For a 100-foot bed a nipple may be inserted in the bottom of the bed every 20 to 25 feet. All these connect to the feed line beneath the bench which in some cases is of decreasing size to promote even flow. Such a bed is filled faster and more evenly and is drained more quickly.

Asphalt-sand mix construction for ground beds was developed at the J. W. Davis Company, Terre Haute, Indiana. The Army hydroponics garden on Ascension and the C.P.I.M. garden on Curaçao are made in this manner also. They are quite serviceable and reasonably cheap to install. The usual proportion of the mix is 70 to 85 per cent sand and 15 to 30 per cent asphalt. Two methods may be followed in the actual preparation.

First, the form of the bed is cut out in the fill. Then the asphalt-sand blend, which is mixed like concrete, is put in place by the use of forms. The sand is heated to dryness, then raised to a temperature of 350° to 400°F. The asphalt is also heated to the same temperature. Both are then placed in a portable concrete mixer which is heated by large burners. The asphalt is added first to the mixer bowl. The hot mix is poured into forms to make the 1 to 2-inch thick bed sides or walls. To prevent sticking to the metal or wooden forms, molasses or medium-hard grease may be used. When the molten mixture is set, the forms are removed and the bottom is poured. The 1 to 2-inch bottom may be troweled by hand or by a convenient movable metal form shaped to form the proper cross-wise slope to the bed bottom.

The other technique is similar to that used to construct macadam roads. A thin layer of hot asphalt is poured upon the soil or fill. Then a thin layer of dry sand is spread upon the asphalt before it cools. This process is carried out until the proper thickness is reached, usually one to two inches. With both means of fabrication, a final coating of hot asphalt is mopped upon the complete bed. (Note: Either a coarse sand or a fine gravel is suitable.)

Now for some suggested dimensions. The size of the bed varies according to the particular needs of the individual units; usually the maximum length is 100 feet. If the nipple is placed in the center, or at every 20 to 25 feet along the bottom, 150-foot benches may be installed. Widths from 30 to 60 inches are practical, depending upon the kind of crop to a large extent. Tomatoes are suited for 30 to 36-inch beds, while many floral crops can be grown in 48 to 60-inch beds. The depth must be sufficient to hold at least 6 inches of gravel in temperate climates. In the tropics 6 to 9 inches of gravel are recommended.

To provide ample drainage, a lengthwise slope of 1 to 2 inches per 100 feet is used. Sometimes the entire bench is tilted. When this means is used, the gravel depth must be less at the upper end of the bed. Quite often the bench is built with the top of the bed on the level. All the slope is provided in the bottom; that is, the bed becomes progressively deeper. This is the most satisfactory method of installation.

A cross-wise slope of 1 to 2 inches from the edge to the center of the bench should be provided. Such design insures complete removal of all free liquid from the bed.

A word must be said at this point in respect to the width of the walks between the growing beds. Two to 3-foot walks are utilized in the green house. Outdoor gardens may well use 3 or 4-foot walks if plenty of space is available. But the wider the walks the more expensive the overhead shade framework (if needed). This is particularly true on coral islands wherein it is not convenient to set up individual posts for each bed. In such circumstances 2 to 3-foot walks are recommended. The wider walks are cheaper when the fill is soil or sand.

Tile Construction. The "tile" placed on the bottom of the bed may be made of many materials. Wood, soil tile,¹ roofing gutters, roofing tile, fiber conduits and wire mesh are usable. Pieces of 1-inch



Figure 5-16. Showing placement of half-round tile in bottom of gravel bench, (Ohio Agricultural Experiment Station)

lumber, cypress or redwood, may be nailed or screwed together to form an inverted trough; some growers use 1 × 3 and 1 × 4 inch, while others use 1 × 5 and 1 × 6 inch lumber. The trough is coated with asphalt to preserve it.

Four to 6-inch soil tile cut in half serves quite well, as indicated in Figure 5-16. These work well in raised concrete benches with a

¹ Manufactured by Lavy Pottery Company, Milan, Ohio.

slight slope to the center.¹ In the older type Winandy concrete benches, where a 5-inch pitch to the center was used, full round soil tile, 4 to 6 inches in diameter, is serviceable.

Galvanized roofing gutters or eaves troughs, 4 to 6-inch size, may be used. Sometimes the bead is cut off because it is difficult to asphalt inside the roll. However, it is much better to flatten the bead with a hammer to produce a more suitable supporting edge. Usually an asphalt paint is applied to the trough, but hot asphalt may be used. In this case, preheating the tile before coating is helpful.

One-third round roofing tile of six to eight inch radius is quite satisfactory. Terra cotta tile or asphalted concrete "tile" is used.

Fiber electrical conduits are used in Aruba. Four-inch conduits are cut in half and then coated with hot asphalt.

All solid types of tile² should be in relatively short lengths. Five to 10 foot lengths are the maximum recommended. The opening between the bed bottom and the tile edge should be large enough to allow rapid flow of nutrient solution. If the bottom of the bed is reasonably rough, no shims will be necessary to hold the tile up off the bottom of the bed. Sometimes a thin layer of asphalt may be poured on the bottom of the bed, and before it cools gravel is spread upon it. This forms a rough bottom which enables the tile to rest loosely upon the bed bottom. A coarse gravel, about $\frac{1}{4}$ -inch size, is suggested for this purpose.

The size of the gravel particles limits the size of the cracks between tiles. If relatively fine gravel is used, it is suggested that some coarse gravel be placed about the tile. An opening of at least $\frac{1}{8}$ to $\frac{1}{4}$ inch is recommended for the best results. Thus, a layer of $\frac{1}{4}$ to $\frac{3}{4}$ -inch gravel may be placed about the tile, the fine gravel medium being put in next.

If large cracks occur between the tile and the bottom of the bed, some provision must be made to prevent entrance of the gravel into the tile. If gravel enters the tile, clogging occurs, which seriously

¹ Designed and installed by Winandy Greenhouse Construction Company, Richmond, Indiana.

² A recent development is the "side flume type of tile." A partition is placed between the gravel and one side of the bed to maintain a two to three inch wide channel. Either an asphalted wire screen, $\frac{1}{4}$ "- $\frac{3}{8}$ " hardware cloth, or a loosely fitting pre-cast concrete slab forms this partition. This type of "tile" may be easier to keep clean, that is, free of plant roots.

interferes with proper filling and draining of the beds. Such openings are best plugged with a wad of glass wool. Hold the glass wool in place by some gravel. Rock wool is not as durable as glass wool and is not recommended. A convenient way to handle glass wool is to place it in a bucket of water before use. This reduces the blowing about of glass sinters. Of course, heavy leather gloves and safety goggles should be worn by the workman.

Heavy-gauge wire mesh or hardware cloth may be shaped to form a "V"- or a "U"-shaped trough; $\frac{1}{4}$ -inch mesh is suggested. Either galvanized wire or Monel screen may be used. The mesh should be hot-mopped with asphalt. Some benches are constructed with a depression down the center to form the "tile" which is covered with wire. A trench 4 to 6 inches wide and 2 to 3 inches deep is made. Construction difficulties exist with this type of tile and it is not fully recommended as yet.

However, if a good job is done with this depression in the bottom of the bed, better filling and draining of the bed is possible. A 2 to 3-inch square or triangular "trench" beneath the tile is suggested.

Drainage Trench or Flume Construction. This part of the installation is usually employed in the gravity-feed system. An open flume is the usual construction. Concrete or wooden trenches are built to convey the nutrient solution, which drains from the growing bed to the pump sump or to the storage cistern. This trench may or may not be covered to keep it clean and to reduce algae growth. Wooden or metal covers are satisfactory. The dimensions of the trench or flume, that is, the width and depth, depend upon the volume of liquid to be handled (see Figures 5-13 and 5-13A).

The trench really serves two purposes: (1) it conducts the nutrient solution from the bed to the cistern, and (2) it diverts excess rain water to a dry well or a sewer line. The flume in addition conducts the solution from the reservoir to the beds. In large units, sluice gates may be used to direct the liquid. In Aruba, a three-way valve (see Figure 5-13) serves this purpose.

Cistern Construction. Concrete is the most suitable construction material for the cistern or solution storage tanks. In places wherein a high water table exists, waterproofed concrete is suggested. However, if good drainage exists in the excavation area and if the water table is low, this precaution is not absolutely necessary.

Some growers do not protect the internal surfaces of the cistern,

but the best practice is to coat the surface with asphalt. Either hot-mop asphalt or asphalt emulsion is utilized. The same precautions and procedures for coating concrete benches apply for this job also. It is necessary to coat only the bottom and sides of the cistern.

Naturally, the size of the cistern depends upon the number of beds it serves. The long range view favors a relatively large cistern. This provides for excess nutrient solution volume, which reduces the amount of operational control and provides for better stabilization of the nutrient level. A cistern which will hold 1.5 to 2.0 times the volume of solution required to flood the media in the growing beds is suggested. The latter figure is most highly recommended and is well worth the extra construction costs. This is particularly true for outdoor gardens in areas wherein considerable rainfall occurs at certain times of the year. A large cistern allows for the collection of some rain water without immediately overflowing the cistern.

An easy way to figure the necessary size of the cistern for a given number of beds is to calculate the total volume of the empty beds (without the gravel). The cistern should have a capacity equal to 50 to 100 per cent of this total volume. These figures are based upon the fact that average sized gravel holds about one-half its volume of nutrient solution; that is, a bench 100 feet long, 2.5 feet wide, and 0.5 feet deep (0.5 feet of gravel) has a gravel volume of 125 cubic feet. One-half of this volume is equal to 62.5 cubic feet, or about 475 gallons. Thus, at least 475 gallons, preferably 725 to 950, of nutrient solution should be available.

Distribution Tanks. Reinforced concrete is given first choice for the construction material. However, quite durable redwood tanks may be installed, and even metal tanks are quite acceptable. All surfaces should be asphalted.

The size of the tank will determine the strength of construction. The number of beds to be served and the method of distribution determines the tank size. Only a small tank is required if a standpipe system is installed. A large tank is necessary if all the solution needed for a given set of beds is temporarily stored in the above-ground structure.

When the standpipe system is used (see above and Figure 5-13) a tank 18 by 18 inches square and as long as needed should be suffi-

cient. The rate of pumping is adjusted to supply solution to this tank just as fast as it flows out through the standpipes. This tank is large enough to handle this volume of solution plus a slight excess. The 4 to 6-inch high standpipes may be made of wood, black iron or steel, or of concrete. Asphalt coating is suggested. The distance from the top of the standpipe to the bottom of the bed is designed to be from 6 to 12 inches. Of course, the tops of all the standpipes must be on the level. A cross-sectional area of each standpipe should be at least 36 square inches. The standpipe fits into a 3 to 4-inch hole in the bottom of the tank, and is connected with the bed by a similar size pipe which passes into the end wall of the upper end of the bed. If the system is well engineered and built, no valves are necessary. However, valves may be installed in the bed nipple if desired; in fact, in a roughly designed unit they will be necessary for flow adjustment purposes. When no valves are utilized, wooden plugs are satisfactory to plug the hole in the tank to shut off a bed. The intake for the nutrient solution into the distribution tank should enter at the center. It may be fitted into the bottom or come in over the top. A wooden or metal top which is easily removed in sections is suggested for the tank.

The Lago unit operates nine beds at one time. Possibly 15 to 25 beds may be operated at one time if adequate pump capacity is provided. The size of each section depends upon the volume of solution to be moved and the time permitted. Most gravel beds of 100 foot length require 475 to 700 gallons of nutrient solution, depending upon the width of the bed and upon the depth and the particle size of the gravel. This volume should be moved in at least 15 to 30 minutes (some recent evidence indicates that a 5 to 10-minute period is more satisfactory). Assume that 10 beds require 500 gallons each, or a total volume of 5,000 gallons. This quantity of solution should be moved in 15 minutes. This means that the pump must have a capacity of about 340 gallons per minute.

It may be cheaper to construct a large enough tank to hold sufficient solution to just flood the beds in a particular section; in this case a smaller pump is needed to fill the tank because several hours are then available to fill it. Naturally the cistern must be large enough to hold all the solution. In conjunction with the large distribution or gravity tank, the solution may be metered to the beds in at least three different ways.

The bed valve may be directly connected to the gravity tank. It is opened to a pre-determined setting to fill the bed. Another method is to connect the gravity tank to a smaller standpipe tank. The rate of flow to the smaller tank is regulated by a float valve (see the Ohio drip culture regulation device discussed in Chapter 4). Thus the solution is supplied to the standpipe unit as fast as it flows out into the beds. A third means is a special type of adjustable equalizing valve which is installed between the gravity tank and the pipe manifold system to the beds.

In cases where excavation costs are extremely high, it may be more feasible to build the upper tank large enough to hold excess solution. In other words, it could serve as the storage cistern as well as the gravity or distribution tank. In such a case a small pump sump would be necessary at the lower end of the bed section to collect the solution from the drainage trench. A float valve arrangement could operate the pump to transfer the nutrient solution to the upper tank. When the sump pit becomes empty, the float valve drops and closes the power switch. It is obvious that this system requires a pump whose capacity is as large as that noted above for the unmodified standpipe installations. When heavy rains occur, the pump can be shut off through a master switch actuated by another float valve in the upper tank when the volume reaches a certain point. Excess water would then pass from the pump sump to a dry well or a sewer line through an overflow channel.

Pumps. Centrifugal pumps are required for the gravel culture unit. They may be sump pumps or direct-driven pumps in a pump pit. The first type is satisfactory for many commercial installations. Their special use fits places where flooding conditions exist. Under such circumstances a pump pit may easily become flooded and drown the motor. Maintenance of a sump pump may be greater than for the usual type of centrifugal pump. A direct drive coupling usually requires less mechanical inspection than the long sump pump shaft. Also, corrosion of the sump pump may be greater because it is submerged in the solution.

Figure 5-17 shows a sump pump installation in a greenhouse. Figure 5-18 is a photograph of the Lago Unit pumping installation. The picture shows the auxiliary Ford motor-driven centrifugal pump. The electric motor at the lower left drives the regularly used pump.

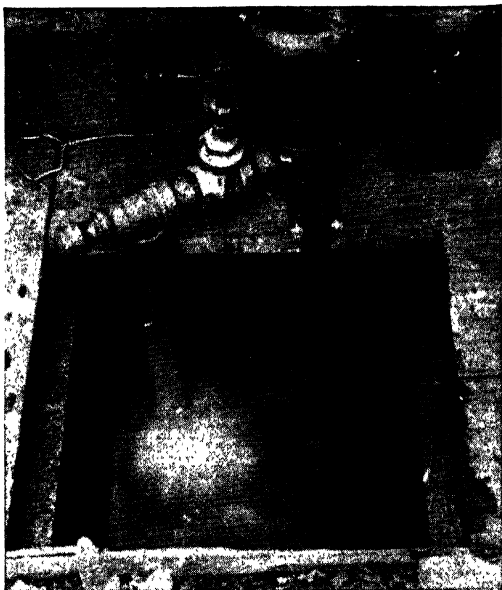

Figure 5-17. Sump pump installation at greenhouse of Geo. J. Ball, Inc.



Figure 5-18. Lago unit pumping installation. (Courtesy *Esso Farm News*)

All-iron pumps are recommended.¹ A typical pump has an iron body and a steel impeller. The bearings may be bronze if no other bronze is present in the pump. Pump capacity is dependent upon the requirements of the gravel culture unit. A pump with at least a 10-foot head is recommended to insure sufficient pressure.

Motors. Electric motors are the common source of power. They are cheap and may be automatically operated if desired. Small units may operate from a 110-volt line, medium-sized units from a 220-volt line; large units often use a 440-volt source. The actual horsepower requirements are determined by the power needs of the pump. This information can be supplied by the manufacturer. Quite often it is cheaper in the end to buy a complete pump and motor assembly. Small units, for use where only 500 to 1,000 square feet are to be flooded, will operate with a $\frac{1}{4}$ -horsepower electric motor. Large units require much more power. The Lago unit operates with a 10-horsepower motor on a 150-gallon per minute pump.

Gasoline motors are serviceable, but they do not lend themselves readily to automatic operation. Small motors of $\frac{1}{2}$ to 1 horsepower capacity are satisfactory for the small units. These motors are commonly used for washing machines, lawn motors, portable sprayers, well-water pumps, etc. Larger units may be powered with an old automobile motor. A Ford 60 motor is used as a standby in the Lago unit in Aruba.

This is a good time to discuss the value of the use of a gasoline-driven auxiliary or standby pump for large units. It is well worth the extra installation cost to prevent crop loss in case a pump, motor, or electric power failure occurs. Another precaution is to interconnect the various separate pump units; thus, if one unit burns

¹ Some sources of suitable pumps include the following firms:

- (a) Deming Company, Salem, Ohio.
 - (1) Deming No. 4000 Side Suction Centrifugal Pump. Capacity 30 gpm, head 10 foot.
 - (2) Deming No. 4602 Sump Pump. Capacity 40 gpm, head 10 foot.
 - (3) This firm also manufactures larger sizes of all iron pumps.
- (b) Gould Pumps, Inc., Seneca Falls, New York: Gould "Cid" Sump Pump, No. 3151.
- (c) F. E. Meyers and Bros. Co., Ashland, Ohio: Meyers No. 6101 Sump Pump. Capacity 25 gpm, head 10 foot.
- (d) Gardner-Denver Co., Quincy, Ill.
- (e) Arthur Wagner Co., Chicago, Ill.
- (f) Sears Roebuck and Co., Chicago, Ill. and Philadelphia, Pa.
- (g) Yoeman Brothers Company, Chicago, Ill.
- (h) Fairbanks-Morse Co., Chicago, Ill.
- (i) American Well Works, Aurora, Ill.

out, the solution may be pumped into the beds by a neighboring unit or by the auxiliary unit. Of course the auxiliary pump assembly could be portable.



Figure 5-19. General Electric Company time clock.

Time Clocks. Time clocks¹ may be used if the unit is designed to be operated automatically. Direct-feed units and closed gravity-feed systems may be run by the use of a time clock. The clock

¹ General Electric Company, Schenectady, New York:

Type T-27 Time Switch, Single Pole, Single Throw. 3T27BAA for 60 cycle 115 volt circuit. 3T27BAB for 60 cycle 230 volt circuit.

This type of switch can be supplied with any number of tabs to set up any num-

starts the electric motor and stops it after the pump has run for the proper length of time. Setting of the various adjustable tabs on the face of the clock determines the full pumping cycle. Figure 5-19 illustrates a satisfactory time clock.

Piping and Valves. Black iron or steel pipe is recommended. Galvanized pipe should not be used unless the zinc is removed by an acid bath. The same applies to all fittings.

All-iron or steel valves are recommended. Although it is not suggested, brass-seated valves may be used if no other kind are available. Usually gate type valves are used; they may be either the wheel-operated or the quick-opening type.

Media. Numerous materials are suitable for the media or gravel. These include Haydite,¹ soft-coal cinders, hard-coal cinders, volcanic cinders or lava, crushed granite, trap rock, silica gravel, quartz gravel, non-calcareous river gravel,² calcareous bank gravel, crushed limestone and crushed coral. If any of the media are quite dirty and full of silt and soil, they should be washed. The choice of medium is determined by its cost and its cultural characteristics (see p. 87).

The gravel size usually employed runs between $\frac{1}{16}$ and $\frac{1}{2}$ inch in diameter. A good range recommended for many crops is from $\frac{1}{8}$ to $\frac{3}{8}$ inch. The gravel size is actually expressed in screen size. That is, a gravel of $\frac{1}{16}$ to $\frac{1}{4}$ -inch specifications is composed of material which passes through a $\frac{1}{4}$ -inch wire mesh and is retained upon a $\frac{1}{16}$ -inch wire mesh.

Another factor of considerable importance is the relative percentage of the several sizes of gravel within the specific range. Sometimes gravel is delivered which contains too many of the finer particles and not enough of the coarser ones. Thus, a finer gravel is

ber of pumpings. Also, a 10 minute pump operation period can be set.

Sangamo Electric Company, Springfield, Illinois:

Type K-11 Sangamo Time Switch, No. 110913, one pole, one throw, 60 cycles, 115 volts.

This time clock may only be set for one, two, or three pumpings per day, which is sufficient for practically all purposes. But it cannot be set any closer than a 20 minute pump operation period.

¹ Haydite is a proprietary material, a burnt shale product. Several sources of supply are available, including Hydraulic Pressed Brick Company, South Park, Ohio, and Western Brick Company, Chicago, Illinois.

² Some sources of supply for good grades of river gravel for the mid-west include Carl Lotz Sand and Gravel Company, Wausau, Wisconsin, and R. P. Kuhlman, Chicago, Ill.

actually used than the specifications state. If a $\frac{1}{8}$ to $\frac{3}{8}$ -inch gravel is used, 50 per cent of the particles should fall in the $\frac{1}{8}$ to $\frac{1}{4}$ -inch size and the other half in the $\frac{1}{4}$ to $\frac{3}{8}$ -inch size.

Special treatments are in order when certain media are used. Cinders often contain high concentrations of water-soluble alkali salts, which are readily leached out. The cinders are placed in the bed and soaked in water for 16 to 24 hours. This procedure is repeated as often as necessary. Usually a final flushing is given by a hose.

Sometimes water-leaching does not suffice and an acid treatment is necessary. The medium is soaked in a 5 per cent (by volume) sulfuric acid solution over night. To prepare 1,000 gallons of 5 per cent sulfuric acid solution, add 50 gallons of acid to 950 gallons of water. (First see Chapter 7 for method and precautions to follow in the preparation of sulfuric acid solutions.) If this acid solution in the bed becomes alkaline in reaction, add more acid. Finally, when the soaking solution has remained definitely acidic for several hours, drain it out. Flush the medium with fresh water to remove the excess acid. A final check upon the treatment must be made. Fill a quart jar one-half full with the treated cinders. Add distilled water to just flood these cinders and let soak over night. If the acidity of this water does not go beyond neutrality or pH 7.0 (see Chapter 7) the cinders are suitable for use.

If cinders are very acidic in nature, it is cheaper not to treat them. It requires considerable alkali solution to do the job. Thus, to soak a bed of acidic cinders with a 5 per cent lye (sodium hydroxide) solution, it requires about 450 pounds for 1,000 gallons of water.

It will be noted here that although the initial cost of cinders may be practically zero, the preparation is expensive. Considerable expense is also entailed in screening and cleaning the cinders.

Cinders, Haydite and calcareous gravels are often benefited by pre-treatment with a concentrated calcium phosphate solution. Treble superphosphate (see Table 6-1, p. 135) is probably the cheapest material for this purpose. Ordinary superphosphate contains too much insoluble material which will deposit within the gravel. It requires about 10 to 20 pounds of treble superphosphate per 1,000 gallons. The gravel is soaked until a rapid decrease in the phosphate content of the soaking solution stops. If all the phosphate is removed from the solution, add more. When a stable content in the

solution is reached, no lower than 5 to 10 parts per million (see Chapter 12), the soaking period may be discontinued. If the final concentration of the phosphate treating solution is over 125 parts per million, the medium should be flushed. In case the phosphate level is below this figure, just drain the solution to the cistern. Add the other salts to prepare the nutrient solution and add sufficient phosphate to have 62 to 125 parts per million in the nutrient solution.

Unit Operation

Because the various operational directions for gravel culture are discussed in greater detail in Chapters 6 to 12 inclusive, only a brief outline is presented here. The reader will obtain at this point a general view of the operation of a gravel culture unit. Included in the many cultural operations are (1) seeding, (2) transplanting, (3) pumping, (4) maintenance of solution volume, (5) adjustment of nutrient ion level and (6) regulation of the solution acidity.

Seeding. Gravel culture lends itself readily to sowing of various seeds, from small to large ones. However, slightly greater depths are used than for soil because of the greater coarseness of the gravel, which dries out more readily at the surface. The advantage of seed germination and seedling development over soil are similar to those listed for sand culture in Chapter 4. Good control of the moisture and nutrient levels and better control of damping-off is possible. Either water or nutrient solution may be used to germinate the seeds. More specific instructions are presented in Chapter 9 (p. 202).

Transplanting. Transplanting of plants into gravel is done in the same manner as setting in water culture, sand or soil. The plants may be transferred from seed beds of soil, sand, or gravel. When soil- or sand-grown seedlings are transplanted, the soil or sand may be transferred along with the plant roots, or be washed off. The particular culture conditions govern this decision. Chapter 9 discusses this matter in greater detail (p. 205).

Pumping. The nutrient solutions may be transferred from the reservoir to the gravel bed by means of pumps or gravity, or both. Buckets containing the solution are raised to above the level of the plant boxes at certain intervals during the day to flood the media of small units. When the medium is full of solution, the

buckets are immediately lowered to drain the solution from the gravel bed.

Direct-pumping systems operate by forcing the solution from the cistern directly into the gravel bed by means of a centrifugal pump. When the proper volume of liquid is transferred, the pump motor is stopped manually or automatically. The nutrient solution flows back into the cistern by the same route that it went into the bed.

Large commercial units also employ gravity in conjunction with centrifugal pumps to put the nutrient solution into the gravel beds. In this case the solution is pumped from a storage cistern to an elevated tank from which the solution flows by gravity into the beds. A standpipe system or a pressure-equalizing valve provides the proper rate of flow into a number of beds at one time; or each bed in a given unit connected to the distribution tank may be flooded separately by manipulation of the valve at each bed. Or, in the case of the flume system, the solution is pumped to the beds via the flume. When the bed is filled with solution, it is immediately drained out by opening a valve or removing a plug (pipe cap or wooden plug) at the bottom of the lower end of the bed. The solution flows by gravity from the bed into the cistern.

The tile in the center of the bed, which is placed loosely upon the bottom, affords a means of distributing the solution uniformly within the medium. The solution flows through the nipples in the bed into the channel formed by the tile. Then it seeps out into the medium under the crack or opening formed between the bottom of the bed and the bottom of the tile. This flow occurs throughout the entire length of the bed. The return flow of the solution to the cistern runs through the same channel.

The selection of the pumping schedule is considered in Chapter 9.

Solution Volume. Actually the solution volume should be considered from two standpoints. (1) The total volume of solution used, that is, the amount of solution in the cistern, must be kept within certain limits; this is necessary to maintain the proper concentration of chemicals in the nutrient solution as explained in Chapter 7. (2) The level to which the solution is permitted to rise within the medium must be regulated. Although the solution level is not as critical in gravel as it is in water culture, a reasonably constant level should be maintained; that is, the upper level of the solution, when it is pumped into the bed, should be duplicated every

time. The plants appear to grow better under such circumstances and the incidence of some types of diseases seems to be less. This is particularly true for fungus diseases like damping-off, which are less prevalent if the gravel surface is kept dry. Chapters 8 and 10 consider these matters more fully.

Nutrient Ion Additions. The nutrient solution composition should be held within certain limits to support good crop production. Chapter 7 is devoted entirely to the technical control of the nutrient solution. Both chemical analyses and arbitrary means of regulating the nutrient ion level are discussed in respect to macro or major ions and to micro or minor nutrient ions. Chapter 12 includes methods of analyses of the nutrient solution.

Solution Acidity. The proper degree of solution acidity should be checked frequently—at least daily until experience dictates otherwise. See Chapter 7 for details.

Chapter 6

The Nutrient Solution

Nutrient solutions are not of recent origin, as supposed by popular opinion. Botanists and plant physiologists have worked with artificial cultures, that is, soilless cultures, for many years. The modern nutrient solution dates back to 1860 as an experimental tool in the plant culture laboratory. Commercial interest was first established in the United States between 1929 and 1936.

The practical man should have a knowledge of several factors pertaining to the formulation of the nutrient solution. These include: (1) a brief general theory of the nutrient solution; (2) the chemicals required; (3) the kind of water needed; (4) the composition of nutrient solution and (5) the method of preparation.

Theory of Nutrient Solutions

As stated in Chapter 2, a nutrient solution is in a sense an artificial soil solution. All the necessary inorganic elements required for plant growth, which include nitrogen, potassium, calcium, magnesium, sulfur, phosphorus, iron, manganese, boron, copper and zinc, must be supplied in this solution in a readily available form. Thus complete solubility of the essential ions in water is a prerequisite for an inorganic nutrient solution. Nitrogen, potassium, calcium, magnesium, sulfur and phosphorus—the major or macro elements—must be included in the chemicals added to the water to form the nutrient solutions. The other elements, iron, manganese, boron, copper and zinc—the minor or micro elements—often are included as impurities in the above chemicals and in the water, and are only added when necessity occurs. Various factors influence the solution make-up apart from merely supplementing the essential ions; also, some ions must be in a particular chemical state to be utilized by the plant. Moreover, certain mathematical expressions are necessary in order to formulate a nutrient solution.

General Requirements. The total quantity of salts permitted in a nutrient solution consistent with satisfactory plant growth is fully discussed in Chapter 7 (p. 163). It suffices at this point to state that this quantity expressed in osmotic concentration is usually from 0.5 to 2.0 atmospheres. The amounts of the individual ions and the proportions of the ions to one another must be properly regulated, but under practical conditions considerable variance is usually permitted. This spread may be noted by a study of the several nutrient solutions suggested for practical purposes in Table 6—6 (p. 142). Plants can grow in a fairly wide pH range, varying from 4.0 to 8.0 (see Chapter 7) or from strongly acid to slightly alkaline conditions. However, most plants develop best in the range of pH 5.0 to 6.5, which is from medium to slight acidity.

Plant physiologists state that within the proper limits any well-balanced solution will support satisfactory growth. Such a definition implies that a theoretical “best” solution for a particular crop does not exist. However, under practical conditions data are accumulated to support the contention that a “best” solution does exist for a particular crop under specific growing conditions. It was found in the United States that greenhouse cucumbers thrive best with a low concentration while greenhouse tomatoes do best with a medium concentration of the same nutrient solution. In Aruba it was observed that lettuce produced better when the potassium and nitrogen proportion was properly balanced (a one-to-one ratio). However, a good nutrient solution will support general satisfactory growth of many crops and it is suggested that all crops be grown with a recommended solution until conditions dictate a specific solution for a specific crop.

Form in which Element is Available to the Plant. The plant must not only have the essential nutrients in solution, but they must be in a specific ionic form to be available. Nitrogen is absorbed either as the nitrate (NO_3^-) or as the ammonium ion (NH_4^+). Nitrate, a negative ion or anion, is the most satisfactory source of nitrogen for plants, particularly in practical culture. Ammonium nitrogen, a positive ion or cation, is more difficult to handle and should be used only as a supplementary nitrogen source, except under specific conditions.

Plants absorb potassium, calcium and magnesium as positive ions or cations, that is, in the ionic form of potassium ion (K^+), calcium ion (Ca^{++}), and magnesium ion (Mg^{++}).

Sulfur and phosphorus must be in the oxidized state to be available. Thus we consider the sulfate ion (SO_4)⁻ and the phosphate ion (PO_4)⁻⁻⁻ which are divalent and trivalent negative ions or anions respectively.

Iron and manganese must be in the reduced state to be used by the plant, according to some published data. Thus the ferrous ion (Fe^{++}) and the manganese ion (Mn^{++}) are required. But, in the case of organic iron compounds, the plant is apparently capable of utilizing oxidized iron as a ferric (Fe^{+++}) iron organic complex.

Boron is universally supplied as boric acid, sometimes as borax. Since boron exists in nature usually as an oxygen complex, it may be the necessary state for plant use.

Published data do not indicate in what form copper and zinc are required for plant growth. Apparently the cupric ion (Cu^{++}) and the zinc ion (Zn^{++}) are available, because these are the commonly used sources.

Solution Mathematics. The nutrient solution formulated may be expressed mathematically in three general ways. These are the molar concept, the normal concept and the parts per million concept. For practical purposes the macro elements are best expressed in molar units, while the minor elements are most conveniently designated in parts per million units. For general completeness all three forms of nutrient ion calculations are briefly discussed in the following paragraphs.

Molar Concept. The molar concept may be sub-divided into two means of expression, the Partial Volume Molecular (*PVM*) and the millimole (*mm*) unit. Mathematically, the two units are equal, but are expressed in different terms. The millimolar unit is the more practical to use. Both designations are based upon the definition of a molar solution.

A molar solution is one composed of a gram molecular weight (or a mole) of the chemical dissolved in one liter of water. This solution is expressed as a volume molar or a molar solution. Actually in practical work a weight molar solution or a molal solution is often prepared. This differs from a volume molar solution in that a mole of the chemical is dissolved in 1000 grams of water (practically equal to one liter); therefore, the total volume is greater than one liter because the added chemical possesses a volume in solution. But the difference between a molar and a molal solution is not significant under practical conditions.

Thus a nutrient solution chemical may be expressed in partial molecular volume (*PVM*) which indicates the decimal fraction of the molecular weight of the particular salt dissolved in one liter of nutrient solution. Also, this same concentration may be expressed in millimolar units, which states how many one-thousandths of a gram molecular weight (or a mole) is present in the solution. In other words, a molar concentration of potassium nitrate of 0.007 may be expressed as 0.007 *PVM* or 7.0 mm.

Normal Concept. The normal concept is derived from the theory of normal solutions. Normality is based upon the molecular weight basis of a solution, but ions in the solution vary in activity according to their valence, which governs the hydrogen equivalent value of the ion. The hydrogen equivalence is a measure of the number of replaceable hydrogen atoms there are in a compound, or the reaction power of another atom for hydrogen atoms. Since atoms become ions in solution, a monovalent ion has a hydrogen equivalence of one, a divalent ion of two, and so on. Thus a normal solution contains an *equivalent* weight of the substance rather than a *molar* weight. In nutrient solution culture work a normal solution is usually expressed as an equivalent solution in terms of milliequivalents (*me*), or one-thousandths of an equivalent weight. It must be noted that an equivalent solution is based upon the concentration of a particular ion of the salt in solution, not upon the total salt. This is where the *me* system differs from the *mm* system.

A comparison of the two methods will indicate how the milliequivalent concentration is calculated. Suppose a nutrient solution contains 5 mm, or 0.005 mole of calcium nitrate of the formula $\text{Ca}(\text{NO}_3)_2$. Calcium has a valence of two; hence a normal or equivalent solution of calcium nitrate contains half as much as does a molar solution. Stated in reverse, a solution containing so many millimoles of calcium contains twice as many milliequivalents. Thus a 5 mm solution of calcium nitrate has a calcium content of 5 mm or 10 *me*.

Theoretically the milliequivalent concept is the more correct nomenclature to express the ionic concentration of the nutrient elements. But the millimolar system is simpler for further calculations in determining the amount of salts to add to a given volume of water (see below, p. 146).

Another point to be considered in a discussion of the ionic con-

cept of the nutrient solution is the estimation of the relative number of the ions contained in a solution when a certain salt is dissolved in water. The chemicals commonly used for solution culture units are readily ionized in water, at least 80 to 90 per cent, at ordinary concentrations. For practical purposes the ionization may be considered complete, or 100 per cent. Thus when 0.005 mole or 5 mm of calcium nitrate, $\text{Ca}(\text{NO}_3)_2$, is dissolved in one liter the number of moles of calcium and nitrate in solution may be expressed as "ions." In this solution there are 5 moles (or "ions") of calcium and 10 moles (or "ions") of nitrate. Likewise, there are 10 me of calcium and 10 me of nitrate.

Parts Per Million Concept. The third method of expressing the solution make-up is in parts per million (ppm). This is a weight basis method, but it is indirectly related to the molar solution. If one gram of a substance is dissolved in 1,000,000 grams of water, a one part per million solution results. Usually the concentration of the particular ion rather than the salt is expressed in a nutrient solution formula. Thus the nitrate level may be given as 400 ppm. Considerable calculating is required to ascertain how much potassium nitrate is necessary to supply 400 ppm of the nitrate ion to a given solution volume (refer to the calculations for adding minor elements, page 151). The ppm system does not express the ionic content of a nutrient solution; therefore it has less theoretical value to the grower. Also, it is less practical, as mentioned above. However, the ppm of the various ions may be readily converted to mm. Divide the ppm of the particular ion (or mole) by the atomic weight of the mole concerned. To convert 160 ppm of calcium to 4 mm, divide the 160 ppm by 40, the atomic weight of calcium. This will also indicate that 4 mm of calcium sulfate are used if this is the only calcium salt in the nutrient solution.

Chemicals Required

This discussion may be sub-divided into three sections. The macro elements are supplied by a number of common chemicals; this is also true of the micro elements, but the list is smaller. Certain non-nutrient, but necessary chemicals will also be discussed.

Macro Element Chemicals. The simplest nutrient solution is composed of three salts, namely magnesium sulfate, calcium nitrate and monopotassium phosphate. A typical commercial solution con-

tains magnesium sulfate, monocalcium phosphate, potassium nitrate, and calcium sulfate. For practical purposes commercial or technical grade chemicals are satisfactory, though for exact experimental work chemically pure salts are necessary. The soilless culture gardener has a choice of several commonly used salts with which to prepare his nutrient solution.

The necessary six elements, namely, nitrogen, potassium, calcium, magnesium, sulfur, and phosphorus, may be obtained from the list of chemicals given in Table 6-1. The approximate molecular weights are listed in this table; these include the impurities and any water of crystallization. For example, pure potassium nitrate has a molecular weight of 101, but that of the commercial grade may be considered to be 110. Thus, when calculating a nutrient solution the final weight of the salts is figured directly by using the approximate molecular weight.

Nitrogen. Usually potassium nitrate is the most economical and satisfactory nitrogen source. Calcium nitrate is a good nitrogen source, but expensive. Sodium nitrate is a cheap nitrogen source, but its use is limited, because the sodium ion level must be kept relatively low in the nutrient solution.

Ammonium salts should be used with caution and only as a supplementary nitrogen source, except under special conditions. Ammonium sulfate is most commonly used, but urea is a good substitute. Ammonium nitrate is not recommended; for some unknown reason this chemical does not support good plant growth, even when used only as a supplementary source of nitrogen as ammonium.

Potassium. Potassium nitrate is a good source of potassium and is often used as the sole supply of both nitrogen and potassium. Potassium chloride and potassium sulfate are satisfactory potassium sources. However, care must be exercised to prevent the chloride and sulfate ions from building up to too high a concentration in the nutrient solution.

Phosphorus. Potassium and ammonium phosphate salts are too expensive to be considered for commercial use. Mono calcium phosphate, as a food grade, treble superphosphate and regular grade superphosphate are the most desirable phosphate sources. The food grade chemical is more expensive per pound, but less material is used than with the other grades. All three may be used success-

Table 6-1. Nutrient Solution Chemicals: Major or Macro Elements.

Type of Salt	Compound	Chemical Symbol	Approx. Molecular Weight
Nitrogen	Potassium nitrate	KNO_3	110
	Calcium nitrate	$\text{Ca}(\text{NO}_3)_2$	180
	Sodium nitrate	NaNO_3	90
Ammonium	Ammonium sulfate	$(\text{NH}_4)_2\text{SO}_4$	140
	Urea	$(\text{NH}_2)_2\text{CO}$	60
	Ammonium nitrate	NH_4NO_3	80
	Mono-ammonium phosphate (Ammophos A)	$\text{NH}_4\text{H}_2\text{PO}_4$	140
	Mono-ammonium phosphate*	$\text{NH}_4\text{H}_2\text{PO}_4$	120
	Di-ammonium phosphate*	$(\text{NH}_4)_2\text{HPO}_4$	140
Potassium	Potassium nitrate	KNO_3	110
	Potassium chloride	KCl	80
	Potassium sulfate	K_2SO_4	200
Phosphate	Potassium phosphate (Monobasic)	KH_2PO_4	140
	Mono-ammonium phosphate (Ammophos A)	$\text{NH}_4\text{H}_2\text{PO}_4$	140
	Mono-ammonium phosphate*	$\text{NH}_4\text{H}_2\text{PO}_4$	120
	Di-ammonium phosphate*	$(\text{NH}_4)_2\text{HPO}_4$	140
	Mono-calcium phosphate*	$\text{CaH}_4(\text{PO}_4)_2 \cdot \text{H}_2\text{O}$	270
	Mono-calcium phosphate (Treble superphosphate)	$\text{CaH}_4(\text{PO}_4)_2 \cdot \text{H}_2\text{O}$	310
	Mono-calcium phosphate (Common superphosphate)	$\text{CaH}_4(\text{PO}_4)_2 \cdot \text{H}_2\text{O}$	750
Magnesium	Magnesium sulfate (Epsom salts)	$\text{MgSO}_4 \cdot 7\text{H}_2\text{O}$	260
	Magnesium sulfate (anhydrous)	MgSO_4	130
Calcium	Calcium nitrate	$\text{Ca}(\text{NO}_3)_2$	180
	Calcium sulfate	$\text{CaSO}_4 \cdot 2\text{H}_2\text{O}$	190
	Calcium chloride	$\text{CaCl}_2 \cdot 2\text{H}_2\text{O}$	150
Sulfur	Calcium sulfate	$\text{CaSO}_4 \cdot 2\text{H}_2\text{O}$	190
	Potassium sulfate	K_2SO_4	200

* Food grade

fully. Depending upon price, it may be found that the food grade will be the cheapest per unit volume of nutrient solution. Less insoluble residue develops in the solution tank, and there is less danger of possible, but highly improbable, fluorine toxicity than when superphosphate is used. But superphosphate contains considerable calcium sulfate, often 20 per cent, which supplies some of the calcium requirements and it may also supply some minor elements as

impurities. The choice of the calcium phosphate source lies primarily upon price.

Magnesium. Epsom salts appears to be the most practical source of magnesium. Anhydrous magnesium sulfate is more expensive per pound, but only one-half as much is needed. Actually, the price differential per unit of solution volume is not great. However, the anhydrous chemical requires special care in dissolving. It must be added slowly with much stirring into the water to prevent formation of hard, poorly soluble lumps. Epsom salts dissolves easily, regardless of how it is handled, and it will not absorb moisture in storage.

Calcium. Calcium is usually added in several salts in the nutrient solution. All the calcium may be supplied by one salt, including calcium nitrate, calcium sulfate and calcium chloride. Calcium nitrate is a good, but expensive source. Calcium sulfate is the most practical. Calcium chloride may be used in limited quantities. Calcium phosphate may not be used as the total calcium source, as the amounts required would raise the phosphate level too high in the nutrient solution.

Sulfur. Sulfur is usually handled in the same manner as calcium. Ammonium sulfate and magnesium sulfate may partially supply the sulfur requirements. Both potassium sulfate and calcium sulfate may be used to fully satisfy the sulfur needs. Usually calcium sulfate is utilized as the source of both calcium and sulfur.

Table 6-2 gives a partial list of suppliers of these chemicals.

Table 6-2. Partial List of Source of Supply of Major or Macro Element Chemicals.

Chemical	Company	Address
Potassium nitrate	F. W. Berk & Company, Inc.	New York, N. Y.
	Synthetic Nitrogen Products Co.	New York, N. Y.
	General Chemical Co.	New York, N. Y.
	American Cyanamid & Chemical Corp.	New York, N. Y.
Calcium nitrate	J. T. Baker Chemical Co.	Phillipsburg, N. J.
	Synthetic Nitrogen Products Co.	New York, N. Y.
Sodium nitrate	Swift Fertilizer Works	Chicago, Ill.
	American Cyanamid & Chemical Corp.	New York, N. Y.
	Chilean Nitrate Co.	New York, N. Y.
Ammonium sulfate	Armour Fertilizer Works	Chicago Heights, Ill.
	Synthetic Nitrogen Products Co.	New York, N. Y.
	Swift Fertilizer Works	Chicago, Ill.
	American Cyanamid & Chemical Corp.	New York, N. Y.
Urea	E. I. du Pont de Nemours & Co.	Wilmington, Del.

Chemical	Company	Address
Ammonium nitrate	Hercules Powder Co.	Wilmington, Del.
Mono-ammonium phosphate	Monsanto Chemical Co.	St. Louis, Mo.
Ammonium phosphate (dibasic)	Monsanto Chemical Co. Merck & Co.	St. Louis, Mo. Rahway, N. J.
Potassium chloride	N. V. Potash Export Mfg. Co. Inc. American Cyanamid & Chemical Corp. American Potash & Chemical Corp.	Chicago, Ill. New York, N. Y. New York, N. Y.
Potassium sulfate	N. V. Potash Export Mfg. Co., Inc. Armour & Company J. T. Baker Chemical Co. American Potash & Chemical Corp.	Chicago, Ill. Chicago, Ill. Phillipsburg, N. J. New York, N. Y.
Mono-calcium phosphate (food grade)	Monsanto Chemical Co.	St. Louis, Mo.
Treble superphosphate	Victor Chemical Co.	Chicago, Ill.
Common superphosphate	Any Agricultural Supply Store	
Potassium phosphate (monobasic)	F. W. Berk & Co., Inc. General Chemical Co. Mallinckrodt Chemical Works	New York, N. Y. New York, N. Y. New York, N. Y.
Magnesium sulfate (anhydrous)	F. W. Berk & Co., Inc. American Cyanamid & Chemical Corp.	New York, N. Y. New York, N. Y.
Magnesium sulfate (Epsom salts)	Kauffman Lattimer Co. Baugh & Sons Co. Dow Chemical Co. McKesson & Robbins, Inc. F. W. Berk & Co., Inc. General Chemical Co. American Cyanamid & Chemical Corp. Merck & Co.	Columbus, Ohio Baltimore, Md. Midland, Mich. Chicago, Ill. New York, N. Y. New York, N. Y. New York, N. Y. Rahway, N. J.
Calcium sulfate	United States Gypsum Co. The Ohio Horticultural Services American Cyanamid & Chemical Corp.	Chicago, Ill. Columbus, Ohio New York, N. Y.
Calcium chloride	The Solvey Process Co.	Syracuse, N. Y.

Micro Element Chemicals. Table 6-3 lists the common technical or commercial grade materials utilized to supply the necessary micro elements. Also included is a column of conversion factors. These figures indicate how many units of the salt are needed to supply one unit of the desired micro element, that is, how many grams of the salt are required to supply one gram of the element.

Iron is usually supplied as ferrous sulfate, which is the most practical salt. Iron citrate, ferric ammonium citrate and iron tartrate are better sources of iron under high pH conditions. However, care

Table 6-3. Nutrient Solution Chemicals: Minor or Micro Elements.

Type of Salt	Compound	Chemical Symbol	Approx. Conversion Factor
Iron	Ferrous sulfate (Copperas)	$\text{FeSO}_4 \cdot 7\text{H}_2\text{O}$	5.0
	Ferric chloride	$\text{FeCl}_3 \cdot 6\text{H}_2\text{O}$	4.8
	Iron tartrate	$\text{FeC}_4\text{H}_4\text{O}_6$	3.6
	Iron citrate	$\text{FeC}_6\text{H}_5\text{O}_7 \cdot 3\text{H}_2\text{O}(?)$	5.3
	Ferric ammonium citrate	$\text{Fe}(\text{NH}_4)_3(\text{C}_6\text{H}_5\text{O}_7)_2$	8.7
Manganese	Manganese sulfate	$\text{MnSO}_4 \cdot 4\text{H}_2\text{O}$	4.0
	Manganese chloride	$\text{MnCl}_2 \cdot 4\text{H}_2\text{O}$	3.6
Copper	Copper sulfate (blue vitriol)	$\text{CuSO}_4 \cdot 5\text{H}_2\text{O}$	3.9
	Copper chloride	$\text{CuCl}_2 \cdot 2\text{H}_2\text{O}$	2.7
Zinc	Zinc sulfate	$\text{ZnSO}_4 \cdot 7\text{H}_2\text{O}$	4.4
	Zinc chloride	ZnCl_2	2.1
Boron	Boric acid	H_3BO_3	5.6
	Borax	$\text{Na}_2\text{B}_4\text{O}_7 \cdot 10\text{H}_2\text{O}$	3.5

must be taken to prevent decomposition of stock solutions because they are organic compounds. Manganese sulfate and manganese chloride may be used, but the former is the more common. This salt is hygroscopic and it must be kept in air-tight containers. Copper chloride and copper sulfate are available copper sources, but the sulfate (blue vitriol) is usually used; as to zinc, again the sulfate rather than the chloride is preferred. Either borax or boric acid can be used to supply boron. However, boric acid is better, as it mixes well with the other compounds in a stock solution because of its acidic nature. Granulated boric acid is recommended rather than the powdered material because it dissolves more readily.

Table 6-4 presents a partial list of suppliers.

Other Chemicals. Acids and alkalies must be supplied to adjust the pH (acidity) of the nutrient solution. Sulfuric, nitric and phosphoric acid are commonly used. Technical or commercial grades are usually satisfactory. Sulfuric acid is the universal acid for this purpose. However, under special conditions, particularly when saline water is used, the other acids are more practical. Nitric acid is suitable under conditions of high nitrate uptake from the nutrient solution, but it is rather unpleasant to use. Phosphoric acid must be handled with care or the phosphate level in the solution will increase too much.

Table 6-4. Partial List of Source of Supply of Minor or Micro Element Chemicals.

Chemical	Company	Address
Iron sulfate	McKesson and Robbins, Inc.,	Chicago, Ill.
	American Cyanamid & Chemical Corp. Any Chemical Supply House	New York, N. Y.
Iron tartrate	J. T. Baker Chemical Co., Any Chemical Supply House	Phillipsburg, N. J.
Iron citrate	J. T. Baker Chemical Co., Any Chemical Supply House	Phillipsburg, N. J.
Manganese sulfate	McKesson and Robbins, Inc.,	Chicago, Ill.
	Mallinckrodt Chemical Works,	New York, N. Y.
	J. T. Baker Chemical Co., Any Chemical Supply House	Phillipsburg, N. J.
Manganese chloride	McKesson and Robbins, Inc.,	Chicago, Ill.
	Mallinckrodt Chemical Works	New York, N. Y.
	J. T. Baker Chemical Co., Any Chemical Supply House	Phillipsburg, N. J.
Copper sulfate	Merck and Co.	Rahway, N. J.
	J. T. Baker Chemical Co.,	Phillipsburg, N. J.
	Any Chemical Supply House	
Copper chloride	Merck and Co.,	Rahway, N. J.
	J. T. Baker Chemical Co.,	Phillipsburg, N. J.
	Any Chemical Supply House	
Zinc sulfate	Merck and Co.,	Rahway, N. J.
	J. T. Baker Chemical Co.,	Phillipsburg, N. J.
	Any Chemical Supply House	
Zinc chloride	Merck and Co.,	Rahway, N. J.
	J. T. Baker Chemical Co.,	Phillipsburg, N. J.
	Any Chemical Supply House	
Boric acid	American Potash and Chemical Corp.	New York, N. Y.
	Merck and Co.,	Rahway, N. J.
	Any Chemical Supply House	
Borax	American Potash and Chemical Corp. Any Chemical Supply House	New York, N. Y.

Three alkalis are suggested to adjust the solution pH (acidity): potassium, sodium and ammonium hydroxide. The first hydroxide is recommended. Sodium hydroxide must be used with caution, or else the sodium ion concentration may increase too greatly in the nutrient solution. Ammonium hydroxide is both unpleasant to use and subject to limitations in the amounts permitted.

A partial list of sources of supply is tabulated in Table 6-5.

Table 6-5. Partial List of Source of Supply of Other Chemicals.

Chemical	Company	Address
Sulfuric acid	J. T. Baker Chemical Co.	Phillipsburg, N. J.
	Central Chemical Co.	Chicago, Ill.
	Grasselli Chemical Division, E. I. du Pont de Nemours & Co.	New York, N. Y.
	Any Chemical Supply House	
Nitric acid	Central Chemical Co.	Chicago, Ill.
	Monsanto Chemical Co.	St. Louis, Mo.
	Any Chemical Supply House	
Phosphoric acid	Mallinckrodt Chemical Works	New York, N. Y.
	J. T. Baker Chemical Co.	Phillipsburg, N. J.
	Any Chemical Supply House	
Potassium hydroxide	American Cyanamid and Chemical Corp.	New York, N. Y.
Sodium hydroxide	Any Chemical Supply House	
	Merek and Co.	Rahway, N. J.
	J. T. Baker Chemical Co.	Phillipsburg, N. J.
Ammonium hydroxide	Any Chemical Supply House	
	J. T. Baker Chemical Co.	Phillipsburg, N. J.
	Grasselli Chemical Division, E. I. du Pont de Nemours & Co.	New York, N. Y.
	Any Chemical Supply House	

Water

Fresh water should be used. This includes ordinary tap water, well water, rain water and distilled water. Generally most tap water supplies are satisfactory. Well water is usually so, but in arid areas the salinity must be considered. Water with a chloride content of 250 to 500 ppm may be used if no other source is available. Rain water is a practical supply if provisions are present to collect and store it. Laboratory grade distilled water and evaporated sea water (a crude distilled water) are usable but expensive.

Before any unit is started the water supply should be analyzed. The following ions should be tested for: ammonium, nitrate, potassium, calcium, magnesium, phosphate, sulfate, chloride, ferrous iron, manganese, boron, copper and zinc.

Usually ammonium, nitrate, potassium and phosphate are not present in water, and if they are, the amount is generally small. Some very hard water contains much calcium and magnesium. In these cases the nutrient solution formula must be modified and these ions may be either partially or wholly omitted from the solution; that is, the calcium and magnesium salts may be either added in less quantities or left out completely.

Sulfate and chloride are mostly present as calcium and magnesium salts. However, in water of appreciable salinity considerable sodium chloride and sodium sulfate are present, particularly the former. When the water contains appreciable amounts of sulfate and chloride ions the choice of salts should preclude extensive use of sulfate and chloride chemicals. Such waters cause these ions to build up rapidly in the nutrient solution and retard plant growth. Thus the nutrient solution must be altered more often to rectify the situation.

Often the water furnishes sufficient minor elements to supply the plant needs. No evidence of iron, manganese and copper toxicity traceable to the water supply has been reported. Boron may be present in sufficient amounts in very saline water to be toxic. Zinc toxicity, because of storage and conduction of water in galvanized tanks and pipes, is not likely. Usually the average tap water is slightly alkaline and practically no zinc will go into the solution.

Some Typical Nutrient Solutions

Numerous types of nutrient solutions may be formulated, but the practical grower of plants wants to use tested formulas. Table 6-6 lists several commercially established nutrient solutions. Any one of these compositions will produce satisfactory plant growth. Experience will determine in time which general type of nutrient solution is most feasible for any particular condition. Table 6-7 lists the quantities of the chemicals required for several volumes of these nutrient solutions. Tables 6-8 and 6-9 tabulate the minor element requirements.

Preparing the Nutrient Solution

Preparation of the nutrient solution may be divided into two general steps: (1) addition of the major or macro elements, and (2) addition of the minor or micro elements.

Major or Macro Elements. Three methods are generally used in the actual preparation of the nutrient solution. The specific conditions of the cultural unit and the personal desires of the operator govern the choice of the method. The first technique, the use of stock solutions, is convenient for some experimental work where many small and separate plant cultures are operated. A second means is to add the dry salts separately and directly to the water.

Table 6-6. Some Typical Nutrient Solutions
(Millimole Concentration and Basic Gram Weights)

Chemical Formula	Lago		Shell		Ohio State		Purdue		California		New Jersey	
	mm	gms/l*	mm	gms/l*	mm	gms/l*	mm	gms/l*	mm	gms/l*	mm	gms/l*
MgSO ₄ (Epsom salts)	3.0	0.780	2.0	0.520	2.2	0.572	1.0	0.260	2.0	0.520	2.3	0.598
CaH ₄ (PO ₄) ₂ (Food grade)	1.5	0.405	2.0	0.540	1.4	0.378	0.5	0.135	—	—	—	—
KNO ₃	7.0	0.770	7.0	0.770	6.9	0.759	5.0	0.550	6.0	0.660	—	—
CaSO ₄	7.5	1.425	7.0	1.330	7.5	1.425	4.0	0.760	—	—	—	—
(NH ₄) ₂ SO ₄	—	—	—	—	0.9	0.126	1.0†	0.140†	—	—	0.7	0.098
KCl	—	—	—	—	—	—	5.0	0.400	—	—	—	—
Ca(NO ₃) ₂	—	—	—	—	—	—	—	—	4.0	0.720	4.5	0.810
KH ₂ PO ₄	—	—	—	—	—	—	—	—	—	—	2.3	0.322
NH ₄ H ₂ PO ₄ (Food grade)	—	—	—	—	—	—	—	—	1.0	0.120	—	—

* Use approximate molecular weights

† Use four liters equal one gallon

‡ Add only as supplementary source of nitrogen if culture conditions permit

Table 6-7. Some Typical Nutrient Solutions: Approximate Quantities of Chemicals Required

Chemical Formula	Lago			Shell			Ohio State			Purdue			California			New Jersey		
	tsp.* 5 gal.	grams 1000 1000 l	lbs.-oz.† 1000 gal.	tsp.* 5 gal.	grams 1000 1000 l	lbs.-oz.† 1000 gal.	tsp.* 5 gal.	grams 1000 1000 l	lbs.-oz.† 1000 gal.	tsp.* 5 gal.	grams 1000 1000 l	lbs.-oz.† 1000 gal.	tsp.* 5 gal.	grams 1000 1000 l	lbs.-oz.† 1000 gal.	tsp.* 5 gal.	grams 1000 1000 l	lbs.-oz.† 1000 gal.
MgSO ₄ (Epsom salts)	3½	780	6-14	2½	520	4-9	2½	572	5-1	1¼	260	2-5	2½	520	4-9	2½	598	5-4
CaH ₄ (PO ₄) ₂ (Food grade)	¾	405	3-9	1	540	4-12	¾	378	3-5	¼	135	1-3	—	—	—	—	—	—
KNO ₃	3½	770	6-13	3½	770	6-13	3½	759	6-11	2½	550	4-13	3	660	5-13	—	—	—
CaSO ₄	2¼	1425	12-9	2½	1330	11-11	2¼	1425	12-9	1½	760	6-11	—	—	—	—	—	—
(NH ₄) ₂ SO ₄	—	—	—	—	—	—	¾	126	1-2	¾††	140†	1-4†	—	—	—	½	98	0-14
KCl	—	—	—	—	—	—	—	—	—	1½	400	3-8	—	—	—	—	—	—
Ca(NO ₃) ₂	—	—	—	—	—	—	—	—	—	—	—	—	3½	720	6-5	4	810	7-2
KH ₂ PO ₄	—	—	—	—	—	—	—	—	—	—	—	—	—	—	—	1¼	322	2-13
NH ₄ H ₂ PO ₄ (Food grade)	—	—	—	—	—	—	—	—	—	—	—	—	—	120	1-1	—	—	—

* Teaspoon full (tsp) level full; approximate values only

† Use 454 grams equal one pound

‡ Use only as supplementary source of nitrogen if culture conditions permit

Table 6-8. Minor or Micro Element Requirements for the Nutrient Solution: Basic Unit Quantities for Commercial Cultures.

Nutrient Ion	Ion Concentration in ppm*	Chemical Source	Grams of Chemical for	
			1000 Liters	1000 Gallons
Iron	0.5	FeSO ₄	2.5	10.0
	1.0		5.0	20.0
Manganese	0.25	MnSO ₄	1.0	4.0
	0.5		2.0	8.0
Boron	0.25	H ₃ BO ₃	1.4	5.6
	0.5		2.8	11.2
Copper	0.025	CuSO ₄	0.1	0.4
	0.05		0.2	0.8
Zinc	0.025	ZnSO ₄	0.1	0.4
	0.05		0.2	0.8

* For practical cultures it is often advisable to use the lesser quantities listed until experience dictates a need for greater concentrations.

Table 6-9 Minor or Micro Element Requirements for the Nutrient Solution: Stock Solutions for Home Garden Cultures.

Stock Solution	Chemical	Grams per Liter	Directions for Preparation of Stock Solutions	Directions for Use of Stock Solutions
A	FeSO ₄	50	(1) Add 5 to 10 milliliters of concentrated sulfuric acid to each Stock Solution.	(1) Add 1.0 to 2.0 milliliters or 20 to 40 drops to 5 gallons of Nutrient Solution.
B	FeSO ₄ MnSO ₄	50 20		
C	H ₃ BO ₃	28	(2) Read context on preparation of Minor or Micro Elements before making these Stock Solutions. (See pages 151 to 154)	Iron 0.5 to 1.0 ppm
	CuSO ₄	2		Manganese 0.25 to 0.5 "
	ZnSO ₄	2		Boron 0.25 to 0.5 "
D	FeSO ₄	50	Copper 0.025 to 0.05 "	
	MnSO ₄	20	Zinc 0.025 to 0.05 "	
	H ₃ BO ₃	28		
	CuSO ₄	2		
	ZnSO ₄	2		

This is the usual commercial procedure. The third method is to mix the dry chemicals together (if they are compatible) like an ordinary fertilizer and then add the proper amount of this mixture directly to the water.

Stock Solution Method. The various chemicals to be used are first dissolved in water to make a concentrated solution. Usually for most salts, one-half molar solutions are prepared. However, chemicals like mono calcium phosphate and calcium sulfate have relatively low solubility, and only one-tenth molar stock solutions are

made up. Any volume of stock solution may be made, but 18 liters is the common quantity, because 5-gallon glass carboys are readily available. To illustrate the preparation of a stock solution the directions for making a one-half molar potassium nitrate solution are given. Weigh out 990 grams of material and dissolve it in 18 liters or about 4.5 gallons of water.

The stock solution may be dispensed from the glass carboy by a glass siphon tube. Any kind of container suitable to store chemical solutions may be used for storage of these stock solutions.

Before the stock solution chemicals are added to the water in preparing the nutrient solution, the amounts required must be ascertained. Following the recommended procedure for expressing the theoretical constitution of the nutrient solution, write down the millimolar concentration of the nutrient chemicals. Now if the stock solutions were one molar the number of milliliters to be added to the water to make one liter of nutrient solution would be equal to the millimolar concentration. But actually one-half and one-tenth molar solutions are used. When one-half molar stock solutions are used, the number of milliliters required is twice the millimolar (mm) concentration. For one-tenth molar stock solutions use ten times the number of millimoles (mm). Two examples will clarify these directions. To make one liter of nutrient solution containing 7 mm of potassium nitrate, add 14 milliliters of the one-half molar stock solution to the water; likewise, to prepare a nutrient solution which contains 1.5 mm mono calcium phosphate, use 15 milliliters of the one-tenth molar stock solution.

Of course many growers may be more interested in gallons and ounces. For practical purposes one gallon is equivalent to four liters and one fluid ounce is equal to 30 milliliters. Thus to prepare one gallon of nutrient solution containing 7 mm of potassium nitrate, use about two ounces of the one-half molar stock solution. For the amateur, a baby bottle is a convenient measuring device.

Before adding the proper amounts of stock solutions to the water, have at least 80 per cent of the volume present in the container. Then add the chemicals to the water one at a time. Be sure that the liquid is well mixed after each addition and before adding the next chemical. A definite order of addition is advisable; it varies according to the kind of salts used. For the typical three-salt laboratory type of nutrient solution, add magnesium sulfate, calcium nitrate

and monobasic potassium phosphate in the order named. Epsom salt is a very soluble salt, thus it is usually added first. Calcium nitrate is also quite soluble and it will not precipitate the Epsom salts (magnesium sulfate). Further, it is an acidic salt and it lowers the pH (acidity) of the nutrient solution. This aids in the prevention of phosphate precipitation when the monobasic potassium phosphate is added.

A four-salt commercial nutrient solution, like the Lago solution, is prepared by adding the salts in the following order; magnesium sulfate, monocalcium phosphate, potassium nitrate and calcium sulfate. Again the Epsom salts are added first. The phosphate salt is second because it is an acidic salt which lowers the pH (acidity) of the nutrient solution. Potassium nitrate, a highly soluble salt, but which dissolves more slowly than magnesium sulfate, is added next. Finally the least soluble calcium sulfate is added.

After all the nutrient chemicals are dissolved in the water, add more water to make up the proper volume. Then measure the pH or acidity (see Chapters 7 and 12) before using the nutrient solution and adjust to the correct range if necessary.

Dry Salt Method. This method differs from the previous one in that the dry chemicals are added directly to the water. To determine the right amount of each salt for a given volume of nutrient solution refer again to the solution formula expressed in millimoles (mm). One mole of a salt in one liter of solution requires the molecular weight of that chemical, or in other words the weight in grams equivalent to its molecular weight. To allow for impurities the approximate rather than the theoretical molecular weight is used for nutrient solution culture work. Since one millimole is one-thousandth of a mole, it must be expressed in this form for calculation purposes; that is, the number of millimoles must be expressed as a decimal fraction of a mole.

This figure is multiplied by the molecular weight of the salt to obtain the number of grams of salt needed to make one liter of nutrient solution. As an illustration, the amount of potassium nitrate required to produce a liter of 7 millimoles concentration is herein calculated. Seven millimoles (7.0 mm) is written as seven thousandths molar, *i.e.*, 0.007 molar (*M*). Multiply 0.007*M* by 110 (approximate molecular weight of potassium nitrate) to obtain 0.770 gram. This is the weight of potassium nitrate to add to one

liter of solution to attain a nutrient solution of 7.0 mm concentration.

The practical man usually deals with gallons; to convert to gallons, multiply the number of liters by 4, and to change to pounds divide the number of grams by 454. An example will illustrate a recommended procedure to follow in the calculations. Convert the above 0.770 gram of potassium nitrate per liter to 3.080 grams per gallon by multiplying by 4. This figure, grams per gallon, may be considered as the basic unit for calculating for any volume of solution. Before changing the grams to pounds (or ounces), determine the number of grams needed for 1000 gallons. Then divide the gram weight by 454 to obtain the number of pounds per 1000 gallon sub-unit. Continuing the specific example, multiply the 3.080 grams per gallon by 1000 to obtain 3080 grams. Dividing this figure by 454 gives 6.75 pounds per 1000 gallons of nutrient solution.

The above calculation may fit commercial needs, but the amateur wishes to operate on a smaller scale. In this case gallons and ounces are in order. The same procedures of arithmetic are followed except that the final amount of grams is converted to ounces instead of pounds. This statement may be best illustrated by continuation of the above example. To prepare 50 gallons of nutrient solution containing 7.0 mm of potassium nitrate, multiply the 3.080 grams per gallon by 50 to obtain 154 grams. For practical purposes 30 grams are equal to one avoirdupois ounce. Therefore divide the 154 grams by 30 to obtain approximately 5 ounces. This is the amount of potassium nitrate in ounces required for the 50 gallons of nutrient solution.

After the necessary amounts of chemicals are weighed they are added separately to the water in the container. Adequate stirring and mixing are a prerequisite. The same order of addition as mentioned in the discussion of the stock solution method holds for the dry salt method. Several procedures of adding the dry chemicals to the water are followed. The exact technique used often depends upon the size and the physical characteristics of the culture unit.

For very small volumes (5 to 10 gallons), the separate salts may be dissolved in one liter (about one quart) of water before adding them to the full volume of water in the nutrient solution container. Salts like Epsom salts and potassium nitrate are completely dissolved in the liter of water. Less soluble salts like monocalcium

phosphate and calcium sulfate are merely dispersed in this small volume and then are poured slowly into the solution with stirring.

For large volumes, from one hundred to several thousand gallons, three methods may be followed. The salts may be dissolved separately in a number of 5-gallon cans and then added to the main volume in the proper order. This technique is slow and time-consuming. Another way is to place the chemical in a pail suspended over the top of the solution tank and allow the water to overflow from the pail. The chemical is then washed into the cistern as rapidly as it is dissolved in the pail. This procedure is carried out with each separate salt. Salts like calcium nitrate are well handled in this manner, because of the slow solubility of this chemical, *i.e.*, although this salt is very soluble, it goes into solution rather slowly. A third technique is to throw slowly small quantities, *i.e.*, a trowel full, into the stream of water pouring into the cistern. This method is dependent upon sufficient water pressure. When water pressure is too low the mixing by-pass (see Chapter 5) discharge line from the solution pump may be used. The salts will then be added to a stream of the circulating nutrient solution.

When preparing large volumes of nutrient solution, at least 50 per cent of the water should be present in the cistern and the remaining water added along with the salts. This should insure proper mixing of the chemicals. However, where water pressure is low, it is not possible to add the dry salts directly to the water in the proper manner and obtain dissolution. All the water should be present in the cistern and kept circulated by the pump, as mentioned above, to dissolve the chemicals. Of course when all the chemicals and water are added and properly mixed the pH (acidity) of the nutrient solution should be checked and corrected as needed.

Mixed Dry Salts Method. As the method implies, all the chemicals are mixed together in the dry form like a commercial fertilizer. Then the proper quantity of this mixture is added to the water. The choice of salts determines whether or not this method is applicable. Hygroscopic salts, like calcium nitrate, cannot be easily used because they absorb moisture readily from the air and cause the mixture to become sticky and lumpy. The Purdue, Ohio State and Lago type solutions are well adapted for preparation of the dry mixture.

Now for the mathematics of the dry mix. All the chemicals are

mixed together in the same proportion as exists in the final solution. For convenience, enough is mixed to prepare several volumes of the nutrient solution. To illustrate the principle, assume that a dry mix is to be prepared for a 1000-gallon unit. Refer to Table 6-5 for the quantities of chemicals required. Then take four times the amount

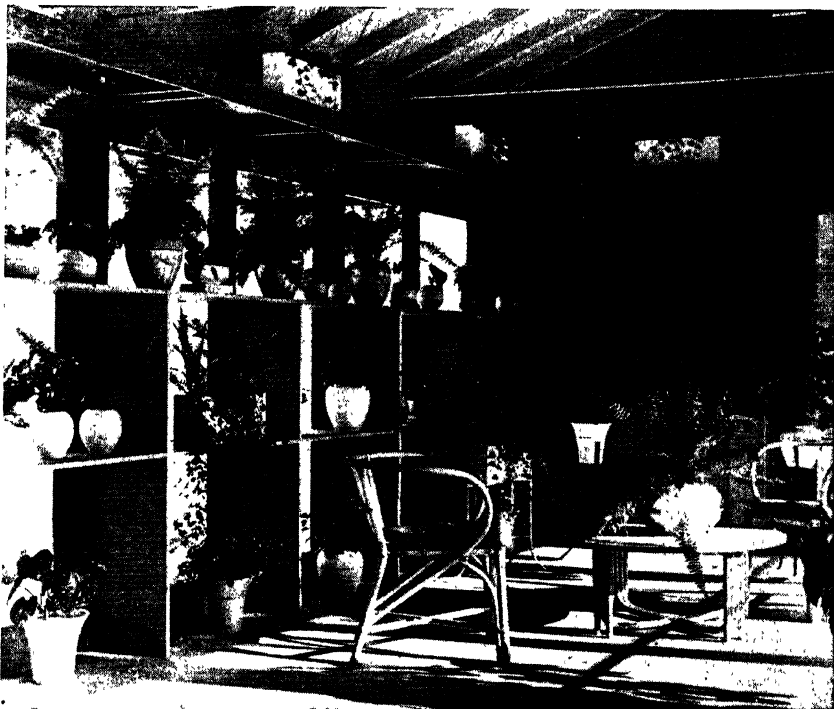

Figure 6-1. Display room of Mineral Maid Gardens, Montebello, California.

of each salt listed and mix together. Thus a supply of complete fertilizer for four complete solution volumes is prepared.

These chemicals may be mixed by hand or by machine. Several turnings on a concrete floor and then a couple of passes through a one-sixteenth inch wire screen are sufficient to blend them effectively. An ordinary concrete mixer is a suitable machine.

Special precaution must be taken in adding these mixtures to the water in making up a nutrient solution. The chief danger is that the amateur will try to dissolve the mix in too small a volume of water. Under such conditions a high salt concentration exists which may cause precipitation of the phosphate ion. For small volumes the full

amount of water should be present in the container. The salt mixture may be stirred in a liter of water, allowed to settle a moment, and then decanted into the solution container. This procedure may



Figure 6-2. Another wick device, Mineral Maid Garden.

be repeated several times until all the salts are added. The total solution volume should be vigorously stirred during the entire process.

In handling large volumes of nutrient solution two methods of dissolving the fertilizer mix are applicable. The mixture may be placed in a pail suspended over the water and overflowed with water until all the material is dissolved. Also the mix may be thrown directly into the stream of water or circulating solution, as mentioned in the discussion of the dry salt method above. Finally, the pH (acidity) of the solution is determined and corrected as necessary.

Minor or Micro Elements. The various chemicals used to supply the necessary minor elements are dissolved in water prior to addition to the nutrient solution. Usually the solubility of these salts is such as to allow the preparation of a fairly concentrated stock solution. A full complement of minor element salts for a 5,000 to 10,000 gallon unit may be dissolved in three or four liters of water. Either the separate solutions may be prepared or a complete mixture may be used.

To make these minor element solutions, certain calculations are necessary to ascertain the quantities required. Because the amounts involved are so small, the millimole (mm) system of expressing the micro nutrient ion concentration is not practicable. The parts per million (ppm) system is more adaptable. Thus, it is a general practice to express minor element concentrations on this basis. Since the ppm is expressed for the particular ion desired, not for the total salt, a conversion factor (see Table 6-3) must be calculated to obtain the correct weight of the salt required. In simpler terms, the problem is to find out how many grams of the salt are needed to supply so many grams of the necessary ion which the salt contains. To simplify calculation, it is practical to determine how many grams of the nutrient ion are required for the total volume of nutrient solution to meet the concentration desired. Then this weight is multiplied by the conversion factor of the salt needed.

An example will aid in illustrating the above discussion. One ppm of iron is needed for a 1000-gallon solution. First determine the conversion factor for ferrous sulfate. The molar weight of this salt is 278, while the atomic weight of iron is 56. Divide 278 by 56 to obtain a conversion factor of approximately five. Thus for every gram of iron necessary five grams of ferrous sulfate must be supplied. Second, determine the number of grams of iron required for the 1000 gallons or 4000 liters of nutrient solution. One part per million (ppm) means that one gram is dissolved in 1,000,000 milliliters or 1000 liters. For 4000 liters 4 grams of iron are needed. Now the amount of ferrous sulfate is calculated by multiplying the 4 grams of iron by the conversion factor of 5 to obtain 20 grams needed for the 4000 liters or 1000 gallons of nutrient solution.

After the calculations are finished the salts must be prepared for addition to the nutrient solution. Whether separate solutions or complete mixtures of the minor element salts are used depends

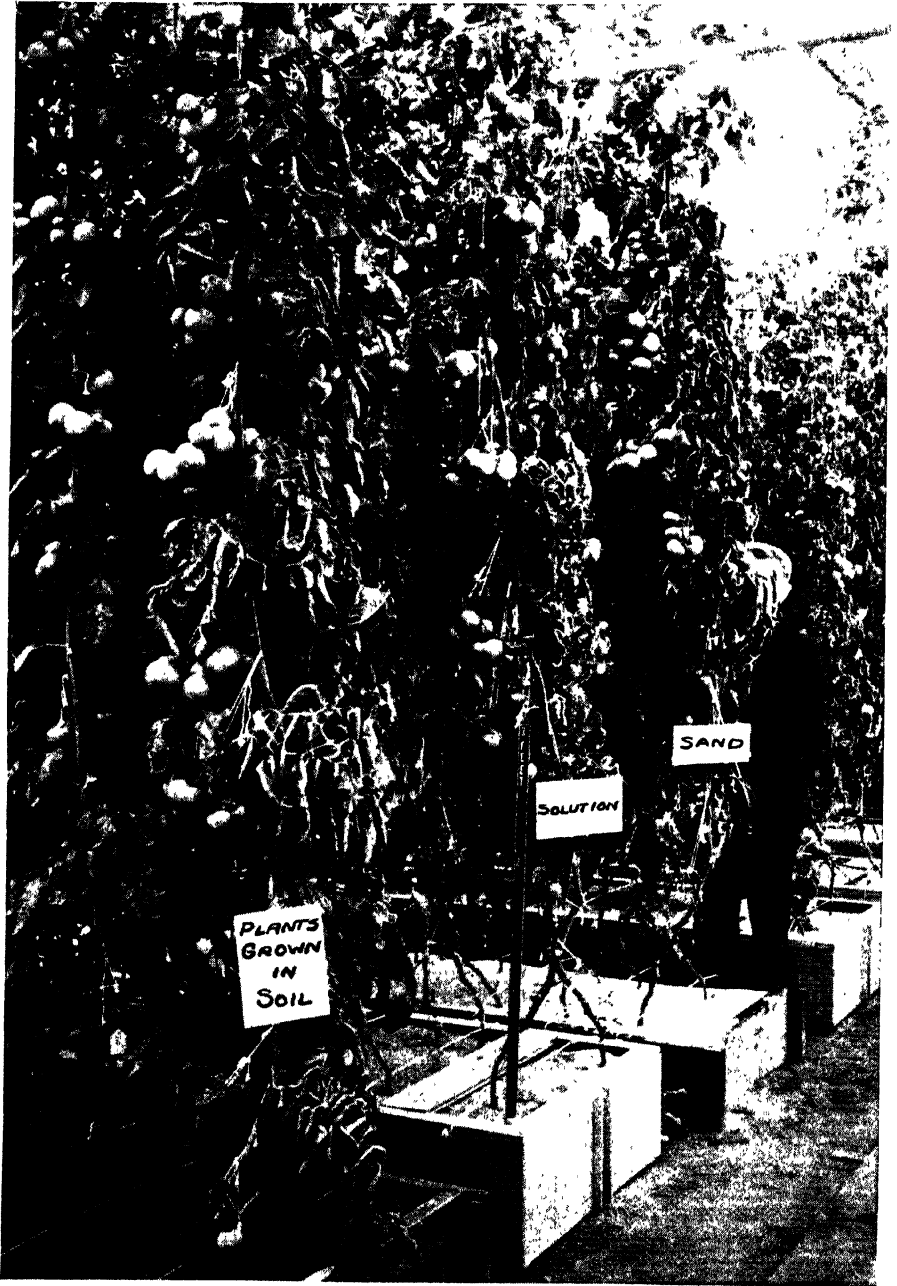

Figure 6-3. Relative greenhouse tomato production in soil, solution and sand culture. (California Agricultural Experiment Station)

upon the requirements of the culture unit. Usually the kind of element needed and the frequency of addition necessary govern the choice. Often iron is the only element needed, or it is needed more often than the others. Manganese may be added as often as iron in some cases. Under such conditions the iron and manganese may be



Figure 6-4. Wooden water-culture tanks on roof of building. Tanks are covered with roofing material to prevent flooding in case of rain. Holes are cut in this roofing through which the stems of the plants pass. Cheesecloth covering overhead is needed only for those species which normally cannot tolerate full sunlight.

either mixed together or added separately. The remaining ions, *i.e.*, boron, copper and zinc, are usually blended in a stock solution.

Since ferrous sulfate is easily oxidized in a non-acid solution, it is necessary to add some acid to the water before dissolving the iron salt preparatory to adding it to the nutrient solution. At least 5 to 10 milliliters of concentrated sulfuric acid are added to the liter of water (more acid may be added if so desired). Then the ferrous sulfate is dissolved in this acidified water along with the manganese sulfate. This micro ion solution is then slowly poured into the nutrient solution tank with adequate stirring or circulation.

Sometimes it is most convenient to prepare a complete mixture

of the micro element salts. A stock solution may be prepared so that 1 to 4 liters contains the full complement of the minor element nutrient ions. The following mixing order is recommended, and any omission of a salt will not alter this procedure. Dissolve the boric acid in about 800 milliliters of hot water for a stock solution of 1 liter. Then add the sulfuric acid which was previously poured on ice. (Pour both the acid solution and the ice together into the hot boric acid solution.) This mixes safely with no spattering. Then add the zinc sulfate, which dissolves easily. Next add together the iron sulfate and the manganese sulfate. When these salts are in the solution, add the copper sulfate. Finally adjust the volume of the solution with sufficient water. The final solution is a clear light green in color and quite stable.

A specific example will point out the procedure in detail. The following stock solution suffices for commercial purposes, wherein one-half the usually recommended concentrations are used. Dissolve 48 grams of boric acid in 1000 milliliters of hot water. Then add 50 milliliters of concentrated sulfuric acid on cracked ice. Pour this mixture of cracked ice and acid into the hot boric acid solution. Next dissolve 4.0 grams of zinc sulfate in this solution. Follow with 85 grams of ferrous sulfate. The 34 grams of manganese sulfate are added next. Finally, dissolve the 4.0 grams of copper sulfate in the solution. The final volume is made up to 1500 milliliters. This makes a permanent stock solution. If only a temporary stock solution is desired, the starting volume may be 800 milliliters and the final volume may be only one liter.

Chapter 7

Technical Control of the Nutrient Solution

Although plants will grow reasonably well in nutrient solution culture within relatively wide limits of nutrition, the limits of the various essential factors vary; that is, the root environment must be held within certain conditions if adequate growth is to be obtained. The pH, or degree of acidity, of the nutrient solution should be adjusted and maintained at certain levels to secure satisfactory results. Extremes of low and high pH may even become toxic. Proper solution volume must be maintained to hold the osmotic concentration within reasonable bounds. Of course the concentration, both required and tolerated, of the various nutrient ions should be properly regulated. Too little or too much of these essential minerals in the nutrient solution will adversely affect plant growth. The limits of the macro or major elements (referring to quantities only, not to relative nutrient importance) are much more flexible than those of the micro or minor elements.

Solution Acidity or pH

The pH of the nutrient solution is an extremely important factor in plant growth, whether in soil or in soilless growth. This factor is often improperly handled and poor growth responses result. Plant roots absorb water and nutrients at optimum rates within specific pH ranges of the nutrient solution. This varies according to the kind of plant and the kind of nutrient solution. The differential uptake by the plant roots of the alkaline and acidic nutrient ions profoundly affect the pH of the solution. Although the practical plant grower should have a general idea of pH, what it is and what it does to the plant, he is mainly interested in how to control it.

Theory of pH. The term "pH" as indicated is a physical-chemical measurement of the acidity or alkalinity of weak electrolytic solutions. It is the negative logarithm of the hydrogen ion concentration

in a solution. Mathematically, it is expressed in molarity units of 10 to a negative power. Pure water is used as the basis for establishing the pH scale. Water (HOH) is a neutral substance and contains 10^{-7} mole of both hydrogen ions, (H^+) and hydroxyl ions (OH^-). Thus pH 7.0 is designated as the neutral point in the pH scale which ranges from pH 0 to 14. A solution possessing a pH below 7 is acidic, while one with a pH above 7 is alkaline. Since the scale is logarithmic, it forms a geometric rather than an arithmetic series based on units of 10. In other words, a solution at pH 5 is 10 times as acid as one at pH 6, or a solution at pH 9 is 10 times as alkaline as one at pH 8.

Effect of Solution pH on Plants. Most plants usually tolerate in a nutrient solution a pH range of 5 to 6.5. However, for general use, both in the home garden unit and in the commercial unit, a pH range of 6 to 6.5 is recommended. The maintenance of a relatively narrow pH range usually promotes more satisfactory growth. Some practical evidence appears to support this contention. It has been noted that wide daily fluctuations in the pH of the culture solution is not beneficial to plant growth.

A pH of 4.0 is usually accepted as the lowest tolerated in solution culture for most green plants. Usually root growth is retarded and even injured under such acid conditions. When plants are grown in solutions with a pH below 5.0, rather high levels of calcium are required to permit satisfactory growth. Often attempts are made to grow plants in a pH range of 4.0 to 5.0 with solutions containing large amounts of ammonium ion, usually in the form of ammonium sulfate. Such a procedure is not to be recommended. Poor growth and root injury often occur. Plants absorb the ammonium ion, but do not utilize it rapidly, with resultant toxic accumulation within the plant tissue.

When the solution pH gets above 7.0 plant growth is usually retarded. However, such lime-loving plants as sweet pea do well in a pH range of 7.0 to 8.0. Also, plants do reasonably well under slightly alkaline conditions if a large part or all of the nitrogen is supplied as the ammonium ion; plants absorb and utilize this ion quite well at such a high pH. However, alkaline solutions are not too satisfactory for most crops under commercial or home garden conditions. The high pH causes precipitation of iron, manganese, phosphate, calcium and magnesium to insoluble and unavailable salts.

The greatest difficulty is in maintaining sufficient iron in solution for the plant needs. Plants require iron in the reduced or ferrous state, at least when the iron source is an inorganic salt such as ferrous sulfate. Under alkaline conditions, ferrous iron is readily oxidized to the ferric and unavailable form. However, several organic iron salts, such as ferric citrate, ferric ammonium citrate and ferrous tartrate, are available to plants under slightly alkaline conditions, chiefly because of their greater solubility over a wider pH range.

Adjustment of pH. Several techniques may be used to stabilize the pH of a solution. These include (1) use of ammonium sulfate, (2) adjustment of the phosphate level and (3) addition of acids and alkalis. Two other factors are quite important: proper acidification of the water and proper choice of the nutrient solution. Finally, the frequency of checking the pH must be established.

Use of Ammonium Sulfate. It has been indicated both theoretically and experimentally that addition of ammonium sulfate to the solution helps to stabilize its acidity. Plants absorb the ammonium ion more rapidly than the sulfate ion, thus leaving residual sulfate, which is an acidic ion, in the nutrient solution. This increase in acidic ions counteracts the alkalinity building up in the solution as the nitrate ion is rapidly absorbed, leaving a residual accumulation of alkaline ions. Ammonium nitrogen solutions tend to increase in acidity as the plants take up the nutrient ions. However, it has been practical experience that this technique of making ammonium sulfate additions to the usual nitrate nitrogen solution is not too satisfactory under all conditions.

Adjustment of Phosphate Level. A more successful method of stabilizing the nutrient solution pH is to adjust the phosphate level properly. Ohio State Experiment Station workers several years ago pointed out that such a procedure is possible, and experience in Aruba substantiated these observations. In other words, it is possible to raise the phosphate level in the nutrient solution sufficiently high to effect a buffering action. Also, the level is not too high to cause trouble in precipitation of iron, manganese, calcium and magnesium. This technique works even when the other ions, namely nitrate, potassium, calcium, sulfate and chloride, are widely varied in the nutrient solution. A minimum level of phosphate of 2.0 millimoles (a 2.0 to 4.0 mm range is in order) is required to effect

this pH stabilization satisfactorily. Nutrient solutions rarely need pH adjustment more often than once every week or two weeks, depending upon the rate of nitrate uptake by the plants. At least, with the Lago nutrient solution, a pH range of 6.0 to 6.5 is fairly well stabilized.

Addition of Acids and Alkalies. When the solution pH does go out of control, it must be adjusted by the use of acids or alkalies. As the solution becomes too alkaline, sulfuric acid (common technical grade) is added to reduce it to the proper level. Some workers recommend nitric acid, which is satisfactory; but sulfuric acid is more pleasant to use if the proper safety cautions are followed. A simple technique of handling this acid is to pour it on cracked ice before adding it to the nutrient solution or water. This prevents excessive heating and possible danger of spattering when adding the concentrated acid to water. Phosphoric acid has been suggested to adjust the pH of the nutrient solution. Difficulty has been experienced in some cases because the phosphate level of the solution was increased too much, with resulting iron chlorosis in the plants. This acid must be used with care whenever special circumstances suggest its use, such as in cases of highly alkaline waters and media.

Whenever the nutrient solution becomes too acidic, as when much ammonium sulfate or calcium phosphate is used, some alkali is added. Potassium hydroxide is usually recommended for this purpose. Prolonged use of sodium hydroxide may build up sodium ions and soften growth too much. Excessive use of ammonium hydroxide also may soften growth or even reduce yields, particularly in the tropics or during dark winter weather in a greenhouse. This is caused by using too much ammonium ion in the nutrient solution.

It is convenient to use a certain concentration of acid or alkali for adjusting the pH. This depends upon the volume of the nutrient solution in use. For small volumes (5 to 10 gallons) 10 per cent solutions of acids and alkalies are in order. Large nutrient solution volumes of 50 to 500 gallons are best handled with 25 to 50 per cent concentrations. Culture units of 1000 gallons or over may utilize concentrated acids and alkalies.

Water Acidification. One factor which is often neglected in a consideration of pH is the effect of the addition of make-up water necessary to maintain a constant volume in the solution tank. Usually ordinary tap water is alkaline. Thus the solution pH is

affected whenever additional water is added to replenish losses. This necessitates additional work in restoring it to the proper value. It is much simpler and more satisfactory to adjust the pH of the water either before it is added or as it is being added to the nutrient solution. Whenever conditions permit, the pH of the water should be adjusted with sulfuric acid to pH 5.7 to 6.0 in a supply tank.



Figure 7-1. General view of Army Air Force Hydroponics Garden at Coral Gables, Florida. (Courtesy J. P. Biebel)

When this acidified water is then added to the nutrient solution, the desired pH range of 6.0 to 6.5 of the solution is not altered.

For small units, 50-gallon lots of water in steel drums are acidified prior to use and only this water is used for making up the solution. This acidification is brought about by adding either 50 per cent or concentrated sulfuric acid to the water until the desired pH is reached. This procedure may also be followed for large units if storage space is available for the quantity of water required. But where sufficient storage facilities do not exist, the water must be acidified as it is being added to the nutrient solution. The amount of acid to add to so many gallons of water will be determined by two methods. Experience with the particular unit will indicate the requirements in method one. Method two is based upon a simple titration of a sample of the water to be used (see Chapter 12 for procedure). It is very important to add the acid to the nutrient solution before extra water is put in. Sometimes when a large amount

of very hard make-up water is added before any acid, the solution alkalinity is raised high enough to initiate phosphate precipitation. In cases where the water contains large percentages of sulfate, either nitric or phosphoric acid may be used.

Choice of Nutrient Solution. When a fresh nutrient solution is made, the choice of the type of solution governs the need of acids or alkalies to adjust the initial pH. Some solutions require the addition of acids, while others need alkalies. The Lago nutrient solution is so buffered by the phosphate concentration that it produces an initial pH of 6.0 to 6.5, regardless of whether relatively soft or quite hard water is used.

Checking the pH. The pH of the nutrient solution should be checked as often as necessary. Frequency of checking and adjustment depends upon the several factors discussed above. Also, the general character of the plant growth, that is, the kind of plant and the rate of growth, materially affects the pH by removing the various ions from the nutrient solution at different rates. Experience is the only judge for establishing a set routine. It is recommended that the pH be tested daily and adjusted if necessary, until definite knowledge is secured under the given conditions as to its behavior; then it may be possible to check the pH at less frequent intervals. For example, if experience indicates that the pH range of the solution is properly maintained for periods of one to two weeks, it is not absolutely necessary to measure it more often. However, to follow good technical control practices, daily pH checks are highly recommended in commercial units.

Solution Volume

The solution volume must be kept relatively constant in order to secure adequate plant growth. If the solution becomes too concentrated, plant growth is altered. Plants take up much more water and at a much greater rate than the essential mineral elements. As water is removed from the nutrient solution, the volume of solution naturally decreases. This effects an increase in the total solution concentration and in the concentration of the individual nutrient ions.

Theory of Osmotic Concentration. The total salt concentration of the nutrient solution is expressed as the osmotic concentration in terms of atmospheres. The dissolved molecules and ions of a

substance (the solute) in a dilute solution (the solvent) behave similarly to gas molecules in a closed container. In other words, it is theoretically possible to apply the gas laws to dilute solutions. One mole of a gas, such as oxygen or nitrogen, at standard conditions (0°C or 32°F and one atmosphere pressure) occupies a volume



Figure 7-2. View of top of nutrient solution cistern at Modern Farms, Kendall, Florida. (Courtesy J. P. Biebel)

of 22.4 liters. Conversely, if this mole of gas were compressed to a volume of one liter, the pressure would be 22.4 atmospheres. Extending this principle to dilute solutions, it can be shown that one gram molecular weight of a non-ionizable chemical, such as sugar, dissolved in one liter of water exerts a theoretical pressure of 22.4 atmospheres. An ionizable salt, such as potassium nitrate, breaks up into three fractions when dissolved in water. They are undissociated molecules of potassium nitrate, ions of potassium and ions of nitrate. All three fractions exert a pressure as if they were separate molecules; thus the osmotic pressure is increased in proportion to the degree of dissociation or ionization.

This osmotic pressure is usually determined for nutrient solutions by the freezing point depression method. Solutes dissolved in solvents lower the freezing point of the solvent. It is established that when one gram molecular weight of an un-ionized substance is dissolved in one liter of water, the freezing temperature is reduced 1.86°C (about 3.35°F). Formulas have been set up by which the

osmotic concentration in atmospheres of a nutrient solution can be calculated once the freezing point depression is experimentally determined by a Beckmann thermometer.

Effect of Osmotic Concentration on the Plant. As the osmotic concentration of a nutrient solution increases, the availability of water to the plant roots decreases. The osmosis of water through the membranes of the root tissues is retarded. Water will pass through a permeable membrane from an area of high water concentration to an area of low water concentration. A nutrient solution containing a high concentration of salts may be considered as a system of low concentration of water molecules. It is analogous to a bottle which contains comparatively few gas molecules connected by a permeable membrane to another bottle with a great many gas molecules. The concentration of both the water molecules and the gas molecules in the respective systems will tend to become equal on both sides of the permeable membrane. The plant root tissues in a relative sense contain a highly concentrated solution of both inorganic and organic solutes. A properly formulated nutrient solution is a relatively dilute solution. Thus when the plant root is in contact with the nutrient solution water will pass from the nutrient solution into the plant root by osmosis. As the solution concentration increases, the rate of water transfer through the tissues of the plant root decreases. It is entirely possible to stop the growth of the plant with a solution of high osmotic concentration or even kill the plant.

Usually a range of 0.5 to 2.0 atmospheres is used for most nutrient solutions. For many crops under practical conditions one atmosphere produces the most satisfactory plant growth. Often a 0.5-atmosphere solution supplies too low a level of nutrition. At least for the tropics (in Aruba) the low nitrate level appears to be the limiting factor. If the solution concentration is much over 1.5 atmospheres, a harder type of growth occurs. In fact, this technique may be used to regulate the type of plant growth desired.

Maintenance of the Solution Volume. This manipulation merely entails the addition of water at certain intervals to the existing nutrient solution to bring it up to its original volume. Two general methods may be followed to establish the nutrient solution volume within the proper limits. One is the daily method and the other the weekly method. Of course this discussion refers only to water cul-

ture and gravel culture, wherein the same nutrient solution is used over and over again for either a definite or an indefinite period. For unmodified sand culture, in which the slop method is used and the nutrient solution is not recovered, this discussion does not apply.

Usually the safest and simplest procedure is to make daily additions of water to the nutrient solution to adjust the volume. In other words, if a tank contains 50 gallons of solution and the volume is reduced daily to 45 gallons, 5 gallons of water must be added every day as long as this solution is used. It is common to experience a daily water loss of from 5 to 30 per cent, depending upon the volume of the unit.

The other means is to add water weekly. This method requires closer control of the plant growing conditions and is not recommended for the amateur, but only for the experienced soilless culturist. It is a more practical method for the commercial installation because it reduces the amount of labor required for technical control. When water is added weekly, water in excess of the original volume of the solution is introduced. The solution is then allowed to concentrate as the plants remove water to below the original solution level. Usually the best procedure is to allow the solution volume to fluctuate equally on both sides of the original level. (Note: Sometimes a biweekly schedule is preferable.)

The weekly schedule works if the growing conditions are such that ion uptake by the plants is at such a rate as to counteract the concentrating effect of water uptake by the plants and evaporation from the gravel. In other words, the solution must not become too concentrated; the osmotic concentration must not deviate from a range of 0.5 to 1.5 atmospheres. It follows that a solution testing technique (see Chapter 12) must be used in conjunction with this method of regulation of the solution volume. Analyses of the nutrient solution will indicate whether or not the ionic concentration of the essential elements is within the proper range.

Nutrient Ion Concentration

The amounts of the various nutrient ions in the solution must be properly adjusted. An unbalance of the concentration of the individual nutrient ions and of various extraneous ions common to nutrient solutions materially affects plant growth. A great accumulation of even one macro ion will raise the osmotic pressure of the

solution. Too little of an essential element naturally retards growth. Too much of these minerals, especially of the micro ions, also will retard or even prevent plant development.

Major or Macro Nutrient Ion Concentration. Correcting the ionic concentration of the solution depends upon many factors. At



Figure 7-3. View of tomatoes growing in the Lago Hydroponics Garden, Aruba, N.W.I. (Courtesy J. R. Knoll)

least for practical crop production it is difficult to lay down any fast and hard rules to govern these factors without knowledge and experience with plant growth. Several general physiological factors alter the control of the macro nutrient ion concentration. From the practical aspect three things must be taken into account in this respect. They are the influence of osmotic concentration, and the lower and the upper permissible limits of the macro ion concentration.

General Physiological Factors: Macro Ions. The type of nutrient solution, the type of water, the type of medium, the climatic conditions, the kind of plant, the age of the plant and the plant itself all affect the solution balance. The original amounts of the various

nutrient ions in any given solution are related to what fluctuations are permitted consistent with adequate plant growth; that is, the fluctuation allowed for a low nitrate solution would be less than that permitted for a high nitrate solution. Likewise, the mineral content of the water used affects the control of the solution, particularly the calcium, magnesium, sulfate and chloride ions. Some media contain certain minerals which influence growth, particularly calcareous gravels which contain sufficient calcium and magnesium to alter their concentration in the solution. Also, calcareous media tend to raise the pH of the nutrient solution, which in turn directly affects the iron and phosphorus stability. Climatic conditions influence the type and rate of growth of the plant, which in turn regulates the mineral uptake from the nutrient solution to a large extent. The age of the plant governs this factor in a similar manner, young plants requiring small to medium quantities of nutrients, maturing plants a great deal, and matured plants again relatively small amounts. The plant itself absorbs minerals for both growth needs and excess storage. Many plants appear to grow better if their tissues are loaded with nutrients still in the mineral state well in excess of nutritive requirements.

Influence on Osmotic Concentration: Macro Ions. An improper amount of nutrient ions can alter the solution concentration and consequently affect plant growth. Even a high concentration of a single ion, although not at a toxic level, will raise the overall concentration. This point was well established under practical conditions with lettuce in Aruba. When the phosphorus concentration of the Lago solution was raised to 8 millimoles yields were reduced. Similar results were secured with magnesium. Additions of extra sulfate, as sodium sulfate, up to 20 to 40 millimoles, retarded growth. Similar additions of 5 to 30 millimoles of sodium chloride caused growth reduction. These amounts of sulfate and chloride were constituted as extraneous ions in the nutrient solution. In all these observations no evidence of toxicity was noted to either the tops or the roots of the plants. But the osmotic concentration of the solutions was appreciably increased and the type of plant growth achieved was similar to that obtained in cultures of high solution concentration.

The other nutrient ions, namely, potassium, nitrate and calcium, under special conditions may be increased sufficiently to increase the

concentration of a nutrient solution. In fact, this technique is recommended by some authorities to control plant growth.

Lower Limits: Macro Ions. Usually the major problem in controlling the concentration of the macro nutrient ions is preventing the level from falling too low to support satisfactory crop production. All the factors briefly enumerated above have a bearing on the maintenance of the proper nutrient level. Further, the plant exercises differential absorption of the various ions from the solution. Rapidly growing crops may remove as much as 25 to 50 per cent of the nitrate from a given solution within one week. Potassium uptake is almost as great. If ammonium is contained in the solution, removal is even greater than for nitrate. Calcium and magnesium may either increase or decrease in quantity, depending upon the water and the media. The phosphorus level may be reduced as much as 15 to 25 per cent in a week.

A general practice to follow in regulation of the nutrient ion level is not to allow the separate ion concentrations to drop more than 50 per cent before replenishing the losses. Under commercial conditions, the ionic concentrations are determined by chemical analyses (see Chapter 12). Of course solutions that have low levels of certain ions originally may have to be replenished before the level drops to 50 per cent. The best index is to associate the chemical analyses of the solution with the general growth responses and the production records. In the case of sand or slop culture, wherein the nutrient solution is not saved or reused, this problem is not involved.

But where chemical analyses are not possible, a usual safe rule is to change the nutrient solution completely at definite intervals, that is, dump the used solution out and replace it with a fresh one. For small volumes of 5 to 10 gallons, a weekly or ten-day change schedule is suggested. With solution volumes of 100 gallons or over, a two- to four-week turnover is in order. In any case, the general plant growth must be correlated with any given procedure. Also, it is understood that the number of plants per volume of solution directly affects the rate of depletion of the nutrient ions (see Chapter 8).

Upper Limits: Macro Ions. The opposite problem to too little nutrients is too much. If recommended nutrient solution formulas are followed, this problem should not occur; but it is always possible to make an error: which would place excessive amounts of

essential macro ions in the solution. The first response to be expected would be a hardening of the growth comparable to that effected by a high osmotic solution concentration. A chemical analy-



Figure 7-4. Close-up of tomatoes in C.P.I.M. Hydroponics Garden, Curaçao, N.W.I. (Courtesy W. R. Mullison)

sis would confirm the excessive quantity of any particular ion. Prolonged exposure to such unfavorable conditions reduces growth and yield and may even produce foliar symptoms (see Chapter 8).

Fairly high levels of nitrate and potassium are tolerated by most plants. Some nutrient solutions possess 15 to 25 millimoles of these ions and support plant growth without any toxicity. Five to 10 millimoles of phosphate are tolerated by plants; magnesium as high as 8 millimoles is not toxic. Calcium may be increased to at least

18 millimoles without plant injury. Although sulfate and chloride levels of at least 40 and 30 millimoles, respectively, are not toxic, growth is definitely retarded.

Higher levels of ions are required to cause actual tissue damage, but it is suggested not to let the ions become any higher in concentration than mentioned above. In fact, lesser amounts should be maintained because production is reduced at these levels.

When the content of an ion in a solution becomes high, but is still short of toxic levels, its concentration should be reduced by disposing of part of the solution and replenishing it with fresh solution of the proper quantity of ions. However, when a toxic condition is reached, the solution should be completely discarded. Then the gravel should be flushed with fresh water. An analysis of the flushing water will indicate when the concentration of the excess ion or ions has been reduced to a safe level. A new solution correctly formulated should then be made (see Chapter 10).

Minor or Micro Nutrient Ion Concentration. These mineral nutrient ions, which are quite essential for proper plant growth, include iron, manganese, boron, copper and zinc. They are called minor or micro elements purely from the viewpoint that only minute amounts are required. Often under practical culture conditions, in which commercial or technical grade chemicals, tap water and mineral-bearing media are used, it is not necessary to add minor elements to the nutrient solution, as enough of them is present as impurities to supply the plant needs. However, when occasion demands addition, only one-half of the quantities recommended for pure chemical cultures are suggested. This is a safety provision. Careless use of minor elements in practical cultures often causes retardation of growth, because the addition of a full complement of minor elements to systems, which often contain adequate resources, raises their concentration to or beyond the danger point. Thus certain general physiological factors and the lower and the upper limits must be understood.

General Physiological Factors: Micro Ions. Several physiological factors also govern the control of the micro ion concentration in the nutrient solution. These include the water source, the root aeration, the pH of the nutrient solution and the phosphate content of the nutrient solution.

Observations obtained in Aruba indicate that the water may be

a major source of minor elements in soilless culture. It was not necessary to add these ions to the cultures until considerable amounts of evaporated water (evaporated sea water), which is a crude grade of distilled water, were added to the fresh water supply. These observations support others made elsewhere.

Another factor which governs the minor element problem in the nutrient solution is the degree of aeration in the root environment. This factor is quite important in water culture, but it may also be a major factor in gravel culture. California research men have reported that plants require lower minor element concentrations if the nutrient solution (water culture) is properly aerated. These data were substantiated in Aruba in practical gravel culture units. As mentioned in Chapters 3, 4, and 5, aeration of the nutrient solution is accomplished in several ways, depending upon the type of culture. If adequate rates of filling and draining of gravel culture beds are not used, root aeration is reduced. The plants then require a greater amount of minor elements to sustain reasonable production.

Since the solubility of several of these essential ions is a function of pH, the pH of the solution and the media should not go beyond 7.0 unless special precautions are taken. Usually iron precipitation, as phosphate salts, is the major concern with alkaline systems. Either greater or more frequent additions are necessary. In the case of iron, organic salts may be used which remain soluble at higher pH ranges than do the inorganic. However, since high solution pH causes other troubles, as mentioned earlier in this chapter, a pH range of 6.0 to 6.5 is suggested. In this range, the recommended amounts of minor elements listed below for practical cultures usually remain in solution reasonably well and are available to the plant.

Of course with alkaline media, like limestone, coral, or highly calcareous gravels, the pH of the general root environment is well above 7.0. To reduce minor element precipitation (as well as phosphate precipitation) two methods are presented which may partially counteract this problem. One way is to use a type of solution which contains a high proportion of acid-forming salts, such as recommended by Purdue. The principal salts are ammonium sulfate, potassium sulfate and potassium chloride as the sources of nitrogen and potassium. These salts leave a residue of acidic sulfate and

chloride ions which theoretically reduce the pH immediately around the root absorption zone. The other method is to pretreat the media with a concentrated phosphate solution (see Chapter 5) prior to use. The alkaline media particles are coated with a film of phosphate salt, chiefly calcium phosphate, which tends to maintain a lower pH level in the root environment.

A factor which is often overlooked is the effect of a high phosphate level in the nutrient solution on the availability of minor elements to the plant. Again, iron is the chief offender in this respect. Solutions high in phosphate (5 to 10 millimoles) often rapidly precipitate iron when it is added to the solution. Low phosphate levels reduce this effect, but very low concentrations permit excessive fluctuations of the solution pH. A range of 2 to 4 millimoles of phosphate usually balances the problem satisfactorily.

Lower Limits: Micro Ions. When recommendations are given for specific concentrations of minor element nutrient ions, the rate of application must be stated. If frequent additions are made, lower concentrations are added at each application, and vice versa. Iron, as ferrous sulfate, is added at the rate of 0.5 to 1.0 ppm (parts per million) once or twice a week. Iron citrate and iron tartrate are also recommended at similar concentrations by various authorities. Manganese is usually added at the rate of 0.25 to 0.5 ppm as manganese sulfate along with the iron. However, manganese is often not needed as much as iron in practical cultures, and less frequent additions are in order—say, once every week or two. Boron at 0.25 to 0.5 ppm as boric acid, copper at 0.025 to 0.05 as copper sulfate, and zinc at 0.025 to 0.05 ppm as zinc sulfate are not added more often than once or twice a month.

The best way to ascertain the need for minor elements is by practical judgment. Deficiency symptoms are quite definite (see Chapter 10) and experience with plant growth will help the grower determine the need for the minor elements, particularly iron, manganese and boron.

Upper Limits: Micro Ions. Since the tolerance of plants for minor elements is small, it is easy to run into toxicity problems. (Symptoms will be discussed in Chapter 10.) It is not recommended to use more than 5 to 10 ppm of iron at any one time. Boron and manganese safety limits appear to stop at 5 ppm. Zinc and copper should not be allowed to exceed 1 to 2 ppm.

Many factors affect the tolerance of minor elements, including kind of plant, rate of growth, type of solution, solution pH, and type of medium. For practical units it is best not to use any greater amounts of these ions than listed for normal plant needs. In case of a deficiency, keep adding the same quantities, but more often, rather than dump a large amount into the solution. To illustrate this point, proportions of 0.5 ppm boron, 0.05 ppm copper and 0.05 ppm zinc were added three times within two weeks to clear up a serious meristematic (top of plant) chlorosis or yellowing in tomatoes in Aruba.

When a minor ion toxicity develops, the best thing to do is to stop adding ions. It may be possible in an incipient case to allow the pH and the phosphate level to increase to hasten precipitation of the excess ions. Usually the high pH technique is more satisfactory. In serious cases the nutrient solution should be discarded and the gravel media flushed with water (see Chapter 10).

Solution Changes

How often the nutrient solution should be completely changed is a question with numerous answers. Authorities suggest all the way from weekly, bimonthly, and monthly to quarterly, semi-annually and annually. Practical experience indicates that a solution could be used indefinitely if no disease or excess accumulation of extraneous ions developed to interfere with proper plant growth.

Disease Effect. Although no direct evidence has been reported of the spread of disease organisms from bed to bed through the nutrient solution, it may be possible under practical culture conditions. It is well known that some diseases, such as damping-off, spread through the media within the bed. Spores and pieces of mycelia (vegetative portion of fungi) may pass from the gravel with the solution into the central storage unit and thus infest an entire section.

Extraneous Ion Effect. Extraneous ions, essential ones in excess as well as non-essential ions, build up in the nutrient solution with time. The nature of the water supply, the type of medium, the type of salts used, and the rate of uptake by the plants are important factors. If the water is hard, appreciable amounts of calcium and magnesium, mostly as sulfate and chloride salts, are often contained in it. In some areas the water is somewhat saline and

contains sodium chloride and sodium sulfate. The water supply should be checked before use. Changes in the nutrient solution formula are often necessitated; in some cases it is possible to leave out all the calcium and magnesium salts. Under some practical conditions these ions may increase in excess of original concentrations because of the water supply, as make-up water is added over a period of time.

Calcareous gravels often supply enough calcium and magnesium to suffice partially or entirely for the plant needs. It is doubted if an excess of these ions will develop from this source in the solution because of the relatively low solubility of the gravel components.

The type of salts used affects the rate of build-up of certain ions. Large quantities of sodium, sulfate and chloride salts tend to raise the level of these ions.

The main reason why certain ions increase to excessive levels in the nutrient solution is because the plant exerts differential ion uptake. Some ions are used in relatively small amounts. Constant addition of more chemicals and water to the nutrient solution raises the content of these extraneous ions faster than the plants absorb them. Eventually their concentration reaches a point where the plant growth is affected. The first response by the plant is a general retardation of the rate of growth, because the osmotic concentration of the solution is increased. If the concentration of a particular ion or several ions is increased sufficiently, actual toxicity may result. Under practical culture conditions, the hardening of growth caused by the osmotic concentration warns the grower to correct the condition.

When to Change. Sulfate and chloride ions are usually the ones which must be watched in the solution. When the upper limits are reached, the concentration of these ions, considered as sodium salts, must be lowered. The most practical procedure is to reduce the concentration of the unbalanced ion to a safe level, at least to 50 per cent of the existing content. This is accomplished by dumping out one-half of the nutrient solution. Then more water and chemicals are added to bring the solution volume and nutrient ion content to the proper values. Of course if it is so desired, the entire old solution may be discarded and replaced with a fresh one. Whenever the salt content of the solution gets very high, it would be advisable, if experience dictates, to flush the gravel with water.

Nutrient solutions have been used for as long as six months in Aruba without changing. Experience will indicate whether shorter or longer periods are practical, depending upon the local conditions with which the grower must contend. This applies to both partial changes and complete changes. Chemical analyses are necessary to follow the nutrient changes in the solution in order to make the required chemical additions. The general condition of plant growth must be correlated with the results to determine the correct time to add the salts. Actually, an experienced grower can estimate the proper times of chemical make-up just by studying the plant responses. The reader is referred again to the foregoing section on lower limits permitted for macro nutrient ions in respect to solution changes.

Chapter 8

Technical Control of the Plant Culture

This chapter deals with actual technical control of plant growth in soilless culture apart from direct control of the nutrient solution in the storage cistern. In other words, certain environmental factors definitely associated with the handling of nutrient solutions, but still to a large degree distinct from it, must be considered in operating a nutrient solution culture unit. These factors may be subdivided into two major portions, namely, the medium environment and the atmospheric environment. The medium environment is directly concerned with the root-growing conditions. Atmospheric environment deals more directly with the top of the plant. Regardless of any attempt to separate these two factors completely, they are closely interrelated and they are subdivided here only for convenience of discussion.

Medium Environment

Medium environment concerns the handling of the gravel medium and the nutrient solution. Certain physical and chemical operations are required to grow plants properly. The physical factors include the pumping cycle and the temperature of the root medium. Chemical manipulations include various means of altering the plant growth to fit special conditions and aims.

Pumping Cycle of the Nutrient Solution.¹ The major thesis in establishing a definite pumping cycle is based upon supplying an adequate water source to the plant roots. Many cultural factors are responsible for determining the frequency of pumping the nutrient

¹ The pumping cycle discussion herein pertains solely to gravel sub-irrigation units. In water culture the roots grow in free liquid, thus pumping cycles *per se* are not a factor. However, circulation of the nutrient solution, which is a pumping problem, is discussed in Chapter 3.

Frequency of moisture additions to sand cultures are governed by the same factors as discussed in the context for gravel cultures; but usually finer media are used, hence less frequent moisture applications are performed.

solution into the plant growing beds. These considerations include the effect of the following items: the gravel, the nutrient solution, the plant and the climatic conditions. After these various plant cultural factors are considered the physical operational problems must be met. These include (1) how often and when to pump the nutrient solution, (2) the speed of filling and draining the gravel bed,



Figure 8-1. Nutrient solution being distributed by means of flume, Flagler Farms, Kendall, Florida. (Courtesy J. P. Biebel)

(3) the level of the nutrient solution in the gravel bed and (4) the variance of growth by manipulation of the pumping schedule.

Cultural Factors. The effect of the gravel on the frequency of nutrient solution application depends upon its nature, particle size, and depth. Porous materials, like cinders and Haydite, hold moisture longer than non-porous gravels. Further, the particle size of the gravel definitely affects its moisture retention. Fine gravel does not have to be pumped as often as coarse. Also, the shape of the gravel particle is a factor; rounded particles hold less water than flat particles because less particle surface is present to attract and retain a film of moisture. Naturally a deep bed of gravel holds a greater moisture supply than a shallow bed.

Nutrient solutions which have a high osmotic concentration, either by virtue of the formula or by the use of very hard or even slightly saline water, affect the rate of water uptake by the plant. Osmosis of water through the root tissue is slowed down when the solution

concentration is relatively high. Thus the plants cannot reduce the water content in the gravel to as low a point as when lower concentrations of nutrient solution are used; in such cases the solutions

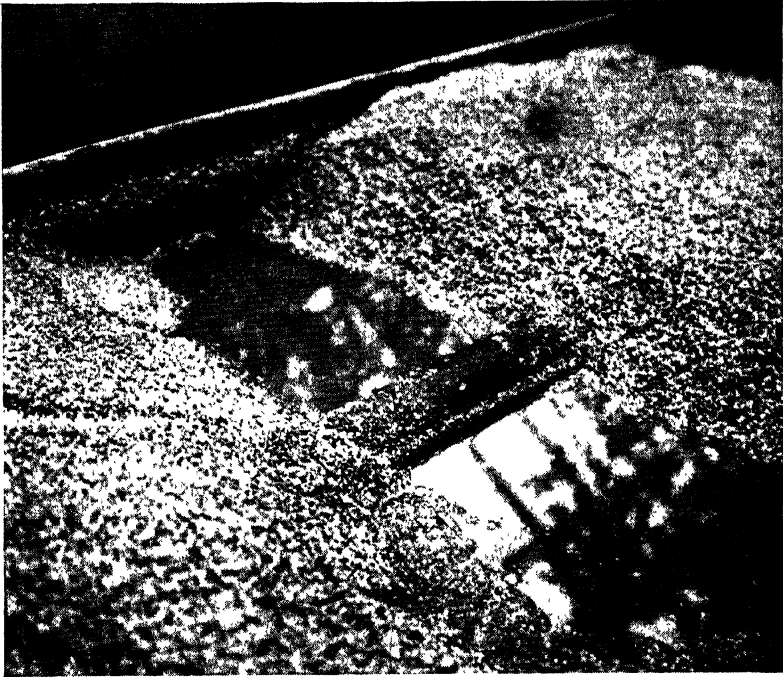

Figure 8-2. Standing water in a flat-bottomed bench—an undesirable environment for optimum plant growth. (Courtesy Ohio Agricultural Experiment Station)

must be pumped more often into the plant growing bed to supply adequate available moisture.

Further, the actual ionic proportions of the nutrient solution will alter the moisture needs. Nutrient solutions of very high nitrate levels produce a soft type of growth. Such plants use much greater quantities of water; hence the medium must be supplied with moisture more often. Both the solution concentration effect and the nitrate content effect have been substantiated in tropical work.

The plant itself, by its very nature, is the major factor governing the pumping cycle of the nutrient solution. Naturally, large, actively growing plants require more water than small plants. Thus more frequent pumpings are necessary for large plants. Some kinds

of plants require more water than others, due in part to size difference and in part to specific inherent characteristics. Lettuce requires less water than tomato chiefly because of size difference. However, tomato and cucumber plants differ mostly because of inherent requirements, the cucumber needing greater quantities of water. Finally, the number of plants per volume of gravel must be considered; when widely spaced they require less pumping of the gravel bed than when closely spaced. Also, plants growing in shallow beds reduce the moisture content more rapidly than those grown in deep beds.

As with soil culture, climatic conditions also influence the moisture needs of plants grown in soilless culture. These factors will be discussed more fully later in this chapter (page 191). However, it suffices at this point to mention these factors. They include (1) the air temperature, (2) the light intensity, (3) the carbon dioxide content of the atmosphere, (4) the relative humidity, (5) the wind velocity and (6) the rainfall. These climatic variables all affect the physiological responses of the plant, including moisture requirements. In other words, the plant grower must take weather conditions into consideration in setting up a pumping schedule.

How Often and When to Pump. Usually one pumping per day is sufficient for young plants. As the plants increase in size, it is necessary to increase the frequency of pumping to two to four times a day. Three times a day is usually sufficient for most purposes, but special conditions sometimes require an extra pumping. In other words, it is best to supply just enough moisture, rather than great excess. The best procedure is to watch the plants and vary the pumping cycle if wilting occurs. Growth will be retarded by too much as well as by too little pumping of the nutrient solution. Under such conditions the plants become hardened, light green in color and in some cases chlorotic. The major difference between the two extremes of moisture condition is that wilting readily occurs as soon as the moisture supply is deficient. Plants will recover from the unfavorable cultural conditions more quickly when the cause is too little water rather than when it is too much. Too frequent solution application in gravel units has been observed to cause chrysanthemum plants to become chlorotic. Also in the tropics tomato, radish and lettuce plants were found to be definitely retarded by excess pumping of the nutrient solution.

After the number of pumpings per day is established, the next problem is to determine the time of day at which to pump. Practical experience definitely dictates the need of pumping only during the daylight period. Pumping at night is not necessary. Experimental work under practical conditions in the tropics has borne out these recommendations. Of course, the relative humidity of the air will affect this recommendation. (It may be possible in a warm climate with a very low percentage of moisture in the air that experience will indicate the value of a night pumping.)

Pumping at intervals not any closer than three to four hours is in order for most practical conditions. This schedule can fit into the period of 6:00–8:00 A.M. to 4:00–6:00 P.M., depending upon the length of daylight. In the tropics, where the daylight averages about 12 hours, a period of 7:00 A.M. to 5:00 P.M. is satisfactory. In the temperate zones during the summer a 6:00 A.M. to 6:00 P.M. and during the winter an 8:00 A.M. to 3:00 P.M. period may be set up. These pumping periods extend from the time the pump is started for the morning pumping to the time the bed is practically drained after the last pumping in the afternoon.

The actual number of pumpings per day will to some extent indicate the time of day for each operation. When one pumping per day is performed, it should be done during the warmest part of the day when the water needs of the plant are the greatest, *i.e.*, between 11:00 A.M. and 1:00 P.M. For two solution applications per day a mid-morning, 8:00 to 9:00 A.M., and a mid-afternoon, 2:00 to 3:00 P.M. application are recommended. If three or four pumpings are required, the schedule is spaced evenly over the total cycle, for example 7:00 A.M., 11:00 A.M. and 4:00 P.M., or 7:00 A.M., 10:00 A.M., 1:00 P.M. and 4:00 P.M.

Speed of Pumping and Drainage. The physiological consideration in the regulation of the speed of pumping and draining of the nutrient solution from the gravel is the aeration of the root system. Roots require oxygen to carry on respiration, growth and the function of the uptake of water and nutrient ions. If insufficient oxygen is present around the plant roots, growth is retarded and yields are consequently reduced. Even definite plant injury is possible. An extreme case of poor aeration that occurred in Aruba well illustrates this point. In error, a bed of tomatoes was left full of the nutrient solution overnight, about a 15-hour period. Later during the next day severe wilting occurred, particularly during the hot period of the

day. This condition re-appeared every day for the following three or four days until the plants fully recovered. The root tissues were injured and were not capable of absorbing enough water for the



Figure 8-3. Tomato crop, Lago Hydroponics Garden, Aruba, N.W.I. (Courtesy J. R. Knoll)

plants' requirements. This damage occurred because the prolonged submergence reduced the oxygen supply to the roots to an insufficient level.

Another observation made in the tropics will also help stress the importance of adequate root aeration as related to the speed of filling and draining the gravel bed. In some large commercial beds wherein the design was faulty, a deficiency of minor elements developed when the water supply was materially changed. Similar plants under similar conditions, except that much greater speeds of filling and draining of the gravel beds were practiced, did not develop this difficulty. As mentioned in Chapter 7, the availability of minor or micro elements to the plant is associated with nutrient solution aeration.

To clarify the relationships of speed of filling and draining of the

gravel bed to root aeration, the physical problem must be briefly discussed. As the nutrient solution fills the gravel voids from below, it pushes out air which has a relatively low content of oxygen and a high content of carbon dioxide. Then as the nutrient solution flows from the gravel it sucks air into the medium. This new supply of air has a relatively high content of oxygen and a low content of carbon dioxide. The greater the speed of solution movement in the gravel medium, the greater the speed of air displacement. Also, since the solubility of oxygen in water is low, the period of low oxygen supply, while the free water is in the gravel, is shortened if the speed of filling and draining is rapid.

This factor of aeration is also related to the frequency of pumping as well as the rate in the same manner. When free water is present too often in the gravel, the voids (air spaces between the particles) are filled with water rather than with moist air. Thus the oxygen concentration around the roots is lowered.

This rate of filling and draining a sub-irrigation gravel unit is still established arbitrarily. Work must be done to compare crop yields with rate of solution movement in the media. Such data are of importance from a practical viewpoint in designing commercial installations. The pump capacity and the power requirements are much greater for a 10-minute filling time per section of 10 to 25 beds than for a 30-minute period. It is usually recommended at present that the gravel bed should fill in 30 minutes and drain in the same length of time. Thus there is a total period of 60 minutes when free water is present in the bed. Evidence secured at several gardens in the tropics suggests that a much shorter period is desirable; possibly a 10 to 15 minute period for filling and draining respectively, or a total time of 20 to 30 minutes may be necessary for a practical unit, at least in the tropics. This is probably one reason why results secured in small sub-irrigation units are often not directly adaptable to large commercial beds, wherein the small unit completely fills and drains in a total time of 5 to 10 minutes as compared to a 60-minute period for the large unit.

An additional point to consider in the removal of the free solution from the bed is the degree of drainage. Nothing less than complete drainage is recommended. All free solution must be removed from the growing unit. Only a film of moisture on the gravel particle is desired. Bench construction, as described in Chapter 5, is designed

to facilitate complete drainage. Both experimental and commercial work has indicated that poor growth results if puddles of solution remain in the bottom of the plant bed. Ohio State research men reported defoliation of roses under such circumstances when the old type flat bottom beds were used. The V-type bottom eliminates this difficulty.

This entire discussion of flooding and emptying the nutrient solution in the gravel bed may be briefly expressed as follows:

- (a) fill the bed rapidly;
- (b) drain the bed rapidly;
- (c) get all the solution out.

The Nutrient Solution Level in the Gravel Bed. The control of the height which the solution reaches in the medium is chiefly governed by factors other than strictly physical. Of course there is no point in applying more nutrient solution than will just flood the bed. It is desirable, often absolutely necessary, to keep the gravel

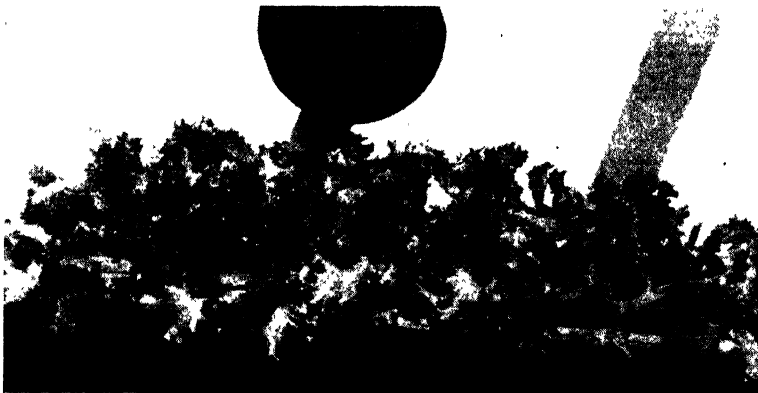

Figure 8-4. Excellent leaf lettuce grown under shade, Aruba, N.W.I.
(Courtesy R. W. Schlageter)

surface dry. This is done to help reduce the growth of algae and to retard the development of several plant diseases. The small algae plants often grow profusely on the gravel surface if it remains wet all the time. Besides being objectionable in smell and appearance, the solution pH is often lowered (see Chapter 3). Diseases, chiefly fungous ones, may be partially controlled by a dry gravel surface. This applies principally to those types of diseases, such as damping-off, which attack the lower portion of the stem of the plant.

Maintenance of a dry gravel surface helps reduce the incidence and spread of these types of troubles. To aid in this respect it is important to have the beds filled evenly. Proper design of the bed will take care of this physical problem. This will enable the operator to control the solution level in the gravel medium and provide more even moisture conditions throughout the entire bed. At least the upper one-half to one inch, sometimes the upper one to two-inch, portion of the gravel should be kept dry.

Varying the Pumping Cycle. As mentioned above, the selection of the pumping cycle materially influences the type of growth responses; in fact this technique is recommended by various authorities to control the growth of the plants to some degree in soilless culture. It really is an adaptation of the well known soil culture method of regulating water application to alter the plant growth as desired.

By reducing the number of nutrient solution pumpings the moisture content in the gravel medium is lowered. This has a concentrating effect on the nutrient ions contained in the water film on the gravel particle. Whenever the osmotic concentration of the nutrient solution is increased, the water-absorbing power of the plant is reduced. This also reduces the nutrient ion uptake. Consequently the rate of plant growth is retarded and a harder and firmer type of growth develops.

In the greenhouse during the dark, cloudy, short days of winter, reduction of the number of pumpings per day will help keep the plants reasonably hard and sturdy. Often one pumping every day or every other day is practical. Some people use this technique to set gardenia beds for Christmas crops in the greenhouse. In the tropics it may be possible to maintain a better carbohydrate balance in the plant by withholding the water supply, especially during the early stages of growth. This aids in improving the fruit set under some conditions.

Gravel Temperature. The temperature of the root medium profoundly influences the growth of the plant. Usually two extreme problems must be solved in the practical culture unit. In the greenhouse in the winter the major problem is to maintain a high enough temperature. In the tropics, under conditions of bright sunshine, the medium often becomes too warm if no protection is afforded. Here the problem is to keep it cool.

Heating the Root Medium. Numerous research men and practical men have reported upon the effect of the soil or the gravel temperature upon plants. From a physiological standpoint much of this data is highly significant and valuable, but from the practical or commercial aspects the results reported are quite controversial.



Figure 8-5 Windbreak for Lago Hydroponics Garden, Aruba, N.W.I. (Courtesy J. R. Knoll)

Probably one reason why the results of applied research have not been too reliable is that the influence of the air temperature and the light conditions in relation to the root medium temperature were not fully appreciated.

One factor must be mentioned in connection with the heating of the nutrient solution. During the winter in a greenhouse the make-up water and the water used in preparation of fresh solutions is quite cool. The temperature of this water may be sufficiently low to retard water uptake by the plants and cause wilting. An actual case of the wilting of young cucumber plants was observed in a greenhouse when the fresh nutrient solution was prepared with water at a temperature of about 40°F.

Of course the answer to the problem is obvious. The water should be heated to at least greenhouse temperature before it is used. This may be done by passing steam directly into the water, mixing with hot water or heating with suitable electrical coils in the water storage tank or in the nutrient solution cistern.

The problem of adjusting the temperature of the nutrient solution

cannot be based upon a simple set of rules. Every plant has an ideal temperature range most suitable for its growth under any particular set of conditions. The air temperature in a greenhouse is regulated to meet these particular conditions. As long as the nutrient solution temperature does not deviate appreciably from the air temperature there is no serious need of heating the solution. Although increasing the temperature of the nutrient solution may actually increase yields under certain conditions, the economics must be considered. Yield increases of tomatoes are reported with the solution temperature raised 10° to 30° F above the night temperature of the greenhouse. However, other reports with several vegetable and floral crops are conflicting.

Of course the nutrient solution temperature must not become abnormally low, that is, down to 40° to 50° F, for many crops. Under such circumstances plant damage may occur. The first effect of a too low temperature is a sudden wilting of the plants. Later, slowing down of the growth rate, chlorosis of the foliage, necrosis (dying) of the foliage, loss of foliage and root damage occur if these unfavorable conditions persist. These physiological effects are caused by several factors. Apparently the viscosity of water is sufficiently increased to retard passage through the root tissue. Further, the root tissue itself is altered. Permeability of the semi-permeable root membranes is decreased and respiration rate is lower. Both these responses reduce the absorption of mineral elements and water. Also the rate of new root formation is retarded and eventually a small root system results.

Several techniques are available for heating the root media if conditions warrant the need and the expense. Electric heating cables—the regular hot bed variety—are satisfactory if properly coated to eliminate danger of lead toxicity. Coating with hot asphalt, emulsion or paint, will work, or the cables may be passed through black iron pipes. The properly prepared cables then may be inserted 4 to 6 inches apart in the solution cistern, in the water culture basin or in the gravel bed. The temperature of the medium is then automatically regulated by a thermostat. In a greenhouse, hot-water or steam pipes may be placed beneath raised benches. They may also be placed in the bed, like the electrical cables. Of course smaller lines must be used than when the pipes are placed beneath the bench. One-half inch pipes may be laid about 6 inches

apart. Electrically operated thermostats will control the proper temperature range.

Sometimes the heating units may be placed in the solution storage cistern, and the heated solution is then pumped into the unheated beds. Usually, under such conditions the differential between air temperature and temperature of the medium is not as great as desired, and is not constant.

Cooling the Root Medium. Cooling the root medium may be considered for two general purposes. The first is to lower its temperature to a specific range to vary the type of plant growth; the second is to reduce the temperature from a harmful range to a more moderate range suitable for satisfactory crop production.

The first aim is well illustrated by published data upon the effect of lowering the root temperature in gardenia production. Reducing the root temperature several degrees below the night air temperature of the greenhouse initiates bud setting. The buds are then developed by raising the root temperature above the air temperature. However, as inspection of the literature will indicate, agreement among authorities on this procedure is incomplete. Various combinations of root temperature, air temperature, light intensity and light duration will produce various results. No attempt is made to present precise recommendations in this text. This brief discussion is merely intended to show what effect a low temperature of the medium will have upon plant growth. Of course the practicability of such a scheme must be ascertained for commercial purposes before it is used.

Another aspect of this problem is the use of refrigeration equipment to cool the medium in tropical gravel culture gardens. Cooling coils may be placed either within the plant-growing medium or in the storage cistern. At present, research is planned on this subject in Aruba. Considerable influence upon production of such crops as lettuce and tomato may be expected by establishing a differential between air and root temperatures.

The second purpose of reducing the high temperature of the gravel is not only important but absolutely necessary. This problem exists in the greenhouse in the summer and in the open in the tropics. When the bright sunlight falls on the exposed gravel, the temperature is greatly increased. This effect is altered somewhat by the type of medium in use, some types heating up more than others.

For an illustration, it may be stated that several media were tested in this respect in Aruba. The temperature of the medium was higher with each succeeding material, namely, crushed coral, local bank gravel, Haydite, and crushed granite.

Whenever the root medium gets beyond 100° F, growth is usually retarded. The air temperature, the light intensity, the relative humidity and the kind and age of plant all affect the specific range at which growth occurs. A high root temperature eventually reduces the transpiration rate of the plant because water uptake by the roots is lessened. This induces wilting, and eventually foliage and root injury, and is followed by death of the plant if these temperature conditions are prolonged.

The practical problem is to keep the gravel temperature as close to air temperature as possible, or even a little cooler if practicable. Besides reducing the temperature to a more desirable range for the roots, water losses by direct evaporation from the gravel are also reduced by cooling the medium. It may be cooled by providing a shade over the entire garden, thus affecting both the plants and the gravel. In other cases it may be more practical to shade only the medium.

Overhead shade is installed primarily to reduce the amount of light on the plants, but it also takes care of cooling the medium. The direct rays of the sun are shut off and the medium naturally remains cooler. If the shade is reasonably heavy the gravel will be maintained at air temperature. This technique works well for salad and cooking-green types of crops like lettuce, chard, turnip greens, mustard greens and Chinese cabbage greens. Many methods may be used to provide overhead shade; these will be discussed below in the discussion of atmospheric environmental factors.

With crops which require very little or no overhead shade, like tomatoes, the gravel must be shaded at least until the plants are large enough to shade the gravel themselves. Numerous materials are usable for this purpose. The main caution is to use non-toxic materials. It will help reduce any possible danger of root toxicity by keeping the gravel surface next to the mulch dry, thus reducing possible extraction of any toxic principles and prevent decomposition of the mulch, which may cause difficulty. Loose mulch should be at least two inches thick. Excelsior, wood shavings, salt hay, shredded paper, ground cork, ground asbestos, wheat straw (if kept

dry), tree leaves, dry grass cuttings and palm fronds may be used. Glass wool and rock wool are not satisfactory. These materials act like a window pane; heat builds up underneath them and the gravel temperature increases instead of decreasing. Masonite, asbestos sheets, burlap strips, muslin strips and paper strips are effective if properly handled. They should be raised several inches above the gravel surface to permit air circulation beneath them; otherwise these solid mulches will not be satisfactory.

An important consideration in relation to the temperature of the root media is the influence upon seed germination, young seedlings and transplants. Some seeds, such as lettuce, do not germinate well if the germinating medium becomes warmer than 80° to 85° F. Young seedlings are easily burned when the gravel becomes hot. Freshly transplanted plants wilt readily if the temperature of the medium is too high. Overhead shading is thus recommended for these problems, particularly in the tropics. Sometimes transplants may be handled without overhead shading if the gravel itself is mulched. But more care is needed in subsequent handling of the plants.

Manipulation of the Nutrient Solution to Alter Plant Growth.

As suggested in Chapters 6 and 7, the nutrient solution may be altered from time to time to change the type of growth response. Usually four different variables are considered in the practical culture unit, namely, the nutrient solution concentration, the potassium concentration, the chloride concentration, and the ammonium concentration.

The Nutrient Solution Concentration. Most plants grow well under a wide range of conditions with a nutrient solution concentration of approximately one atmosphere. The type of growth may be altered by either increasing or decreasing this total salt concentration. When the solution concentration is increased, the availability of water to the plant is reduced. A harder and firmer growth results. Such plants may often produce more buds and fruit. In fact this technique may be used to set flower buds on some floral crops. Gardenia culture is an example. Bud set may be initiated by a high solution concentration, two to four times normal, and then these buds are developed into blossoms by forcing with a low solution concentration. A more practical technique is to regulate the water supply.

Another example of the use of highly concentrated nutrient solutions is suggested by Purdue University data. The procedure is to harden young plants, such as tomatoes, for field setting. Plants are grown in soilless culture beds and the osmotic concentration of the nutrient solution is gradually increased to 8 to 10 atmospheres to secure the correct degree of hardness. This gradual change in the solution content is done over a two to four-week period prior to field setting. The various changes are spread evenly over this hardening period. Single salts are added to the basic nutrient solution. Potassium sulfate, potassium chloride, and potassium nitrate are more suitable than calcium nitrate or calcium chloride. Potassium sulfate is the preferred salt. To produce an increase of one atmosphere it takes 20 mm of potassium sulfate, or 4000 grams per 1000 liters, or 35 pounds per 1000 gallons. This procedure is too expensive in sub-irrigation culture and is more adaptable to sand or sloop culture from the practical aspect. It still is quite expensive when used with sloop culture. Control of the water supply is a more economical method of hardening plants prior to field setting.

Aside from special effects desired in plant growth, the nutrient solution concentration may also be altered to fit the weather conditions. It is recommended by many authorities in the United States to use a high solution concentration during the short, cloudy days of winter in the greenhouse and a low concentration during the long, bright days of summer. This means that 1.5 to 2.0 atmospheres are used in winter and 0.5 to 1.0 atmosphere in summer. This may be translated into practical terms by doubling the regular quantity of salts in the solution for winter weather and halving the quantity for summer weather. However, one atmosphere is the best all-around concentration for all weather conditions, both in temperate and tropic climate. Again the cheapest way is to alter the water supply (solution pumping cycle) to change the effective solution concentration immediately around the roots.

The Potassium Ion Concentration. Both research workers and practical growers report that the type of plant growth may be directly affected by varying the potassium content of the nutrient solution. This response was observed for both vegetable and floral crops. An interpretation of the theoretical aspects mentioned should be made. The potassium ion has been credited with the response obtained, that is, of hardening the growth. Other research reports,

however, suggest that the potassium ion has a softening effect upon plant growth. Thus it is apparent that two schools of thought exist pertaining to its gross effects upon plant growth. Many cultural conditions influence the results of any study of the proportion of ions in the nutrient solution. The plant, the base nutrient solution, the solution concentration and the climatic conditions are all inter-related and profoundly influence the growth responses. Further, in some work reported, the nitrate level was reduced as the potassium level was increased. The lower nitrogen level was definitely found to produce a harder type of vegetation; also, the proportions of potassium utilized to develop the reported hardening and firming effect were quite high. Sufficient extra potassium salts are added to approximate an addition of one atmosphere to the nutrient solution concentration. An increased osmotic concentration also slows the rate of growth and causes the plant to become less vegetative.

High levels of potassium—about 15 to 25 mm—are suggested to harden the growth and improve the crop under cloudy weather and short daylight conditions in the greenhouse in winter. This is highly probable, but it really is a matter of nutrient solution concentration effect and of increasing the potassium-nitrogen ratio, rather than a direct effect of potassium. This method of controlling plant growth in the greenhouse is commendable and worthy of trial for any particular set of conditions, especially for tomatoes and roses. But it appears more practical to control the plant growth of most crops by varying the pumping cycle.

The Chloride Ion. Investigations by research men show that the chloride ion has a balancing effect in the nutrient solution. It is possible to improve the growth of plants that are growing in poorly balanced nutrient solutions by addition of the chloride ion. Further, the water utilization of the plant is influenced by this ion. Plants appear to contain more water in their tissues and to be more capable of utilizing their moisture supply efficiently. The latter point has been proved under commercial conditions with cucumbers in the greenhouse. Plants absorb potassium more readily in the presence of the chloride ion, which also improves the internal water relations.

Usually 5 mm of chloride, as potassium chloride, is added to the solution, with beneficial effects. It is not recommended to add potassium chloride indiscriminately, but with proper moderation. The

chloride ion should not be allowed to build up too much, as mentioned in Chapter 7. Probably not more than 10 to 15 mm of chloride should be tolerated in the nutrient solution. The chloride content of the solution is added by substituting it for some other anion, such as the nitrate and the sulfate ion; thus the total solution concentration is not increased. There is no particular point in adding chloride to a solution of non-chloride composition unless circumstances warrant it. If all growth factors are in order and growth is still not satisfactory, then try the chloride ion. It may sufficiently alter the solution balance and the water relations of the plant to improve the growth. In fact, this was the major reason for the development of the Purdue nutrient solution listed in Table 6-6 (page 142). Part of the potassium nitrate in the Purdue 2E solution was replaced with potassium chloride to form the Purdue 2F nutrient solution.

The Ammonium Ion Concentration. The ammonium ion must be handled with caution in the nutrient solution. This source of nitrogen should be used only as a supplementary supply, except under special circumstances. Ammonium may be the sole nitrogen source in the nutrient solution when alkaline media are used in the culture unit. This was considered in Chapter 6. (It may be mentioned at this point that fair growth of tomato, lettuce, and radish was obtained in crushed coral with an all-nitrate ion nutrient solution in Aruba.)

The main reason why the ammonium ion must be carefully handled is that plants absorb and utilize it extremely rapidly; in fact, it is used more rapidly than the nitrate ion. Because of this rapid utilization, the carbohydrate reserves in the plant are quickly reduced, particularly under conditions of slow carbohydrate formation and of low accumulation. In extreme cases the plant may also absorb excess amounts of ammonium nitrogen, and toxicity will result if the carbohydrate supply is depleted. This will occur more quickly when the pH of the nutrient solution is appreciably below 6.0, that is, from 4.5 to 5.0. Plants can absorb this ion at this low pH value, but cannot utilize it efficiently. Nitrate nitrogen is more usable at a low pH. Ammonium nitrogen is best assimilated at pH range 7.0 to 8.4, but under practical conditions such a high pH of the nutrient solution is not recommended. The ammonium ion will act as a quick source of extra nitrogen at a pH range of 6.0 to 6.5 if used in small applications at proper intervals.

Under bright weather conditions with a moderate air temperature ammonium ion will often be beneficial if used at the rate of one to two millimoles. It should not be used during the cloudy, short days of winter. Further, under conditions of high air temperature, especially high night temperature, coupled with a high relative humidity, this ion should not be used or at least only with extreme care. Present experimental data in the tropics indicate that ammonium nitrogen may be used only in low amounts, 0.5 to 1.0 mm, for tomato during the first three to four months of growth. Lettuce may be grown in the tropics with 0.5 mm in the winter, but with no ammonium ion in the summer.

The ammonium ion concentration may be maintained at the levels suggested above, or it may be added at certain intervals. It is satisfactory to add one to two millimoles to the nutrient solution and make additional increments when the level drops 50 to 75 per cent. The extra nitrogen may also be handled by adding the above amount one to three times per week. Such concentrations of ammonium ion will speed vegetative development without excessive growth softness if adequate light and a moderate temperature are present. Experience is the chief requirement for the grower in controlling ammonium nitrogen in the nutrient solutions.

The usual source of the ammonium ion is ammonium sulfate. However, some evidence secured indicates that urea may be even better. It is definitely a satisfactory substitute for ammonium sulfate. Urea also appears to have a higher tolerance range, that is, higher concentrations may be used more safely. However, the same quantities of urea are suggested as for ammonium sulfate. Ammonium nitrate is not recommended, as stated in Chapter 6.

Atmospheric Environment

A study of the effect of the atmospheric environment upon the plant is a study of the response of the plant to its climatic surroundings. These factors, with which the grower is directly concerned, include the air temperature, the light intensity and duration, the carbon dioxide content of the air, the relative humidity of the air, wind velocity, and rainfall. Some of the factors may be partially controlled under some conditions, but usually the grower must alter his technique to fit the weather conditions. Any discussion of these climatic factors implies that they all interact; thus each one must be considered in relation to all the others.

Air Temperature. The effect of air temperature upon plant growth must be considered under two separate, but interrelated, categories—the day temperature and the night temperature. This distinction is well recognized by the commercial greenhouse grower. It is universal practice to operate a greenhouse with a differential between the range of air temperature maintained during the day and the night. The difference is normally 10° to 20° F.

Each kind of plant possesses a specific temperature range most suitable for its development. It is not within the scope of this book to list these data. However, for greenhouse crops a general division of cool-season crops and warm-season crops is usually set up. Cool-season crops are usually grown at a night temperature of 50° to 60° F, and at a day temperature of 60° to 70° F. Crops like lettuce and chrysanthemums are of this type. Warm-season crops are grown at a night temperature of 60° to 70° F and at a day temperature of 70° to 80° F. This group includes crops like tomatoes, cucumbers and roses.

The temperature can be regulated in the greenhouse in the cool part of the year, but not during the summer. Thus, during the winter, growth may be partly controlled, particularly at night, by raising or lowering the air temperature. If more rapid, softer vegetative growth is desired, a few degrees increase in air temperature is helpful, while a comparable decrease will often harden the growth. Manipulation of the temperature is usually a common tool in regulating the type of growth during prolonged cloudy periods during the short days of winter.

In the greenhouse during the summer and in the tropics no direct regulation of the air temperature is possible; in fact, no control exists in relation to the night temperature. But partial shading will help reduce the air temperature around the plant during the daylight period.

Besides alteration of the plant growth by slight changes, extreme temperature conditions are sometimes set up to produce certain effects. An example is the standard procedure of bud-setting gardenias in the greenhouse in the fall to produce a Christmas crop. The temperature is lowered considerably to slow the rate of growth, which is conducive to bud formation. After the buds are definitely set, the air temperature is raised quite a bit to hasten blossom development. Of course other cultural practices are followed in con-

junction with the temperature change, but the latter is the major factor.

Experimental data obtained in the tropics indicate that the air temperature is a limiting factor in the production of certain temperate-zone vegetable crops. Leaf lettuce can be grown only to a small size because the stem elongates too much. Head lettuce cannot be grown satisfactorily because the temperature range is well above the optimum. Tomato fruit setting is dependent upon the air temperature, especially upon the night temperature. Present evidence is that the dividing line is 80° F for the production of many varieties. When the average night temperature goes above this point fruit set is decreased.

Seed germination, as well as vegetative and fruiting characteristics, respond to air temperature. Some varieties of lettuce refuse to germinate properly when the air temperature reaches 80° to 85° F or above; other seeds, like okra, pea and lima beans, germinate, but are easily subject to rotting during the germination stages.

Sunlight. All plants require adequate light for growth. As they vary as to their specific optimum range of light intensity, it is often necessary to provide shade. Most plants appear to require at least 1000 foot-candles (practical unit for measurement of light intensity) of light to support growth. Higher levels improve growth—up to 6000 to 10,000 foot-candles—depending upon the kind of plant. When the light intensity goes beyond 10,000 foot-candles most vegetable and floral crops will benefit by some shade. A general rule may apply to practical conditions. Leaf-producing crops, like lettuce, usually require less light than seed-bearing or fruit-producing crops like tomato. Most floral crops fall into the latter class, but many exceptions exist, largely affected by whether the plant is of the hardwood or the softwood type. Softwood floral crops generally produce better under lower light intensities than do hardwood varieties.

Short days along with much cloudy weather in some areas cause light to be a limiting factor in greenhouse crop production during the winter, but in summer both the day length and the light intensity afford abundance of light. In fact, light becomes a limiting factor in that it is in excess. Coupled with high air temperature, high light intensities will adversely affect the growth of some plants; thus it is common practice to whitewash the glass of greenhouses in

the summer. Outdoors some crops are grown under tobacco cloth, cheesecloth or coarse muslin shade to obtain more satisfactory growth. Sometimes wooden lattice is installed, or in the tropics palm fronds serve the purpose. Neither of the latter materials is as satisfactory as fabric because uniformity of light intensity under the shaded area is not fully possible.

The problem of how much shade depends upon the kind of plant, the cultural conditions and the climatic factors. Too little shade or no shade on some crops under strong sunlight definitely retards the growth rate and the quality of the produce. This was established in Aruba where crops like lettuce, radish, turnip greens, mustard greens and Chinese cabbage greens grew faster and developed better succulence and quality when grown under a light-to-medium shade.

Too much shade can also be detrimental, especially under high temperature conditions. Carbohydrate formation is retarded while respiration still functions at a high rate. Thus the plant becomes too soft and weak. Floral crops produce weak stems and light-colored blossoms. Salad crops become soft, light in color and produce elongated stems. Fruit-producing crops become weak, set less fruit and develop smaller fruit. Further, such soft plants are more susceptible to fungal and bacterial diseases.

Since conditions vary widely between different areas, it is not intended to establish concrete recommendations in this book. Experience will dictate the proper degree of shade. Often a reduction of 25 to 50 per cent of the sunlight will be sufficient for salad crops. Either no shade or only 10 to 20 per cent reduction is necessary for the crops like tomato. If a light meter is available, quantitative data may be secured and more exact knowledge of shading requirements determined.

Carbon Dioxide. The atmosphere contains about 0.03 per cent carbon dioxide and is the source of this essential compound for plant growth. Usually carbon dioxide is not a limiting factor in crop production. But under conditions of bright sunlight the plant may be able to efficiently use greater concentrations of carbon dioxide than normally exist in the atmosphere. During periods of low light intensity carbon dioxide is not a limiting factor of growth.

Data reported for the use of additional carbon dioxide in the greenhouse atmosphere in the winter are conflicting. Several reasons may explain the apparent discrepancies. Experiments con-

ducted in the winter are operated under a more serious limiting factor, low light intensity. Also, if incomplete combustion of the charcoal takes place, sufficient highly toxic carbon monoxide forms which is injurious to the plants. Other experiments run in bright sunlight periods, but under high temperature conditions, are also subjected to another limiting variable, the high respiration rate.

It may be possible to improve plant growth in the commercial greenhouse with additional carbon dioxide if certain conditions are fulfilled, namely, bright sunshine and moderate temperature, but the economics of the procedure must be taken into account. At the present the only suggestion to offer is to tell the interested grower to try it. The extra carbon dioxide may be supplied by properly burning charcoal or releasing carbon dioxide gas from cylinders or from Dry Ice.

Caution must be exercised to eliminate excessive concentration of carbon dioxide in the greenhouse atmosphere. This gas produces inhibiting growth effects when the concentration reaches 15 to 20 per cent. Such a high concentration would be improbable in the greenhouse. However, if poor circulation facilities are present around the generator, such a condition may occur. Probably an increase up to 1 to 2 per cent would be within practicable limits. A point must be mentioned here in that light intensity and carbon dioxide concentration act as limiting factors upon each other. Thus at a low light intensity level less carbon dioxide can be utilized by the plant than at a high light intensity, and *vice versa*.

Relative Humidity. This factor plays an important part in the general vegetative responses of the plant and its susceptibility to diseases. Low relative humidity of the atmosphere is conducive to a hard type of growth, while high relative humidity causes a soft type, if all other cultural factors are similar. Also, the moisture content of the air directly affects the transpiration rate of the plant. Water losses from the plant are much higher when the relative humidity of the atmosphere is low.

The maintenance of adequate humidity conditions in the greenhouse is a major practical problem. Many techniques are used to raise the humidity. Walk ways and areas under raised benches are kept wet. Plants are often lightly sprinkled with a fine stream of water. In the winter steam injections appear to be feasible. This will influence both the air temperature and the moisture content.

Light shade on the glass in the summer will also aid in raising the greenhouse humidity by lowering the air temperature.

Quite often the disease factor is of major concern. Most disease organisms develop best under relatively high moisture conditions. Thus roses are readily attacked by mildew and black spot if the relative humidity of the greenhouse atmosphere is too high. Carnations are more susceptible to rust. Tomatoes are troubled more with leaf mold. The list is endless, and these are only representative examples.

Paradoxically, a relatively high humidity may be helpful in reducing the incidence of some diseases. A typical case is the control of blossom-end rot in tomatoes. Constant sprinkling of the walks between the gravel beds appeared to help reduce the percentage of loss in the tropics.

Wind. Wind is not a direct factor in greenhouse crop production. However, for outdoor culture it is an important and direct cultural factor. Many crop plants cannot tolerate strong wind and sustain mechanical damage to the foliage and the stems. Even when the wind velocity is not sufficient to cause mechanical injury, transpiration is increased by appreciable air motion. Thus water losses may be increased. It is imperative in areas of strong prevailing winds to erect wind protection. The wind velocity should be slowed down to at least five miles per hour in the garden.

Another problem in connection with wind is the maintenance of suitable shade for some crops. The various fabrics, tobacco cloth, cheesecloth, and coarse muslin, are easily damaged by the strong wind, and it is difficult to keep these materials in adequate repair. Sometimes it is necessary to use less desirable types of shade because of wind velocity.

For best results, a windbreak should be constructed to allow some wind to blow through. A solid windbreak creates more Eddy currents in the garden than does a slatted one. Several means are suggested for wind protection. These include wood lattice, slatted wood fence, palm frond fence, burlap fence, heavy muslin fence, willow trees, privet hedges, pine trees, seagrape trees (Aruba) and cactus trees. The spacing interval for the windbreak depends upon the size of the garden and the wind velocity. Each windbreak should be at least 10 to 20 feet high. Such a structure usually protects an area whose width is 4 to 5 times the height of the windbreak.

Complete stoppage of all air motion is not to be permitted around the plants. At least under tropical conditions, the air temperature will increase considerably if no air motion occurs. This will lower the relative humidity around the plant and increase water losses. Danger of blossom-end rot of tomato is then more prevalent. Also, it appears that some insects may be more serious in areas of little air motion, but this by no means applies to all insects.

Rain. Rain is not normally a production factor in greenhouse culture, but outdoors it is a considerable problem. In some tropical areas the rainfall is so heavy and violent at times that actual mechanical damage to the plant is experienced. A light overhead shade will help reduce this trouble to some extent; but even under a fabric shade, the leaves of lettuce seedlings are easily injured by being beaten onto the gravel particles.

Excessive rainfall will flush the nutrients from the gravel. Sometimes it is not possible to flood the bed with nutrient solution because of too much rain. Consequently, the plants become softer and lighter green in color. The best procedure to follow during a prolonged rainy spell is to pump the nutrient solution into the bed at least once a day if possible. If the rainy period is short of duration a day's pumping may be omitted without any adverse effect.

Of course if it rains much, enough water will enter the storage cistern via the gravel bed to increase the solution volume markedly or even to overflow the cistern. Proper construction of the unit (see Chapters 3 and 5) will permit diversion of the excess water. If excess water enters the solution storage tank two things may be done. If the excess is not too great, the solution volume will return to normal within a few days to a week by normal losses, and the slight change in concentration will not greatly affect the plant growth. But if a large quantity was added and it is wished to save the "free" water, sufficient chemicals are added to adjust the concentration of the nutrient ions.

With outdoor culture it is recommended to follow construction principles whereby the system is open; that is, the growing bed must be capable of complete and free drainage at all times. When it rains, water will not accumulate in the beds and cause root damage (see above, p. 178).

Chapter 9

General Plant Culture

In general, plants are handled in a similar manner, whether grown by soil, water, sand or gravel culture. But certain special procedures must be followed in soilless crop production because they are peculiar to this type of culture. Sand and gravel culture are handled more like soil culture than is water culture. The special distinctive techniques required by water culture are discussed in Chapter 3. The present chapter deals primarily with cultural procedures of gravel culture *per se* (sand or slop culture is covered in a similar manner in Chapter 4). Before discussing cultural details, several general aspects or generalizations must be considered in relation to soilless culture.

General Aspects

This discussion differs from the "Plant Culture" section below pertaining to actual cultural practices, in that only a general view of soilless culture is given. Such a discourse is necessary to impress upon the plant grower the true potentialities of soilless culture. Important considerations are the spacing of the plants, expected plant yields, produce quality and what plants to grow.

Spacing of Plants. The nature of the plant root substrate does not materially alter the spacing requirements if adequate nutrition is supplied. Plants require adequate light, regardless of the root media.

Production of crops in the field in respect to spacing of the plants is governed by soil fertility and cultural operations. Poor soils are not capable of supporting as many plants per acre as good ones; hence, tomato plants may be spaced five by five feet instead of four by four feet. Also, it is more economical to have wide spacing on large acreages in order to use modern labor-saving machinery.

In the greenhouse or in the intensified market garden, forcing cultural practices are employed. Here plants may be grown much

closer together than in field crop culture. Soil fertility is high, irrigation supplies adequate water and the return per unit of crop permits high labor costs. Soilless culture of plants is essentially another forcing technique for crop production. Thus, greenhouse forcing methods are usually practiced, whether in the greenhouse or in the open. For this reason, a great difference is apparent when the spacing of plants in soilless culture is compared with that in field culture. When compared with greenhouse culture, the difference does not exist in a practical sense.

The same spacings recommended for commercial greenhouse production in soil apply to soilless culture production. Practical problems aside from fertility of the root media govern this decision to a large extent. More efficient use of labor in training and picking the crops is possible if the plants are not planted too closely. Also, more adequate protection with spraying and dusting operations for insect and disease control is possible. Again, each plant requires adequate light conditions, and very close setting definitely reduces the amount of light available to each plant. When closely planted, the plant will become too soft and vegetative, less fruitful and more susceptible to disease and insect infestations.

Of course, the above discussion can be modified to fit the needs and desires of the hobbyist, who usually has plenty of time to spare. Thus, interplanting of several crops, closely packed into a small soilless garden, is often utilized. A study of the nature of the various crops will aid in the proper selection. Early crops may be replaced by later crops, although they all may be started at the same time. Also, plants which grow well in a fair amount of shade will produce satisfactorily beneath taller plants which require more intense sunlight. For example, crops like swiss chard, turnip greens and lettuce may be grown to advantage beneath tomato, cucumber, eggplant and pepper plants.

Plant Yield and Quality. Yields of crops grown in soilless culture are similar to those secured in soil under similar culture conditions. In other words, a nutrient solution only simulates a good soil in respect to plant crop potentials. Each plant possesses a genetic inheritance which governs its possibilities for growth, regardless of the environmental factors. All the plant grower can do with a given plant is to attempt to keep its environment as close to the known optimum conditions as possible. When yields of crops grown in soil-

less culture are compared with those of good soil culture under the same environmental conditions, the yields are not significantly different; but when compared with usual field yields, the differences are naturally tremendous.

The quality of produce grown in soilless culture is similar to that grown in good soil. This applies to both floral and vegetable crops.



Figure 9-1. Gravel culture grown tomatoes in Aruba, N.W.I. (Courtesy J. R. Knoll)

Vegetable crops are just as nutritious as soil-grown ones, nor do they contain any appreciably greater quantities of minerals.

The differences reported in yield and quality between plants grown in soil versus soilless culture are often caused by particular conditions existing in the plant-growing establishment. Sometimes roses and carnations may have stronger stems or better bloom color in soilless culture. More succulent lettuce or greater yields of tomatoes may be possible under other circumstances. The long-term advantage of soilless culture lies in the reproducibility of the nu-

trient conditions possible year in and year out. Soil is a complex system and practical control of it is an art which is not as yet infal-
 lible. Soilless culture lends itself better to standardization of crop
 production, particularly intensified production.

Crops to Grow. Numerous plants may be grown in soilless culture. A partial list of some that may be commercially profitable crops is given below. This list is by no means complete, but is merely representative. A glance through the literature on nutrient solution culture will indicate a practically endless list of plants grown in soilless culture, in the laboratory, in the garden and in the green-
 house.

<i>Floral Crops</i>	<i>Vegetable Crops</i>
Rose	Tomato
Gardenia	Green Bean
Boston Yellow Daisy	Cucumber
Pansy	Eggplant
Carnation	Pepper
Chrysanthemum	Radish
Stocks	Green Onion
Aster	Lettuce
Snapdragons	Turnip Greens
Lily	Mustard Greens
Sweet Pea	Cabbage Greens (Chinese)
Feverfew	Chard
Begonia	Celery (soup or cutting)
Geranium	Spinach (New Zealand)
Calendula	
Larkspur	
Marigold	

An important feature of crop production, whether in soil or soil-
 less culture, is the proper choice of variety to fit the particular cul-
 tural and climatic conditions. This factor was found to be extremely
 important in the development of gravel culture in the tropics. In
 fact the choice of variety is one of the absolutely necessary problems
 to solve in setting up any unit, especially in new areas wherein
 variety knowledge is not available.

Plant Culture

The same culture procedures necessary for soil culture apply to gravel culture. This discussion bears primarily upon points wherein slight changes in detail are recommended for gravel culture.

Seeding. Most plant seeds may be sowed directly into the gravel. However, it is usually best to sow some seeds a little deeper than commonly done in the soil. This is necessary to insure good germination by maintaining proper moisture conditions in the upper layer of gravel. Gravel dries out more readily than soil because it is less absorbent and coarser. Several examples will indicate the recommendations for similar size seeds. Celery is sowed one-eighth inch deep, turnip, lettuce and tomato, one-quarter inch deep, and beet, radish and beans, one-half inch deep.

When the seeds are placed directly into the crop bed, they are put into "hills" properly spaced for the mature crop; but in the seeding bed, the seeds are sowed thinly in rows or in closely spaced hills. When the seedlings come up, they are thinned to one per hill, whether in the crop bed or the seedling bed. If in rows, they are thinned to meet the necessary requirements.

Of course certain crops are not transplanted and are usually directly seeded, such as radish and bush-type green beans. These seeds are sowed in properly spaced rows in the crop bed.

Several types of installations may be used for the seedling beds. Benches containing soil, sand or gravel may be used. Sand and gravel culture may be operated by the slop culture technique; small sub-irrigation gravel installations may also be set up for the propagation unit. If so desired, certain beds in the crop cultural units may be periodically set aside for propagation purposes.

The seeds may be germinated with either nutrient solution or water. When the seeds are placed directly in the crop bed, it is sometimes simpler to flood the gravel with nutrient solution than to sprinkle the surface with water. In the seedling bed, it is easier to use water to germinate the seeds. In this case the nutrient solution is usually first applied one day after the seedlings emerge. During the germination and the young seedling stage, moisture application twice a day is sufficient if proper cultural conditions are in order.

To insure even moisture conditions in the upper surface of the gravel surrounding the seed, a mulch should be used. When the

seeds are sowed, a suitable piece of fabric, muslin or burlap, should be placed on top of the gravel until the seedlings come up. If the fabric is of coarse weave, the seed bed is watered without removing the fabric. If the fabric is of close weave, it should be removed dur-



Figure 9-2. Gravel culture grown chard in Curaçao, N. W. I.
(Courtesy W. R. Mullison)

ing the watering operation to insure uniform sprinkling. Other materials which may be used for this solid mulch include Masonite, lumber, asbestos sheets and palm fronds.

In areas of bright sunshine, an overhead shade must be used in conjunction with the solid mulch on the gravel surface, particularly when fabric is used. These materials often cause the gravel to be-

come hotter (and drier) beneath them when the direct sun rays fall upon them. Fabric supplies the best overhead shade for propagation units.

If widely spaced crops, like tomatoes, are directly seeded into the crop bed, loose mulch materials may be used to cool the gravel and



Figure 9-3. Gravel culture grown eggplant in Curaçao, N.W.I.
(Courtesy W. R. Mullison)

to conserve moisture. These materials do not require an overhead shade. Materials which may be used for a loose mulch are straw, hay, salt hay, excelsior, wood shavings, ground cork and ground asbestos. As the seedlings come up, the mulch is pushed back to allow the young plants to emerge.

Propagation of Cuttings. It is an accepted commercial practice to root various kinds of floral cuttings in sand beds. Sometimes peat may be mixed with the sand (ordinary building grade) to im-

prove aeration and moisture retention. These propagation benches are usually watered by sprinkling with water. Sub-irrigation units containing a coarse sand or a fairly fine gravel may also be used for this purpose.

Transplanting. Plants are easily transplanted into gravel. These transplants may be transferred from other gravel, sand or soil. Plants transferred from other gravel will be handled as "pulled" plants. If sand or soil is used as the seeding media, "blocked" plants may be used. In handling "pulled" plants, they must be lifted from the medium with great care to keep practically all the root system intact. Flooding the gravel in the case of sub-irrigation propagation units is helpful in this respect. Wetting the sand thoroughly and carefully lifting the plant by inserting a trowel in the sand underneath the root system is suggested.

"Blocked" plants are transferred with a cube of medium along with the plant. This may be accomplished by two means: either the plants may be grown in pots or plant bands and "knocked out" when ready to set in the crop bed, or the plants may be grown in benches, and a block of soil or sand cut out along with them. Usually "blocked" plants transfer better than "pulled" plants, particularly in soil culture. Although this is true in soilless culture, the difference is not so great. In fact "pulled" plants transfer readily in soilless culture.

The plants to be transplanted should be in good shape prior to setting out into the crop bed. The most practical means of hardening the plants appears to be the proper withholding of the water supply. Nutrient solution pumping or application should be reduced to at least once a day, if possible. This reduction should occur several days to a week before transplanting. In cool areas where it is possible, the air temperature should be reduced 5° to 10° F to slow the rate of growth and harden the plants.

The usual procedures in handling the young transplants are followed as local conditions dictate. If sprinkling of the plant is required, do it sparingly; just moisten the plant and the surface of the gravel. Shade the plants if necessary. Pump the nutrient solution into the root medium only once a day, until the plants actually need more water. The less free water present, the sooner the plants become established; too much water retards the development of new roots.

Mulching the gravel is recommended where the sunlight is quite intense. This will keep the medium cool and retain moisture better. Of course, if overhead shade is sufficient, no mulching is necessary. Often it is possible to transplant tomatoes, even in the tropics, without use of overhead shade if proper mulching and light sprinkling with water are accomplished. The sprinkling is continued only until the plants are well established and stop wilting. The mulch may be removed, if it is so desired, when the plants are large enough to shade the gravel themselves.

Transplanting Versus Direct Seeding of Plants. Transplanting is not absolutely necessary for plants that are started from seed. Direct seeding is entirely possible, as mentioned above in the discussion of seeding. Actually, yields are higher with directly seeded plants than with transplanted plants. Labor requirements are comparable in the two methods. However, it is often more practical in commercial units to transplant in spite of the lower yields. Whenever practicability permits, direct seeding is recommended, both in the commercial unit and in the home garden.

Training. Plants that required support under forcing conditions are handled much as in soil culture. However, a few alterations are necessary by virtue of the type of plant culture. Supports must be mainly based upon the walls of the bed rather than upon the root substrate. The soilless culture unit is usually of shallow construction and the density of the medium is insufficient to hold any great amount of support firmly. Also, in greenhouse culture, wherein standard galvanized metal rods are used as plant supports, the portion inserted in the medium should be coated with asphalt to eliminate zinc toxicity. Hot asphalt, asphalt emulsion, or asphalt paint may be used for this purpose.

Spraying. Plants grown in soilless culture must be protected from disease and insect attacks. The standard fungicides, insecticides and fumigants may be safely used if properly handled.

The main problem is to prevent excessive quantities of these toxic materials from accumulating in the gravel to injure the roots. Insecticides handled with standard spraying equipment must be used with caution. For the greatest safety under a prolonged and extensive spray schedule, the gravel should be flooded with water or old nutrient solution during the spraying operation. Thus, when drip-page of the spray materials into the gravel from the foliage occurs,

it is so highly diluted by the water that no root injury develops. At the completion of the spraying operation, the water in the plant bed is drained out to the sewer.

The same precaution may be used with dusting and fumigation if

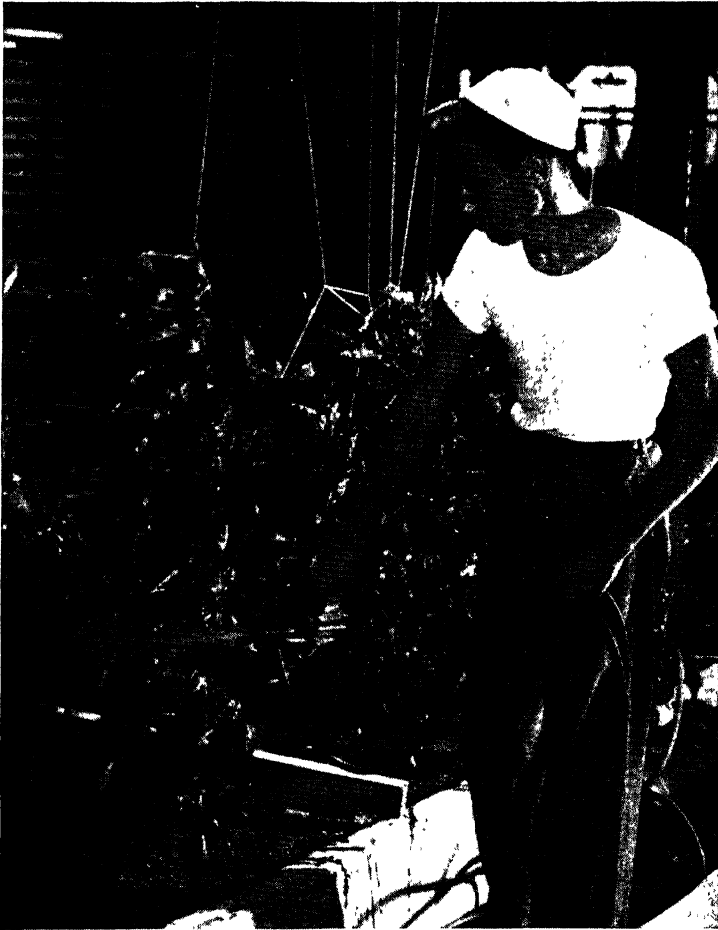

Figure 9-4. Spraying peppers with the compressed air sprayer.
(Courtesy *Esso Farm News*)

circumstances warrant it. Occasional sprayings, dustings and fumigations may be safely performed, if care is taken, without flooding the gravel.

But the use of proper spraying equipment will eliminate the need for flooding the beds. Such equipment is based upon the well known

compressed-air paint-spray equipment, which was developed in Aruba. This equipment requires one-half the volume of spray at similar concentrations for comparable insect control as that used in conventional equipment. Thus insecticide costs are halved. Further, less residue accumulates on the sprayed plants. Practically no drippage occurs from the foliage into the gravel, and the operation is safe without using water to flood the gravel. Figure 9-4 shows this equipment in operation.

Air under pressure may be supplied either by an air compressor or by cylinders (a pressure regulating valve must be used to reduce the 2000 p.s.i. in the cylinder down to the operating pressure) of compressed air, depending upon the requirements of the garden unit. The average operating pressure used is 100 pounds per square inch, the range being between 90 and 125 pounds.

The insecticide container is shown in Figure 9-5. It must be strong enough to operate at a maximum air pressure of 125 pounds per square inch. The body of the Aruba unit is an 18-inch piece of heavy steel pipe of 8-inch diameter. Heavy steel caps are welded to each end, making the entire length 26 inches with a five-gallon capacity. Two-inch threaded nipples are welded to the top of the cylinder to receive the brass filling plug (1) and the brass plug (2) containing the air and the spray piping assembly. Rubber washers are inserted under these brass plugs to insure an airtight fit. Smaller threaded nipples are welded to the body of the container to receive the one-half inch drain valve (3) and the pressure gauge (10). Casters (12) are attached to a suitable framework (13) and a handle (14) is provided to enable the operator to move the equipment readily.

All fittings shown in Figure 9-5 are of $\frac{1}{4}$ -inch size except the drain valve (3) which is $\frac{1}{2}$ -inch size. All valves and external piping should be of steel construction for safety. The drain valve (3) facilitates draining and cleaning of the container. A pressure release valve (4) is necessary to release the air pressure when refilling the unit. For safety reasons this valve is attached to the filling plug (1).

The spray fluid pipe (5) contains a valve (6) which shuts off the spray supply to the spray nozzle. A $\frac{1}{4}$ -inch copper tube (7) inside the unit reaches to within $\frac{1}{4}$ -inch of the bottom of the container. The spray fluid is forced through this tube from the container by the air pressure within it.

The air line (8) supplies air to both the container and the spray nozzle. A valve (9) may be used to regulate the air pressure in the container, as indicated by the pressure gauge (10). A copper extension of the air line into the container may or may not be installed. For completely dispersable contacticides, no agitation of the spray in the container is necessary. Agitation should be provided when

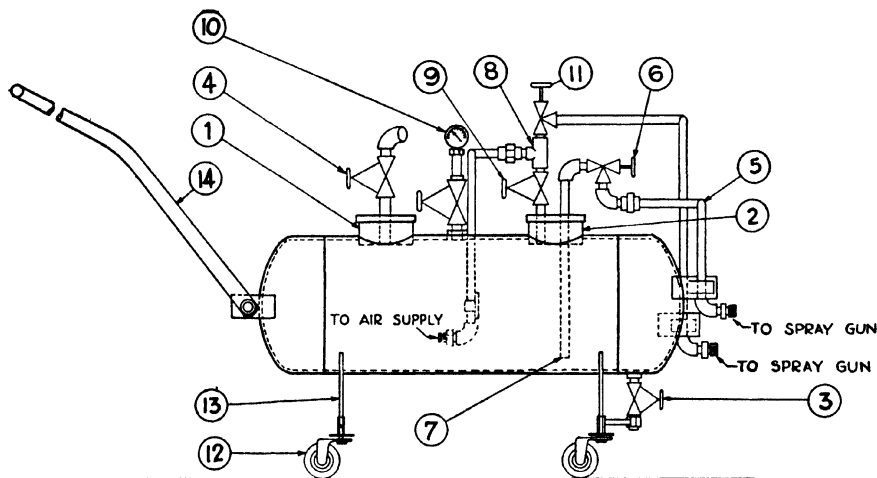

Figure 9-5. Diagrammatic sketch of insecticide container for compressed air sprayer.

less stable sprays are used. Any length of copper tubing may be threaded into the assembly plug (2). Operating experience indicated that when an agitation tube is used it should terminate some distance, at least 6 to 12 inches, from the fluid outlet. When the air intake and the fluid outlet are too close, air mixes with the fluid in the spray line and interferes with proper operating performance. At least, for stable contacticides the air pressures direct to the spray gun and into the spray container are equal.

Another valve (11) controls the air supply to the spray nozzle. Heavy-walled rubber tubing, usually $\frac{1}{4}$ -inch oxygen or paint hose, is used to convey the air from the source to the container and from the container to the spray nozzle. A similar hose also conveys the spray fluid from the container to the spray nozzle. The two hoses to the spray nozzle are taped together to facilitate handling. Special adapter nipples are used to connect the hose couplings to the container piping.

The spray nozzle is the important feature of this type of equipment. In fact, the operating principle of the usual paint-spray gun is the chief reason why this type of sprayer is superior to the usual agricultural sprayer. The admixture of spray fluid and air in the nozzle produces good atomization of the insecticide.¹

Any type of paint-spray gun suitable for high-pressure operation is satisfactory. A low-pressure type of paint gun which operates at a maximum pressure of 40 to 50 pounds does not work. A De Vilbiss, type MBC, paint-spray gun works well. The fluid and the air adjustment valves are set to provide a finely divided spray. For the greatest convenience, an adaptor arm should be attached to the spray gun for operation, particularly with large plants. However, by using the paint gun with no modification, tomato plants ten feet tall were sprayed satisfactorily.

This type of plant spraying equipment has definite possibilities for use, both in research and in commercial work. Plans have been formulated to construct a central spray unit for the Aruba soilless garden. An air compressor will be hooked up with two spray containers and both spray and air will be piped out to suitable locations in the garden.

Sprinkling and Syringing. Where it is necessary to sprinkle the plants lightly with water to control the relative humidity of the atmosphere around them, soilless culture does not differ from soil culture. Care should be exercised to use the water sparingly to prevent excessive flushing of nutrients from the gravel. This holds true for the job of syringing crops like roses in the control of red spider in the greenhouse. Actually during periods of great water losses, these water additions will help replenish the losses from the nutrient solution.

Flushing the Gravel. The actual necessity of flushing the gravel at certain times with fresh water depends upon the specific cultural conditions; as long as no unusual circumstances arise there is no point in doing so. A close watch upon the growth of the plants and upon the chemical analyses of the nutrient solution will indicate any possible need of flushing. There are some conditions which may

¹ This type of equipment also permits use of organic and petroleum solvents as the spray carrier, instead of water. Such sprays, under trial in Aruba, appear to be an improvement over conventional sprays. The use of conventional spray equipment is not possible with these new sprays.

necessitate it, however. These include great changes in the nutrient solution, accumulation of undesirable ions, actual cases of toxicity, and the effects of certain types of media.

Sometimes the nutrient solution must be radically changed in a hurry. This will occur when a change from a high to a low concentration of the nutrient solution is desired or a great change in the actual proportions of the ions is necessary. Considerable quantities of nutrient ions may accumulate in the medium. It may take a week or two to effect a change by the normal processes of plant uptake of the minerals, and this often is too slow to achieve the desired results. Thus, it is imperative to flush the gravel with fresh water.

It is possible to develop a high concentration of certain extraneous ions in the nutrient solution. If growth is adversely affected by such conditions it may be advisable to flush the gravel with fresh water. Of course, the best solution of the problem is to prevent the accumulation of these extraneous ions in the nutrient solution by utilizing chemical tests.

In the case of an actual toxicity, whether due to excess of a macro or a micro nutrient ion, or to an insecticide or fungicide, it is recommended that the gravel be flushed thoroughly with plenty of fresh water (see Chapter 10).

Some types of media, being quite porous, may accumulate some ions in large quantities. When they become saturated, leaching may occur as the nutrient solution is pumped into the gravel. Under such circumstances it would be necessary to try to flush these materials from the media. Coal cinders, lava cinders and Haydite may fall into this category, but no definite evidence is reported of such a condition occurring in practical plant cultures.

Usually most undesirable conditions may be ameliorated by a simple flushing with the plants present in the medium. However, in more serious cases, this will not suffice. If root injury is not too severe it may be possible to save a crop by several successive soakings with fresh water for one or two-hour periods. Of course if fairly insoluble residues form, the crop will have to be discontinued and more stringent methods of cleaning the gravel undertaken (refer to Chapter 10).

Harvesting. No difference in procedure is necessary in harvesting soilless culture crops from that used for soil culture.

Removing the Old Plants. The greatest difference between removing a plant from gravel compared to soil is that it is easier and more of the roots can be removed. The best procedure to follow is first to cut the plant off a few inches above the gravel surface. Then clean up all debris before pulling out the roots.

After some time, roots will accumulate in the gravel, especially under and around the tile. This will slow up the filling and draining of the bed. Thus it becomes necessary to remove the gravel and the tile to clean out the roots. The frequency of this change depends upon the crop and the cultural conditions. Crops like roses and gardenias, which may produce in the same bed for several years, of course cannot be disturbed; but when the bench is changed, the gravel and the tile should be cleaned. Other less permanent crops like tomato produce large root systems. Probably one clean-out a year is sufficient. In the tropics it may be advisable to clean-out at the completion of every crop, or every six months. With small crops like lettuce, radish and turnip greens, root accumulation is not rapid. A clean-out once a year or so is probably sufficient.

Chapter 10

Common Detriments

Plants are beset by numerous environmental factors which tend to inhibit or even prevent their proper growth. These include various diseases and pests. Diseases may be classified into two general listings, non-parasitic and parasitic; pests include insects and a host of other troublesome animal life.

Diseases

Non-parasitic diseases are caused by non-biologic agents. Parasitic diseases are caused by biologic organisms.

Non-Parasitic Diseases and Their Correction. The non-parasitic diseases which may be experienced in soilless culture include essential nutrient ion deficiency and toxicity. Neither too little nor too much of the essential mineral materials is conducive to good plant development and specific symptoms develop. Other diseases caused by environmental non-biologic factors include toxic gases and spray injury.

Mineral Deficiencies. Plants develop characteristic symptoms when an essential nutrient ion becomes a limiting factor in the nutrient solution.¹ It is beyond the scope of this book to discuss all the specific deficiency symptoms of the many plants that may be grown in soilless culture units. The general key listed in Table 10-1 gives the plant grower a general index to follow. This key is based upon both practical observations and published data for various vegetable and tree crops. It will also serve for floral crops, except no mention of peculiarities of bloom responses are noted.

It must be mentioned that development of actual deficiencies of macro elements is not usual in soilless culture gardens. The more prevalent problem is the development of low concentrations which retard growth and reduce crop yield, low nitrogen being the most

¹ Some data secured in the tropics recently indicate that the "so-called" symptoms do not always develop; just a hardening and stunting of plant growth occurs.

Table 10-1. General Key to Foliar Symptoms of Mineral Deficiencies in Plants¹

	Mineral Deficiency
I. INITIAL INJURY ON MATURE FOLIAGE	
A. Site of Injury General	
1. Necrosis of tissue	
a. Stunted, light green plants; older leaves yellow green to yellow in color, followed by drying and browning in advanced stages	NITROGEN
2. No necrosis of tissue	
a. Stunted, abnormally dark green plants usually with narrow petiole angles; abundant reddish or purplish pigmentation; sometimes chlorosis of older leaves	PHOSPHORUS
B. Site of Injury Localized	
1. Chlorosis starts at tips and margins of older leaves, progressing between veins, followed by brown necrotic spots which usually fall out, giving ragged appearance; leaves crinkled and curled, most noticeable in early stages	POTASSIUM
2. Irregular chlorotic spots between veins of older leaves, followed by rapid necrosis and defoliation; die-back of twigs and small-leaved rosettes common in fruit trees	ZINC
3. Chlorosis starts between veins in older leaves; leaves become yellow or almost white with veins usually remaining green; necrosis not usual	MAGNESIUM
II. INITIAL INJURY ON IMMATURE FOLIAGE	
A. Site of Injury General	
1. Entire plant light green to yellowish green in color; chlorosis most pronounced in young leaves which become yellow.	SULFUR
B. Site of Injury Localized	
1. Necrosis of tissue	
a. Intervenal chlorosis of young leaves; leaves become yellow or white in color, all veins remaining green; small, brown necrotic spots follow chlorosis	MANGANESE
b. Chlorosis generally begins at bases and margins of young leaves, followed by necrosis; leaves become distorted or in more severe deficiencies terminal buds die and turn brown or black in color; gummy or corky deposits occur in fleshy organs	BORON
c. Chlorosis generally begins at tips and margins of young leaves, progressing between veins, followed by necrosis; leaves become distorted or in more severe deficiencies terminal buds die and turn brown or black in color; roots characteristically short, bulbous, with necrotic apical meristems	CALCIUM
2. No necrosis of tissue	
a. Intervenal chlorosis of young leaves, veins remaining green; entire leaf including veins becomes yellow or white in color	IRON
b. Plants exhibit lack of turgor; wilting most pronounced in tops; sometimes chlorosis of young leaves	COPPER

¹ This table was originally prepared by T. M. Eastwood and C. H. Hobbs for a Plant Physiology Seminar Course at Purdue University, Lafayette, Indiana, 1942.

common occurrence. Experience with the particular culture unit will aid in eliminating this problem. But knowledge of general deficiency symptoms will help the grower in detecting an incipient case.

However, it is entirely possible to encounter an actual deficiency of a micro element. This is probably because the quantities tolerated by plants are quite small in comparison to macro nutrient ions; as a result, the quantity of micro elements present in a nutrient solution system is always close to possible deficiency levels. Sudden changes in the water supply, in the phosphate level or in the pH of the nutrient solution will quickly affect the minor element supply to the plants.

Naturally the control of either shortages or actual deficiencies of the necessary nutrient elements is to add them when necessary to support adequate plant growth.

Mineral Toxicities. Although some work is published upon the effect of too much essential nutrient ions and other certain extraneous ions upon the plant in soilless culture, the data are still incomplete. A brief and tentative key is presented for the macro and the micro elements in Table 10-2. The observation of these excesses under practical conditions is complicated by the fact that often an excess of one ion causes symptoms to develop in the plant which are similar to symptoms of deficiency for another ion. Chemical analyses will reveal the real situation.

Further, in the case of minor elements, slight toxicity appears to produce symptoms similar to those of a slight deficiency. Naturally this perplexes the plant grower. The safest rule to follow is to omit minor element additions and wait for several days to see what happens. If the trouble clears up, it was probably caused by a slight toxicity, but if it persists and even becomes more severe, it may be due to a slight deficiency. Then start adding minor elements to clear up the situation. Of course, if proper chemical tests are available for the minor elements, they should be used to determine the best method of solving the problem.

The observations upon the toxic effect of excessive quantities of nutrient ions are practical support for the theory of antagonism. Laboratory research with both plants and water animals indicates that the nutrient ion must be properly balanced to permit growth. Certain ions counteract the toxic actions of other ions when in high

Table 10-2. Tentative General Key to Foliar Symptoms of Mineral Toxicities in Plants¹

	† Toxicity due to
I. INITIAL INJURY ON MATURE FOLIAGE	
A. Site of Injury General	
1. Necrosis of tissue	MAGNESIUM
a. Leaves become slightly darker green, slightly smaller; sometimes abnormal rolling and curling of young leaves occur; in advanced stages growing tips wilt and die, especially in bright weather	
b. General yellowing of leaves, older leaf tips and margins later become yellowish or brownish, followed by colored necrotic spots; leaf abscission develops (similar to potassium deficiency in some plants and nitrogen excess in others)	POTASSIUM
2. No necrosis of tissue	
a. General hardening of plant, dull green, small leaf, hard stems; some plants have purplish-brown spots on older leaves, followed by leaf drop	CHLORIDE
b. General hardening of plant, bluish-green color of leaf, small leaf, hard stems; later leaves may become curled inward and pimples, leaf margins brown and terminal growth becomes pale yellow	SULFATE
c. Early stages: — slender growth, longer internodes, light green leaves; later stages: — stunted growth in general, leaves develop mosaic-like mottling, followed by dull colored spots; leaf wilting and abscission occurs	POTASSIUM
B. Site of Injury Localized	
1. Necrosis of tissue	
a. Marginal chlorosis of leaves develops, which extends inward between veins, followed by brown necrosis and curling of leaf edge; leaf abscission (injury similar to potassium deficiency in some plants and iron deficiency in others: — a terminal chlorosis)	NITROGEN (NO₃ and NH₄)
b. Intervenal chlorosis develops, spots becoming whitish and necrotic, may become colored or possess water-soaked concentric rings, some plants have rosette-leaf growth and twig die-back with defoliation (injury similar to magnesium deficiency in some plants, in others iron deficiency)	CALCIUM
c. Chlorosis of leaf margins and tips, chlorosis extends inward, particularly between the veins until whole leaf becomes pale yellow or whitish; marginal burning and necrosis with crinkling of leaf edges; leaf abscission	BORON
d. Water-soaked areas develop along main veins which remain green in leaf of some plants; areas become transparent; intervenal chlorosis develops also, later turning brown and when entire leaf is brown defoliation occurs (also see zinc toxicity below)	ZINC
e. Chlorosis of lower leaves followed by brown spots, then defoliation (also see copper toxicity below)	COPPER

II. INITIAL INJURY ON IMMATURE FOLIAGE

A. Site of Injury General

1. Necrosis of tissue

- a. Chlorosis of leaves, young leaves become quite yellow; terminal buds die; also older leaves may droop without wilting, veins become colored, red or black; leaf abscission (injury in early stages similar to iron deficiency) **ZINC**

B. Site of Injury Localized

1. Necrosis of tissue

- a. Intervenal chlorosis of young leaves, become yellow or whitish with dark brown or nearly white necrotic spots; leaf becomes distorted and crinkled (this is main difference from deficiency); plants like corn have whitish streaks in older leaves **MANGANESE**

2. No necrosis of tissue

- a. Intervenal chlorosis of young leaves, veins remain green, later entire leaf becomes yellow or whitish (similar to a deficiency) **IRON**
- b. Chlorosis of young leaves, veins remain green **COPPER**

¹ This table was compiled from a résumé of available literature and practical observations. (This table is by no means complete and final; it is to be construed only as a preliminary attempt to classify available information.)

concentration. This is called "antagonism" by the physiologist. Thus, when a particular ion becomes highly concentrated in the nutrient solution and within the plant tissues, toxicity may result because the relative concentration of the antidoting ion or ions is too low. As the toxic symptoms of a particular ion often appear similar to the deficiency symptoms of another ion, a nutrient ion deficiency may be also considered to some extent from the antagonism aspect, as well as from straight nutritional requirements.

Correction of a toxic condition is usually accomplished by flushing the gravel thoroughly with water. In severe cases it may be necessary to discontinue the crop and leach the medium with several soakings of water. This should remove all the macro elements and boron. Boron excess may also be corrected by adding a 10 ml per 100 gallon dilution of sodium silicate (water glass) solution to the gravel bed. This may even be done when the plants are in the bed, according to Ohio State University workers.

The other minor elements, namely, iron, manganese, copper and zinc, may not be too soluble under some conditions. Treating with a 5 to 10 per cent solution of sulfuric acid is recommended. It may require one or several separate soakings of 16 to 24 hours' duration. As a final check, a chemical analysis of the final soaking or flushing water should be made. Naturally, the circumstances warrant a complete change of nutrient solution.

Toxic Gases. Many industrial gases are quite toxic to plants in minute quantities in the atmosphere. These include carbon monoxide, sulfur dioxide, illuminating or heating gas, ammonia, chlorine, gases from zinc smelters, etc. Illuminating or heating gas may often be a source of trouble for the amateur gardener, particularly in the house and in the small greenhouse connected to the house. It causes drooping or epinasty of the plant, as indicated in Figure 10-1, or even necrosis, as shown in Figure 10-2. Fumes from the coal furnace or the oil burner also will cause trouble if proper precautions for adequate ventilation are not maintained.

Various agricultural fumigants or gases may often cause plant injury when used in too high concentrations. Chlorosis of the foliage, chiefly of the younger leaves, occurs and retardation of meristems (stem tips) is also common. In severe cases even necrosis (death) of the plant tissues develops, usually starting at the top of the plant.

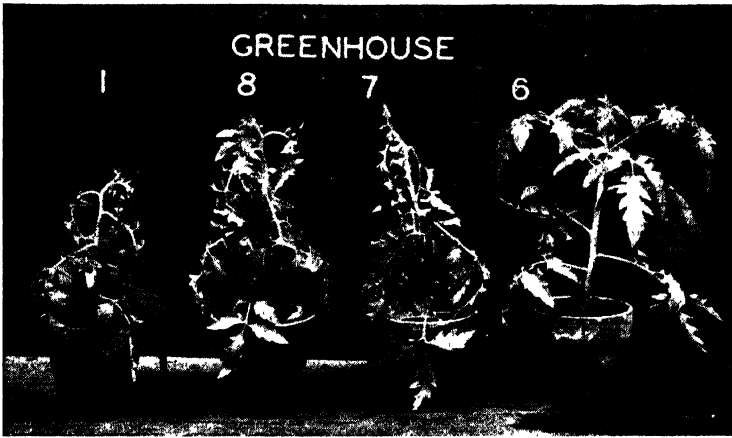

Figure 10-1. Effect of illuminating gas on tomato plants. These remained for twenty-eight hours in various greenhouses in which gas leaks were suspected. No. 1 plant was removed from a house in which acacias showed almost complete bud and leaf fall. No. 8 and No. 7 plants were in a house in which roses showed leaf fall. No. 6 was in a house not subjected to gas leaks. Healthy tomato plants are often used now in detecting gas leaks. (Courtesy Dr. William Crocker, Boyce Thompson Institute for Plant Research, Yonkers, N. Y.)



Figure 10-2. Large begonia (left) photographed on day it was brought into room known to possess slight gas leak. Photo on right shows same plant two days later.

Further, it is possible in soilless culture units to produce root injury if too frequent or excessive quantities of fumigants are used. This danger exists because the root medium is much more porous than soil.

In cases of difficulty, thorough airing of the atmosphere and the medium is suggested. Flooding the gravel may displace many obnoxious gases. This may even remove some insoluble precipitates, like sulfur and naphthalene, by mechanical action if they have not too strongly adhered to the media particles and the roots. Under such circumstances actual flooding of the bed over its walls will remove a lot of toxic material.

If the plants are injured beyond recovery the crop should be removed. Several water flushings or soakings, or both, should be tried to remove the water-soluble and completely volatile gases. Materials like deposited sulfur and naphthalates may be removed by heating the gravel with a weed burner to volatilize them. Of course the last resort is to replace the gravel.¹

Spray and Dust Injury. If proper precautions are not followed when spraying or dusting with fungicides or insecticides, both foliage and root injury may result. Thorough leaching by soaking and flushing of the medium will remove some of these materials. Of course it may be necessary to discontinue the crop if damage is extensive, or even to change the gravel.¹

Chlorine in the Water. Use of city water supplies which normally contain not over 0.3 to 0.5 ppm of residual chlorine is entirely safe. As high as five ppm of chlorine can be tolerated by many plants in soilless culture.

Water Relations. As mentioned in Chapter 9, blossom-end rot of tomatoes is caused by an unbalance of water supplies to the plant. Too infrequent pumping of the nutrient solution into the gravel bed supplies insufficient water, and blossom-end rot will often result. Too low relative humidity of the atmosphere is another factor. On the other hand, too frequent pumping will also cause blossom-end rot. Root aeration will be restricted, which in turn reduces water uptake by the roots.

Parasitic Diseases and Their Correction. Parasitic diseases are caused by such organisms as bacteria, fungi and virus. Bacterial and fungous diseases are caused by living biologic organisms. Virus diseases apparently are caused by complex protein molecules,

¹ If reasonable precautions are followed this should not be necessary.

which must be associated with living protoplasm to function; hence they are considered at this point under true parasitic diseases. Standard procedures of control are recommended.

Diseases Caused by Bacteria and Fungi. Commercial sprays and dusts may be used if necessary. These include sulfur, copper, zinc and certain organic chemicals. Also, the use of resistant varieties is quite helpful. Keeping the gravel surface dry is suggested to partially control some diseases which attack the lower leaves and stem. Sterilization of the gravel is practical in cases of heavy infestations of such diseases as damping-off (see below).

Diseases Caused by Virus. These diseases cannot be controlled by sprays and dusts. They are systemic and internal diseases of the plant. The usual practices are (1) rouging (pulling out) diseased plants with care; (2) control of insect vectors (insects which carry and spread the virus); and (3) growing of virus-resistant varieties (if they exist for the particular crops concerned).

Seed Protectants and Sterilizing Agents. Control of such seed-borne plant diseases as damping-off may be partially achieved by the use of seed protectants. A number of materials on the market may be used if the seeds are sown in soil or slop culture plant beds. However, for germination in gravel sub-irrigation plant beds or for direct seeding in gravel crop beds, caution must be practiced.

It is best to use minimum amounts of the protectant in order to reduce the quantity carried into the gravel upon the seed coat. Several commercial materials are safe to use, including red copper oxide, Arasan and Spergon. However, the use of seed protectants does not afford complete protection. At times gravel sterilization is also necessary.

If difficulty with plant toxicity occurs with excessive use of seed protectants, other means of seed treatment should be used. Three methods of seed sterilization (referring to disease organism control) are available, depending upon the disease problem. Some seeds, like cabbage, may be soaked for 15 to 30 minutes in hot water (110° F) to control internal disease-causing fungi. External fungi on the seed coat may be controlled by soaking the seed in aqueous solutions of formaldehyde or chlorine for 15 minutes.

One per cent (10,000 ppm) formaldehyde solution is a reasonably reliable material to effect practically complete sterilization of the seed surfaces. It requires 27 ml (about one fluid ounce) of com-

mercial formalin (37 per cent formaldehyde) diluted to one liter (about one quart) to prepare this solution. At least two to four times the quantity of liquid necessary to just cover the seeds should be used. The container should be covered to confine the fumes, and the seeds should be stirred every five minutes. The seeds are drained on a piece of cheese-cloth or fine netting and may be planted as soon as they are dry.

Chlorine solutions produce more reliable results than formaldehyde solutions. One per cent (10,000 ppm) chlorine solutions (or 2 per cent or 20,000 ppm of available chlorine which includes the nascent oxygen) slightly acidified to pH 8.0 to 10.0 give the most consistent results. Non-acidified chlorine solutions may be used, but the results are not as reliable.

Any commercial grade of bleaching powder or aqueous solution may be used to prepare the chlorine solution. Calcium hypochlorite is commonly available in the powder form. B-K and HTH are satisfactory commercial brands. Sodium hypochlorite is usually in the liquid form; Chlorox is a well known brand. It requires 18 grams per liter (0.6 ounce per quart) of pure calcium hypochlorite [$\text{Ca}(\text{OCl})_2$] or 21 grams per liter (0.7 ounce per quart) of pure sodium hypochlorite [NaOCl] to prepare a 1 per cent solution of chlorine. But these materials are not present as 100 per cent pure in commercial preparations. To ascertain the amount needed, the degree of purity of the compound must be considered in preparing the chlorine solution. To illustrate, the following examples are presented. A commercial bleaching powder may contain 50 per cent of calcium hypochlorite. Thus it will be necessary to weigh out twice the amount, or 36 grams, for one liter (1.2 ounces per quart) of solution. Or, if a 5 per cent sodium hypochlorite solution is used, dilute 420 milliliters to one liter (approximately 14 fluid ounces per quart).

To use the acidified chlorine solutions properly, the pH must be adjusted to 8.0 to 10.0. This requires the use of a glass electrode pH meter. The amount of concentrated hydrochloric acid needed will vary, but 10 to 20 milliliters per liter of solution will usually adjust the pH within the proper range. The acid is added to the chlorine solution just before application to the seeds.

The seed-treating procedure with chlorine solution is the same as outlined above for formaldehyde solution.

Gravel Sterilization. Gravel is easier to sterilize than soil. Two types of materials which have been tested in the laboratory and in the field are formaldehyde and chlorinated phenol salts. The final cost per culture unit determines the choice of the chemical.

Formaldehyde is the easiest material to use. A dilution of 1 part of commercial formalin to 100 parts of water is effective. This concentration is prepared by adding 10 gallons of formalin to 1000 gallons of water, or 10 liters of formalin to 1000 liters of water. When handling concentrated formalin, use rubber gloves, rubber apron and a gas mask.

The gravel is soaked with this solution for 16 to 24 hours. During the sterilization period the bed is covered with a canvas to confine the fumes. It is completely safe to sterilize a bed immediately next to one containing plants, whether in the greenhouse or outside. At the completion of the soaking period the formalin solution is drained to the sewer (or it may be used to sterilize the cistern before pumping out to the sewer). One to two flushings of the gravel with fresh water completely removes the chemical if a non-porous medium is treated. The flushing may be done by passing a stream of water produced by a rose-type sprinkler across the gravel surface. With porous media several 6 to 24-hour soakings are necessary. Usually three or four soakings are sufficient to leach out all the formalin. Then the medium is given a final flushing. The final flushing water should be checked for residual formaldehyde (see Chapter 12 for test), which should be zero; or, a small quantity of medium may be soaked in just enough water to cover it in a jar for 30 to 60 minutes, and then tested.

The sodium salts of chlorinated phenolic compounds are suitable if properly used. Care must be employed in handling these materials. This necessitates rubber gloves, rubber apron and a gas mask. These compounds are sodium 2,4,5-trichlorophenate (Dowicide B), sodium 2,3,4,6-tetrachlorophenate (Dowicide F) and sodium pentachlorophenate (Santobrite or Dowicide G). The first material is the most expensive, but it is the best sterilizing agent, the most soluble and more soluble over a wider pH range.

All these materials possess relatively low solubility and are best dissolved in alkaline solutions. The use of sodium hydroxide or potassium hydroxide will prevent precipitation upon the gravel particles. Similar quantities of alkali and phenate are dissolved,

300 ppm each, which means 300 grams of each per 1000 liters, or about 2.5 pounds per 1000 gallons of water. The alkali is first dissolved in about 10 gallons of water, then the phenate is added, and this concentrated solution is slowly poured into the full volume of the water.

The sterilization period for the gravel is 16 to 24 hours. If plants are in nearby beds, it is suggested to cover the treated beds with canvas. At the completion of the soaking period the phenate solution is drained to the sewer (or the cistern may be sterilized first). Now the major problem is to remove the residual chemical from the gravel. The following procedure is necessary because no simple chemical test exists for the determination of chlorinated phenols. This technique was developed at Purdue University, using biologic methods to ascertain its efficacy. The gravel is soaked for 16 to 24 hours with a 300 ppm alkali solution. This solution is drained to the sewer (or run into the cistern if the above phenate solution was used to sterilize it). Next the gravel is soaked with fresh water for a 16 to 24-hour period. Following drainage of this water to the sewer, the gravel is flushed once. This procedure is satisfactory for non-porous media, but for porous media, three to four soakings with water are required.

In cases where water is expensive, the amount of water needed to flush out the phenate salts from the gravel makes this method costly. Work in Aruba with a non-porous gravel indicated that although the phenate salts are cheaper than the formaldehyde, the water cost determined the total cost. In fact, the water cost for the phenate treatment was almost as great as the total cost for the formaldehyde treatment. Even with porous media, fewer soakings may be required with formalin because chemical analyses are readily available to check the residual content, whereas that "extra soaking" for the phenate method is desired for safety purposes.

Relation of the Nutrient Solution to Disease Incidence. Some data secured under tropical conditions in Aruba indicated that the incidence of damping-off was greater under certain unbalanced nutrient solution cultural conditions. It was noted that this disease was more serious in lettuce when the solution concentration was high, that is, when double amounts of salts were used. The same held true when either the phosphate or the magnesium level was raised to at least eight millimoles. Recent published data also support the

contention that the incidence of plant disease is directly related to nutritional conditions.

Pests. Insects readily attack plants grown in soilless culture. Other predatory animal life includes nematodes, ants, rats, mice, lizards and birds.

Insects. The various commercial poison baits, dusts, sprays and fumigants may be used safely on plants grown in gravel if proper culture procedures are followed as recommended in Chapter 9. Stomach poisons like Paris green, lead arsenate, calcium arsenate and fluoro-silicates may be utilized if needed. Contacticides, including pyrethrum, rotenone or derris, nicotine, summer oils, DDT and organic thiocyanates may be used. The same holds true for the usual fumigants, such as nicotine and calcium cyanide.

Nematodes. Nematodes will infest gravel-grown plants. The usual materials used for soil treatment are suggested. If the bed construction will physically stand it, steam or hot water treatment is in order. The temperature of the medium should be held up to at least 160° to 180° F for 60 minutes. It is questionable whether the usual asphalt coating in the bed will "stay put," or will be fluid at this temperature. Chemicals which may be considered are carbon disulphide, emulsified carbon disulphide, formaldehyde, chloropicrin, methyl bromide, dichloroethyl ether, dichloropropane, dichloropropylene, calcium cyanamide and chlorinated phenols.

The nematode problem in gravel appears to be of recent origin. It has been observed in tropical gardens. The recommendations listed above are purely suggestions. It may be possible to control nematodes with a formaldehyde concentration of 1-50 or with the chlorinated phenates at 150 ppm. These are suggested for trial by the grower who encounters the problem. Another suggestion is to heat the gravel with a weed burner or a propane burner.

Ants. Ants often remove seeds from the gravel beds, particularly flat-shaped seeds like lettuce and tomato. Spraying the ants, placing various baits and powders around the bed and attempting to destroy the nests are all recommended. In the tropics ants become a major problem in some areas. Protection of the garden area with an oil trench is helpful.

Some ants devour the leaves, young growing tips and roots of some plants. The usual insecticide sprays are recommended—stomach poisons mixed with pyrethrum or pyrethrum and DDT

blends. Ants invading the roots may be flushed out by flooding the gravel with water and spraying the fleeing ants. (It may be mentioned at this point that cutworms are removed from the gravel by flooding with water.)

Rats and Mice. These animals usually attack the plants at three stages, (1) the seed, (2) the young seedling and (3) the fruit. The usual practices of control are suggested. These include traps, poison baits, cats and shooting. Another technique may be utilized to protect the seed and the seedlings. This is the use of a $\frac{1}{4}$ -inch wire mesh screen cover over the plant bed.

Lizards. Lizards are troublesome in some areas. They attack the plants in a manner similar to rats and mice. The same control methods are in order. Bacon and cheese are recommended for baiting traps.

Birds. Birds also attack plants in much the same manner as rats, mice and lizards. Wire screen will protect seed and seedling beds. Cats and shooting are in order to frighten the birds away from the ripe fruit.

Chapter 11

Special Chemicals

The discussions in this chapter are concerned with materials not directly necessary in the growth of the plants in soilless culture. They may be considered as special aids in improving plant growth. Numerous special substances may be listed in this respect, but only those materials which appear to be of immediate practical value will be mentioned. These chemical complexes include (1) soil blocks in the gravel, (2) manure extracts, (3) thiourea, (4) hormones and (5) vitamins (?).

Soil Blocks. As mentioned in Chapter 9, plants may be transplanted from the seedling bed to the crop bed with a block of either soil or sand attached to the roots. Practical experience with soilless culture often indicates that soil-grown plants develop faster during the young stages, but the final yields are comparable. It appears that the soil supplies some growth factors, other than essential minerals, necessary for the plants when they are small. One opinion is that certain hormones may be supplied to the plant, which is not yet capable of manufacturing adequate quantities for its own needs.

This problem was studied in the tropics in Aruba during the past year. The present preliminary results indicate that the early vegetative growth of tomato (Firesteel variety) was remarkably superior when the seed was sowed in a 4-inch cube of good soil placed in the medium (Haydite). This difference persisted until these plants produced a number of blooms and had a considerable fruit set. Then the plants which were grown from seed placed directly in the medium caught up with the other plants in vegetative expanse. The soil block plants started to produce ripe fruit two weeks earlier; but after six weeks of production, both lots of plants were equal in production. Figures 11-1 and 11-2 show these plants at different ages. At the completion of the experiment the plants started directly in the media out-yielded the others by one pound.

These tentative results well substantiate general practical ob-



Figure 11-1. Soil block experiment. Plants 6 weeks old. (Left, soil blocks; right, no soil blocks)



Figure 11-2. Soil block experiment. Plants 21 weeks old. (Left, soil blocks; right, no soil blocks)

servations and are in agreement with published data. Satisfactory results were secured with transplanting tomato and cucumber plants with attached soil blocks in the greenhouse. Ohio State workers obtained better yield with roses when transplanted to the gravel with the soil block intact upon the roots. It appears that softwood plants are safely handled even if the soil is removed from the roots prior to transplanting to gravel. Hardwood plants, however, appear to do better when transplanted with the soil on the roots.

Several precautions must be considered with the soil technique. The soil must be free of disease organisms, such as damping-off fungi, and animal parasites, such as nematodes. Further, the use of soil blocks may alter the nutrient solution pumping cycle, especially when the plants are small. Soil retains moisture longer than the gravel and the frequent solution applications usually required by the gravel medium may keep the soil block too wet if the pumping cycle is not reduced. Thus, never put plants with soil blocks in the same bed in which no soil blocks are used. Lastly, when removing a crop, special care must be taken to remove the soil blocks.

Manure Extracts. Some preliminary work upon the addition of manure extracts to the nutrient solution indicates growth improvement. This is really nothing new, because for years practical gardeners have used manure-steeped liquors to grow fine cabbages and roses in soil. The same postulate suggested above for the soil blocks may also apply to the use of manure extracts, that is, certain hormones or other essential organic chemicals are supplied to the plant.

The use of urinized peat in water culture improves the root development of sweet potato plants. Figure 11-3 is a photograph of the root response.

In Aruba a commercial standardized manure extract¹ was tested in slop culture. This material was added to the regular nutrient solution only once a week. Both the recommended dosage (a 1-1000 dilution) and a double dosage were used. Vegetative growth of tomatoes was superior until the plants were three months old, when the growth was equalized because of fruit set. For a considerable time during this period the single dosage-treated plants were twice the size of the untreated plants which received only regular nutrient solution. The double dosage-fed plants were about 50 per cent larger than the untreated plants. Figure 11-4 shows the vegetative

¹ Liqua-Nure, produced by West Point Lawn Products, West Point, Pa.

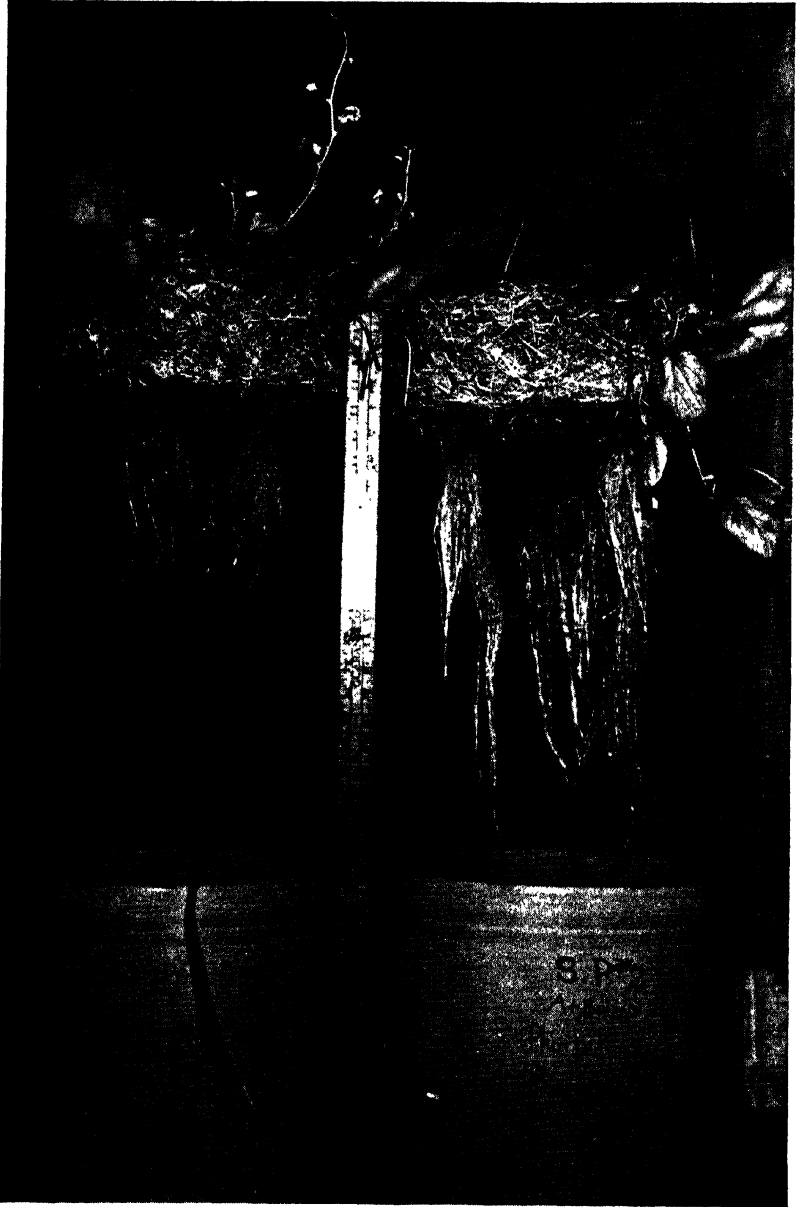

Figure 11-3. Root growth of the sweet potato stimulated by urine constituents. The untreated plants (left) were grown in nutrient solution without root stimulants. Jar on right received urinized peat.



Figure 11-4. Eight-week old plants treated with Liqua-Nure. (Top, control; middle, single dose; and bottom, double dose)

conditions of the plants when they were eight weeks old. Figure 11-5 shows the same plants at the age of 15 weeks.

The early yield of tomatoes was much greater on the plants given the single dosage of manure extract; but the final yield was only slightly less than one-half a pound per plant greater than the plants



Figure 11-5. Fifteen-week old plants. (Left, treated with single dose of Liqua-Nure; right, control)

which received no manure extract in the nutrient solution. The doubly dosed plants produced about $1\frac{1}{4}$ pounds of tomatoes less than the untreated plants.

These data point out that root growth and top growth are stimulated when the plant is young; so it appears to be worth while to suggest the use of such material during the early life of the plant (the first three to four months for tomato). More work is necessary to fully confirm these preliminary results, but the technique is ready for trial by the interested grower.

Thiourea. The United States Department of Agriculture recommends the use of thiourea to improve the germination of lettuce seed under high air temperature conditions. Seeds of some varieties of lettuce do not germinate satisfactorily when the temperature goes beyond 80° to 85° F. Treatment consists of an eight to ten hour

soaking at 70° F in a 0.5 per cent thiourea solution in darkness. The treated seed is then washed with tap water and then rapidly dried at a temperature of 65°–75° F. The seeds may be planted at once or put into storage for several days. It is important to follow the instructions carefully, because slight changes alter the results.

Hormones. We consider here not true plant hormones, but hormone-like chemicals, which produce similar responses in plants. The practical grower is interested in the rooting and the fruiting effects.

Rooting Effects. Numerous commercial preparations are on the market which improve the vegetative propagation of various cuttings. They are used mostly as water solutions or as talc dusts. These compounds usually contain a single hormone chemical or a mixture. Indoleacetic acid, indolebutyric acid, indolepropionic acid, naphthaleneacetic acid, naphthalene acetamide and naphthalenebutyric acid are the chemicals most commonly utilized for this purpose.

These substances stimulate the root formation of vegetative cuttings by a hormone reaction. Some types of cuttings have either insufficient amounts or practically no root stimulating hormones within their tissues. The tissues are capable of absorbing adequate quantities of an external source of hormone-like chemicals. Thus, with an adequate supply of carbohydrates and proteins present, the hormone-like chemicals aid in the initiation and development of roots.

The nursery man and the greenhouse man are particularly interested in the practical applications of hormones. Numerous softwood and hardwood plants are propagated by vegetative cuttings and the use of hormones is quite beneficial. The average practical grower probably prefers the commercial ready-to-use preparations. If the use of pure chemicals is desired, the necessary instructions may be obtained from the various agricultural experimental stations.

Fruiting Effects. Many people are interested in the effect of several hormone-like chemicals upon the fruiting responses of some plants. The commercial man is primarily interested in improving the fruit set, the hobbyist in producing seedless fruit.

Several commercial preparations are on the market. The chemicals most effective to date include indolebutyric acid, beta-naph-

thoxyacetic acid, 2,4-dichlorophenoxyacetic acid, beta-naphthoxypropionic acid, etc.

These chemicals stimulate fruit development, even in the absence of natural pollination. One theory of the action of these hormone-like substances is that natural hormones are involved in normal pollination and fertilization. If these reactions can be initiated artificially by an external source of hormone, pollination is not necessary for fruit development. A good source of information upon this subject is the Botany Department of the University of Michigan.

Several means of applications may be utilized to apply these materials to the flowers of the plant, such as lanolin pastes, water solutions, emulsions and aerosols. The paste and emulsions are placed directly on the style of the flower. The water solutions are sprayed upon the blossom. The aerosol may be fogged directly onto the blossom, or be dispensed in the entire surrounding atmosphere in a confined space.

When treating blossoms with either pastes or emulsions the style may or may not be cut prior to application. Some disagreement exists as to the advisability of cutting the style. Some people claim better results with cutting the style, and others without cutting it. Approximately one-half the style (referring to tomato) is cut off and the hormone substance is then applied to the cut surface. When the style is not cut, the hormone carrier is placed upon the end of the style. *More recent work recommends placing the material at the base of the flower.* Pastes may be applied with a small spatula. Emulsions may be applied either with a hypodermic syringe, minus the needle, or with an atomizer, depending upon the consistency.

Sprays are often applied with a small atomizer. The liquid is directed chiefly to the base of the flower to wet the ovary well.

Aerosols may be dispensed into the greenhouse atmosphere by use of bombs similar to the popular DDT bombs. For outdoor work the gas stream from the bomb may be directed upon the flower only. Caution must be used with this method of application. These hormones produce other effects upon plants besides making seed-less fruit. Various malformations of the stem and foliage are also effected. This is more pronounced when excessive amounts are used or when certain materials are used. Some materials produced greater morphogenic responses than others.

The effect desired governs whether or not the stamens (male

portion) of the flower are removed. If only improved set of normally pollinated (and seeded) fruit is wanted, no emasculation (removing the stamens) is performed. If seedless fruit are desired, the stamens must be removed before they shed pollen.

Some peculiarities of response with greenhouse tomatoes and outdoor tomatoes are reported. Quite often only the first two clusters on outdoor tomatoes are responsive. The reader is referred to the Ohio Agricultural Experiment Station for further detailed information upon the practical applications with fruit-setting hormones.

The carriers most usually used in practical work are lanolin, various emulsions and water. Lanolin pastes are made by dissolving 0.2 to 0.5 gram of indolebutyric acid in 100 grams of lanolin. The lanolin (wool fat) is melted and maintained at a temperature of 110° C (230° F). The acid is added and the mix is stirred until solution is complete. Sometimes the acid is dissolved in 10 milliliters of alcohol (grain alcohol) which is then added to the lanolin. The mix is stirred and heated until all fumes of alcohol are dissipated.

Emulsions are prepared by dissolving 0.2 to 0.3 gram of indolebutyric acid in various water-dispersable carriers. The materials used include lanolin, polyvinyl alcohol and vegetable waxes along with organic wetting agents. The situation in these types of carriers is in a state of flux. The interested reader is referred to the Horticulture Department of Purdue University¹ for the latest in-

¹ Herein are a few emulsion formulæ which are effective, courtesy of Drs. R. B. Withrow and A. P. Withrow.

I. Part A.

- (1) 5.0 grams lanolin
- (2) 0.2 gram indolebutyric acid
- (3) 1.0 gram stearic acid

Part B.

- (4) 100.0 ml water
- (5) 0.3 gram triethanolamine

Heat (1) to not over 110° C, then add (2); when dissolved add (3). Next heat (4) to boiling and add (5). Put Part B in a mechanical mixer and slowly add Part A to make a thin emulsion.

II. Part A.

- (1) 20.0 grams Wax G
- (2) 0.2 gram indolebutyric acid

Part B.

- (3) 80.0 ml water
- (4) 2.0 grams Polyvinyl alcohol-RH 403
- (5) 0.3 gram sodium bicarbonate

formation. Data secured in the tropics indicate that carriers other than lanolin alone are desirable. Under conditions of high temperature and intense sunshine lanolin tends to burn the ovary. Also 0.2 per cent of the active ingredient appears to be more satisfactory than 0.3 per cent.

Water sprays are prepared with beta-naphthoxyacetic acid and indolebutyric acid. The former is dissolved at the rate of 50 ppm while the latter is prepared as a 0.2 per cent solution with triethanolamine as a solution agent. Other materials and other means of applications are still in the experimental and developmental stage. The best sources of information for further knowledge upon this phrase of the problem are the United States Department of Agriculture for aerosol techniques and the Boyce Thompson Institute for Plant Research (Yonkers, N. Y.) for new chemicals and aerosol methods.

Vitamin B₁. The supposed benefits of vitamin B₁ to plant growth in practical plant culture, either soil or soilless, have been much publicized. It is true that certain plants under special circumstances respond to additions of vitamin B₁; but under practical culture conditions, such results have not been secured. Plants are capable of producing their own vitamin supply. In fact, plants are the prime source of natural vitamins. Thus, the use of vitamin B₁ is not recommended upon the basis of present data. If any desirable growth improvement is effected in a practical soilless culture unit, it would be probably during the early life of the plant.

Heat (1) and dissolve (2) in it. Add (4) to (3), then add (5). Put Part B in a mechanical mixer and slowly add Part A.

Wax G formulae

No. 1 45 grams carnauba wax

50 grams lanolin

5 grams cetyl alcohol

No. 2 25 grams carnauba wax

70 grams lanolin

5 grams cetyl alcohol

Heat the wax and the lanolin together. Place in a mechanical mixer and add the cetyl alcohol.

Chapter 12

Analyses of the Nutrient Solution

Analysis of the nutrient solution is essential for successful commercial crop production in soilless culture. Several types of analyses are required; these include direct analyses of the nutrient solution and also other analyses, not directly associated with the nutrient solution, but nevertheless necessary for crop culture.

Solution Analyses

The major analysis problems with the nutrient solution are the determination of the pH and the nutrient ion concentrations. The pH is usually measured by colorimetric means, but it can also be determined by the glass electrode pH meter. This discussion is solely concerned with the colorimetric method.

Analyses of the nutrient ion concentration may be conveniently subdivided into two sections: (1) the instructions for measuring the amount of macro elements in the solution and (2) those for measuring the amount of micro elements. The greatest detail will be devoted to the macro ion testing procedures. Two methods are adaptable for the commercial unit, depending upon the facilities available and the degree of accuracy required. Quick tests developed for rapid soil analyses, employing semi-microchemical techniques, are satisfactory if used properly. More accurate laboratory methods, employing mostly volumetric means, are also available.

Micro ion testing methods are usually colorimetric.

Measurements of the pH. Both the pH of the water and of the nutrient solution are determined by the same means. The colorimetric method employs the use of complex organic dyes which change to distinctive colors through a specific pH range of the aqueous solutions. For most purposes four dyes suffice. These are brom-cresol green, chlorophenol red, brom-thymol blue and phenol red. Actually only one dye is absolutely necessary, chlorophenol red, which reacts in a pH range of 5.2 to 6.8. This dye is easily read

within the range of 5.8 to 6.6, which is the usual range of fluctuation in a well regulated nutrient solution.

The pH of the nutrient solution is checked by comparing the color developed in the sample with a series of permanent standards. The dye concentration is adjusted at the rate of one ml of the dye



Figure 12-1. Lago Hydroponics Garden Laboratory. (Courtesy Esso Farm News)

solution to 20 ml of the sample. Most commercial kits use 0.5 ml to 10.0 ml or 0.25 ml to 5.0 ml or one drop per 20 drops (1.0 ml) of dye solution to the test sample solution. Either standard sealed tubes or color charts are used for the basis of comparison. The standard tube sets, which are used in a convenient comparator block, are recommended.

The practical grower should purchase ready-to-use commercial pH kits. Two kits which are satisfactory are the La Motte¹ and the Taylor² outfits. Both use standard tubes in a block comparator. Either the complete set of dyes suggested above may be obtained or only the chlorophenol red series may be bought. Other makes of this type of equipment are on the market; these two are mentioned only

¹ La Motte-Morgan Chemical Co., Baltimore, Maryland.

² W. A. Taylor and Co., 7300 York Road, Baltimore, Maryland.

as a guide. Any chemical supply house is a good source of information and materials.

Some growers and hobbyists may wish to prepare their own pH indicators. The following directions may be used as recommended by Purdue University.

pH Reagents: Four-dye Series.

(a) Test range pH 6.0-7.6

0.04 gm brom-thymol blue. Dissolve in 5 ml 95% ethyl alcohol. Add 95 ml distilled water. Adjust to pH 6.6.

(b) Test range pH 4.0-5.4

0.04 gm brom-cresol green. Same procedure as above, but adjust to pH 4.6

(c) Test range 5.2-6.8

0.04 gm chlorophenol red. Same procedure as above, but adjust to pH 5.6

(d) Test range 6.8-8.4

0.04 gm phenol red. Same procedure as above, but adjust to pH 7.4

Note (1) Use very dilute sodium hydroxide solution drop by drop to adjust

(2) Use the pH color chart or the standard tube for comparison. Tilt the container and compare a thin film of liquid in the neck of the bottle with the standard.

(3) If the proper pH point is passed use a very dilute hydrochloric acid solution drop by drop to re-adjust.

Sometimes it is desired to use a two-series indicator set instead of the four series set above. The United States Army Air Force Hydroponics Branch recommends the following reagents.

pH Reagents: Two-dye Series.

(1) Methyl red: Dissolve 60 mg of methyl red in 444 ml of 0.05 normal NaOH and make to 200 ml volume with alcohol (95 per cent).

(2) Brom-thymol blue: Dissolve 0.1 gm brom thymol blue in 8.0 ml of 0.02 normal NaOH and make to 250 ml volume with distilled water.

Analyses for Macro Nutrient Ions:—Quick Tests. As mentioned above, quick test methods are semi-microchemical in nature. These tests are colorimetric and turbidimetric. The nutrient solution is treated in the same manner as described for the soil extract. In other words the aqueous solution is the extract in a sense. However, temporary standards are recommended rather than the use of the prepared color charts often supplied with commercial kits.¹

¹The Simplex or Spurway testing technique is the basic system used for the quick tests herein described. These chemicals may be prepared from chemicals obtained from the usual supply houses. Or the grower may wish to purchase a complete kit from the Edwards Laboratory, Lansing, Michigan. Do not use the color standards in the bulletin accompanying this test kit. Use temporary standards instead. If facilities do not permit preparation of the standards consult the local druggist or high school chemistry instructor for assistance. Some of the test reagents are slightly modified as found in these test kits. However, the greatest change is in the phosphorus test. The procedure listed in this text is better for solution culture work.

Greater accuracy and reproducibility is possible with temporary standards.

A. Range of Tests and Calculation of Results. The various solution samples must be diluted to the proper range for each test in order to carry out the determinations. These tests possess a relatively narrow range of concentration in which the results can be properly observed. The discussion of the standards below indicate the amount of dilution necessary for each test. Of course the final concentration in the actual nutrient solution is calculated by multiplying the quantity obtained with the diluted sample by the dilution factor. An example will point out the necessary mathematics.

The phosphorus level of a nutrient solution is to be checked. A phosphorus test is run in conjunction with the standards wherein the approximate contents of the standards lie between 5 and 15 ppm. This solution usually contains 90 ppm of phosphorus. Thus the original solution should be diluted with distilled water; a ten times dilution is suggested. Add 9 ml of water to 1 ml of the nutrient solution sample. Mix well and take 1 ml of the diluted sample for the chemical test. This diluted sample tests about 11 ppm when checked against temporary standards. Therefore $11 \text{ ppm} \times 10$ gives 110 ppm of phosphorus present in the solution.

B. Standard for Comparison. This method was originally based upon the use of separate temporary standards. Thus to test for nitrate a potassium nitrate solution is used for comparison to estimate the concentration of nitrate in the nutrient solution. Each ion test is then run in conjunction with its own individual standard. Since these standards possess an exact quantity of the particular element, a rough quantitative test is possible in parts per million. These standards may also be expressed in millimolar concentrations. However, since for soil work the ppm system is often used, the same system is used for nutrient solutions analyses. Conversion from one system to the other is carried out as explained in Chapter 6. Actually, the millimolar system should probably be used in soilless culture work to simplify testing because this system is used for calculating the nutrient solution. But the low concentrations which are within the test ranges produce a small fraction of the molecular concentrations used. Thus, the ppm system still prevails. Table 12-1 lists the mm and ppm data for the six solutions listed in Chapter 6, Tables 6-6 and 6-7 (pages 142 and 143).

Table 12-2 further gives necessary data for salt additions, wherein the chemicals are listed to add one mm of each ion to 1000 liters or to 1000 gallons.

However, the testing technique may be modified to use a portion of complete nutrient solution as the standard. In some cases this



Figure 12-2. Tomatoes growing at Modern Farms, Kendall, Florida. (Courtesy J. P. Biebel)

may even improve the results obtainable by compensating for the presence of some interfering ions. Thus a similar concentration of any ion which may interfere with the reaction of the ion to be tested will be present in both the unknown sample and the standard sample. This complete solution sample may be prepared from chemically pure salts, or it may be a sample of a fresh solution prepared for the plant culture unit. To eliminate phosphate precipitation, make sure the pH of this standard is the same as the cultural solution, or at pH 6.0 to 6.5. Add a few drops of sulfuric acid to the sample to reduce the pH if it is too high.

Regardless of the kind of standards utilized, they must be diluted with distilled water to the proper range for each ion. Thus the actual operating standard is highly diluted in respect to the stock

Table 12-1. Millimolar and Parts per Million* Concentration of Nutrient Ions in Six Nutrient Solutions in Chapter Six, Tables 6-6 and 6-7

Nutrient Solution	Nitrate		Phosphorus		Sulfate		Chloride		Potassium		Magnesium		Calcium		Ammonium	
	mm	ppm	mm	ppm	mm	ppm	mm	ppm	mm	ppm	mm	ppm	mm	ppm	mm	ppm
Lago	7.0	434	3.0	93	10.5	1008	0	0	7.0	273	3.0	72	9.0	360	0	0
Shell	7.0	434	4.0	124	9.0	864	0	0	7.0	273	2.0	48	9.0	360	0	0
Ohio State	6.9	428	2.8	87	10.6	1018	0	0	6.9	269	2.2	53	8.9	356	1.8	32
Purdue	5.0	310	1.0	31	6.0	576	5.0	178	10.0	390	1.0	24	4.5	180	2.0	36
California	14.0	868	1.0	31	2.0	192	0	0	6.0	234	2.0	48	4.0	160	1.0	18
New Jersey	9.0	558	2.3	71	3.0	288	0	0	2.3	90	2.3	55	4.5	180	1.4	25

* Note: Conversion from mm to ppm

Ion	mm	ppm
Nitrate	1	62
Phosphorus	1	31
Sulfate	1	96
Chloride	1	35.5
Potassium	1	39
Magnesium	1	24
Calcium	1	40
Ammonium	1	18

Table 12-2. Quantity of Chemicals Used to Add One Millimole* of Each Nutrient Ion to the Nutrient Solution of the Indicated Volumes

Chemicals	Nitrate		Phosphorus		Sulfate		Chloride		Potassium		Magnesium		Calcium		Ammonium	
	gm. 1000 l.	lb.-oz. 1000 gal.	gm. 1000 l.	lb.-oz. 1000 gal.	gm. 1000 l.	lb.-oz. 1000 gal.	gm. 1000 l.	lb.-oz. 1000 gal.	gm. 1000 l.	lb.-oz. 1000 gal.	gm. 1000 l.	lb.-oz. 1000 gal.	gm. 1000 l.	lb.-oz. 1000 gal.	gm. 1000 l.	lb.-oz. 1000 gal.
KNO ₃	110	1-0							110	1-0						
Ca(NO ₂) ₂	90	0-13											180	1-9		
NaNO ₃	90	0-13			140	1-4									70	0-10
(NH ₄) ₂ SO ₄															30	0-4
(NH ₂) ₂ CO															80	0-11
NH ₄ NO ₃	80	0-11													140	1-4
NH ₄ H ₂ PO ₄			140	1-4											120	1-1
(Ammonophos A)																
NH ₄ H ₂ PO ₄			120	1-1											70	0-10
(Food grade)																
(NH ₄) ₂ HPO ₄			140	1-4												
(Food grade)																
KH ₂ PO ₄			140	1-4				80	0-11	140	1-4					
KCl										80	0-11					
K ₂ SO ₄					200	1-12				100	0-14					
CaH ₄ (PO ₄) ₂			135	1-3									270	2-6		
(Food grade)																
CaH ₄ (PO ₄) ₂			155	1-6									310	2-12		
(Treble super)																
CaH ₄ (PO ₄) ₂			375	3-5									750	6-10		
(Common super)																
MgSO ₄					260	2-5						260				
(Epsom salts)																
MgSO ₄					130	1-2						130				
(Anhydrous)																
CaSO ₄					190	1-11									190	1-11
CaCl ₂							75	0-11							150	1-5

* See note to Table 12-1.

solutions. The test range of the ions in parts per million (ppm) is as follows:

- (a) Nitrate—10, 15, 30
- (b) Phosphorus—5, 10, 15
- (c) Sulfate—40, 60, 80 or 80, 120, 160
- (d) Chloride—5, 10, 15 or 10, 20, 30
- (e) Potassium—10, 15, 20 or 20, 30, 40
- (f) Magnesium—10, 15, 20 or 20, 30, 40
- (g) Calcium—75, 100, 150, 200
- (h) Ammonium—2.5, 5, 10

C. Using the Tests. These tests are based upon a null method, that is, the temporary standards are used to partially compensate for variabilities of the test conditions. Differences in temperature and solution composition affect the test results. Each solution sample is tested concurrently with the standards for the particular ion in question. Not more than three or four unknown or used solution samples are run at one time along with the standard samples. The following illustration will point out the procedure.

Several solutions are to be tested for calcium. Each sample is properly diluted. Then add the necessary reagents in the proper sequence to the solution sample and the standard samples at the same time. The turbidity developed in the solution samples is then matched with the turbidity produced in the 75, 100, 150 and 200 ppm calcium standards. If an unknown sample matches the 150 ppm standard, the quantity of calcium in the solution is equivalent. Or if the turbidity appears to lie between 100 and 150 ppm, the approximate amount is estimated in this range upon the relative turbidity, that is, it may be considered to lie halfway, or at 125 ppm.

Since these tests are not highly accurate (estimated accuracy is 10 to 15 per cent) duplicate unknown samples should be run. But identical dilutions are not necessary, except for the nitrate test. In other words, when running the calcium test use a 1 to 2 and a 1 to 4 dilution. Run these two samples at the same time along with the standards. The final results obtained from each test should check within 10 to 15 per cent. If they are at a great variance the test should be rechecked.

The nitrate test should be checked at two dilutions and with each dilution in duplicate. Also, run the standards in pairs.

D. Testing Procedures.

- (a) Nitrate: blue color formed in spot plate.
1 drop diluted solution
6 drops No. 2 reagent
Read in five minutes
- (b) Ammonium: orange turbidity in spot plate.
3 drops diluted solution
2 drops No. 9 reagent
Read in one to two minutes
- (c) Phosphorus: blue color in test tube.
1 ml diluted solution
0.5 ml No. 3 reagent
1 pellet No. 4 reagent
Make to 10.0 ml volume with distilled water
Read in five to ten minutes—SHAKE OCCASIONALLY
- (d) Magnesium: orangish brick-red turbidity in test tube.
1 ml diluted solution
2 drops No. 11 reagent
2 drops No. 12 reagent
Read in one-half to one minute
- (e) Chlorides: white turbidity in test tube.
1 ml diluted solution
1 drop No. 17 reagent
1-2 drops No. 1a reagent
Read in one minute
- (f) Potassium: reddish-orange to yellowish-orange turbidity in test tube.
1 ml diluted solution
3-4 drops No. 5a reagent
1 ml No. 5 reagent—SHAKE
1 ml No. 6 reagent: add slowly down sides of test tube, then shake
Read in one to two minutes
- (g) Calcium: white turbidity in test tube.
1 ml diluted solution
2 drops No. 7 reagent
Read in one minute
- (h) Sulfate: white turbidity in test tube.
1 ml diluted solution
2 drops No. 16 reagent
2 drops No. 1a reagent
Read in one minute

E. Testing Precautions. Any kind of chemical analysis requires a certain degree of cleanliness and skill to achieve good results. Experience is necessary with the quick test method to secure reasonable results. Some precautions are necessary in order to produce reliable analyses.

Since all these tests are either colorimetric or turbidimetric, good judgment is needed to make comparisons by visual inspection.¹

¹Electrical photometers are on the market which greatly improve the accuracy of these tests. Some sources of supply include (1) Photovolt Corporation, New York, (2) Leeds and Northrup, Philadelphia and (3) Central Scientific Company, Chicago.

A convenient light box with a sloping ground-glass face is a suitable aid. Place a 60-watt bulb inside the box, which is internally painted white. If no color comparator is available, compare the color against a white background, a piece of white paper or a white wall. Use reflected light rather than direct sunlight or direct mazda light. The pH block comparator is useful to compare the colors, particularly in the phosphate test.

Each test has certain peculiarities which the operator must be familiar with. The nitrate test is very sensitive and must be used extremely carefully to secure satisfactory results. Many other chemical ions like the nitrite and the chromate ions produce the same test. Thus, it is better to use hydrochloric acid to wash the spot plates, rather than chromic acid washing solution. Careless rinsing with distilled water after the latter cleaning fluid is used leads to incorrect nitrate analyses. Also, keep the nitrate reagent in the ice box between tests to slow down its decomposition. When it becomes quite dark in color or possesses a bluish coloration, replace it. Also, the reagent works best within the temperature range of 60° to 90° F under the conditions of the technique. When it is used cold the test is not rapid and reliable. Also, when the working conditions are quite hot the color fades rapidly and good agreement between duplicate samples is hard to obtain.

The brucine method is better for nitrate determination as per Peech and English's article. This test is adaptable for a photometer and it is available commercially in simple comparator kits.¹

The ammonium test is reasonably simple. Sometimes, as the reagent ages its yellowish color becomes deeper. To circumvent this trouble just run a water blank in the spot plate to estimate the slight error.

Phosphorus may be tested by the colorimetric method with a multitude of reagents; the basic reactive reagent is the same, but is merely prepared in different ways. Numerous reducing agents are adaptable. The use of the original type of molybdate reagent seems to be the most suitable for nutrient solution testing. Thus, only sulfuric acid is the reagent solvent; hydrochloric and nitric acid are omitted because they interfere with the test. Tin metal pellets appear to be quite suitable for this test as the reducing agent. As long as bright clear pellets are used for every test, full coloration

¹ W. A. Taylor and Co., 7300 York Road, Baltimore, Maryland.

develops. Although stannous chloride solutions are used for more accurate test methods, the simplicity of the tin pellet makes it more adaptable for the quick test method. Reducing agents in

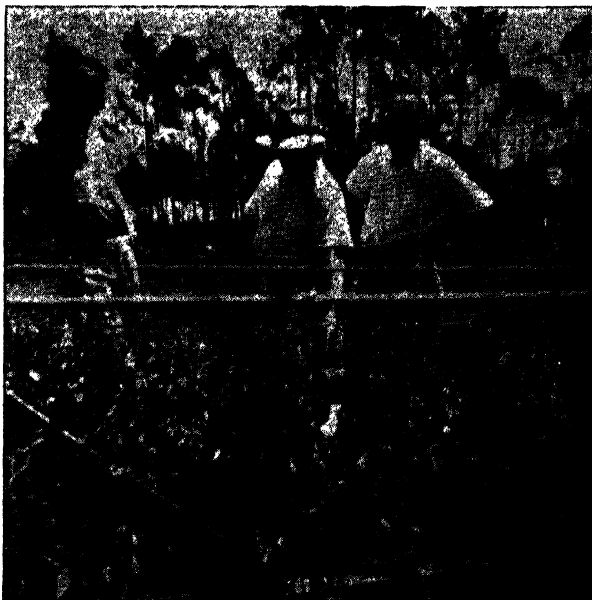

Figure 12-3. Tomatoes in gravel culture, Modern Farms, Kendall, Florida. (Courtesy J. P. Biebel)

solution form are not too stable unless especially prepared. The phosphate reagents react to temperature in the same way as does the nitrate reagent.

Magnesium tests sometimes give trouble. Actually the Titan yellow test is not too commendable for the amateur chemist. The source of dye influences the test. Dr. G. Gruber and Company Titan yellow usually gives better tests than other sources. The nutrient solution composition also introduces considerable error at times. Solutions containing a lot of calcium give poor readings. Also, a water supply which contains much ferric iron (often found in evaporated sea water) interferes with the test. The complicating factor is that the relative proportions of the calcium and iron concentration in respect to magnesium content influence the degree of interference. If a variable water supply, which contains a lot of calcium, ferric iron or both, is used, it is difficult to prepare suitable compen-

sating solutions. Usually the best compensating solution to use is a complete nutrient solution minus the magnesium; that is, when running the magnesium test, it is often of value to add one ml of this solution to each of the standards. Of course the nutrient solution sample is diluted with one ml of distilled water to give the same volume. If the complete solution standard method is used, no compensating solution is necessary. The advanced solution tester is



Figure 12-4. Strawberries produced by Hydroponics, Flagler Farms, Kendall, Florida. (Courtesy J. P. Biebel)

referred to the reference list for Peech and English's article for more information about the magnesium test and other quick tests.

The potassium test is another problem at times. If no ammonium is used in the nutrient solution the formaldehyde may be omitted. Although the liquid reagent is not very stable, it probably is reactive over a wider range of conditions than the dry type reagent. If the liquid reagent is kept in the ice box while not in use it should be satisfactory for one month. Then it should be replaced to insure the reagent is always reactive. Dry sodium cobaltinitrite is hard to keep dry in the tropics, which interferes with its test value. When it is used as a liquid reagent this problem is solved. Another problem is at what temperature should this test be run. Some place the test reagents and the solutions to be tested in the ice box to be cooled to about 40° F; others operate at a temperature of about 80° F. Both methods have been used in the tropics with

similar results, but the results are not always equivalent. Therefore, the method should be standardized as to temperature.

The calcium, chloride and sulfate tests are purely turbidimetric. They are not highly accurate, but are close enough for commercial nutrient solution work. As a guide for comparison with standards, a series of India ink lined tracing paper is suggested. Lines varying in width from very fine to several times the width of a soft pencil are placed on the paper. The tubes containing the precipitates are placed at a 60° angle with the lines. The lines are viewed through the tubes, which are moved until the broadest of the lines cannot be seen through the cloudy opalescence. If the unknown sample and a particular standard cut out the same width line they are of similar concentration.

The potassium test is handled in the same manner.

F. Test Reagents. All reagent chemicals are C.P. (chemically pure) and distilled water is used.

- (a) Nitrate reagent
No. 2—0.10 gram diphenylamine
50.0 ml sulphuric acid
- (b) Phosphorus reagents
No. 3—ammonium molybdate reagent
2.50 grams ammonium molybdate
20.0 ml water
Heat to 60° C to dissolve
Filter
Add 80 ml dilute sulphuric acid to filtered solution (prepare dilute sulphuric acid by adding 28 ml concentrated acid to 40 ml of water and then make to 80 ml volume with more water)
No. 4—clean, bright tin pellets, the size of a small pea seed
- (c) Potassium reagents
No. 5—sodium cobalti-nitrite reagent
Sub-reagent No. A—5.0 grams sodium cobalti-nitrate
30.0 grams sodium nitrite
Dissolve in 50 ml water. Add more water to make 100 ml volume
Allow stand a few days to permit escape of gasses (DO NOT STOPPER TIGHTLY).
Sub-reagent No. B—75.0 sodium nitrite
500.0 ml water
No. 5—reagent (final)—add 25.0 ml of sub-reagent No. A to all of sub-reagent No. B
No. 5a—37 per cent formaldehyde
No. 6—95 per cent ethyl alcohol (grain alcohol) or iso-propyl alcohol
- (d) Calcium reagents
No. 7—5.0 grams ammonium oxalate
100.0 ml water
- (e) Ammonium reagent
No. 9—Nessler's reagent
Sub-reagent No. A—5.0 grams potassium iodide
5.0 ml water

Sub-reagent No. B—8.0 grams mercuric chloride
100.0 ml water

Heat to dissolve, then cool

Sub-reagent No. C—Pour sub-reagent No. B slowly with stirring into sub-reagent No. A until a very slight red precipitate is formed. This precipitate will form earlier, but will disappear upon stirring. As soon as a permanent precipitation occurs stop adding sub-reagent No. B. When precipitate settles filter the solution.

Sub-reagent No. D—Add 40.0 ml of potassium hydroxide to the filtered solution (Prepare potassium hydroxide solution by dissolving 18.0 grams of potassium hydroxide in 36.0 ml of water)

No. 9 reagent (final)—Dilute solution to 150 ml volume with water. Allow to settle before use. Do not filter.

(f) Magnesium reagents

No. 11—5.0 grams sodium hydroxide
100.0 ml water

No. 12—0.15 gram Titan yellow (Dr. G. Gruber and Co.)

100.0 ml 50 per cent methyl alcohol solution (methyl alcohol solution is prepared by adding 50 ml of methyl alcohol to 50 ml of water).

Note: Sometimes a water solution is prepared instead of the alcohol solution. Filter if necessary in this case.

(g) Sulfate reagents

No. 16—7.0 grams barium chloride
100.0 ml water

No. 12a—25.0 ml glacial acetic acid
75.0 ml water

(h) Chloride reagents.

No. 17—5.0 grams silver nitrate
100.0 ml water

Note: Place in brown bottle and keep stored in dark place. When in use do not place in direct light

No. 1a—same as above for sulfate reagents

G. Standard Reagents. All reagents are made with C.P. chemicals and distilled water. To facilitate ease and accuracy of preparation, concentrated stock standards are made up which are further diluted with water to prepare the operating standards.

Stock standards:

- (a) 200 ppm phosphorus standard
0.877 gram monobasic potassium phosphate
1000.0 ml water
- (b) 200 ppm potassium standard
0.382 gram potassium chloride
1000.0 ml water
- (c) 200 ppm calcium standard
0.555 gram anhydrous calcium chloride
1000.0 ml water
- (d) 200 ppm magnesium standard and
800 ppm sulfate standard
2.028 grams magnesium sulfate (Epsom salts)
1000.0 ml water
- (e) 200 ppm ammonium standard and
400 ppm chloride standard

- 0.594 gram ammonium chloride
1000.0 ml water
- (f) 200 ppm nitrate standard
0.326 gram potassium nitrate
1000.0 ml water

Operating standards:

(a) <i>Potassium</i>	10 ppm	15 ppm	20 ppm	
Potassium stock solution	30 ml	45 ml	6.0 ml	
Water	57.0 ml	55.5 ml	54.0 ml	
(b) <i>Calcium</i>	75 ppm	100 ppm	150 ppm	200 ppm
Calcium stock solution	22.5 ml	30.0 ml	45.0 ml	60.0 ml
Water	37.5 ml	30.0 ml	15.0 ml	
(c) <i>Phosphorus</i>	5 ppm	10 ppm	15 ppm	
Phosphorus stock solution	1.5 ml	3.0 ml	4.5 ml	
Water	58.5 ml	57.0 ml	55.5 ml	
(d) <i>Magnesium</i>	10 ppm	15 ppm	20 ppm	
Magnesium stock solution	30 ml	4.5 ml	6.0 ml	
Water	57.0 ml	55.5 ml	54.0 ml	
(e) <i>Ammonium</i>	25 ppm	5 ppm	10 ppm	
Ammonium stock solution	0.75 ml	2.5 ml	3.0 ml	
Water	59.25 ml	58.5 ml	57.0 ml	
(f) <i>Nitrate</i>	10 ppm	15 ppm	20 ppm	
Nitrate stock solution	30 ml	4.5 ml	6.0 ml	
Water	57.0 ml	55.5 ml	54.0 ml	
(g) <i>Sulphate</i>	40 ppm	60 ppm	80 ppm	
Sulphate stock solution	30 ml	4.5 ml	6.0 ml	
Water	57.0 ml	55.5 ml	54.0 ml	
(h) <i>Chloride</i>	5 ppm	10 ppm	20 ppm	
Chloride stock solution	0.75 ml	1.5 ml	3.0 ml	
Water	59.25 ml	58.5 ml	57.0 ml	

H. Materials.

- (a) Chemicals, as listed above
(b) Glassware

All glassware should be clean. Probably the best cleaning fluid for the soilless garden laboratory is 50 per cent hydrochloric acid. To prepare add 1000 ml of water to 1000 ml of commercial grade acid. Soak the glassware in a porcelain crock for about an hour. Then rinse the acid off with tap water. A final rinse with distilled water follows. Let the glassware dry in a clean place.

The following items of glassware are not all absolutely essential, but it is usually convenient to have a reasonably well stocked laboratory. Any druggist or high school chemistry teacher will be in a position to suggest a local source of supply.

- (1) 24 test tubes, shell vials of 15–20 ml capacity, 10 cm length, 1.5 cm external diameter. May be calibrated and marked at 5.0 ml and 10.0 ml with a file.

- (2) 2 porcelain Coors, No. 1 (spot plates).
- (3) 12 one-ml graduate medicine droppers (0.25 ml graduations).
- (4) 12 pipettes, one-ml capacity, graduated to 0.1 ml.
- (5) 12 pipettes, one-ml capacity, volumetric.
- (6) 48 dropping bottles, pipette type, 30 to 60 ml capacity.
- (7) 24 reagent bottles, one-pint capacity.
- (8) 6 reagent bottles, one-liter capacity.
- (9) 6 glass stirring rods, 6 inches long
- (10) 6 glass funnels, 60°, two-inch diameter, short stems.
- (11) 6 pipettes, 5 ml capacity, graduated to 0.25 ml.
- (12) 6 graduates, 100-ml capacity.
- (13) 6 graduates, 50-ml capacity.

The above materials are essential, while the remaining list is desirable, but not absolutely necessary.

- (14) 2 graduates, 10-ml capacity.
- (15) 2 graduates, 25-ml capacity.
- (16) 1 graduate, 250-ml capacity.
- (17) 1 graduate, 500-ml capacity
- (18) 1 graduate, 1000-ml capacity.
- (19) 2 pipettes, 10-ml capacity, graduated.
- (20) 1 burette, 50-ml capacity.
- (21) 2 pipettes, volumetric, 5-ml capacity
- (22) 2 pipettes, volumetric, 10-ml capacity.
- (23) 1 pipette, volumetric, 25-ml capacity.
- (24) 1 pipette, volumetric, 50-ml capacity.
- (25) 1 flask, volumetric, 100-ml capacity.
- (26) 1 flask, volumetric, 250-ml capacity.
- (27) 1 flask, volumetric, 500-ml capacity.
- (28) 1 flask, volumetric, 1000-ml capacity.
- (29) 2 flasks, Florence, 500-ml capacity.
- (30) 2 beakers, 100-ml capacity.
- (31) 2 beakers, 600-ml capacity.
- (32) 2 beakers, 1000-ml capacity.

(c) Other equipment

These items are necessary and should be purchased to complete the laboratory.

- (1) Balance, may be triple-beam type, 0.01 to 100-gram capacity or may be platform type, 0.1 to 200-gram capacity (if prepare own reagents, obtain the first type).
- (2) Test tube rack: fabricate locally out of plywood or Masonite to fit particular sized tubes used.
- (3) Cleaning brush, at least 0.5 inch diameter.
- (4) Filter paper, Whatman No. 1 and Whatman No. 5, one pack of each type or equivalent grade.
- (5) Hot plate, three heat range.
- (6) Burette stand.
- (7) Standard mercury laboratory thermometers, one with 0° to 100° C range and one with 20° to 220° F range.
- (8) One-gallon porcelain crock.

Analyses for Macro Nutrient Ions:—Laboratory Tests. These volumetric, colorimetric and turbidimetric analyses are developed for use in the regular chemical laboratory. They are standard methods of analyses adapted for nutrient solution testing.¹ These tests are more accurate than the quick type tests. For large-scale commercial production by soilless culture these laboratory analyses are more satisfactory. A closer check upon the exact nutrient level in the culture solution is possible with no more work involved. However, the services of a trained practical chemist are recommended.

A. Range of Tests and Calculation of Results. The various tests are determined directly upon the nutrient solution. Necessary dilutions are given for the specific analyses. Calculation of the results, expressed in parts per million, are listed for each test.

B. Standards for Comparison. All these tests are volumetric except the potassium and the phosphorus ones. No temporary standards are needed for the volumetric analyses because standardized reagents are used. Thus the results are calculated directly from the test data. The turbidimetric potassium test uses temporary standards under certain controlled conditions. Phosphorus is tested by a colorimetric Taylor² boiler water kit which uses permanent standards.

C. Using the Tests. If the nutrient solution samples are not crystal clear, they must be filtered before analysis. Use one or two discs of No. 1 Whatman qualitative paper, 15 cm diameter (or equivalent filter paper). Each test should be run to completion before starting another one, but several samples may be run at one time. The use of a daylight lamp is helpful in the titration procedures to determine the endpoints more accurately. A box-type comparator, containing lights and an opaque window is suggested equipment for the colorimetric and the turbidimetric analyses. All necessary precautions listed for the individual tests should be observed.

D. Apparatus, Reagents and Procedures. In keeping with the usual standard laboratory practices, the apparatus, reagents and procedures are given individually for each chemical test. In section [h] (page 258) the preparation of the reagents is listed.

¹ Adapted by Dr. R. K. Broz of the Technical Service Department, Lago Oil and Transport Company, Limited, Aruba, Curaçao, N.W.I.

² W. A. Taylor and Co., 7300 York Road, Baltimore, Maryland.

a. Nitrate Determination

Apparatus

4 pipettes, 1 ml
 1 pipette, 2 ml
 2 pipettes, 5 ml
 1 pipette, 10 ml
 1 Nessler tube, 50 ml
 1 "Pyrex" ignition tube or evaporating dish
 1 funnel, 2-inch diameter, short stem
 Whatman No. 4 filter paper

Reagents

0.2*N* Potassium permanganate
 12*N* Potassium hydroxide
 Phenoldisulfonic acid

Procedure

Measure by means of a volumetric pipette 1 ml of the clear nutrient solution into the ignition tube or the evaporating dish. Add several drops of 0.2*N* potassium permanganate, or enough to just make a definite pink color remain. Evaporate the sample to dryness on a water bath. Do not allow the sample to spatter or a loss will occur. When the sample is dry, add 2 ml of the phenoldisulfonic acid reagent. Stir the sample by rotation of the container until all the dry residue is dissolved, then add 3 ml of distilled water. Next add WITH CAUTION enough 12*N* potassium hydroxide to obtain a maximum yellow coloration. This reaction is violent, thus add the alkali *very slowly and carefully*. Stir the sample after each small addition of the alkali reagent. Let the sample cool to room temperature. Filter the cooled sample and wash the ignition receptacle and the solid residue upon the filter paper with small quantities of distilled water to remove all yellow color. Collect the filtered sample and washings in the Nessler tube and make up to 50 ml volume with more distilled water. Mix contents of tube by inverting at least two times. Compare the color with a series of temporary-permanent standards. Multiply the reading by 50 to obtain the nitrate concentration in the nutrient solution.

These standards are prepared from the stock potassium nitrate solution. They should be checked once a month against temporary standards. Keep the standards in well stoppered (rubber) 100 ml Erlenmeyer flasks or in 50-ml Nessler tubes. If stored in the flasks, be sure to transfer all the solution back into the flask after comparator use in the Nessler tubes. At least four standards should be employed. The stock standard solution is used in the same manner as the nutrient solutions. That is, an analysis is made but standard solutions are used. The following quantities of standard potassium nitrate solution are used.

- (a) 5 ppm color standard: 0.25 ml stock solution
- (b) 10 ppm color standard: 0.50 ml stock solution
- (c) 15 ppm color standard: 0.75 ml stock solution
- (d) 20 ppm color standard: 1.00 ml stock solution

b. Potassium Determination

Apparatus

10 vials, 75 mm. × 22 mm.
 10 vials, 62 mm. × 8 mm.
 10 beakers, 100 ml
 2 pipettes, 1 ml each
 1 pipette, 1 ml
 1 medicine dropper
 1 block of Taylor comparator

Reagents

Standard potassium chloride solution, 40 ppm K

Sodium cobalti-nitrite reagent

Isopropyl alcohol, C.P.

Formaldehyde, C.P. 37%

Procedure

Stock standard solution containing 40 ppm of K is diluted into various small bottles in such a way that at all times solutions will be available containing 8, 10, 12, 14, 16, 18, 20, 22 and 24 ppm of K. Each time when determination of K in an unknown sample is made, fresh standard solutions have to be used, since the test is turbidimetric, and after several hours the standards precipitate, with no turbidity remaining in solution.

Sodium cobalti-nitrite, when not used, must be kept at all times in icebox.

Prepare 12 beakers of 100-ml capacity each. Place in each of the beakers a large and a small vial. Make ready small bottles containing K in amounts from 8 to 24 ppm as described in paragraph above. Dilute the unknown sample so that final reading falls somewhere between 8 and 24 ppm of K. Dilute 5 ml of the original nutrient solution sample to 100 ml with distilled water; place this solution behind the last beaker containing a large and a small vial. By means of a pipette, measure exactly 2 ml of each of the standards and the unknown diluted sample into one large vial in each beaker. Add to each vial 6 drops of formaldehyde, mix and allow to stand for about 5 minutes. Then add to each vial, by means of a pipette, 1 ml of the sodium cobalti-nitrite reagent and again mix well. Add, by means of a pipette, 2 ml of isopropyl alcohol down the side of the vials, so as to form a layer of alcohol on top of the solution. It is imperative that the alcohol be added without mixing the solutions at this stage. After the last addition of alcohol to the standards as well as to the unknown sample, mix the two layers uniformly and rapidly by swirling the vial for about 30 seconds. After about 24 minutes, transfer each solution from large vial to a small one, and compare the turbidities of the standards with that of the unknown sample in a Taylor block comparator. After matching the right turbidity, read ppm of K of the standard which the unknown sample matches and multiply by 20. This is the content of K in ppm in the unknown solution.

*c. Phosphorus Determination**Apparatus*

1 burette, 50 ml

1 graduate, 50 ml

1 graduate, 100 ml

1 graduate, 200 ml

1 graduate, 500 ml

1 Erlenmeyer flask, 500 ml

1 test tube graduated to 5 ml and 15 ml

1 pipette, 5 ml

Reagents

Complete Taylor phosphate comparator

Ammonium molybdate solution

Stannous chloride, concentrated solution

Stannous chloride, diluted

2% Sulphuric acid solution

Chlorox, 5% available chlorine

Procedure

Measure, by means of a graduate, 50 ml of a clear, filtered *and colorless* sample into one of the three graduates (100 ml, 200 ml and 500 ml), and dilute it in such a way that the reading in Taylor comparator falls between 20 and 50 ppm. After prop-

erly diluting the sample with distilled water, pour 5 ml of the sample into a calibrated test tube up to the 5 ml mark. Add ammonium molybdate up to 15 ml mark, then from a burette exactly 2.5 ml of a freshly prepared diluted stannous chloride solution, which is made by diluting 2.5 ml of a concentrated stannous chloride solution up to 100 ml with distilled water. Shake well, then fill a comparator tube with the blue-colored solution and compare the intensity of the color with the standards in Taylor comparator. If the sample was not diluted, read ppm of PO_4 directly by matching the color. If diluted with distilled water to 100, 200 or 500 ml, the reading multiplied by 2, 4 or 10 indicates ppm of PO_4 present. This figure, multiplied by 0.3229, gives ppm of P present.

d. Magnesium Determination

Apparatus

- 3 burettes, 50 ml each
- 1 Erlenmeyer flask, 500 ml
- 1 pipette, 5 ml
- 1 graduate, 100 ml

Reagents

- 0.1N Potassium palmitate solution
- 10% Potassium oxalate solution
- 0.1N Hydrochloric acid solution
- 0.1N Sodium hydroxide solution
- 1% Phenolphthalein indicator

Procedure

Measure, by means of a graduate, 100 ml of a clear filtered sample into an Erlenmeyer flask. Add about 10 ml of 0.1N hydrochloric acid and heat to boiling. By means of a pipette, add to the boiling solution drop by drop 5 ml of 10% potassium oxalate solution, then cool. Add 2 ml of phenolphthalein indicator and neutralize to slightly pink color by means of 0.1N sodium hydroxide. Destroy pink color by addition of few drops of 0.1N hydrochloric acid, then titrate to sharp red end point with 0.1N potassium palmitate. Deduct 0.3 ml from total ml of potassium palmitate used, and calculate the amount of Mg in ppm as follows:

$$\text{Mg (ppm)} = \text{ml potassium palmitate} \times N \times 120$$

e. Calcium Determination

Apparatus

- 3 burettes, 50 ml each
- 2 Erlenmeyer flasks, 500 ml each
- 1 graduate, 100 ml

Reagents

- 0.1N Potassium palmitate solution
- 0.1N Hydrochloric acid solution
- 0.1N Sodium hydroxide solution
- 1% Phenolphthalein indicator

Procedure

Measure, by means of a graduate, 100 ml of a clear filtered sample into an Erlenmeyer flask, add few drops of phenolphthalein indicator, and titrate with 0.1N sodium hydroxide to red end point. Calculate the number of ml of sodium hydroxide in terms of exactly 0.1N as follows: ml sodium hydroxide $\times 10 \times N$, and designate this number as (A).

Measure, by means of a graduate, 100 ml of a clear filtered sample into an Erlenmeyer flask, add 2 ml of phenolphthalein indicator, and titrate with 0.1N potassium palmitate to a sharp red end point, deducting 0.3 ml from the number of ml of potassium palmitate used. Calculate Ca in ppm as follows:

$$\text{Ca (ppm)} = [(\text{ml potassium palmitate} \times 10 \times N) - (A)] \times 20 - [\text{ppm Mg} \times 1.667]$$

f. Sulfate Determination

Apparatus

- 2 burettes, 50 ml
- 1 graduate, 50 ml
- 1 Erlenmeyer flask, 500 ml
- 1 pipette, 1 ml
- 1 pipette, 2 ml

Reagents

- Standard BaCl_2 solution, 34.4099 gms $\text{BaCl}_2 \cdot 2\text{H}_2\text{O}$ per liter
- Standard K_2CrO_4 solution, 13 6338 gms K_2CrO_4 per liter
- Approx. *N* hydrochloric acid
- Approx. 2*N* ammonium hydroxide solution
- Distilled water

Procedure

By means of a graduate, measure 50 ml of a clear, filtered sample into a 500-ml Erlenmeyer flask. Add by means of a pipette 1 ml of *N* hydrochloric acid. Heat to boiling, then add exactly 10 ml of standard BaCl_2 from a burette, and about 50 ml of distilled water. Heat again to boiling, and keep the liquid as close to boiling point as possible during the rest of analysis. Add by means of a pipette 2 ml of 2*N* ammonium hydroxide, then start to add from a burette potassium chromate solution to hot water in portions of 0.5 ml. After each addition, observe the color of the supernatant water, which should be clear. If colorless, add more potassium chromate, till it turns slightly yellow. The end point is shown by the first appearance of yellow color in the water (not of the precipitate). Keep the liquid throughout as hot as possible. Note the volume in ml of potassium chromate consumed, and calculate parts per million of SO_4 from the attached table.

SULFATE CALCULATION TABLE

Potassium chromate used (ml)	SO_4 (ppm)	Potassium chromate used (ml)	SO_4 (ppm)
18.0	297	9.0	1,636
17.5	372	8.5	1,711
17.0	446	8.0	1,785
16.5	520	7.5	1,859
16.0	595	7.0	1,934
15.5	669	6.5	2,008
15.0	744	6.0	2,082
14.5	818	5.5	2,157
14.0	892	5.0	2,231
13.5	967	4.5	2,306
13.0	1,041	4.0	2,380
12.5	1,116	3.5	2,454
12.0	1,190	3.0	2,529
11.5	1,264	2.5	2,603
11.0	1,339	2.0	2,677
10.5	1,413	1.5	2,752
10.0	1,487	1.0	2,826
9.5	1,562	0.5	2,900

g. Chloride Determination

Apparatus

- 1 burette, 50 ml
- 1 graduate, 100 ml
- 1 Erlenmeyer flask, 500 ml

Reagents

- 0.1*N* Silver nitrate solution
10% Potassium chromate indicator

Procedure

Measure by means of a graduate 100 ml of a clear, filtered sample into an Erlenmeyer flask. Add 1 ml of potassium chromate and titrate to a slightly red end point with 0.1*N* silver nitrate solution. Calculate the amount of chlorides as Cl as follows: Cl (ppm) = ml 0.1*N* silver nitrate \times Normality \times 355

h. Test Reagents

Name of reagent	Preparation	Used in analysis of
1. Phenoldisulfonic acid	Dissolve 25 gm of pure white phenol in 150 ml of pure concentrated H ₂ SO ₄ . Add 75 ml of fuming H ₂ SO ₄ (15 per cent free SO ₃); stir well. Heat for 2 hours at about 100° C	NO ₃
2. Approximately 12 <i>N</i> KOH	Dissolve 672 gm of KOH in about 500 ml H ₂ O and dilute to 1000 ml.	NO ₃
3. Approximately 0.2 <i>N</i> KMnO ₄	Dissolve 6.3 gm of KMnO ₄ in about 500 ml H ₂ O and dilute to 1000 ml. Store in dark bottle.	NO ₃
4. Standard KNO ₃ Solution	Dissolve 34.4099 gm BaCl ₂ · 2H ₂ O in 1000 ml Solution contains 1000 ppm nitrate.	NO ₃
5. Standard BaCl ₂ Solution	Dissolve 34.4099 gm BaCl ₂ · 2H ₂ O in 1000 ml distilled water. If desired, standardize with AgNO ₃ volumetrically.	SO ₄
6. Standard K ₂ CrO ₄ Solution	Dissolve 13.6338 gm K ₂ CrO ₄ in 1000 ml distilled water. If desired, standardize with BaCl ₂ .	SO ₄
7. Approximately <i>N</i> HCl	Dilute 100 ml of conc. HCl to 1000 ml with distilled water.	SO ₄
8. Approximately 2 <i>N</i> NH ₄ OH	Dilute 125 ml of ammonium hydroxide to 1000 ml with distilled water.	SO ₄
9. Silver Nitrate 0.1 <i>N</i>	Dissolve 16.989 gm of C.P. AgNO ₃ in dist. water and dilute to 1000 ml. Standardize with 0.1 <i>N</i> C.P. NaCl.	Cl
10. Potassium Chromate (10%)	Dissolve 100 gm of C.P. K ₂ CrO ₄ in dist. water and dilute to 1000 ml.	Cl
11. Ammonium Molybdate Solution	Dissolve 12 gm of (NH ₄) ₂ MoO ₄ in 200 ml of dist. water to which 50 ml conc. H ₂ SO ₄ was added, dilute to 1000 ml with dist. water.	P
12. Stannous Chloride Conc. Solution	Dissolve 110 gm of C.P. SnCl ₂ · 2H ₂ O in about 250 ml of conc. HCl, heat till solution is clear, cool and add conc. HCl up to 1000 ml.	P
13. Stannous Chloride Diluted Solution	Dilute 2.5 ml of concentrated stannous chloride solution to 100 ml with dist. water.	P
14. Sulfuric Acid 2%	Dilute 12 ml of C.P. H ₂ SO ₄ to 1000 ml with distilled water.	P
15. Potassium Palmitate Sol. (0.1 <i>N</i>)	Dissolve 25.6 gm of C.P. palmitic acid in a mixture of 500 ml 95% ethyl alcohol, 300 ml dist. water and 0.1 gm phenolphthalein. Heat and add clear alcoholic KOH solution till color changes to slight pink (8 gm KOH dissolved in 50 ml ethyl alcohol). After cooling, add alcohol up to 1000 ml.	Mg, Ca

Name of reagent	Preparation	Used in analysis of
16. Potassium Oxalate Sol. (10%)	Dissolve 100 gm of C.P. potassium oxalate in 1000 ml of dist. water.	Mg
17. Hydrochloric Acid 0.1N	Measure 9.5 ml conc C.P. HCl and dilute to 1000 ml with distilled water. Standardize against C.P. Na_2CO_3 .	Mg, Ca
18. Sodium Hydroxide 0.1N	Weigh about 4 gm of C.P. NaOH and dissolve in 1000 ml of dist. water. Standardize against 0.1N HCl.	Mg, Ca
19. Standard KCl Solution	Dissolve 0.0763 gm of C.P. KCl in 1000 ml of dist. water. Solution contains 40 ppm potassium.	K
20. Phenolphthalein Indicator (1%)	Dissolve 10 gm of C.P. phenolphthalein powder in 1000 ml of 95% ethyl alcohol.	Mg, Ca
21. Sodium Cobalti-Nitrite Solution	In a 250 ml vol. flask, dissolve 6.25 gm of cobalti-nitrate, $\text{Co}(\text{NO}_2)_2 \cdot 6\text{H}_2\text{O}$, and 75 gm NaNO_2 in about 175 ml of dist. water; add 5 ml of 99.5% acetic acid and mix very gently at first to prevent loss by foaming; cover with a beaker and allow to stand overnight to permit the escape of nitric oxide. Dilute to 250 ml, mix well, and filter. When stored in a refrigerator in a glass-stoppered Pyrex bottle this reagent will keep for at least 1 month.	K

Analyses for Micro Nutrient Ions. Minor element testing of the nutrient solution is usually confined to iron analysis if such testing is done. For large-scale units the use of tests for iron, manganese, boron, copper and zinc is suggested. Semi-microchemical techniques are required because the concentrations of these ions utilized in the nutrient solution are extremely low. The standard procedure, however, is to use the plant as the indicator rather than the chemical test. Plants are more accurate testers than some of the chemical tests now in use. But a tie-in between good plant growth and definitely reliable chemical tests will insure better nutritional control. The tests herein listed are inserted at this point only to offer the experienced and more advanced soilless garden operator a guide for minor element analyses. Chemical literature and the local State Agricultural Experiment Station should be consulted for more detailed information.

(a) Iron test

1. Ortho-phenanthroline test: yellowish color

Reagents

- (1) 10 per cent hydroxylamine hydrochloride solution in water.
- (2) 0.1 per cent ortho-phenanthroline¹ in 50 per cent ethyl alcohol solution.
- (3) 1 ppm ferrous iron standard solution (0.007 gram ferrous ammonium sulfate in 1000 ml water containing 0.1 ml concentrated H_2SO_4).

¹ From G. Frederick Smith Chemical Co., Columbus, Ohio.

Procedure

- (1) Use 50-ml samples of nutrient solution and standards (Nessler tubes are handy).
- (2) Add 1 ml hydroxylamine hydrochloride solution and shake.
- (3) Add 2.5 ml phenanthroline solution and shake.
- (4) Compare color in 10 minutes against 1, $\frac{1}{2}$ and $\frac{1}{4}$ ppm ferrous iron standards.

This test may utilize temporary-permanent standards. They should be checked every month and if fading occurs prepare new standards.

This procedure tests for ferric iron before reduction by the hydroxylamine solution. After reduction the total iron is determined as ferrous iron. Thus the relative amounts of both ferric and ferrous iron may be ascertained. Apparently, plants require iron in the reduced state, particularly when it is in the inorganic form.

2. Thiocyanate test: pink color

Reagents

- (1) 60N nitric acid (about 382 ml of concentrated nitric acid specific gravity of 1.42 added to 618 ml of water).
- (2) 0.2N potassium permanganate (dissolve 6.3 grams of potassium permanganate in one liter of distilled water). Store in dark bottle.
- (3) 2 per cent potassium thiocyanate solution in water.
- (4) 1 ppm ferric iron standard solution (0.0048 gram ferric chloride in 1000 ml water).

Procedure

- (1) Use 50-ml samples of nutrient solution and standards in 125-ml Erlenmeyer flasks.
- (2) Add 5.0 ml of nitric acid solution.
- (3) Boil for 10 minutes.
- (4) Add three drops of permanganate solution (pink color should remain for at least five minutes).
- (5) Cool to room temperature.
- (6) Make to 50 ml volume with distilled water in Nessler tube.
- (7) Add 5.0 ml of thiocyanate reagent.
- (8) Compare color with ferric iron standard at 1, $\frac{1}{2}$ and $\frac{1}{4}$ ppm.

Temporary standards are used each time. Only ferric iron is tested, because all the ferrous iron is oxidized to the ferric state. Further the color tends to fade more rapidly than the color developed in the ortho-phenanthroline test. The thiocyanate test is not recommended, unless the phenanthroline reagent is unobtainable.

(b) Manganese test

1. Bismuthate test: pink color

Reagents

- (1) Concentrated sulfuric acid, specific gravity 1.84.
- (2) Sodium bismuthate powder.
- (3) One ppm manganese standard solution (0.004 gram manganese sulfate in 1000 ml water).

Procedure

- (1) Use two ml samples of nutrient solution and standards in test tubes.
- (2) Add 0.2 ml sulfuric acid. CAUTION!
- (3) Cool to room temperature.
- (4) Add a pinch (about 0.1 gram) of bismuthate powder.
- (5) Shake about 30 seconds.

(6) Allow excess bismuthate to settle out.

(7) Compare color, after 30 minutes, with 1, $\frac{1}{2}$ and $\frac{1}{4}$ ppm standards.

The color should be compared as soon as the excess solid reagent settles out. If too long a period elapses beyond this point the color fades slightly. This test is suggested to be more reliable and stable than the benzidine test described below.

2. Benzidine test: blue color

Reagents

- (1) Benzidine solution (0.1 gram benzidine dissolved in 20 ml of glacial acetic acid. Dilute to 200 ml with water and filter).
- (2) 15 per cent sodium hydroxide solution.
- (3) One ppm manganese standard solution (0.004 gram manganese sulfate in 1000 ml water).

Procedure

- (1) Use one ml samples of nutrient solution and standards in spot plate.
- (2) Add two drops of benzidine solution.
- (3) Add two drops of sodium hydroxide solution.
- (4) Compare color *at once* with 1, $\frac{1}{2}$ and $\frac{1}{4}$ ppm standards.

The color developed by this test fades quite rapidly, thus it is difficult to obtain satisfactory results.

(c) Copper test: brown color

Reagents

- (1) Sodium diethyldithiocarbamate solution (dissolve 1 gram in 1 liter of distilled water). Store in dark bottle.
- (2) Ammonium hydroxide solution (add 500 ml of ammonium hydroxide, specific gravity 0.9, to 2500 ml distilled water)
- (3) 0.05 ppm copper standard solution (0.195 gram copper sulfate in 1000 ml water. Dilute one ml of this solution to one liter to make final one ppm standard).

Procedure

- (1) Use 40-ml samples of nutrient solution and standards in 50-ml Nessler tubes.
- (2) Add 5.0 ml of ammonium hydroxide solution.
- (3) Filter if a precipitate occurs.
- (4) Add 5.0 ml of carbamate reagent to filtered solution.
- (5) Compare color, in about 45 to 60 minutes, with 1, $\frac{1}{2}$ and $\frac{1}{4}$ ppm standards

The iron in the nutrient solution may interfere with the test unless it is removed. This is handled by addition of the ammonium hydroxide and subsequent precipitation.

(d) Boron and Zinc tests

Sufficient information is not available to offer recommended tests for these ions in the nutrient solution. Inspection of chemical literature, particularly colorimetric tests, is suggested for the interested reader. Experimentation with published methods of analyses will indicate the suitability to nutrient solutions if a definite need arises for a particular culture unit.

Other Analyses

The analyses discussed here are not directly concerned with the nutrient solution. But they are necessary parts of the analysis scheme required for the commercial soilless culture unit. These tests are (1) a method for a simple water titration, (2) a test method for formaldehyde used in sterilizing the gravel and (3) plant tissue tests.

Water Titration. In cases where the water supply is quite variable, it is recommended to titrate the water to ascertain its acid requirements. This matter was discussed in Chapter 7 under the pH adjustment of the nutrient solution section. The following procedure is a simple volumetric titration except that the sample is titrated to a definite pH value rather than to a definite end point or a complete color change of a standard titration indicator.

Apparatus

- 1 burette stand
- 1 burette, 50-ml
- 1 graduate, 1000-ml
- 1 beaker, 1000-ml
- 1 porcelain coor, No. 1 (spot plate)
- 1 pH comparator block
- 1 set chlorophenol red pH standard tubes

Reagents

- (a) 1-1000 H_2SO_4 (add 1 ml concentrated H_2SO_4 to 999 ml distilled water)
- (b) Chlorophenol red pH indicator solution

Procedure

Place a 1000-ml sample of water in the beaker. Dispense 1-1000 sulfuric acid from the burette into the water by 1 to 2-ml increments. (Experience will indicate the rate of addition for the specific conditions to save time. In Aruba 10 ml of acid are added first, then 2-ml increments follow until pH 6.2 is reached, wherein 1-ml additions follow until the final pH is reached.) Stir the sample well with the glass rod. Transfer by means of the glass rod about 1 ml of the acidified water to a depression on the spot plate (almost fill a depression). Add one drop of chlorophenol red solution to this 1-ml sample. Stir with a glass rod and compare the color with standard tubes. Continue these operations until the water sample is adjusted to pH 5.7 to 6.0. Calculate the amount of concentrated sulfuric acid required for the number of gallons of water added to the nutrient solution by the following formula:

$$\text{ml conc. H}_2\text{SO}_4 = \text{ml 1-1000 H}_2\text{SO}_4 \times 0.0038 \times \text{number gallons water needed.}$$

A chart may be calculated for convenience for use by untrained personnel.

Analyses for Formaldehyde. When formaldehyde is used to sterilize the medium, all of it must be removed prior to replanting

the beds. The reagent used to test for ammonium gives a similar reaction for formaldehyde. The coloration and turbidity produced are read in the same manner.

The test is used for two purposes. In order to conserve formalin, it is often desired to sterilize only a few beds at a time. Then the residual solution is tested, brought up to full strength and then pumped into the neighboring beds. The second purpose is to test the final wash water to ascertain if all the formaldehyde is removed from the gravel.

A. Range of Test. The formalin solution must be highly diluted in order to fit the readable range of the test. Usually dilution factors of the samples (unknowns and standards) are of the magnitude of 1-200, 1-100 and 1-50.

B. Standards for Comparison. A sample of 1-100 formalin (37 per cent formaldehyde) is used as the temporary standard.

C. Use of the Test and Calculation of Results. Three dilutions of the above standard solution are used, namely 1-200, 1-100 and 1-50. Usually one dilution at 1-50 of the used formalin from the beds just sterilized is compared at the same time with the standards. If the unknown sample at 1-50 dilution compares with the standard at 1-50 dilution, the formalin solution is still at full strength. If the unknown compares with the 1-100 dilution of the standard, only 50 per cent of the formalin is present in the sterilizing solution. Likewise, if the unknown compares with the 1-200 dilution of the standard, it is only at 25 per cent strength, that is, 75 per cent of the formalin has been used up.

A specific illustration will fully explain the above instructions. First, a sample of the used formalin solution from the gravel beds is diluted 1-50 with distilled water. In other words, 1 ml of the old formalin solution is mixed with 49 ml of water in a 50-ml graduate. Second, the standard solution is diluted at 1-200, 1-100 and 1-50 by adding 1 ml to 199 ml, 99 ml and 49 ml of water, respectively. An aliquot is taken from each of these diluted solutions for the test.

After the sterilizing bed is washed, a sample of the final wash water is checked for residual formalin. The test reaction is checked against a tap-water blank because the reagent gives a slight yellow cast to the solution. If a negative test results, the beds are ready for replanting.

D. Testing Procedure

- (a) Add 5.0 ml reagent No. 9 (quick tests) to test tube.
- (b) Add 1.0 ml sample solution.
- (c) Shake.
- (d) Read at once.
- (e) Compare yellowish to orangeish turbidity.

E. Test Reagents

- (a) Reagent No. 9.
(Nessler's reagent used in quick tests)
- (b) Formalin standard
1.0 ml 37 per cent formaldehyde (commercial grade)
99.0 ml water (tap)

F. Materials

- (a) Four glass vials (see quick tests).
- (b) Four graduates, 100-ml capacity.
- (c) Four pipettes, 1-ml, graduated to 0.1 ml.
- (d) Four pipettes, 1-ml, volumetric.
- (e) One pipette, 5-ml, volumetric.
- (f) Four beakers, 100-ml capacity.
- (g) One reagent bottle, one pint (for standard).

Plant Tissue Test. Sometimes it is of value to test the plant tissue to check up on the plant growth. Several methods are available, but the following technique lends itself to rough quantitative estimate. The reagents used for the quick test methods are used to test the mineral element concentration within the plant tissue. Carbohydrate level is checked by an iodine-potassium iodide reagent.

About one gram of tissue, either leaf petiole and blade or young stem material is finely cut with a knife. Then this tissue is ground with some pure quartz or silica sand in a small mortar. The ground material is stirred with 10 ml of distilled water and filtered into a large test tube. Add about $\frac{1}{4}$ teaspoon (level full) of charcoal¹ to this filtered tissue extract. Stopper the test tube and shake side-wise for about one minute. Allow the solution to settle and decant the cleared solution (it may be slightly greenish). This solution is used for analyses. If qualitative data are desired, no dilution is necessary. Quantitative analyses will require proper dilution of the extract. Remember that an extraction factor of 10 must be considered along with any extract dilution factor in the calculation of the quantitative data.

¹ Darco G, activated charcoal; Darco Sales Corporation, New York.

A qualitative estimation of the tissue carbohydrates may be ascertained with an iodine-potassium iodide reagent. The chlorophyll (green coloring matter) of the leaf blade is removed by boiling a few minutes in 95 per cent ethyl alcohol or in acetone. Then remove the bleached leaf and transfer to a beaker full of warm iodine reagent. Allow it to remain in this solution for a minute or two. Remove and observe the relative degree of blue-black to light brown coloration of the leaf blade. A dark blue-black color indicates an ample carbohydrate (as starch) supply. The iodine-potassium iodide reagent is prepared by dissolving 3.0 grams of potassium iodide in about 25 ml of water. Next add 0.6 gram of iodine and stir until dissolved. Sometimes a very slight amount of heat is helpful, but do not volatilize the iodine. Finally, make up the volume to 200 ml with distilled water and store in a dark bottle in a cool place.

Selected Reference List

This reference list is by no means complete, but it offers the interested student a source of information in case further detail is desired. It is felt that the list offers a good basis for a practical reference upon soilless culture methods and technicalities.

Books

- Connors, C. H., and Tiedjens, V. A., "Chemical Gardening for the Amateur," Wm. H. Wise & Co., N. Y., 1939.
- Gericke, W. F., "The Complete Guide to Soilless Gardening," Prentice-Hall Inc., N. Y., 1940.
- Hambidge, Gove, Editor, "Hunger Signs in Crops," The American Society of Agronomy and the National Fertilizer Association, Published by Judd and Detweiler, Washington, D. C.
- Hald, F. D., "Manual of Plant Diseases," McGraw-Hill Book Co., Inc., N. Y., 1933.
- Laurie, Alex, "Soilless Culture Simplified," Whittelsey House, N. Y., 1940.
- Metcalf, C. L., and Flint, W. P., "Destructive and Useful Insects," McGraw-Hill Book Co., Inc., N. Y., 1939.
- Meyer, B. S., and Anderson, D. B., "Plant Physiology," D. Van Nostrand Co., Inc., N. Y., 1939.
- Miller, E. C., "Plant Physiology," McGraw-Hill Book Co., Inc., N. Y., 1939.
- Turner, W. I., and Henry, V. A., "Growing Plants in Nutrient Solutions," John Wiley & Sons, Inc., N. Y., 1939.

Bulletins and Circulars

- Alexander, L. J., Morris, V. H., and Young, H. C., "Growing Plants in Nutrient Solution," Special Circular 56, Ohio Agr. Expt. Sta., Wooster, Ohio, 1939.
- Ball, Victor, "Gravel Crops," Published by Geo. J. Ball, Inc., West Chicago, Ill., 1939.
- Ball, Victor, "Gravel Crops and Sub-irrigation," Second Edition, Published by Geo. J. Ball, Inc., West Chicago, Ill., 1941.
- "If They Could Speak," Chilean Nitrate Educational Bureau, Inc., N. Y., 1941.
- Davis, M. B., and Hill, H., "Tomatoes Make Known Their Diet Needs" (Central Experimental Farm, Ottawa, Canada). Reprint from *Better Crops with Plant Food Magazine*, American Potash Institute, Inc., Washington, D. C.
- Dunlap, A. A., "The Sand Culture of Seedlings and Mature Plants," Connecticut Agr. Station Circular 129, New Haven, Conn., 1939.
- Eaton, F. M., "Automatically Operated Sand-culture Equipment," Reprinted from *Journal of Agricultural Research*, 53, 443-444, Washington, D. C. (1936).
- Fisher, P. L., "Responses of the Tomato in Solution Cultures with Deficiencies and Excesses of Certain Essential Elements," Maryland Agricultural Experiment Station, Bulletin No. 374, College Park, Maryland, 1935.
- Gericke, W. F., and Tavernetti, J. R., "Heating of Liquid Culture Media for Tomato Production," Reprinted from *Agricultural Engineering*, 17, 141-143 (1936).
- Gustafson, F. G., "Parthenocarpic and Normal Fruits Compared as to Percentage of Fruiting and Size." Reprint from *Botanical Gazette*, 102, 280-286 (1940).
- Gustafson, F. G., " β -Naphthoxyacetic Acid As an Inductor of Parthenocarpy in Tomatoes." Reprint from *Journal of American Society for Horticultural Science*, 40, 387-389 (1942).

- Hill, H., and Davis, M. B., "Chrysanthemums Thrive in Sand Cultures" (Central Experimental Farm, Ottawa, Ontario). Reprint from *Better Crops with Plant Food Magazine*, American Potash Institute, Inc., Washington, D. C.
- Hill, H., "Malnutrition Symptoms and Plant Tissue Tests of Vegetable Crops" (Central Experimental Farm, Ottawa, Canada). Reprint from *Better Crops with Plant Food Magazine*, American Potash Institute, Inc., Washington, D. C.
- Hoagland, D. R., and Arnon, D. I., "The Water-culture Method for Growing Plants without Soil," California Agricultural Experiment Station Cir. 347, Berkeley, Calif., 1938.
- Jones, L. H., "Relation of Soil Temperature to Chlorosis of Gardenia," Reprint from *Journal of Agricultural Research*, 57, 611-621 (1938).
- Kiplinger, D. C., and Laurie, Alex., "Growing Ornamental Greenhouse Crops in Gravel Culture," Ohio Agr. Expt. Sta. Bul. 634, Wooster, Ohio. 1942.
- Laurie, Alex, and Kiplinger, D. C., "Culture of Greenhouse Roses," Ohio Agr. Expt. Sta. Bul. 654, Wooster, Ohio, 1941.
- Laurie, Alex, and Kiplinger, D. C., "Growing Ornamental Greenhouse Crops in Gravel Culture," Ohio Agr. Expt. Sta. Bul. 616, Wooster, Ohio. 1940.
- Mitchell, J. W., and Rice, R. R., "Plant-growth Regulators," United States Department of Agriculture, Misc. Pub. No. 495, Washington, D. C.
- Morgan, M. F., "Microchemical Soil Tests," Connecticut Agricultural Experiment Station, Bul. 333, New Haven, Conn. 1932.
- Peach, M., and English, L., "Rapid Microchemical Soil Tests," *Soil Science*, 57, 167-195 (1944).
- Shive, J. W., and Robbins, W. R., "Methods of Growing Plants in Solution and Sand Culture," New Jersey Agr. Expt. Sta. Bul. 636, New Brunswick, N. J., 1942.
- Spurway, C. H., "Soil Testing—A Practical System of Soil Fertility Diagnosis," Mich. Agr. Expt. Sta. Bul. 132, Lansing, Mich., 1938
- Strong, M. C., "The Effect of Various Growth-promoting Chemicals on the Production of Tomato Fruits in the Greenhouse," Reprint from *Michigan Agricultural Experiment Station Quarterly Bull.*, 24, 56-64 (1941).
- Thompson, R. C., and Horn, N. L., "Germination of Lettuce Seed at High Temperature (25 to 35° C) Stimulated by Thiourea," Reprint from *Journal of American Society for Horticultural Science*, 45, 431-439 (1944).
- Withrow, R. B., Biebel, J. P., and Eastwood, T. M., "Nutrient Solution Culture of Greenhouse Crops," Purdue University Agricultural Experiment Station, Circular 277, Lafayette, Indiana, 1943.
- Withrow, R. B., "Hydroponics," Technical Mimeograph Manual for United States Army Air Force Hydroponics Units, 1945.

Periodicals

- Anon., "New Soilless Gardens," *Science News Letter*, November 24, 1945.
- Ball, Victor, "A Garden Grows on Iwo," *Grower Talks*, Geo. J. Ball Company. Vol. 9, No. 10, February 1946 (back cover).
- Schriftgiesser, C., "Army Grows Miracle Salad On Mid-Atlantic Rock," *Newsweek*, May 21, pp. 38-39, 1945.
- Thone, F., "Vegetables Without Soil," *Science News Letter*, June 16, 1945.
- Vogel, M. R., "Gardens Without Soil," *Compressed Air Magazine*, 50, 161-163 (1945).

Index

(Asterisk refers to illustration)

- A**bsorption, 6, 7
- Acidity,
adjustment of, 157-160
definition of, 155
effect on plants, 156
of nutrient solutions, 155-160
 in gravel culture, 85, 128
 in sand culture, 61, 82
 in water culture, 45, 60
see also pH
- Acids, 125, 138, 140, 158
see also Nitric acid, Phosphoric acid,
Sulfuric acid
- Aeration,
device for, 47, 54 *
and drainage, 179
effect on nutrient concentration, 169
forced, 46,* 47, 54
in gravel culture, 87, 88
in sand culture, 63
in water culture, 47, 54
- Aerosol, 234, 236
- Alexander, Dr. L. J.*, 24
- Algae, 46, 72, 96
- Alkalies, 87, 158
see also Ammonium hydroxide, Potassium hydroxide, Sodium hydroxide
- Alkalinity of media, 62, 87, 169
- Amling, A. F., Co.*, 35
- Ammonium hydroxide, 139, 140, 158
- Ammonium ion,
in acidity, 156
concentration of, 190
and growth control, 190
test for, 245, 246
- Ammonium nitrate, 134, 135, 137, 191
- Ammonium sulfate, 134, 135, 136, 157, 191
- Ants, 225
- Arasan, 221
- Asphalt, 41,* 52, 55, 56,* 57, 68, 72, 73, 76,
77, 78, 111, 112, 114, 206
- Asphalt-sand mix, 113
- Assimilation, 7, 13, 17
see also Metabolism
- Aster, 37, 38
- B**acteria, 221
- Ball, Geo. J., Inc.*, 34, 91,* 93,* 99,* 111,*
121 *
- Bedding, *see* Litter
- Beds,
in gravel culture, 30, 34,* 110-115
improvement of, 35, 36
in sand culture, 70, 71,* 73, 76, 82
see also Litter tray
- Begonia, 2-3,* 50,* 219 *
- Benches, *see* Beds
- Birds, 226
- Blossom development, 192
see also Bud set
- Blue lace flower, 28
- Borax, 131, 138, 139
- Boric acid,
in nutrient solutions, 138, 139, 154, 170
source of boron, 131
- Boron,
deficiency, 17, 214
functions of, 17
in nutrient solutions, 131, 138, 144, 153,
170
in plant, 17
test for, 261
toxicity, 216, 218
- Boyce Thompson Institute for Plant Research*, 219,* 236
- Broz, Dr. R. K.*, 253
- Brundin, Ernest*, 24 *
- Bucket and gravity unit, 90, 91 *

- Bud set, 185, 187, 192
 Buffer action, 11, 15, 46, 86, 157
- C**
 Cabbage, 28
- Calcium,
 deficiency, 14, 214
 functions of, 14
 in nutrient solution, 130, 135, 136, 165, 167
 in plant, 14
 tests for, 245, 249, 256
 toxicity, 216
- Calcium chloride, 135, 136, 137
 Calcium nitrate, 133, 134, 135, 136
 Calcium phosphate, 86, 125, 136
 Calcium sulfate, 134, 135, 136, 137, 146
 Calendulas, 37, 38
California Agricultural Exper. Sta., 22, 152 *
- Cambium tissue, 3, 4
 Candy tuft, 28
- Carbohydrate,
 composition of, 8
 function of, 1, 5
 metabolism, 8, 14, 15, 17
 testing level of, 264
- Carbon, 3, 9
 Carbon dioxide, 6, 194
 Carbon monoxide, 195, 218
- Carnation,
 cuttings, 59
 in gravel culture, 35, 37, 38, 39
 and rust, 196
 in sand culture, 28
- Carrot, 51, 59
- Catalyst,
 boron as, 17
 chlorophyll as, 6
 copper as, 18
 enzymes as, 5
 iron as, 16
 manganese as, 17
 minerals as, 11
 potassium as, 13
- Celery, 36,* 202
- Cell, 1, 4
 effect of nutrients on, 13-18
see also Cambium tissue
- Cellulose, 1, 8
Central Experimental Farm, 29
- Chemicals,
 as hormones, 233
 ionic form of, 130
 necessary to plant, 133-140
 supply houses for, 136, 139, 140
see also Macro elements, Micro elements
- Chloride ion,
 effect on plant, 165, 168, 189
 limits of, 168
 tests for, 245, 250, 257
- Chlorine,
 solutions, 222
 in water, 220
- Chlorophyll, 3, 6, 16, 17, 18
- Chrysanthemum,
 in gravel culture, 35, 37, 38, 39
 in sand culture, 28, 63
 in slop culture *vs.* dry salt, 84 *
 temperature for, 192
 water requirements of, 177
- Churchward, Ross*, 37
- Cinders,
 in gravel culture, 40, 87, 124, 125
 in sand culture, 62, 76
- Circulation of nutrient solution, 48
- Cistern, 77, 117-120, 161 *
- Cleaning out crops, 212
- Climate, 177, 188
see also Environment
- Coleus, 66,* 68
- Compressed-air sprayer, 208-210
- Compressed air unit, 95-98, 96 *
- Concrete,
 for beds, 76, 110
 for flumes, 105
 for tanks, 55, 105, 117, 118
- Conducting bundles, 3
- Containers, 55-57, 68, 69,* 70,* 71,* 75,*
 77, 101-103, 117-120, 161 *
see also Beds, Tanks
- Copper,
 deficiency, 18, 214
 functions of, 18
 in nutrient solution, 131, 138, 144, 153, 170
 test for, 261
 toxicity, 216
- Copper chloride, 138, 139
- Copper sulfate, 138, 139, 154, 170
- Cooling, 49, 185-187
- Coral, crushed, 124, 190

- Corn, 46,* 47 *
- Costs for soilless growth, 21, 32, 37, 44, 89
- Crops, list of, 201
see also individual crops
- Cucumber,
and chloride ion, 189
in gravel culture, 5,* 30-31,* 40, 44
nutrient solution for, 130
with soil blocks, 229
temperature for, 183, 192
in water culture, 23, 25, 26,* 56
water requirements for, 177
- Culture methods, 19, 21-44
see also Drip culture, Dry salt culture, Gravel culture, Sand culture, Slop culture, Water culture
- Cupric ion, *see* Copper
- Cuttings, propagation of, 11, 204, 205
see also Transplanting
- D**affodil, 38
- Damping off, 78, 128, 171 181, 221, 224
- Davis, J. W., Co., 24, 30-31,* 39, 113
- DDT, 225
- 2,4-Dichlorophenoxyacetic acid, 234
- Dicots, 2, 4
- Digestion, 5
- Dillon, J. L., 37
- Direct-feed unit, 100
- Diseases of plant, 213-225
bacterial, 221
control of, 221-224
fungous, 181, 221
and humidity, 196
due to mineral deficiency, 213-215
due to mineral toxicity, 215-218
and shade, 194
due to spray, 220
due to toxic gases, 218-220
virus, 221
due to water unbalance, 220
- Dowicide B, F, G, 223
- Drainage,
and aeration, 179
in gravel culture, 87, 89, 117
in sand culture, 63, 68
trench, 41,* 103, 117, 175 *
see also Flume unit
- Drip culture,
flushing in, 65, 82
nutrient solution for, 82
unit for, 72-75
water application to, 80
see also Sand culture, Slop culture
- Dry salt culture,
advantages of, 83
application of, 59, 76
nutrients for, 83
vs. slop culture, 84 *
see also Sand culture
- E**aton, Dr. Frank M., 75, 82
- Eggplant, 204 *
- Environment, 191-197
see also Climate
- Enzymes, 5, 8, 13, 17
- Epsom salt, 83, 135, 136, 137, 146
- Equivalent solution, 132
- Euphorbia, 63
- Excelsior, 56,* 58, 186
- F**ats, 1, 5, 8
- Ferric ammonium citrate, 137, 138, 157
- Ferric ion, 131, 156
- Ferrous ion, 131, 156, 170
- Ferrous sulfate, 137, 138, 139, 151, 170
- Fertilizer, 21, 83
- Flagler Farms, 32,* 42, 175,* 248 *
- Flower,
cuttings, 204
development, *see* Bud set, Blossom development
parts of, 3
- Flume unit, 105, 106,* 117, 175 *
- Flushing medium,
in drip culture, 65
in gravel culture, 87, 89, 210
in sand culture, 64
- Food, *see* Metabolism
- Formaldehyde,
solution, 221, 223
test for, 262
- Formulas for nutrient solutions, 141-143
- Fruiting effects,
and hormones, 233-235
and pumping, 182
and shade, 194
and temperature, 193
- Fuchsia, 70 *
- Fumes, *see* Gases, toxic

Fumigants, *see* Sprays
Fungi, 181, 221

Galvanized materials, 124

Gardenia,

- bud set, 182, 187, 192
- by gravel culture, 39
- temperature for, 185

Gases, toxic, 218, 219 *

Geranium, 71,* 72 *

Gericke, Dr. W. F., 22

Germination, *see* Seed germination

Glass wool, 63, 70,* 71,* 98, 99,* 187

Gloxinia, 70 *

Granite, crushed, 62, 87, 124

Gravel,

- calcareous, 40, 87, 124
- characteristics of, 124
- sterilization of, 223
- types of, 124

Gravel culture, 29-44, 85-128

- advantages of, 30-34
- applications of, 30, 41
- costs of, 32, 37, 44
- crops by, 5,* 7,* 9,* 32, 35, 37, 38, 39, 40, 203,* 204 *

cultural problems of, 85-90

definition of, 29

unit construction, 90-126

unit operation, 30, 126-128

Gravity feed units, 101-110

closed, 108-110, 109 *

open, 101-108, 102 *

Growth of plants,

- and nutrient ion balance, 163, 213-217
- and osmotic concentration, 162
- and pH, 156, 157

Hardening of plants, 188, 205

Harvesting, 211

Hay, 58

Haydite,

- in gravel culture, 37, 38, 87, 124, 125
- in sand culture, 29,* 62

Heating, 48, 183

units, 49, 183, 184

Hill and Davis, 83

Hormones, 233-236

- application of, 234-236
- chemicals as, 233

for fruiting, 11, 233-236

for rooting, 233

Hoses, 78

Humidity, 195

Hyacinth, 51 *

Hydroponics, definition of, 22

Indoleacetic acid, 233

Indolebutyric acid, 233

Indolepropionic acid, 233

Insecticides, *see* Sprays

Insects, 197, 225

Iris, 28, 38

Iron,

deficiency, 16, 214

functions of, 16

level, 46, 62, 86

in nutrient solution, 137, 138, 144, 153

in plant, 16

test for, 259

toxicity, 217

Iron citrate, 137, 138, 139, 157, 170

Iron tartrate, 137, 138, 139, 157, 170

Labor requirements, 21

Lago Oil & Transport Co., Ltd., Aruba,

N. W. I., 9,* 33,* 34,* 42, 92,* 102,*

121,* 164,* 179,* 181,* 183,* 200,*

207,* 238 *

Lanolin, 234

Larkspur, 28

Laurie, Alex, 83

Leaching, 87, 125

see also Flushing medium

Leaf, 3

Lettuce,

in gravel culture, 44

nutrient solution for, 130, 190, 191

in sand culture, 65, 76

seed germination, 187, 193, 232

in shade, 181,* 186, 194

sunlight for, 193

temperature for, 192

in thiourea solution, 232

in water culture, 51

water requirements of, 177

Light, 46, 72, 96

see also Sunlight

Lily, 38

Lima bean, 193

- Limestone, crushed, 124
 Liqua-Nure, 229, 231,* 232
 Litter,
 depth of, 49
 material for, 56,* 57
 porosity of, 50
 tray, 22, 48, 56,* 57
 see also Bed
 Lizards, 226
 Lye, 125
- M***McFarland, F. E.*, 28
 Macro elements, 12-16, 129, 133-137, 141-150, 164-168
 see also Calcium, Magnesium, Nitrogen, Phosphorus, Potassium, Sulfur
 Magnesium,
 deficiency, 14, 214
 and fertilizers, 83
 functions of, 13
 in nutrient solution, 130, 135, 136, 165, 167
 in plant, 13
 tests for, 245, 247, 250, 256
 toxicity, 216
 Magnesium chloride, 139
 Magnesium sulfate, 133, 135, 136, 137, 146
 Magnetite, 62
 Manganese,
 deficiency, 17, 214
 functions of, 17
 in nutrient solution, 131, 138, 144, 170
 in plant, 16
 test for, 260
 toxicity, 217
 Manganese chloride, 138, 139
 Manganese sulfate, 138, 139, 154, 170
 Manure extracts, 229-232
 Mass flow theory, 9
 Media,
 alkaline, 87, 169
 for gravel culture, 87, 124-126
 for sand culture, 62, 77
 Meristem activity, *see* Cambium tissue, Cell
 Metabolism, 7-9, 17
 Mica, granulated, 63
 Mice, 226
 Micro elements, 16-18, 129, 137-144, 151-154, 168-171
 see also Boron, Copper, Iron, Manganese, Zinc
 Milliequivalent concentration, 132
 Millimolar system, 132
Mineral Maid Gardens, 149,* 150*
 Minerals, 1, 2, 19
 deficiencies of, 213-215
 functions of, 11-18
 toxicities of, 215-218
 see also Macro elements, Micro elements
 Mitosis, 4
 see also Cell
Modern Farms, 31,* 42, 161,* 241,* 247*
 Modified slop culture, 75, 76
 Moisture, *see* Water
 Molal solution, 131
 Molar concept, 131
 Monocalcium phosphate, 134, 135, 146
 Monocots, 2, 4
 Monopotassium phosphate, 133, 135
 Motors, 93, 120, 121,* 122
 Mulch, 186, 202-204, 206
 Multiple cropping, 199
- N**aphthalene acetamide, 233
 Naphthaleneacetic acid, 233
 Naphthalenebutyric acid, 233
 β -Naphthoxyacetic acid, 233, 234
 β -Naphthoxypropionic acid, 234
 Narcissus, 28
 Nematodes, 225
New Jersey Agricultural Exper. Sta., frontispiece, 2-3,* 27, 28, 29, 52,* 53,* 59,* 73**
 Nitrate ion, 130, 165, 167
 tests for, 245, 246, 249, 254
 Nitrate-nitrogen, 2, 7, 13, 14, 15, 16
 Nitric acid, 138, 140, 158
 Nitrogen,
 deficiency, 12, 214
 functions of, 12
 in nutrient solution, 130, 134
 in plant, 12
 tests, *see* Nitrate ion
 toxicity, 216
 Nitrophoska, 83
 Normal concept of solutions, 132
 Nutrient solution, 129-154
 acidity of, 45, 61, 85, 155-160

- Nutrient solution, (*continued*)
 aeration of, 47, 63, 87, 88, 169
 analysis of, 237-261
 calculations and measurements for,
 131-133, 134, 141-149, 151
 changing of, 171-173
 chemicals for, 129, 133-140, 142, 143
 circulation, 48, 117, 175 *
 composition of, 141
 concentration of, 130, 163-171, 187, 224
 containers, 55-57, 68, 77, 101-103, 117-
 120, 161 *
 control of, 45, 155-173
 drainage of, 63, 87, 89
 dry salt mix, 146-150
 formulas for, 141-143
 in gravel culture, 85, 89, 127, 128
 iron level of, 46, 62, 86
 phosphate level of, 45, 61, 86, 157
 physical aspects of, 46-49, 62-66, 86-90
 preparation of, 141-154
 pumping cycle for, 174-182
 and rainfall, 49, 66, 90
 and root darkness, 46
 in sand culture, 61-66, 81-83
 stock solutions for, 141, 144
 temperature of, 48, 65
 theory of, 129-133
 and type of medium, 62
 water for, 140
 in water culture, 45-50, 60
 volume of, 89, 127, 160-163, 181
- O**hio State Agricultural Exper. Sta.,
 46,* 47,* 48, 73, 80, 82, 95,* 96,* 97,*
 115,* 157, 176,* 235
- Ohio State University, 29, 95, 113, 218
- Okra, 193
- Osmosis, 2, 6, 13
- Osmotic concentration, 130, 160-162, 165
- Osmotic pressure, 161
- Oxygen, 6, 9, 22, 47
see also Aeration
- P**aint, 72, 112
- Palisade cells, 3
- Pan American World Airways Co., 23
- Parts per million concept, 133
- Pea, 193
- Peat moss, 28, 58, 62, 63, 80, 204
- Pepper, 9,* 207 *
- Pests, 225
- Petunia, 63, 65, 72 *
- pH,
 determination of, 237-239
 optimum for plants, 130
see also Acidity
- Phenol salts, chlorinated solution, 223
- Phloem tubes, 2, 9
- Phosphate, 135
 ion, 131, 167
 leaching with, 87
 level, 45, 61, 86, 157
- Phosphoric acid, 138, 140, 158
- Phosphorus,
 deficiency, 15, 214
 functions of, 15
 in nutrient solution, 134, 135, 165
 in plant, 15
 tests for, 245, 246-249, 255
 toxicity, 216
- Photosynthesis, 6
- Pine, 65
- Piping systems,
 in gravel culture, 96, 101, 118, 124
 in sand culture, 77
- Plant,
 functions of, 4-18
 structure of, 1-4
 tissue test, 264
- Poinsettia, 2-3 *
- Pollination, 4, 11
- Potassium,
 deficiency, 13, 214
 functions of, 13
 in nutrient solutions, 130, 134, 165, 167,
 188
 in plant, 12
 tests for, 245, 248, 249, 254
 toxicity, 216
- Potassium chloride, 134, 135
- Potassium hydroxide, 139, 140, 158
- Potassium nitrate, 134, 135, 146
- Potassium sulfate, 134, 135
- Potato, 23
- Proteins, 8
- Protoplasm, 1, 6, 10
- Pumice, 63, 71 *
- Pump and motor unit, 93, 94 *
- Pumping,
 and aeration, 178-180

- cycles, 174-182
 diseases and, 177, 181
 factors affecting, 175-177
 frequency of, 174, 177
 in gravel culture, 88, 89, 126
 and soil blocks, 229
 speed of, 178-181
 time of, 178
 Pumps, 30,* 48, 77, 93, 94,* 100, 103, 108,
 119, 120, 121,* 122, 126
Purdue University Agricultural Exper. Sta., 7,* 29, 100, 235, 239
 Pyrethrum, 225
- Q**uartz sand, 62
- R**adish,
 in gravel culture, 44
 nutrient solution for, 190
 in sand culture, 65, 79 *
 seedlings, 79 *
 shade for, 194
 water requirements of, 177
- Rainfall, 197
 in gravel culture, 90
 in sand culture, 66
 in water culture, 49, 50, 153 *
- Rasmussen, A., and Son*, 40
- Rats, 226
- Removing old plants, 212
- Reproduction, 10
- Reservoir, *see* Cistern, Tanks, Containers
- Respiration, 5
- Rhode Island Agricultural Exper. Sta.*, 27
- Rise of Solutes in plant, 9
- Rock wool, 63
- Root,
 aeration, 17, 47, 63, 88
 darkness, 46
 function of, 2
 growth and acidity, 156
 hairs, 6
 hormones, 230,* 233
 injury by spray, 220
 nodules on legumes, 15, 17
- Root pressure theory, 10
- Rose,
 in cinder, 40
 diseases of, 181, 196
 in gravel culture, 37, 39, 40, 97 *
- in Haydite, 29 *
 nutrient solution for, 189
 in sand culture, 67,* 68, 73,* 74,* 76
 temperature for, 192
 transplant with soil block, 229
 in water culture, 51
Ruetenick Gardens, 24, 25,* 26 *
- S**alts, *see* Chemicals, Minerals
- Sand, 58, 62, 63, 77
 Sand culture, 27-29, 61-84
 advantages of, 27
 applications of, 27
 costs of, 29
 crops by, *frontispiece*,* 2-3,* 66,* 67,*
 71,* 73,* 74,* 76
 cultural problems of, 61-66
 definition of, 27
 unit construction, 67-78
 unit operation, 27, 78-84
see also Drip culture, Dry salt culture,
 Slop culture
- Santobrite, 223
- Sawdust, 58
- Seasons, 188
- Seed germination,
 device for, 59 *
 in gravel culture, 126, 202-204
 in sand culture, 28, 78
 and temperature, 187, 193
 in water culture, 58
- Seed protectants, 221
- Seed sterilization, 221
- Shade, 40,* 181,* 186, 192, 194
- Shell Oil Co. (C.P.I.M.)*, *Curacao*,
N.W.I., 35,* 36,* 37,* 42, 98,* 108-
 110, 109,* 113, 167,* 203,* 204 *
- Silica sand, 62
- Siphon devices, 68, 69,* 75,* 101, 108, 110
- Slop culture,
vs. dry salt culture, 84 *
 modified, 75, 76
 solution application to, 80, 81
 unit construction, 68-72
see also Sand culture
- Snapdragon,
 in gravel culture, 35, 38, 39
 in sand culture, 28
- Sodium hydroxide, 125, 139, 140, 158
- Sodium nitrate, 134, 135, 136

- Sodium silicate**, 111, 218
- Soil blocks**, 227-229
- Soilless culture**,
 adaptability of, 21
 advantages of, 20
 definition of, 19
 functions of, 19
vs. soil culture, 19-21
 in tropics, 41-44
- Solution**, *see* Nutrient solution
- Spacing of plants**, 198
- Spergon**, 221
- Sphagnum**, 58
- Spinach**, 65
- Sprayer**, compressed air, 207,* 208-210
- Sprays**, 206-210, 220, 221, 225, 226
- Sprinkling**, 78, 210
- Standpipe system**, 102
- Stock**, 35, 38
- Stomata**, 3, 10
- Straw**, 58
- Strawberry**, 248 *
- Sub-irrigation culture**, *see* Gravel culture
- Sulfate ion**, 131, 165, 168
 tests for, 245, 249, 250, 257
- Sulfur**,
 deficiency, 16, 214
 functions of, 15
 in nutrient solution, 135, 136
 in plant, 15
 tests, *see* Sulfate ion
 toxicity, 216
- Sulfur dioxide**, 218
- Sulfuric acid**, 125, 138, 140, 154, 158, 159
- Sunlight**, 186, 193
see also Shade, Temperature
- Superphosphate**, 125, 134, 135
- Support of plant**, 20, 23, 206
- Sweet pea**,
 in gravel culture, 35, 37, 38
 pH for, 156
 in water culture, 56
- Sweet potato**, 229, 230 *
- Swiss chard**, 36,* 37,* 203 *
- Tanks**, 101-103, 118-120, 153
see also Cistern, Containers
- Temperature**, 48
 of air, 192
 of medium, 66, 90, 182-187
- Tests**,
 for carbohydrate level, 264
 for formaldehyde, 262-264
 laboratory, 253-259
 for nutrient ions in solution, 239-261
 for pH, 237-239
 precautions for, 245-249, 253
 quick, 239-252
 water titration, 262
- Thiourea solution**, 232
- Tile**, 74, 76, 111,* 115-117
- Time clocks**, 94, 123
- Tomato**,
 diseases of, 171, 196
 effect of gas on, 219 *
 fruit set of, 193
 in gravel culture, 7,* 9,* 31,* 32,* 33,*
 36,* 39, 40, 41, 42, 44, 98,* 114, 164,*
 167,* 179,* 200,* 241,* 247 *
 in Liqua-Nure, 229, 231,* 232
 nutrient solutions for, 130, 189, 190, 191
 in sand culture, *frontispiece*,* 2-3,* 28,
 65, 69,* 76, 82, 152 *
 seedlings, 79 *
 in shade, 186, 206
 in soil blocks, 227, 228,* 229
 sunlight for, 193
 temperature for, 184, 192
 in water culture, 24, 25, 51, 56, 59
 water requirements of, 177
- Trace elements**, *see* Micro elements
- Translocation**, 9
- Transpiration**, 10
- Transplanting**, 205
vs. direct seeding, 206
 in gravel culture, 126
 in sand culture, 79
 and temperature, 187
 in water culture, 59
- Treble superphosphate**, *see* Superphosphate
- Trench**, 41,* 103, 117, 175 *
see also Flume unit
- U. S. Army Air Force Hydroponics**, 104
Ascension Island, 5,* 38,* 39,* 40,* 41,*
 43, 113
Atkinson Field, British Guiana, 42,* 43
Coral Gables, 43, 44,* 159
Iwo Jima. 43.* 44

- Units,
 commercial,
 for gravel culture, 100-126
 for sand culture, 76-78
 for water culture, 55-58
 home,
 for gravel culture, 90-100
 for sand culture, 68-76
 for water culture, 52-55
University of Michigan, Botany Dept.,
 234
 Urea, 134, 135, 191
 Urinized peat, 229, 230 *
- V**alves, 103, 104, 120, 124
 Vigoro, 83
 Virus disease, 221
 Vitamin B₁, 236
- W**ater, 20
 absorption, 6
 acidification of, 158-160
 application to nutrient solution, 60, 63,
 64, 80, 162, 176 *
 conduction in plant, 10
 leaching, 87, 125
 see also Flushing medium
 in nutrient solution, 140
 in sand culture, 63, 64, 80
 titration, 262
 unbalance and disease, 220
 in water culture, 60
 Water cohesion theory, 10
 Water culture, 22-26, 45-60
 applications of, 23
 costs of, 25
 crops by, 23-25, 26,* 50,* 51
 cultural problems of, 45-51
 definition of, 22
 unit construction, 51-58, 52,* 53,* 55,*
 153 *
 unit operation, 22, 58-60
 Water glass, 111, 218
 Weather, 10
 see also Climate, Environment
 Wick devices, 98, 99,* 150 *
 Wind, 196
 Windbreak, 183 *
 Wire mesh, 56,* 57, 117
- X**ylem tissue, 2, 3, 9
- Y**oder Brothers, 28, 29,* 30,* 39
- Z**inc
 deficiency, 18, 214
 functions of, 18
 in nutrient solution, 131, 138, 144, 153,
 170
 test for, 261
 toxicity, 217
 Zinc chloride, 138, 139
 Zinc sulfate, 138, 139, 154, 170

DATE OF ISSUE

This book must be returned within 3,7,14 days of its issue. A fine of ONE ANNA per day will be charged if the book is overdue.

--	--	--	--	--	--

