

Birla Central Library

PILANI (Rajasthan)

Class No .. 6.24.....

Book No S.3.87.S.....

Accession No 5.5.2.8.1

**STRUCTURAL DESIGN
IN STEEL**

BY THOMAS C. SHEDD

Structural Design in Steel

A discussion of the fundamental principles, illustrated by numerous sets of design calculations. 580 pages. 6 by 9. 254 figures. 12 plates. 21 sets of calculations. Cloth.

**BY THOMAS C. SHEDD AND
JAMISON VAWTER**

Theory of Simple Structures

An unusually simple and direct discussion of the subject. Second edition. 505 pages. 5½ by 8¾. 278 figures. 4 plates. Cloth.

PUBLISHED BY

JOHN WILEY & SONS, Inc.

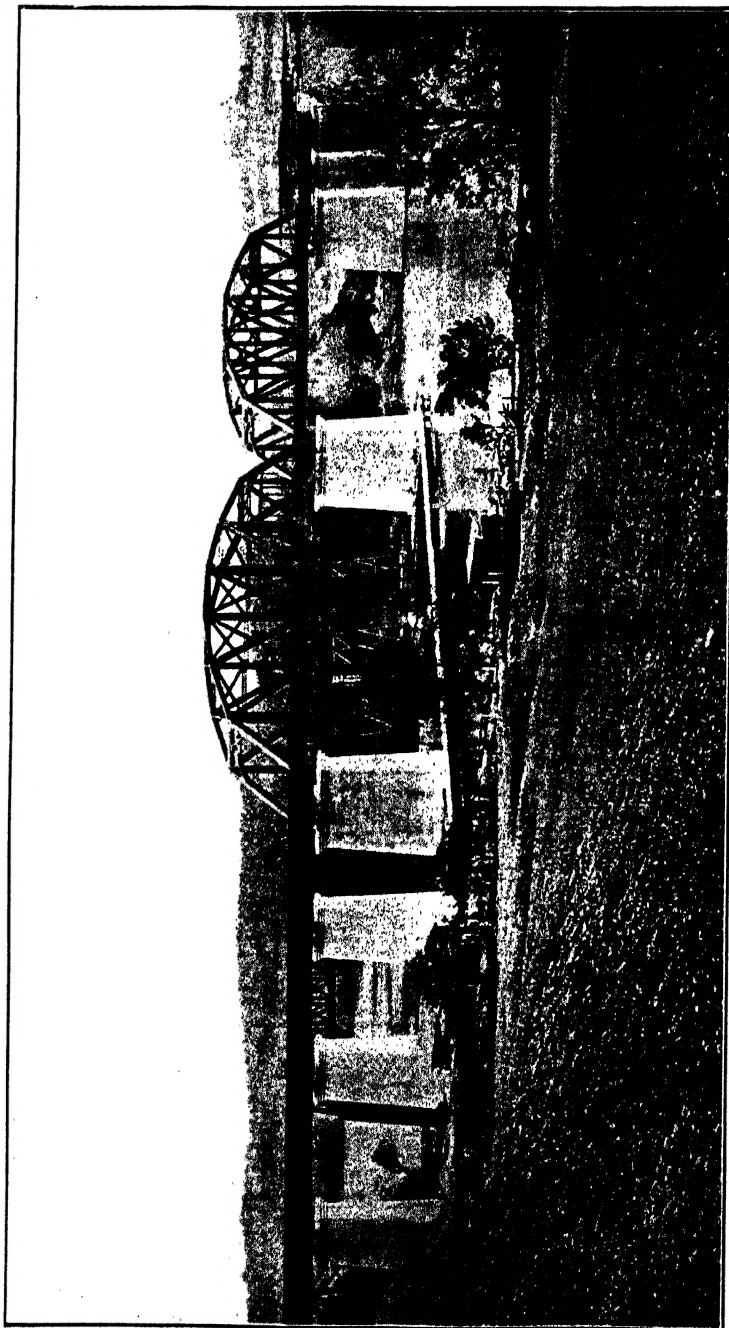

2—247'-11" Double Track Through Riveted Truss Spans.
6—69'-10" Double Track Deck Plate Girder Spans.

OCCOQUAN CREEK BRIDGE—WASHINGTON SOUTHERN RAILWAY COMPANY.

Courtesy of The Phoenix Bridge Company.

STRUCTURAL DESIGN IN STEEL

BY

THOMAS CLARK SHEDD

*Professor of Structural Engineering
University of Illinois*

NEW YORK

JOHN WILEY & SONS, INC.

LONDON: CHAPMAN & HALL, LIMITED

COPYRIGHT, 1934

BY

THOMAS CLARK SHEDD

All Rights Reserved

*This book or any part thereof must not
be reproduced in any form without
the written permission of the publisher.*

SIXTEENTH PRINTING, FEBRUARY, 1957

PRINTED IN U. S. A.

PREFACE

THE field of structural design is so large, even when restricted to construction in a single material, that it is impossible to cover it adequately in one volume. It has seemed best therefore to confine this text to a presentation of the fundamental principles underlying all design in structural steel, with the interpolation of numerous sets of design calculations illustrating the application of the principles discussed.

These sets of design calculations—twenty-four in number—are a special feature of the book, and are presented in all cases as the brief, concisely arranged calculations of the practicing designer. In the earlier parts of the book explanations of and comments on the calculations are sufficiently extended, it is believed, to enable the student to follow the procedure with little help from the instructor; in the later parts explanations and comments are more brief, as it is assumed that the student has become familiar with the form of the calculations. It is hoped that the content and manner of presentation of the illustrative design calculations will make the book helpful to the young practicing engineer as well as to the student.

One of the major difficulties of the beginning student of structural design is in getting a clear mental picture of the structural member he is designing and of how it fits into the structure as a whole. Also he frequently fails to realize that the most complex structure contains only three kinds of structural members, though some may be compelled to serve in a double capacity. In the hope of aiding the beginner in this difficulty the author has included a chapter describing ordinary building and bridge frames illustrated with numerous sketches, and with photographs of actual structures.

Following Chapter II, descriptive of structures in general, are the three major chapters of the book, discussing in detail the design of the three primary structural forms and their connections. This portion of the text contains eighteen of the twenty-four sets of illustrative design calculations.

Most teachers, including the author, prefer to base their instruction in design on problems involving actual structures. There are included therefore two chapters dealing with the design of structures

as a whole: Chapter VI on buildings—primarily of the industrial type—and Chapter VII on bridges, both highway and railway. Both chapters are illustrated with sets of design calculations.

Although fusion welding is a recognized and widely used tool of the modern structural engineer the methods of design of welded joints are not so well standardized as the older forms, and it seemed desirable therefore to concentrate the discussion of this method of making connections in the chapter which closes the text proper.

Design specifications for structural steel for bridges and buildings are included in three appendices. As stated in Appendix A and in Appendix B, the material therein is based on previously published specifications for the design of structural steel for bridges, with some modification by the author. The specifications for the design of structural steel for buildings, Appendix C, are those of the American Institute of Steel Construction, to which the author is indebted for permission to reprint.

The contents of the book are based on a course in structural design beginning with the second semester of the junior year and extending through the senior year, but throughout, the discussion proceeds from the simple to the more complex, and it is believed that no difficulty will be encountered in using the text for briefer courses. The experienced teacher requires no suggestions as to which parts are most suited to his needs.

Although the field covered is old, the text includes original material which is believed to be new; the author hopes not only that the new will be of interest and value, but also that the method of presenting the old will be helpful and stimulating.

The author and publisher have taken special pains to reduce errors to a minimum but cannot hope for perfection in a book including so large an amount of design calculations: they will welcome notification of errors and suggestions for improvement.

The author wishes to express his indebtedness to many individuals and firms for photographs, tables, and suggestions, credit for which has been given in the text where the material is presented.

THOMAS C. SHEDD

URBANA, ILLINOIS
August 27, 1934

CONTENTS

CHAPTER I

| | PAGE |
|--|------|
| INTRODUCTION | 1 |
| The General Problem—The Functional Design—The Structural Design—Relation between Functional and Structural Plans—Four Parts in Structural Design—Loads—Arrangement—Determination of Stresses—Proportioning—Scope of Book—Preparation Expected of Reader. | |

CHAPTER II

| | |
|---|---|
| TYPES OF STRUCTURES AND STRUCTURAL FRAMING | 9 |
| Fundamental Forms—Beams and Girders—Tension Members—Compression Members—Beam and Column Framing—Industrial Buildings—Bracing for Buildings—Bracing for Beam and Column Buildings—Bracing for Industrial Buildings—Illustrative Examples—Classification of Bridges—Beam Bridges—Girder Bridges—Viaducts or Trestles—Truss Bridges—Detailing and Fabrication. | |

CHAPTER III

| | |
|---|----|
| THE DESIGN OF BEAMS AND GIRDERS | 63 |
| General—Rolled Steel Beams; Selection by Section Modulus—Safe Load Tables—Illustrative Example—Beams without Lateral Support—Straight-Line Reduction Formulas—Second Degree Reduction Formulas—Illustrative Example—Web Strength of Steel Beams—Shear—Diagonal Buckling—Vertical Buckling—Direct Compression—Illustrative Examples—Allowance for Holes in Beam Flanges—Beams with Cover Plates—Bending in Two Directions—Limited Deflection <i>Plate Girders</i> —Design Assumptions—Basis of First Assumption—Basis of Second Assumption—Design of Web—Approximate Method of Flange Design—Summary—Girder Depth—Web Thickness—Effective Depth—Flange Proportioning—Net Section—Illustrative Example—Details of Design—Length of Cover Plates—Length Determined from Parabola—Graphical Determination of Length—Algebraic Determination of Length—Web Stiffeners—Design of Bearing Stiffeners—Riveting of Bearing Stiffeners—Design of Intermediate Stiffeners—Spacing of Intermediate Stiffeners—Rivet Pitch—Web and Flange Splices—Illustrative Example DP9—Girders with Web Reinforcement—Illustrative Example DP10—Plate Girder Design by Moment of Inertia—Modified Method of Design—Girders without Lateral Support—Girders Subject to Lateral Loads—Illustrative Example DP11—Economical Depth of <i>Plate Girders</i> . | |

CHAPTER IV

| | PAGE |
|--|------|
| TENSION AND COMPRESSION MEMBERS..... | 196 |
| Suitability of the Common Types—Net Section—General Appearance—Design of Members Subject to Direct Tension and Bending—Approximate Effect of Eccentricity Due to Deflection—Illustrative Example DP12—Compression Members—Design—Straight-Line Formulas—Rankine-Gordon Formula—Proportioning—Required Area—Actual Column Stresses—Limiting Thickness—Economical Proportions—Convenient Relations—Design of Compression Members Subjected to Bending—Effect of Deflection Due to Transverse Loads—Alternate Method of Design—Safe Load Tables—Illustrative Example DP13—Columns Loaded at Two Levels—Illustrative Example DP14—Batten Plates and Lacing. Common Requirements—Illustrative Calculations DP15—Shear in Columns—Maximum Spacing of Lattice Points—Illustrative Calculations DP16—References for Further Study. | |

CHAPTER V

| | |
|---|-----|
| CONNECTIONS | 261 |
| Types of Connections—Fundamental Considerations—Design of Riveted Connections—Ordinary Beam Connections—Standard Connections—Seat Connections—Illustrative Example DP17—Connections to Resist Moment: Rivets in Shear—Connections to Resist Moment: Rivets in Tension—Initial Tension—Effect of Initial Tension on Connections—Beam and Girder Connections to Resist Moment: Rivets in Tension—Illustrative Example DP18—Net Section in Tension Members—Calculation of Net Section—Riveted Connections for Tension and Compression Members (page 329)—Single-Plane Trusses—Double-Plane Trusses—Tension Member Splices—Ordinary Tension Splices—Tension Splices for Heavy Members—Compression Member Splices. | |

CHAPTER VI

| | |
|--|-----|
| DESIGN OF STRUCTURAL STEEL FOR BUILDINGS..... | 367 |
| Loads—Roof Loads—Floor Loads—Wall Loads—Special Loads—Design of Purlins—Design of Trusses—Design of Columns—Illustrative Problems. | |

CHAPTER VII

| | |
|--|-----|
| DESIGN OF STRUCTURAL STEEL FOR BRIDGES..... | 422 |
| Live Loads—Impact—Dead Load—Weight of Superstructure: Highway Bridges—Weight of Superstructure: Railroad Bridges—Design of Layout—Economic Span Length—Economic Proportions—Design of Girder Spans—Cover Plate Lengths—Design of Truss Spans: Deck—Design of Truss Spans: Stringers and Floorbeams—Design of Truss Spans: Trusses—Truss Bracing—Illustrative Material. | |

CONTENTS

ix

CHAPTER VIII

| | PAGE |
|---|-----------------------------|
| STRUCTURAL WELDING | 481 |
| Types of Welding—Types of Welded Joints—Welding Clearances and Positions—Strength of Ordinary Welds—Strength of Shielded Arc Welds—Fillet Welds: Direct Stress—Fillet Welds: Bending—Welded Connections: Beams and Columns—Welded Plate Girders—Welded Trusses—Stresses in Welds. | |
| APPENDIX A | |
| GENERAL SPECIFICATIONS FOR THE DESIGN OF STEEL RAILWAY BRIDGES..... | 511 |
| APPENDIX B | |
| GENERAL SPECIFICATIONS FOR THE DESIGN OF STEEL HIGHWAY BRIDGES..... | 534 |
| APPENDIX C | |
| A.I.S.C. SPECIFICATION FOR THE DESIGN, FABRICATION, AND ERECTION OF STRUCTURAL STEEL FOR BUILDINGS..... | 547 |
| INDEX | 555 |
| PLATE I..... | 401 |
| PLATES II TO X..... | Inside pocket on back cover |

STRUCTURAL DESIGN IN STEEL

CHAPTER I

INTRODUCTION

1. The design of a steel bridge or building presents a many-sided problem. A successful solution requires a thorough study of the service the proposed structure is intended to render as well as the layout and proportioning of the frame of that structure. The first part of the general problem of design, the study of the proposed service and planning the structure to perform it, may be called the **functional design**; the second part, the planning and proportioning of the frame of the structure, may be called the **structural design**.

2. **The General Problem.**—The general problem of design involves, among other things: coordinating the frequently conflicting claims of the functional plan and the structural plan; adjusting both functional and structural plans to keep costs within the available funds; decision as to the character and magnitude of the loads to be provided for; choice of the materials of construction and specifying their quality; and writing or designating the specifications for the design, manufacture, and erection of the various parts.

3. **The Functional Design.**—Some of the matters which must be considered in the functional design may be mentioned.

In the case of a bridge, for example:

- (a) It must be so located that the traffic it is expected to bear can reach and leave it conveniently.
- (b) Its capacity must be adequate for present and future needs, but provision for future needs must not impose too great a cost on present users.
- (c) If it crosses a navigable river, the requirements of water-borne traffic must be met by fixed spans of adequate length and height above the water, or by means of one or more movable spans.
- (d) If it crosses railways or highways, proper clearance must be provided and suitable provision made for future extensions, if likely to be necessary.

- (e) If water pipes, gas pipes, electric power and light lines, telephone cables, or other public utilities are to be carried, their effect on the plans must be considered.

Similarly, a building which is to house an industrial process must:

- (a) Be located with regard to necessary transportation services.
- (b) Provide adequate protection from the weather.
- (c) Provide suitable clearances around machinery and adequate working areas.
- (d) Have satisfactory natural and artificial lighting facilities.
- (e) Have ventilation proportioned in accordance with the character of the process housed.
- (f) Provide proper protection to the public from dangerous operations or obnoxious fumes.
- (g) Provide proper protection, facilities, and conveniences for the employees.
- (h) Provide adequate means for the handling and storing of material.
- (i) Provide for any other features peculiar to the process housed.

An office building must be so designed and located that it will be attractive to and convenient for the prospective tenants, and must provide:

- (a) Satisfactory natural and artificial lighting for the various offices.
- (b) Adequate elevator service and stairways.
- (c) Protection from fire.
- (d) Sufficient flexibility in partition arrangement to meet the needs of any user.
- (e) Any large areas, unobstructed by columns, which may be required by the occupants it is expected to serve.

The above are not intended as complete lists, nor are they necessarily in the order of importance. They are presented merely as some of the problems which must be given proper weight and settled before the structure may be said to have been designed in a *functional* sense.

4. The Structural Design.—Having the functional plan laid out, the engineer may proceed to plan the structural frame, which must be so designed that it will:

- (a) Have adequate strength and rigidity.
- (b) Not interfere with use of the structure or the operations housed
- (c) Be economical in first cost and in maintenance.

- (d) Have length of life suited to the service in view.
- (e) Be readily adaptable for future extensions which may be foreseen as necessary but which are not justified by conditions at the time of construction.

5. Relation between Functional and Structural Plans.—Too much emphasis cannot be placed on the importance of closely correlating the functional and structural designs. In general, the latter should be controlled by the former, as the structural frame is usually (nearly always in buildings) a rather small part of the total cost of the project. Special arrangements in the framing plan which perhaps add a large percentage to the cost of the structural frame may add relatively little to the total cost of the project and result in operating economies far outweighing the added expense of design and construction.

6. Four Parts in Structural Design.—The actual designing of the structural frame for a bridge or building may be divided into four parts:

First: Determining the forces or loads which the frame will be required to support.

Second: Arranging a system of beams, columns, and tension members in various forms and combinations to support the proposed construction adequately.

Third: Calculating the direct stresses, shears, and moments, caused by the applied loads, in the members of the frame.

Fourth: Proportioning the members to resist safely and economically the forces to which they are subjected.

7. Loads.—The loads to which a structure will be subjected are its own weight and that of whatever objects it is designed to support, plus other external forces such as windstorms and earthquake shocks.

It is seldom that the designer has to deal only with fixed loads, that is, loads which are of unchanging magnitude and location. The weight of the material of which a structure is composed is a load of this character and is called the **dead load**. Dead load is always vertical and always acting.

In addition to the dead load there are generally loads which are more or less temporary and which vary in magnitude, such as:

The goods stored on a warehouse floor.

The furniture, fixtures, and occupants of an office.

Snow on the roof of a building or deck of a bridge.

Cranes on the crane runways of a building.

Coal in the bunkers of a coaling station or power house.

Wind or earth shocks on any structure.

Trains or other vehicles on a bridge, etc.

Such loads are called **live loads**. Live loads should be further divided into two classes:

1. Live loads which *move*, such as trains, trucks, cranes, etc.
2. Live loads which are *movable*, such as goods on a warehouse floor, furniture in an office, books in a library, etc.

Live loads of the first class generally produce an effect greater than would be produced by loads of the same magnitude fixed in position. This additional effect is called **impact** and may be of great importance.

In making an estimate of the dead load, the designer is confronted with the difficulty that it must be known with fair accuracy in advance of design and yet cannot be definitely known until the design is completed, when it may be calculated to whatever degree of accuracy seems desirable.

The weight of structures of common types usually may be estimated with sufficient accuracy for design purposes by comparison with the known weights of similar structures already built. This is the easiest and most satisfactory procedure when such records are available, but the designer should not neglect to check his assumptions by actual calculation of the weight of the structure as finally designed.

In the case of large and somewhat unusual structures it is necessary to make an estimate of the dead weight, using whatever data are available, and carry out a design from which the weight may be calculated. With the information thus made available, the dead load and its distribution are re-estimated and the original design revised where necessary. For very unusual work the original estimate may be much in error, perhaps necessitating two revisions, but generally the experienced designer will not need to make more than one.

The live load to which a structure will be subjected is in some cases very definite, but is often more or less uncertain. The matter of future development must always be taken into consideration, and that is difficult to do. Loads, particularly bridge loads, have changed rapidly in recent years, and there is no positive evidence to indicate that they will not change as rapidly in the future.

Of course, to the young engineer or designer the live load to be used is a matter of design specifications, but some one must write the specifications and in doing so must consider carefully many questions, some of which are:

1. What is the greatest load to which the structure will ever be subjected? How often?

2. What are the largest loads to be regularly expected? May these change?
3. If the usual loads may change, are they likely to increase materially during the expected life of the structure?
4. What added present cost to provide against a possible increase in future loads is justified?
5. Should all parts of the structure be designed for the same loads? If not, what reductions are permissible or increases necessary?

These are merely some of the problems which must be considered and settled. They are evidently matters which cannot be decided off-hand, and it should be clear that the engineer responsible for their solution needs an equipment of common sense and trained judgment, as well as a thorough knowledge of the past development in loads of the type to which the proposed structure is likely to be subjected.

8. Arrangement.—The arrangement of the structural members to support the proposed construction depends on the conditions surrounding the particular case. The fundamental problem, however, is always the same. The earth is, and must always be, the ultimate source of support, and whenever a structure of any kind is contemplated, it merely means that it is necessary to keep a certain object from touching the ground immediately below by supporting it on some form of framework. This framework must, of course, rest on the earth at some point or points away from the place which it is necessary to keep the supported object from touching.

A little thought should show that the problem of arrangement is likely to be very varied and may require a great deal of study before the desirable simplicity, economy, and ease of construction are secured. Also it should be clear that the best solution of the problem will require the exercise of good judgment, a broad knowledge of construction, and technical skill.

9. Determination of Stresses.—Having decided on the proper loads to use and arranged a satisfactory framing plan, the designer is in a position to calculate the greatest direct stresses, shears, and moments which the dead load and assumed live loads may produce in the various members.

This is the simplest part of the design procedure and the most definite. It requires a thorough understanding of and ability to apply the laws of statics, and, in many cases, the principles underlying the analysis of statically indeterminate structures. But within the limits imposed by the differences between the ideal structure assumed and the practical

structure dealt with, there is no room for opinion or the exercise of judgment, and only one answer.

Because of its logical and definite character, within the limits mentioned, this step in the problem of design is particularly useful in the mental training of the engineer and is consequently given especial emphasis in technical school curricula. This emphasis is quite natural, and in fact very desirable, but it is important that the instruction be in the hands of a teacher who, through training and engineering experience, has developed a sense of proportion. Otherwise there is danger of giving students the impression that the calculation of stresses is the principal factor in design and the supreme intellectual achievement of the engineer. Unfortunately, this attitude, if developed, is apt to be carried beyond student days, and we have then the technician who delights in long and needlessly complicated mathematical analyses—frequently founded on assumptions which have little basis in fact.

There is no wish to belittle the importance of training in statics, but in fact the wish to emphasize the importance of more thorough training in this subject, which is fundamental in the curriculum of the civil engineer. The training of the civil engineer (particularly one who wishes to specialize in structures) in statics and analysis should be thorough enough that the methods and principles become so completely a part of his mental equipment that they are merely useful tools which he handles with the unconscious skill displayed by a carpenter with his hammer and saw. Thus his calculation of stresses will be a matter of course and his mind left free to consider the aspects of his design in which technical skill, opinion, and judgment are all important.

10. Proportioning.—The final step in the problem of design is the proportioning of the various members of the structure to resist safely and economically the maximum direct stresses, shears, and moments to which they may be subjected by the expected loads.

This involves first the selection of a suitable material, and second a decision as to proper working stresses, after which the principles of structural design may be applied in the determination of required areas, selection of sections, make-up of members, and their assembly into the completed structure.

The choice of a material not only requires a knowledge of the properties of materials which may be used for structural purposes, but also depends on a knowledge of which are most easily obtained at the site, and on the nature of the structure. Sometimes the character of a structure fixes the choice of a material.

The decision as to working stresses in the material chosen depends on many factors, among which may be mentioned:

- (a) Grade and reliability of the material.
- (b) Character of the structure; i.e., whether permanent or temporary, and whether or not failure could result in loss of life or serious property damage.
- (c) Frequency of application of load—if fatigue is a factor, which is rarely if ever the case in bridges or buildings.
- (d) What has been generally used and found satisfactory for similar structures under similar conditions.
- (e) Sometimes on what provision is to be made for future increase in loading.
- (f) The accuracy and thoroughness of the design studies and calculations.
- (g) Sometimes on the extent of exposure to the weather or other deteriorating influences.

Item (g) is often and probably better met by a definite increase in thickness of the exposed parts rather than by a reduction in allowable intensity of stress.

As in the matter of loads, the question of material and unit stresses is likely to be definitely answered for the young engineer by the specifications for design. But again some one must write the specifications, and it should not be necessary to add that the engineer responsible for doing so must have not only a thorough knowledge of engineering materials and their properties, but also a broad experience with the design and construction of the type of structure concerned.

11. Scope of Book.—This text has been restricted to a discussion of the fundamental principles underlying all design in structural steel, but there has been included a number of sets of design calculations intended to illustrate the application of the principles discussed. Some of these sets of design calculations are practically complete for a given structure, and some are carried only far enough to illustrate the principles involved. In all cases the calculations are presented in the concise form used in actual design, and if comments have seemed necessary they have been given separately. The design calculations should be studied carefully in connection with the text.

12. Preparation Expected of the Reader.—The user of this book is expected to have had the usual undergraduate courses in the theory of simple structures and in the mechanics of materials.*

It is important that the student of design be possessed of considerable skill in the calculation of shears, moments, direct stresses, and intensities of stress in structural parts. The student deficient in such

* See also Art. 29, Chapter II.

matters should thoroughly review them, preferably in the texts previously used, or if these are not available through study of one or more of the standard texts listed below.

“ Theory of Simple Structures,” Shedd and Vawter.*

“ Stresses, Graphical Statics, and Masonry,” Swain. †

“ Structural Theory,” Sutherland and Bowman.*

“ Modern Framed Structures,” Part I, Johnson, Bryan, and Turneaure.*

“ Theory of Structures,” Spofford. †

“ Resistance of Materials,” Seely.*

“ Strength of Materials,” Swain. †

“ Strength of Materials,” Morley. ‡

“ Strength of Materials,” Boyd. †

“ Strength of Materials,” Poorman. †

“ Strength of Materials,” Slocum and Hancock.§

* John Wiley & Sons, New York.

† Longmans & Co., London.

‡ McGraw-Hill Book Co., New York.

§ Ginn & Co., Boston.

CHAPTER II

TYPES OF STRUCTURES AND STRUCTURAL FRAMING

13. One of the principal difficulties experienced by the student beginning the study of structural design is in getting a clear mental picture of the structure with which he is concerned. This is the natural result of lack of familiarity with the fundamental structural members, the ways in which they may be arranged to form the framework for a building or bridge, and their functions in the completed structure.

It is the purpose of this chapter to describe by means of sketches, drawings, and illustrations these fundamental structural forms, the ways in which they are often arranged in the more common types of buildings and bridges, and their functions in the completed structures. The author would like to add, however, that no amount of text discussion can take the place of personal observation and reflection on the part of the student.

14. **Fundamental Forms.**—There are only three kinds of structural members:

- (a) Beams, including girders.
- (b) Tension members, or “ ties.”
- (c) Compression members, or “ columns”; also called “ struts.”

No matter how complicated a structure may appear to be, it must consist of some combination of these basic forms. The beams may appear as extremely heavy built-up girders, and the columns and ties may be combined to form heavy trusses in an intricate and extensive framework; but if the structure is reduced to its component parts no other forms will be found, although, as will appear later, some members may be designed to serve in a double capacity.

15. **Beams and Girders.**—A **beam** is a structural member the primary function of which is to support loads normal to its axis. The word “ beam ” and the word “ girder ” are used more or less interchangeably, and it is impossible to give a strict definition of one which excludes the other. The word **girder** is perhaps most commonly applied to a large beam built up from plates and angles, but it is also used to distinguish the heavy beams, in a building floor, to which are connected the ends of lighter beams running in another direction. The word is used in the latter sense in Fig. 6.

The most common steel beam is the ordinary rolled I beam, which varies in size from 3 in. to 36 in., and in weight from about 6 lb. per ft. of length to 300 lb. per ft. of length. Although the I beam is the most common form of steel beam, any steel shape may be used to support transverse loads, and under the varying conditions met in structural design practically every rolled shape is used as a beam at one time or another.

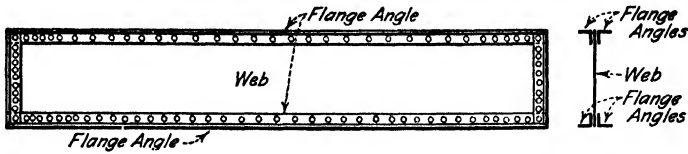

FIG. 1.

When a section larger than can be obtained in a rolled beam is necessary to support the loads, a built-up I beam called a **plate girder** may be used.

A **plate girder** consists essentially of a wide plate, called the **web** or **web plate**, with a pair of angles, called the **flange angles**, riveted along each edge. Certain auxiliary fittings such as **web stiffeners**, **fillers**, **splice plates**, etc., are generally required in addition to the main material. Figure 1 is a sketch of a plate girder of the most elementary

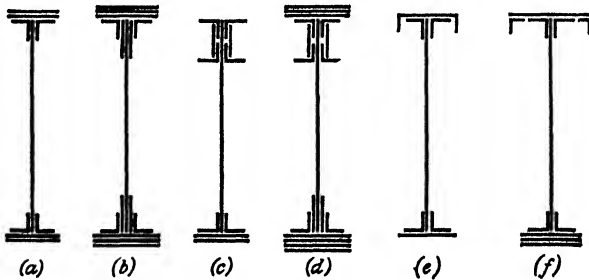

FIG. 2.

form. When additional strength is required, plates, called **cover plates** or **flange plates**, are riveted to the top of the flange angles. Figure 2 shows in section plate-girder forms which are frequently used. In Fig. 2: (a) shows the most common type of girder section; (b) a modification of (a) used for heavier girders; (c) a form sometimes used for deck girders of railroad bridges; (d) a heavy type sometimes used for long spans carrying heavy loads; (e) and (f) forms frequently used for crane runway girders, (f) being used for long spans. Figure 3 shows a

large girder, of the type shown in Fig. 2 (*d*) built for the Erie Railroad Co. for Bridge 21.94, Hawthorne, New Jersey, by the Phoenix Bridge Company. The girder has a length of 126 ft. $3\frac{1}{2}$ in. and weighs 105 tons.

The vertical angles fastened to the web of the girder shown in Fig. 3 are the web stiffeners mentioned above; these parts will be more fully described in connection with the discussion of girder design.

16. Tension Members.—A **tension member**, as the name indicates, is one which is intended primarily to resist a tensile stress. Occasionally it is necessary to design such members to resist bending in addition to the direct stress. All tension members, unless vertical, must sup-

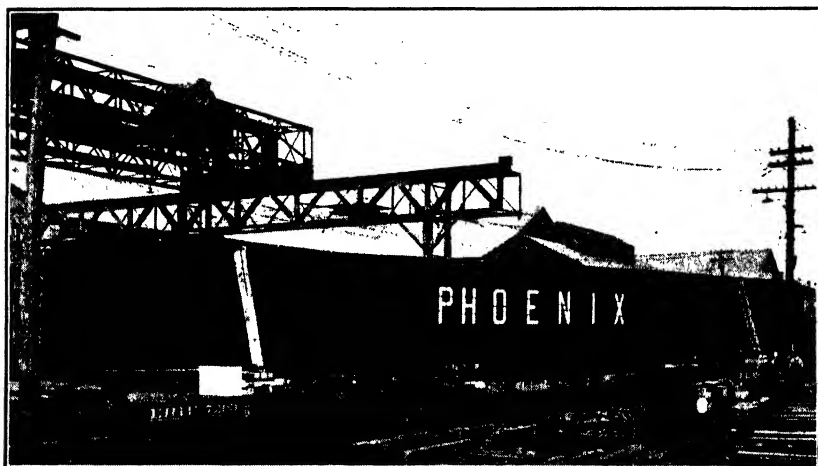

Courtesy of The Phoenix Bridge Company.

FIG. 3.—Girder for Erie R. R. Co., Bridge 21.94, Hawthorne, N. J.
Length, 126'- $3\frac{1}{2}$ "; Depth, 11'- $9\frac{1}{2}$ "; Weight, 105 Tons.

port their own weight in bending, but this is nearly always neglected in design, except for long and heavy pieces.

Figure 4 shows in section some of the more common forms of tension members used in structures of various kinds. At (*a*) is the ordinary rod frequently used as a tension member in bracing buildings, and still used as a tension member in timber trusses; (*b*) is a "flat" or plate sometimes used as a tension member in light, riveted, building or elevated railway trusses; when used in pin-connected trusses, it has an enlarged head (containing a hole through which the pin may pass) forged on each end, and is called an **eye bar**; (*c*) and (*d*) show single and double angle members extensively used in single plane * trusses;

* See page 21 for definition of single plane and double plane trusses.

(e) shows a form of tension member sometimes used for single plane trusses when bending must be resisted in addition to direct stress; (f) and (g) show two angle and four angle members frequently used in light double plane * riveted trusses, the dotted lines may be either intermittent tie plates or lattice bars † and may be replaced by solid plates; (h) is the same form as (g) with a solid web and is frequently increased in capacity by plates as shown in dotted lines; (i), (j), and (k) are forms used for heavier trusses, their open sides must be provided with intermittent tie plates or lattice bars as shown by the horizontal dotted lines, they are frequently increased in capacity by additional plates shown by dotted vertical lines; (l) is a type which has been used in some recent bridges, differing from the form shown in (j) by the addition of a solid plate in place of tie plates or lacing on the top. Other arrangements of material are used, but the forms shown are the most common.

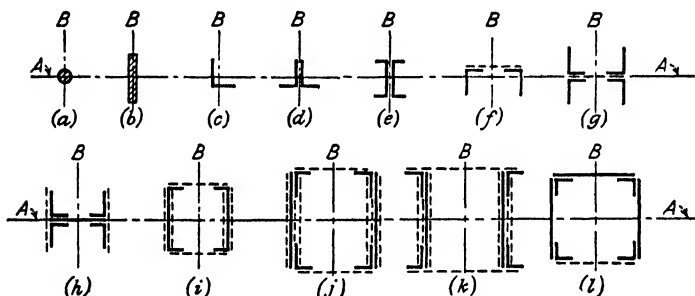

FIG. 4.

17. Compression Members.—Compression members, or columns as they are more commonly called, are intended primarily to resist a compressive stress. They may be called upon sometimes to resist loads applied transversely and, unless vertical, must always resist the bending caused by their own weight. As in the design of tension members, bending from the latter source is generally neglected except for long, heavy pieces.

All the forms shown in Fig. 4, except those at (a) and (b), are used for compression members, and in addition members shown in section in Fig. 5 are in common use.

The form shown at (a) Fig. 5 is much used for light highway bridges, and the forms at (b) and (c) for heavier highway bridges and railroad

* See page 21 for definition of single plane and double plane trusses.

† See Figs. 101 and 102.

bridges. The sections shown at (d), (e), and (f) are often used in building construction, but the use of closed sections, such as shown at (d), has decreased in recent years. At (g) is shown the rolled H column which has had widespread use in building construction, particularly for the modern, tall, steel-frame office building. At (h) is shown a heavy section sometimes used for large bridges. It has been used with top and bottom cover plates when the sections required were large enough to permit a man to pass through the member for riveting during construction, and for inspection and painting afterwards. The open sides of members such as shown in (a), (b), (c), and (h) of Fig. 5 must be pro-

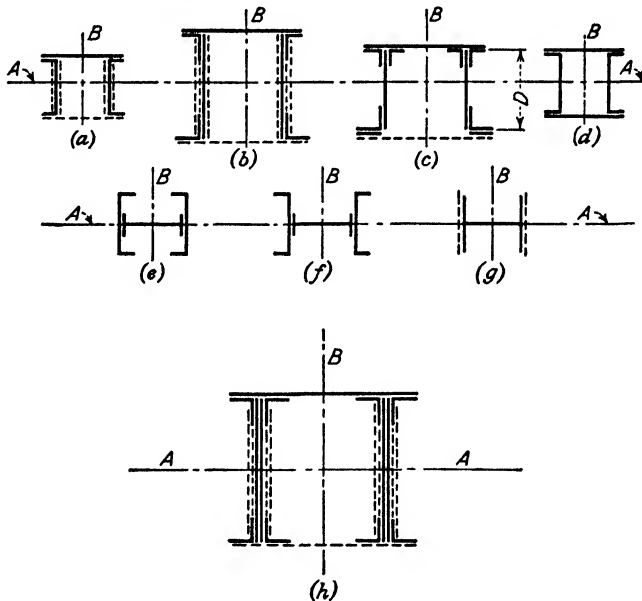

FIG. 5.

vided with lattice bars and batten plates, indicated by the horizontal dotted lines; members such as shown in (e) and (f) are preferably provided with lattice bars and batten plates, or batten plates alone, on their open sides, but these details are often omitted on short columns of these types. All the sections shown in Fig. 5 are sometimes increased in area by the addition of plates as shown by dotted vertical lines in (a), (b), (g), and (h).

Most of the fundamental structural forms just described will appear many times in the following illustrations of typical structures, and the student should carefully study the ways in which they have been

arranged and connected in constructing the buildings and bridges shown.

18. Beam and Column Framing.—The simplest form of steel building frame is the **beam and column frame**. As the name implies, it is composed of an arrangement of vertical columns to which are connected horizontal beams and girders which support the various floors. Figure 6

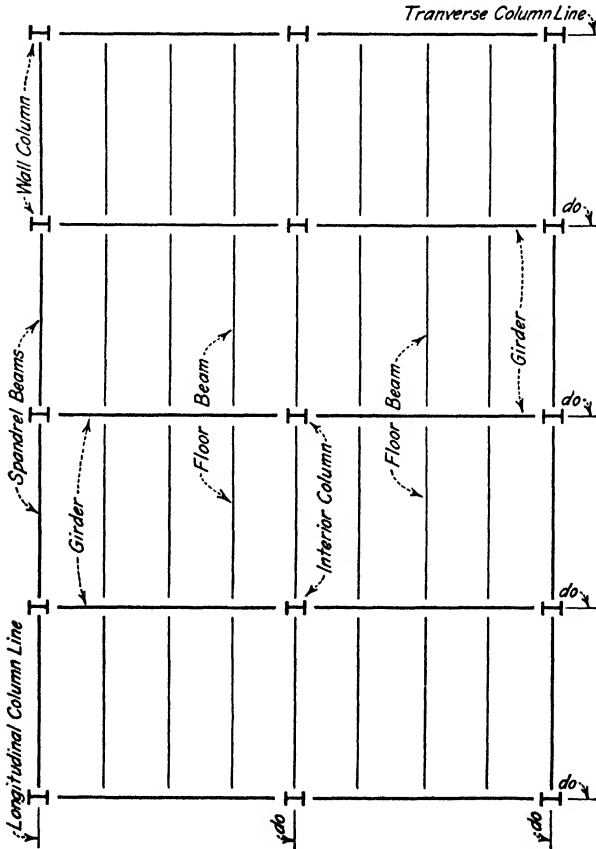

FIG. 6.

shows a plan of one floor for a building of this kind. The flooring, which may consist of wood or concrete, or even steel plates in some cases, is supported on the floorbeams. The floorbeams are supported by the girders, or directly by the columns (in the case of beams which are placed on the column lines), and the girders are supported by the columns to which they connect. The columns are supported on concrete or

masonry footings or pedestals resting on the earth, which is thus, as must always be the case, the ultimate support for the frame as a whole. Columns in general extend the full height of the building, but not always.

In buildings of this kind the beams around the outside edge of the floor usually support the walls of the building, from the floor in which the beams occur to the floor above, in addition to a part of the floor itself. Such beams are called **wall beams**, or more commonly **spandrel beams**. Spandrel beams are often connected to the outside face of the wall columns, instead of on their center lines as shown in Fig. 6.

Figure 7 shows very clearly a building frame of the beam and column



Courtesy of McClintic-Marshall Company.

FIG. 7.—Building for Berkshire Knitting Mills, Textile Machine Works, Reading, Penna.

type just described, and the student should note that in this case the spandrel beams are connected to the outside of the wall columns. Figure 8 gives a closer view of the framing for one floor of a building of this kind, and shows how the floorbeams are connected to the girders and the girders to the columns.

In modern construction the steel frames of practically all beam and column buildings are protected from fire by a covering of heat-resisting material such as terra-cotta, brick, gypsum, concrete, etc. In Fig. 8 may be seen expanded metal around the beams, intended to reinforce and hold in place the concrete encasement which will be placed as protection for the floor framing.

The most common use of beam and column framing is in the construction of office buildings, hotels, apartment houses, warehouses, school buildings, and similar structures. Many office buildings of this type are carried to great heights and may be referred to as **tier buildings**.

Sometimes in buildings of this kind it is necessary to provide a space free from columns which is considerably larger than that between the columns as normally located. Examples of such areas are banking

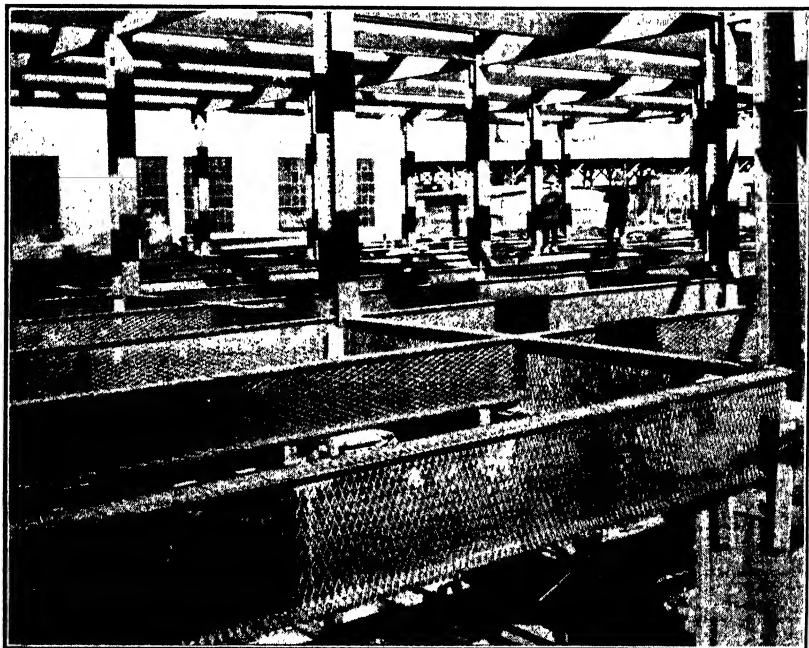

Courtesy of Illinois Central System. F. R. Judd, Engineer of Buildings.

FIG. 8.—Storehouse Illinois Central System Shops, Paducah, Kentucky.

rooms, banquet halls, dance halls, auditoriums, gymnasiums, and so on, which may be wanted at almost any place in a large tier building. As the clear area is usually required for only one or two stories in height, there are likely to be interior or exterior columns of normal spacing above the room which must be supported in some way. Such columns are often called **cut-off columns**, and are supported on heavy girders or trusses which are in turn supported by columns outside the area which must be kept clear. Figure 9 shows a view of the framing for the United States Mail Terminal Building at the Chicago Union Station,

in which this condition occurs, and Fig. 10 shows a closer view of the truss which supports six cut-off wall columns.

19. Industrial Buildings.—Industrial processes are widely different in character, and so also must be the framing for buildings to house them. It is consequently difficult to give a description of the typical industrial building. Nevertheless, buildings for industrial purposes have certain characteristics which are fairly common, although they may be considerably modified in some instances.

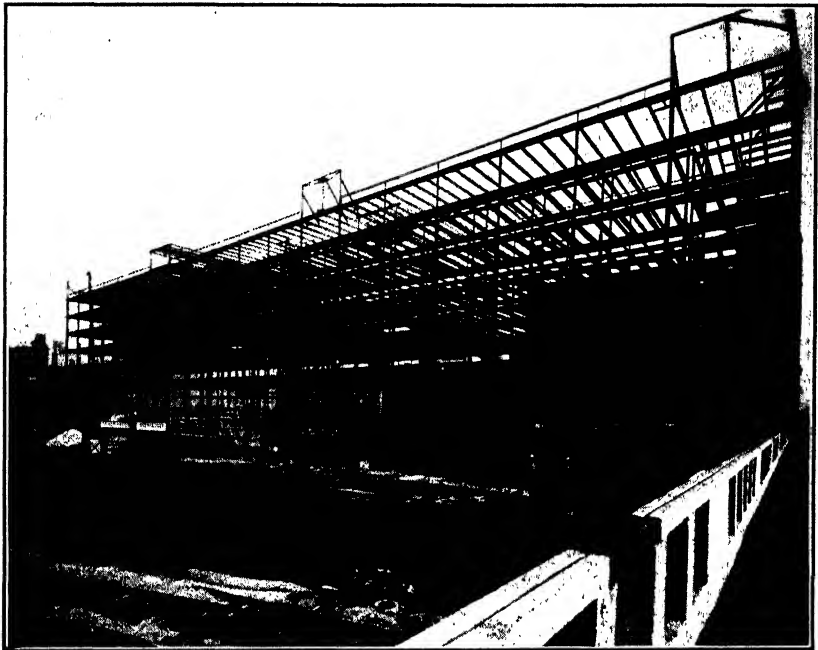

Courtesy of McClintic-Marshall Company.

FIG. 9.—U. S. Mail Terminal Building, Chicago Union Station.

The principal difference between industrial buildings and buildings of the office or hotel type is that in the former interior columns are eliminated as far as possible in order to provide large, clear working areas. Industrial buildings are very commonly of one story only, although this is not always the case.

The simplest form of industrial building is the one-story structure consisting of a series of transverse trusses which support longitudinal roof beams generally called **purlins**. The trusses are supported at their ends by columns which are in the walls of the building, or in some

cases on brick or concrete walls alone. A truss and the columns which support it are usually referred to together as a **bent** of the building, and an industrial building may be said to consist of a series of bents supporting the roof. The distance between two bents is generally called the **bay length**, and an industrial building is said to have a length of so many **bays** of so many feet each, for example a length of ten bays of 20 ft. each, or 200 ft. in all.

The bents are braced together at intervals which depend on the

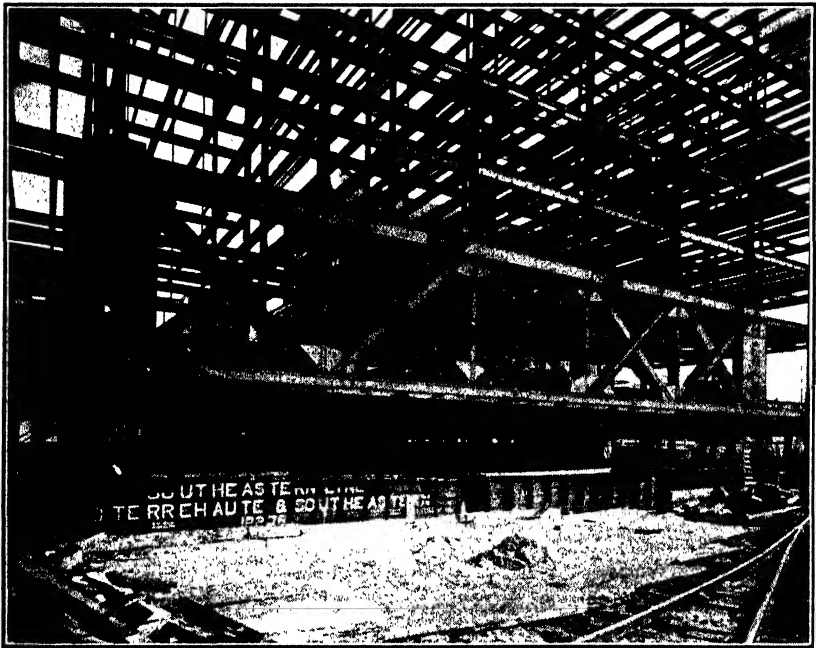

Courtesy of McClintic-Marshall Company.

FIG. 10.—U. S. Mail Terminal Building, Chicago Union Station.

character of the building, its width, length, covering, exposure, and so on. A very rigid structure results when the bents are braced together in pairs, but this is not always necessary. Two bents braced together form a **braced bay**.

The space between two column lines is usually called an **aisle**. Industrial buildings are most commonly single-aisle structures, but two-aisle and three-aisle buildings are not infrequent and structures of four or five, or more, aisles in width have been built. The machine and erecting shop of the Baldwin Locomotive Works at Eddystone, Pennsylvania, has a width of eleven aisles.

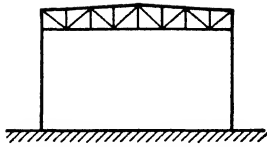

(a)
Single Aisle Warren Truss

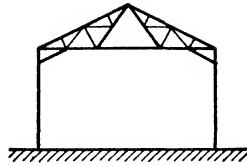

(b)
Single Aisle Fink Truss

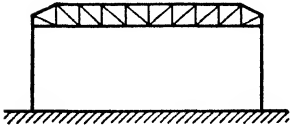

(c)
Single Aisle Pratt Truss

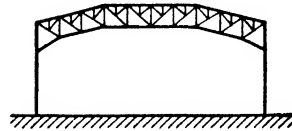

(d)
Long Span Subdivided Pratt Truss

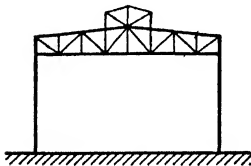

(e)
Warren with Monitor

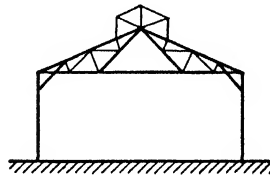

(f)
Fink with Monitor

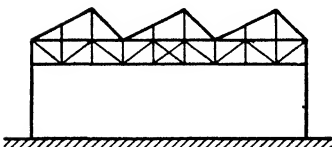

(g)
Saw Tooth without Interior Columns

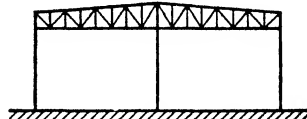

(h)
Double Aisle

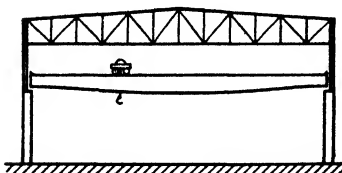

(i)
Single Aisle with Crane Runway

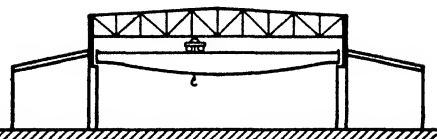

(j)
Main Aisle with Side Aisles

FIG. 11.

Figure 11 shows a few common types of industrial building bents. It would be impossible to show all the arrangements which are used, but a more complete set of diagrams may be found in texts devoted exclusively to the design of industrial buildings. There are no rigidly fixed standards, and the designer should feel free to use any arrangement of framing which seems to him best suited for the problem in hand.

In double-aisle buildings such as shown at (h) in Fig. 11, it is not uncommon to omit every other column on the center column line and support the ends of the transverse trusses which meet where the column is omitted on a longitudinal truss which in turn is supported by the



Courtesy of McClintic-Marshall Company.

FIG. 12.—Gowanus Bay Pier Shed.

alternate columns along the center line. Longitudinal trusses introduced to permit the omission of columns are called **carrying trusses**. Figure 12 shows the framing for a pier shed in which this arrangement has been followed. Figure 13 shows a three-aisle building in which every other column on the center aisle column lines has been cut off at the level of the bottom chord of the side aisle roof trusses, the part above this level being supported by a longitudinal carrying truss.

Single Plane and Double Plane Trusses.—The student should note that both the transverse and longitudinal trusses of the pier shed shown in Fig. 12 are made up of members of the type shown in (d) of Fig. 4. Trusses made up of members of this kind have the connections between

the various members made with a single gusset plate at each joint, the gusset plate coinciding with the central plane of the truss; such trusses are called **single plane** trusses. The longitudinal trusses of the building in Fig. 13 are made up of members such as are shown at (f) and (g) in Fig. 4, with the central plane of the truss coinciding with the axis *B*. Trusses of this kind require two gusset plates at each joint, one on each side of the joint and parallel to the central plane of the truss; such trusses are called **double plane** trusses. The heavy carrying truss shown in Figs. 9 and 10 is a double plane truss, as are all the bridge trusses shown as illustrations later in this chapter. Single plane trusses are the most common in industrial buildings, but double

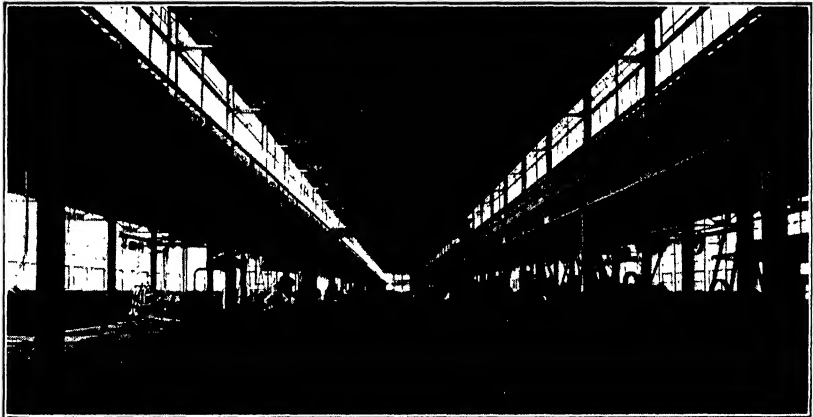

Courtesy of McClintic-Marshall Company.

FIG. 13.—Factory Building, Parish and Bingham Co., Cleveland, Ohio.

plane trusses may occasionally be used for carrying trusses, and are sometimes required for long-span transverse trusses.

20. Bracing for Buildings.—The bracing of buildings to secure proper rigidity under the action of wind and the vibration caused by cranes, or other moving equipment within the building, is an important part of the structural design. In high tier buildings the matter of bracing is usually very carefully studied, but in office buildings of moderate height, and particularly in single-story industrial buildings, it is sometimes given insufficient attention. In the case of high tier buildings both the arrangement of the bracing and its proportioning for strength are likely to be important, whereas in single-story industrial buildings the matter of arrangement may be the important factor and its proportioning for strength purely nominal.

21. Bracing for Beam and Column Buildings.—Beam and column buildings generally depend on the rigidity of the connections between the beams and columns for their ability to resist wind pressure or lateral forces of other kinds. In Fig. 14 (a) there is shown diagrammatically an ordinary beam and column building. If the connections of the beams to the columns are made rigid enough so that the angles between them must always remain the same, it should be clear that the structure as shown will be able to resist the lateral forces acting, assuming of course that the beams and columns are strong enough to withstand the resulting shears and moments. If these connections are not rigid the structure will evidently collapse sideways as shown in (b) of Fig. 14. If diagonal bracing can be introduced, as shown in (c), rigidity of the joints is not necessary. Diagonal bracing is seldom practicable in office buildings, except at rather isolated points, such as the walls of

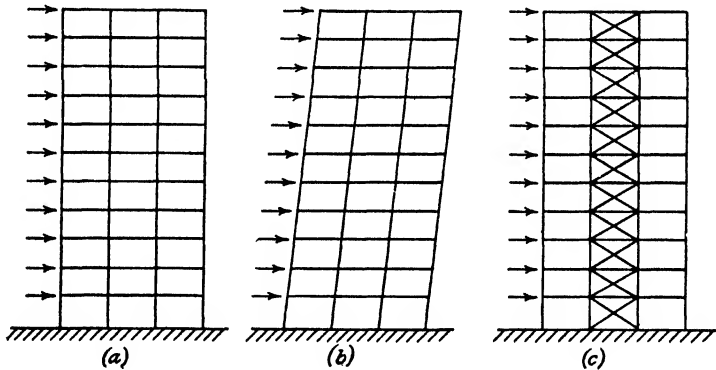

FIG. 14.

elevator shafts, and in permanent partitions at points where there are no doors or windows. Advantage is frequently taken of the opportunity for diagonal bracing of some sort which elevator shafts present, but it is not often possible to completely brace a tier building through its elevator shafts, and in general such structures must depend on joint rigidity for the resistance to lateral forces which their structural frames must offer. The walls, partitions, and floors unquestionably stiffen the frame and aid in resisting lateral forces. The extent to which help from this source can be counted on is not known, and it has been most common to consider that the frame alone must provide full resistance, although practice has not been entirely consistent in this respect. Some of the earliest high-building frames were designed under the assumption that the frame resisted the major portion, but not all, of the wind

pressure. A very general and considerable increase in the height of steel-frame buildings in recent years has increased the importance of wind bracing, and renewed interest in, and study and investigation of,

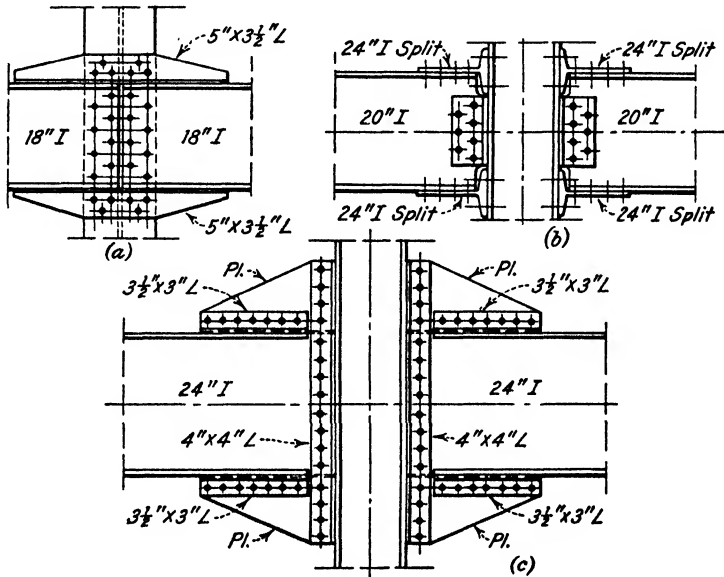
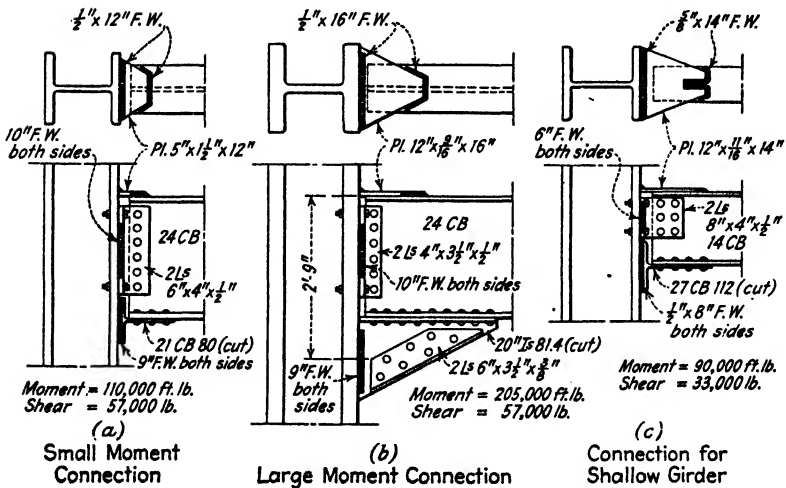

FIG. 15 A.



Engineering News-Record, Sept. 18, 1930.

FIG. 15 B.

the subject have resulted. The stiffening effect of walls, partitions, and floors is being given considerable study, and more definite information and consistent practice may result.

The bracing of beam and column buildings which cover considerable ground area and are of moderate height will not as a rule require particular attention, the standard connection of beams and girders to

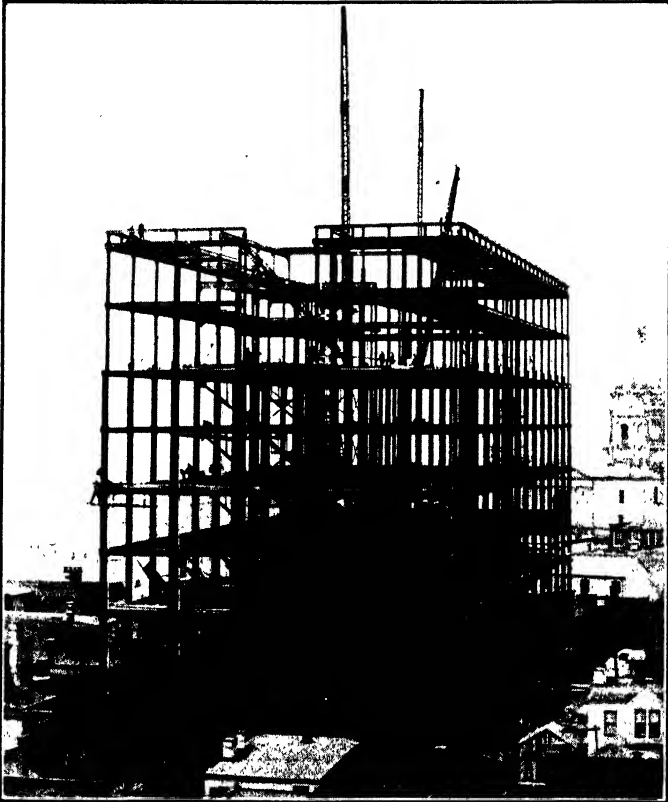

Courtesy of The Phoenix Bridge Company.

FIG. 16.--Bell Telephone Building, Harrisburg, Penna.

columns providing sufficient rigidity. High tier buildings, and those of less height which are very narrow or have small ground area, require joints of greater rigidity than that of ordinary beam connections, and elaborate beam and girder to column connections are often used in such cases. Figure 15 A shows three types sometimes used for riveted structures, and Fig. 15 B shows three types used in a building, erected

for the Edison Electric Illuminating Company of Boston, in which all field connections are arc-welded. The connections shown in these figures are typical, but much more massive connections are sometimes required, examples of which occasionally may be seen in technical periodicals.

Figure 16 shows the Bell Telephone Building in Harrisburg, Pennsylvania, in which connections similar to that shown at (a) in Fig. 15 A

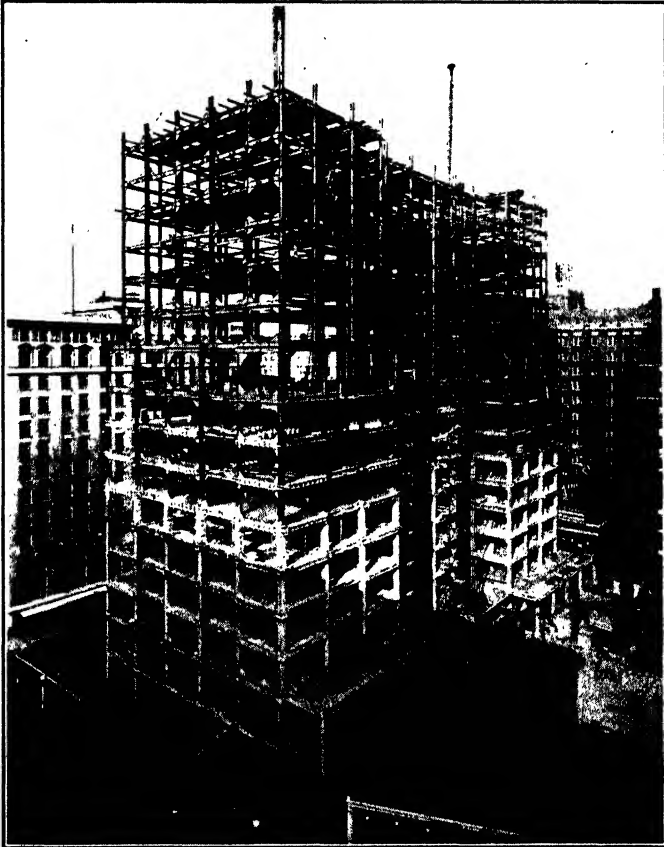

Holabird and Root, Architects.

Lundoff-Bicknell Co., General Contractors.

FIG. 17.—Palmolive Building, Chicago.

were used for the spandrel beams and in which some diagonal bracing was used, as may be seen by close scrutiny of the picture. Figure 17 shows the Palmolive Building in Chicago, in which particular attention was devoted to rigidity of the joints, concrete evidence of which is given by the massive wind brackets clearly shown in the illustration.

It is impossible here to give more attention to the details of wind bracing for office and other tier buildings. Further information may be found in texts devoted exclusively to building design and in technical periodicals. The design of wind-bracing connections is discussed in Chapter V.

22. Bracing for Industrial Buildings.—Bracing for industrial build-

ings is almost always provided by a system of diagonal bracing combined with the transverse bending resistance of the bents. Sometimes bents are so constructed as to have little if any transverse bending resistance, and in such cases dependence must be placed entirely on a system of diagonal bracing.

Bent with Knee Braces.—If the bent shown in (a) Fig. 18 has fixed, or nearly fixed, column bases it evidently will deform somewhat as shown in (b), of the same figure, under the action of the wind loads shown in (a). If the column bases are hinged or practically so (column bases are seldom, if ever, actually hinged in buildings), the deformation of the bent will be somewhat as shown in (c) of Fig. 18. In either case if the columns and other members have sufficient strength the bent will have lateral stability. However, if the wind acts normal to the plane of the bent it should be clear that the bent alone will have little resistance and it becomes necessary to brace it to another to secure sufficient stability against wind or other forces acting along the axis of the building.

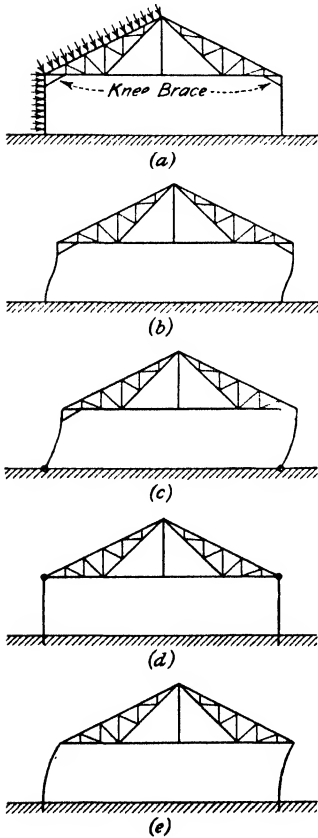

FIG. 18.

The two bents thus braced together are referred to as a braced bay, as previously stated. The form which this bracing takes is shown in Fig. 19, which illustrates a building composed of thirteen bents (twelve bays) like that shown in Fig. 18. As shown the building has four braced bays, each braced bay having a complete set of diagonals in the planes of the top chords of the trusses, in the plane of the bottom chords,

and in the planes of the side walls. These diagonals, which are marked *D* in the figure, together with the members marked *S* or *ES*, the truss chords, and the columns, form a system of double intersection trusses which has the column pedestals (or the earth) for its supports and which will evidently resist forces applied to the building along its axis. For example, wind acting on the end of the building must be resisted by the siding supported on the horizontal beams called girts (unless the side and end walls are self-supporting), shown dotted in the figure. The girts are in turn supported by the end wall framing columns; these columns react against the struts marked *S* in the end bay 1-2, and the struts have their reaction on the bracing trusses in the planes of the top and bottom chords of the roof trusses. The bracing trusses, which are thus loaded by the wind pressure acting on the end of the building, have their reactions at the top of the frames formed by the columns of bents 2 and 3 and the diagonals, *D*, and struts, *ES*, between these columns, and these reactions reach the ground through the pedestals on which the columns rest. The struts marked *ES* are generally called **eave struts**, and as will be seen later sometimes take the form of small trusses.

If the members marked *T* in Fig. 19 are stiff members capable of resisting compression some of the wind pressure acting on the end of the building will be transferred by them to the braced bays beyond 2-3; but if they are ties, capable of resisting tension only, the entire wind pressure on the end must be resisted by the braced bay 2-3. Should there be a pressure from the inside of the building acting in an outward direction, of course the ties would be as effective as struts in distributing the resulting load to the several braced bays. There will be some pressure acting from the inside, as a partial vacuum is created on the leeward end or side of a building.* The members marked *T* are made capable of resisting compression by some designers and as ties only by others. If they are made as ties it is important for them to be placed under initial tension by being made a trifle short and stretched into place when erected. Diagonals in the planes of the roof truss chords are nearly always made as tension members only, and they also should be placed under initial tension. Diagonals in the walls are usually tension members but are sometimes made stiff enough to resist compression.

The stresses in the bracing members cannot be accurately estimated and are seldom of sufficient magnitude to control their proportioning. Such members are generally dimensioned to meet minimum requirements set by the design specifications. Nevertheless, it is important for the

* See page 64, "Wind Stresses in Buildings," by Robins Fleming, John Wiley & Sons, 1930, and Chapter VI in this book.

designer to form a clear picture of the action of the bracing system in order to be sure that the arrangement of members chosen will be effective in resisting any lateral or longitudinal loads to which the structure may be subjected.

It should be seen that, if the longitudinal members of the bracing system for the building in Fig. 19, i.e., the members marked *S*, *T*, and *ES*, are all capable of resisting compression, a single braced bay would

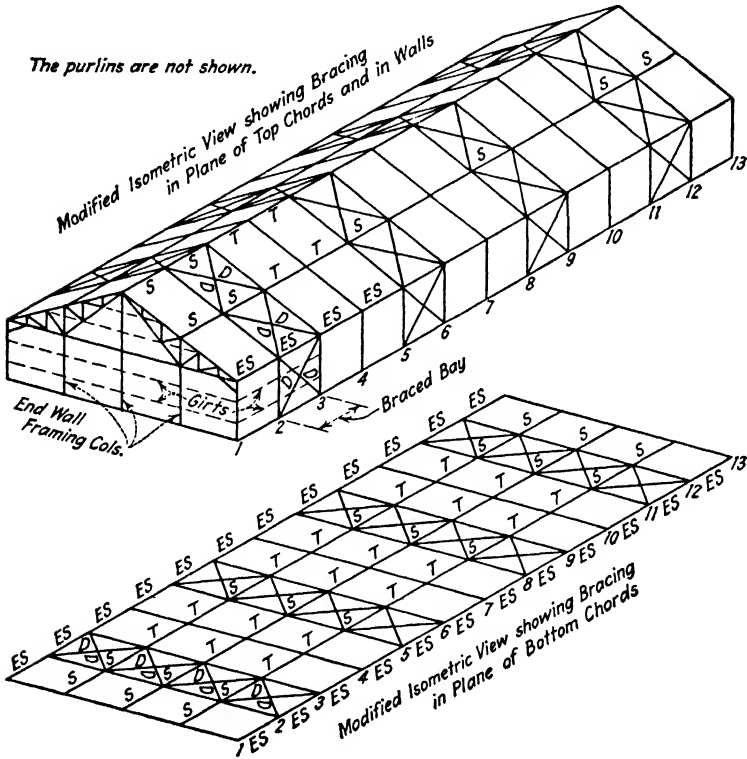

FIG. 19.—Bracing for Building with Knee-Braced Bents.

be sufficient for stability, but to secure rigidity and freedom from pronounced vibration more frequent bracing is desirable. Some designers would use more bracing than is shown and some less.

Bent without Knee Braces.—Sometimes the necessity for maximum headroom around the walls of a building may require the omission of knee braces resulting in a bent as shown in (d) of Fig. 18. It is difficult in such cases to secure much rigidity at the connection of the truss to the column without changing the shape of the truss, and unless the

column bases are heavy and rigidly attached to heavy pedestals the bent will not have adequate resistance to transverse forces. If the columns can be fixed at their bases the bent will deform somewhat as shown in (e), but attempting to secure transverse resistance in this

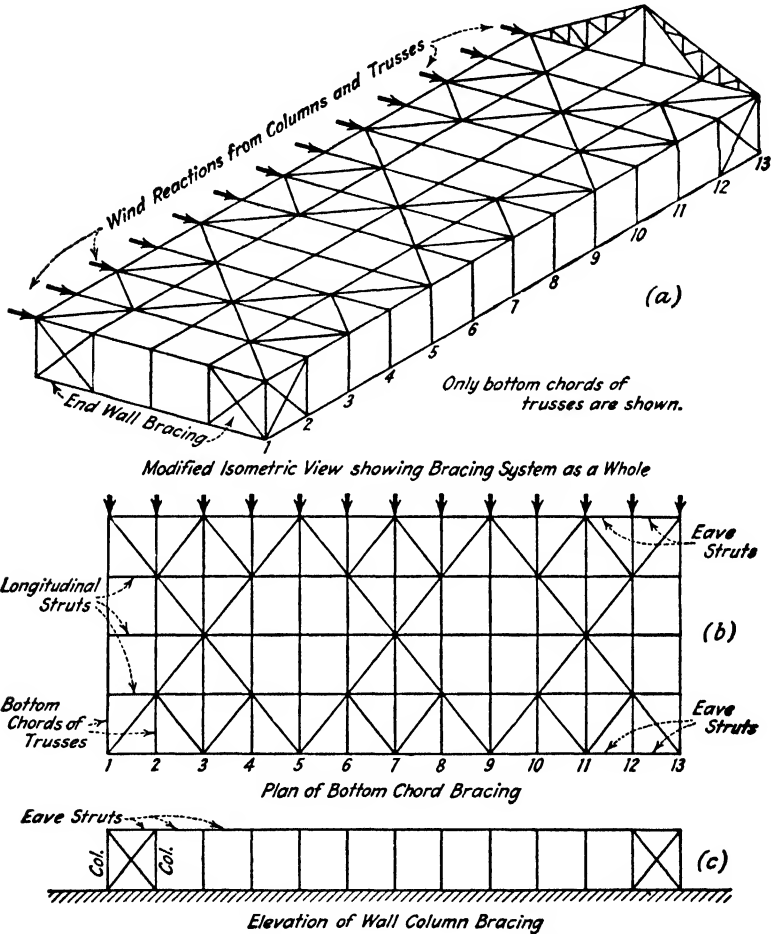
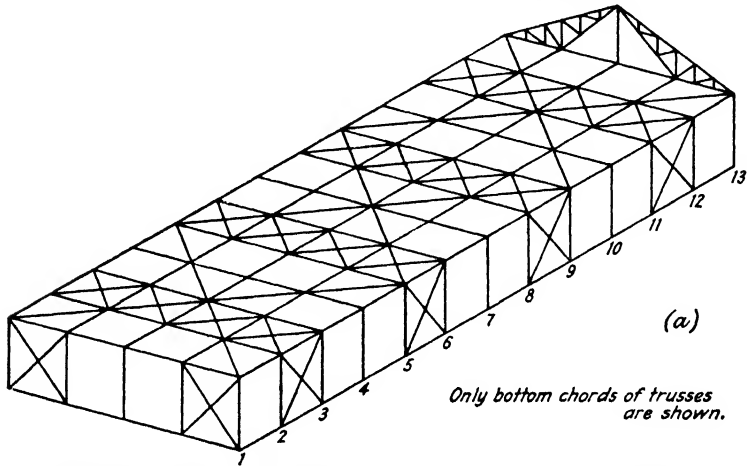

FIG. 20.—Bracing for Building without Knee Braces.

manner will result in severe column bending and unreasonably heavy bases. Buildings containing bents of this kind are preferably braced by means of a system of diagonals which in connection with the chords of the roof trusses and the bracing struts will form a complete truss system having reactions at the ends of the building where diagonals in

the end framing form frames capable of transferring these reactions to the ground. Figure 20 (a) shows diagrammatically the essential bracing for a building of this kind. The trusses, above the bottom chords, have been omitted in this sketch for the sake of clearness. There should



Modified Isometric View showing Combination Bracing System as a Whole

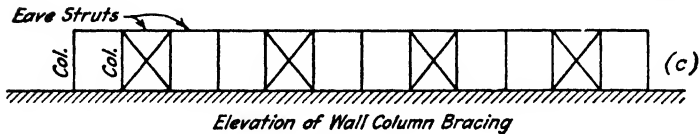
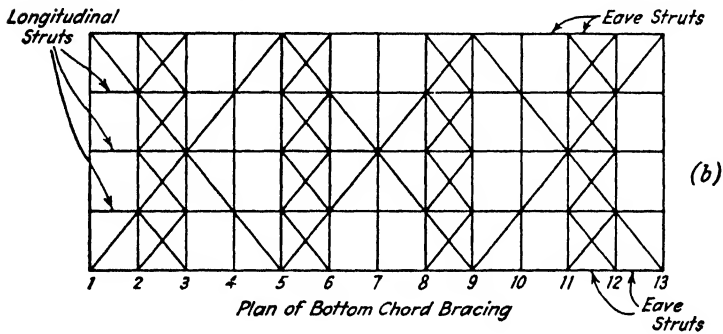

FIG. 21.—Combination Bracing System for Buildings with or without Knee Braces

be bracing in the planes of the top chords in braced bays 1-2 and 12-13, like the top chord bracing shown in Fig. 19, and of course struts or ties connecting the top chords of intermediate trusses to the braced bays. Figure 20 (b) shows a plan of the bracing in the plane of the bottom

chords of the roof trusses; in this plan the vertical lines represent the bottom chords of the roof trusses and the horizontal lines longitudinal bracing members. The student should determine which of the longitudinal bracing members are necessary to make the bottom chord bracing a complete truss for the loads shown, and also which are necessary if there is unsymmetrical loading.

Although the bracing shown is sufficient for stability it is more common to combine bracing such as shown in Fig. 20 with braced bays such as shown in Fig. 19, the resulting bracing system being as shown diagrammatically in Fig. 21. In this figure also the trusses are omitted above the bottom chords, and therefore the top chord bracing which would occur in the braced bays is not shown. Figure 22 shows an arrangement of bracing in the plane of the bottom chords of the roof trusses which is sometimes used instead of the arrangement shown in Fig. 21. Except as shown in Fig. 22 the systems are the same.

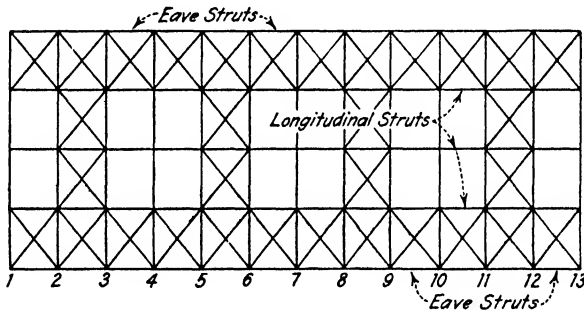
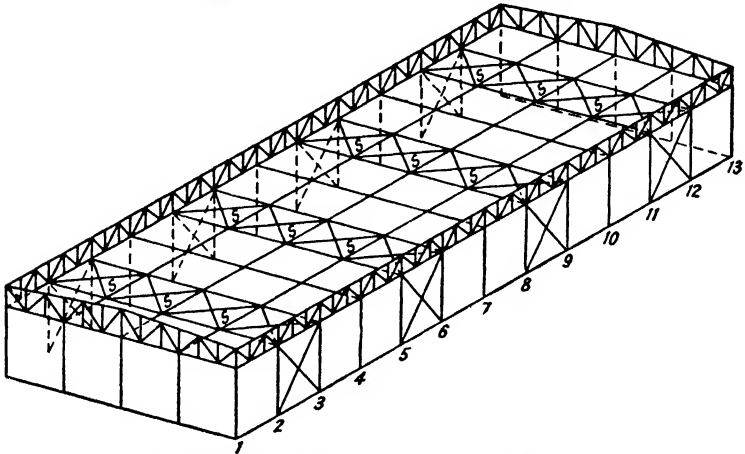

FIG. 22.—Alternate Bottom Chord Bracing Plan for Buildings without Knee Braces.

Buildings with Flat Roofs.—The bracing for buildings constructed with bents such as shown at (a), (c), (d), (e), (g), (h), (i), or (j) in Fig. 11 follows the same general arrangement as that for buildings having knee-braced bents. Bracing in the planes of the top chords of the roof trusses is less important in buildings with flat roofs and is sometimes omitted. Although not essential for stability, bottom chord bracing such as shown in Fig. 20 is sometimes combined with bracing as shown in Fig. 23 (b) for buildings with flat roofs. Such a combination results in increased rigidity and is desirable in a building in which heavy cranes operate. In a building braced as shown in Fig. 19 or Fig. 23, a transverse force applied at a bent not part of a braced bay, bent 4 for example, must be resisted entirely by that bent, whereas if the combined system is used a load applied at any bent is partly distributed to adjacent bents. Buildings in which cranes operate are subject to concen-

trated transverse loads resulting from side thrust or "nosing" of the cranes, and a combination bracing system contributes to rigidity and helps to prevent undue lateral distortion of the crane runway.

In flat-roof buildings the eave struts are sometimes made as small



*Modified Isometric View showing Bracing System as a Whole
Only end trusses and bottom chords of others are shown.*

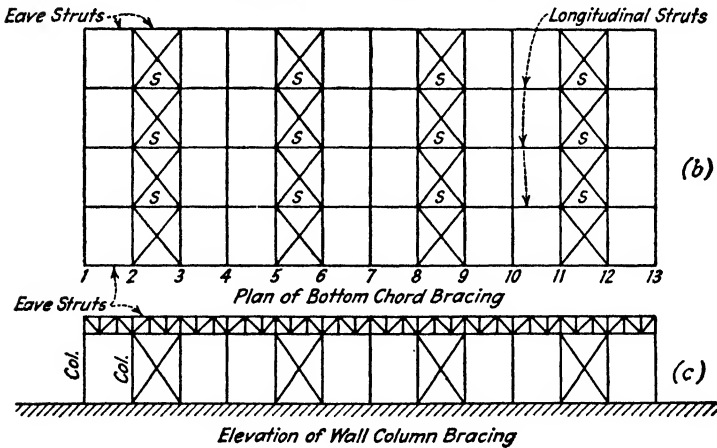

FIG. 23.—Typical Bracing System for Flat-Roofed Building.

trusses, having their bottom chords in the same plane as the bottom chords of the roof trusses and their top chords in the plane of the tops of the purlins in order to serve as spandrel purlins. The eave struts in the bracing system shown in Fig. 23 are of this type. If trussed eave struts are not used it is important to have effective struts between all columns

in the plane of the bottom chord bracing. Similar trussed frames are also used as longitudinal struts in the braced bays in some buildings; i.e., the members marked *S* in Fig. 23 (*a*) and (*b*) are sometimes made similar to the eave struts in the same figure.

The bracing between the wall columns in all the sketches presented has been shown as single-story bracing. In buildings which require large headroom this leads to diagonals having too steep a slope, and in such cases one, two, or three intermediate struts between the eave struts and the ground may be required. This is nearly always true in buildings containing crane runways, and for such structures it is desir-



Courtesy of Illinois Central System. F. R. Judd, Engineer of Buildings.

FIG. 24.—Boiler Erecting Shop, Illinois Central System Shops, Paducah, Ky.

able that an intermediate strut be placed at or near the level of the crane runway.

Figures 24, 25, 26, and 27 are presented to show the bracing in actual structures. In all these pictures the mass of steelwork and the small scale tend to obscure the details, but close examination will enable the student to gain some idea of how the framework of an industrial building goes together and appears as actually built. The views show large rather than average structures. In the foreground of Fig. 24 may be seen a typical braced bay, and wall column bracing two panels in height. It will also be noted that the longitudinal struts are trussed but in this particular instance it was due primarily to the special char-



Courtesy of Illinois Central System. F. R. Judd, Engineer of Buildings.

FIG. 25.—Blacksmith Shop, Illinois Central System Shops, Paducah, Ky.



Courtesy of McClintic-Marshall Company.

FIG. 26.—General Interior View of Erecting Shop,
Westinghouse Electric and Mfg. Co., Essington, Penna.

acter of the roof framing. In Fig. 25 may be seen bracing of the general character of that shown in Fig. 21. Figures 26 and 27 show very clearly

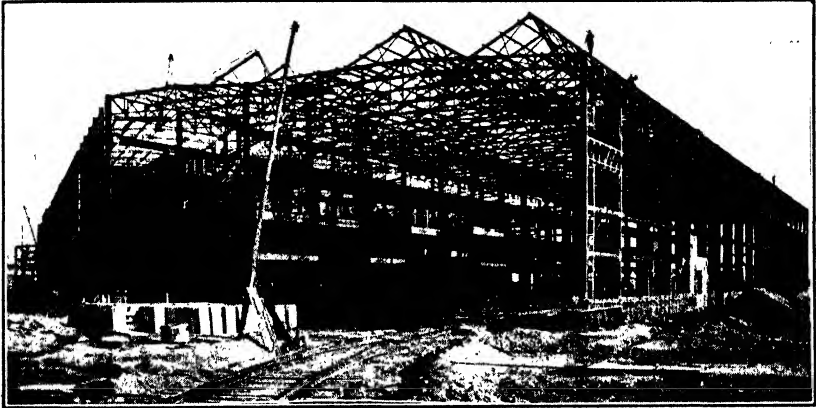

Courtesy of McClintic-Marshall Company.

FIG. 27.—General Exterior View of Erecting Shop,
Westinghouse Electric and Mfg. Co., Essington, Penna.

the wall column bracing of the building illustrated, and are of further interest in that they show the steel sash being placed. The student

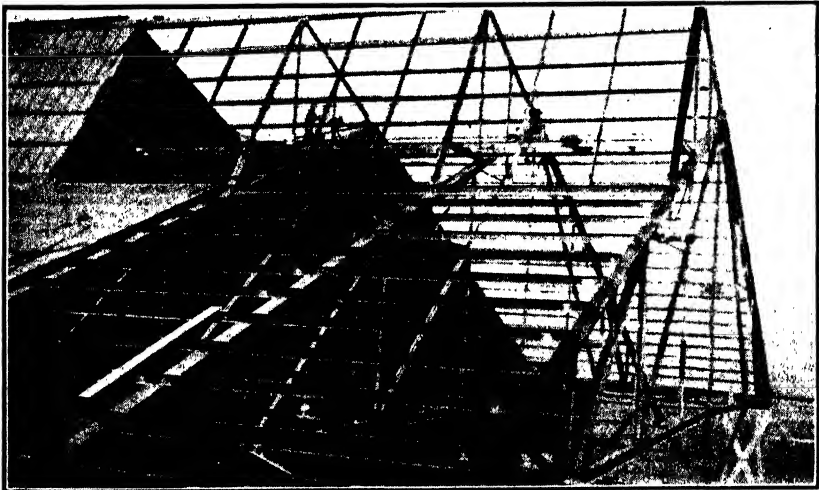

Courtesy of American Bridge Company.

FIG. 28.

should note the trussed eave struts, the line of trussed struts at the crane runway level, and the two lines of struts below the crane runway

level. The trussed eave struts in this building not only act as spandrel purlins, but also serve as carrying trusses supporting roof trusses placed between the main bents, the spacing of the main bents being two roof bays.

23. Illustrative Examples.—As further illustrations of the previous discussion of industrial building framing Figs. 28, 29, and 30 are given.

Figure 28 shows clearly the longitudinal roof beams, called purlins, resting on the top chord of the trusses. At the left of the two open bays may be seen the roof sheeting laid on the purlins. In the left open bay may be seen **sag rods** extending between the purlins. Sag rods are used to give lateral support to purlins on relatively steep roofs.

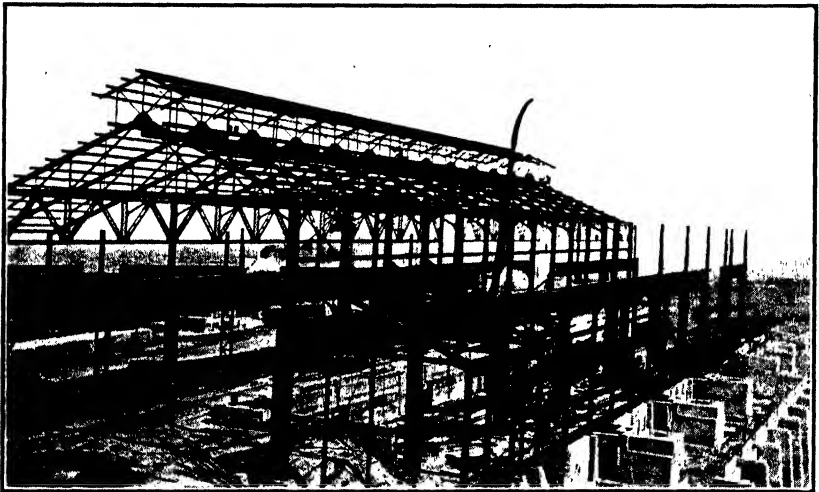

Courtesy of American Bridge Company.

FIG. 29.

The sag rods have not been placed in the right open bay, but holes to receive them are visible in some of the purlins. The view shows an extension to the Gary works of the American Sheet and Tin Plate Company.

Figure 29 is a construction view of the Soaking Pit Building for the Illinois Steel Company's Gary plant. It consists of a main aisle, of the general form shown at (f) in Fig. 11, with a lean-to on each side. The purlins may be seen distinctly on the roof over the main aisle and on the roof over the lean-to on the right-hand side. The student should particularly note the carrying trusses on the left-hand side of the main aisle, used to support two roof trusses and allowing a column spacing of three roof bays on the column line between the main aisle and the left-

hand lean-to. On this line the carrying trusses are at the eave strut level, while on the right-hand side of the main aisle there are carrying trusses at the crane runway level which support two cut-off roof columns of the regular spacing giving a column spacing below the runway level of three roof bays. Notice should also be taken of the heavy crane runway girders required by the three bay spacing of their supporting columns.

Figure 30 is a later view of the building shown in Fig. 29 and shows the steel frame complete and roof sheeting being placed. This view is of especial interest in that it shows the columns and girts of the end wall framing.

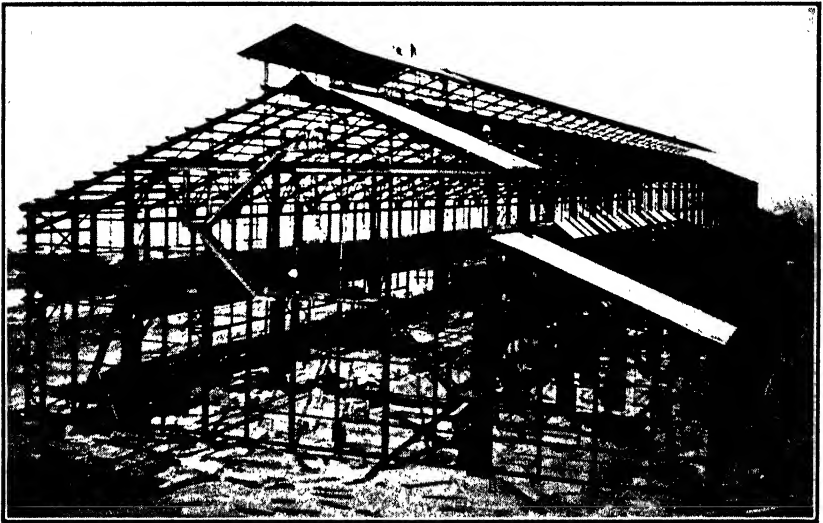

Courtesy of American Bridge Company.

FIG. 30.

BRIDGES

24. Classification of Bridges.—Bridges may be roughly divided into three principal classes which are descriptive of the service they render. These general classes are:

- 1st: Highway bridges.
- 2nd: Railway bridges.
- 3rd: Combined highway and railway bridges.

The list is in the order of the total number of each. The total number of bridges in the third class is small compared with the numbers in the first two, but what this class lacks in numbers it makes up in

importance, as many outstanding structures have been built for combined traffic. Bridges are built for many purposes not included in the above classification, such as for the support of water pipes, gas or oil pipes, conveyor machinery, and so on; but nearly all bridges of any importance are built primarily for the purpose of carrying a highway, railway, or both, over a river, ravine, freight yard, another highway or railway, or some other natural or artificial obstacle. Each of these major groups may be further divided into various types, and these types are in general common to each major group.

In each major group we find **deck bridges** and **through bridges**.

A **deck bridge** is one in which the roadway, whether railway or highway, rests on top of the supporting structure, and a **through bridge** one in which the railway or highway passes through the supporting structure. Some important bridges of the third major group are arranged with a *deck* highway and a *through* railway, and vice versa.

We also find in each of the three major groups **fixed bridges** and **movable bridges**. A **fixed bridge** is one which remains in a constant position. If it crosses a navigable stream the elevation of the roadway must be high enough above the waterway so that vessels may pass below without interference. A **movable bridge** generally crosses a navigable stream and is one in which the elevation of the roadway is such that vessels cannot pass beneath but one or more portions must be so arranged as to permit removing them from the passageway required for safe navigation. Not many bridges are entirely movable; probably a majority of those which interfere with navigation consist of a series of fixed spans with one or more movable portions. Movable bridges will not be further considered in this text. The principles of structural design which are discussed later are applicable to the structural portions of movable spans, but there are many special features connected with such bridges—machinery, signal equipment, counterweights, and so on—which depend on matters that cannot be considered here. Illustrations of some movable bridges are used later, however, to show structural features common to all bridges.

The general classification given above may be still further subdivided into:

- Beam bridges.
- Girder bridges.
- Viaducts or trestles.
- Truss bridges.

In the following discussion of these more specific subdivisions it is to be understood that the types and characteristics described are common

to all the major groups listed at the beginning of the article, unless it is otherwise stated, and further that this text is confined to steel structures although many statements may be equally applicable to those of other materials.

25. Beam Bridges.—Beam bridges consist of steel I beams placed parallel to the direction of traffic and close enough together so that the roadway, whether highway or railway, may be supported directly on their top flanges. There may be anywhere from four or five beams to a dozen or more, depending on the length and width of the bridge and the loads which are expected to cross it. The beam bridge is the simplest and most economical of all types when the opening to be spanned does not exceed forty or fifty feet for a highway structure or about twenty to thirty feet for a railway structure. Where foundation conditions are suitable, beam spans, supported on small piers with shallow footings or on pile bents, will form an efficient and low-cost structure which may be of considerable length. Beam spans are relatively less economical for railway structures than for highway structures because the heavier loads to be carried in the former case usually require stiffening the webs of the beams at the ends, and this is a costly shop operation. The conditions which lead to a combination highway and railway bridge are not those favorable to beam bridges, and this type will rarely if ever occur in the third general group.

Figure 31 (a) shows a sketch of a typical beam bridge for highway traffic and Fig. 31 (b) one for railway traffic. Many modifications of these typical arrangements are used. As shown, diagonal bracing is sometimes placed between the two groups of beams used for railway beam bridges, but in the corresponding highway structure such bracing is not necessary since the top flanges of the beams are usually encased in a concrete slab deck.

26. Girder Bridges.—Girder bridges are really large beam spans in which the beams are built-up plate girders instead of rolled I beams, because the greater lengths require stronger beams than can be obtained in a rolled section. There are other differences such as the number of girders used, the manner of supporting the roadway, and the possibility of building a girder bridge as a through span, or a half-through span as it is often called. Girder spans also are more carefully braced than beam spans, largely because of their greater length and less stocky construction.

Deck Girder Spans.—The most common girder span for railway use is the deck plate-girder bridge. It consists essentially of two girders spaced from about six and a half feet to as much as ten feet apart, on top of which ties and rails are placed directly. Figure 32, which is a

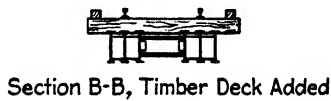
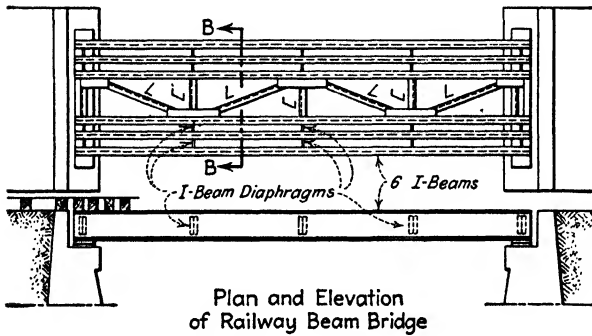
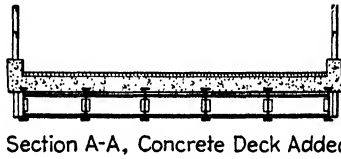
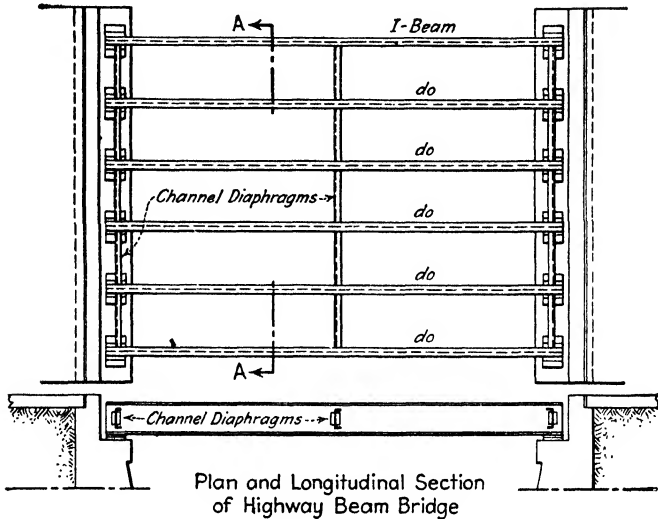
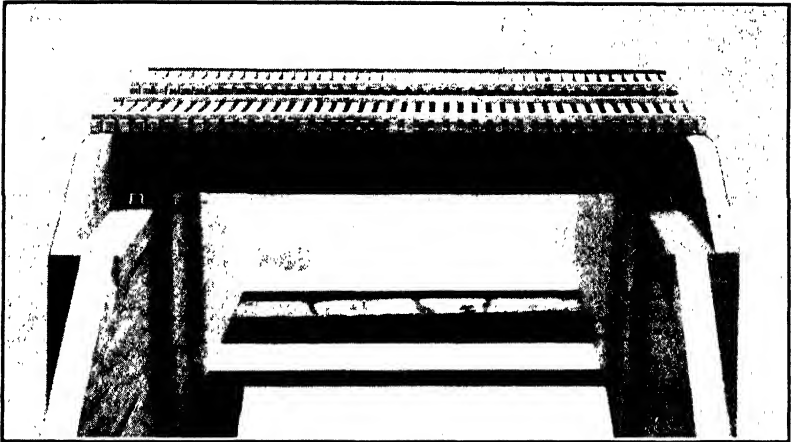
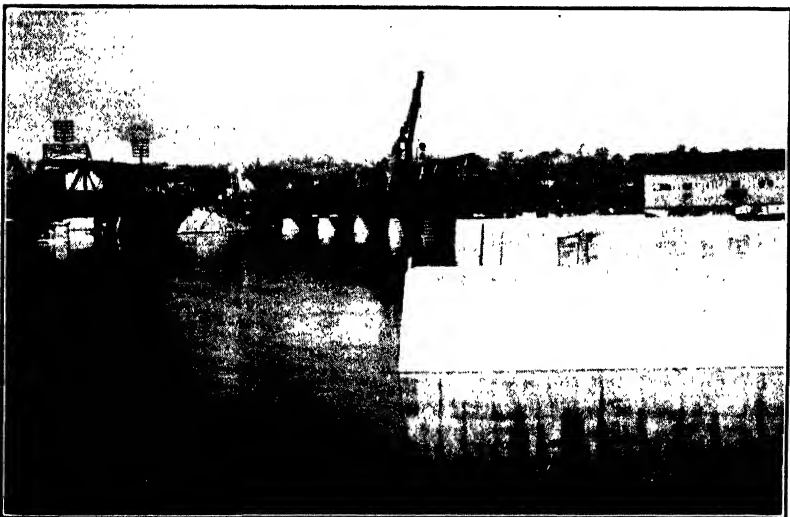

FIG. 31.



Courtesy of P. G. Lang, Jr., Engineer of Bridges.

FIG. 32.—The Baltimore and Ohio Railroad Centenary Bridge Models.



Courtesy of Atchison, Topeka and Santa Fe Railway.

FIG. 33.—West Approach to Bridge over Mississippi River at Fort Madison, Iowa.

photograph of a model plate-girder bridge, shows the type clearly. The illustration is of a double-track bridge, and to secure a double-track plate-girder deck bridge it is usual merely to place two single-track bridges side by side on common abutments or piers. Figure 33, a view taken during the construction of the double-track plate-girder approach to the Sante Fe Railroad bridge over the Mississippi River at Fort Madison, Iowa, shows this construction.

The horizontal bracing of a deck plate-girder bridge consists of diagonal angles, called the laterals or lateral bracing, connected between the top flanges, as shown in Fig. 34. Spans less than fifty feet in length usually have lateral bracing between the top flanges only, but spans greater than fifty feet in length have a similar system between the bottom flanges. In addition to the lateral bracing deck plate-girder bridges

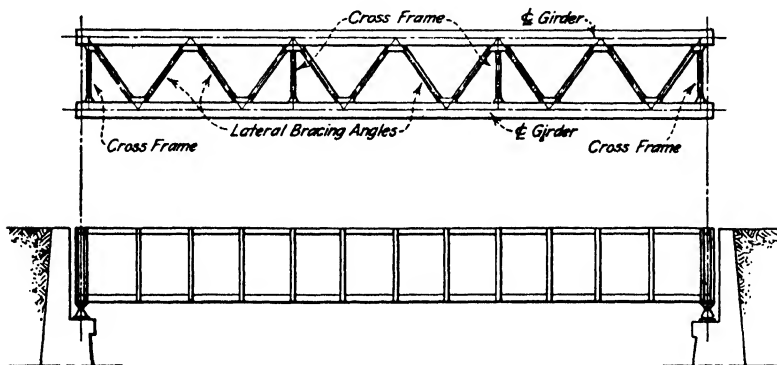

FIG. 34.—Plan and Elevation of Railroad Deck Girder Bridge, Showing Top Lateral Bracing.

are provided with cross frames at each end, and at intervals of about twelve to twenty feet between the ends. A cross frame consists of two horizontal struts, one at the level of the top flanges and one at the level of the bottom flanges, and two diagonals which are riveted to the horizontal struts and the girders in the form of an X. The end cross frames may be seen clearly in Fig. 33. The purpose of the end cross frames is to transfer the reactions from the top lateral bracing truss to the masonry, and that of the intermediate frames to assist in keeping the cross-section rectangular and check relative vibration of the girders.

Deck plate-girder spans may also be used for highway bridges, but in such cases it is usually desirable that some sort of steel framing be used for a floor system to support the roadway. Many forms of floor

framing are used for the support of the roadway but the most common are illustrated by the two sketches in Fig. 35.

The members of the floor system may be defined as follows. A **floorbeam** is a beam usually running at right angles to the main girders, which is connected to or rests on the main girders and supports the

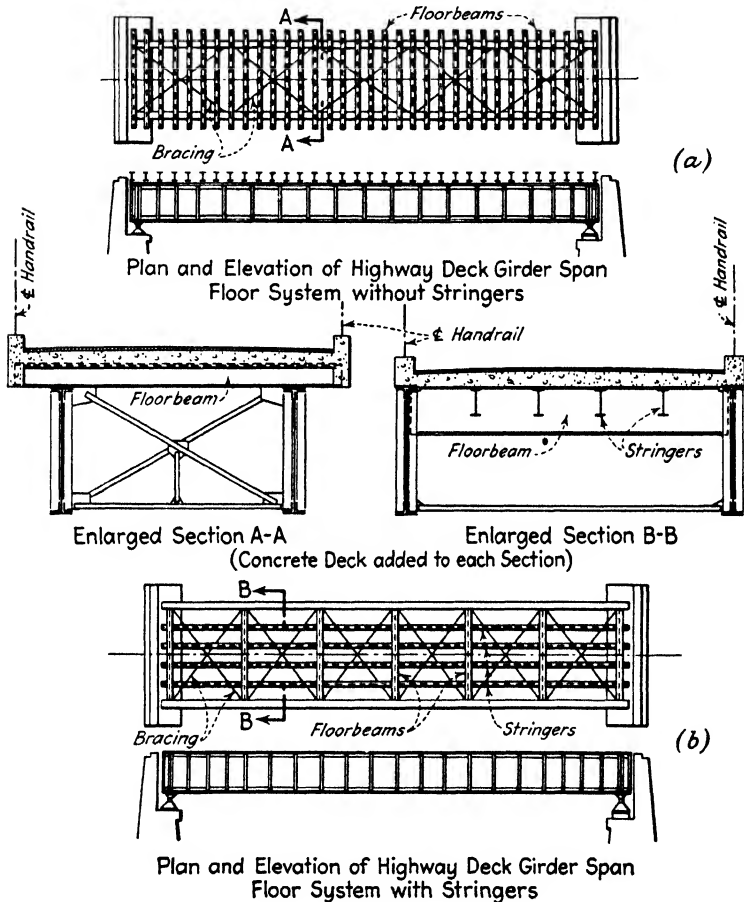

FIG. 35.

roadway between the girders. A **stringer** is a longitudinal beam, which is connected to or rests on floorbeams and supports the roadway between the floorbeams. These definitions are illustrated by the sketches. When floorbeams alone are used to support the highway deck they are sometimes connected to the webs of the girders with their top flanges

in the same plane as the top flange of the girders, instead of being supported directly on the top flanges of the girders as shown in Fig. 35 (a). The type of floor system in Fig. 35 (b) is sometimes made with cantilever brackets when the roadway is wide. Figure 36, which is a view of the Perth Amboy approach to the Outerbridge Crossing, built for the Port of New York Authority, illustrates this case. In the Outerbridge Crossing the roadway is 42 ft. between curbs with a sidewalk 5 ft. wide added on each side. The girders are spaced 32 ft. center to center with the out-



Courtesy of Waddell and Hardesty, Consulting Engineers.

FIG. 36.—Perth Amboy Approach, Outerbridge Crossing,
Port of New York Authority.

side 10 ft. of roadway and the two sidewalks carried on cantilever brackets.

Railroad deck girder bridges are sometimes provided with a floor system, such as is shown in Fig. 35 (a), and a concrete or timber trough, in which ballast is placed, constructed on this floor system.

Through Girder Spans.—Through girder bridges are constructed for both highway and railway service. In this type a floor system is required for either railway or highway use. Through girder bridges are used when a limited distance is available between the roadway and the underclearance line. Figure 35 (b) will serve very well as an illustra-

tion of a through girder highway bridge except that in the section the floor system should be as close to the bottom of the girders as possible. The roadway deck would then of course be entirely between the girders, and it would be necessary for them to be spaced farther apart than in the deck bridge. The floor system for a railway through girder bridge is similar to that for a highway through bridge except that usually only two stringers would be required, one for each rail.

Figures 37 and 38 illustrate portions of a highway through plate-girder bridge, the former taken from above and the latter from below. Figures 39 and 40 show through railway girder bridges. The reasons

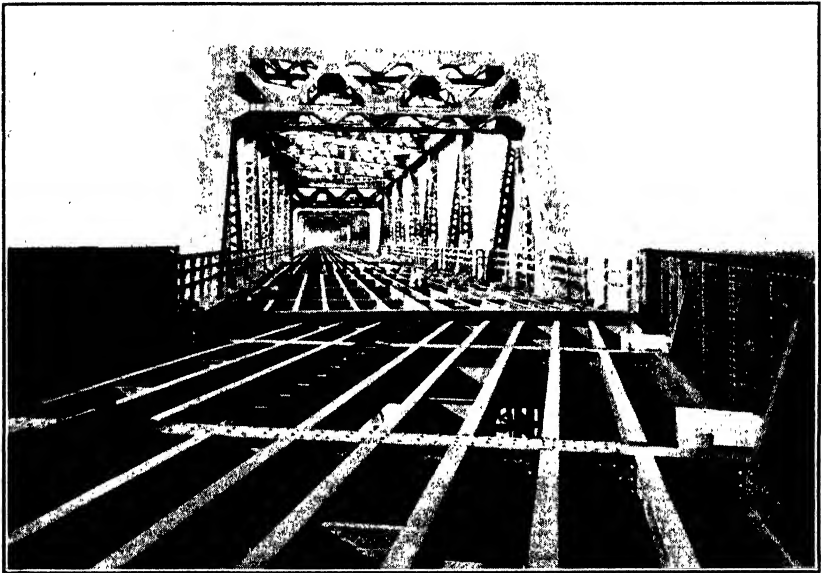

Courtesy of Atchison, Topeka and Santa Fe Railway.

FIG. 37.—West Approach to Bridge over Mississippi River, Fort Madison, Iowa.

for using through spans in these cases should be clear. The student should note the triangular brackets, called **knee braces**, connecting the ends of the floorbeams to the girders. Knee braces are intended to provide lateral support for the unbraced top flanges of the girders. Figure 41 shows a through girder double-track bascule bridge and is presented here because the open position shows clearly the character of bracing employed for through girder spans and also shows clearly the relation of the floor system to the girders. It should be noted that the bracing in this case is a double system, used because of the large distance between girders necessary for two tracks. If the student lays a sheet



Courtesy of Atchison, Topeka and Santa Fe Railway.

FIG. 38.—West Approach to Bridge over Mississippi River, Fort Madison, Iowa.

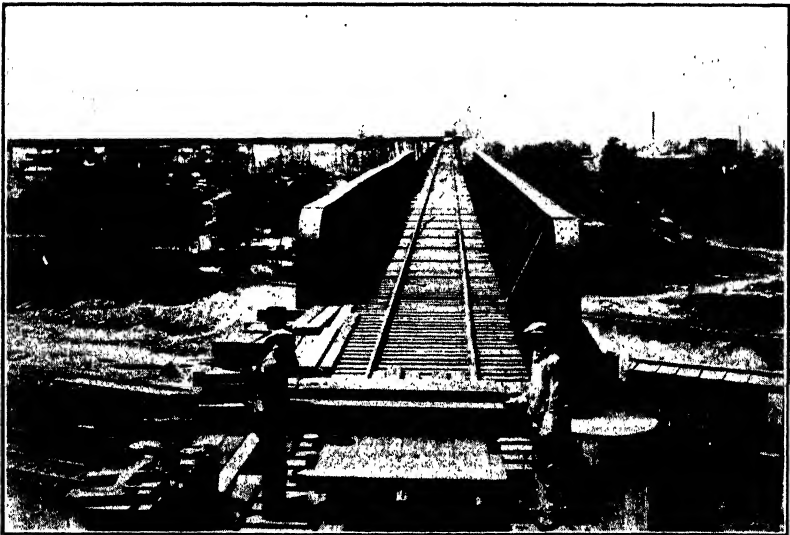

Courtesy of C. C. C. and St. L. Railway.

FIG. 39.—Approach to Bridge over Ohio River at Louisville, Ky.

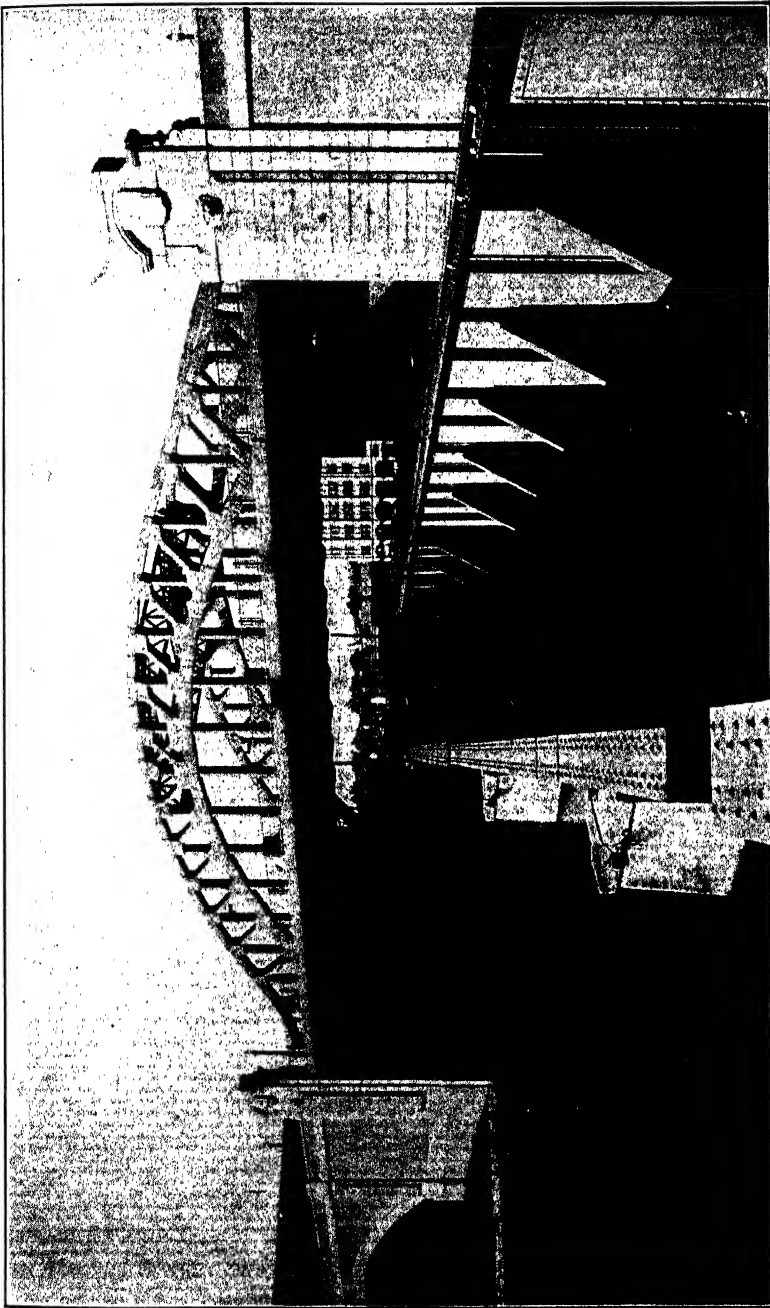

Courtesy of The Phoenix Bridge Company.

Fig. 40.—Through Plate Girder Span Passing under Two-Hinged Arch. Cottage Farm Bridge, Metropolitan District Commission, Massachusetts.

of paper on the picture (with its edge parallel to the girder flange) so that it covers up one half of the bracing, the visible portion will be an excellent illustration of the usual bracing for a single-track through girder span.

27. Viaducts or Trestles.—Sometimes it is necessary to carry a railway or highway across a wide ravine or valley at a considerable

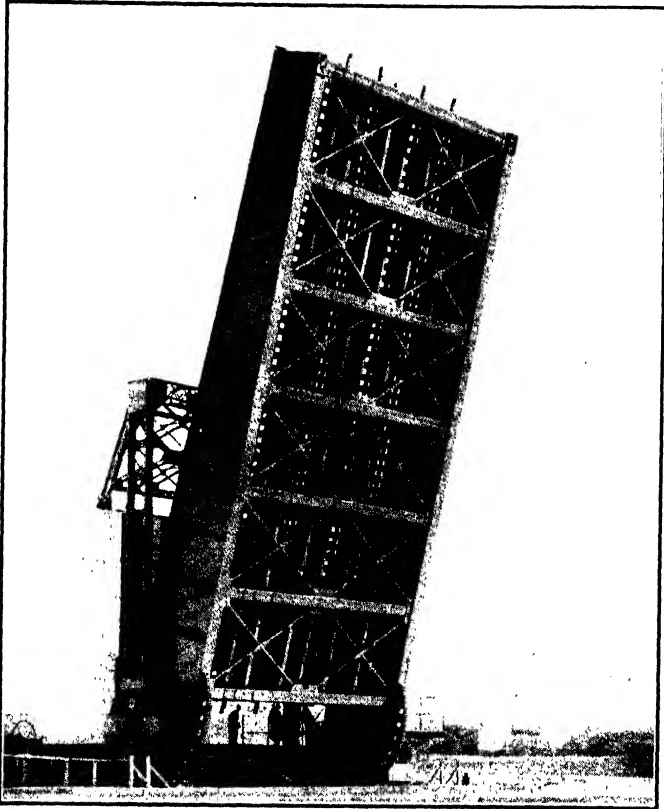

Courtesy of The Strauss Engineering Corporation.

FIG. 41.—Manchester Bridge, Boston and Maine Railroad.

height above the ground. In such cases plate-girder spans supported on steel towers are often used. A structure of this kind is called a **viaduct** or sometimes merely a **trestle**. Figures 42 and 43 show typical railway viaducts, the former a single-track and the latter a double-track structure. As may be clearly seen in the illustrations a viaduct consists of a series of towers or towers and bents supporting the girder spans.



Courtesy of McClellin-Marshall Company.

FIG. 42.—Tennessee Viaduct.

A **bent** consists of two columns braced together in a plane perpendicular to the center line of the track or bridge, and a **tower** consists of two bents which are connected by bracing parallel to the center line of the bridge. The bracing between two columns forming a bent is called the **transverse bracing**, and the bracing connecting two bents to form a tower is called the **longitudinal bracing**. A viaduct is generally considered as being made up of tower spans and intermediate spans. A

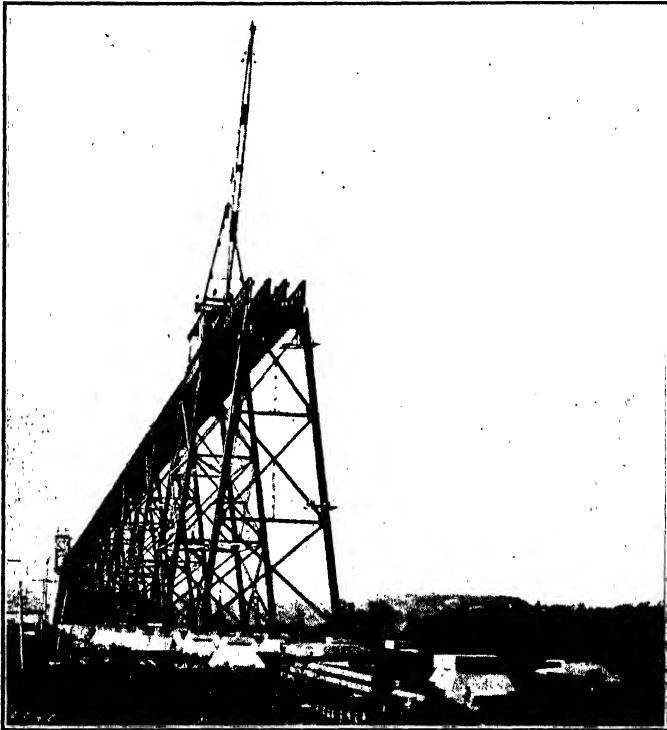

Courtesy of New York Central Railroad.

FIG. 43.—East Approach to Hudson River Bridge, Castleton, N. Y.

tower span is a span extending between two bents forming a tower, and an intermediate span one extending between two towers. Viaducts sometimes contain single bents as well as towers.

Tower spans are commonly 30 to 50 ft. in length, and intermediate spans from 40 to 100 ft. in length. The length of the tower spans and intermediate spans depends on the height and length of the viaduct as well as on the loads to be carried. The use of single bents in combina-

tion with towers, or towers alone, also depends on length and height as well as the loads.

Viaducts or trestles are often used as approaches to the main spans of a bridge when these are at a considerable height above the water and a long way from the point at which the highway or railway leaves the ground. The trestle shown in Fig. 43 is the east approach to the New York Central's Hudson River bridge at Castleton, New York.

28. Truss Bridges.—When bridges must be of greater length than can be economically built with plate girders, trusses are resorted to. Truss spans usually range from about 130 ft. up, but half-through or pony trusses are sometimes used for highway (occasionally railway pony trusses are built) bridges with spans as short as 60 ft.

Figure 44 shows a photograph of a model of a modern riveted truss bridge. The various parts have been marked so far as they are visible.

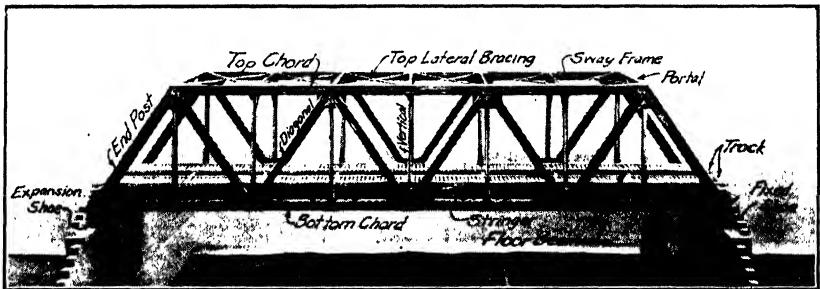

Courtesy of P. G. Lang, Jr., Engineer of Bridges.

FIG. 44.—The Baltimore and Ohio Railroad Centenary Bridge Model.

The **chord members**, or more commonly the **chords**, are the members forming the perimeter of the truss figure. The **diagonals** and **verticals** form the **web system** or **web** of the truss. The end members of the perimeter are often considered as part of the web system and are called the **end posts**. The floorbeams and stringers, previously defined, form the floor system or floor. The top lateral bracing consists of the diagonal members and the top struts of the sway frames, lying in a horizontal plane, which connect the top chords of the two trusses in the bridge; the diagonals are commonly called the **top laterals**. The **sway frames** are light trussed bracing frames which connect the two trusses of the bridge; they are usually vertical, at right angles to the axis of the bridge, and fastened to corresponding verticals in the two trusses. The **portals** are the end sway frames and are connected between the end posts of the two trusses. The top laterals, sway frames, and portals taken together form the top lateral bracing system, and with the top

chords of the bridge form a horizontal truss. The **bottom laterals** are not visible in this figure but are similar to the top laterals and connect the bottom chords of the two trusses. The floorbeams are part of the bottom lateral bracing system, and with the bottom laterals and bottom chords of the bridge form a horizontal truss.

The points at which chords and web members of a truss intersect

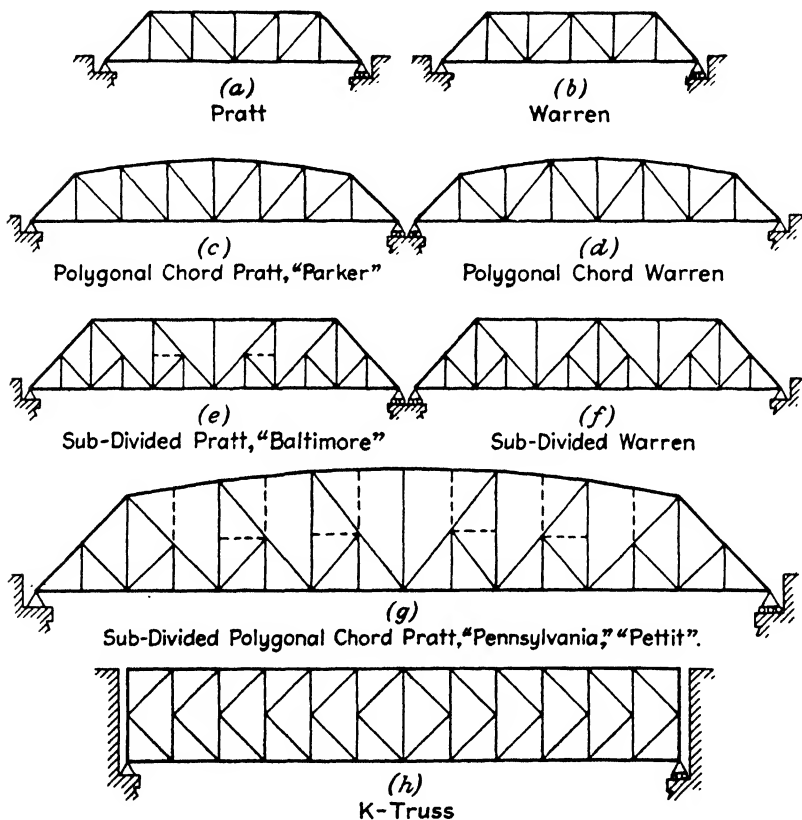

FIG. 45.—Modern Truss Types.

are called the **panel points**, and the horizontal distance between adjacent panel points is the panel length. A truss span is said to have a length of so many panels at so many feet each, for example a length of 8 panels of 25 ft. each, or 200 ft. Floorbeams and sway frames generally connect to the trusses at panel points.

Truss bridges are built in many forms, but simple spans are usually of one of the common types shown in Fig. 45. The Pratt truss, (a), with

parallel chords is used for both railway and highway bridges for spans up to about 200 ft. for railway and 180 ft. for highway bridges; these



Courtesy of McClintic-Marshall Company.

FIG. 46 (a).—Potomac River Bridge, Norfolk and Western Railway, Sheperdtown, W. Va.

limits are not definite and under peculiar conditions may be raised or lowered. The Warren truss, (b), with parallel chords, is used under the

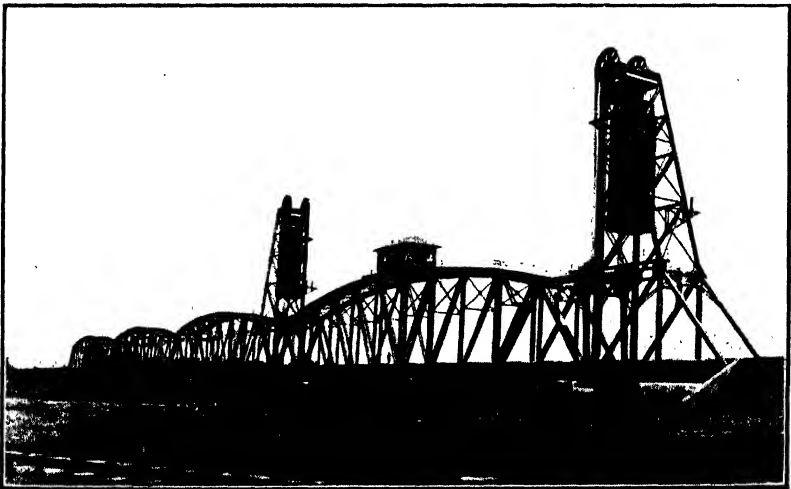

Courtesy of Waddell and Hardesty.

FIG. 46 (b).—Missouri River Bridge, Great Northern Railway.

same conditions as the Pratt and with about the same limits as to length. The Warren type has grown in favor with the increasing use of riveted

connections for trusses; it is not so well suited to pin connections as the Pratt truss. The polygonal chord Pratt and Warren trusses, (c) and (d), are commonly used for spans up to 360 ft. and have been used for lengths as great as 670 ft.

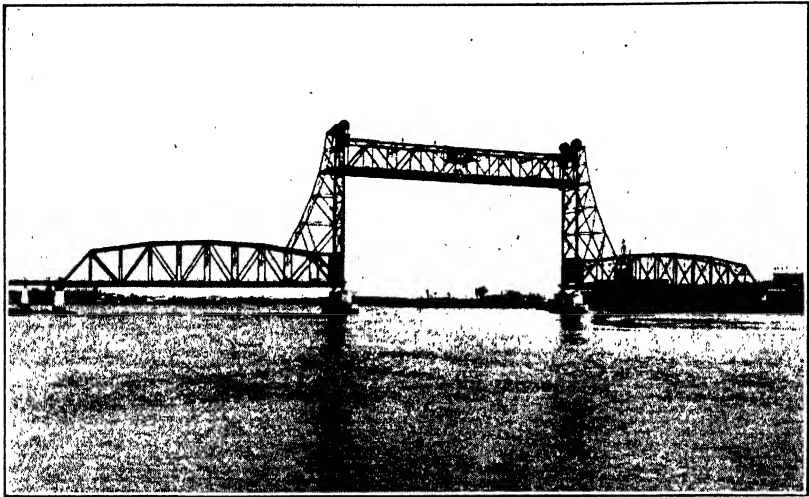

Courtesy of Waddell and Hardesty.

FIG. 46 (c).—Piscataqua River Bridge, Portsmouth, N. H.

The most economical truss results when the angle between the diagonals and the horizontal lies between 45° and 60° , while panel lengths for trusses range between about 20 ft. (sometimes less for unusual



Courtesy of C. C. C. and St. L. Railway.

FIG. 46 (d).—Louisville and Jeffersonville Bridge over Ohio River.

conditions) and 45 ft. When the depth of a truss must be large and the panels short it is impossible to maintain the proper slope for the diagonals with the ordinary truss forms shown in (a), (b), (c), and (d). In such cases subdivided trusses, shown in (e), (f), and (g), are used.



Courtesy of The Phoenix Bridge Company.

FIG. 46 (e).—Goffs Falls, N. H.

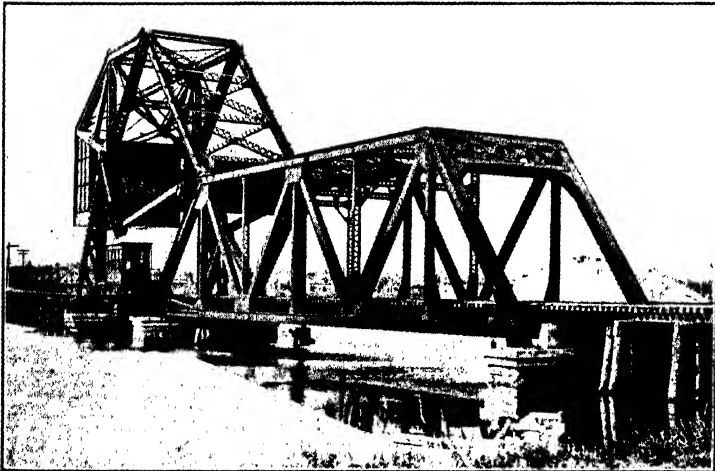

Courtesy of The Strauss Engineering Corporation.

FIG. 46 (f).—Cape Cod Canal Bridge at Buzzards Bay, Mass.

The horizontal dotted members in the trusses in (e) and (g) are to provide lateral support for the long compression members; they do not carry calculated stress, and are not considered as primary members of the truss. The dotted vertical members shown in the truss in (g)

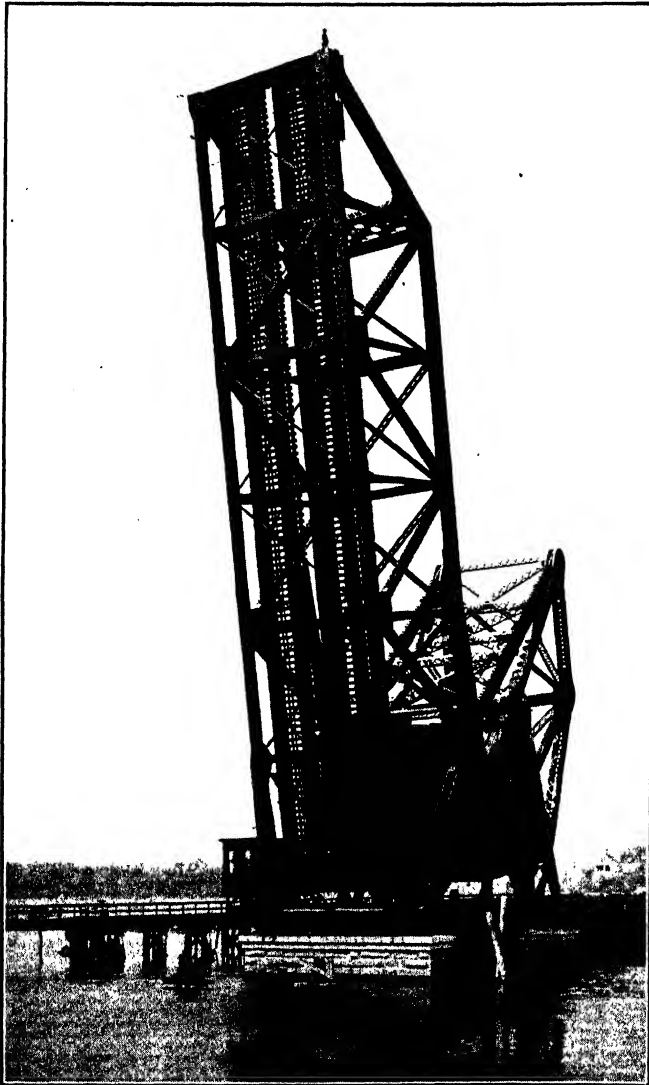

Courtesy of The Strauss Engineering Corporation.

FIG. 46 (g).—Cape Cod Canal Bridge at Buzzards Bay, Mass.

support the top chords at intermediate points; they are subjected to dead load only and sometimes are omitted. The K truss, (*h*), is a relatively new form developed to secure economical diagonal slope and short panel lengths. It is thought to have several advantages over the ordinary subdivided truss.

All the truss diagrams in Fig. 45 are drawn to the same scale for comparison. The diagrams in (*a*) and (*b*) have panels 28 ft. long, those in (*e*) and (*f*) panels 20 ft. long, and the rest panels 30 ft. long.

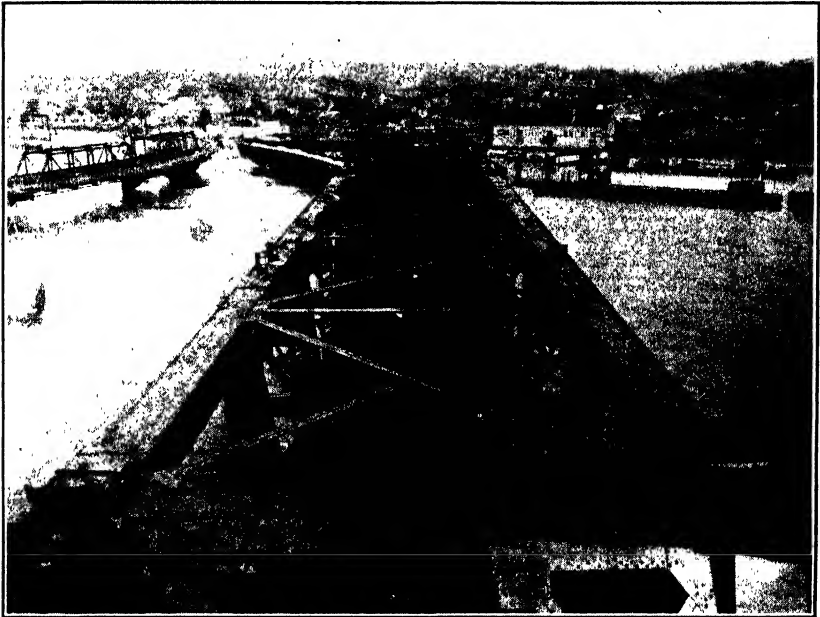

Courtesy of Atchison, Topeka, and Santa Fe Railway.

FIG. 46 (*h*).—Top Lateral Bracing, Swing Span, Mississippi River Bridge, Fort Madison, Iowa.

Figures 46 (*a* to *k*, inclusive) are presented to illustrate the preceding discussion of bridge types and construction. These views should be studied carefully, the truss types identified, and the general character of the construction and bracing for the different bridges observed and compared.

Figure 46 (*a*) shows a deck truss of the parallel chord Pratt type: note the viaduct approach on the far end. Figure 46 (*b*) shows a through railroad bridge consisting of three approach spans about 275 ft. long and a lift span about 300 ft. long all of the "Parker" or

polygonal chord Pratt type: note the timber trestle approach at the far end. Figure 46 (c) shows a modern highway bridge with a central lift span in the open position: the lift span is of the parallel chord Warren type, and the flanking spans of the polygonal chord Warren type. Each of the three main spans has a length of about 300 ft. Figure 46 (d), at the far end a Parker truss of about 210 ft.; the three main spans of the Pennsylvania type, each about 550 ft. long; and at the near end two Parker trusses of about 340 ft. each. Figure 46 (e)



Courtesy of Atchison, Topeka and Santa Fe Railway.

FIG 46 (i).—Portal at End of Main Span at Upper Deck, Mississippi River Bridge, Fort Madison, Iowa.

shows subdivided Warren trusses exactly like the one shown in Fig. 45 (f). Figures 46 (f) and (g) show a Strauss trunnion bascule over the Cape Cod canal at Buzzards Bay in the closed and open positions. These two views should be studied with particular care as they show very clearly the character of the framing and bracing for a typical through railroad truss span. Although the bridge is a movable structure the details are not materially different from the ordinary span except at the end near the tower: the elaborate system of bottom bracing in the panel next to the tower is for the support of the tracks when the span is up.

Figure 46 (h) shows clearly the top lateral bracing for a heavy, double-deck bridge. The general construction of this bracing is like that for any through bridge except that it is somewhat heavier than that for an ordinary structure. Figure 46 (i) shows the portal for one end of an approach span of the bridge the top laterals of which are shown in the



Courtesy of C. C. C. and St. L. Railway.

FIG. 46 (j).—Portal of 210-Ft. Span, Louisville and Jeffersonville Bridge, over Ohio River.

preceding illustration. Figure 46 (j) shows the portal of the 210-ft. span, and Fig. 46 (k) the portal of the 340-ft. spans of the bridge shown in Fig. 46 (d). The portals in Figs. 46 (i), (j), and (k) should be compared with the portals of the bridges in the frontispiece and in Figs. 46 (b) and (e).



Courtesy of C. C. C. and St. L. Railway.

FIG. 46 (k).—Portal of 340-Ft. Span, Louisville and Jeffersonville Bridge, over Ohio River.

DETAILING AND FABRICATION

29. A working knowledge of drawing-room, shop, and erection methods is essential to the designing engineer, but time cannot be spared in a college course for thorough study of these matters. Nevertheless, it is important for the student of structural design to be able to read structural drawings; to understand the difference between stress sheets, general design drawings and details, and shop drawings; to be able to make simple design drawings; and to have some understanding of the fundamental shop processes in the fabrication of structural steel.

There is much excellent material on these subjects in the following references, which should be consulted:

- "Detailing and Fabricating Structural Steel," F. W. Dencer.*
- "Structural Drafting and the Design of Details," C. T. Bishop. †
- "Structural Steel Drafting and Elementary Design," C. D. Conklin, Jr. †
- "Structural Engineer's Handbook," M. S. Ketchum.*

In addition to these books there are excellent chapters on fabrication and erection methods by F. W. Dencer, assistant division engineer of the American Bridge Company, in "Steel and Timber Structures," by Hool and Kinne.* The chapter entitled "Shopwork as Affecting Bridge Design" in "Bridge Engineering," Vol. I, by J. A. L. Waddell, † should also be read by every student of bridge design. The user of this book is presumed to have mastered the usual college course in engineering drawing and to be able to interpret ordinary structural drawings correctly, and make the simple design drawings necessary in connection with his study of structural design. Practice in the preparation of shop drawings is not identical in all fabricating plants. The differences, however, are in minor details, and the draftsman capable of making satisfactory shop details for use in one structural shop should not have difficulty in adapting himself to the methods in use in others. The making of shop plans should preferably be studied in the drawing-room of some fabricating plant, and the matter will not be further discussed here.

The structural engineer deals with drawings of all kinds but most of his work falls within the range of four major types which are defined and described below. The student should have some familiarity with these types.

THE STRESS SHEET.—A stress sheet is usually a line diagram showing the arrangement of the various members of a structure. It should give the controlling dimensions, the loads on which the design was based, the specifications controlling the design, the stress produced in the various members by the design loads, the section or sections required for each member of the structure, and any other data necessary for the preparation of all drawings required for the construction of the bridge or building concerned. For a large project more than one stress sheet may be necessary. For office buildings and similar structures there are usually a series of floor plans, made as line diagrams,

* McGraw-Hill Book Co.

† John Wiley & Sons.

and a column schedule, instead of a stress sheet in the more strict sense of the word. Such plans are often called the engineer's plans, instead of the stress sheets. The engineer's plans for a tier building give all data as to sections used, and should also give shears, moments, and stresses for the various members unless their connections are controlled by standards.

THE DESIGN DRAWING.—Design drawings are midway between stress sheets and shop drawings: they show the character of connections and connection material but do not locate the various holes and rivets or give accurate information as to the length or number of pieces of detail material. Design drawings should be approximately to scale, i. e., they should be made nearly enough to scale to make sure that the parts can be put together as shown but need not be drawn accurately enough, or to a scale large enough, to permit measuring dimensions which depend on clearances and so on.

THE LAYOUT.—Layouts are pencil drawings made to a large scale—usually $1\frac{1}{2}$ in. or 3 in. to the foot, but sometimes as small as 1 in. to the foot—of important details for a steel structure. A layout is made to permit the determination of clearances, distances from working points to ends of members, sizes of gusset plates, and so on, by actual measurement from the drawing. It should be clear that it must be made with care. The designer often finds it desirable to make layouts of some features of the structure on which he is engaged, but the principal use of such drawings is by the engineering force of the steel fabricator in connection with the preparation of shop drawings and material orders.

THE SHOP DRAWING.—Shop drawings for a structure must give to the shop all the information necessary for the cutting and shaping of every piece of material required, the size and location of every hole required, information as to what pieces are to be put together and riveted in the shop, what pieces are to be bolted together during shipment, instructions as to painting and marking for shipment, finish required, and so on. Shop drawings should be clear, concise but complete, and above all accurate. Such work is often monotonous and tiring, but it is an extremely important part of the engineering of any project. The difference between a profit and a loss may depend on the intelligence and care used in the preparation of the shop drawings, and lack of attention to seemingly minor details may result in costly errors, difficulties, and delays in both shop and field. Many young engineers fail to appreciate the importance and responsibility of work of this character and try to avoid it. The author considers drawing-room experience to be of inestimable value, if not absolutely essential, in the professional training of a structural engineer.

CHAPTER III

THE DESIGN OF BEAMS AND GIRDERS

30. The previous chapter describes the fundamental members used in steel construction and the common arrangements of these members to form the complete structural frames for ordinary buildings and bridges.

As stated at the beginning of the previous chapter there are only three kinds of structural members, and it is the purpose of this and the succeeding chapter to discuss and illustrate the application of the principles underlying their design.

It is essential that the student of design have at hand some handbook or catalog giving the properties of structural steel shapes. The most complete, generally available books of this sort are the handbooks "Steel Construction" published by the American Institute of Steel Construction and the "Pocket Companion" published by the Carnegie Steel Company and by the Illinois Steel Company. The former contains not only the properties of steel shapes and much useful information for the designer, but also the Institute's "Specification for the Design, Fabrication, and Erection of Structural Steel for Buildings" to which the reader of this text will be frequently referred.

31. General.—In the design of beams of constant section, such as rolled-steel beams or timber beams, it is necessary to compute only the maximum moment and maximum shear. For beams which are to be made with varying section, such as steel beams and plate girders with cover plates of different lengths or concrete beams in which part of the reinforcement is discontinued or bent up, it is necessary to know how the moment and shear vary along the beam. However, in the majority of problems in practical design the variation in shear and moment is known, or may be approximated with sufficient accuracy for design purposes, without actual computation of more than the maximum values.

32. Rolled-Steel Beams; Selection by Section Modulus.—The usual procedure in the design of a steel beam, having computed the maximum shear and maximum moment, is to determine the section modulus required from the beam formula:

$$\frac{I}{c} \text{ or } S = \frac{M}{s} \quad (1)$$

where M = the maximum bending moment, in inch-pounds or inch-kips;

s = the maximum allowable intensity of stress in bending, in pounds per square inch or kips per square inch;

$I/c = S$ = the section modulus,

I being the moment of inertia of the cross-section in inch units and c the distance from the neutral axis to the extreme fiber in inches. A beam having a section modulus equal to or greater than the required amount is then chosen from a table giving the properties of rolled-steel beams. Such tables are given in "Steel Construction," in steel manufacturers' catalogs, and in practically every engineer's handbook, whether civil, electrical, mechanical, or mining.

The student should understand that this procedure assumes the plane of the bending moment, M , to coincide with a principal plane of the beam and the beam to be perfectly homogeneous and perfectly straight. The assumptions on which the beam formula rests are, of course, also necessary. A beam having these characteristics would have no tendency to sideways deflection, i.e., deflection laterally from the plane of the bending moment, but since no beam fulfills all these requirements it is necessary that the top flange be supported against lateral movement if the above procedure is to be applied directly. It is also assumed that the shear is not large enough to dictate the choice of a section. This is nearly always true in steel framing, but cases in which shear is, or may be, of controlling importance will be discussed later.

It will be noticed that there are usually several beams having a section modulus close to the required value, and often the proper beam to select has a section modulus which is not the nearest to the required value. For example, suppose that a beam to resist a moment of 860 in.-kips is to be selected using an allowable stress of 18 kips per sq. in.

$$\frac{I}{c} \text{ or } S = \frac{860}{18} = 47.8$$

In a table of properties of American Standard Beams it will be found that a 12-in. I at 45 lb. having a modulus of 47.3, and a 12-in. I at 50 lb. having a modulus of 50.3, are the nearest to the required value. In the ordinary case, however, a 15-in. I at 42.9 lb., having a modulus of 58.9, would be selected because it is lighter than either of the other sections. Sometimes architectural or other limitations would compel the choice of one of the 12-in. beams in order to keep the depth as small as possible.

One of the newer Carnegie or Bethlehem sections will furnish the required section modulus at a smaller weight than the standard beams

given above, and if readily available at a competitive price might be chosen.

33. Safe Load Tables.—Steel beams may be selected also from tables of “safe loads.” Safe load tables are of two types. The more common type is that which gives the total uniformly distributed load which a given beam can carry on various spans without exceeding the maximum allowable fiber stress for which the tables are prepared. Since the loads given are the *total* loads, and therefore include the weight of the beam, this weight must be assumed or estimated in advance of design. Examples of this type of table may be found in the handbook “Steel Construction” previously mentioned, in engineers’ handbooks, and steel manufacturers’ catalogs. If the moment given above is caused by a total load of 28,700 lb. or 14.35 tons on a span of 20 ft., the same beams will be found to answer from safe load tables.

Comprehensive safe load tables based on 18,000 lb. per sq. in. are given in “Steel Construction.” These tables include practically every American rolled-steel I beam.

The method of using such tables needs no further explanation, but it may be worth while to note that, in using one constructed for an extreme fiber stress different from that which the designer is using, the load to be carried should be multiplied by the ratio of the tabular stress to the desired stress and a beam selected to carry the thus modified total load. As an illustration, to select a beam to carry the total uniformly distributed load of 28,700 lb., mentioned above, from the safe load tables given in “Steel Construction,” but at a permissible unit stress of 16,000 lb. per sq. in. a beam should be taken from the table for a load of

$$\frac{18,000}{16,000} \times 28,700 = 32,300 \text{ lb.}$$

on a span of 20 ft.

A less commonly available, but in many ways more convenient, safe load table is one which gives the uniformly distributed load in pounds per linear foot which a given beam can carry on various span lengths without exceeding the extreme fiber stress for which the table has been prepared. As in the total load tables the permissible loads per foot include the weight of the beam, which of course must be assumed or estimated in advance. A table of this type, for American Standard I beams, based on 18,000 lb. per sq. in., is given in the “Pocket Companion” published by the Carnegie Steel Company (pages 210, 211, and 212 in the 1931 abridged edition). The method of use with different fiber stresses is indicated above in connection with total load tables.

Many designers depend almost entirely on tables of safe loads and develop very ingenious methods of including the effect of concentrated loads. The author prefers to determine the maximum moment and select the beam according to the required section modulus or from a table of maximum moments.

MAXIMUM MOMENT TABLES.—Tables giving the maximum moment which a given beam can resist are also frequently given, and in many ways are more convenient than safe load tables. Like safe load tables, they must be based on some assumed fiber stress, and the method of use for different fiber stresses is the same in principle.

34. Illustrative Example.—To illustrate the foregoing discussion the calculation sheets for the design of the steel framing for a wall and pier bearing floor are presented: Sheets 1 and 2 of DP1. As indicated by the plan of the floor framing and the sketch of the floor construction given on these sheets, a 1-in. maple finish floor is laid over a 3-in. plank sub-floor. The sub-floor is spiked to the timber nailers which are fastened to the steel beams by means of bent plate clamps, the bent plate clamps being connected to the nailers by lag screws or bolts. The transverse beams, *B1*, etc., are supported on the masonry walls at their outer ends and connected to the girders *G1* at their inner ends. The girders *G1* are supported on the masonry walls and piers as indicated.

In general the calculations should be easily understood, but since certain conventional notations are used which will be followed in subsequent designs it may be well to explain in detail the calculations for one or two beams.

Consider beam *B1*, for example. In the calculation:

$$150 \times 8 = 1200 \text{ lb. per ft.}$$

$$\times \frac{20^2}{8} = 60.0 \text{ ft.-kips}$$

$$\text{at } \frac{12}{18}, \frac{I}{c} = 40.0$$

the first line, $150 \times 8 = 1200$ lb. per ft., indicates that since the beam *B1* supports a strip of floor 8 ft. wide, and the floor load is 150 lb. per sq. ft., the total load supported by the beam is 1200 lb. per ft., as should be clear. The second line, $\times 20^2/8 = 60.0$ ft.-kips, indicates the determination of the bending moment at the center of a beam which is 20 ft. long center to center of bearings supporting a load of 1200 lb. per ft. It should be noted that although the first line gives the load in pounds per foot the second line gives the moment in foot-kips, the division by

Steel Framing for Floor

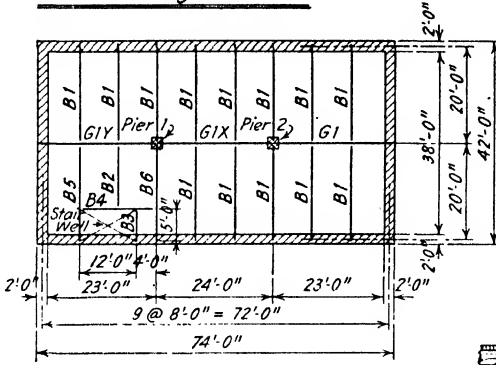

Plan of Floor Framing

| | |
|------------------------------------|--------|
| DP 1 | |
| Wall and Pier Bearing Floor | |
| 1931 | T.C.S. |
| Sheet 1 of 2 | |

A. I. S. C. Specs.

| | |
|------------------|----------------|
| <u>Live Load</u> | 125#/ft |
| <u>Dead Load</u> | |
| Fin. floor | 3 |
| Rough " & | 12 |
| Steel | 10 |
| Total | 150#/ft |

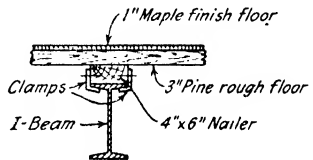

Sketch of Floor Construction

Beam B1
 $150 \times 8 = 1200 \#/\text{ft}$
 $\times \frac{20'}{8} = 60.0 \text{ k}$
 $\text{@ } \frac{12'}{18}, \frac{I}{C} = 40.0$

12" I @ 40.8 # $\frac{I}{C} = 44.8$
 1-12" I @ 40.8 # x 20.5' = 835 #
 1- Std. Conn. = 13
 1- " Wall plate = 31
 879 # x 13 = 11,430 #

Beam B2
 $150 \times 8 = 1200 \#/\text{ft}$
 $\times \frac{15'}{8} = 33.8 \text{ k}$
 $\text{@ } \frac{12'}{18}, \frac{I}{C} = 22.6$

10" I @ 25.4 # $\frac{I}{C} = 24.4$
 1-10" I @ 25.4 # x 15.0' = 381 #
 2- Std. Conns. = 26
 407 # x 1 = 410

Beam B3
 $150 \times 2 = 300 \#/\text{ft}$
 $\times \frac{5'}{8} = .94 \text{ k}$
 $\text{@ } \frac{12'}{18}, \frac{I}{C} = .63$

10" I @ 25.4 # $\frac{I}{C} = 24.4$
 1-10" I @ 25.4 # x 5.5' = 140 #
 1- Std. Conn. = 13
 153 # x 1 = 150

Beam B4

| | | |
|--------------------------------------|----------|-----------------------------------|
| $1200 \times \frac{12}{2} = 9000 \#$ | B2 B3 | $750 \# = 300 \times \frac{5}{2}$ |
| 4500 | ↓ ↓ | 4500 |
| 190 | 8' 4' 4' | 560 |
| 4690 # | 16' | 5060 # |

$4690 \# \times 8' = 37.5 \text{ k}$
 $\text{@ } \frac{12'}{18}, \frac{I}{C} = 25.0$

10" I @ 30.0 # $\frac{I}{C} = 26.7$
 1-10" I @ 30.0 # x 16.0' = 480 #
 2- Std. Conns. = 26
 506 # x 1 = 510
 12,500 #

1000 being understood and indicated only by the units stated for the moment. The third line, at $\frac{1}{8}$, $I/c = 40.0$, indicates that the moment of 60.0 ft.-kips is multiplied by 12 to convert it to inch-kips and divided by 18 kips per sq. in., the allowable intensity of bending stress, to determine that a section modulus of 40.0 is required for the beam $B1$.

It will be noted that in making the calculations for beams $B5$ and $B6$ the location of the point of maximum moment has been determined in each case and the moment itself found as the center moment in an equivalent beam subjected to a uniform load. The maximum moment in $B5$, for example, occurs 11.0 ft. from the right end of the sketch, and since there is only uniform load on this portion of the beam the maximum moment must be the same as the moment at the center of a beam 22.0 ft. long subjected to a uniform load of 1200 lb. per ft. Similarly for $B6$.

The stairway from the floor shown to the basement below has a width of 4 ft. overall, a horizontal run of 14 ft. 3 in., and is assumed to support a total load, including its own weight, of 120 lb. per sq. ft. of horizontal projection. The stair stringer will connect to $B5$ as close to $B4$ as possible, and for design purposes the loads from $B4$ and the stringer are assumed to be applied at the center of $B4$. The stairway reaction on $B5$ then is

$$14.25 \times 4 \times 120 \times \frac{1}{4} = 1710 \text{ lb. as shown.}$$

The girders $G1$, $G1X$, and $G1Y$ are not exactly alike but are so nearly the same that $G1$ was designed and the same section used for the other two. The sketch on the calculation sheet shows that one end of $G1$ was assumed supported at the center of the end wall, and the other 6 in. from the center of Pier 1. Some designers would assume that the supports of $G1$ were at the center of the end wall and the center of the pier, or 24 ft. center to center, which is conservative and would result in a slightly heavier section.

Another approximation which should be noted is the assumption of the weight of the steel framing made in advance of design and the use made of this weight. As shown on Sheet 1 the steel was assumed to weigh 10 lb. per sq. ft. (which is about 3 lb. per sq. ft. more than the calculated weight—a negligible difference in the total floor load) and this weight used in the calculations for all beams. Since the weight of girders $G1$, $G1X$ and $G1Y$ must be included in the total it is clear that the calculations as made assume the beams $B1$, $B2$, etc., to support a load to which they are not subjected. The error in this procedure is not great, however, and is on the safe side. When the girders are of ordinary size, as in this case, this practice is generally followed, but when

Steel Framing for Floor (Concl.)

DP 1

Wall and Pier
Bearing Floor

1931 T.C.S.

Sheet 2 of 2

Beam B5

Brought forward 12,500#

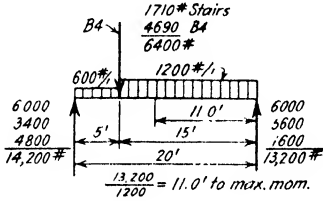

Mom. $1200 \times \frac{22^2}{8} = 72.6^k$
 $\text{@ } \frac{12}{18}, I_c = 48.4$
 $12''I @ 45\# \frac{I}{c} = 47.4$
 $15''I @ 42.9\# \frac{I}{c} = 58.9$
 1-15''I @ 42.9# x 20.5' = 875#
 1-Std. Conn. = 19
 1-Std. Wall plate = 31
 $929\# \times 1 = 930$

Beam B6

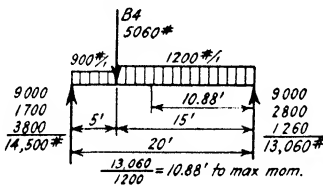

Mom. $1200 \times \frac{10.88 \times 2^2}{8} = 71.0^k$
 $\text{@ } \frac{12}{18}, I_c = 47.3$
 $15''I @ 42.9\# \frac{I}{c} = 58.9$
 Wt. same as B5 = 930

Girder G1

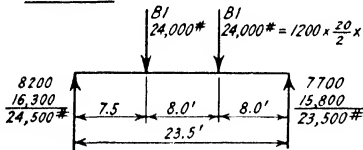

Mom $8' \times 23,500\# = 188.0^k$
 $\text{@ } \frac{12}{18}, I_c = 125.3$
 $20''I @ 75.0\# \frac{I}{c} = 126.4$
 1-20''I @ 75.0# x 24.3 av. = 1823
 2-Std. Wall plates = 146
 1969#
 $\times 3 = 5910$

G1X and G1Y same as G1

Total = 20,270#

$\frac{20,500}{40 \times 72} = 7.1\#/\text{sq ft}$

Say 20,500#

heavy girders of long span are necessary the weights of the beams and girders are considered separately.

The student should note that the beam selected for $B3$ has a section modulus greatly in excess of that required: it was made of the same depth as $B4$ for the sake of appearance and convenience in finishing around the stair opening. A 10-in. channel could have been used, with a slight saving in weight, but there is some advantage in keeping the number of different sections as small as possible.

Attention should be called to the fact that American Standard beams were chosen in all cases although Carnegie, Bethlehem, or light-weight Phoenix sections would effect some saving in weight. The decision as to whether American Standard beams or beams of lighter weight should be selected would depend on market conditions, geographical location in some cases, time necessary for delivery, or other conditions of a like nature, and these are matters which cannot well be given specific consideration in a text such as this.

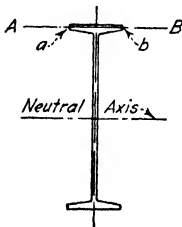

FIG. 47.

The standard connections and standard wall plates called for in connection with the various beams may not be used in all cases: they are assumed here merely to make possible a reasonably accurate estimate of weight as part of the design, and are satisfactory for that purpose.

35. Beams without Lateral Support.—The discussion so far has assumed a perfect beam loaded under ideal conditions, i.e., a perfectly straight beam of homogeneous material loaded vertically in the plane of one of its principal axes. Under such conditions the intensity of stress at any point in a horizontal line, as $A-B$ in Fig. 47, is presumably equal to the intensity of stress at any other point in the same line. The actual beam, however, is not straight, is not homogeneous, and is rarely loaded exactly in the plane of a principal axis. Under actual conditions then the stress at a may be more than the stress at b . This difference may be due to a lack of homogeneity, small kinks and bends resulting from rolling, cooling, or fabrication, or to any one or combination of a number of defects occurring in beams as actually manufactured. Whatever the cause the fiber at a (if in compression) will tend to shorten more than the fiber at b and the beam will tend to deflect sideways from a towards b . If the beam flange is encased in a concrete floor, or otherwise restrained laterally, the tendency to sideways deflection cannot develop and there will be merely a lack of uniformity in stress distribution. If the beam flange is not restrained laterally the sideways

deflection will develop and the flange will move out of line as shown in an exaggerated manner by the dotted lines in Fig. 48, which is a view looking down on the top flange of the beam in Fig. 47. It is not impossible that defects on opposite sides of the flange might cause a tendency to deflect into an S-shaped curve instead of the curve shown in Fig. 48, but deflection as shown would be more serious and would control design. Since the flange under consideration is in compression it will evidently act somewhat as a bent column and the total stress in the flange (not acting in the same line throughout its length) will produce a bending moment in a horizontal direction. This moment will tend to produce compression at a and tension at b , thus increasing the difference in stress and aggravating the tendency to deflect sideways. The stress at a will increase more rapidly than the load, and eventually the beam will buckle sideways and collapse at a load smaller than would have been required to produce failure had the beam remained in a vertical plane. A little reflection will lead to the conclusion that sideways collapse will occur at about the time the maximum fiber stress in the compression



FIG. 48.

flange reaches the yield point of the flange material. The student should see that this sideways buckling will be confined to the compression flange; the tension flange will tend to pull into line since an increase in load tends to correct rather than increase any lack of uniformity in tensile stress distribution.

36. Straight-Line Reduction Formulas.—For the maximum stress at a we may write:

$$s = s_1 + s_2 \quad (2)$$

where s = the maximum intensity of stress at a ;

s_1 = the intensity of stress at a due to vertical loading;

s_2 = the intensity of stress at a due to the sideways buckling tendency.

Or

$$s_1 = s - s_2 \quad (3)$$

Since we may write $s_1 = Mc/I$ or $I/c = M/s_1$, if M = the moment due to vertical loading, we can evidently select a beam having a section modulus which will keep the maximum intensity of stress within any desired value, s , *provided* we can evaluate s_2 . Since s_2 is dependent largely on the extent of accidental kinks, bends, and variations in

material quality it is evident that its determination is necessarily a matter for experiment. It can never be predicted with much precision because of the infinite number of ways in which the various defects may occur in combination. It seems fair, however, to assume that the longer the beam the more likely and the more pronounced these accidental defects will be, and the wider the flange the less pronounced they will be because of the greater lateral rigidity. If we assume then that s_2 varies directly as the unsupported length, L , and inversely as the flange width, b , we may write:

$$s_2 = k \frac{L}{b}$$

Where L and b are as above, both measured in inches or both in feet, and k is a factor to be determined experimentally. Replacing s_2 in (3) by this value

$$s_1 = s - k \frac{L}{b} \quad (4)$$

This is a widely used type of "reduction formula" for the determination of the allowable intensity of stress in the compression flange of a beam without lateral support, or with lateral support only at widely spaced points.

Not many experiments have been made with a view to determination of the factor k , and the data available seem rather inadequate. But from studies based partly on analytical investigations, considering the top flange of a beam as a column, and partly on the experimental data so far available, a number of formulas of this type have been written into design specifications. One which has had wide use is:

$$s_1 = 16,000 - 150 \frac{L}{b} \quad (5)$$

The application of this formula in design is evidently a matter of trial since the width of the flange, b , is not known in advance.

Suppose that a beam subjected to a bending moment of 760 in.-kips has its top flange unsupported for the full length of its 20 ft. span. Since a 15-in. I at 42.9 lb. is required for a fully supported flange, evidently a larger beam will be needed when the permissible stress is reduced and we may assume a 6-in. flange width.

$$s_1 = 16,000 - 150 \times 240/6.0 = 10,000 \text{ lb. per sq. in.}$$

$$\frac{I}{c} = 760 \div 10 = 76.0$$

$$18\text{-in. I at } 54.7, \frac{I}{c} = 88.4, b = 6.0 \text{ in.}$$

The student should notice that even if a beam having exactly the required section modulus were available the maximum stress in the extreme fiber would not be the 10,000 lb. per sq. in. determined from the reduction formula, but an unknown amount which *might* reach 16,000 lb. per sq. in., the 10,000 lb. per sq. in. being the stress resulting from vertical loading only, and the additional 6000 lb. per sq. in. being a possible stress resulting from defects incidental to manufacture and from sideways bending. Since the section modulus actually provided is larger than required we may presume that the actual fiber stress from each source is proportional to the section modulus, i.e., $76.0/88.4 \times 10,000 = 8600$ lb. per sq. in. from vertical loads and $76.0/88.4 \times 6000 = 5160$ lb. per sq. in. from lateral deflection.

Many engineers are of the opinion that for an unsupported length of 10 to 15 times the flange width a reduction in extreme fiber stress is not necessary. If no reduction in stress is made for an unsupported length less than 15 times the flange width, the use of the reduction formula given above will lead to inconsistent results. For example, if a beam having a flange width of 5 in. has an unsupported length of 74 in. ($L/b = 74 \text{ in.}/5 = 14.8$) the allowable design stress is 16,000 lb. per sq. in., while an unsupported length of 76 in. would lead to a permissible design stress of

$$16,000 - 150 \times \frac{76}{5} = 13,700 \text{ lb. per sq. in.}$$

It is evidently absurd to say that a change in unsupported length of 2 in. makes necessary a reduction of 14 per cent in the extreme fiber stress.

To overcome this inconsistency expressions have been used, of the same type, having for s in (4) a value such that at $L/b = 10$ to 15 the value of s_1 becomes whatever the specification considers proper as the maximum allowable stress when the beam has continuous lateral support. One of the best-known expressions of this kind is given in the American Bridge Company's "Specifications for Steel Structures," 1912 Edition, which is ("Pocket Companion," 23rd Edition, page 96)

$$s_1 = 19,000 - 300 \frac{L}{b}$$

with a maximum of 16,000 lb. per sq. in. This reduction formula gives a regular change in permissible stress with small increases in length, but is inconsistent in that it apparently sanctions a maximum fiber stress of 19,000 lb. per sq. in. for a beam with continuous lateral support ($L/b = 0$) although as a matter of fact the basic stress in the specification is 16,000 lb. per sq. in. Such a formula, however, is almost entirely

empirical, and it probably makes little difference what form it is in so long as it gives satisfactory values within the range in which it is applicable, and provided its range of applicability is clearly stated and understood.

37. Second Degree Reduction Formulas.—From the discussion leading to expression (2) it should be evident that s_2 is to some extent dependent on s_1 . The use of a reduction formula of the type of (4), however, assumes that the effect of s_1 on s_2 is entirely overshadowed by the effect of accidental defects in the beam. Some engineers believe, or imply, that the effect of s_1 on s_2 is more important than the physical defects. Working under that assumption we may say that

$$s_2 = \frac{m'c'}{I'}$$

where m' = the lateral moment at a , Fig. 47, caused by s_1 as a result of lack of homogeneity, etc.;

c' = the distance from the neutral axis in a horizontal plane to the fiber at a , Fig. 47;

I' = the moment of inertia in a horizontal plane of the part of the beam resisting m' ;

s_1 and s_2 are the same as in Art. 36.

Assuming that only the top flange resists the lateral moment, let

A = the area of the flange;

r = the radius of gyration of the flange in a horizontal plane;

$I' = Ar^2$;

e = eccentricity in the axis of the compression flange, partly the result of lateral deflection caused by non-uniform distribution of bending stress.

Then

$$m' = k_1 s_1 A e$$

where k_1 is a factor which allows for the fact that s_1 is not uniform across A .

$$s_2 = \frac{k_1 s_1 A e c'}{Ar^2}$$

and

$$s = s_1 + \frac{k_1 A e c'}{Ar^2} s_1$$

As stated above it seems fair to assume that e varies directly as L , the length; c' also varies directly as L , i.e., the larger the span the larger

the beam and hence the wider its flange; and r varies directly as the flange width, i.e., $r = k_2b$, approximately, when k_2 is some constant factor.

Combining all the constant and empirical factors into one, k , we may write

$$s = s_1 + k \frac{L^2}{b^2} s_1$$

and

$$s_1 = \frac{s}{1 + k \frac{L^2}{b^2}} \quad (6)$$

where k is a factor partly dependent on accidental defects and partly on the properties of the beam flange.

This is a type of reduction formula which has had considerable use and is becoming more common.

If s in (6) is the basic fiber stress in design, as it should be in view of the method of derivation, and we follow the practice of making no reduction in fiber stress for ratios of L/b less than 10 or 15, the same inconsistency arises in the use of this formula than arises in the use of the straight-line type (4). The difficulty is overcome in the same manner as in the straight-line formula, i.e., s is made such that at L/b equal to 10 to 15, s_1 becomes the value permitted as the basic fiber stress.

A recent formula of this type is given in the design specifications* sponsored by the American Institute of Steel Construction. It is:

$$s_1 = \frac{20,000}{1 + \frac{1}{2000} \frac{L^2}{b^2}} \quad (7)$$

with a maximum value of 18,000 lb. per sq. in. For $L/b = 15$, $s_1 = 18,000$ lb. per sq. in., the basic stress.

Many reduction formulas of both types have been developed without reference to experiments—though perhaps indirectly guided by them—by applying a column formula to the top flange of the beam, using for L in the formula some fraction of the unsupported length and for r some constant times b , the flange width.

Both types of reduction formulas given above are defective in that they do not take account of the depth of the beam and the thickness of the web. Their use, however, has given satisfactory results in design,

* See "Steel Construction," Second Edition, January, 1934, or Appendix C.

and it is not yet clear that greater refinement is warranted in view of the few data available and the uncertainties as to magnitude and distribution of defects.

38. Illustrative Example.—The design calculations for the framing over a gravel storage bin given on Sheet 1, DP2, illustrate the use of a reduction formula in designing beams which have no lateral support for

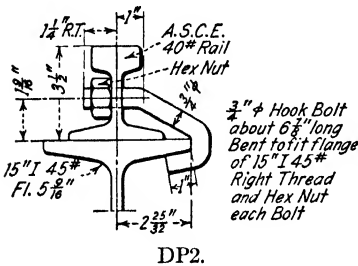

their top flanges. As indicated by the framing plan the longitudinal track beams, *TB1*, are supported by cross beams, *CB*, the latter being built into the concrete walls of the bin. The track beams support on their top flanges 30-lb. rails over which distributing buggies operate. The rails are connected to the top flange of the track beams by hook

bolts. A common form of hook bolt is shown in the accompanying figure, DP2.

In determining the permissible unit stress the first step is to find the minimum flange width which is acceptable. In this case the specifications place an upper limit on L/b of 40, which fixes the minimum flange width as 4.5 in. as given on the design sheet. When $L/b = 40$ the permissible unit stress is about 11 kips per sq. in., and a mental estimate shows at once that I/c must be about 62. Reference to a table of properties of American Standard beams indicates that some 15-in. I will probably be the most suitable. As the flanges of standard 15-in. I's are $5\frac{1}{2}$ in. or more in width the permissible stress for $\frac{L}{b} = \frac{15 \times 12}{5.5} = 33$

is found to be 12.95 kips per sq. in., which gives a required section modulus of 53.5 as shown in the calculations. A 15-in. I at 42.9 lb. is the lightest standard beam which meets the requirements. The selection of a beam with unsupported top flange is necessarily a matter of trial, but in most cases a mental estimate will give the approximate section modulus closely enough to locate the required beam within a relatively narrow range of flange widths. With this information the permissible intensity of stress generally may be estimated with sufficient accuracy to make possible selection of the required beam on the first trial.

Further comment on these calculations should be unnecessary, but it may be noted that, as in the design calculations discussed in Art. 34, standard connections and wall plates were assumed to permit making a reasonably accurate estimate of weight in advance of actual detailing of the connections and wall plates.

Framing to Support Track over Storage Bin

| | |
|------------------------|--------|
| DP 2 | |
| Track over Storage Bin | |
| 1931 | T.C.S. |
| Sheet 1 of 1 | |

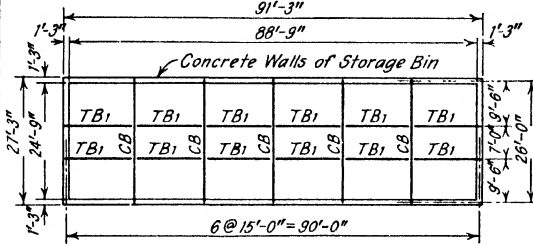

A.I.S.C. Specs.

Assumed Loads $\left\{ \begin{array}{l} \text{Live Load as shown} \rightarrow \\ \text{Dead Load Track Beam TB}_1 = 40\#/ft \\ \text{Rail } 30\#/yd. = \frac{10}{3} \times 30 = 10\#/ft \end{array} \right.$

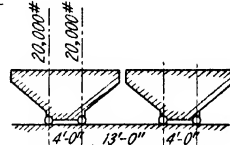

Distributing Buggy Axle Loads

Track Beam "TB1"

Max. Moment L.L. = $2 \times 10 \times \frac{6.5^2}{15} = 56.3'k$
 { Assumed Wt of TB1 & Rail } D.L. = $50 \times \frac{15^2}{8} = \frac{1.4}{57.7'k}$
 Total =

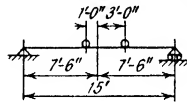

Min. flg. width $\frac{15 \times 12}{40} = 4.5''$

@ $\frac{12.0}{12.95}, I_c = 53.5$

For 5.5" flg. $\frac{1}{b} \frac{15 \times 12}{5.3} = 33$
 $s = 12.95 \frac{1}{2}''$

15" I @ 42.9# $I_c = 58.9 \quad \delta = 5.5''$

1-15" I @ 42.9# x 14.9' = 639#
 2-Std. Conns. = 38
 $\frac{677}{15} = 45\#/ft \times 8 = 5420\#$
 1-15" I @ 42.9# x 15.4' = 661
 1-Std. Conn. = 19
 1-Std. Wall Pl. = 55
 735
 x 4 = 2940

Cross Beam "CB" $17.35'k = 20'k \times \frac{13}{15}$
 $1.33 = 10'k \times \frac{2}{15}$
 $\frac{.83}{15} = 5.5\#/ft \times 15' \text{ (Corrected dead load)}$
 $19.51'k$

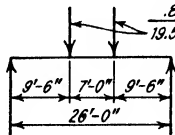

1-20" I @ 75.0# x 27.0' = 2025
 2-Std. Wall Pls. = 146
 2171

x 5 = $\frac{10,860}{19,220\#}$

Mom. $19.51 \times \frac{25}{8} = 185.3'k$
 $\frac{75\#/ft \times 26.0^2}{191.6'k} = 6.3$

@ $\frac{12}{18}, I_c = 127.8$

18" I @ 75.6# $I_c = 126.9$
 20" I @ 75.0# $I_c = 126.4$
 24" I @ 79.9# $I_c = 173.9$

Say 19,500#
 This weight does not include rails or hook bolts.

39. Web Strength of Steel Beams.—As stated above it is seldom that shear is a factor in the choice of an I beam. The proportions of ordinary rolled-steel beams are such that for common spans of 10 to 20 times the depth their strength in shear is greater than their strength in bending. When spans are short and loads heavy, however, it becomes necessary to investigate the strength of the web.

Web strength should be examined from three standpoints: shear, vertical buckling over a support or under a concentrated load, and compression in the web (at its junction with the flange) immediately above a support or below a concentrated load. A fourth factor sometimes considered is diagonal buckling; its investigation is not necessary in beams of ordinary proportions but may become so in those with abnormally thin webs.

40. Shear.—The resistance of a beam in shear is considered to be the product of its web area and the intensity of shearing stress allowed in the design specifications. This assumes that the shear is uniformly distributed across the web, which, as the student will remember from mechanics, is not true. The error for minimum weight sections is about 15 per cent, and increases 7 or 8 per cent for the maximum weight section of any given depth. This error is generally recognized in the unit stress permitted, but it is on the unsafe side, i.e., the actual maximum intensity of shear is greater than is obtained by assuming it uniformly distributed, and in the design of beams of maximum weight supporting heavy loads the intensity of shear is sometimes estimated by the more precise formula developed in mechanics

$$v = \frac{VQ}{It} \quad (8)$$

in which v = the intensity of shear at any horizontal section;

V = the external shear at the section;

I = the moment of inertia of the cross-section, about the neutral axis;

t = the thickness of the web at the section;

Q = static moment about the neutral axis of the area above the horizontal section on which v is desired.

The intensity of horizontal or vertical shear is a maximum at the neutral axis.*

* In beams supporting concentrated loads in such a position that a large bending moment and a large vertical shear occur at the same section there may be a diagonal shear in the web just under the flange of a greater intensity than that existing (horizontally and vertically) at the neutral axis. This is seldom, if ever, of importance in design, but the possibility of its existence should be noted by the student.

The web area is generally taken as the product of the beam depth and the web thickness, although some engineers prefer to use the product of the *clear* depth (the distance between the flanges) and the web thickness as additional compensation for the error made in assuming uniform distribution of the shear across the section.

When the web of an I beam is overstressed in shear an attempt is sometimes made to reinforce it by riveting plates between the flanges. This is inefficient and often the desired result is not attained. For example, suppose that a short beam is subjected to a bending moment of 46,000 ft.-lb. and a shear of 80,000 lb. A 12-in. I at 31.8 lb. is adequate to resist the moment but the average web shear is

$$\frac{80,000}{12 \times 0.35} = 19,000 \text{ lb. per sq. in.}$$

which is too high. Two plates 9 in. by $\frac{5}{16}$ in. riveted to the web between the flanges as shown in Fig. 49 reduce the average shear to

$$\frac{80,000}{12 \times 0.35 + 9 \times \frac{5}{16} \times 2} = 8200 \text{ lb. per sq. in.}$$

which, if it were somewhere near the true maximum intensity, would be entirely satisfactory. It is easy to show by the application of $v = VQ/It$, (8), that there is a much higher intensity of shear just above the so-called reinforcing plates

$$v = \frac{80,000 \times 17.1}{254 \times 0.35} = 15,400 \text{ lb. per sq. in.}$$

This is the intensity of shear at a section $1\frac{1}{2}$ in. below the top of the beam, just at the top edge of the plates. The intensity would be somewhat higher at the top line of rivets connecting the plates to the web.

Examination of the expression $v = VQ/It$ will convince the student of the inefficiency of trying to reinforce the web of an I beam with side plates. When studying the intensity of shear in the web just above the side plates or just above the top line of rivets the quantities V , Q , and t are the same whether side plates are used or not. Consequently to reduce the shear by one-half requires that I be doubled. To double the moment of inertia in the case in question would require the addition of 2 plates $9\frac{3}{4}$ in. by $1\frac{7}{8}$, which would be absurd. It is generally much better to use a heavier beam than to try to reinforce the web. If it is possible to provide a direct connection between the reinforcing plates and the flange of the beam or girder the web may be efficiently reinforced. Such connection is simple in a plate girder but rather imprac-

licable in an I beam with sloping flanges and riveted connections for the reinforcing plates.

If the spaces between the edges of the reinforcing plates and the flanges are filled with weld metal, as shown in Fig. 50, both t and I , in the expression $v = VQ/It$, are affected by the addition of these plates and they become fully effective (assuming adequate strength in the weld metal) in reducing the intensity of shearing stress. The average intensity of shearing stress becomes:

$$\frac{80,000}{0.975 \times 12} = 6850 \text{ lb. per sq. in.}$$

and the maximum intensity

$$\frac{80,000 \times 29.4}{277 \times 0.975} = 8700 \text{ lb. per sq. in.}$$

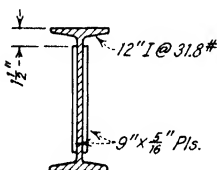

FIG. 49.

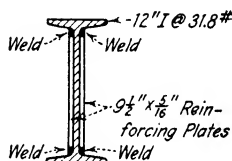

FIG. 50.

In the latter expression 29.4 and 277 are, nearly enough, the static moment of one-half the reinforced beam and the moment of inertia of the entire reinforced beam, respectively, about the neutral axis. The weld metal is included approximately in calculating each quantity. The student should note that the difference between the average intensity of shearing stress and the maximum intensity is considerable in this case, as would be expected since the reinforced web becomes a relatively large part of the total area.

41. Diagonal Buckling.—The tendency of the web of an I beam or plate girder to buckle diagonally is the result of the compressive stress which accompanies shear. At the neutral axis the intensity of the diagonal compression is equal to the intensity of the shear and acts at an angle of 45° with the horizontal. There is diagonal tension of equal intensity acting at right angles to the diagonal compression. Above and below the neutral axis the intensity and direction of the diagonal compression and diagonal tension are modified by the direct stresses resulting from bending. In design the general direction of the diagonal compression is considered to be at 45° with the horizontal and its

intensity assumed equal to the average intensity of the shear, i.e., the external shear divided by the area of the web.

It has been common for many years to permit the omission of intermediate web stiffeners on plate girders in which the thickness of the web is equal to or greater than $1/60$ of the clear depth. In recent years there has been a tendency to increase this thickness requirement to $1/50$ of the clear depth. Since the main function of intermediate stiffeners on plate girders is to stiffen the web against diagonal buckling, it is clear that the requirements just given are equivalent to stating that if the ratio of the clear depth of the web to its thickness does not exceed 50 or 60 there is no danger of diagonal buckling. The same principle should, of course, apply to I beams, and most designers consider that it is unnecessary to investigate for diagonal buckling any rolled beam which has a web thickness equal to or greater than $1/50$ or $1/60$ of the clear depth. There are only a very few rolled-steel beams with a web thickness less than $1/60$ of the clear depth, and these are special sections not widely used. There are, however, some of the recently developed wide-flange sections with a web thickness less than $1/50$ of the clear depth,

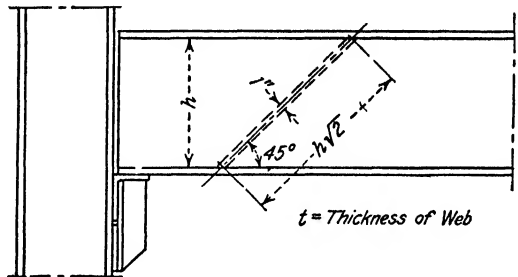

FIG. 51.

and for this reason it seems advisable to discuss approximate methods for estimating resistance to diagonal buckling.

Resistance to diagonal buckling is estimated by assuming a strip of web along a 45° line to act as a rectangular column. The dotted lines in Fig. 51 show the strip assumed. A column formula is applied to this strip to determine the permissible intensity of stress. As previously stated, at the neutral axis the intensities of diagonal compression and vertical (or horizontal) shear are of course equal, and as the compression here is taken as the critical stress in the diagonal column strip it should be clear that the intensity of stress permitted in the column strip also determines the permissible intensity of shear.

The application of a column formula to the diagonal strip shown in Fig. 51 is necessarily very uncertain. The strip is not separate from the rest of the web and the diagonal tension along the edges restrains the buckling tendency and in addition the relatively rigid flanges at the ends of the strip control the direction of the ends. In view of these

conditions it is not reasonable to consider the entire length of the diagonal strip as a free column in applying a column formula. Designers differ as to what portion of the length should be used, and many expressions for the permissible intensity of diagonal compression have been developed by applying various column formulas to the diagonal strip, using for L , in the column formulas, values varying from $\sqrt{2}h/4$ to $\sqrt{2}h$ (usually about $\sqrt{2}h/2$) and for r , $t/\sqrt{12}$. Some published formulas developed in this manner are needlessly conservative.

The author considers that the most consistent result will be obtained when the column formula is adjusted to give a permissible intensity of diagonal compression equal to the permissible intensity of average shear, when the thickness of the web is $1/50$ or $1/60$ (depending on the design specifications) of its clear depth. This has been done in some recent specifications and has the desirable result of making the analysis of the strength of rolled-beam webs consistent with what has long been standard practice and proved satisfactory, in the design of webs for built-up girders.

This will be illustrated by showing the modifications necessary to adapt two widely used column formulas* for use in estimating the intensity of shear which will insure safety against diagonal buckling.

The straight-line formula:

$$s_1 = 16,000 - 70 \frac{L}{r} \quad (a)$$

and the Rankine-Gordon formula:

$$s_1 = \frac{18,000}{1 + \frac{1}{18,000} \cdot \frac{L^2}{r^2}} \quad (b)$$

in which s_1 = the allowable *average* stress;

L = length of the column between points of free rotation, in inches;

r = the radius of gyration of the column section, in inches; taken about the axis corresponding to L , and so that L/r is a maximum.

Specifications using the first of these formulas generally permit an average intensity of stress in shear of 10,000 lb. per sq. in. and those using the second an average intensity of shear of 12,000 lb. per sq. in. Referring to Fig. 51 it is clear, as previously stated, that if these formulas are applied to the dotted strip, considered as a rectangular column, L is

* See Chapter IV, or any standard treatise on strength of materials for a discussion of column formulas.

some function of h , and r some function of t . Considering first formula (a) we may rewrite it as follows

$$v = 16,000 - k \frac{h}{t}$$

where k is a new constant which takes account of the relation between h and L and between t and r , and which is to have such a value that $v = 10,000$ lb. per sq. in. when $h/t = 50$ or 60 .

Therefore

$$10,000 = 16,000 - k \times 60$$

for which

$$k = 100$$

and

$$v = 16,000 - 100 \frac{h}{t} \quad (9)$$

is the expression for the permissible average intensity of shear or of diagonal compression in the web of rolled beams which have a web thickness less than $h/60$. In this expression

v = permissible average intensity of shear or diagonal compression;

h = clear depth of web in inches;

t = thickness of web in inches.

Following the same line of reasoning for the formula (b), and a permissible average intensity of shear of 12,000 lb. per sq. in.:

$$12,000 = \frac{18,000}{1 + k' 60^2}$$

from which

$$k' = \frac{6000}{12,000 \times 3600} = \frac{1}{7200}$$

and

$$v = \frac{18,000}{1 + \frac{1}{7200} \frac{h^2}{t^2}} \quad (10)$$

is the expression for permissible average intensity of shear or of diagonal compression in the webs of rolled beams which have a web thickness less than $h/60$. In this expression v , h , and t have the same significance as before.

It should be clear that (9) and (10) are consistent only for column formulas and allowable intensities of shear given in this article, but it is a simple matter to develop similar formulas which will fit any condition specified.

These formulas become:

$$v = 16,000 - 120 \frac{h}{t}; \quad (9')$$

and

$$v = \frac{18,000}{1 + \frac{1}{5000} \frac{h^2}{t^2}} \quad (10')$$

when the adjustment is made to be consistent with permitting the maximum intensity of shear for web thicknesses equal to or greater than $h/50$.

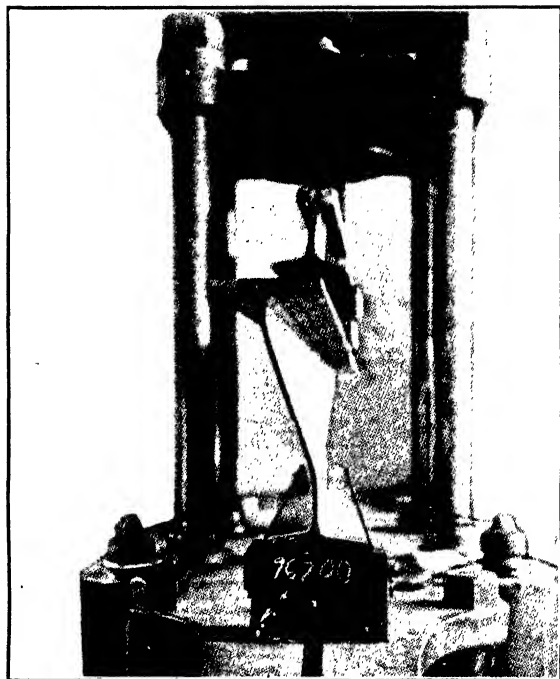

FIG. 52.

42. Vertical Buckling.—Directly above a bearing block used to distribute a reaction or below a bearing block used to distribute a concentrated load there is a tendency for the web of an I beam to buckle laterally because of high compressive stress resulting in column action. The student should not confuse this with diagonal buckling; a beam may be amply strong with respect to diagonal compression and yet fail by buckling laterally at a bearing block. Figure 52, taken from Bul-

letin 86, Engineering Experiment Station, University of Illinois, shows failure by buckling above an end bearing block.

The method of estimating the strength of a web in vertical compression is similar to that used with respect to diagonal compression. A vertical strip of web is assumed to act as a column and a column formula applied to determine the permissible intensity of compression in this strip.

It is generally assumed that buckling may occur in one of the ways shown in Fig. 53 (a) and (b). Failure in the manner indicated in Fig. 53 (a) can result only when both flanges of the beams are held against lateral deflection, and against rotation, by positive connections to the frame; that shown in Fig. 53 (b) may result when only the bottom flange is so restrained.

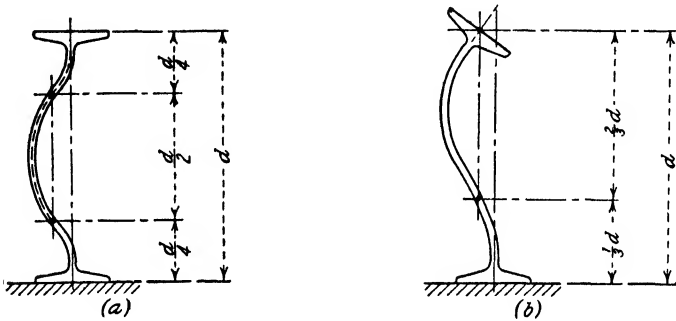

FIG. 53.

If the top and bottom flanges are restrained against relative lateral movement or rotation the web must act as a fixed-end column, and if only the bottom flange is held in position it may act as a column having one end fixed and the other end hinged. The lengths which may be used in applying a column formula to the two cases are 1/2 the depth and 2/3 of the depth as noted in the figure—the latter generally being taken as 7/10.

The dotted lines in Fig. 54 show the strips assumed; applying the column formula

$$s_1 = 16,000 - 70 \frac{L}{r}$$

to the two ways of failure there results:

$$s_1 = 16,000 - 70 \frac{d/2}{t/\sqrt{12}} = 16,000 - 121 \frac{d}{t} \tag{11a}$$

and

$$s_1 = 16,000 - 70 \times \frac{0.7d}{t/\sqrt{12}} = 16,000 - 170 \frac{d}{t} \quad (11b)$$

In these formulas:

- s_1 = the allowable intensity of compression in the vertical strip of web;
- t = the thickness of the web in inches;
- d^* = the beam depth in inches.

In most specifications using this column formula s is limited to a maximum of 14,000 lb. per sq. in.

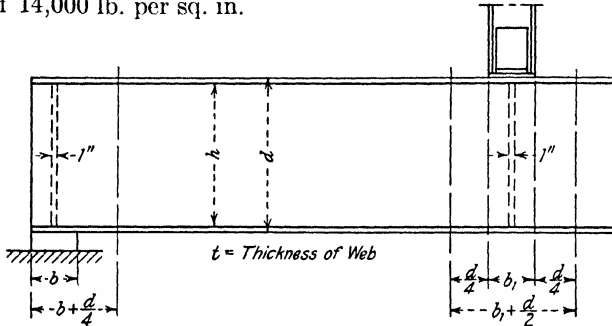

FIG. 54.

Using the same notation and employing the American Institute of Steel Construction column formula, we have

$$s_1 = \frac{18,000}{1 + \frac{1}{18,000} \cdot \frac{L^2}{r^2}}$$

$$s_1 = \frac{18,000}{1 + \frac{1}{18,000} \cdot \frac{d^2/4}{t^2/12}} = \frac{18,000}{1 + \frac{1}{6000} \cdot \frac{d^2}{t^2}} \quad (11c)$$

and

$$s_1 = \frac{18,000}{1 + \frac{1}{18,000} \cdot \frac{(0.7d)^2}{\frac{t^2}{12}}} = \frac{18,000}{1 + \frac{1}{3000} \cdot \frac{d^2}{t^2}} \quad (11d)$$

In both (11c) and (11d), s should be limited to a maximum of 15,000 lb. per sq. in.

* The actual depth is generally used, but the *clear* depth would be more consistent, and in making use of these formulas later in illustrative examples the author has used clear depth.

Some designers are of the opinion that the stiffness of the flange and the restraint generally to be expected from the load will keep the top flange in a horizontal plane, and that buckling, when this flange is not connected to the frame, may occur as shown in Fig. 52 or Fig. 55 (a), but not as shown in Fig. 53 (b). If this is the case the length to be used in applying the column formula is the full depth of the web, as it is clear from Fig. 55 (a) that either half of the web is equivalent to one half of a pin-ended column. The formulas are easily adjusted to this condition if it can occur.

The author considers it pertinent to point out that if both lateral movement and rotation of the top flange are possible, buckling as indicated in Fig. 55 (b) may be as likely as that in Fig. 53 (b). The student

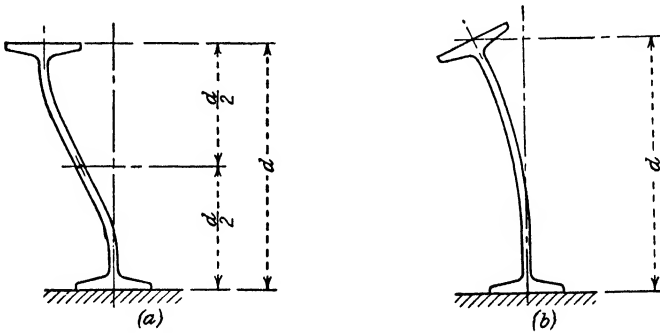

FIG. 55.

should recall that a column buckling in this manner (Fig. 55, b) has the strength (or weakness) of a hinged column of twice its length ($2d$ in this case), and should immediately recognize the danger in such a situation.

The length of the web along the beam which may be considered as resisting the column action due to the vertical load is almost universally taken as the length of the bearing block plus $1/4$ of the depth of the beam for an end reaction or load, and the length of the bearing block + $1/2$ of the depth of the beam for an interior load or reaction. These lengths are indicated in Fig. 54. Using the notation shown in Fig. 54 and that used above for formulas (11) we may write:

R = maximum allowable end reaction or load;

W = maximum allowable interior load or reaction.

$$R = s_1 t \left(b + \frac{d}{4} \right) \tag{12}$$

$$W = s_1 t \left(b_1 + \frac{d}{2} \right) \tag{13}$$

The effective lengths of web to be used in computing the resistance to vertical loads given here are those recommended in the "Pocket Companion," published by the Carnegie Steel Company. They are said to be based on numerous tests and have been very widely accepted. So far as the author knows the records of the tests have not been published.

43. Direct Compression.—Whatever length of web may be assumed as resisting the column action, above or below a concentrated reaction or load, it should be borne in mind that the load must be delivered to the web directly over or under the bearing block. In deep beams there may be severe overstressing of the web at the junction of the web and flange, even though application of the above formulas indicates adequate resistance to vertical buckling. As pointed out by C. W. Hudson

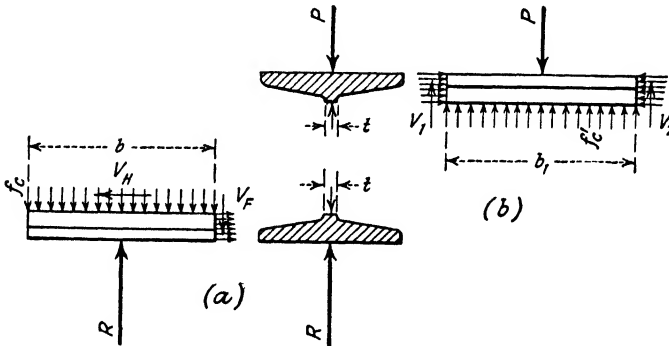

FIG. 56.

(*Engineering News*, Dec. 9, 1909) the intensity of vertical compression in the web under a bearing block may be estimated from

$$f_c = \frac{P}{bt} \quad (14)$$

where f_c = the intensity of vertical compression in the web;
 P = the reaction or load;
 b = the length of the bearing block along the web;
 t = the thickness of the web.

Figure 56 (a) shows an enlarged view of a portion of the beam in Fig. 54, cut from around the end bearing block by a vertical plane at the right-hand edge of the bearing block and a horizontal plane coincident with the plane of intersection between the web and the flange.

The internal and external forces acting to hold the part in equilibrium are indicated. It should be clear that

$$R = f_s bt + V_F$$

Brief consideration of the distribution of shear across the section of an I beam should convince the student that the quantity V_F is very small, and that no material error results from neglecting it so long as the beam formula is valid, i.e., for stresses within the elastic limit. If V_F is neglected Hudson's formula follows directly.

Even though actual calculation of V_F is never necessary in actual design, it is desirable that the student get a reasonable notion of how large it may be under normal conditions. The following simple analysis will permit calculation of V_F with any desired precision, for stresses within the elastic limit, and the approximate form will give values of V_F , as a percentage of the external shear at the section, which are always within 2 per cent and generally within 1 per cent.

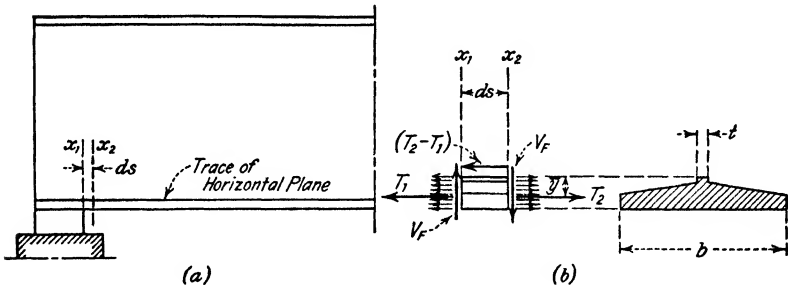

FIG. 57.

Cut a very short section of flange from the beam by two vertical planes X_1 and X_2 (X_1 is coincident with the right edge of the end bearing block), and a horizontal plane which is coincident with the plane of intersection of the web and flange. Figure 57 (a) shows the planes which cut out the portion of flange, and Fig. 57 (b) shows to an enlarged scale the piece cut out and the forces acting on it.

Applying the laws of statics:

$$(T_2 - T_1)\bar{y} = V_F ds$$

If the beam formula is valid, i.e., if the stresses are within the elastic limit,

$$(T_2 - T_1) = \frac{VQ}{r} ds$$

In which V , Q , and I have the usual significance. (See Art. 40.) Then

$$(T_2 - T_1)\bar{y} = \frac{VQ}{I}\bar{y} ds = V_F ds$$

and

$$V_F = \frac{VQ}{I}\bar{y} \quad (15)$$

\bar{y} = the distance from the horizontal plane to the line of action of the total direct stress acting on the portion of flange under consideration.

This expression may be used for as precise an estimate of V_F as is wanted, but the labor of finding \bar{y} may be considerable, and the following approximation is sufficiently accurate.

Let m = the flange thickness; *average* thickness for tapering flanges;
 b = flange width, as shown.

Assume $\bar{y} = m/2$, and that the distance from the horizontal plane to the centroid of the flange area = $m/2$ (not an assumption for flanges with parallel sides).

Then $Q = bm\left(\frac{d-m}{2}\right);$

$$I = 2bm\left(\frac{d-m}{2}\right)^2$$

neglecting the web. And

$$\begin{aligned} V_F &= V \times \frac{bm\left(\frac{d-m}{2}\right)}{2bm\left(\frac{d-m}{2}\right)^2} \times \frac{m}{2} \\ &= V \frac{m/2}{(d-m)} \end{aligned} \quad (16)$$

It will be of interest to apply this approximate formula to a specific case. For example, consider a 12-in. I at 31.8 lb. per ft.

$$m = \frac{0.738 + 0.350}{2} = 0.544, \quad \frac{m}{2} = 0.272$$

$$d - m = 12.00 - 0.544 = 11.456$$

$$V_F = \frac{0.272}{11.46} \quad V_F = 2.37\% \text{ of } V$$

Use of the more precise formula shows that, more accurately,

$$V_F = 3.32\% \text{ of } V$$

In other words the approximate formula gives an estimate of V_F in terms of V which is within 1 per cent of being exact. Applying the approximate and precise formulas to a 3-in. I at 7.5 lb. (the case for which the approximate formula is least accurate) leads to the following results:

$$\text{Approximate formula: } V_F = 4.75\% \text{ of } V$$

$$\text{Precise formula: } V_F = 6.83\% \text{ of } V$$

Applying the formulas to the Carnegie wide-flange beam 36 in. deep at 300 lb. per ft. gives the following:

$$\text{Approximate formula: } V_F = 2.43\% \text{ of } V$$

$$\text{Precise formula: } V_F = 2.07\% \text{ of } V$$

The cases cited illustrate the comparative accuracy of the precise and approximate methods of estimating V_F , and, which is more important, indicate the accuracy with which Hudson's formula gives the vertical compression over or under a bearing block for stresses within the elastic limit of the material.

As implied in Art. 40, it is always assumed that the web of an I beam resists all the shear. The approximate formula for V_F just found permits an easy and reliable estimate of the accuracy of this assumption. Evidently the web actually resists a shear of

$$V_w = V - 2V_F = V \left(\frac{d - 2m}{d - m} \right) \quad (17)$$

The figures previously cited show that the web resists from 90 to 96 per cent or more of the external shear at any section so long as stresses are within the elastic limit.

It should be noted that the intensity of stress found by the methods just discussed is not the maximum intensity of web compression, but only a very close approximation of the intensity of compression in a vertical direction. The direction and magnitude of the maximum intensity of web compression at a bearing block depend also on the intensity of direct stress due to flexure. When the direct stress is small compared with the vertical stress, as at an end bearing block, the magnitude and direction of the maximum intensity of web compression will not differ greatly from the magnitude and direction of the vertical compression, and the latter may be used for design purposes. At an interior bearing block the direct stress from flexure will be large, but the shear is

likely to be small or zero, and the magnitude and direction of the maximum intensity of web compression still will not differ greatly from that of the vertical compression, which may be used for design purposes. At a bearing block where both direct stress from flexure and shear are high, as for a beam with an overhanging end, the maximum intensity of web compression may be appreciably increased and in such cases the intensity of vertical compression should be kept low.

The intensity of stress which should be permitted in vertical compression in the web is not mentioned in any specification so far as the author knows. Professor Moore, in Bulletin 68, University of Illinois Engineering Experiment Station, and Professors Moore and Wilson in Bulletin 86, University of Illinois Engineering Experiment Station, state as a result of their tests that: "It is unwise to regard the ultimate compressive fiber stress in the web adjacent to a bearing block as higher than the yield-point strength of the material at the root of the flange. Moreover, the fact should be borne in mind that the material at the root of the flange of an I beam has a yield-point strength somewhat lower than the material in the flange or in the web. In the absence of special tests the yield-point strength of structural steel at the root of the flange of an I beam may be taken as about 30,000 lb. per sq. in." It has been common practice for some years to allow a compressive stress of 24,000 lb. per sq. in. on the ends of stiffener angles and in other cases of metal bearing on metal. Assuming this to be a satisfactory value (some engineers consider it too high) it seems reasonable to say that the vertical compression in the web at its junction with the flange should certainly not exceed that amount. The two cases are not strictly analogous, and the author believes that 24,000 lb. per sq. in. is high rather than low. Failure of an I beam could result more easily from local crushing of the web over a bearing block (by the flange folding over towards the web followed by buckling of the web) than from local crushing of the ends of stiffeners. There could evidently be considerable local crushing (not buckling) of stiffener ends without the stiffeners allowing the flange to fold over towards the web.

Other engineers apparently do not agree with the author regarding this permissible intensity of stress. For example, a table of maximum bending moments and web resistances of standard I beams (page 127, "Pocket Companion" 1931 Abridged Edition) gives the safe end reaction for a 20-in. I at 65.4 lb. on a $3\frac{1}{2}$ -in. bearing block as 49,900 lb. The vertical compression in the web just above the bearing for that load would be

$$\frac{49,900}{3.5 \times 0.5} = 28,500 \text{ lb. per sq. in.}$$

Beams for Underpinning of Col. D11

| | |
|--------------------------|--------|
| DP3 | |
| Framing for Underpinning | |
| 1932 | T.C.S. |
| Sheet 1 of 2 | |

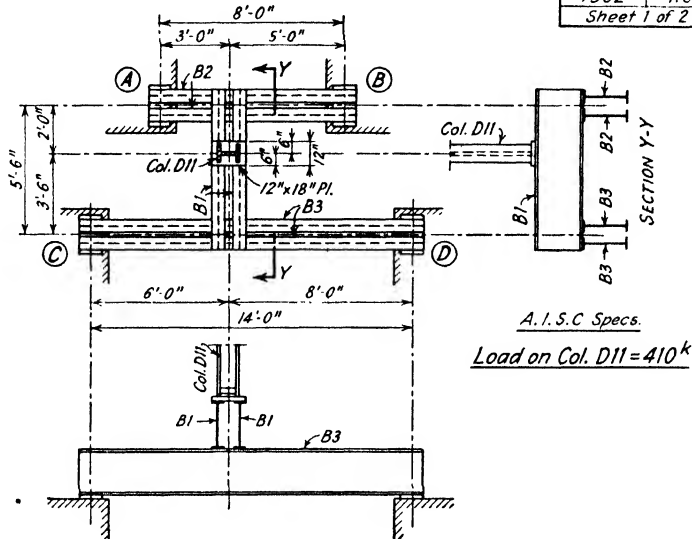

A.I.S.C. Specs.
Load on Col. D11 = 410^k

Beams B1

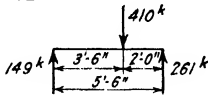

Shear

149^k and 261^k
 @12 = 12.4^{sq in} @12 = 21.76^{sq in} web area in shear
 @24 = 6.21^{sq in} @24 = 10.88^{sq in} " " " bearing

Moment

2.0 x 261 = 522^{ft-k}
 @ $\frac{12}{18}$, $\frac{I}{c} = 348$
 2-24" I @ 100# $\frac{I}{c} = 2 \times 197.7 = 395.4$

Direct Compression

410^k
 @24 = 17.08^{sq in} necessary web area under col. seat
 ÷ 12" = 1.42" necessary web thickness

Web thickness = 2 x .747 = 1.49"
 Web area = 2 x .747 x 24 = 35.8^{sq in}
 Flange width 7.25"

Vertical Buckling

$$s = \frac{18,000}{1 + \frac{1}{6000} \times \left(\frac{21.72}{.747}\right)^2} = 15,800 \#/sq in \quad \frac{410}{15.0} = 27.3 \text{ sq in needed}$$

15,000 #/sq in max.
 (12+12) x .747 x 2 = 35.8^{sq in} available

For the same beam and same length of bearing "Steel Construction" and "Pocket Companion," 24th Edition, give for the safe end reaction 60,400 lb., making the vertical compression

$$\frac{60,400}{3.5 \times 0.5} = 34,500 \text{ lb. per sq. in.}$$

As would be expected from the manner in which these tables are computed the intensity of vertical compression is high for deep beams and less for shallow beams, becoming less than 24,000 lb. per sq. in. for standard I's 9 in. deep and smaller.

Whenever the vertical compressive stress over or under a bearing block becomes excessive one of three things should be done: the bearing block should be made longer, a beam with a thicker web should be used, or tight-fitting bearing stiffeners should be provided. The latter course is objectionable because of the expensive shop work necessary to secure the tight fit against the flange of the beam, which is essential in a bearing stiffener.

44. Illustrative Examples.—The design of beams in which web strength is a factor is illustrated by the calculations given on Sheets 1 and 2 of DP3, and Sheets 1 and 2 of DP4.

DP3.—The sketch on Sheet 1 of DP3 shows the framing arrangement planned to support an existing building column temporarily during a reconstruction operation. The column in its original position has a 12 by 18 base plate through which it is bolted to a cast-steel pedestal. The plan of procedure is to place the beams *B2* and *B3*, after the supports *A*, *B*, *C*, and *D* are prepared, then by means of attachments connected to the column some distance above the base, and jacks supported on temporary timber cribbing, lift the column enough to allow removing its pedestal and placing the beams *B1*. After all beams are in place the column will be brought to a bearing on them and the jacks and cribbing removed, allowing the necessary work beneath the column to be performed.

The student should note that two 24-in. I's at 79.9 lb. would have sufficient strength to resist the bending moment developed in the beams *B1* ($I/c = 2 \times 173.9 = 347.8$) but that their webs would not provide sufficient area for direct compression under the base plate of the column ($2 \times 12 \times 0.5 = 12.0$ sq. in.; 17.08 sq. in. needed), or sufficient web area to resist safely the tendency to vertical buckling under the column ($(12 + 12) \times 0.5 \times 2 = 24.0$ sq. in., 27.3 sq. in. needed). Note also that two 24-in. I's at 85 lb. would provide more than enough bending strength and sufficient web area to resist buckling ($(12 + 12) \times 0.563 \times 2 = 27.0$ sq. in.) but not enough web area to

Beams for Underpinning Col. D11

| | |
|-----------------------------|----------|
| DP3 | |
| Framing for Underpinning | |
| 1932 | T. C. S. |
| Sheet 2 of 2 | |

Beams B2

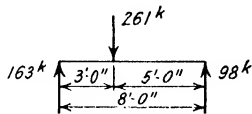

Shear

98k and 163k
@ 12 = 13.6"
@ 24 = 6.8"

Moment

$$3.0 \times 163 = 489 \text{ k}$$

$$\text{@ } \frac{12}{18}, I_c = 326$$

$$2 - 24'' I @ 79.9 \# \frac{I}{c} = 2 \times 173.9 = 347.8$$

Direct Compression

261k
@ 24 = 10.88" web area under Beams B1
÷ 2 × 7.25
= .75" web thickness

Web thickness = 2 × .50 = 1.00"

Web area = 2 × .50 × 24 = 24.0"

Flange width = 7.0"

Beams B3

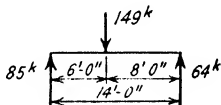

Shear o.k.

Moment

$$85.0 \times 6.0 = 510 \text{ k}$$

$$\text{@ } \frac{12}{18}, I_c = 340$$

$$2 - 24'' I @ 79.9 \# \frac{I}{c} = 2 \times 173.9 = 347.8$$

Direct Compression

149k
@ 24 = 6.20"
÷ 2 × 7.25 = .428" web thickness

Web thickness = 2 × .50 = 1.00"

Wall Pls.

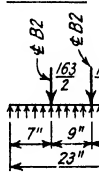

Largest reaction = 163k at (A)
@ .6 = 272" on masonry
12" × 23" = 276"
All plates 12" × 2 1/4" × 23"

$$\text{Mom.} = \frac{163}{276} \times 7 \times \frac{I}{2} = 14.5 \text{ k}$$

$$\frac{1}{6} \times 1 \times 6^2 = \frac{14.5}{18.0} \quad t = 2.19 \text{ say } 2 \frac{1}{4}''$$

Weight

2 - 24'' Is @ 100# × 6.3' = 1260
2 - do @ 79.9 × 9.0 = 1440
2 - do @ 79.9 × 15.0 = 2400
4 - 12 × 2 1/4 @ 91.8 × 1.9 = 700
5800#

resist vertical compression in the webs under the column base plates. The design of the beams *B1* is then controlled by vertical compression in the webs under the bearing block.

Attention is called to the use of *clear* depth in applying the column formula to determine permissible intensity of stress in the web as a column. The author pointed out in the footnote on page 86 that the use of clear depth is consistent although the overall depth is perhaps more commonly used. Had overall depth been used here the permissible column stress in the web would have been found to be

$$\frac{18,000}{1 + \frac{1}{6000} \times \left(\frac{24}{0.747}\right)^2} = 15,400 \text{ lb. per sq. in.}$$

Attention is called to the fact that the calculations as given assume the top flanges to be held against lateral movement or rotation at the load point by the load.

Particular emphasis should be placed on the necessity for laterally bracing beams which rest freely on supports, or on other beams, against the possibility of overturning. In temporary construction of the kind illustrated in the design, DP3, the bracing would probably be in the form of bolted timber struts. In the next design, DP4, the grillage is part of the permanent construction and the beams will be braced by solid concrete encasement.

DP4.—The design calculations for the grillage footing are based on the assumptions: (a) the column load is uniformly distributed over its area in contact with the slab, (b) the load applied to the slab is uniformly distributed over its bottom area in contact with the upper tier beams, (c) the load from the upper tier beams is uniformly distributed over their area in contact with the lower tier beams, and (d) the total load is uniformly distributed to the caisson over the area determined by the outer boundary lines of the lower tier of beams. The last assumption can be true only if the concrete encasement between the beams is fully effective in distributing load from above into the caisson.

With these assumptions in mind the student should be able to follow the design calculations for the beams. It may be well to point out that in determining the necessary web area to resist buckling a side calculation for the permissible intensity of stress was made and found to be in excess of 15,000 lb. per sq. in. for any beam within reasonable range; consequently 15,000 lb. per sq. in., the maximum permissible stress, was used in all cases. It will be noticed that 20-in. I's at 70 lb. would have had sufficient bending strength for the upper tier beams but insuffi-

I-Beam Grillage for Column H-4

| | |
|------------------|--------|
| DP 4 | |
| Grillage Footing | |
| 1932 | T.C.S. |
| Sheet 1 of 2 | |

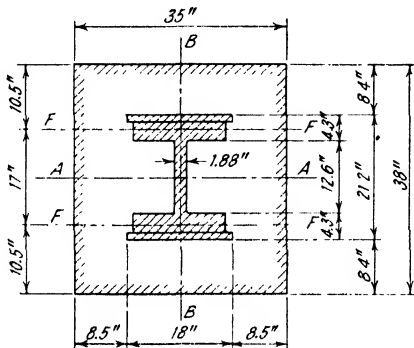

A.I.S.C. Specs.

Total Load on Col. H-4 = 2500^k
 H-4 { 1-14" WF @ 426*
 2-18" x 1/4" Pls.
Area = 170.30"

Footing Area $600^*/ft$
 $\frac{2500}{6} = 4170^{"}$
 $66^{"} \times 64^{"} = 4224^{"}$

Slab

Mom. Line F-F = $\frac{2500}{38} \times \frac{10.5^2}{2} = 3630^{"k}$

Line B-B = $\begin{cases} 71.4 \times \frac{35^2}{8} = 10930 \\ 119.5 \times \frac{9^2}{2} = 4840 \end{cases}$
 $6090^{"k}$

$\frac{2500}{170.3} \times 1.88 \times 12.6 = 348^k$

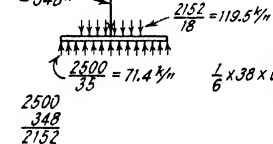

$\frac{1}{6} \times 38 \times t^2 = \frac{6090}{18}$ $t^2 = \frac{6090}{3 \times 38} = 53.4$
 $t = 7.32^{"}$

Use Slab 35" x 8" x 3'-2" rough size

Wt. = $35 \times 8.0 \times 3.4 \times 3.17' = 3020^*$

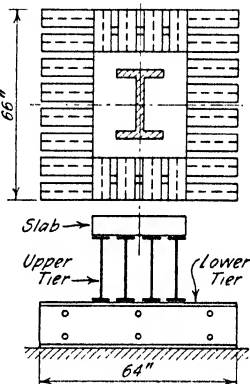

Upper Tier Beams

Mom. $\frac{2500}{8} (66-38) = 8750^{"k}$
 @ 18 1/2% $\frac{I}{C} = 486$
 Investigate for Direct Comp. $\frac{2500}{24} = 104^{"}$ $\div 4 = 26^{"}$ per beam $\div 4 = 121.5$ per beam
 $\frac{26}{38} = .685^{"}$ min. web thickness

Buckling $\frac{2500}{15} = 166.7^{"}$ $\div 4 = 41.6^{"}$ per beam Use 4-20" I @ 100*
 $\frac{I}{C} = 164.8$ $t = .873^{"}$

$\frac{41.6}{(38+9)} = 886^{"}$ min. web for 18" I

$\frac{41.6}{(38+10)} = 868^{"}$ " " " 20" I

$\frac{41.6}{(38+12)} = 832^{"}$ " " " 24" J

Wt. = $4 \times 100 \times 5.5 = 2200$

Sheet 5220*

cient web thickness to resist safely either direct compression or buckling, and attention is called to the fact that *any* standard 24-in. I has sufficient strength in bending but that *no* standard 24-in. I has sufficient web strength. The latter statement is also true with regard to standard 18-in. I beams.

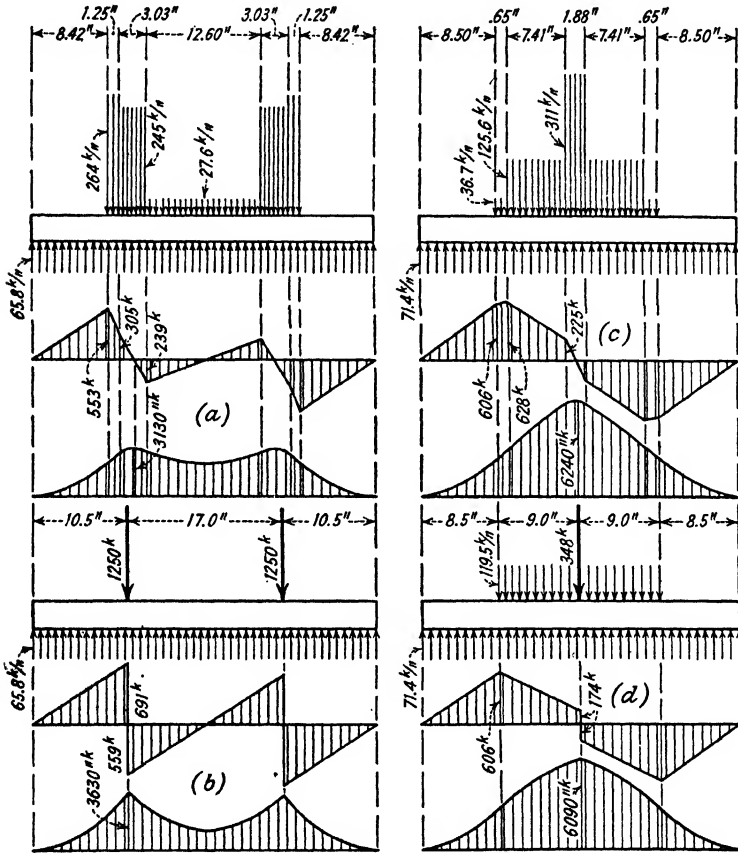

FIG. 58.

In order to clarify the calculations made in designing the slab, Fig. 58 is presented. Figures 58 (a) and (c) show the distribution of load and the resulting shear and moment diagrams for the slab in exact accordance with the assumptions of the first paragraph in this article, and Figs. 58 (b) and (d) show the distribution of load and the resulting shear and moment diagrams as actually used in making the design.

I-Beam Grillage for Column H-4

| | |
|------------------|--------|
| DP 4 | |
| Grillage Footing | |
| 1932 | T.C.S. |
| Sheet 2 of 2 | |

Lower Tier Beams

Moment = $\frac{2500}{8} (64 - 35) = 9060''k$ Forward 5220*
 @ 18 3/4" $\frac{I}{c} = 503$
 = 83.9 per beam for 6 beams
 = 71.9 " " " 7 "
 = 67.9 " " " 8 "

Direct Compression = $\frac{2500}{24} = 104.0''$
 $\frac{104}{6 \times 4 \times 7.27} = .596''$ min. web for 6 beams
 = .511" " " " 7 "
 = .448" " " " 8 "

Buckling = $\frac{2500}{15} = 166.7''$
 $\frac{166.7}{6(35 + 7.5)} = .654''$ min. web for 6-15" Is
 .560" " " " 7- "
 .490" " " " 8- "

Use 8-15" I @ 50.0*

$\frac{I}{c} = 64.15$

$t = .550''$

Wt. = 8 x 50 x 5.33 = 2130*

Gas pipe separators, bolts, etc. = 180

Total = 7530*

Say 7600*

Other modifications of the assumptions illustrated in (a) and (c) of Fig. 58 are used in design and may be found stated in various textbooks and in steel manufacturers' handbooks. It seems pertinent to point out, however, that *stiffness* of the slab is more important than *strength*; its function is to distribute the column load over the beams, and that duty is most effectively met where the slab is made thick to minimize its deflection into a dish shape. "Dishing" of the slab necessarily reduces the pressure on the beams at the outer edges of the slab and intensifies it at the center. Consequently "dishing" should be reduced as much as possible, and not used as an argument for a thinner slab.

45. Allowance for Holes in Beam Flanges.—Occasionally it is necessary to provide open holes in one or both flanges of an I beam to receive brick and stone anchors, to allow passing wall reinforcement rods through the flanges, or to allow bolting on a timber nailing strip. Such

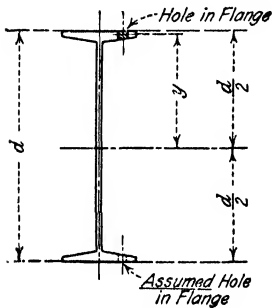

FIG. 59.

holes reduce the strength of the beam and are usually allowed for in design if near the section of maximum moment. At first glance such an allowance would seem to be a simple matter, but the effect of holes in one flange of an I beam is not definitely known. Some designers assume that the neutral axis of an I beam with holes in one flange shifts to the center of gravity of the net section; others consider that the position of the neutral axis is dependent on the deflection or bending of the beam and that a few holes in one flange cannot affect

it appreciably. The latter view seems the more reasonable, but a thoroughly satisfactory analysis has not yet been developed from either assumption. As a matter of practical design the matter hardly seems worth extensive debate. The author makes a practice in design computations of deducting holes from both flanges if there are holes in either. The error, judged by such standards as are available, is on the safe side, and usually quite immaterial. It is probably more important to note that whereas many designers and textbooks are concerned only by holes in the tension flange, holes in the compression flange are just as weakening, since brick and stone anchors, or bolts for fastening on nailing strips, do *not* fill the holes.

The obvious way to make an allowance for flange holes is to deduct the moment of inertia of the material cut out by the holes from that of the gross section and from this corrected moment of inertia compute the fiber stress or the net section modulus. This method is direct and

always correct, but the following approximation is simpler as a design procedure, and the author has found it entirely satisfactory.

Figure 59 shows an I beam with a hole in one flange. In accordance with the procedure stated above, *assume* a hole of equal size in the opposite flange. The reduction in the moment of inertia due to the actual hole and the assumed hole is

$$2Ay^2$$

in which A = the area of the metal cut out by the hole;

y = distance from neutral axis to center of gravity of hole, as indicated.

Similarly the reduction in section modulus is

$$\frac{2Ay^2}{\frac{d}{2}} = \frac{4Ay^2}{d}$$

d = the depth of the beam.

The y is very nearly equal to $d/2$ and may be assumed equal with sufficient accuracy. The reduction in section modulus then is

$$\frac{4A\left(\frac{d}{2}\right)^2}{d} = Ad$$

The design procedure then is to find the necessary section modulus, without holes in the beam, add to it the quantity Ad , and select a beam accordingly.

As an illustration assume that a beam having a span of 20 ft. is to carry a uniformly distributed load of 1750 lb. per ft., and to require one line of 7/8-in. holes in one flange (actual hole 13/16 in. for 3/4 in. bolt).

$$\text{Moment} = 1750 \times \frac{20^2}{8} = 87.5 \text{ ft.-kips}$$

$$\text{at } \frac{12}{18}, \frac{I}{c} = 58.3 \text{ net}$$

$$\text{For a standard 15-in. I, } Ad = \frac{7}{8} \text{ in.} \times \frac{5}{8} \text{ in.} \times 15 \text{ in.} = 8.2 \left\{ \begin{array}{l} \text{allowance} \\ \text{for holes} \end{array} \right.$$

$$\text{Required } I/c = 66.5 \text{ gross}$$

$$\text{Use 15-in. I at 55 lb., } I/c = 67.83$$

In the above calculation the quantity 7/8 in. \times 5/8 in. is the area of metal cut out by a 7/8-in. hole from the flange of a standard 15-in. I—

the thickness of the flange of a 15-in. I, at the point where a hole is usually placed, being 5/8 in. if the beam weighs 55 lb. per ft.

46. Beams with Cover Plates.—It is sometimes necessary to rivet a plate on one flange, or one on each flange, of an I beam to support brick, stonework, sash or doors, etc., or to increase the capacity of the beam. The increase in the capacity of a beam resulting from the addition of a plate on one flange is small, unless the beam is to be designed with different intensities of flange stress; in that case the addition of a plate on the flange which is to have the lower intensity of stress will be a material help.

The design of a beam with a plate on one flange is necessarily a matter of trial, assuming a beam and plate, with the aid of whatever limits are available, and calculating either the section moduli of the

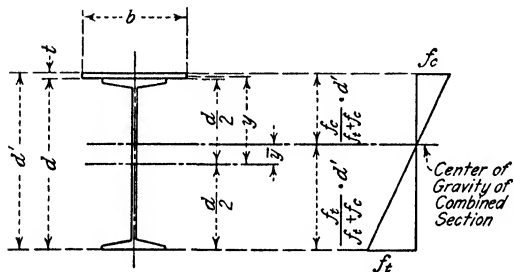

FIG. 60.

combination or the extreme fiber stresses produced by the load it supports. Often limitations are placed on the size of the beam or plate by the character of the material supported or the conditions of support.

The author has frequently found the following approximate procedure helpful in selecting a trial beam and plate. Figure 60 shows an I beam with a cover plate on the compression flange. Using the notation given in the figure, and also

- A_I = the area of the I beam;
- A_p = the area of the plate;
- f_c = the maximum permissible intensity of stress in the compression flange;
- f_t = the maximum permissible intensity of stress in the tension flange;

$$\frac{f_t}{(f_t + f_c)} \cdot d' = \frac{d}{2} + \bar{y} = \frac{d}{2} + \frac{A_p y}{A_p + A_I}$$

In this expression d' and d are very nearly equal and y is nearly equal to $d'/2$. It is not much in error to say that

$$d' = d \quad \text{and} \quad y = \frac{d'}{2}$$

and making these substitutions

$$\frac{f_t}{f_t + f_c} \cdot d' = \frac{d'}{2} + \frac{A_p}{A_p + A_I} \cdot \frac{d'}{2} \text{ very nearly.}$$

Solving this expression for A_p

$$A_p = \frac{A_I}{2} \cdot \left(\frac{f_t - f_c}{f_c} \right) \quad (18)$$

The student should understand clearly that this expression is approximate and should be used primarily as a guide in selecting a suitable combination. The combination chosen should always be checked by the fundamental procedure outlined at the beginning of the article. In making use of the expression, f_t is taken from the design specifications. The intensity f_c is determined by the design specifications also, but only after b , the width of the plate, has been chosen (the width of the plate is often fixed by the load to be supported or by limits on compression flange width). A_I may be estimated by finding an I beam which will carry the given loads at the usual stress of f_t and choosing a beam of the same depth about two weights lighter; i.e., if an 18-in. I at 65 lb. per ft. (without any cover) is strong enough to support the given loads at the usual stress try an 18-in. I at 54.7 lb. per ft. and add a cover plate the area of which is determined from expression (18).

DP5.—As an illustration the design calculation sheet DP5, Sheet 1 is presented. It will be noticed that the I/c required for a beam without covers, working at the usual unit stress of 18,000 lb. per sq. in., was first found as 63.8. The nearest standard I beam of reasonable depth is the 15-in. I at 50 lb. per ft. having an I/c of 64.2. A size two weights lighter, i.e., the 15-in. I at 42.9 lb. per ft., was chosen for trial. The I beam having been chosen, a plate width of 9 in. was selected which made it possible to determine the permissible compression stress from the specifications. The trial area for the plate was then found as indicated, the properties of the compound section calculated, and the actual fiber stresses found. The author would consider the stresses found on the first trial as satisfactory, but a second trial was made to indicate the effect of adding 1/16 in. to the cover plate thickness. The student will find that generally a plate of slightly larger area than is given by (18) is desirable.

It may be well to point out in connection with this problem that a wide-flange beam (either Bethlehem or Carnegie), 14 in. WF at 68 lb. per ft., having a permissible compressive stress of 12,140 lb. per sq. in. for a laterally unsupported span of 30 ft., has adequate strength, and if

there is no objection to the bottom flange being as wide as the top may be more economical even though about 12 lb. per ft. heavier. The designer must always keep in mind that the use of compound sections requiring considerable shop work may sometimes be more costly than heavier rolled sections which do not require so much shop work. No general rule can be laid down; a satisfactory solution depends on the costs for a particular shop and on material prices at the time of construction, neither of which can be taken into account in a textbook discussion.

When plates are to be riveted to both flanges to increase the capacity of the beam the following procedure is sufficiently accurate in most cases. Subtract from the moment to be resisted the moment which the beam alone is capable of resisting, and divide the remainder by the depth of the beam plus the estimated thickness of the plate on one flange; this evidently gives the total stress in the plate on each flange, and dividing this total stress by the permissible fiber stress gives the net area required for the plate on the tension flange. The plate on the compression flange is ordinarily made the same size. In determining the bending moment which the beam alone can resist it must be remembered that the extreme fiber stress on the beam is not the maximum permissible, but that amount multiplied by the ratio of the depth of the beam to the overall depth of the compound section, and also that holes must be placed in the flange of the beam for riveting on the covers—unless they are welded on. The holes in the beam flange can be allowed for nearly enough by adding their area to the required net area of the cover plate.

The method of design described above results in a very close approximation and has been found satisfactory in all cases in which the author has applied it. If greater precision is wanted, however, it is easy to modify the method to secure results which are exact, so far as the beam formula is exact when applied to compound sections with the component parts riveted together.

If the plates are not required for the full length of the beam the points at which they may be cut off can be determined by one of the methods given under "Plate Girders."

So wide a range of heavy rolled-beams is now available that there is seldom any occasion for adding plates to beams. Reinforcing an I beam with cover plates results in expensive shop work and should not be resorted to unless conditions prevent the use of a heavier or deeper beam. However, it is sometimes necessary to make use of available material, and adding cover plates may be unavoidable.

Increasing the capacity of a rolled beam by the addition of cover

Beam BH4 with Top Cover Plate

| | |
|------------------------------|--------|
| DP 5 | |
| Beam with Top Cover Plate | |
| 1932 | T.C.S. |
| Sheet 1 of 1 | |

Span 30'-0" c.c. Bgs. (No lateral support for top flange except at ends.)

Load 850# / total

Moment $\frac{850 \times 30^2}{8} = 95.6'k$

$\otimes \frac{12}{18}, \bar{c} = 63.8$
Try 15" I @ 42.9

A.I.S.C. Specs.

Min. width for top flg.
 $= \frac{30 \times 12}{40} = 9"$

$f_c = 11.1$
 $f_t = 18.0$
 $4p = \frac{12.49}{2} \times \frac{(18-11.1)}{11.1}$
 $= 3.88$

Try $9 \times \frac{7}{16}$
area = 3.94"

First Trial

| Section | Area | 1st. Mom. | I |
|-----------------------------|--------------------|----------------|-------|
| 1-15" I @ 42.9# | 12.49" | | 441.8 |
| 1-9" x $\frac{7}{16}$ " Pl. | 3.94 x 7.72 = 30.4 | x 7.72 = 235.0 | |
| | 16.43" | 30.4 | 676.8 |
| | | 1.85" | 56.2 |
| | | | 620.6 |

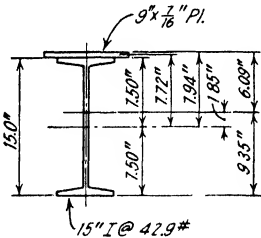

Actual Stress

$\frac{95.6 \times 12}{620.6} \times 6.09" = 11.25' / a$ top fibers
 $\times 9.35 = 17.28' / a$ bott. "

Second Trial

| Section | Area | 1st. Mom. | I |
|----------------------------|--------------------|----------------|-------|
| 1-15" I @ 42.9# | 12.49 | | 441.8 |
| 1-9" x $\frac{1}{2}$ " Pl. | 4.50 x 7.75 = 34.9 | x 7.75 = 270.5 | |
| | 16.99 | 34.9 | 712.3 |
| | | 2.06" | 71.7 |
| | | | 640.6 |

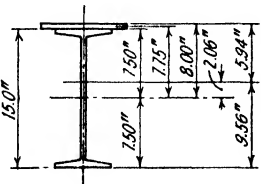

Actual Stress

$\frac{95.6 \times 12}{640.6} \times 5.94 = 10.64' / a$ top fibers
 $\times 9.56 = 17.13' / a$ bott. "

plates will result in larger shears than are usual in the unreinforced beam, and the student is cautioned always to investigate the strength of the web in such cases.

DP6.—In order to illustrate the design procedure just described, the design calculations on Sheet 1, DP6, are presented. No explanation should be necessary except perhaps that it is customary to assume in design calculations that the holes for 3/4-in. rivets are 7/8 in. in diameter, as will be noted later. In the calculation for area of holes in the I beam flange, $7/8 \times 13/16 \times 2$, the 7/8 in. is the diameter of the hole as just stated, the 13/16 is the thickness of the beam flange at the point where rivets are generally located (taken from "Steel Construction"), and the 2 for 2 holes as shown. The capacity of the unpunched I beam, 189.5 ft.-kips, was also taken from "Steel Construction."

As stated previously in this article, the design procedure presented is easily modified to secure an "exact" design, if that is wanted. On the same sheet with the approximate design two exact solutions are given without explanation. They are "exact" in the sense that if cover plates 3/4 in. thick, each of exactly 8.68 sq. in. net area, are provided, and the moment of inertia of the compound section with two holes out of each flange is computed, application of the beam formula will give a computed extreme fiber stress of exactly 18,000 lb. per sq. in., within the limits of accuracy of the slide-rule calculations leading to the 8.68 sq. in. net area for each cover plate. These solutions should be carefully studied to make sure that the underlying principles are clearly understood.

47. Bending in Two Directions.—Beams subjected to inclined loads or to lateral as well as vertical loads have sometimes to be considered. Like beams with plates on one flange their design is largely a matter of trial. It consists in choosing what seems to be a reasonable section or combination of sections, aided by whatever facts are available, and computing the maximum fiber stress to make sure that it does not exceed the allowable value. If the maximum stress is found to be materially in error the section must be modified and the stress recomputed. The analysis is most easily made by resolving the inclined load into components parallel to the **principal axes** of the section, computing the stress in the extreme fibers due to each component, and adding the values algebraically.

It should be recalled from study of the mechanics of materials that the extreme fiber stress in such cases may be found from:

$$s = \frac{M_1 c_1}{I_1} \pm \frac{M_2 c_2}{I_2} \quad (19)$$

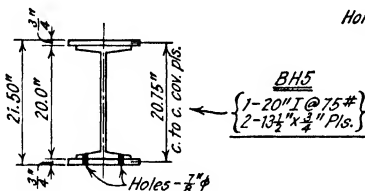
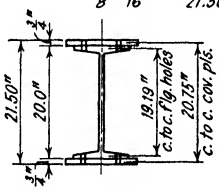
| | | | | | | | | | |
|---|---|------|--|-------------------------------------|--|------|--------|--------------|--|
| <p>Beam BH5</p> <p>Span = 20'-0" c. to c. Bgs. (Continuous lateral support for top flange)</p> <p>Load = 8000 #/l Total</p> <p>20" I @ 75 #/l to be used with covers</p> <p style="text-align: right;">Moment = $\frac{1}{8} \times 8^2 \times 20^2 = 400^k$</p> <p>Assume $\frac{3}{4}$" covers and $\frac{3}{8}$" holes for $\frac{3}{4}$" rivets</p> <p>Moment carried by I = $\frac{20.0}{21.5} \times 189.5 = 176$</p> | <table border="1" style="width: 100%; border-collapse: collapse;"> <tr> <td colspan="2" style="text-align: center;">DP 6</td> </tr> <tr> <td colspan="2" style="text-align: center;">Beam with Top & Bottom Cover Plates</td> </tr> <tr> <td style="text-align: center;">1932</td> <td style="text-align: center;">T.C.S.</td> </tr> <tr> <td colspan="2" style="text-align: center;">Sheet 1 of 1</td> </tr> </table> <p style="text-align: center;">A.I.S.C. Specs.</p> | DP 6 | | Beam with Top & Bottom Cover Plates | | 1932 | T.C.S. | Sheet 1 of 1 | |
| DP 6 | | | | | | | | | |
| Beam with Top & Bottom Cover Plates | | | | | | | | | |
| 1932 | T.C.S. | | | | | | | | |
| Sheet 1 of 1 | | | | | | | | | |
|  <p style="text-align: center;">BHS { 1-20" I @ 75 # 2-13 1/2" x 3/4" Pls. }</p> | <p>Holes in flange of I = $\frac{7}{8} \times \frac{13}{16} \times 2 = \frac{1.42}{8.62}$ net</p> <p>Use $13 \frac{1}{2} \times \frac{3}{4}$ covers</p> <p>Net area = $(13 \frac{1}{2} \times 2 \times \frac{3}{4}) \times \frac{7}{8} = 8.81$ net</p> | | | | | | | | |
| <p><u>Design by Exact Moment Method</u></p> <p>$M_I =$ moment carried by I-beam alone</p> <p>$M_I = 189.5 \times \frac{20.0}{21.5} = 176.3^k$</p> <p>Allowance for holes (both flanges)</p> <p>$\frac{7}{8} \times \frac{13}{16} \times 2 \times \frac{19.19}{21.50} \times 18 \times \frac{19.19}{12.0} = \frac{36.4^k}{139.9^k}$</p>  | <p style="text-align: right;">Moment = 400^k</p> <p style="text-align: right;">+ $\frac{20.75}{12} = 129.5^k$ in cover</p> <p style="text-align: right;">@ 18^{1/2} in area = 720ⁱⁿ net</p> <p style="text-align: right;">+ $\frac{20.75}{12} = 129.5^k$ in cover</p> <p style="text-align: right;">@ 18^{1/2} in area = 720ⁱⁿ net</p> <p style="text-align: right;">Use $13 \frac{1}{2} \times \frac{3}{4}$ covers</p> <p style="text-align: right;">Net area = $(13 \frac{1}{2} \times 2 \times \frac{3}{4}) \times \frac{7}{8} = 8.81$ net</p> | | | | | | | | |
| <p><u>Design by Exact Section Modulus Method</u></p> <p>$S_I =$ Equivalent Section Modulus of I-beam alone</p> <p>$A_{cn} =$ Required net area of cover plate</p> <p>$S_I = 126.35 \times \frac{20.0}{21.5} = 117.5$</p> <p>Allowance for holes (both flanges)</p> <p>$\frac{7}{8} \times \frac{13}{16} \times 2 \times \frac{19.19}{21.50} \times 19.19 = \frac{24.4}{93.7}$</p> | <p style="text-align: right;">Moment = 400^k</p> <p style="text-align: right;">@ $\frac{12}{18}, I_c = 266.7$</p> <p style="text-align: right;">$\frac{93.1}{173.6}$</p> <p style="text-align: right;">$A_{cn} = \frac{173.6}{20.75} \times \frac{21.50}{20.75} = 8.68$ net</p> | | | | | | | | |

in which s = the resultant stress in the fiber in question;
 M_1 = the bending moment about principal axis 1-1;
 c_1 = the distance from axis 1-1 to the fiber in question;
 I_1 = the moment of inertia of the section about axis 1-1;
 M_2 , c_2 , and I_2 are corresponding quantities referred to
principal axis 2-2.

The axes 1-1 and 2-2 are perpendicular to each other, and the axis 1-1 is generally, but not always, horizontal. Of course this rela-

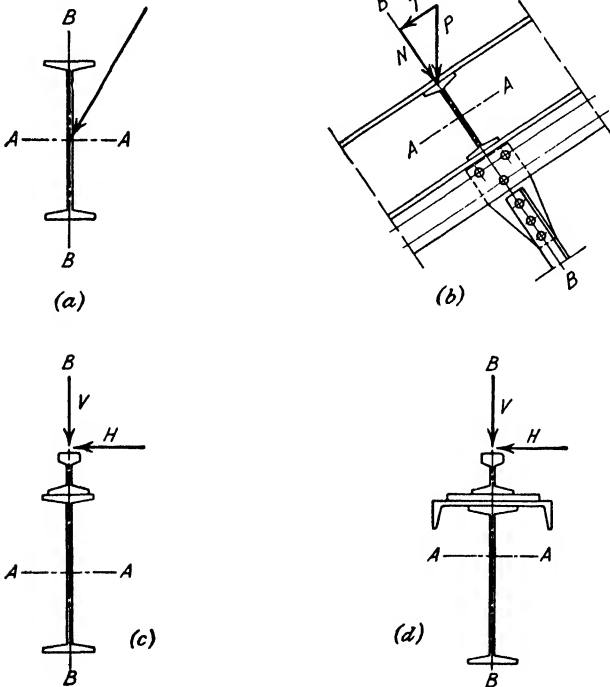

FIG. 61.

tion can be true only when the resultant load passes through the center of gravity of the section as shown in Fig. 61 (a), and though this condition of loading is desirable it is not common. More common conditions of loading are shown in Fig. 61 (b), (c), and (d). Applying the general method in such cases ignores the fact that the resultant load does not pass through the centroid, and leads to results which are erroneous. Exact analysis necessarily involves consideration of the torsion of non-circular sections, which is extremely difficult and complicated, and a

practical impossibility as a design procedure. The author considers it sufficiently accurate to assume that the vertical component of the load is resisted by the beam as a whole, and that the horizontal component is resisted by the loaded flange alone—the top flange in the cases illustrated.

Unsymmetrical sections are sometimes encountered, such as shown in Fig. 62. A common mistake in dealing with unsymmetrical sections is to assume that the beam formula may be applied about axis $A-A$ for vertical loads, or about axis $B-B$ for horizontal loads; this is not true unless the conditions of support compel the section to deflect about these axes without twisting. The *principal* axes are inclined, and in Fig. 62 are indicated as $A'-A'$ and $B'-B'$; but having found these axes and the properties of the section referred to them it is incorrect to apply the general expression given in this article unless the resultant of the loads passes through the shear center of the section.

In general, unsymmetrical sections should be avoided in structural design unless they can be so supported as to compel deflection, about some convenient axis, *without rotation*. The student should be able to analyze such sections, however, and will find the appropriate methods discussed in texts* on the mechanics of materials.

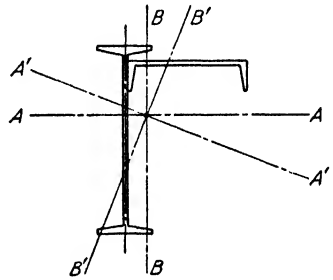

FIG. 62.

DP7.—The preceding discussion is illustrated by the calculations shown on the design sheet DP7, Sheet 1. In each of the two designs shown, the beam under consideration is subjected to lateral forces, resulting from the side thrust or nosing of the crane, in addition to the vertical loads. Furthermore, the top flanges are without lateral support between the ends and therefore must have a reduced intensity of working stress in the compression flange in order to comply with the design specifications. As previously stated any design of this type is a matter of trial, and the design sheet shows only the determination of the maximum moment and the calculation of actual fiber stress in the section finally chosen. A mental estimate is sufficient in each case to show that shear is not a factor in the design. Attention is called to the fact that in estimating the stress due to lateral forces the top flange in each case is assumed to resist all the lateral force. It will be noticed that the moment of inertia (or section modulus) of the top flange of the

* "Strength of Materials," G. F. Swain, McGraw-Hill. "Advanced Mechanics of Materials," F. B. Seely, Wiley & Sons.

beam, about the axis in the central plane of the web, is taken as one-half the moment of inertia (or section modulus) of the entire beam about the same axis. Such a procedure neglects the web of the beam; the student should investigate the matter and satisfy himself that it yields a substantially correct result.

It is important to observe that a single rolled section, a 30-in. WF at 172 lb. per ft., would serve as well as the compound section chosen for the beam *RB6*. Also it would be only about 32 lb. per ft. heavier than the compound section, a difference so small as to be more than offset, in most cases, by the cost of fabricating the former. This is a further illustration of the statement that the present range of wide-flange heavy beams is such that compound sections are now justified only in unusual cases.

It may be worth while to explain a procedure which is sometimes useful in selecting a single rolled section to resist bending in two directions. If

- s = the maximum permissible fiber stress
- M_1 = bending moment about axis 1-1
- M_2 = bending moment about axis 2-2
- S_1 = section modulus about axis 1-1
- S_2 = section modulus about axis 2-2 *

then

$$s = \frac{M_1}{S_1} + \frac{M_2}{S_2}$$

$$= \frac{1}{S_1} \left(M_1 + M_2 \frac{S_1}{S_2} \right)$$

and

$$S_1 = \frac{\left(M_1 + M_2 \frac{S_1}{S_2} \right)}{s} \quad (20)$$

The axis 1-1 is generally the axis about which the bending moment has the larger value. The ratio S_1/S_2 varies approximately in accordance with the depth but bears no exact relation thereto. The variation is from 4 to 14 for standard beams, from 3 to 12.5 for light wide-flange beams, and from 3 to 8 for heavy wide-flange beams. These ratios are based on S_2 for the entire section and would be doubled if the lateral forces were to be resisted by one flange only. Experienced designers have

* Section modulus about axis 2-2 should be for one flange only if lateral force acts on but one flange.

Crane Runway Beams RB3

Span 20'-0" c. to c. Bgs. No lateral support between ends.

Vertical Moment

L.L. = $112.5 \times \frac{20}{4} = 22.5 \times 20$
 Impact 25% = 28.2
 D.L. = $\frac{5.5}{2} = .11 \times \frac{20^2}{8}$
 Total = 146.2'k

Lateral Moment

$\frac{1}{22.5} \times 112.5 = 5.0'k$

Trial Section 16" WF @ 85#

$\frac{L}{b} = \frac{20 \times 12}{11.50} = 20.9$
 $s = 16.42 \frac{1}{2} \text{in}$

$s = \frac{146.2 \times 12}{151.3} + \frac{5.0 \times 12}{\frac{3.7}{2} \times 32.2} = 15.3 \frac{1}{2} \text{in} \text{ a.k.}$

Use 16" WF @ 85#

DP 7

Crane Runway Beams

1932 T.C.S.

Sheet 1 of 1

A.I.S.C. Specs.

Live Load: Bucket Crane

22,500# 22,500#

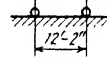

Impact: 25%

Lateral Load: 1k/wheel

Est. Dead Load:

Beam = 85#/
 Rail = 20
 Bolts, etc. = 5
 110#/
 110#

Crane Runway Beam RB6

Span 30'-0" c. to c. Bgs. No lateral support between ends.

Vertical Moment

L.L. = $297'k = 2 \times 30.9 \times \frac{12}{30} \times 12$
 Impact 25% = 74
 D.L. = $\frac{20}{2} = .175 \times \frac{30^2}{8}$
 Total = 391'k

Lateral Moment

$\frac{1.5}{30.9} \times 297 = 14.4'k$

Trial Section

| | Area | Ist. Mom. | I _{AA} | I _{BB} |
|------------------|----------|-----------|-----------------|-----------------|
| 1-24" I @ 105.9# | = 30.98" | | 2812 | 39# |
| 1-15" L @ 33.9 | = 9.90 | 11.61 | 1334 | 313 |
| | 40.88 | 115 | 4154 | 352 |
| | | 281" | 323 | 3837 |
| | | | (* 1/2 of 78.9) | |

Live Load: Whiting Crane

15 T + 3 and 5 Aux.

30,900# 30,900#

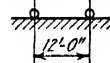

Impact: 25%

Lateral: $\frac{30' \times 2}{4} = 1.5'k/\text{wheel}$

Est. Dead Load:

Beam = 150#/
 Rail = 20
 Bolts, etc. = 5
 175#/
 175#

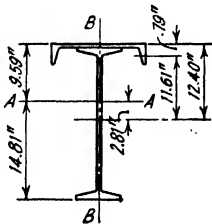

$\frac{L}{b} = \frac{30 \times 12}{15} = 24$

$s = 15.5 \frac{1}{2} \text{in}$

Actual fiber stress

Vert. $\frac{391 \times 12}{3837} \times 9.39 = 11.75 \frac{1}{2} \text{in}$
 $\times 14.81 = 18.2 \frac{1}{2} \text{in}$ bott. fiber

Lat. $\frac{14.4 \times 12}{352} \times 7.5 = 3.68$

$15.4 \frac{1}{2} \text{in} \text{---} 15.4 \frac{1}{2} \text{in}$ top fiber

Use $\left\{ \begin{array}{l} 1-24" I @ 105.9\# \\ 1-15" L @ 33.9\# \end{array} \right.$

a.k.

these approximate ratios in mind and use the above relation to get a quick mental estimate of the necessary beam size, after which it is easy quickly to select the most suitable section. The author has plotted the ratio S_1/S_2 against beam depth but does not find that such charts are much more useful than remembering the approximate range of the ratios.

48. Limited Deflection.—When beams support a plastered ceiling it is usual to specify that their total deflection, or sometimes their live load deflection, may not exceed a certain amount, in order to prevent cracking of the plaster. A common limit, which seems to have developed as the result of general observation and experience rather than by specific tests, is $1/360$ of the span. The application of this limit is not uniform, some authorities limiting the total deflection to that amount and others limiting the live load deflection to the same amount. The reason generally given for limiting live load deflection only is that the plaster is put on after practically all the dead load is in place and that therefore it is only the further deflection due to live load that needs to be considered. The author has not as yet found any positive evidence to support either position, other than the dogmatic statement of various authorities. It seems best, however, to limit the total deflection; limiting live load deflection only will result in a rather flexible structure in many cases.

Most specifications for bridge design, and some which govern building design, restrict deflection by establishing limits on the ratio of the depth of beams to their span length. Common limits are $1/15$ for railway bridge work, $1/20$ for highway bridges, and $1/25$ for buildings. Of course many other limits have been proposed and used but these represent probably the most common practice. Placing a limit on the depth-span ratio is not definite unless the permissible fiber stress is also fixed, and the limits just given were established, in most cases, for a unit stress of 16,000 lb. per sq. in.

The student will remember from mechanics that the deflection at the center of a uniformly loaded prismatic beam may be found from

$$\Delta = \frac{5}{384} \frac{WL^3}{EI} \quad (21)$$

in which Δ = the deflection, in inches;

W = the total load, in pounds;

L = the span, in inches;

I = the moment of inertia about the neutral axis, in inch units;

E = the modulus of elasticity, in pounds per square inch.

This may be written

$$\Delta = \frac{5}{48} \frac{sL^2}{Ec}, \quad \text{or} \quad \frac{10}{48} \frac{sL^2}{Ed} \quad \text{for symmetrical beams}$$

in which Δ , E , and L are as before;

s = the extreme fiber stress, in pounds per square inch;

c = the distance from the neutral axis to the fiber in which s occurs, in inches;

d = the depth of the beam, in inches.

In general this may be expressed by

$$\Delta = C_1 \cdot \frac{sL^2}{Ed} \quad (22)$$

In which Δ , s , L , E , and d are as before, and C_1 is a factor which takes account of the condition of loading, and lack of symmetry when this occurs. This is a very important relation and states that for a given span and condition of loading the deflection varies directly as the fiber stress and inversely as the depth.

$$\text{If } k = \frac{\Delta}{L}, \quad k = C_1 \frac{sL}{Ed}$$

For a uniformly loaded beam $C_1 = 10/48$, and when, for a stress of 16,000 lb. per sq. in., d/L is fixed at:

$$\frac{1}{15}, \quad k = \frac{10}{48} \times \frac{16}{30,000} \times 15 = \frac{1}{600}$$

$$\frac{1}{20}, \quad k = \frac{10}{48} \times \frac{16}{30,000} \times 20 = \frac{1}{450}$$

$$\frac{1}{25}, \quad k = \frac{10}{48} \times \frac{16}{30,000} \times 25 = \frac{1}{360}$$

If the unit stress is 18,000 lb. per sq. in. these become for

$$\frac{d}{L} = \frac{1}{15}, \quad k = \frac{18}{16} \times \frac{1}{600} = \frac{3}{1600}$$

$$\frac{d}{L} = \frac{1}{20}, \quad k = \frac{18}{16} \times \frac{1}{450} = \frac{1}{400}$$

$$\frac{d}{L} = \frac{1}{25}, \quad k = \frac{18}{16} \times \frac{1}{360} = \frac{1}{320}$$

Specifications for design often require that when a beam depth less than a certain limiting fraction of the span must be used the extreme fiber stress must be so modified that the deflection will not be more than would occur if a beam of the limiting depth, working at the usual fiber stress, had been used.

For example, given a basic unit stress of 18,000 lb. per sq. in. and a d/L limit of $1/25$, assume that a beam 12 in. deep must be used on span of 30 ft.

$$\frac{30 \times 12}{25} = 14.4 \text{ in.}$$

and the stress used in design must be

$$\frac{12}{14.4} \times 18,000 = 15,000 \text{ lb. per sq. in.}$$

Many instances occur in design in which deflection may be an important factor. In Fig. 63 is shown a combination of two beams of different

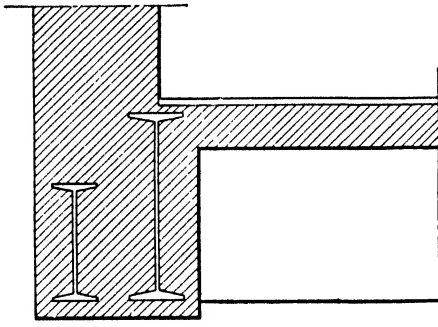

FIG. 63.

depths serving as a spandrel girder in the wall of a building. Such combinations are often seen, and the beams are sometimes designed separately at the basic unit stress. It seems obvious that these beams must have equal deflection, unless relative movement inside the wall is to take place. If the beams are to act together they must be designed to work at unit stresses proportional to their depths. Another way of

saying the same thing is that they must partition the total load in proportion to their respective moments of inertia. This may be expressed mathematically as follows:

- W = total load to be carried;
- W_1 = part of load carried by beam 1;
- W_2 = part of load carried by beam 2;
- I_1 = moment of inertia of beam 1;
- I_2 = moment of inertia of beam 2.

$$W_1 = \frac{I_1}{I_2} \cdot W_2 = \frac{I_1}{(I_1 + I_2)} W \quad (23)$$

PLATE GIRDERS

49. Design Assumptions.—Plate girders are ordinarily designed by a method based on the following assumptions:

1. The shear is carried entirely by the web and is uniformly distributed over it.

2. The intensity of stress in the flange (flange angles and plates) is uniform across the flange section, and the intensity of stress in the web varies as the distance from the neutral axis, the intensity on its extreme fiber being equal to the intensity of the flange stress.

50. Basis of First Assumption.—Figure 64 shows in full lines the variation in intensity of shear across a plate girder section as computed by VQ/It , and in dotted lines the distribution generally assumed. As shown by the diagram the intensity of shear is fairly uniform over the greater portion of the depth, and evidently most of the shear is carried

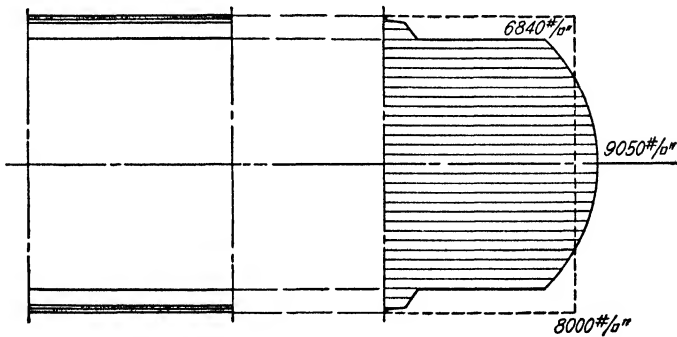

FIG. 64.

by the web. For the girder shown, about 93 per cent of the total shear is carried by the web, and the intensity of shear, assuming it to be uniformly distributed, is 8000 lb. per sq. in., while the intensity of shear at the neutral axis as computed from VQ/It is 9050 lb. per sq. in. Design specifications recognize that the *average* shear is less than the maximum by setting the permissible average shear at a lower figure than the maximum safe intensity.

51. Basis of Second Assumption.—The second assumption is made because it is convenient to consider the entire flange stress as acting at the center of gravity of the flange area. Evidently if the stress were uniformly distributed the center of gravity of the total stress and the center of gravity of the area on which it acts would coincide. Figure 65 shows the variation in stress intensity across two girders, one deep and the other shallow. If the extreme fiber stress is the same for each it is

obvious by inspection that the assumption of uniform distribution across the flange though approximately true for the deep girder becomes considerably in error for the shallow one. For very shallow girders the method of design under discussion results in a section which is too light, and should be modified or some other method used.

52. Design of Web.—The design of the web is fairly obvious from the first assumption given above.

If V = the maximum shear;
 v = the allowable intensity of shear;
 A_w = the area of the web;

then

$$A_w = \frac{V}{v} \quad (24)$$

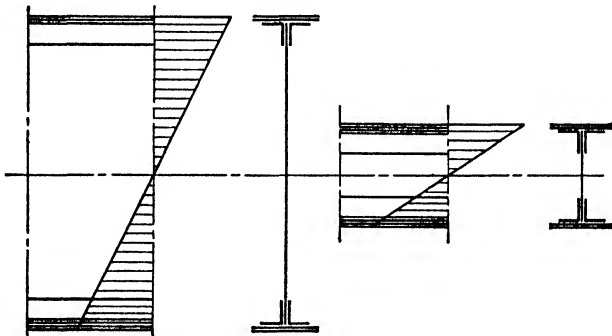

FIG. 65.

The student should note particularly that the area thus found is a *minimum* value; the web must have at least that much area. As a matter of fact the area of the web is more commonly determined by the limits placed on its thickness by what is considered good practice and the limits placed on the depth of the girder by regard for economy. These matters will be discussed later. It should also be noted that the area determined may be net area or gross area depending on whether v is given as the allowable intensity on net area or gross area.

53. Approximate Method of Flange Design.—Figure 66 (a) shows the intensity of stress across the section of a plate girder in accordance with the second assumption. Figures 66 (b) and 66 (c) show the distribution across the flange and web separately.

Adopting the notation shown in the figure,

s = the intensity of stress in the flange;
 A = the area of the flange (flange angles and flange plates of any kind);

- d = the distance between the centers of gravity of the flanges; called the "effective depth";
- d_1 = the overall depth of the web;
- t = the thickness of the web;
- A_w = the area of the web = td_1 ;
- T = the total tension in the tension flange;
- C = the total compression in the compression flange;
- T_w = the total tension in the web below the neutral axis;
- C_w = the total compression in the web above the neutral axis;
- M = the moment of resistance of the girder;
- M_f = the moment of resistance of the flanges;
- M_w = the moment of resistance of the web.

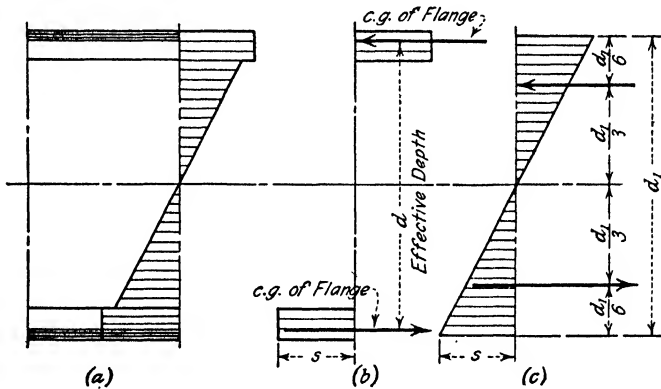

FIG. 66.

Assuming for the present that there are no holes in either flanges or web we may write

$$\begin{aligned}
 T &= C = sA \\
 T_w &= C_w = \frac{s}{2} \times \frac{d_1}{2} \times t = \frac{1}{4}sd_1t \\
 M_f &= Td = Cd = sAd \\
 M_w &= T_w \frac{2}{3}d_1 = C_w \frac{2}{3}d_1 = \frac{1}{6}sA_wd_1 \\
 M &= M_f + M_w = sAd + \frac{1}{6}sA_wd_1
 \end{aligned}$$

In the actual girder (unless welded) there are rivet holes for connecting the flange angles to the web, the flange plates to the angles, and stiffener angles and splice plates to the web. In design these holes should be taken into account. To do so it is necessary to deal with the *net* area of the tension flange, i.e., the area of the flange material minus the area cut out by rivet holes on any section. It is also necessary to

remember that there are holes in the web and we must use instead of the entire web area a fractional part depending on how many holes have been taken out. Web holes for stiffeners, etc., are for all practical purposes uniformly spaced throughout the depth. If the holes are 1 in. in diameter, and if they are on 4-in. centers, the available web area is $\frac{3}{4}$ of the gross, if on 5-in. centers $\frac{4}{5}$ of the gross, if on 3-in. centers $\frac{2}{3}$ of the gross, and so on. For ordinary girders 4-in. spacing is about average and is usually assumed in computations.

In what follows it will be assumed that holes on the tension side do not affect appreciably the center of gravity of the tensile forces, and also that the position of the neutral axis is not affected by such holes. The latter point was mentioned briefly in discussing the design of I beams with holes in one flange only. There are, of course, holes in the compression side of the girder, but it is generally assumed that the rivets so completely fill the holes that the entire compression area is available.

Supplementing the notation given above, let

A_n = net flange area;

A = gross flange area as before;

s_1 = intensity of stress on net flange area;

s = intensity of stress on gross flange area as before.

Then, assuming 4-in. spacing of vertical web rivets:

$$T = s_1 A_n = C = sA$$

$$T_w = \frac{s_1}{2} \times \frac{d_1}{2} \times t \times \frac{3}{4} = \frac{3}{16} s_1 d_1 t = C_w = \frac{s}{2} \times \frac{d_1}{2} \times t = \frac{1}{4} s d_1 t$$

$$M_f = Td = s_1 A_n d = Cd = sAd$$

$$M_w = T_w \frac{2}{3} d_1 = \frac{3}{16} s_1 d_1 t \frac{2}{3} d_1 = \frac{1}{8} s_1 d_1 t d_1 = \frac{1}{8} s_1 A_w d_1$$

$$= C_w \frac{2}{3} d_1 = \frac{1}{4} s d_1 t \frac{2}{3} d_1 = \frac{1}{6} s d_1 t d_1 = \frac{1}{6} s A_w d_1$$

$$M = M_f + M_w = s_1 A_n d + \frac{1}{8} s_1 A_w d_1 = sAd + \frac{1}{6} s A_w d_1$$

In girders in which the approximate method of design is sufficiently accurate d_1 may be taken as equal to d without material error. Making this substitution we have:

$$M = s_1 A_n d + \frac{1}{8} s_1 A_w d \quad (25)$$

$$= sAd + \frac{1}{6} s A_w d \quad (26)$$

From (25)

$$A_n = \frac{M}{s_1 d} - \frac{1}{8} A_w \quad (27)$$

and from (26)

$$A = \frac{M}{s d} - \frac{1}{6} A_w \quad (28)$$

Evidently we may say from (27) that $1/8$ * of the gross area of the web may be considered as flange area and write

$$A_n + \frac{1}{8} A_w = \text{total net flange area} = A_T$$

and

$$A_T = \frac{M}{s_1 d} \quad (29)$$

Similarly from (28), if $A_G =$ total gross flange area:

$$A + \frac{1}{6} A_w = \frac{M}{sd}$$

and

$$A_G = \frac{M}{sd} \quad (30)$$

* The student should see clearly, and remember, that the use of $1/8$ of the gross area of the web as net flange area involves the assumption of rivet holes 1 in. in diameter spaced uniformly 4 in. center to center throughout the depth of the web. Actually the rivet holes may be more or less than 1 in. in diameter, and they may be spaced more or less than 4 in. center to center. Consequently it is desirable to study the effect of such differences on the fraction of the gross web area which may properly be considered as flange area. It has already been shown that an unpunched web is equivalent (in resisting moment) to $1/6$ of its area concentrated at the center of gravity of the flange, and if, as is assumed, the holes do not affect appreciably the center of gravity of the tensile forces it should be clear, as indicated in the development of (25), that $1/6$ of the net area of the punched web may be considered as net flange area. Using the notation already stated, and also the following:

n = the number of rivet holes in the web

p = the pitch of the holes in the web (assumed to be uniform)

A_{wn} = the net area of the web

A_w = the gross area of the web

h = the diameter of the rivet hole in inches

then

$$A_w = td_1$$

$$A_{wn} = td_1 - nth$$

$$n = \frac{d_1}{p} \text{ very nearly}$$

and

$$A_{wn} = td_1 - \frac{d_1}{p} th$$

$$= (1 - h/p)td_1$$

$$= (1 - h/p)A_w$$

Therefore the fraction of the gross web area which may be considered as flange area is

$$\frac{1}{6} \left(1 - \frac{h}{p} \right) A_w$$

Study of this factor will show that $1/8$ is a fair approximation for most cases.

In most cases the design of a girder is made with reference to the tension flange, i.e., the total net area of the tension flange is determined from (29), the flange proportioned, and the compression flange made like it. Sometimes, however, it is necessary to limit the intensity of stress in the compression flange because of lack of lateral support, in which case it may have to be different from the tension flange and may be proportioned to include $1/6$ of the gross area of the web, as indicated by expression (30). Many designers prefer to use $1/8$ whether dealing with the tension flange or compression flange. Girders which have a compression flange different from the tension flange will be considered further in another place.

54. Summary.—We may now summarize the steps to be taken in the determination of the cross-section of a girder by the method just discussed. It is assumed that the maximum shear and maximum moment have been computed.

1. Assume the girder depth.
2. Select the web.
3. Estimate the effective depth and determine the required flange area.
4. Proportion the flange.
5. Check the effective depth and revise the area if necessary.

The usual range of girder depths, limits on web thickness, range of effective depth, and restrictions on flange proportions will now be discussed.

55. Girder Depth.—Long experience has shown that the most economical depth for ordinary girders varies from about $1/8$ to $1/14$ of the span length. The greater depths are used for girders carrying heavy loads, particularly large concentrated loads, and the shallower depths for girders carrying rather light uniformly distributed loads. Average values are about $1/10$ the span for bridge girders and about $1/12$ the span for building girders. Frequently architectural considerations, limited headroom, or other local peculiarities require depths which vary considerably one way or the other from the depth which would give the greatest economy of material. As will be seen later certain types of girders carrying very heavy concentrated loads (fixed or moving) require depths considerably greater than the range given above.

It is a simple matter to develop formulas for the least weight depth of a girder based on the moment, permissible intensity of stress, web thickness, etc. Some factors which are difficult to express mathematically are involved, and the result is sometimes of doubtful value. However, if used with discretion such formulas are often helpful and will

be fully discussed later. As a matter of fact, a considerable change in depth has comparatively little effect on the total weight of a girder, and for ordinary work the range of depths given above can be used with satisfactory results. When many girders of the same length, subject to the same loads, are to be built, comparative designs furnish the best criterion of economy.

56. Web Thickness.—The depth of the girder having been determined, the *minimum* web thickness is fixed by the area required to resist the maximum shear. As already indicated its thickness is more likely to be determined by the application of limits given in the specifications for design. The web of a girder should never have a thickness less than 1/4 in. and preferably not less than 5/16 in. Many specifications make 3/8 in. the minimum thickness, and some 1/2 in. The web thickness is also generally limited to a certain fraction of the “clear depth” or unsupported depth of the web, i.e., the distance between the inside edges of the flange angles, or side plates if they are used. The most common fraction is 1/160, but 1/200 is given in some specifications. The 1931 “General Specifications for Steel Railway Bridges” of the American Railway Engineering Association limits the web thickness to $1/20\sqrt{D}$ where D is the distance between the flanges in inches. This would allow a 1/2-in. web for a girder 10 ft. deep which is a limit of 1/209. Many girders have been built with 120 in. by 1/2 in. webs and so far as the writer knows have given satisfaction. Most fabricators of structural steel prefer the 1/160 limit, as wide thin webs tend to buckle and are hard to handle in the shop. The approved 1935 A.R.E.A. “Specifications for Steel Railway Bridges” adopted a limit of 1/170.

57. Effective Depth.—After the web depth has been selected it is easy to estimate the effective depth. If no cover plates are to be used the effective depth is the distance between the centers of gravity of the flange angles, and a little study of the properties of angles will indicate that it will usually lie between 2 in. and 4 in. less than the distance back to back of angles. If cover plates are to be used, inspection of the table on page 420 will indicate that the effective depth will usually lie between the distance back to back of angles and a distance about 2 in. less.

The distance back to back of angles is generally made from 1/4 in. to 1/2 in. more than the depth of the web. The reason is that web plates seldom have straight, smooth edges and an attempt to keep the angles flush with the edges of the web will result in projections which must be chipped off. Two exceptions sometimes made will be mentioned later.

58. Flange Proportioning.—The proportioning of the flange section merely requires selecting angles and plates which will give the necessary area, but some specifications place restrictions on the relation between the areas of angles and plates and these must also be complied with. Many of the older design specifications required that a certain definite part of the flange area must be in the angles, the amount varying from 40 to 60 per cent. Current practice is to require that the center of gravity of the flange be kept within the back of the angles: to meet this requirement it is necessary that about $1/3$ of the total flange area be in the flange angles, or about $4/10$ of the flange area excluding the portion of the web available. No infallible rule can be laid down, and these proportions are approximate.

It is not considered good practice in proportioning flanges to use any cover plate thicker than the angles. In general it is better to have plates of equal thicknesses, but when they are different it is usual to place the thickest plate next to the angles and put on the others in order of decreasing thickness. The A.R.E.A. specifications, referred to under "Web Thickness," make this a definite requirement.

When areas are required that would make it impossible to keep the center of gravity inside the back of the angles, even with the largest angles available, side plates are resorted to as shown at (b) in Fig. 2. If used, side plates should be at least 3 in. wider than the leg of the flange angles against the web to permit placing a line of rivets below the angles; often they are made wide enough to secure two lines of rivets below the angles.

59. Net Section.—The number of rivet holes to be deducted in determining net section depends on the size of the angles and on the pitch, and also on whether cover plates are used or not.

If there are no cover plates one hole from each angle should be a sufficient deduction, unless 8-in. legs are used against the web with very close pitch, when it may be necessary to deduct two holes from each angle. If cover plates are used it is necessary to deduct two holes from each cover plate and two from each angle; if 8-in. legs are used against the web it may be necessary to deduct three holes from each angle. It is sometimes necessary to take three or more holes from each cover plate when they are wide and close rivet pitch is required. There are numerous rules regarding the stagger of rivets on different lines necessary to maintain net sections, and the student should study the specifications used to be sure that the requirements are met. The matter of maintaining net sections will be more fully discussed elsewhere.

In computing net section it is universal practice, so far as the writer knows, to consider that all rivet holes have a diameter $1/8$ in. larger

than the nominal diameter of the rivet, i.e., if 3/4-in. rivets are used 7/8-in. holes are assumed in computation; if 7/8-in. rivets, 1-in. holes. The actual hole is punched, reamed, or drilled 1/16 in. larger in diameter than the rivet, but the process results in minute cracks and scratches around the edge, and the use in computations of a larger hole is an attempt to allow for this injury to the metal. Furthermore, in assembling the various parts in the shop mismatched holes must be corrected by reaming to allow the rivets to be entered. The reaming tool used is 1/16 in. larger than the rivet but sometimes it is impossible to avoid enlarging a hole more than 1/16 in. If the mismatch is lateral, i.e., at right angles to the line of stress, the reduction in area may be considerable; Fig. 67 illustrates the point. There is a growing tendency to require that main material in structures be "sub-punched and reamed," which means that all holes are punched smaller than the finished size (usually 1/4 in.) and reamed to size after the various parts have been assembled and bolted up.

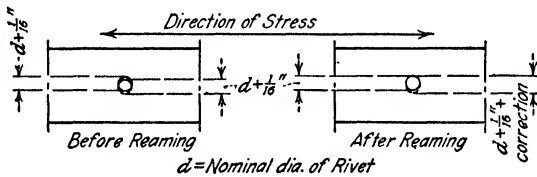

FIG. 67.

60. Illustrative Example.—The calculations on Sheet 1, DP8, illustrate the application of the approximate method of design, just discussed, to the determination of the maximum section of a typical plate girder. The student should make sure that he thoroughly understands the procedure. In these calculations are shown some steps which the experienced designer makes mentally or by slide rule and does not show on his design sheet. For example, the statements of the assumed web depth of 50 in. (1/12 of span), the assumed effective depth of $49\frac{3}{4}$ in. = 4.14 ft., and the minimum web thickness of $(50\frac{1}{2} - 12)/160 = 0.241$ in. generally would not appear on the design sheet. The web depth is given in the statement of the section to be used, the assumed effective depth is indicated by the division of the moment by a quantity which must necessarily be the assumed effective depth, and the investigation of minimum web thickness permissible generally would be made as a slide-rule computation with the result merely given (if controlling) by the statement of web thickness to be used. The check on effective depth should be made, but usually it would not appear on the designer's calculation sheet, since if he is experienced his first estimate will be

sufficiently accurate in the ordinary case, and if it is an unusual girder he will make sure by means of a trial section that his estimate is within reasonable limits before proceeding. The designer should keep all the calculations made for a design until certain that there will be no further use for them, but the various trial sections and trial calculations need not appear on the final design sheets.

There are many steps in the complete design of a girder which do not appear on the sheet under discussion—the purpose here is merely to illustrate the design of the main section.

61. Details of Design.—The main section of the girder having been determined, a number of detail matters must be considered, such as length of cover plates, web stiffeners, rivet pitch, and web and flange splices, if the latter are required. These will be taken up in order.

62. Length of Cover Plates.—Since the bending moment generally varies from a maximum at or near the center, to zero at the ends, it is evident that the section designed to resist the maximum moment is not required throughout the length of the girder. It is usual to take advantage of this fact and cut off cover plates at points where their area is not required, in order to save material.

The length computed by any one of the methods given below is called the “theoretical length,” because it is the distance between the points at which the cover plate in question should begin to take stress. In order to be certain that the plate is taking stress at the points where it begins to be needed it is carried beyond a short distance and connected to the flange with several rivets between the theoretical ends and the actual ends. It used to be common practice to require that a cover plate be fully developed at the points where it is first needed. Present practice is to require that from 9 in. to 2 ft. be added on each end with as many rivets put between the actual ends and the theoretical ends as can be at the regular rivet pitch, i.e., the rivet spacing is not decreased at the end of a cover as used to be common. A requirement typical of recent practice is that given in Art. 325 of the “Final Report on Specifications for Design and Construction of Steel Railway Bridge Superstructure,” *Transactions* of the American Society of Civil Engineers, Vol. 86, page 482, which states in part: “Any additional flange plates shall be of such length as to allow two rows of rivets of the regular pitch to be placed at each end of the plate, beyond the theoretical point required, and there shall be a sufficient number of rivets at the ends of each plate to transmit its stress value before the theoretical point of the next outside plate is reached.” *

* The increase in length of cover plates beyond the theoretical length provided by these arbitrary rules is satisfactory from the standpoint of practical design, but

Design of Girder G4

Span 50'-0" c. to c. Bgs. (Top flange has lateral support)

Moment

$$\frac{6.8}{8} \times 50^2 = 2130^k$$

$$+ 4.14' = 514^k \text{ Flg. Str.}$$

$$@ 18 = 28.55^{in} \text{ Net Area}$$

Shear

$$6.8 \times \frac{50}{2} = 170^k$$

$$@ 12 = 14.2^{in} \text{ gross}$$

Rivets $\frac{3}{4} \phi$

Girder Section

| | | | | |
|---------------|-----------------------|------------------------------|---------------|-------------------------|
| 1-Web | 50 x $\frac{5}{16}$ | = 15.63 ⁱⁿ gr. | $\frac{1}{8}$ | = 1.95 |
| 2- Bott. Ls | 6 x 6 x $\frac{5}{8}$ | = 14.22 ⁱⁿ - 2.19 | | = 12.03 |
| 1- Bott. Cov. | 14 x $\frac{5}{8}$ | = 8.75 - 1.09 | | = 7.66 |
| 1- " " | 14 x $\frac{9}{16}$ | = 7.88 - .98 | | = 6.90 |
| | | | | 28.54 ⁱⁿ net |

Assume 50" web ($\frac{1}{2}$ of span)
 Assume $d = 49\frac{3}{4} = 4.14'$
 Min. web thickness $\frac{(50\frac{1}{2} - 12)}{160} = .241"$

DP 8

Girder G4

| | |
|--------------|--------|
| 1932 | T.C.S. |
| Sheet 1 of 1 | |

A.I.S.C. Specs.
 External Load 6500#/ft
 Girder Wt. $\frac{300}{8800\#/ft}$
 Total

Check on Effective Depth

| |
|--|
| $14.22 \times 1.73 = 24.60$ |
| $\frac{16.63 \times .594 = 9.88}{30.85}$ |
| $\frac{14.72}{.48}$ |
| $\times 2 = \frac{50.50}{.96}$ |
| $49.54 = 4.13'$ |

63. Length Determined from Parabola.—When the load is uniform so that the moment curve is a parabola the simplest method of determining the proper length of cover plates is to make use of the well-known properties of the parabola. Figure 68 shows a parabola, assumed to represent a moment curve, and a flange section required to

in some cases may not be entirely consistent with methods sometimes employed for computing the pitch of the flange rivets. As will be pointed out later, it is usual to assume, in computing rivet pitch, that the *change* in flange stress is divided among the component parts of the flange in proportion to their areas. Careful study of the discussion of flange rivet pitch (Art. 71) will show that in order to be consistent with the assumption a cover plate should be resisting at its theoretical end a part of the total flange stress at that point which is proportional to its area as compared with the total flange area at that point. That is, the cover plate should extend far enough beyond its theoretical end, and have enough rivets between its theoretical and actual ends, so that at the theoretical end it will have an intensity of stress equal to that in the rest of the flange section at that point. The number of rivets required to meet this condition may be found as follows:

- n = number of rivets required;
 A_C = net area of cover plate in question;
 A_T = total net flange area (at the theoretical end of cover plate) including $1/8$ of the web but *not* including the cover plate in question;
 R = the rivet value;
 s_1 = the maximum permissible intensity of stress on the net area.

Then

$A_T s_1$ = total flange stress at the theoretical end of the cover in question;

$\frac{A_T s_1}{(A_T + A_C)}$ = intensity of flange stress at the section if the cover is taking its share of the total stress;

$\frac{A_T s_1}{(A_T + A_C)} \cdot A_C$ = total stress in the cover if it is taking its share of the total flange stress at the section;

and the number of rivets required to develop this total stress in the cover is:

$$n = \frac{A_T}{(A_T + A_C)} \cdot \frac{A_C s_1}{R}$$

Since the quantity $s_1 A_C / R$ is the number of rivets necessary to develop the full capacity of the cover plate, evidently we may say that, in accordance with the reasoning presented in this footnote, we should provide between the theoretical and actual ends of a cover plate a number of rivets equal to that required to fully develop the plate multiplied by the ratio of the total flange area at the theoretical end excluding the cover plate to the total flange area (at that point) including the cover plate. This is generally a considerably larger number of rivets than will result from compliance with the rule cited in Art. 62.

resist the maximum moment. It is evident from (29) and (30), Art. (53), that the flange area varies directly as the moment and consequently the moment curve may also represent a required flange area curve, the maximum ordinate of the moment curve being equal (to some scale) to the flange area at the center, and any other ordinate representing the area required at the ordinate. To find the necessary length of any cover then it is only necessary to find the points at which ordinates to the curve are equal to the flange area *without* the cover in question and without any covers above it. The distance between these ordinates is the required theoretical length of the cover plate in question. In Fig. 68 the following notation is used:

- L_n = the necessary theoretical length of the cover in question;
- a = the area of the cover in question plus all covers above it;
- A_T = the total flange area including 1/8 the web;
- L = the length of the span.

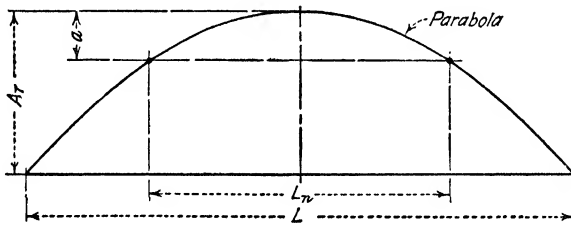

FIG. 68.

Then from the properties of the parabola

$$L_n = L\sqrt{\frac{a}{A_T}} \tag{31}$$

The areas may be net areas for the tension flange and gross areas for the compression flange. The difference in length obtained by the use of net or gross area is small, and general practice is to determine the lengths of the plates on the tension flange and make those on the compression flange the same.

Using the above method the cover plate lengths for the girder discussed in Art. 60, if the 5/8-in. cover is placed next the angles, would be.

- Top cover or 9/16, $L = 50\sqrt{6.90/28.54} = 24.5$ ft.
- Bottom cover or 5/8, $L = 50\sqrt{14.56/28.54} = 35.6$ ft.

The student should see clearly that this method of determining the cover plate lengths assumes:

1. That the total area A_T in the flange is exactly that required from $A_T = M/(s_1d)$.
2. That the effective depth is constant throughout the length of the girder.

If the area provided is greater than is required the plates will be longer than is necessary, by this method, and shorter if the area is deficient. If desired it is easy to modify the method to include the effect of over or under proportioning. The error is immaterial if the area provided is in reasonable agreement with that required, and is usually, if not always,

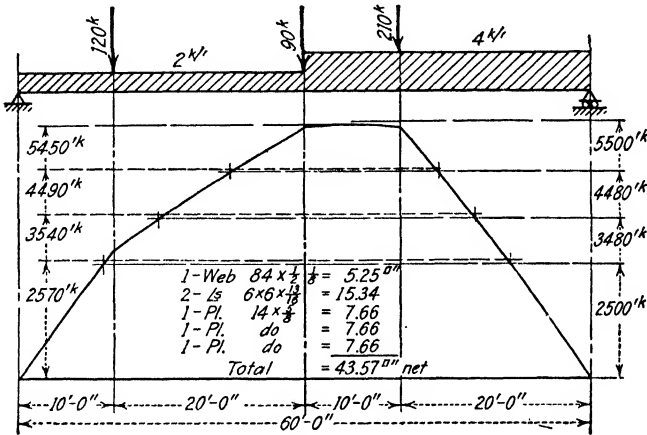

FIG. 69.

neglected. The error involved in the second assumption results in the computed lengths being too short. It is easy to make a correction but the error is small and generally neglected.

64. Graphical Determination of Length.—The theoretical lengths of cover plates may be determined graphically by drawing the moment diagram to scale, and plotting on its maximum ordinate (to the same scale) the moments which the girder can resist with angles and web alone; angles, web, and one cover plate; angles, web, and two cover plates, and so on. Horizontal lines drawn through the plotted moments of resistance intersect the moment curve at points where the material, not included in the moment of resistance in question, can be dispensed with. Figure 69 shows the application of this method to a specific case. The graphical method is perfectly general and may be applied

to any girder under any conditions of loading. It is often the most convenient solution for girders with unsymmetrical and complicated loading. The effect of over or under proportioning and variation in effective depth are automatically provided for when the method is used as described above.

The use of this method may be, and frequently is, considerably shortened by omitting the computation of the actual moments of resistance, and laying off on the maximum ordinate of the moment curve the areas of the flange material to such a scale that the maximum ordinate represents the total flange area. Horizontal lines drawn through the ordinates representing the various areas determine the necessary lengths as before. The dotted lines in Fig. 69 show this abridgment applied to that case. This shortened procedure is evidently subject to the same approximations introduced in determining lengths from the properties of the parabola, and the statements made regarding the errors involved apply here.

65. Algebraic Determination of Length.—An algebraic solution of necessary cover plate length may be obtained by writing the equation of the moment curve in terms of the known loads and reactions and the unknown distance from one end of the girder to the corresponding end of the cover plate the length of which is to be determined; this expression is placed equal to the computed moment of resistance of the girder without the cover plate in question or any of the plates outside of it. The only unknown is the distance from the end of the girder to the end of the cover plate, which may be found by solving the equation. Although available whenever the curve of moments can be expressed as an algebraic function the method is apt to be long and tedious and is not often used. The principal difficulties are: (1) whenever the moment curve is unsymmetrical about the center line two equations must be solved for each cover plate, and (2) when concentrated loads are involved the equation of the moment curve changes at each load and unless it can be seen by inspection about where the cover ends it may be necessary to make two or more trials to find the equation which is applicable.

66. Web Stiffeners.—Unlike the normal I beam, which has a web so thick that diagonal buckling is rarely a factor, the normal plate girder has a web so thin that diagonal buckling must always be considered and guarded against. It is sometimes economical to design a girder with an abnormally thick web in order to avoid the rather expensive additional shop work necessary when stiffeners are used.

Stiffeners are of two kinds: bearing or load stiffeners, the function of which is to distribute concentrated loads to the web; and intermediate stiffeners, the function of which is to prevent buckling or

wrinkling of the web. Figure 70 is a sketch of a plate girder showing the kinds of stiffeners. Those marked *A* and *B* are bearing stiffeners; those at *A* are designed to distribute the reaction (end shear) to the web, and those at *B* are designed to distribute to the web the load from the column resting on the top flange. The stiffeners marked *C* are intermediate. The end stiffeners marked *D* are not bearing stiffeners, but are in a sense load stiffeners. Their primary function is to connect the girder to the column and transfer its end reaction (end shear) to the column. They also serve to stiffen the web and prevent buckling at the end. They are generally called **connection angles**.

Stiffeners are fastened to the girder over the flange angles which evidently leaves a gap between the back of the stiffener angle and the web, this gap being equal to the thickness of the flange angle. A plate called a **filler** may be used to fill this gap, or the stiffener angle may be bent in against the web; in the latter event the stiffener is called a

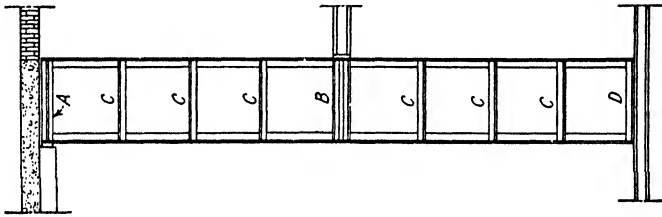

FIG. 70.

crimped stiffener. Intermediate stiffeners may be crimped or on fillers, whichever is the more economical, but bearing stiffeners should never be crimped, because of their column action. Stiffeners which have holes in their outstanding legs for the connection of beams, bracing, girders, or other framing members, should preferably not be crimped. A filler used back of a stiffener angle is said to be a **loose filler** or a **tight filler** depending on whether it is just as wide as the leg of the stiffener which bears against it, or whether it is wider than the stiffener to allow it to be connected directly to the web with one or more lines of rivets outside of those connecting the stiffener angle to the web. Figure 71 illustrates loose and tight fillers.

67. Design of Bearing Stiffeners.—Figure 72 shows a part section through the girder of Fig. 70 looking towards the wall and showing the bottom of the end stiffeners. It will be seen that the only way in which the end stiffeners can deliver their load to the wall on which the end of the girder rests is through bearing of the outstanding legs of the stiffener angles on the horizontal legs of the flange angles; these rest on the sole

or wall plate which in turn rests on and distributes the load over the wall. Evidently the outstanding legs of the stiffener angles must have sufficient area to keep them from crushing under the load they transmit, and their size is generally determined by this requirement. The entire area of the outstanding leg is not available as bearing area, as is shown in Fig. 72. The stiffener angle cannot be counted on to bear tightly against the fillet in the corner of the flange angle, in fact it is frequently ground off flat to clear this fillet entirely. The area available in one angle is the product of its thickness and the width of that part which is bearing against the flat part of the horizontal leg of the flange angle. This bearing width is generally the width of the outstanding stiffener leg minus the radius of the fillet in the corner of the flange angle. The fillet radius varies according to the size of the angle and the manufacturer, but may be safely taken as 5/8 in. for 8-in. angles, 1/2 in. for 5-in. or 6-in. angles, and 3/8 in. for smaller sizes.

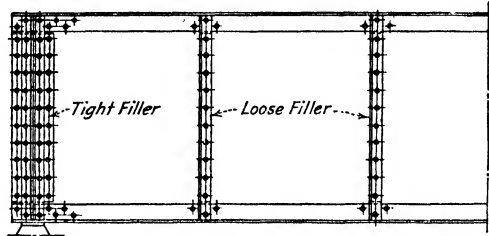

FIG. 71.

The end stiffeners act somewhat as a column, different from the ordinary column in that they have full load at one end and no load at the other, picking up their load gradually from one end to the other instead of being subjected to the full load throughout their length. Some design specifications require that end stiffeners be investigated as a column tending to buckle about an axis in the girder web; in deep

girders with light loads the size of end stiffeners may be determined by such an analysis. Because of the fact that the load is gradually applied the length used in the column formula is generally taken as one-half the actual length of the stiffeners.

Bearing stiffeners should have outstanding legs as wide as the flange angles will permit in order to distribute the load as much as possible and reduce the tendency of the flange angles to curl under the

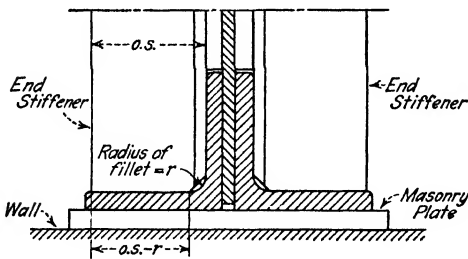

FIG. 72.

applied load. Evidently there is no advantage in having the outstanding legs project beyond the edge of the flange angles, unless additional stiffness as a column is necessary about the axis parallel to the web.

68. Riveting of Bearing Stiffeners.—Rivets connecting a pair of bearing stiffeners to the web of a girder are in bearing against the web and in shear on each side of the web, i.e., in double shear. The load picked up must be distributed to the web without overstressing the rivets in either manner. It is generally assumed that when loose fillers are used the rivets are subjected to considerable bending in addition to the shear and bearing, and it is common to allow for this empirically by increasing the computed number about one-third or one-half. When tight fillers are used they are riveted directly to the web outside of the stiffeners as shown in Fig. 71. There should be at least enough rivets through the fillers to transmit the entire load of the stiffeners to the web without overstressing the rivets in bearing on the web, and enough of the total number of rivets through the fillers should also pass through the stiffener angles to transmit the entire

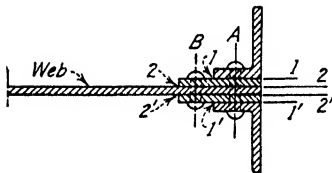

FIG. 73.

stiffener load to the fillers in double shear. Figure 73 will help to make this statement clear. From the figure it is evident that the load from one stiffener must be delivered to the filler on that side through shear on plane 1-1 and the load from the other stiffener to the filler on the other side

through shear on the plane 1'-1', or the entire stiffener load must be delivered to the fillers through double shear by the rivets on the line A. If more rivets are required than can be put in a single line a leg against the web wide enough to accommodate two lines must be used. The entire load from the stiffener has now been transmitted to the fillers, and evidently the filler load on one side must be delivered to the web through shear on plane 2-2 and the filler load on the other side must be delivered to the web through shear on plane 2'-2'. However, if the web thickness is such that the strength of a rivet is less in bearing against it than in double shear the number of rivets to transfer the load in the fillers to the web cannot be determined by double shear on planes 2-2 and 2'-2', but must be determined from the bearing value of the rivet. That is, there must be enough rivets on lines A and B to transfer the entire stiffener load to the web without overstress in bearing. This discussion does not take account of the fact that at least two of the rivets

through the stiffeners, on line *A*, will pass through the flange angles, and that therefore the entire stiffener load will not be delivered to the fillers, but the procedure is sufficiently accurate for design purposes. Nor is account taken of the fact that the stiffener load is delivered to the fillers eccentrically, which must cause an added stress on the outer rivets, if the friction between the parts is broken. It would be easy to calculate the addition to the stress in the rivets but it is not generally done in practical design. When the web is thick enough to make double shear the controlling value about half as many rivets are placed on line *B* as are required on line *A*. The same analysis is evidently applicable to connection angles.

69. Design of Intermediate Stiffeners.—Intermediate stiffeners do not carry load and they are designed by empirical rules. The most common requirement is that their outstanding legs shall have a width not less than $1/30$ of the depth of the girder plus 2 in. The thickness is not to be less than $1/16$ of the width of the outstanding leg, and not less than the minimum metal requirement of the specification used.

70. Spacing of Intermediate Stiffeners.—The primary function of intermediate stiffeners, as already stated, is to prevent the failure of the web by buckling or wrinkling. The tendency to buckle is a result of the diagonal compression which accompanies shear, and the manner of failure is shown in Figs. 74 and 75 taken from Bulletin 86, Engineering Experiment Station, University of Illinois. Figure 74 shows the failure of a web without intermediate stiffeners in the ordinary sense, the stiffeners near the center of the girder being under load points. It is interesting to note that the ridge or trough of a buckle seems to extend approximately from corner to corner of the unsupported rectangle of web. Figure 75 shows the failure of a web with intermediate stiffeners spaced at a distance practically equal to the clear depth of the web, and it is interesting again to note that a trough or ridge of a buckle extends approximately from corner to corner of the unsupported web rectangle. The two girders were exactly alike except for the two pairs of intermediate stiffeners on each side of the center line.

The spacing of intermediate stiffeners has been the subject of considerable study, but only a small amount of experimental work has been done. The general method of attack has been, as in studying I beam webs, to assume a strip of web along a 45° line and apply a column formula. In Fig. 76 are shown dotted strips at *A* and *B*, the strip at *A* having a free length of $\sqrt{2}d_2$, and the strip at *B* having a free length of $\sqrt{2}d_1$. The shorter free length of the strip at *B* is due to the pair of

stiffeners, e , placed at the center. These stiffeners evidently will prevent the web from buckling at right angles to the plane of the paper at the line where they are placed, thus making the free length along a 45° line about one-half what it would be without them. The student should notice that the free length of a 45° strip is limited by the clear depth of the web when the stiffeners are spaced a distance apart equal

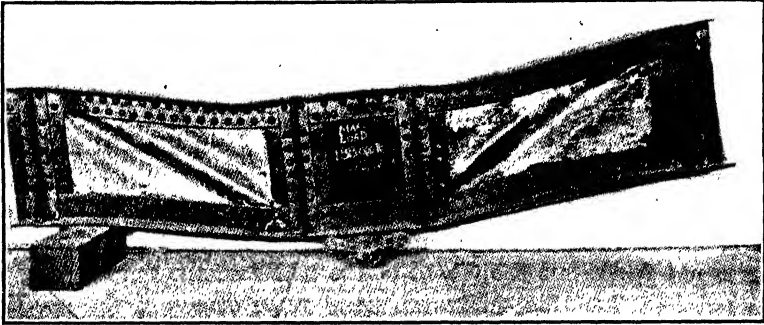

FIG. 74.

to, or greater than, the clear depth, and limited by the spacing of the stiffeners when they are closer together than the clear depth. It is clear that if we apply a column formula to these strips we shall obtain a higher permissible stress for the strip at B than for the strip at A , because of its shorter length. Because of the restraining action of the flanges, stiffeners, and adjacent web, the length used in applying a

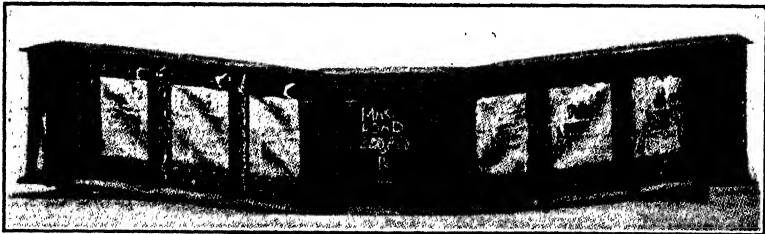

FIG. 75.

column formula should not be the free length shown in the sketch but some fraction of it. The fractional part which should be used is not known; it can be determined only by experiment, and the data from the few tests so far made seem to be insufficient. The formulas which have been developed up to the present time were derived in general by *assuming* a fractional part of the free length. Let ϕ equal a fraction

such that ϕ times the actual free length of the strip is the equivalent length and apply the straight-line formula $s_1 = s - k L/r$ to a 45° strip

$$s_1 = s - \frac{k\sqrt{2}\phi d}{t} = s - k\phi\sqrt{24} \frac{d}{t\sqrt{12}}$$

- where s_1 = the allowable intensity of diagonal compression or shear;
- s = the basic intensity of stress in tension or compression;
- k = a constant;
- ϕ = a fraction defined above;
- t = the web thickness;
- d = the clear distance between the flanges, or between adjacent stiffeners, whichever is the smaller.

The intensity of diagonal compression is equal to the intensity of shear at the neutral axis, and we may write v for s_1 or

$$v = s - k\phi\sqrt{24} \frac{d}{t} \tag{32}$$

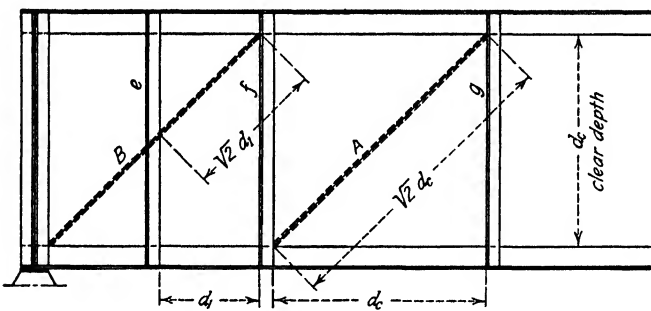

FIG. 76.

which is the basic formula for stiffener spacing rules based on a straight-line column formula. It is a simple matter to apply the same procedure with a second degree column formula. The factor ϕ , as mentioned before, is unknown, and it is evident that since it must be assumed we may obtain practically any result we choose. It is the uncertainty of this factor which leads many engineers to the conclusion that our present knowledge of the action of girder webs is so limited that the use of any formula to determine stiffener spacing is unjustified and misleading. A fact which tends to confirm such an opinion is that many girders, having stiffener spacing considerably in excess of that allowed by any spacing formula in use, have carried loads in excess of

their design loads for a good many years without any sign of web distress.

In the application of a formula such as the above the web thickness and the intensity of shear are generally known and the stiffener spacing, d , is wanted, or

$$d = \frac{t}{k\phi\sqrt{24}} (s - v) \quad (33)$$

which is the form in which such formulas are generally given. If the straight-line formula $16,000 - 70 L/r$ is used and ϕ is assumed as $1/4$, (33) becomes

$$d = \frac{t}{86} (16,000 - v) \quad (34)$$

which gives results in fair agreement with current practice.

A well-known formula for stiffener spacing is that published in the A.R.E.A. "General Specifications for Railway Bridges," Fourth Edition, May, 1931,

$$d = \frac{t}{40} (12,000 - v) \quad (35)$$

A recent formula based on a second degree column formula is that given in the A.I.S.C. "Standard Specification for Structural Steel for Buildings":

$$d = 85t \sqrt{(18,000/v) - 1} \quad (36)$$

As is clear from Fig. 76 stiffeners spaced farther apart than the clear depth of the web have no effect on the free length of a 45° strip. Since the basis of web strengthening with stiffeners is the shortening of the buckling length when the intensity of shear (and therefore the intensity of diagonal compression) is high, it is evident that the clear depth of the web is the limit of spacing which is effective. Many specifications give such a limit, but many designers use the total web depth rather than the clear depth as the upper limit, with a maximum of 6 ft. for girders exceeding that depth.

There have been attempts in recent years to place the spacing of web stiffeners on a more rational basis.* Based on these studies the

* "Problems Concerning Elastic Stability in Structures," S. Timoshenko, *Proceedings Am. Soc. C.E.*, April, 1929. "Stiffener Spacing for Plate-Girder Webs," O. E. Hovey, *Engineering News-Record*, March 12, 1931. "Stability of Plate Girder Webs," S. Timoshenko, presented before Semi-Annual Meeting Am. Soc. C.E. and Am. Soc. M.E., Chicago, June, 1933.

recently revised and adopted specifications of the American Railway Engineering Association require that: *

If the depth of the web between the flanges or side plates of a plate girder exceeds 60 times its thickness, it shall be stiffened by pairs of angles riveted to the web. The spacing of the stiffeners, center to center, shall not exceed 72 in. nor shall the clear spacing be greater than that given by the formula:

$$d = \frac{255,000t}{v} \sqrt[3]{\frac{vt}{a}} \quad (37)$$

d = clear distance between stiffeners, in inches;
 t = thickness of web, in inches;
 a = clear depth between flanges or side plates, in inches;
 v = unit shearing stress, gross section, in web at point considered.

As stated previously the thickness of girder webs is more likely to be fixed by arbitrary limits than by permissible intensity of shear and when this is the case a in (37) may be replaced by

$$a = ft$$

in which f is an arbitrary constant. This stiffener spacing formula then reduces to the following, in which v is in kips per sq. inch

$$d = 2550t \sqrt[3]{\frac{1}{v^2 f}} \quad (38)$$

When $f = 160$, this becomes, nearly:

$$d = 470t \sqrt[3]{\frac{1}{v^2}} \quad (39)$$

and if $f = 170$ as in the proposed A.R.E.A. specifications

$$d = 460t \sqrt[3]{\frac{1}{v^2}} \quad (40)$$

The advanced student will do well to compare the results of these formulas with those from the older types.

71. Rivet Pitch.—Suppose that Fig. 77 represents a short piece of flange cut from a plate girder, the moment at the left side of the section being M and that at the right side M' . The effective depth of the girder is d . Assume first that there are no vertical loads between the two sections. The forces acting on the flange are as shown. There is shear on each side of the section, but in accordance with the fundamental assumption it is considered as resisted entirely by the web. Since C'

* "Specifications for Steel Railway Bridges," *Bulletin* A.R.E.A. February, 1935, Vol. 36, No. 374.

and C are not equal there is a tendency for the flange section to slide along the web, and this tendency must be resisted by the rivets connecting the flange to the web. The magnitude of this tendency is

$$C' - C = \frac{M' - M}{d} = \text{change in flange stress}$$

The change in flange stress per inch, or *rate of change of the flange stress*, is evidently the total change divided by the length over which the change takes place, or

$$\text{Rate of change of flange stress} = \frac{C' - C}{a} = \frac{M' - M}{ad}$$

The quantity $(M' - M)/a$ is evidently the rate of change of the moment, which, the student will recall from mechanics, is the shear.

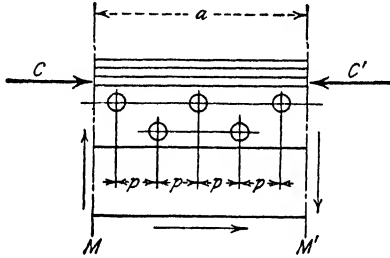

FIG. 77.

$$\therefore \text{Rate of change of flange stress} = \frac{V}{d} = \frac{\text{shear}}{\text{effective depth}}$$

It is assumed that each rivet resists the change in flange stress which develops in the distance between adjacent rivets, that is, in the **pitch** of the rivets. Calling the stress on each rivet R

$$R = \text{rate of change of flange stress} \times \text{the pitch}$$

Or

$$\text{Pitch} = \frac{R}{\text{rate of change of flange stress}}$$

Since the stress on any rivet should not exceed its strength, evidently the quantity R should be the maximum load the rivet can resist, or it is the **rivet value**. Consequently we may write

$$\text{Pitch} = \frac{\text{rivet value}}{\text{rate of change of flange stress}}$$

Using p for pitch, and the other symbols as above

$$p = \frac{R}{V/d} = \frac{Rd}{V} \quad (41)$$

This expression could have been developed easily in two lines but the author considers it very important for the student to fix the physical meaning in mind rather than the formula.

It is assumed above that the entire change in flange stress is resisted by the rivets connecting the flange to the web. This is not true since the web resists moment, and part of the change in total stress between the sections occurs in the web and is resisted by the web in longitudinal shear, and not by the rivets connecting the flange to the web. The above procedure is on the safe side and is commonly used. Sometimes it is desirable to make the pitch as large as possible, in which case account may be taken of the fact that the flange rivets do not resist all the change in stress.* The part of the total flange stress resisted by any component area of the flange is proportional to its area, and similarly the part of the change in stress resisted by any part is proportional to its area. Consequently

Change resisted by flange angles and covers

$$= \text{total change} \times \frac{\text{area of flange angles and covers}}{\text{total flange area (angles, covers, and } \frac{1}{8} \text{ web)}}$$

or

$$\frac{V}{d} \times \frac{A_n}{A_n + \frac{1}{8}A_w}$$

We may then write

$$p = \frac{R}{\frac{V}{d} \times \frac{A_n}{A_n + \frac{1}{8}A_w}} = \frac{Rd}{V} \times \frac{A_n + \frac{1}{8}A_w}{A_n} \quad (42)$$

Strictly speaking, this is for the tension flange only, and for the compression flange we would have

$$p = \frac{Rd}{V} \times \frac{A + \frac{1}{6}A_w}{A} \quad (43)$$

* The student should refer to the footnote on pages 124 and 126 and should see clearly that, unless the cover plates are extended and the ends riveted in accordance with the discussion presented there, it is not correct to assume that the flange rivets do not resist all of the change in flange stress, in girders which have cut-off cover plates, except from the end of the girder to the end of the first cut-off cover plate.

The difference is small, and the pitch is generally kept the same in both flanges for convenience in shop work. It should be noted that A_n and A , as used above, are the net and gross areas of the flange proper *at the point where the pitch is being computed*. They are not the net and gross areas at the point of maximum moment, although frequently taken as such because they are more convenient in calculation and the error is not large.

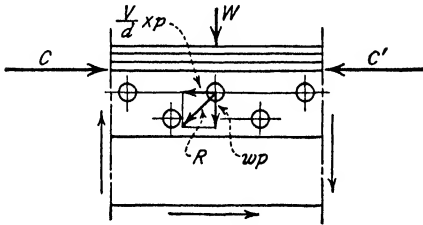

FIG. 78.

If a vertical load is applied directly to the top flange of the girder as in Fig. 78 there is no change in the above reasoning except that in addition to the

horizontal stress on the rivet due to the change in flange stress there is a vertical load. If the vertical load per unit of length is w

$$R = \sqrt{wp^2 + \left(\frac{V}{d}p\right)^2}$$

and

$$p = \frac{R}{\sqrt{w^2 + \left(\frac{V}{d}\right)^2}} \quad (44)$$

As before, this assumes all the change in flange stress to be resisted by the web rivets, and if desired it can be modified to take account of the part of the change resisted by the web, then

$$p = \frac{R}{\sqrt{w^2 + \left(\frac{V}{d} \times \frac{A_n}{A_n + \frac{1}{8}A_w}\right)^2}} \quad (45)$$

The student should notice that w is the vertical load in pounds per inch of length. A concentrated load must be assumed as distributed over some length along the girder. Concentrated loads on the top flange of a girder are very common, and the distances over which they are assumed as distributed have become fairly well standardized. The wheel loads of cranes are generally assumed as distributed uniformly over a length of 24 to 30 in., and the wheel loads from locomotives on the top flange of open deck girder bridges are almost universally assumed as distributed uniformly over three ties.

If the rivets connecting the cover plates to the flange angles are placed opposite those connecting the flange to the web, as is very common, it is unnecessary to investigate the cover plate pitch, as adequate strength will be provided. If the cover plate pitch is made different, as is becoming more and more common, the allowable pitch may need to be computed. It is generally assumed that the distribution of stress across the flange is uniform and that in consequence any component part of the flange resists a part of the change in flange stress which is proportional to its area.*

If A_c = area of cover plates at any section,

A_T = total flange area at the *same* section,

$A_T = A_n + \frac{1}{8}A_w$ where A_n = net area angles and covers at same section,

and the rate of change of flange stress = V/d as before, then the part of the rate of change in flange stress resisted by the cover plates is:

$$\frac{V}{d} \times \frac{A_c}{A_T}$$

and

$$p = \frac{R}{\frac{V}{d} \times \frac{A_c}{A_T}} = \frac{Rd}{V} \times \frac{A_T}{A_c} \quad (46)$$

As stated above, the validity of this formula depends on uniform distribution of the flange stress over all the material at the section in question. The distribution of stress is never exactly uniform, and at the ends of cover plates the assumption must be considerably in error. Consequently the formula must be considered as approximate, at least near the ends of cover plates. It is commonly used, however, when cover plate rivets are spaced differently from those between the flange and web. Regardless of how the pitch is determined, rivets at the end of a cover plate must be stressed considerably more than they are assumed to be. In determining R above, it should be remembered that there are usually two rivets side by side in cover plates, one on each side of the

* The student should refer again to the footnote on pages 124 and 126 (and also that on page 139) and should be sure he clearly understands that unless a cover plate is properly developed at its theoretical end it must resist more of the change in flange stress between its theoretical end and that of the next cover outside than the part proportional to its area. If the cover actually began at its theoretical end it would necessarily resist *all* the change in flange stress between its end and that of the next cover outside. These facts should be kept in mind when designing cover plate riveting.

web, as shown in Fig. 79. R is therefore the value of two rivets in single shear, or bearing on the cover or angles if very thin material is used.

The same general principles may be used in determining the required pitch in girders with side plates. For example, in Fig. 80 there must be rivets enough on lines A , B , and C to resist that part of the change in flange stress which is cared for by the side plates, angles, and cover plates; these rivets are in double shear and bearing on the web, bearing

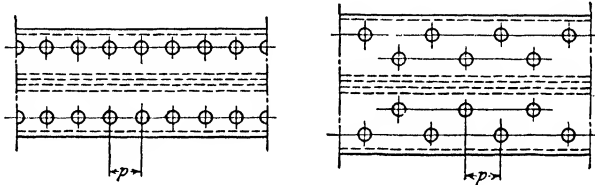

FIG. 79.

on the web probably governing. There must be rivets enough on lines A and B to resist that part of the change in flange stress cared for by the angles and cover plates and these rivets are in bearing on the web plus the side plates and in double shear—double shear being certain to govern. The change in flange stress is allocated to the various parts in accordance with the areas.

72. Web and Flange Splices.—Splices in the web or flanges of a plate girder are avoided whenever possible. They add considerably

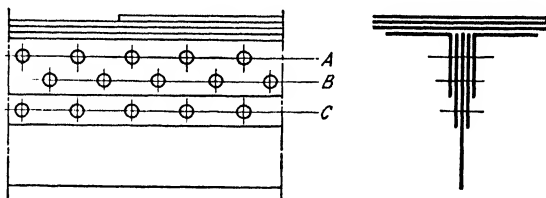

FIG. 80.

to the shop cost and somewhat to the weight. Flange splices are rarely necessary as angles and cover plates may generally be obtained in lengths great enough for all but the largest girders. Girders which are shipped by water may require field splicing of flanges as well as web. Web plates as wide as 96 in. may be obtained in lengths up to 60 ft., but not many mills roll plates of such size and in general a plate girder having a length of 60 ft. or more will require one or more web splices.

WEB SPLICES.—Some design specifications require that a splice must be fully equivalent to the web in both moment and shear acting simultaneously. This is quite severe as the web is rarely subjected to maximum shear at points of splicing. A more common and more reasonable requirement is that the splice be fully equivalent to the web in moment-resisting capacity and able to resist at the same time the maximum shear at the section where spliced. Some engineers require also that the splice be able to resist in shear the maximum capacity of the web, but not at the same time it is resisting maximum moment.

Three types of web spllices in common use are shown in Fig. 81. The splice at (a), type A, may be designed to resist shear only, or shear and moment. It has been much used by designers who ignore the bending strength of the web in designing girders, proportioning the

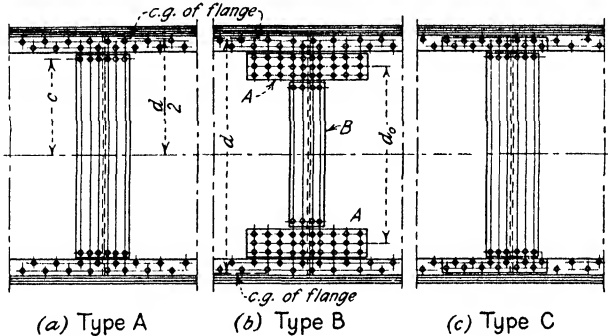

FIG. 81.

flanges to resist all the moment. In such applications it is usually designed to resist shear only, and is often referred to as a **shear splice** even when designed to resist moment as well as shear. The splice shown at (b), type B, has been much used particularly for deep girders. It has undesirable features which become pronounced in shallow girders. It is sometimes referred to as a **moment splice** although it is designed to carry shear also. The splice shown at (c), type C, is generally called a **rational splice**. It is the most satisfactory of the three in common use. The plate shown on the flange may be omitted when there is excess flange area sufficient to replace it or when a cover plate may be extended to serve its purpose. The methods of design of the three types will be briefly discussed.

73. Design of Type A.—The design of this splice is mostly a matter of trial, so far as the number of rivets is concerned. There are two

splice plates, one on each side, and their combined moment of inertia should equal the moment of inertia of the web, or their combined area should equal the area of the web times the square of the ratio of the web depth to the splice plate depth, i.e.,

$$A_s = A_w \left(\frac{h}{h_0} \right)^2 \quad (47)$$

- A_s = splice plate area;
 A_w = web area;
 h = depth of web;
 h_0 = depth of splice plate.

The number of rivets must be assumed, the stress on the outer rivets computed, and the rivet group revised if necessary. There must be several more than the number of rivets required to resist the shear, on each side of the cut.

The shear is assumed to be equally distributed among all the rivets. The stress in the extreme rivet due to bending may be found from

$$S_r = \frac{Mc}{I_r} * \quad (48)$$

where M = the bending moment resisted by the web;

c = the vertical distance from the neutral axis to the rivet in question;

I_r = the moment of inertia of the rivet group about the neutral axis = Σd^2 , d being the vertical distance from the neutral axis to any rivet;

S_r = the stress on the rivet in question due to bending.

The stress on the rivet in question is the resultant of the component due to shear and the component due to bending and of course should not exceed that allowed. It should be kept in mind that the component due to bending must not exceed the allowable rivet value multiplied by the ratio of the vertical distance from the neutral axis to the rivet in question to the distance from the neutral axis to the center of gravity of the flange. If R = the rivet value and R_H = the component due to bending in the extreme rivet in the splice

$$R_H = R \frac{c}{d/2} \quad (49)$$

The student should check the relations given above. The discussion as given is for the case in which moment and shear are resisted.

*** Is this exact? If not why not? If this is not correct what is correct?**

The author does not believe a web splice should be designed under the assumption that it resists shear only.

74. Design of Type B.—In this type of splice there are four **moment plates**, marked *A* in Fig. 81 (*b*), and two **shear plates**, marked *B*. It is assumed that the moment which the uncut web could resist is resisted, at the cut, by the moment plates *A*, and that the shear is resisted by the shear plates *B*. Of course each set of plates resists both shear and moment, but in deep girders the shear carried by plates *A* is small compared with that carried by plates *B*, and similarly the moment resisted by plates *B* is small compared with that resisted by plates *A*. In shallow girders the assumption becomes considerably in error, and this type of splice is not generally considered satisfactory for such cases. Engineers do not hold the same opinion as to when a girder becomes a shallow girder, but the author prefers not to use a splice of this type for a girder less than about 6 ft. deep.

The same general principles are to be observed in design as before. Stress is proportional to its distance from the neutral axis and therefore the plates *A* must resist the same moment the uncut web can resist, at a lower unit stress and a reduced effective depth. If A_s = the net area of two moment plates *A*; d_0 = the distance center to center of moment plates; and d , s_1 , and A_w are as before

$$\frac{1}{8}A_w d s_1 = A_s s_1 \frac{d_0}{d}$$

and

$$A_s = \frac{1}{8}A_w \frac{d^2}{d_0^2} \quad (50)$$

Similarly it can be shown that the number of rivets, on each side of the cut, in the splice plates *A* must be

$$N = \frac{A_s s_1}{R} \quad (51)$$

where N = the number of rivets;

R = the rivet value;

A_s and s_1 are as before.

The shear plates must have sufficient area to resist the maximum shear at the section, and in deep girders many designers make them equivalent to the uncut web in shear. The number of rivets on each side of the cut must be sufficient to develop the shear for which the splice is designed, but there should not be less than two rows of rivets on each side of the cut.

75. Design of Type C.—The plates for the splice shown at (c) in Fig. 81 are intended to splice that part of the web which they cover for both shearing stress and bending stress, i.e., each part of the splice material is expected to resist the stress which the part of the web it covers would resist if the web were not cut.

Let Fig. 82 (a) and (b) represent the bending stress and the shearing stress which (in accordance with the usual assumptions) would exist in the web at the splice if the web were not cut, and let Fig. 82 (c) represent the part of the splice plates to one side of the cut with a row of rivets connecting them to the web. There is no problem in the design of the splice plates. Since they are to replace that part of the web which they cover they will have sufficient area if their combined thickness equals that of the web; as a matter of fact their combined thick-

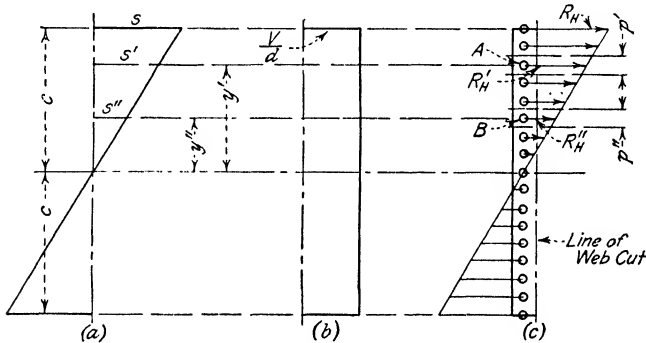

FIG. 82.

ness will generally exceed that of the web, but it should not be less. The rivets in the splice plates should be spaced uniformly throughout the depth of the web, and the problem is to determine this spacing, or if the spacing is assumed or fixed, to determine the number of lines of rivets required at that spacing.

To show that the spacing of the rivets in a vertical line should be uniform consider two rivets at random, *A* and *B*, located at distances y' and y'' from the neutral axis, and assume that the spacing is such that rivet *A* resists the stress developed over a distance p' , and rivet *B* that developed over a distance p'' . If the stress varies as the distance from the neutral axis the horizontal component of the stress on rivet *A* will be R'_H and

$$R'_H = \frac{y'}{c} R_H$$

where R_H = the horizontal component of the stress on a rivet at the

outer edge of the web and y' and c are as shown in Fig. 82. R_H must not exceed a value such that

$$R_H^2 + R_v^2 = R^2$$

where R_H = as stated above;

R_v = the vertical component on the same rivet;

R = the strength of the rivet (bearing on the web or double shear).

Similarly the horizontal component on rivet B will be R''_H and

$$R''_H = \frac{y''}{c} R_H$$

If s' = the intensity of bending stress at rivet A ,

s'' = the intensity of bending stress at rivet B ,

s = the intensity of bending stress at the outer fiber of the web, and

t = the thickness of the web

then $s'p't = R'_H$ and $s''p''t = R''_H$

But since $s' = \frac{y'}{c} s$ and $s'' = \frac{y''}{c} s$

$$\frac{y'}{c} sp't = R'_H = \frac{y'}{c} R_H$$

and

$$\frac{y''}{c} sp''t = R''_H = \frac{y''}{c} R_H$$

From this $p' = p''$

or the distance between the rivets (the pitch) must be the same throughout the depth of the web, if the stress in the plate and in the rivets is proportional to the distance from the neutral axis.

To determine the required pitch, consider a rivet at the extreme fiber of the web having a strength R . If p = the pitch in the splice

$$\frac{V}{st} + \left(\frac{V}{d}\right)^2 = R^2$$

or

$$p = \frac{R}{\sqrt{\frac{V}{st} + \left(\frac{V}{d}\right)^2}} \tag{52}$$

It should be noted that s in this expression is the intensity of stress on

the extreme fiber of the *gross* section. It is somewhat more convenient to use the intensity of stress on the net section, and as the discrepancy is on the safe side and not large many designers use the more convenient value.

The use of $1/8$ the gross web area as flange section presumes $7/8$ -in. rivets (1-in. holes) not less than 4 in. centers in the web, and when the computed pitch, from (52), is less than 4 in. an additional line or lines should be used. For example, if p is computed as 2 in., two lines with rivets 4 in. center to center should be used; if $1\frac{1}{2}$ in., three lines with rivets $4\frac{1}{2}$ in. center to center should be used. Not less than two lines on each side of the cut should be used in any case.

If it were possible to extend the plates over the entire depth of the web they would completely splice it, if the rivets were properly spaced. It is impossible, however, to extend them beyond the edge of the flange angles, and the part of the web covered by the angles is spliced by excess area in the flange, by extending a cover plate which would normally end near the splice, or more commonly by adding plates on the vertical legs of the flange angles as shown in Fig. 81 (c). The area of this additional splice material, whether provided in excess flange area, an extended cover plate, or plates on the vertical legs of the flange angles, must be at least equal to the area of the part of the web not covered by the plates which are between the flange angles. In determining the riveting of these added plates the stress is assumed uniform across the part of the web spliced by them, and equal to the extreme fiber stress. If a is the width of the web provided for by these plates their area must be at , and the number of rivets required to develop the stress in them

$$n = \frac{sat}{r}$$

where n = the number of rivets required;

s = the extreme fiber stress, in pounds per square inch;

r = the rivet value, in pounds;

a and t are as defined above.

For plates on the compression flange s is the intensity of stress on the gross area and a the gross width; for plates on the tension flange s is the intensity of stress on the net area and a the net width. Generally the plates and their riveting are determined for one flange and both flanges made alike.

Students sometimes find the riveting necessary for these splice plates rather confusing, and to assist in understanding the conditions which

must be met Figs. 83 and 84 are presented. Figure 83 shows the top part of a splice of the type under consideration: the plates marked C

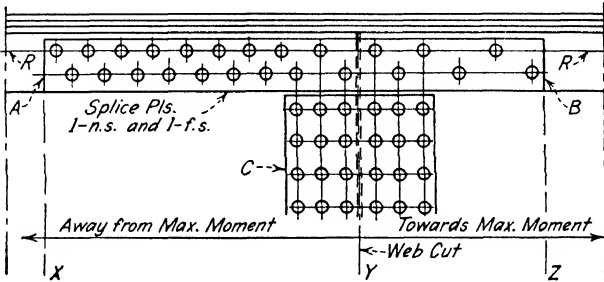

FIG. 83.

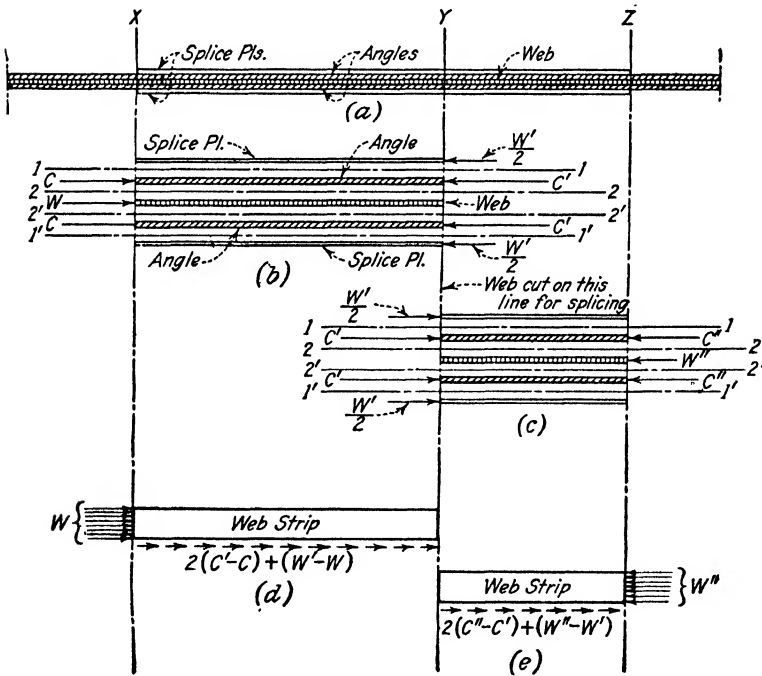

FIG. 84.

are the plates which splice that portion of the web between the flange angles, and the plates AB are those which splice that part of the web under the angles. Figure 84 shows at (a) a section looking down on

line $R-R$ in Fig. 83; at (b) the part of the section in (a) between lines X and Y , with the parts separated for clarity, and the forces acting on the cut ends of the component pieces; at (c) the same as at (b) but between lines Y and Z ; at (d) an elevation of the web strip under the angles between lines X and Y , with the internal stresses acting on the boundary lines; and at (e) the web strip under the angles between lines Y and Z , with the internal stresses acting on the boundary lines. The student should note that the flange parts shown in Fig. 84 are not in equilibrium under the action of the internal stresses indicated; they are held in equilibrium by the flange rivets which are not shown.

As indicated in Fig. 83 the moment increases from left to right on the portion of the girder shown in these figures. At the line X there is a total stress in the strip of web under the angles of W (as shown at [b] in Fig. 84), and if the web were not cut the stress in the strip would be W' at line Y , the difference between W' and W being that part of the change in flange stress between lines X and Y which stays in the web. Since the web is cut at line Y it should be clear that the stress W' must be transferred to some other material, in this case the splice plates AB placed on the vertical legs of the angles. That part of the change in flange stress between lines X and Y which goes into the flange proper (i.e., angles and cover plates) is transferred through the *regular* flange rivets between X and Y , and since we must also transfer from the web into the flange in this same distance the stress W' , from the web strip, it should be clear that we shall have to add to the regular number of flange rivets between X and Y a number sufficient to transfer W' . Consequently it will be necessary to reduce the regular flange pitch between X and Y to an amount which will permit including the necessary number of additional rivets. The transfer of stress, W' , from the web strip to the splice material is made by means of rivets bearing on the web or in shear on each side of the web, and the bearing value of these rivets will control the number necessary unless the web is thick enough so that double shear is a smaller quantity. Between lines Y and Z the rivets holding the web strip in equilibrium are relieved of a portion of the stress they would be compelled to transfer if the web were not cut at line Y , as study of Fig. 84 (c) will show. Additional rivets between Y and Z are then not needed, and it is only necessary to extend the plates AB from the web-cut towards maximum moment far enough to include the number of rivets required to transfer to the flange angles (at double shear) the stress existing in these plates at the web-cut. If the web is cut for splicing at the point of maximum moment of course

the same number of rivets must be placed in these plates on each side of the cut. Should the number be only that which is required to develop the splice plate stress or that number in addition to the regular flange rivets?

It is important to note that the same number of additional rivets will be required on the side of the cut away from maximum moment whether the web strip under the angles is spliced by plates on the angles, by excess flange area, or by an extended cover plate.

The analysis presented above neglects the longitudinal shear between the plates *C* (Fig. 83) and the flange angles. Some designers consider it objectionable to neglect this matter and modify the splice as shown in Fig. 85. This modification has one advantage not yet mentioned, namely, that the extra rivets required on the side away from the maximum moment may be put in the plates *AB* below the flange without interference with the regular flange pitch. It has one very real disadvantage—small and troublesome fillers required below the flange.

Since additional rivets are needed on the side of the web-cut away from maximum moment it is clear that the regular flange rivet pitch must be reduced in the vicinity of the splice, unless the splice is made as in Fig. 85.

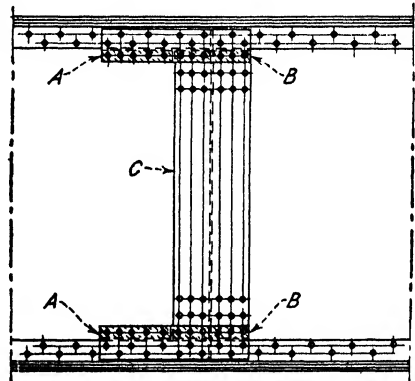

FIG. 85.

The number of spaces of reduced pitch, or the reduced pitch to secure the added rivets in a given number of spaces, may be found as follows:

- p = the regular pitch;
- p' = the reduced pitch;
- m = the number of additional rivets;
- n = the number of regular spaces p which will have to be replaced by $(n + m)$ spaces of p' .

Evidently

$$np = (n + m)p'$$

from which

$$n = \frac{mp'}{p - p'} \tag{53}$$

or

$$p' = \frac{np}{(n + m)} \quad (54)$$

It should be clear that these expressions merely give an arithmetical relation between, n , the number of spaces of p inches which must be reduced to p' inches in order to get m additional rivets in the same distance. If for any reason the actual flange pitch, p , is less than is permissible (as often happens) the splice plate will be unnecessarily long if n is determined from (53). This difficulty may be overcome by calculating n from (53) using the *permissible* pitch for p , instead of the actual; then the true number of spaces of the actual pitch which must be reduced to p' inches will be:

$$\frac{\text{Number determined} \times \text{permissible pitch}}{\text{actual pitch}}$$

For example, suppose that: 8 extra rivets are required, the *permissible* pitch = 9 in., the *actual* pitch = 6 in., the reduced pitch = 3 in. Proceeding as just outlined:

$$n = \frac{8 \times 3}{9 - 3} = 4$$

and the number of *actual* spaces of 6 in. to be reduced =

$$\frac{4 \times 9}{6} = 6$$

The direct application of (53) would give

$$n = \frac{8 \times 3}{6 - 3} = 8$$

The problem may be attacked in a different manner.

Let N = number of rivets needed in the splice plates on side *away*
from maximum moment;

p' = the pitch of the rivets in the splice plate on the same side;

V = the average external shear in the length of the splice plate
(shear at the cut may be used with sufficient accuracy);

d = the effective depth of the girder, in inches;

R = the rivet value;

m = the additional number of rivets needed on the side *away*
from maximum moment.

Then

$$NR = \frac{V}{d} p'N + mR$$

$$N = \frac{mR}{R - \frac{V}{d} p'}$$

It should be clear that mR is the stress in the web strip under the angles, and if we let S_w = stress in the web strip under the angles this may be written

$$N = \frac{S_w}{R - \frac{V}{d} p'} \quad *$$
(55)

It may be well to point out that flange pitch is determined by maximum shear at the section in question and that the number of additional rivets required in the splice plates AB is determined under the assumption that the bending stress in the web is a maximum. These conditions may not occur simultaneously (usually they do not) but the discrepancy is on the side of safety, and the procedure as given is usually followed.

FLANGE SPLICES.—Flange splices should be avoided if possible, and, as indicated at the beginning of Article 72, generally can be for all but the longest girders. The lengths of angles and cover plates which may be obtained depends to some extent on the rolling mill manufacturing them, but in general angles and cover plates can be obtained without much trouble in lengths up to 100 ft. Some mills can roll all but the heaviest 8-in. angles in lengths up to 136 ft., and some mills can furnish any 8-in. angle in lengths of 120 ft., and even longer by special arrangement.

In spite of the great length of angles and cover plates which may be obtained it is sometimes necessary to make flange splices, and they will be briefly discussed.

Splices of flange angles are sometimes made by means of a single splice angle covering the cut, when sufficient area can be obtained in

* In this expression V/d is the rate of change of the flange stress, and since part of this may be resisted by the web itself we may multiply $\frac{V}{d}$ by $\frac{A_n}{A_n + \frac{1}{8}A_w}$, if the cover plates have been extended to the proper point. Such precision, however, is hardly justified.

this way, with an angle on each side, or with an angle on one side and a plate on the other. Figure 86 shows the usual forms in section. The two-angle splice, shown at (b), Fig. 86, is required in some design specifications, for example the A.R.E.A. "General Specifications for Steel

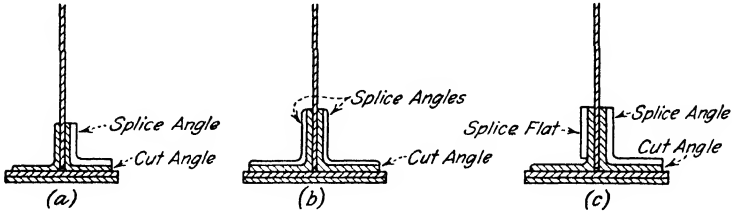

FIG. 86.

Railway Bridges," Fourth Edition, May, 1931, Art. 122. It is customary to splice an angle for its full capacity (some specifications for design require that any splice have 10 per cent greater computed strength than the piece spliced) even though the splice may be located at a point where the flange has excess area.

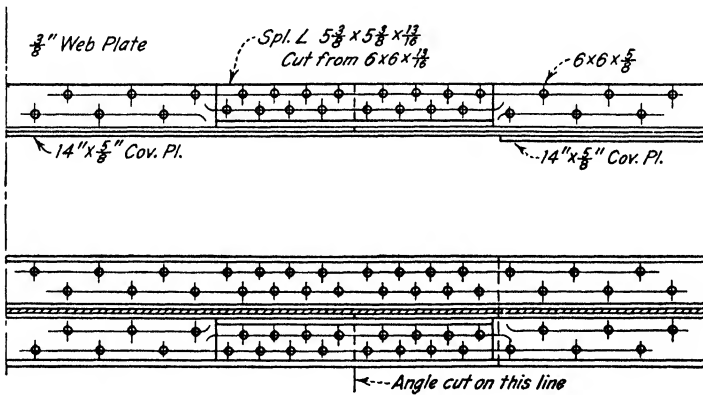

FIG. 87.

The splice of a flange angle by a single cover angle is shown in Fig. 87. The necessary calculations are as follows, assuming 7/8-in. rivets.

$$\begin{aligned} \text{Net area} &= 1 - 6 \text{ in.} \times 6 \text{ in.} \times \frac{5}{8} \text{ in. angle} = 5.86 \quad \text{2 holes out} \\ &\text{Add } 10\% = 0.59 \end{aligned}$$

6.45 sq. in. net for
splice angle.

Cut $5\frac{3}{8} \times 5\frac{3}{8} \times \frac{1}{8}$ from a 6 in. \times 6 in. \times $\frac{1}{8}$ angle.

$$\text{Gross area} = \begin{cases} 5\frac{3}{8} \times \frac{1}{8} = 4.37 \\ (5\frac{3}{8} - \frac{1}{8})\frac{1}{8} = 3.71 \\ \hline \text{Total} = 8.08 \end{cases}$$

Deduct 2 holes, $2 \times 1 \times \frac{1}{8} = 1.63$

Net = 6.45 sq. in.

$$\frac{6.45 \times 18}{8.1} = 14.3, \text{ 15 rivets on each side of cut.}$$

The same rivets which connect the flange angles to the web are effective in transferring stress from the cut angle to the splice angle, as the stress is transferred on a different plane. However, if the flange angle is so thin that the bearing value of a rivet against it is less than double shear, additional rivets may be necessary, as the sum of the shears on the two sides must not exceed the allowable stress in bearing. The shear on the inside of the flange angle, from change in flange stress, and the shear on the outside, from splice angle stress, are additive (i.e., in the same direction) only on the side of the cut towards maximum moment, but the splice angle is commonly made symmetrical in any case. Also the flange pitch is usually reduced in order to make the splice angle as short as possible. Care should be exercised, however, to see that placing the rivet holes closer together does not reduce the net area of the flange below that required at the section in question.

Instead of securing additional area by means of an angle or a flat, on the far side, as in Fig. 86 (b) and (c), a cover plate may sometimes be extended. For example, in Fig. 87 the 14 by $\frac{5}{8}$ cover plate shown ending just to the right of the splice could be extended to the left and used as added area if needed.

When a splice of the type shown at (c) in Fig. 86 is used the riveting will require more attention. Figure 88 is presented, not as an actual case, but to bring out the conditions to be met. Figure 88 (a) illustrates a typical splice of the type in question. Figure 88 (b) shows diagrammatically the component parts of the flange and strip of web between the flange angles extending between lines X and Y; the various parts are separated to facilitate study, and consistent internal stresses are shown acting on the parts cut by planes passing through the flange on lines X and Y. Figure 88 (c) shows the same as (b) but for the portion of flange between lines Y and Z. Study of Fig. 88 (b) and (c)

shows that if the near flange angle were not cut there would be a shear between each flange angle and the web, between lines X and Y, and between lines Y and Z, of 38 kips. With the near flange angle cut and its stress at line Y (162 kips) divided, 122 kips to the splice angle on the near side and 40 kips to the splice flat on the far side, conditions are different. There will now be a shear between the far flange angle and the web, between lines X and Y, of 78 kips; and there will be an equal shear between the near flange angle and the web, between lines Y and Z. Although the stresses given in Fig. 88 (b) and (c) are not

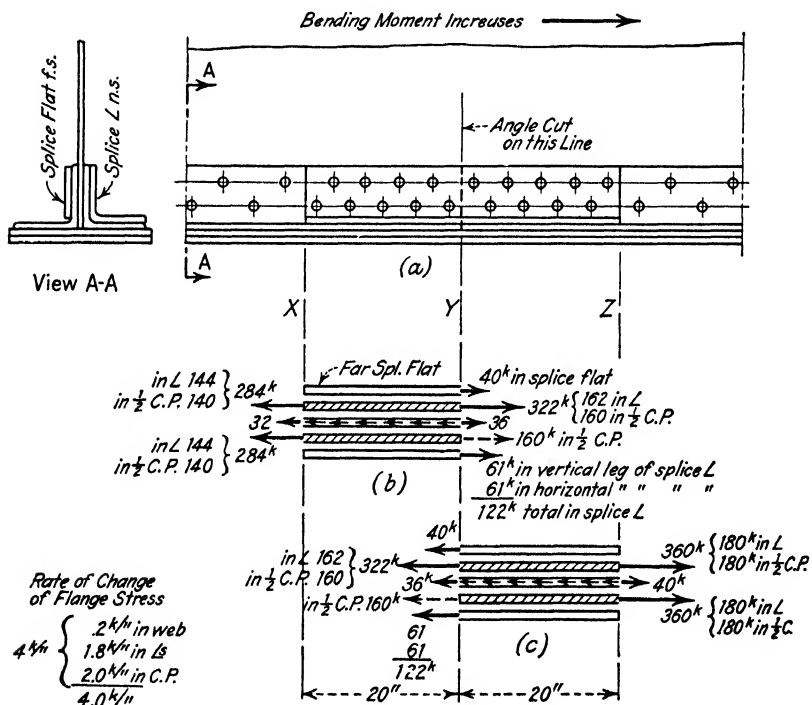

FIG. 88.

for any specific case they indicate at once the general statement that the riveting of the splice flat on the far side must provide, by rivets in single shear, not only for the actual stress to be carried by the flat but also for the regular change in flange stress between one flange angle and the web over the length of the flat from the angle cut to each end. This may be expressed mathematically as follows:

- V = average external shear over length of splice flat (shear at cut sufficiently accurate);
 d = effective depth of the girder;
 p = pitch of rivets in splice flat;
 N = number of rivets required in splice flat on each side of cut;
 R = value of rivet in single shear;
 S_F = stress to be carried by splice flat.

Then

$$NR = S_F + \frac{1}{2} \frac{V}{d} pN$$

and

$$N = \frac{S_F}{R - \frac{1}{2} \frac{V}{d} p} \quad (56)$$

This is the number of rivets which would be required making no allowance for the fact that the flat on the far side is not a *direct* splice, and should be increased in accordance with the requirements for an indirect splice. These requirements differ in various specifications, two common requirements being (a) an increase of one-third for each intervening plate, and (b) at least two extra rows for each intervening plate.*

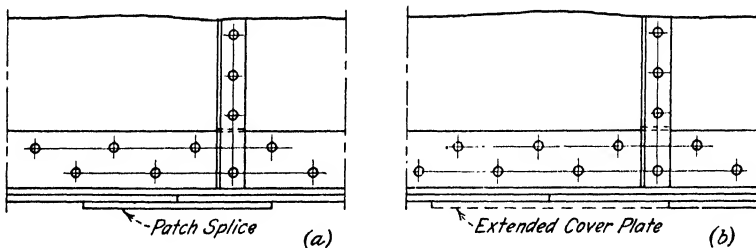

FIG. 89.

If a cover plate splice is required it may be made by a simple patch splice as shown in Fig. 89 (a) or by extending the next cover above as shown at (b) in the same figure. In the latter case it is of course necessary that the extended plate have at least as great a thickness as the plate spliced. If all covers must be spliced one of the methods shown in Fig. 90† is generally used, the second being preferable for field splices.

*A.R.E.A. "General Specifications for Railway Bridges," (a) 1910, and (b) 1931.

†"Design of Steel Bridges," F. C. Kunz, McGraw-Hill Book Company, New York.

It is necessary that the top splice plate have an area at least equal to the heaviest plate cut, and it is preferable that the design be made with covers of equal thickness.

76. Illustrative Example DP9.—To illustrate the discussion of the details of design presented in Arts. 62–75 inclusive, complete design calculations and a general design drawing are given for a girder 90 ft. 0 in. long; DP9, Sheets 1 to 5 inclusive and Detail Sheet 1. All the design details discussed are illustrated including the design of a flange angle splice, although the latter is not necessary for a girder 90 ft. long and is not shown on the design drawing. The calculations are given in more detail than is really necessary for actual design, but it seemed best to make them as nearly self-explanatory as possible in this case.

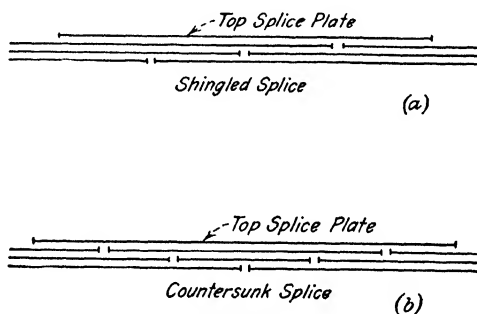

FIG. 90.

The reader should be sure that he understands clearly the computations presented; in subsequent designs many of the calculations will be more abbreviated and some steps given here will not be shown. Attention is called to the use of the actual effective depth in calculating rivet pitch at the four points studied; as stated in the previous discussion it is common to use the effective depth at the center in all rivet pitch calculations, and the student should observe how much the pitch would be affected by following usual practice in this respect. The rivet pitch diagram shows the computed maximum pitch assuming that the flange rivets resist all the change in flange stress and assuming that the web resists a portion of the change. As previously pointed out the latter assumption should not be used unless the cover plates are properly developed before the theoretical ends. The student should determine what rivet pitch between the actual ends and the theoretical ends would be necessary to develop the plates properly within the lengths added to the theoretical lengths. The rivet pitch noted on the design detail

| <u>Design of Girder G10</u> | | DP 9 | |
|---|--|--|--------|
| Span 90'-0" c.to.c. Bg's (Top flange laterally supported) | | Girder G10 | |
| | | 1932 | T.C.S. |
| | | Sheet 1 of 5 | |
| | | <u>A.I.S.C. Specs.</u> | |
| <u>Moment</u> | <u>Shear</u> | Live Load = 7500*# | |
| Live Load = $7500' \times 25 \times \frac{80}{8}$ | Live Load = $337.5' \times \frac{80}{2} \times 7.5' \#$ | Dead " = 2500 | |
| Dead " = $2530 = 2.5 \times \frac{80}{8}$ | Dead " = $112.5 = \frac{80}{2} \times 2.5' \#$ | Total = 10,000*# | |
| Total = 10,120* | Total = 450.0* | | |
| + 8.35' = 1212* Flg. stress | @ 12 = 37.50** Gross web area | | |
| @ 18 1/2" = 67.3** net flg. area | @ 24 = 18.75** a.s. legs bg. stiff's. | | |
| | @ 13.13 = 34.30 rivs. bg. on web | | |
| | @ 16.24 = 27.70 " d.s. | | |
| | @ .5 = 750** bg. area on masonry | | |
| <u>Material for 1-Girder "G-10"</u> | | | |
| 1-Web | $100 \times \frac{1}{2}'' = 50''$ gr., $\frac{1}{8} = 6.25''$, $\frac{1}{4} = 8.33''$ | Web Pl. Excess $3 \frac{1}{2} \% 540*$ | |
| 2- Bott. B's | $8 \times 8 \times \frac{1}{2}'' = 26.46 - 3.50 = 22.96$, + 6.25 = 29.21** | @ 170*# x 90.3' = 15,350 | |
| 1- Bott. Pl. | $18 \times \frac{1}{8}'' = 14.63 - 1.63 = 13.00$, + 29.21 = 42.21 | @ 49.7' x 71.0 = 3530 | |
| 1- do. | do. = 14.63 - 1.63 = 13.00, + 42.21 = 55.21 | @ 49.7' x 58.0 = 2880 | |
| 1- do. | $18 \times \frac{1}{2}'' = 13.50 - 1.50 = 12.00$, + 55.21 = 67.21**net | @ 45.9' x 41.0 = 1880 | |
| 2- Top B's | $8 \times 8 \times \frac{1}{2}'' = 26.46$, + 8.33 = 34.79** | @ 45.0' x 90.3 = 8130 | |
| 1- Top Pl. | $18 \times \frac{1}{8}'' = 14.63$, + 34.79 = 49.42 | @ 49.7' x 71.0 = 3530 | |
| 1- do. | do. = 14.63, + 49.42 = 64.05 | @ 49.7' x 58.0 = 2880 | |
| 1- do. | $18 \times \frac{1}{2}'' = 13.50$, + 64.05 = 77.55**gross | @ 45.9' x 41.0 = 1880 | |
| 4- End Stiffs. | $6 \times 4 \times \frac{1}{2}'' = 4 \times 5 \frac{1}{2} \times \frac{1}{2} = 18.81''$ bg. on a.s. legs | @ 27.2' x 8.2 = 890 | |
| 2- End Fills | $8 \times \frac{1}{2}''$ | @ 23.8' x 7.0 = 330 | |
| 2- End Conn. B's | $4 \times 4 \times \frac{1}{2}''$ | @ 11.3' x 8.2 = 190 | |
| 2- End Fills | $7 \times \frac{1}{2}''$ | @ 20.8' x 7.0 = 290 | |
| 4- Spl. Pls. | $18 \times \frac{1}{2}''$ | @ 22.95' x 7.0 = 640 | |
| 32- Int. Stiffs. | $6 \times 3 \frac{1}{2} \times \frac{1}{2}$ Crimped | @ 11.7' x 8.2 = 3070 | |
| 4- " " | " " | @ 11.7' x 8.2 = 380 | |
| 4- Fills | $3 \frac{1}{2} \times \frac{1}{2}$ | @ 3.95' x 7.0 = 170 | |
| | Rivet Heads and Variation Abt. $2 \frac{1}{2} \%$ | | |
| | | Total for 1-Girder = 56,000*# | |
| <u>Cover Plate Lengths</u> | | | |
| Top Cover | $L = 90 \sqrt{\frac{1200}{67.21}} = 38.1' \sim 41'$ | | |
| 2nd " | $L = 90 \sqrt{\frac{25.00}{67.21}} = 54.9' \sim 58'$ | | |
| Bott. " | $L = 90 \sqrt{\frac{38.00}{67.21}} = 67.7' \sim 71'$ | | |
| <u>Curve of Maximum Shear</u> | | | |
| | | | |

Design of Girder "G10"

$\frac{7}{8}$ " Rivs., Bg. on $\frac{1}{2}$ " web = $\frac{7}{8} \times \frac{1}{2} \times 30 = 13.13^k$

| | |
|--------------|--------|
| DP 9 | |
| Girder "G10" | |
| 1932 | T.C.S. |
| Sheet 2 of 5 | |

Rivet Pitch Calculations

End

$\frac{450}{95.9} = 4.69^k/a$ $\frac{13.13}{4.69} = 2.80^k a$
 $\times \frac{22.96}{29.21} = 3.69^k/a$, $\frac{13.13}{3.69} = 3.56^k b$

$\frac{1}{2}$ th. Point

$\frac{309.4}{97.8} = 3.16^k/a$ $\frac{13.13}{3.16} = 4.16^k a$
 $\times \frac{35.96}{42.21} = 2.69^k/a$, $\frac{13.13}{2.69} = 4.88^k b$

$\frac{1}{3}$ rd. Point

$\frac{187.5}{100.2} = 1.87^k/a$ $\frac{13.13}{1.87} = 7.03^k a$
 $\times \frac{60.96}{67.21} = 1.70^k/a$, $\frac{13.13}{1.70} = 7.72^k b$

Center

$\frac{84.4}{100.2} = .84^k/a$ $\frac{13.13}{.84} = 15.63^k a$
 $\times \frac{60.96}{67.21} = .76^k/a$, $\frac{13.13}{.76} = 17.28^k b$

Stiffener Spacing Calculations

End

$85 \times \frac{1}{2} \sqrt{\frac{18000}{9000} - 1} = 42.5^k$

$\frac{1}{2}$ th. Point

$85 \times \frac{1}{2} \sqrt{\frac{18000}{6160} - 1} = 58.8^k$

$\frac{1}{3}$ rd. Point

$85 \times \frac{1}{2} \sqrt{\frac{18000}{3750} - 1} = 82.9^k$

Center

$85 \times \frac{1}{2} \sqrt{\frac{18000}{1690} - 1} = 132.0^k$

Diagram of Maximum Rivet Pitch

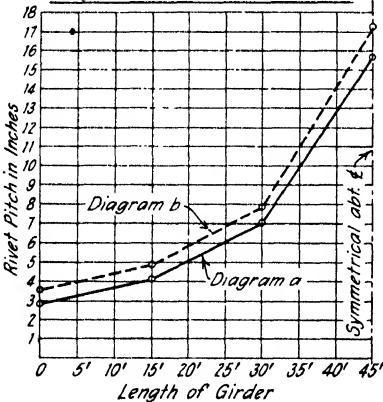

Diagram of Maximum Stiffener Spacing

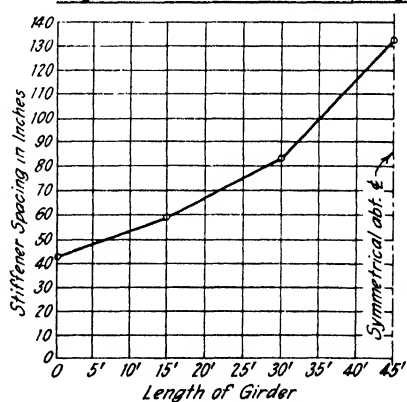

Diagram "a" assumes all change in flange stress to be transferred by flange rivets.
 " " "b" " some " " " " " " resisted by web.

Design of Girder "G-10"

| | |
|---------------|--------|
| DP 9 | |
| Girder "G-10" | |
| 1932 | T.C.S. |
| Sheet 3 of 5 | |

Web Splice Calculations

Splice at $\frac{1}{3}$ rd Points

Web $100'' \times \frac{1}{2}''$

Area = 50 in^2
 $\frac{1}{3} A = 6.25 \text{ in}^2$

Max. Shear = 188 k
 " Mom. = $11,250 \text{ in}^k = \frac{50}{8} \times 18 \times 100$
 $\frac{7}{8}'' \phi$ Rivs. Bg. on $\frac{1}{2}''$ web = $\frac{50}{8} \times \frac{1}{2} \times 30 = 18.75 \text{ per rivet}$

Type "A"

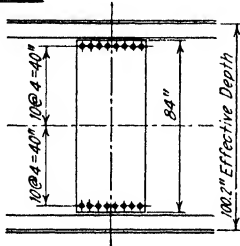

Area of Spl Pls. = $50 \times \left(\frac{100}{84}\right)^2 = 70.8 \text{ in}^2$ gross
 $\frac{70.8}{84} = .845''$ total thickness
 Use 2-84" x $\frac{1}{8}''$ Spl. Pls.

Max. H-Comp. Rivet Stress in Spl. Pl.
 $= 13.13 \times \frac{80.0}{100.2} = 10.5 \text{ k}$

$\sum d^2 = \frac{10}{6} \times (10+1)(2 \times 10+1) 4^2 \times 2 \times 4 = 49,280$

$R_H = \frac{11,250 \times 40}{49,280} = 9.15 \text{ k}$

$R_V = \frac{188}{4 \times 21} = 2.24 \text{ k}$

$R = \sqrt{R_H^2 + R_V^2} = \sqrt{9.15^2 + 2.24^2} = 9.42 \text{ k}$

Type "B"

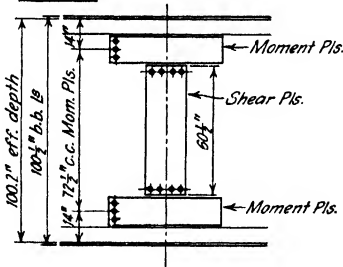

Area of Moment Pls.

$\frac{50}{8} \left(\frac{100.2}{72.5}\right)^2 = 11.94 \text{ in}^2$ net
 2-Pls. $11'' \times \frac{7}{8}'' = (11-3) \frac{7}{8} \times 2 = 14.0 \text{ in}^2$ net
 $\frac{11.94 \times 18}{13.13} = 16.4$

17 rivets on each side of cut

Area of Shear Pls.

$\frac{188}{12} = 15.7 \text{ in}^2$ gross

2-Pls. $60 \frac{1}{2} \times \frac{3}{8} = 45.4 \text{ in}^2$ gross

$\frac{188}{13.13} = 14.3$ rivets on each side of cut

Use 2-rows on each side, 4" to 6" c.c.

Design of Girder "G-10"

Type "C"

DP 9

Girder "G-10"

| | |
|--------------|--------|
| 1932 | T.C.S. |
| Sheet 4 of 5 | |

$$p = \frac{13.13}{\sqrt{18 \times \frac{1}{2}^2 + \left(\frac{188}{100}\right)^2}} = \frac{13.13}{9.19} = 1.43''$$

3 rows @ $3 \times 1.43 = 4.32''$

Use 3 rows on each side 4" pitch

Flange Plates

$(8.00 - 1.00) \frac{1}{2} = 3.50''$ net area

Use 2-6 1/2" x 1/8" Pls.

$2 \times (6.50 - 1.00) \times \frac{1}{8}$
= 4.13'' net area

$\frac{3.5 \times 18}{13.13} = 4.8 \sim$ 5 extra rivets on side away from max. mom.

$\frac{3.5 \times 18}{16.2} = 3.9 \sim$ 4 regular rivets on side towards max. mom.

or

$\frac{3.5 \times 18}{13.13 - \frac{188}{100} \times 3} = 8.4 \sim$ 9 rivets @ 3" pitch on side away from max. mom.

$\left(\frac{15.1}{45.0}\right)^2 \times 67.3 = 7.59''$ excess area at splice;

Flange plates are not needed for type "C" splice

Design of Girder "G-10"

DP 9

Girder "G-10".

1932 T.C.S.

Sheet 5 of 5

Flange Angle Splice

Splice at 23'-3" from ϵ , Shear = 255k

$$8" \times 8" \times \frac{7}{8}" L = 13.23^{in^2} \text{ gross}$$

$$\frac{1.75}{11.48^{in^2}} \text{ net}$$

$$\text{Splice L } 7\frac{1}{2}" \times 7\frac{1}{2}" \times \frac{7}{8}" = 7\frac{1}{2}" \times \frac{7}{8}" = 6.23$$

$$(7\frac{1}{2}" - \frac{7}{8}") \times \frac{7}{8}" = 5.47$$

$$\frac{11.70^{in^2} \text{ gross}}{1.75 \text{ 2-rivet holes}} = 9.95^{in^2} \text{ net}$$

$$\text{Splice Flat } 6" \times \frac{5}{16}" = (6.0 - 1.0) \times \frac{5}{16} = 1.56$$

$$\frac{1.56}{11.31^{in^2}} \text{ net total splice area}$$

Rivets for splice L $\frac{9.95 \times 18}{8.1} = 22.1$ rivets each end, 11 each leg each end

" " " flat $\frac{1.56 \times 18}{8.1 - \frac{1}{2} \times \frac{25.5}{39.1} \times 3} = \frac{28.1}{4.2} = 6.7$

+ $\frac{2}{3}$ for indirect splice = 11 rivets

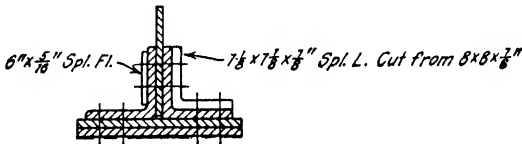

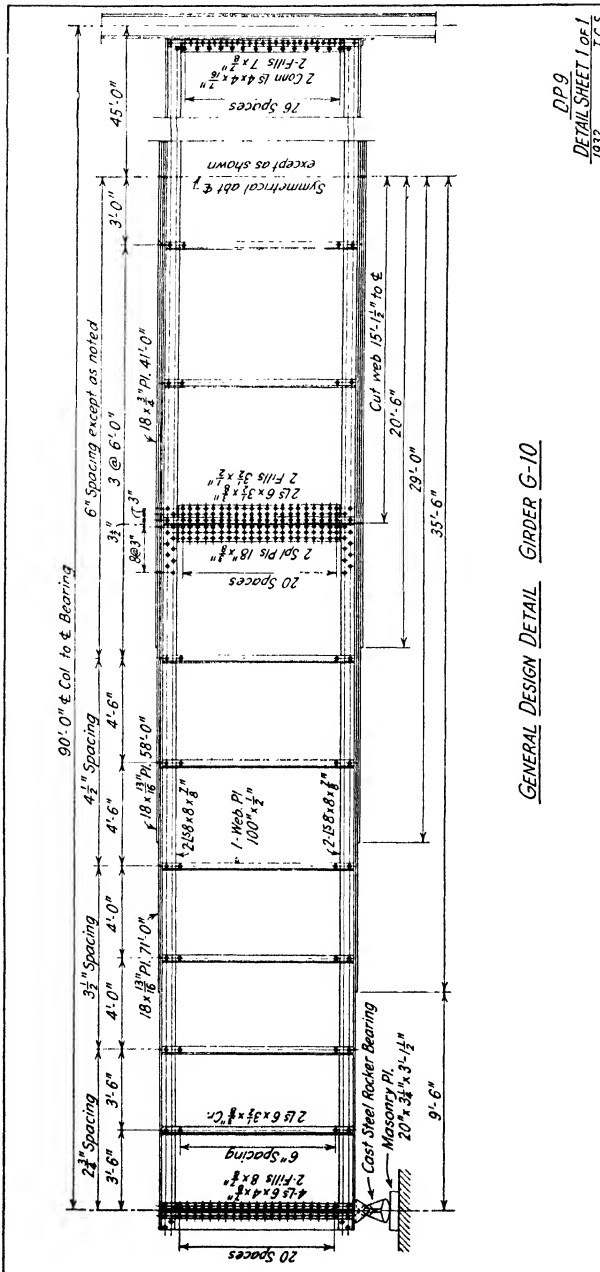

DP9
 DETAIL SHEET 1 of 1
 1932
 T.C.S.

GENERAL DESIGN DETAIL GIRDER G-10

follows Diagram *a*. To be in strict accord with the varying effective depths these diagrams evidently should show a jump in rivet pitch wherever a cover plate is cut off.

Examples of web splice design for all three types are given. The four lines of rivets on each side of the cut shown for Type *A* result in an extreme rivet stress of less than is permissible; some rivets may be omitted in this case but it will be found that three lines on each side, at the pitch used (4 in. center to center), will not have adequate strength.*

* The calculation of Σd^2 in connection with the Type *A* splice design may perhaps require some explanation. If the figure represents a vertical row of rivets at a uniform pitch, it is clear that with reference to line 1-1

$$\begin{aligned} \Sigma d^2_{1-1} &= (\overline{1p}^2 + \overline{2p}^2 + \overline{3p}^2 + \dots \overline{np}^2) \\ &= p^2(1^2 + 2^2 + 3^2 + \dots n^2) \end{aligned}$$

The sum to *n* terms of the series in parentheses is

$$S_n = \frac{n}{6} (n + 1)(2n + 1)$$

and it follows that

$$\Sigma d^2_{1-1} = p^2 \frac{n}{6} (n + 1)(2n + 1)$$

In the calculations for the splice referred to there are four such vertical lines of rivets above the reference line (the neutral axis) and four below, and *n* = 10.

It may be of interest to note that the sum of the squares may be referred to some other line, such as 2-2, *e*'' inches below the original line, as follows:

As before let

$$d_1 = 1p$$

$$d_2 = 2p$$

$$d_3 = 3p$$

$$\dots$$

$$d_n = np$$

Then

$$\begin{aligned} \Sigma d^2_{2-2} &= \{e^2 + (\overline{p + e})^2 + (\overline{2p + e})^2 + (\overline{3p + e})^2 + \dots (np + e)^2\} \\ &= \{e^2 + (d_1 + e)^2 + (d_2 + e)^2 + (d_3 + e)^2 + \dots (d_n + e)^2\} \\ &= \{e^2 + (d_1^2 + 2d_1e + e^2) + (d_2^2 + 2d_2e + e^2) + \dots \\ &\quad + (d_n^2 + 2d_n e + e^2)\} \\ &= \Sigma d^2_{1-1} + 2e\Sigma d_{1-1} + (n + 1)e^2 \end{aligned}$$

Σd_{1-1} may be found as before

and

where

$$\Sigma d_{1-1} = \frac{n}{2}(a + l) = \frac{n}{2}(n + 1)p$$

n = number of rivets;

a = first term of series = *p*;

l = last term of series = *np*.

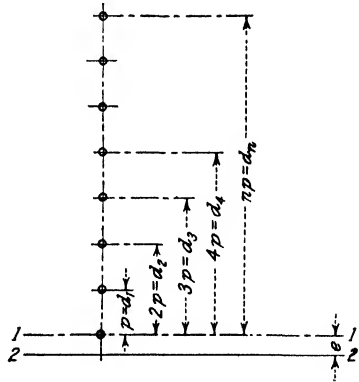

Later it will be pointed out that when the shear is not large at the point of splice (as is usually true) the number of rows on each side of the cut, at a given pitch, may be determined by direct computation for a splice of Type A. Attention is called to the facts that the splice finally adopted was of the so-called rational type and that excess flange area was utilized in splicing the web strip. The design detail sheet shows the reduced pitch necessary on the side of the cut away from maximum moment.

77. Girders with Web Reinforcement.—Girders are sometimes required to resist a very high shear for a short distance near a support. In order to avoid using a web throughout the length of the girder thick

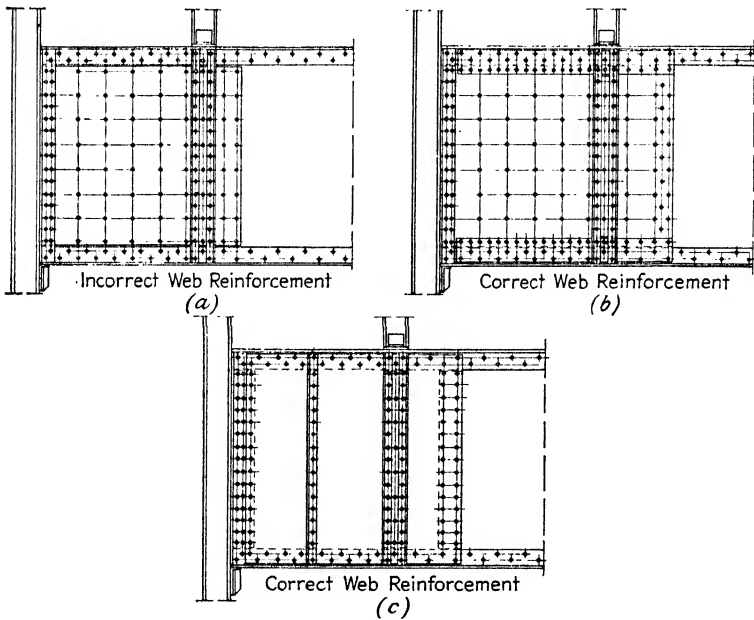

FIG. 91.

enough to resist this shear the web may be reinforced in the region of high shear by the addition of plates between the flange angles, or sometimes by plates over the flange angles. As pointed out in considering the reinforcement of beam webs there will be severe stress in the web just above the reinforcing plates unless the plates are connected to the flange angles. Figure 91 (a) shows a girder web as frequently, but incorrectly, reinforced. Figures 91 (b) and (c) show correct methods of reinforcement. The plates between the flanges are frequently made of the same thickness as the flange angles although generally the thickness

required is considerably less. The reinforcing strap plates shown in Fig. 91 (b) must have sufficient thickness to resist the part of the change in flange stress taken by the main reinforcing plates. If

t_r = thickness of 1 main reinforcing plate,

t_w = thickness of web,

then the part of the change in flange stress resisted by each reinforcing strap plate is approximately

$$\frac{V}{d} \times \frac{t_r}{t_w + 2t_r}$$

V and d having the usual significance. This assumes the entire moment to be resisted by the flange. Considering the web as resisting its proper share of the moment the above becomes

$$\frac{A_n}{A_T} \frac{V}{d} \times \frac{t_r}{t_w + 2t_r}$$

A_n and A_T having the meaning previously given. If R = the rivet value, and p the pitch of the rivets connecting the strap plate to the flange and the reinforcing plate

$$p = \frac{R}{\frac{V}{d} \times \frac{t_r}{t_w + 2t_r}} \quad (57)$$

or more accurately *

$$p = \frac{R}{\frac{A_n}{A_T} \times \frac{V}{d} \times \frac{t_r}{t_w + 2t_r}} \quad (58)$$

The student should note that R is here the value of a rivet in single shear. Evidently the pitch of the rivets connecting the reinforcing strap to the flange angles must also be determined with reference to the part of the change in flange stress resisted by the web.

Of the two correct methods of web reinforcement that are shown, that at (b), Fig. 91, is the easier to fabricate, while that shown at (c) is generally somewhat lighter. The principal difficulty encountered in fabricating girders with the web reinforced by the latter method is in placing the necessary fillers under the reinforcing webs. The reinforcing webs in this type must also comply with the usual limits on web thickness and stiffener spacing. The girder shown at (c) in Fig. 91 requires a pair of stiffeners between the column resting on top of the girder and the left end because the reinforcing webs cannot be riveted to the main web as they can in (b).

* Cover plates usually cannot be cut off in the region of high shear for a girder of the type under discussion.

78. Illustrative Example DP10.—The complete design calculations for a girder with the web reinforced as shown in Fig. 91 (*b*) are given on Sheets 1 to 5 inclusive of DP10. On Sheet 6 of the same set the girder is redesigned with web reinforcement as shown in Fig. 91 (*c*). In the case shown, the difference between the two girders is small.

In studying the design the reader should notice that the area of the bearing stiffeners and the fills between their outstanding legs was determined by assuming a permissible intensity of stress of 24,000 lb. per sq. in. Some engineers would consider this stress too high since the entire areas of the stiffener angles are in contact with the horizontal legs of the flange angles and are included in the bearing area available. Although recognizing that there is room for a legitimate difference of opinion the author considers the design as prepared safe and satisfactory. The stiffeners are closely riveted to a large mass of steel in the web, web reinforcing plates, and fillers, and buckling as a column seems to be improbable. It is worth while here to call the student's attention to the fact that no set of design specifications can be so written as to cover every possible point in the design of even the simplest structure or structural member. The exercise of judgment is always necessary, and there are always matters which must be decided by the *opinion* of the engineer. It is well to keep in mind the statement which was printed on the cover of design specifications* issued by the late Theodore Cooper: "The most perfect system of rules to insure success must be interpreted upon the broad grounds of professional intelligence and common sense."

It should not be necessary to call attention to the great importance of providing rigid horizontal bracing for the top flange of the girder and for the top of the column on which its left-hand end is supported.

As a further example of web reinforced girders, drawings for D-S9 and E-S9 are presented as Fig. 92. These were taken by permission from the plans prepared by Smith, Hinchman, and Grylls of Detroit for a building for Newcomb-Endicott Company. These girders are of the type shown in Fig. 91 (*c*).

79. Plate Girder Design by Moment of Inertia.—Some engineers prefer to design plate girders by what is known as the "moment of inertia method." The required moment of inertia is determined from the beam formula,

$$I = \frac{Mc}{s}$$

* "General Specifications for Steel Railroad Bridges and Viaducts," and "General Specifications for Steel Highway and Electric Street Railway Bridges and Viaducts." both by Theodore Cooper, consulting engineer, Engineering News Publishing Company.

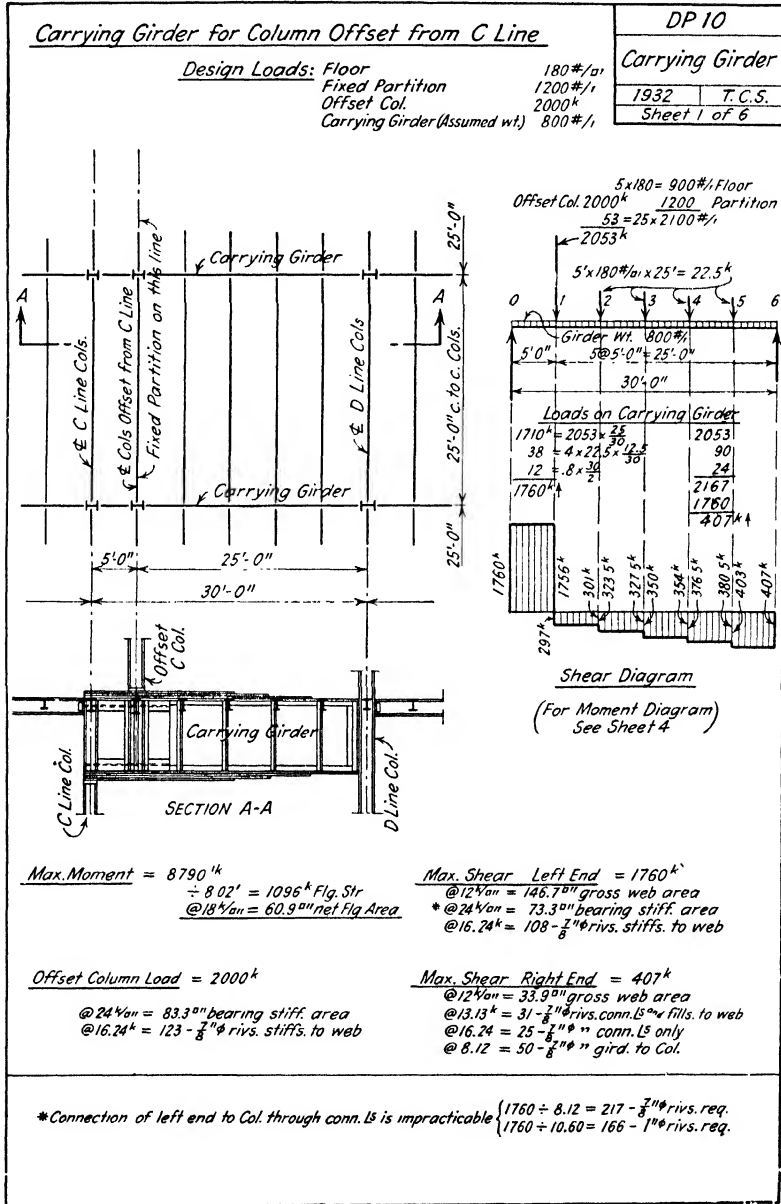

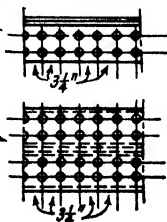
| <u>Carrying Girder (Cont.)</u> | | DP 10 | |
|--|--|--|----------------------------|
| <i>Reinforcing webs between flange angles (See alternate design) Sheet 6</i> | | Carrying Girder | |
| | | 1932 | T.C.S. |
| | | Sheet 2 of 6 | |
| <u>1- Girder</u> | | Web Pl. Ex. 4% = | 200 |
| 1- Main Web $96 \times \frac{1}{2} = 48^{00} gr.$ | | Reinf. Pl. Ex. 2½% = | 80 |
| 2- Reinf. Webs $80 \times \frac{3}{8} = 100$ | } = 148^{00} gr. $\frac{1}{2} = 16.45^{00} \times \frac{1}{2} = 24.67$ | @ 163.2 ⁰⁰ x 30.3' = | 4950 |
| 2- Bott. L ^s $8 \times 8 \times \frac{3}{8} = 19.22 - 5.00 = 14.22^{00} + 16.45^{00} = 30.67$ | | @ 32.7 x 30.3 = | 3130 |
| 1- Bott. Pl. $20 \times \frac{3}{8} = 12.50 - 2.50 = 10.00, + 30.67 = 40.67$ | | @ 42.5 x 26.6 = | 1130 |
| 1- do. $20 \times \frac{3}{8} = do = 10.00, + 40.67 = 50.67$ | | @ 42.5 x 21.8 = | 930 |
| 1- do. $20 \times \frac{3}{8} = do = 10.00, + 50.67 = 60.67^{net}$ | | @ 42.5 x 17.0 = | 720 |
| 2- Top L ^s $8 \times 8 \times \frac{3}{8} = 19.22, + 24.67 = 43.89^{00} gr.$ | | @ 32.7 x 30.3 = | 1980 |
| 1- Top Pl. $20 \times \frac{3}{8} = 12.50, + 43.89 = 56.39$ | | @ 42.5 x 26.6 = | 1130 |
| 1- do. $20 \times \frac{3}{8} = 12.50, + 56.39 = 68.89$ | | @ 42.5 x 21.8 = | 930 |
| 1- do. $20 \times \frac{3}{8} = 12.50, + 68.89 = 81.39^{00} gross$ | | @ 42.5 x 17.0 = | 720 |
| 4- Strap Pls. $13 \times \frac{3}{8}$ | | @ 27.6 x 9.2 = | 1020 |
| 8- End Stiffs. $6 \times 4 \times \frac{3}{8} = 55.52^{00}$ | | @ 23.6 x 7.9 = | 1490 |
| 4- End Flats $6 \times \frac{3}{8} = 18.00, + 55.52 = 73.52^{00} Bg. area$ | | @ 15.3 x 7.9 = | 480 |
| 2- End Fills. $25 \times \frac{3}{8}$ | | @ 53.1 x 5.7 = | 610 |
| 8- Col. Stiffs. $6 \times 4 \times \frac{3}{8} = 55.52^{00}$ | | @ 23.6 x 7.9 = | 1490 |
| 4- Col. Flats. $6 \times 1 \frac{1}{8} = 28.50, + 55.52 = 84.02^{00} Bg. area$ | | @ 24.2 x 7.9 = | 760 |
| 2- Col. Fills. $26 \times \frac{3}{8}$ | | @ 55.3 x 5.7 = | 630 |
| 2- End Conn. L ^s $4 \times 4 \times \frac{3}{8}$ | | @ 15.7 x 7.9 = | 250 |
| 2- End Fills. $7 \times \frac{3}{8}$ | | @ 14.9 x 6.7 = | 200 |
| 8- Int. Stiffs. $5 \times 3 \frac{1}{2} \times \frac{3}{8}$ | | @ 10.4 x 7.9 = | 560 |
| 8- Int. Fills. $3 \frac{1}{2} \times \frac{3}{8}$ | | @ 7.4 x 6.7 = | 400 |
| 1- Sole Pl. 20×1 | | @ 68.0 x 2.1 = | 140 |
| 1- Col. Bg. Pl. 20×3 | | @ 204.0 x 2.2 = | 450 |
| 8- Beam Conn. L ^s $5 \times 3 \frac{1}{2} \times \frac{3}{8}$ and 2- L ^s $3 \frac{1}{2} \times 3 \frac{1}{2} \times \frac{3}{8}$ | | @ 13.6 x 1.8 = | 110 |
| | | @ 8.5 x 1.0 } = | 630 |
| Riv. Heads, etc. <i>abt. 2½%</i> | | Total for 1-Girder | 27,800⁰⁰ |
| <u>Rivet Pitch</u> | | | |
| $\frac{7}{8}'' riv.$ s.s. = | = 8.12 ^{1/2} riv. | | |
| d.s. = | = 16.24 | | |
| bg. on $\frac{1}{2}'' pl.$ | = 13.13 | | |
| Change in flg. stress = $\frac{1760}{96.2} \times \frac{44.22}{60.67} = 13.32^{1/2} in$ to L ^s and covers | | | |
| | $\times \frac{1}{16} = 3.81^{1/2} in$ from $\frac{1}{2}'' web$ | | |
| | $\times \frac{1}{16} = 4.77^{1/2} in$ " $\frac{5}{8}''$ reinf. web | | |
| | | (Total thickness of web and reinf. pls. = $\frac{1}{2} + \frac{5}{8} + \frac{1}{8} = 1\frac{1}{4}$) | |
| <u>From 0 to 1</u> $p = \frac{2 \times 8.12}{4.77} = 3.4''$ | | | |
| | Use $3\frac{1}{2}''$ for double line | | |
| Cover plates $\frac{1760}{96.2} \times \frac{30.00}{60.67} = 9.05^{1/2} in$ to covers | | | |
| | $p = \frac{4 \times 8.12}{9.05} = 3.6''$ | | |
| | Use $3\frac{1}{2}''$ for quadruple line | | |
| | |  | |

Carrying Girder (Cont.)

| | |
|-----------------|----------|
| DP 10 | |
| Carrying Girder | |
| 1932 | T. C. S. |
| Sheet 3 of 6 | |

Rivet Pitch (Cont.)

From 1 to 2

Change in flange str. $\frac{301.0}{96.1} \times \frac{50.47}{56.47} = 2.80\frac{1}{2}''$ $p = \frac{13.13}{2.80} = 4.7''$ use $4\frac{1}{2}''$ LS to web and covers to LS

From 2 to 3

Change in flange str. $\frac{327.5}{95.1} \times \frac{39.22}{45.22} = 2.99\frac{1}{2}''$ $p = \frac{13.13}{2.99} = 4.4''$ use $4\frac{1}{4}''$ LS to web and covers to LS

From 3 to 4

Change in flange str. $\frac{354.0}{93.9} \times \frac{27.97}{33.97} = 3.11\frac{1}{2}''$ $p = \frac{13.13}{3.11} = 4.22''$ use $4\frac{1}{4}''$ LS to web and covers to LS

From 4 to 5

Change in flange str. $\frac{380.5}{92.0} \times \frac{16.72}{22.72} = 3.05\frac{1}{2}''$ $p = \frac{13.13}{3.05} = 4.30''$ use $4\frac{1}{4}''$ LS to web and covers to LS

From 5 to 6

Change in flange str. $\frac{407.0}{92.0} \times \frac{16.72}{22.72} = 3.26\frac{1}{2}''$ $p = \frac{13.13}{3.26} = 4.03''$ use $4''$ LS to web and covers to LS

* Note that from the right end of the reinforcing webs to the right end of the girder, 2-holes are assumed out of each angle and each cover plate, and that $\frac{1}{4}$ of the web is considered effective as flange area. Also that pitch calculations are based on each cover plate taking a part of the total flange stress at its theoretical end proportional to its area. To ensure this participation requires for the top cover plate:

$$\frac{45.22}{36.47} \times 18 \times \frac{11.25}{8.12} = 20 \text{ rivets between its theoretical end}$$

and its actual end. To provide this riveting add about 3'-4" to the right end of each cover plate. The reader should calculate the pitch required when the cover plates are not developed and decide whether the greater pitch permissible when the plates are so developed offsets the addition of such lengths to the cover plates.

Cover Plate and Web Reinforcement Lengths

| | | |
|---|--|--------------------|
| Moment resisted by main web, LS, and 3-cover pls. | $= \frac{96.1}{12.0} \times 56.47 \times 18.0 =$ | 8140 ^{1k} |
| " " " " " " " " 2- " | $= \frac{95.1}{12.0} \times 45.22 \times 18.0 =$ | 6460 ^{1k} |
| " " " " " " " " 1- " | $= \frac{93.9}{12.0} \times 33.97 \times 18.0 =$ | 4790 ^{1k} |
| " " " " " and angles | $= \frac{92.0}{12.0} \times 22.72 \times 18.0 =$ | 3140 ^{1k} |

For moment diagram and cut-off points for cover plates and web reinforcement plates see Sheet 4.

For design sketch of girder see Sheet 5.

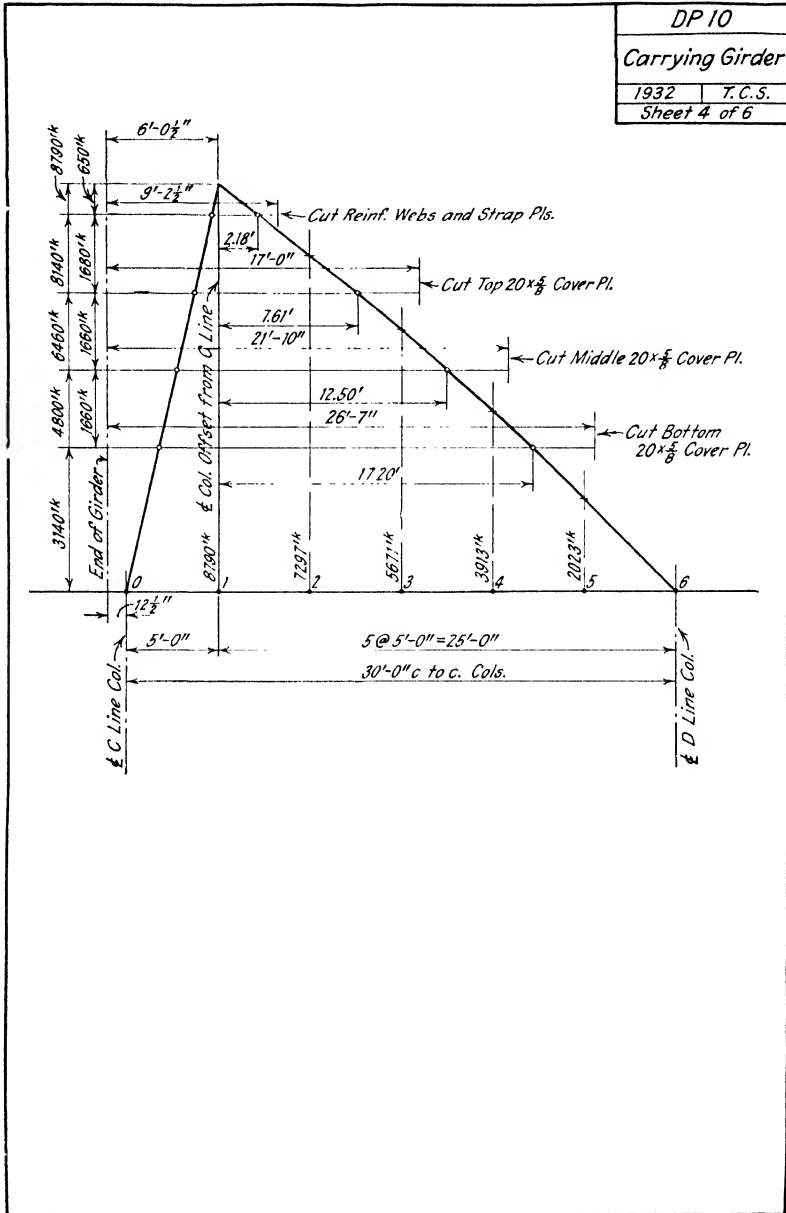

DP10.

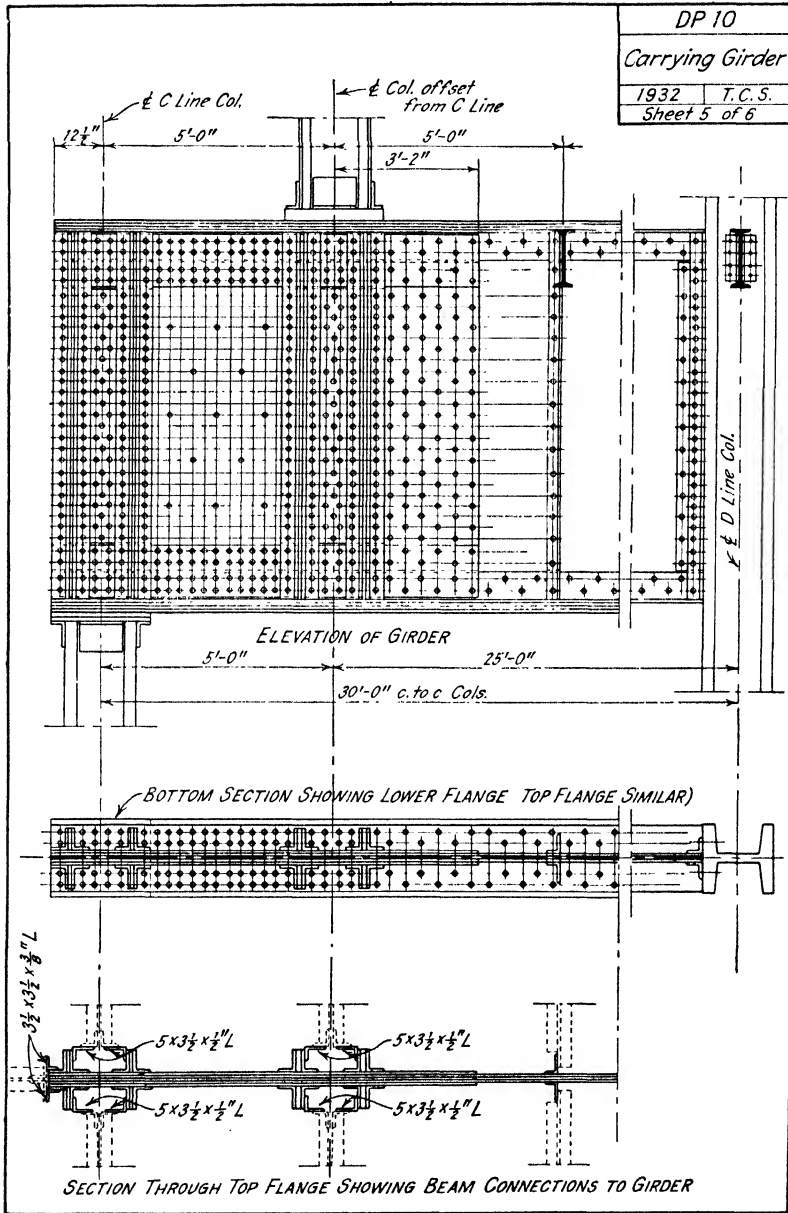

DP10.

| | | | | | | | | | | | | | | | | | | | | | | | | | | | | | | | | | | | | | | | | | | | | | | | | | | | | | | | | | | | | | | | | | | | | | | | | | | | | | | | | | | | | | | | | | | | | | | | | | | | | | | | | | | | | | | | | | | | | | | | | | | | | | | | | | | | | | | | | | | | | | | | | | | | | | | | | | | | | | | | | | | | | | | | |
|--|--|---|----------------------------------|--|----------------|----------------------------------|-------------------------------------|----------------------------------|-------------|---|------------------|-------------------|--------------|---------------------------------|------------------|-------------------|-------|---------------------------------|-------------------|--|-------|---------------------------------|--|--|-----------|---|--|--|------------|---------------------------------|--|--|-------|---------------------------------|--|--|-------|---------------------------------|--|--|----------------|---|--|--|--------------|--------------------------------|---|--|--------------|---------------------------------|--|--|-----------------|---|--|--|---------------|--------------------------------|---|--|---------------|---------------------------------|--|--|-----------------|---|--|--|--------------|--------------------------------|--|--|-----------------|---|--|--|---------------|---|--|--|---------------|--------------------------------|-----------------------|--|-------------|-----------------------|--|--|-----------------|-----------------------|--|--|------------------|---|--|--|----------|--|--|--|-----------------|-----------|--|--|--|------|----------|--------------|--|--------------------------|--|---------------------|--|----------------------------------|--|-----------------------------|--|-----------------------------|--|-----------------------------|--|----------------------------|--|----------------------------|--|-----------------------------|--|-----------------------------|--|----------------------------|--|----------------------------|--|----------------------------|--|---------------------------|--|---------------------------|--|----------------------------|--|---------------------------|--|---------------------------|--|---------------------------|--|---------------------------|--|---------------------------|--|--------------------------|--|---------------------------|--|---------------------------|--|----------------------------|--|-------------------------|--|-------------------------|--|-------|--|-------------------------------------|--|
| <p>Carrying Girder Alternate Design</p> <p><u>Reinforcing webs over flange angles</u></p> <p><i>All calculations not shown on this sheet same as for 1st. design</i></p> <p>1-Girder</p> <table style="width: 100%; border: none;"> <tr> <td style="width: 30%;">1- Main web</td> <td style="width: 30%;">$96 \times \frac{1}{2} = 48.00$</td> <td style="width: 30%;"></td> <td style="width: 10%;"></td> </tr> <tr> <td>2- Reinf. webs</td> <td>$34 \times \frac{3}{8} = 105.75$</td> <td>$= 153.75 \text{ in}^2 \text{ gr.}$</td> <td>$\frac{1}{2} = 17.08 \text{ in}$</td> </tr> <tr> <td>2- Bott. Ls</td> <td>$8 \times 8 \times \frac{1}{2} = 19.22$</td> <td>$- 5.00 = 14.22$</td> <td>$+ 17.08 = 31.30$</td> </tr> <tr> <td>1- Bott. Pl.</td> <td>$20 \times \frac{1}{2} = 12.50$</td> <td>$- 2.50 = 10.00$</td> <td>$+ 31.30 = 41.30$</td> </tr> <tr> <td>1- do</td> <td>$20 \times \frac{1}{2} = 10.00$</td> <td>$+ 41.30 = 51.30$</td> <td></td> </tr> <tr> <td>1- do</td> <td>$20 \times \frac{1}{2} = 10.00$</td> <td>$+ 51.30 = 61.30 \text{ in}^2 \text{ net}$</td> <td></td> </tr> <tr> <td>2- Top Ls</td> <td>$8 \times 8 \times \frac{1}{2} = 19.22$</td> <td></td> <td></td> </tr> <tr> <td>1- Top Pl.</td> <td>$20 \times \frac{1}{2} = 12.50$</td> <td></td> <td></td> </tr> <tr> <td>1- do</td> <td>$20 \times \frac{1}{2} = 10.00$</td> <td></td> <td></td> </tr> <tr> <td>1- do</td> <td>$20 \times \frac{1}{2} = 10.00$</td> <td></td> <td></td> </tr> <tr> <td>8- End Stiffs.</td> <td>$6 \times 4 \times \frac{1}{2} = 55.52$</td> <td></td> <td></td> </tr> <tr> <td>4- End Flats</td> <td>$6 \times \frac{1}{2} = 18.00$</td> <td>$= 73.52 \text{ in}^2 \text{ Bearing area}$</td> <td></td> </tr> <tr> <td>2- End Fills</td> <td>$25 \times \frac{1}{2} = 55.52$</td> <td></td> <td></td> </tr> <tr> <td>8- Col. Stiffs.</td> <td>$6 \times 4 \times \frac{1}{2} = 55.52$</td> <td></td> <td></td> </tr> <tr> <td>4- Col. Flats</td> <td>$6 \times \frac{1}{2} = 28.50$</td> <td>$= 84.02 \text{ in}^2 \text{ Bearing area}$</td> <td></td> </tr> <tr> <td>2- Col. Fills</td> <td>$26 \times \frac{1}{2} = 55.33$</td> <td></td> <td></td> </tr> <tr> <td>2- End Conn. Ls</td> <td>$4 \times 4 \times \frac{1}{2} = 14.00$</td> <td></td> <td></td> </tr> <tr> <td>2- End Fills</td> <td>$7 \times \frac{1}{2} = 10.40$</td> <td></td> <td></td> </tr> <tr> <td>8- Int. Stiffs.</td> <td>$5 \times 3 \frac{1}{2} \times \frac{1}{2} = 10.40$</td> <td></td> <td></td> </tr> <tr> <td>8- Int. Fills</td> <td>$3 \frac{1}{2} \times \frac{1}{2} = 7.40$</td> <td></td> <td></td> </tr> <tr> <td>2- Int. Fills</td> <td>$7 \times \frac{1}{2} = 14.90$</td> <td>at end of reinf. webs</td> <td></td> </tr> <tr> <td>1- Sole Pl.</td> <td>$20 \times 1 = 20.00$</td> <td></td> <td></td> </tr> <tr> <td>1- Col. Bg. Pl.</td> <td>$20 \times 1 = 20.00$</td> <td></td> <td></td> </tr> <tr> <td>8- Beam Conn. Ls</td> <td>$5 \times 3 \frac{1}{2} \times \frac{1}{2} = 13.60$</td> <td></td> <td></td> </tr> <tr> <td>2- " " "</td> <td>$3 \frac{1}{2} \times 3 \frac{1}{2} \times \frac{1}{2} = 8.50$</td> <td></td> <td></td> </tr> <tr> <td>Riv. Heads etc.</td> <td colspan="2">abt. 2.2%</td> <td></td> </tr> </table> | 1- Main web | $96 \times \frac{1}{2} = 48.00$ | | | 2- Reinf. webs | $34 \times \frac{3}{8} = 105.75$ | $= 153.75 \text{ in}^2 \text{ gr.}$ | $\frac{1}{2} = 17.08 \text{ in}$ | 2- Bott. Ls | $8 \times 8 \times \frac{1}{2} = 19.22$ | $- 5.00 = 14.22$ | $+ 17.08 = 31.30$ | 1- Bott. Pl. | $20 \times \frac{1}{2} = 12.50$ | $- 2.50 = 10.00$ | $+ 31.30 = 41.30$ | 1- do | $20 \times \frac{1}{2} = 10.00$ | $+ 41.30 = 51.30$ | | 1- do | $20 \times \frac{1}{2} = 10.00$ | $+ 51.30 = 61.30 \text{ in}^2 \text{ net}$ | | 2- Top Ls | $8 \times 8 \times \frac{1}{2} = 19.22$ | | | 1- Top Pl. | $20 \times \frac{1}{2} = 12.50$ | | | 1- do | $20 \times \frac{1}{2} = 10.00$ | | | 1- do | $20 \times \frac{1}{2} = 10.00$ | | | 8- End Stiffs. | $6 \times 4 \times \frac{1}{2} = 55.52$ | | | 4- End Flats | $6 \times \frac{1}{2} = 18.00$ | $= 73.52 \text{ in}^2 \text{ Bearing area}$ | | 2- End Fills | $25 \times \frac{1}{2} = 55.52$ | | | 8- Col. Stiffs. | $6 \times 4 \times \frac{1}{2} = 55.52$ | | | 4- Col. Flats | $6 \times \frac{1}{2} = 28.50$ | $= 84.02 \text{ in}^2 \text{ Bearing area}$ | | 2- Col. Fills | $26 \times \frac{1}{2} = 55.33$ | | | 2- End Conn. Ls | $4 \times 4 \times \frac{1}{2} = 14.00$ | | | 2- End Fills | $7 \times \frac{1}{2} = 10.40$ | | | 8- Int. Stiffs. | $5 \times 3 \frac{1}{2} \times \frac{1}{2} = 10.40$ | | | 8- Int. Fills | $3 \frac{1}{2} \times \frac{1}{2} = 7.40$ | | | 2- Int. Fills | $7 \times \frac{1}{2} = 14.90$ | at end of reinf. webs | | 1- Sole Pl. | $20 \times 1 = 20.00$ | | | 1- Col. Bg. Pl. | $20 \times 1 = 20.00$ | | | 8- Beam Conn. Ls | $5 \times 3 \frac{1}{2} \times \frac{1}{2} = 13.60$ | | | 2- " " " | $3 \frac{1}{2} \times 3 \frac{1}{2} \times \frac{1}{2} = 8.50$ | | | Riv. Heads etc. | abt. 2.2% | | | <p style="text-align: right;">DP 10</p> <p style="text-align: center;">Carrying Girder</p> <table border="1" style="width: 100%; border-collapse: collapse;"> <tr> <td style="width: 50%;">1932</td> <td style="width: 50%;">T. C. S.</td> </tr> <tr> <td colspan="2" style="text-align: center;">Sheet 6 of 6</td> </tr> </table> <table style="width: 100%; border: none;"> <tr> <td style="width: 50%;">4% Main web excess = 200</td> <td style="width: 50%;"></td> </tr> <tr> <td>3% Reinf. " " = 100</td> <td></td> </tr> <tr> <td>@ 163.2# / $\times 30.3' = 4950$</td> <td></td> </tr> <tr> <td>@ 179.8 $\times 9.2 = 3310$</td> <td></td> </tr> <tr> <td>@ 32.7 $\times 30.3 = 1980$</td> <td></td> </tr> <tr> <td>@ 42.5 $\times 26.6 = 1130$</td> <td></td> </tr> <tr> <td>@ 42.5 $\times 21.8 = 930$</td> <td></td> </tr> <tr> <td>@ 42.5 $\times 17.0 = 720$</td> <td></td> </tr> <tr> <td>@ 32.7 $\times 30.3 = 1980$</td> <td></td> </tr> <tr> <td>@ 42.5 $\times 26.6 = 1130$</td> <td></td> </tr> <tr> <td>@ 42.5 $\times 21.8 = 930$</td> <td></td> </tr> <tr> <td>@ 42.5 $\times 17.0 = 720$</td> <td></td> </tr> <tr> <td>@ 23.6 $\times 7.9 = 1490$</td> <td></td> </tr> <tr> <td>@ 15.3 $\times 7.9 = 480$</td> <td></td> </tr> <tr> <td>@ 53.1 $\times 6.7 = 710$</td> <td></td> </tr> <tr> <td>@ 23.6 $\times 7.9 = 1490$</td> <td></td> </tr> <tr> <td>@ 24.2 $\times 7.9 = 760$</td> <td></td> </tr> <tr> <td>@ 55.3 $\times 6.7 = 740$</td> <td></td> </tr> <tr> <td>@ 15.7 $\times 7.9 = 250$</td> <td></td> </tr> <tr> <td>@ 14.9 $\times 6.7 = 200$</td> <td></td> </tr> <tr> <td>@ 10.4 $\times 7.9 = 660$</td> <td></td> </tr> <tr> <td>@ 7.4 $\times 6.7 = 400$</td> <td></td> </tr> <tr> <td>@ 14.9 $\times 6.7 = 200$</td> <td></td> </tr> <tr> <td>@ 68.0 $\times 2.1 = 140$</td> <td></td> </tr> <tr> <td>@ 204.0 $\times 2.2 = 450$</td> <td></td> </tr> <tr> <td>@ 13.6 $\times .8 = 90$</td> <td></td> </tr> <tr> <td>@ 8.5 $\times 1.0 = 20$</td> <td></td> </tr> <tr> <td>= 540</td> <td></td> </tr> <tr> <td>Total for 1-Girder = 26,700#</td> <td></td> </tr> </table> | 1932 | T. C. S. | Sheet 6 of 6 | | 4% Main web excess = 200 | | 3% Reinf. " " = 100 | | @ 163.2# / $\times 30.3' = 4950$ | | @ 179.8 $\times 9.2 = 3310$ | | @ 32.7 $\times 30.3 = 1980$ | | @ 42.5 $\times 26.6 = 1130$ | | @ 42.5 $\times 21.8 = 930$ | | @ 42.5 $\times 17.0 = 720$ | | @ 32.7 $\times 30.3 = 1980$ | | @ 42.5 $\times 26.6 = 1130$ | | @ 42.5 $\times 21.8 = 930$ | | @ 42.5 $\times 17.0 = 720$ | | @ 23.6 $\times 7.9 = 1490$ | | @ 15.3 $\times 7.9 = 480$ | | @ 53.1 $\times 6.7 = 710$ | | @ 23.6 $\times 7.9 = 1490$ | | @ 24.2 $\times 7.9 = 760$ | | @ 55.3 $\times 6.7 = 740$ | | @ 15.7 $\times 7.9 = 250$ | | @ 14.9 $\times 6.7 = 200$ | | @ 10.4 $\times 7.9 = 660$ | | @ 7.4 $\times 6.7 = 400$ | | @ 14.9 $\times 6.7 = 200$ | | @ 68.0 $\times 2.1 = 140$ | | @ 204.0 $\times 2.2 = 450$ | | @ 13.6 $\times .8 = 90$ | | @ 8.5 $\times 1.0 = 20$ | | = 540 | | Total for 1-Girder = 26,700# | |
| 1- Main web | $96 \times \frac{1}{2} = 48.00$ | | | | | | | | | | | | | | | | | | | | | | | | | | | | | | | | | | | | | | | | | | | | | | | | | | | | | | | | | | | | | | | | | | | | | | | | | | | | | | | | | | | | | | | | | | | | | | | | | | | | | | | | | | | | | | | | | | | | | | | | | | | | | | | | | | | | | | | | | | | | | | | | | | | | | | | | | | | | | | | | | | | | | | |
| 2- Reinf. webs | $34 \times \frac{3}{8} = 105.75$ | $= 153.75 \text{ in}^2 \text{ gr.}$ | $\frac{1}{2} = 17.08 \text{ in}$ | | | | | | | | | | | | | | | | | | | | | | | | | | | | | | | | | | | | | | | | | | | | | | | | | | | | | | | | | | | | | | | | | | | | | | | | | | | | | | | | | | | | | | | | | | | | | | | | | | | | | | | | | | | | | | | | | | | | | | | | | | | | | | | | | | | | | | | | | | | | | | | | | | | | | | | | | | | | | | | | | | | | |
| 2- Bott. Ls | $8 \times 8 \times \frac{1}{2} = 19.22$ | $- 5.00 = 14.22$ | $+ 17.08 = 31.30$ | | | | | | | | | | | | | | | | | | | | | | | | | | | | | | | | | | | | | | | | | | | | | | | | | | | | | | | | | | | | | | | | | | | | | | | | | | | | | | | | | | | | | | | | | | | | | | | | | | | | | | | | | | | | | | | | | | | | | | | | | | | | | | | | | | | | | | | | | | | | | | | | | | | | | | | | | | | | | | | | | | | | |
| 1- Bott. Pl. | $20 \times \frac{1}{2} = 12.50$ | $- 2.50 = 10.00$ | $+ 31.30 = 41.30$ | | | | | | | | | | | | | | | | | | | | | | | | | | | | | | | | | | | | | | | | | | | | | | | | | | | | | | | | | | | | | | | | | | | | | | | | | | | | | | | | | | | | | | | | | | | | | | | | | | | | | | | | | | | | | | | | | | | | | | | | | | | | | | | | | | | | | | | | | | | | | | | | | | | | | | | | | | | | | | | | | | | | |
| 1- do | $20 \times \frac{1}{2} = 10.00$ | $+ 41.30 = 51.30$ | | | | | | | | | | | | | | | | | | | | | | | | | | | | | | | | | | | | | | | | | | | | | | | | | | | | | | | | | | | | | | | | | | | | | | | | | | | | | | | | | | | | | | | | | | | | | | | | | | | | | | | | | | | | | | | | | | | | | | | | | | | | | | | | | | | | | | | | | | | | | | | | | | | | | | | | | | | | | | | | | | | | | |
| 1- do | $20 \times \frac{1}{2} = 10.00$ | $+ 51.30 = 61.30 \text{ in}^2 \text{ net}$ | | | | | | | | | | | | | | | | | | | | | | | | | | | | | | | | | | | | | | | | | | | | | | | | | | | | | | | | | | | | | | | | | | | | | | | | | | | | | | | | | | | | | | | | | | | | | | | | | | | | | | | | | | | | | | | | | | | | | | | | | | | | | | | | | | | | | | | | | | | | | | | | | | | | | | | | | | | | | | | | | | | | | |
| 2- Top Ls | $8 \times 8 \times \frac{1}{2} = 19.22$ | | | | | | | | | | | | | | | | | | | | | | | | | | | | | | | | | | | | | | | | | | | | | | | | | | | | | | | | | | | | | | | | | | | | | | | | | | | | | | | | | | | | | | | | | | | | | | | | | | | | | | | | | | | | | | | | | | | | | | | | | | | | | | | | | | | | | | | | | | | | | | | | | | | | | | | | | | | | | | | | | | | | | | |
| 1- Top Pl. | $20 \times \frac{1}{2} = 12.50$ | | | | | | | | | | | | | | | | | | | | | | | | | | | | | | | | | | | | | | | | | | | | | | | | | | | | | | | | | | | | | | | | | | | | | | | | | | | | | | | | | | | | | | | | | | | | | | | | | | | | | | | | | | | | | | | | | | | | | | | | | | | | | | | | | | | | | | | | | | | | | | | | | | | | | | | | | | | | | | | | | | | | | | |
| 1- do | $20 \times \frac{1}{2} = 10.00$ | | | | | | | | | | | | | | | | | | | | | | | | | | | | | | | | | | | | | | | | | | | | | | | | | | | | | | | | | | | | | | | | | | | | | | | | | | | | | | | | | | | | | | | | | | | | | | | | | | | | | | | | | | | | | | | | | | | | | | | | | | | | | | | | | | | | | | | | | | | | | | | | | | | | | | | | | | | | | | | | | | | | | | |
| 1- do | $20 \times \frac{1}{2} = 10.00$ | | | | | | | | | | | | | | | | | | | | | | | | | | | | | | | | | | | | | | | | | | | | | | | | | | | | | | | | | | | | | | | | | | | | | | | | | | | | | | | | | | | | | | | | | | | | | | | | | | | | | | | | | | | | | | | | | | | | | | | | | | | | | | | | | | | | | | | | | | | | | | | | | | | | | | | | | | | | | | | | | | | | | | |
| 8- End Stiffs. | $6 \times 4 \times \frac{1}{2} = 55.52$ | | | | | | | | | | | | | | | | | | | | | | | | | | | | | | | | | | | | | | | | | | | | | | | | | | | | | | | | | | | | | | | | | | | | | | | | | | | | | | | | | | | | | | | | | | | | | | | | | | | | | | | | | | | | | | | | | | | | | | | | | | | | | | | | | | | | | | | | | | | | | | | | | | | | | | | | | | | | | | | | | | | | | | |
| 4- End Flats | $6 \times \frac{1}{2} = 18.00$ | $= 73.52 \text{ in}^2 \text{ Bearing area}$ | | | | | | | | | | | | | | | | | | | | | | | | | | | | | | | | | | | | | | | | | | | | | | | | | | | | | | | | | | | | | | | | | | | | | | | | | | | | | | | | | | | | | | | | | | | | | | | | | | | | | | | | | | | | | | | | | | | | | | | | | | | | | | | | | | | | | | | | | | | | | | | | | | | | | | | | | | | | | | | | | | | | | |
| 2- End Fills | $25 \times \frac{1}{2} = 55.52$ | | | | | | | | | | | | | | | | | | | | | | | | | | | | | | | | | | | | | | | | | | | | | | | | | | | | | | | | | | | | | | | | | | | | | | | | | | | | | | | | | | | | | | | | | | | | | | | | | | | | | | | | | | | | | | | | | | | | | | | | | | | | | | | | | | | | | | | | | | | | | | | | | | | | | | | | | | | | | | | | | | | | | | |
| 8- Col. Stiffs. | $6 \times 4 \times \frac{1}{2} = 55.52$ | | | | | | | | | | | | | | | | | | | | | | | | | | | | | | | | | | | | | | | | | | | | | | | | | | | | | | | | | | | | | | | | | | | | | | | | | | | | | | | | | | | | | | | | | | | | | | | | | | | | | | | | | | | | | | | | | | | | | | | | | | | | | | | | | | | | | | | | | | | | | | | | | | | | | | | | | | | | | | | | | | | | | | |
| 4- Col. Flats | $6 \times \frac{1}{2} = 28.50$ | $= 84.02 \text{ in}^2 \text{ Bearing area}$ | | | | | | | | | | | | | | | | | | | | | | | | | | | | | | | | | | | | | | | | | | | | | | | | | | | | | | | | | | | | | | | | | | | | | | | | | | | | | | | | | | | | | | | | | | | | | | | | | | | | | | | | | | | | | | | | | | | | | | | | | | | | | | | | | | | | | | | | | | | | | | | | | | | | | | | | | | | | | | | | | | | | | |
| 2- Col. Fills | $26 \times \frac{1}{2} = 55.33$ | | | | | | | | | | | | | | | | | | | | | | | | | | | | | | | | | | | | | | | | | | | | | | | | | | | | | | | | | | | | | | | | | | | | | | | | | | | | | | | | | | | | | | | | | | | | | | | | | | | | | | | | | | | | | | | | | | | | | | | | | | | | | | | | | | | | | | | | | | | | | | | | | | | | | | | | | | | | | | | | | | | | | | |
| 2- End Conn. Ls | $4 \times 4 \times \frac{1}{2} = 14.00$ | | | | | | | | | | | | | | | | | | | | | | | | | | | | | | | | | | | | | | | | | | | | | | | | | | | | | | | | | | | | | | | | | | | | | | | | | | | | | | | | | | | | | | | | | | | | | | | | | | | | | | | | | | | | | | | | | | | | | | | | | | | | | | | | | | | | | | | | | | | | | | | | | | | | | | | | | | | | | | | | | | | | | | |
| 2- End Fills | $7 \times \frac{1}{2} = 10.40$ | | | | | | | | | | | | | | | | | | | | | | | | | | | | | | | | | | | | | | | | | | | | | | | | | | | | | | | | | | | | | | | | | | | | | | | | | | | | | | | | | | | | | | | | | | | | | | | | | | | | | | | | | | | | | | | | | | | | | | | | | | | | | | | | | | | | | | | | | | | | | | | | | | | | | | | | | | | | | | | | | | | | | | |
| 8- Int. Stiffs. | $5 \times 3 \frac{1}{2} \times \frac{1}{2} = 10.40$ | | | | | | | | | | | | | | | | | | | | | | | | | | | | | | | | | | | | | | | | | | | | | | | | | | | | | | | | | | | | | | | | | | | | | | | | | | | | | | | | | | | | | | | | | | | | | | | | | | | | | | | | | | | | | | | | | | | | | | | | | | | | | | | | | | | | | | | | | | | | | | | | | | | | | | | | | | | | | | | | | | | | | | |
| 8- Int. Fills | $3 \frac{1}{2} \times \frac{1}{2} = 7.40$ | | | | | | | | | | | | | | | | | | | | | | | | | | | | | | | | | | | | | | | | | | | | | | | | | | | | | | | | | | | | | | | | | | | | | | | | | | | | | | | | | | | | | | | | | | | | | | | | | | | | | | | | | | | | | | | | | | | | | | | | | | | | | | | | | | | | | | | | | | | | | | | | | | | | | | | | | | | | | | | | | | | | | | |
| 2- Int. Fills | $7 \times \frac{1}{2} = 14.90$ | at end of reinf. webs | | | | | | | | | | | | | | | | | | | | | | | | | | | | | | | | | | | | | | | | | | | | | | | | | | | | | | | | | | | | | | | | | | | | | | | | | | | | | | | | | | | | | | | | | | | | | | | | | | | | | | | | | | | | | | | | | | | | | | | | | | | | | | | | | | | | | | | | | | | | | | | | | | | | | | | | | | | | | | | | | | | | | |
| 1- Sole Pl. | $20 \times 1 = 20.00$ | | | | | | | | | | | | | | | | | | | | | | | | | | | | | | | | | | | | | | | | | | | | | | | | | | | | | | | | | | | | | | | | | | | | | | | | | | | | | | | | | | | | | | | | | | | | | | | | | | | | | | | | | | | | | | | | | | | | | | | | | | | | | | | | | | | | | | | | | | | | | | | | | | | | | | | | | | | | | | | | | | | | | | |
| 1- Col. Bg. Pl. | $20 \times 1 = 20.00$ | | | | | | | | | | | | | | | | | | | | | | | | | | | | | | | | | | | | | | | | | | | | | | | | | | | | | | | | | | | | | | | | | | | | | | | | | | | | | | | | | | | | | | | | | | | | | | | | | | | | | | | | | | | | | | | | | | | | | | | | | | | | | | | | | | | | | | | | | | | | | | | | | | | | | | | | | | | | | | | | | | | | | | |
| 8- Beam Conn. Ls | $5 \times 3 \frac{1}{2} \times \frac{1}{2} = 13.60$ | | | | | | | | | | | | | | | | | | | | | | | | | | | | | | | | | | | | | | | | | | | | | | | | | | | | | | | | | | | | | | | | | | | | | | | | | | | | | | | | | | | | | | | | | | | | | | | | | | | | | | | | | | | | | | | | | | | | | | | | | | | | | | | | | | | | | | | | | | | | | | | | | | | | | | | | | | | | | | | | | | | | | | |
| 2- " " " | $3 \frac{1}{2} \times 3 \frac{1}{2} \times \frac{1}{2} = 8.50$ | | | | | | | | | | | | | | | | | | | | | | | | | | | | | | | | | | | | | | | | | | | | | | | | | | | | | | | | | | | | | | | | | | | | | | | | | | | | | | | | | | | | | | | | | | | | | | | | | | | | | | | | | | | | | | | | | | | | | | | | | | | | | | | | | | | | | | | | | | | | | | | | | | | | | | | | | | | | | | | | | | | | | | |
| Riv. Heads etc. | abt. 2.2% | | | | | | | | | | | | | | | | | | | | | | | | | | | | | | | | | | | | | | | | | | | | | | | | | | | | | | | | | | | | | | | | | | | | | | | | | | | | | | | | | | | | | | | | | | | | | | | | | | | | | | | | | | | | | | | | | | | | | | | | | | | | | | | | | | | | | | | | | | | | | | | | | | | | | | | | | | | | | | | | | | | | | | |
| 1932 | T. C. S. | | | | | | | | | | | | | | | | | | | | | | | | | | | | | | | | | | | | | | | | | | | | | | | | | | | | | | | | | | | | | | | | | | | | | | | | | | | | | | | | | | | | | | | | | | | | | | | | | | | | | | | | | | | | | | | | | | | | | | | | | | | | | | | | | | | | | | | | | | | | | | | | | | | | | | | | | | | | | | | | | | | | | | |
| Sheet 6 of 6 | | | | | | | | | | | | | | | | | | | | | | | | | | | | | | | | | | | | | | | | | | | | | | | | | | | | | | | | | | | | | | | | | | | | | | | | | | | | | | | | | | | | | | | | | | | | | | | | | | | | | | | | | | | | | | | | | | | | | | | | | | | | | | | | | | | | | | | | | | | | | | | | | | | | | | | | | | | | | | | | | | | | | | | |
| 4% Main web excess = 200 | | | | | | | | | | | | | | | | | | | | | | | | | | | | | | | | | | | | | | | | | | | | | | | | | | | | | | | | | | | | | | | | | | | | | | | | | | | | | | | | | | | | | | | | | | | | | | | | | | | | | | | | | | | | | | | | | | | | | | | | | | | | | | | | | | | | | | | | | | | | | | | | | | | | | | | | | | | | | | | | | | | | | | | |
| 3% Reinf. " " = 100 | | | | | | | | | | | | | | | | | | | | | | | | | | | | | | | | | | | | | | | | | | | | | | | | | | | | | | | | | | | | | | | | | | | | | | | | | | | | | | | | | | | | | | | | | | | | | | | | | | | | | | | | | | | | | | | | | | | | | | | | | | | | | | | | | | | | | | | | | | | | | | | | | | | | | | | | | | | | | | | | | | | | | | | |
| @ 163.2# / $\times 30.3' = 4950$ | | | | | | | | | | | | | | | | | | | | | | | | | | | | | | | | | | | | | | | | | | | | | | | | | | | | | | | | | | | | | | | | | | | | | | | | | | | | | | | | | | | | | | | | | | | | | | | | | | | | | | | | | | | | | | | | | | | | | | | | | | | | | | | | | | | | | | | | | | | | | | | | | | | | | | | | | | | | | | | | | | | | | | | |
| @ 179.8 $\times 9.2 = 3310$ | | | | | | | | | | | | | | | | | | | | | | | | | | | | | | | | | | | | | | | | | | | | | | | | | | | | | | | | | | | | | | | | | | | | | | | | | | | | | | | | | | | | | | | | | | | | | | | | | | | | | | | | | | | | | | | | | | | | | | | | | | | | | | | | | | | | | | | | | | | | | | | | | | | | | | | | | | | | | | | | | | | | | | | |
| @ 32.7 $\times 30.3 = 1980$ | | | | | | | | | | | | | | | | | | | | | | | | | | | | | | | | | | | | | | | | | | | | | | | | | | | | | | | | | | | | | | | | | | | | | | | | | | | | | | | | | | | | | | | | | | | | | | | | | | | | | | | | | | | | | | | | | | | | | | | | | | | | | | | | | | | | | | | | | | | | | | | | | | | | | | | | | | | | | | | | | | | | | | | |
| @ 42.5 $\times 26.6 = 1130$ | | | | | | | | | | | | | | | | | | | | | | | | | | | | | | | | | | | | | | | | | | | | | | | | | | | | | | | | | | | | | | | | | | | | | | | | | | | | | | | | | | | | | | | | | | | | | | | | | | | | | | | | | | | | | | | | | | | | | | | | | | | | | | | | | | | | | | | | | | | | | | | | | | | | | | | | | | | | | | | | | | | | | | | |
| @ 42.5 $\times 21.8 = 930$ | | | | | | | | | | | | | | | | | | | | | | | | | | | | | | | | | | | | | | | | | | | | | | | | | | | | | | | | | | | | | | | | | | | | | | | | | | | | | | | | | | | | | | | | | | | | | | | | | | | | | | | | | | | | | | | | | | | | | | | | | | | | | | | | | | | | | | | | | | | | | | | | | | | | | | | | | | | | | | | | | | | | | | | |
| @ 42.5 $\times 17.0 = 720$ | | | | | | | | | | | | | | | | | | | | | | | | | | | | | | | | | | | | | | | | | | | | | | | | | | | | | | | | | | | | | | | | | | | | | | | | | | | | | | | | | | | | | | | | | | | | | | | | | | | | | | | | | | | | | | | | | | | | | | | | | | | | | | | | | | | | | | | | | | | | | | | | | | | | | | | | | | | | | | | | | | | | | | | |
| @ 32.7 $\times 30.3 = 1980$ | | | | | | | | | | | | | | | | | | | | | | | | | | | | | | | | | | | | | | | | | | | | | | | | | | | | | | | | | | | | | | | | | | | | | | | | | | | | | | | | | | | | | | | | | | | | | | | | | | | | | | | | | | | | | | | | | | | | | | | | | | | | | | | | | | | | | | | | | | | | | | | | | | | | | | | | | | | | | | | | | | | | | | | |
| @ 42.5 $\times 26.6 = 1130$ | | | | | | | | | | | | | | | | | | | | | | | | | | | | | | | | | | | | | | | | | | | | | | | | | | | | | | | | | | | | | | | | | | | | | | | | | | | | | | | | | | | | | | | | | | | | | | | | | | | | | | | | | | | | | | | | | | | | | | | | | | | | | | | | | | | | | | | | | | | | | | | | | | | | | | | | | | | | | | | | | | | | | | | |
| @ 42.5 $\times 21.8 = 930$ | | | | | | | | | | | | | | | | | | | | | | | | | | | | | | | | | | | | | | | | | | | | | | | | | | | | | | | | | | | | | | | | | | | | | | | | | | | | | | | | | | | | | | | | | | | | | | | | | | | | | | | | | | | | | | | | | | | | | | | | | | | | | | | | | | | | | | | | | | | | | | | | | | | | | | | | | | | | | | | | | | | | | | | |
| @ 42.5 $\times 17.0 = 720$ | | | | | | | | | | | | | | | | | | | | | | | | | | | | | | | | | | | | | | | | | | | | | | | | | | | | | | | | | | | | | | | | | | | | | | | | | | | | | | | | | | | | | | | | | | | | | | | | | | | | | | | | | | | | | | | | | | | | | | | | | | | | | | | | | | | | | | | | | | | | | | | | | | | | | | | | | | | | | | | | | | | | | | | |
| @ 23.6 $\times 7.9 = 1490$ | | | | | | | | | | | | | | | | | | | | | | | | | | | | | | | | | | | | | | | | | | | | | | | | | | | | | | | | | | | | | | | | | | | | | | | | | | | | | | | | | | | | | | | | | | | | | | | | | | | | | | | | | | | | | | | | | | | | | | | | | | | | | | | | | | | | | | | | | | | | | | | | | | | | | | | | | | | | | | | | | | | | | | | |
| @ 15.3 $\times 7.9 = 480$ | | | | | | | | | | | | | | | | | | | | | | | | | | | | | | | | | | | | | | | | | | | | | | | | | | | | | | | | | | | | | | | | | | | | | | | | | | | | | | | | | | | | | | | | | | | | | | | | | | | | | | | | | | | | | | | | | | | | | | | | | | | | | | | | | | | | | | | | | | | | | | | | | | | | | | | | | | | | | | | | | | | | | | | |
| @ 53.1 $\times 6.7 = 710$ | | | | | | | | | | | | | | | | | | | | | | | | | | | | | | | | | | | | | | | | | | | | | | | | | | | | | | | | | | | | | | | | | | | | | | | | | | | | | | | | | | | | | | | | | | | | | | | | | | | | | | | | | | | | | | | | | | | | | | | | | | | | | | | | | | | | | | | | | | | | | | | | | | | | | | | | | | | | | | | | | | | | | | | |
| @ 23.6 $\times 7.9 = 1490$ | | | | | | | | | | | | | | | | | | | | | | | | | | | | | | | | | | | | | | | | | | | | | | | | | | | | | | | | | | | | | | | | | | | | | | | | | | | | | | | | | | | | | | | | | | | | | | | | | | | | | | | | | | | | | | | | | | | | | | | | | | | | | | | | | | | | | | | | | | | | | | | | | | | | | | | | | | | | | | | | | | | | | | | |
| @ 24.2 $\times 7.9 = 760$ | | | | | | | | | | | | | | | | | | | | | | | | | | | | | | | | | | | | | | | | | | | | | | | | | | | | | | | | | | | | | | | | | | | | | | | | | | | | | | | | | | | | | | | | | | | | | | | | | | | | | | | | | | | | | | | | | | | | | | | | | | | | | | | | | | | | | | | | | | | | | | | | | | | | | | | | | | | | | | | | | | | | | | | |
| @ 55.3 $\times 6.7 = 740$ | | | | | | | | | | | | | | | | | | | | | | | | | | | | | | | | | | | | | | | | | | | | | | | | | | | | | | | | | | | | | | | | | | | | | | | | | | | | | | | | | | | | | | | | | | | | | | | | | | | | | | | | | | | | | | | | | | | | | | | | | | | | | | | | | | | | | | | | | | | | | | | | | | | | | | | | | | | | | | | | | | | | | | | |
| @ 15.7 $\times 7.9 = 250$ | | | | | | | | | | | | | | | | | | | | | | | | | | | | | | | | | | | | | | | | | | | | | | | | | | | | | | | | | | | | | | | | | | | | | | | | | | | | | | | | | | | | | | | | | | | | | | | | | | | | | | | | | | | | | | | | | | | | | | | | | | | | | | | | | | | | | | | | | | | | | | | | | | | | | | | | | | | | | | | | | | | | | | | |
| @ 14.9 $\times 6.7 = 200$ | | | | | | | | | | | | | | | | | | | | | | | | | | | | | | | | | | | | | | | | | | | | | | | | | | | | | | | | | | | | | | | | | | | | | | | | | | | | | | | | | | | | | | | | | | | | | | | | | | | | | | | | | | | | | | | | | | | | | | | | | | | | | | | | | | | | | | | | | | | | | | | | | | | | | | | | | | | | | | | | | | | | | | | |
| @ 10.4 $\times 7.9 = 660$ | | | | | | | | | | | | | | | | | | | | | | | | | | | | | | | | | | | | | | | | | | | | | | | | | | | | | | | | | | | | | | | | | | | | | | | | | | | | | | | | | | | | | | | | | | | | | | | | | | | | | | | | | | | | | | | | | | | | | | | | | | | | | | | | | | | | | | | | | | | | | | | | | | | | | | | | | | | | | | | | | | | | | | | |
| @ 7.4 $\times 6.7 = 400$ | | | | | | | | | | | | | | | | | | | | | | | | | | | | | | | | | | | | | | | | | | | | | | | | | | | | | | | | | | | | | | | | | | | | | | | | | | | | | | | | | | | | | | | | | | | | | | | | | | | | | | | | | | | | | | | | | | | | | | | | | | | | | | | | | | | | | | | | | | | | | | | | | | | | | | | | | | | | | | | | | | | | | | | |
| @ 14.9 $\times 6.7 = 200$ | | | | | | | | | | | | | | | | | | | | | | | | | | | | | | | | | | | | | | | | | | | | | | | | | | | | | | | | | | | | | | | | | | | | | | | | | | | | | | | | | | | | | | | | | | | | | | | | | | | | | | | | | | | | | | | | | | | | | | | | | | | | | | | | | | | | | | | | | | | | | | | | | | | | | | | | | | | | | | | | | | | | | | | |
| @ 68.0 $\times 2.1 = 140$ | | | | | | | | | | | | | | | | | | | | | | | | | | | | | | | | | | | | | | | | | | | | | | | | | | | | | | | | | | | | | | | | | | | | | | | | | | | | | | | | | | | | | | | | | | | | | | | | | | | | | | | | | | | | | | | | | | | | | | | | | | | | | | | | | | | | | | | | | | | | | | | | | | | | | | | | | | | | | | | | | | | | | | | |
| @ 204.0 $\times 2.2 = 450$ | | | | | | | | | | | | | | | | | | | | | | | | | | | | | | | | | | | | | | | | | | | | | | | | | | | | | | | | | | | | | | | | | | | | | | | | | | | | | | | | | | | | | | | | | | | | | | | | | | | | | | | | | | | | | | | | | | | | | | | | | | | | | | | | | | | | | | | | | | | | | | | | | | | | | | | | | | | | | | | | | | | | | | | |
| @ 13.6 $\times .8 = 90$ | | | | | | | | | | | | | | | | | | | | | | | | | | | | | | | | | | | | | | | | | | | | | | | | | | | | | | | | | | | | | | | | | | | | | | | | | | | | | | | | | | | | | | | | | | | | | | | | | | | | | | | | | | | | | | | | | | | | | | | | | | | | | | | | | | | | | | | | | | | | | | | | | | | | | | | | | | | | | | | | | | | | | | | |
| @ 8.5 $\times 1.0 = 20$ | | | | | | | | | | | | | | | | | | | | | | | | | | | | | | | | | | | | | | | | | | | | | | | | | | | | | | | | | | | | | | | | | | | | | | | | | | | | | | | | | | | | | | | | | | | | | | | | | | | | | | | | | | | | | | | | | | | | | | | | | | | | | | | | | | | | | | | | | | | | | | | | | | | | | | | | | | | | | | | | | | | | | | | |
| = 540 | | | | | | | | | | | | | | | | | | | | | | | | | | | | | | | | | | | | | | | | | | | | | | | | | | | | | | | | | | | | | | | | | | | | | | | | | | | | | | | | | | | | | | | | | | | | | | | | | | | | | | | | | | | | | | | | | | | | | | | | | | | | | | | | | | | | | | | | | | | | | | | | | | | | | | | | | | | | | | | | | | | | | | | |
| Total for 1-Girder = 26,700# | | | | | | | | | | | | | | | | | | | | | | | | | | | | | | | | | | | | | | | | | | | | | | | | | | | | | | | | | | | | | | | | | | | | | | | | | | | | | | | | | | | | | | | | | | | | | | | | | | | | | | | | | | | | | | | | | | | | | | | | | | | | | | | | | | | | | | | | | | | | | | | | | | | | | | | | | | | | | | | | | | | | | | | |

Rivet Pitch

$\frac{7}{8}$ " riv. s.s. = 8.12"
 d.s. = 16.24"
 bg. on $\frac{1}{2}$ " pl. = 13.13"

From 0 to 1

Change in flange stress = $\frac{1760}{96.2} \times \frac{4.4}{61.30} = 13.25\% \text{ to Ls and cover pls.}$

$\times \frac{8}{26} = 4.08\% \text{ from } \frac{1}{2} \text{ " web}$
 $\times \frac{8}{26} = 4.58\% \text{ " } \frac{8}{16} \text{ " reinf. web}$

$p = \frac{2 \times 8.12}{4.58} = 3.54 \text{ "}$ for double line use $3 \frac{1}{2}$ "

Cover Plates

$\frac{1760 \times 30.00}{96.2 \times 61.30} = 8.98\% \text{ to cover pls.}$

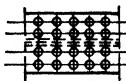
$p = \frac{4 \times 8.12}{8.98} = 3.62 \text{ "}$ for quadruple line

and a girder having this I built up by trial. The value of c may not be known in advance but it can be estimated with sufficient accuracy for a trial design and corrected as the girder is proportioned. The distance, c , sometimes can be fixed and the proportions of the girder adjusted to fit. Tables giving the moment of inertia of four angles of different sizes and

| SCHEDULE OF GIRDER MATERIALS | | | | | | |
|------------------------------|--|----------------------------|--|-------------------------|-------------------------|----------------------|
| Girder Mark | Web Pls. | Flg. Ls | Flg. Pls. | Fills "a" | Fills "b" | Billet Thickness "c" |
| A-S9 | 1Pl.-80"x $\frac{3}{8}$ " 2Pl.-78"x $\frac{3}{8}$ " | 4Ls-8"x8"x $\frac{1}{8}$ " | d-2Pl.18"x $\frac{3}{8}$ " e-2Pl.18"x $\frac{3}{8}$ " | | 6"x2 $\frac{5}{8}$ "Pl. | 2 $\frac{3}{8}$ " |
| B-S9 | 1Pl.-80"x $\frac{1}{2}$ " 2Pl.-78"x $\frac{1}{2}$ " | 4Ls-8"x8"x $\frac{1}{8}$ " | d-2Pl.18"x $\frac{1}{2}$ " e-2Pl.18"x $\frac{1}{2}$ " | 6"x1 $\frac{5}{8}$ "Pl. | 6"x2 $\frac{5}{8}$ "Pl. | 1 $\frac{1}{2}$ " |
| C-S9 | 1Pl.-80"x $\frac{3}{8}$ " 2Pl.-78"x $\frac{3}{8}$ " | 4Ls-8"x8"x $\frac{1}{8}$ " | d-2Pl.18"x $\frac{1}{2}$ " e-2Pl.18"x $\frac{1}{2}$ " | 6"x1 $\frac{5}{8}$ "Pl. | 6"x2 $\frac{5}{8}$ "Pl. | 1 $\frac{1}{2}$ " |
| D-S9 | 1Pl.-80"x $\frac{1}{2}$ " 2Pl.-78"x $\frac{1}{2}$ " | 4Ls-8"x8"x $\frac{1}{8}$ " | d-2Pl.20"x $\frac{1}{2}$ " e-2Pl.20"x $\frac{1}{2}$ " f-2Pl.20"x $\frac{1}{2}$ " | 6"x1 $\frac{5}{8}$ "Pl. | 6"x2 $\frac{5}{8}$ "Pl. | $\frac{3}{4}$ " |
| E-S9 | 1Pl.-120"x $\frac{1}{2}$ " 2Pl.-118"x $\frac{1}{2}$ " | 4Ls-8"x8"x $\frac{1}{8}$ " | d-2Pl.20"x $\frac{1}{2}$ " e-2Pl.20"x $\frac{1}{2}$ " f-2Pl.20"x $\frac{1}{2}$ " | 6"x3"Pl. | 6"x4 $\frac{3}{8}$ "Pl. | 1" |

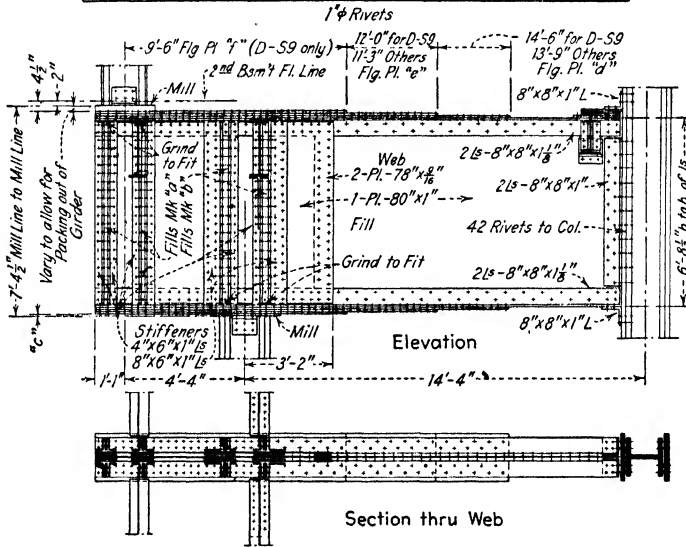

FIG. 92(a).—Detail of Girders A-S9, B-S9, C-S9, and D-S9. Girder D-S9 Shown.

weights, and the moment of inertia of plates of different thicknesses, placed as shown in Fig. 93, are essential in the design of girders by this method. Such tables are given in the "Design of Plate Girders" * by

* McGraw-Hill Book Company.

L. E. Moore, the "Structural Engineer's Handbook" * by M. S. Ketchum, and in the later printings of the first edition of "Steel Con-

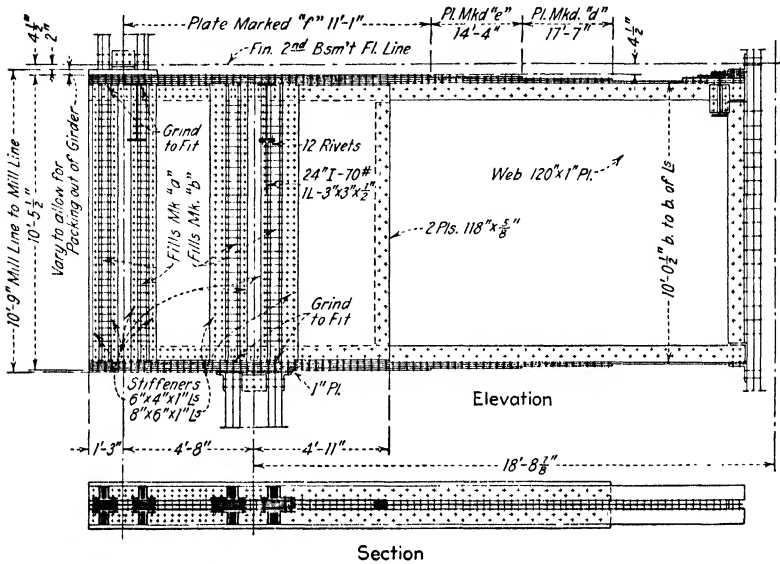

FIG. 92(b).—Detail of Girder E-S9.

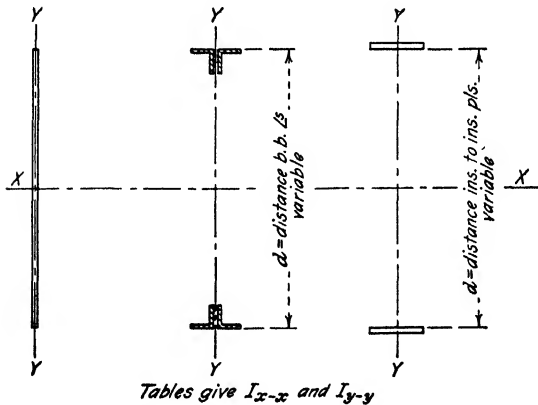

FIG. 93.

struction," issued by the American Institute of Steel Construction. Such tables give the moment of inertia of the gross area of the angles and

* McGraw-Hill Book Company.

plates, but the moment of inertia of the net area may be taken as proportional to the net area, i.e.,

$$I_n = I_g \frac{A_n}{A_g}$$

- where I_n = the moment of inertia of the net area;
- I_g = the moment of inertia of the gross area;
- A_n = the net area;
- A_g = the gross area.

This relation is sufficiently accurate for all practical purposes but the student will do well to investigate in a few cases the extent of the approximation involved.

The simplest procedure, having selected the web, is to determine from the tables the moment of inertia of the selected web and four assumed angles, subtract their sum from the required value, and determine by means of the tables a cover plate thickness and width which will furnish the balance required. Symmetrical girders may be proportioned in this manner by experienced designers with considerable speed and with the extreme fiber stress strictly limited to the specified value. The design of unsymmetrical girders is more tedious but not difficult.

The lengths of cover plates may be found by modifying any one of the methods described under the usual method of design. The graphical method is easily used by plotting moments of inertia of the web and angles, web angles and one cover, and so on, instead of areas or moments of resistance. Obviously moments of resistance can be used with equal simplicity. For uniform loads the lengths may be determined from the properties of the parabola:

$$L_n = L \sqrt{\frac{I_c}{I}} \tag{59}$$

- where L_n = the required length of the cover plate in question;
- L = the length of the span;
- I = the moment of inertia of the entire girder;
- I_c = the moment of inertia of the cover plates in question plus any covers outside of it.

I and I_c are computed about the neutral axis, and I_c must include the covers on both flanges. This method evidently assumes that c in Mc/I is constant, which is not true when covers are cut off. The error is small and on the safe side but may be corrected if desired.

In computing rivet pitch in girders designed by this method, the usual procedure may be used or the longitudinal shear per linear inch on any plane (which is the rate of change of the stress in the material outside of the plane) may be found from

$$\frac{VQ}{I}$$

V = the external shear at the section in question;

Q = the static moment about the neutral axis of all material above the plane;

I = the moment of inertia of the girder at the section in question, about the neutral axis.

I and Q may be based on gross areas for the compression flange and net areas for the tension flange, but usually whichever is available is used and both flanges made alike. If vertical loads are applied directly to a flange the longitudinal shear per inch times the pitch is the horizontal component of the rivet stress, and the vertical load per inch times the pitch is the vertical component of the rivet stress, from which the pitch may be computed in the same manner as described for the usual method of design.

80. Modified Method of Design.—As is well known a girder designed by the usual method (first discussed in this chapter) will have an extreme fiber stress greater than that for which it was designed, unless the flange is liberally proportioned. The error is small for deep girders and increases to 10 or 15 per cent, or more, for shallow girders with heavy flanges. Many specifications for design require that: "For unusual sections, the net section modulus shall be used," in designing plate girders, and some recent specifications have a requirement similar to that of the American Institute of Steel Construction's "Standard Specifications for Structural Steel for Buildings," which is: "Plate girders with webs fully spliced for tension and compression shall be so proportioned that the unit stress on the net section does not exceed the stresses specified in Section five (5) as determined by the moment of inertia of the net section."

To keep the extreme fiber stress within the amount used in design requires a somewhat larger flange area than would be obtained in the ordinary method of design. The larger area required can be obtained very closely by multiplying the area obtained in the usual way by the ratio of the overall depth to the effective depth. For deep girders the procedure gives results which are very close to those obtained by the moment of inertia method, and for shallow girders it gives flanges which

are somewhat larger than required by the moment of inertia method, the excess for a girder with a 36-in. web and a flange area of about 100 sq. in. being about 5 per cent, and for a girder with an 112-in. web and a flange area of about 90 sq. in., less than 0.5 per cent. The results are always on the safe side, and the excess area provided rarely exceeds 5 per cent, even for very shallow girders with heavy flanges using side plates.

To show the application of this modified method of the author's it will be used in comparison with the usual method of design. Assume that a girder to resist a maximum moment of 4000 ft.-kips is to be designed, and that conditions point to an 84-in. web. The experienced designer, proceeding in the usual manner, notes, almost subconsciously, that the flange stress will be between 500 and 600 kips and that at 18 kips per sq. in. a little over 30 sq. in. will be required. After estimating the effective depth and finding that the actual area required is

$$\frac{4000 \text{ ft.-kips}}{6.95 \text{ ft.}} = 575 \text{ kips}$$

$$\text{at 18 kips per sq. in.} = 31.95 \text{ sq. in. net}$$

he proportions the flange section, and, if designing closely, may wish to check the effective depth and add to or subtract from the area provided. Designing by the modified method the designer takes exactly the same steps and obtains the area of 31.95 sq. in. net. He then estimates mentally that there will be about $1\frac{1}{4}$ in. of cover plates on each flange and modifies the area by multiplying by the ratio of the *estimated* overall depth to the *estimated* effective depth.

$$31.95 \times \frac{87.00}{83.50} = 33.25 \text{ sq. in. net}$$

The flange is then proportioned as usual, and as before the designer may wish to check the assumed depths and add to or subtract from the area provided. Summarizing: the designer's calculations for the two methods will be as follows:

USUAL METHOD

$$\frac{4000}{6.95} = 575 \text{ kips}$$

$$\text{at 18 kips per sq. in.} = 31.95 \text{ sq. in. net}$$

AUTHOR'S MODIFIED METHOD

$$\frac{4000}{6.95} = 575 \text{ kips}$$

$$\text{at 18 kips per sq. in.} = 31.95$$

$$\times \frac{87.0}{83.5} = 33.25 \text{ sq. in. net}$$

The author finds this method simpler and quicker in application than the moment of inertia method and of comparable accuracy. It may be applied to unsymmetrical sections, i.e., unsymmetrical about the neutral axis, with a slight modification in the case of girders which have a much greater distance from the center of gravity to the outer fiber in one flange than in the other. The necessity for such modification is rare.

81. Girders without Lateral Support.—Girders without lateral support are sometimes necessary, and in their design the intensity of stress on the compression flange should be reduced. The discussion under "Beams without Lateral Support" applies to girders, and the same reduction formulas for allowable fiber stress are used.

The method of design is the same as in girders with lateral support except that the compression flange will generally have to be made of greater gross area than the tension flange. The total flange stress

$$T = C = \frac{M}{d}$$

and

$$A_T = \frac{T}{s_1} \quad \text{and} \quad A_C = \frac{C}{s'}$$

where s_1 = the allowable intensity of stress on the net section of the tension flange;

s' = the allowable stress on the gross area of the compression flange obtained from a reduction formula.

It is desirable, though not essential, that the flange angles of the compression flange be of the same thickness as the angles of the tension flange and the difference in area made in the size of the flange angle or in the width and thickness of cover plates. When the flanges of the girder are not very different in area 1/6 of the gross area of the web may be considered as compression flange area. When the girder is very unsymmetrical, i.e., when the compression flange is much larger in gross area than the tension flange, 1/6 the web area should not be considered as available.*

82. Girders Subject to Lateral Loads.—In the most common case of girders without lateral support—crane runway girders—the girders are also subjected to lateral loads. The design of rolled sections subjected to lateral loads is largely a matter of trial, as already pointed out, but in built-up girders the following direct method is very satisfactory.

* Why not? How much may be considered as available?

- M = the maximum moment due to vertical loads;
 m' = the maximum moment due to horizontal loads;
 A_T = the total net area of the tension flange;
 A_G = the total gross area of the compression flange;
 d = the effective depth;
 r = the radius of gyration of the compression flange about the vertical axis;
 c = the horizontal distance from the vertical axis to the extreme fiber of the compression flange;
 s_1 = the allowable intensity of stress on the net section of the tension flange;
 s' = the allowable intensity of stress on the compression flange, obtained from a reduction formula;
 I_G = the moment of inertia of the compression flange about the vertical axis through the centroid.

Assuming that the lateral load is applied to, and resisted entirely by, the compression flange,

$$A_G = \frac{M}{ds'} + \frac{m'c}{s'r^2} \quad (\text{approx.}) \quad (60)$$

and

$$A_T = \frac{M}{ds_1} \quad \text{as usual.}$$

The determination of the required net area of the tension flange requires no further explanation, but the basis of the determination of the required gross area of the compression flange should be stated.

The assumption that the lateral load is resisted entirely by the compression flange (when applied to the compression flange) is made because of the great flexibility of the web in a lateral direction. If the tension flange is to help in resisting a lateral load applied to the compression flange it must be pushed sideways by the web. The lateral stiffness of the web, as compared to that of the compression flange, is so small that the help from the tension flange must be considered entirely negligible. If s is the maximum intensity of stress in the compression flange due to vertical and lateral loading we may write

$$s = \frac{M}{dA_G} k' + \frac{m'c}{I_G} k''$$

This expression is fairly evident except for the factors k' and k'' . If the compression flange were supported laterally $M/(dA_G)$ would be

the intensity of stress due to vertical loads (within the limits of accuracy of the usual plate girder theory), but since the flange has no lateral support the intensity of stress is larger owing to lateral bending of the flange; the factor k' is to allow for this increase in stress. Similarly $m'c/I_G$ would correctly give the intensity of stress due to the lateral moment m' if the flange were homogeneous, straight, and held in line; since it is not, the factor k'' is introduced to allow for the increase in stress due to defects.

If we substitute $A_G r^2$ for I_G , as is common, in the above expression for s we may write

$$A_G = \frac{M}{d} \frac{k'}{s} + \frac{m'c}{r^2} \frac{k''}{s} \quad (\text{approx.})$$

Since the factors k' and k'' are larger than one, s/k' and s/k'' are intensities of stress less than the maximum allowed. If we can evaluate k' and k'' we can determine a gross area for the compression flange which will keep the maximum intensity of stress within the limit s . In the absence of data from which to determine k' and k'' the intensities of stress s/k' and s/k'' are usually taken as equal to each other and to the value obtained from a reduction formula for unsupported compression flanges—resulting in the expression for A_G given above in (60).

The width of the flange, b , and its radius of gyration, r , are unknown and must be estimated or assumed in advance of design. A preliminary assumption for r which is a fair average is $r = 0.3b$. After the flange has been proportioned r should be checked, and the section revised if necessary.

Although the above method has been used considerably in the form given and has resulted in satisfactory designs it is inaccurate in the assumption that

$$I_G = A_G r^2$$

Designing by the procedure outlined a portion of the gross web area, usually $1/6$, is considered as flange area. This is entirely correct in considering the girder's resistance to vertical loads, but not in considering the resistance of the top flange to horizontal loads. If F is a factor such that

$$F A_G = A_G - 1/\phi A_w,$$

A_w = the gross area of the web,

$1/\phi$ = the fraction of the gross web area available as flange area, usually $1/\phi = 1/6$,

A_G = the total gross flange area,

and

$A_G - 1/\phi A_w =$ the gross area of the actual compression flange, i.e., flange angles and cover plates only

we may rewrite (60) to read

$$A_G = \frac{M}{ds'} + \frac{m'c}{Fs'r^2} \quad (61)$$

which is correct within the limitations of the approximate method of girder design. The value of F will generally range between about 0.75 and 0.95, and for the ordinary case will not be far from 7/8; it can be quickly and accurately determined from the diagram in Fig. 94.

It should be noted that although the compression flanges of girders may generally be designed on the basis of gross area it is often necessary

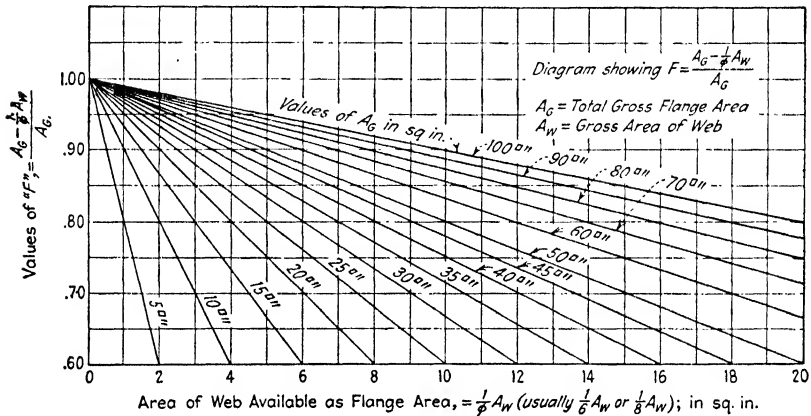

FIG. 94.

to deduct holes for rail-clip bolts from the compression flanges of crane runway girders. This does not affect the use of the 1/6 of the web as flange area in the compression flange.

If the tension flange is subject to lateral loads we may find the required net area as

$$A_T = \frac{M}{s_1 d} + \frac{m'c}{Fs_1 r^2} \quad (62)$$

where s_1 = the allowable intensity of stress on the net section and the other terms have the same significance as before, but are of course based on the tension flange. F and r may both be based on the net section or both on the gross section; there will be little difference in the values. If the net section is preferred the diagram in Fig. 94 may still be used to find F by substituting A_T for A_G and letting $1/\phi = 1/8$, or whatever fraction of the web is considered available as flange area.

83. Illustrative Example DP11.—Complete designs of the girders for an outdoor crane runway are given, on Sheets 1 to 4 inclusive of DP11, to illustrate the application of the principles just discussed.

Some general comments on the design are in order. It should be noticed that in each case the effective span was taken as the distance center to center of A frames, whereas the true distance center to center of girder bearings is less, as will be clear from a study of the sketch on Sheet 4 of the calculations. It is usual to assume the effective span as in these calculations, but when the girders rest on top of the supporting columns in such a way that rotation of the end of a girder does not compel an equal rotation of the top of the supporting column (as is true in this case) the author considers it correct to use the true distance center to center of bearings as the effective span, if the designer wishes to make the small saving in weight which will result from so doing. He must not forget, however, the eccentric application of the load on the top of the column which results from the manner of supporting the girders indicated on Sheet 4 of the calculations, and of course assuming the effective span as the distance center to center of supporting columns does not offset this eccentricity in any way. The student will do well to investigate approximately the saving in weight which will result from using the true effective span in the design of the girders supported as shown on Sheet 4. It will be necessary of course to make at least an approximate design of the A frames before the effective span can be determined with any accuracy. It will be found that a total saving of approximately 6300 lb. of material may be made in this way, which at present prices (1934) means about \$100 in cost. This is not a large sum in comparison with the total cost of the girders of about \$8000, and many engineers would prefer the more conservative assumption of effective span length.

Attention is also called to the use of net area in designing the compression flanges. The holes allowed for in the compression flanges are not rivet holes, which are assumed filled by the rivets, but holes for rail-clip bolts which will not be tight fitting.

Another matter which should receive mention is the rivet pitch diagram. Two curves are shown for each girder: *a* assumes that only the horizontal component of rivet stress, i.e., that due to change in flange stress, is to be resisted by the flange rivets; and *b* assumes that the vertical load of the wheel plus 25 per cent impact (distributed over an assumed length of 24 in.) must be resisted in addition to the change in flange stress. Girders of this type are sometimes fabricated with the upper edge of the web faced to a true surface, and set slightly above the backs of the flange angles (usually $1/32$ or $1/16$ in.) so that the load

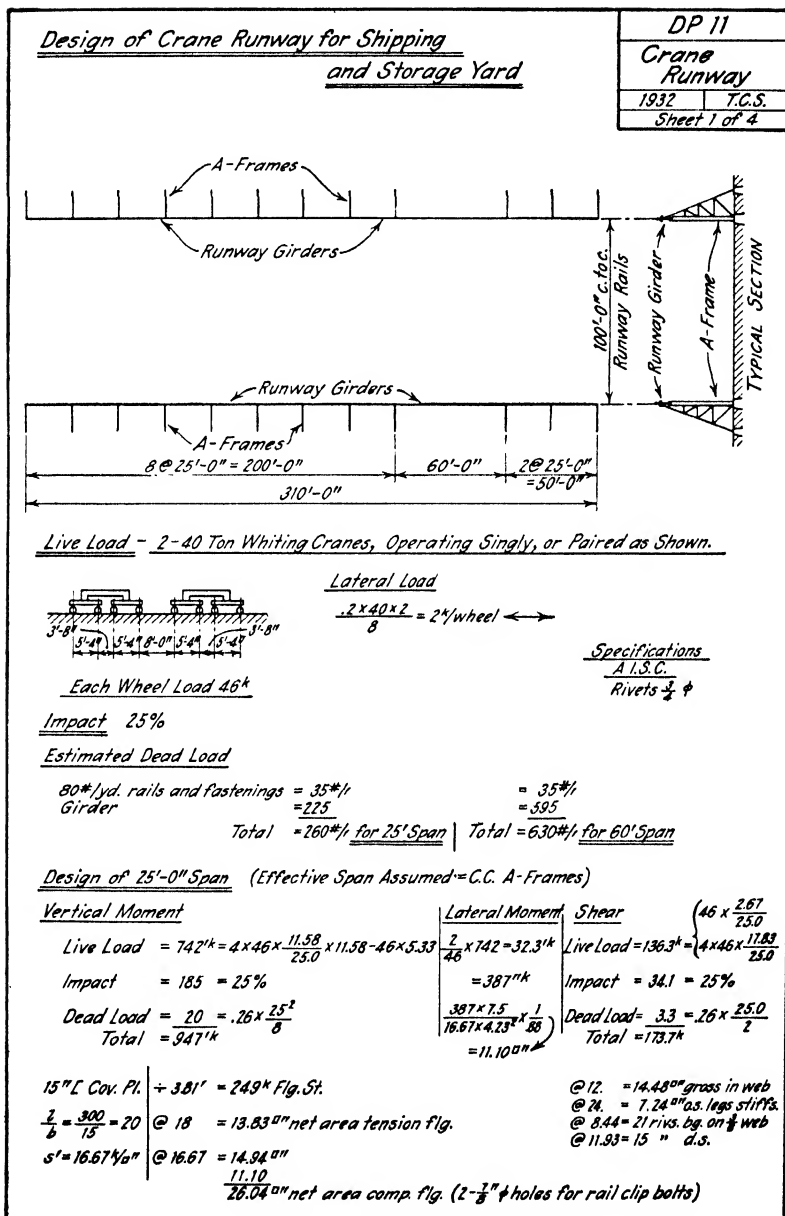

Crane Runway for Shipping and Storage Yard

Design of 25'-0" Span (Cont.)

| | |
|-----------------|--------|
| DP 11 | |
| Crane Runway | |
| 1932 | T.C.S. |
| Sheet 2 of 4 | |

| | | | | |
|----------------|--|--------------------------|----------------------|--------------------------------------|
| 1-Web | $48" \times \frac{3}{8}" = 18.00$ | gr. $\frac{1}{8} = 2.25$ | $\frac{1}{2} = 3.00$ | Web Pl. Excess $7\frac{1}{2}\%$ = 40 |
| 2-Top Is | $6 \times 6 \times \frac{9}{16}" = 12.96$ | $-.98 = 11.88$ | + 3.00 = 14.88 | @ $61.2 \times 24.96 = 1530$ |
| 1-Top L | $15" @ 4.5" = 13.17$ | $-1.08 = 12.09$ | + 14.88 = 26.97 | @ $21.9 \times 24.96 = 1085$ |
| 2-Bott Is | $6 \times 6 \times \frac{9}{16}" = 12.96$ | $-.98 = 11.88$ | + 2.25 = 14.13 | @ $45.0 \times 24.96 = 1125$ |
| 4-End Stiffs | $5 \times 3\frac{1}{2} \times \frac{3}{8}" = 2 \times \frac{11}{16} \times 4.5 = 7.31$ | net comp. fig. | | @ $21.9 \times 24.96 = 1095$ |
| 4-End Fills | $6\frac{1}{2} \times \frac{3}{8}"$ | bg. area each end | | @ $21.3 \times 3.94 = 335$ |
| 14-Int. Stiffs | $5 \times 3\frac{1}{2} \times \frac{3}{8}"$ | | | @ $12.4 \times 3.02 = 150$ |
| 14-Int. Fills | $3\frac{1}{2} \times \frac{3}{8}"$ | | | @ $10.4 \times 3.94 = 575$ |
| 2-Sole Pls. | $13 \times \frac{3}{8}"$ | | | @ $6.7 \times 3.02 = 285$ |
| Riv. Hds. etc. | abt. $2\frac{1}{2}\%$ | | | @ $38.7 \times .75 = 60$ |
| | | | | = 160 |
| | | | | Total for 1-Girder = 6450* |

Stiffener Spacing

Rivet Pitch

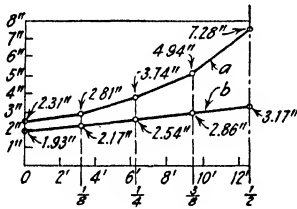

End

$$85 \times \frac{3}{8} \sqrt{\frac{18000}{9650} - 1} = 29.7"$$

$\frac{1}{4}$ Pt.

$$85 \times \frac{3}{8} \sqrt{\frac{18000}{6000} - 1} = 45.1"$$

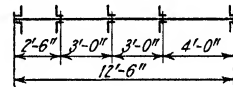

Diagram "a"

Vertical load transmitted through faced edge of web.

16-Girders as above @ 6450 103,200
4- " Special Ends @ 6900 27,600

Diagram "b"

Vertical load transmitted through rivets. Wheel load + 25% impact assumed distributed over 24".

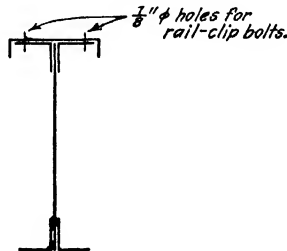

Forward 130,800

Crane Runway for Shipping and Storage Yard

Design of 60'-0" Span (Effective Span Assumed=c.to.c.A-Frames)

DP 11

Crane
Runway

1932 T.C.S.

Sheet 3 of 4

Vertical Moment

$$\text{Live Load} = 3492^{\text{ft}} \text{k} = \begin{cases} +368 \times \frac{28^2}{60} \\ -184 \times 7.17 \end{cases}$$

$$\text{Impact} = 873 = 25\%$$

$$\text{Dead Load} = 284 = .63 \times \frac{60^2}{8}$$

$$\text{Total} = 4649^{\text{ft}} \text{k}$$

$$+ 6.93^{\text{ft}} = 6.71^{\text{ft}} \text{ Fig. Stress}$$

$$\text{@ } 18^{\text{ft}}/4 = 31.26^{\text{ft}} \text{ net ten. flg.}$$

$$\text{@ } 15.65 = 42.85$$

Lateral Moment

$$\frac{2}{40} \times 3492 = 151.8^{\text{ft}} \text{k}$$

$$= 1820^{\text{ft}} \text{k}$$

$$\frac{1820 \times 15.25}{15.65 \times 9.23^2} \times \frac{1}{.90}$$

$$= 23.04^{\text{ft}} \text{k}$$

Shear

$$\text{Live Load} = 256^{\text{ft}} \text{k} = 368 \times \frac{41.67}{60.0}$$

$$\text{Impact} = 64 = 25\%$$

$$\text{Dead Load} = 19 = .63 \times \frac{60}{2}$$

$$\text{Total} = 339^{\text{ft}} \text{k}$$

$$\text{@ } 12 = 28.20^{\text{ft}} \text{ gr. in web}$$

$$\text{@ } 24 = 14.10^{\text{ft}} \text{ o.s. legs stiff's.}$$

$$\text{@ } 9.84 = 34.4 \text{ rivs. } \text{fg. on web}$$

$$\text{@ } 11.93 = 28.4 \text{ " d.s.}$$

Forward 130,800

$$\frac{l}{b} = \frac{12 \times 60}{30.5} = 23.6$$

$$s' = 15.65^{\text{ft}} \text{ in comp. flg.}$$

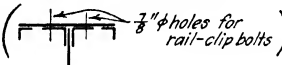
$$65.89^{\text{ft}} \text{ net comp. flg.}$$

Material for 1-Girder

- 1- Web $84 \times \frac{7}{16} = 36.75^{\text{ft}} \text{ gr. } \frac{1}{4} = 4.60^{\text{ft}} \text{, } \frac{1}{8} = 6.13^{\text{ft}}$ @ $125.0^{\text{ft}} \times 38.86^{\text{ft}} = 7495$
- 2- Top ls $8 \times 6 \times \frac{13}{16} = 21.44 - 1.42 = 20.02 \text{, } + 6.13 = 26.15^{\text{ft}}$ @ $36.5 \times 59.96 = 4375$
- 1- Top Pl. $30 \times \frac{1}{2} = 22.50 - 1.31 = 21.19 \text{, } + 26.15 = 47.34$ @ $76.5 \times 59.96 = 4585$
- 2- Top ls $6 \times 6 \times \frac{13}{16} = 18.18$ @ $31.0 \times 59.96 = 3720$
- 2- Bott. ls $6 \times 6 \times \frac{13}{16} = 18.88 - 2.62 = 14.26 \text{, } + 4.60 = 18.86$ @ $28.7 \times 59.96 = 3440$
- 1- Bott. Pl. $14 \times \frac{1}{2} = 10.50 - 1.31 = 9.19 \text{, } + 18.86 = 28.05$ @ $35.7 \times 46.00 = 1640$
- 1- Bott. Pl. do = do = 9.19, + 28.05 = 37.24^ft net @ 35.7 x 35.00 = 1250
- 8- End Stiff's. $5 \times 3 \frac{1}{2} \times \frac{11}{16} = 4 \times 4.5 \times \frac{11}{16} = 14.63^{\text{ft}} \text{ bg. on each end}$ @ $21.6 \times 6.92 = 1195$
- 4- End Fills $7 \times \frac{1}{2} = 3.5$ @ $17.9 \times 6.01 = 430$
- 28- Int. Stiff's. $5 \times 3 \frac{1}{2} \times \frac{11}{16} = 16 \text{ on fills, } 12 \text{ crimped}$ @ $10.4 \times 6.92 = 2015$
- 16- Fills $3 \frac{1}{2} \times \frac{11}{16} = 2.34$ @ $8.9 \times 6.01 = 855$
- 2- Spl. Pls. $24 \times \frac{1}{2} = 12$ (4 lines @ 5" or less each side of web cut) @ $30.6 \times 6.01 = 370$
- 4- do $4 \times \frac{1}{2} = 2$ (6 rivs. @ 3" on each side of web cut) @ $5.7 \times 3.00 = 70$
- 2- Sole Pls. $14 \times \frac{1}{2} = 7$ @ $41.7 \times 0.75 = 65$
- 8- Flange Supports* at points marked S @ 30^{ft} each = 835
- Rivet Hds. etc. abt. $2 \frac{1}{2}\%$ +
- * See Sheet 4 for sketch

Total for 1-Girder = 33,000^ft

x 2 = 66,000

Total for Girders = 196,800^ft

Rivet Pitch

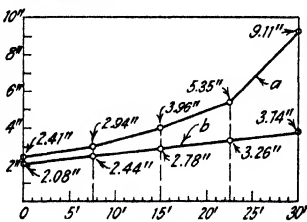

Stiffener Spacing

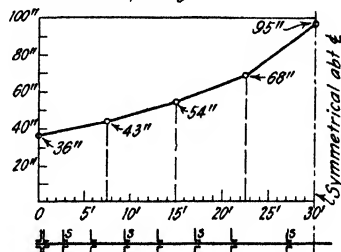

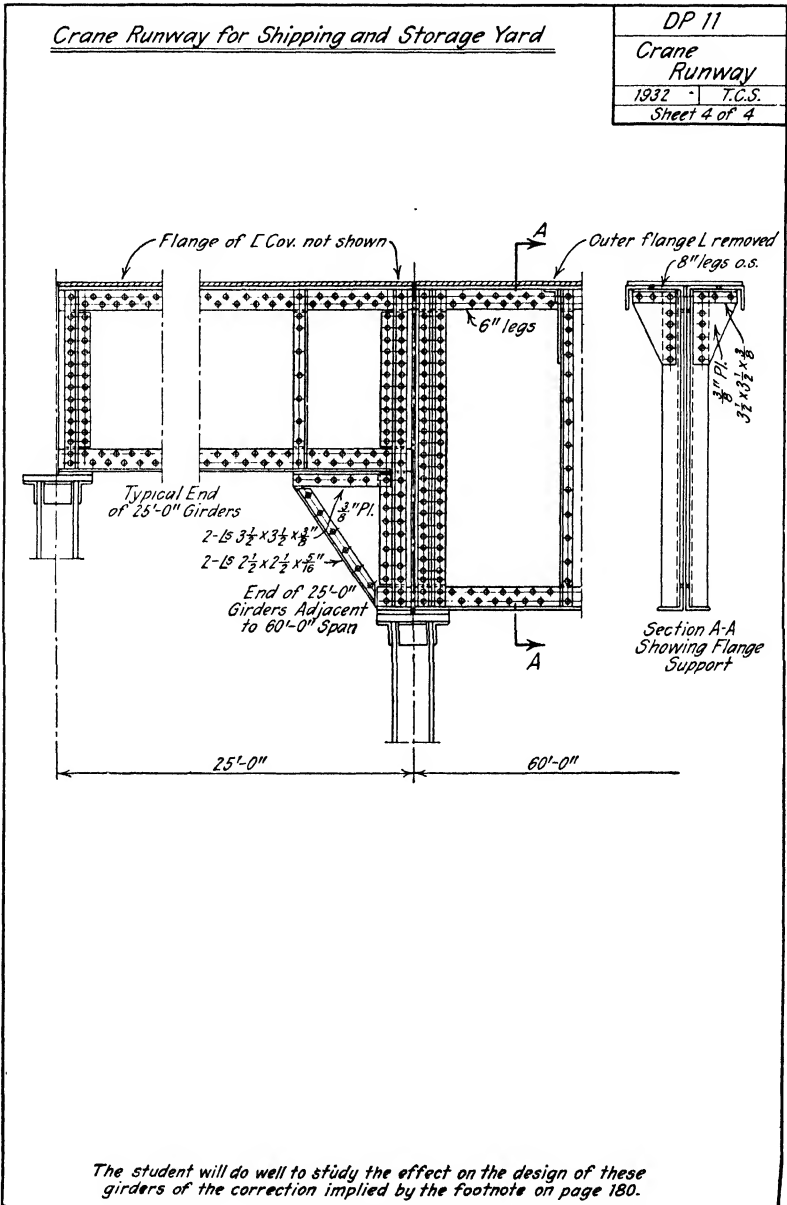

DP11.

from the rail must pass into the web by direct bearing, without affecting the flange rivets. When this is done the flange rivets resist the change in flange stress only. The design of the web splice for the 60 ft. 0 in. girder, in this example, assumes the faced web construction.

The reader will notice that the assumed weight of the 25-ft. span proved to be too small (225 lb. per ft. assumed, 258 lb. per ft. actual) while the assumed weight of the long span proved to be large (595 lb. per ft. assumed, 550 lb. per ft. actual). The percentages of error in the assumptions are considerable, but the effect on the designs is entirely negligible. This is the natural result of the fact that the dead load is small in comparison with the live load.

84. Economical Depth of Plate Girders.—It was stated in Art. 55 that the least weight depth for plate girders has been fairly well established by the results of experience. As was also stated, formulas for the depth giving the least weight may be derived, but as they are necessarily based on assumptions regarding average flange area and weight of details, and are affected by other factors which are not constant and which are difficult to express in usable mathematical terms, they must be regarded as approximate. Moreover, as mentioned before, a considerable departure from the depth giving the least weight results in a comparatively small increase in weight, and in addition the use of the depth giving the lightest girder may affect other items of cost or convenience so adversely as to more than offset the saving in material. In spite of their limitations such formulas are helpful guides if the designer does not allow their use to obscure the importance of factors other than least weight.

An investigation of about fifty girders, designed under different specifications, indicates the following relations between the average gross area of girder flanges and the net area at the point of maximum moment.

(a) When the design specifications require that one cover plate on both top and bottom flanges extend the full length of the girder the average gross area of a flange lies between 96 and 103 per cent of the net area at the point of maximum moment.

(b) When the design specifications require that one cover plate on the top flange extend the full length of the girder, but allow the bottom cover plates to be cut off in accordance with the curve of maximum moments, the average gross area of the two flanges lies between 93 and 97 per cent of the net area at the point of maximum moment.

(c) When the design specifications allow all top and bottom cover plates to be cut off in accordance with the curve of maximum moments, the average gross area of a flange lies between 89 and 93 per cent of the

net area at the point of maximum moment. These data are for symmetrical girders (top and bottom flanges alike), with each flange having two or more cover plates.

The author also has found girder details, i.e., stiffeners, fills, splice plates, rivet heads, etc., to average between 40 and 50 per cent of the weight of the web when crimped intermediate stiffeners are used, with an increase of about 20 per cent if fillers are used under intermediate stiffeners. This is a matter which depends to a considerable extent on the limitations placed on stiffener spacing, and strict interpretation of some stiffener spacing formulas will raise these averages about 10 per cent in ordinary cases, and as much as 25 or 30 per cent for shallow girders with relatively thin webs.

Assuming that for ordinary girders the average gross area of a flange may be taken as 95 per cent of the net area at the point of maximum moment, that the weight of details may be taken as 45 per cent of the web weight if crimped intermediate stiffeners are used and 65 per cent if intermediate stiffeners are on fills, and remembering that 1 sq. in. of steel 1 ft. long weighs 3.4 lb., the following formulas may be written:

Let w = the weight of the girder, in pounds per linear foot;

d = the depth of the web, in inches, also to be taken as the effective depth generally;

M = the maximum bending moment, in inch-pounds;

s_1 = the allowable intensity of stress on the net section, in pounds per square inch.

Then

$$\begin{aligned} w &= 2 \times 3.4 \times .95 \left(\frac{M}{s_1 d} - \frac{1}{8} td \right) + 1.45 \times 3.4td \\ &= 6.46 \frac{M}{s_1 d} + 4.12td \text{ for crimped intermediate stiffeners.} \end{aligned} \quad (63)$$

If t is dependent only on the designer's choice we may differentiate this expression and find that for any particular value of t the depth giving the least weight is

$$d = 1.25 \sqrt{\frac{M}{s_1 t}} \quad (64)$$

when intermediate stiffeners are crimped.

If intermediate stiffeners are on fillers, we have

$$\begin{aligned} w &= 2 \times 3.4 \times .95 \left(\frac{M}{s_1 d} - \frac{1}{8} td \right) + 1.65 \times 3.4td \\ &= 6.46 \frac{M}{s_1 d} + 4.80td \end{aligned}$$

which upon differentiation yields

$$d = 1.16\sqrt{\frac{M}{s_1 t}} \quad (64a)$$

as the least weight depth when intermediate stiffeners are placed on fillers.

Formula (64a) is commonly given in textbooks as the relation determining the least weight depth with a coefficient of 1.1 instead of 1.16 as given above.

As a matter of fact, formula (64a) is seldom correct, no matter which coefficient is used, as t is generally not dependent on the designer's choice only, but is a function of the depth. The most common case in which formulas (64) and (64a) may be applicable is that in which the shear is so large that the area of the web is determined by it and not by a limit on minimum thickness. Specifications for design usually limit the minimum thickness of the web to $1/160 D$, $1/170 D$, $1/200 D$, or $1/20\sqrt{D}$, where D is the clear depth of the web, and in the majority of cases the thickness is determined by such a limit.

Letting $k =$ a factor based on the depth of the web, rather than the clear depth, such that

$t = d/k$ has the same value as

$t = D/160$ or $D/170$ or $D/200$ or $\sqrt{D}/20$, as the case may be, we may rewrite (63)

$$w = 6.46 \frac{M}{s_1 d} + \frac{4.12d^2}{k} \quad (65)$$

Differentiating we find

$$d = 0.92\sqrt[3]{\frac{Mk}{s_1}} \quad (66)$$

for the least weight depth of girders having crimped intermediate stiffeners, and

$$d = 0.88\sqrt[3]{\frac{Mk}{s_1}} \quad (66a)$$

for the least weight depth of girders having intermediate stiffeners on fillers.

If $D =$ the clear depth of the web, $d =$ the overall web depth in inches as above, and $A =$ the total width of flange material against the web, evidently

$$D = d - A$$

and

$$k = 160 \frac{d}{(d - A)} \text{ or } 170 \frac{d}{(d - A)} \text{ or } 200 \frac{d}{(d - A)} \text{ or } 20 \frac{d}{\sqrt{d - A}}$$

or if some other factor than 160, 170, or 200 is used, and K is that factor,

$$k = K \frac{d}{(d - A)}$$

Figure 95 shows values of the cube root of k for the most common limits on t . These diagrams are drawn for $A = 12$ for 6-in. angle legs against the web, and $A = 16$ for 8-in. angle legs against the web. The student will have noticed of course that k is dependent on d which is not known, but examination of the diagrams in Fig. 95 will show that the cube root of k has very little change over a considerable range in depth of web and it will be found sufficiently accurate in using the above and subsequent formulas to take $\sqrt[3]{k}$, from the diagrams, for a depth of web equal to about 1/10 of the span, or whatever other depth experience indicates as probably about right.

Diagrams are also given for $K = 50$ and $K = 60$, for three values of A . It is often desirable to design plate girders so that intermediate stiffeners may be omitted. Most specifications permit this omission when the web has a thickness of not less than $D/60$, while some require a thickness of not less than $D/50$. In such cases the percentage of details becomes small and somewhat variable but may generally be taken as about 10 per cent of the web weight. Assuming this percentage of detail material we may find by the methods given above that the least weight depth is

$$d = 1.03 \sqrt[3]{Mk/s_1} \quad (67)$$

It is sometimes desirable to design girders without cover plates or with one full length cover plate, as is frequently done in stringers for railroad bridges. In this case the average gross area of the flange is about 15 per cent more than the net area at the point of maximum moment. Proceeding as before we may find that the least weight depth becomes

$$d = \sqrt[3]{Mk/s_1} \quad (68)$$

for girders without cover plates and with crimped intermediate stiffeners. And

$$d = 0.95 \sqrt[3]{Mk/s_1} \quad (68a)$$

for girders without cover plates and with intermediate stiffeners on fills. When a girder is designed without cover plates the difference

between the effective depth and the web depth becomes appreciable, and the depth found by (68) and (68a) should be taken as the effective depth.

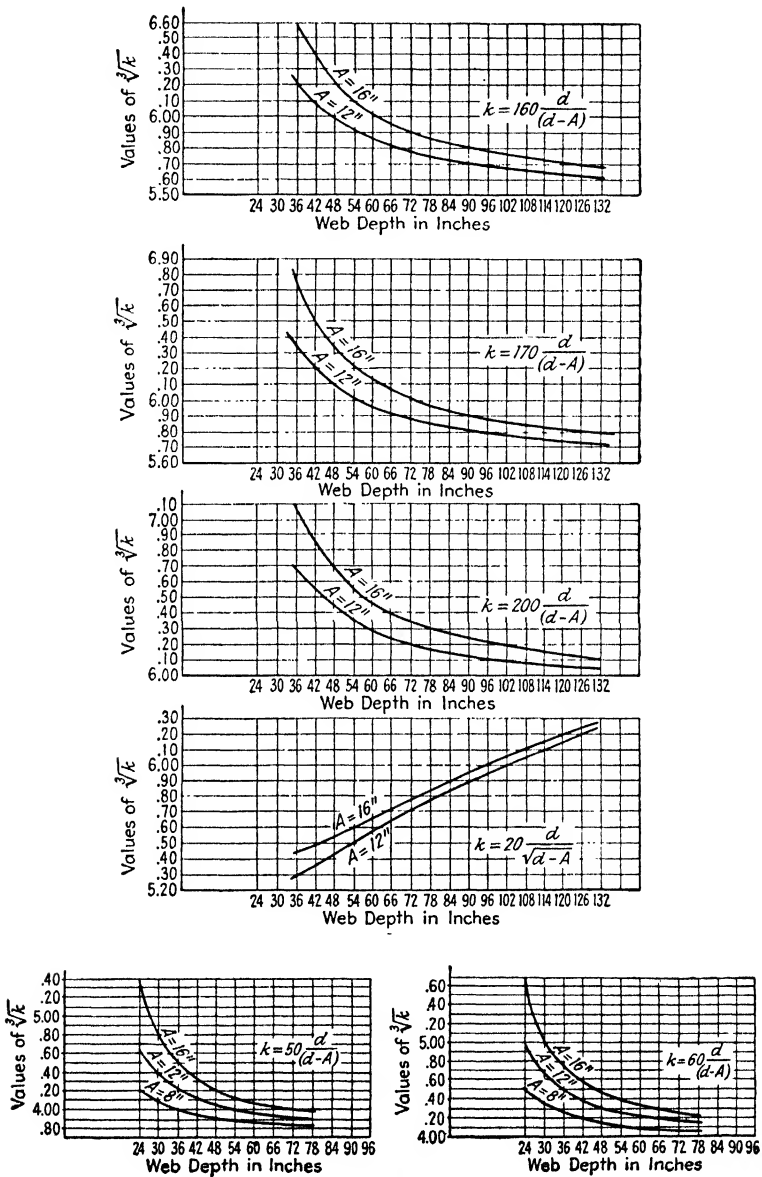

FIG. 95.

If a girder is to be designed without cover plates and without intermediate stiffeners its least weight depth will be

$$d = 1.12 \sqrt[3]{Mk/s_1} \quad (69)$$

Formulas (66) to (69) inclusive were developed originally by the author and have never before been published. They have been found to give satisfactory results when checked against designs of known economy in weight.

Although formulas (66) to (69) inclusive are simple and easy to apply, many designers will prefer relations which may be used without the aid of the diagrams shown in Fig. 95, even though they be less exact. For such the results may be summarized into two formulas which are given below. For girders with intermediate stiffeners the economic depth may be taken as:

$$d = 5.5 \sqrt[3]{M/s_1} \quad (70)$$

And for girders without intermediate stiffeners the economic depth may be taken as:

$$d = 4.6 \sqrt[3]{M/s_1} \quad (71)$$

Formulas (70) and (71), although more approximate than those from which they are deduced, will give results within a small percentage of the least weight depth, and in the hands of the designer who has studied the variations in depth, as determined by formulas (66) to (69), will prove adequate for probably a majority of applications.

Of course it is also true that if greater exactness is desired, in a particular case, one may adjust the constants in the fundamental relation to any conditions which unusual requirements impose and develop formulas of as great exactness as available data will permit.

It should be pointed out that these formulas assume a continuous variation in the web thickness, whereas the thickness actually varies in jumps of 1/16 in. Consequently when the formula pertinent to the governing conditions indicates a least weight depth which is near the lower limiting depth for a given thickness, it may be found that the actual least weight depth is nearer the upper limit of depth for that thickness, the reason being that the web weight increases directly as the depth (instead of as the square of the depth) within the range in which a given thickness may be used. For example, strictly applying the 1/160 limit means that any girder having a depth of more than 76 in. (8-in. flange angles) must, and one having a depth less than 86 in. may, have a web thickness of 7/16 in. If the least weight depth formula indicates 82 in. as the proper depth, it may be true that a greater depth

(up to 86 in.) may give as light a girder or perhaps a slightly lighter one than the depth of 82 inches.

It seems desirable to repeat the warning, given at the beginning of this article, against using formulas for economic depth automatically, and allowing them to blind the user to the existence of other factors which may be of controlling importance. The designer who wishes to employ such formulas should acquaint himself with the assumptions made in their development, and study the effect on the validity of the formulas of variations in the assumed data. The author would like to add that this procedure should not be restricted to formulas for economic depth.

CHAPTER IV

TENSION AND COMPRESSION MEMBERS

85. The most common types of tension members and compression members are shown in section in Figs. 4 and 5 and were very briefly described in Chapter II. It is the purpose of this chapter to discuss briefly the suitability of the various types and the general principles involved in their design, and to illustrate with design calculations.

86. Suitability of the Common Types.—To facilitate reference to the sections, Figs. 4 and 5 are reproduced here as Figs. 96 and 97: the letters at the headings of the following paragraphs refer to the individual sketches in these figures.

TENSION MEMBERS, FIG. 96.—(a) Rods in the form of “loop rods,” or plain rods with clevis connections, were formerly used extensively in

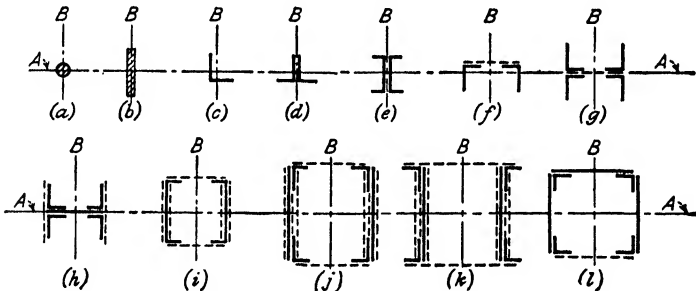

FIG. 96.

steel structures. They are not so common in current practice, being generally restricted to relatively unimportant bracing members, temporary erection ties, and bracing in more or less temporary structures. Upset ends, that is, ends which are enlarged so that the area at the root of the thread is at least equal to, and generally greater than, the area of the body of the rod, will result in a saving in weight in long rods but unless the saving is considerable the cost of upsetting may exceed it.

(b) The type of tension member shown at (b) has had extensive use in eye bars for pin-connected structures. Flats and plates have had some use as tension members in riveted trusses of small capacity.

(c) Single-angle tension members are commonly used for bracing in buildings, plate-girder bridges, and light truss bridges. They are sometimes used in building trusses but are undesirable in such cases except for hangers which carry no computed stress. As ordinarily connected single-angle members are subjected to severe bending stresses which are frequently ignored. Some specifications contain a clause similar to the following:* “When single-angle members subject to direct tension are fastened by one leg, only 75 per cent of the net area shall be considered effective. Angles with lug angle connections shall not be considered as fastened by both legs.” This is equivalent to assuming that the bending stress is 25 per cent of the intensity of stress ordinarily allowed. The actual bending stress is dependent on the manner in which the angle is connected and the relative rigidities of the angle and the member to which it is connected; under the most favorable conditions the bending stress may be practically zero, and under common conditions it may be as much as or more than the intensity of direct stress. The author does not consider single-angle tension members suitable except for secondary members carrying no calculated stress or for bracing members which connect to rigid members such as the flanges of plate girders or the chords of trusses.

(d) The form shown at (d) is widely used for single plane trusses of all kinds and is satisfactory in such cases for stresses which require only two angles. This form is sometimes modified by the addition of one or more cover plates, on the outstanding legs, to secure additional area. Obtaining additional area in this manner is objectionable in an open web girder or truss as each plate added changes the location of the center of gravity of the chord section. It is generally impracticable to shift the position of the chord to accommodate the new position of the centroid, and the resulting eccentricity produces bending stresses which may be large. Such stresses are commonly neglected, but when combined with the direct stress may give a total intensity from 50 to 100 per cent greater than the designer assumed in his calculations.

(e) The form shown at (e) is suitable for tension diagonals in heavy single plane trusses. It has no advantage for such use over angle members of the form shown at (d) except that it is possible to obtain the required number of rivets in a somewhat shorter distance. It is suitable for the lower chords of ore bridge trusses or other trusses which must carry moving loads directly on the chord. The size of the

* Art. 46, General Specifications for Steel Frame Buildings, “Structural Engineers Handbook,” p. 77. Third Edition, McGraw-Hill Book Company. See also Art. 54, “General Specifications for Steel Railway Bridges.” Fourth Edition, 1931, American Railway Engineering Association.

channels in such cases is generally determined by the space needed for the wheels of the hoists which move along the chord. A chord of this section lacks lateral rigidity which makes fabrication in the shop and erection in the field difficult, for long trusses, and requires lateral support at frequent intervals in the completed structure.

(*f*), (*g*), and (*h*) These forms are all suitable for tension diagonals in light and moderately heavy double plane trusses. The form shown at (*f*) is frequently used for lateral bracing and secondary members. The form shown at (*g*) is also used for lateral bracing members in bridges, and may be used for the tension chords of light trusses. The form shown at (*h*) is suitable for tension chords of moderate capacity.

(*i*) The form shown at (*i*) is much used for the diagonals and chords of short-span railroad bridges and moderately long-span highway bridges. Definite limits cannot be set because of the wide variation in loads. The flanges of the channels may be turned out instead of in when they will not interfere with the floor system of the truss. When the flanges are turned out the fabrication is much easier but the detail material (batten and tie plates or lacing) must be heavier and cannot be carried beyond the edge of the gusset plates. When additional area is required vertical plates of the same depth as the channels may be added on their backs or plates having a smaller depth may be added between the flanges, as shown by the dotted lines. Full-depth plates are more efficient but frequently less convenient in detailing. Because of their larger radius of gyration, members of this type are more efficient than the four-angle types shown at (*g*) and (*h*) for tension diagonals which must also resist reversal of stress; they are less efficient for diagonals carrying tension only because of their greater amount of detail material.

(*j*) and (*k*) The forms shown at (*j*) and (*k*) are suitable for heavy riveted trusses. They are of course of the same basic form as that shown at (*i*), and the statements made in connection with it are equally applicable here. The forms shown at (*j*) and (*k*) are more expensive in the shop than that shown at (*i*) because of the greater amount of riveting required in their fabrication, and they should not be used when the latter type has adequate capacity for the member in question. In general, it is not desirable to have one or more sections of the form (*i*) combined in the same truss chord with sections of the form (*j*) or (*k*).

(*l*) The form shown at (*l*) has not been extensively used. As already pointed out it is more economical of material, for the same capacity, than the forms shown in (*i*), (*j*), and (*k*) because it has only one plane of detail material. The transfer of stress in the cover plate is indirect, and the shop work is expensive under current methods. Most

fabricators would prefer to build an equivalent member of the type shown at (i) or (j), and because of the simpler shop work the total cost may frequently be less for the latter types, in spite of the greater amount of detail material required.

COMPRESSION MEMBERS, FIGS. 96 AND 97.—Much that has been said concerning the suitability of the types of tension members applies equally well when those same types are used as compression members.

(c), Fig. 96. The form shown at (c), Fig. 96, is used a great deal for the columns of light water towers, transmission towers, and similar

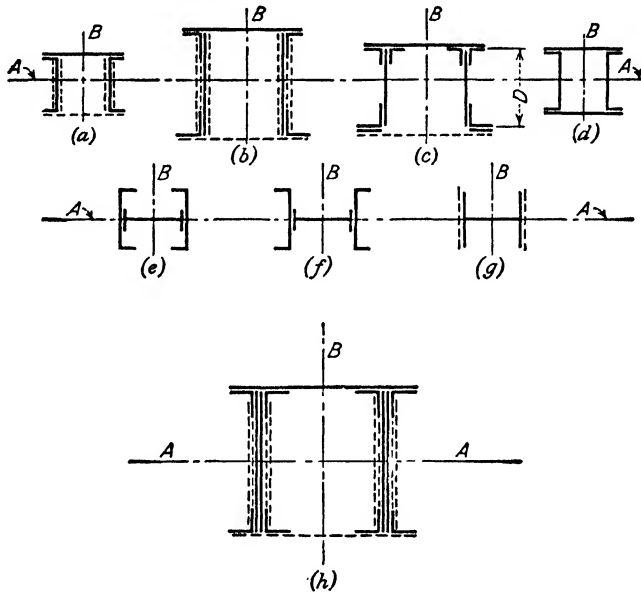

FIG. 97.

structures. It is also widely used for short bracing members in plate-girder bridges and buildings. It is sometimes used for very short compression members in roof trusses of the Fink type, and for secondary members carrying no computed stress in building trusses of other types. When connected by one leg, as is usual in building trusses, it may be subjected to severe bending stresses resulting from the eccentricity. The author does not consider the single-angle compression member suitable for primary members in a building truss. Some engineers do not approve of its use as a secondary member, i.e., as a bracing member in plate-girder bridges for example, but it has been very extensively

employed in such cases and the author does not know of any instance in which it has not proved satisfactory.

(*d*), Fig. 96. The form shown at (*d*) in Fig. 96 is common in single plane trusses, and the statements made in connection with tension members of this form apply also to compression members.

(*e*), Fig. 96. The form shown at (*e*), Fig. 96, is not an economical compression member. It lacks lateral rigidity and must have lateral support at frequent intervals. It is seldom used unless the member must resist bending in a vertical direction. If a third channel, or a plate, placed horizontally is riveted to the top flanges of the vertical channels the resulting member is satisfactory but expensive to fabricate.

(*f*), Fig. 96. This form is used to a considerable extent for struts which do not carry computed stress and for bracing members in bridges and buildings. Its small radius of gyration about an axis parallel to the plane of the lacing makes it unsuited for members of great length. It is less commonly used as a column than as a tension member.

(*g*) and (*h*), Fig. 96. These forms are very widely used for columns in all kinds of structural work. They are easily fabricated, require a minimum of detail material, and the connection of other framing members to them is simple, direct, and economical. They are unsuited for great lengths because of the small radius of gyration about the axis parallel to the web. The outstanding legs of the angles tend to buckle locally if made too thin, and there is danger that these legs will be crippled locally by accidents in handling. They are less economical of main material and less rugged than the box forms shown in (*i*), (*j*), and (*k*) of Fig. 96 and (*d*), (*e*), and (*f*) of Fig. 97, but the advantages mentioned above make them strong competitors and more popular for office buildings, industrial buildings, and light bridges. The rolled H column shown at (*g*), Fig. 97, belongs to this group and is more common in office-building work than the four-angle fabricated type.

(*i*), (*j*), and (*k*), Fig. 96. These forms are suitable for compression chords and diagonals in riveted trusses and have been used to some extent for such members in pin-connected bridges. The form shown at (*i*) is not suitable for very heavy members, but those shown at (*j*) and (*k*) may be used for the largest stresses. They are often reinforced with added material as shown by the vertical dotted lines.

(*l*), Fig. 96. The statements made regarding the use of this type as a tension member apply also to its use as a column. Though admitting its economy of detail material the author doubts its economy as a whole with fabricating shop practice as it is at present.

(*a*), (*b*), and (*c*), Fig. 97. These forms are widely used as top chord and end post sections for bridge trusses. The form shown at (*a*) has

been used to some extent for viaduct columns as has that at (b). The form shown at (c) is not popular with fabricating shops because of the difficulty in driving all the rivets by machine. The only excuse for its use is that the inside angles at the top permit a thinner cover plate to be used than is possible in a section of the type shown at (b), and that is sometimes convenient when the specifications with which the designer is working have an abnormal limit on cover plate thickness. All the rivets generally can be driven by machine if the distance D , Fig. 97 (c), is not more than about 18 in. In (a) and (b), Fig. 97, dotted lines show how additional area may be obtained; plates may be added in a similar manner to the member at (c). In adding plates outside, care must be taken not to add so great a thickness that riveting in the flanges will be interfered with.

(d), Fig. 97, shows a form which has had considerable use in building work. It is efficient and requires little detail material. Connections to it are not so easy as to the four-angle I type and after fabrication it cannot be painted or inspected inside. It has had less use in recent years than formerly.

(e) and (f), Fig. 97, show forms which are frequently employed in viaducts and elevated railway structures. As shown they are of rolled channels and I's, but may be built of plates and angles, as is also true of the section shown at (d). The section shown at (e) built up of plates and angles has been used in heavy bridge work, and makes an efficient and economical column for heavy loads. The open sides should be connected with battens or lacing or both, but this detail is often neglected.

DESIGN

TENSION MEMBERS

87. The design of a tension member is simple in principle. If A_n is the required *net* area:

$$A_n = \frac{P}{s_1} \quad (72)$$

where P = the total stress to be resisted;

s_1 = the allowable intensity of stress on the net section.

The proportioning of the member to obtain economically the required net area is not so simple, and may, in heavy riveted members, become rather difficult.

The material composing a tension member should be so chosen and arranged that as large a part of it as is practicable may be directly connected to the gusset plates, splice plates, or supports. It is impor-

tant also that the net area be as large a proportion of the gross area as is possible, but it is a mistake to try to take out too few holes. The net area will seldom exceed 92 or 93 per cent of the gross and generally should not be less than 80 per cent. The net area is a larger proportion of the gross when the member is composed of large thin shapes and plates rather than smaller and thicker material, but the use of thin material if carried to extremes results in a member of such width that secondary stresses will be abnormal. The width in the plane of the truss should not exceed one-tenth of its length, to comply with most specifications, and it is desirable that it be made less. When the member under consideration is one section of a truss chord it is necessary that it be considered in relation to the other parts. It must be possible to pass from one section to another without difficult and expensive connections, and the changes in area between sections should be possible by easy additions of material without change in form. For example, if one section of a chord is a member such as shown at (*g*) in Fig. 96 the other sections should be of the same shape and additions in area, if necessary, made by the addition of plates, as shown in (*h*), Fig. 96.

88. Net Section.—The size of holes to be deducted in design computations has already been discussed in connection with plate girders, and in the design of tension members the only point needing further mention is the number of holes to deduct in any case.

The number deducted in design should be the smallest which can be maintained in detailing without the use of splices and connections of excessive length, or the necessity of distances between adjacent rivets which violate the limits permitted in the specifications. It is impossible to lay down rigid rules; it is necessary that the designer be familiar with what can be and is done in detailing and fabricating structural steel. The following may be used as a guide in designing the forms shown in Fig. 96:

(*a*) The area at the root of the thread for threaded ends, unless the rod is "upset" so that the area at the root of the thread exceeds the area of body of the bar.

(*b*) One rivet for flats 6 in. or less in width and two rivets up to 12 in., which is about as wide as such members should be made. Of course when the member is an "eye bar" the entire cross-section of the bar is available, if the head is properly proportioned. The heads of eye bars have been well standardized.*

(*c*) One hole generally, but two may be necessary if clip angles are used at the connections.

* See "General Specifications for Steel Railway Bridges," Fourth Edition, 1931. A.R.E.A., Arts. 138, 250, 251, and Appendix A, Arts. 440 and 529.

(*d*) One hole from each angle is generally sufficient, but splices, bracing, or other framing connections may require additional holes to be deducted.

(*e*) Two holes from each channel web or one from each flange whichever deducts the most area. Deduction of holes in web and flanges may be necessary because of lateral bracing connections.

(*f*) and (*g*) One hole from each angle.

(*h*) Two holes from each angle and two from each plate if side plates are used, and one hole from each angle and two from the web if not.

(*i*) Two holes from each channel web or one from each flange, if no reinforcing plates are used. If reinforcing plates are used two from each web and one from each flange.

(*j*), (*k*), and (*l*) Two from each angle, three from each plate, for plates not over 18 in. or 20 in. wide, and four or five from each plate for plates up to about 36 in. in width. If reinforcing plates are added between the angles at least four holes must be deducted from each web and at least two holes from each plate between the angles.

The student should understand that these are approximate rules, and it may be necessary in some cases to deduct more holes where lacing bars or splice material require close riveting. Riveted tension members are made deeper than 36 in. and about the same relative number of holes should be deducted, but the matter of detailing increases in importance with the size of the member, and for large sections the design can hardly be separated from it without resulting in a considerable amount of wasted effort on the part of both designer and detailer.

89. General Appearance.—The matter of general appearance should be given some weight in proportioning members, whether tension or compression. The more important members should look more massive than the less important, and to that end, chords should generally be a little wider than the diagonals and verticals and the width of the diagonals should decrease towards the center of the span, or have the same width throughout. It does not look well, to the author at least, to have the diagonals at the ends of the truss of more slender proportions than those near the center, although this condition is sometimes hard to avoid when the diagonals are designed to resist reversal of stress. This is particularly true in pin-connected structures, where eye bars may be used for the diagonals near the end, but riveted members must be used near the center if they are to resist compression as well as tension.

90. Design of Members Subject to Direct Tension and Bending.—Tension members which are to resist bending in addition to direct stress must sometimes be designed.

Let A_n = the net area required;

s_1 = the maximum allowable intensity of stress on the net section, in pounds per square inch, or kips per square inch;

P = the direct stress, in pounds or kips;

M = the bending moment, in inch-pounds, or inch-kips;

c = the distance from the neutral axis to the extreme tension fiber, in inches;

r = the radius of gyration of the net section about the neutral axis, in inches.

Then

$$s_1 = \frac{P}{A_n} + \frac{Mc}{A_n r^2}$$

and

$$A_n = \frac{P}{s_1} + \frac{Mc}{s_1 r^2} \quad (73)$$

In this formula the student should notice that the term P/s_1 is the area required to resist the direct stress and $Mc/(s_1 r^2)$ the area required to resist the bending.

It is necessary to estimate r and c in advance of design. The distance c frequently may be definitely fixed, and r may be estimated most easily with the aid of a table of approximate radii of gyration such as Table II, page 421. It should be noted that r is given above as the radius of gyration of the *net* section, but since the moment of inertia of the net section is approximately to the moment of inertia of the gross section as the net area is to the gross area, r may be taken for either net or gross section with sufficient accuracy.

The moment M in the above is the bending moment due to transverse loads (including the weight of the member if desired) and does not take account of the eccentricity resulting from deflection due to the loads, or that caused by manufacturing and fabricating defects. Eccentricity due to the latter cause is uncertain. In a tension member it tends to correct itself and is always neglected in design. Eccentricity due to deflection caused by the transverse loads may be estimated and is sometimes considered. Although it is seldom of much importance, it may be desirable to take account of it in some cases and it will be discussed approximately in the next article.

91. Approximate Effect of Eccentricity Due to Deflection.—When the designer wishes to include the effect of deflection due to transverse loads the following approximate analysis may be used.

- P = the direct stress in the member;
- M = the bending moment at the center due to the transverse loads only;
- Δ = the deflection of the neutral axis at the center, away from its unstressed position;
- M' = the bending moment at the center taking account of the direct stress, P , as well as the transverse loads.

The quantity Δ may always be expressed approximately as

$$\Delta = \frac{1}{\phi} \frac{M'L^2}{EI} \tag{74}$$

in which $1/\phi$ = a factor depending on the conditions of end restraint and the distribution of the loads;

L = the length of the member, in inches;

I = the moment of inertia of the gross section;

E = the modulus of elasticity;

M' is as previously defined.

| $\frac{1}{\phi}$ | Condition of ends | Distribution of loads | Center deflection |
|------------------|-------------------|--|-----------------------------------|
| $\frac{5}{48}$ | Free | Uniform load | $\frac{5}{48} \frac{M'L^2}{EI}$ |
| $\frac{1}{12}$ | Free | Concentrated load at center | $\frac{1}{12} \frac{M'L^2}{EI}$ |
| $\frac{23}{216}$ | Free | Equal concentrated loads at $\frac{1}{3}$ points | $\frac{23}{216} \frac{M'L^2}{EI}$ |
| $\frac{19}{192}$ | Free | Equal concentrated loads at $\frac{1}{4}$ points and at center | $\frac{19}{192} \frac{M'L^2}{EI}$ |
| $\frac{1}{16}$ | Fixed | Uniform load | $\frac{1}{16} \frac{M'L^2}{EI}$ |
| $\frac{1}{24}$ | Fixed | Concentrated load at center | $\frac{1}{24} \frac{M'L^2}{EI}$ |
| $\frac{5}{72}$ | Fixed | Equal concentrated loads at $\frac{1}{3}$ points | $\frac{5}{72} \frac{M'L^2}{EI}$ |
| $\frac{1}{18}$ | Fixed | Equal concentrated loads at $\frac{1}{4}$ points and at center | $\frac{1}{18} \frac{M'L^2}{EI}$ |

In terms of center moment M'

| $\frac{1}{\phi}$ | Condition of ends | Distribution of loads | Center deflection |
|------------------|-------------------|--|-------------------------------------|
| $\frac{1}{32}$ | Fixed | Uniform load | $\frac{1}{32} \frac{M'_c L^2}{EI}$ |
| $\frac{1}{24}$ | Fixed | Concentrated load at center | $\frac{1}{24} \frac{M'_c L^2}{EI}$ |
| $\frac{5}{144}$ | Fixed | Equal concentrated loads at $\frac{1}{3}$ points | $\frac{5}{144} \frac{M'_c L^2}{EI}$ |
| $\frac{1}{30}$ | Fixed | Equal concentrated loads at $\frac{1}{4}$ points and at center | $\frac{1}{30} \frac{M'_c L^2}{EI}$ |

} In terms of end moment M'_e

The table above gives approximate values of Δ and $1/\phi$ for a few of the simpler conditions of loading, for ends without restraint and also for fixed ends. It should be particularly noted that the center deflection is expressed in terms of the *center* moment in the first eight cases and in terms of the *end* moment in the last four.

The effect of the direct stress, *in a member subjected to tension*, is evidently to reduce the bending moment due to transverse loads, and for ends without restraint (i.e., pin-connected ends) we may write

$$M' = M - P\Delta \quad (75)$$

and for fixed ends it is sufficiently accurate for practical purposes to write

$$M' = M - P \frac{\Delta}{2} \quad (76)$$

These expressions are for the center moment as stated. If the end moments are to be considered, and they may be important, we may write with sufficient accuracy

$$M'_e = M_e - P \frac{\Delta}{2} \quad (77)$$

in which M_e = the end moments due to the transverse loads only;

M'_e = the end moments taking account of the direct stress P

Substituting the value of Δ given by (74) in the expressions (75), (76), and (77) there result

$$M' = \frac{M}{1 + \frac{1}{\phi} \frac{PL^2}{EI}} \quad (75a)$$

$$M' = \frac{M}{1 + \frac{1}{\phi} \frac{1}{2} \frac{PL^2}{EI}} \quad (76a)$$

$$M'_e = \frac{M_e}{1 + \frac{1}{\phi} \frac{1}{2} \frac{PL^2}{EI}} \quad (77a)$$

The value of $1/\phi$ may be taken from the table for the more common conditions of loading, or evaluated from the fundamental definition for other conditions. Study of the table will show that $1/10$ is a fair approximation for the first four cases and is generally used for practical purposes.

Then as in Art. 90

$$s_1 = \frac{P}{A_n} + \frac{M'c}{A_n r^2}$$

or

$$s_1 = \frac{P}{A_n} + \frac{Mc}{A_n r^2} \left(\frac{1}{1 + \frac{PL^2}{10EI}} \right) \quad (78)$$

and

$$A_n = \frac{P}{s_1} + \frac{Mc}{s_1 r^2} \left(\frac{1}{1 + \frac{PL^2}{10EI}} \right) \quad (79)$$

In this expression I is the moment of inertia of the gross section, as stated above, and may be written Ar^2 . For the sections most commonly used for tension members r varies from about $2/10 d$ to $35/100 d$, where d is the depth of the member in inches. Using a value of $3/10 d$ (79) may be written

$$A_n = \frac{P}{s_1} + \frac{Mc}{s_1 r^2} \left(\frac{1}{1 + \frac{10}{9} \frac{PL^2}{EA d^2}} \right) \quad (80)$$

Except for the term in the parentheses this is exactly the same as equation (73). Since the term in the parentheses is less than 1 in all cases evidently the influence on the design of including the effect of deflection is to reduce the area which must be added to resist bending.

It will be worth while to devote a little study to the term in the parentheses to see how much the design is really affected when deflection is included.

Suppose, for example, that the basic stress allowed in design is 18,000 lb. per sq. in. on the net section, and that the area required to resist the direct stress is a large proportion of the total area, say 90 per cent. Then if the net area is 86 per cent of the gross (a fair average) the quantity P/A in the parentheses in (80) will be, $0.90 \times 0.86 \times 18,000 =$ about 14,000 lb. per sq. in. If the moment is relatively small, as it must be when the area to resist the direct stress is a large proportion of the total, the ratio L/d is likely to have a fairly high value but would seldom exceed 20 to 25. Assuming for the case in question that $L/d = 25$ and $E = 30,000,000$, the term in the parentheses becomes

$$\left(\frac{1}{1 + \frac{10 \times 14,000 \times 625}{9 \times 30,000,000}} \right) = 0.76$$

which means that the area to be added to resist bending may be 24 per cent less than would be found neglecting the deflection. The area to be added to resist bending, however, is only 10 per cent of the total, and the effect on the member as a whole is then,

$$0.10 \times 24 = 2.4 \text{ per cent}$$

i.e., taking account of the deflection would permit a 2.4 per cent reduction in the area of the member. If the ratio L/d were 20, which would be more likely, the saving would be only 1.7 per cent.

Going to the other extreme and assuming that the area to resist direct stress is only 30 per cent of the total, and that $L/d = 10$, which would be likely for a member carrying a large moment, the term in the parentheses becomes

$$\left(\frac{1}{1 + \frac{10 \times 4600 \times 100}{9 \times 30,000,000}} \right) = 0.98$$

or the reduction in the area to be added to resist moment is 2 per cent, and the saving in the member as a whole is $0.02 \times 0.70 = 1.4$ per cent.

It must be kept in mind that the above analysis is approximate, but

Tension Members Single Plane TypeStress = 125^k Length 10'-0" Ends without restraint

| | |
|-----------------|--------|
| DP 12 | |
| Tension Members | |
| 1932 | T.C.S. |
| Sheet 1 of 2 | |

(a) Neglecting own weight

$$\frac{125^k}{18 \times 0.9} = 6.95 \text{ net}$$

$$\text{Use } \# \quad 2-1\frac{1}{2} \times 3\frac{1}{2} \times \frac{1}{2} = 8.00 - .88 = 7.12 \text{ net}$$

$$\text{or } \# \quad 2-1\frac{1}{2} \times 7 \times 3\frac{1}{2} \times \frac{1}{8} = 7.60 - .66 = 6.94 \text{ net}$$

A.I.S.C. Specs. $\frac{3}{4}$ " ϕ Rivets

(b) Considering own weight, neglecting effect of deflection - ends free

$$\text{Wt.} = 28 \#/\text{ft, nearly } M = \frac{28 \times 10^2}{8} \times 12 = 4200 \text{ in}^k$$

$$A_n = \frac{125}{18} + \frac{4.20 \times 1.66}{18 \times 1.58^2} = \frac{6.95}{7.11} \text{ net}$$

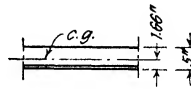

$$A_n = \frac{125}{18} + \frac{4.20 \times 2.48}{18 \times 2.27^2} = \frac{6.95}{7.06} \text{ net}$$

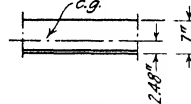

(c) Considering own weight and taking account of deflection - ends free

$$A_n = \frac{125}{18} + \frac{4.20 \times 1.66}{18 \times 1.58^2} \left(\frac{1}{1 + \frac{125 \times 120 \times 120}{10 \times 30,000 \times 20.0}} \right)$$

$$= 6.95 + .16 \times .769 = 6.95 + .12 = 7.07 \text{ net}$$

$$A_n = \frac{125}{18} + \frac{4.20 \times 2.48}{18 \times 2.27^2} \left(\frac{1}{1 + \frac{125 \times 120 \times 120}{10 \times 30,000 \times 39.24}} \right)$$

$$= 6.95 + .11 \times .867 = 6.95 + .10 = 7.05 \text{ net}$$

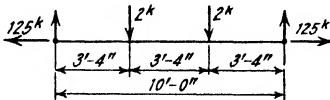
(d) Same member and stress, supporting also 2^k at each $\frac{1}{3}$ point - ends free

$$\text{Moment} = 2 \times 3.33 = 6.66 \text{ k}$$

$$= 80 \text{ in}^k$$

$$A_n = \frac{125}{18} + \frac{80 \times 2.53}{18 \times 2.25^2} = \frac{6.95}{9.17} \text{ net}$$

$$2-1\frac{1}{2} \times 7 \times 3\frac{1}{2} \times \frac{1}{2} = 10.00 - .88 = 9.12 \text{ net}$$

it should be sufficient to show that it will seldom be necessary to include the effect of deflection in the design of tension members subjected to bending in addition to direct stress. Moreover, this analysis assumes that the member acts as a simple beam, i.e., that there is no moment at the ends, whereas as a matter of fact every tension member has some restraint at the ends which generally reduces the center deflection and therefore generally reduces the saving in area resulting from including its effect in design.

Equation (79) gives the area as determined by the intensity of stress at the *center* of the member. When the ends have considerable restraint the intensity of stress at the ends may govern the required area. The end moments are affected by the deflection between the supports, although not necessarily entirely dependent thereon. If the end moments control the required area and the designer wishes to allow for the effect of deflection between the supports, the method expressed by (80) is applicable, but of course the constants must be adjusted to fit the end conditions: the method of attack is the same; the effect of the deflection, however, is even less than at the center and seldom if ever need be included. When the effect of deflection is neglected the method of design expressed by (73) is directly applicable, using for M the maximum moment on the member whether it occurs at the end, at the center, or elsewhere.

92. Illustrative Example. DP12.—As an illustration of the foregoing discussion of the design of tension members the calculations on Sheets 1 and 2 of DP12 are presented.

The student will notice that the design when there is no bending to be considered is perfectly direct. When bending moment must be provided for, the design is necessarily cut and try, i.e., the properties of the member are involved and these cannot be definitely determined until the member has been proportioned. The approximate radii of gyration given in Table II, page 421, are very useful in such cases. For example in the calculations under b , Sheet 2 of DP12, the approximate radius of gyration is found as 8.1. Recognizing that the values given in the table are somewhat large for thick webs we may assume $r = 8.0$, in estimating the area required to resist bending. Actual computation shows it to be 7.76.

The student will do well to assume that the members designed on Sheet 1 are fixed ended and see what effect this has on the design for cases (b), (c), and (d). In doing so he should keep in mind that the top fibers of the member will be in tension at the fixed ends instead of the bottom fibers as at the center. In dealing with unsymmetrical members this is a matter of importance.

Tension Members Double Plane Type

| | |
|-----------------|--------|
| DP 12 | |
| Tension Members | |
| 1932 | T.C.S. |
| Sheet 2 of 2 | |

Stress in Member = 900*; Length = 30'-0"; Ends Free

(a) Neglecting own weight

$$A_n = \frac{900}{18} = \underline{50.0 \text{ in}^2 \text{ net}}$$

$$4\text{-}1\frac{1}{2} \times 6 \times 4 \times \frac{5}{8} = 23.44 - 5.00 = 18.44$$

$$2\text{-Pls. } 22 \times \frac{7}{8} = 38.50 - 7.00 = 31.50$$

$$61.94 \text{ in}^2 \text{ gross } \underline{49.94 \text{ in}^2 \text{ net}}$$

A.I.S.C. Specs.
 $\frac{7}{8}$ " ϕ Rivets

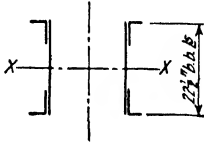

$$\text{Wt.} = 61.94 \times 3.4 = 210 \text{ #/ft}$$

$$\text{Batten Pls., Lacing etc.} = \frac{30}{240} \text{ #/ft}$$

(b) Taking account of own weight, but neglecting effect of deflection - ends free

Assume Wt. = 250 #/ft

$$r_{x-x} = .36 \times 22.5 = 8.1 \text{ approx. say } 8.0$$

$$\text{Moment} = \frac{250 \times 30^2}{8} \times 12 = 338 \text{ ft-k}$$

$$A_n = \frac{900}{18} + \frac{338 \times 11.25}{18.0 \times 8.0^2} = \frac{50.00}{3.30} = \underline{53.30 \text{ in}^2 \text{ net}}$$

Gross I_{x-x}

$$4\text{-}1\frac{1}{2} \times 6 \times 4 \times \frac{5}{8} = 27.76 - 6.00 = 21.76 \quad 2432$$

$$2\text{-Pls. } 22 \times \frac{7}{8} = 38.50 - 7.00 = 31.50 \quad 1553$$

$$66.26 \text{ in}^2 \text{ gross } \underline{53.26 \text{ in}^2 \text{ net}} \quad 3986$$

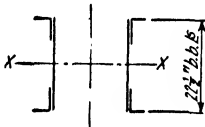

$$r_{x-x} = \sqrt{\frac{3986}{66.26}} = 7.76$$

$$\text{Wt.} = 66.26 \times 3.4 = 225$$

$$\text{Battens, lacing, etc.} = \frac{35}{260} \text{ #/ft}$$

Assumed Wt. = 250 #/ft } Corrected area
" $r_{x-x} = 8.0$ } to resist bending

$$= 3.30 \times \frac{260}{250} \times \left(\frac{8.00}{7.76}\right)^2 = 3.65 \text{ in}^2$$

$$\text{Corrected } A_n = \underline{53.65 \text{ in}^2 \text{ net}}$$

(c) Taking account of own weight and effect of deflection - ends free

$$\text{Assume moment} = \frac{260}{250} \times 338 = 352$$

$$A_n = \frac{900}{18} + \frac{352 \times 11.25}{18 \times 7.76^2} \left(\frac{1}{1 + \frac{900 \times 360 \times 360}{10 \times 30,000 \times 3986}} \right)$$

$$= 50.0 + 3.65 \times .911 = \frac{50.00}{3.33} = \underline{53.33 \text{ in}^2 \text{ net}}$$

Use same section as for (b)

COMPRESSION MEMBERS

93. The design of compression members is less definite than is the design of tension members. The properties of the section are always involved and must be assumed in advance of design. In tension members the effects of eccentricities due to defects in manufacture tend to decrease with increase in load, but, as has been indicated in discussing unsupported compression flanges for beams and girders, the reverse is true in columns.

The discussion of columns in this text will be confined to design but it is important for the student to have studied carefully the development of the rational theories and the experimental work on which practical design procedure must be based. Most texts on strength of materials discuss these matters: a particularly valuable chapter is that on "Columns" in "Strength of Materials," by the late George F. Swain.* A book which gives an extended discussion of columns and in addition contains a valuable bibliography on the subject is that entitled "Columns," by E. H. Salmon.†

94. **Design.**—The design of compression members has been the subject of an enormous amount of study and much experimentation. In spite of these efforts, which have extended over a period of about two hundred years, the design of columns is still, and, in the opinion of many engineers, will always remain, an empirical process. Scores of column formulas have been developed, some frankly empirical, others claiming a rational basis but depending on empirical constants.

Current practice in structural design in the United States depends mainly on two types of column formulas:

- (a) The straight-line formula.
- (b) The Rankine-Gordon formula.

Other types are frequently suggested and have some advocates.‡

* McGraw-Hill Book Company, New York.

† Henry Frowde and Hodder and Stoughton, London.

‡ As a result of the studies and reports of the special Committee on Steel Columns and Struts, and the Special Committee on Steel Column Research, of the American Society of Civil Engineers, it seems not unlikely that the near future may see the well-known secant formula written into design specifications as a standard measure of column strength, with simplified parabolic formulas (adjusted to limited ranges of L/r) used for practical design purposes.

The student of column theory and design should acquaint himself with the reports and recommendations of the American Society of Civil Engineers' column committees: they may be found in the *Transactions* of that Society as follows: Vol. 66, 1910; vol. 83, 1919-20; vol. 89, 1926; vol. 95, 1931; vol. 98, 1933.

95. Straight-Line Formulas.—All straight-line formulas are of the general form:

$$s_1 = s - k \frac{L}{r} \quad (81)$$

where s_1 = the allowable average stress = P/A , P = load, A = area;
 L = the length of the column, in inches;

r = the radius of gyration, in inches, of the column section,
 about such an axis that L/r is a maximum;

k = an empirical constant;

s is generally equal to the maximum permitted fiber stress in tension or compression, but may be an arbitrary factor so chosen that it gives the desired values of s_1 when reduced by $k L/r$.

This type of column formula, which was suggested by Professor William H. Burr in a discussion * of some experiments on Phoenix columns made at the Watertown Arsenal for Clark, Reeves, and Company (now the Phoenix Bridge Company), has been very widely used in American practice, although its popularity was not fully attained until after the presentation to the American Society of Civil Engineers in 1885 of a paper, "On the Strength of Columns: Discussing the Experiments Which Have Been Accumulated and Proposing New Formulas," by Thomas H. Johnson.† Some of the best known forms now in use are:

$$s_1 = 16,000 - 70 L/r, \text{ max.} = 14,000, \text{ A.R.E.A., 1910, and others} \quad (82)$$

$$s_1 = 15,000 - 50 L/r, \text{ max.} = 12,500, \text{ A.R.E.A., 1920, 1923, } \left. \begin{array}{l} \\ \\ 1925, 1931 \end{array} \right\} \quad (83)$$

$$s_1 = 19,000 - 100 L/r \ddagger, \text{ max.} = 13,000, \text{ American Bridge Co. } \left. \begin{array}{l} \\ \\ 1912 \end{array} \right\} \quad (84)$$

$$s_1 = 16,000 - 60 L/r, \text{ fixed ends} \left. \begin{array}{l} \\ \\ \end{array} \right\} \quad (85)$$

$$s_1 = 16,000 - 80 L/r, \text{ hinged ends} \left. \begin{array}{l} \\ \\ \end{array} \right\} \text{ J. A. L. Waddell, 1916} \quad (86)$$

96. Rankine-Gordon Formula.—The Rankine-Gordon formula is of the general form

$$s_1 = \frac{s}{1 + a \frac{L^2}{r^2}} \quad (87)$$

* *Trans. Am. Soc. C.E.*, 1882, Vol. 11, p. 113.

† *Trans. Am. Soc. C.E.*, 1886, Vol. 15, p. 517.

‡ 13,000 - 50 L/r for values of L/r between 120 and 200.

where a = an empirical constant and s_1 , s , L , and r are as defined in the previous article.

The Rankine-Gordon formula was apparently the main reliance of structural engineers until the introduction of the straight-line formula, when its use in American practice decreased considerably. It is now regaining its popularity, and well-known recent forms are:

$$s_1 = \frac{16,000}{1 + \frac{1}{13,500} \left(\frac{L}{r}\right)^2} \text{*, with a maximum value not to exceed that for } L/r = 40 \quad (88)$$

$$s_1 = \frac{18,000}{1 + \frac{1}{18,000} \left(\frac{L}{r}\right)^2} \text{†, with a maximum value not to exceed that for } L/r = 60 \quad (89)$$

There are many others differing more or less in the constants and the basic intensity of stress permitted but of the same form.

Although generally known by the name Rankine-Gordon this formula was, according to Salmon,† introduced in 1822 by Thomas Tredgold, a famous English engineer. Lewis Gordon adapted it to fit the experiments of Hodgkinson in the form

$$s_1 = \frac{s}{1 + a \left(\frac{L}{D}\right)^2}$$

and Rankine later modified it to the form now used.

97. Proportioning.—The proper proportioning of a column requires first of all that it have an area sufficient to withstand the stress or load to which it will or may be subjected without the material at any point being stressed beyond a safe intensity. The required area must be obtained with the use of a shape or shapes such that there will not be undue danger of local failure, i.e., the material must not be so thin that the column is weaker in certain parts than it is as a whole, but on the other hand the area must not be so concentrated that the column will be too slender as a whole. The column should be proportioned in such a way that the required area is the least consistent with the physical conditions, and last, but not by any means least, the column must be so

* *Trans. Am. Soc. C.E.* "Report on Design and Construction of Steel Railway Bridge Superstructure," Vol. 86, 1923.

† American Institute of Steel Construction, "Standard Specifications for Structural Steel for Buildings."

‡ "Columns," by E. H. Salmon, p. 132.

proportioned that it fits into the structure as a whole without requiring that any other part be of abnormal proportions. To satisfy *all* these conditions is frequently difficult and often impossible. It is sometimes necessary that an area greater than is needed to resist the actual load be used in order to keep the slenderness of the column within the limits which "good practice" has set, and sometimes an abnormal area must be furnished to resist the load because of unavoidable restrictions on the dimensions of the member.

98. Required Area.—If

- P = the total stress or load,
 A = the required gross area,
 s_1 = the allowable intensity of stress,

then

$$A = \frac{P}{s_1} \quad (90)$$

The problem here of course is the determination of s_1 . The specifications with which the designer is working will generally fix the allowable intensity of stress in terms of the length of the column, L , and the radius of gyration of the section, r . Whereas L may ordinarily be determined within reasonable limits, r is not known and cannot be definitely determined until the section has been proportioned. The design then is necessarily a trial-and-error procedure, although with the use of approximate data concerning r ,* the design generally may be made satisfactorily with one or two trials.

In order to make use of tables of approximate radii of gyration it is necessary to select the general shape of the cross-section and its general dimensions. This may be done from the character of the structure and the magnitude of the stress to be resisted. Most specifications have an upper limit on the "slenderness ratio," i.e., L/r , and since the length is known this limit fixes the minimum value of r which will be satisfactory. Also most specifications fix a maximum value of the unit stress corresponding to some lower value of L/r , and this lower ratio fixes a value of r which there is no advantage in exceeding. The type of column to be used having been decided upon and the limiting values of r being known, a table of approximate radii enables the designer to fix the dimensions within which the column should lie. Since the intensity of stress for the maximum value of L/r and the maximum intensity permitted are known, evidently there are also known limits between which the area must lie. The experienced designer will not need actually to

* See page 421.

calculate these limits but will make mental estimates of them and proportion the trial section accordingly.

For example, suppose that a column having an unsupported length of 20 ft. 0 in. and subjected to a load of 360 kips is to be designed for a structure that restricts the section to a four-angle and plate I shape with a web not exceeding 14 in. in width. Assume that the specifications limit L/r to 120, and allow a permissible stress of

$$s_1 = \frac{18,000}{1 + \frac{1}{18,000} \left(\frac{L}{r}\right)^2}$$

but not more than the value for $L/r = 60$ or 15,000 lb. per sq. in.

The designer notes mentally that the least r which the column can have and comply with the specifications is 2, and that to obtain such an r the flange of the column must be at least 10 in. wide,* i.e., angles with 5-in. legs outstanding will be the smallest which can be used. He will naturally use larger angles, if possible, in order to reduce the required area, and will consider a column with 6-in. legs outstanding and one with 8-in. legs outstanding, noting mentally that the least r 's will be about 2.5 and 3.3 respectively, with values of L/r between 90 and 100, and between 70 and 80. The unit stresses permissible will then be about 12,000 and 13,500, and the required area about 30 sq. in. and 27 sq. in. Two columns are then proportioned as follows, and the actual r 's computed.

| 6-IN. LEGS O.S | 8-IN. LEGS O.S |
|--|--|
| 4 - $\angle 6 \times 4 \times \frac{5}{8} = 23.44$ | 4 - $\angle 8 \times 6 \times \frac{1}{2} = 27.00$ |
| 1 - Pl. $14 \times \frac{1}{2} = 7.00$ | 1 - Pl. $14 \times \frac{1}{2} = 7.00$ |
| 30.44 | 34.00 |
| $r = \sqrt{206.3/30.44} = 2.6$ | |

There is no need of going further with the column with 8-in. legs outstanding as its area is greater than that of the column with 6-in. legs outstanding. Computing the value of L/r and the permissible stress a new area is found.

$$\frac{L}{r} = \frac{240}{2.6} = 92$$

$$s_1 = 12,200 \text{ lb. per sq. in.}$$

$$A = \frac{360}{12.2} = 29.5 \text{ sq. in. gr.}$$

* Table II, page 421.

The column as first proportioned is satisfactory but if the designer is anxious to get the closest possible design he may revise the section using a 14 in. by 7/16-in. web giving an area of 29.57 sq. in.

99. Actual Column Stresses.—It is important for the student to understand that when he obtains a permissible intensity of stress from a column formula, that intensity of stress is *not* the maximum stress permitted in the column but the *average* intensity permitted; similarly when the total load is divided by the area of the column the result is the *average* intensity of stress, and to obtain the *maximum* intensity there must be added to this average intensity an additional stress resulting from bending caused by the small kinks and bends, lack of homogeneity, and other imperfections in the actual column. The amount of this additional stress is uncertain and variable, but it is presumed that it *may* amount to the quantity $k L/r$ when using a straight-line reduction formula, and $s_1 a L^2/r^2$ when using a Rankine-Gordon reduction formula. In design work the engineer is interested primarily in knowing the maximum intensity of stress, rather than the amount of additional stress resulting from bending as a result of the column's imperfections, and this may be found directly.

For example, suppose that a column having an unsupported length of 300 in. carries a load of 400 kips, has a least radius of gyration 4.3 and an area of 40 sq. in. The average intensity of stress is

$$400/40 = 10 \text{ kips per sq. in.}$$

The actual intensity of stress is not known and cannot be determined. The value which it *may* reach according to the column formula

$$s_1 = 16,000 - 70 L/r$$

may be found as follows. According to this formula the maximum permissible *average* stress for this column is

$$16,000 - 70 \times 300/4.3 = 11,100 \text{ lb. per sq. in.}$$

and the formula states that *if* the average stress is 11,100 lb. per sq. in. the maximum *may* be 16,000 lb. per sq. in., but presumably will not be more. With an actual average stress of 10,000 lb. per sq. in. the maximum stress may be $10,000/11,100 \times 16,000 = 14,400$ lb. per sq. in., and presumably is not more.

There is no way of knowing what fiber is subjected to the maximum stress; it may be any fiber (presumably an outside fiber), and its actual intensity of stress may be anywhere between 10,000 and 14,400 lb. per sq. in. Obviously it is necessary in design to assume that the actual

intensity of fiber stress has the largest possible value, and that it occurs in that fiber which would make its effect on the column most serious.

If some other column formula is used by the designer the maximum intensity of stress may be found by the same general procedure. In the above example if the American Society of Civil Engineers' "Specifications for Design and Construction of Steel Railway Bridge Superstructure," 1923, compression formula is used

$$s_1 = \frac{16,000}{1 + \frac{1}{13,500} \times \left(\frac{300}{4.3}\right)^2} = 11,740 \text{ lb. per sq. in.}$$

and the maximum intensity of stress, corresponding to an average of 10,000 lb. per sq. in., may be

$$10,000/11,740 \times 16,000 = 13,600 \text{ lb. per sq. in.}$$

Or we may find directly that the maximum intensity may be

$$10,000 \left[1 + \frac{1}{13,500} \times \left(\frac{300}{4.3}\right)^2 \right] = 13,600 \text{ lb. per sq. in.}$$

100. Limiting Thickness.—The student will notice that, in Art. 98, 8 in. by 6 in. by 1/2 in. angles were used in making up the column with 8-in. legs outstanding, although thinner 8 in. by 6 in. angles are available, the use of which would reduce the area to an amount less than that in the column with 6-in. legs outstanding. Thin angles are apt to buckle locally giving a column which is weaker in detail than as a whole. The least thickness considered satisfactory for an outstanding leg is 1/16 of its width, and some specifications place a limit of 1/12 of the width.*

There are limits also on the thickness of web plates and cover plates in columns; the requirements † of the specifications of the American Railway Engineering Association are typical of such limits. Specifications for highway bridges allow somewhat thinner cover plates in some cases.‡

101. Economical Proportions.—It is impossible to lay down hard and fast rules for the most economical proportions of compression members, but there are a few general principles which should be observed. The material in a member should be so arranged that the least radius of gyration is as large as can be obtained with the shapes used and is

* Art. 66, A.R.E.A., 1931, "General Specifications for Steel Railway Bridges." See also Art. 405 of Specifications in Appendix A.

† Art. 65, A.R.E.A., "General Specifications for Steel Railway Bridges," 1931.

‡ "Specifications for Design and Construction of Steel Highway Bridge Superstructure," *Trans. Am. Soc. C.E.*, Vol. 87, page 1283.

determined by their properties and not by the spacing of the ribs, i.e., in a member such as that shown at (i), (j), or (k), Fig. 96, the channels (rolled or built) should be separated far enough so that the least radius of gyration is determined by the properties of the shapes about the axis $A-A$, and not by the spacing about the axis $B-B$. The same is true of members such as shown at (a), (b), (c), and (d), Fig. 97. For the members shown at (d), (f), (g), and (h), Fig. 96, unequal leg angles should generally be used and the long legs placed perpendicular to the axis $A-A$. Occasionally a pair of equal leg angles will give the most economical column of the types shown at (d), Fig. 96, and when the unsupported lengths about the two axes are different it may be most advantageous to use unequal leg angles and place the short legs perpendicular to axis $A-A$. The aim in all cases should be of course to make L/r as small as is possible with the material used. Similarly in members such as those at (e) and (f), Fig. 97, the channels and beam (whether rolled or built) should be so chosen that the radii about the two axes are as nearly equal as possible, when the unsupported lengths about the two axes are the same. It should be noted that in a member of this type increasing the area of the central web or diaphragm, either by adding to its thickness or its width, will decrease somewhat the radius of gyration about the axis $A-A$, and when area must be added it should be added in the flanges as well as in the web, unless the conditions prevent. On the other hand, in a member of the type shown at (i), (j), and (k), Fig. 96, when the ribs have been placed far enough apart so that the radius of gyration about the axis $B-B$ is equal to that about $A-A$ a further increase in the distance between them has no effect on the permissible intensity of stress; if the unsupported lengths about the two axes are the same, and when it is convenient, for local reasons, to make the distance between the ribs greater than that necessary to make $r_{B-B} = r_{A-A}$ no disadvantage results except in a small increase in the weight of the detail material.

102. Convenient Relations.—The following *approximate* relations are convenient in proportioning columns.

In a member such as that shown at (i), Fig. 96, if the distance back to back of the channels is made not less than 8/10 of their depth plus 1 in. the radius of gyration about the axis $B-B$ will not be less than that about the axis $A-A$. If the flanges of the channels are turned out, the distance between their backs should not be less than 3/4 of their depth, in which case the radius of gyration about the axis $B-B$ will not be less than that about axis $A-A$.

In a member composed of built-up channels, as shown at (j), Fig. 96, if the distance back to back of angles measured along axis $A-A$ is not

less than $8/10$ of the distance back to back of angles measured along $B-B$, plus 1 in., the radius of gyration about axis $B-B$ will not be less than that about axis $A-A$. If the flanges are turned out, as at (*k*), Fig. 96, and the distance back to back of angles measured along $A-A$ is made not less than $3/4$ of the distance back to back of angles measured along $B-B$, the radius of gyration about axis $B-B$ will not be less than that about $A-A$.

In members such as shown at (*a*), (*b*), and (*c*), Fig. 97, if the clear distance between the webs (channel or plate) measured along $A-A$ is made not less than $3/4$ of the distance back to back of flanges measured along $B-B$, the radius of gyration about the axis $B-B$ will not be less than that about axis $A-A$.

In the above relations if the limits on rib spacing along axis $A-A$ are met exactly, the radii of gyration about the two axes will be approximately equal, with that about $B-B$ generally a trifle larger than that about $A-A$. If the limiting spacing of the ribs is exceeded the radius of gyration about the axis $B-B$ will of course be increased, while the radius of gyration about axis $A-A$ will not be affected in members without cover plates and very slightly increased for members with cover plates.

Adding vertical reinforcing plates as shown by dotted lines at (*i*), (*j*), and (*k*), Fig. 96, and (*a*) and (*b*), Fig. 97, decreases the radius of gyration about the axis $A-A$, but has little effect on the radius of gyration about axis $B-B$. Full-depth plates have less effect on the radius of gyration about axis $A-A$ than plates added between the flanges.

103. Design of Compression Members Subjected to Bending.—

Columns which are subjected to bending in addition to direct compression are quite common. The maximum intensity of stress in such a column is made up of two parts: the stress due to the direct load, and the stress due to bending.

- Let s' = the maximum intensity of stress on the extreme fiber;
 P = the total direct compression, or load;
 M = the bending moment due to loads applied transversely, or eccentrically;
 A = the area of the column;
 I = the moment of inertia of the column about the principal axis perpendicular to the plane of bending;
 c = the distance from the neutral axis to the extreme fiber in compression due to bending;
 s_c = the intensity of stress in the column due to direct load;
 s_b = the intensity of stress due to bending.

Then

$$s' = s_c + s_b \quad (91)$$

In this expression

$$s_c = \frac{P}{A} k$$

and

$$s_b = \frac{Mc}{I} k'$$

Where k is a factor, greater than 1, which takes account of the fact that the maximum intensity of stress in a column subjected to direct load only is always greater than the average stress, because of unavoidable defects in the column resulting from the process of manufacture; and k' is a factor which is not less, and may be greater, than 1 and which takes account of the fact that a beam with an unsupported compression flange tends to buckle sideways producing an intensity of bending stress greater than is given by the beam formula. Substituting these values in (91) it becomes

$$s' = \frac{P}{A} k + \frac{Mc}{I} k' \quad (92)$$

and since

$$I = Ar^2$$

$$A = \frac{P}{s'} k + \frac{Mc}{r^2 s'} k' \quad (93)$$

Since k is a factor greater than 1, s'/k is an intensity of stress less than the maximum allowable, and is the allowable intensity of average stress given by the column formula, i.e., if a straight-line column formula is used

$$\frac{s'}{k} = s_1 = s - K \frac{L}{r}$$

or if a Rankine-Gordon formula is used

$$\frac{s'}{k} = s_1 = \frac{s}{1 + a \frac{L^2}{r^2}}$$

This assumes that the factor k is not affected by the bending moment due to the transverse loads. This assumption is commonly made but may not be true. Similarly since k' is a factor which *may* (depending on the conditions of lateral support) be greater than 1, s'/k' is an intensity of stress which may be less than the maximum allowable.

Evaluation of the quantity s'/k' is uncertain. Since in (93) the term $\frac{Mc}{r^2} \frac{k'}{s'}$ is the area which must be added to resist bending it seems not unreasonable to say that s'/k' is the intensity of stress which may be allowed in the unsupported compression flange of a beam and may be found from (4) or (6) in Chapter III, i.e.,

$$\frac{s'}{k'} = s'_1 = s - k \frac{L}{b} *$$

or

$$\frac{s'}{k'} = s'_1 = \frac{s}{1 + k \frac{L^2}{b^2}} *$$

This assumes, however, that the flange in the column, which is in compression from bending, acts in the same manner as the compression flange in a beam. So far as the author knows there are no experimental data either to support or disprove this assumption. Some engineers claim that it is obviously wrong, because in a beam the compression flange is restrained from lateral deflection by the web and opposite flange, which is in tension, whereas in the column both flanges are in compression. There is some question in the author's mind as to whether the support of the compression flange in a beam by the web and tension flange is appreciable. Furthermore, the reduction formulas which are commonly applied to beam flanges in compression were developed under the assumption that the compression flange is a column and take no account of such support. The author believes that in the absence of data to the contrary the designer is justified in determining s'/k' in (93) from a beam flange reduction formula. Substituting s_1 for s'/k and s'_1 for s'/k' , (93) becomes

$$A = \frac{P}{s_1} + \frac{Mc}{s'_1 r^2} \quad (94)$$

where

$$s_1 = s - k \frac{L}{r} \quad \text{or} \quad \frac{s}{1 + a \frac{L^2}{r^2}}$$

and

$$s'_1 = s - k \frac{L}{b} \quad \text{or} \quad \frac{s}{1 + k \frac{L^2}{b^2}}$$

* s_1 given in (4) and (6), Chapter III, is here changed to s'_1 to avoid confusion with s_1 as used in the ordinary column formula: k is a constant, not the k in (92) and (93).

as indicated above. In these latter formulas k is used merely to indicate an empirical constant and does not have the same numerical value in the various cases, and is not the same as in (92) and (93).

Engineers who do not approve of the use of a beam reduction formula for evaluating s'/k' generally use the permissible stress obtained from a regular column formula for both s'/k and s'/k' , and then (94) becomes:

$$A = \frac{P}{s_1} + \frac{Mc}{s_1 r^2} \quad (94a)$$

The above discussion assumes bending in the plane of only one principal axis. If there is bending in the planes of both axes the required area becomes:

$$A = \frac{P}{s_1} + \frac{Mc}{s'_1 r^2} + \frac{M''c'}{s''_1 r_1^2} \quad (95)$$

where M , c , and r are the bending moment, distance from neutral axis to extreme fiber, and radius of gyration referred to one of the principal axes, and M'' , c' , r_1 are the corresponding quantities referred to the other principal axis. s'_1 and s''_1 are the permissible intensities of stress for beam flanges without lateral support referred to the appropriate axes.

If we wish to assume that s_1 , s'_1 , and s''_1 should all have the same value, that obtained from the column formula, (95) will become:

$$A = \frac{P}{s_1} + \frac{Mc}{s_1 r^2} + \frac{M''c'}{s_1 r_1^2} \quad (95a)$$

104. Effect of Deflection Due to Transverse Loads.—The method of design just presented neglects the lateral deflection of the column due to the bending. In a compression member the deflection causes an increase, rather than a decrease, in the bending moment. The increase in the moment is approximately the same as the decrease in moment in a tension member, which was discussed briefly in Art. 91 of this chapter. The effect of the deflection is generally neglected, being small; but some engineers prefer, and some specifications require, that it be included in designing. It may be done in the manner outlined in Art. 91. Following the reasoning of that article and using the notation given there and in Art. 103, we may write

$$s' = \frac{P}{A} k + \frac{M'c}{Ar^2} k'$$

and

$$A = \frac{P}{s'} k + \frac{M'ck'}{r^2 s'} \quad (96)$$

Using the approximate value for M' given in Art. 91 this becomes

$$A = \frac{Pk}{s'} + \frac{Mck'}{r^2s'} \left(\frac{1}{1 - \frac{PL^2}{10EI}} \right) \quad (97)$$

Substituting the values of s'/k and s'/k' given in Art. 103, and the approximation for $PL^2/10EI$ given in Art. 91, (97) may be written

$$A = \frac{P}{s_1} + \frac{Mc}{s_1r^2} \left(\frac{1}{1 - \frac{10PL^2}{9EAd^2}} \right) \quad (98)$$

or

$$A = \frac{P}{s_1} + \frac{Mc}{s_1r^2} \left(\frac{1}{1 - \frac{10PL^2}{9EAd^2}} \right) \quad (98a)$$

These equations are identical with (94) and (94a) in Art. 103 except for the term in the parentheses, the effect of which is to increase somewhat the area which must be added to resist bending. Some idea of the amount of the increase may be obtained from the study of the term in the parentheses in Art. 91. In compression members the quantities P/A and L/d will generally be somewhat smaller than in tension members, making the increase in area for compression members usually somewhat less than the decrease in area for tension members.

The statements made in Art. 91 regarding end restraint apply also to the design of compression members subject to bending.

105. Alternate Method of Design.—Some designers prefer to use a trial and error method in the design of members subjected to bending. The procedure is simply to assume a member having an area greater than is required for the direct stress and to compute the stress on the extreme fiber. If the stress is very different from the allowable, the area is revised and the stress recomputed. The method is entirely satisfactory but less direct if the effect of deflection is neglected, than the method given above. The maximum fiber stress may be found from

$$s' = \frac{P}{A} k + \frac{Mc}{I} k', \quad (99)$$

when the effect of deflection is neglected, and from

$$s' = \frac{P}{A} k + \frac{Mck'}{I} \left(\frac{1}{1 - \frac{PL^2}{10EI}} \right) \quad (100)$$

when it is included.

Emphasis should be placed on the fact that $\frac{P}{A}k$ is the *maximum* fiber stress due to the direct load and that similarly

$$\frac{Mc}{I} k', \text{ or } \frac{Mc}{I} k' \left(\frac{1}{1 - \frac{PL^2}{10EI}} \right)$$

is the maximum fiber stress due to bending. $(P/A)k$ may be found by the procedure given in Art. 99, and the bending stress may be found in a similar manner. It should be noted that

$$k' \text{ in } \frac{Mc}{I} k' \text{ or } \frac{Mc}{I} k' \left(\frac{1}{1 - \frac{PL^2}{10EI}} \right)$$

will be unity if the flange in compression from bending is adequately supported laterally at the point where the stress is being computed.

Some engineers compute the stress in a column subjected to bending from

$$s = \frac{P}{A} + \frac{Mc}{I} \tag{101}$$

or from

$$s = \frac{P}{A} + \frac{Mc}{I} \left(\frac{1}{1 - \frac{PL^2}{10EI}} \right) \tag{102}$$

The author does not consider this method to be correct as it is the sum of an *average* direct stress and a bending stress which *may* be a maximum.

When this procedure is followed, if the total stress is not allowed to exceed the permissible average stress obtained from the column formula, the error will generally be small and on the safe side, if the usual limits on L/r and L/b are observed. The method is

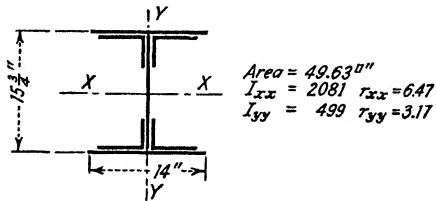

FIG. 98.

equivalent to designing the area to resist bending using the unit stress obtained from the column formula, and if the column flange is held against lateral deflection at the point of maximum moment the added area may be unnecessarily large.

To show the application, assume that a column having an unsupported length of 22 ft. 0 in., carrying a load of 400 kips is subjected to a bending moment of 80 ft.-kips. A trial section shown in Fig. 98 has

been selected. The design is to be governed by the column formula $16,000 - 70 L/r$ and the beam flange reduction formula $16,000 - 150 L/b$.

$$16,000 - 70 \times 264/3.17 = 10,200 \text{ lb. per sq. in.}$$

$$16,000 - 150 \times 264/14 = 13,200 \text{ lb. per sq. in.}$$

The bending moment acts in the plane of the axis $Y - Y$. The maximum stress, neglecting deflection, is:

$$\frac{P}{A} = \frac{400}{49.63} = 8.06 \text{ kips per sq. in.}$$

$$\frac{P}{A} k = \frac{8.06}{10.2} \times 16.0 = 12.7 \text{ kips per sq. in.}$$

$$\frac{Mc}{I} = \frac{960 \times 7.88}{2081} = 3.62 \text{ kips per sq. in.}$$

$$\frac{Mc}{I} k' = \frac{3.62}{13.2} \times 16.0 = 4.4 \text{ kips per sq. in.}$$

$$\text{Total} = 12.7 + 4.4 = 17.1 \text{ kips per sq. in.}$$

Including deflection the term $(Mc/I)k'$ must be multiplied by

$$\frac{1}{1 - \frac{400,000 \times 264}{10 \times 30,000,000 \times 2081}} = 1.04$$

and the total becomes

$$12.7 + 1.04 \times 4.4 = 17.3 \text{ kips per sq. in.}$$

Following the method expressed by equations (101) and (102) the totals will be:

$$8.06 + 3.62 = 11.68 \text{ kips per sq. in.}$$

and

$$8.06 + 1.04 \times 3.62 = 11.82 \text{ kips per sq. in.}$$

The first method gives overstresses of 1.1 kips per sq. in. and 1.3 kips per sq. in.; the second gives 1.5 kips per sq. in. and 1.6 kips per sq. in. The error in the second method is on the safe side and immaterial in this case.

106. Safe Load Tables.—Some engineers prefer to select columns from tables of safe loads rather than from required area. Most engineers' handbooks and all steel manufacturers' catalogs give such

| <u>Compression Members</u> | <u>Single Plane Type</u> | DP 13 |
|--|--------------------------|----------------------------|
| <u>Stress = 125k; Length = 10'-0"; Ends without restraint.</u> | | <u>Compression Members</u> |
| | | 1932 T.C.S. |
| | | Sheet 1 of 4 |
| | | A.I.S.C. Specs. |
| | | <u>3/4" Rivets</u> |

(a) Neglecting own weight. $Min. r = \frac{120}{120} = 1.0$
 $Max. r = \frac{120}{60} = 2.0$

$2-L 6 \times 6 \times \frac{1}{2}$  $r = 1.88$

$\frac{L}{r} = \frac{120}{1.88} = 63.8$ $s_1 = 14.68^4/ain$ $Use 2-L 6" \times 6" \times \frac{1}{2} = 8.72^{00} gross$

$A = \frac{125}{14.68} = 8.52^{00} gr.$

(b) Considering own weight, neglecting effect of deflection—ends unrestrained.

$\frac{L}{r} = \frac{120}{1.88} = 63.8$ $s_1 = 14.68^4/ain$ $\frac{L}{b} = \frac{120}{12.5} = 9.6$ $s'_1 = 18^4/ain$

Assume Wt. = 30/; Mom. = $\frac{30 \times 10^2}{8} \times 12 = 4.5''k$*

$A = \frac{125}{14.68} + \frac{4.5 \times 1.64}{18 \times 1.88^2} = \frac{8.52}{8.64''}$

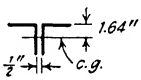

$2-L 6 \times 6 \times \frac{1}{2} = 8.72^{00} gross$

(c) Considering own weight and taking account of deflection—ends unrestrained

$\frac{L}{r} = \frac{120}{1.88} = 63.8$ $s_1 = 14.68^4/ain$ $\frac{L}{b} = \frac{120}{12.5} = 9.6$ $s'_1 = 18^4/ain$

Assume wt. and moment as in (b)

$A = \frac{125}{14.68} + \frac{4.5 \times 1.64}{18 \times 1.88^2} \left(\frac{1}{1 - \frac{125 \times 120 \times 120}{10 \times 30,000 \times 30.8}} \right)$

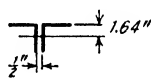

$2-L 6 \times 6 \times \frac{1}{2} = 8.72^{00} gross$

$= 8.52 + .12 \times 1.24$
 $= 8.52 + .15 = 8.67^{00} gross$

(d) Same member and stress, supporting also 2k at each 1/3rd point—ends unrestrained

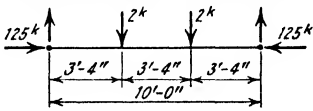

125^k 2^k 2^k 125^k

$3'-4''$ $3'-4''$ $3'-4''$ $10'-0''$

$Mom. = 2^k \times 3.33' = 6.66^k = 80''k$

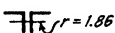
$2-L 6 \times 6 \times \frac{1}{2}$  $r = 1.86$

$\frac{L}{r} = \frac{120}{1.86} = 64.6$ $s_1 = 14.61$ $\frac{L}{b} = \frac{120}{12.5} = 9.6$ $s'_1 = 18$

$A = \frac{125}{14.61} + \frac{80 \times 1.68}{18 \times 1.86^2} = \frac{8.55}{10.72^{00} gr.}$

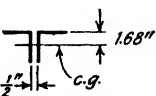

$2-L 6 \times 6 \times \frac{1}{2} = 11.50^{00} gross$

tables. Like safe-load tables for beams they must be based on a specific intensity of stress, but unlike beam tables it is usually not convenient to select columns to comply with a given formula from a table of safe loads based on another formula. The slenderness ratio is involved, and the relation between different column formulas is not direct.

Selection of columns from tables to resist direct load only requires no explanation. When columns must resist bending in addition to direct stress they may also be taken from safe load tables, simply by converting the bending moment into an "equivalent" direct load which is added to the ordinary direct load, the column selected from the table being based on the resultant load. Brief study of the expressions for required area (94) and (94a) should make the proper procedure obvious. If the designer is using the method expressed by (94), the bending moment may be converted to an equivalent direct load by multiplying it by $(c/r^2)(s_1/s'_1)$; if proceeding in accordance with the method expressed by (94a), the moment should be multiplied by c/r^2 .

The factor c/r^2 is given in most steel handbooks for rolled column sections. If not given it may be quickly computed—most easily from the relation

$$\frac{c}{r^2} = \frac{A}{S_c}$$

in which A = the area of the column;

S_c = the section modulus of the column—

these quantities being given in every table of properties of rolled columns.

107. Illustrative Example. DP13.—Illustrations of the principles of column design just discussed are given by the calculations on Sheets 1, 2, 3, and 4 of DP13.

The student should note the relative efficiency of the members designed under (d) and (e) on Sheets 1 and 2: these members offer an illustration of the result of using an unsymmetrical section when it cannot be turned in the most favorable position. Attention is also called to the fact that two 8 in. by 6 in. by 1/2 in. angles with long legs together will satisfy the arithmetical requirements of (e), Sheet 2, at slightly less weight than the 6 by 6 angles used. There are at least two valid objections to the use of the 8 by 6 angles for this member: (1) the long upstanding legs which are relatively thin present an invitation to local buckling, and (2) angles larger than 6 in. on either leg are outside the range of "structural sizes" and command an extra price—usually 0.1 cent per pound. The possibility of local buckling of thin outstanding parts of compression members is a matter on which engineers are not in complete agreement. The limits noted in Art. 100

| <u>Compression Members</u> | <u>Single Plane Type</u> | DP 13 |
|---|--------------------------|---------------------|
| (e) Same as (d) but <i>Is</i> must be turned up | | Compression Members |
| | | 1932 T.C.S. |
| | | Sheet 2 of 4 |

$\frac{L}{r} = \frac{120}{1.84} = 65.3 \quad s_1 = 14.55 \quad \frac{L}{b} = \frac{120}{12.5} = 9.6^* \quad s'_1 = 18$

$A = \frac{125}{14.55} + \frac{80 \times 4.27}{18 \times 1.84^2} = \frac{8.59}{5.61} = 14.20 \text{ in}^2 \text{ gross}$

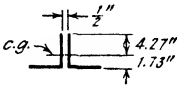

$2-15 \ 6 \times 6 \times \frac{5}{8} = 14.22 \text{ in}^2 \text{ gross}$

* This assumes that the upstanding legs are prevented from buckling laterally by the horizontal legs. The vertical legs should be connected by stitch rivets at intervals not exceeding 2'-0" (See Art. 14(b) of Specs.)

(f) Stress = 10k; Length = 12'-0"

$\text{Min. } r = \frac{12 \times 12}{120} = 1.20$

If min. *r* is used $\frac{L}{r} = 120$ and $s_1 = 10^k/\text{in}$

$A = \frac{10}{10} = 1.0 \text{ in}^2 \text{ gr.}$

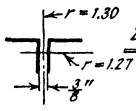

$2-15 \ 4 \times 3 \times \frac{5}{16} = 4.18 \text{ in}^2 \text{ gross}$

Note that 2-15 4x3x $\frac{5}{16}$ having an area = 3.54 in² gross and radii of 1.28 and 1.29 will be satisfactory if obtainable and if thickness meets requirements of specifications.

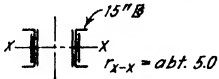
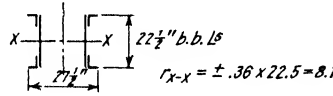
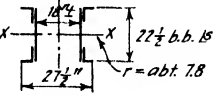
| <u>Compression Members</u> | <u>Double Plane Type</u> | DP13 |
|---|--|-----------------------------------|
| <u>Stress in member = 900k;</u> | <u>Length = 30L0";</u> | Compression Members |
| <u>Ends unrestrained.</u> | | 1932 T. C. S. Sheet 3 of 4 |
| (a) <i>Neglecting own weight</i> | | <u>A. I. S. C. Specs.</u> |
|  | Min. $r = \frac{30 \times 12}{120} = 3.0$ Max. $r = \frac{30 \times 12}{60} = 6.0$ | |
| $A = \frac{900}{13.98} = 64.40^{in} gross$ | $\frac{L}{r} = \frac{30 \times 12}{5.0} = 72 \quad s_1 = 13.98^{in}$ | <u>Gross I_{X-X}</u> |
| Corrected $\frac{L}{r} = \frac{30 \times 12}{4.68} = 77 \quad s_1 = 13.54^{in}$ | Use $\begin{cases} 2-15'' @ .55'' = 32.22 & 858 \\ 2-Pls. 15 \times \frac{3}{4} = 22.50 & 422 \\ 2-Pls. 12 \times \frac{3}{4} = 12.00 & 144 \end{cases}$ | <u>66.72^{in} gross 1424</u> |
| Corrected $A = \frac{900}{13.54} = 66.47^{in} gross$ | $r_{x-x} = \sqrt{\frac{1424}{66.72}} = 4.68$ | |
| (aa) | | |
|  | $\frac{L}{r} = \frac{30 \times 12}{8.1} = 44.5 \quad s_1 = 15^{in} \text{ for } \frac{L}{r} = 60 \text{ or less}$ | <u>Gross I_{X-X}</u> |
| $A = \frac{900}{15} = 60.0^{in} gross$ | Use $\begin{cases} 4-15 6 \times 4 \times \frac{3}{4} = 27.76 & 2432 \\ 2-Pls. 22 \times \frac{3}{4} = 33.00 & 1331 \end{cases}$ | <u>60.76^{in} gross 3763</u> |
| | $r_{x-x} = \sqrt{\frac{3763}{60.76}} = 7.88$ | |
| | Wt. = 60.76 x 3.4 = 206*/l Details, battens, lacing = 34 240*/l | |
| (b) <i>Considering own weight but neglecting effect of deflection - ends unrestrained</i> | | |
|  | Assume Wt. 250*/l | |
| $\frac{L}{r} = \frac{360}{7.8} = 46.2 \quad s_1 = 15^{in} \quad \frac{L}{b} = \frac{360}{27.5} = 13.1 \quad s_1' = 18^{in}$ | Moment = $\frac{250 \times 30^2}{8} \times 12 = 338^{in} k$ | <u>Gross I_{X-X}</u> |
| $A = \frac{900}{15} + \frac{338 \times 11.25}{18 \times 7.8^2} = \frac{60.00}{3.47} = 63.47^{in} gross$ | Use $\begin{cases} 4-15 6 \times 4 \times \frac{3}{4} = 27.76 & 2432 \\ 2-Pls. 22 \times \frac{3}{4} = 35.75 & 1442 \end{cases}$ | <u>63.51^{in} gross 3874</u> |
| | $r_{x-x} = \sqrt{\frac{3874}{63.51}} = 7.81$ | |
| | Wt. = 63.51 x 3.4 = 216*/l Dets. say = 34 250*/l | |

Compression Members Double Plane Type

| | |
|---------------------|--------|
| DP 13 | |
| Compression Members | |
| 1932 | T.C.S. |
| Sheet 4 of 4 | |

(c) Considering own weight and taking account of deflection — ends unrestrained

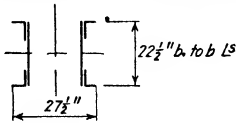

Assume $Wt = 250 \#/\text{ft}$ A I S. C. Specs
 Mom. = $\frac{250 \times 30^2}{8} \times 12 = 338 \text{''k}$

Unit stresses same as for (b)

$$A = \frac{900}{15} \times \frac{338 \times 11.25}{18 \times 7.8^2} \left(\frac{1}{1 - \frac{900 \times 360 \times 360}{10 \times 30,000 \times 3874}} \right)$$

$$= 60.0 + 3.47 \times 1.11 = \frac{60.00}{63.86} \text{''gross}$$

Use same section as for (b)

(d) Same member and direct stress but supporting 2000 #/ft in addition to own weight
 Effect of deflection neglected — ends unrestrained

Assume that overall dimensions must remain the same as for (b) and (c) $r_{x-x} = 7.5 \pm$

Live Load = 2000 #/ft
 Assume $Wt = 400$
 Total Load = 2400 #/ft

Unit stresses same as for (b) and (c)

$$A = \frac{900}{15} + \frac{3240 \times 11.25}{18 \times 7.5^2} = \frac{60.00}{96.00} \text{''gross}$$

Moment = $\frac{2.4 \times 30^2}{8} \times 12 = 3240 \text{''k}$

| | |
|--------------------------|-----------------|
| 4 Ls 6 x 4 x 3/8 = 27.76 | Gross I_{x-x} |
| 4 PIs. 22 x 1/2 = 71.50 | 2432 |
| 99.26''gross | 2884 |
| | 5316 |

$$r_{x-x} = \sqrt{\frac{5316}{99.26}} = 7.32$$

Corrected mom. = $\frac{2.39 \times 30^2}{8} \times 12 = 3225 \text{''k}$

$Wt = 99.26 \times 3.4 = 338 \#/\text{ft}$
 Batts., diaphs., lacing, etc = 50
 388 #/ft

Corrected area

$$A = \frac{900}{15} + \frac{3225 \times 11.25}{18 \times 7.32^2} = \frac{60.00}{97.65} \text{''gross}$$

Say 390 #/ft

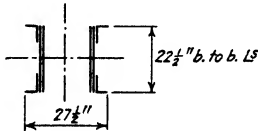

represent current practice. It should be observed that if $1/16$ of the outstanding portion is considered satisfactory as a limiting thickness 8 by 6 by $1/2$ angles will be acceptable; but if the A.R.E.A. requirement of $1/12$ for main members, or $1/14$ for secondary members, is considered to represent better design they will not.

The calculations for (d), Sheet 4, illustrate the penalty in added weight which limitations on size will impose. The reader should redesign the member using 6 by 6 angles and webs 28 or 30 in. deep. In an actual structure an increase in depth may be impossible, and even when possible the increase must not be carried so far as to violate the limitations placed on web thickness. See Art. 14 (a), A.I.S.C. Specifications.

It will have been noticed in studying these calculations, and also those of DP12, that taking into account the bending produced by the weight of the members adds an appreciable percentage to the required area for the longer and heavier members. This at once suggests the question as to how far the designer should go in neglecting the bending due to the weight of a member. Opinions differ, and definite rules are not easily laid down. The margin of safety between the so-called working stress and the yield point of the material should evidently be a factor in reaching a decision: the smaller this margin the more carefully should stress from various sources be considered. As previously stated, stress from this source is generally neglected except for long, heavy members, but the dividing line between members which are "long and heavy," and those which are not, is not well defined. One design specification contains the following clause: * "Stress Due to Weight of Member.—Where the stress due to the weight of the member or due to an eccentric load exceeds the allowable stress for direct loads by more than 10 per cent, the section shall be increased until the total stress does not exceed the above allowable stress for direct loads by more than 10 per cent." The basic intensity of stress in this specification is 16,000 lb. per sq. in. Large and important structures have been designed using basic stresses of 18,000 lb. per sq. in., 20,000 lb. per sq. in., and even more, in which bending stress due to the weight of members has been ignored. The author likes the idea of a definite limit, and favors a clause like that quoted above, particularly when the basic stress is made as high as 20,000 lb. per sq. in. for carbon steel of structural grade. A definite limit automatically takes care of length and weight, and also slenderness which is equally important.

In studying the effect of deflection on the area required to resist

* "General Specification for Steel Frame Buildings" by M. S. Ketchum. See "Structural Engineer's Handbook" by the same author, McGraw-Hill Book Company.

bending, in examples DP12 and DP13, it should be kept in mind that the ends were assumed unrestrained, i.e., pin-connected, in all cases. End restraint, which is always present to some extent, will modify the results. The reader will find it instructive to investigate this matter sufficiently to get some idea of what may be expected in the practical structure.

108. Columns Loaded at Two Levels.—A design problem which occasionally arises is that of a column loaded not only at its upper end but in addition at some intermediate point, support in the direction of only one axis being provided at the intermediate load point. Figure 99 shows the conditions.

The column AB is loaded at the top A and there supported in all directions; it is also loaded at D but there supported only in the direction of the axis $x-x$ as shown in Section 1-1. It is always safe of course to assume that the sum of the loads applied at A and D acts at the top. It seems clear, however, that such an assumption is unnecessarily severe; the true condition of the column must lie somewhere between one having a length AB and one having a length DB , each supporting the full load.

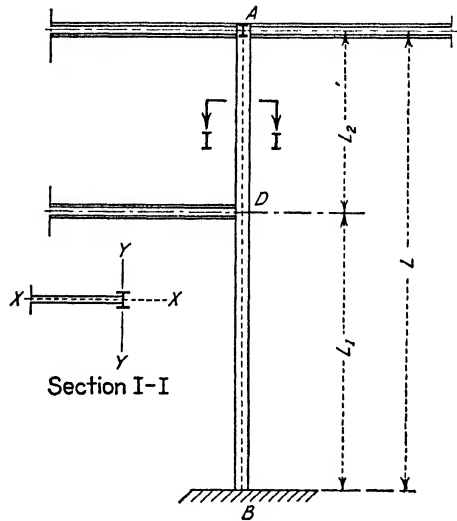

FIG. 99.

The author considers the following *approximate* solution satisfactory for the design of such a column.

This solution is based on three assumptions. It is *assumed*: (a) that the deflection curve of the column is a parabola; (b) that the maximum lateral deflection of the column occurs at midheight; (c) that the experimental coefficient in the Rankine-Gordon column formula is applicable to this case. These assumptions should be clearly understood and kept in mind in studying the solution.

There are two cases to be considered: (a) that in which the intermediate load is applied above the center, and (b) that in which the intermediate load is applied below the center. Either will reduce to the more common case of the intermediate load applied at the center

Figure 100 shows the two cases diagrammatically. The following notation and that shown in the figure will be used:

- P_1 = the load applied at the top;
- P_2 = the intermediate load;
- $P = P_1 + P_2$;
- k = a factor such that $P_1 = kP$;
- k' = a factor such that $P_2 = k'P$;
- k'' = a factor such that $P_2 = k''P_1$;
- e = the maximum lateral deflection of the column in the direction of no intermediate support—assumed to be at the center;
- m = the distance above or below the center at which the intermediate load is applied, in inches;

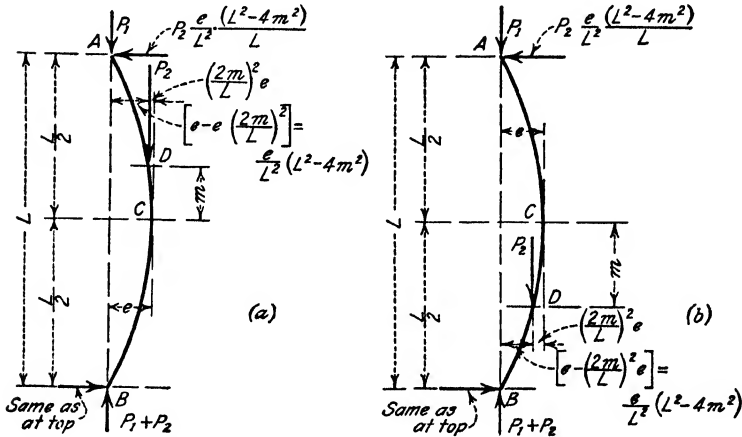

FIG. 100.

- L = the total length of the column, in inches;
- M_c = the bending moment at the center, caused by the fact that lateral deflection of the column axis produces eccentricity of the loads;
- M_d = the bending moment in the column at the intermediate load point;
- c = the distance from the neutral axis to the extreme fiber in the column in the direction of bending;
- s = the maximum fiber stress in the column;
- s_1 = the average fiber stress in the column = P/A ;
- A = the area of the column;
- I = the moment of inertia of the column about the axis perpendicular to the plane of bending, $I = Ar^2$;
- r = the radius of gyration about the axis of I .

Referring to Fig. 100 (a) it is clear that

$$\begin{aligned} M_c &= P_1 e + P_2 \frac{e}{L^3} (L^2 - 4m^2) \frac{L}{2} + P_2 \left(\frac{2m}{L} \right)^2 e \\ &= P_1 e + \frac{P_2 e}{2L^2} (L^2 + 4m^2) \end{aligned}$$

Substituting kP for P_1 , and $k'P$ for P_2 this becomes

$$M_c = \frac{Pe}{2L^2} [L^2(1+k) + 4m^2k']$$

Then we may write at the center of the column

$$\begin{aligned} s &= \frac{P}{A} + \frac{M_c c}{Ar^2} \\ &= \frac{P}{A} + \frac{Pc}{2L^2} [L^2(1+k) + 4m^2k'] \frac{c}{Ar^2} \end{aligned}$$

and

$$\frac{P}{A} = s_1 = \frac{s}{1 + \frac{cc}{r^2} \left[\frac{(1+k)}{2} + \frac{1}{2} \left(\frac{2m}{L} \right)^2 k' \right]} \quad (103)$$

This expression must be correct so far as the assumptions made above and the flexure formula are correct. It cannot be used in this form, however, as e is not known. The amount of e depends largely on accidental defects (arising during the process of manufacture) which cause initial eccentricity and result in bending stress as the load is applied to the column. The amount of this bending stress is not known, of course, but we may say in general that

$$e = \frac{s_i L^2}{Ec}$$

in which s_i = the unknown bending stress resulting from initial eccentricity;

L = the length of the column, in inches;

E = the modulus of elasticity;

c = as defined at the beginning of the article.

If we replace s_i/E by an experimental factor a we may say that

$$ec = aL^2$$

Replacing ec in (103) by aL^2 we have

$$s_1 = \frac{s}{1 + a \frac{L^2}{r^2} \left[\frac{(1+k)}{2} + \frac{1}{2} \left(\frac{2m}{L} \right)^2 k' \right]} \quad (104)$$

which is the familiar Rankine-Gordon formula with the term aL^2/r^2 multiplied by a factor depending on the location and magnitude of the intermediate load. If $m = 0$, probably the most common case, this reduces to

$$s_1 = \frac{s}{1 + a \frac{L^2}{r^2} \left(\frac{1+k}{2} \right)} \quad (104a)$$

Where the intermediate load is below midheight it is necessary to consider the stress at two places, the point of maximum deflection (assumed at midheight) and just under the intermediate load. Proceeding in the same way as before we may find that at midheight the *permissible average stress* is:

$$\frac{P_1}{A} = s_{1c} = \frac{s}{1 + a \frac{L^2}{r^2} \left[1 + \frac{k''}{2} \left\{ 1 - \left(\frac{2m}{L} \right)^2 \right\} \right]} \quad (105)$$

Just below the intermediate load the *permissible average stress* is:

$$\frac{P}{A} = s_{1d} = \frac{s}{1 + a \frac{L^2}{r^2} \left[k + \frac{k'}{2L} (L + 2m) \right] \left[\frac{L^2 - 4m^2}{L^2} \right]} \quad (106)$$

When $m = 0$, (106) reduces to (104a), which of course should be true.

The student should also notice that if the intermediate load is above the center the permissible stress becomes smaller as m increases, as should be the case, and when $m = L/2$, (104) reduces to the usual Rankine-Gordon formula for a single load at the top. Similarly when the intermediate load is below the center the permissible stress at the center increases as m increases, and (105) reduces to the usual Rankine-Gordon formula when $m = L/2$; i.e., we again have a column with a single load at the top.

109. Illustrative Example. DP14.—The design method just presented is illustrated by the calculations on Sheet 1 of DP14.

The student should notice that if the column had been designed considering all the load applied at the top (as is sometimes done) the permissible stress in (a) would have been about 12.5 kips per sq. in. corresponding to an L/r of $576/6.48 = 89$, which would require an area of $600/12.5 = 48.0$ sq. in., while in (b) the permissible stress would have been about 12.36 kips per sq. in. corresponding to an L/r of $576/6.36 = 90.6$, requiring an area of $600/12.36 = 48.5$ sq. in. These figures are not exact, of course, as changing the area would also change the radii of gyration slightly; they are sufficiently accurate, however, to indicate

Two Story Column "H5"

| | |
|------------------|--------|
| DP 14 | |
| Two Story Column | |
| 1932 | T.C.S. |
| Sheet 1 of 1 | |

A.I.S.C. Specs.

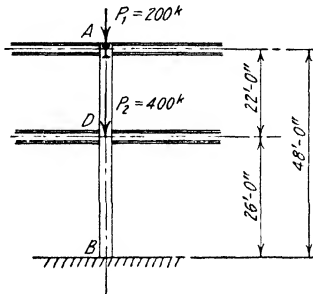

Column supported in both directions at A and B.

No support at D perpendicular to plane of paper.

$$k = \frac{200}{200+400} = .333$$

$$k' = \frac{400}{200+400} = .667$$

$$m = 2'-0''$$

$$\frac{1+k}{2} = \frac{1+.333}{2} = .667$$

$$\frac{1}{2} \left(\frac{2m}{L} \right)^2 k' = \frac{1}{2} \times \left(\frac{4}{48} \right)^2 \times .667 = \frac{.0023}{.6690}$$

$$\therefore S_1 = \frac{18000}{1 + \frac{1}{18000} \times \frac{L^2}{r^2} \times .669}$$

(a) Built up column

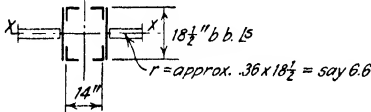

$$A = \frac{600}{14.03} = 42.7 \text{ in}^2 \text{ gross}$$

Equivalent Corrected $\frac{L}{r} = \frac{48 \times 12}{6.48} \times \sqrt{.669} = 72.7$

$$S_1 = 13.91 \text{ in}^3$$

$$A = \frac{600}{13.91} = 43.1 \text{ in}^2 \text{ gross}$$

Section o.k.

$$S_1 = \frac{18000}{1 + \frac{1}{18000} \times \left(\frac{48 \times 12}{6.6} \right)^2 \times .669} = 14.030 \text{ in}^3$$

| | |
|-----------------------------------|-------------|
| 4-15 4x4x1/2 = 16.72 | 1105 |
| 2-Pls. 18x1/2 = 21.00 | 729 |
| 43.72 in² gross | 1834 |

$$r_{x-x} = \sqrt{\frac{1834}{43.72}} = 6.48$$

(b) Rolled Section

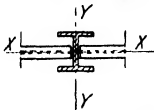

Try 14" WF @ 150#

Axis X-X, $\frac{L}{r} = \frac{48 \times 12}{6.36} \sqrt{.669} = 74.1$

Axis Y-Y, $\frac{L}{r} = \frac{26 \times 12}{3.99} = 78.2$ controls

$$S_1 = 13.44 \text{ in}^3$$

$$A = \frac{600}{13.44} = 44.6 \text{ in}^2 \text{ gross}$$

14" WF @ 150#/ft = 44.13 in² gross

14" WF @ 158#/ft = 46.44 in² gross

that designing by the method under discussion results in a column approximately 15 lb. per ft. lighter than would be obtained by considering all the load at the top.

The easiest way to use any Rankine-Gordon formula is to prepare a table or diagram giving values of permissible intensity of stress corresponding to various ratios of L/r . Attention is called to the fact that formulas (104), (104a), (105), and (106) may be used in this manner if the L/r , in the direction of no intermediate support, is multiplied by the square root of the factor in the denominator enclosed in parentheses or brackets. This is illustrated in the calculations for DP14.

The reader should also observe that when a column is used which has quite different radii of gyration about the two axes, the permissible intensity of stress may be determined by L/r about the axis of less unsupported length as in (b) of DP14.

110. Batten Plates and Lacing. Common Requirements.—When tension and compression members are of the form shown at (f), (g), (i), (j), (k), and (l) in Fig. 96, and at (a), (b), (c), and (h) in Fig. 97, the two segments or ribs of the member must be connected by means of batten plates or batten plates and lattice bars. It is desirable that members of the forms shown at (c) and (f) of Fig. 97 have their flanges tied together by batten plates or batten plates and latticing, but this detail is sometimes omitted, particularly on short columns. Batten plates are also referred to as tie plates or stay plates, and lattice bars or latticing as lacing bars or lacing.

Figure 101 shows some of the forms of latticing used for compression members. Except in one case the figure shows single latticing for members with flanges turned in and double latticing for members with flanges turned out, but both forms of latticing are used on both types of members. Many other forms of latticing are used, but those shown in the figure are the most common. Figures 37, 38, and 46 (e) to (k) inclusive show batten plates and latticing on members in actual structures. Figure 102 shows three additional forms of latticing. Those shown at (a) and (b) are often used, and that shown at (c) has been used for heavy members in large bridges. Some writers and investigators have criticized all these forms of non-intersecting lattice.* It seems probable that non-intersecting lattice may cause severe bending moments at the lattice points under high stresses, resulting in a tendency to local failure of the flange. The intersecting lattice forms are preferable for primary members.

Tension Members.—The function of batten plates on a tension member is to hold the segments together to enable handling as one

* See "Columns," by E. H. Salmon, pages 194, 195, 196.

piece in the shop and in the field, and to make the member act as a unit in resisting the pull for which it is designed, by helping to equalize the stress in the segments. As previously stated, inequality of stress in the

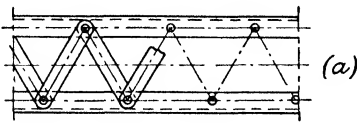

Bar Lattice, Single

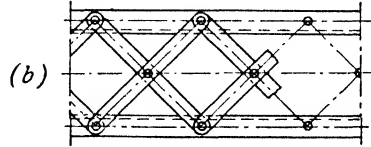

Bar Lattice, Double

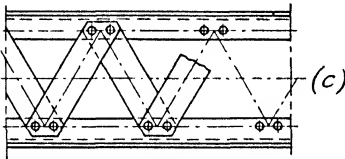

Flat Lattice, Single

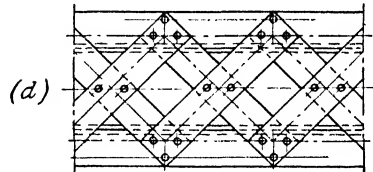

Flat Lattice, Double

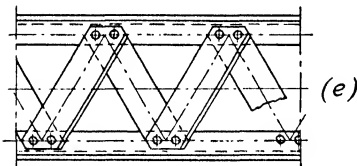

Angle and Flat Lattice,
Single

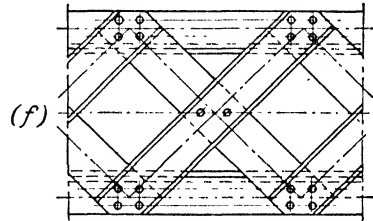

Channel and Flat Lattice,
Double

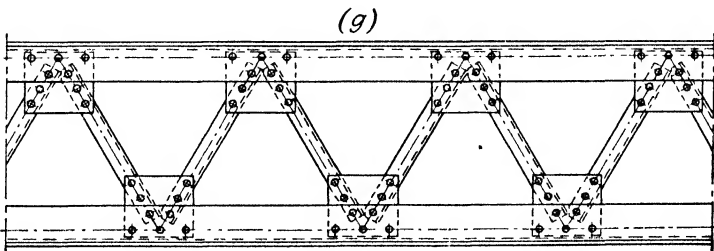

Single Angle Lattice with Gussets

FIG. 101.

various parts of a tension member tends to be self-correcting under increase in load, and the batten plates for such members are usually

proportioned without particular reference to equalizing the stress but in compliance with nominal rules which are given in some specifications.

The end batten plates should be as near the ends as practicable and usually have a length about equal to the distance between the rivet lines connecting them to the member. Intermediate batten plates are generally spaced about 3 to 5 ft. center to center, and are made about half as long as the end batten plates, but in any case long enough to accommodate at least three rivets in each end. The thickness of batten plates for tension members should not be less than $1/50$ to $1/60$

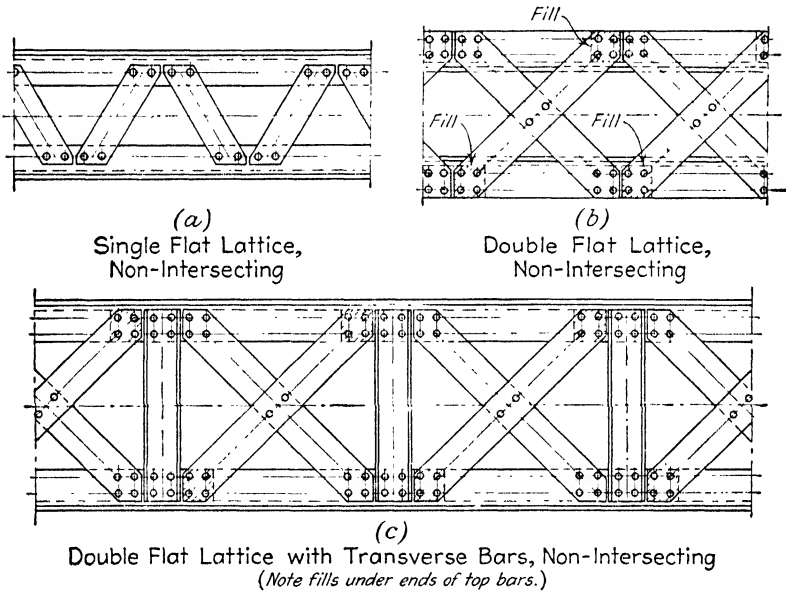

This type may also be constructed by placing alternate diagonal bars under the flange with a filler plate at the intersection.

FIG. 102.

of the distance between the rivet lines connecting them to the member and never less than $3/8$ in. for railway bridges, $5/16$ in. for highway bridges, or $1/4$ in. for buildings. Batten plates which comply with the requirements just stated will have sufficient capacity to transfer from one segment to the other more stress than should be necessary to equalize the load between ribs in the tension members of a well-built structure. It is sometimes desirable to substitute lacing for the intermediate batten plates in long and heavy tension members to minimize the possibility of distortion during fabrication, shipping, and erection.

Compression Members.—The function of batten plates and latticing on a compression member is not only to hold the segments together to enable handling as one piece, but also to equalize the stress between the segments and so to support them that the strength of an individual segment, acting as an independent column between lattice points, will be at least relatively equal to that of the column as a whole.

The fastening together of the segments of compression members has been the subject of much study and some experimentation, particularly since the collapse, during erection, of the first Quebec bridge, which has generally been attributed to inadequate latticing of the principal compression members.

The minimum proportions, spacing, and riveting of lattice bars have become pretty well standardized in recent design specifications, but there are still quite marked differences in ultimate requirements. The following clauses * are typical of the minimum requirements for latticing:

Single lattice-bars shall generally be inclined at an angle of 60° with the axis of the member, and double lattice-bars at an angle of 45° , riveted at the intersection. Single lattice-bars shall have a thickness of not less than one-fortieth, and double lattice bars not less than one-sixtieth, of the distance between rivets connecting them to the compression member.

And for width:

The diameter of the rivets shall not exceed one-third the width of the bar.

The specifications † of the A.R.E.A. are more severe for double lacing requiring that:

The ratio of length to least radius of gyration shall not exceed:

140 for single lacing, and for double lacing not riveted at intersections.

170 for double lacing riveted at intersections.

The 140 limit on L/r is almost exactly equivalent to a limiting thickness of $1/40$, while the 170 limit on L/r is equivalent to a limiting thickness of $1/49$. A limitation on L/r seems preferable to the author since it automatically provides for any shape used as a lattice bar. The A.R.E.A. specifications have substantially the same limit on bar width as the Am. Soc. C.E. specifications, requiring that bars are not to have a width less than 3 in. for 1-in. rivets, $2\frac{3}{4}$ in. for $7/8$ -in. rivets, $2\frac{1}{2}$ in. for $3/4$ -in. rivets, and 2 in. for $5/8$ -in. rivets.

* "Final Report on Specifications for Design and Construction of Steel Railway Bridge Superstructure," *Transactions Am. Soc. C.E.*, Vol. 86, page 471 (1923), par. 314 and 316.

† "General Specifications for Steel Railway Bridges," Fourth Edition, May 1931, Art. 49.

The conventional limits, just illustrated by quotations from common specifications, suffice for the proportioning of latticing for the ordinary columns in building work and light bridges. In the design of heavy members such rules may not provide adequate strength in the latticing, and it becomes necessary to investigate the matter further. In practical design this is done in accordance with further rules in the specifications in use. Typical requirements will be given and later discussed.

The specifications of the Am. Soc. C.E. previously quoted require that: *

The latticing of compression members shall be proportioned to resist shearing stress normal to the member not less than that calculated by the formula:

$$R = \frac{PL}{4000y}$$

in which R = normal shearing stress in pounds;

P = strength of column as a compression member, expressed in pounds;

L = length of column, in inches;

y = the distance from the neutral axis to extreme fiber in inches.

In a compression member with a cover plate, the cover plate shall be assumed to take one-half the shear.

The A.R.E.A. specifications require that †

The lacing of compression members shall be proportioned to resist a shearing stress of $2\frac{1}{2}$ per cent of the direct stress.

The maximum and minimum requirements just quoted from representative design specifications all have to do with the proportioning of the lattice bars themselves, and only indirectly bear on the principal function of the latticing, viz., the support of the separate column segments or ribs in such a way as to make the individual segment, acting as an independent column between lattice points, at least as strong relatively as the column as a whole. This requirement is generally met indirectly by the limit on the angle which the lacing bars may make with the axis of the column. In some cases this may not be sufficient, and the matter is usually covered by direct statement. Quoting from the same specifications as before we find the following requirements: ‡

The distance between the connections of latticing shall be such that the individual members between them shall be relatively stronger than the columns as a whole.

* *Loc. cit.*, Art. 315.

† *Loc. cit.*, Art. 68.

‡ Am. Soc. C.E., 1923, "Specifications," Art. 312.

Column Latticing

Column Designed under (aa) Sheet 3, DP13.

| | |
|------------------|--------|
| DP 15 | |
| Column Latticing | |
| 1932 | T.C.S. |
| Sheet 1 of 4 | |

(a) In accordance with A.S.C.E. Specifications for minimum thickness and minimum shear. (1923)

A.I.S.C. Specs. for allowable stresses.

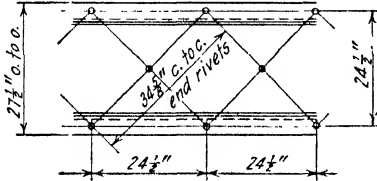

$\frac{3}{4}$ " ϕ Rivets s.s. = 5960*
 $3 \times \frac{3}{4}$ " = $2\frac{1}{4}$ " min. bar width

Min. thickness = $\frac{34.63}{60} = .577$ " say $\frac{5}{8}$ "

Min. shear = $\frac{900,000 \times 360}{4000 \times 13.75} = 5880$ #
 = 2940# per lattice plane

Stress in one bar = $\frac{2940}{2} \times \frac{34.63}{24.50} = 2080$ #

$\frac{L}{r} = \frac{34.63}{.625} \times \sqrt{12} = 192$ $s_1 = 5905$ #/in

$A = \frac{2080}{5903} = .352$ in² gross

Min. bar = $2\frac{1}{4} \times \frac{5}{8} = 1.41$ in² gr.

$n = \frac{2080}{5960} = .35 \sim 1$ -rivet each end
 $\times \sqrt{2} = .495 \sim 1$ -rivet to flange

a.k.

(b) In accordance with A.R.E.A. Specifications for min. shear and thickness. (1931)

Min. r = $\frac{34.63}{170} = .204$ min. t = $.204 \times \sqrt{12} = .706$ " say $\frac{3}{4}$ "

Min. shear = $.025 \times 900 = 22.5$ k
 = 11.25k per lattice plane.

Stress in one bar = $\frac{11.25}{2} \times \frac{34.63}{24.50} = 7.95$ k

$\frac{L}{r} = \frac{34.63}{.75} \times \sqrt{12} = 160$ $s_1 = 7.43$ k/in

$A = \frac{7.95}{7.43} = 1.07$ in² gross



$2\frac{1}{4} \times \frac{3}{4} = 1.69$ in² gr. a.k. for area

$4 \text{ in} \times \frac{3}{4} \text{ in} = 3.00$ in² gross
 necessary for 2-rivets

$n = \frac{7.95}{5.96} = 1.3 \sim 2$ -rivets each end
 $\times \sqrt{2} = 1.84 \sim 2$ -rivets to flange

This is no more than a statement of principle, but in the A.R.E.A. "Specifications" the matter is made very definite: *

Lacing bars of compression members shall be so spaced that the L/r of the portion of the flange included between their connections will be not greater than 40, and not greater than two-thirds of the L/r of the members.

The requirements just quoted should be compared with Art. 16(d) of the A.I.S.C. "Specifications" given in Appendix C.

Particular attention should be given to the proper distance between lattice points in members which are wide, for example the member shown in Fig. 101 (g). In ordinary members the rules just quoted will provide adequate strength in this respect.

Application of the rules given in this article for the latticing of compression members will be illustrated by sample calculations, after which the basis for the common requirements will be discussed.

111. Illustrative Calculations. DP15.—The proportioning of the latticing for the column designed under (aa), Sheet 3, DP13, is given on Sheets 1 and 2, DP15. The unit stresses used are in accordance with the A.I.S.C. specifications, but the minimum requirements as to thickness and shear were taken from the three design specifications noted. The latticing determined under (a), Sheet 1, also satisfies the A.I.S.C. specifications as to width and thickness.

The student should study the calculations carefully and notice the wide difference in shear obtained by applying the requirements of the three specifications.

The calculations given are for double latticing, but the procedure in designing single latticing is the same. Attention may be called to the fact that if single latticing is placed at an angle of 60° with the column axis the stress transfer from the lattice to the flange, at a lattice point, is exactly equal to the stress in one lattice bar. Consequently the riveting required to transfer the stress to the lattice bars is also sufficient to effect the transfer of stress increment from the lattice to the column flange. In double latticing this is not the case as indicated in the illustrative calculations.

112. Shear in Columns.—Shear in columns is seldom a matter of importance in itself, but as a measure of possible stress in the latticing it is worthy of some study, particularly in view of the marked differences in design specifications regarding the shear to be assumed in proportioning the latticing.

Figure 103 shows three common conditions, other than actual transverse loads, which produce shear in columns.

* *Loc. cit.*, Art. 70.

Column Latticing (Cont.)

Column Designed Under (aa) Sheet 3, DP.13. (Cont.)

(c) In accordance with specifications in Appendix A, for min. shear and thickness.

| | |
|------------------|--------|
| DP 15 | |
| Column Latticing | |
| 1932 | T.C.S. |
| Sheet 2 of 4 | |

Max. $\frac{L}{r}$ double lattice = 200 $r = \frac{t}{\sqrt{12}}$ Min. $t = \frac{L\sqrt{12}}{200} = \frac{L}{58} \therefore \text{Min. } t = \frac{34.63}{58} = .597$ say $\frac{5}{8}"$

$r_{y-y} = 10.1$

$\frac{L}{r}(y-y) = \frac{30 \times 12}{10.1} = 35.6$ Shear = $\frac{900}{100} \left(\frac{35.1}{100} + \frac{48}{35.1} \right) = 15.5k$
 $x^2 = 7.75k^2$ per lattice plane

Stress in one bar = $\frac{7.75 \times 34.63}{2 \times 24.50} = 5.48k$

$\frac{L}{r} = \frac{34.63}{.625} \sqrt{12} = 192$ $s_1 = 5.91k/0.11$

$A = \frac{5.48}{5.91} = .93" \text{ gross}$

$n = \frac{5.48}{5.96} = .92 \sim 1\text{-rivet each end for bar stress}$
 $x\sqrt{2} = 1.3 \sim 2\text{-rivets to connect bars to flange}$

* $\left\{ \begin{array}{l} \text{Min. bar for 2-rivet} \\ \text{connection} \\ 4" \times \frac{5}{8}" = 2.50" \text{ gross} \end{array} \right.$

Investigation of $\frac{L}{r}$ of 1 segment between lattice points

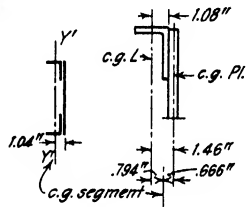
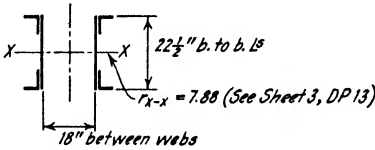

$\frac{L}{r} = \frac{360}{7.88} = 45.6$ for column as a whole

$\frac{L'}{r'} = \frac{24.5}{1.06} = 23.1$ $\left\{ \begin{array}{l} \text{for segment of column} \\ \text{between lattice points} \end{array} \right.$ $\frac{I \text{ of segment about c.g. of angles}}{2 - \text{L} 6 \times 4 \times \frac{5}{8} = 13.88} = 17.36$

$23.1 < \frac{2}{3} \times 45.6 < 50$

a.k.

$\frac{I - \text{Pl. } 22 \times \frac{5}{8}}{30.38} = \frac{16.50 \times 1.46 + 24.10 \times 1.46}{30.38} = \frac{35.20}{30.38} = 1.158$
 $\frac{24.10}{1.794} = 13.43$
 $\frac{19.15}{1.794} = 10.67$
 $I_{y-y'} = 34.18$

$r_{y-y'} = \sqrt{\frac{34.18}{30.38}} = 1.06$

* If the designer does not wish to use a 2 rivet connection and a 4" bar, the lattice riveting may be made with $\frac{3}{4}"$ rivets, if consistent with the rest of the structure, and a bar $2\frac{3}{4}" \times \frac{5}{8}"$ with a single rivet at each end used.

Column Latticing (Cont.)U4Us For 300' Truss Span (See Sheet 11, DP21)

$$\text{Length} = 30'-0'' = 360''$$

$$P = 2567^k$$

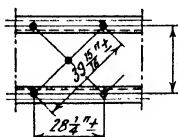
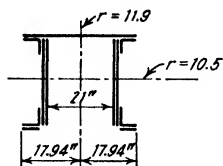
1923 A.S.C.E. Specs.
for allowable stresses

$$\frac{7}{8} \phi \text{ Rivets} = 7.22^k \text{ s.s.}$$

$$3 \times \frac{7}{8}'' = 2\frac{5}{8}'' \text{ min. bar width}$$

| | |
|------------------|--------|
| DP 15 | |
| Column Latticing | |
| 1932 | T.C.S. |
| Sheet 3 of 4 | |

(a) In accordance with A.S.C.E. Specifications

$$\text{Min. thickness} = \frac{39.94}{60} = .666'' \text{ say } \frac{11}{16}''$$

$$\text{Min. Shear} = \frac{2,567,000 \times 360}{4000 \times 17.94} = 12,900^* \text{ shear}$$

$$= 6450^* \text{ per lattice plane}$$

$$\text{Stress in one bar} = \frac{6450}{2} \times \frac{39.94}{28.25} = 4560^*$$

$$\frac{L}{r} = \frac{39.94}{.688} \times \sqrt{12} = 201 \quad s_1 = \frac{16,000}{1 + \frac{1}{13,500} \times 201^2} = 4010^* / \text{in}^2$$

$$A = \frac{4560}{4010} = 1.14 \text{ in}^2 \text{ gross}$$

$$n = \frac{4560}{7220} = .63 \sim 1\text{-rivet each end}$$

$$x\sqrt{2} = .89 \sim 1\text{-rivet to flange}$$

$$\text{Min. bar } 2\frac{3}{4} \times \frac{11}{16} = 1.89 \text{ in}^2 \text{ gross}$$

a.k.

(b) In accordance with A.R.E.A. Specifications for min. thickness and shear.

$$\text{Min. } r = \frac{39.94}{170} = .235, \text{ min. } t = .235 \times \sqrt{12} = .814'', \text{ say } \frac{13}{16}''$$

$$\text{Min. shear} = .025 \times 2567 = 64.1^k$$

$$= 32.05^k \text{ per lattice plane}$$

$$\text{Stress in one bar} = \frac{32.05}{2} \times \frac{39.94}{28.25} = 22.7^k$$

$$\frac{L}{r} = \frac{39.94}{.813} \times \sqrt{12} = 170 \quad s_1 = \frac{16,000}{1 + \frac{1}{13,500} \times 170^2} = 5.09^k$$

$$A = \frac{22.7}{5.09} = 4.46 \text{ in}^2$$

$$\text{Min. bar } 7\frac{1}{2} \times \frac{13}{16} = 6.09 \text{ in}^2$$

a.k.

$$n = \frac{22.7}{7.22} = 3.14 \sim 3\text{-rivets each end}$$

$$x\sqrt{2} = 4.45 \sim 5\text{-rivets to flange}$$

$7\frac{1}{2}''$ bar necessary for 5-rivets.
See Sheet 4 for Sketch

Column Latticing (Concl.)

U4U5 for 300' Truss (Concl.) (See Sheet 11, DP21)

(c) In accordance with Specifications in Appendix A for min. thickness and shear

| | |
|------------------|--------|
| DP 15 | |
| Column Latticing | |
| 1932 | T.C.S. |
| Sheet 4 of 4 | |

Min. r for lacing bars $r = \frac{39.94}{200} = .20$, min. $t = .20\sqrt{12} = .692''$ Say $\frac{11}{16}''$

$\frac{L}{r}(y-y) = \frac{30 \times 12}{11.9} = 30.2$

Min. shear = $\frac{2567}{100} \left(\frac{30.2}{100} + \frac{48}{30.2} \right) = 48.8^k = 24.4^k$ per lattice plane

Stress in one bar = $\frac{24.4}{2} \times \frac{39.94}{28.25} = 17.2^k$

$\frac{L}{r} = \frac{39.94}{.688} \sqrt{12} = 201$, $s = \frac{16,000}{1 + \frac{1}{13,500} \times 201^2} = 4020 \#/\text{in}^2$

$A = \frac{17.2}{4.02} = 4.28 \text{ in}^2 \text{ gr.}$, $\frac{4.28}{5.5} = .78''$ Say $\frac{13}{16}''$

Min. bar $\frac{5\frac{1}{2}'' \times 13''}{16} = 4.47 \text{ in}^2 \text{ gross}$

$n = \frac{17.2}{8.12} = 2.12$ Say 3-rivets each end
 $\times \sqrt{2} = 3$ rivets to flange

See sketch below

Investigation of $\frac{L}{r}$ of one segment between lattice points

$\frac{L}{r} = \frac{360}{10.5} = 34.3$ for column as a whole

r of segment = $6 \times .285$, approx. = 1.71 approx.

$\frac{L'}{r'} = \frac{28.25}{1.71} = 16.5$ for segment between lattice points

(See Table II, Chap. 6)

$16.5 < \frac{2}{3} \times 34.3 < 50$ a.k.

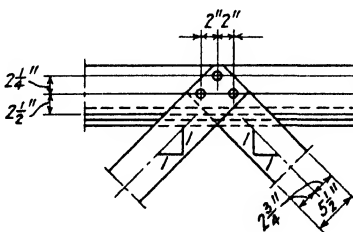

5 1/2" Bar, 3-Rivet Group

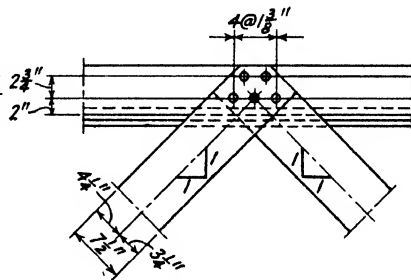

7 1/2" Bar, 5-Rivet Group

Figure 103 (a) represents the deflected shape of a centrally loaded column. Of course a perfectly homogeneous, originally straight, centrally loaded column would not deflect laterally, but practical columns are never homogeneous, and seldom, if ever, perfectly straight. Consequently, even if the practical column is loaded exactly through its centroid, lateral deflection must be expected. If the deflection curve is known the shear and moment at any section can be determined. Since the column is not homogeneous or originally straight it is impossible to determine exactly the deflection curve, and it is commonly *assumed* to be either a parabola or a sine curve.

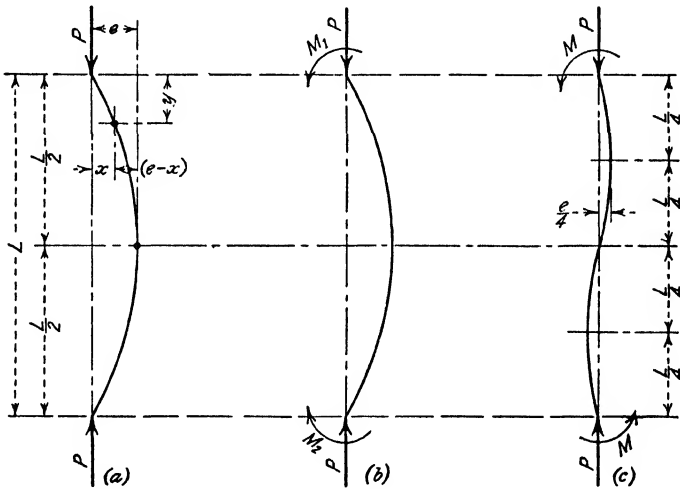

FIG. 103.

Using the notation shown in Fig. 103 (a) it is clear that the bending moment at any point which is at a distance y below the upper end is:

$$M_y = Px$$

Also it is clear that the shape of the bending moment curve must be the same as the shape of the deflection curve, and that the rate of change of the bending moment (i.e., the shear) must be greatest at the ends. If the deflection curve is a parabola

$$x = e - \left(\frac{L/2 - y}{L/2} \right)^2 e = \frac{4e}{L^2} (Ly - y^2)$$

Then

$$M_y = \frac{4Pe}{L^2} (Ly - y^2)$$

and

$$\text{Shear} = V = \frac{dM}{dy} = \frac{4Pe}{L^2} (L - 2y)$$

And since we are interested in maximum shear which occurs when $y = 0$ or L we have:

$$V_{\max.} = \frac{4Pe}{L} \quad (107)$$

in which P = the load on the column;
 L = the length of the column;
 e = the maximum center deflection;
 V = the shear.

If the deflection curve is assumed to be a sinusoid there follows:

$$x = e \sin\left(\frac{\pi}{L} y\right),$$

$$M_y = Px = Pe \sin\left(\frac{\pi}{L} y\right)$$

$$\text{Shear} = V = \frac{dM}{dy} = \frac{\pi}{L} Pe \cos\left(\frac{\pi}{L} y\right),$$

and $V = \max.$ when $y = 0$ (or $y = L$),

$$V_{\max.} = \frac{\pi Pe}{L}. \quad (108)$$

Figure 103 (b) shows the same column with end moments acting as shown. Neglecting the effect of these moments in producing additional lateral deflection of the column * the shear in the column is the same as in Fig. 103 (a) plus that produced directly by the end moments. When these end moments are equal they produce no shear directly. When the end moments have the greatest difference (in general when the moment at one end is zero) they produce their greatest shear, which is additive to that caused by lateral deflection at the end of the column which has the smaller moment. Assuming that the moment at the upper end is zero and that at the lower end is M , the shear at the top is

$$V_{\max.} = \frac{4Pe}{L} + \frac{M}{L} \quad (109)$$

* The lateral deflection caused by the end moments can be taken into consideration if desired, but its effect on the shear, in the important case of moment at one end only, is small—less than 6 per cent when the shear itself is small, decreasing to less than 2 per cent as the shear approaches its maximum values in practical columns.

assuming that the deflection curve is a parabola. The coefficient 4 in the first term on the right, of (109), will be replaced by π , if the deflection curve is assumed to be a sine curve.

If end moments act to produce reverse curvature, as in Fig. 103 (c), the shear due to lateral deflection is decreased but the shear due to the end moments is increased. If there are equal end moments, M , and if the maximum lateral deflection of the column is $e/4$,* as shown in

* It should be clear that the actual deflection is indeterminate: it is partly the result of accidental defects which may occur in an infinite number of positions. Nevertheless, acceptance of Rankine's column formula requires for consistency the assumption that the deflection in Fig. 103(c) may be one-fourth that in Fig. 103(a), for the same column under the same direct load, *neglecting the effect of the end moments in producing additional deflection*. As in the case of single curvature with end moments, the effect of the end moments in increasing deflection may be included, but their effect is not large, and the uncertainties involved in any estimate of column shears make the added complication unjustifiable.

The general statement of the Rankine-Gordon column formula may be written

$$\frac{P}{A} = \frac{s}{1 + \frac{s_c}{n^2 \pi^2 E} \frac{L^2}{r^2}}$$

in which P = the total direct load;

s = the *maximum* fiber stress under load P ,

s_c = the ultimate strength of the material in compression (the elastic limit in steel columns);

n = the number of complete "waves" in the deflection curve of the column axis;

and π , E , A , L , and r have the usual significance. The quantity $\frac{s_c}{\pi^2 E}$ is a constant for a given material, and letting

$$\frac{s_c}{\pi^2 E} = a$$

we may write

$$\frac{P}{A} = \frac{s}{1 + \frac{a}{n^2} \frac{L^2}{r^2}}$$

The second term in the denominator represents the variation in bending stress due to lateral deflection. In Fig. 103(a) $n = 1$ and in Fig. 103(c) $n = 2$; therefore the bending stress in the latter case should be one-fourth that in the former, and the lateral deflections in the same ratio.

The student must not get the impression that the general statement of Rankine's column formula given in this footnote is fully rational and exact. A very plausible derivation can be given but such a derivation depends on the assumption of an *ideal* column, i.e., one which has perfect initial straightness, perfect homogeneity, perfect and uniform elasticity, definite end conditions, and so on. Such columns do not exist practically, and the constant, a , which theoretically is given by the relation noted above, must actually be determined from experimental investigations.

Fig. 103 (c), the shear at the *center* of the column is

$$V_{\max.} = \frac{2Pe}{L} + \frac{2M}{L} \quad (110)$$

In order to make use of (107), (109), and (110) in calculating the shear, the deflection, e , and the end moments, M , must be known or estimated.

The straight-line column formula and the Rankine-Gordon column formula each contain a factor which represents the bending stress due to lateral deflection. In the straight-line formula the factor is * $k(L/r)$, and in the Rankine-Gordon formula the factor is † $s_1 a(L^2/r^2)$. No matter which column formula is considered preferable the maximum bending moment due to lateral deflection occurs at the section of greatest deflection and is Pe . Applying the beam formula in each case there result:

$$\frac{Pec}{Ar^2} = k \frac{L}{r}, \quad e = \frac{kALr}{Pc} \quad (111)$$

and since

$$s_1 = \frac{P}{A}$$

$$\frac{Pec}{Ar^2} = \frac{P}{A} a \frac{L^2}{r^2}, \quad e = \frac{aL^2}{c} \quad (112)$$

The moments which the author has in mind in connection with (109) and (110) are not moments due to known lateral forces ‡ or loads applied with definite eccentricities, but so-called "secondary" moments which arise from deformation of the structure of which the columns in question are a part.§ Secondary moments vary in magnitude but in well-proportioned structures should not produce a bending stress of more than 25 to 30 per cent of the direct stress. Assuming that the

* See (81), Art. 95.

† See (87), Art. 96.

‡ Shears due to known lateral forces should be added to those estimated by the methods under discussion.

§ In general it is desirable that a column be so designed that a solid web is available to resist the shear incident to definite transverse loads or intentional eccentricity of loading, i.e., columns such as shown at (i) and (j), Fig. 96, should be turned so that the channels are parallel to the plane of bending, or a column of the type shown at (e) and (f), Fig. 97, may be used with the diaphragm web placed parallel to the plane of bending.

end moments may be such as to produce a bending stress as high as 30 per cent of the primary we may write:

$$\frac{Mc}{Ar^2} = 0.3 \frac{P}{A}$$

$$M = \frac{0.3Pr^2}{c}$$

Using the value of e from (112) the expressions for shear, (107), (109), and (110) may be written

$$V = 4 \frac{PaL}{c}$$

$$V = 4 \frac{PaL}{c} + \frac{M}{L}$$

$$V = \frac{2PaL}{c} + \frac{2M}{L}$$

These expressions are in general form and may be used for estimating shear whenever the secondary moments, M , are known. Assuming end moments equivalent to 30 per cent secondary stress and $a = 1/16,000$, the expressions become

$$V = \frac{PL}{4000c} \tag{113}$$

$$V = \frac{PL}{4000c} + \frac{0.3Pr^2}{Lc} \tag{114}$$

$$V = \frac{PL}{8000c} + \frac{0.6Pr^2}{Lc} \tag{115}$$

It should be clear that r and c represent properties of the section *about an axis perpendicular to the plane of the latticing*, and also that the shears given by these expressions will be developed only if the column tends to buckle in a plane parallel to the latticing. If the column tends to buckle in a plane perpendicular to the latticing the stress in the lattice bars will be very small. The designer should not assume, however, that a column will necessarily deflect in the direction of its larger slenderness ratio, and skimp the design of the latticing when this direction is perpendicular thereto.

For sections which require latticing the ratio, r/c , varies within a relatively small range, averaging about 0.8. The above expressions for

shear, (113), (114), and (115), may be considerably simplified, and still be sufficiently accurate for practical purposes, by replacing either r or c in terms of the other by means of the *approximate* relation $r/c = 0.8$. The dimension c may be the more convenient term to deal with, and replacing r with $0.8c$ these expressions become:

$$V = \frac{PL}{4000c} \tag{113'}$$

$$V = \frac{PL}{4000c} + 0.192 \frac{Pc}{L} \tag{114'}$$

$$V = \frac{PL}{8000c} + 0.384 \frac{Pc}{L} \tag{115'}$$

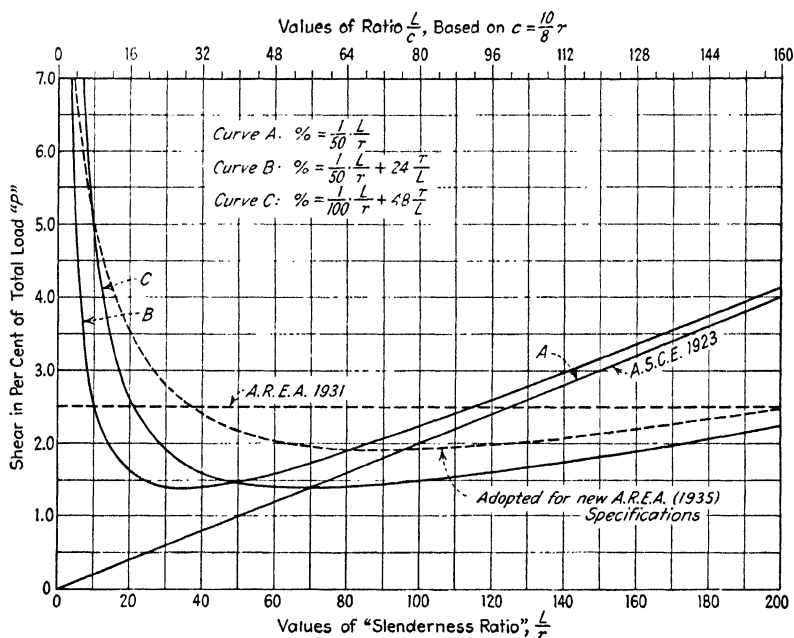

FIG. 104.

Curves representing V as a percentage of P are given in Fig. 104 for various values of L/c or L/r (the formulas convert to L/r as the variable by replacing c with $r/0.8$).

Shear computed from these expression represents quite severe conditions, and it seems reasonable to suppose that columns latticed in accordance with them should be entirely satisfactory. In addition to

the curves defined by these expressions, Fig. 104 shows the requirement of the A.R.E.A. 1931 specifications for bridge design, that of the A.S.C.E. 1923 specifications, and that suggested for the proposed revision of the A.R.E.A. specifications.

Accepting shears computed from these relations as satisfactory for proportioning column latticing, we may rewrite them as follows:

$$V = \frac{P}{100} \left(\frac{1}{50} \cdot \frac{L}{r} + 24 \frac{r}{L} \right) \tag{114''}$$

$$V = \frac{P}{100} \left(\frac{1}{100} \cdot \frac{L}{r} + 48 \frac{r}{L} \right) \tag{115''}$$

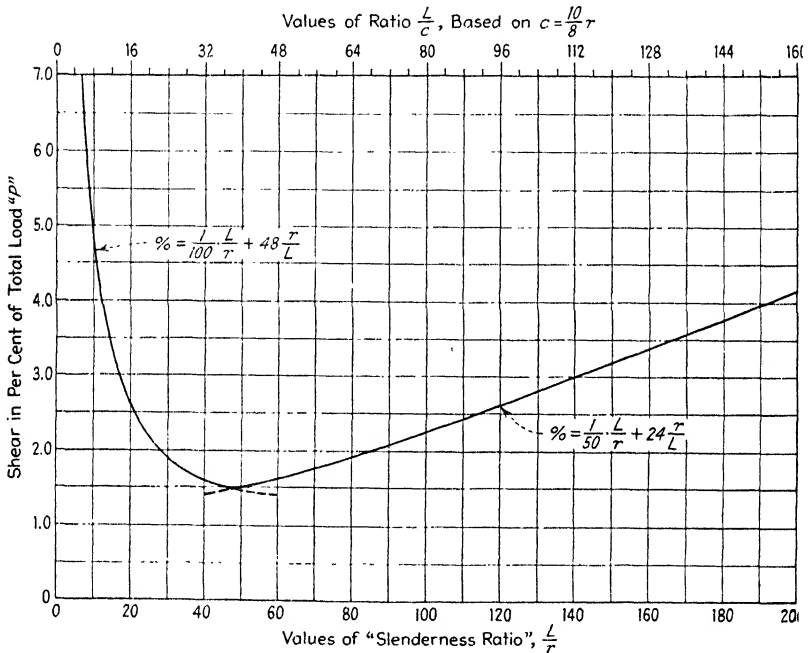

FIG. 105.

It is clear that the term in parentheses may be taken as the percentage of column load to be used as shear in proportioning the latticing. The specifications in Appendix A require that latticing be proportioned for a shear not less than that given by these expressions, and Fig. 105 gives a graphical representation of the requirement.

The discussion of shear in compression members so far has been confined to that arising from service conditions. Another source of

transverse forces, which may be of considerable importance in long and heavy members, is the weight of the members themselves. During the handling incident to fabrication, shipping, and erection a member may occupy almost any position and be supported in various ways, and the latticing obviously should be capable of resisting whatever shears may arise in this way. Compression members latticed in accordance with the limits given above will rarely, if ever, be inadequate in strength to resist such forces, but heavy tension members, which are frequently latticed rather nominally, may require special consideration.

113. Maximum Spacing of Lattice Points.—In Art. 110 the requirements of well-known design specifications regarding the maximum spacing of lattice points were quoted or referred to. The matter seems of sufficient importance to justify further discussion.

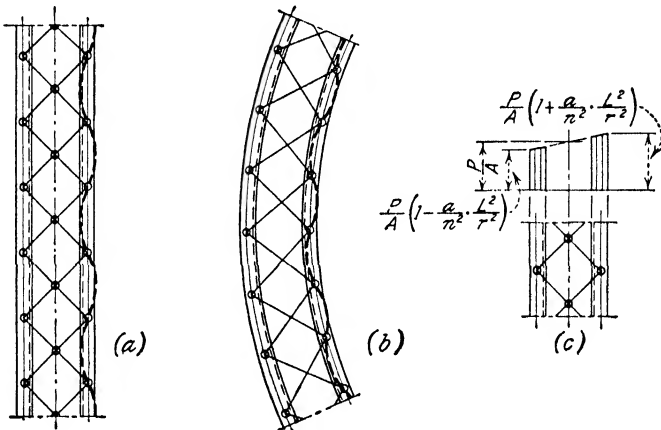

FIG. 106.

Figure 106 (a) shows a portion of a latticed column. It seems clear that regardless of the end conditions of the column as a whole one rib may bend between lattice points as a strictly pin-ended column. There can be little or no restraint against alternate in and out deflection, as shown by the heavy dotted line, particularly when the latticing consists of single riveted bars, and even heavier plates or shapes with multiple riveting cannot offer much restraint to such buckling. Main compression members which are truly pin-ended are nearly impossible in ordinary structural work, and since the individual segments must be considered truly pin-ended between lattice points it follows that the slenderness ratio of the segment between lattice points should generally be less than that of the column as a whole. For uniform strength the

individual segment should have a maximum intensity of stress, acting as a column between lattice points, equal to that in the column as a whole. Applying the Rankine-Gordon formula in its most general form (see footnote, page 250) we may write

$$s = \frac{P}{A} \left(1 + \frac{a}{n^2} \cdot \frac{L^2}{r^2} \right) = \frac{P'}{A'} \left(1 + \frac{a}{n_1^2} \cdot \frac{L_1^2}{r_1^2} \right)$$

in which s = maximum allowable intensity of stress;

P/A = average stress on column as a whole;

P'/A' = average stress on one rib;

L = length of column as a whole;

L_1 = distance between lattice points on one rib;

r = radius of gyration of column as a whole;

r_1 = radius of gyration of one rib about its centroidal axis perpendicular to the plane of latticing;

n = number of " waves " in column axis as a whole;

n_1 = number of " waves " in rib between lattice points;

a = a constant dependent on properties of the material.

In an initially straight, centrally loaded column

$$\frac{P}{A} = \frac{P'}{A'}$$

and we have

$$\frac{L_1}{r_1} = \frac{n_1}{n} \cdot \frac{L}{r} \quad (116)$$

as the relation between the slenderness ratio of the column as a whole and that of one rib between lattice points.

Main compression members will generally have end conditions which approximate one of, or a combination of, those shown in Fig. 107. The values of n for the cases shown are as follows:

- | | |
|--|-----------|
| (a) One end fixed, other entirely free: | $n = 1/2$ |
| (b) Pin-ended | $n = 1$ |
| (c) Fixed-ended | $n = 2$ |
| (d) One end fixed, other pinned but free to turn | $n = 3/2$ |
| (e) Pin-ended reverse flexure | $n = 2$ |

Assuming that practical columns in actual structures will have end conditions somewhere between (b) and (c), or perhaps about equal to (d), we may say, since $n_1 = 1$, that:

$$\frac{L_1}{r_1} = \frac{2}{3} \frac{L}{r} \quad \text{to} \quad \frac{3}{4} \frac{L}{r}$$

These limits on the slenderness ratios are very commonly specified, but it has been pointed out by several writers * that they should not be considered sufficient in all cases.

Figure 106 (b) shows to a greatly exaggerated scale a portion of a deflected, latticed column, and Fig. 106 (c) shows the distribution of stress across the section resulting from the column-action of the column as a whole. Inspection of the stress distribution diagram shows that the maximum stress from column-action as a whole is substantially uniform across the rib on the concave side, i.e., it is very nearly true that:

$$\frac{P'}{A'} = \frac{P}{A} \left(1 + \frac{a}{n^2} \cdot \frac{L^2}{r^2} \right)$$

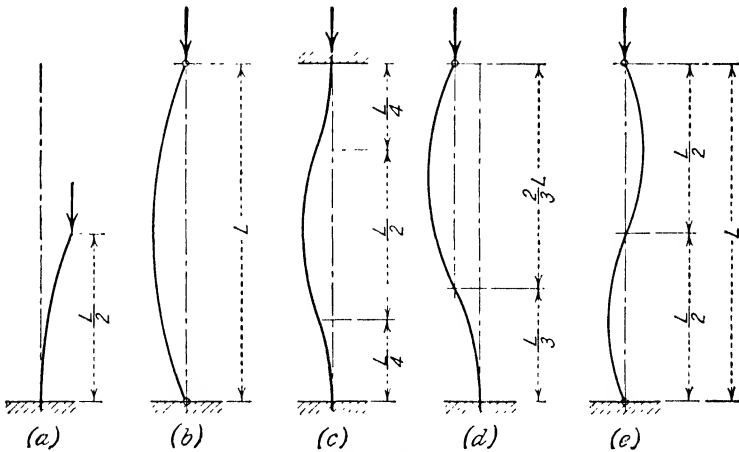

FIG. 107.

This stress may be considerably increased by column-action of the rib itself between lattice points, and the maximum intensity of stress in the rib (and necessarily that in the column) will then be:

$$s = \frac{P'}{A'} \left(1 + \frac{a}{n_1^2} \cdot \frac{L_1^2}{r_1^2} \right) = \frac{P}{A} \left(1 + \frac{a}{n^2} \cdot \frac{L^2}{r^2} \right) \left(1 + \frac{a}{n_1^2} \cdot \frac{L_1^2}{r_1^2} \right)$$

From this

$$\frac{P}{A} = \frac{s}{\left(1 + \frac{a}{n^2} \cdot \frac{L^2}{r^2} \right) \left(1 + \frac{a}{n_1^2} \cdot \frac{L_1^2}{r_1^2} \right)} \tag{117}$$

* Prof. G. F. Swain in "Strength of Materials," McGraw-Hill Book Company; E. H. Salmon in "Columns," Henry Frowde and Hodder & Stoughton, London; Wm. Alexander in "Columns and Struts," E. & F. N. Spon, London; and others.

If the column is to be of uniform strength, i.e., if an individual rib is to be relatively as strong as the column as a whole, it is necessary that the lattice points be spaced so that column-action of the column as a whole will produce a maximum intensity of stress equal to that produced by column-action of the individual rib acting between lattice points. A little study will show at once that this is impossible: if the condition is fulfilled we will have,

$$\frac{P}{A} \left(1 + \frac{a}{n^2} \cdot \frac{L^2}{r^2} \right) = \frac{P'}{A'} \left(1 + \frac{a}{n_1^2} \cdot \frac{L_1^2}{r_1^2} \right)$$

which $\left[\text{remembering that } \frac{P'}{A'} \text{ is nearly equal to } \frac{P}{A} \left(1 + \frac{a}{n^2} \frac{L^2}{r^2} \right) \right]$ leads to

$$\frac{L_1}{r_1} = 0$$

This result, *if correct*, means that it is impossible to design a latticed column which does not have its strength limited by that of the individual rib, and also that it is incorrect to apply the Rankine-Gordon formula as usually stated in the design of latticed columns.

The defect in the reasoning leading to this conclusion is the tacit assumption that the Rankine-Gordon column formula is applicable for all values of L/r , whereas experimental investigations of columns seem to indicate that when the slenderness ratio falls below a certain limiting value the strength of the column ceases to be a function of the L/r ratio. In view of this it seems reasonable to conclude that if the L/r values of the individual segments are kept below the limit at which strength becomes a function of this ratio there will be no buckling or column-action of the segments, aside from that of the column as a whole, and that compliance with this requirement will make the segments of the latticed column relatively as strong as the column as a whole.

There does not seem to be complete agreement among engineers as to the exact limit of the slenderness ratio below which strength is no longer a function of the L/r ratio. Limits of 40, 50, 60, and even 80 have been suggested. Current design practice implies that the limit lies between 40 and 60. This is reflected in such requirements as that the L/r of the flange of a latticed column, between lattice points, shall not exceed two-thirds that of the member as a whole, or be more than 40 in any case.

The application of such limits in the design of main compression members is in line with good practice. In the design of long secondary members, such as bracing struts, the author sees no objection to allowing the slenderness ratio of the ribs, between lattice points, to exceed 40,

Bracing - Secondary Strut

| | |
|-----------------|--------|
| DP 16 | |
| Secondary Strut | |
| 1932 | T.C.S. |
| Sheet 1 of 1 | |

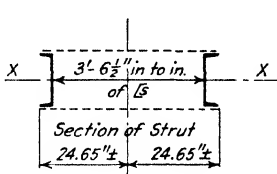

Length of Strut = 60' = 720"
 Total Stress = 60k
 Max. $\frac{L}{r} = 200$
 Min. $r = \frac{720}{200} = 3.6$
 Try 2-15" Channels

A.I.S.C. Specs.
 for allowable stress

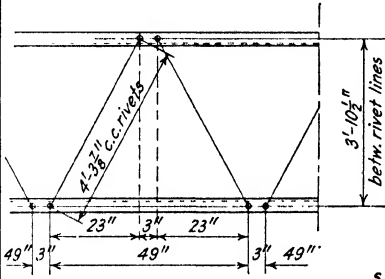

Max. $\frac{L}{r}$ single lattice = 140
 Min. r , lattice bar, = $\frac{51.88}{140} = .37$
 1-L $2\frac{1}{2} \times 2 \times \frac{5}{16}$ least $r = .42$
 Channel flange $\frac{L}{r} = \frac{49}{.79} = 62$
 Strut, axis x-x, $\frac{L}{r} = \frac{720}{5.62} = 128$

$$s_1 = \frac{18,000}{\left(1 + \frac{1}{18,000} \times 128^2\right) \left(1 + \frac{1}{18,000} \times 62^2\right)} = 7760 \text{*/in}^2$$

Area (neglecting own weight)
 = $\frac{60,000}{7760} = 7.72 \text{ in}^2 \text{ gross}$

2-15" \bar{S} @ 33.9# = 19.80 in² gross
 Wt. = 2 x 33.9 = 67.8 \bar{S}
 $\frac{51.8}{23.0} \times 4.5 \times 2 = 20.8$ Lattice
 89.6
 Say 90# / i

Taking account of own weight
 Moment = $\frac{90 \times 60^2}{8} = 40,500 \text{ ft}^2 = 486 \text{ in}^2 \text{ k}$

$$A = \frac{60.00}{7.76} + \frac{486 \times 7.5}{18 \times 5.62^2} = \frac{7.72}{6.43} = 14.15 \text{ in}^2 \text{ gross}$$

Section o.k.

Lattice Bar Stress

Shear (A.R.E.A. Specs.) = $.025 \times 60 \text{ k} = 1.5 \text{ k}$
 Shear, (own weight end supports) = $\frac{90 \times 60}{2} = 2.7 \text{ k} = 1.35 \text{ k per lattice plane}$

Stress = $1.35 \times \frac{51.8}{46.5} = 1.5 \text{ k per bar}$
 $\frac{L}{r} = \frac{51.8}{.42} = 124, s_1 = 9.7 \text{ k/in}^2$

$A = \frac{1.5}{9.7} = .16 \text{ in}^2$ 1- $2\frac{1}{2} \times 2 \times \frac{5}{16} \text{ L} = 1.31 \text{ in}^2$ o.k.

or even that of the column, *provided* the required capacity is so small that extravagant use of material does not result and provided the permissible intensity of stress is determined from a column formula such as (117). In this connection it is of interest to note that if the condition expressed by (116) is complied with, (117) becomes:

$$\frac{P}{A} = s_1 = \frac{s}{\left(1 + \frac{a}{n^2} \cdot \frac{L^2}{r^2}\right)^2} \quad (118)$$

114. Illustrative Calculations DP16.—To illustrate the application of the principles just discussed calculations for the design of a long strut subject to small direct stress are given on Sheet 1 of DP16.

Attention is called to the non-intersecting single lattice. As previously stated the author considers such latticing undesirable for main members; for secondary members subjected to small stress, and designed primarily to satisfy L/r requirements, it does not seem objectionable and is much less expensive when angles or other shapes are used for lattice bars. Either 10- or 12-in. channels will satisfy the L/r requirements, but if account is taken of the stress due to bending under its own weight the strut will be heavier than when using the 15-in. channels. The student should notice that the capacity of the strut (i.e., permissible intensity of stress) is fixed by the strength of one rib as a column between lattice points, but this is of small consequence here since the stress to be resisted is so small. It is important to notice also that the lattice stress is entirely nominal but that the larger stress will result from the member acting as a beam, resisting its own weight, if it should be turned with the latticing vertical and supported at the ends, during fabrication, shipping, storage, or erection. It is improbable (but not impossible) that the latticing, as such, will be stressed in service by deflection parallel to its plane in a member of such proportions.

115. References for Further Study.—In addition to texts and papers referred to during the discussion in this chapter the following sources are valuable for further study:

- Proceedings*, American Society for Testing Materials. Vol. IX, page 413, paper by J. E. Howard.
- "Reports of Tests of Metals," Watertown Arsenal, 1908, 1909, 1910, and 1911.
- Journal* of the Western Society of Engineers, Vol. XVIII, June, 1913, page 457, "Columns" by O. H. Basquin.
- "Modern Framed Structures," Part III, by Johnson, Bryan, and Turneure, John Wiley & Sons.

CHAPTER V

CONNECTIONS

116. The preceding chapters have discussed the design of the three fundamental structural forms of which every structure, no matter how complicated, must be composed. A structure, however, is an assemblage of various members which must be fastened together to make the finished product, and no matter how scientifically and efficiently the members may have been designed, if the necessary connections are inadequate the result will be a poor structure. The importance of good connections cannot be over-emphasized, but they are often not given the attention they deserve.

It is the purpose of this chapter to discuss the fundamental principles of the design of connections. The methods presented are, for the most part, in common use, and, although not entirely satisfactory in many respects, they represent the best that designing engineers have been able to develop up to the present.

117. Types of Connections.—There are at present three general types of connections used in structures:

1. Pin connections.
2. Riveted connections (including bolted connections).
3. Welded connections.

Pin Connections.—A pin connection, as the name implies, is essentially a fastening together of the members meeting at a joint by means of a round steel pin passing through bored holes in the ends of the members. Figure 108 shows a typical pin connection for a single-track railway bridge of moderate span, and Fig. 109 shows partial pin connections at the center of a modern, heavy, double-deck, swing bridge. Pin connections formerly were used almost exclusively in American bridge practice but during the past twenty years they have been largely replaced by riveted connections. Some engineers maintain that they will regain their popularity for spans of moderate length; the author does not think so. One of the principal advantages of pin connections was the speed with which structures so connected could be erected. Another advantage claimed for them is the saving in weight of tension

members; since eye bars may be used there are no holes to be deducted for rivets. This saving is not so large as sometimes supposed; extra material must be added to form the eyes, which, with the expensive shop work required for forging the heads and boring the pin holes, largely offsets the saving in actual area of the cross-section. It has also been claimed that pin connections are desirable because the members connected are free to turn upon the pins as the truss deflects, without causing secondary stresses. The members are not "free to turn" on the pin, friction is high, and paint films and corrosion tend to increase greatly the resistance to turning. Furthermore, it is very much to be

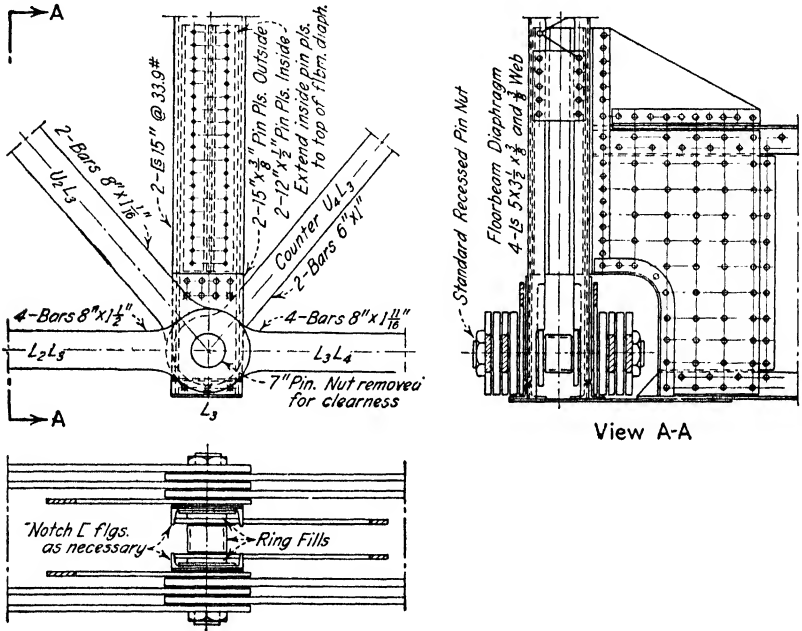
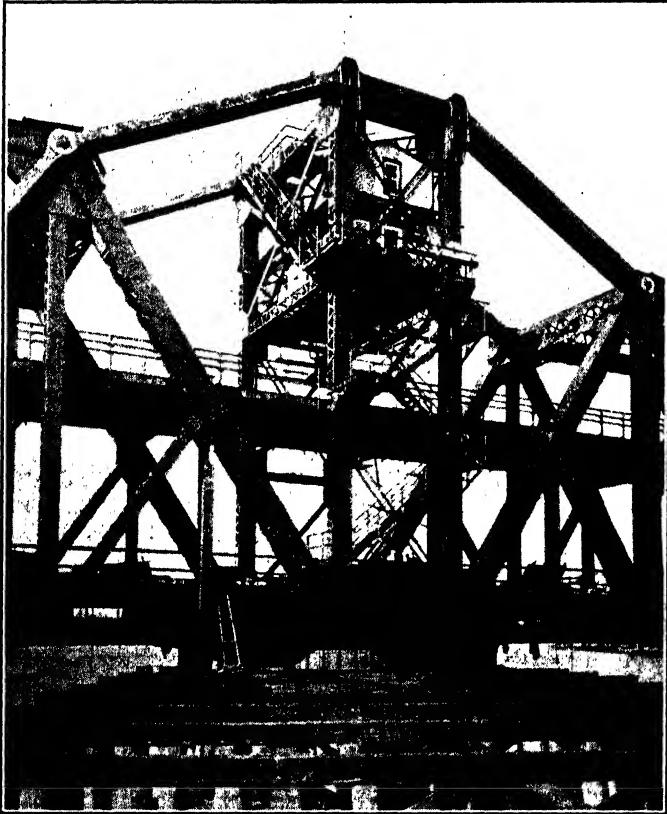

FIG. 108.

hoped that turning does not occur at all, since, at the bearing pressures used in design, wear would inevitably result, causing enlargement of the pin holes and grooving of the pins, and eventually necessitating expensive repairs or replacements. It does not seem likely that members turn on the pins in structures in which there is any justification for pin connections: the secondary stresses, however, may be considerably smaller than in the corresponding riveted truss because eye bars are seldom much more than half the width of riveted tension members of equal capacity.

RIVETED CONNECTIONS.—Without having actual figures to prove or disprove the statement the author thinks that rivets (and bolts) are used in more than 95 per cent of all connections in present structural practice. Riveted joints have become practically standard in bridge construction and have been used in some of the heaviest of railway bridges—notably the Sciotoville bridge, having a two-span continuous



Courtesy of Atchison, Topeka and Santa Fe Railway.

FIG. 109.—Pin Connections at Center of Swing Span, Mississippi River Bridge, Fort Madison, Iowa.

truss 1550 ft. in length, and the New York Central's Hudson River bridge at Castleton, New York, which has double-track spans of 400 ft. and 600 ft. in length. In building work riveted connections had been practically universal until the recent development of arc and gas welding into commercially practicable structural tools.

Riveted joints have gained in popularity because structures so connected are credited with being more rigid, less subject to wear and resulting vibrations, more durable, and generally safer. Modern shop and erection facilities and methods have greatly reduced the difference in cost which formerly existed between pin-connected and riveted structures.

Most of the figures appearing in Chapter II show riveted connections, and Fig. 110 is presented to illustrate the character of riveted joints occurring in modern, heavy railway bridges. Figure 110 is of special

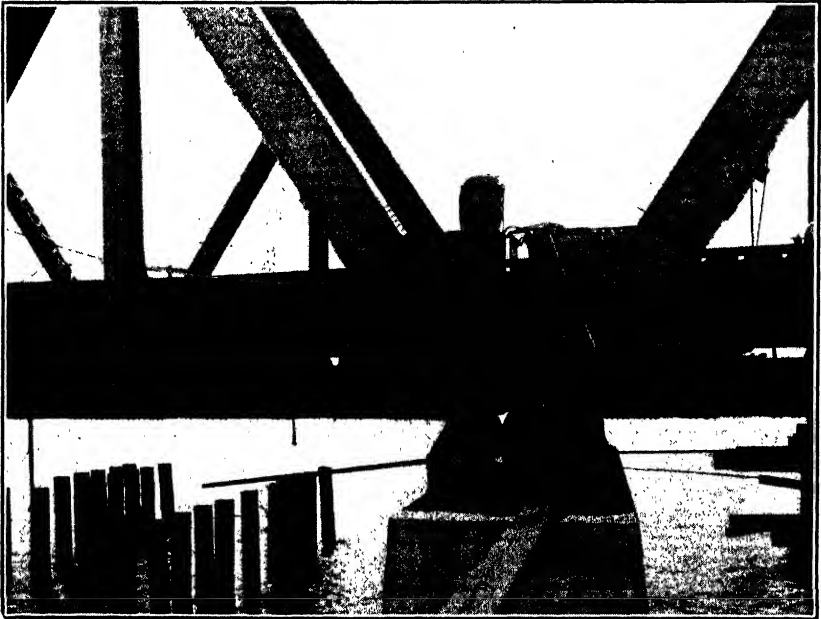

Courtesy of Atchison, Topeka and Santa Fe Railway.

Fig. 110.—End Bearings on Pier 10, Mississippi River Bridge,
Fort Madison, Iowa.

interest because it shows at the left an Lo joint fully riveted, and at the right an identical joint in the bolted stage which precedes riveting. Figure 109 also shows heavy riveted connections.

Bolts are often used in place of rivets for connections in such close quarters that rivets cannot be driven. In the past, many engineers have preferred bolts to rivets for connections in which the rivets would be subjected to definite tension; it is now the fairly general belief that well-made rivets of good material are reliable in resisting tension, and the

use of bolts, because of tension, has decreased. Bolts are frequently used in place of rivets for temporary structures; in industrial buildings for connections which do not resist computed stress, such as in purlin clips; and sometimes in steel-frame office buildings for interior beam connections not subjected to wind moments. When used in place of rivets for connections carrying computed stress it is usual to require *turned bolts*, i.e., bolts which have their shanks machined to fit tight in the holes; the diameter of the threaded portion of turned bolts is usually made $1/16$ in. less than the diameter of the shank. Bolts in connections carrying calculated stress should have lock nuts, or the threads should be deformed, after turning up the nuts, to prevent vibration loosening the nuts.

WELDED CONNECTIONS.—Welded joints first appeared in steel construction in about 1915,* and since then the development has been so rapid that now (1934) fusion welding by the arc and gas processes has become an important and recognized tool in the construction industry.

Up to the present time the greatest application of welding has been in the field of building construction, but there has been some experimental work in new bridge construction and a fairly large amount of repair work and strengthening of old bridges by this method.

Several advantages are claimed for welded connections: in trusses there is a considerable saving in tension members since holes for rivets are not required; there may be complete continuity of joints in wind-bracing connections leading to greater rigidity; connections in the field may be made with almost complete absence of noise, a very important matter in construction work in office or residential districts.

Methods of design and construction of welded connections are not as well standardized as are those of pin and riveted connections, and it has seemed worth while to bring all the discussion of welding together. The matter will therefore not receive further consideration here but will be treated in a separate chapter devoted to the design of welded structures in general.

118. Fundamental Considerations.—In what has gone before it has been assumed that the student has been acquainted, through his study of the mechanics of materials, with the fundamental principles involved in estimating the strength of riveted connections. Before going into the design of connections, however, it seems desirable to review briefly the principles on which the discussion must be based.

* According to paper presented before Philadelphia Section of the Am. Soc. C.E., March 14, 1928, by Frank P. McKibben.

RIVETED CONNECTIONS.—In Fig. 111 (a) is shown the simplest of riveted connections—the ordinary lap joint. Some joints in structures are of this general type, but it is not common in building and bridge construction. In Fig. 112 (a) is shown a type of riveted connection which is probably the most common in bridge and building construction.

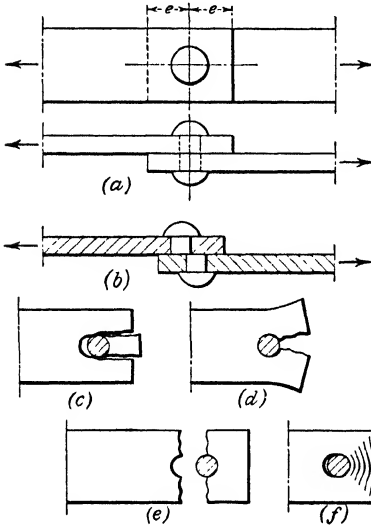

FIG. 111.

In Fig. 113 (a) and (b) are shown the butt joint with single strap, and with double strap: these occur frequently in steel construction—

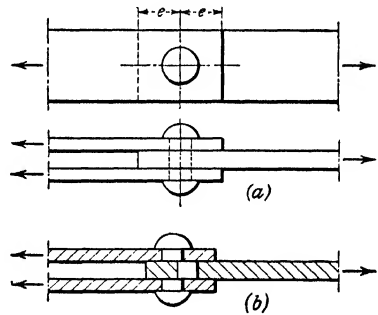

FIG. 112.

the butt joint with double strap is essentially the same as shown in Fig. 112.

The rivet in the connection in Fig. 111 (a) may fail in shear, as shown at (b), or it may fail by crushing against the plate. The plate may fail by a strip shearing out back of the rivet, as in (c); by cracking back of the rivet, as in (d); by a transverse tension failure, as in (e); or by crushing under the rivet, as in (f). The rivet in the connection in Fig. 112 (a) may fail by shearing, as in (b), or by crushing against one or more of the plates. Any or all the plates may fail in any one of the ways shown in connection with Fig. 111.

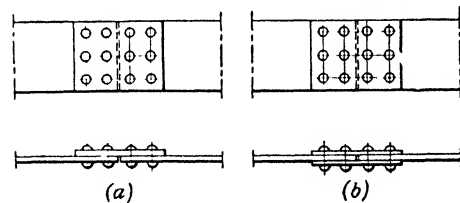

FIG. 113.

Shearing of a rivet as in Fig. 111 (b) is called failure by *single shear*,

and that in Fig. 112 (b) failure by *double shear*. The strength of a rivet in single shear is:

$$R_s = \frac{\pi d^2}{4} s_s$$

in which R_s = the strength of the rivet in single shear;

d = the diameter of the rivet, in inches;

s_s = the permissible *average* intensity of shearing stress in the rivet, in pounds per square inch.

The strength of a rivet in double shear is of course twice that in single shear.

The strength of a rivet in bearing against a plate is:

$$R_b = dt s_b$$

in which R_b = the strength of the rivet in bearing against the plate;

d = the diameter of the rivet, in inches;

s_b = the permissible intensity of stress in bearing, in pounds per square inch;

t = the thickness of the plate, in inches.

This assumes that the pressure acts on the cylindrical surface in such a way that the maximum intensity of bearing pressure is the same as though the rivet load were distributed uniformly over a diametrical section or over the projection of the rivet on the plate. There is no reason to suppose that this is true; in fact, it seems clear enough that it cannot be true; nevertheless this assumption is always made and evidently is satisfactory for design purposes so long as the permissible intensity is based on test data reduced in accordance with the same assumption.



FIG. 114.

Bending also occurs in rivets, but it is practically impossible to make a reasonable estimate of the intensity of stress produced by it and it is neglected, or allowed for by rule-of-thumb additions to the number of rivets required in a given case. Figure 114 shows to a greatly exaggerated scale the bending action to which rivets in lap joints are subjected. Joints of this type which occur in steel construction, other than tanks, are usually of considerable length which tends to reduce the bending. Rivets in joints such as that shown in Fig. 112 are subjected to some bending: if many thicknesses of plate are riveted together the bending may be considerable, particularly if some of the plates act only as fillers. Figure 115 (a) shows to an exaggerated scale the bending

action produced, and Fig. 115 (b) shows the construction usually adopted to reduce the bending when some of the plates act only as fillers. When all the thicknesses through which the rivets pass are parts of the main member it is usual to require extra rivets in connections if the total thickness exceeds a certain amount; a common requirement is as follows: *

Rivets which carry calculated stress and whose grip exceeds four and one-half diameters shall be increased in number at least 1 per cent for each additional 1/16 in. of grip. If the grip exceeds six times the diameter of the rivet, specially designed rivets shall be used.

The last sentence in the quotation just given occurs in many specifications but without statement as to what "specially designed rivets" are like: presumably rivets with tapered shanks are intended. The reader will be interested in the rivets used for large grips in the construction of the Hell Gate arch, and will find them described in O. H. Ammann's paper in Vol. 82 of the *Transactions* of the Am. Soc. C.E.

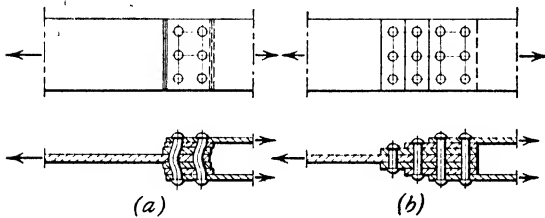

FIG. 115.

will be prevented if proper *edge distance*—marked e in Figs. 111 (a) and 112 (a)—is provided. The amount of edge distance necessary has been standardized through long experience, and the requirements of the most widely used specifications are quite uniform in this respect. The student will do well, however, to study the possibility of plate failure, in these ways, in plates having standard edge distance, to satisfy himself that the requirements commonly imposed are satisfactory. Failure of a plate by crushing, as in (f), Fig. 111, will not occur if proper consideration is given to the bearing strength of the rivet.

PIN CONNECTIONS.—A pin joint does not differ much from a riveted joint: it is essentially a joint in which a single large rivet is used in place of many small ones. The large rivet, or pin, is subjected to forces tending to cause failure in the same way a small rivet may fail: it is in shear, usually on at least two planes, and frequently on a great many planes—of course the plane on which the greatest shear occurs is the one to be investigated; it is in bearing against plates and eye bars, and

* "General Specifications for Steel Railway Bridges," A.R.E.A., Fourth Edition, May, 1931, Art. 62.

the thickness of these plates and bars must be such as to prevent crushing either the pin or the plates and bars; it is in bending, and the pin must be investigated as to its bending strength and often increased in size because of bending stress—this is the principal difference between pins and rivets; the latter are not directly proportioned for bending strength.

The matter of crushing of the pin against an eye bar is taken care of by requiring that the smallest pin used in a joint have such a size that its strength in bearing against the bar is at least equal to the strength in tension of the widest bar attached at the joint.

- Let w = the width of the eye bar, in inches;
- t = the thickness of the eye bar, in inches;
- d = the diameter of the pin hole, in inches;
- s = the permissible tension in the eye bar, in pounds per square inch;
- s_b = the permissible bearing stress against the pin, in pounds per square inch.

Then

$$wts = dts_b$$

and

$$d = w \frac{s}{s_b} \tag{119}$$

Common values of s and s_b are as follows:

| s | s_b | Minimum Diameter |
|--------|--------|--------------------|
| 16,000 | 24,000 | $d = \frac{2}{3}w$ |
| 18,000 | 24,000 | $d = \frac{3}{4}w$ |
| 18,000 | 27,000 | $d = \frac{2}{3}w$ |
| 20,000 | 30,000 | $d = \frac{2}{3}w$ |

The A.R.E.A. "Specifications," 1931, have basic stresses of 16,000 and 24,000 lb. per sq. in., for s and s_b , and require that: "The diameter of the pin shall not be less than seven-eighths of the width of the widest bar attached." The specifications in Appendix A require that the diameter of the pin shall not be less than three-fourths of the width of the bar.

In calculating the stress in pins the forces are assumed applied at the centers of the bearing areas as shown in Fig. 116 (b). Of course the

loads are not concentrated in this way but are distributed in some manner across the bearing areas. Partly because of this assumption of concentrated loads the permissible intensity of bending stress in pins is set at a considerably higher amount than is allowed for other members in flexure.

Built-up members which have pin connections usually require reinforcement around the pin holes to secure sufficient bearing area against the pin. This is accomplished by means of short plates called *pin plates* which are arranged to distribute pressure from the pin across the section of the member as a whole. Figure 116 (a) shows a typical case.

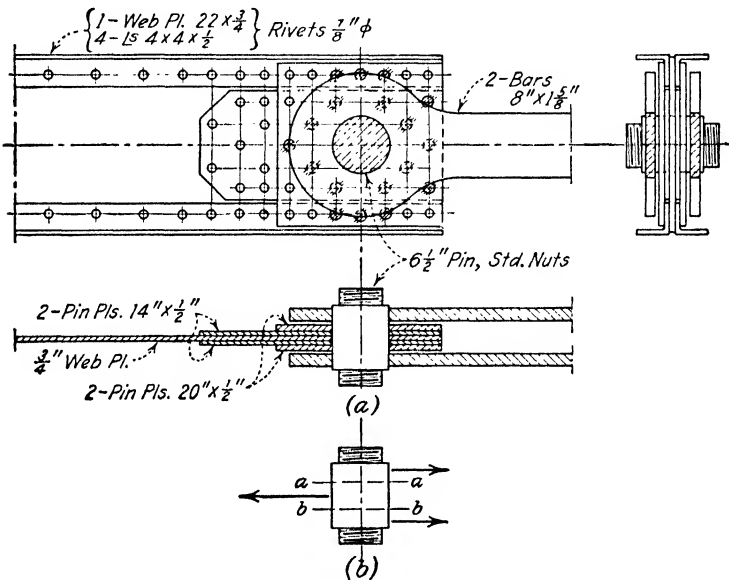

FIG. 116.

119. Design of Riveted Connections.—In addition to the matters discussed in the previous article the following assumptions and principles should be kept in mind in designing riveted connections:

- (a) It is assumed that the total direct stress is distributed uniformly among a group of rivets.
- (b) It is assumed that the shear on a given rivet is uniformly distributed over its cross-section.
- (c) It is assumed that the rivets completely fill the holes.
- (d) The center of gravity of a rivet group should coincide with the center of gravity of the connected member.

- (e) The rivets should be arranged to give the largest practicable net area in tension members.
- (f) The length of the connection should be kept as short as is practicable.

Brief comments on these points follow.

(1) Assumption (a) is necessary but is generally not (probably never) true, and sometimes is grossly in error. It is the only practicable basis of design so far advanced, in the opinion of most American engineers.

(2) Assumption (b) is obviously untrue, but is satisfactory as a working basis if the permissible intensity of average shear is established from tests reduced in accordance with the same assumption. It will be well for the designer to study the distribution of transverse shear across a circular section in order to have in mind some idea of the relation between the *average* intensity of shear and the *maximum*.

(3) Assumption (c) is claimed by some authors to be necessarily untrue. The author thinks that in high-grade shop work power-driven rivets fill the holes; rivets driven with a pneumatically or electrically operated hammer probably do not because the light blows of such hammers cannot produce enough or sufficiently sustained pressure to expand the hot rivet into the metal of the member as can the enormous pressure exerted by power riveting machines. The hammer-driven rivets probably fill the holes when driven but later may not because of shrinkage in cooling. Mr. R. F. McKay in his book, "The Principles of Machine Design,"* on page 148 makes the following statement:

According to Mr. F. A. Hayward a 3/4-in. rivet just fills a 13/16-in. hole in two 1/2-in. plates when subjected to a load of 25 tons. Under a load of 100 tons, however, the rivet takes the form shown in Fig. 32 and dimensions for the final form of rivet under various loads are given in Table 32. A pressure of 100 tons per square inch of area of rivet holes is found to be ample for riveting pressure, while anything above 150 tons per sq. in. may prove dangerous.

Mr. McKay's Table 32 and Fig. 32 are reproduced as Fig. 117 with his permission. The data given in the above quotation were taken from Mr. Hayward's discussion of a paper by Dr. James Montgomerie on "Experiments on Riveted Joints," Vol. 63 of the *Transactions* of the Institution of Engineers and Shipbuilders in Scotland. These data are based on a relatively small grip; for larger grips conditions may be quite different.

(4) In symmetrical members it is a simple matter to make the rivet group symmetrical about the center of gravity of the connected member. In unsymmetrical sections some difficulty may be experienced, but in a

* Edward Arnold & Co., London.

large group of rivets the dissymmetry will seldom be sufficient to require special attention. Attempts to locate the center of gravity of the resisting force exerted by a group of rivets must be based on the assumption of equal distribution of the load among all the rivets, and on the assumption that the rivets are exerting their resistance through bearing and shear. As previously stated the load is probably never partitioned equally among the rivets, and it is probable that at working loads a good part of the resistance developed by a group of rivets is the result of friction between the surfaces. Consequently an attempt to insure the exact coincidence of the centers of gravity of the stress in the member and the resistance of the rivet group by painstaking balancing of the rivets about the centroidal axis of the member may be wasted energy. Nevertheless the principle should be followed as closely as is practicable without special computations, and when the eccentricity of the rivet group is obviously large it may be desirable to estimate

DISTORTION OF RIVETS BY PRESSURE
(According to T.A. Hayward)

| Tons | A Inches | B Inches |
|------|-----------------|-----------------|
| 25 | $\frac{13}{16}$ | 1 |
| 50 | $\frac{27}{32}$ | $\frac{31}{32}$ |
| 75 | $\frac{7}{8}$ | $\frac{15}{16}$ |
| 100 | $\frac{29}{32}$ | $\frac{29}{32}$ |

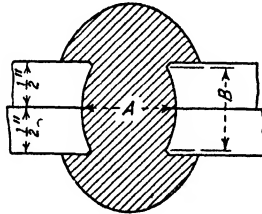

FIG. 117.

its effect on the outer rivets. These comments do not apply to eccentric brackets or other cases of intentional eccentricity; in such cases estimating the effect of the resulting moment on the rivet group is of primary importance.

(5) The matter of net section was considered to some extent in Chapters III and IV and will be more fully discussed later.

(6) It is desirable to keep connections short (in truss members) in order to reduce the secondary moments which result from deformation of the structure. Also short connections reduce the necessary size of connection or gusset plates and consequently the weight of detail material. Here again the comments are not applicable to connections intended to resist moments: it is usually desirable to spread out such connections as much as the conditions will permit.

The discussion of riveted connections will be presented in the same order as the discussion on design of the fundamental structural forms.

120. Ordinary Beam Connections.—Figure 118 (a) shows a typical connection of a beam to a column, and Fig. 118 (b) the connection of two beams, opposite each other, to the web of a third beam. Connections of this type are sometimes called **framed connections**, as dis-

tinguished from those in which the supported beam rests on a shelf angle or similar support.

It seems clear that the number of rivets required on line $w-w$ to fasten the connection angles to the web of the beam, in Fig. 118 (a), is the end reaction of the beam divided by the rivet value: the rivet value is determined by its strength in *double shear*, in bearing on the web of the beam, or in bearing on the connection angles, whichever is the smallest. Similarly the number of rivets required to make the connection to the column is the end reaction divided by the rivet value: and here the rivet value is determined by the strength of the rivet in *single shear*, or in bearing against the connection angle or against the column flange, whichever is the smallest. A connection angle should always be made thick enough so that the strength of a rivet in bearing against it is greater than the strength of the rivet in single shear: if

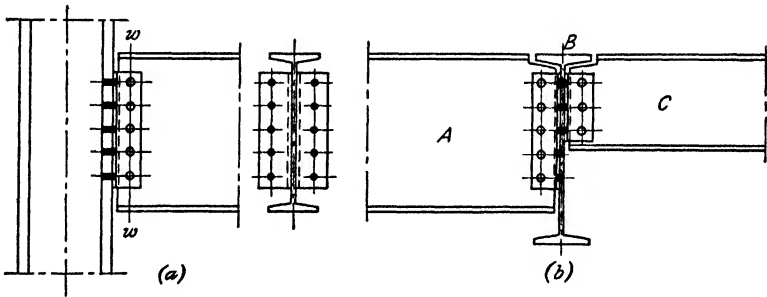

FIG. 118.

this thickness is provided, bearing on the connection angle is never a factor in design. This condition will be met if:

$$tds_b = \frac{\pi d^2}{4} s_s$$

$$t = \frac{\pi d}{4} \cdot \frac{s_s}{s_b} \quad (120)$$

in which t = minimum thickness of connection angle, in inches;

d = diameter of rivet, in inches;

s_s = permissible intensity of shear, in pounds per square inch;

s_b = permissible intensity of bearing pressure, in pounds per square inch.

Based on the stresses permitted in the A.I.S.C. "Specifications" connection angles should have minimum thicknesses as follows:

| Rivet Diameter | $\frac{5}{8}$ | $\frac{3}{4}$ | $\frac{7}{8}$ | 1 | $1\frac{1}{8}$ | $1\frac{1}{4}$ |
|-------------------|----------------|----------------|----------------|----------------|----------------|----------------|
| Single shear..... | $\frac{5}{16}$ | $\frac{3}{8}$ | $\frac{7}{16}$ | $\frac{7}{16}$ | $\frac{1}{2}$ | $\frac{9}{16}$ |
| Double shear..... | $\frac{1}{4}$ | $\frac{5}{16}$ | $\frac{5}{16}$ | $\frac{3}{8}$ | $\frac{7}{16}$ | $\frac{7}{16}$ |

The connection of Fig. 118 (b) needs no comment except the design of the riveting to the web of beam B. It should be clear that in determining the number of rivets required to transmit the end reactions from beams A and C to the web of beam B the shear per rivet used must be such that the sum of the loads from the two sides on a given rivet will not be so great as to overstress that rivet in bearing on the web of beam B. If the web of beam B is thick enough so that the strength of a rivet bearing against it is greater than the strength of the rivet in double shear the problem is merely to determine the number of rivets required to transmit each reaction to the web of beam B by rivets in single shear. However, if the web of beam B is so thin that the strength of a rivet bearing against it is less than double shear, the shear per rivet used to determine the number of rivets required to transmit the end reactions must be less than the single-shear strength of a rivet, at least on one side. For example, if the rivet strength in single shear is 6 kips and the strength in bearing on the web of beam B is 8 kips per rivet, we may use 4 kips per rivet on each side, 5 kips per rivet on one side and 3 on the other, or 6 kips per rivet on one side and 2 on the other.

The student should see clearly that the design procedure just described assumes that the connections are subjected to shear only. Actually the connections are subjected to considerable moment caused by deflection of the beam. The effect of this moment is to produce uncomputed stresses and distortion in the connection angles and rivets.

Figure 119 (a) shows a section through the column and beam web just above the connection angles of the beam in Fig. 118 (a); it is assumed that the rivets connecting the beam to the column have been driven. If the column and connection angles were unyielding the moment acting on the connection angles would necessarily be the fixed end moment in the beam. Actually the column yields somewhat, and the connection angles, which are relatively flexible, yield a good deal. The resulting moment is quite indeterminate. Figure 119 (b) shows to an exaggerated scale the general character of the distortion

which takes place at the top of the connection angles. There is considerable **initial tension** in all rivets which are driven hot, owing to contraction accompanying subsequent cooling. In well-driven rivets of good material the initial tension will approach the elastic limit of the rivet steel, and unless the connection angles are stiff will be sufficient to prevent them from pulling away from the face of the column at the rivets, as indicated in the figure. If the heads of the rivets connecting the angles to the column flange fitted snugly against the angles and column flange, but had no initial tension due to cooling, tension in the upper rivets would be produced by the deflection of the beam. When initial tension exists it is not appreciably added to by the deflection, however, until the connection angles actually separate from the face of the column around the rivets.

If the friction between the connection angles and the web of the beam is broken down by the moment there will be both horizontal and

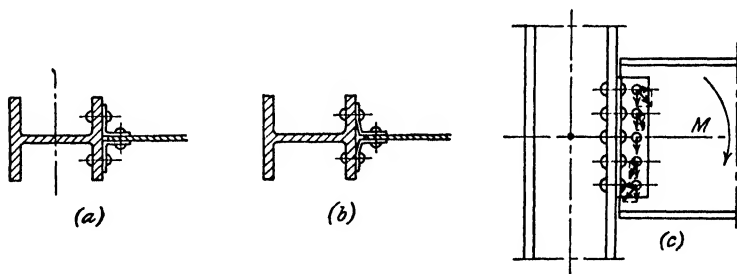

FIG. 119.

vertical components of shear acting on the rivets, as indicated in Fig. 119 (c), and the resultant shear on the outer rivets will be increased.

Connections for simple beams are always designed under the assumption that there is no end moment. The connection angles are made as thin as is practicable (sufficient to make bearing on the angle larger than single shear) in order to reduce the stress due to the inevitable distortion accompanying beam deflection. Beam connections have been designed in this manner for many years and the results have proved satisfactory. *Nevertheless the importance of the student's visualizing the distortion which takes place in the actual structure and the importance of his recognizing the existence of stresses which may not be computed in the usual design procedure cannot be overemphasized.*

Plate-girder connections have the same characteristics as the beam connections discussed in this article. Girder connections were taken up in connection with the discussion of girder design in Chapter III and do not need further consideration here.

121. Standard Connections.—In order to reduce the great amount of work which would be necessary in the design office and in the shop to provide each beam in a structure with connections just strong enough for its reactions, **standard connections** have been adopted for all sizes of beams. Standard connections are so proportioned that they are

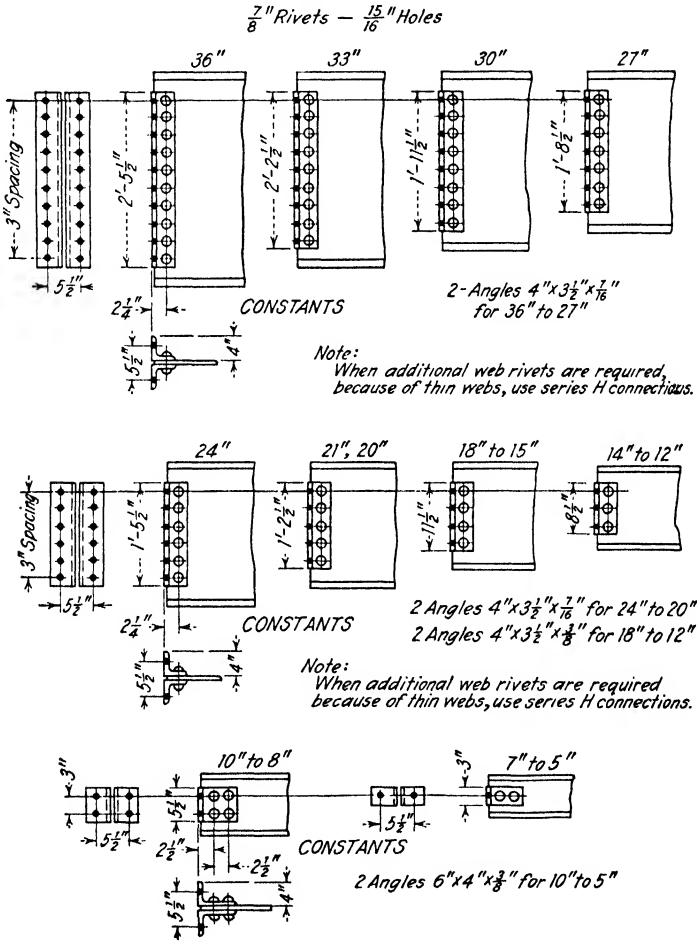

FIG. 120.

capable of supporting the maximum distributed load which the beam can carry on all normal spans. If the beams have very thin webs, or are very short, or support concentrated loads near the ends, the standard connections may prove inadequate. All steel manufacturers' handbooks of structural shapes and nearly all engineers' handbooks

show standard connections, give their capacity, and state the minimum length of span on which the end connections can support the full capacity of the beam in bending as a distributed load.

Figure 120 shows the standard connections adopted by the American Bridge Company, and Fig. 121 shows connections used when thin webs, short spans, or concentrated loads require connections of greater capacity than the standard. These illustrations were taken with permission from the Abridged Edition of the "Pocket Companion."*

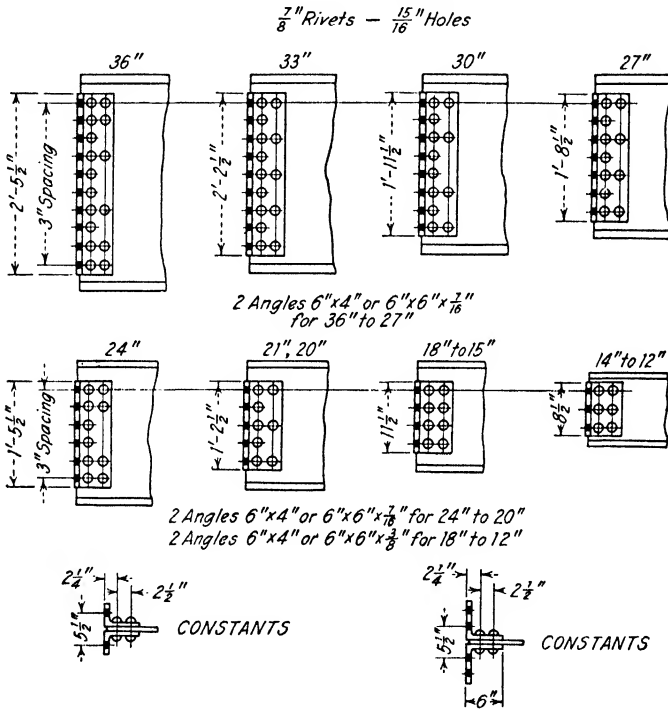

FIG. 121.

The standard connections adopted by the American Institute of Steel Construction are exactly the same as the American Bridge Company Series A Connections, for standard beams up to 24 in. in depth, except that $\frac{3}{4}$ -in. rivets are used instead of $\frac{7}{8}$ -in.

122. Seat Connections.—In connecting beams to columns, seat connections are sometimes used. Figure 122 shows typical seat connections for light and heavy beams. The conditions encountered are so varied that standards are not used for connections of this type.

* "Pocket Companion," Abridged Edition, 1931, pages 298 and 299.

Seat connections which consist merely of a shelf angle on which the beam is rested can be used for only small loads, preferably not over 10,000 or 12,000 lbs. The limit depends on the width and thickness of the horizontal leg of the shelf angle, which must have sufficient strength to support the load in bending (the load acting at about the center of the horizontal leg), and on the number of rivets which can be placed in the downstanding leg against the column. The rivets in the leg against the column must be capable of transmitting the end reaction of the beam to the column, acting in single shear, or in bearing on the web when beam seats are placed on opposite sides of a thin web.

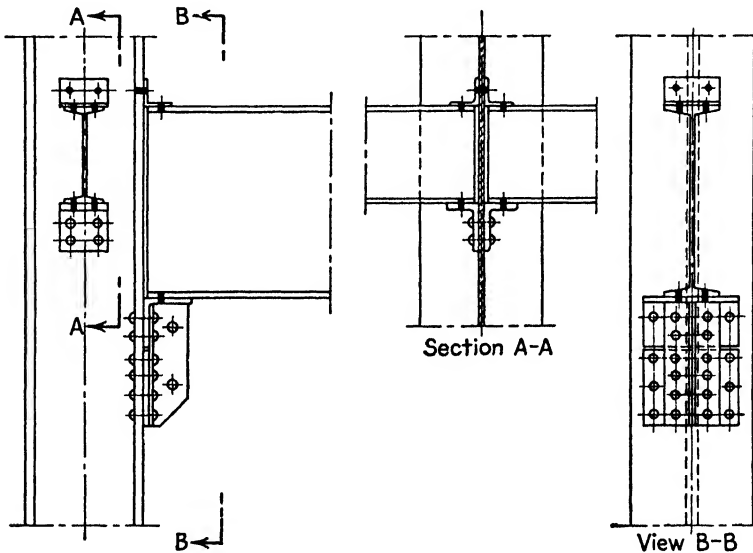

FIG. 122.

Seat connections which have stiffener-supported shelf angles can carry much larger loads. The stiffeners under the seat must fit tight against the seat and have sufficient area in the outstanding legs to support the entire beam reaction at a safe bearing stress. There must be a sufficient number of rivets in the stiffener legs against the column to transmit the entire beam reaction to the column. These rivets are in single shear, and attention should be given to the fact that they pass through a filler; their number should be increased from one-third to one-half and the extra rivets preferably placed in the filler extended beyond the stiffeners (as in Fig. 122) when this is possible.

The designer must keep in mind the possibility of over-stressing the

Beams and Connections, for Part of Floor 2

| | |
|------------------------------------|--------|
| DP 17 | |
| Beams & Connections for Floor 2 | |
| 1932 | T.C.S. |
| Sheet 1 of 5 | |

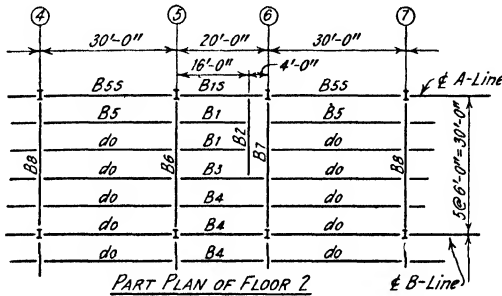

A.I.S.C. Specs.

$\frac{3}{4}$ " ϕ Rivets

Dead Load

Slab = 50#/ar
Surface = 15
Steel = 15 average

Live Load = 80

Total = 280#/ar

Beam B1

$280 \times 6 = 1680 \#/\text{ft}$

Shear

$\times \frac{16^2}{8} = 53.8 \text{ 'k}$
@ $\frac{12}{18}, I_c = 35.0$

$6 \times 280 \times \frac{16}{2} = 13.45 \text{ 'k}$

$12'' I @ 31.8, I_c = 35.97$

Beam B2

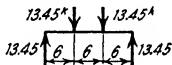

Mom.

$13.45 \times 6 = 80.7 \text{ 'k}$

Shear

13.45 'k

@ $\frac{12}{18}, I_c = 53.8$

$15'' I @ 42.9, I_c = 58.91$

Beam B3

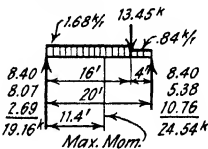

Mom.

$\frac{19.16}{2} \times 11.4 = 109.2 \text{ 'k}$

Shear

19.16 'k and 24.54 'k

@ $\frac{12}{18}, I_c = 72.8$

$15'' I @ 60.8, I_c = 81.20$

$18'' I @ 54.7, I_c = 88.39$

Beam B4

$280 \times 6 = 1680 \#/\text{ft}$

Shear

$\times \frac{20^2}{8} = 84.0 \text{ 'k}$

$6 \times 280 \times \frac{20}{2} = 16.8 \text{ 'k}$

@ $\frac{12}{18}, I_c = 56.0$

$15'' I @ 42.9, I_c = 58.91$

Beam B5

$280 \times 6 = 1680 \#/\text{ft}$

Shear

$\times \frac{30^2}{8} = 189 \text{ 'k}$

$6 \times 280 \times \frac{30}{2} = 25.2 \text{ 'k}$

@ $\frac{12}{18}, I_c = 126.0$

$20'' I @ 75.0, I_c = 126.35$

web in direct compression (see Art. 43, Chapter III) and be sure that the seat has sufficient length to prevent this. If the seat cannot be made long enough the web of the beam should be fitted with stiffeners or a beam with a thicker web should be selected.

The function of the clip angle connecting the top flange of the beam to the column is to steady the beam on the seat and prevent lateral movement of the top flange at the end. The clip angle is not expected to resist any of the vertical load. The connection of the beam to the seat and to the top clip angle is sometimes made with bolts instead of rivets.

A special case of a seat connection is that in which a girder rests on top of a column as in Fig. 92. Seat connections in such cases are necessary because of the overhanging ends of the girders, and may be necessary even without overhanging ends when the reaction to be transferred from the girder to the column is of such size that framed connections are impracticable. The girder designed in the illustrative example DP10, pages 169-174, furnishes another illustration of the use of a seat connection on top of a column because of the impracticability of a framed connection.

123. Illustrative Example, DP17.—To illustrate the discussion of beam connections the calculations, DP17, Sheets 1 to 5 inclusive, are presented. Comment on the calculations relating to the design of the beams is not necessary. Calculations relating to the proportioning of the connections are given on Sheet 4, DP17, for a few of the typical cases, and sketches of the connections designed are given on Sheet 5, DP17. The calculations on Sheet 4 are much fuller than necessary for actual design and are intended to be self-explanatory.

Attention is called to the fact that the standard framed connections are in all cases more than adequate for the beams in the portion of the floor under consideration; this is the usual situation in ordinary floor framing.

In calculating the proportions for seated connections the student should notice that the minimum length of bearing was determined on the basis of 24,000 lb. per sq. in. direct bearing on the web above the seat. As stated in Art. 43 there are few data on this point and no mention of it in design specifications. It should also be noted that the computed number of rivets for connecting seats to the column flange or web has been increased by one-half when these rivets pass through a filler: in one case the extra rivets were included in the main group and in the other placed in the filler extended beyond the main group.

The 5/16-in. intermediate stiffeners used on the substitute for *B6*, *B7*, and *B8* do not satisfy the principle that no connection angle should

Beams and Connections, for Part of Floor 2

| | |
|-----------------------|--------|
| DP 17 | |
| Beams and Connections | |
| 1932 | T.C.S. |
| Sheet 2 of 5 | |

Spandrel Beam Bis

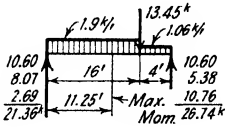

Uniform Load

$$\begin{aligned} \text{Floor } & \frac{6 \times 280}{2} = 840 \#/\text{ft} \\ \text{Wall} & = 1060 \\ \text{Total} & = 1900 \end{aligned}$$

Mom.

$$\frac{21.36}{2} \times 11.25 = 120.2'k$$

Shear

$$21.36k \text{ and } 26.74k$$

$$\text{@ } \frac{12}{18}, \frac{I}{c} = 80.1$$

$$15'' I @ 60.8, \frac{I}{c} = 81.20$$

$$18'' I @ 54.7, \frac{I}{c} = 88.30$$

Spandrel Beam B55

Uniform Load

$$\begin{aligned} \text{Floor } & \frac{6 \times 280}{2} = 840 \#/\text{ft} \\ \text{Wall} & = 1060 \\ \text{Total} & = 1900 \#/\text{ft} \end{aligned}$$

Mom.

$$1900 \times \frac{30^2}{8} = 213.8'k$$

Shear

$$1900 \times \frac{30}{2} = 28.5k$$

$$\text{@ } \frac{12}{18}, \frac{I}{c} = 142.5$$

$$20'' I @ 81.4, \frac{I}{c} = 146.63$$

Beam B6

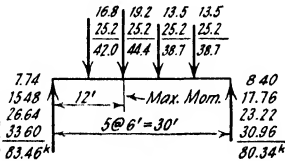

Moment

$$\begin{aligned} 83.46 \times 6.0 & = 501 \\ 41.46 \times 6.0 & = 249 \\ \hline & 750'k \end{aligned}$$

Shear

$$83.5k \text{ and } 80.3k$$

$$\text{@ } \frac{12}{18}, \frac{I}{c} = 500$$

$$36'' WF @ 150\#, \frac{I}{c} = 507.5$$

Beam B7

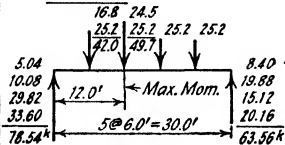

Moment

$$\begin{aligned} 78.54 \times 6.0 & = 471 \\ 36.54 \times 6.0 & = 207 \\ \hline & 678'k \end{aligned}$$

Shear

$$78.5k \text{ and } 63.6k$$

$$\text{@ } \frac{12}{18}, \frac{I}{c} = 458$$

$$36'' WF @ 150\#, \frac{I}{c} = 507.5$$

Beams and Connections, for Part of Floor 2

DP 17

Beams and
Connections

1932 T.C.S.

Sheet 3 of 5

Beam B8

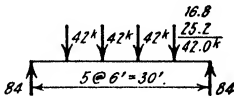

Moment

$$\begin{aligned} 84 \times 6 &= 504 \\ 42 \times 6 &= 252 \\ \hline &756^k \\ &\text{@ } \frac{12}{18}, \frac{I}{c} = 504 \end{aligned}$$

Shear

$$84.0^k$$

$$36'' \text{ WF @ } 150^{\#}, \frac{I}{c} = 507.5$$

Built-up Girder, Substitute for Beams B6, B7 and B8

Max. Mom.

$$\begin{aligned} 756^k \\ + 3.42' &= 221^k \text{ Flg. St.} \\ \text{@ } 18 &= 12.30'' \text{ net} \end{aligned}$$

Max. Shear

$$\begin{aligned} 84.0^k \\ \text{@ } 12 &= 7.0'' \text{ gross} \\ \text{@ } 7.03 &= 12.1 \sim 12 \text{ rivs. bg. on web} \\ \text{@ } 11.93 &= 7.04 \sim 7'' \text{ d.s.} \\ \text{@ } 24.0 &= 3.50'' \text{ o.s. legs stiff.} \\ \text{@ } 5.36 &= 14.1 \sim 14 \text{ rivs. to col.} \end{aligned}$$

Material for 1-Girder (With stiffeners)

- 1 - Web $42'' \times \frac{5}{16}'' = 13.13'' \text{ gr. } \frac{1}{8} = 1.64'' \text{ net, } \frac{1}{8} = 2.19$
- 2 - Bott. L_s $6'' \times 3\frac{1}{2}'' \times \frac{11}{16}'' = 12.12 - 1.20 = 10.92, + 1.64 = 12.56'' \text{ net}$
- 2 - Top L_s $6'' \times 3\frac{1}{2}'' \times \frac{11}{16}'' = 12.12, + 2.19 = 14.31'' \text{ gross}$
- * { 4 - End Conn. L_s $4'' \times 3\frac{1}{2}'' \times \frac{3}{8}''$
- 4 - End Fills $6'' \times \frac{11}{16}''$
- 18 - Int. Stiffers. $4'' \times 3\frac{1}{2}'' \times \frac{3}{8}''$
- 18 - " Fills $3'' \times \frac{11}{16}''$

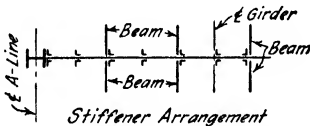

* If seat connection to column is to be required, use { 4 - End Stiffers $5 \times 3\frac{1}{2}'' \times \frac{7}{16}''$, $2 \times 4.5 \times \frac{7}{16}'' = 3.94'' \text{ bg. o.s. legs}$
4 - " Fills $6'' \times \frac{11}{16}''$

Material for 1-Girder (Without stiffeners) $756^k + 3.02' = 250^k \text{ Flg. St. @ } 18 = 13.88'' \text{ net.}$

- 1 - Web $38'' \times \frac{1}{2}'' = 19.00'' \text{ gr. } \frac{1}{8} = 2.38'' \text{ net, } \frac{1}{8} = 3.17''$
- 2 - Bott. L_s $6'' \times 4'' \times \frac{11}{16}'' = 12.80 - 1.20 = 11.60, + 2.38 = 13.98'' \text{ net}$
- 2 - Top L_s $6'' \times 4'' \times \frac{11}{16}'' = 12.80 + 3.17 = 15.97'' \text{ gross}$
- * { 4 - End Conn. L_s $4'' \times 3\frac{1}{2}'' \times \frac{3}{8}''$
- 4 - End Fills $6'' \times \frac{11}{16}''$

* See note above

Beams and Connections, for Part of Floor 2

DP 17

Beams and
Connections

1932 T.C.S.

Sheet 4 of 5

ConnectionsRivets: $\frac{3}{4}$ " ϕ in all connectionss.s. = 5.96^k per rivet
D.S. = 11.92^k " "B1 and B5 to B6Bg. on web of B1 = .35 x .75 x 30 = 7.88^kB1 to web of B1 $\frac{19.5}{7.88} = 2$ rivs. Std. Conn. o.k.

" " " " B5 = .64 x .75 x 30 = 14.40 > D.S.

" " " B5 $\frac{28.5}{11.92} = 3$ " " " "

" " " " B6 = .61 x .75 x 30 = 13.71 > D.S.

B1 and B5 to web of B6B1 $\frac{19.5}{5.96} = 3$ rivs. Std. Conn. o.k.B5 $\frac{28.5}{5.96} = 5$ " " " "B1 and B5 to B6 SubstituteBg. on web of B1 = .35 x .75 x 24 = 6.30^kB1 to stiff. $\frac{19.5}{5.63} = 3$ rivs.

" " " " B5 = .64 x .75 x 24 = 11.50

B5 to stiff. $\frac{28.5}{5.63} = 5$ rivs." $\frac{3}{16}$ stiff. B6 Sub = .93 x .75 x 24 = 5.63B15, B55 and B7 to Col. A6 Col. A6 - 14" W @ 87#; web = .42" thk.; flg. = .69" thk.Seat ConnectionsB15 $\frac{26.7}{24} = 1.11^{\text{in}}$ web area in bearing
 $\div .46^{\text{in}} = 2.42^{\text{in}}$ min. length of bearing $\frac{26.7}{5.96} = 5$ rivs. in s.s.B55 $\frac{28.5}{24} = 1.19^{\text{in}}$ web area in bg.
 $\div .60 = 1.98^{\text{in}}$ min. length of bearing $\frac{28.5}{5.96} = 5$ rivs. in s.s.B15 & B55 $\frac{26.7 + 28.5}{9.45} = 6$ rivs. in bg. on col. webUse connection forZ-B55 $\frac{2 \times 28.5}{9.45} = 6$ " " " " " " add 50% for filler = 9 + say 10 rivs.B7 Use connection for B8B8 $\frac{84}{24} = 3.5^{\text{in}}$ web area in bg.
 $\div .61 = 5.74^{\text{in}}$ min. length of bearing $\frac{84.0}{5.96} = 14$ rivs. in s.s.
add 1 rivs. for fillerFramed ConnectionsB1 to web of B15 $\frac{26.7}{10.35} = 3$ rivs.B15 to Col. $\frac{26.7}{5.96} = 5$ rivs. in s.s.B1 to web of B55 $\frac{28.5}{11.92} = 3$ rivs.B55 to Col. $\frac{28.5}{5.96} = 5$ rivs. in s.s.

B15 and B55 (Use Z-B55) to Col. web

 $\frac{2 \times 28.5}{9.45} = 6$ + rivs. in bg.B1 to web of B7 (Use B8 conn.) $\frac{84.0}{11.92} = 8$ rivs. B7 (Use B8) to Col. $\frac{84.0}{5.96} = 14$ + rivs. in s.s.Standard
Connections
o.k.Std. Conn.
o.k.

Beams and Connections, for Part of Floor 2

| | |
|-----------------------|--------|
| DP 17 | |
| Beams and Connections | |
| 1932 | T.C.S. |
| Sheet 5 of 5 | |

TYPICAL FRAMED CONNECTIONS

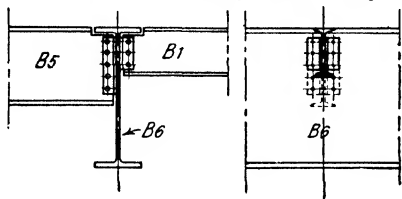

TYPICAL CONNECTION, BEAMS TO BUILT GIRDER

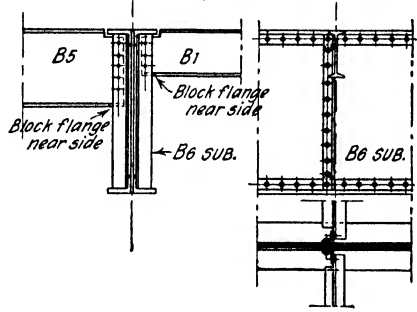

SEAT CONNECTIONS TO COL. A6

FRAMED CONNECTIONS TO COL. A6

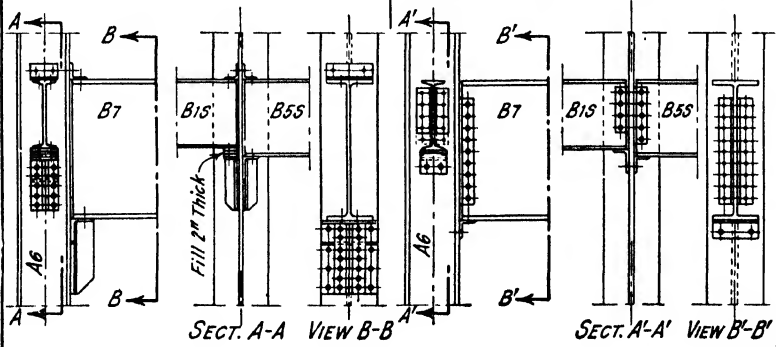

have a thickness such that the strength of the rivets bearing against it is less than their strength in single shear. It will be noticed, however, that making the stiffeners 3/8 in. thick (which would satisfy the limit) would not reduce the necessary number of rivets in the connections to their outstanding legs and would add about 80 lb. to the weight of the girder. When stiffeners are used as connection angles the designer must make sure that the rivets connecting them to the web are sufficient in number to transfer the beam reaction to the web; such stiffeners are usually on fillers, and this fact should be considered in proportioning their riveting.

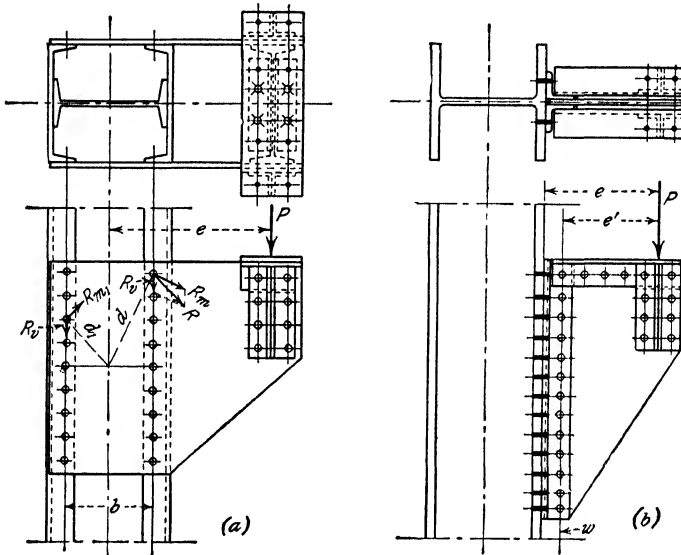

FIG. 123.

124. Connections to Resist Moment: Rivets in Shear.—Connections which must resist computed bending moments are fairly common. Figure 123 shows two types of bracket connections which are subjected to known bending moments. The ends of beams and girders which form part of the wind-bracing system in a high building must also have connections capable of resisting definite bending moments; Figs. 15A and 15B show examples of such connections.

A general method of design for connections which must resist definite moment is to assume what seems to be a reasonable group of rivets and compute the load on the most-stressed rivet to see whether it is greater or less than its capacity. If the load on the most-stressed rivet is too

large the number of rivets in the group must be increased, or the arrangement must be modified; if the load is less than is permissible the number may be decreased. It is sometimes difficult to make a satisfactory assumption of the number of rivets in a group and several trials may be necessary; on the other hand, in many cases the necessary number may be computed directly, and the methods applicable will prove helpful in making preliminary estimates in other cases.

The general method of calculating the stress in any one of the rivets of a group will be discussed first, and then the method of directly calculating the number of rivets required in certain cases will be presented.

Referring to Fig. 123 (*a*) it will be clear that the rivets in the group connecting the bracket to the column are subjected to stress from two sources: the bending moment, and the direct load. It is generally most convenient to compute the effects due to bending moment and direct load separately and combine them afterwards.

Dealing with the effect of moment first, it is assumed that the stress on a given rivet due to moment alone is proportional to its distance from the point about which the moment alone tends to rotate the rivet group. A little reflection will make it clear that if the stress is proportional to the distance from the center of rotation (due to moment alone) the laws of statics will not be satisfied unless the center of rotation is the center of gravity of the group. In dealing with the direct load it is assumed, as usual, that the direct load is distributed uniformly among the rivets of the group.

Using the following notation (see also Fig. 123[*a*]):

R_m = the stress due to the moment on the most-stressed rivet;

R_{m_1} = the stress on rivet 1 due to the moment;

R_{m_2} = the stress on rivet 2 due to the moment;

d = the distance from the center of gravity of the rivet group to the most-stressed rivet;

d_1 = the distance from the center of gravity of the rivet group to rivet 1;

d_2 = the distance from the center of gravity of the rivet group to rivet 2;

R_v = the stress on any rivet due to the direct load;

P = the direct load;

e = the distance from the center of gravity of the rivet group to the line of action of P ;

n = the number of rivets in the group;

R = the resultant stress on the most-stressed rivet;

M = the moment acting on the group.

Keeping in mind the assumptions just stated we may write:

$$\begin{aligned} \frac{R_m}{d} &= \frac{R_{m_1}}{d_1} = \frac{R_{m_2}}{d_2} = \dots \\ Pe = M &= R_m d + R_{m_1} d_1 + R_{m_2} d_2 + \dots \\ &= R_m d + R_m \frac{d_1^2}{d} + R_m \frac{d_2^2}{d} + \dots \\ &= \frac{R_m}{d} \Sigma d^2 \end{aligned}$$

And

$$R_m = \frac{Md}{\Sigma d^2} \tag{121}$$

Also

$$R_v = \frac{P}{n} \tag{122}$$

The resultant stress, R , may be obtained graphically as in Fig. 123(a), or, if the angle between R_v and R_m is θ , we may say that

$$R^2 = R_m^2 + R_v^2 + 2R_m R_v \cos \theta \tag{123}$$

These relations are perfectly general and are applicable to any rivet group in bending whether symmetrically arranged, as in Fig. 123 (a), or not.

When the rivets are uniformly spaced in a single straight line (or in parallel lines close together) as in the bracket in (b), Fig. 123, the stress in the outer rivet due to moment may be found by the general method expressed by (121), but the following analysis gives a more convenient procedure. In Fig. 124 is shown a line of rivets uniformly spaced at p inches. Since we are assuming that rivet stress is proportional to the distance from the point of no bending, i.e., the neutral axis, and since the rivets are uniformly spaced, it seems clear that we may consider the stress diagram for a row of n rivets spaced p inches apart as being the same as that for a rectangular beam np inches in depth, each rivet

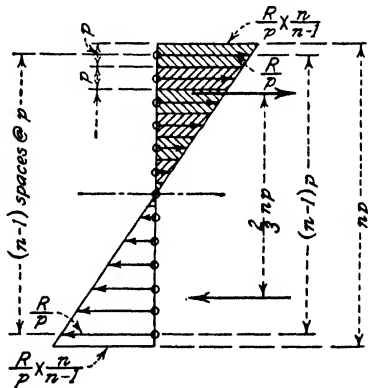

FIG. 124.

is the same as that for a rectangular beam np inches in depth, each rivet

resisting the stress on a strip p inches in height.* Figure 124 shows the stress strips acting on the various rivets. † If the stress on the outer rivet is R , the *average* stress per inch of height on this rivet is R/p , and the maximum stress per inch of height on the equivalent rectangular beam is $\frac{R}{p} \times \frac{n}{n-1}$, as shown in the figure. It follows at once that:

$$M = \frac{1}{2} \times \frac{R}{p} \times \frac{n}{(n-1)} \times \frac{np}{2} \times \frac{2}{3} np$$

$$M = \frac{Rpn^2}{6} \times \frac{n}{(n-1)}$$

and

$$R = \frac{6M}{pn^2} \times \left(\frac{n-1}{n} \right) \quad (124)$$

This may be used to determine the necessary number of rivets to resist a given moment at a given pitch and rivet value; i.e.:

$$n = \sqrt{\frac{6M}{pR} \times \left(\frac{n-1}{n} \right)} \quad (125)$$

The factor $\frac{n-1}{n}$ is nearly 1, and the error introduced by neglecting it is small, and always on the safe side. However, it is easy to include the factor if desired. ‡

This expression, (125), for the number of rivets gives of course only the number of rivets needed to resist the bending moment; the shear produces a vertical force on each rivet which must be combined with the horizontal force produced by the moment to determine the true

* The student should refer to Art. 75 for a discussion of the necessity for uniform pitch if the stress in the rivets, and in the plate to which they connect, is to vary as the distance from the neutral axis.

† It should be noted that the center of gravity of the stress strip acting on the rivet is assumed to be at its midheight. Of course this is not quite true, but the error involved is less than 1 per cent for groups containing more than 11 rivets in a line and only about 2 per cent for groups containing as few as 7 rivets in a line.

‡ If the quantity $\frac{6M}{pR}$ is set on the *A* scale of the slide rule the value of n (neglecting the factor $\frac{n-1}{n}$) appears immediately below on the *D* scale; using this value of n multiply $\frac{6M}{pR}$ by the ratio $\frac{n-1}{n}$, on the *A* scale, and find below on the *D* scale the always sufficiently accurate value of n .

stress on the rivet. The shear is usually a minor item in brackets and if the number of rivets is determined from (125), *neglecting the factor* $\left(\frac{n-1}{n}\right)$, it will seldom be found necessary to increase the number because of shear. This may be illustrated in connection with the bracket shown in Fig. 123 (b). Assume the following data:

$$P = 57 \text{ kips}$$

$$e' = 13\frac{3}{4} \text{ in.}$$

$$p = 2\frac{1}{2} \text{ in.}$$

$$\frac{9}{16}\text{-in. web; } \frac{3}{4}\text{-in. rivets; d.s.} = 11.92 \text{ kips}$$

$$\text{bg. on } \frac{9}{16} \text{ plates} = \frac{9}{16} \times \frac{3}{4} \times 30 = 12.67 \text{ kips}$$

Then $M = Pe' = 57 \times 13.75 = 784 \text{ in.-kips}$

$$R = 11.92 \text{ kips}$$

$$n = \sqrt{\frac{6 \times 784}{11.92 \times 2.5}} = 12.6 \quad 13 \text{ rivets}$$

$$R_v = \frac{5.7}{1.3} = 4.38 \text{ kips}$$

$$R_H = \frac{6 \times 784}{13 \times 13 \times 2.5} \times \frac{12}{13} = 10.28 \text{ kips}$$

$$R = \sqrt{10.28^2 + 4.38^2} = 11.18 \text{ kips}$$

When the shear is high as compared with the moment it will be necessary to add some rivets to the number calculated by (125). Trial solution is generally simplest, but, neglecting the factor $\left(\frac{n-1}{n}\right)$, we may write:

$$\begin{aligned} R^2 &= R_H^2 + R_v^2 \\ &= \left(\frac{6M}{n^2p}\right)^2 + \left(\frac{V}{n}\right)^2 \end{aligned}$$

or

$$n^4 - \left(\frac{V}{R}\right)^2 \cdot n^2 = 36 \left(\frac{M}{pR}\right)^2 \quad (126)$$

from which n may be determined by direct calculation. Because of neglecting the factor $\left(\frac{n-1}{n}\right)$ the value of n computed in this way will be mathematically a trifle larger than is necessary, but the error in any

practical case will be only a fraction of a rivet, which of course is meaningless.

A little reflection should make it clear that the relation expressed by (125) may be applied to a bracket such as that shown in Fig. 123 (a) to determine by direct calculation a number of rivets which will be, in many cases, a fairly close estimate of that necessary. For example, assume the following data in connection with Fig. 123 (a):

$$\begin{aligned} e &= 21 \text{ in.} \\ P &= 82 \text{ kips, 41 kips per side} \\ p &= 3 \text{ in. vertically} \\ b &= 11\frac{1}{2} \text{ in.} \\ \frac{7}{8}\text{-in. rivets, s.s.} &= 8.1 \text{ kips} \end{aligned}$$

Then

$$\begin{aligned} M &= 41 \times 21 = 861 \text{ in.-kips} \\ \Sigma d^2 * &= 4 \times \frac{4}{6} \times 9 \times 5 \times 3^2 = 1080 \end{aligned}$$

$$18 \times 5.75^2 = \frac{595}{1675}$$

$$R_m = \frac{861 \times 13.31}{1675} = 6.84$$

$$R_v = \frac{41}{18} = 2.28$$

$$R^2 = \overline{6.84^2} + \overline{2.28^2} + 2 \times 6.84 \times 2.28 \times \frac{5.75}{13.31}$$

$$R = 8.09 \text{ kips}$$

That is, the 18 rivets shown on each side of the bracket are just sufficient for the conditions assumed. Estimating the number of rivets required by means of (125), taking into consideration the factor $\left(\frac{n-1}{n}\right)$:

$$n = \sqrt{\frac{6 \times 861}{2 \times 8.1 \times 3} \times \frac{n-1}{n}} = 9.8, \text{ say 10 rivets in each vertical line.}$$

The student will notice that in the solution, R , in (125), was multiplied by 2, since there are two lines of vertical rivets, and the formula was derived for a single line. It may be found necessary to add some rivets when the shear is high as compared with the moment; in this case, for example, if the load is doubled and the arm, e , made one-half that assumed here, it will be found that with 10 rivets in each vertical line, as determined by (125), the outer rivet has a stress slightly greater than the permissible 8.1 kips.

* See footnote, page 165.

It is clear of course that an adequate number of rivets for a bracket connection of this type may always be calculated directly from (126), but the student must not forget to replace R by $2R$ since there are two vertical lines of rivets. The results obtained must necessarily be on the safe side since the application of the relation to a connection such as that in Fig. 123 (a) assumes that the sum of the squares of the distances, from the center of rotation due to moment, to the various rivets of the group is substantially equal to the sum of the squares of the vertical projections of these distances. If the horizontal distance between the rivet lines is not great the result will be quite accurate. Some notion of the accuracy to be expected may be obtained by applying (126) to the problem of the previous paragraph, from which the following results will be obtained:

When $P = 82$ kips, 41 kips per side
 and $e = 21$ in.
 $n = 10.4$ rivets per line, say 10.
 When $P = 164$ kips, 82 kips per side
 and $e = 10\frac{1}{2}$ in.
 $n = 10.9$ rivets per line, say 11.

The reader will recall that the 9 rivets per line on each half of the bracket shown in Fig. 123 (a) proved to be just adequate for the first case, and that 10 rivets per line for the second case resulted in the outer rivet being stressed slightly beyond the permissible 8.1 kips—8.19 kips, to be precise.

125. Connections to Resist Moment: Rivets in Tension.—In all the cases discussed in the previous article the ability of the rivet group to resist moment depended on the strength of the rivets in shear and in bearing. Many connections resisting moment necessarily depend on rivets in tension: the bracket in Fig. 123 (b) is connected to the column flange by rivets in tension, and the ends of beams and girders which are parts of the wind-bracing system of a building are generally connected to the building columns by rivets which are in tension.

The principal difficulty in the problem of connections by means of rivets or bolts in tension is the location of the neutral axis, i.e., the center of rotation of the plane between the connection and the member connected to: in Fig. 123 (b) the plane between the back of the bracket connection angles and the flange of the column. If the connecting rivets or bolts are entirely without initial tension (a condition which rarely, if ever, occurs) the neutral axis has one location; if initial tension exists the neutral axis has some other location. It is never correct to assume that the center of rotation due to moment is at the bottom of

the bracket; it is probably correct in most cases, and it is always conservative, to assume that the center of rotation due to moment is at the center of gravity of the rivet group.

Accepting the center of gravity of the rivet group as the axis of rotation due to moment it seems clear that the number of rivets required to resist the moment can be calculated directly from (125) provided R is the value of a rivet in tension, the other symbols having the significance previously given. If the spacing of the rivets is not uniform in a vertical line the general method expressed by (121) must be applied.

The direct calculation of the number of rivets required may be illustrated by considering the connection of the bracket in Fig. 123 (b) to the column flange.

$$\begin{aligned}
 P &= 57 \text{ kips} \\
 e &= 16 \text{ in.} \\
 p &= 2\frac{1}{2} \text{ in.} \\
 \text{Rivets } &\frac{3}{4} \text{ in. } \phi \\
 R &= 13.5 \times 0.44 = 5.96 \text{ kips (in accordance with A.I.S.C.} \\
 &\quad \text{"Specifications")} \\
 M &= 57 \times 16 = 912 \text{ in.-kips} \\
 n &= \sqrt{\frac{6 \times 912}{2 \times 5.96 \times 2.5}} \times \frac{n-1}{n} = 13.05, \text{ say 13 rivets in each} \\
 &\quad \text{vertical line.}
 \end{aligned}$$

The rivet value is used as $2R$ in this solution since there are two vertical lines of rivets in the connection. Attention should be called to the fact that there is shear on the plane between the column flange and the bracket connection angles. The A.I.S.C. "Specifications" permit rivets in beam and bracket connections to be designed to resist tension at 13,500 lb. per sq. in. *in addition* to their shearing and bearing stresses. In connections which resist moment the number of rivets which would be required for shear alone is generally much less than the number required to resist the moment (in this case 10 for shear and 26 for moment), and the shear per rivet is therefore small. Furthermore, it is probable that in many connections of this kind the shear is resisted entirely by the friction between the connection angles and the column so that the rivets are subjected to tension only. Nevertheless it seems desirable to the author to limit the average intensity of shear in rivets which are in tension through computed moment, or through moment known to be considerable whether computed or not, to not more than 5/6 of that permitted for rivets which transfer stress through shear and bearing only.

If conditions are such that initial tension cannot exist, as when a connection is made by bolts on which the nuts are turned up until they just touch, but do not press against, the surface of the column flange or connection angles, the center of rotation due to moment will be below the center of gravity of the rivet or bolt groups. The neutral axis may be located by trial calculations after which the stress in any bolt may be found by applying the beam formula. The case is not of common occurrence, but has some interest from the standpoint of investigation of existing bolted connections.

It is clear that as load is applied the bracket will tend to rotate about the neutral axis. As a result of this tendency to rotate, the bolts above the neutral axis will be in tension while below the neutral axis the connection angles will be in compression against the column flange. The student will recall from his study of the mechanics of materials that the neutral axis lies at the center of gravity of the section, if stress is proportional to the distance from this axis. Assume that stress is proportional to the distance from the neutral axis and that the compression across the connection angles is uniform at a given distance below the neutral axis. It follows that the static moment about the neutral axis of the area of the connection angles in compression must be equal to the static moment about the neutral axis of the area of all bolts above this axis, and application of this principle will locate the axis. Referring to Fig.

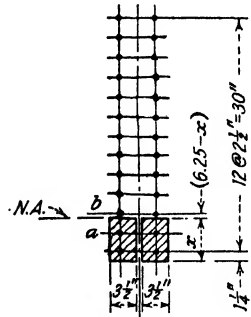

FIG. 125.

125, trial calculations will show that the static moment of the area of all bolts above line *a*, about line *a*, is greater than the static moment of the shaded area below *a*, about *a*; and that the static moment about line *b* of the area of all bolts above line *b*, is less than the static moment of the area of connection angles in compression below *b*, about *b*. Therefore the neutral axis lies between the lines *a* and *b*, and we may write the following relation, in which *x* is the distance from the bottom of the bracket to the neutral axis.

$$\begin{aligned}
 7 \frac{x^2}{2} - 2 \times 0.52(x - 3.75) - 2 \times 0.52(x - 1.25) \\
 = 2 \times 0.44[2.5 \frac{1}{2} \times 11 + 11(6.25 - x)]^*
 \end{aligned}$$

* This relation is based on 13/16-in. holes in the angles (the area of one 13/16-in. hole is 0.52 sq. in.) and on 3/4-in. bolts (the area of a 3/4-in. bolt is 0.44 sq. in.). The

Solving the above relation we find:

$$x = 6.09 \text{ in.}$$

The neutral axis is 6.09 in. above the bottom of the bracket. The moment of inertia about the neutral axis may be calculated as follows:

$$\begin{aligned} 2 \times 0.44 \left[\frac{1.0}{8} \times 11 \times 21 \times \overline{2.5}^2 + 2 \times 0.16 \times \frac{1.0}{2} \times 11 \times 2.5 + 11 \times \overline{0.16}^2 \right] &= 2160 \\ \frac{1}{3} \times 7 \times \overline{6.09}^3 &= 527 \\ & \underline{\hspace{10em}} \\ & 2687 \\ \text{Deduct } 2 \times 0.52 \times \overline{2.34}^2 &= 6 \\ \text{Deduct } 2 \times 0.52 \times \overline{4.84}^2 &= 24 \\ & \underline{\hspace{10em}} \\ I &= 2657 \end{aligned}$$

For an explanation of the quantity in brackets see the footnote on page 165.

Assuming a moment of

$$Pe = 57 \text{ kips} \times 16 \text{ in.} = 912 \text{ in.-kips}$$

and applying the beam formula the stress in the upper bolts is

$$R = \frac{0.44 \times 912 \times 25.16}{2657} = 3.80 \text{ kips each}$$

It will be well for the student to reflect on the conditions which must exist if the analysis just made is to be correct, and on whether the probability of their occurring is sufficient to justify the use of a smaller

quantity on the right of the expression is obtained as follows: The static moment of a vertical line of equal individual areas, equally spaced, about the line 1-1 is:

$$\begin{aligned} \text{S.M.} &= ap + a2p + a3p + \dots anp \\ &= ap(1 + 2 + 3 + 4 + \dots n) \\ &= ap \frac{n}{2} (n + 1) \end{aligned}$$

The static moment of the same group of areas about a parallel line e inches below 1-1, i.e., about line 2-2 is:

$$\begin{aligned} \text{S.M.} &= ae + a(p + e) + a(2p + e) + \dots a(np + e) \\ &= a[p(1 + 2 + 3 + \dots n) + (n + 1)e] \\ &= a \left[p \frac{n}{2} (n + 1) + (n + 1)e \right] \end{aligned}$$

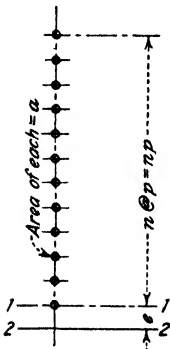

number of bolts than would be required under the assumption that the neutral axis is at the center of gravity of the bolt group. The conditions are: there must be no initial tension in any bolt, but each bolt must have its head and nut just touching the surface of the column flange or connection angle. If some bolts are drawn up tighter than others not only will the foregoing analysis be in error (perhaps grossly so), but an accurate estimate of bolt stress will be impossible.

126. Initial Tension.—Initial tension in rivets and its effect on the action of connections resisting moment is a matter worthy of considerable thought on the part of the student and the designing engineer.

That initial tension occurs in all hot-driven rivets, and that it must be considerable, seems evident a priori, but owing to lack of adequate data quantitative results can be determined only by experiment. The most comprehensive investigation of the matter known to the author is that reported by Professor W. M. Wilson and Mr. W. A. Oliver in Bulletin 210 of the University of Illinois Engineering Experiment Station, entitled "Tension Tests of Rivets." Professor Wilson and Mr. Oliver found that "hot-driven rivets in general are subjected to an initial tensile stress nearly equal to the yield-point strength of the material." The average yield-point strength of the rivet rods which they used was 37,000 lb. per sq. in., and the initial tension of rivets with button heads on each end ranged between about 80 and 100 per cent of the yield-point strength, indicating that an initial tension in the neighborhood of 34,000 lb. per sq. in. may be expected to occur in hot-driven rivets with button heads.

Some engineers hold the opinion that if rivets under initial tension are subjected to external load there will be no increase in the rivet tension caused by the external load until the latter exceeds the initial tension, i. e., that external load applied to rivets under initial tension will not add to the stress in the rivet until the external load exceeds the initial tension. The author does not consider the statement to be exact, but it is sufficiently accurate for practical purposes. It can be shown that, under conditions which may be nearly met in some structural connections, the relation between actual rivet tension, initial rivet tension, and external load may be expressed by:

$$T = T_0 + W \left(\frac{1}{1 + \frac{A_g E_g}{A_r E_r}} \right) \quad (127)$$

in which T = actual tension per rivet due to initial tension and external load;

T_0 = initial tension per rivet;

W = external load per rivet;
 A_r = area of rivet;
 A_g = area of material gripped per rivet;
 E_r = modulus of elasticity of rivet material;
 E_g = modulus of elasticity of gripped material.

Of course in structural work

$$E_r = E_g$$

and the relation reduces to

$$T = T_0 + W \left(\frac{1}{1 + \frac{A_g}{A_r}} \right) \quad (128)$$

Under the most unfavorable circumstances the ratio A_g/A_r might be as little as 9 (usually it will be from 16 to 20), and under present design specifications W might be as much as 50 per cent of T_0 : we would then have:

$$T = T_0 + 0.05T_0 = 1.05T_0$$

That is, under the most unfavorable conditions the initial stress in a rivet will not be increased more than 5 per cent by the application of an external load per rivet equal to 50 per cent of the initial tension, and under what may be considered normal conditions the increase will be less than 1 or 2 per cent. From these considerations it seems clear that a satisfactory working basis is the statement that the application of external load does not increase the tension in rivets under initial tension unless the external load per rivet exceeds the initial tension.

The analysis given in the preceding paragraph has long been familiar to students of machine design, and is similar to that first presented in *The Locomotive* for November, 1897, in a paper entitled, "The Strains on Cover Plate Bolts."

127. Effect of Initial Tension on Connections.—The effect which initial tension has on a beam, girder, or bracket connection may be illustrated diagrammatically as in Fig. 126. At (a) in the figure is represented a portion of a connection with the initial tension in the rivets and the resulting compression against the back of the connection by the member connected to shown by the arrows. The compression against the back of the connection, induced by the initial tension in the rivets, is represented as being uniformly distributed, which is the simplest and most convenient assumption; the actual distribution of the pressure between the connected surfaces evidently depends on their

rigidity and on the location of the loads acting on them. Figure 126 (b) represents a moment applied to the connection and shows the distribution of resisting stress across the back of the connection which will result if this surface does not lose its contact with the adjacent surface. The student should see clearly that the tension represented as occurring at the top of the connection in (b) may not be an actual tension but merely a *relief* of a greater compression. Figure 126 (c) shows the combination of (a) and (b) based on the acceptance, as a working hypothesis, of the principle that the application of external load does not increase the tension existing in a rivet under initial tension until the external load exceeds the initial tension.

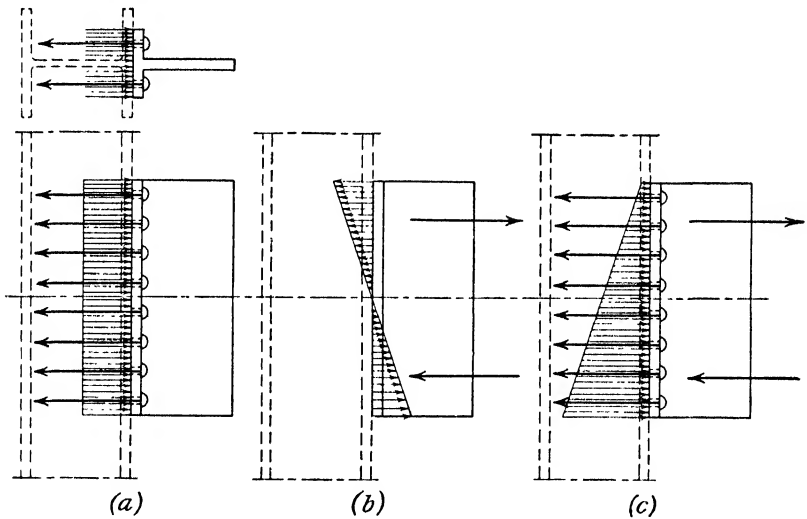

FIG. 126.

It seems clear that the object of the designer should be to make certain that there is no actual separation at the rivets between the back of the connection and the surface of the member to which the connection is made. This will be accomplished if the correctly computed tension in the outer rivet is less than its initial tension. Correct computation of the tension in the outer rivet, resulting from application of external loads, involves not only the bending moment at the connection, the number and arrangement of the rivets, but also consideration of the distortion of the connection material as well as that of the main members, and is a matter of such complexity and difficulty that it is impossible in the routine design of connections; in fact, it is perhaps better to say that with our present inadequate data it is impossible in

any case. It becomes necessary, therefore, to determine, from study of test data and mathematical investigations, what rivet stress computed by methods of sufficient simplicity for use in routine design procedure will provide a proper margin of safety in the connection. Present design specifications permit a tension in rivets, computed by currently accepted

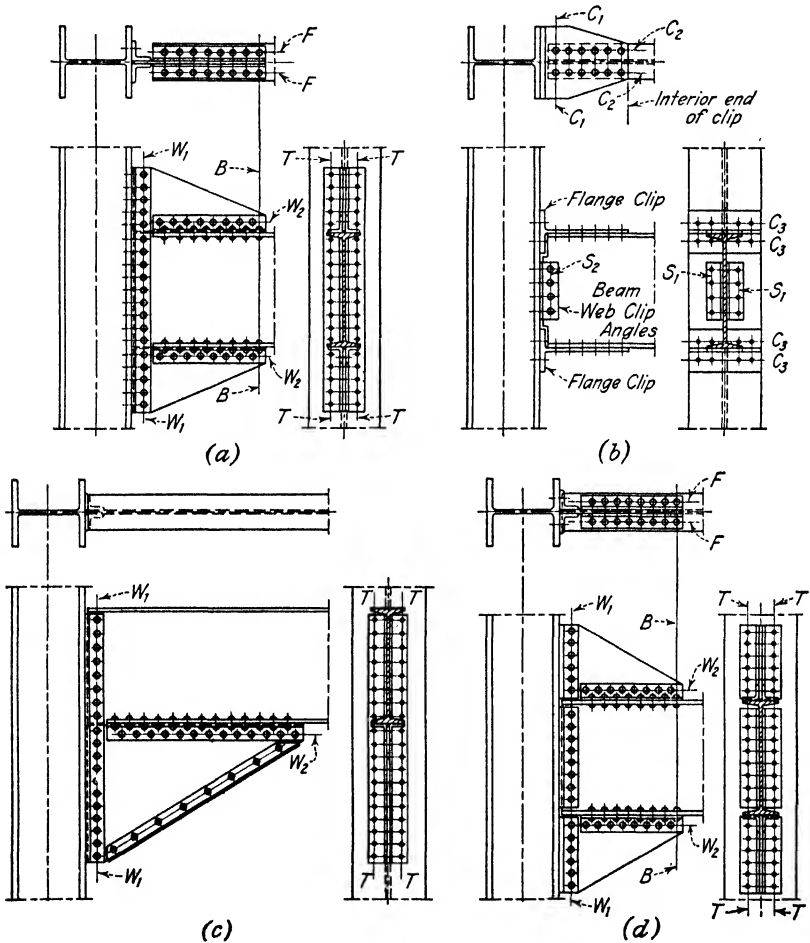

FIG. 127.

methods, ranging from one-third to one-half the amount which may be expected as initial tension. Higher values have been suggested, and used in some cases. The specifications for design which are most widely used at present permit a computed tension of 13,500 lb. per sq. in. on the

nominal area of the rivet, with an increase of one-third when the effect of wind forces is included with that of the other external loads.

128. Beam and Girder Connections to Resist Moment: Rivets in Tension.—All beam and girder connections resist some moment, although the moment, as previously stated, is generally ignored.

The object of this article is to discuss the design of beam and girder connections which are to resist computed moments through rivets in tension. The principles already presented are for the most part sufficient for the design of such connections, but there are some matters which merit further discussion.

Figure 127 illustrates two of the most common types of moment-resisting beam connections: the connections in (a) and (b) are fundamentally different; those shown in (c) and (d) are merely modifications of the type shown in (a). A heavy connection of the type in Fig. 127 (b) is shown in Fig. 133, and a modification of the type in Fig. 132.

Consider first the connection shown in Fig. 127 (a). It is clear that there must be a sufficient number of rivets on line $W_1 - W_1$ to resist the moment and shear without overstressing the outer rivet in double shear or in bearing on the bracket plate (for ease in construction the thickness of the bracket plate should be the same as that of the beam web). The number of rivets may be determined by trial and the stress in the outer rivet computed by the general method presented in Art. 124, or if uniform pitch is used the number necessary to resist moment may be calculated directly by the special method presented in the same article. Because of the necessity of providing proper edge distances in the web of the beam and in the bracket plate at the junction of the bracket and beam it may be found impracticable to maintain exactly uniform rivet pitch in the vertical line $W_1 - W_1$, but a little thought should make it clear that if the number of rivets determined from (125) is provided, no harm will result from some increase in one or two spaces in order to clear the edges of the beams; the result will be substantially correct and on the safe side.* There must be a sufficient number of rivets in the lines $T-T$ to resist the moment without the outer rivets having a *computed* tension exceeding a safe fraction of the probable initial tension. Here again the number may be selected by trial, but it is preferable that it be determined by direct calculation using the

* It is desirable in all connections of the types under discussion that there be a sufficient number of rivets between the web of the beam proper and the connection angles to fully transfer the end shear from one to the other. If this condition is met the author considers that the possibility of a vertical component (due to shear) on the top or bottom rivet in line $W_1 - W_1$ may be ignored and the number of rivets necessary to resist moment, as calculated from (125), used without further investigation.

method expressed by (125). There must be a sufficient number of rivets on the lines W_2, W_2 , to resist in bearing or double shear the greatest stresses resulting from the total horizontal force acting between the beam flange and the bracket, and there must be a sufficient number of rivets on lines $F-F$ to resist in single shear and direct tension the effect of the same force. In addition to these requirements it is necessary that the web of the beam together with the bracket plates have sufficient strength as a rectangular beam to resist the bending moment acting at line W_1-W_1 . It is perhaps pertinent to point out here that the connection requires rivet holes in the flanges of the beam on line $B-B$ and that the weakening effect of these holes should be considered in selecting the beam.

The calculation of the number of rivets required on lines W_2, W_2 , and F, F , requires merely the application of principles already presented. Examination of Fig. 128 (a) will make it clear that the total horizontal force acting between the flange of the beam and the upper bracket must be the sum of the horizontal components acting on rivets 5 to 9 inclusive. The resultant of these horizontal components lies at some distance above the lines W_2 and F, F , and as a result the rivets along these lines must resist bending moment as well as shear. The forces acting on the bracket plate above the beam are shown in Fig. 128 (b), and it seems clear that the design of the riveting on lines W_2 and F, F , may be handled exactly as the riveting for the bracket shown in Fig. 123 (b) and discussed in Arts. 124 and 125.

The computation of the total horizontal force acting on the bracket, i.e., the sum of the horizontal forces on rivets 5 to 9 inclusive in Fig. 128 (a), seems fairly obvious but it may be stated as follows:

Let H = total horizontal force acting along lines W_2 or $F-F$;

R_{w_1} = computed horizontal component on extreme rivet in line W_1-W_1 ;

d_r = distance from neutral axis to extreme rivet in line W_1-W_1 ;

d = distance from neutral axis to any other rivet in line W_1-W_1 .

$$H = R_{w_1} \cdot \frac{\sum d}{d_r} \quad (129)$$

$\sum d$ being the sum of all d distances *above* the plane on which H is to be calculated. This relation is of course true whether the rivets are spaced uniformly or not, but when the spacing of the rivets is uniform the number of spaces of any rivet from the neutral axis may be used for the distance and the calculations made mentally. For example,

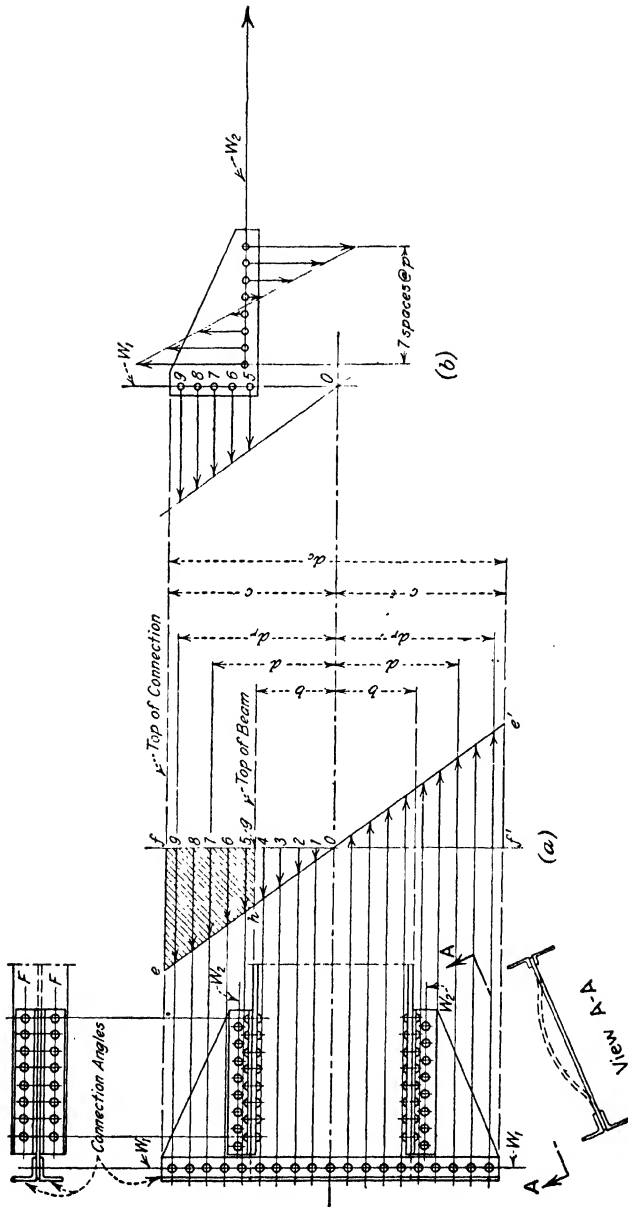

FIG. 128.

in Fig. 128 (a) the rivets are spaced uniformly in the line W_1-W_1 , and the horizontal force acting along the lines W_2 or $F-F$ will be

$$H = \frac{R_{w_1}}{9} (5 + 6 + 7 + 8 + 9) = \frac{35}{9} R_{w_1} \quad (130)$$

As stated above, the strength of the web of the beam and the bracket plates as a rectangular beam must be sufficient to resist the moment acting at line W_1-W_1 . It is important to take into consideration the holes in the plates and web. Evidently the stress at the outer fiber of the rectangular beam formed by the web and bracket plates is

$$s = \frac{Mc}{I_n}$$

where I_n = the *net* moment of inertia and the other symbols have the usual significance. As previously stated,* the net moment of inertia is very nearly proportional to the net area, and we may rewrite this expression using the following notation as well as that shown in Fig. 128 (a):

- d_c = overall depth of bracket connection = $2c$;
- t = thickness of beam-web and bracket plates;
- A_n = net area of web and plates along line W_1-W_1 ;
- A_g = gross area of web and plates along line W_1-W_1 ;
- s = intensity of stress on extreme fiber;
- M = moment at line W_1-W_1 .

Then

$$s = \frac{Mc}{I_n} = \frac{M \frac{d_c}{2}}{\frac{1}{12} t d_c^3 \times \frac{A_n}{A_g}} = \frac{6M}{t d_c^2} \times \frac{A_g}{A_n} \quad (131)$$

If the holes in the line W_1-W_1 are spaced at a uniform vertical pitch and

- p = pitch of rivets in the vertical line,
- h = diameter of the holes,

(131) may be written

$$s = \frac{6M}{t d_c^2} \times \frac{p}{p - h} \quad \dagger \quad (132)$$

* See discussion of plate-girder design, Chapter III, page 177.

† $A_g = t d_c$

$A_n = t d_c - d_c h t / p$, since d_c / p = number of holes in the vertical line

$$\frac{A_g}{A_n} = \frac{t d_c}{t d_c - \frac{d_c}{p} h t} = \frac{p}{p - h}$$

Obviously this relation may be used to determine the necessary thickness of web for a given intensity of stress, or to determine any one of the quantities involved when the others are fixed by known conditions.

It is also of interest here to note that this relation furnishes another convenient method of computing the horizontal force between the beam flange and the part of the bracket above. The product st is the stress per unit of height at the extreme fiber of the rectangular beam, formed by the beam web and bracket plates, on line W_1-W_1 . In Fig. 128 (a) the triangles oef and $oe'f'$ may be taken as representing the distribution of stress (not intensity of stress in this case) across the section of this rectangular beam. It follows at once that since the line ef represents the stress per inch of height at the outer fiber we may say

$$ef = st = \frac{6M}{d_c^2} \times \frac{p}{p-h}$$

and the shaded area $efgh$ represents the horizontal force in question. It is easy to write an expression for this area in terms of the moment, the depth of the beam, and the overall depth of the bracket, but it is preferable to compute it directly from known dimensions and the extreme stress rather than from a general formula.

A matter of some importance in the design of bracket connections is the strength of the bracket plates along the inclined edges. The top or the bottom bracket plate will be in compression along the inclined edge, depending on whether the moment is positive or negative, and will obviously have a tendency to buckle laterally as indicated by the dotted lines in View $A-A$, Fig. 128. It is necessary that the bracket plate have sufficient thickness to prevent this buckling or the edge must be stiffened by angles as in Fig. 127 (c). The required thickness perhaps may be estimated with sufficient accuracy for design purposes by considering the edge of the bracket plate to act somewhat as a column, and applying the limits used for column design. Accepting a slenderness ratio of 60 as that below which buckling is not a factor, in a round end column, we may estimate that, if the ends of the bracket plate are free to rotate, buckling will not occur if:

$$\frac{L}{\frac{t}{\sqrt{12}}} < 60 \quad \text{or} \quad \frac{L}{t} < 17 < \frac{60}{\sqrt{12}}$$

and if the ends are restrained against rotation as indicated in Fig. 128, View $A-A$; buckling will not occur if

$$\frac{1}{2} \frac{L}{\frac{t}{\sqrt{12}}} < 60 \quad \text{or} \quad \frac{L}{t} < 34 < \frac{120}{\sqrt{12}}$$

In these relations,

- L = the unsupported length of the plate edge, in inches;
- t = the thickness of the plate, in inches.

Of course, such an analysis should not be regarded as much more than suggestive. The plate edge receives some restraint from adjacent metal, the extent of the restraint of the ends by the connection or clip angles is uncertain, and the distance from the unsupported edge of the bracket plate to the beam or column is unquestionably a factor.

The similarity of the above limit to that commonly accepted for the maximum spacing of points of lateral support for compression flanges of beams ($L/b = 15$) which are to be subjected to the basic intensity of stress will at once suggest to the student the treatment of bracket-plate edges as beam flanges which are supported laterally only at their ends.*

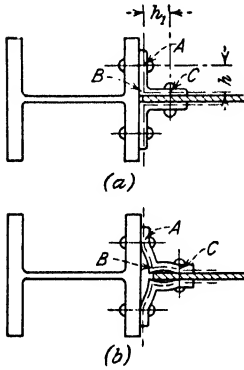

FIG. 129.

In addition to the matters already discussed it is necessary to investigate the ability of the connection angles to resist the bending stresses induced. Figure 129 shows a section through an end connection and the column to which it is fastened: (a) shows the unstressed connection, and (b) shows, to a greatly exaggerated scale, the shape which the angles tend to take on the tension side of the connection under severe loading. If it is assumed

* In computing the stress on the inclined edges of bracket plates it is important to recognize that the conventional methods of calculation may be considerably in error. Referring to the footnote figure, if f'' is the intensity of stress at A along the edge of the plate, and f' and f are intensities of stress in the directions indicated, that

$$f'' = f' \sec^2 \alpha, \text{ or } f'' = f \sec^2 \beta$$

is a matter of statics, but that

$$f' = \frac{M'c'}{I'} \text{ and } f = \frac{Mc}{I}$$

(where M', c', I' ; $M, c,$ and I have the usual significance with respect to sections $X'-X'$ and $X-X$) is not so clear. The author has not been able to find or to develop a thoroughly satisfactory solution of this problem. When the angle α used in calculating f'' is small (say 20° or less) the conventional procedure probably results in a reasonable estimate; if the angle is as large as 45° the author thinks the conventional procedure is 20 per cent or more in error, but on the side of safety.

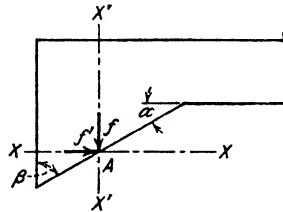

lines of the angle legs, at points *A* and *C*, parallel to their original positions as shown in (a), Fig. 129 (in spite of the deformation indicated in [b], Fig. 129), it may be shown * that:

$$M_A = Th \frac{(2h + h_1)}{(4h + h_1)} \tag{133}$$

in which M_A = the bending moment in the angle leg at *A*;
 T = the pull applied to one angle;
 h and h_1 = the distances indicated in Fig. 129 (a).

The bending moments at *A* and *B* are often estimated for design purposes by assuming that the tangents to the elastic line of the angle leg at *A* and *B* remain parallel to their original positions after deformation. This assumption results in

$$M_A = M_B = \frac{Th}{2} \tag{134}$$

It may be noted also that the distances h and h_1 are often taken as the clear distances, i.e., h , as the distance from the center of the rivet at

* Assume that the right-angle frame shown at (a) is pulled sideways, by a force T , applied horizontally at *B*, in such a way that the original directions at *A* and *C* are not changed. Then since the rotations of *BA* and *BC*, at *B*, must be equal

$$\frac{1}{2}(M_A - M_B)h \times \frac{1}{EI} = \frac{1}{2}(M_B - \frac{1}{2}M_B)h_1 \times \frac{1}{E_1I_1}$$

if $EI = E_1I_1$, which is true in the case of the angle, $M_A = M_B \left(\frac{2h + h_1}{2h} \right)$

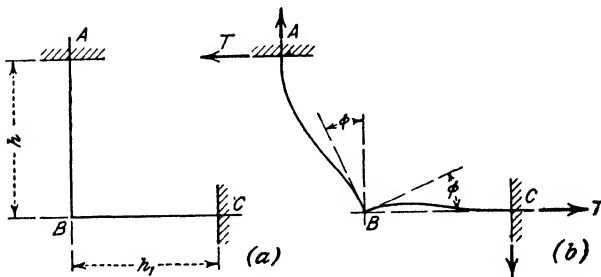

But since

$$M_A + M_B = Th$$

$$M_A = Th \cdot \frac{(2h + h_1)}{(4h + h_1)}$$

Similarly

$$M_B = Th \cdot \frac{2h}{(4h + h_1)}$$

A to the face of the angle at B ; similarly for h_1 . Since the moment at A is usually the critical one it is more nearly correct to use the definition of h and h_1 given in Fig. 129 (*a*).

Referring now to Fig. 130, which represents the upper portion of a connection such as that in Fig. 128 (*a*), it is clear that if we assume a section of the angle p inches long to resist this moment we may write, using the moment given by (133):

$$\frac{Th}{s} \cdot \frac{(2h + h_1)}{(4h + h_1)} = \frac{1}{6} pt^2$$

in which s = the intensity of bending stress in the angle;

p = the length of angle leg assumed to resist the moment = the pitch;

t = the thickness of the angle leg;

T , h , and h_1 = the same as before.

The pull, T , is evidently the calculated pull on the upper rivet of the connections and should not exceed the *rivet value*. Letting $T = R$ = the rivet value in tension

$$\frac{Rh}{s} \cdot \frac{(2h + h_1)}{(4h + h_1)} = \frac{1}{6} pt^2$$

and

$$t = \sqrt{\frac{6Rh}{ps} \cdot \frac{(2h + h_1)}{(4h + h_1)}} \quad (135)$$

When $h = h_1$, as is often the case, this reduces to

$$t = \sqrt{\frac{6Rh}{ps} \times \frac{3}{5}} = 1.9 \sqrt{\frac{Rh}{ps}} \quad (135a)$$

If s_r = the permissible intensity of tension in the rivet and

d = the diameter of the rivet in inches

$$R = \frac{\pi d^2}{4} s_r$$

Then

$$t = 2.17 \sqrt{\frac{s_r h}{ps} \cdot \frac{(2h + h_1)}{(4h + h_1)}} \cdot d$$

and if $h = h_1$

$$t = 1.68 \sqrt{\frac{s_r h}{sp}} \cdot d \quad (136)$$

By estimating h and p in terms of d the necessary thickness of the

connection angles may be found in terms of rivet diameter, for a given ratio of permissible stresses. A little study of this relation will indicate that thick angles are desirable for such connections. A common rule is to make the thickness of the angles equal to the nominal diameter of the rivet, and to keep the angle gages as small as possible.

It should be noted that the analysis above ignores the effect of the rivet holes, in the angle-leg, i.e., the analysis presumes a solid section of angle-leg p inches long as resisting the moment, whereas actually there is a hole in the center of this length. Of course the designer may substitute the *net* length (p -diameter of hole) for p in (135), but since the analysis as given also neglects the effect of the rivet head pressing down on the angle around the hole, as well as the fact that the block of angle-leg assumed is continuous with the rest of the angle (which is not so highly stressed), it is not at all certain that the accuracy of the estimate of necessary thickness will be increased by so doing. In fact, it may be well here to caution the student again against blindly accepting as the final and correct answer formulas, such as (135), in the development of which many factors may be necessarily neglected or approximated. Formulas for design purposes must be simple, and easily and quickly applied, and effects which are uncertain or complicated often must be dealt with by simplifying assumptions. If the approximations and assumptions are reasonable the inexactness of the resulting

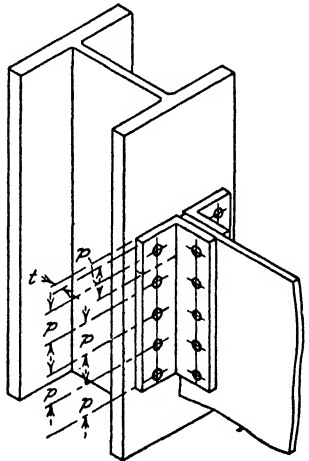

FIG. 130.

formulas does not detract from their usefulness as a means of comparing different designs, or as a means of comparing designs with laboratory data. On the other hand, the advanced student or designer should not always reject complex analyses on the ground that they are too cumbersome for use in design; in spite of their complexity and cumbersomeness such analyses may be useful in guiding the designer's thought about, and investigation of, matters which must, in routine design work, be simplified, approximated, and perhaps standardized.

SPLIT-BEAM CONNECTIONS.—The design of “split-beam” connections such as shown in Fig. 127 (b) needs little discussion. That the following principles should be complied with seems obvious:

(a) The direct tension (or compression) in the flange clip is equal to the moment acting on the connection divided by the depth of the beam

plus the thickness of the web of one clip (or one-half the sum of the web thickness of both clips if they are different).

(b) There should be a sufficient number of rivets connecting the flange clip to the flange of the column to resist in tension the total pull in the clip: these are the rivets on lines C_3-C_3 in the figure.

(c) There should be a sufficient number of rivets connecting the flange clip to the flange of the beam to resist in single shear the total pull in the clip: these are the rivets on lines C_2-C_2 in the figure.

(d) There should be sufficient *net* area in the web of the flange clip on line C_1-C_1 to resist the total pull in the clip without exceeding the permissible intensity of stress in tension. If the web of the clip has tapered edges, as in the figure, there should be sufficient *net* area on any section parallel to C_1-C_1 to resist the total pull developed at that section by the number of rivets between the section and the interior end of the clip.

(e) The flange of the clip should have sufficient thickness to resist the bending moment acting along the lines C_3 and at the junction of the flange and web of the clip. It seems clear that the flange clip tends to bend as shown, greatly exaggerated, in Fig. 131 (b). If the rivets at C_3-C_3 have sufficient initial tension to prevent changing the direction of the elastic line at C_3-C_3 , during the deformation, the bending moments in the flange will be as indicated in Fig. 131 (c), since the elastic line at B must remain parallel to its unstressed position. The distance h is as defined in the figure, and T is the *total* pull in the clip. If b is the width of the flange of the clip, t its thickness, and s the permissible bending stress, evidently:

$$\frac{Th}{4} = \frac{s}{6} bl^2$$

$$t = \sqrt{\frac{3Th}{2sb}} \quad (137)$$

This assumes that the pressure of the rivet heads around the holes offsets the effect of the holes along line C_3-C_3 , but the designer may use the *net* width in place of b if he considers it desirable.

(f) Web clip angles are assumed to transmit the end shear from the beam to the column, and to be capable of performing that function must meet the usual requirements of connection angles regarding rivets on lines S_1 and S_2 in Fig. 127 (b).

Of course the web clip angles resist some of the end moment, but in the usual case it is a small part of the total moment and may be neglected. If the beam is very deep the web clip angles may be made long

enough and provided with a sufficient number of rivets to be of appreciable help in resisting the moment acting on the connection. In the latter case the amount of moment resisted by the web connection should be deducted from the total moment acting on the end of the beam before the flange clips and their riveting are designed.

The discussion of split-beam connections so far has assumed but one line of rivets on each side of the web of the flange clip and has not raised the question as to whether all the rivets in the group are equally effective in resisting the pull on the clip. The question of distribution of pull among the various rivets in the group becomes more important when two lines of rivets on each side of the web are used as in Fig. 133.

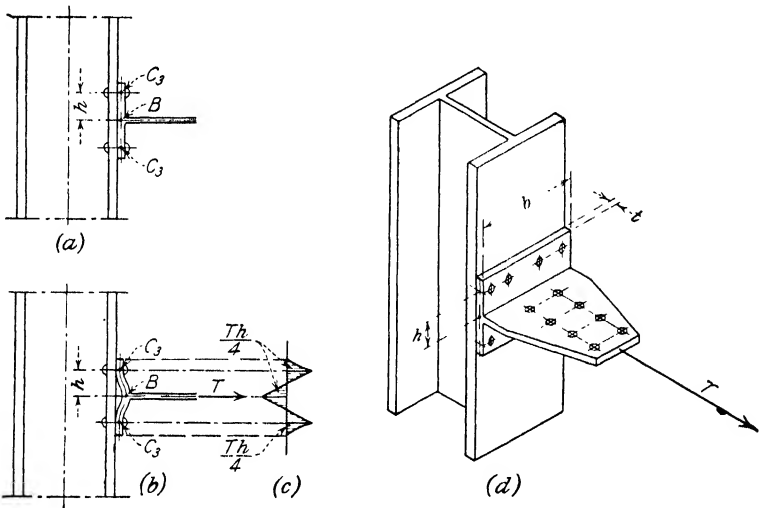

FIG. 131.

Many engineers insist that rivets in the outer lines, C_4 , are useless, claiming that they cannot act until those on the inner lines, C_3 , are stressed beyond their yield point. Similarly the outer four rivets in the two-line connection of Fig. 127 (b) are under suspicion, some engineers believing that they are ineffective, or at least much less effective than the inner four rivets of the group.

The effectiveness of rivets in the outer rows, C_4 , or in the outer ends of the inner rows, C_3 , obviously is a function of the stiffness of the flange clip: if it were possible to have a flange clip of infinite stiffness and to have such initial tension in the rivets that separation between the clip and the part connected to it could not occur there could be no question regarding the effectiveness of the rivets in the outer lines, C_4 , or the

outer rivets in the C_3 lines. This at once suggests the qualitative conclusion that the thicker the flange clips are the more effective outer rivets in the group will be in adding to the capacity of the connection.

Doubt regarding the effectiveness of four-line rivet groups, as in Fig. 133, leads some designers to reduce the pull on flange clips, to that which can be resisted by a smaller number of rivets, by increasing the depth of the beam or offsetting the flange clips as in Fig. 132.

It seems probable that investigations now under way* will throw more light on this matter and result in the development of quantitative data regarding the efficiency of such rivet groups.

Knowledge of the actual value of the various rivets in such groups is not essential to the present discussion, however, as the principles underlying the design of the connection are not materially altered thereby. It seems reasonable to follow the same design procedure whether one or two lines on each side of the web are used and whether the rivets have equal values or not. In estimating the necessary thickness of the flange, from the expression (137), of course, T remains the *total* pull on the clip regardless of how that pull is allocated among the various rivets of the group.

Symmetry in the rivet group is desirable, about both the vertical central plane of the beam and

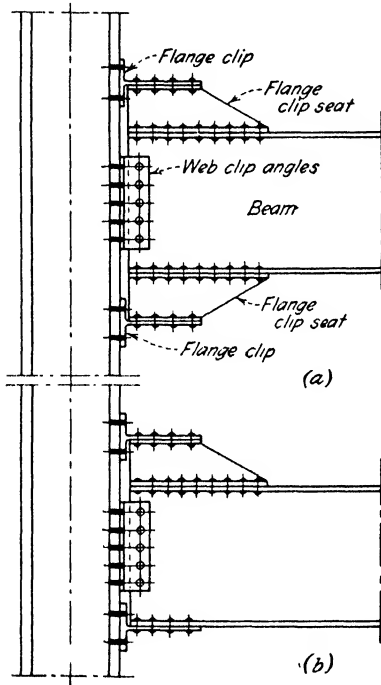

FIG. 132.

the horizontal central plane of the flange clip: it is clear that if it is made symmetrical about these planes the number of rivets in the group must be a multiple of 4. Symmetry may not be possible in all

* See discussions by W. C. Huntington and Paul Nielsen, and A. Torrigin and Erle Cope in September, 1932, *Proceedings of the Am. Soc. C.E.* These are discussions of a paper on "Wind-Bracing Connection Efficiency" by V. T. Berg published in the January, 1932, *Proceedings of the Am. Soc. C.E.* A further report on the progress of the investigations was given in a paper by W. C. Huntington on "Tests of Split-H End Connections for Wind Girders," presented before the summer Convention of the Am. Soc. C.E., June, 1933.

Rolled-Beam Connections: Bracket Type

Beam WB3

Max. End Shear = 34k
Max. End Mom. = 275k

| | |
|-----------------------------------|--------|
| DP 18 | |
| Beam Connections to Resist Moment | |
| 1933 | T.C.S. |
| Sheet 1 of 4 | |

A.I.S.C.
Specifications

Rivets $\frac{7}{8}$ " ϕ

Beam 24" I @ 78.9# web $\frac{1}{2}$ " thick

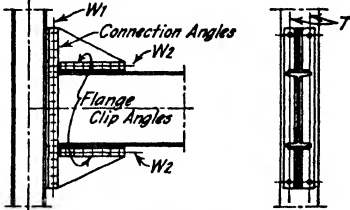

TYPE OF CONNECTION

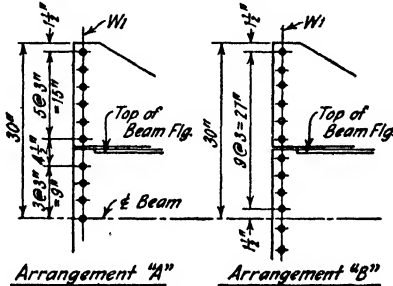

Arrangement "A"

Arrangement "B"

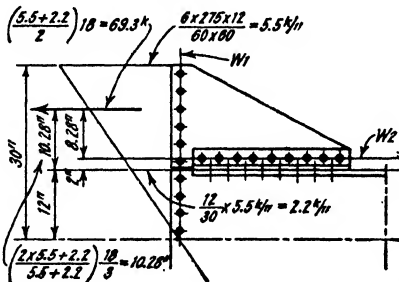

| | Without Wind | With Wind |
|----------------------------|--------------|-----------|
| s.s. | = 8.1k | 10.8k |
| d.s. | = 16.2k | 21.6k |
| bg. on $\frac{1}{2}$ " pl. | = 13.1k | 17.5k |
| tension | = 8.1k | 10.8k |

Rivets Line W1 : pitch = 3"

$$n = \sqrt{\frac{275 \times 12 \times 6}{17.5 \times 3.0} \times \frac{n-1}{n}} = 12.9, \text{ say } 13$$

Rivets on Line T : pitch = 3"

$$n' = \sqrt{\frac{275 \times 12 \times 6}{2 \times 10.8 \times 3.0} \times \frac{n'-1}{n'}} = 17.0 \text{ per line}$$

Minimum Plate Thickness

$$t = \frac{6 \times 275 \times 12}{\frac{2}{3} \times 18 \times 80 \times 80} \times \frac{3}{3-1} = 3.44"$$

Use $\frac{1}{2}$ " pl., same as beam web.

Rivets on Lines W2 and F,F

$$\text{Mom. at Line W2} = 69.3k \times 0.28 = 57k$$

$$= 5 F,F = 69.3 \times 10.28 = 712k$$

Rivs. on Line W2

$$n'' = \sqrt{\frac{57 \times 8}{17.5 \times 3}} = 2.1 \text{ say } 3$$

Rivs. on Lines F,F

$$n''' = \sqrt{\frac{712 \times 8}{10.8 \times 2 \times 3} \times \frac{n'''-1}{n'''}} = 7.6 \text{ say } 8$$

cases, and if dissymmetry is permitted it should be about the horizontal central plane of the flange clip, symmetry about the vertical axis being maintained.

129. Illustrative Example DP18.—To illustrate the discussion of connections to resist moment the calculations DP18, Sheets 1 to 4 inclusive, are presented. It should be noted that an end shear, end moment, and beam size have been arbitrarily assumed. The end moment is assumed to be largely the result of wind forces, and unit stresses used

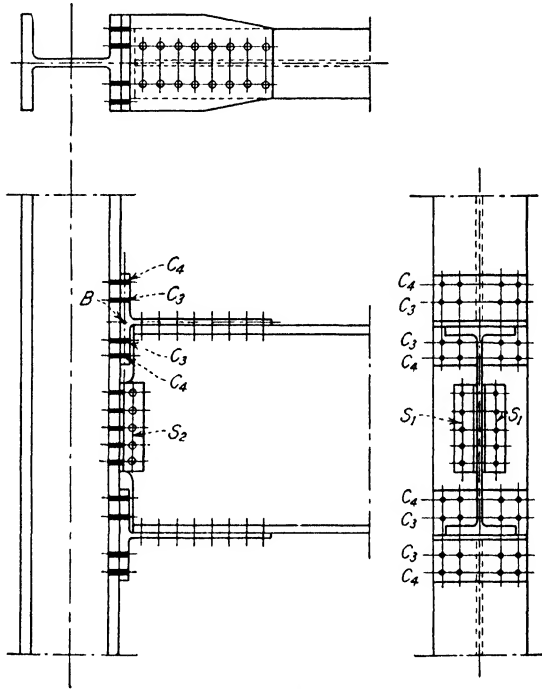

FIG. 133.

in the calculations are increased one-third, as allowed by the specifications, except that in the estimate of rivets required for the web clip angles, in the split-beam type of connection (Sheets 3 and 4 of the calculations), the common unit stresses have been used under the assumption that the critical end shear is the result of loads other than wind.

In general, the calculations follow directly along the lines of the discussion in the preceding article and need little comment. However, the student should note particularly that in this design, as in most

Rolled-Beam Connections: Bracket Type

DP 18

Beam Connections
to Resist Moment

1933 T.C.S.

Sheet 2 of 4

Connection Angle Thickness

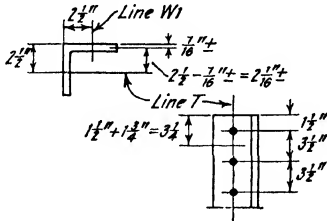

Using 17 rivets per line on T Lines

Actual stress in top rivet
average pitch = $\frac{60}{17} = 3.53"$

$$\therefore R = \frac{275 \times 12 \times 6}{2 \times 17^2 \times 3.53} \times \frac{16}{17} = 9.14k$$

$$t = 1.9 \sqrt{\frac{9.14 \times 2.06}{24 \times 3.25}} = .934" \text{ say } \frac{15}{16}"$$

Conn. ls 2-15 4" x 4" x $\frac{15}{16}"$

Flange Clip Angle Thickness

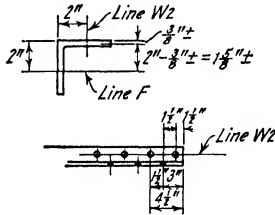

Using 8 rivets per line on F Lines

Actual stress in outer rivet

$$R = \frac{712 \times 6}{2 \times 8^2 \times 3} \times \frac{7}{8} = 9.74k$$

$$t = 1.9 \sqrt{\frac{9.74 \times 1.63}{24 \times 4.5}} = .73" \text{ say } \frac{3}{4}"$$

Flg. Clip ls 2-15 3 1/2" x 3 1/2" x $\frac{3}{4}"$

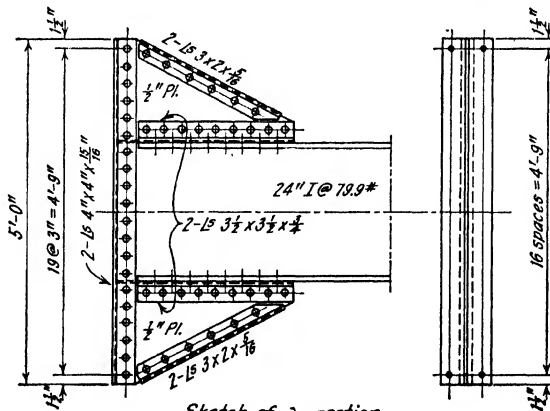

Sketch of Connection

Rolled-Beam Connections: Split-Beam Type

| | |
|--------------------------------------|--------|
| DP 18 | |
| Beam Connections to Resist Moment | |
| 1933 | T.C.S. |
| Sheet 3 of 4 | |

Beam WBS

Max. End Shear = $34k$
Max. End Mom. = $275k'$

Beam $24'' I @ 79.9\#$, web $\frac{1}{2}''$ thick

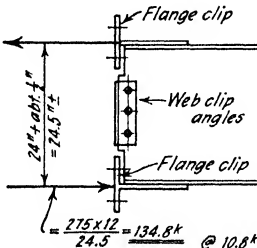

Web clip angles

$$\frac{34}{8.1} = 4 + \text{rivets } \frac{3}{8}'' \text{ s.s. in outstanding legs of web clip angles}$$

$$\frac{34}{13.1} = 3 - \text{rivets } \frac{1}{8}'' \text{ bg. on } \frac{1}{2}'' \text{ web in web legs of web clip angles}$$

Use 2-4x3 1/2 x 1/2 L5
3-rivets L5 to web
6- " " " col.

@ 10.8k = 12.5 rivets $\frac{3}{8}'' \phi$ } direct tension in flange
@ 14.1 = 9.6 " $1'' \phi$ } of flange clip
@ 17.9 = 7.5 " $1 \frac{1}{8}'' \phi$ }

@ 10.8 = 12.5 ~ 14 rivets $\frac{3}{8}'' \phi$ s.s. in flange of beam.
@ 24.0k/m = 5.62 min net area in web of flange clip

Flange clip

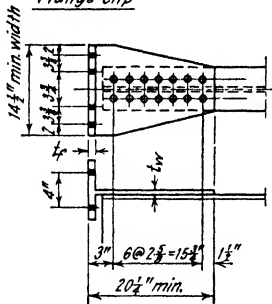

$$t_f = \sqrt{\frac{3 \times 134.8 \times 2}{2 \times 24 \times 14.5}} = 1.08''$$

$$t_w = \frac{5.62}{14.5 - 2} = \frac{5.62}{12.5} = .449'' \text{ min.}$$

Cut flange clip from 22" WFB @ 96#

$$t_w = .545''$$

$$t_f = 1.088''$$

8-1 1/8" ϕ rivets clip to col.
14- 3/8" ϕ " " " beam

Rolled - Beam Connections: Modified Split-Beam Type

| DP 18 | |
|-----------------------------------|--------|
| Beam Connections to Resist Moment | |
| 1933 | T.C.S. |
| Sheet 4 of 4 | |

Beam WB3

Max. End Shear = 34k
Max. End Moment = 275k'

Beam 24" I @ 79.9#

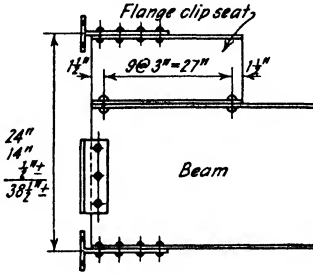

Web clip angles same as on Sheet 3

Flange clip to have $8 - \frac{3}{8}$ " ϕ rivets

Flange clip pull = $8 \times 10.8 = 86.4k$

distance c. to c. flange clips

$$= \frac{275k' \times 12}{86.4k} = 38.2"$$

Use 14" Beam as flg. clip seat

Flange Clip

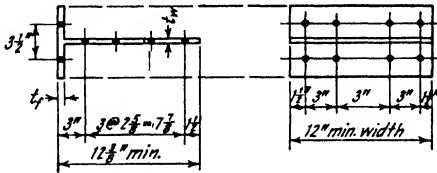

$\frac{86.4}{10.8} = 8$ rivets $\frac{3}{8}$ " ϕ , flange clip to flange of seat

$$t_p = \sqrt{\frac{3 \times 86.4 \times 1.75}{2 \times 24 \times 12}} = .975"$$

$$t_w = \frac{86.4}{24(12-2)} = .360" \text{ min.}$$

Cut 2-Clips from 26" WFB @ 91#

$$t_w = .475"$$

$$t_p = .974"$$

Flange Clip Seat

Moment at connection of seat to beam flange
= $86.4 \times 14.24 = 1220k'$

Rivets

$$n = \sqrt{\frac{1220 \times 6}{2 \times 10.8 \times 3} \times \frac{n-1}{n}} = 10.16 \text{ say } \underline{10 \text{ rivets per line @ } 3" \text{ c. to c.}}$$

Length of seat = 30"

$$\text{Min. web thickness} = t = \frac{1220 \times 6}{24 \times 30^2} = .338"$$

Check web of seat for shear

$$\frac{3}{2} \times \frac{86.4}{16.0} = 8.10k' \text{ min. area of web parallel to beam flange: area provided} = \underline{30 \times .335 = 10.10k'}$$

Use 14" WF @ 47# for flange clip seat

$$t = .335"$$

practical work, the calculations serve to set limits and minimum requirements, the actual choice of parts and their arrangement depending to a large extent on physical limitations, such as necessary driving clearances for rivets, proper edge distance, obtainable shapes, and so on.

The calculations for the number of rivets in the outstanding legs of the connection angles show that 17 on each line at 3 in. center to center will be adequate, but this number, at that spacing, would give a connection only 51 in. deep whereas the rivets in the line against the web of the beam require an overall depth of 60 in. as shown. Spreading out the rivets in the outstanding legs to cover the greater depth increases their resistance to bending moment, and fewer rivets would answer. An estimate of the required number of rivets in terms of depth may be made by rewriting the expression

$$n = \sqrt{\frac{6M}{Rp} \times \frac{n-1}{n}}$$

Squaring and dividing by n this becomes

$$n = \frac{6M}{Rpn} \times \frac{n-1}{n}$$

If the spacing of the rivets is uniform and if the edge distance is equal to one-half the pitch (as is usually actually or very *nearly* true) pn is equal to the overall depth and we may then say that

$$n = \frac{6M}{Rd} \times \frac{n-1}{n}$$

where d = overall depth in inches, and the other terms have their usual significance. As before, the term $\frac{n-1}{n}$, on the right-hand side may be neglected, resulting in a small error on the safe side, but the term may be easily included.

Applying this relation to the calculation of the rivets on the T lines we have:

$$n = \frac{6 \times 275 \times 12}{2 \times 10.8 \times 60} = 15.28$$

neglecting the term $\frac{n-1}{n}$. Including the term,

$$n = 15.28 \times \frac{14.28}{15.28} = 14.28 \text{ * rivets in each line, say 15,}$$

which shows that we may use 15 rivets on each T line instead of the 17 given on the calculation sheets. It would be well to use the smaller number, particularly if there is a large number of such connections. Decreasing the number of rivets would increase the stress on the outer rivet and also increase the length to be used in calculating the necessary thickness of the connection angles.

Attention is called to the calculations for and choice of riveting on line W_2 (see Sheet 1 of calculations). The term $\frac{n'' - 1}{n''}$ has been omitted leading to $n'' = 8.1$. Had this term been included it would have modified the result to

$$n'' = 7.6$$

Nine rivets were used. Study will show that had 8 rivets been used the outer rivet would be slightly overstressed owing to the horizontal component resulting from the horizontal pull of 69.3 kips acting on the bracket plate in addition to the bending moment. The calculations

* It will at once be noticed that the more accurate number is one less than that obtained by neglecting the term, $\frac{n - 1}{n}$. One should satisfy himself that this result

will be sufficiently accurate in all cases by using more accurate values of $\frac{n - 1}{n}$.

That is, a first approximation of n is 15.28, obtained by neglecting the term $\frac{n - 1}{n}$.

A second, and more accurate, approximation is:

$$n = 15.28 \times \frac{14.28}{15.28} = 14.28$$

A third approximation is:

$$n = 15.28 \times \frac{13.28}{14.28} = 14.21$$

A fourth approximation:

$$n = 15.28 \times \frac{13.21}{14.21} = 14.20$$

The reader will do well to study in the same way the variation in the value of n computed from

$$n = \sqrt{\frac{6M}{Rp} \times \frac{n - 1}{n}}$$

for the stress on the end rivet in line W_2 using 8 rivets and 9 rivets respectively are shown in Fig. 134.

The horizontal pull of 69.3 kips acting on the bracket plate may be calculated from the sum of the horizontal components of rivet stresses acting on the plate as well as by the method shown on the calculation sheets. The calculations would be as follows:

$$R = \frac{275 \times 12 \times 6}{20^2 \times 3} \times \frac{19}{20} = 15.68 \text{ horizontal component on top rivet}$$

$$\text{Total} = 15.68 \times \frac{(4\frac{1}{2} + 5\frac{1}{2} + 6\frac{1}{2} + 7\frac{1}{2} + 8\frac{1}{2} + 9\frac{1}{2})}{9\frac{1}{2}} = 69.3 \text{ kips}$$

It will be noted that angles have been added to the inclined edges of the bracket plates to stiffen them against lateral buckling when in

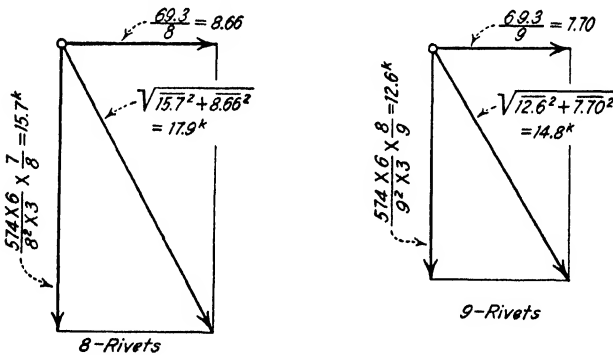

FIG. 134.

compression. There is no definite basis for the choice of such angles, and no attempt has been made to estimate their strengthening effect. It seems wise that the total width of the outstanding legs be at least 1/15 to 1/10 the unsupported length of the plate edge. A single angle with an outstanding leg $2\frac{1}{2}$ in. or 3 in. wide would meet this requirement and would often be used in such cases; the author prefers symmetry in section for primary members.

In studying the calculations for the design of the split-beam type of connection it is important to notice that the attachment of the flange clips to the columns requires eight $1\frac{1}{8}$ ϕ rivets in each clip. In many cases the use of such large rivets would be objectionable, and it would be necessary to use a larger number of smaller rivets. If a larger number of smaller rivets were chosen it would be necessary to use four horizontal

lines of rivets in each flange clip, and as already stated there is considerable uncertainty concerning the effectiveness of rivets in the outer lines. If such rivets are accepted at full value the most satisfactory solution would be to use twelve 7/8-in. ϕ rivets and place the flange clips on fillers of sufficient thickness to make this number adequate. The necessary distance center to center of flange clips would be:

$$\frac{275 \times 12}{12 \times 10.8} = 25.5 \text{ in.}$$

Since the flange clip web has a thickness of about 1/2 in. this would require a fill 1 in. thick on one flange, or a 1/2-in. fill on each flange.

If the designer cannot accept more than two horizontal lines of rivets in a flange clip and still must use ordinary rivets, the flange clips may be separated a sufficient distance by the use of one or two flange clip seats as illustrated in Fig. 132. The design of this modified type of split-beam connection involves no new principles and no additional calculation except that necessary to proportion the flange clip seat. It seems obvious that the flange clip seat may be treated exactly the same as a bracket on a column, and the calculations on Sheet 4 of DP18 are based on that procedure. The calculations for the connection of the flange clip to the flange clip seat and of the latter to the beam flange need no comment. As the calculations show, the web of the seat has been treated as a rectangular beam, and its thickness determined from the moment and shear to which it is subjected.

It may be well to point out that in the calculation for area of the web of the seat, $\frac{3}{2} \times \frac{86.4}{16.0} = 8.10$ sq. in., the intensity of stress, 16 kips per sq. in., is the usual permissible stress increased by one-third because the effect of wind is included, and the factor 3/2 takes account of the parabolic variation of shear across a rectangular beam; students often overlook the latter principle. This procedure of course is open to the objection that it assumes the beam formula applicable to a beam having a length less than its depth. In spite of the probable inaccuracy of the beam formula in such cases its use seems to provide the most practicable estimate of the strength of a column bracket or flange clip seat.

If it seems desirable to cut the seat with a sloping end, as shown in Fig. 132, there is the added uncertainty as to the action of a beam with an inclined edge. Even in this case the use of the beam formula seems to provide the only simple design procedure.*

* The student will do well to reflect on the situation presented by the use of the ordinary beam formula in connection with a beam with one edge sharply inclined. For example, consider the accompanying figure. Both beams are rectangular and

130. Net Section in Tension Members.—Before proceeding with a discussion of the design of riveted connections for tension and compression members it is necessary to establish a working definition for the determination of *net section*.

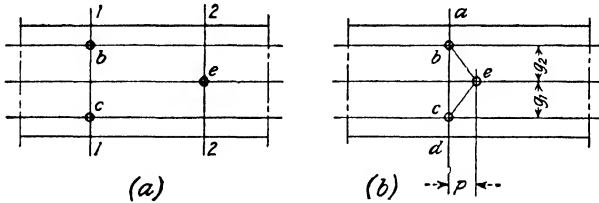

FIG. 135.

Referring to Fig. 135 (a), it is clear enough that at 1-1 the net section is the gross area of the plate minus the area cut out by two holes, and that at 2-2 the gross area minus the area cut out by one hole. In

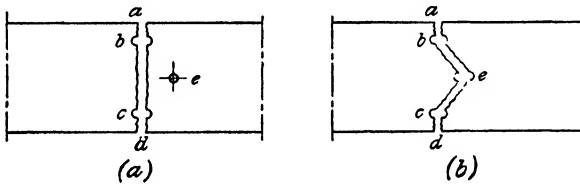
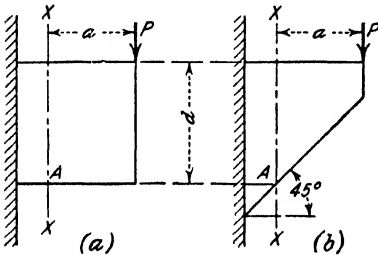

FIG. 136.

Fig. 135 (b), however, the net section is not so obvious. There would be no question in the mind of the reader but that the plate in Fig. 135 (a) would break, if tested to destruction, along section 1-1 through the holes *b* and *c*. It would not be evident by inspection whether the plate

have the same depth and width at section *x-x*, and consequently the same moment of inertia at this section. Applying the beam formula to each of them will give a



horizontal intensity of stress at *A* in the beam shown in (b) equal to the intensity of stress at *A* in the beam shown in (a); call this intensity *f*. But, as stated in the footnote on page 304, if the horizontal intensity of stress at *A* in the beam shown in (b) is *f*, the stress along the edge is, $f \sec^2 45^\circ$, or $2f$, as a matter of statics. This means that if one accepts intensity of stress as a measure of strength, the bracket shown in (b) is only half as strong, at section *x-x*, as

the one shown in (a). The author doubts whether many engineers will accept this conclusion; certainly he does not.

in Fig. 135 (b) would break through holes b and c along the transverse line a, b, c, d , as illustrated in Fig. 136 (a), or whether it would break through holes b, e , and c , along the zigzag line a, b, e, c, d , as illustrated in Fig. 136 (b). There must be a location of hole e with respect to holes b and c which will make the breaking of the plate along the transverse line $abcd$ through holes b and c , or along the zigzag line $abcd$ through holes b, e , and c *equally probable*, i.e., which makes the strength of the plate along the zigzag line equal to its strength along the right transverse line.

There have been several attempts to establish mathematically a relation between the pitch of the rivets or holes, p —see Fig. 135 (b)—the gages, g_1 and g_2 , and the diameter of the holes, which will make possible the location of the hole e to produce equal strength along the transverse and zigzag sections. Formulas which are presumed to do this have been published in various sources, but the author has not seen a demonstration consistent with the generally accepted principles of mechanics. There are so many complicating factors—intensification of stress at the edge of a hole, the concentration of the load at points (the rivets), the fact that the holes are not empty but contain rivets which may not quite fill them, may exactly fill them, or may be expanding them, and so on—that a mathematical solution of the problem seems impracticable if not impossible.

The designing engineer, however, does not need to have a formula (and does not want it if it is complicated) which *exactly* locates the position to produce equal strength; what he would like to have is a simple relation between the net area on a zigzag line and the net area on a right transverse line by means of which he can space rivets with definite assurance that the member in question is not weaker (preferably a little stronger) along a zigzag section than along a right transverse section, or by means of which he can estimate the strength along a zigzag section in comparison with the strength along a right transverse section. This want has been met in design specifications in the past by rules setting up a minimum ratio between net area along a zigzag section and net area on a right transverse section. The specifications written by the late Theodore Cooper,* for example, stated that: “The rupture of a riveted tension member is to be considered as equally probable, either through a transverse line of rivet holes or through a

*“General Specifications for Steel Railroad Bridges and Viaducts,” Seventh Edition, 1906. Mr. Cooper based his requirements on the results of an elaborate series of tests performed by the Research Committee of the Institution of Mechanical Engineers which were reported in the *Proceedings* of that society for April, 1885, and in *Engineering* for July 3 and 10, 1885.

zigzag line of rivet holes, where the net section does not exceed by 30 per cent the net section along the transverse line. The number of holes to be deducted will be determined by this condition." Other specifications of about the same period had similar requirements in which the excess area demanded for the zigzag section ranged from 15 to 30 per cent. More recently, conference committees from the American Society of Civil Engineers and the American Railway Engineering Association suggested a definition * which substantially requires that the excess area along a zigzag section be 10 per cent.

Although an immense amount of study and experimentation † has been devoted to the subject of riveted joints the matter of net section, from the viewpoint of the structural designer, seems not to have been as carefully studied as other phases, and *conclusive* experimental support of any of the various requirements regarding net section is not available. It is consequently necessary more or less arbitrarily to adopt some definition by which net section may be estimated. Therefore pending experimental (or analytical) demonstration that some other definition is more nearly in accordance with the facts the author has adopted the following and has incorporated it in the bridge design specifications given in Appendix A. ‡

The net section of riveted tension members shall be the least area found as follows:

(a) A right section with the holes in that section only deducted.

(b) A zigzag section with all holes in the zigzag section deducted and the net diagonal distances taken at $5/6$ of their values; except that the area thus found is not to be used if less than a right section with the holes cut by the zigzag section deducted.

The application of this definition will be discussed and illustrated in the next article.

131. Calculation of Net Section.—The problem of net section commonly occurs in two ways. First, if the plate in Fig. 137 has been designed deducting one hole § from the gross area, what must be the pitch, p ,

* Art. 408, "General Specifications for Steel Railway Bridges," *Proceedings Am. Soc. C.E.*, December, 1929.

† Some idea of the amount may be obtained from the comprehensive "Bibliography on Riveted Joints" by A. E. R. de Jonge, "Research Publications," A.S.M.E., 1934.

‡ The results of a systematic but brief series of tests conducted at the University of Illinois under the direction of Professor W. M. Wilson seem to support this definition, but the number of tests is not great enough to consider the result final. Not all the data have been published, but those which do not appear in Bulletin 239 of the Engineering Experiment Station, University of Illinois, are recorded in a graduate thesis written by C. O. Harris.

§ The dissymmetry resulting from staggering the holes is neglected. There are no data concerning the effect, if any, of this dissymmetry, and perhaps most com-

in order to maintain the net section, i.e., in order to insure that a right section a, b, e , through hole b with one hole deducted, is at least as strong as a zigzag section a, b, c, d with two holes deducted? Second, if the pitch, p , must be less than is necessary if only one hole is to be deducted, what is the net area of the piece?

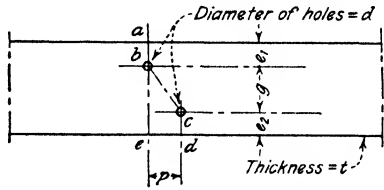

FIG. 137.

These two problems are readily solved by application of the definition of net section stated in the preceding article.

$$(e_1 + g + e_2 - d)t = \text{net section on } abc$$

or

$$\left[e_1 - \frac{d}{2} + \frac{5}{6}(\sqrt{g^2 + p^2} - d) + e_2 - \frac{d}{2} \right] t$$

$$[e_1 + e_2 - d + \frac{5}{6}(\sqrt{g^2 + p^2} - d)]t = \text{net section on } abcd$$

The second of these expressions answers the second question just stated, and equating the two expressions will answer the first.

$$(e_1 + g + e_2 - d)t = [e_1 + e_2 - d + \frac{5}{6}(\sqrt{g^2 + p^2} - d)]t$$

from which
$$p^2 = 0.44g^2 + 2.4gd + d^2 \tag{138}$$

If one wishes to do so it is a simple matter to draw a curve relating p and g for the values of d that most commonly occur, and such a diagram is often very convenient. A more comprehensive diagram which may be constructed for answering the second question in complicated cases will also serve to represent this relation between p and g .

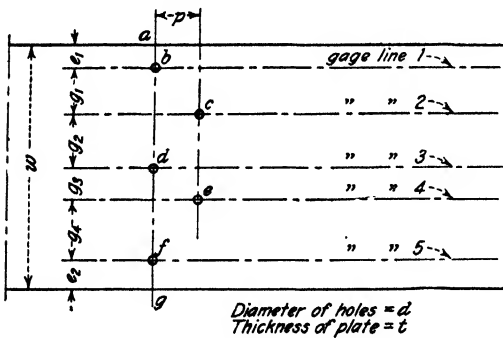

FIG. 138.

The fundamental way in which the definition of net section adopted was applied in determining the net area

monly pieces—such as flange angles of girders—in which staggered riveting occurs are so restrained by connected parts that deflection out of line is impossible.

on section $abcd$ in Fig. 137 may be used in any case, but in more complicated arrangements, such as that shown in Fig. 138, it may be necessary to try several ways to determine the least net area. For example, in Fig. 138 it is not clear by inspection whether section $abdfg$ with three holes deducted, section $abcdfg$ with four holes deducted, or section $abcdfg$ with five holes deducted will give the least area in accordance with our definition. To try all these, and other possible sections, by the fundamental method would be quite time-consuming, and some means of expediting the work will be helpful.

It seems clear that in determining the net section on line $abdfg$ in Fig. 138 we may say that between the upper edge of the member and gage line 1 we deduct $\frac{1}{2}$ of a hole, between gage lines 1 and 2 we deduct $\frac{1}{2}$ of a hole, between gage lines 2 and 3, $\frac{1}{2}$ of a hole, and so on, the total deduction being

$$\frac{1}{2} + \frac{1}{2} + \frac{1}{2} + \frac{1}{2} + \frac{1}{2} + \frac{1}{2} = 3 \text{ holes}$$

and the net area is then

$$(w - 3d)t$$

Similarly in discussing section $abcdfg$ we could think of the total deduction as

$$\frac{1}{2} + x_1 + x_2 + x_3 + x_4 + \frac{1}{2}$$

where the first $\frac{1}{2}$ is the half-hole deducted between the upper edge and gage line 1; the second $\frac{1}{2}$, the half-hole deducted between gage line 5 and the lower edge; and $x_1, x_2, x_3,$ and x_4 , the fractional parts of a hole deducted between gage lines 1 and 2, 2 and 3, 3 and 4, and 4 and 5. Then if these fractional parts were properly determined the net width would be:

$$\begin{aligned} (e_1 - \frac{1}{2}d + g_1 - x_1d + g_2 - x_2d + g_3 - x_3d + g_4 - x_4d + e_2 - \frac{1}{2}d) \\ = [e_1 + g_1 + g_2 + g_3 + g_4 + e_2 - (1 + x_1 + x_2 + x_3 + x_4)d] \\ = [w - (1 + x_1 + x_2 + x_3 + x_4)d]. \end{aligned}$$

Applying our definition we may write

$$(g_1 - x_1d) = \frac{5}{8}[\sqrt{g_1^2 + p^2} - d]$$

from which

$$x_1 = \frac{g_1 + \frac{5}{8}d - \frac{5}{8}\sqrt{g_1^2 + p^2}}{d} \quad (139)$$

Although developed for x_1 this expression is perfectly general and may be used with any gage to calculate the corresponding value of x . If

some simple and quick way to determine the values x_1, x_2 , and so on, is available we may always find net area on any zigzag section as the gross right section with a certain number of holes deducted, that number being, $1 + \Sigma x$, where Σx is the sum of all x quantities. Figures 139, 140, and 141 show solutions of the expression (139) for varying values of g and p , Fig. 139 being for 3/4-in. rivets and 7/8-in holes, Fig. 140 for

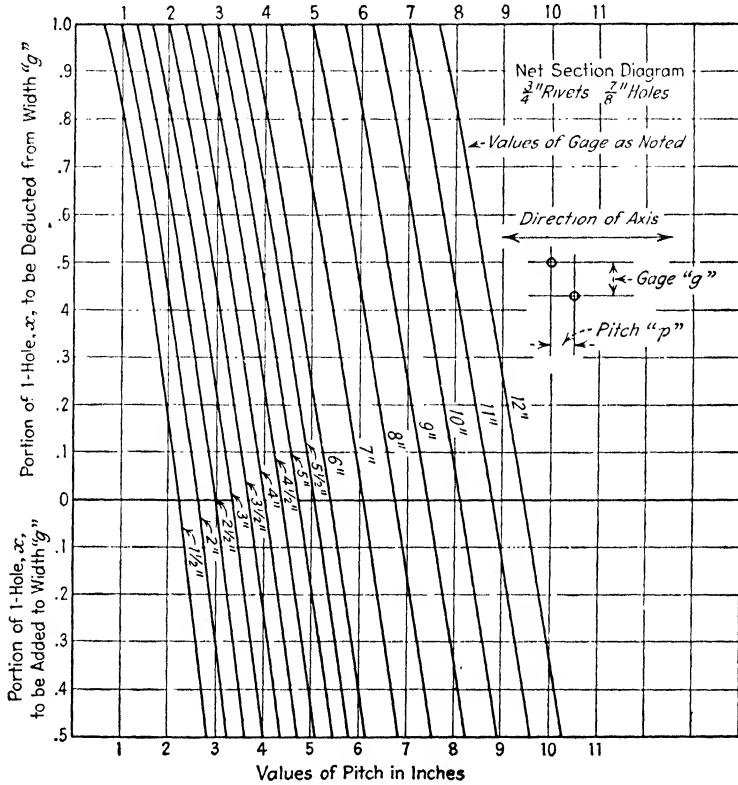

FIG. 139.

7/8-in. rivets and 1-in. holes, and Fig. 141 for 1-in. rivets and 1 1/8-in. holes.

Referring again to Fig. 137 it is clear that we may apply (139) in this case to determine the net area on section a, b, c, d . Also if we equate (139) to zero and solve for p we will get expression (138) as we should; evidently then the diagrams in Figs. 139, 140, and 141 may be used to obtain a solution of (138) for varying values of g and p within the range of d covered by the diagrams.

To illustrate the numerical application of the definition of net section, and to show how the diagrams of Figs. 139, 140, and 141 may be used in connection therewith, two or three typical problems will be considered.

Assume that the plate in Fig. 137 is 6 in. wide, the gage g is 3 in., the edge distances are equal and $1\frac{1}{2}$ in. each, and the rivet holes are to be taken as 1 in. in diameter for $7/8$ -in. rivets.

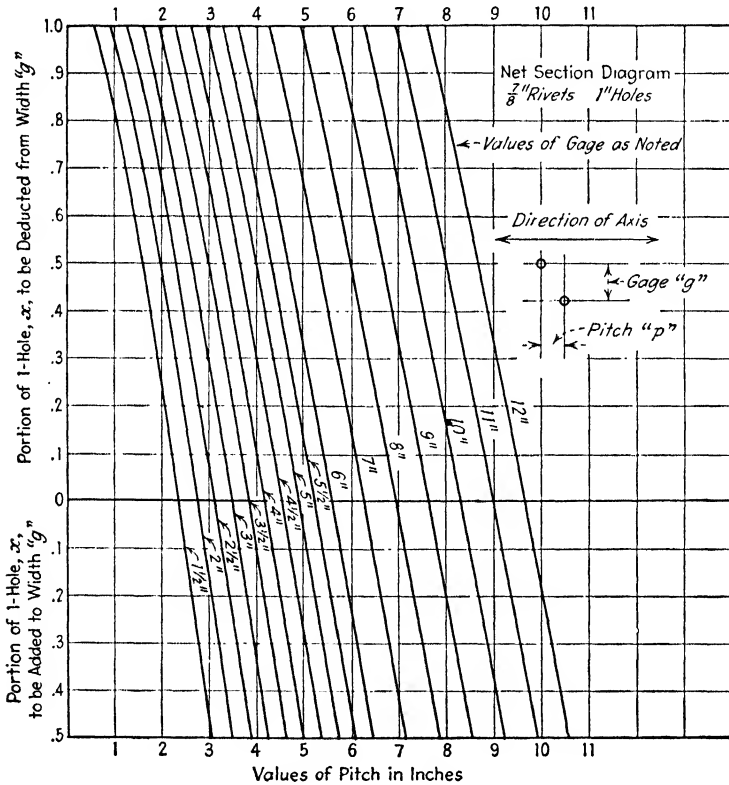

FIG. 140.

1. What is the actual net width if the pitch p is 2 in.?

$$\begin{aligned}
 1.50 - 0.50 &= 1.00 \\
 \frac{5}{8}(\sqrt{3^2 + 2^2} - 1.00) &= 2.17 \\
 1.50 - 0.50 &= 1.00 \\
 \hline
 &4.17 \text{ in. net width}
 \end{aligned}$$

From Fig. 140

$$g = 3, \quad p = 2, \quad x = 0.83$$

$$\text{Net width} = 6 - (0.5 + 0.83 + 0.5) = 4.17 \text{ in.}$$

That is, from the diagram Fig. 140 we find that 1.83 holes must be deducted from the cross-section to determine the net section.

2. What should be the pitch to maintain a net section deducting only one hole?

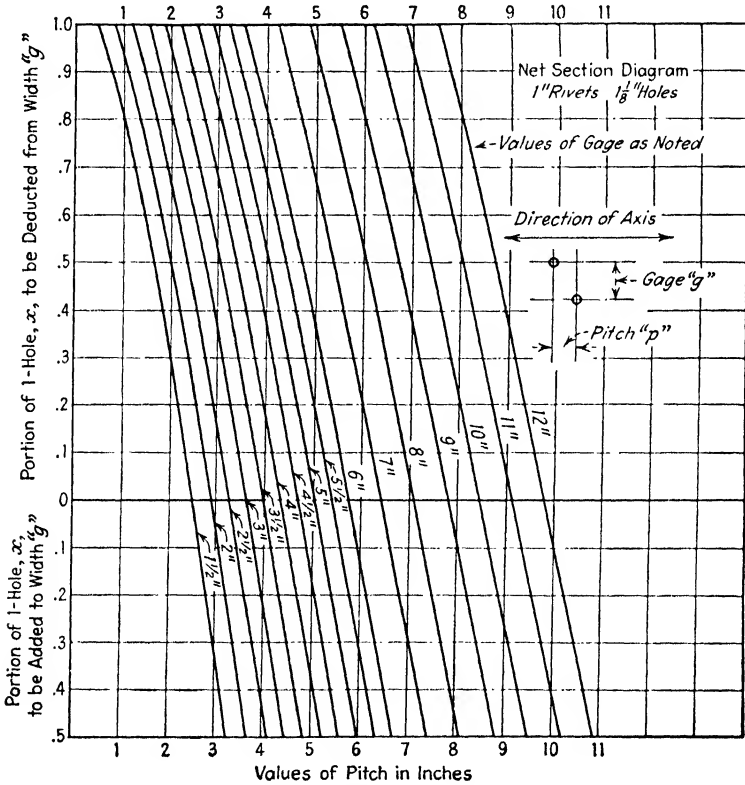

FIG. 141.

Direct application of relation in (138)

$$0.44 \times 3^2 = 3.96$$

$$2.40 \times 3 \times 1 = 7.20$$

$$1^2 = 1.00$$

$$p^2 = 12.96$$

$$p = 3.487 \text{ in. or } 3\frac{1}{2} \text{ in.}$$

From Fig. 140 $g = 3$ in., $x = 0$ and $p = 3.5$ in.

Referring to Fig. 138, assume that the plate is 20 in. wide, the holes are 1 in. in diameter for 7/8-in. rivets, the edge distances e_1 and e_2 are equal and $1\frac{1}{2}$ in. each, the gages are as follows:

- $g_1 = 4$ in.
- $g_2 = 5$ in.
- $g_3 = 3$ in.
- $g_4 = 5$ in.
- and the pitch $p = 3$ in.

The right section deducting the three holes a , d , and f should be considered as well as a zigzag section a, b, c, d, e, f, g deducting one-half hole above gage line 1, one-half hole below gage line 5, and fractional parts of holes between gage lines 1 and 2, 2 and 3, 3 and 4, and 4 and 5.

The net width on the right section deducting 3 holes of course is 17 in. Making use of the diagram in Fig. 140 the net width on the zigzag line is

| | | |
|-------------|---------------|----------------------------------|
| | | 0.50 above gage line 1 |
| $p = 3$ in. | $g_1 = 4$ in. | $x_1 = 0.66$ between 1 and 2 |
| | $g_2 = 5$ in. | $x_2 = 0.97$ between 2 and 3 |
| | $g_3 = 3$ in. | $x_3 = 0.30$ between 3 and 4 |
| | $g_4 = 5$ in. | $x_4 = 0.97$ between 4 and 5 |
| | | 0.50 below gage line 5 |
| | | <u>3.90</u> holes to be deducted |

net width = 20 - 3.90 = 16.1 in.

In this case the zigzag section controls. The student should assume the pitch to be 4 in. and compare the right section and the zigzag section. He will find that the right section controls and that between gage lines 3 and 4, 0.35 of a hole should be added rather than deducted.

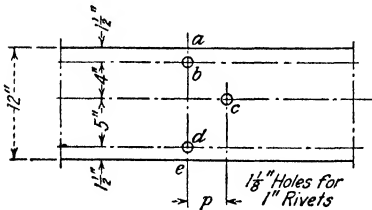

FIG. 142.

As a final example consider Fig. 142. The calculation of net section on the zigzag for a given pitch follows exactly the same procedure as

before. Frequently the question of what pitch must be used to make the net area on the zigzag section, a, b, c, d, e , the same as that on the

right section a, b, d, e , must be answered. Clearly the net width on the right section is

$$12 - 2 \times 1\frac{1}{8} = 9\frac{3}{4} \text{ in.}$$

On the zigzag section it is

$$12 - (0.5 + x_1 + x_2 + 0.5)1\frac{1}{8}$$

and evidently to have the net width the same in the two cases it is necessary that

$$x_1 + x_2 = 1$$

From Fig. 141 we may determine by trial a pitch such that this will be true with the gages of 5 in. and 4 in. shown. The student should do this; he will find that the pitch should be between 3.7 in., when the values of x_1 and x_2 are 0.35 and 0.67 respectively, and 3.8 in. when x_1 and x_2 are 0.30 and 0.62.

The pitch of course will ordinarily be in multiples of $\frac{1}{4}$ in. and in this case should not be less than $3\frac{3}{4}$ in.

The discussion so far has been restricted to plates, but angles and other shapes may be treated in the same manner by imagining the shape flattened out into a plate as in Fig. 143. The gages adjacent to a corner are generally added together and the thickness of the shape deducted as indicated. As a matter of convenience these gages are sometimes added and the thickness neglected, which of course results in an error on the safe side.

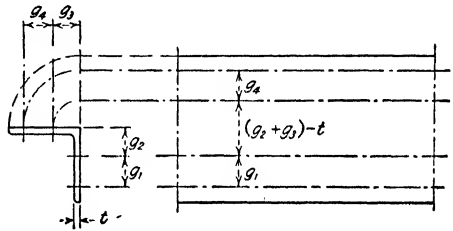

FIG. 143.

RIVETED CONNECTIONS FOR TENSION AND COMPRESSION MEMBERS

132. Single Plane Trusses.—The application of the fundamental principles and assumptions of riveted connections to the actual design of truss joints may best be discussed in connection with specific examples. A joint from a moderately heavy roof truss has therefore been chosen, and the stresses in and make-up of the members meeting at the joint are shown in Fig. 144. It should be noted that the tension members were all designed assuming only one hole deducted from each angle, and the connection must be designed to maintain that condition.

Three designs for the joint are shown; in the first, Fig. 145, the bottom chord has not been spliced (the section of L_2L_3 continuing across the joint for member L_1L_2), and in the second and third, Figs. 147 and

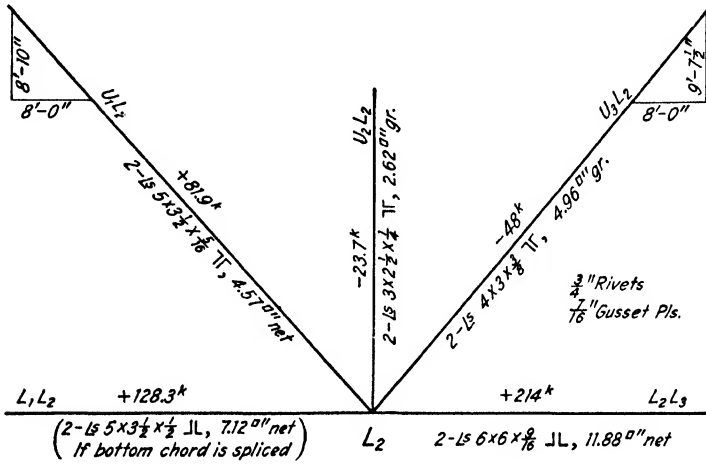

FIG. 144.

149, the chord has been spliced at or near the panel point. The question of whether the chord should or should not be spliced is in general one of

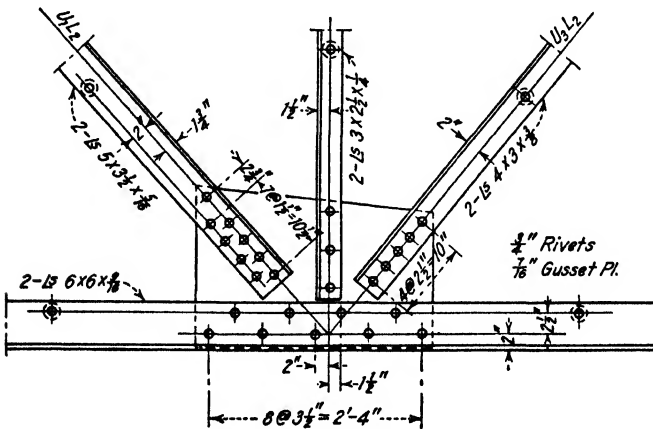

FIG. 145.

economy; if the saving in material effected by changing the size of the chord is greater than the additional cost of the joint resulting from the splice, the splice should be made, otherwise not. It is impossible in a

text such as this to enter into a discussion of so variable a thing as the cost of fabrication, but rather casual observation should indicate that a considerable saving in main material must be made to justify the joints of Fig. 147 or 149 as compared with that of Fig. 145. Of course in some cases a splice may be dictated by the lengths of material obtainable or on hand.

In studying the design of the joint in Fig. 145 the following data are needed:

| | |
|--|------------|
| Single shear $\frac{3}{4}$ -in. rivet | = 5960 lb. |
| Bearing on $\frac{7}{16}$ -in. gusset (double shear) | = 9840 lb. |
| Bearing on $\frac{1}{4}$ -in. angle (single shear) | = 4500 lb. |

These data may be calculated in accordance with the principles previously discussed or may be taken directly from an engineers' handbook, a steel manufacturer's catalog, or "Steel Construction," the handbook of the American Institute of Steel Construction.

The numbers of rivets required for the different members are as follows:

$$U_1L_2 \frac{81.9}{9.84} = 8.32-9 \text{ rivets}$$

$$U_2L_2 \frac{23.7}{9.00} = 2.63-3 \text{ rivets}$$

$$U_3L_2 \frac{48.0}{9.84} = 4.88-5 \text{ rivets}$$

The reason for the different rivet stress used in calculating the number of rivets for U_2L_2 is that the sum of the bearing values on the two $\frac{1}{4}$ -in. angles (9000 lb.) is less than the bearing value on the $\frac{7}{16}$ -in. gusset plate, and of course controls the design for the connection of U_2L_2 .

The student will notice that the horizontal component of U_1L_2 (55.0 kips) tends to *pull* the gusset plate to the left, and the horizontal component of U_3L_2 (30.7 kips) tends to *push* the gusset to the left. Evidently there must be a sufficient number of rivets between the gusset and the bottom chord to resist the combined horizontal components of the diagonals, or

$$\frac{55.0 + 30.7}{9.84} = 8.72-9 \text{ rivets}$$

Obviously the sum of the horizontal components of the diagonals must equal the difference between the stresses in L_2L_3 and L_1L_2 , if the

stresses shown are simultaneous stresses. The necessity for the use of simultaneous stresses is sometimes overlooked in dealing with trusses which are designed for moving loads. In such cases it must be kept in mind that the connection for an individual member must be designed for the maximum stress in that member, but that when sums or differences of stresses or their components are concerned the stresses or components used should be those which act simultaneously; the error resulting from the use of maximum stresses or components rather than simultaneous values will be on the safe side of course when sums are involved, but may be on the unsafe side for differences.

The number of rivets required for each member having been determined, the joint may be sketched in, showing the rivets in place, giving proper attention to edge distances, driving clearance, and so on. In tension members particular attention should be given to proper spacing to maintain net section. In the riveting of U_1L_2 in Fig. 145, it should be noticed that the space between the first two rivets at the edge of the gusset is $2\frac{3}{4}$ in. Reference to Fig. 139 will show that for a 2-in. gage distance the least pitch to take out only one hole should be about 2.6 in. Rivet spaces are in general most convenient if in multiples of $\frac{1}{4}$ in., but if multiples of $\frac{1}{8}$ in. are satisfactory this first space may be $2\frac{5}{8}$ in. The space between the second and third rivets need not be so great since some stress has been taken out of the member by the first rivet and less net area is needed thereafter. In this particular case, if the rivets are equally stressed, the first rivet takes out of each angle of the member:

$$\frac{1}{2} \times \frac{81.9}{9} = 4.55 \text{ kips}$$

Each hole reduces the capacity of each angle of the member by

$$\frac{5}{16} \times \frac{7}{8} \times 18 = 4.92 \text{ kips}$$

Consequently a zigzag section through the second and third rivets may deduct not more than

$$1 + \frac{4.55}{4.92} = 1.92 \text{ holes}$$

which requires a pitch of not less than about 1.15 in.; the actual pitch of $1\frac{1}{2}$ in. is desirable to secure convenient driving space center to center of rivets. As sections are taken nearer the inner end of a tension member less and less stress remains in the member, the net area required is also less, and more holes may be deducted than at the edge of the gusset plate. Much use is made of this condition in designing connections for large heavy members.

Following the same line of reasoning as above it will be found that the least pitch permissible at the right-hand edge of the connection to the bottom chord is about 3.0 in., the actual pitch of $3\frac{1}{2}$ in. being that which distributes the necessary number of rivets along the width of gusset made necessary by the rivet groups for the diagonals.

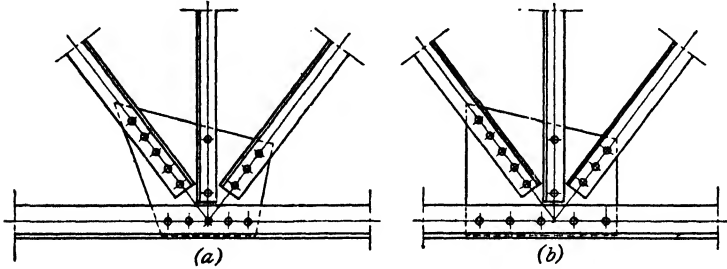

FIG. 146.

When the connection of a gusset to a chord requires only a few rivets, beginners are inclined to cut a gusset as shown in Fig. 146 (a). Ordinarily it is better to make the sides of the gussets normal to the chord as in Fig. 146 (b) and increase the spacing of the necessary rivets

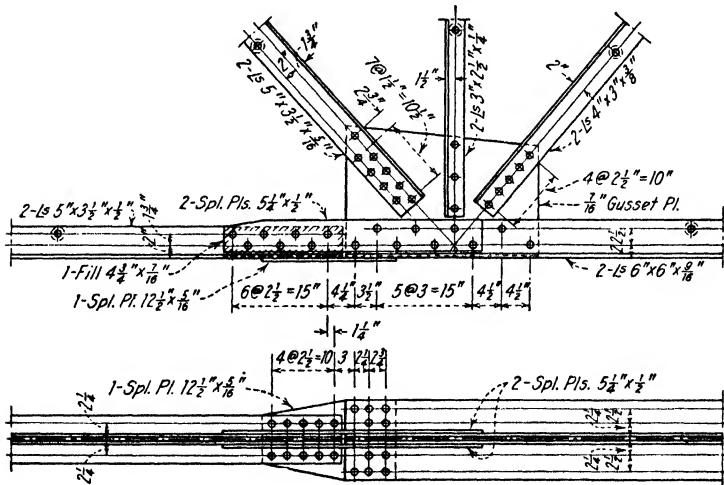

FIG. 147.

to cover the greater length, adding one or more extra rivets if the spacing becomes excessive.

The calculations for the design of the connections for U_1L_2 , U_2L_2 , and U_3L_2 are the same whether or not the chord is spliced; and in con-

sidering the joints of Figs. 147 and 149 only the calculations for the chord connection and splice will be given.

In the detail of the joint shown in Fig. 147 the 5 by $3\frac{1}{2}$ by $\frac{1}{2}$ angles of L_1L_2 have been cut at the left edge of the gusset plate. It is therefore necessary to provide splice material at this section having a net area at least equal to that of the angles and to provide riveting which will transfer the stress from the main section to this splice material. It is desirable in all cases that the transfer of stress from main section to splice material be as direct as possible, and to that end the latter should, so far as is practicable, take stress only from that portion of the main section with which it is in direct contact, i.e., it is desirable that the bottom splice plate take its stress from the outstanding angle-legs with which it is in direct contact, and that the stress in the side splice plates come from the upstanding legs of the angles which are in contact with them. The stress of 128.3 kips in the main member and the splice material areas should therefore be distributed as follows:

$$\text{Bottom plate } \left(\frac{3\frac{1}{2}}{3\frac{1}{2} + 5} \right) \times 128.3 \text{ kips} = 52.8 \text{ kips @ } 18 = 2.93 \text{ sq. in. net}$$

$$\text{Side plates } \left(\frac{5}{3\frac{1}{2} + 5} \right) \times 128.3 \text{ kips} = \frac{75.5 \text{ kips @ } 18 = 4.20 \text{ sq. in. net}}{128.3 \text{ kips @ } 18 = 7.13 \text{ sq. in. net}}$$

The areas actually provided are:

$$\text{Side plates } \left(5\frac{1}{4} - \frac{7}{8} \right) \times \frac{1}{2} \times 2 = 4.38 \text{ sq. in. net}$$

$$\text{Bottom plate } \left(12 - 2 \times \frac{7}{8} \right) \times \frac{5}{16} = 3.20 \text{ sq. in. net}$$

$$\text{Total} = 7.58 \text{ sq. in. net}$$

The student will note that the bottom plate is marked as $12\frac{1}{2}$ in. wide, but at the critical section through the two rivets at the ends of the 5 by $3\frac{1}{2}$ by $\frac{1}{2}$ angles the edges are tapered and the gross width is scaled as 12 in. Since each piece of splice material receives its stress through rivets which act in single shear in transferring that stress, the calculated number of rivets for each piece is as follows:

$$\text{Bottom plate } \frac{52.8}{5.96} = 8.86$$

$$\text{Each side plate } \frac{1}{2} \times \frac{75.5}{5.96} = 6.34$$

Of course fractional rivets are impossible, and it is desirable that there be an *even* number of rivets on the bottom splice plate for the sake of symmetry; therefore the joint has been detailed with 7 rivets in the

side splice plate and 10 in the bottom plate. There is some justification here for reasoning that, since only

$$\frac{128.3}{5.96} = 21.5, \text{ say } 22$$

shearing areas are necessary, it would be sufficient to provide 6 rivets (12 shearing areas) in the side splice plates in addition to the 10 in the bottom plate. There is always some doubt as to whether a splice is the full equivalent of uncut material, and it is not desirable to be parsimonious in proportioning one; the student will find that many engineers and some specifications require that a splice have a calculated strength about 10 per cent greater than that of the member which it replaces.

Having gotten the stress from the 5 by $3\frac{1}{2}$ by $\frac{1}{2}$ angles into the splice material, it is necessary to transfer it from the latter to the 6 by 6 by 9/16 angles. Evidently the same number of rivets will be necessary in each piece of splice material to take the stress out as was necessary to get it in, and they are shown in the portions which connect to the 6 by 6 by 9/16 angles. The splicing of the angles of L_1L_2 to the angles of L_2L_3 provides for the stress in the former but leaves the difference between it and the larger stress in the latter to be taken care of. As noted previously, the difference in stress in the two chords must be brought in (or taken out) through the gusset plate since this increment (or decrement) of stress is equal to the sum of the horizontal components of the web members connecting at the joint, and the only connection between the chord and the web members is the gusset plate. It seems clear, therefore, that there must be a sufficient number of rivets between the 6 by 6 angles of L_2L_3 and the gusset plate to transfer the difference in chord stresses. As the reader noted in connection with the discussion of Fig. 145 these rivets are in bearing on the 7/16-in. gusset plate and the number required is:

$$\frac{214 - 128.3}{9.84} = 8.72 - 9 \text{ rivets}$$

Nine rivets are shown passing through the angles of L_2L_3 and the gusset plate. It should be noticed that 7 of the 9 rivets also pass through the side splice plates and are therefore acting not only to transfer stress from the side splice plates to the angles of L_2L_3 , but also to transfer stress from L_2L_3 to the gusset plate, or vice versa. Since these stress transfers occur on different planes there is no objection except that care must be taken to see that shears on opposite sides of a piece do not combine to overstress the rivet in bearing against that piece. In this par-

ticular case the number of rivets was determined from the strength of the rivet in bearing against the gusset, and the splice plate has bearing against it from shear on one side only. The angle, however, has shear on the rivets on each side, and these shears are in the same direction, so it is necessary to see that their sum does not exceed the strength of a rivet bearing against the angle. The shears are as follows:

$$\begin{aligned} \text{Side next to gusset} &= \frac{1}{2} \times \frac{214 - 128.3}{9} = 4.76 \\ \text{Side next to splice plate} &= \frac{1}{2} \times \frac{75.5}{7} = 5.39 \\ \text{Sum} &= 10.15 \text{ kips} \end{aligned}$$

The strength of a $3/4$ -in. rivet in bearing against a $9/16$ -in. shape or plate, when the rivet is in double shear, is

$$\frac{3}{4} \times \frac{9}{16} \times 30 = 12.66 \text{ kips}$$

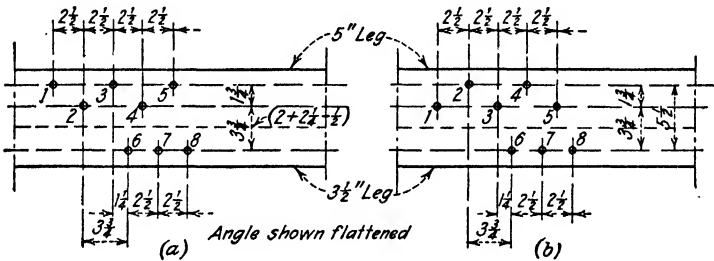

FIG. 148.

The required number of rivets in each part of the splice, having been determined, they must be so spaced as to maintain the net area necessary at different sections. The chosen arrangement is fully dimensioned to permit checking its adequacy at any section. In studying the detail the readers should investigate spacing to protect net section

- (a) in the angles of L_1L_2 at the left end of the splice;
- (b) in the side and bottom splice plates at the ends of the angles of both members;
- (c) in the angles of L_2L_3 at the right end of the splice and gusset.

The arrangement of rivets in one angle of L_1L_2 at the left end of the splice is shown in Fig. 148 (a), and in Fig. 148 (b) is shown an arrangement using the same spacing but reversed stagger in the upstanding 5-in. leg of the angle; the angle has been assumed flattened out in the figure. In each case the net section has been maintained with reference

to holes 1 and 2, but it should be observed that while a section through holes 2 and 6 in (a) deducts an area a little less than $0.5 + 0.1 + 0.5 = 1.1$ holes a section through holes 2 and 6 in (b) deducts an area $0.5 + 0.78 + 0.5 = 1.78$ holes. Since the rivet in hole 1 takes out of the angle only

$$\frac{128.3}{24} = 5.35 \text{ kips}$$

and since an added hole reduces the capacity of the angle

$$\frac{1}{2} \times \frac{7}{8} \times 18 = 7.87 \text{ kips,}$$

a section through holes 2 and 6 should not deduct more than

$$1 + \frac{5.35}{7.87} = 1.68 \text{ holes}$$

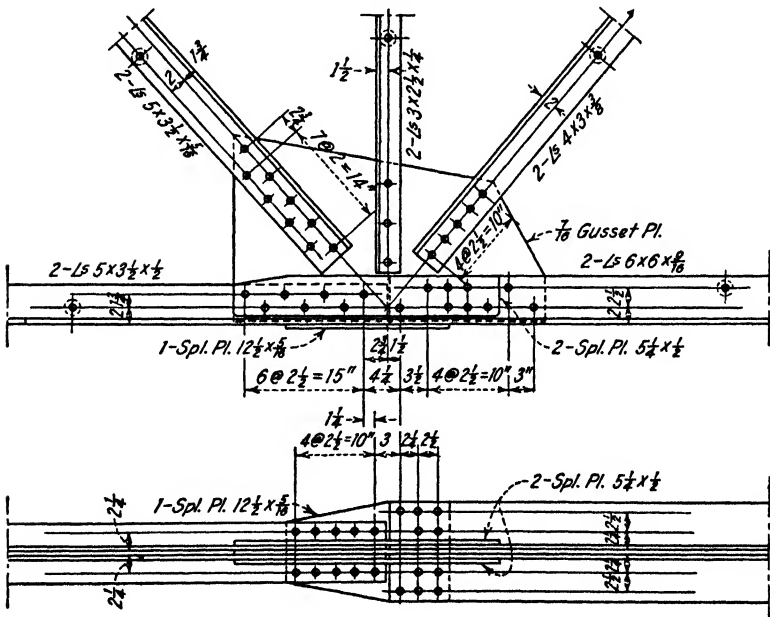

FIG. 149.

Therefore the arrangement shown in Fig. 148 (a) was chosen in preference to that in (b) of the same figure. One may raise a question as to whether the data supporting the adopted definition of net section are sufficiently conclusive to justify such a hairline decision. The answer

is that they are not, but having adopted a definition or specification for design purposes one should generally follow it.

The detail of the joint under discussion shown in Fig. 149 is very similar to that given in Fig. 147 except that the critical section of the splice is at the panel point instead of beyond the gusset plate. Unless there is some reason for not splicing at the panel point the author prefers the second detail as more compact. It is sometimes desirable to make the chord splice entirely independent of the joint, in which case the heavier section should be carried far enough to the left of the gusset plate to permit splicing on the side of smaller chord stress. The joint detail itself would then be exactly the same as shown in Fig. 145, and

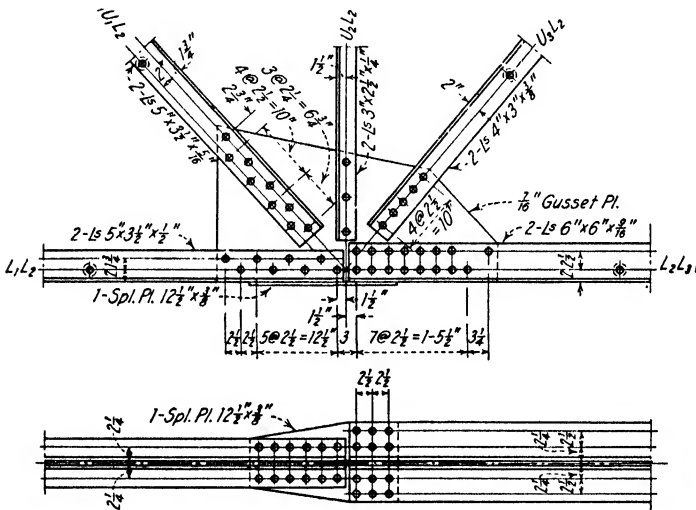

FIG. 150.

the chord splice similar to that in Fig. 147 except that the 7/16-in. filler needed between the upstanding legs of the angles could be made use of as splice material permitting a reduction in the thickness of the side splice plates.

A detail sometimes employed in splicing chords, which the student should be warned against using without very careful investigation, is shown in Fig. 150. In this design the gusset plate is presumed to act as splice material for the upstanding legs of the chord angles in addition to transferring the difference in chord stresses to or from the web members. When chord stresses are small such a detail may prove satisfactory, but as generally designed the detail is likely to be inade-

quate for larger stresses. It is usual to assume that the bottom splice plate transfers from one member to the other the stress carried by the outstanding legs of the smaller, and that the stress in the upstanding legs must be transferred into the gusset. The detail in Fig. 150 has been proportioned on that basis. It should be checked by the reader, who in doing so will note that there are 12 rivets in each end of the bottom splice plate instead of 10 as shown in Figs. 147 and 149, although the stress in the outstanding legs of L_1L_2 must be the same in each case. The reason for this difference is that in Fig. 150 the single shear value of the rivets transferring stress to the bottom splice plate is limited to one-half the bearing value on the 7/16-in. gusset, since all rivets transferring stress to or from one chord angle act in single shear on the back of the angle, and are assumed to transfer equal portions of the total stress in that angle. It will be noted that the number of rivets in the

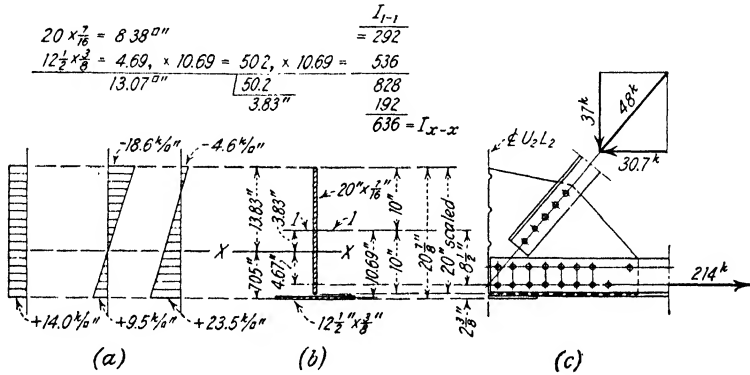

FIG. 151.

web members must be the same as in other details of the joint but those in U_1L_2 are spread out to cover the larger gusset plate needed for the riveting of the bottom chord.

Figure 151 (c) shows the right-hand portion of the joint cut off by a section on the center line of U_2L_2 , and Fig. 151 (b) shows in section the material which must resist the forces acting on that section. Although the horizontal splice plate and the vertical gusset plate are not in actual contact they are held together by the angles and may be treated as a T-shaped beam subjected to direct stress and bending moment in estimating their stresses.

Direct stress = $214 - 30.7 = 183.3$ kips

Moment = $(214 - 30.7)4.67$ in. = 856 in.-kips

The data for I , c , and A are given in the figure

$$s = \frac{183.3}{13.07} \pm \frac{856 \times \begin{cases} 7.05 \\ 13.83 \end{cases}}{636}$$

$$= + 14.0 \text{ kips per sq. in. } \begin{matrix} + 9.5 \\ - 18.6 \end{matrix} = \begin{matrix} + 23.5 \\ - 4.6 \end{matrix} \text{ kips per sq. in.}$$

It should be emphasized that these stresses are based on gross area and gross moment of inertia. Assuming that the stress in the splice plate at the critical section is inversely proportional to the net section we have

$$23.5 \times \frac{4.69}{3.38} = 32.6 \text{ kips per sq. in.}$$

as the intensity of stress on the net area. Of course this is too high, and furthermore the reader should observe that instead of 12 rivets on each end of the splice there should be

$$\frac{23.5 \times 4.69}{4.92} = 22.4 \text{ or } 24 \text{ rivets}$$

The 4.92 in the denominator of this calculation is one-half the value of a 3/4-in. rivet in bearing on a 7/16-in. gusset plate.

The author prefers to splice chords with splice material at least equal in area to the member spliced and in as close contact with the parts spliced as possible. In general the gusset plate should not be called on for any duty other than transferring the increment (or decrement) of chord stress to or from the web members.

In this connection it may be pointed out that every gusset plate is subjected to shearing and bending forces even when it serves only to transfer differences in chord stress. Referring to Fig. 145, for example, it is clear that there will be a bending moment, vertical shear, and a horizontal pull or push on any vertical section passed either side of the center line of U_2L_2 . Generally these forces are not of great importance when a gusset is used only to transfer increments or decrements of chord stress, but it is very important to recognize their existence and the resulting stresses should be estimated occasionally to help the designer develop a sense of proportion. The shear in a gusset on a plane passed parallel to the chord and between the chord and the ends of the web members meeting on that gusset may be important in joints at or near the ends of a truss and should always be investigated.

To illustrate the method of estimating the stresses in a gusset and also to give some notion of their magnitudes the stresses in the gusset of

Fig. 145 will be investigated on a vertical plane 6 in. to the left of the center line of U_2L_2 , Section A-A, and on a horizontal plane 6 in. above the working line of the lower chord, Section B-B. Figure 152 (a) shows the portion of the gusset to the left of the vertical section with the forces acting on it, and 152 (b) the portion below the horizontal section and the forces acting on it. The forces shown acting must be resisted by the internal stresses acting on the sections. The calculations are given below.

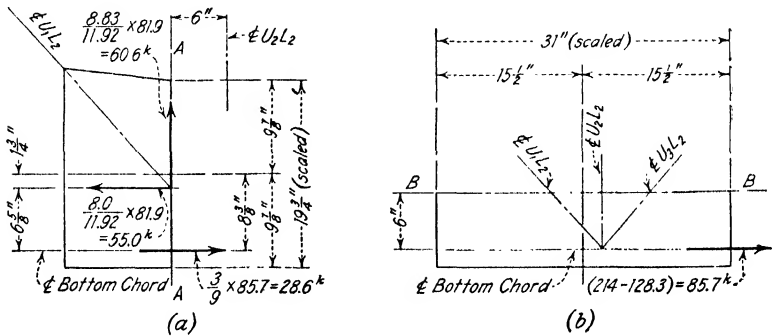

FIG. 152.

Section A-A

$$I \text{ of } 19\frac{3}{4} \times \frac{7}{16} = 281 \text{ in.}^4$$

$$A \text{ of } 19\frac{3}{4} \times \frac{7}{16} = 8.64 \text{ sq. in.}$$

$$\text{Shear} = 60.6 \text{ kips}$$

$$\text{Bending moment} = (28.6 \times 8.38 - 55.0 \times 1.75) = 143.4 \text{ in.-kips}$$

$$\text{Horizontal force} = 55.0 - 28.6 = 26.4 \text{ kips}$$

$$v = \frac{60.6}{8.64} \times \frac{3}{2} = 10.5 \text{ kips per sq. in.}$$

$$s = \frac{26.4}{8.64} \pm \frac{143.4 \times 9.88}{281} = \begin{cases} + 8.1 \text{ kips per sq. in.} \\ - 1.9 \text{ kips per sq. in.} \end{cases}$$

Section B-B

$$I \text{ of } 31 \times \frac{7}{16} = 1086 \text{ in.}^4$$

$$A \text{ of } 31 \times \frac{7}{16} = 13.56 \text{ sq. in.}$$

$$\text{Shear} = 85.7 \text{ kips}$$

$$\text{Moment} = 85.7 \times 6 = 514.2 \text{ in.-kips}$$

$$v = \frac{85.7}{13.56} \times \frac{3}{2} = 9.5 \text{ kips per sq. in.}$$

$$s = \frac{514.2 \times 15.5}{1086} = \pm 7.3 \text{ kips per sq. in.}$$

The student should clearly understand that these calculations *assume* the applicability of the beam formula to a beam which is deeper than it is long and in which the loading is quite unlike that in the usual beam; no data are known to the author on which to base an opinion as to the accuracy of the stresses thus estimated. At present the method used seems to be the only practicable one and appears to give satisfactory results for design purposes.

Attention should be called to the calculation estimating the intensity of shearing stress on the sections investigated. It will be noted that the *maximum* intensity of stress has been calculated as $3/2$ times the *average* intensity. In investigations of gusset plates it is common to calculate merely the *average* intensity and compare that with the intensity of shear permitted in the webs of I beams and plate girders. The two cases are not comparable. As pointed out in Chapter III, on beam and girder design, the assumption of uniform distribution of shear across the web of an I beam or plate girder is not much in error: a gusset plate is a rectangular beam (if it is correct to call it a beam at all), and in a rectangular beam the shear is not and cannot be uniformly distributed; the maximum intensity of shear must be $1\frac{1}{2}$ times the average intensity as a matter of statics, *if* the beam formula is applicable. There does not seem to be any reason for limiting the maximum intensity of shear in a gusset plate to that permitted in the webs of beams and girders. The maximum intensity occurs near the middle of the plate, and buckling failure seems improbable in view of the support of the gusset by members riveted thereto. The author believes that for ordinary structural steel the maximum intensity of stress in shear in gusset plates may be taken at $3/4$ to $8/10$ of the permissible intensity in tension.

In detailing joints, students and young designers who have not thought carefully about the matter sometimes get the notion that the joint in Fig. 153 (a) is eccentric and that it should be made as in Fig. 153 (b). A little thought should make it clear that the gusset plate in the joint at (a) in Fig. 153 is entirely comparable to the rectangular plate shown at (c); in the latter, the forces shown are presumed to be applied to the plate through frictionless pins, and certainly no student

with a reasonable understanding of elementary mechanics will claim any tendency for the plate to turn. Of course there are bending and shearing stresses in the plates in (a) and (c) of Fig. 153, as there are also

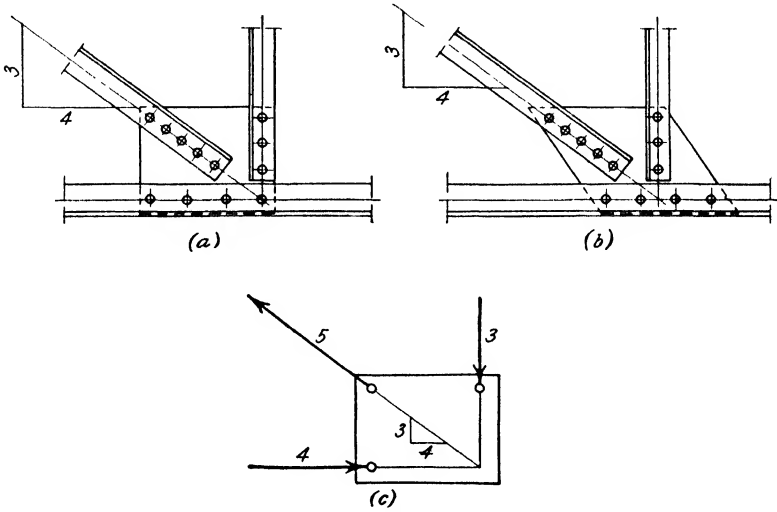

FIG. 153.

in (b), and at the critical section they are greater in the latter. There is no advantage in making the joint at (a) in Fig. 153 as shown at (b).

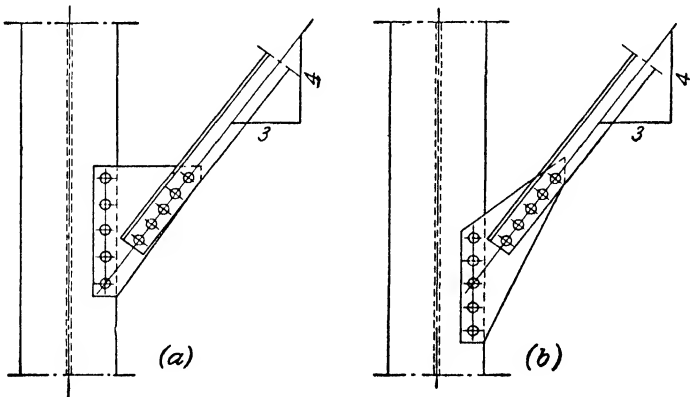

FIG. 154.

The reader may make a mild test of his ability to think clearly in this matter by studying the connections in Fig. 154 (a) and (b). Should

the connection at (a) be made as shown at (b)? If so, why? If not, why not? Are the joints shown in Figs. 153 (a) and 154 (a) comparable? If so, why? If not, why not?

Figure 155 shows two possible details of the end joint of a single plane truss. In the first, (a), the working lines of the chord and diagonal intersect on the center line of the column to which the truss connects. This detail relieves the column of moment due to eccentric application of the load, but subjects the connection itself to some moment which is generally not large enough to be of any consequence; e.g., the moment which the rivets on line $G-G$ in Fig. 155 (a) must resist is the horizontal component of the chord stress times the distance marked e . While the detail shown in (a) of Fig. 155 is generally considered the ideal arrangement, it is often true that the detail shown in (b) is a more satisfactory solution: it is more compact and does not need quite so large a gusset

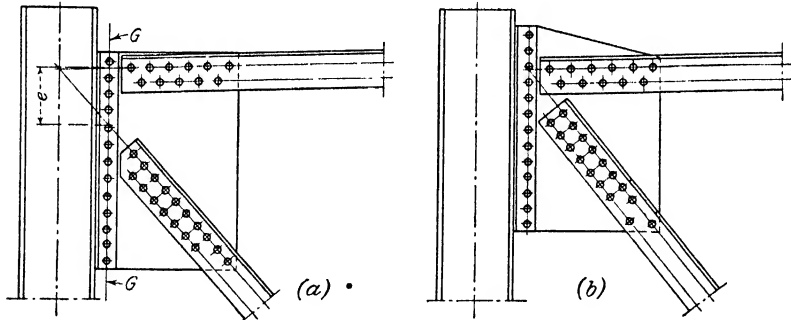

FIG. 155.

plate. The moment produced in the column by the detail at (b) is small, and frequently, if not generally, will have no effect on its design; when that is true this detail is preferable to that at (a). The designer should not adopt a general rule but decide each case in accordance with the conditions affecting it.

Sometimes lug angles are used in single plane truss joints to reduce the length of the connections and the size of the gussets. For example, the joint in Fig. 156 (a) would sometimes be detailed as at (b). This at once raises the question of whether rivets placed in the lug angle are as effective in transferring stress as those which are in the main angle, and that is a matter on which engineers do not fully agree. Qualitative consideration of the relative rigidities and deformations of the stress paths will lead one to the conclusion that lug angle rivets cannot be very effective. The general problem is one which is difficult if not impossible to study quantitatively by mathematical methods. There has been some

rather abbreviated experimental study of the question * which seems to support the belief that lug angles are not efficient. When necessary or desirable to reduce the length of a connection such as that in Fig. 156 (a) it is better to redesign the members using angles with legs wide enough to permit two lines of rivets, than to use lug angles. If the designer insists on the use of lug angles he will do well to place them at the *beginning* of the connection, as in Fig. 156 (c) and (d), although doing so will result in troublesome detailing if the main member is designed with only one hole deducted from each angle. As a matter of fact, the saving in gusset plate size resulting from the use of lug angles will in many cases be more

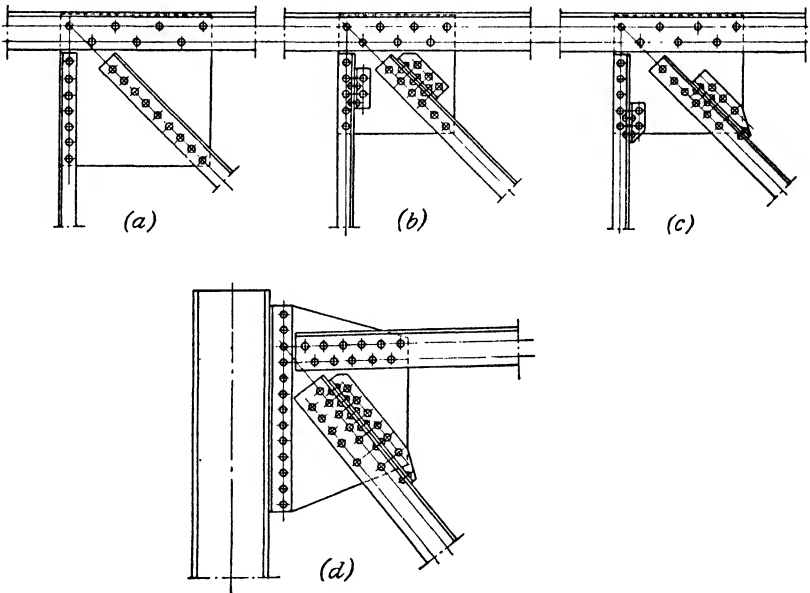

FIG. 156.

than offset by the additional shop cost of the lug angles; e.g., the joint in Fig. 155 (b) is shown detailed with lug angles in Fig. 156 (d). The author does not recommend the use of lug angles, even when located at the beginning of the connection as in Figs. 156 (c) and (d), and is convinced that their use when placed at the middle or near the end of a connection is entirely futile.

* "The Effect of End Connections on the Distribution of Stress in Certain Tension Members" by Cyril Batho, *Journal of the Franklin Institute*, Vol. 180, page 129. See also "Tension Tests of Steel Angles" by F. P. McKibben, *Proceedings of the American Society for Testing Materials*, 1906, Vol. VI, page 267.

133. Double Plane Trusses.—The design of joints for double plane trusses differs very little from that for single plane trusses. The total stress in each member is divided (generally equally) between the two planes, and the connection of each half, or rib, to its gusset plate is similar to a single plane truss connection; the rivets connecting one rib to its gusset, however, are generally in single shear rather than in bearing on the gusset or in double shear.

To illustrate the design procedure a joint from a moderately heavy double plane truss has been chosen, the data for which are given in Fig. 157. The joint chosen is from a deck bridge truss, and in order to concentrate the attention on fundamentals all lateral and sway-bracing

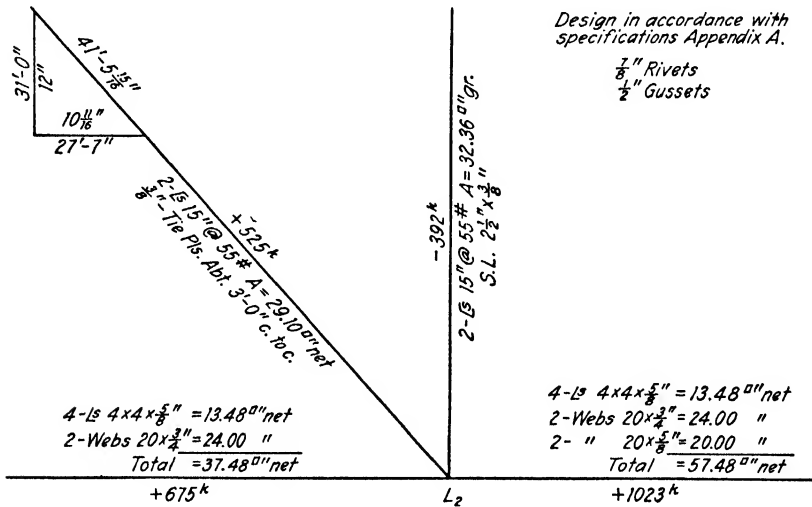

FIG. 157.

members meeting at the panel point have been ignored and not shown. The detailed joint and a chord splice are shown in Fig. 158; a discussion of the design follows.

Of course the first step, as in any joint design, is to lay out the center lines of the members meeting at the joint and sketch in the outlines of the members *to scale*. The longitudinal rivet lines should then be decided upon and drawn in. Generally there should be as many longitudinal rivet lines as the member can accommodate with a transverse spacing *not less* than three rivet diameters (preferably not less than $2\frac{1}{2}$ in. for 3/4-in rivets; 3 in. for 7/8-in. rivets, or $3\frac{1}{2}$ in. for 1-in. rivets) giving proper attention to the location of the lines nearest the sides of the member with respect to driving clearance. A normal number of longitudinal

rivet lines is shown for each member in Fig. 158. The members and rivet lines having been drawn in, the riveting for each member may be proportioned.

The rivets connecting the various members to the gusset plates act in single shear between the gussets and the ribs adjacent thereto. The rivets are 7/8 in. in diameter and the single shear value is 8120 lb. per rivet, assuming that all rivets will be driven by machine in the shop or by pneumatic or electric hammers in the field.

U_1L_2

The rivets required will be:

$$\frac{525}{8.12} = 64.6, \text{ say } 33 \text{ rivets per rib}$$

As may be noted from the data given in Fig. 157, this member was designed deducting two holes from the web of each channel,* and it is therefore necessary that not more than two rivets be placed in the first transverse line at the edge of the gusset plate. Additional rivets may be placed in succeeding transverse rows as rapidly as justified by stress transfer by preceding rivets. In U_1L_2 each additional web hole reduces the capacity of the member by

$$0.81 \times 1 \times 18 \text{ kips per sq. in.} = 14.6 \text{ kips}$$

and there must therefore be

$$\frac{14.6}{8.12} = 1.8 \text{ rivets}$$

preceding the deduction of each additional hole. Consequently the detail in Fig. 158 shows 2 rivets in the first transverse row, 3 in the second, and 4 thereafter.

U_2L_2

The rivets required for the connection of U_2L_2 are:

$$\frac{392}{8.12} = 48.2, \text{ say } 24 \text{ per rib.}$$

This number is shown in each rib of the member in Fig. 158. The reader should note that the upper edge of the gusset plate was located by the rivet group in U_1L_2 , and the space resulting from the connection of U_2L_2 was much larger than that necessary to contain the required

* The data for areas of channels and angles were taken from "Structural and Shipbuilding Shapes," published by the Phoenix Iron Company, Philadelphia, in which areas are given in accordance with listed weights.

sary to transfer the difference in chord stress to or from the gusset plates. The number of rivets required is

$$\frac{1023 - 675}{8.12} = 42.8, \text{ say } 22 \text{ per rib.}$$

The size of gusset plate determined by the rivet group for U_1L_2 provides more area in contact with the chord than can be satisfactorily covered by 22 rivets, and 34 are shown in the connection. The matter of net section must be given careful attention to see that no more than the permissible number of holes be deducted at the right-hand edge of the gusset.

Gusset Plates.—The design of the joint is now complete except for the thickness of the gusset plates. Generally gusset-plate thicknesses are chosen in accordance with average values used for similar trusses. It is desirable, however, for the designer to form the habit of investigating gusset plates occasionally to make sure that they are neither inadequate nor wasteful. It is desirable that the main gusset plates in a truss be the same distance apart at each joint, and to secure this condition all gusset plates should have the same thickness. It will be found sufficient, therefore, to investigate gusset plates at or near the ends of the truss where the differences in stress in the various members are largest. In heavy trusses multiple or reinforced gusset plates may be necessary or desirable in joints near the ends.

In Fig. 159 the gusset alone from the joint in Fig. 158 is shown. The gussets are assumed 1/2 in. thick. Below are given the calculations for stress on sections $X-X$ and $Y-Y$, assuming that the beam formula may be applied.

Section $X-X$

Although this section is passed through the bottom line of holes in the vertical it is assumed that the rivets in these holes act *above* the section but not below. Also the very slight taper at the right end of section $X-X$ has been ignored in the calculations below.

$$\begin{aligned} \text{Direct stress on section } X-X &= 0 \\ \text{Moment on section } X-X &= 392(11.5 - 0.875) \\ &= 4167 \text{ in.-kips} \\ I \text{ of two 45-in. by } \frac{1}{2}\text{-in. plates} &= 7594 \text{ in.}^4 \\ \text{Area of 45-in. by } \frac{1}{2}\text{-in. plates} &= 45 \text{ sq. in. gross} \\ s &= \frac{4167 \times 22.5}{7594} = \pm 12.4 \text{ kips per sq. in.} \\ \text{Shear on section } X-X &= 348 \text{ kips} \\ v &= \frac{348}{45} \times \frac{3}{2} = 11.6 \text{ kips per sq. in.} \end{aligned}$$

Section Y-Y

Although this section passes through a vertical line of rivets in the bottom chord these rivets are assumed to act on the part to the right but not on the part to the left. The difference in chord stress is assumed divided equally among the rivets connecting the gussets to the chord.

Direct stress on section Y-Y = $348 \times \frac{2}{3/4} \dots \dots = 225$ kips

Moment on section Y-Y $\left. \begin{aligned} \frac{1}{3/4} \times 348 \times 14.25 &= 1752 \\ 348 \times 1.125 &= 392 \end{aligned} \right\} \text{in.-kips}$

1360 in.-kips

I of two 47-in. by $\frac{1}{2}$ -in. plates $\dots \dots \dots = 8652$ in.⁴

Area of 47- by $\frac{1}{2}$ -in. plates $\dots \dots \dots = 47$ sq. in.

$s = \frac{225}{47} \pm \frac{1360 \times 23.5}{8652} = + 8.5$ kips per sq. in. or $+ 1.1$ kips per sq. in.

Shear on section Y-Y $\dots \dots \dots = 392$ kips

$u = \frac{392}{47} \times \frac{3}{2} = 12.5$ kips per sq. in.

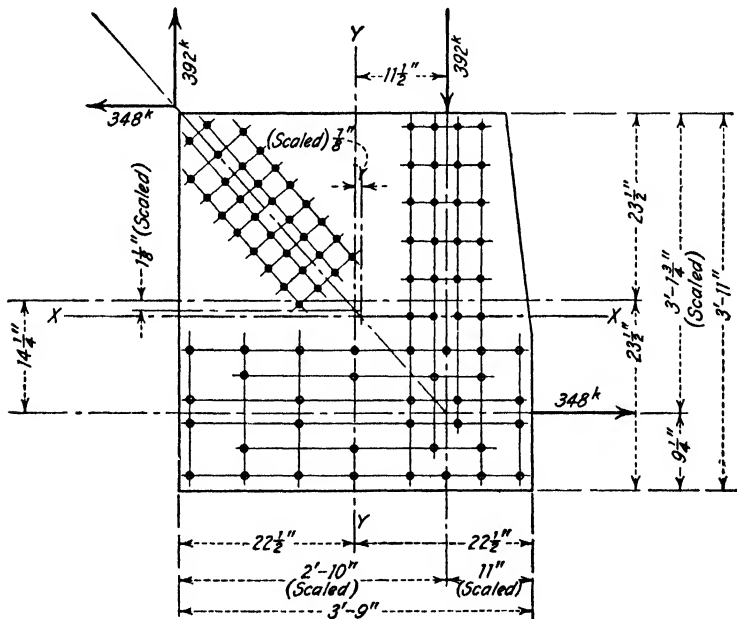

FIG. 159.

Again the student should be warned against placing too much reliance on these estimated stresses in the gussets. They are necessarily based on the assumption that the beam formula holds; the accuracy of the

beam formula when applied to short deep beams, where highly localized effects occur, is quite uncertain.

134. Tension Member Splices.—There are two methods of splicing riveted tension members: the butt splice, which is most common for light and moderately heavy members; and the lap or shingle splice, sometimes used for heavy members built up with four or more web plates. In the butt splice all parts of the member spliced are cut at one section, and at the cut are replaced by at least an equal net area of splice material. In the lap or shingle splice the different parts of the members are cut at different sections which enables the use of splice material having an area considerably less than that of the whole member.

135. Ordinary Tension Splices.—The splice of L_0L_2 in the joint shown in Fig. 158 illustrates a common butt splice. As shown there are two vertical splice plates on each rib of the member, one inside against the web plate and one outside against the angles; and two horizontal splice plates, one on the outstanding legs of the top angles and the other on the outstanding legs of the bottom angles. The vertical splice plates are assumed to replace the 20 by $\frac{3}{4}$ webs and the upstanding legs of the angles, while the horizontal splice plates are presumed to replace the outstanding legs of the angles to which they connect.

In accordance with the above assumption as to distribution of stress the splice plates have minimum net areas as follows:

MAIN SECTION—1 RIB

| | |
|--|---------------------|
| 1 web 20 × $\frac{3}{4}$ | = 12.00 sq. in. net |
| 2 upstanding 4-in. legs = $\frac{13.48}{4} \times \frac{1}{2} \times 2$ | = 3.37 |
| <i>Both Ribs</i> | { 15.37 sq. in. net |
| | { 15.37 |
| 4 outstanding 4-in. legs = $\frac{13.48}{4} \times \frac{1}{2} \times 4$ | = 6.74 sq. in. net |
| | 37.48 sq. in. net |

SPLICE PLATES—1 RIB

| | |
|-------------------|---|
| 8.00 sq. in. net | = 1 inside splice plate 20 × $\frac{1}{2}$ |
| 7.88 | = 1 outside splice plate 18 × $\frac{9}{16}$ |
| 15.88 sq. in. net | |
| 15.88 | <i>Both Ribs</i> |
| 16.13 | = 2 hor. splice plates 23 $\frac{1}{2}$ × $\frac{3}{8}$ |
| 47.39 sq. in. net | |

The two horizontal splice plates have more than twice the necessary area and are used simply because it is convenient to have a single plate covering the top (or bottom) of the member, connecting to the angles. This excess area has objectionable features as will be noted later.

The riveting required for the splice material is as follows:

$$\frac{15.37}{37.48} \times \frac{675}{8.12} = 34.1 \text{ rivets in vertical splice plates for one rib.}$$

$$34.1 \times \frac{8.00}{15.88} = 17.2, \text{ say 18 rivets for inside plate.}$$

$$34.1 \times \frac{7.88}{15.88} = 16.9, \text{ say 17 rivets for outside plate.}$$

$$\frac{6.74}{37.48} \times \frac{675}{8.12} \times \frac{1}{4} = 3.7, \text{ say 4 rivets in each outside angle-leg.}$$

The calculations for riveting of the splice material seem clear but it may be well to point out that $675/8.12$ is the number of single shear rivets required to transfer the entire stress in L_0L_2 to the splice material, and that these rivets are allocated to the various parts of the splice material in proportion to the parts of the area of the main member which they splice. Since the two vertical splice plates on one rib are presumed to act together in caring for the stress transferred to them from the 20 by $3/4$ web and the vertical legs of the chord angles the $34 +$ rivets required for that stress are divided between them in proportion to their own areas. It should be observed that each horizontal angle-leg requires:

$$\frac{1.685}{37.48} \times \frac{675}{8.12} = 3.74, \text{ say 4 rivets}$$

to transfer its stress to the splice plate. The detail in Fig. 158 shows four rivets in each angle-leg. Although four rivets in each horizontal angle-leg are necessary to be consistent with the assumed distribution of stress to the splice material that number in a vertical leg is not essential for consistency; the stress in a vertical leg is presumably divided more or less equally to the two vertical splice plates.

The riveting of the fillers necessary in the splice should be given some explanation. As stated earlier in the chapter it is usual to require that rivets carrying calculated stress and passing through loose fillers be increased in number, or that the loose fillers have additional rivets placed outside of the part carrying calculated stress. Many design specifications give arbitrary rules regarding the amount of extra riveting, and such rules result in some cases in what seems to be excessive and in others inadequate riveting. The author considers it desirable

that there be sufficient riveting in fillers which do not act as splice material to provide uniform distribution of the entire stress in the member concerned over the area of the member, *plus that of the fillers*, at the section where the transfer of stress to the splice material begins. In the particular splice in question this means that at the left-hand edge of the 20 by $\frac{1}{2}$ and 18 by $\frac{9}{16}$ vertical splice plates, the 675 kips in L_0L_2 should be distributed uniformly across the following section:

| | Net Area |
|--|---------------|
| 4 angles $4 \times 4 \times \frac{5}{8}$ | 13.48 |
| 2 webs $20 \times \frac{3}{4}$ | 21.00 |
| 2 fills $12 \times \frac{5}{8}$ | 10.00 |
| 2 fills $18 \times \frac{5}{8}$ | 15.00 |
| | 59.48 sq. in. |

Of course more holes may be deducted from the various parts at the critical section than are deducted in the body of the member since a considerable amount of area is added in the fillers. In this case 6 holes were deducted from each main web plate at the critical section (the edge of the splice) as compared with 4 in the design of the body of the member. Care should be taken to see that the added area is properly developed before more holes are deducted from the cross-section. In this instance the main web is $\frac{3}{4}$ in. thick and an added hole requires the addition of $\frac{3}{4} \times 1 = 0.75$ sq. in. of area. To develop this area would require

$$\frac{0.75 \times 18}{8.12} = 1.7, \text{ say 2 rivets}$$

in the material being added: 4 rivets were placed in the 12 by $\frac{5}{8}$ fill at the left of the cut in L_0L_2 , Fig. 158, before the two additional holes were deducted from the cross-section.

To secure the uniform distribution of stress desired in this case requires

$$\frac{5.00}{59.48} \times \frac{675}{8.12} = 7.0 \text{ rivets in each } 12 \text{ by } \frac{5}{8} \text{ fill}$$

$$\frac{7.50}{59.48} \times \frac{675}{8.12} = \frac{10.5}{17.5}, \text{ say 18 in both fills}$$

It will be noted that there are 8 rivets in the 12 by $\frac{5}{8}$ fill and 12 in the 18 by $\frac{5}{8}$ giving a total of 20 instead of the 18 required; considerations of symmetry in rivet spacing prevent a closer correspondence.

The same line of reasoning should be applied in connection with the 12 by 5/8 fill on the right of the cut.

| | Net Area |
|--|-------------------|
| 4 angles $4 \times 4 \times \frac{5}{8}$ | 13.48 |
| 2 webs $20 \times \frac{3}{4}$ | 21.00 |
| 2 webs $20 \times \frac{5}{8}$ | 17.50 |
| 2 fills $12 \times \frac{5}{8}$ | 10.00 |
| | 61.98 sq. in. net |

The required number of rivets for one fill:

$$\frac{5.00}{61.98} \times \frac{675}{8.12} = 6.7, \text{ say } 7$$

Eight rivets are shown in place.

Although the splice in L_0L_2 , Fig. 158, is what one would often find in such a truss, the author, as previously indicated, does not like the excess area in the horizontal splice plates. At the splice the member is a rigid, symmetrical, four-sided box, and relative deflection vertically or horizontally is impossible. The result is that at the cut the total stress in L_0L_2 must be divided among the pieces of splice material in proportion to their stiffnesses, which, since only direct pull is involved, must be in proportion to their areas, assuming adequate riveting. Each horizontal splice plate then would receive

$$\frac{8.07}{47.89} \times 675 = 114 \text{ kips}$$

and would require

$$\frac{114}{8.12} = 14 \text{ rivets}$$

or 7 in each horizontal angle-leg, instead of the 4 shown. It is inevitable with the large excess in area in the horizontal splice plates that the 4 rivets in each horizontal angle-leg will be overstressed and suffer severe deformation. It may be, and usually is, argued that the total number of rivets provided in the splice material is adequate for the total stress involved, and if the rivets in the horizontal legs don't like the overstress they can "get out of the way," i.e., deform. The facts probably are that the rivets *don't* like the overstress and *do* "get out of the way," and as they are of very ductile material it may be that no great harm results. Nevertheless, the author would prefer to use four, 4 in. by 9/16 in. flats, having a net area of $4 \times 3 \times 9/16 = 6.75$ sq. in. for splicing the hori-

zontal legs of the angles, in spite of the greater number of pieces of splice material to deal with. If this were done tie plates should be placed as close to the cut as possible on both sides of the cut and on both top and bottom.

The importance of continually endeavoring to visualize the deformations which *must* take place in a joint or connection is so great that the author would like to re-emphasize it here, even at the risk of being bore-some. If the designer will carefully trace the transfer of the stress in each piece of a member from that piece to the splice material, connection plate, column, or base plate, as the case may be, and try to picture in his mind the inevitable deformations and their effects, he will avoid many of the common errors in detailing. Very few accidents or failures have resulted from faulty proportioning of main members, but the technical press will be found to contain the records of many accidents and failures caused by poorly proportioned details. It may be added that such records are probably far from complete.

136. Tension Splices for Heavy Members.—The term “heavy member” may be interpreted to cover a quite wide range, but in the present article the term will be applied to built-up members containing at least two full-depth web plates in *each* rib.

Figures 160 to 164 inclusive illustrate diagrammatically several methods of splicing multiple web members. Although six splices are shown, in fact only three actually different methods are illustrated: those in Figs. 161, 162, and 163 are closely related. In all the cases presented only the full-depth plates for one rib are shown, the angles being removed to simplify both the diagrams and the discussion. In each case the riveting has been calculated on the basis of 18 kips per sq. in. on the net section of the main plate, four holes being deducted, i.e., each main plate is assumed to be subjected to a total stress of

$$(20 - 4)\frac{3}{4} \times 18 = 216 \text{ kips}$$

The rivets are 7/8 in. in diameter, and the single shear value is taken as 8.12 kips.

Figure 160 illustrates the ordinary butt splice applied to a multiple web member. The upper portion of the figure shows the splice in plan and elevation, and the lower portion illustrates diagrammatically the assumed distribution of stress among the various parts. Studying the lower portion of the figure, and considering the part between sections 1 and 2, it will be noted that there is a shear of 216 kips on the plane between plates SP_1 and P_1 and an equal shear on the plane between P_2 and SP_2 ; these shears determine the riveting between sections 1 and 2, and from symmetry the riveting between sections 2 and 3 must be the

same. For larger members it may be necessary to use two or more splice plates on each side of each rib to secure the necessary area. The advantages of the butt splice for multiple web members are that it is shorter and more compact and that there is less uncertainty regarding the distribution of stress. Its disadvantages are that it requires splice plates of considerable thickness which may result in rivets having excessive grip, and also in difficulties with rivets in the outstanding legs of the chord angles.

Figures 161, 162, and 163 illustrate the more common forms of the lap or shingle splice; the splices in Figs. 161 and 162 differ from those in

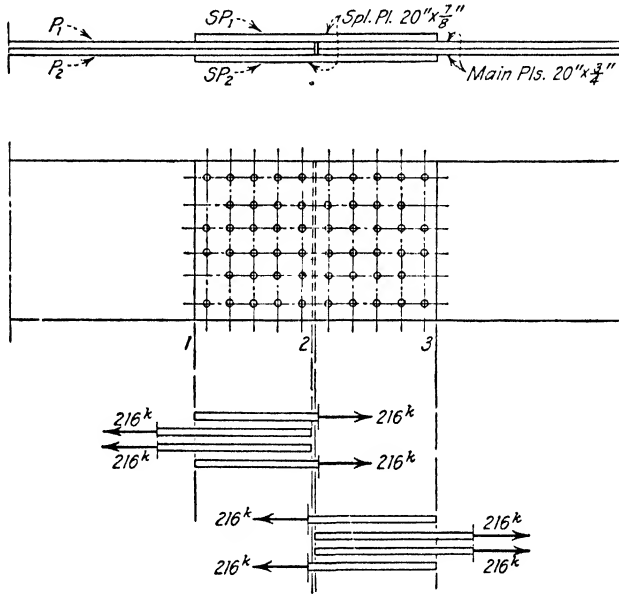

FIG. 160.

Fig. 163 only in the fundamental assumption regarding the distribution of stress.

The distinguishing characteristic of the form of lap splice shown in Figs. 161 and 162 is that the stress in the cut plate is assumed to be divided between the splice plates in inverse ratio to their distances from the former. The assumed distribution is illustrated in Fig. 161 (c), the stress in P₁ being assumed to be divided between splice plates SP₁ and SP₂ as shown. With this assumption as a basis in mind the diagrammatic representation of the stress in the various parts of the main member and splice material shown in Fig. 161 (b) should be clear. Study of the diagram will show that: The greatest shear between

sections 1 and 2 occurs on the plane between P_1 and SP_1 ; it is 147.3 kips and requires not less than $147.3/8.12 = 18.1 +$ rivets between those sections. The greatest shear between sections 2 and 3 occurs on the plane between P_1 and P_2 ; it is 137.4 kips and requires not less than $137.4/8.12 = 16.9 +$ rivets between those sections. The greatest shear

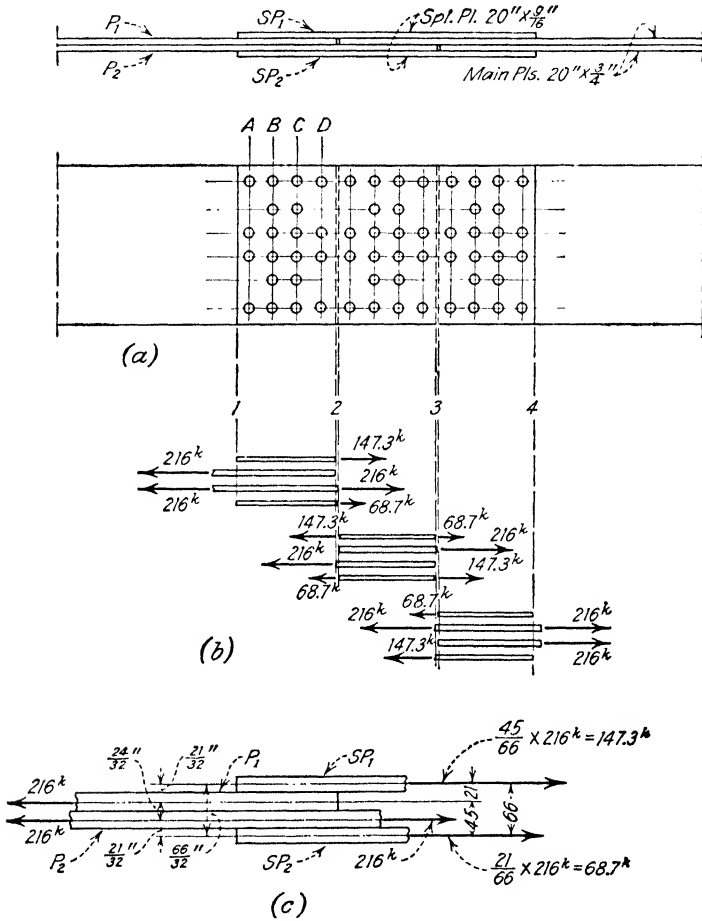

FIG. 161.

between sections 3 and 4 occurs between plates P_2 and SP_2 ; it is 147.3 kips and requires the same riveting as that between sections 1 and 2. The areas of the splice plates are of course determined from the greatest stress occurring in them: in this case the area of SP_1 is determined from the stress at section 2, and that of SP_2 from the stress at section 3.

The reader probably has already noticed that the thickness of the splice plates must be assumed *before* the stresses in them can be calculated. It is easy to make approximate preliminary calculations which will lead to assumed thicknesses which are nearly always correct or within 1/16 in. When the main member is composed of pieces of different areas, the splice plates may be found to require different areas. No matter how complicated a splice may be it can be analyzed in this manner, by studying the shear on the various planes between successive sections. Attention should be called to the fact that the riveting between some sections may sometimes be determined by the strength of rivets in bearing if the main section contains relatively thin plates.

It is desirable that the splice plates be as thin as is practicable, and naturally the fewer rivet holes there are at the critical section the thinner the plates may be. However, it is a mistake to try to deduct too few holes at the ruling section, and of course it is very important to make certain that at every section through the splice there is at least as much net area as in the body of the member spliced. In Fig. 161 the splice plates have been kept down to 9/16 in. in thickness by deducting only 4 holes from the critical section on the rivet row marked *D* in Fig. 161 (*a*). The student should particularly note that rivet rows *B* and *C* in the same figure have 6 rivets, or 6 holes deducted from the section, while rivet row *A* is the same as *D*; it is important to see clearly what this means with respect to assumed distribution of stress in the plate P_2 , which has not been cut at section 2. As shown in the diagram of Fig. 161 (*b*), plate P_2 is assumed to be resisting a pull of 216 kips at section 1 and also at section 2. At rivet row *A* only 4 holes are deducted from plate P_2 , and at an average intensity of stress of 18 kips per sq. in. it can resist 216 kips. At rivet row *B*, however, 6 holes are deducted from P_2 and at an average intensity of stress of 18 kips per sq. in. it can resist only 189 kips. At rivet row *C* we find the same conditions as at *B*, while at row *D* we are back to the situation at row *A*. With the splice detailed as in Fig. 161 (*a*) we are then clearly assuming that a stress of 27 kips is transferred from plate P_2 to splice plate SP_2 between rivet rows *A* and *B*, and the same stress transferred back to plate P_2 from splice plate SP_2 between rivet rows *C* and *D*. Some designers object to the assumption of stress zigzagging back and forth in this manner and prefer to detail such a splice as shown in Fig. 162. Here the splice plates are made thick enough to permit the deduction of 6 holes on the critical section at rivet row *D*, and it will be observed that stress is not assumed to zigzag back and forth between main plate and splice plate, but there is presumably a more or less continuous transfer of stress from the main plates to the splice plates from the beginning of the splice

plates to the ends of the main plates. Attention should be called to the diagrammatic representation of stress distribution in Fig. 162 (b), where it will be noted that the 27 kips presumably transferred from plate P_2 to the splice material between sections 1 and 2 (because of two additional holes in the rivet rows) is assumed to be divided between the splice plates in inverse ratio to their distances from P_2 .

The author is not prepared to say which of the details is the better; he prefers that in Fig. 162, but both types have been used with entirely satisfactory results so far as is known.

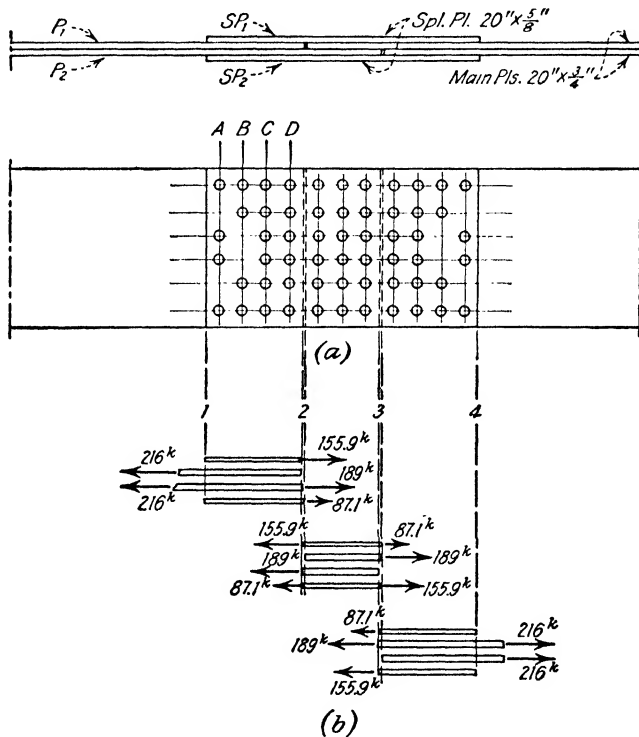

FIG. 162.

Some engineers do not accept the assumption as to distribution of stress on which the splices shown in Figs. 161 and 162 are based, and maintain that the stress in a cut plate is divided at the cut in such a way that the total stress in the member is distributed uniformly across all uncut material at that section. There is considerable merit in the latter assumption, and in many ways it forms the most satisfactory basis for proportioning lap splices. The rib which has been under

discussion is shown in Fig. 163 spliced in accordance with this assumption: at (a) are shown the details of the splice, and at (b) a diagrammatic representation of the distribution of stress among the various parts at the different sections. In Fig. 163 (c) is shown a splice based

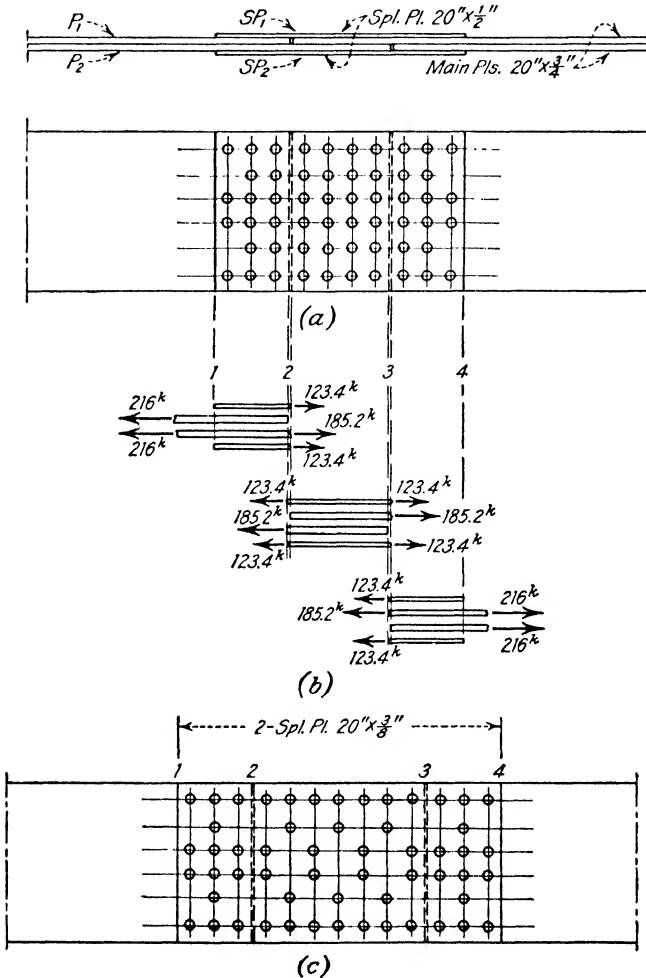

FIG. 163.

on the same assumption but deducting only 4 holes at the critical section of the splice plate. The reader should check the splice shown in (a) and (b) as well as that shown in (c), and with respect to the latter should make a diagram showing the stress distribution, and note that since

stress in the splice plate is constant between sections 2 and 3 (a result of the basic assumption of this method) not more than 4 holes may be deducted on any rivet row between these sections.

In Fig. 164 is shown a lap splice made with a single splice plate for each rib. This type has been used in some structures, but most engineers prefer one of the other types. Study of the diagram of stress distribution shown in (b) of Fig. 164 will disclose the basis of the riveting shown, which should be checked. It should be noted that if the splice plate is made the same thickness as the main plates not more than 4 holes may

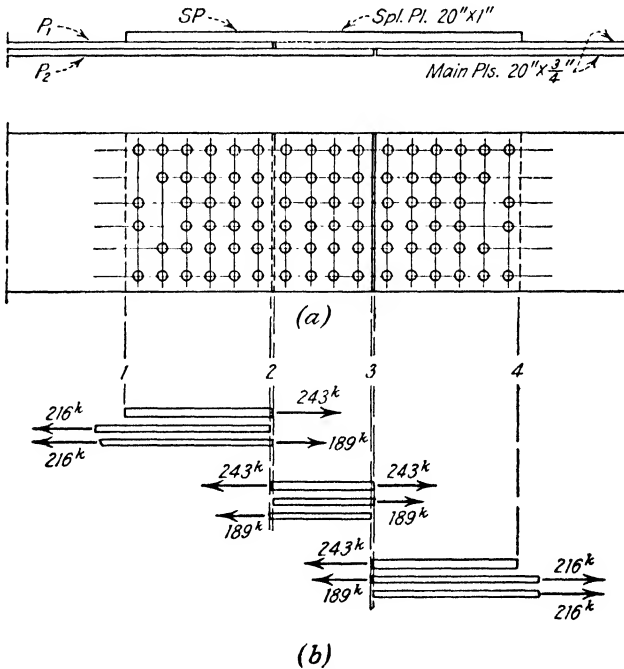

FIG. 164.

be deducted on any vertical row of rivets, and 7 vertical rows of 4 rivets each will be required between each pair of sections 1-2, 2-3, and 3-4.

All the methods of making lap splices which have been discussed have been successfully used and have their advocates. The distribution of stress among the various parts of the member and splice material, and among the rivets in such splices is extremely complex and uncertain. Test data on the actual strength of such splices are entirely lacking. The author believes that the assumption on which the splice of Fig. 163 is based is most nearly in accordance with the facts, but in the absence

of test data on splices of this kind is inclined to favor the splice of Fig. 162 as being somewhat more conservative. Although the splices presented in the previous discussion have been based (for the sake of simplicity) on the actual stress in the member the author advocates the practice of making the calculated strength of lap splices somewhat greater than the stress to be resisted—the excess strength provided generally ranges from none at all to as much as 10 per cent.

As an illustration of the lap splice of a definite truss member, Fig. 165 is presented: this splice follows the method of that used in Fig. 162 and is designed to have a capacity 5 per cent greater than that of the member. The assumed distribution of stress among the various

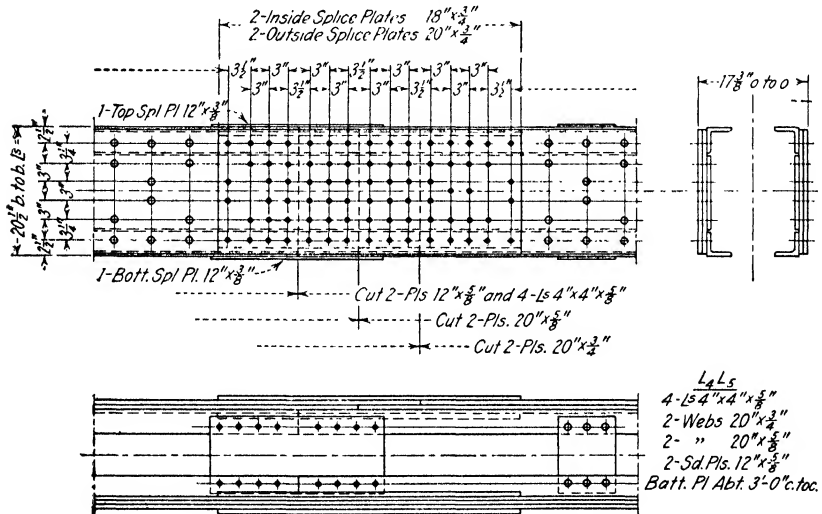

FIG. 165.

pieces of material is illustrated diagrammatically in Fig. 166, except that the stress assumed to be in the outstanding legs of the angles has not been shown. It should also be noted that the 12 in. by 5/8 in. plates between the flange angles, and the vertical legs of the flange angles, have been taken together. One 12 by 5/8 plate with 2 holes deducted and the vertical legs of two 4 by 4 by 5/8 angles with 2 holes deducted from each angle (1 from each leg) give a combined net area of 9.61 sq. in. as noted in Fig. 166. Attention is called to the fact that the net area of the 12 by 3/8 horizontal splice plates placed on the outstanding legs of the flange angles, and assumed to splice these outstanding legs, is very little greater than the net area of the outstanding legs themselves: the criticism in Art. 135 of splicing outstanding angle-legs

with single plates having a large excess area is therefore not applicable in this case.

The principle of the lap splice may also be applied in the joints of very heavy trusses. In such cases two or more gusset plates in each

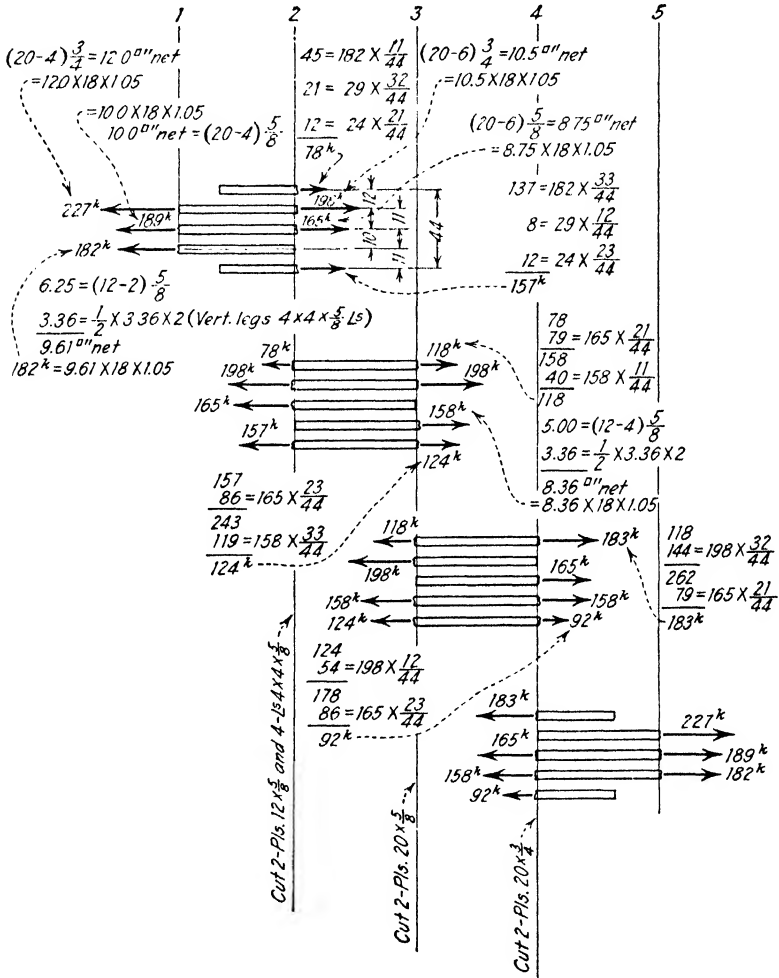

FIG. 166.—Assumed Distribution of Stress. One Rib.

rib at each joint may be used and multiple webs (having the same thicknesses as the gusset plates) in the diagonals and verticals shingled or lap spliced to them.

For examples of very heavy lap splices and multiple gusset plate

joints the student should refer to Chapter XXII, Vol. I, of "Bridge Engineering" * by Dr. J. A. L. Waddell.

137. Compression Member Splices.—Splices of compression members differ from those in tension members in two ways:

1. In American practice the rivets are assumed to fill the holes, and the entire, or gross, area of the member is assumed to resist stress. Because of this the spacing of rivets is controlled only by limiting distances center to center of rivets or by the area to be covered by the rivets.

2. In butt splices the adjacent ends are accurately faced to bear against each other, and generally some portion of the stress is assumed to be transmitted by direct bearing through the faced surfaces in contact. The amount of stress which is assumed to be transmitted by direct contact varies from about 25 to 75 per cent.

The method of design of compression splices needs little comment. The procedure is to decide what portion of the stress is to be transmitted by direct contact and to provide a sufficient area of splice material to transmit the balance. In general the area of splice material should be determined on the basis of the intensity of stress for which the member was designed, i.e., if 40 per cent of the stress is to be resisted by direct bearing and 60 per cent by splice material, the area of the latter should be 60 per cent of the area of the member. When a splice is so located that deflection of the member at that point is impossible, so that column action is not a factor, the area of the splice material may be determined using an intensity of stress equal to that permitted for short columns.

The proportioning of the riveting for the fillers and splice material should be based on the same reasoning as for tension members.

Lap splices are not commonly used for compression members, but when their use is expedient the design should be on the same basis as for tension members except that net section is not a factor. Of course, lap splices must be complete; that is, facing the ends of material in lap splices is impracticable and the entire stress must be transmitted by the splice material and its riveting. It is usual to provide the same excess in calculated strength in a compression lap splice as is provided in the corresponding tension splice, although sudden failure of a compression lap splice is hard to picture.

As an illustration of a compression splice the detail shown in Fig. 167 is presented. The splice has been made away from the joint but as close thereto as possible. The splice is shown on the side of smaller stress, as is desirable unless cantilever erection makes splicing ahead of

tribution of stress between the splice material and the contact surfaces, although with perfect surfacing and exact matching of holes the total stress would presumably be distributed more or less uniformly across the total material (splice material plus main material) at the cut. The vertical splice plates are assumed to resist 60 per cent of the stress carried by the webs and vertical legs of the angles, and their area and riveting have been proportioned on that basis. Similarly the top splice plate is assumed to resist 60 per cent of the stress carried by the cover plate and the outstanding legs of the top angles, and the bottom splice plate is assumed to resist 60 per cent of the stress carried by the bottom plates and the outstanding legs of the bottom angles. It will be noted that the bottom splice plate has nearly twice the area necessary for the work it is supposed to do, but that its riveting is just adequate for that work. The thickness of the bottom plate has been fixed by application of the requirement for compression member cover plates, and the minimum thickness thus determined forces the use of the plate shown in spite of the excess area. It will at once occur to the reader that this excess area is open to the objection raised in Art. 135 in connection with the horizontal splice plates for splicing the chord in Fig. 158. The criticism although partly justified is much less valid in the case of a compression splice with faced contact ends, since a very small yielding of the rivets will throw more load on the contact ends of the main chords.

CHAPTER VI

DESIGN OF STRUCTURAL STEEL FOR BUILDINGS

138. The preceding chapters have discussed the fundamental principles of design of the primary structural forms and their connections. It is the purpose of this chapter to illustrate the application of these principles in the design of simple building frames.

It is impossible within the space of a text of this kind to present an exhaustive discussion of the details of framing for such structures. Matters such as the character of roof surfaces and roof insulation; composition and support of walls; framing for the support of doors and windows; construction of floors; arrangement of partitions; provision for elevators, stairways, pipe shafts; and so on, are of great importance in devising the plan of beams or girders, columns, and tension members which are to support the proposed construction, and the professional designing engineer must acquire a fund of information about these features. Such considerations do not, however, affect the fundamental principles on which the efforts of the beginning student of design should be concentrated. Consequently attention will be centered, in the illustrative problems, on the design of steel framing for a specific set of conditions, and little space devoted to discussing the endless ways in which variations in these conditions may affect the details of arrangement.

139. Loads.—Since the first step in design is to estimate the loads which the proposed building is, or may be, required to support, a brief discussion of such loads is in order. This matter has been touched on in a previous volume,* and the material presented here may be considered an amplification of the former discussion.

It seems logical to present the matter in the preferable order of design, and the loads will therefore be considered in order as roof loads, floor loads, wall loads, and special loads.

140. Roof Loads.—The load on a roof may be classified, as usual, into live load and dead load. Generally, only two kinds of live load are to be considered in the design of a roof—snow and wind. Occasionally there may be live loads of other character such as goods tempo-

* Introduction to "Theory of Simple Structures," Shedd and Vawter, John Wiley & Sons, New York.

rarily placed on the roof of a pier shed, or mechanical equipment on a power-house roof, and sometimes it may be necessary to provide for the storage, on one part of a roof, of material to be used in the reconstruction or repair of another part; these are special cases, however, and need not be discussed here.

Snow.—The amount of snow load to be expected depends on the geographical location of the structure, the velocity of the wind, and the slope of the roof. Suggested snow loads which have been widely used are given in the accompanying table.*

SNOW LOADS FOR ROOF TRUSS DESIGN IN POUNDS PER SQUARE FOOT OF ROOF-SURFACE

| Locality | Slope of Roof | | | | |
|--|---------------|-------|-------|-------|-------|
| | Flat | 20° | 25° | 30° | 45° |
| Northwestern and New England States..... | 40 | 35 | 25-30 | 15-20 | 10-15 |
| Western and Central States..... | 35 | 25-30 | 20-25 | 10-15 | 5-10 |
| Southern and Pacific States..... | 10 | 5-10 | 5-10 | 5-10 | 0-5 |

The basis for these loads, although not given, is presumably the known weight of snow and estimated or recorded depths of fall. Some support is given to these values by Mr. Sidney Wilmot who reported † that students acting under his direction weighed the snow from a measured area and found it to be 35 lb. per sq. ft., the area being on a level portion of ground and 40 ft. from the nearest building.

Of course, maximum snow load and maximum wind load need not be considered together, but severe winds may accompany a sleet storm or follow a fall of wet snow, and much of the snow may freeze in position on the roof. It has become fairly common to include full wind load with half snow load, and vice versa. For ordinary roofs (spans of about 100 ft. or less) it is sufficiently accurate to use a so-called “equivalent vertical load” of such magnitude that it may be assumed to provide for either snow or wind or both snow and wind. Representative values of equivalent vertical loads to be used for this purpose are given in the accompanying table.‡

* Reprinted by permission from Kidder-Parker's “Architects’ and Builders’ Handbook,” published by John Wiley & Sons.

† *Engineering News-Record*, June 24, 1920, page 1269.

‡ Reproduced by permission from Kidder-Parker's “Architects’ and Builders’ Handbook,” published by John Wiley & Sons.

EQUIVALENT UNIFORM VERTICAL LOADS TO REPLACE COMBINED SNOW AND WIND LOADS FOR CALCULATING MAXIMUM STRESSES IN ROOF-TRUSSES. VALUES IN POUNDS PER SQUARE FOOT OF ROOF SURFACE.*

| Locality | Slope of Roof | | | | |
|--|---------------|-----|-----|-----|-----|
| | Flat | 20° | 30° | 45° | 60° |
| Northwestern and New England States..... | 40 | 35 | 24 | 26 | 28 |
| Western and Central States..... | 35 | 30 | 24 | 26 | 28 |
| Southern and Pacific States..... | 30 | 20 | 24 | 26 | 28 |

* Values corrected for an allowable increase in working unit stress for wind stresses of 33½ per cent.

Wind.—The pressure on structures exerted by wind has been the subject of much discussion and some experimentation, extending over more than one hundred years, but there is still considerable difference of opinion among engineers concerning the proper pressure to be used in design. The most comprehensive summary of the subject known to the author is that presented by Mr. Robins Fleming in his book, “Wind Stresses in Buildings.” † The late Professor George Fillmore Swain also presented an excellent discussion of wind pressures in his “Stresses, Graphical Statics, and Masonry,” ‡ and every student of the subject should examine carefully the treatment in these books.

The pressure of the wind is given by

$$p = KV^2 \tag{140}$$

in which p = the pressure, in pounds per square foot;

V = the velocity of the wind, in miles per hour;

K = a factor which depends on the shape and proportions of the object against which the wind is blowing.

The values of K frequently quoted range from 0.0025 to 0.0040, with about 0.003 as perhaps the most common.

The pressure given by (140) is for surfaces normal to the direction of the wind, which is assumed parallel to the surface of the earth. When the surface on which the wind acts is not normal to the direction of the wind the air currents are deflected and the pressure exerted normal to the surface is diminished. In 1829 a French army officer,

† John Wiley & Sons, New York.

‡ McGraw-Hill Book Company, New York.

Colonel Duchemin, made experiments to determine the magnitude of such pressures and developed the relation:

$$p_n = p \cdot \frac{2 \sin \theta}{1 + \sin^2 \theta} \tag{141}$$

which bears his name, and is still accepted as the most accurate available.* In this expression

- p = the pressure on a surface normal to the direction of the wind;
- p_n = the pressure normal to the inclined surface;
- θ = the angle between the inclined surface and the horizontal.

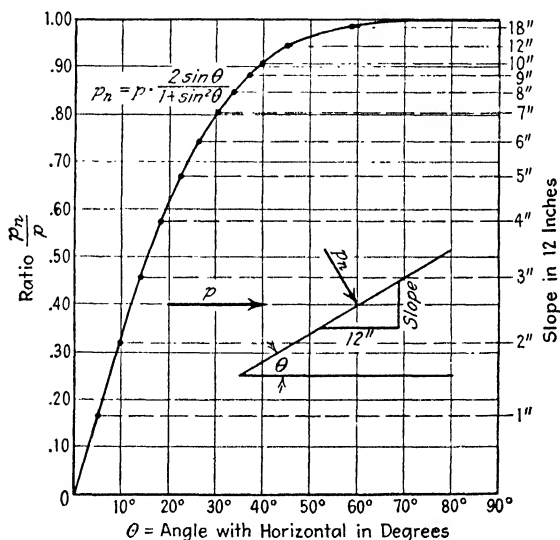

FIG. 168.

Figure 168 indicates the notation, and gives a curve showing the relation between p_n and p for angles from 0 to 90°. It will be noted that for angles exceeding 45° the pressure on the inclined surface is substantially equal to that on a surface normal to the direction of the wind.

When air is at rest there is acting on a structure, inside and out, a uniform pressure due to the normal atmospheric pressure of about

* S. P. Langley is said to have made experiments on this subject in 1888 and to have obtained results which checked with those of Duchemin with remarkable accuracy. Duchemin's work was unknown to Langley at the time.

14.7 lb. per sq. in. Hugh L. Dryden and George C. Hill in "Wind Pressures on Structures"* state that:

The effect of the motion of the air is a modification of this normal pressure, at some points an increase in pressure, at others a decrease in pressure. The magnitude of these changes is only a small percentage of the normal atmospheric pressure, and the words "suction" or "vacuum" as commonly used in this connection do not imply any large change in density or pressure. The condition indicated by these words is merely a decrease of the normal pressure by amounts which are usually less than 2 per cent of the normal pressure.†

The "suction" or "vacuum" referred to in this quotation is that occurring toward the leeward side of a structure standing in the path of a wind. Deflection of the air currents by a structure in their path causes eddying, particularly so in the case of the ordinary structure because of abrupt and irregular outlines, and "piling up" of the air at some points and consequent increase in pressure, with thinning of the air and decrease in pressure at other points. In an article in *Engineering News-Record* for July 24, 1930, Mr. Wilbur J. Watson stated that as a result of experiments made at the Auteuil Laboratory, France, by G. Eiffel, it was concluded that "there are no positive pressures except on the vertical walls struck by the wind and on the first third of the roof; elsewhere negative pressures prevail, attaining their maximum near the ridge and sometimes before reaching it." In the same article, and in an article on the same subject in *Civil Engineering* for November, 1930, Mr. Watson gave a diagram showing the pressures plotted as the result of experiments on a model of the Goodyear-Zeppelin hangar at Akron, Ohio; the diagram is reproduced here as Fig. 169, and clearly shows negative pressure existing over the larger portion of the cross-section. The existence of negative pressures on the leeward side of structures subjected to wind storms has long been known, but has not received much recognition in American design practice, except indirectly through requirements for positive anchoring of trusses, purlins, and

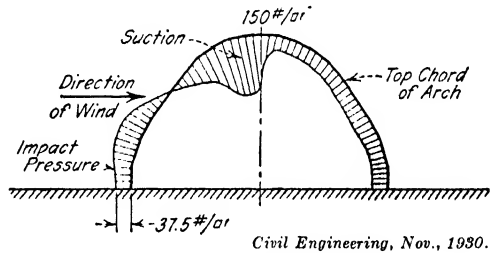

FIG. 169.

France, by G. Eiffel, it was concluded that "there are no positive pressures except on the vertical walls struck by the wind and on the first third of the roof; elsewhere negative pressures prevail, attaining their maximum near the ridge and sometimes before reaching it." In the same article, and in an article on the same subject in *Civil Engineering* for November, 1930, Mr. Watson gave a diagram showing the pressures plotted as the result of experiments on a model of the Goodyear-Zeppelin hangar at Akron, Ohio; the diagram is reproduced here as Fig. 169, and clearly shows negative pressure existing over the larger portion of the cross-section. The existence of negative pressures on the leeward side of structures subjected to wind storms has long been known, but has not received much recognition in American design practice, except indirectly through requirements for positive anchoring of trusses, purlins, and

* Scientific Papers of the Bureau of Standards No. 523, Superintendent of Documents, Government Printing Office, Washington, D. C.

† The student should note that a decrease of the normal pressure of 2 per cent means a change of: $0.02 \times 14.7 \times 144 = 42.3$ lb. per sq. ft.

roof coverings, and the making of certain light-tension members in trusses of "stiff" section as a guard against collapse in case of reversal of the tension by negative pressure on the leeward side. Interesting data from experiments on models, showing suction or negative pressure on the leeward side, are recorded in a paper by Thomas E. Stanton, "On the Resistance of Plane Surfaces in a Uniform Current of Air," *Proceedings of the Institution of Civil Engineers of Great Britain*, Vol. 156, 1903.

The pressures actually used in design range from 15 to 30 lb. per sq. ft. of area exposed to the wind, the area taken being that projected on a vertical plane. The pressures on inclined surfaces are modified in accordance with Duchemin's formula. For structures to be erected in tropical countries or at coast sites in Florida or on the Gulf of Mexico, a pressure of 40 lb. per sq. ft. has been specified in some cases.

Dryden and Hill in the monograph previously quoted give the following table of velocity pressures based on their experiments and recommend that for design the velocity pressure be multiplied by a factor dependent on the form of the structure; these recommendations are appended to the table.

VELOCITY PRESSURE *v.* TRUE AND INDICATED WIND SPEED

| Speed Indicated by U. S. Weather Bureau 4-Cup Robinson Anemometer | True Wind Speed | Velocity Pressure |
|--|--------------------|---------------------------|
| Miles per hour | Miles per hour | Pounds per square foot |
| 10 | 9.5 | 0.23 |
| 20 | 17.8 | 0.81 |
| 30 | 25.7 | 1.69 |
| 40 | 33.3 | 2.84 |
| 50 | 40.7 | 4.23 |
| 60 | 48.0 | 5.89 |
| 70 | 55.2 | 7.80 |
| 80 | 62.2 | 9.90 |
| 90 | 69.2 | 12.25 |
| 100 | 76.1 | 14.8 |
| 110 | 82.9 | 17.6 |
| 120 | 89.7 | 20.6 |
| 130 | 96.4 | 23.8 |
| 140 | 103.1 | 27.2 |
| 150 | 109.7 | 30.8 |

Log true speed = 0.9012 (log indicated speed) + 0.079.

Velocity pressure in pounds per square foot = 0.001189 ($V \times 22/15$)² where V is the true speed in miles per hour.

| Model Investigated | Coefficient | Application |
|---|-------------|------------------------------|
| Rectangular flat plate of infinite length, normal to the wind | 2.0 | Radio towers, bridge girders |
| Rectangular prism, 1 : 1 : 5, 1 : 5 face normal to the wind | 1.6 | Tall buildings |
| Cylinder, 1 by 5, axis normal to the wind | .8 | Chimneys, standpipes |
| Short cylinder, 1 by 1, axis normal to the wind | .7 | Water tanks |
| Square flat plate, normal to the wind | 1.1 | Square signboard |

Roofing.—The weight of roofing depends on the material employed and also on the distance between purlins. Approximate weights of common roofing materials are given in the accompanying table.

APPROXIMATE WEIGHTS OF ROOFING MATERIAL

| Roofing Material | Weight per Square Foot, Pounds |
|---|--------------------------------|
| Copper roofing, sheets | 1½ |
| Corrugated galvanized iron, No. 20 B.W.G. | 2¼ |
| Corrugated galvanized iron No. 26 B.W.G. | 1¼ |
| Felt, 2 layers | ½ |
| Felt and asphalt or coal-tar | 2 |
| Glass, ⅛ in. thick | 1¾ |
| Lath and plaster ceiling | 6 to 8 |
| Lead, ⅛ in. thick | 7½ |
| Mackite, 1 in. thick with plaster | 10 |
| Sheathing, hemlock, 1 in. thick | 2 |
| Sheathing, white pine, spruce, 1 in. thick | 2¼ to 2½ |
| Sheathing, yellow pine, 1 in. thick | 3½ |
| Shingles, 6 by 18 in., 6 in. to weather | 2 |
| Skylight, glass ⅜ to ½ in., including frame | 4 to 10 |
| Slag roof, 4-ply, with cement and sand | 4 |
| Slate, ⅛ in. thick, 3 in. double lap | 4½ |
| Slate, ⅜ in. thick, 3 in. double lap | 6¾ |
| Tar and Gravel Roofing, without sheathing | 8 to 10 |
| Terneplate, 1C | 5½ |
| Terneplate, 1X | ½ |
| Tiles, flat | 15 to 20 |
| Tiles, corrugated | 8 to 10 |
| Tiles, on concrete slabs | 30 to 35 |
| Tin, without sheathing | 1 to 1½ |
| Zinc, No. 20 B.W.G. | 1½ |

Courtesy of the Phoenix Bridge Company.

It is impossible to give complete information here; manufacturers' catalogs, Kidder's "Architects' and Builders' Handbook," Sweet's "Architectural and Engineering Catalogues," and similar sources should be consulted for more specific data.

Roof Framing.—The framework supporting a roof consists of the purlins (or purlins and rafters) and trusses, and the necessary bracing.

Purlin weights range from about 1.5 to 5 lb. per sq. ft. of roof surface, depending of course upon the span and spacing of the purlins and on the kind of roofing employed. A preliminary estimate of purlin weight may easily be made in the manner to be described later for estimates of the weight of floor framing.

The weight of trusses and bracing ranges between 2 to 10 or 12 lb. per sq. ft. of horizontal projection for ordinary buildings with spans from about 40 ft. to 100 ft. The weight of trusses depends on the pitch, the spacing of the trusses, the span, the type of roof surface to be used, the specifications for design, and to a less extent on the designer.

Numerous formulas for roof truss weights have been devised, but so many variables are involved that great accuracy should not be expected. Such formulas may be found in handbooks dealing with building design and in many texts on the subject.

An expression which the author developed for his own use for the weight of the trusses and bracing for ordinary flat roofs is:

$$W_t = \frac{Cwl}{s} \quad (142)$$

W_t = weight of trusses and bracing, in pounds per square foot of horizontal projection;

C = a coefficient given by Fig. 170;

w = the load, in pounds per square foot of horizontal projection, which the truss supports including the weight of the trusses and bracing;

l = the span center to center of supports, in feet;

s = the permissible intensity of stress in tension, in pounds per square inch.

The weight of trusses and bracing given by this expression will err on the side of safety, especially for short spans, if single-angle members are permitted, but the results will be entirely satisfactory for design purposes. Ordinarily this relation may be taken as

$$W_t = \frac{16wl}{s} \quad (143)$$

with sufficient accuracy for design purposes.

The student should note that the weight of the trusses and bracing in most cases will be roughly 10 per cent of the weight to be supported; consequently a considerable error in estimating their weight will have little effect on the design. Nevertheless, trusses which are unusual in span, loads to be supported, or depth to be used, should receive special consideration.

The weight of trusses and bracing for pitched roofs may be taken, for the purpose of design, at about 90 per cent of the weights given by (142).

The weight of the bracing in a roof will generally range from 10 to 15 per cent of the weight of the trusses. If the weight of the trusses only is wanted it may be found by taking from 87 to 91 per cent of the amount given by (142).

141. Floor Loads. *Live Load.*—The live load to be expected on a floor depends mostly on the type of building in which the floor occurs.

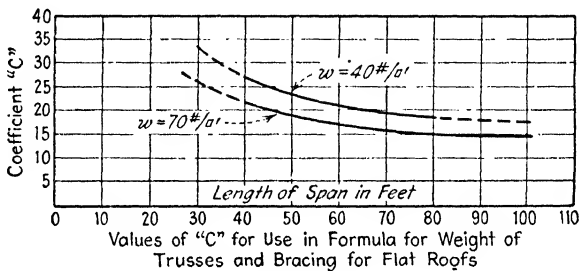

FIG. 170.

The load which must be used in actual design, however, may depend more on the building code governing the locality in which the building is to be constructed. Building codes for different cities vary widely in their requirements, even with respect to buildings constructed for identical purposes: in some cases these variations exceed 200 per cent, and variations of 100 per cent are common.

In an effort to secure more reasonable and more uniform requirements in building codes former President Hoover, while serving as Secretary of Commerce, appointed a Building Code Committee which made an elaborate study of actual loads in buildings. As a result of this study the committee made a report in November, 1924, entitled "Minimum Live Loads Allowable for Use in Design of Buildings." The report may be obtained from the Superintendent of Documents Government Printing Office, Washington, D.C., and should be in the library of, and carefully studied by, everyone concerned with the

design of buildings. The recommendations of the committee, and a general discussion of the subject of live loads on building floors are given in "Theory of Simple Structures."* The recommendations of the committee are also to be found in "Steel Construction" issued by the American Institute of Steel Construction.

The student is referred to the sources just noted for further data, but it may be well to remark here that it is sometimes necessary to give consideration to loads which may occur during construction, particularly in buildings designed for small live and dead loads.

Dead Load.—The dead loads encountered in floor design are dependent on so many factors that generalization is not informative. Type of construction and nature of occupancy are the major variables, but their variations cover a wide range. It is impracticable here to discuss the

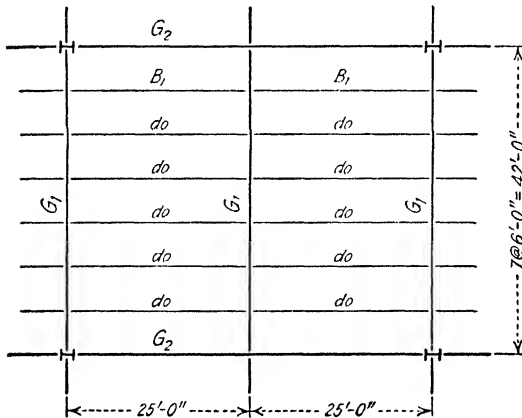

FIG. 171.

types of construction used in building-floors, and the student is referred to standard books dealing with building construction.

Floor Framing.—

The weight of steel floor framing will range from as little as 4 or 5 lb. per sq. ft. of floor surface in ordinary office buildings or apartment hotels to as much as 15 to 20 lb.

per sq. ft. for heavy storage warehouses. These weights are for floor joists or beams only and do not include girders, which will add from 3 or 4 lb. per sq. ft. to 20 or 25 lb. per sq. ft., depending on loads to be supported and on the spacing of columns.

The most satisfactory procedure in every case is to make an estimate of the weight of the framing based on the conditions which are peculiar to the project.

It may be well to point out that if a design is carried out in logical order it is not necessary to assume any weight except that of the member under consideration. For example, suppose that a design is to be made for a floor system consisting of a reinforced-concrete slab supported on steel beams which are in turn supported by girders which

* John Wiley & Sons, New York.

deliver the load finally to the columns. If the slab is designed first it is only necessary to assume its own weight before making its design calculations. After the slab has been designed its actual weight is easily determined so that in designing the beams it is only necessary to make an assumption regarding their own weight. Similarly if the girders are next designed the weights of the parts which they support—the slab and the beams—are known and it is only necessary that an estimate of their own weight be made, and so on. Whenever practicable this procedure in design should be followed.

As an illustration of the method of attack the floor panel shown in Fig. 171 will be considered. It is assumed that the slab has been designed and found to be 4 in. thick, and that there will be a sandcushion on the slab, 1/2 in. thick, on which are placed 3-in. creosoted wood blocks. The live load is to be taken as 250 lb. per sq. ft. The floor slab is to be poured around the top flanges of the beams and girders, but the beams and girders will not be encased. The specifications of the A.I.S.C. control.

Beam B1

$$\begin{array}{r}
 \text{Live load} = 250 \text{ lb. per sq. ft.} \\
 \text{Dead load} = 50 = \text{slab } 4 \text{ in.} \times 12.5 \text{ lb. per in.} \\
 \quad \quad \quad 5 = \text{sand } \frac{1}{2} \text{ in.} \times 10 \text{ lb. per in.} \\
 \quad \quad \quad 15 = \text{blocks } 3 \text{ in.} \times 5 \text{ lb. per in.} \\
 \quad \quad \quad = \text{beams} \\
 \text{Total} \quad \quad \quad = \text{lb. per sq. ft.}
 \end{array}$$

Having proceeded so far the designer notes the subtotal floor load as 320 lb. per sq. ft. and makes the following calculation on scratch paper or slide rule.

$$\text{Moment} = 320 \times 6 \times \frac{25^2}{8} = 150 \text{ ft.-kips}$$

$$\text{at } \frac{12}{18}, \frac{I}{c} = \text{about } 100$$

$$20 \text{ in. I at } 65.4 \text{ lb. } I/c = 117.5$$

$$\frac{65.4}{6} = 10.9, \text{ say } 11 \text{ lb. per sq. ft.}$$

This information is then added to that given, and the complete calculations appear as follows:

The approximate weight thus found is based on the fact that the *average* gross area of each flange is roughly equal to the net area at the point of maximum moment and that the girder details (stiffeners, fills, connection angles, rivet heads, etc.) will run around 60 per cent of the weight of the web. The approximate weight having been estimated it is added to the *known* weights and the design completed as usual.

The student should realize that the approximate methods described above are only suggested methods of attack, and that they may be extended to the other fundamental structural forms, and combinations of them. They may be used with fair success by the designer with little experience, but when supplemented by experience in design and by study of actual weights they will become valuable tools which will keep the engineer from becoming dependent on tables and empirical formulas. Tables and empirical formulas are often helpful, but the author does not know of any substitute for the intelligent use of the results of experience.

142. Wall Loads.—The weights of walls, in modern skeleton construction, become very important in high buildings, and in recent years many attempts to devise lighter forms have been more or less successfully made.

The more common types of enclosure walls in modern steel-frame construction are: plain stone; plain brick; hollow tile; hollow tile faced with brick or stone; concrete block; or ordinary concrete. Such walls should not be less than 8 * and may be 12 to 16 in. thick. The weights will range from about 35 to 125 lb. per sq. ft. of surface for the masonry portions. The windows (glass and sash), which in modern construction may exceed 50 per cent of the wall area, will weigh from 4 to 10 lb. per sq. ft. of window area. These are average values and actual weights may be quite different in special cases.

143. Special Loads.—Special loads may be of various kinds, but those which the author has in mind are the cranes required in many industrial buildings. Cranes are of many types, but those most commonly encountered are monorail hoists, which may lift and travel by hand power or by electric power; jib cranes, which are usually attached to the building columns; traveling jib cranes, which may move along a track supported by the steel frame; and overhead electric traveling cranes, consisting of two main parts, first a girder bridge spanning the building transversely and arranged to travel on a longitudinal run-

* "Recommended Minimum Requirements for Masonry Wall Construction," Report of U. S. Department of Commerce Building Code Committee, June, 1924. May be obtained from Superintendent of Documents, Government Printing Office, Washington, D. C.

way, and second a traveling trolley which carries the hoisting mechanism and is arranged to move across the building on the girder bridge. Figure 172 shows a hoist of the first type, equipped with an electric hoist, but traveling on the monorail beam, from which it is suspended, under hand power. Figure 173 shows cranes of the last-named type. The large 250-ton crane on the upper runway is equipped with two trolleys for lifting locomotives as shown. The 15-ton messenger cranes on the

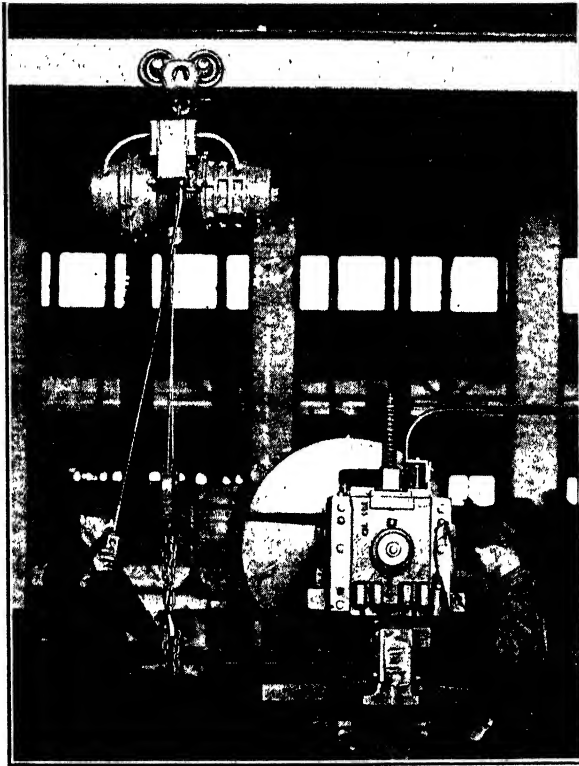

Courtesy of The Harnischfeger Corporation.

FIG. 172.—Monorail Hoist.

lower runway are standard one-trolley cranes; the trolley of the messenger crane in the foreground is shown at the right lifting a pair of locomotive driver wheels and axle.

The loads from cranes of various types range from the nearly insignificant wheel loads of small-capacity hoists to the enormous wheel concentrations from large-capacity cranes, the greatest wheel loads with which the structural engineer has to deal.

Tables giving data for cranes of various capacities may be found in many handbooks containing engineering information. "Crane Engineering" published by the Whiting Corporation, Harvey, Illinois, contains the most complete information known to the author.

144. Design of Purlins.—Purlins are beams, and the principles of design presented in Chapter III are applicable and sufficient. For roofs having slopes of less than 1 or $1\frac{1}{2}$ in. per ft. the purlins may be assumed to be vertical, and the lateral support of the compression flange is the only matter likely to require particular attention. The

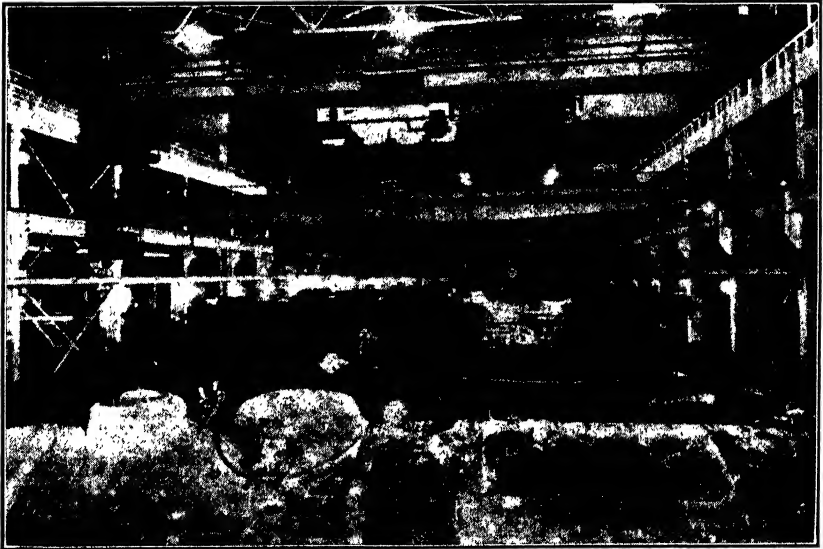

Courtesy of The Whiting Corporation.

FIG. 173.—250-Ton Whiting Locomotive Crane, and Three 30-Ton Whiting "Tiger" Messenger Cranes in the Shops of the Chesapeake and Ohio Railroad, Huntington, West Virginia.

more common forms of construction used for flat roofs are generally satisfactory from this standpoint, but with some types of pressed metal roofing it may be desirable to treat the purlins as being without lateral support between trusses.

Purlins on pitched roofs may be called on to resist load components acting parallel to the roof surface which must be taken into consideration in their design. Whether such forces are actually effective depends on the type of roofing and its construction at the ridge, but it is always conservative and generally desirable to provide against them.

In Fig. 174 (a) the roofing is represented as being supported on a ball at each purlin and is prevented from rolling off by clips bearing against the purlin flanges. It is obvious in this case that the purlins must resist the load components parallel to the plane of the roof. If the two planes of roofing are connected at the ridge, as represented in Fig. 174 (b), it seems clear that the components parallel to the plane of the roof must be resisted by the roofing itself, the purlins being subjected only to the components normal to the plane of the roof. Of course these are the two extremes, and actual purlins lie between them.

The shapes generally used as purlins (light beams and channels) are

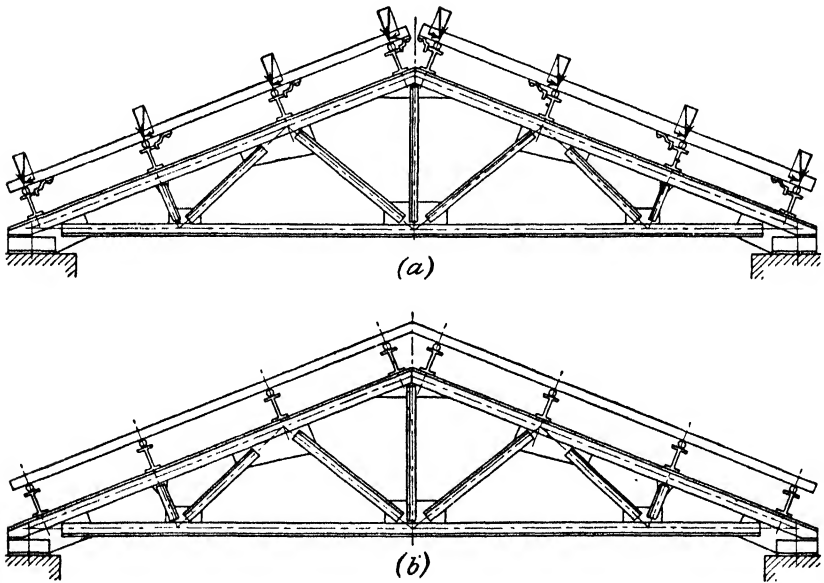

FIG. 174.

not efficient in resisting forces acting normal to the plane of the web, and on pitched roofs it is common to provide sag-rods to assist them in resisting load components parallel to the roof. Sag-rods are shown in Fig. 28 on page 35. Lines of sag-rods are generally spaced from 6 to 10 ft. center to center.

Figure 175 shows common methods of fastening purlins to the chords of roof trusses. Study of the figure will make it clear that the top flanges of purlins receive practically no support from such connections in a direction parallel to the slope of the roof. To make the top flange effective in resisting load components parallel to the roof the sag-rods

should be placed as near the top flange as is practicable and there should be a line of rods at each end of the purlins as indicated in Fig. 176. When sag-rods are placed near the top of the purlins, and at the ends, the purlins may be designed under the assumption that the top flange resists the load components parallel to the roof. When there are no sag-rods at the ends (and usually there are none) the intermediate sag-rods should be as near the bottom flange as is practicable and the purlins designed under the assumption that the *bottom* flange resists the components parallel to the roof surface.

Under either of the assumptions in the preceding paragraph the purlin is designed to resist a bending moment normal to the roof surface

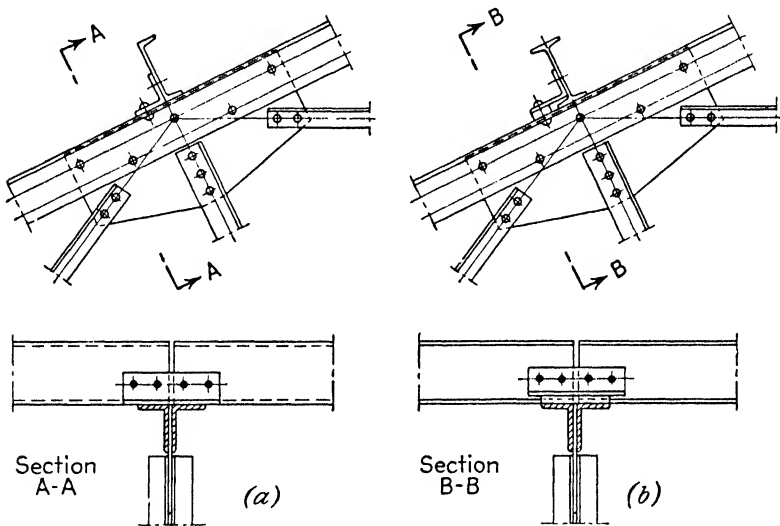

FIG. 175.

and a bending moment parallel to the roof surface, the latter applied wholly to one flange. The components of load normal and parallel to the roof surface are indicated in Fig. 177 in which W is the vertical load per linear foot of purlin span. In Fig. 178 are shown the moment diagrams for one and two intermediate lines of sag-rods which obtain if the sag-rods are all in perfect adjustment so that the purlin flange is exactly straight before loading. The student will do well to reflect on the probability of sag-rods being drawn up to exact adjustment and on the effect of some being drawn up tighter than others.

At the ridge of the roof two purlins may be used, connected by short, bent sag-rods, as shown in Fig. 179 (a), or a single purlin set vertically

as in Fig. 179 (b). In either case it should be clear that these purlins are subjected to additional loads from the sag-rods due to the change in direction of the latter. The magnitude of these loads may be *estimated*

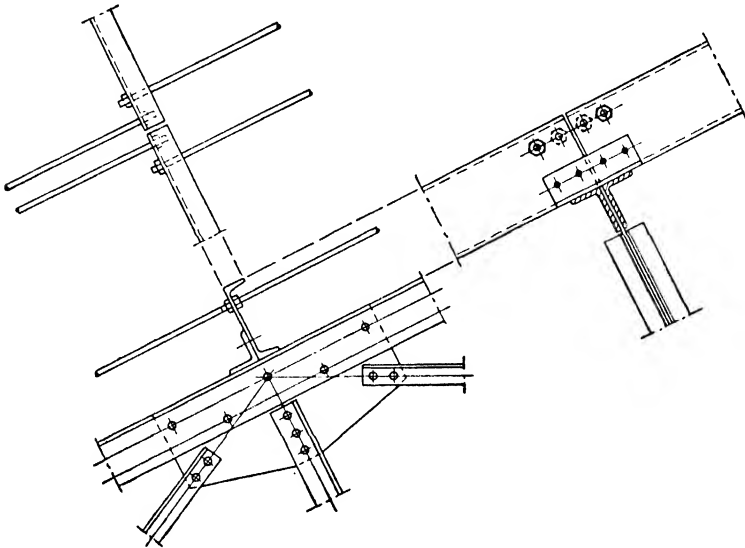

FIG. 176.

by treating the sag-rod pulls as reactions on continuous beams, as indicated in Fig. 178. The student should see clearly that the *actual* magnitudes of these loads depend on how the nuts on the sag-rods are

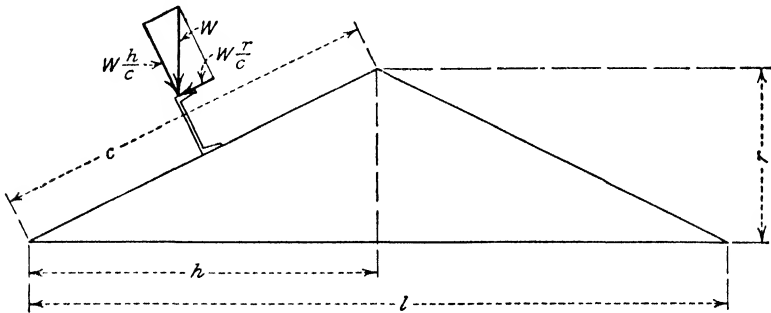

FIG. 177.

adjusted, and that they are very uncertain. These additional loads may be rather large on steep roofs and are sometimes avoided by directing the ridge sag-rods to the supports as indicated in Fig. 180.

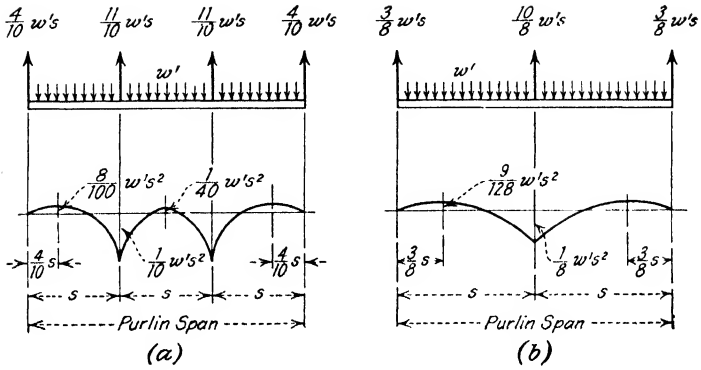

FIG. 178.

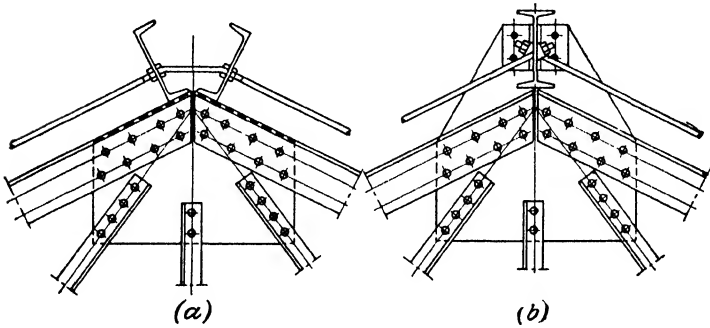

FIG. 179.

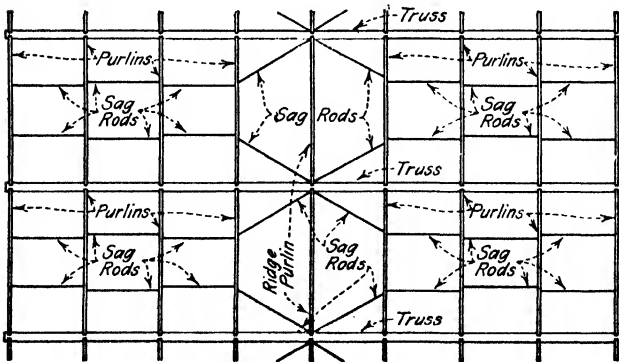

FIG. 180. Plan showing sag-rods.

145. Design of Trusses.—Some of the more common forms of roof trusses are shown in Fig. 11 which is reproduced here as Fig. 181 for

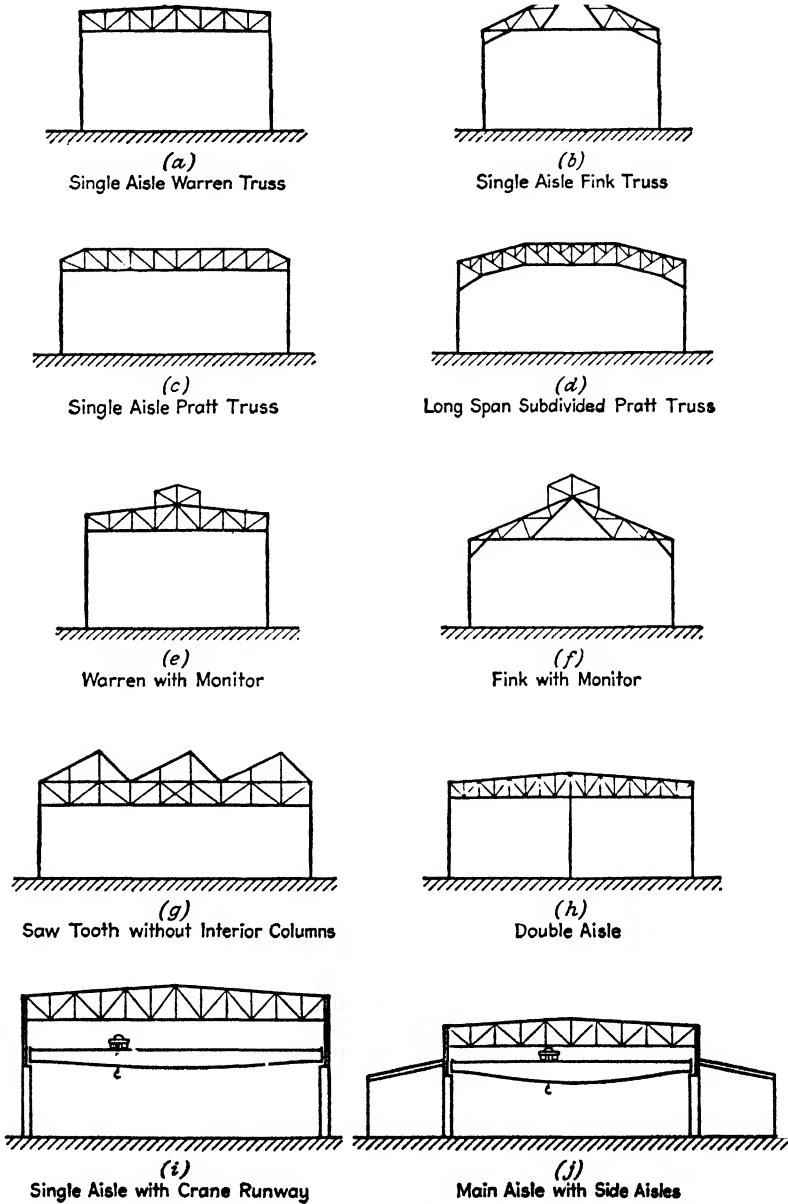

FIG. 181.

easy reference. Other types are shown in a previous volume,* and in various texts having to do with building design and construction.

The first step in the design of a roof truss is a decision as to general proportions.

The span, of course, is fixed by the dimensions of the area to be kept free of columns. The slope of the top chord will often be fixed within limits dictated by the type of roofing selected, and in some cases may be affected by requirements for ventilation, lighting, etc.

Shingles, slate, corrugated metal, and most forms of roofing tile

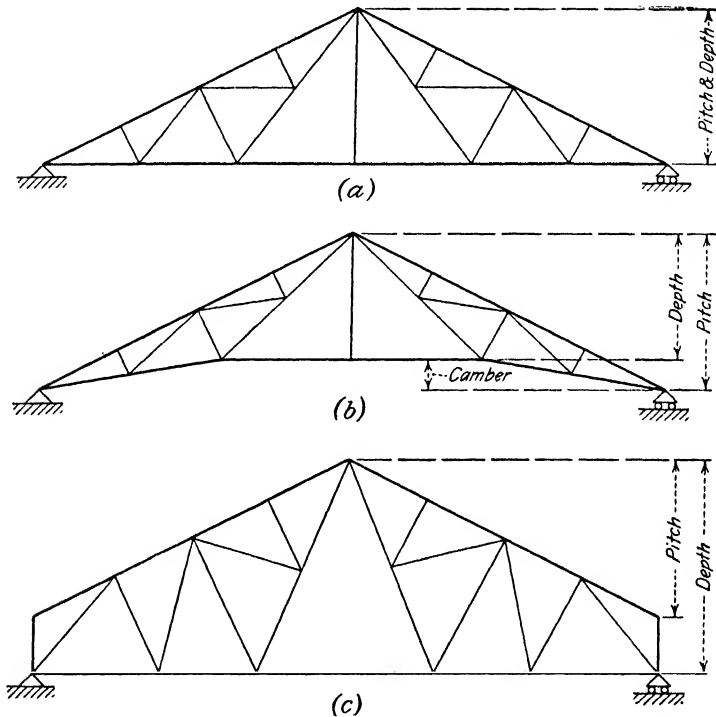

FIG. 182.

require a pitched roof,† while tar and gravel surfaces generally should be used on a flat roof or one having very little slope. The pitch for

* "Theory of Simple Structures," Shedd and Vawter, John Wiley & Sons, New York.

† The pitch of a roof is defined as the ratio of the rise of the slope to the span length: i.e., a roof having a span of 80 ft. and a rise from eaves to center of 20 ft. is said to have a one-quarter pitch; if the rise from eaves to center is 16 ft. the pitch is one-fifth, and so on.

slate and shingle roofs should not be less than one-quarter and preferably should be from one-third to one-half; the pitch for corrugated metal roofs should not be less than one-fifth (unless the joints are soldered or cemented) and preferably should be one-quarter or more. The pitch for the various forms of tile roofs generally ranges from a minimum of about one-quarter to whatever amount the architect considers suitable. Roofs surfaced with tar and gravel or similar materials have slopes

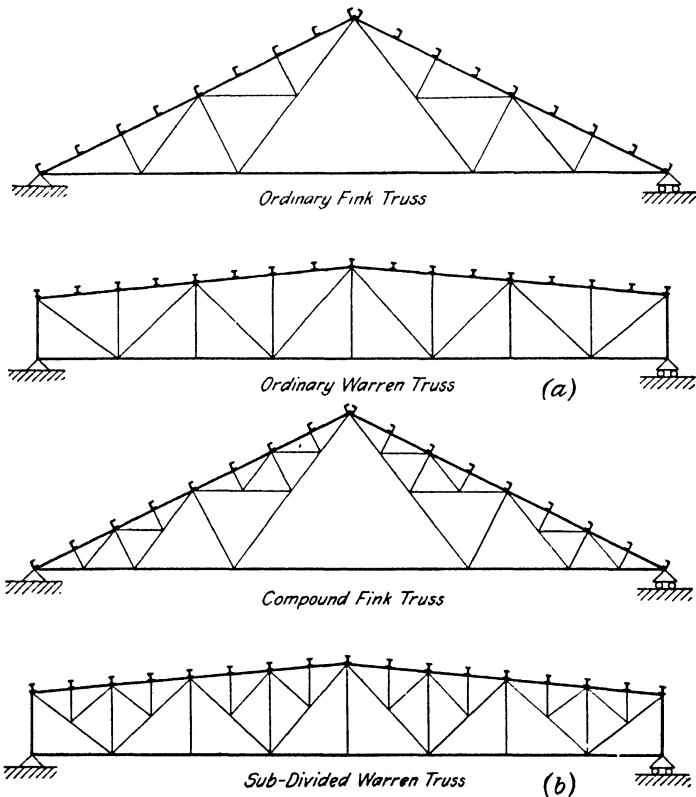

FIG. 183.

ranging from nothing at all to not more than 2 in. per ft.—from $1/4$ to $3/4$ in. per ft. being most common.

The depth of the truss for an ordinary pitched roof is generally fixed when the pitch is selected, as shown in Fig. 182 (a), but may be reduced by cambering as shown at (b) in the same figure, or increased as shown at (c). The depth of the truss for a so-called "flat" roof is a matter of choice by the designer; and the common range is from

1/12 to 1/8 of the span. In general the ratio, $\frac{\text{truss depth}}{\text{span length}}$, varies inversely as the span and directly as the load, and abnormal values of either span or load may result in the economic value of this ratio falling outside of the common range given.

The length of panels in a roof truss depends on two factors which may conflict: (1) on the spacing of purlins, which of course depends on the type of roofing or roof surface; and (2) on the slope for the truss diagonals, which should not be much less than 45° with the horizontal and not more than 60° with the horizontal. In trusses for "flat" roofs a common rule is to make the *average* slope of the diagonals about 45° .

When the roof surface is such that the purlin spacing must be relatively small and the depth of the truss is such that long panels are required for proper diagonal slopes it is necessary that the top chord of the roof truss support purlins between panel points (which of course

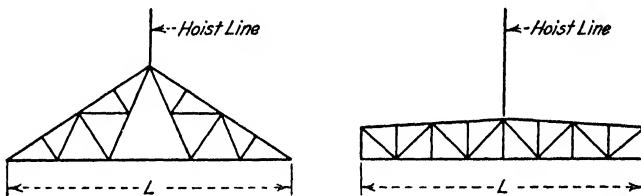

FIG. 184.

results in bending stress in addition to direct stress) as in Fig. 183 (a), or that some form of subdivided truss be used as in Fig. 183 (b).

Having estimated the loads which the truss is to support and established the general proportions such as slope of chords, depth, and panel dimensions, the designer is prepared to calculate the stresses in the various members and proceed to their proportioning.

Proportioning.—The fundamental principles to be observed in the design of tension and compression members were discussed in Chapter IV; the following comments are merely to emphasize those points particularly pertinent to roof-truss design, and to suggest some practical matters which should be considered.

When a truss is handled during fabrication or erection by lifting with the hoist line attached at one point, as indicated in Fig. 184, the bottom chord is in compression and of course has a tendency to sideways buckling. Experience has shown that to permit lifting safely with one point attachment (as is generally most convenient) the bottom

chord should have a width, measured perpendicular to the plane of the truss, not less than is given by

$$b = \frac{L}{125} \tag{144}^*$$

in which b = width of chord at the center;
 L = span of the truss.

L and b are measured in the same units, either feet or inches.

The top chord generally will have a width not less than that of the bottom chord.

It is desirable that the joints be kept as small as is practicable, and to that end web members and gusset plates should be so chosen that it will not be necessary to have more than seven or eight rivets in a single gage line. Thus in the joint shown in Fig. 185 (a) it is preferable that a gusset plate be of such thickness that not over seven

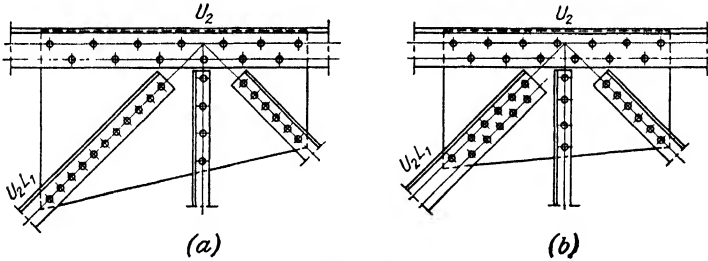

FIG. 185.

or eight rivets are required for the connection of U_2L_1 , or that the member be redesigned with a wider leg against the gusset plate to permit the use of two lines of rivets as shown at Fig. 185 (b). The latter is generally to be preferred if practicable since the gusset plates should have the same thickness throughout the truss and that thickness is better chosen for the *average* joints than for those at the ends where the web member stresses are highest.

The compression diagonals and verticals of single-plane trusses will ordinarily be most efficient if composed of unequal-leg angles with the long legs together. This may be illustrated by study of the sections shown in Fig. 186. The three sections shown have equal areas, but it is clear that for a given length the one in (c) will have the least L/r ratio, and therefore the largest capacity when the slenderness-ratio limits the permissible intensity of stress. However, it is sometimes true

* The author is indebted to Mr. Roberts S. Foulds, of the Phoenix Bridge Company, for this information.

that a pair of equal-leg angles of larger size may be more economical of metal than a pair of unequal-leg angles when the stress to which the member is subjected happens to lie between the capacity of successive sizes of the unequal-leg angles. This may be observed in the situation illustrated by Fig. 187. The stress to which the member is subjected happens to lie between the capacity of the two members of 6 by 4 angles and to be practically equal to the capacity of the member com-

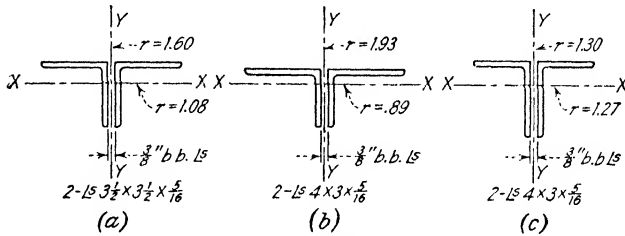

FIG. 186.

posed of 6 by 6 angles. The student should note that a member composed of 2 \angle 7 by 5 by $\frac{1}{2}$,* long legs together, would have a capacity of almost exactly 136 kips and a weight of 39.6 lb. per ft. compared with 43.8 lb. per ft. for the member composed of 6 by 6 angles; the 7 by 5 angles are not so readily obtainable, however, and may command an extra price.

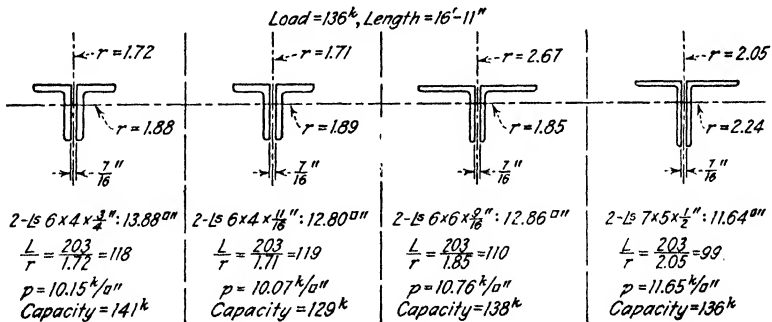

FIG. 187.

Tension diagonals near the center, subjected to small computed stress, may have their stress reversed by wind, or by snow drifting on one side of the roof, and should be designed sufficiently stiff to resist some compression. It does not seem necessary to apply to such mem-

* Angles of this size are not generally listed but are rolled by the Phoenix Iron Company of Phoenixville, Pennsylvania.

bers the same slenderness-ratio restrictions as are applied to main compression members, but the author thinks that the L/r ratio in such cases should not exceed 200 and may perhaps better be kept within 175.

It may be noted that compression diagonals in subdivided single plane trusses, such as U_4L_2 in Fig. 183 (b), will generally be most efficient if designed using unequal-leg angles with the short legs together

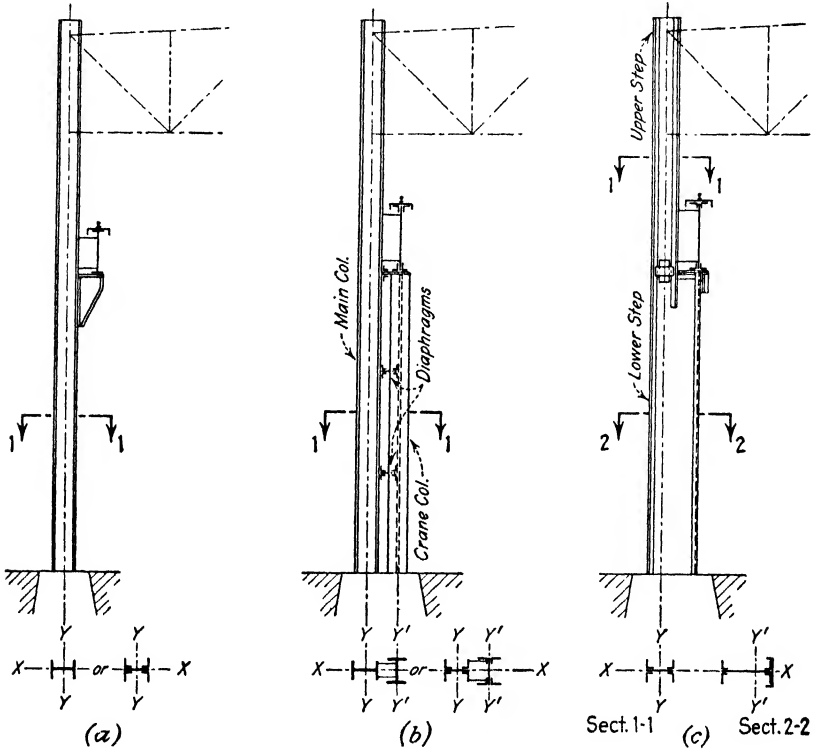

FIG. 188.

as this tends to equalize the L/r ratios about the two axes. The same statement applies of course to compression chords which have lateral support at intervals farther apart than the panel points.

As stated in Chapter IV, the author does not approve of the use of single angles for members carrying calculated stress in single-plane trusses. In addition to the severe bending stresses in the angles themselves such members tend to twist the chords of the truss. There does not seem to be any serious objection to the use of single-angle hangers in

Warren trusses when the weight of the chord is the only load applied at the bottom.

146. Design of Columns.—The fundamental principles discussed in Chapter IV are sufficient for the design of columns for buildings but it seems desirable to add some comments concerning columns which are to support runways for overhead cranes.

The runways for cranes having wheel concentrations of not more than 25,000 to 30,000 lb. are often supported on brackets as indicated in Fig. 188 (a). Runways for cranes with heavier wheel concentrations are generally supported on separate columns set inside the main building columns, as shown in Fig. 188 (b), or on *stepped* or *hammer-head* columns as in Fig. 188 (c). The more common sections of the columns used are shown in Fig. 188, and Fig. 189 shows heavier sections sometimes used for stepped columns. Large industrial buildings may require two or even three levels of crane runways in a single aisle, and it is necessary sometimes to design columns which support two or more crane runways in one aisle and one or more in an adjacent aisle in addition to roof trusses for both aisles. Figure 173 shows columns which support runways in two aisles; other illustrations of such buildings may be found in Chapter II.

Columns supporting runways on brackets should be braced laterally at the bracket level if practicable, particularly if the height of the building exceeds the bay length. Estimating the bending moments due to the eccentricity of the load is difficult as the amount of restraint at the base and at the top is uncertain. It is always safe (though not accurate) to assume that the column is pin-ended in estimating the bending moments: in practical design it is very common to use as a design moment from 6/10 to 8/10 of the maximum moment found assuming pin-connected ends. To the bending moment due to eccentricity should be added that due to side thrust from the cranes. Moments due to wind forces must also be considered; common approximate methods of estimating them were presented in a previous volume.*

* "Theory of Simple Structures," Shedd and Vawter, John Wiley & Sons.

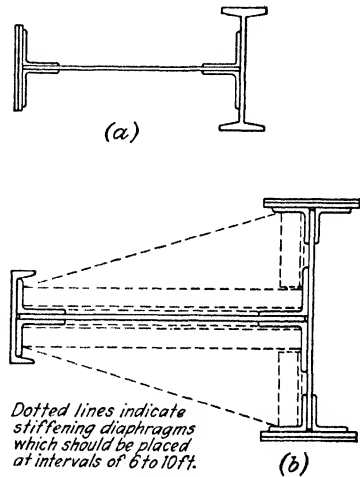

FIG. 189.

When runways are supported on separate columns as in Fig. 188 (b) the main column should be designed to resist the roof loads and the bending moments due to side thrust from the crane and wind forces. The crane column is then proportioned to resist the vertical loads from the runway girders, and the designer should not fail to note that these loads may be eccentrically applied: Fig. 190 illustrates the situation which may occur when the outstanding legs of bearing stiffeners are placed over the flanges of the column as they should be.

The design of any column is necessarily a cut-and-try process and this is particularly true in the stepped column carrying one or more

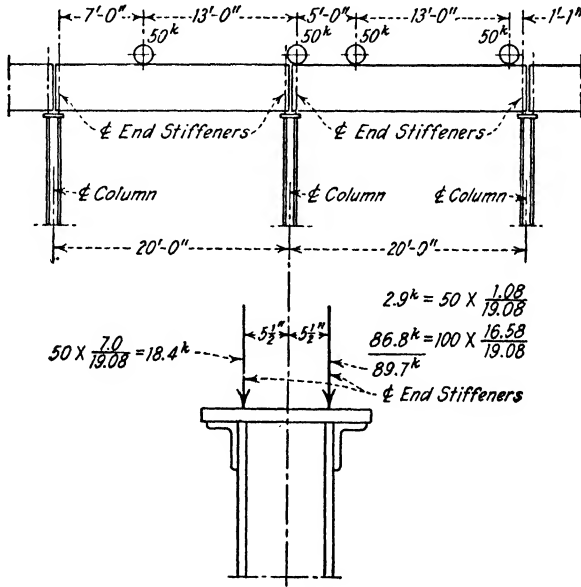

FIG. 190.

crane runways; the design of such columns is often a troublesome problem.

The upper step in stepped columns may be designed as an ordinary column to support the roof load and resist the bending moments resulting from wind forces and side thrust from the cranes; the bending moments are likely to be of controlling importance. In estimating the strength of the upper (and for that matter the lower) step the designer is confronted with the question of what is the L/r ratio about the $Y-Y$ axis; see Fig. 191. It is evidently less than L/r_1 and more than

L/r_2 . As an approximation for design purposes the author suggests an "equivalent" slenderness-ratio of

$$\frac{\frac{L}{r_1} l_1 + \frac{L}{r_2} l_2}{(l_1 + l_2)} = \frac{l_1}{r_1} + \frac{l_2}{r_2} \tag{145}$$

Usually the slenderness-ratio about axis X-X will control the permissible intensity of stress in both the upper and lower steps, but this is not always the case.

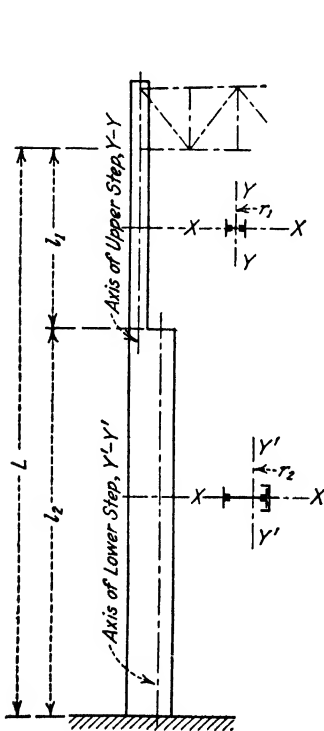

FIG. 191.

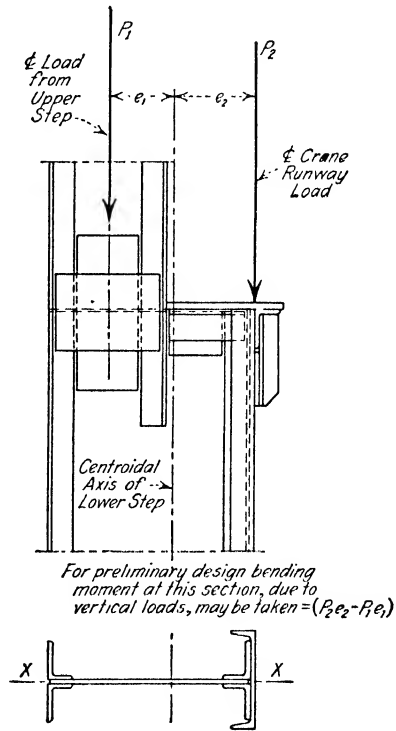

FIG. 192.

To obtain a preliminary section the lower step may be designed to resist the sum of the loads from the roof and the crane runway, acting eccentrically as shown in Fig. 192, plus the bending moments due to side thrust from the crane, and wind forces. A tentative design for both steps having been obtained, the bent may be studied more carefully

by the method of moment distribution or the column analogy * developed by Professor Hardy Cross of the University of Illinois. The designer should be on his guard, however, about accepting too trustfully analyses based on the assumption of fixed ends for the bent. The bending moments at the bottom of the columns which will be developed if the ends are fixed will be large, and though it is possible to design bases which will be fixed to the masonry such bases will be expensive, and there is considerable doubt, at least in the author's mind, as to whether the masonry itself will remain fixed in position when subjected to such severe moments.

147. Illustrative Problems.—To illustrate the application of the foregoing discussion of building design four sets of design calculations are presented: DP 19, DP 20, DP 20A, and DP 20B. The first two are complete and independent, but the last two are carried only far enough to illustrate the design of building parts not covered in the first two examples; in both DP 20A and DP 20B the roof construction is presumed to be the same as in DP 20, although in DP 20B the trusses could be somewhat lighter since there would not be monorail hoists carried on the trusses in high aisles served by bridge cranes.

In studying the design calculations for DP 19 the reader will notice that the purlins have been designed under the assumption that the bottom flange resists the forces parallel to the roof surface and that the bending moment due to these forces has been calculated assuming perfect adjustment of the sag-rods. In designing the top chord of the truss it has been assumed in the first calculation of area that the purlins resting on the chord between panel points provide lateral support for the chord. Some designers prefer to consider that such purlins do not provide lateral support, and of course such an assumption is conservative. In this case, however, the result would not be altered since the requirements at the panel point control the required area. The student will note that the bottom chord, L_2L_3 , does not quite meet the requirement that $L/b = 125$, but comes near enough so that it did not seem necessary to use $3\frac{1}{2}$ legs outstanding with a consequent waste of area.

The second stress diagram on Sheet 3 of DP 20 may be puzzling unless it is recalled that the stress in any bar in the right half of the truss, due to a load at L_3 on the left half, is equal to the stress in the corresponding bar in the left half of the truss due to an equal load at L'_3 on the right half. Keeping this fact in mind the stress in any bar of the truss due to any combination of loads at L_3 and L'_3 may be calculated easily from the diagram for the single 10-kip load.

* See "Continuous Frames of Reinforced Concrete," Cross and Morgan, John Wiley & Sons.

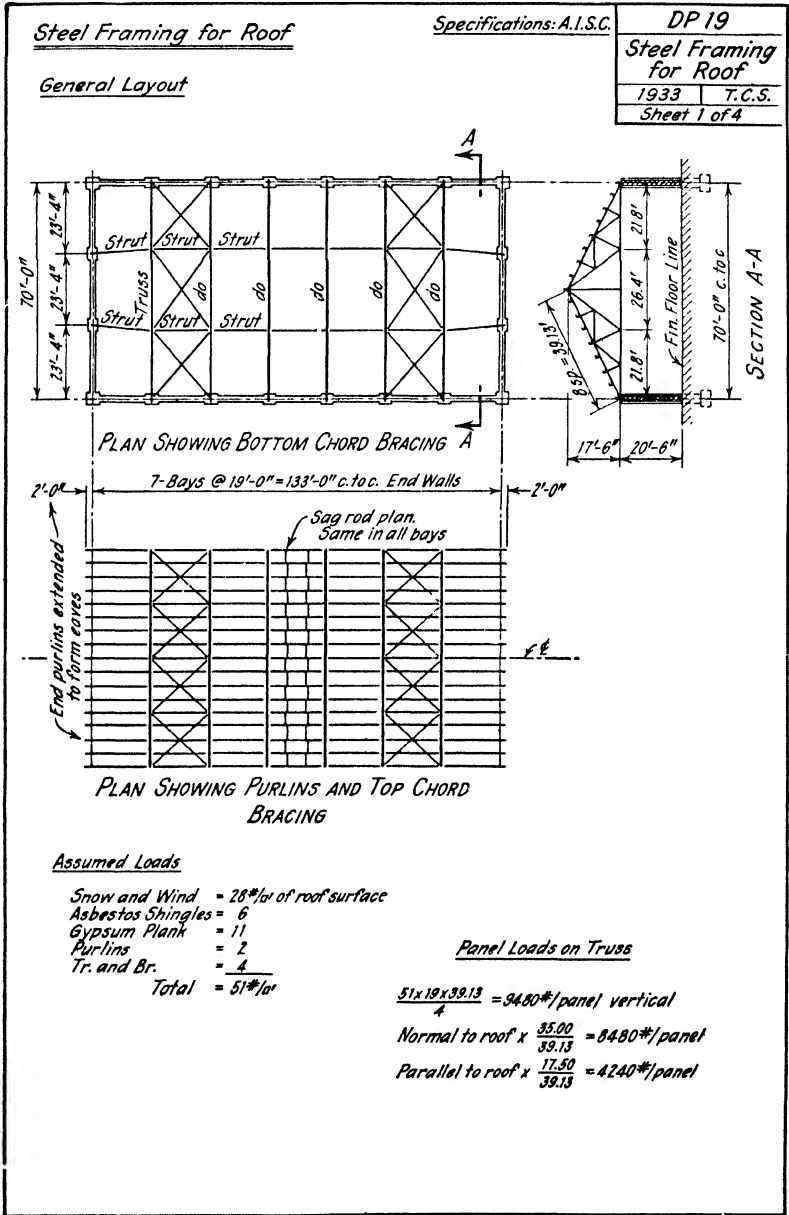

| | |
|-------------------------------|----------|
| DP 19 | |
| Steel Framing for Roof | |
| 1933 | T. C. S. |
| Sheet 2 of 4 | |

Steel Framing for Roof

Purlins

$$\frac{47 \times 39.13}{8} = 230 \#/\text{ft vertical}$$

$$\times \frac{35}{39.13} = 206 \#/\text{ft normal}$$

$$\times \frac{19^2}{8} = 9280 \# \text{ at center}$$

$$\times \frac{6.33 \times 12.67}{2} = 8250 \# \text{ at third pts.}$$

$$230 \times \frac{17.5}{39.13} = 103 \#/\text{ft} \parallel \text{ to roof}$$

$$103 \times \frac{6.33^2}{10} = 412 \# \left\{ \begin{array}{l} \text{parallel to roof} \\ \text{at third pts.} \end{array} \right.$$

Assume $\frac{S}{I} = 22 \pm$

$$S = \frac{I}{C} = \frac{8250 \times 12}{18000} + \frac{412 \times 12}{18000} \times 22 = 11.54 \pm$$

$$\frac{5.50}{6.04}$$

Use $10'' \text{ L @ } 15.3 \#/\text{ft} \frac{I}{C} = 13.4$

$$16 \text{ - lines } \times (133+4)' \times 15.3 \#/\text{ft} = 33,540 \#$$

Ridge Purlin

$$47 \times \frac{19}{3} \times 39.13 \times \frac{17.5}{39.13} = 5210 \#$$

$$5210 \times \frac{17.50}{39.13} = 2370 \#$$

$$230 \#/\text{ft}$$

$$2 \times 2370 \# = 4740 \#$$

$$230 \times \frac{19^2}{8} = 10,380 \#$$

$$4740 \times \frac{19}{3} = \frac{30,020}{40,400 \#}$$

$$\text{@ } \frac{12}{18000}, \frac{I}{C} = 26.9$$

$$10'' \text{ I @ } 30 \#/\text{ft} \frac{I}{C} = 26.7$$

$$12'' \text{ I}_p \text{ @ } 25 \#/\text{ft} \frac{I}{C} = 30.8$$

$$1 \text{ - line } \times (133+4)' \times 30 \#/\text{ft} = 4,110$$

Sag Rods

$$32 \times 7 = 224 \text{ rods @ } 5.33 \times 104.3 = 1250 \#$$

$$448 \text{ nuts @ } 10 \#/100 = \frac{50}{1300} = 1,300$$

Top Chord Bracing

$$\frac{7}{8}'' \phi \text{ Rods (no upset)} \quad 16 \text{ - } \frac{7}{8}'' \text{ Rods @ } 2.044 \#/\text{ft} \times \text{abt. } 26.8' = 875$$

$$32 \text{ - Std. Nuts @ } 18 \#/100 = \frac{5}{880}$$

Sheet = 33,830 #
Forward to Sheet 4

| <u>Steel Framing for Roof</u> | | | | | DP 19 |
|--|---------------|------------------|----------------|-------------|---------------------------|
| <u>Trusses (For truss diagram and stresses see Sheet 3)</u> | | | | | Steel Framing for Roof |
| <u>Member</u> | <u>Stress</u> | <u>Req. Area</u> | <u>Section</u> | <u>Area</u> | 1933 T.C.S. |
| | | | | | Sheet 4 of 4 |
| Forward = 39,830* | | | | | |
| $5,180 \text{#}^*$ Lo U1 - 74,000# $\ddagger = 8.61 \text{in}^2 \text{gr.}$ U1 U2 - 69,800 U2 U3 - 65,500 U3 U4 - 61,300 Lo L1 + 66,700 @ 18.0 = 3.68 net } 2-1 $\frac{1}{2}$ 6 x 3 $\frac{1}{2}$ x $\frac{1}{2}$ T = 9.00 in gr. @ 15.3 #/ft x 40.1' = 2450* L1 L2 + 56,800 @ 18.0 = 3.16 " } L2 L3 + 37,900 @ 18.0 = 2.11 " } 2-1 $\frac{1}{2}$ 3 x 2 $\frac{1}{2}$ x $\frac{1}{4}$ JL = 3.64 net @ 7.2 x 209 = 600 U1 L1 - 8,500 @ 13.6 = 0.63 gr. } 2-1 $\frac{1}{2}$ 3 x 2 $\frac{1}{2}$ x $\frac{1}{4}$ JL = 2.18 " @ 4.5 x 260 = 235 U3 M3 - 8,500 @ 13.6 = 0.63 gr. } 2-1 $\frac{1}{2}$ 2 $\frac{1}{2}$ x 2 x $\frac{1}{4}$ T = 2.12 gr @ 3.6 x 4.2 = 60 U2 L2 - 17,000 @ 10.9 = 1.56 " } 2-1 $\frac{1}{2}$ do " @ 3.6 x 4.2 = 60 U2 L1 + 9,400 @ 18.0 = 0.52 net } 2-1 $\frac{1}{2}$ 3 $\frac{1}{2}$ x 2 $\frac{1}{2}$ x $\frac{1}{4}$ T = 2.88 " @ 4.9 x 9.1 = 180 U2 M3 + 9,400 @ 18.0 = 0.52 " } 2-1 $\frac{1}{2}$ 2 $\frac{1}{2}$ x 2 x $\frac{1}{4}$ T = 1.68 net @ 3.6 x 9.6 = 140 U4 M3 + 28,400 @ 18.0 = 1.58 " } 2-1 $\frac{1}{2}$ do " @ 3.6 x 9.6 = 140 M3 L2 + 19,000 @ 18.0 = 1.06 " } 2-1 $\frac{1}{2}$ do " @ 3.6 x 20.6 = 285 U4 L3 - - - - - } 1-L 2 $\frac{1}{2}$ x 2 x $\frac{1}{4}$ = .84 net @ 3.6 x 16.3 = 60 Details abt. 23% (includes wall plates) = 980 Total for 1-Truss = 5200 | | | | | |
| * Mom. = $\pm \frac{4240 \times 9.78}{8} = \pm 5180 \text{#}$ | | | | | |
| $\ddagger \left\{ \begin{aligned} A &= \frac{74,000}{14,900} + \frac{5180 \times 12 \times 2.08}{18000 \times 1.92^2} = 6.91 \text{ in}^2 \text{ gr.} \\ \text{or } A &= \frac{74,000}{15,000} + \frac{5180 \times 12 \times 3.92}{18000 \times 1.92^2} = 8.61 \text{ in}^2 \text{ gr.} \end{aligned} \right.$ | | | | | x 6 = 31,200 |
| <u>Bottom Chord Bracing</u> | | | | | |
| All diagonals 1-L 3 x 2 $\frac{1}{2}$ x $\frac{1}{4}$ 8-1 $\frac{1}{2}$ abt. 27.5' @ 4.5 = 990 4-1 $\frac{1}{2}$ " 30.9 @ 4.5 = 555 Details abt. = 685 2730 | | | | | |
| | | | | | 2,230 |
| <u>Struts</u> | | | | | |
| 2-1 $\frac{1}{2}$ 4 x 3 x $\frac{1}{4}$ JL @ 5.8 x 18.3 = 210 Dets. average = $\frac{5}{215 \text{#}}$ x 14 | | | | | |
| | | | | | 3,010 |
| Total = 76,270 | | | | | |
| <u>Say 76,300#</u> | | | | | |

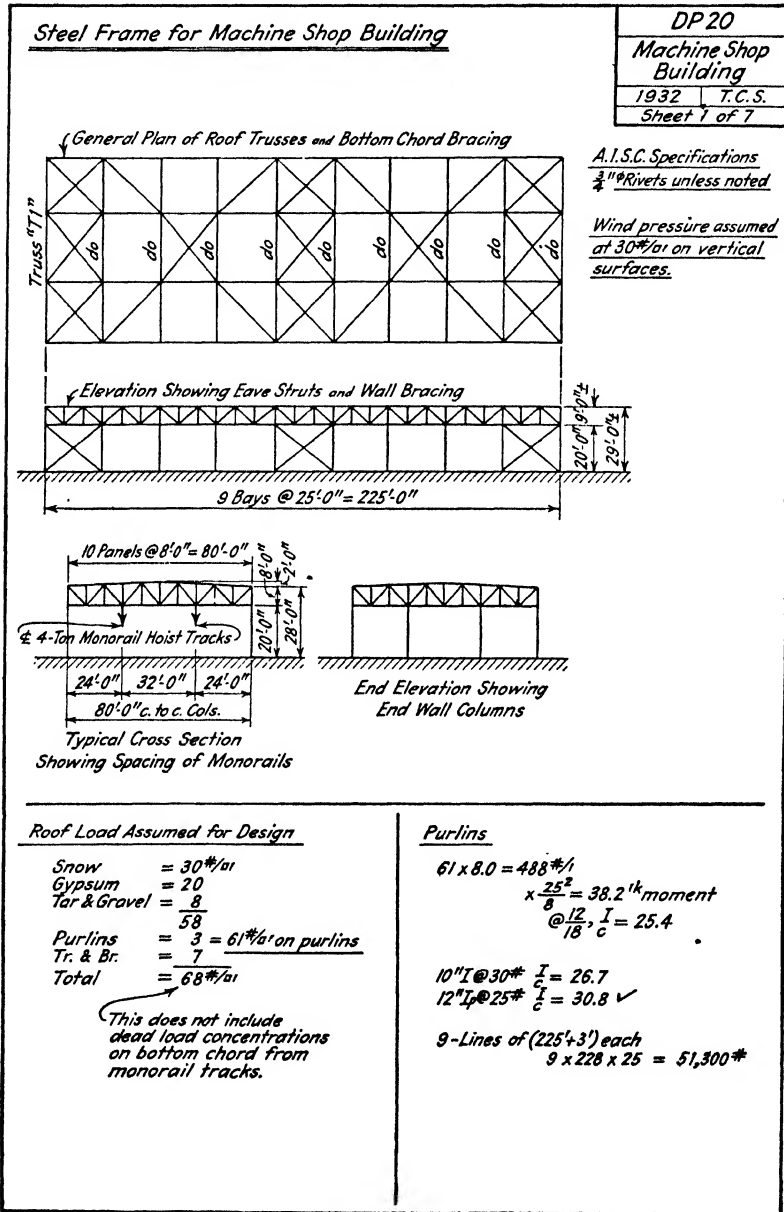

Steel Frame for Machine Shop Building

| | |
|-----------------------|--------|
| DP 20 | |
| Machine Shop Building | |
| 1932 | T.C.S. |
| Sheet 2 of 7 | |

Monorail Track

| | |
|-----------------------------|--|
| Capacity 4-Tons = 8000* | <u>Moment</u> |
| Weight of Hoist = 2500* | L.L. = $10.5 \times \frac{25}{8} = 65.6^k$ |
| 10,500* | Imp. = 25% = 16.4 |
| Wt. of Track assumed 60*/ft | D.L. = $.06 \times \frac{25^2}{8} = 4.7$ |
| | Total = 86.7^k |
| | $\times 12 = 1040^k$ |

Min. width of comp. flange = $\frac{25 \times 12}{40} = 7.50''$ $\frac{L}{b} = 40$
 $s = 11.1$
 $\frac{I}{C} = \frac{1040}{11.1} = 93.6$
 { 18" W₈ @ 52 $\frac{I}{C} = 94.6$
 Fig. width = 7.53"

Composite Section

| | | | | |
|----------------------------|--------------------|------|---------|------------------|
| | A | y | Ay | I _{x-x} |
| 15" I _p @ 36.0* | 10.59 in | | | 400.9 |
| 8" L @ 11.5 | 3.36 x 7.14 = 24.0 | 7.14 | = 171.3 | 7.3 |
| 47.5* | 13.95 in | | 24.0 | 573.5 |
| | | | 1.72 in | 41.2 |
| | | | | 532.3 |

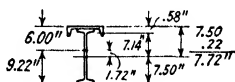

$s = \frac{1040 \times \left\{ \frac{6.00}{9.22} \right\}}{532.3} = \left\{ \begin{array}{l} 11.72^k \text{ in top flange} \\ 18.01^k \text{ in bott. } \end{array} \right\}$ o.k.

$\frac{L}{b} = \frac{25 \times 12}{8} = 37.5$
 $s_c = 11.74^k \text{ in}$

1 - 15" I_p @ 36.0* x 24.96' = 900*
 1 - 8" L @ 11.5* x 24.96' = 280
 Riv. Hds. + c = 20
 1200* x 18 = 21,600*

Truss

Panel loads { Top = $68 \times 8.0 \times 25 = 13.6^k$ per panel from snow, deck, +c.
 Bott: = $52 \times 25 = 1.3$ " " " " monorail track

Monorail $\left. \begin{array}{l} 10.5^k \text{ L.L.} \\ 2.6 \text{ Imp.} \end{array} \right\} = 13.1^k$ at each or either L3 point

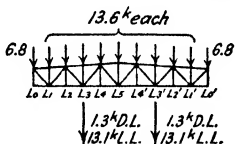

See Sheet 3 for stress diagrams.

Min. width for bott. chord = $\frac{80 \times 12}{125} = 7.7$ Say 8"

Steel Frame for Machine Shop Building

(See Sheet 3 for stress diagrams)

| | |
|-----------------------|--------|
| DP20 | |
| Machine Shop Building | |
| 1932 | T.C.S. |
| Sheet 4 of 7 | |

Truss "T1"

| Member | Stress | Section | Area |
|-------------|-----------------------------|------------------------|---|
| UoU2 | -71,500* @ 14.5 = 4.93" gr. | 2-15 5/8 x 3 1/2 x 1/8 | $\Gamma = 5.12^{\text{a}} \text{ gr.} @ 8.7^{\text{a}}/1 \times 14.4' = 500^{\text{a}}$ |
| U2U4 | -161,200 @ 15.0 = 10.73 " | 2-15 5/8 x 6 x 1/2 | $\Gamma = 11.50 \text{ gr.} @ 19.6 \times 24.8' = 1940$ |
| U4U5 | -170,300 @ 15.0 = 11.35 " | | |
| LoL1 | -20,700* @ 13.6 = 1.14 " | 2-15 5/8 x 3 x 1/4 | $\Gamma = 3.38 \text{ gr.} @ 5.8 \times 6.7 = 160$ |
| L1L3 | +124,500 @ 18.0 = 6.92" net | 2-15 5/8 x 6 x 1/2 | $\text{JL} = 9.74 \text{ net} @ 19.6 \times 65.5 = 2570$ |
| L3L5 | +171,700 @ 18.0 = 9.53 " | | |
| UoL1 | +101,300 @ 18.0 = 5.63 " | 2-15 5/8 x 3 x 1/8 | $\Gamma = 5.86 \text{ net} @ 11.3 \times 9.5 = 430$ |
| U2L1 | -79,000 @ 11.7 = 6.75 gr. | 2-15 5/8 x 3 1/2 x 1/8 | $\Gamma = 7.05 \text{ gr.} @ 12.0 \times 10.8 = 520$ |
| U2L3 | +54,800 @ 18.0 = 3.04 net | 2-15 3/8 x 2 1/2 x 1/8 | $\Gamma = 3.02 \text{ net} @ 6.1 \times 10.8 = 260$ |
| U4L3 | -23,200 @ 10.1 = 2.35 gr. | 2-15 5/8 x 3 x 1/4 | $\Gamma = 3.38 \text{ gr.} @ 5.8 \times 11.3 = 260$ |
| U4L5 | -6,300 @ 10.1 = .62 gr. | 2-15 5/8 x 3 x 1/4 | $\Gamma = 3.38 \text{ gr.} @ 5.8 \times 11.4 = 260$ |
| Vert. Posts | -13,600 @ 10.3 = 1.23 gr. | 2-15 3/8 x 2 1/2 x 1/4 | $\Gamma = 2.62 \text{ gr.} @ 4.5 \times 8.3 \text{ av.} = 370$ |
| Hangers | - | 1-L3 x 2 1/2 x 1/4 | $L = 1.09 \text{ net} @ 4.5 \times 8.3 \text{ av.} = 150$ |
| Details | - abt. 16% | | $= 1180$ |
| | * Wind Stress See Sheet 5 | | 8600^{a} |
| | | | $\times 10 = 86,000^{\text{a}}$ |

Bracing (See Sheet 1 for general layout)

Bottom Chord Bracing: all 1-L3 x 2 1/2 x 1/4"

20 - 3 x 2 1/2 x 1/4 L3 @ 4.5* / x 38.5' av. = 3020
 10 - do @ 4.5 x 38.5' av. = 1730
 Conn. pls. and riv. hds. abt. = 850
 5600 = 5,600

Wall Bracing: all diagonals 2-15 2 1/2 x 2 x 1/4"

24 - 2 1/2 x 2 x 1/4 L5 @ 3.6* / x 31.5' av. = 2720
 Conn. details abt. = 400
 3120 = 3,120

Eave Struts:

$g^2 = 81.0$
 $8.3^2 = 69.4$
 $12.3 = 150.4$

61 x 10 x 5/8 = 381 # / 1 fram roof
 54 " strut
 435 # / 1 total

2-Top 15 5/8 x 4 x 1/2 @ 6.6 x 24.8' = 330
 2-Bot 15 5/8 x 4 x 1/2 @ 6.6 x 24.8' = 330
 6-Diag. 15 2 1/2 x 2 x 1/4 @ 3.6 x 11.8' = 260
 2-Vert. 15 3 x 3 x 1/2 @ 4.9 x 8.6' = 80
 Details abt. = 150
 1150*
 $\times 18 = 20,700$

Top Chord:
 Top Chord Moment
 $= \frac{435 \times 8.33^2}{8} \times \frac{3}{4} = 2830 \text{ #}$
 $A = \frac{3360}{13,400} + \frac{2830 \times 12 \times 2.91}{18,000 \times 1.25^2} = .25 + 3.51 = 3.76^{\text{a}} \text{''}$

Bot. Chord:

Make same as top to permit turning over

Diagonals: Max. $\frac{L}{r} = 200$, min. $r = \frac{12.3 \times 12}{200} = .74$
 Each 2-15 2 1/2 x 2 x 1/4

Verticals:

Min. $r = \frac{108}{200} = .54$, Each 1-L3 x 3 x 1/4

Steel Frame for Machine Shop Building

| | |
|-----------------------|----------|
| DP 20 | |
| Machine Shop Building | |
| 1932 | T. C. S. |
| Sheet 5 of 7 | |

Columns

Side Wall Columns

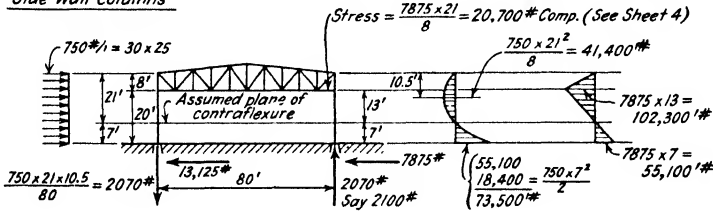

Col. Load

$$\begin{aligned} \frac{25 \times 80}{2} \times 68 &= 68,000 \# \text{ from roof} \\ 1,200 & \text{ " monorail track} \\ 13,100 & \text{ " " hoist, load and impact} \\ 2,100 & \text{ " lateral wind force} \\ \hline & 84,400 \# \text{ Total} \end{aligned}$$

Required area at point of max. mom.

$$A = \frac{84,400}{\frac{2}{3} \times 15,000} + \frac{102,300 \times 12 \times 6.03}{\frac{2}{3} \times 18,000 \times 5.23^2} = 4.22 + 11.28 = 15.50 \text{ in}^2 \text{ gr.}$$

Required area 4' below bottom of truss $\frac{L}{b} = \frac{240}{10} = 24, s_c = 15,500$

$$\text{Moment} = \frac{9}{13} \times 102,300 = 70,800 \# \quad \frac{L}{r} = \frac{240}{2.48} = 97, s_1 = 11,700:$$

$$A = \frac{84,400}{\frac{2}{3} \times 11,700} + \frac{70,800 \times 12 \times 6.03}{\frac{2}{3} \times 15,500 \times 5.23^2} = 5.41 + 9.08 = 14.49 \text{ in}^2 \text{ gr.}$$

$$\begin{aligned} 1 - 12 \text{ " WF @ } 53 \times 28.9 \text{ '} &= 1530 \# \\ \text{Base abt.} &= \frac{600}{2130 \#} \\ &\times 20 = 42,600 \end{aligned}$$

End Wall Columns (Design calculations based on girts 6'-7' apart)

$$\begin{aligned} \frac{30(24 + 32)}{2} &= 840 \#/\text{ft} \\ &\times \frac{20^2}{8} = 42,000 \# \\ &\text{ @ } \frac{12}{24,000}, I_c = 21 \\ &10 \text{ " } I_p \text{ @ } 21.0 \# \quad I_c = 21.7 \\ &10 \text{ " } I \text{ @ } 25.4 \quad I_c = 24.4 \end{aligned}$$

$$\begin{aligned} 1 - 10 \text{ " } I_p \text{ @ } 21.0 \times 19.9 \text{ '} &= 420 \# \\ \text{Base abt.} &= \frac{55}{475 \#} \times 4 = 1,900 \end{aligned}$$

Steel Frame for Machine Shop Building

| | |
|-----------------------|----------|
| DP 20 | |
| Machine Shop Building | |
| 1932 | T. C. S. |
| Sheet 6 of 7 | |

Wall Column Base

Moment = 73,500*
 Direct Load = { 84,400* maximum
 41,300* minimum (no snow or hoist load)

Max. permissible masonry pressure = $\frac{4}{3} \times 600 = 800 \text{*/sq"}$

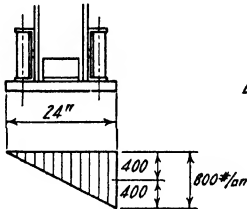

400*/sq" initial pressure
 400*/sq" bending pressure
 800*/sq"

$bd^2 = \frac{6M}{s} = \frac{6 \times 73,500 \times 12}{400} = 13,230$

$d = 24 \text{"}$

$b = \frac{13,230}{24 \times 24} = 23.0 \text{"}$

Base 23" x 24"

Initial pressure = $23 \times 24 \times 400 = 220,800 \text{#}$
 Col. Load (min.) = 41,300

Initial anchor bolt pull = 179,500*

$\frac{179,500}{2} = 89,750 \text{# anchor bolt pull per side}$

@ 24,000*/sq" Area = 7.48 sq" at root of thread
 + 4 = 1.87 sq" per bolt

@ $24 \times \frac{4}{3} = 2.81 \text{ sq" in stiffeners}$

Use 4 - 1 7/8" # bolts { Hook bottom ends or provide with nut & washer 4 x 4 x 3/4"

@ $5.96 \times \frac{4}{3} = 11.3 \sim$ not less than 12 rivets per flange

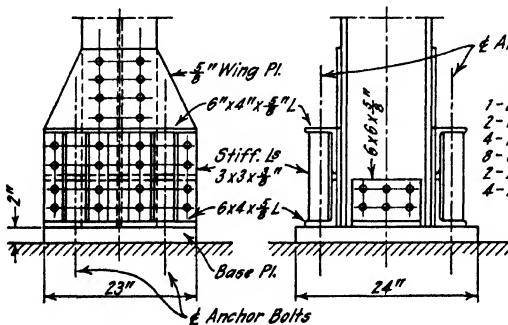

Material for Base

- 1- Base Pl. 23" x 2" x 2'-0"
- 2- Wing Pls. 23" x 5/8" x 2'-0" ±
- 4- Ls 6" x 4" x 5/8" x 1'-11"
- 8- Stiff. Ls 3" x 3" x 5/8" x 1'-0" ±
- 2- Ls 6" x 6" x 5/8" x 9" ±
- 4- Anchor Bolts 1 7/8" # x 5'-6"

Steel Frame for Machine Shop Building

DP 20

Machine Shop Building

1932 T.C.S.
Sheet 7 of 7

Alternate Design of Wall Columns (Assuming bottom ends hinged)

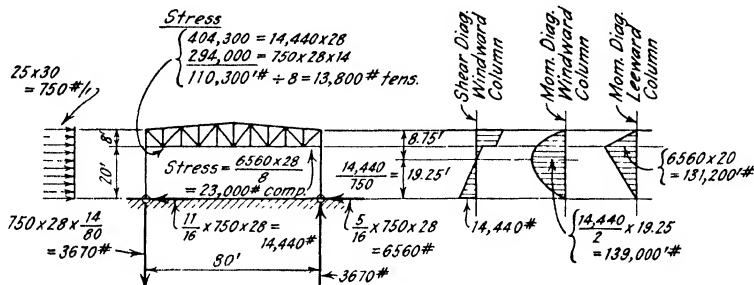

Column Load

| | |
|--|---|
| $\frac{25 \times 80}{2} \times 68 = 68,000 \#$ | from roof |
| 1,200 | " monorail track |
| 13,100 | " " hoist, load & impact |
| <u>82,300 #</u> | without wind $\pm 3,800$ " lateral wind force |
| 86,100 # | on leeward column |
| 78,500 | " windward " |

Required area at point of max. positive moment

$$A = \frac{78,500}{\frac{4}{3} \times 15,000} + \frac{139,000 \times 12 \times 6.96}{\frac{4}{3} \times 18,000 \times 5.98^2} = 3.93 + 13.53 = 17.46 \text{ "gr.}$$

Required area 4' below bottom of truss, windward side.

$$\text{Moment} = \left\{ 1 - \left(\frac{3.25}{19.25} \right)^2 \right\} 139,000 = 135,000 \#$$

$$\frac{L}{r} = \frac{240}{3.08} = 79 \quad s_1 = 13,370 \#/\text{in} \quad \frac{L}{b} = \frac{240}{12.04} = 19.9 \quad s_c = 16,690 \#/\text{in}$$

$$A = \frac{78,500}{\frac{4}{3} \times 13,370} + \frac{135,000 \times 12 \times 6.13}{\frac{4}{3} \times 16,690 \times 5.31^2} = 4.40 + 15.84 = 20.24 \text{ "gr.}$$

Base

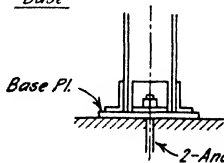

- 1-12" WF @ 72# x 28.9 = 2080#
- Base abt. = 720
- 2300#
- 1 - Base Pl. 14 x 1 1/2 x 1'-10"
- 2 - LB 6 x 4 x 1/2 x 1'-2"
- 2 - L₂ 6 x 6 x 1/2 x 9"
- 2 - Anchor Bolts 1 1/2 x 3'-0"

Steel Framing for Industrial Building

| | |
|----------------------------|----------|
| DP 20A | |
| Industrial Building | |
| 1934 | T. C. S. |
| Sheet 1 of 5 | |

General Plan of Roof Trusses and Bottom Chord Bracing same as for "DP 20"

A.I.S.C. Specifications
 $\frac{3}{4}$ " Rivets unless noted

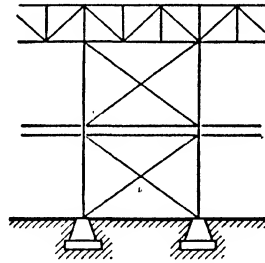
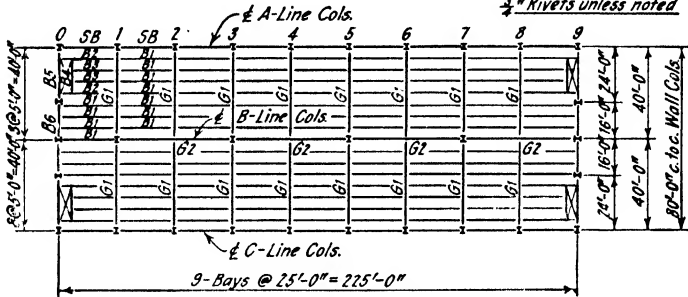

Elevation of Typical Braced Bay
 (See Sheet 4 for Typical Cross Section)

Steel Framing for Industrial Building

Beams "B1" (Other beams not included in these calculations)

$352\#/or \times 5' = 1760\#/l$
 $\times \frac{25^2}{8} = 137.5\#k$

Shear $1760 \times \frac{25}{2} = 22,000\#$

$\text{Live Load} = 250\#/or$
 Dead Load
 $5\frac{1}{2}$ Slab = 69
 Wood Blocks = 15
 Sand Cushion = 5
 Beams = $13 - 102\#/ord.l.$
Total = 352\#/or

$\text{at } \frac{12}{18} \cdot \frac{I}{c} = 91.6$
 $\frac{18'' I}{60\#} \cdot \frac{I}{c} = 93.1$

DP 20A

Industrial Building

1934 T.C.S.
Sheet 2 of 5

Girder "G1"

Max. Moment
 $154 \times 20 = 3080$
 $3 \times 44 \times 10 = 1320$
 $.25 \times \frac{40^2}{8} = 50$
 Total = $1810\#k$
 $+ 4.70' = 385\# \text{ Ftg. Str.}$
 $\text{at } 18' = \underline{21.40\#net}$

Max. Shear
 $159\#k$
 $\text{at } 12\frac{1}{2}' or = 13.25\# gr. web$
 $\text{at } 8.45\# = 19 rivs. \text{ by on } \frac{3}{8}'' \text{ web}$
 $\text{at } 11.88\# = 14'' \text{ in conn. } l\#$
 $\text{at } 3.94\# = 21'' \text{ to column}$

Shear Diagram

| | |
|--|---|
| <p>1- Web $58 \times \frac{3}{8} = 21.75\#k, \frac{1}{2} = 2.72\#k$</p> <p>2- Top l# $6 \times 6 \times \frac{3}{8}$</p> <p>1- Top Pl. $14 \times \frac{3}{8}$</p> <p>2- Bott. l# $6 \times 6 \times \frac{3}{8} = 14.22 - 2.19 = 12.03, + 2.72 = 14.75$</p> <p>1- Bott. Pl. $14 \times \frac{3}{8} = 7.88 - .39 = 6.89, + 14.75 = 21.64\#net$</p> <p>4- Conn. l# $4 \times 4 \times \frac{3}{8}$</p> <p>4- End Fills $7 \times \frac{3}{8}$</p> <p>18- Int. Stiffs. $5 \times 3 \times \frac{3}{8}$</p> <p>18- Int. Fills $3 \times \frac{3}{8}$</p> <p>4- Seat l# $3\frac{1}{2} \times 3\frac{1}{2} \times \frac{3}{8}$</p> <p>4- Beam Fills $8 \times \frac{3}{8}$</p> <p style="text-align: center;">Rivet Hds. etc. abt. $2\frac{1}{2}\%$</p> | <p>$2\frac{1}{2}\%$ Pl. excess = 75</p> <p>@ $74.0 \times 39.8 av. = 2945$</p> <p>@ $24.2 \times 39.8 = 1925$</p> <p>@ $26.8 \times 24.0 = 645$</p> <p>@ $24.2 \times 39.8 = 1925$</p> <p>@ $26.8 \times 24.0 = 645$</p> <p>@ $11.3 \times 4.8 = 215$</p> <p>@ $14.9 \times 3.9 = 230$</p> <p>@ $8.2 \times 4.8 = 710$</p> <p>@ $6.4 \times 3.9 = 450$</p> <p>@ $8.5 \times 0.7 = 25$</p> <p>@ $17.0 \times 1.3 = 90$</p> <p>= 250</p> <p>1-Girder Total = 10,130\#</p> <p style="text-align: right;">$\times 16 = 162,080$</p> |
|--|---|

| | |
|---|--|
| <u>Rivet Pitch</u> | <u>Stiffener Spacing</u> |
| 0-1 $\frac{8.45 \times 55.0}{159} = 2.94''$ | 0-1 $85 \times \frac{1}{8} \sqrt{\frac{18000}{7300} - 1} = 39''$ |
| 1-2 $\frac{8.45 \times 55.0}{113} = 4.11''$ | 1-2 $85 \times \frac{1}{8} \sqrt{\frac{18000}{5200} - 1} = 50''$ |
| 2-3 $\frac{8.45 \times 56.5}{69} = 6.32''$ | 2-3 $85 \times \frac{1}{8} \sqrt{\frac{18000}{3170} - 1} = 69''$ |
| 3-4 $\frac{8.45 \times 56.5}{23} = 20.56''$ | 3-4 Not to exceed 60'' |

Steel Framing for Industrial Building

| | |
|---------------------|--------|
| DP 20A | |
| Industrial Building | |
| 1934 | T.C.S. |
| Sheet 3 of 5 | |

Girder "G2"

$318k = 2 \times 159k$
 $89\#/\text{ft}^2$ Slab and Blocks } Floor strip
 250 Live Load
 $1695 = 5' \times 339\#/\text{ft}$
 305 Girder etc.
 $2700\#/\text{ft}$ unit. load

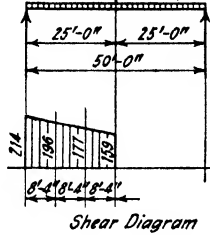

Max. Moment

$$318 \times \frac{50}{4} = 3980'k$$

$$2.2 \times \frac{50^2}{8} = 688$$

$$\text{Total} = 4668'k$$

$$\div 6.04' = 773'k \text{ Flg. Str.}$$

$$\text{@ } 18 = 42.94' \text{ net}$$

Max. Shear

$$318 \times \frac{1}{2} = 159$$

$$2.2 \times \frac{50}{2} = 55$$

$$\text{Total} = 214'k$$

@ 12.0 = 17.83' gr.
 @ 8.45 = 25.4 ~ 26 rivs. bg. on $\frac{1}{2}$ web
 @ 11.88 = 18.1 ~ 18 " in conn. $\frac{1}{2}$
 @ 5.94 = 36.0 ~ 36 " to column

Material for 1-Girder

- 1 - Web $72 \times \frac{1}{2} = 27.00' \text{ gr. } \frac{1}{2} = 3.38' \text{ net}$
 - 2 - Top $\frac{1}{8}$
 - 1 - Top Pl. $14 \times \frac{1}{8}$
 - 1 - do
 - 1 - do
 - 2 - Bott. $\frac{1}{8}$ $6 \times 6 \times \frac{1}{2} = 16.88 - 2.63 = 14.25, + 3.38 = 17.63$
 - 1 - Bott. Pl. $14 \times \frac{1}{8} = 9.63 - 1.20 = 8.43, + 17.63 = 26.06$
 - 1 - do do = do = 8.43, + 26.06 = 34.49
 - 1 - do do = do = 8.43, + 34.49 = 42.92' net
 - 4 - End Conn. $\frac{1}{8}$ $4 \times 4 \times \frac{1}{2}$
 - 4 - End Fills $7 \times \frac{1}{2}$
 - 28 - Int. Stiffs. $5 \times 3 \times \frac{1}{8}$ crimped
 - 2 - Fills $16 \times \frac{1}{2}$
 - 2 - Seat $\frac{1}{8}$ $4 \times 4 \times \frac{1}{2}$
- Riv. Hds. etc. abt. $2\frac{1}{2}'$

- $3\frac{1}{2}'$ Pl. excess = 160#
- @ 91.8 x 49.9 = 4580
- @ 28.7 x 49.9 = 2865
- @ 32.7 x 35.0 = 1145
- @ 32.7 x 25.0 = 820
- @ 32.7 x 14.0 = 460
- @ 28.7 x 49.9 = 2865
- @ 32.7 x 35.0 = 1145
- @ 32.7 x 25.0 = 820
- @ 32.7 x 14.0 = 460
- @ 12.8 x 5.9 = 300
- @ 17.8 x 5.0 = 360
- @ 8.2 x 5.9 = 1355
- @ 40.8 x 4.7 = 385
- @ 12.8 x 1.0 = 25
- = 505

Total for 1-Girder = 18,250#
x 4 = 73,000#

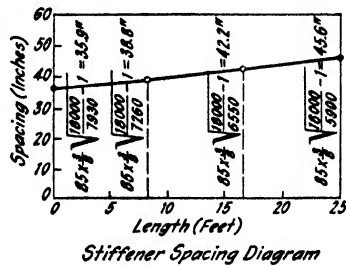
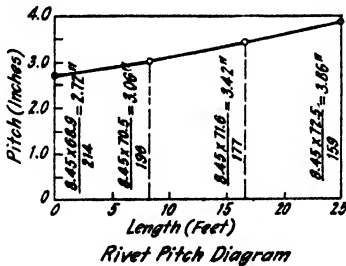

Steel Framing for Industrial Building

DP 20A

Industrial
Building

1934 T.C.S.

Sheet 5 of 5

Columns (Cont.)B-Line Cols.

$$\frac{L}{r} = \frac{17.5 \times 12}{4.10} = 51.2, s_1 = 15,000$$

$$2\text{-Girders "G1"} = 318,000\#$$

$$A = \frac{746,000}{15,000} = 49.7\text{ gr. min.}$$

$$2\text{-Girders "G2"} = 428,000$$

$$\text{Total} = 746,000\#$$

$$A = \frac{746,000}{\frac{4}{3} \times 15,000} + \frac{307,500 \times 12 \times 8.00}{\frac{4}{3} \times 18,000 \times 6.62^2} = 65.35\text{ gr.}$$

$$\underline{\underline{14\text{'' WF @ } 228\# = 67.06\text{ gr.}}}$$

Steel Framing for Industrial Building

Crane Runway Columns

A.I.S.C. Specifications
 $\frac{3}{4}$ " Rivets Unless Noted

General Plan of Roof Trusses and Bottom Chord Bracing Same as for "DP20"

2-60 Ton Whiting O.E.T. Cranes in Aisle
 Wind 30#/ft

DP 20B

Industrial Building

| | |
|--------------|--------|
| 1934 | T.C.S. |
| Sheet 1 of 4 | |

Elevation Showing Typical Wall Bracing

Typical Cross Section

Design "A" Separate Crane Columns.

Main Wall Cols.

Assumed Line of Side Thrust

Assumed Plane of Contraflexure

$\frac{75 \times 33}{2} = 12.38^k$ Shear to each col.

Assumed Moment Diag. Due to Side Thrust

(See DP20 Sheets 1 & 5)

Direct Load from Roof ($\frac{1}{2}$ Snow Load)

$\frac{25 \times 80}{2} \times 53^{\#}/ft = 53^k$

53^k Roof
 5.1 Wind
 58.1^k Total

82.3^k Side Thrust
 309.0 Wind
 391.3^k Total

Windward Assumed Moment Diagrams Due to Wind

Leeward Assumed Moment Diagrams Due to Wind

$A^* = \frac{58.1}{\frac{4}{3} \times 15} + \frac{391.3 \times 12 \times 7.38}{\frac{4}{3} \times 18 \times 6.31^2} = 39.1^{gr}$

2.91 36.2 Use 14" WF @ 136# A = 39.98^{gr}

* Note that $\frac{1}{3}$ is not a factor since moment occurs at a point braced in both directions.

Steel Framing for Industrial Building

Crane Runway Columns (Cont.)

Design "A" Separate Crane Columns

| | |
|---------------------|--------|
| DP 20B | |
| Industrial Building | |
| 1934 | T.C.S. |
| Sheet 2 of 4 | |

Crane Col.

Dead Load: Girder = 250*
 Rail etc. = 30
 Total = 280*

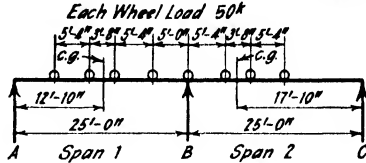

Reaction on Col. B:

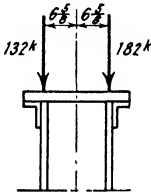

From Span 1 = $4 \times 50 \times \frac{12.83}{25.0} = 102.6k$ From Span 2 = $4 \times 50 \times \frac{17.83}{25.0} = 142.8k$
 25% Impact = 25.7
 D.L. $.28 \times \frac{25}{2} = 3.5$ 25% Impact = 35.7
 D.L. = 3.5
 Total = 131.8k say 132k
 Total = 182.0k

Length of Col. = 24'-4" = 292" (See Sheet 1)

$\frac{L}{r_{x-2}} = \frac{292}{6.13} = 48-$

$\frac{L}{r_{y-1}}$ to be made not more than $\frac{L}{r_{x-2}}$ by diaphragms to main col.

Moment = $(182 - 132) 6.63 = 331.5^{*}k$
 Load = $182 + 132 = 314k$

$A = \frac{314}{15} + \frac{331.5 \times 7.09}{18^{*} \times 8.13^2} = 24.37^{*}gr.$

20.9 3.47 Use 14" WF @ 84# A = 24.71^{gr.}

* $\frac{L}{6}$ of flange to be kept less than 15 by diaphragms to main col.

Design "B" Stepped Crane Col.

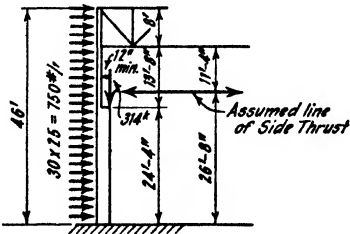

For preliminary design assume moment diagrams for side thrust and wind the same as in Design "A".

Steel Framing for Industrial Building
Crane Runway Columns (Cont.)

| | |
|---------------------|--------|
| DP 20B | |
| Industrial Building | |
| 1934 | T.C.S. |
| Sheet 3 of 4 | |

Design "B" Stepped Crane Col.

Upper Step

Roof Load ($\frac{1}{2}$ Snow) 53.0k
 Wind 5.1
 Total: Leeward Col. = 58.1k

Wind Moment = 309k
 Side Thr. " = 82.3
 Total: Leeward = 391.3k

$$\text{Area Req.} = \frac{58.1k}{\frac{4}{3} \times 15} + \frac{391.3 \times 12 \times 8.25}{\frac{4}{3} \times 18 \times 6.6^2} = 40.1 \text{ in}^2 \text{ gr.}$$

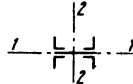

$$\frac{L}{r_{1-1}} = \frac{9.5 \times 12}{2.63} = 43+$$

$\frac{L}{r_{2-2}}$ See Art. 146 and Lower Step

| | A | I_{1-1} | I_{2-2} |
|---|-----------------------|-----------|-----------|
| 1-Web $16 \times \frac{11}{16}$ | = 11.00 | — | 2.85 |
| 4-1 $\frac{1}{2}$ $6 \times 4 \times \frac{11}{16}$ | = 29.88 | 2.83 | 15.64 |
| | 40.88 in ² | 2.83 | 17.99 |

$$r_{1-1} = \sqrt{\frac{2.83}{40.88}} = 2.63$$

$$r_{2-2} = \sqrt{\frac{17.99}{40.88}} = 6.64$$

Lower Step

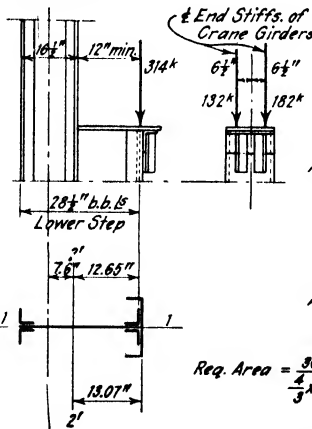

Direct Load Roof 53.0k
 " " Wind 5.1
 " " Cranes 314
 361.9k say 362k

Approx. Bending Moment Axis 2'-2' Wind = 224k
 Side Thrust = 35
 (314k x 12.7" - 48k x 7.6") Crane & Roof = 302
 Total Axis 2'-2' = 561k
 = 6730 in²k

Approx. Bending Moment Axis 1-1
 (182 - 132) 6.5" = 325 in²k

$$\text{Req. Area} = \frac{362}{\frac{4}{3} \times 15} + \frac{6730 \times 18.07}{\frac{4}{3} \times 18 \times 11.6^2} + \frac{325 \times 7.5}{\frac{4}{3} \times 18 \times 3.2^2} = 55.3 \text{ in}^2 \text{ gr.}$$

| | |
|---|-----------------------|
| 1-Web $28 \times \frac{11}{16}$ | = 19.25 |
| 2-1 $\frac{1}{2}$ $6 \times 4 \times \frac{11}{16}$ | = 14.88 |
| 2-1 $\frac{1}{2}$ $6 \times 6 \times \frac{11}{16}$ | = 11.50 |
| 1-L $15" @ 35\#$ | = 10.28 |
| | 55.96 in ² |

Steel Framing for Industrial Building
Crane Runway Cols. (Concl.)

| | |
|---------------------|--------|
| DP20B | |
| Industrial Building | |
| 1934 | T.C.S. |
| Sheet 4 of 4 | |

Design "B" Stepped Crane Col.

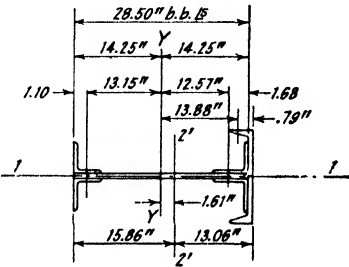

| Area | I_{y-y} | I_{z-z} |
|---|---------------|------------------------------------|
| 1- Web Pl. $28 \times \frac{1}{4} = 19.25$ | 1 | 1258 |
| 2- \bar{F} $6 \times 4 \times \frac{1}{4} = 14.98 \times 13.15 = 197$ | 142 | 2602 |
| 2- \bar{B} $6 \times 6 \times \frac{1}{2} = 11.50 \times 12.57 = 145$ | 120 | 1857 |
| 1- \bar{C} $15'' @ .35'' = 10.23 \times 13.88 = 142$ | 319 | $10.23 \times 13.88^2 = 1965$ |
| 55.96 sq in | 90 | 7690 = I_{y-y} |
| | 1.61'' | 145 = I_{z-z} |
| | | 7545 = I_{z-z} |

$$r_{y-y} = \sqrt{\frac{7690}{55.96}} = 3.22$$

$$r_{z-z} = \sqrt{\frac{7545}{55.96}} = 11.6$$

| |
|--|
| $\frac{L}{r_{z-z}^2} = \frac{13.67 \times 12}{6.64} + \frac{24.33 \times 12}{11.6} = 49.8$ <p>See Art. 146</p> |
|--|

The student should note that the area of the upper step was based on conditions at the bottom of the truss for the leeward column and that the area of the lower step was based on conditions at the base of the windward column, consequently $\frac{1}{2}$ was not a factor in either calculation.

The third term in the calculation for the area of the lower step represents the area required to resist bending about Axis 1-1 caused by eccentricity of the load from crane girders in adjacent spans. This area can be reduced by placing the end stiffeners on the crane girders closer to the Axis 1-1. It should also be noted that the third term is based on the entire column resisting bending about Axis 1-1, whereas it seems likely that this bending is resisted entirely by the flange on which the crane girders rest; recognition of this probability will lead to a smaller computed area.

Attention is called to the approximate nature of the analysis on which the design of the stepped column is based. In important structures the columns so chosen should be checked by more accurate studies.

Attention is called to the fact that in designing the main columns in DP20 the requirements were studied at the section of maximum moment where (in this case) the column had lateral support and the maximum stresses were therefore permissible, and also at a section below where the column was without support and reduced stresses were therefore necessary. This procedure should generally be followed, and when the column is comparatively slender a section where reduced stresses are necessary may control the design even though the moment is not a maximum.

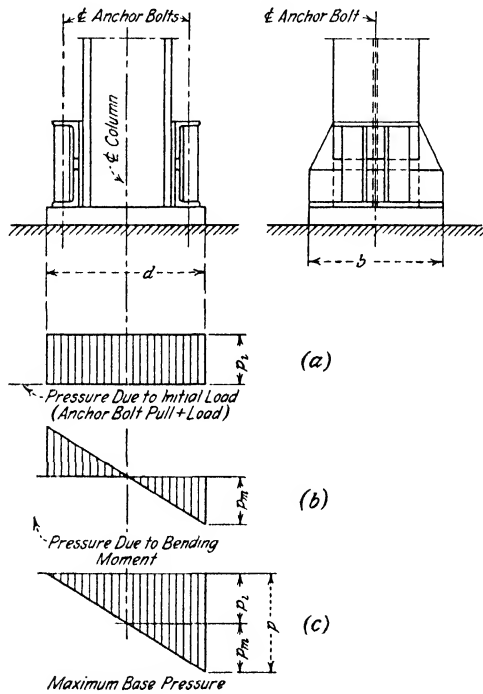

FIG. 193.

The calculations for initial anchor bolt pull on Sheet 6 of DP20 are based on the reasoning illustrated in Fig. 193. Since the base is very rigid it is assumed that the direct column load plus the initial pull of the anchor bolts is uniformly distributed over the base as shown at (a). If the base were part of a rectangular beam the distribution of stress due to the bending moment would be as shown at (b). If the column is to be considered as fixed to the masonry there should not be any separation

between the base plate and the masonry, and to ensure this the *initial* pressure must be at least equal to the bending stress. When the bending stress and the initial stress are exactly equal the resulting stress diagram will be as shown in (c).

The moment diagrams shown on Sheet 4 of DP20A should be noted. The moment diagrams for the upper tier were obtained in the usual manner; those for the lower tier are based on estimated relative moments of inertia. Since the columns have equal lengths the shear will be distributed among them in proportion to their moments of inertia, and in this case the relative moments of inertia were approximated by assuming that they would be proportional to the I 's of the columns which would carry the direct loads alone. For equal column lengths this procedure is satisfactory for design purposes.











The design calculations DP20B are restricted to the columns and illustrate the discussion in this chapter.

The design drawings, Plates I, II, and III, show in more detail some parts of the structures designed in the illustrative calculations. The reader should note that these are not working or shop drawings but such drawings as may be prepared by the designing engineer for the use of the contractor in making the shop drawings.

Tables.—A table giving the location of the centers of gravity of plate girder flanges of various make-ups, and a table giving the approximate radii of gyration of shapes often used as columns, are appended to this chapter. The student will find these tables useful in design work.

TABLE I *











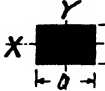
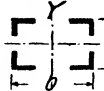
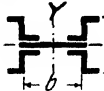
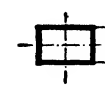

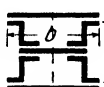



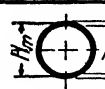

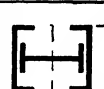
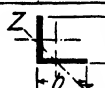
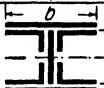
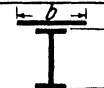
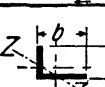

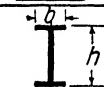
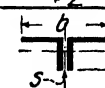
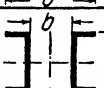
DISTANCES FROM BACK OF ANGLES TO CENTER OF GRAVITY OF FLANGE
(In Inches)

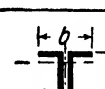
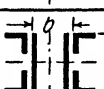
| Total Plate Thickness → | | 3/8 | 1/2 | 3/4 | 1 | 1 1/4 | 1 1/2 | 1 3/4 | 2 | 2 1/4 | 2 1/2 | 2 3/4 | |
|--|-------|-------|-------|------|------|-------|-------|-------|-------|-------|-------|-------|------|
| Cover Plates 9''-2 Δ -6 \times 4 \times  | 1/2 | 3/8 | 1.26 | 1.10 | 0.82 | 0.59 | 0.38 | 0.19 | 0.01 | | | | |
| | | 3/4 | 1.42 | 1.27 | 1.01 | 0.78 | 0.57 | 0.38 | 0.20 | 0.03 | | | |
| | 1 | 3/8 | 1.53 | 1.40 | 1.15 | 0.93 | 0.73 | 0.54 | 0.36 | 0.19 | 0.03 | | |
| | | 3/4 | 1.63 | 1.51 | 1.28 | 1.06 | 0.87 | 0.68 | 0.51 | 0.34 | 0.18 | 0.02 | |
| 10''-2 Δ -6 \times 4 \times  | 1/2 | 3/8 | 1.21 | 1.04 | 0.76 | 0.52 | 0.31 | 0.12 | | | | | |
| | | 3/4 | 1.37 | 1.22 | 0.95 | 0.71 | 0.50 | 0.31 | 0.13 | | | | |
| | 1 | 3/8 | 1.49 | 1.35 | 1.09 | 0.86 | 0.66 | 0.47 | 0.29 | 0.12 | | | |
| | | 3/4 | 1.60 | 1.46 | 1.22 | 1.00 | 0.80 | 0.61 | 0.43 | 0.26 | 0.10 | | |
| 12''-2 Δ -5 \times 3 1/2 \times  | 1/2 | 3/8 | 0.42 | 0.31 | 0.12 | | | | | | | | |
| | | 3/4 | 0.51 | 0.41 | 0.23 | 0.06 | | | | | | | |
| | 1 | 3/8 | 0.59 | 0.50 | 0.32 | 0.16 | | | | | | | |
| | | 3/4 | 0.67 | 0.58 | 0.40 | 0.24 | 0.08 | | | | | | |
| 14''-2 Δ -6 \times 4 \times  | 1/2 | 3/8 | 0.47 | 0.35 | 0.16 | | | | | | | | |
| | | 3/4 | 0.57 | 0.46 | 0.27 | 0.10 | | | | | | | |
| | 1 | 3/8 | 0.65 | 0.55 | 0.36 | 0.20 | 0.04 | | | | | | |
| | | 3/4 | 0.73 | 0.63 | 0.45 | 0.29 | 0.13 | 0.06 | | | | | |
| 14''-2 Δ -6 \times 6 \times  | 1/2 | 3/8 | 0.80 | 0.70 | 0.53 | 0.37 | 0.21 | 0.06 | | | | | |
| | | 3/4 | 0.86 | 0.77 | 0.60 | 0.44 | 0.28 | 0.14 | | | | | |
| | 1 | 3/8 | 0.95 | 0.80 | 0.54 | 0.32 | 0.13 | | | | | | |
| | | 3/4 | 1.09 | 0.95 | 0.70 | 0.48 | 0.29 | 0.11 | | | | | |
| 16''-2 Δ -6 \times 6 \times  | 1/2 | 3/8 | 1.21 | 1.08 | 0.84 | 0.62 | 0.43 | 0.25 | 0.08 | | | | |
| | | 3/4 | 1.31 | 1.18 | 0.95 | 0.74 | 0.55 | 0.38 | 0.21 | 0.04 | | | |
| | 1 | 3/8 | 1.39 | 1.27 | 1.05 | 0.85 | 0.66 | 0.49 | 0.32 | 0.16 | | | |
| | | 3/4 | 1.46 | 1.35 | 1.14 | 0.94 | 0.76 | 0.59 | 0.42 | 0.26 | 0.10 | | |
| 16''-2 Δ -8 \times 6 \times  | 1/2 | 3/8 | 0.90 | 0.74 | 0.47 | 0.25 | 0.06 | | | | | | |
| | | 3/4 | 1.04 | 0.89 | 0.63 | 0.41 | 0.22 | 0.04 | | | | | |
| | 1 | 3/8 | 1.16 | 1.02 | 0.77 | 0.55 | 0.35 | 0.17 | | | | | |
| | | 3/4 | 1.26 | 1.13 | 0.88 | 0.67 | 0.47 | 0.29 | 0.12 | | | | |
| 18''-2 Δ -8 \times 6 \times  | 1/2 | 3/8 | 1.35 | 1.22 | 0.98 | 0.77 | 0.58 | 0.40 | 0.23 | 0.07 | | | |
| | | 3/4 | 1.42 | 1.30 | 1.07 | 0.87 | 0.68 | 0.50 | 0.33 | 0.16 | 0.01 | | |
| | 1 | 3/8 | 1.65 | 1.46 | 1.13 | 0.86 | 0.62 | 0.41 | 0.21 | 0.03 | | | |
| | | 3/4 | 1.80 | 1.62 | 1.31 | 1.04 | 0.81 | 0.59 | 0.39 | 0.21 | 0.03 | | |
| 18''-2 Δ -8 \times 8 \times  | 1/2 | 3/8 | 1.93 | 1.76 | 1.46 | 1.20 | 0.96 | 0.75 | 0.55 | 0.36 | 0.19 | 0.01 | |
| | | 3/4 | 2.03 | 1.87 | 1.58 | 1.33 | 1.10 | 0.89 | 0.69 | 0.51 | 0.33 | 0.16 | |
| | 1 | 3/8 | 2.12 | 1.97 | 1.69 | 1.45 | 1.23 | 1.02 | 0.82 | 0.64 | 0.46 | 0.29 | |
| | | 3/4 | | 0.78 | 0.55 | 0.30 | 0.16 | | | | | | |
| 20''-2 Δ -8 \times 6 \times  | 1/2 | 3/8 | | 0.90 | 0.67 | 0.47 | 0.29 | 0.12 | | | | | |
| | | 3/4 | | 1.00 | 0.78 | 0.58 | 0.40 | 0.23 | 0.07 | | | | |
| | 1 | 3/8 | | 1.09 | 0.87 | 0.68 | 0.50 | 0.33 | 0.17 | 0.02 | | | |
| | | 3/4 | | 1.16 | 0.96 | 0.77 | 0.60 | 0.43 | 0.27 | 0.11 | | | |
| 20''-2 Δ -8 \times 8 \times  | 1/2 | 3/8 | | 1.29 | 1.00 | 0.74 | 0.52 | 0.32 | 0.14 | | | | |
| | | 3/4 | | 1.44 | 1.15 | 0.91 | 0.69 | 0.49 | 0.30 | 0.13 | | | |
| | 1 | 3/8 | | 1.57 | 1.30 | 1.06 | 0.84 | 0.64 | 0.45 | 0.27 | 0.11 | | |
| | | 3/4 | | 1.67 | 1.41 | 1.18 | 0.97 | 0.77 | 0.59 | 0.41 | 0.24 | 0.07 | |
| 20''-2 Δ -8 \times 8 \times | 1 | 3/8 | | 1.77 | 1.52 | 1.30 | 1.09 | 0.89 | 0.71 | 0.53 | 0.36 | 0.20 | 0.04 |
| | | 3/4 | | 1.85 | 1.61 | 1.39 | 1.12 | 1.00 | 0.82 | 0.64 | 0.48 | 0.31 | 0.15 |
| | 1 1/2 | 3/8 | | 0.74 | 0.50 | 0.29 | 0.11 | | | | | | |
| | | 3/4 | | 0.86 | 0.62 | 0.42 | 0.23 | 0.06 | | | | | |
| 20''-2 Δ -8 \times 8 \times | 1 | 3/8 | | 0.96 | 0.73 | 0.53 | 0.34 | 0.17 | 0.01 | | | | |
| | | 3/4 | | 1.04 | 0.82 | 0.63 | 0.44 | 0.27 | 0.11 | | | | |
| | 1 1/2 | 3/8 | | 1.12 | 0.91 | 0.72 | 0.54 | 0.36 | 0.20 | | | | |
| | | 3/4 | | 1.23 | 0.93 | 0.67 | 0.45 | 0.25 | 0.07 | | | | |
| 20''-2 Δ -8 \times 8 \times | 1 | 3/8 | | 1.38 | 1.08 | 0.84 | 0.62 | 0.41 | 0.22 | 0.05 | | | |
| | | 3/4 | | 1.51 | 1.23 | 0.98 | 0.70 | 0.56 | 0.37 | 0.19 | 0.02 | | |
| | 1 1/2 | 3/8 | | 1.62 | 1.34 | 1.11 | 0.98 | 0.69 | 0.50 | 0.33 | 0.15 | | |
| | | 3/4 | | 1.72 | 1.46 | 1.22 | 1.01 | 0.81 | 0.62 | 0.44 | 0.27 | 0.11 | |
| 1 1/2 | 3/8 | | 1.80 | 1.55 | 1.32 | 1.11 | 0.91 | 0.73 | 0.55 | 0.38 | 0.22 | 0.06 | |

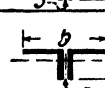
* Courtesy of the Phoenix Bridge Company.

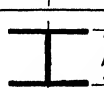
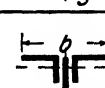
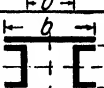
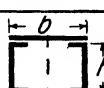
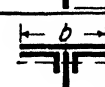
TABLE II*

APPROXIMATE RADII OF GYRATION

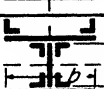
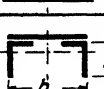
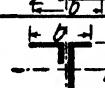
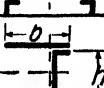
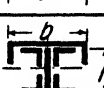
| | | |
|--|---|---|
|  $r_x \cdot 0.29h$ $r_y \cdot 0.29b$ |  $r_x \cdot 0.42h$ $r_y \cdot 0.42b$ |  $r_x \cdot 0.31h$ $r_y \cdot 0.48b$ |
|  $r_x \cdot 0.40h$ $h = \text{mean } h$ |  $r_y = \text{same as for 2 L's}$ |  $r_x \cdot 0.37h$ $r_y \cdot 0.28b$ |
|  $r_x \cdot 0.25h$ |  $r_x \cdot 0.42h$ $r_y = \text{same as for 2 L's}$ |  $r_x \cdot 0.31h$ |
|  $r = \sqrt{\frac{H^2 + h^2}{16}}$ $r = 0.35 H_m$ |  $r_x \cdot 0.39h$ $r_y \cdot 0.21b$ |  $r_x \cdot 0.31h$ |
|  $r_x \cdot 0.31h$ $r_y \cdot 0.31b$ $r_z \cdot 0.197h$ |  $r_x \cdot 0.45h$ $r_y \cdot 0.235b$ |  $r_x \cdot 0.40h$ $r_y \cdot 0.21b$ |
|  $r_x \cdot 0.29h$ $r_y \cdot 0.32b$ $r_z = 0.18 \frac{h \cdot b}{z}$ |  $r_x \cdot 0.36h$ $r_y \cdot 0.45b$ |  $r_x \cdot 0.38h$ $r_y \cdot 0.22b$ |
|  $r_x \cdot 0.31h$ $r_y \cdot 0.215b$ $s = b(0.21 + 0.002s)$ |  $r_x \cdot 0.36h$ $r_y \cdot 0.60b$ |  $r_x \cdot 0.39h$ |
|  $r_x \cdot 0.32h$ $r_y \cdot 0.21b$ $s = b(0.19 + 0.002s)$ |  $r_x \cdot 0.36h$ $r_y \cdot 0.53b$ |  $r_x \cdot 0.35h$ |
|  $r_x \cdot 0.29h$ $r_y \cdot 0.24b$ $s = b(0.23 + 0.002s)$ |  $r_x \cdot 0.39h$ $r_y \cdot 0.55b$ |  $r_x \cdot 0.435h$ $r_y \cdot 0.25b$ |
|  $r_x \cdot 0.30h$ $r_y \cdot 0.17b$ |  $r_x \cdot 0.42h$ $r_y \cdot 0.32b$ |  $r_x \cdot 0.42h$ |
|  $r_x \cdot 0.25h$ $r_y \cdot 0.21b$ |  $r_x \cdot 0.44h$ $r_y \cdot 0.28b$ |  $r_x \cdot 0.42h$ |
|  $r_x \cdot 0.21h$ $r_y \cdot 0.21b$ $r_z \cdot 0.19h$ |  $r_x \cdot 0.50h$ $r_y \cdot 0.28b$ |  $r_x \cdot 0.285h$ $r_y \cdot 0.37b$ |
|  $r_x \cdot 0.38h$ $r_y \cdot 0.19b$ |  $r_x \cdot 0.39h$ $r_y \cdot 0.21b$ |  $r_x \cdot 0.42h$ $r_y \cdot 0.23b$ |

CHAPTER VII

DESIGN OF STRUCTURAL STEEL FOR BRIDGES

148. The purpose of this chapter is to outline the problem of steel bridge design and to give some illustrative calculations showing the application of the principles previously discussed.

Space limitations have compelled the elimination of much material originally planned for this text, and the student should freely consult the larger books devoted exclusively to bridge design for information on many topics which have merely been mentioned in or entirely omitted from this chapter.

149. Live Loads.—The live loads to which bridges may be subjected were briefly considered in another volume;* the following brief discussion is supplementary.

Highway loads have increased greatly in recent years, and though legislative enactment regarding maximum axle loads, width, length, height, number of trailers, and so on, has limited the total load which may be transported by one unit of automotive equipment in practically all states, there seems to be a tendency to relax these restrictions in some cases, particularly in metropolitan areas.

Figures 194, 195, 196, and 197 show four types of modern truck, and truck and trailer units capable of carrying pay loads ranging from 12 tons to 20 tons and having gross weights ranging from 40,000 lb. to more than 60,000 lb. Figure 198 shows an 80-ton bridge girder and Fig. 199 a transformer of about 60 tons' weight being transported on special trailer equipment. Trailers of the general type shown in Figs. 198 and 199 having rated capacities of 100 tons seem to be in common use in England. Recently a bridge over the river Tees at Newport, England, was put into service with a floor system designed for a load of 100 tons carried on four wheels plus 50 per cent impact considered together with a uniform load of 150 lb. per sq. ft.†

The loadings given in the design specification in Appendix B recommended by the American Association of State Highway Officials, represent current practice in the design of highway bridges in the United

* "Theory of Simple Structures," Shedd and Vawter, John Wiley & Sons.

† *Engineering News-Record*, March 15, 1934, page 365.

States. The lower deck of the San Francisco-Oakland Bay bridge, however, was designed for three lanes of H-30 traffic, in addition to the interurban lines.*

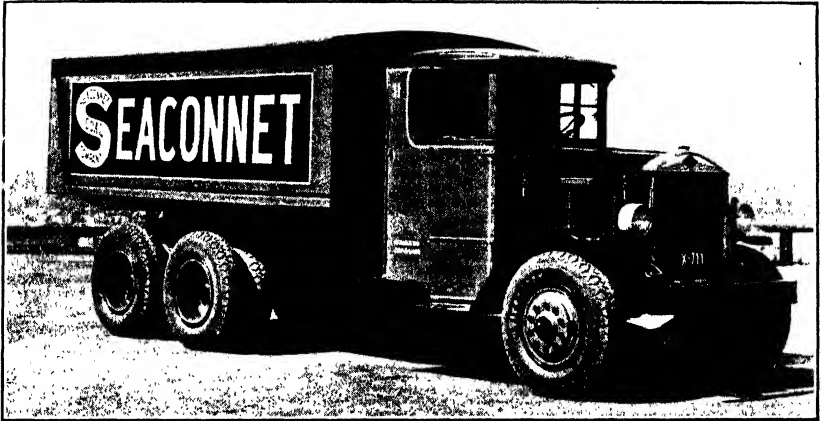

Courtesy of The Seaconnet Coal Company.

FIG. 194.—Six-Wheel Truck.

Railroad bridge loads have not increased so rapidly in recent years as highway bridge loads, in fact there is now (1934) some agita-



Courtesy of The Autocar Company.

FIG. 195.—Four-Wheel Tractor with Semi-Trailer and Trailer.

tion for faster moving of a greater number of units carrying smaller loads. Nevertheless the latest tentative specifications for railroad

* *Engineering News-Record*, March 22, 1934.

bridge* design recommend Cooper's E-72 for all main line bridges. Figures 200, 201, and 202 show examples of modern locomotives having axle loads ranging from over 66,000 lb. to more than 77,000 lb.

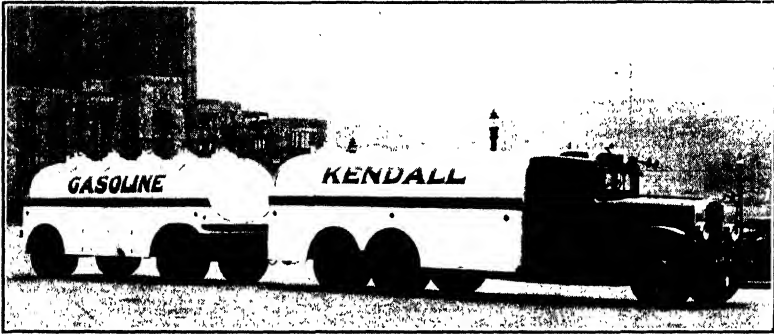

Courtesy of The Autocar Company.

FIG. 196.—Six-Wheel Truck with Four-Wheel Trailer.

Such locomotives are followed by trains weighing from 5000 to 7500 lb. per ft. of length.

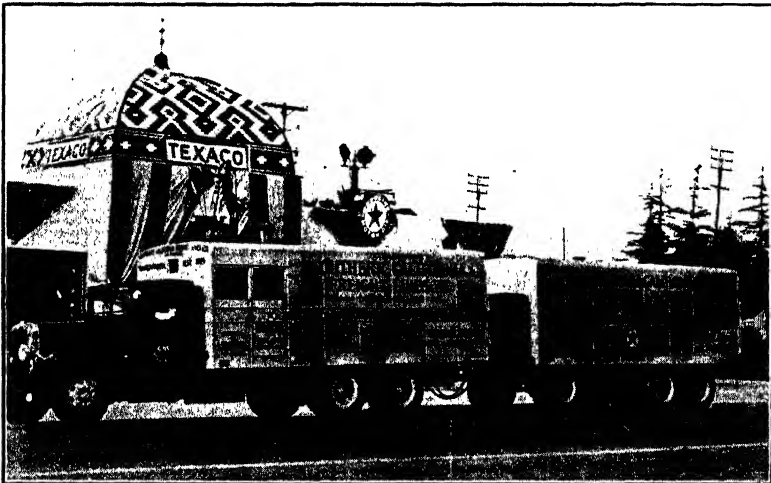

Courtesy of The General Motors Truck Company.

FIG. 197.—Six-Wheel Truck with Six-Wheel Trailer.

150. Impact.—Recent studies of impact from the theoretical as well as the experimental approach have led to the proposal of factors differing

* "Specifications for Steel Railway Bridges," *Bulletin A.R.E.A.*, February, 1934.

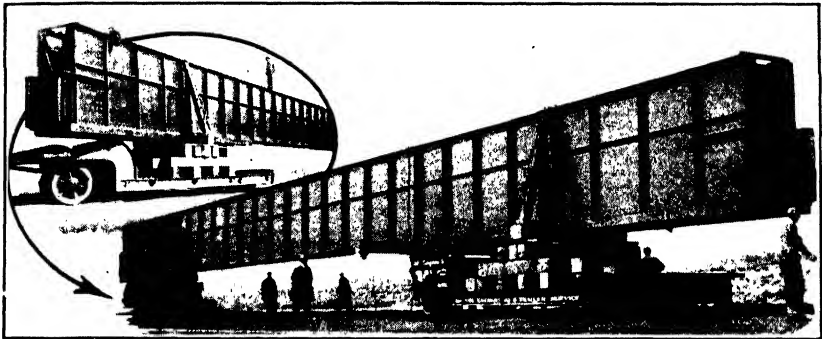

Courtesy of The Rogers Tractor and Trailer Company.

FIG. 198.—Tractor-Trailers for Special Service.

in form, but not greatly in result, from those listed in the chapter on loads in the volume * previously mentioned. The specifications in Appendix A give:

$$I = \frac{400 - L/2}{400 + L}$$

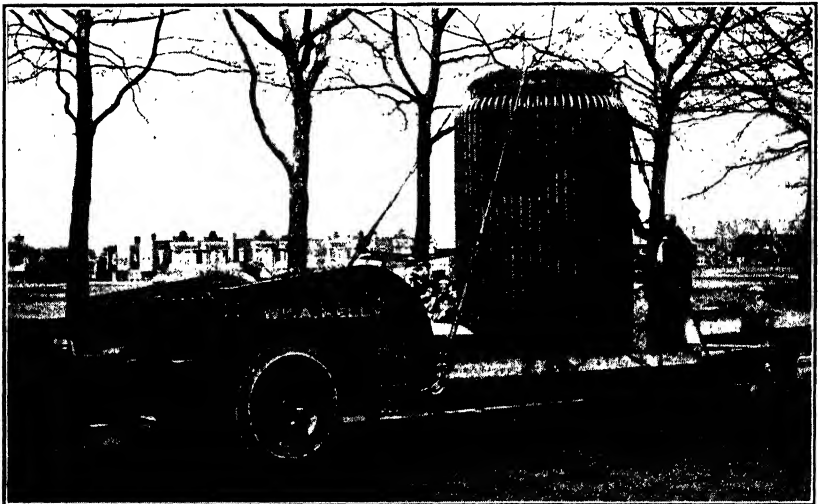

Courtesy of The Rogers Tractor and Trailer Company.

FIG. 199.—Tractor-Trailer for Special Loads.

in which L is the loaded length of track for single-track bridges. For multiple-track bridges L is the loaded length of track for that track

* "Theory of Simple Structures," John Wiley & Sons.

which when loaded gives the greatest stress in the truss, with the further provision that impact is to be computed only from the load on that track.

The tentative 1934 A.R.E.A. specifications * propose an interesting procedure for estimating impact. In some ways it is the most reasonable proposal yet advanced. It is as follows:

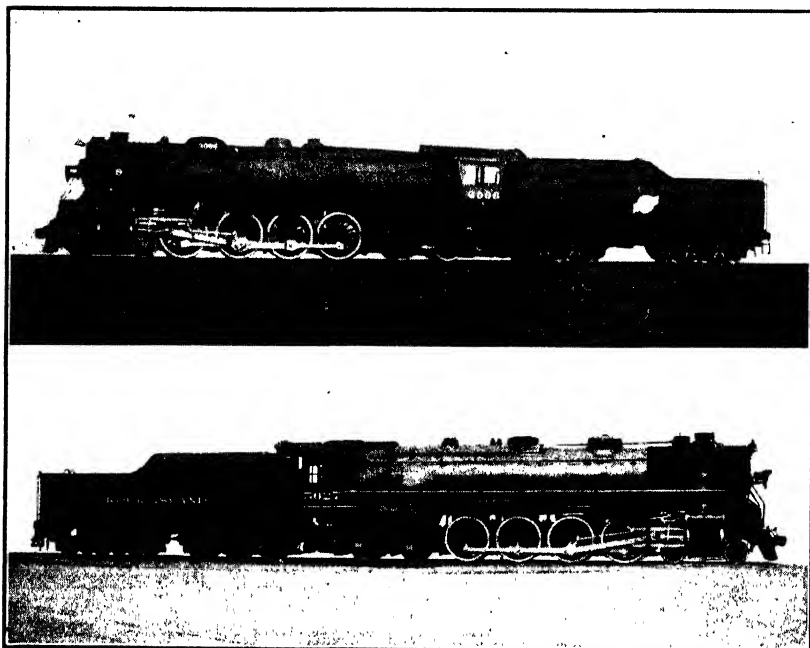

Courtesy of The Baldwin Locomotive Works. The American Locomotive Company.

FIG. 200.—Heavy Locomotive for Passenger or Freight Service: 4-8-4 Type.

Impact.

204. To the maximum computed static live load stress, there shall be added the impact, consisting of:

(a) The rolling or lurching effect:

A percentage of the static live load stress equal to..... $\frac{100}{S}$

S = spacing, in feet, between centers of longitudinal girders, stringers or trusses; or length, in feet, of floorbeams or transverse girders.

* *Bulletin A.R.E.A.*, Vol. 35, No. 364, February, 1934.

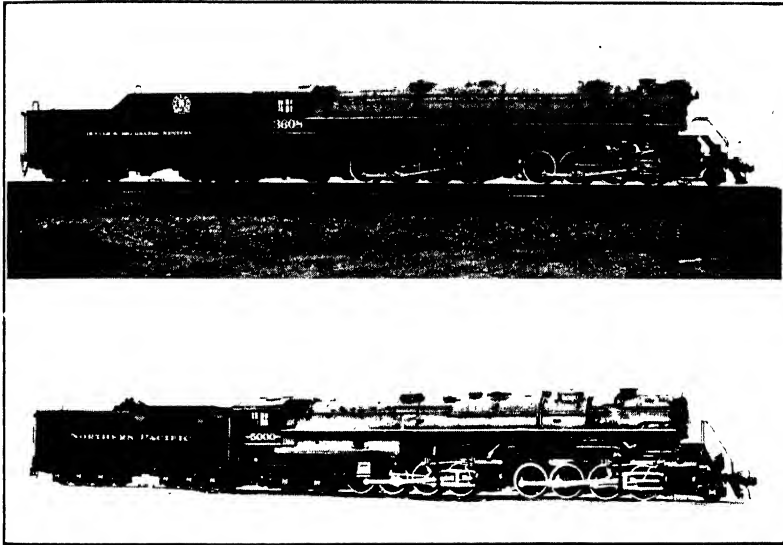

Courtesy of The American Locomotive Company.

FIG. 201.—Heavy Freight Locomotives. Types: 2-8-8-2 and 2-8-8-4.

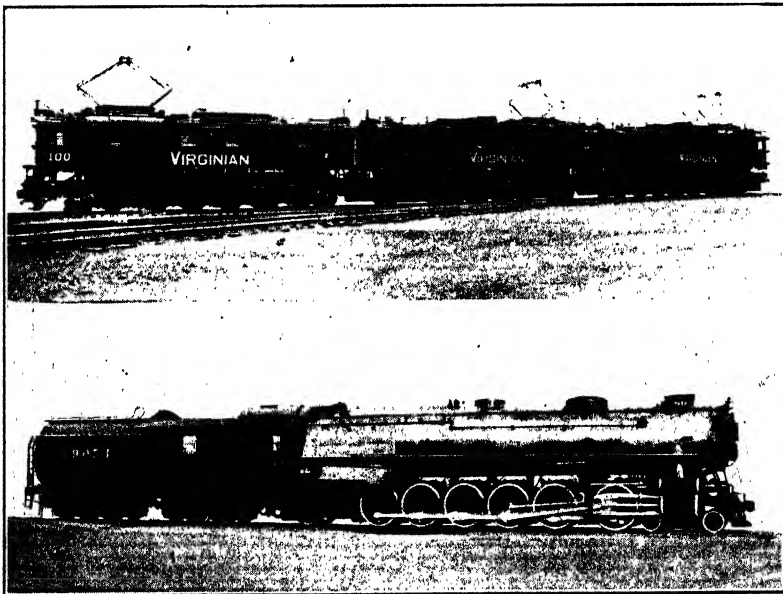

Courtesy of The American Locomotive Company.

FIG. 202.—Heavy Electric Locomotive: 2-8-2; 2-8-2; 2-8-2.
Heavy Steam Locomotive: 4-12-2.

(b) The dynamic effect:

For steam locomotives (hammer blow, track irregularities, and car impact), a percentage of the static live load stress equal to:

$$\begin{aligned} \text{Spans less than 100 ft. in length} & \dots\dots\dots 100 - 0.60L \\ \text{Spans 100 ft. or more in length} & \dots\dots\dots \frac{1800}{L - 40} + 10 \end{aligned}$$

For electric locomotives (track irregularities and car impact), a percentage of the static live load stress equal

$$\text{to} \dots\dots\dots \frac{360}{L} + 12.5$$

L = length, in feet, center to center of bearings for longitudinal stringers, girders, or trusses;

or, L = length of floorbeams or transverse girders, in ft., for floorbeams, floorbeam hangers, and transverse girders.

The impact shall not exceed 100 per cent of the static live load.

For members receiving load from more than one track, the impact percentage shall be applied to the static live load on the number of tracks shown below:

| <i>Loads received from two tracks</i> | <i>Impact applied to</i> |
|---------------------------------------|--------------------------|
| L = less than 175 ft. | Two tracks |
| L = 175 ft. or more. | One track |
| More than two tracks. | Any two tracks |

151. Dead Load.—The dead load to be supported by a bridge frame consists primarily of the roadway and the weight of the frame itself, plus, in some cases, such public utilities as gas pipes, water pipes, or conduits for telephone, power, and light lines.

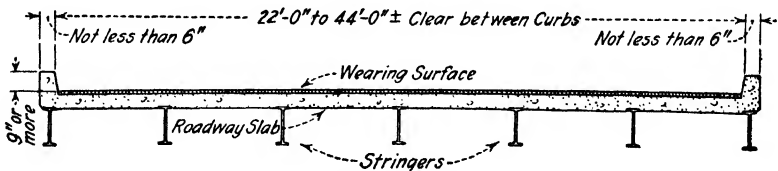

FIG. 203.—Cross Section of Typical Highway-Bridge Floor with Concrete Deck.

The roadway for the modern highway bridge of moderate span generally consists of a reinforced-concrete slab, ranging from 6 to 10 in. in thickness. On this slab there will usually be a wearing surface of asphalt 2 or 3 in. thick; creosoted wood blocks 3 or 4 in. thick, resting on a sand or sand and mastic cushion; brick or granite paving blocks; or in some cases 2 or 3 in. of additional concrete. Laminated timber floors from 4 to 8 in. thick are very common in some parts of the country, and their use seems to be increasing. Laminated floors usually have a wearing surface of hot-laid asphalt, or asphalt plank.

Reinforced-concrete deck construction is generally favored because of its more permanent nature and because it is fireproof. The weight of a concrete slab becomes a serious factor in the long spans which are

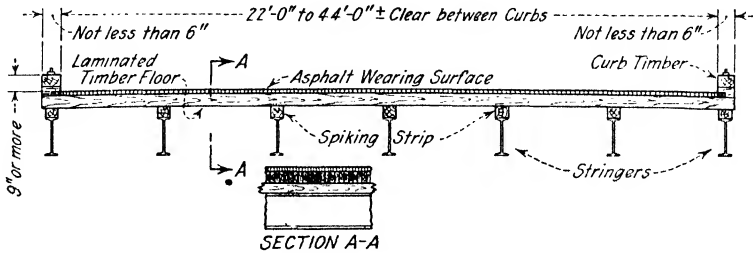

FIG. 204.—Cross-Section of Typical Highway-Bridge Floor with Timber Deck.

increasingly common, and has resulted in the development of a number of forms of light-weight roadway construction of permanent type.

The most common form of roadway for railroad bridges is the open timber deck consisting of ties (at least 10 ft. long) which rest directly on the longitudinal stringers or girders and support the running rails, inside guard rails, and timber guard rails. A ballasted roadway on bridges is used almost exclusively by some railroads and in certain locations by many others. The ballast is carried in a concrete or timber trough and the track laid in the ballast as on the regular roadbed.

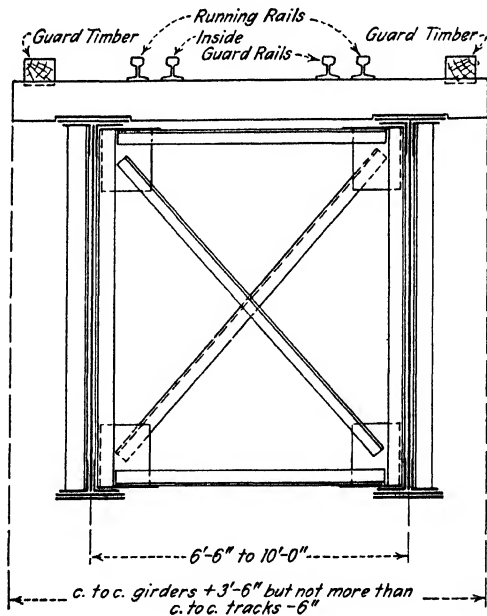

FIG. 205.—Cross-Section of Typical Railroad Girder-Bridge with Open Timber Deck.

The construction of typical roadways is illustrated by Figs. 203, 204, 205, and 206. Descriptions and illustrations of the recent light-weight types of roadway for bridges may be found in the advertising

literature of the organizations which have developed them: among them may be mentioned the Carnegie Steel Company's "Tri-Lok" floor; the Belmont Iron Works' "Interlocking Channel" floor; the so-called "Battle-Deck" floor, consisting of ordinary plates, or checkered plates, riveted or welded to steel stringers; and the various forms of subway grating riveted or welded to steel stringers.

The weights of highway bridge roadways range from as little as 15 to 20 lb. per sq. ft. of roadway surface, for some of the light-weight forms, to as much as 150 to 175 lb. per sq. ft. of surface for some of the higher types used in heavy city bridges; these weights do not include

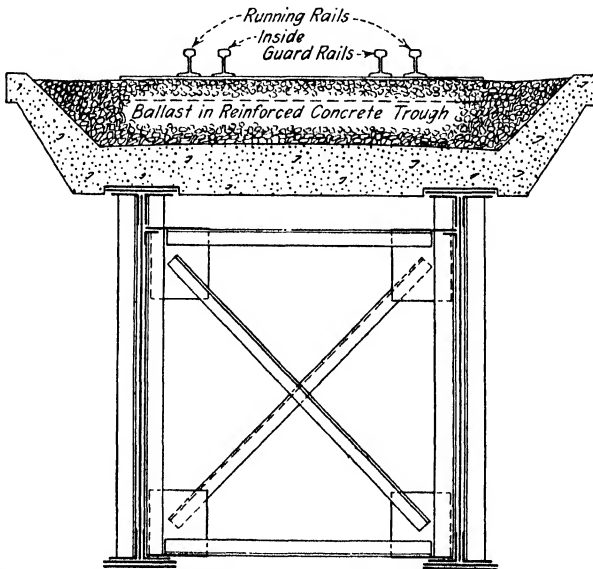

FIG. 206.—Cross-Section of Typical Railroad Girder-Bridge with Ballast Deck.

any part of the supporting framework. The weights of railroad bridge roadways range from 500 to 800 lb. per ft. of track for open timber decks to 2500 to 4500 lb. per ft. of track for ballasted decks of timber or concrete; these weights include all rails and fastenings but do not include any part of the supporting framework.

152. Weight of Superstructure: Highway Bridges.—The weight of the floor system (i.e., the steel framework which supports the roadway between panel points of girders or trusses) for highway bridges may be estimated by the methods discussed in Chapter VI in connection with

the weights of floor framing for buildings, and because of the great variety of conditions to be encountered this procedure will generally prove more satisfactory than dependence on empirical formulas.

The weight of the girders for a highway plate-girder bridge may also be estimated with sufficient accuracy for design purposes by the method used in Chapter VI in connection with floor framing: the weight of the bracing for highway girder bridges will ordinarily range from about 7 to 15 per cent of the weight of the longitudinal girders depending on the type of construction and the specifications for design. Data on the weight of girders in terms of length and total load per foot may be found in "Bridge Engineering" * by J. A. L. Waddell. The data are based on a basic unit stress of 16,000 lb. per sq. in. and must be modified for other unit stresses.

The weight of trusses and bracing for highway bridges may generally be estimated with sufficient accuracy for design purposes by means of Hudson's formula which will be discussed in connection with railroad bridges. Waddell's "Bridge Engineering" * also contains data on the weights of trusses in terms of span length and total load per foot, and a stress intensity of 16,000 lb. per sq. in.; of course the data must be adjusted for basic unit stresses of different amounts.

153. Weight of Superstructure: Railroad Bridges.—Data on the weights of railroad bridge superstructure are more plentiful and more reliable than those for almost any other type of steel structure. The loads for which railroad bridges are designed are better standardized, the variations in form fewer and not so pronounced, and the records of weights of actual structures more complete and better organized. The most complete and reliable information known to the author will be found in Chapter LV of "Bridge Engineering" * by J. A. L. Waddell. Every student of bridge design should become acquainted with the books and papers by Dr. Waddell.

Szlapka's 9-L Formula.—The method of estimating the weight of railroad girder bridges developed by Mr. Peter L. Szlapka, formerly chief designer for the Phoenix Bridge Company, is one of the most accurate and valuable available.

Mr. Szlapka's method has never been published before, so far as the author knows, and it is reproduced here with his permission.

Mr. Szlapka found that the weight of the two girders and the bracing between them could be expressed by

$$w = kl \quad (146)$$

* John Wiley & Sons, New York.

where w = weight, in pounds per foot of bridge, for two girders and their bracing;

l = the length of the span, in feet;

k = a factor which is dependent on the live load, the thickness of the web, the permissible unit stress, and the type of roadway.

For Cooper's E-30 loading, a 3/8-in. web, open timber deck, girder of economical depth (about 1/12 to 1/8 of the span), and specifications for design about the equivalent of the A.R.E.A. 1910, "General Specifications for Steel Railway Bridges" (basic fiber stress, 16,000 lb. per sq. in.) the factor is

$$k = 9$$

and is composed of two other factors

$$\begin{aligned} \text{the flange factor} &= 4.5 \\ \text{and the web factor} &= 4.5 \end{aligned}$$

For other live loads, unit stresses, web thickness, deck construction, or depths, the flange and web factors should be modified as follows:

For live loads different from E-30 the flange factor should be multiplied by the ratio of the load to be used to E-30; i.e., if the live load is Cooper's E-56 the flange factor should be multiplied by 56/30.

For unit stresses different from 16,000 lb. per sq. in. the flange factor should be multiplied by the ratio of 16,000 to the specified unit stress; i.e., if the basic stress is to be 18,000 the flange factor should be multiplied by 16,000/18,000.

For depths differing considerably from the economic depth the flange factor should be multiplied by the ratio of the economic depth to the depth to be used; i.e., if the economic depth is 100 in. and the girders must be built only 80 in. deep the flange factor should be multiplied by 100/80.

For deck construction differing from the open timber type the flange factor should be multiplied by the ratio of the total load (or moment) with the type of deck used to the total load (or moment) with an open timber deck. To determine the ratio for this modification it is necessary to estimate the weight of the girders and bracing in advance in order to include it in the total load.

For web thicknesses differing from 3/8 in. the web factor should be multiplied by the ratio of the thickness to be used to 3/8 in.; i.e., if a 9/16-in. web is to be used the web factor should be multiplied

$$\text{by } \frac{9/16}{3/8} = \frac{9}{6}$$

As described above, the "9-L formula" is directly applicable to spans 60 ft. or more in length. For spans less than 60 ft. in length Mr. Szlapka modified the formula as follows:

$$w = \frac{w'}{480} (5l + 180) \tag{147}$$

in which w = the weight, in pounds per foot of bridge, for two girders and their bracing;

l = the span length, in feet;

w' = the weight, in pounds per foot of bridge, for a span of 60 ft. determined from the 9-L formula for the live load and other conditions under which the bridge is to be designed.

Illustrations of the use of the 9-L formula follow.

Estimate the weight of a plate girder span 96 ft. long to carry Cooper's E-65: basic fiber stress of 18,000 lb. per sq. in. and an open-timber deck.

Economic depth = about 106 in.

Web thickness = about $\frac{1}{160} (106\frac{1}{2} - 16) =$ say $\frac{9}{16}$ in.

Flange factor = $4.5 \times \frac{6.5}{30} \times \frac{1}{8} = 8.66$

Web factor = $4.5 \times \frac{9/16}{3/8} = \frac{6.75}{15.41}$

$$w = 15.41 \times 96 = 1480 \text{ lb. per ft. of bridge}$$

Suppose that the same span is to have a ballast-on-concrete deck weighing 3600 lb. per ft.

Economic depth = about 114 in.

Web thickness = about $\frac{1}{160} (114\frac{1}{2} - 16) =$ say $\frac{5}{8}$ in.

| Loads with: | Open timber deck | Ballast deck |
|--------------|----------------------|--------------------|
| Live load * | = 8,460 | 8,460 |
| Impact 74% † | = 6,260 | 6,260 |
| Dead load ‡ | = 2,080 | 5,250 |
| Total load | = 16,800 lb. per ft. | 19,970 lb. per ft. |

* From chart of equivalent uniform loads, Plate X.

† Am.Soc.C.E. 1923.

‡ Includes an estimated weight of girders and bracing, and the weight of the roadway.

The student should note that the weight of the girders and bracing is so small a part of the total load that an appreciable error in the preliminary estimate will have little effect on the ratio.

$$\text{Flange factor} = 4.5 \times \frac{65}{30} \times \frac{16}{18} \times \frac{19,970}{16,800} = 10.3$$

$$\text{Web factor} = 4.5 \times \frac{5/8}{3/8} = \frac{7.5}{17.8}$$

$$w = 17.8 \times 96 = 1710 \text{ lb. per ft. of bridge}$$

Estimate the weight of a plate girder span 45 ft. long to carry E-70 with an open timber deck and at a basic fiber stress of 16,000 lb. per sq. in.

For a span of 60 ft. to carry the load the weight would be

$$\text{Flange factor} = 4.5 \times 70/30 = 10.5$$

$$\text{Web factor} = 4.5 \times \frac{7/16}{3/8} = \frac{5.3}{15.8 \times 60} = 948 \text{ lb. per ft.} = w'$$

Then

$$w = (948/480) (5 \times 45 + 180) = 800 \text{ lb. per ft. of bridge}$$

Hudson's 100/3 Formula.—Mr. Clarence W. Hudson * developed a method of estimating the weight of trusses and bracing for bridges which is convenient, and, so far as the author has found, always sufficiently accurate for design purposes, although giving weights slightly in error on the safe side for double-track bridges.

Mr. Hudson found that the weight of the trusses and bracing for a bridge may be represented quite accurately by:

$$w = \frac{100}{3} A \quad (148)$$

where w = weight of two trusses and their bracing, in pounds per foot of bridge;

A = the *net* area of the largest tension chord.

The procedure is simply to calculate the maximum stress in the tension chord, divide this stress by the permissible intensity of stress obtaining the required net area, and multiply this net area by the factor 100/3. In calculating the maximum stress in the tension chord, it is necessary to *assume* in advance the weight of the trusses and bracing; generally one trial and a correction will be sufficient to secure satisfactory agreement between the *assumed* weight and that given by this formula.

The method is reproduced here with Mr. Hudson's permission.

* Consulting engineer, New York. Formerly designing engineer with the Phoenix Bridge Company.

To show the application of the method assume that a single-track truss span to carry Cooper's E-50 on a span of 200 ft. c.c. bearings is to be designed, and assume that a Pratt truss 36 ft. 0 in. c.c. of chords with 8 panels of 25 ft. 0 in. has been decided on. If the design is carried out in the proper order the weight of the track and the weight of the floor system will be known. Assume that this has been done with the result given below.

| | | |
|-------------------------------|---|-----------------------------------|
| Track | = | 500 lb. per ft. |
| Floor | = | 560 |
| (assumed) Trusses and bracing | = | <u>1640</u> |
| Total dead load | = | <u>2700</u> lb. per ft. of bridge |

As stated above it is necessary to assume the weight of the trusses and bracing in order to obtain the maximum stress in the tension chord. In this case 1640 lb. per ft. of bridge has been assumed. The maximum stress in the chord of one truss would then be:

| | | | |
|--|--------------|---|------------------------------|
| Stress | Live load | = | 389 kips |
| | Impact 43% * | = | 167 kips |
| | Dead load | = | <u>176</u> |
| | Total | = | <u>732</u> kips max. tension |
| ÷ 16 = 45.8 sq. in. net | | | |
| $w = \frac{100}{3} \times 45.8 = 1530$ lb. per ft. of bridge | | | |

Since the assumed weight of the trusses and bracing was 1640 lb. per ft. of bridge, a second determination of the maximum tension chord stress may be made using a smaller weight. The correct weight will be slightly less than the 1530 lb. found above since it was obtained with a chord stress which was too large. Assume 1500 lb. per ft. for the new weight and find:

| | | | |
|--|---------------------|---|-------------------------|
| Dead load | Track | = | 500 |
| | Floor | = | 560 |
| | Trusses and bracing | = | 1500 |
| | Total dead load | = | <u>2560</u> lb. per ft. |
| Maximum stress | Live load | = | 389 kips |
| | Impact | = | 167 |
| | Dead load | = | <u>167</u> |
| | Total | = | <u>723</u> kips |
| ÷ 16 = 45.2 sq. in. net | | | |
| $w = \frac{100}{3} \times 45.2 = 1510$ lb. per ft. of bridge | | | |

which is a close enough agreement.

* A.R.E.A. "Specifications for Steel Railway Bridges," 1931.

It seems desirable to state the basis of the formula to enable the designer to modify the factor 100/3 if his experience indicates this to be desirable in particular cases.

Mr. Hudson found that the *average* weights per foot of truss could be represented as proportional to the *net* area of the largest tension chord as follows:

| | | |
|---------------------|---|-------------|
| Bottom chord | = | 1.00A |
| Top chord | = | 1.25A |
| Web system | = | 1.25A |
| Details | = | 1.00A |
| Bracing | = | 0.50A |
| Total for one truss | = | <u>5.0A</u> |

Then taking the weight of steel in round numbers be 10 lb. per sq. in. per yd. of length there follows at once for two trusses and bracing

$$w = 2 \times 5A \times \frac{10}{3} = \frac{100}{3} A$$

154. Design of Layout.—Successful determination of the best layout of spans and piers for a particular bridge crossing requires a thorough grasp of the whole field of bridge design and construction, and in addition an intimate knowledge of the physical conditions at the site; the highest degree of skill and the widest experience in the former may be rendered futile by inadequate knowledge of the latter. Adequate treatment of the matter is impossible in the usual undergraduate course, but the problem is of such importance as to warrant emphasizing some of the points involved.

The student should preface his consideration of the problem by a careful reading of a paper entitled, "Suitability of the Various Types of Bridges for the Different Conditions Encountered at Crossings,"* by J. A. L. Waddell, which contains an excellent summary of the more important factors.

The necessity for a knowledge of the subsurface condition at the site seems obvious, and yet it is often impossible to obtain authority for adequate borings. In addition to data on the character and depth of foundation materials it is important to know the nature of the stream, the seasons at which high water occurs, the elevation of ordinary high water and the greatest high water known, whether the stream rises quickly and whether it carries drift or ice at high water and in what quantities, the amount and rapidity of scour around piers of bridges which may have been built in the vicinity, and so on. The design of

* See *Journal of the Western Society of Engineers*, October, 1927, Vol. XXXII, No. 9; also "Memoirs and Addresses of Two Decades."

the layout will be affected not only by natural features such as these enumerated but also by many other factors such as accessibility of the site with respect to supplies of labor and materials, War Department regulations in the case of navigable streams, and in some cases by railways, highways, power lines, etc., which must be crossed by the bridge.

155. Economic Span Length.—In general the best layout of spans is that which provides satisfactory service for the least cost, and the item of cost should include of course not only the actual expenditure for design and construction but also such matters as maintenance and renewals, operation, financing, taxes, and so on. The determination of the best combination of span lengths in general is a matter of trial and error, but a relation between the cost of substructure and superstructure may be established for some cases which will aid in selecting the best span length.

In Fig. 207 is shown a profile and bridge layout in which the conditions affecting the span length approach the ideal. For a given elevation of roadway (whether highway or railway) there is little choice in the

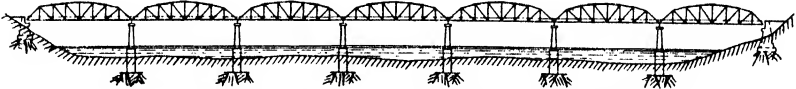

FIG. 207. Layout for a Long Regular Crossing.

location of the abutments, and for the conditions indicated the cost of an intermediate pier is practically a constant; i.e., no matter where a pier is placed in the river its cost will be a reasonably definite sum.*

The variation in total cost of the bridge may be expressed in terms of the following notation:

C = total cost of bridge;

A = cost of the abutments;

P = cost of one pier;

L = total length of crossing (assumed fixed for a given crossing);

l = length of individual span;

n = number of spans = L/l ;

c_s = cost per pound of steel for trusses (or girders) and bracing;

c_f = cost per pound of steel for steel floor system;

* It is evidently tacitly assumed here that the size of a pier is not affected by variations in span length and this is substantially true if the changes are not too great: it makes little or no difference in the size of a pier whether a span is 175 ft. long or 225 ft. long (assuming solid foundations) but of course there would be an appreciable difference in the piers for spans of 175 ft. and 675 ft.

- w = weight, in pounds per foot of span, for trusses (or girders) and bracing;
 w_f = weight, in pounds per foot of span, for steel floor system;
 m = cost per foot of bridge of roadway and miscellaneous items such as guard rails, light standards, etc. ;
 k = a factor such that $w \propto kl$.*

As noted, $w \propto kl$, but a little reflection will show that w_f is a function of *panel* length and does not vary with *span* length; i.e., for a given panel length the weight of the floor system per foot of span is the same whether there are six or ten or twenty panels. The quantity m is of course independent of span length, except in special cases.

We may now write:

$$C = A + nc_s k l^2 + c_f w_f L + mL + (n - 1)P$$

Since $n = L/l$ this may be written

$$C = A + Lc_s k l + c_f w_f L + mL + \left(\frac{L}{l} - 1\right)P$$

and

$$\frac{dC}{dl} = Lc_s k - \frac{LP}{l^2} = 0 \text{ for a minimum.}$$

That is,

$$c_s k = \frac{P}{l^2}$$

or

$$c_s k l = \frac{P}{l}$$

Since $c_s k l$ = the cost † per foot of trusses (or girders) and bracing per foot of span, and P/l = the cost † of substructure per foot of span, we have the classical rule that for a minimum the cost of the superstructure per foot should equal the cost of the substructure per foot. The student will do well to reflect on the assumptions on which this derivation rests in order to get a clear understanding of its limitations.

* The student should notice that k is a function of the total load per foot of bridge, permissible stress, and ratio of depth to length, but for a given set of conditions is practically constant over a fairly wide range in span length — from 15 to 50 per cent depending on conditions.

† Cost may be interpreted here as including not only first cost but also cost of maintenance, operation, renewals, financing, and so on, when it can be shown that such charges vary with the span length.

A common way of stating the rule of the previous paragraph is to say that for a minimum cost of bridge the cost of a given pier should equal one-half the cost of the trusses (or girders) and bracing of the spans which it supports. This is a correct and adequate statement for a crossing such as shown in Fig. 207, but that it may be misleading in some cases will be clear from a study of the exaggerated situation presented by Fig. 208. In Layout A of Fig. 208 (a) it is presumed that the cost of pier A is equal to one-half the cost of the trusses and bracing of spans 1 and 2, and that the cost of pier B is equal to one-half the cost of

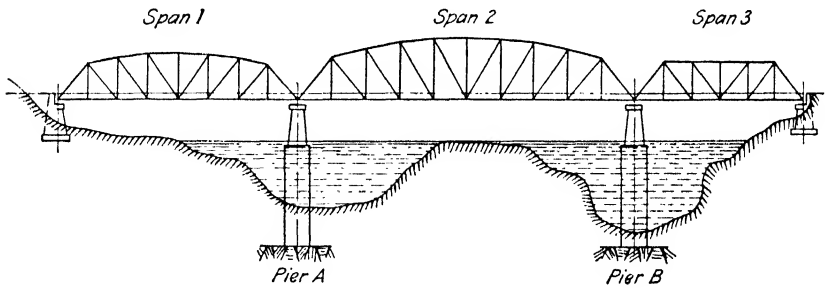

(a) Layout A

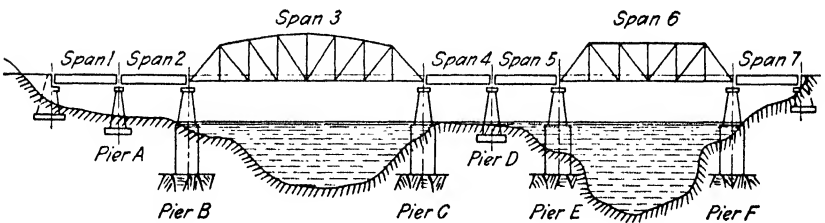

(b) Layout B

FIG. 208.—Contrasted Layouts for a Short Irregular Crossing.

the trusses and bracing of spans 2 and 3: in Layout B it is presumed that the cost of pier A is equal to one-half the cost of the girders and bracing of spans 1 and 2, that the cost of pier B is equal to one-half the cost of the girders and bracing of span 2 plus one-half the cost of the trusses and bracing* of span 3, and so on. The rule is then satisfied for both

* Although the cost of the steel floor system in a truss span is not a direct function of the span length and therefore not a direct factor in selecting the economic span length in a long crossing, attention should be called to the fact that it may be of controlling importance in comparing a truss span with two or three shorter deck girder spans. For example, in studying Layout B, Fig. 208, if the designer wishes to consider a single truss span in place of girder spans 1 and 2 he should compare

layouts. But the most casual observation indicates that Layout A is little short of absurd, and that while Layout B is more reasonable it is not impossible that some other combination of span lengths would also satisfy the rule and have a smaller total cost for the crossing.

Study of the problem will indicate that for a long crossing with foundation bed at a constant depth (such as that in Fig. 207) the pier cost per foot varies inversely as the span length, and the rule is reliable. However, for a short crossing with highly irregular profile (such as that in Fig. 208) the cost of a pier is dependent not only on the length of span *but also on its position in the crossing*. Application of the rule to short irregular crossings will be at best only a rough guide, and comparison of the *total* costs of several layouts may be essential to a satisfactory solution.

156. Economic Proportions.—The least weight depth for a built-up girder was discussed at some length in Chapter III, and unless limited clearances or unusual conditions force the use of a different depth the most favorable proportions for a given set of conditions will be indicated by the data presented there.

Because of inadequate information concerning the relations between chord and web weights, the effect of changes in panel length, the influence of different column formulas, and so on, studies of economic truss depth have not been particularly fruitful as yet, and proportions are based on what experience has shown will give reasonable results.

Ordinarily the depth of trusses lies between $1/8$ and $1/5$ of the span length, the *relative* depth decreasing somewhat as the span increases. In general, deck trusses have relatively less depth than through trusses, and light loads call for relatively less depth than heavy loads. Because of the latter fact highway bridge trusses usually have a smaller depth than railroad bridge trusses of comparable span. With modern loads and clearance requirements it is impracticable to use a depth less than 30 to 32 ft. for through railroad bridges with single track, or 32 to 34 ft. for double track.

Unusual conditions of loading, clearance, width, and so on may compel depths greater or less than those stated, but truss depths less than $1/10$ of the span are considered undesirable and if used generally call for special proportioning to reduce deflection.*

the cost of the trusses and bracing of the truss span plus its floor system with the cost of the two girder spans plus that of pier *A*, since deck girder spans have no floor system.

* See Art. 104 in the specifications, Appendix A. Similar requirements are contained in practically all specifications for design.

Through trusses are generally built with parallel chords for spans up to about 180 ft. for highway bridges, and about 200 ft. for railroad bridges. Deck trusses usually have parallel chords up to spans of 300 to 350 ft. and even longer; in fact the use of non-parallel chords for deck trusses eliminates or reduces one of their important advantages, viz., lower piers.

There is no invariable rule to be followed in selecting intermediate depths in non-parallel chord trusses. A common procedure is to establish the hip and center depths and place intermediate panel points on a parabola which passes through the top chord hip panel points and the center top chord panel point; this is illustrated in Fig. 209. The matter of appearance is important; too great arching of the top chord results in a span that looks "top-heavy." Furthermore, too great

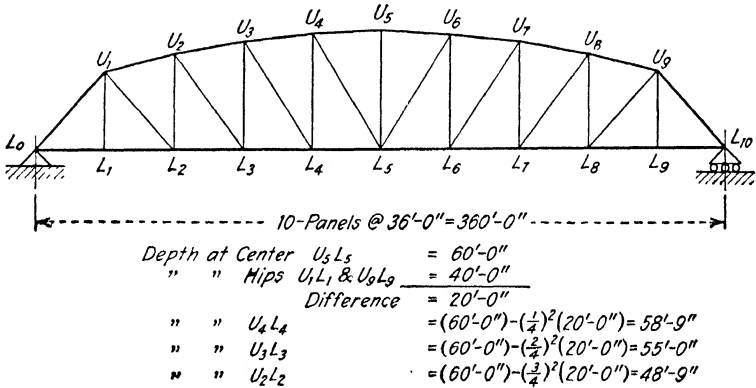

FIG. 209.

arching of the top chord may relieve the stresses in the diagonals to the point of making them so slender that they will be difficult to design and fabricate, and will have a tendency to vibrate under moving loads.

The length of panel and the depth of a truss are related in that the angle which the diagonals make with the horizontal should lie between 45° and 60°—the most favorable angle apparently being between 50° and 55°. Since the depth of a truss should increase with the length of the span it is evident that panel lengths should also increase with the span. Within limits, long panels contribute to economy in the trusses because of the fewer joints required, but of course the weight of the floor system increases with the length of the panels, and these effects tend to offset each other.

Hard and fast rules cannot be laid down, but in general panel lengths range about as follows:

| | |
|-----------------------------|--------------|
| Girder bridges..... | 10 to 20 ft. |
| Highway truss bridges..... | 16 to 32 ft. |
| Railroad truss bridges..... | 22 to 45 ft. |

In order to keep floor weights within reasonable limits and yet maintain favorable angles for the diagonals it becomes desirable to use subdivided or K trusses for highway truss bridges when the spans reach about 320 ft. and for railroad bridges when the spans reach about 400 ft. Of course, unusual conditions may raise or lower these limits, e.g., the necessity for a shallow floor may force the use of subdivided trusses for spans less than half these limits.

157. Design of Girder Spans.—The design of girders was fully discussed in Chapter III, and it is intended here merely to add some comments relating particularly to girder bridges.

The first step in the design of a girder span, having decided on the spacing of the girders, is to lay out the bracing arrangement. In the girder span with a floor consisting of transverse floorbeams and longitudinal stringers there is little to do but provide a system of crossed diagonals in each panel; if the floor system is at the top of the girders (as is usually true in highway girder spans) it is necessary to provide struts for the bottom lateral bracing, and these struts generally occur in the same vertical plane as the floorbeams. If the floor system consists of closely spaced transverse floorbeams resting on the top flanges of the girders the panel length of the bracing should be chosen with reference to favorable slopes for the diagonals. In such spans there should be cross frames at the points where the bracing diagonals connect to the girders, and since there should preferably be a pair of stiffeners at the cross frames, to form its connection to the girders, and since stiffeners must not be spaced more than 6 ft. apart, evidently the bracing panels are preferably made multiples of 6 ft. or as nearly so as is practicable.

In railroad deck girder bridges the general arrangement of the bracing should be as described and illustrated in Chapter II. The first step in arranging the bracing is to locate the intermediate cross frames, which, for reasons stated in the previous paragraph, should be, as nearly as is practicable, at intervals which are multiples of 6 ft. and which design specifications often limit to 18 ft. It is desirable that the cross frames be spaced at equal intervals, but this is not always possible; the interval between cross frames will generally contain from two to four lateral panels.

The function of the end cross frame is to transfer the end reaction from the top lateral system to the masonry abutment or pier, and of course its members must have sufficient strength to perform this duty, but the proportioning of the members is almost entirely a matter of judgment as the stresses are small. The end cross frame should be rigid to check lateral vibration. To secure proper rigidity generally requires that the top and bottom struts in the end cross frame be composed of two angles each ranging in size from $3\frac{1}{2}$ by $3\frac{1}{2}$ by $\frac{3}{8}$ for short spans to 5 by $3\frac{1}{2}$ by $\frac{3}{8}$ for long spans while the diagonals will each be a single angle 5 by $3\frac{1}{2}$ by $\frac{3}{8}$ or 6 by 4 by $\frac{3}{8}$ for spans up to 90 or 100 ft. and two such angles for longer spans.

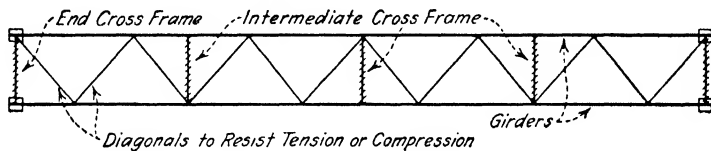

(a)

Single Intersection Lateral System

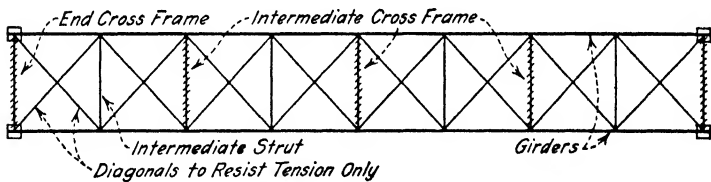

(b)

Double Intersection Lateral System

FIG. 210.—Types of Lateral Bracing for Deck Girder Bridge.

Intermediate cross frames are intended to check relative vertical vibration and will perform this duty if composed of minimum sections.

The top lateral truss in a deck girder span should be proportioned to resist half of the wind force acting on the structure plus the effect of wind on the train and lateral nosing of the train. If the bridge is on a curve the effect of the centrifugal force must also be resisted by the top lateral truss. The bottom lateral truss resists only half of the wind force on the structure.

Both lateral trusses are generally built as single Warren systems and hence must have the members designed to resist either tension or compression since wind and nosing may occur in either lateral direction. Single angle members are generally sufficient but if the girders exceed

7 ft. 0 in. center to center it may be necessary to use double angle members or to use a double intersection system composed of diagonals designed to resist tension only. The two systems are illustrated in Fig. 210.

158. Cover Plate Lengths.—In calculating the required length of cover plates for girders subjected to moving loads it is necessary to

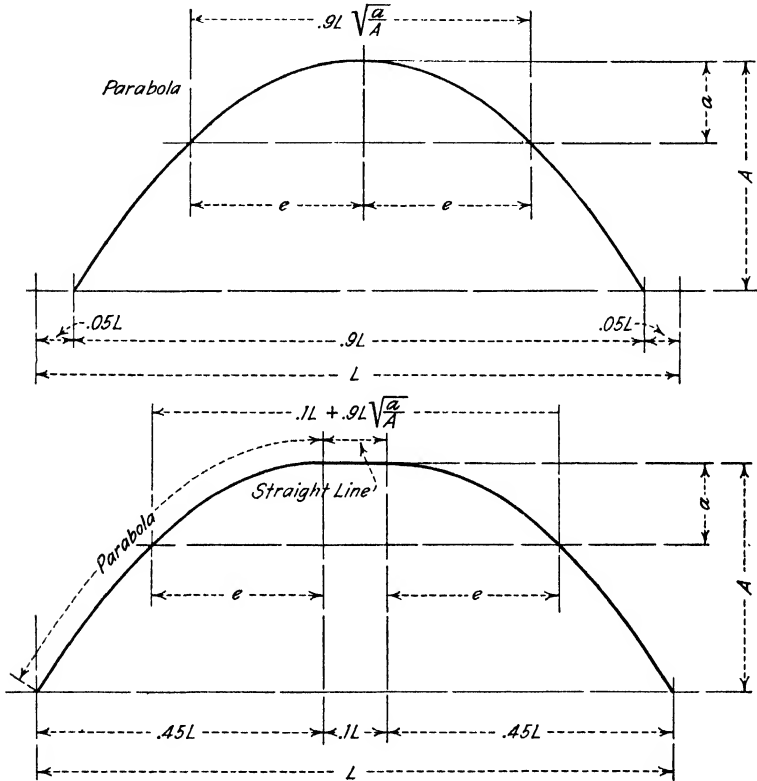

FIG. 211.—Approximate Cover Plate Diagram.

keep in mind that the moment curve which determines the area needed at any section is not a bending moment curve but a curve of maximum moments. Consequently in using the graphical method described in Chapter III it is necessary to compute the maximum moment at several points and construct the curve of maximum moments. After obtaining this curve the rest of the procedure is the same as described for a girder subjected to fixed loads.

The calculation of the maximum moments at several points consumes considerable time, and some more rapid approximate method is generally preferred.

A simple approximate method is given in "Steel Bridge Design" by F. C. Kunz.* It is assumed that the curve of maximum moments may be represented by a parabola drawn on a base of $0.9L$, cut at the center and the two sides separated by a distance $0.1L$. The method and its use is illustrated in Fig. 211. The notation is that used in Chapter III.

An equally convenient and somewhat more accurate method was suggested to the author by Mr. Sumner Gowen,† and is reproduced here with his permission. The method is to calculate the maximum moment due to the actual wheel loads at the center and at four or five points between the end and the center for a number of different spans within the range of span lengths for which plate girders are used. Calling the center moment one and plotting as ordinates the ratios of the moments at intermediate points to the center moment locates points on an envelope curve within which any curve of maximum moments must lie. Such a curve has been plotted in Fig. 212 from data secured from spans varying by intervals of 5 ft. from 30 to 130 ft. A parabola (the bending moment curve for a uniformly distributed load) has been plotted on the same diagram for comparison. The use of the diagram may best be explained by a specific example. Suppose that a girder span of 90 ft. center to center of bearing has been designed having a flange section as follows:

| | |
|------------------------------|----------------|
| 1/8 of 100 in. × 1/2-in. web | = 6.25 |
| 2 angles 8 × 8 × 3/4 | = 19.88 |
| 1 cover 18 × 3/4 | = 12.00 |
| 1 cover 18 × 11/16 | = 11.00 |
| 1 cover 18 × 11/16 | = <u>11.00</u> |

Total = 60.13 sq. in. net

The lengths of the cover plates may be found from the diagram as follows: For the top cover the ratio of its area to the total flange area is $11.00/60.13 = 0.183$. Read down on the scale of flange area ratio on the right to 0.183 and from the intersection of a horizontal line through 0.183, with the envelop curve trace vertically to the cover plate length scale and read there 0.472 as the fractional part of the span; the theoretical length of the cover plate then is $0.472 \times 90 =$

* McGraw-Hill Book Company, New York.

† Chief Designing Engineer, Phoenix Bridge Company, Phoenixville, Pennsylvania.

42.5 ft. to which must be added a proper allowance as usual. Similarly the second cover plate length may be found: ratio of area of second cover plus cover outside of it is $22.0/60.13 = 0.366$, and the theoretical length = $0.638 \times 90 = 57.4$ ft. For the third cover, $34.00/60.13 = 0.565$, and the theoretical length = $0.775 \times 90 = 69.8$ ft.

For the same cover plates Kunz's method gives theoretical lengths of:

$$\text{1st cover} = 90(0.1 + 0.9\sqrt{11.00/60.13}) = 43.5 \text{ ft.}$$

$$\text{2nd cover} = 90(0.1 + 0.9\sqrt{22.00/60.13}) = 57.9 \text{ ft.}$$

$$\text{3rd cover} = 90(0.1 + 0.9\sqrt{34.00/60.13}) = 69.8 \text{ ft.}$$

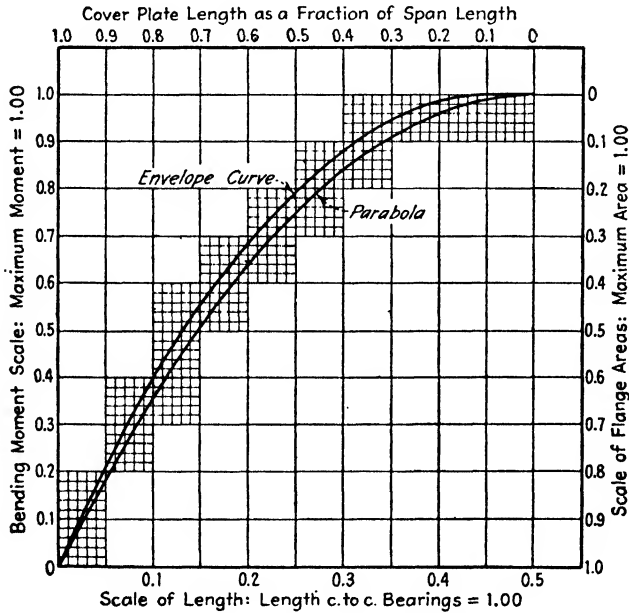

FIG. 212.—Cover Plate Diagram.

159. Design of Truss Spans: Deck.—In designing the floor system the deck is the first member to receive consideration. It is assumed that the student is familiar with the design of concrete slabs * and

* Students not familiar with the design of reinforced-concrete slabs should consult one or more of the standard texts, such as "Reinforced Concrete Design," Sutherland and Clifford; "Principles of Reinforced Concrete Construction," Turneaure and Maurer; "Concrete, Plain and Reinforced," Taylor, Thompson, and Smulski; all published by John Wiley & Sons.

the matter will not be discussed here although the specifications of Appendix B contain clauses concerning effective width of slabs subjected to concentrated loads.

The usual methods of timber design may be applied in proportioning laminated or other wood floors but it is necessary to adopt some rule for determining the width over which concentrated loads may be assumed as distributed in estimating the strength of the floor in shear and moment; practice varies considerably, and experimental data for the

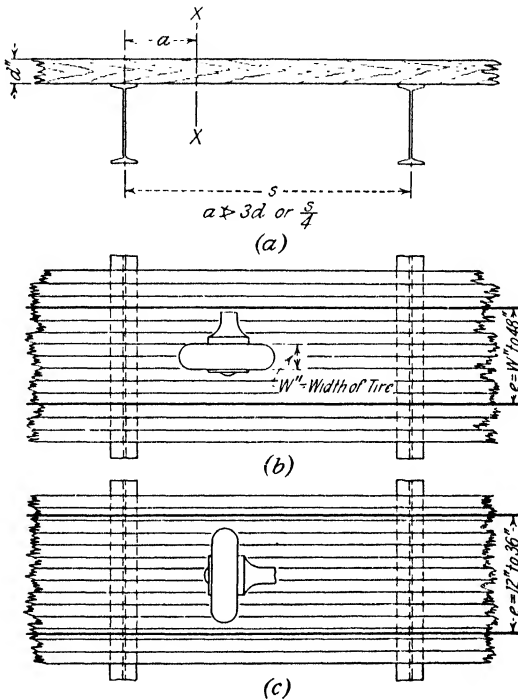

FIG. 213.

support of common rules are meager. The diagrams in Fig. 213 illustrate common assumptions in timber floor design. It is usual to compute the maximum shear in timber beams or floors not at the end but at a section which is three times the depth of the beam, but not more than one-quarter of the span, from the end. Figure 213 (a) shows the location of the section and the limits on a . The widths over which wheel loads may be assumed distributed at right angles to the direction of traffic are shown in Fig. 213 (b) and (c). The Oregon Highway Commission permits distribution of a concentrated wheel load both

longitudinally and transversely in accordance with the following table in which A is the dimension parallel to the center line of roadway and B the dimension across the roadway.

| Thickness of decking, inches | A in feet | B in feet |
|------------------------------|-------------|-------------|
| 2 to 4 | 1.0 | 2.5 |
| 5 to 6 | 1 0 | 4 0 |

Methods for the design of light-weight floors such as the so-called "Battle-Deck," and others mentioned in Art. 151, have not been well established and at present depend largely on empirical data furnished by the manufacturers, or on approximate analyses based on arbitrary assumptions regarding load distribution and the action of the floor construction. The student will do well to estimate the capacity of such floors using the principles of mechanics and his own judgment

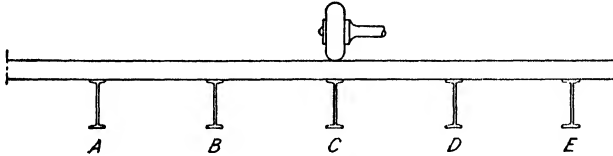

FIG. 214.

regarding load distribution and floor action and compare his results with data published by manufacturers.

160. Design of Truss Spans: Stringers and Floorbeams.—The design of stringers for highway bridges requires consideration of the fact that loads applied directly above a given stringer may be resisted in part by adjacent stringers owing to the stiffness of the deck. For example, in Fig. 214 the load applied directly above stringer C will be resisted in part by stringers B and D since deflection of stringer C , under the action of the load, will necessarily drag down the stringers B and D because of the stiffness of the slab. It seems obvious that the amount of load transmitted to adjacent stringers depends directly on the stiffness of the deck and inversely on the spacing of the stringers. Also it should be clear that the more loads there are on a transverse line the less help any particular stringer will receive from adjacent stringers; e.g., if there were a load above each stringer they would all deflect alike and each stringer would be compelled to carry a full load. The dis-

tribution of a load, or loads, among the stringers may be studied by considering the deck as a continuous beam resting on elastic supports (the stringers), but such a procedure is too long and involved for use in routine design and recourse is had to empirical distribution based on the results of analysis and experiment. The coefficients given in the specifications in Appendix B represent current practice.

In designing floorbeams for highway bridges it is usual to ignore the stringers and treat the dead load of the deck and stringers as uniformly distributed along the floorbeams, and the live loads as applied to the floorbeam directly; of course the weight of the floorbeam itself is a distributed load. The loading for which a floorbeam would be designed in accordance with these assumptions is illustrated diagrammatically in Fig. 215 for a three-lane highway bridge carrying H-20 loading: (a) shows a plan of a portion of the roadway, (b) a cross-section of the floor, and (c) the design sketch of the loading. Sometimes designers treat the dead load of deck and stringers as a series of concentrated loads applied at the centers of the stringers, and of course this is more accurate if the dead-load reactions from the stringers are accurately known.

Little need be said regarding the design of stringers and floorbeams for railroad bridges. The stringers form a series of deck girder bridges supported by the floorbeams, while the floorbeams are girders subjected to known loads (the stringer reactions) at fixed points. Unless floor depths must be kept small the favorable depth for stringers may be estimated by the methods presented in Chapter III.

Floorbeams for single-track bridges with open timber decks are best made deep enough so that the stringers may be framed directly to the web *between* the flange angles, as in Fig. 216. For double-track bridges the floorbeams will have to be much deeper to keep the flange areas within reasonable limits; the favorable depth may be estimated with sufficient accuracy by the methods given in Chapter III although the constants used there are not strictly applicable to floorbeams.

If ballast decks are used it is desirable that the stringers be framed as close up under the outstanding legs of the top flange of the floorbeams as is practicable to prevent undue interruption of the ballast trough.

In through bridges it is generally best to frame the floorbeams with their bottoms flush with the bottom of the lower chord, as indicated in Fig. 216 and on the stress sheet, Plate V.

In deck bridges the floorbeams are generally framed directly under the top chords and the stringers placed on top of the floorbeams as indicated on the stress sheet, Plate VI. Special conditions may make

it necessary or desirable to modify the relative position of floorbeams and stringers, but those noted represent the usual arrangements.

The flanges of floorbeams in through bridges should be kept as narrow as is practicable to reduce stresses due to elongation of the chord.

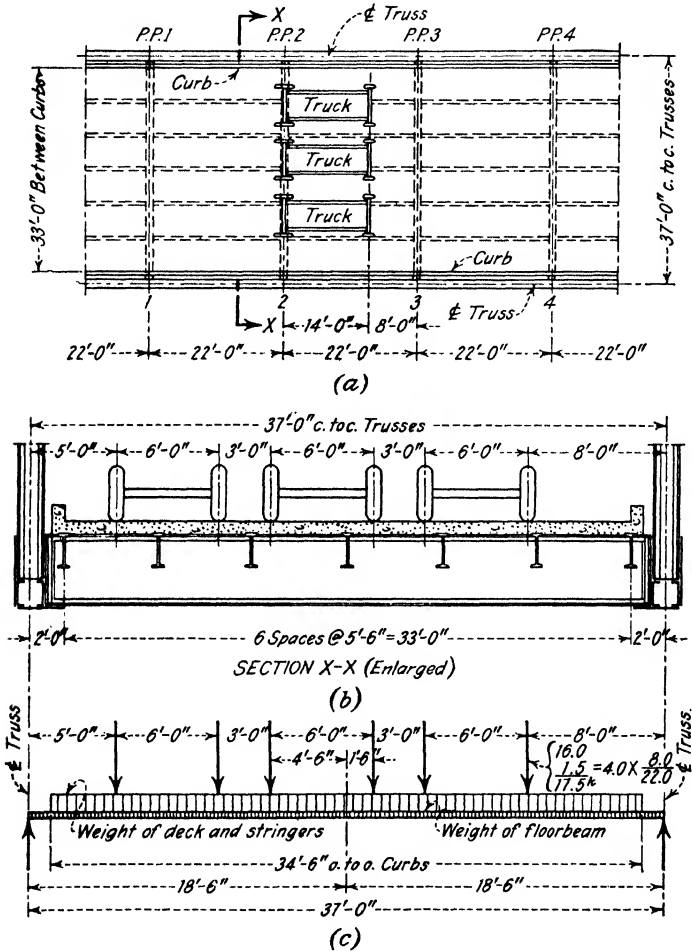

FIG. 215.—Conventional Loading Diagram.

The situation is illustrated to a greatly exaggerated scale in Fig. 217. The elongation of the bottom chord under stress causes the panel points to move from the no-stress positions shown in Fig. 217 (a) to the stressed positions shown in Fig. 217 (b). Since the stringers do not change

length under load the floorbeams are forced into the bent positions shown in Fig. 217 (b). The situation is relieved somewhat by yielding of the stringer connections, but in long spans expansion points must be

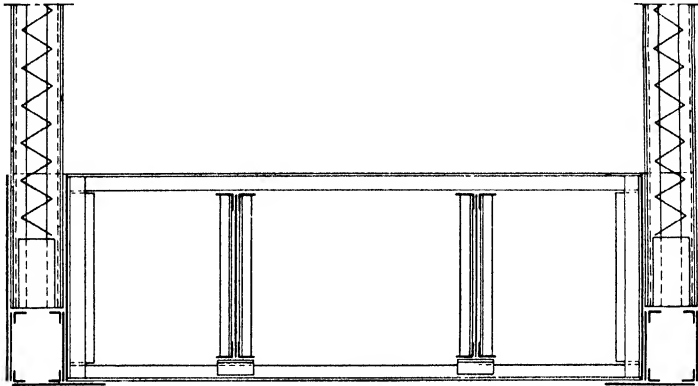

FIG. 216.—Cross-Section of Typical Single-Track Through Truss Bridge.

provided in the floor system to prevent overstressing the floorbeam flanges. For ordinary spans in which floor expansion is not provided some bending of the floorbeams is inevitable and the resulting stresses

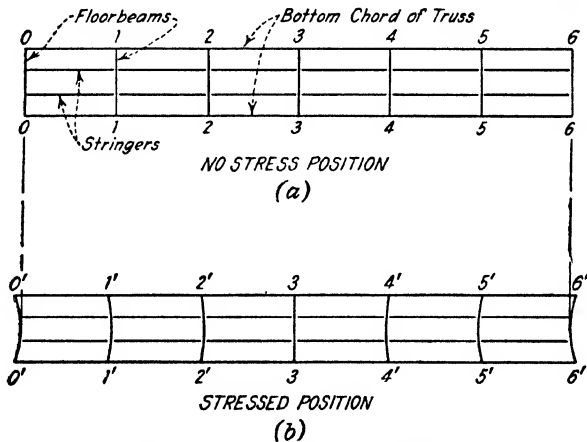

FIG. 217.—Floorbeam Deformation.

will be smaller if the flanges are made as narrow as is convenient. In deck spans with stringers resting on top of the floorbeams the difficulty may be overcome by providing slotted holes at one end of each stringer which permits relative movement of stringers and floorbeams.

161. Design of Truss Spans: Trusses.—The design of tension members and compression members was fully discussed in Chapter IV, and it is proposed in this article merely to make some comments on the proportions of the various members and the relations between them. In designing the members of a truss it is necessary to keep all members in mind when designing one; failure to do so will result in difficult splices and joints, awkward and troublesome erection, and an appearance of the various members not really belonging together.

The student should refer again to Figs. 96 and 97, showing the more common types of truss members, in connection with the following comments.

The design of a truss should begin with the heaviest members which are composed of channels (rolled or built) with flanges turned in, such as those at (i) and (j) in Fig. 96. The clear distance between the toes

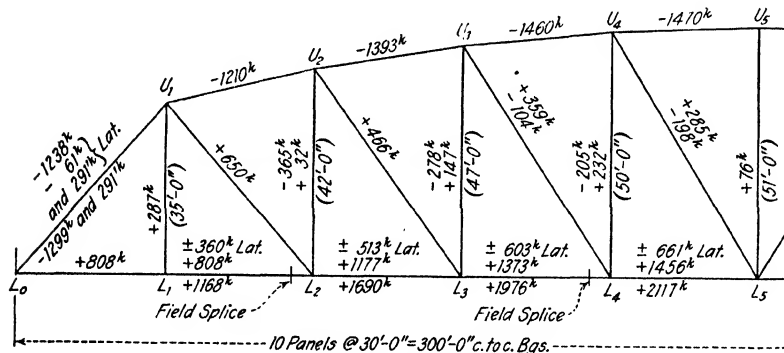

FIG. 218.

of the flanges should not be less than 5 to 7 in. Establishing the clear distance between the toes of the flanges in the heaviest member with flanges turned in will fix the *least* distance between gussets, and the distance between gussets should be constant throughout the truss whenever possible. Following this principle usually requires that the design of a through truss begin with the bottom chords, and the design of a deck truss with the web system.

The method of approach may be illustrated by briefly considering the truss shown in Fig. 218. The design stresses are shown on the various members, tension indicated by + and compression by -. Unless otherwise noted the stresses are the sums of live load, impact, and dead load; the bottom chords and the end posts are increased in area by the stresses due to lateral forces and these are separately indicated.

The first step in the design of the bottom chords is to locate the field splices, and a decision on the matter will be influenced by four factors: (a) convenience in fabrication, (b) convenience in shipping, (c) convenience and capacity of equipment for erection, and (d) convenience in making additions in area from chord to chord. The first three factors are somewhat variable and depend on the organization and equipment of the shops, on the location of the shops with respect to the bridge site, and on the erection equipment. The fourth factor depends of course on the variation in stress from chord to chord and on the type of members chosen. In this particular case the splices were located as shown in the figure.

It is desirable in proportioning the lower chord that the same *type* of member be used throughout and that the changes in area be made by

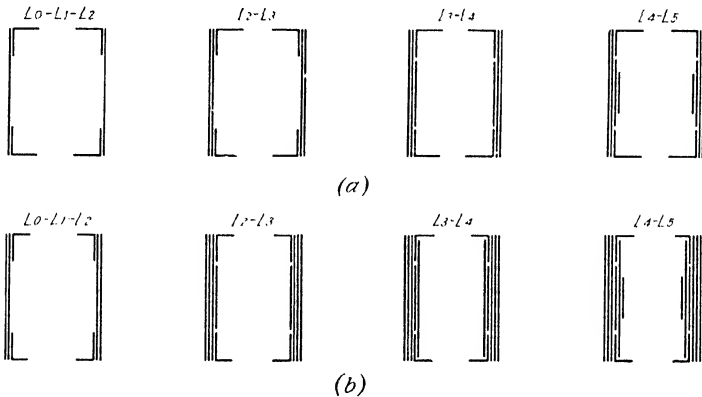

FIG. 219.

the addition of plates to the base section without change in general form. For example, in the truss under consideration the section is composed of two built channels for $L_0L_1L_2$, as shown in Fig. 219 (a). The change in area from L_0L_2 to L_2L_3 is made by the addition of two full-depth web plates, and it is very desirable that the thickness of the added web plates be the same as that of the angles in the base section L_0L_2 . The change in area from L_2L_3 to L_3L_4 is made by the addition of plates between the angles (which can be done without either a shop or field splice at L_3), and here also it is desirable that the thickness of these added plates be the same as the angles between which they are placed if possible; if the added plates from L_0L_2 to L_2L_3 and from L_2L_3 to L_3L_4 are not equal in thickness (at least within 1/16 in.) to the angles, troublesome fillers will be necessary at the splices. The

change in area from L_3L_4 to L_4L_5 is made by the addition (in this case) of narrow plates inside of the ribs, as shown in Fig. 219 (a): since these plates may be cut off at joint L_4 before the splice there is no necessary relation, as to thickness, between them and the other base material.

The general procedure is the same for all chords, but the details will differ in accordance with variations in stress and depth of members. For example, the lower chords for the truss in DP21 are built up as shown in Fig. 219 (b) and on the calculation sheets.

The process is necessarily one of cut and try, and sometimes many combinations will have to be tried before a satisfactory * make-up can be selected. Of course experience in design will gradually develop a sense of proportion and suggest suitable preliminary choices.

Study of the lower chord of the truss in Fig. 218 suggests the following design (based on the specifications in Appendix A) which the student should try to improve.

L_0L_2

1168

at 22.5 † = 51.95 sq. in. net

4 angles 6 in. by 6 in. by 1/2 in. = 23.00 — 4.00 = 19.00 sq. in. net

2 plates 28 by 11/16 = 38.50 — 5.50 = 33.00

Total = 61.50 sq. in. gross = 52.00 sq. in. net

L_2L_3

1690

at 22.5 = 75.20 sq. in. net

Same as L_0L_2 = 61.50 sq. in. gross = 52.00 sq. in. net

Add 2 plates 28 by 1/2 = 28.00 — 4.00 = 24.00

Total = 89.50 sq. in. gross = 76.00 sq. in. net

* Students often raise the question of what is a satisfactory make-up, and the answer is that no hard and fast rule can be laid down. In general the author suggests that no section be allowed to fall short of the required area by more than 1 per cent (preferably $\frac{1}{2}$ per cent) or exceed the required area by more than 1 or 2 per cent. Sometimes it is impossible to proportion so closely. When there are large variations in stress in the chords securing suitable make-up for the heavy-stress members may compel considerable excess area in the light-stress members. In general it may be said that the heavier the structure the more accurately it may be proportioned.

† The intensity has been increased 25 per cent because of the inclusion of stress due to lateral forces. See Art. 213, Specifications, Appendix A.

L_3L_4

1976

at 22.5 = 87.90 sq. in. net

Same as L_2L_3 = 89.50 sq. in. gross = 76.00 sq. in. net

Add 2 plates 16 by 7/16 = 14.00 - 1.75 = 12.25

Total = 103.50 sq. in. gross = 88.25 sq. in. net

L_4L_5

2117

at 22.5 = 94.20 sq. in. net

Same as L_3L_4 = 103.50 sq. in. gross = 88.25 sq. in. net

Add 2 plates 9 by 7/16 = 7.88 - 1.75 = 6.13

Total = 111.38 sq. in. gross = 94.38 sq. in. net

Figure 220 shows the riveting in the body of the member L_4L_5 , and examination of the sketch will show the proper number of holes to be

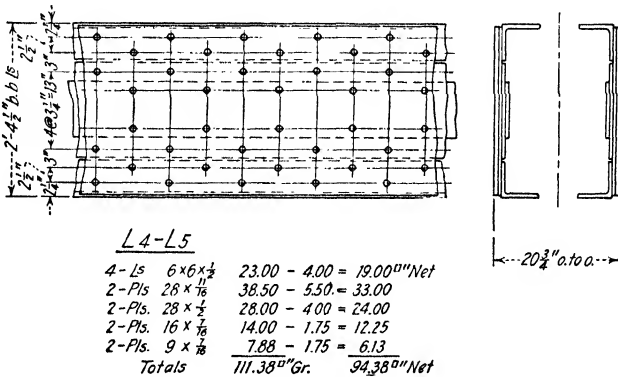

FIG. 220.

deducted from each piece except that it does not show the hole in each outstanding angle-leg which should be deducted because of batten plates, or batten plates and lacing.

Having selected the bottom chords the designer should proceed with the top chords and the end posts. The same general method of proportioning should be followed for the top chords as for the bottom, i.e., a base section should be selected for the minimum-stress chord and the heavier sections built up of the same form either by increasing the web thickness, the addition of plates between the angles, or both. In general the cover plate should be as thin as the specifications will

permit, and, with the angles, kept constant throughout the chords; sometimes changes in angle thickness cannot be avoided. It is necessary that the width of the chord between webs be at least as great as the minimum permissible width of the bottom chord (or web members if the bottom chords have flanges turned out) plus the thickness of the gusset plates—or $20\frac{3}{4}$ in. + $1\frac{1}{4}$ in. = 22 in. for the truss under consideration, assuming 5/8-in. gusset plates (see Fig. 220). It is desirable that the relations between depth and width stated in Chapter IV be maintained and that the depth be great enough to provide a value of r which will permit the maximum intensity of stress for a compression member, but the latter may be impossible in bridges having long panels and light loads. Care must be taken in proportioning compression members that the limits on web and cover plate thicknesses are met.

To illustrate the points mentioned consider the member U_1U_2 in the truss of Fig. 218, the base section for the top chord. The width between webs must be 22 in., and since this should not be less than $\frac{3}{4}$ of the depth the maximum web depth will be

$$\frac{4}{3} \times 22 = \text{about } 29 \text{ in.}$$

The maximum permissible stress occurs for $L/r \cong 56$, and r should preferably be such that $L/r \succ 56$. Therefore

$$r \prec \frac{370}{56} \text{ or } 6.6$$

If $r = 0.4d$ (see table of approximate radii of gyration, page 421)

$$d \prec \frac{6.6}{0.4} \text{ or about } 17 \text{ in.}$$

With these limits in mind the chords may be proportioned by trial and correction.

Study of stresses and trial make-ups suggest the following design (based on the specifications in Appendix A) which the student should try to improve.

U_1U_2

1210

at 15.05 = 80.4 sq. in. gross

| | |
|-------------------------------|-----------------|
| 1 cover plate 32 by 11/16 | = 22.00 sq. in. |
| 2 top angles 4 by 4 by 1/2 | = 7.50–29.50 |
| 2 bottom angles 6 by 6 by 7/8 | = 19.46–48.96 |
| 2 web plates 26 by 5/8 | = 32.50–81.46 |

Total = 81.46 sq. in. gross

U_2U_3

1393

at 15.05 = 92.6 sq. in. gross

Same as U_1U_2 = 81.46 sq. in. gross

Add 2 plates 16 by 3/8 = 12.00

Total = 93.46 sq. in. gross

U_3U_4 and U_4U_5

1470

at 15.05 = 97.7 sq. in. gross

Same as U_1U_2 = 81.46 sq. in. gross

Add 2 plates 16 by 1/2 = 16.00

Total = 97.46 sq. in. gross

U_1L_0

1238

at 15.05 = 82.3 sq. in. gross

or

$$\frac{1299}{15.05 \times 1.25} + \frac{291 \times 12 \times 17.9}{15.68 \times 1.25 \times 10.98^2} = 95.5 \text{ sq. in. gross}$$

Same as U_1U_2 = 81.46 sq. in. gross

Add 2 plates 16 by 7/16 = 14.00

Total = 95.46 sq. in. gross

The student should note that the end posts, which are preferably the same depth as the top chords, may in some cases have a permissible intensity of stress less than the chords because of their greater length and therefore greater L/r ratio. It is necessary to *estimate* the permissible stresses for the design of the end post from *approximate* L/r and L/b ratios and correct these if necessary when definite sections give definite values of r (about both axes) and b .

With the chords proportioned the truss design is completed by working out the make-up for the web members. The same general procedure should be followed. It should be noted that if the diagonals near the center are subjected to reversal of stress it will be necessary to provide counters* or to satisfy the limits on L/r ratio. Because of the small stress and considerable length the design of compression members in the web often resolves into selecting the most favorable member having satisfactory radii of gyration—sometimes this results in unavoidable excess area.

* See Arts. 118 and 125, "Theory of Simple Structures," Shedd and Vawter, John Wiley & Sons.

Consider the diagonal U_4L_5 of the truss in Fig. 218. Maximum L/r permitted is 120. (See Specifications, Appendix A.)

$$r \leq \frac{700}{120} = 5.84$$

and

$$d \leq \frac{5.84}{0.36} = \text{about } 16\frac{1}{2} \text{ in.}$$

Assume 16-in. web plates. Then

$$d = 16\frac{1}{2} \text{ in.} \qquad r = \text{approx. } 0.36 \times 16\frac{1}{2} = 5.95$$

$$\frac{L}{r} = \frac{700}{5.95} = 118 \qquad p = 9.64 \text{ kips per sq. in.}$$

285 kips at 18 kips per sq. in. = 15.82 sq. in. *net*

198 kips at 9.64 kips per sq. in. = 20.52 sq. in. *gross*

2 web plates $16 \times \frac{3}{8} = 12.00 - 1.50 = 10.50$ sq. in. *net*

4 angles $4 \times 3\frac{1}{2} \times \frac{3}{8} = 10.67 - 3.00 = 7.67$

$$\text{Total} = 22.67 \text{ sq. in. gross} = 18.17 \text{ sq. in. net}$$

The student should check the radii of gyration and note that the 4-in. legs of the angles must be against the web and have gage lines $2\frac{3}{4}$ in. from the backs in order to satisfy the limit on web thickness.

In designing the verticals it is important to keep in mind that all intermediate floorbeams should have the same connection* and to proportion the members to permit this.

162. Truss Bracing.—Space would not permit a thorough discussion of the design of bracing even if the subject were one permitting a theoretical presentation. There is no part of the design of a structure, whether bridge or building, more dependent on judgment and experience, particularly for ordinary structures such as are dealt with in this text. But it is also true that adequate bracing is one of the most important requirements in a good design; some designers would consider it the most important.

The principal difficulty in designing bracing is due to the very small stresses which result from the assumed lateral forces. This is particularly true of highway bridges and of the unloaded chords of railway bridges of moderate spans. In such cases the stresses are

* Floorbeam and stringer connections, as well as truss member connections, are often made by drilling the holes through metal templets, and to keep the number of templets small all connections having the same stress should have the same number and arrangement of rivets so far as is practicable.

likely to be so small that almost any section chosen will be more than adequate so far as *area* is concerned, and members which are in compression must be proportioned to satisfy L/r requirements while tension members should bear some relation to the size and importance of the structure. Study of existing structures designed by, and of designs prepared by, recognized engineers will aid in forming good judgment. The illustrations in Chapter II will furnish helpful ideas as to what has been done in bracing some structures.

The bracing between the loaded chords of railway bridges generally will have calculated stresses sufficient in magnitude to lead to satisfactory choice of members, at least in the panels near the ends.

In railroad bridges longitudinal forces resulting from accelerating or braking trains on the structure may result in rather severe bending stresses in the flanges of the floorbeams, at right angles to the plane of the web, unless such forces are transmitted to the main trusses by means of traction frames. In single-track bridges it is sufficient to provide a transverse strut between the points where

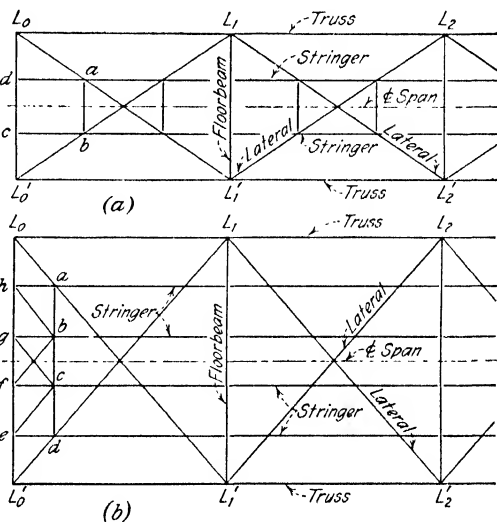

FIG. 221.—Traction Frames for Single-Track and Double-Track Bridges.

the main truss laterals cross and are connected to the stringers. Such a strut is shown in Fig. 221 (a) as ab , and with the laterals, floorbeam, and stringers forms a queen post truss $L_0-a-b-L'_0-c-d$ which transmits longitudinal forces to the main trusses. A traction truss in a double-track bridge may be formed, as shown in Fig. 221 (b), by the addition of members $a, b, c, d; e, c; f, b; g, c;$ and h, b . When the floorbeams in a double-track bridge are so deep that the bottoms of the stringers are a considerable distance above the bottoms of the floorbeams it may be necessary to raise the plane of the main truss laterals from the bottom of the floorbeams (the usual level) to the bottom of the stringers. If this cannot be done a complete and separate traction

frame may be provided either in the plane of the tops of the stringers or in the plane of their bottoms.

In single-track railroad bridges the struts, such as *ab*, in Fig. 221 (*a*) should be provided in each panel as shown in the figure. In double-track bridges one traction frame may be provided in each panel, as has been done in Design Problem DP21. Although a frame in each panel is not necessary it is desirable that such frames be provided at intervals not exceeding about 100 ft. In double-track deck bridges the introduction of traction frames is relatively simple, but in through bridges they may result in troublesome details.

The forces for which traction frames are designed are applied along

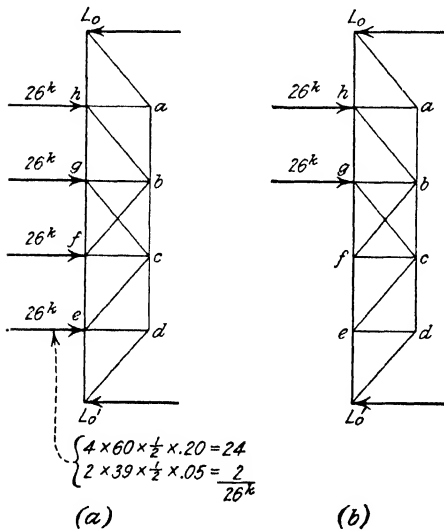

FIG. 222.

the stringers, and their magnitudes will be determined by the number of panels of tractive or braking force which the frames are assumed to provide for. When one frame is designed to provide for several panels the forces may become fairly large. The forces acting on a frame for one panel of 30 ft. in a bridge designed for E-60 on two tracks may be as shown in Fig. 222; the forces in (*a*) will determine the design stresses for the chords and the diagonals except *fb* and *gc*, and the forces in (*b*) will determine the stresses for the latter.

These forces are based on the braking effect given in the specifications of Appendix A.

163. Illustrative Material.—To supplement the foregoing discussion there are presented for further study the design calculations, DP21, two railroad bridge stress sheets, and some typical joint details for the bridge designed in DP21. Lack of space prevents the inclusion of highway bridge material or the details for an entire structure. The student will do well to redesign typical members, using different design specifications, to detail some joints other than those shown, and to study the designs as a whole with a view to improvement.

The design calculations, DP21, are for the bridge crossing shown

T. M. and H. Railroad Bridge at M.P. 168.35

| | |
|------------------------------|--------|
| DP.21 | |
| Double Track Railroad Bridge | |
| 1928 | T.C.S. |
| Sheet 1 of 16+3 | |

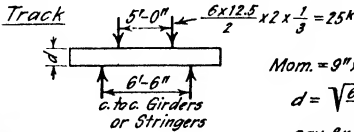

$6 \times 12.5 \times 2 \times \frac{1}{3} = 25k$
 $Mom. = 9'' \times 25k = 225''k @ 2\frac{1}{2}'' \text{ on } \frac{I}{c} = 112.5$
 $d = \sqrt{\frac{6 \times 112.5}{8}} = 9.2''$
 say 8x10 Ties 12'' c. to c. 10' long

Specifications
 A.S.C.E. 1923

 Live Load:
 E-60 Double Track

Rails etc. = 200

Ties $\frac{8 \times 10 \times 5 \times 10}{12} = 333$

Guard Timbers $\frac{8 \times 6}{12} \times 2 \times 5 = 40$

Hook Bolts etc. = 7

Total = 580 #/4 of Track

X2 = 1160 #/4 of Bridge

Determination of Approach Spans

Length of Span 1 Fixed by
 Street and Railroad Clearance
 Requirements.
 See Profile and Plan Plate IX

Approach Spans: Girders on Piers

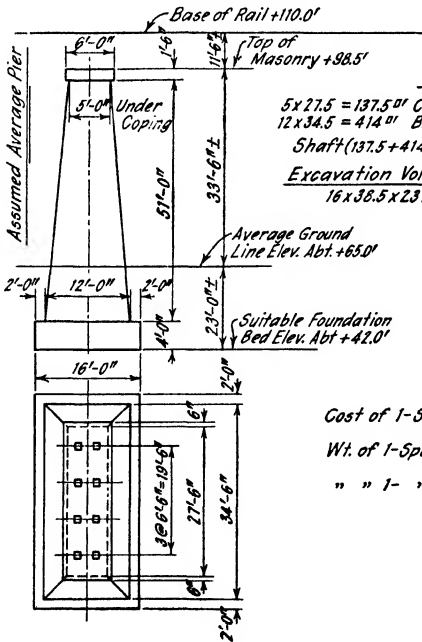

Pier Volume

$5 \times 27.5 = 137.5 \text{ m}^3$ Coping $6 \times 28.5 \times 1.5 \times \frac{1}{2} = 9.5 \text{ yds.}^3$
 $12 \times 34.5 = 414 \text{ m}^3$ Base $16 \times 38.5 \times 4 \times \frac{1}{2} = 91.5$
 $Shaft (137.5 + 414 + \sqrt{137.5 \times 414}) \frac{2}{3} \times \frac{1}{2} = 497$
Excavation Volume 598 yds.^3
 $16 \times 38.5 \times 23 \times \frac{1}{2} = 525 \text{ yds.}^3$

Pier Cost

$598 \text{ yds. conc.} @ \$15.50 = \$9270$
 $525 \text{ " exc.} @ 1.25 = 660$
 $\$9930$
 say \$10,000

Cost of girder spans, .-. / \$100 per ton.

Cost of 1-Span = Cost of 1-Pier = \$10,000

Wt. of 1-Span, 2-Tracks = $\frac{10,000}{100} = 100$ Tons

" " 1- " , 1-Track = 100,000#

$15L^2 = 100,000 \dagger$ Approx.

$L = \sqrt{\frac{100,000}{15}} = 81.5' \text{ span length}$

*The student should note particularly that these are NOT the specifications printed in Appendix A.

† See Szilapkas' Formula, Art. 153.

T. M. and H. Railroad Bridge at M.P. 168.35

Approach Spans: (Cont.)

5-Spans @ 84'-0 $\frac{3}{4}$ " c.to c. bgs. = 420'-1 $\frac{1}{2}$ "
 Clearances (3'-6" + 4 x 7'-5" + 1'-3") = 11'-5"
 $\frac{431'-6\frac{1}{4}" \pm \text{East Bearing Span 1}}{\text{to Backwall Abutment B}}$

15 @ 5'-7 $\frac{1}{2}$ " = 84'-0 $\frac{3}{4}$ " c.c. Bgs.
 85'-8 $\frac{3}{4}$ " c.to c. Piers

DP 21

**Double Track
Railroad Bridge**

| | |
|-----------------|--------|
| 192B | T.C.S. |
| Sheet 2 of 16+3 | |

Dead Load

| | <u>Max. Moment</u> | <u>Max. Pier Reaction</u> | <u>Max. Shear</u> |
|---|-------------------------|---------------------------|-------------------------|
| Track = 580#/ (Sheet 1) | L.L. = 3539'k | L.L. = 315.3 | L.L. = 194.2'k |
| Steel = 1260 = 15L | 79% Imp. = 2796 | 55% Imp. = 173.3 | 79% Imp. = 153.2 |
| Total = 1840#/ | D.L. = 811 | D.L. = 78.9 | D.L. = 38.6 |
| + 2 = 920#/ of girder | Total = 7146'k | Total = 567.5'k | Total = 386.0'k |
| | + 8.28' = 862'k Fig. 5t | @ .6 = 946' on | @ 10 = 38.6' on gr. |
| | @ 16 = 53.9' net | masonry | @ 12 = 32.2' net |
| $\sigma_y = 16 - .15x \frac{13.4}{18} = 14.9$ | @ 14.9 = 57.8' on gr. | | @ 24 = 16.1' on s. legs |
| | | | @ 44 = 26.8 Rivs. d.s. |
| | | | @ 10.5 = 38.8 " bg. w. |
| | | | @ .6 = 64.3' on masonry |

Web Splice

Mom. Pls.

$$\left(\frac{99.3}{74.0}\right)^2 \times 6.25' = 11.25' \text{ net}$$

$$+ 7 = 1.61', 2 \times \frac{18}{16} = 1.63'$$

Use 2-Mom. pls. $10 \times \frac{53}{16} = 2 \times 7 \times \frac{18}{16} = 11.38' \text{ net}$

$$\frac{11.38 \times 16}{10.5} = 17.3 \sim 18 \text{ rivets each side of cut}$$

Shear Pls.

$$(100 - 24) \times \frac{1}{2} = 38.0' \text{ net}$$

$$\frac{38.0 \times 12}{10.5} = 43.5 \text{ say 45 rivets each side of cut}$$

3-rows " " " "

Use 2-Shear Pl. $18\frac{1}{2}' \times \frac{7}{16}$

| <u>T. M. and H. Railroad Bridge at M.P. 168.35</u> | | <u>DP 21</u> |
|---|--|---|
| <u>Approach Spans: (Cont.)</u> | | <u>Double Truss Railroad Bridge</u> |
| <u>Girders</u> | | <u>1928 T.C.S.</u> |
| | | <u>Sheet 3 of 16+3</u> |
| 1 - Web | $100 \times \frac{1}{2} = 50.00^{oo} gr. \frac{1}{2} = 6.25^{oo} \frac{1}{2} = 8.33$ | $3\frac{1}{2}\% \text{ excess} = 510$ |
| 2 - Bott. Is | $8 \times 8 \times \frac{11}{16} = 24.68 - 3.25 = 21.43 + 6.25 = 27.68$ | $@ 170.00' / x 85.2' = 14,480$ |
| 1 - " Pl. | $18 \times \frac{11}{16} = 14.63 - 1.63 = 13.00 + 27.68 = 40.68$ | $@ 41.0 \times 85.2 = 7,150$ |
| 1 - " Pl. | $do = do = 13.00 + 40.68 = 53.68^{oo} net$ | $@ 49.7 \times 85.2 = 4,240$ |
| 2 - Top Is | $8 \times 8 \times \frac{13}{16} = 24.68 + 8.33 = 33.01$ | $@ 49.7 \times 85.2 = 2,410$ |
| 1 - " Pl. | $18 \times \frac{11}{16} = 14.63 + 33.01 = 47.64$ | $@ 47.0 \times 85.2 = 7,150$ |
| 1 - " Pl. | $do = 14.63 + 47.64 = 62.27^{oo} gr.$ | $@ 49.7 \times 85.2 = 4,240$ |
| 8 - End Stiffs. | $6 \times 4 \times \frac{3}{4} = 4 \times 5.38 \times .75 = 16.14^{oo} o.s. legs$ | $@ 23.6 \times 8.2 = 1,620$ |
| 4 - End Fills | $14 \times \frac{11}{16}$ | $@ 38.7 \times 7.0 = 1,080$ |
| 32 - Int. Stiffs | $6 \times 3\frac{1}{2} \times \frac{3}{4}$ Crimp. ex. at. cr. frames | $@ 11.7 \times 8.2 = 3,070$ |
| 4 - End Fills | $3\frac{1}{2} \times \frac{11}{16}$ | $@ 9.7 \times 7.0 = 270$ |
| 4 - Spl. Pls. | $10 \times \frac{11}{16}$ | $@ 27.6 \times 3.0 = 330$ |
| 2 - " " | $18 \times \frac{11}{16}$ | $@ 27.5 \times 5.3 = 290$ |
| 2 - Sole Pls. | $18 \times \frac{11}{16}$ | $@ 53.6 \times 1.2 = 130$ |
| Riv. Hds. etc | $2\frac{1}{2}\% +$ | $= 1320$ |
| | $Wind 30 \times 1\frac{1}{2} \times 9.5 = 430$ | $2 \lambda 30,700 = 101,400^*$ |
| | $x \frac{1}{2} = 215$ | |
| | $.1 \times 6000 = 600$ | $815^* / i \times 5.6' = 4.56^* / panel$ |
| <u>Top Laterals</u> | | |
| a | $\pm \frac{105}{15} \times 4.56 \times \frac{9.58}{6.50} = \pm 42.2^* @ 6 = 7R$ | $1-L 5 \times 3\frac{1}{2} \times \frac{3}{4} @ 16.8 \times 6.4 \times 2 = 215$ |
| b | $\pm 36.6 @ 6 = 6R$ | $1-L 5 \times 3\frac{1}{2} \times \frac{3}{4} @ 13.8 \times do = 175$ |
| c | $\pm 31.4 @ 6 = 6R$ | $1-L 5 \times 3\frac{1}{2} \times \frac{3}{4} @ 12.0 \times do = 155$ |
| d | $\pm 26.5 @ 6 = 5R$ | $1-L 5 \times 3\frac{1}{2} \times \frac{3}{4} @ 10.4 \times do = 135$ |
| e | $\pm 22.1 @ 6 = 4R$ | $1-L do @ 10.4 \times do = 135$ |
| f | $\pm 18.1 @ 6 = 3R$ | |
| g | $\pm 14.5 @ 3R$ | $1-L 3\frac{1}{2} \times 3\frac{1}{2} \times \frac{3}{4} @ 8.5 \times 6.4 \times 5 = 270$ |
| h | $\pm 11.3 @ 3R$ | |
| | | <u>Details = 835</u> |
| <u>Bott. Laterals</u> | | |
| | | <u>1920 x 1 = 1,920</u> |
| All 1-L $3\frac{1}{2} \times 3\frac{1}{2} \times \frac{3}{4} @ 8.5$ | $x 6.4' \times 15 = 815$ | |
| | <u>Details = 375</u> | |
| | <u>1380 x 1 = 1,380</u> | |
| <u>Cross Frames</u> | | |
| <u>End</u> | | |
| Struts Each | $2-15 3\frac{1}{2} \times 3\frac{1}{2} \times \frac{3}{4} @ 8.5 \times 6.2 \times 4 = 210$ | |
| Diags. " | $1-L 6 \times 4 \times \frac{3}{8} @ 12.3 \times 10.3 \times 2 = 255$ | |
| | <u>Details = 125</u> | |
| | <u>590 x 2 = 1,180</u> | |
| <u>Int.</u> | | |
| Struts Each | $1-L 3\frac{1}{2} \times 3\frac{1}{2} \times \frac{3}{4} @ 8.5 \times 6.2 \times 2 = 105$ | |
| Diags. " | $1-L do @ 8.5 \times 10.3 \times 2 = 175$ | |
| | <u>Details = 100</u> | |
| | <u>380 x 4 = 1,520</u> | |
| <u>Total Excluding Bgs. 107,410</u> | | |
| <u>Say 107,500*</u> | | |

T. M. and H. Railroad Bridge at M.P. 168.35

Approach Span Bearings

| | |
|---------------------------------|--------|
| DP21 | |
| Double Track Railroad Bridge | |
| 1928 | T.C.S. |
| Sheet 4 of 16+3 | |

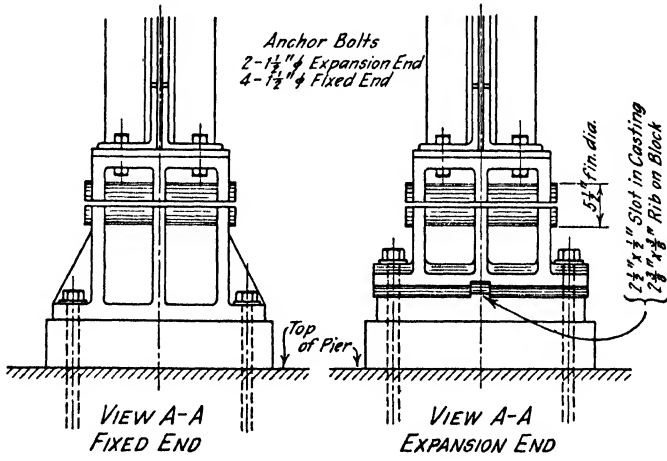
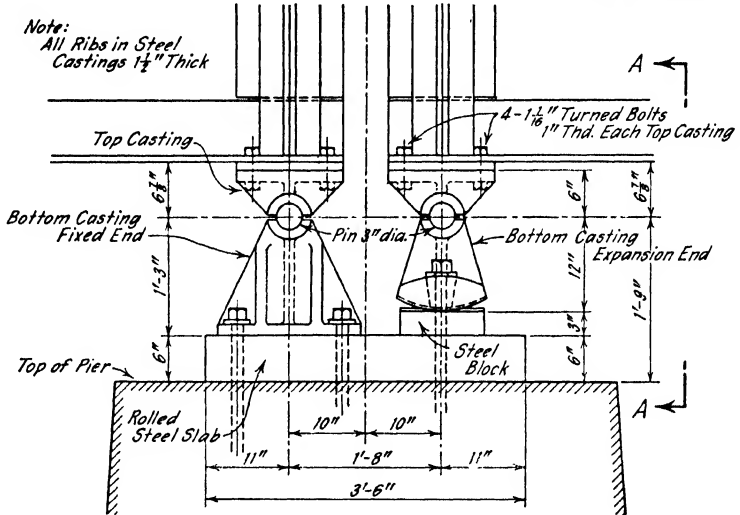

DP21.

T. M. and H. Railroad Bridge at M.P. 168.35

| | |
|---------------------------------|--------|
| DP 21 | |
| Double Track Railroad Bridge | |
| 1928 | T.C.S. |
| Sheet 5 of 16+3 | |

Truss Span: Dimensions

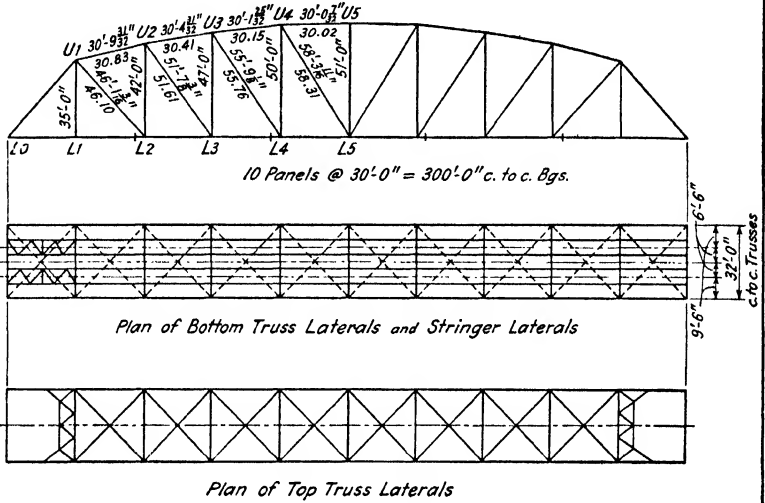

T. M. and H. Railroad Bridge at M.P. 168.35

Truss Span: Floor (Cont.)

Intermediate Floorbeam

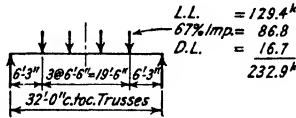

Forward 317,360

| | |
|------------------------------|--------|
| DP 21 | |
| Double Track Railroad Bridge | |
| 1928 | T.C.S. |
| Sheet 7 of 16+3 | |

Max. Mom. L.L. = 2458¹/_k
 Imp. = 1648
 Conc. D.L. = 318
 .5 x 32³/₈ x ¹/₈ Unif. D.L. = 64
 Total = 4488¹/_k

Max. Shear L.L. = 258.8
 Imp. = 173.6
 Conc. D.L. = 33.4
 .5 x ³²/₂ Unif. D.L. = 8.0
 Total = 473.8^k

÷ 7.30' = 615^k Flg. St.
 @ 16.0 = 38.45^o net
 16.0 - 15 x ⁷⁰/₁₃ @ 15.1 = 40.85^o gr.

@ 10 = 47.38^o gr.
 @ 12 = 39.4^o net
 @ 14.4 = 33 Web rivs. d.s.
 @ 11.8 = 40 " " bg.
 @ 6.0 = 79 - 80 field rivs. s.s.



- 1 - Web 88 x ⁹/₁₆ = 49.50^o gr, 39.9^o net ¹/₈ = 6.19, ¹/₄ = 8.25 @ 168.3 x 30.7 = 5170^{*} 3% excess 160
 - 2 - Bot. L^s 6 x 6 x ¹³/₁₆ = 18.18 - 3.25 = 14.93 + 6.19 = 21.12 @ 31.0 x 30.7 = 1900
 - 1 - Bot. Pl. 13 x ¹³/₁₆ = 10.56 - 1.63 = 8.93 + 21.12 = 30.04 @ 35.9 x 30.7 = 1100
 - 1 - do do = do = 8.93 + 30.04 = 38.97^o net @ 35.9 x 18.0 = 650
 - 2 - Top L^s 6 x 6 x ¹³/₁₆ = 18.18 + 8.25 = 26.43 @ 31.0 x 30.7 = 1900
 - 1 - Top Pl. 13 x ¹³/₁₆ = 10.56 + 26.43 = 36.99 @ 35.9 x 30.7 = 1100
 - 1 - do do = do = 10.56 + 36.99 = 47.55^o gr. @ 35.9 x 18.0 = 650
 - 4 - End Conn. L^s 6 x 6 x ³/₈ @ 24.2 x 7.3 = 710
 - 4 - End Fills. 9 x ¹³/₁₆ @ 24.9 x 6.4 = 640
 - 4 - Int. Stiffs. 5 x ³/₂ x ³/₈ Crimped @ 10.4 x 7.3 = 300
 - 8 - Seat L^s 4 x 4 x ³/₈ @ 9.8 x 1.1 = 90
 - 8 - " Stiffs. 3¹/₂ x 3¹/₂ x ³/₈ @ 8.5 x 1.8 = 120
 - 8 - " Fills. 3¹/₂ x ¹³/₁₆ @ 9.7 x 1.1 = 90
 - Riv. Hds., etc. 2¹/₂ % + = 420
 - 1 - Int. Flbm. 15,000^{*}
- x 9 = 135,000

Effective Floor D.L. on Truss
 2 x 15,700 = 31,400 1 - Str. Panel
 15,000 1 Int. Flbm.
 46,400^{*} Total Int. Panel
 ÷ 30 = 1545
 Say 1550^{*}/1 of Bridge

Sheet 452,360

T. M. and H. Railroad Bridge at M.P. 168.35

DP 21

Double Track
Railroad Bridge

| | |
|-----------------|--------|
| 1928 | T.C.S. |
| Sheet 8 of 16+3 | |

Truss Span Floor (Concl.)

End Floorbeam

= 104.7 L.L.
86% L.L. = 90.0 Imp.
 $.56 \times 31.9 \times \frac{15.95}{30.0} = 9.5 \text{ D.L.}$

204.2^k

Forward 452,360*

| | |
|--|---|
| <p>Max. Mom. L.L. = 1989 86% Imp. = 1711 Conc. D.L. = 181 $.4 \times \frac{32}{8} = \text{Unif. D.L.} = 51$</p> <p style="text-align: center;">Total = 3932^k</p> <p>+ 7.30^l = 539^k @ 16.0 = 33.66^o/net @ 15.1 = 35.70^o/gr.</p> | <p>Max. Shear L.L. = 209.4^k 86% Imp. = 180.0 Conc. D.L. = 18.0 $.4 \times \frac{32}{2} = \text{Unif. D.L.} = 6.4$</p> <p style="text-align: center;">Total = 414.8^k</p> <p>@ 10.0 = 41.48^o/gr. @ 12.0 = 34.57^o/net @ 14.4 = 29 rivs in conn. 15 @ 10.5 = 40 rivs. bg. on web @ 6.0 = 70 field rivs. s.s.</p> |
|--|---|

| | |
|---|---|
| <p>1- Web $88 \times \frac{1}{2} = 44.0^{\text{o}}/\text{gr.}, 36.50^{\text{o}}/\text{net}, \frac{1}{8} = 5.50^{\text{o}}/\frac{1}{2} = 7.53^{\text{o}} @ 149.6 \times 30.0 = 4490$</p> <p>2- Batt. 1⁶ $6 \times 6 \times \frac{1}{16} = 15.56 - 2.75 = 12.81, + 5.50 = 18.31 @ 26.5 \times 30.0 = 1590$</p> <p>1- Batt. Pl. $13 \times \frac{1}{8} = 8.94 - 1.38 = 7.56, + 18.31 = 25.87 @ 30.4 \times 30.0 = 910$</p> <p>1- do do = 7.56, + 25.87 = 33.46^o/net @ 30.4 x 17.5 = 530</p> <p>2- Top 1⁶ $6 \times 6 \times \frac{1}{16} = 15.56, + 7.33 = 22.89 @ 26.5 \times 30.0 = 1590$</p> <p>1- Top Pl. $13 \times \frac{1}{8} = 8.94, + 22.89 = 31.83 @ 30.4 \times 30.0 = 910$</p> <p>1- do do = 8.94, + 31.83 = 40.77^o/gr @ 30.4 x 17.5 = 530</p> <p>4- End Conn. 1⁶ $6 \times 6 \times \frac{1}{8} @ 24.2 \times 7.3 = 705$</p> <p>4- End Fills $9 \times \frac{1}{16} @ 21.0 \times 6.4 = 540$</p> <p>4- Seat 1⁶ $4 \times 4 \times \frac{1}{8} @ 9.8 \times 1.1 = 45$</p> <p>8- Stiffs. $3 \frac{1}{2} \times 3 \frac{1}{2} \times \frac{1}{8} @ 8.5 \times 1.8 = 120$</p> <p>2- Fills. $5 \frac{1}{2} \times \frac{1}{8} @ 8.2 \times 1.1 = 70$</p> <p>4- Int. Stiffs. $5 \times 3 \frac{1}{2} \times \frac{1}{8}$ (See Int. Fib'm. for location) Crimp @ 10.4 x 7.3 = 305</p> <p>Riv. Hds. etc. abt. $3 \frac{1}{2} \frac{1}{8} = 430$</p> <p style="text-align: right;">Total for 1-End Flbm. = 12,900*</p> <p style="text-align: right;">x2 = 25,800</p> | <p style="text-align: right;">3% excess = 135</p> |
|---|---|

Floor Total = 478,160*
(Excluding Truss Frames)

| <u>T. M. and H. Railroad Bridge at M.P. 168.35</u> | | | | | | <u>DP21</u> | | | |
|--|------|-------|------|--------|------------|-------------------------------------|-------------------------|-------------------------|--|
| <u>Truss Span</u> | | | | | | <u>Double Track Railroad Bridge</u> | | | |
| <u>Trusses</u> | | | | | | 1928 | T. C. S. | | |
| | | | | | | Sheet 9 of 16+3 | | | |
| <div style="display: flex; align-items: center;">  <div style="margin-left: 10px;"> <p style="margin: 0;">Assumed Dead Load</p> <p style="margin: 0;">Track = 1160 #/ft</p> <p style="margin: 0;">Floor = 1550</p> <p style="margin: 0;">Tr. & Br. = 5100</p> <p style="margin: 0;">Total = 7810 #/ft of Bridge</p> </div> </div> | | | | | | | | | |
| Member | D.L. | L.L. | Imp. | Totals | Design St. | L/R | s _r | Req. Area | |
| U1L0 | -699 | -1240 | -224 | -2163 | -2163 | 51 | 13.42 | 161.2 ^{sq} gr. | |
| U1U2 | -692 | -1201 | -216 | -2109 | -2109 | 33 | 14.30 | 147.4 ^{sq} gr. | |
| U2U3 | -800 | -1382 | -247 | -2429 | -2429 | 34 | 14.30 | 169.8 ^{sq} gr. | |
| U3U4 | -851 | -1440 | -259 | -2550 | -2550 | 34 | 14.30 | 178.2 ^{sq} gr. | |
| U4U5 | -870 | -1438 | -259 | -2567 | -2567 | 34 | 14.30 | 179.8 ^{sq} gr. | |
| L0L1L2 | +460 | +806 | +145 | +1411 | +1411 | 16.00 | 88.3 ^{sq} net | | |
| L2L3 | +676 | +1170 | +211 | +2057 | +2057 | 16.00 | 128.2 ^{sq} net | | |
| L3L4 | +789 | +1363 | +245 | +2397 | +2397 | 16.00 | 149.6 ^{sq} net | | |
| L4L5 | +847 | +1435 | +256 | +2538 | +2538 | 16.00 | 158.3 ^{sq} net | | |
| U1L1 | +79 | +259 | +174 | +512 | +512 | 16.00 | 32.0 ^{sq} net | | |
| U2L2 | -176 | -390 | -94 | -660 | -686 | 59 | 12.72 | 54.0 ^{sq} gr. | |
| | | +148 | +80 | +52 | +78 | | | | |
| U3L3 | -81 | -302 | -82 | -465 | -590 | 66 | 12.10 | 48.8 ^{sq} gr. | |
| | | +230 | +101 | +250 | +375 | | | 23.4 ^{sq} net | |
| U4L4 | -14 | -245 | -78 | -337 | -506 | 77 | 11.12 | 45.5 ^{sq} gr. | |
| | | +299 | +111 | +396 | +565 | | | 35.3 ^{sq} net | |
| U5L5 | +20 | +96 | +17 | +133 | +133 | 16.00 | 8.32 ^{sq} net | | |
| U1L2 | +335 | +661 | +139 | +1135 | +1135 | 16.00 | 71.0 ^{sq} net | | |
| U2L3 | +197 | +494 | +119 | +810 | +815 | 70 | 16.00 | 50.9 ^{sq} net | |
| | | -134 | -73 | -10 | -15 | | | | |
| U3L4 | +109 | +402 | +161 | +672 | +768 | 80 | 16.00 | 48.0 ^{sq} net | |
| | | -209 | -92 | -192 | -288 | | 10.86 | 26.5 ^{sq} gr. | |
| U4L5 | +44 | +338 | +108 | +490 | +659 | 85 | 16.00 | 41.2 ^{sq} net | |
| | | -278 | -103 | -337 | -506 | | 10.43 | 48.5 ^{sq} gr. | |

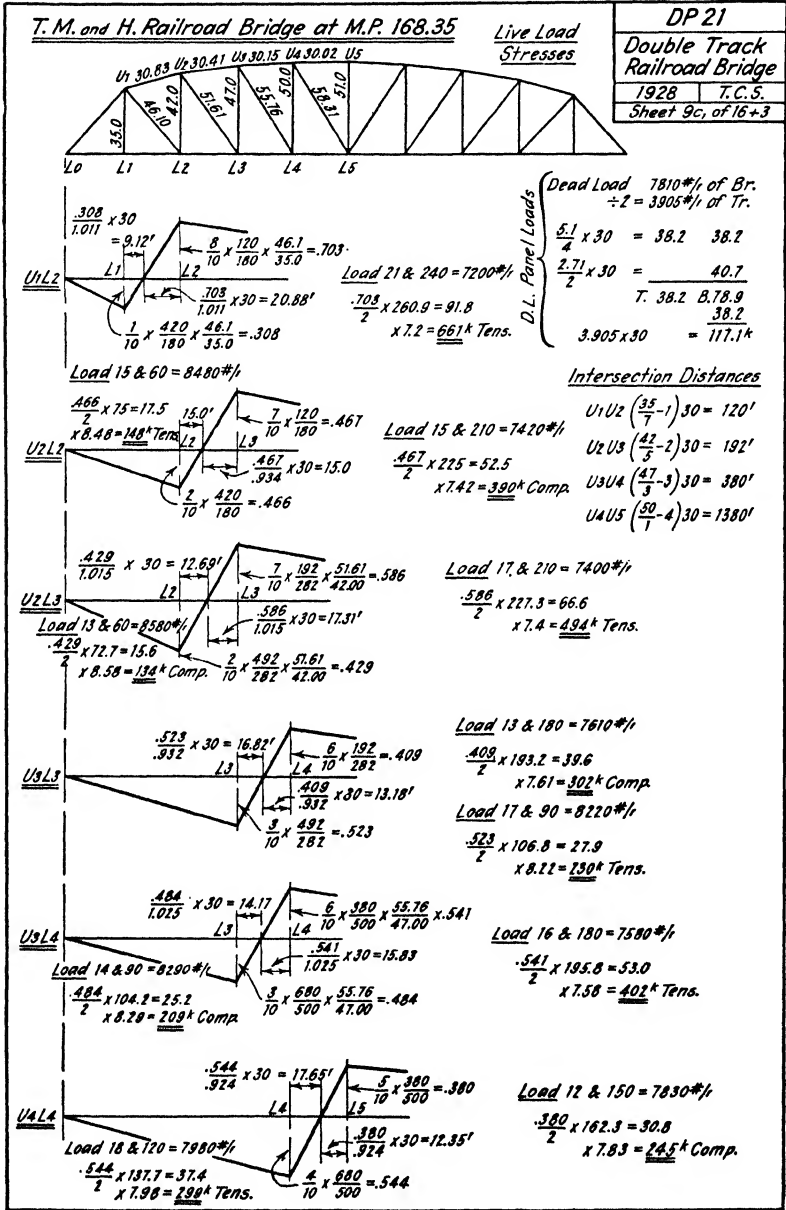

DP21.

T. M. and H. Railroad Bridge at M.P. 168.35

Live Load Stresses (Concl.)

| | |
|---------------------------------|----------|
| DP 21 | |
| Double Track Railroad Bridge | |
| 1928 | T. C. S. |
| Sheet 9c ₂ of 16+3 | |

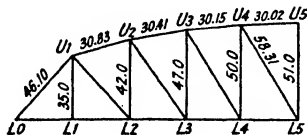

$$\frac{.513}{1.038} \times 30 = 14.82'$$

$$\frac{5}{10} \times \frac{1380}{1530} \times \frac{58.31}{50.00} = .525$$

$$\frac{4}{10} \times \frac{1680}{1530} \times \frac{58.31}{50.00} = .513$$

$$\frac{.525}{1.038} \times 30 = 15.18'$$

U4L5 Load 15 and 150 = 7780 #/1

$$\frac{.525}{2} \times 165.2 = 43.4$$

$$\times 7.78 = \underline{338^k \text{ Tens.}}$$

Load 15 and 120 = 8040 #/1

$$\frac{.513}{2} \times 134.8 = 34.6$$

$$\times 8.04 = \underline{278^k \text{ Comp.}}$$

U1L1 43.1 x 6 = 258.6^k Tens.

L0L2 $\frac{4709 \times 6}{35.0} = +806^k$

U1L0 $\frac{4709 \times 6}{35.0} \times \frac{46.10}{30.00} = -1240^k$

L2L3 $\frac{8180 \times 6}{42.0} = +1170^k$

U1U2 $\frac{8180 \times 6}{42.0} \times \frac{30.83}{30.00} = -1201^k$

L3L4 $\frac{10,678 \times 6}{47.0} = +1363^k$

U2U3 $\frac{10,678 \times 6}{47.0} \times \frac{30.41}{30.00} = -1382^k$

L4L5 $\frac{11,952 \times 6}{50.0} = +1435^k$

U3U4 $\frac{11,952 \times 6}{50.0} \times \frac{30.15}{30.00} = -1440^k$

U5L5 $\frac{1}{30} \times 1438 \times 2 = +96^k$

U4U5 $\frac{12,200 \times 6}{51.0} \times \frac{30.02}{30.00} = -1438^k$

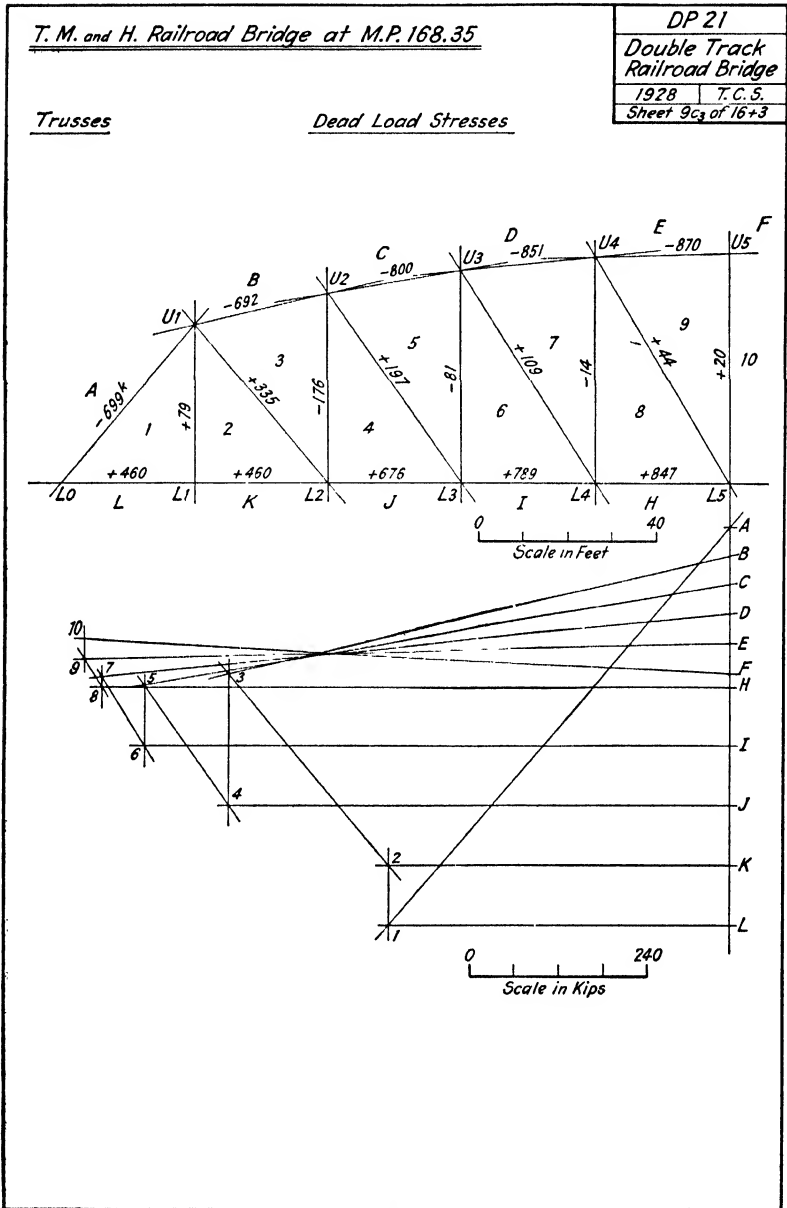

DP21.

T. M. and H. Railroad Bridge at M.P. 168.35

| | |
|---------------------------------|--------|
| DP 21 | |
| Double Track Railroad Bridge | |
| 1928 | T.C.S. |
| Sheet 10 of 16+3 | |

Truss Span

Bottom Chord

L0L2*

+ 1411k
 @ 16 = 88.25⁰⁰ net
 2- Webs 27 x $\frac{13}{16}$ = 43.88 - 6.50 = 37.38
 2- " 27 x $\frac{9}{16}$ = 40.50 - 6.00 = 34.50
 4- Pls 6 x 4 x $\frac{9}{16}$ = 21.24 - 4.50 = 16.74

 105.62⁰⁰ gr. = 88.62⁰⁰ net
 x 3.4 = 359 #/ft x 60' = 21,540 #
 x 4 = 86,160 #

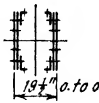

L2L3

+ 2057k
 @ 16 = 128.2⁰⁰ net
 Same as L0L2 = 105.62⁰⁰ gr - 17.00 = 88.62⁰⁰ net
 2- Webs 27 x $\frac{9}{16}$ = 30.38 - 4.50 = 25.88
 2- Pls. 14 $\frac{1}{2}$ x $\frac{9}{16}$ = 16.32 - 2.25 = 14.07

 152.32⁰⁰ gr - 23.75 = 128.57⁰⁰ net
 x 3.4 = 518 #/ft x 30' = 15,540
 x 4 = 62,160



L3L4

+ 2397k
 @ 16 = 149.6⁰⁰ net
 Same as L2L3 = 152.32⁰⁰ gr - 23.75 = 128.57⁰⁰ net
 2- Pls. 25 x $\frac{1}{2}$ = 25.00 - 4.00 = 21.00

 177.32⁰⁰ gr - 27.75 = 149.57⁰⁰ net
 x 3.4 = 604 #/ft x 30' = 18,120
 x 4 = 72,480

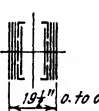

L4L5

+ 2538k
 @ 16 = 158.3⁰⁰ net
 Same as L3L4 = 177.32⁰⁰ gr - 27.75 = 149.57⁰⁰ net
 2- Pls. 9 x $\frac{1}{2}$ = 11.25 - 2.50 = 8.75

 188.57⁰⁰ gr - 30.25 = 158.32⁰⁰ net
 x 3.4 = 642 #/ft x 30' = 19,260
 x 4 = 77,040

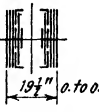

Sheet 297,840 #

* The student should note that placing the shoe pin below the intersection point (See Plate VII) results in bending stress in L0L2 and U1L0 under the action of longitudinal forces: he should make an estimate of the probable and possible magnitudes of these stresses and form an opinion as to their importance. In some cases area must be added to the members concerned to care for the stresses. In this bridge the normal members were found to be adequate.

T. M. and H. Railroad Bridge at M.P. 168.35

DP 21

Double Track
Railroad Bridge

1928 T.C.S.

Sheet 11 of 16+3

Truss SpanTop Chord and End PostU1L0

-2163k

@ 13.42 k/ft = 161.2 gr.

- 1-Cov. Pl. $32 \times \frac{3}{8}$ = 24.00 gr
 2-Top Is $4 \times 4 \times \frac{5}{8}$ = 9.22
 2-Bott Is $6 \times 6 \times \frac{5}{8}$ = 19.46
 2-Bott Fls. $6 \times \frac{1}{2}$ = 11.25
 2-Web Pls. $29 \times \frac{3}{4}$ = 43.50
 2-do $29 \times \frac{1}{16}$ = 39.88
 2-Side Pls. $18 \frac{1}{2} \times \frac{3}{8}$ = 13.88

161.19 gr.

$$x 3.4 = 548 \# / \text{ft} \times 46.1' = 25,300$$

Forward 297,940 #

$$x 4 = 101,200 \#$$

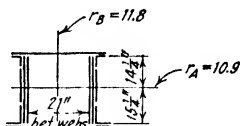
U1U2

-2109k

@ 14.30 k/ft = 147.4 gr.

- 1-Cov. Pl. $32 \times \frac{3}{8}$ = 24.00 gr
 2-Top Is $4 \times 4 \times \frac{5}{8}$ = 9.22
 2-Bott Is $6 \times 6 \times \frac{5}{8}$ = 19.46
 2- " Fls. $6 \times \frac{1}{2}$ = 11.25
 2-Web Pls. $29 \times \frac{3}{4}$ = 43.50
 2- " " $29 \times \frac{1}{16}$ = 39.88

147.31 gr.

$$x 3.4 = 501 \# / \text{ft} \times 30.8' = 15,430$$

$$x 4 = 61,720$$

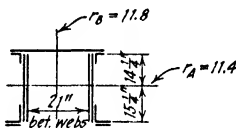
U2U3

-2429k

@ 14.30 k/ft = 169.8 gr.

- Same as U1U2 = 147.31 gr
 2-Side Pls. $18 \frac{1}{2} \times \frac{3}{8}$ = 23.12

170.43 gr.

$$x 3.4 = 580 \# / \text{ft} \times 30.4' = 17,620$$

$$x 4 = 70,480$$

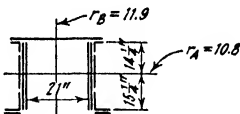
U3U4 & U4U5

-2567k

@ 14.30 k/ft = 179.8 gr.

- Same as U1U2 = 147.31 gr
 2-Side Pls. $18 \frac{1}{2} \times \frac{3}{8}$ = 32.38

179.69 gr.

$$x 3.4 = 611 \# / \text{ft} \times 30.1' = 18,400 \#$$

$$x 4 = U3U4 = 73,600$$

$$604,840 \#$$

$$U4U5 = 73,600$$

$$678,440 \#$$

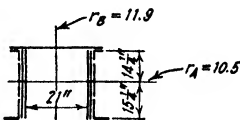

| | | |
|--|--|---------------------------------|
| <u>T. M. and H. Railroad Bridge at M.P. 168.35</u> | | DP 21 |
| | | Double Track Railroad Bridge |
| | | 1928 T.C.S. |
| | | Sheet 12 of 16+3 |

Truss Span

Forward 678,440*

Diagonals

U1L2

+1135k
@ 16k/ft = 71.0⁰⁰ net

4-Webs $27 \times \frac{3}{8} = 60.75^{00} - 6.75 = 54.00$

4-LS $6 \times 4 \times \frac{3}{8} = 21.24 - 4.50 = 16.74$

81.99 - 11.25 = 70.74⁰⁰ net

$x 3.4 = 278\#/\text{ft} \times 46.10' = 12,820\#$

U2L3

+815k @ 16k/ft = 50.94⁰⁰ net

- 15

2-Webs $26 \times \frac{3}{8} = 39.00 - 4.50 = 34.50$

4-LS $6 \times 4 \times \frac{3}{8} = 21.24 - 4.50 = 16.74$

60.24 - 9.00 = 51.24⁰⁰ net

$x 3.4 = 205\#/\text{ft} \times 51.6' = 10,600$

U3L4

+768k @ 16k/ft = 48.00⁰⁰ net

- 288

2-Webs $24 \times \frac{3}{8} = 36.00 - 4.50 = 31.50$

4-LS $6 \times 4 \times \frac{3}{8} = 21.24 - 4.50 = 16.74$

57.24 - 9.00 = 48.24⁰⁰ net

$x 3.4 = 195\#/\text{ft} \times 55.8' = 10,900$

U4L5

+659 @ 16.0k/ft = 41.20⁰⁰ net

- 506 @ 10.4 = 48.70⁰⁰ gr.

2-Webs $23 \times \frac{3}{8} = 28.75 - 3.75 = 25.00$

4-LS $6 \times 4 \times \frac{3}{8} = 21.24 - 4.50 = 16.74$

49.99⁰⁰ gr - 8.25 = 41.74⁰⁰ net

$x 3.4 = 170\#/\text{ft} \times 58.3' = 9,910$

U1L2: $r_A = 9.08$, $r_B = 8.88$, height 27", bottom chord 19"

U2L3: $r_A = 9.08$, $r_B = 8.88$, height 26", bottom chord 19"

U3L4: $r_A = 8.40$, $r_B = 8.88$, height 24", bottom chord 19"

U4L5: $r_A = 8.21$, $r_B = 8.88$, height 23", bottom chord 19"

x 4 = 51,280

x 4 = 42,400

x 4 = 43,600

x 4 = 39,640

Sheet 855,360

| | |
|--|---|
| <u>T. M. and H. Railroad Bridge at M.P. 168.35</u> | DP 21 |
| <u>Truss Span</u> | Double Track Railroad Bridge |
| <u>Verticals</u> | 1928 T.C.S. Sheet 13 of 16+3 |

Forward 855,360

U1L1
+ 512 k @ 16 k/ft = 32.00^{ft} net

1-Web $19 \times \frac{3}{8} = 7.13$ ft - 0.75 = 6.38
 4-Ls $8 \times 6 \times \frac{9}{16} = 30.24$ - 4.50 = 25.74
 $\frac{37.37 - 5.25}{3.4} = 32.12$ ft net
 x 3.4 = 127 #/1 x 35.0'

U2L2
- 686 k @ 12.72 k/ft = 54.0^{ft} gr.
 + 78

2-Webs $24 \times \frac{3}{8} = 36.00$
 4-Ls $4 \times 4 \times \frac{5}{8} = 18.44$
 54.88^{ft} gr.
 x 3.4 = 187 #/1 x 42.0'

U3L3
- 590 k @ 12.10 k/ft = 48.75^{ft} gr.
 + 375 k @ 16.00 = 23.42^{ft} net

2-Webs $24 \times \frac{1}{2} = 33.00$ - 5.50 = 27.50
 4-Ls $4 \times 4 \times \frac{7}{8} = 16.72$ - 4.50 = 12.22
 49.72 - 10.00 = 39.72^{ft} net
 x 3.4 = 169 #/1 x 47.0'

U4L4
- 506 k @ 11.12 k/ft = 45.50^{ft} gr.
 + 565 k @ 16.00 = 35.30^{ft} net

2-Webs $22 \times \frac{1}{2} = 30.25$ - 5.50 = 24.75^{ft} gr.
 4-Ls $4 \times 4 \times \frac{1}{2} = 15.00$ - 4.00 = 11.00
 45.25^{ft} gr. - 9.50 = 35.75^{ft} net
 x 3.4 = 154 #/1 x 50.0'

U5L5
+ 133 k @ 16.00 = 8.32^{ft} net

4-Ls $8 \times 6 \times \frac{7}{16} = 23.72$ - 3.50 = 20.22^{ft} net
 x 3.4 = 80.8 #/1 x 51.0' = 4130 #

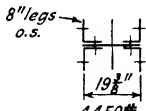
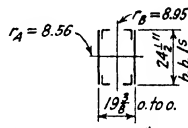
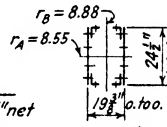
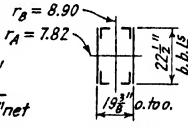
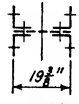
Sheet = 975,380

Total for Trusses Without Details

T. M. and H. Railroad Bridge at M.P. 168.35

| | |
|---------------------------------|--------|
| DP 21 | |
| Double Track Railroad Bridge | |
| 1928 | T.C.S. |
| Sheet 14 of 16+3 | |

Truss Span

Bottom Laterals

$$\begin{aligned} 30^2 &= 900 \\ 32^2 &= 1024 \\ 43.9^2 &= 1924 \end{aligned}$$

Lateral Forces

| | | |
|---------------|---------------|----------------------|
| Wind on Truss | 270#/f | 270#/f |
| " " Floor | | 270 |
| From Train | | 600 = 10% of 6000#/f |
| Totals | 270#/f | 1140#/f |

Top Chord Bott. Chord

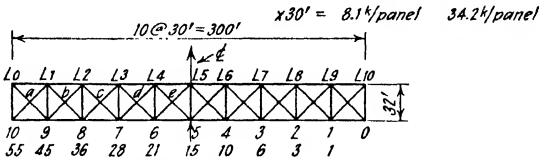

Constant * = $\frac{1}{2} \times \frac{34.2}{10} \times \frac{43.9}{32.0} = 2.34$ Max. unsupported length = $6.5 \times \frac{43.9}{32.0} = 8.9' = 107''$

| | | |
|--|--|---|
| a = 2.34 x 45 = ± 105'k @ 6.0 = 18 field rivs. | { @ 16 = 6.6" net } 2-15 6x6 x $\frac{1}{2}$ { 7.22" net } | ⌋ |
| | { @ 12.2 = 8.6 gr. } | |
| b = " x 36 = ± 84 @ 6.0 = 14 " " | { @ 16 = 5.3 net } 2-15 6x4 x $\frac{1}{2}$ { 5.72 net } | ⌋ |
| | { @ 11.6 = 7.2 gr. } | |
| c = " x 28 = ± 66 @ 6.0 = 11 " " | { @ 16 = 4.1 net } 2-15 5x3 $\frac{1}{2}$ x $\frac{1}{2}$ { 4.60 net } | ⌋ |
| | { @ 10.8 = 6.1 gr. } | |
| d = " x 21 = ± 49 @ 6.0 = 8 " " | { @ 16 = 3.1 net } do { do } | ⌋ |
| | { @ 10.8 = 4.5 gr. } | |
| e = " x 15 = ± 35 @ 6.0 = 6 " " | { @ 16 = 2.2 net } do { do } | ⌋ |
| | { @ 10.8 = 3.2 gr. } | |

- 1- Panel a 4-15 6x6 x $\frac{1}{2}$ @ 14.9#/f x 41.1' av. = 2450#
- 1- " b 4-15 6x4 x $\frac{1}{2}$ @ 12.3 x 41.1 " = 2020
- 1- " c 4-15 5x3 $\frac{1}{2}$ x $\frac{1}{2}$ @ 10.4 x 41.1 " = 1710
- 1- " d do @ 10.4 x 41.1 " = 1710
- 1- " e do @ 10.4 x 41.1 " = 1710

Details average abt. 150# per panel = 3750

13,350# x 2 = 26,700#

Traction Frames

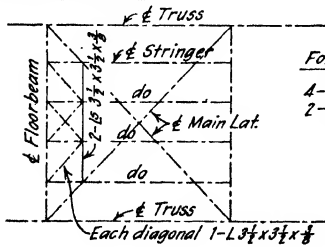

For 1-Panel

4-Diagonal 15 3 $\frac{1}{2}$ x 3 $\frac{1}{2}$ x $\frac{1}{2}$ @ 8.5 x 6.8' = 230
 2-Chord 15 do @ 8.5 x 18.5 = 315
 Details abt. = 205

$\frac{205}{150} \times 10 = 7,500$

Sheet 34,200

* See Art. 141, "Theory of Simple Structures", Shedd & Vawter, John Wiley & Sons, Inc.

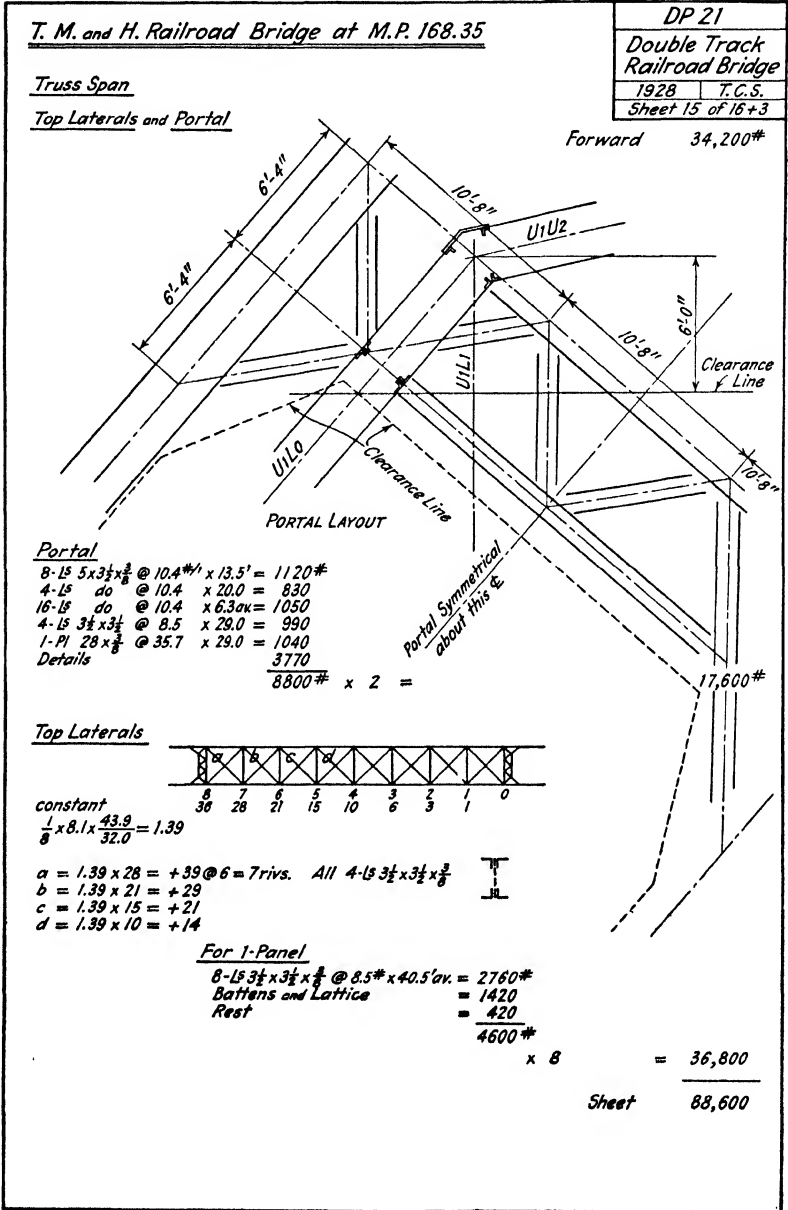

T. M. and H. Railroad Bridge at M.P. 168.35

| | |
|---------------------------------|----------|
| DP21 | |
| Double Track Railroad Bridge | |
| 1928 | T. C. S. |
| Sheet 16 of 16+3 | |

Truss Span

Sway Frames (Frame at U3L3 Assumed as Typical and Average)

Forward 88,600*

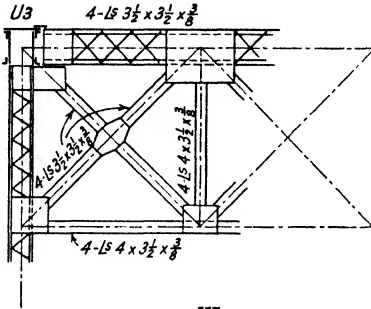

Top Strut 4-1S 3 1/2 x 3 1/2 x 3/8 @ 8.5#/ft x 29.1' av. = 990*

Bott. Strut 4-1S 4 x 3 1/2 x 3/8 @ 9.1 x 30.2 = 1100

Diagonals(each) 4-1S 3 1/2 x 3 1/2 x 3/8 @ 8.5 x 22.0' av. = 2990

Vertical 4-1S 4 x 3 1/2 x 3/8 @ 9.1 x 16.0 = 580

Details abt. = 3340

Total for Average Frame = 9000*

x 7 = 63,000

Bracing Total 151,600

Summary of Truss Weights (Excluding Bearings)

Floor = 478,160 Say 479,000* ÷ 300 = 1600*/ft

Trusses = 1,341,100 " 1,341,000 } ÷ 300 = 4970

Bracing = 151,600 " 152,000 } ÷ 300 = 4970

Total = 1,970,860* 1,972,000* ÷ 300 = 6570*/ft

by Plate IV. The specifications for design * may be found in the *Transactions* of the Am. Soc. C.E., Vol. 86 (1923), page 471.

The design of the single track through truss span, shown by the stress sheet Plate V, was governed by the "General Specifications for Steel Railway Bridges" issued by the American Railway Engineering Association, 1910 Edition; they may be found in the *1915 Manual* of that society but are more generally available in the "Structural Engineers' Handbook" † by M. S. Ketchum.

The design of the double-track deck truss span, shown by the stress sheet Plate VI, was governed by the "General Specifications for Steel Structures" of the Southern Railway Company, 1911 edition. These specifications are not generally available but are substantially the equivalent of the A.R.E.A. 1910 referred to in the preceding paragraph.

* It should be particularly emphasized that these specifications are NOT those printed in Appendix A: the permissible unit stresses and other requirements are materially different, and it is important that the student familiarize himself with them in connection with his study of the design calculations of DP21.

† McGraw-Hill Book Company, New York.

CHAPTER VIII

STRUCTURAL WELDING

164. The practice of making connections between parts of steel structures by structural welding has developed almost entirely within the last twenty years. Structural welding, in the modern sense, first became of practical importance about 1915,* and since that time has become a recognized and widely used tool of the structural engineer.

It is the purpose of this chapter to present very briefly the conventional methods of designing the simpler forms of welded connections. It is not the author's intention to enter into a discussion of the accuracy of the conventional methods so far developed; in spite of their defects and approximate character they perhaps do not suffer in comparison with the conventional methods of design of riveted joints except in the amount of accumulated experience with the product.

The art of structural welding is in the process of development and its experience record is still for the most part to be found in the pages of technical magazines and society publications, but two recent books, "Arc Welded Steel Structures," † by Gilbert D. Fish, and the "Procedure Handbook of Arc Welding Design and Practice," ‡ have begun the systematic recording of data and design methods. The *Journal* of the American Welding Society is also a fruitful source of information, and the student of the subject must keep in touch with the publications of that organization.

165. Types of Welding.—Welded joints in the modern sense are almost universally produced by fusion welding. Fusion welding is defined as "The process of joining metal parts in the molten or molten vapor states, without the application of mechanical pressure or blows." § At present, fusion welds are most commonly made by means of an electric arc which locally melts the parts to be joined and also melts the

* See paper presented before the Philadelphia Section of the American Society of Civil Engineers on March 14, 1928, by Frank P. McKibben, entitled "Arc Welded Steel Buildings at West Philadelphia Works of the General Electric Company."

† McGraw-Hill Book Company, New York.

‡ The Lincoln Electric Company, Cleveland, Ohio.

§ "Code for Fusion Welding and Gas Cutting in Building Construction," 1930 Edition, American Welding Society.

weld-rod which is used to add metal to the joint. There are two types of electric arc welding: the more common uses the weld-rod as an elec-

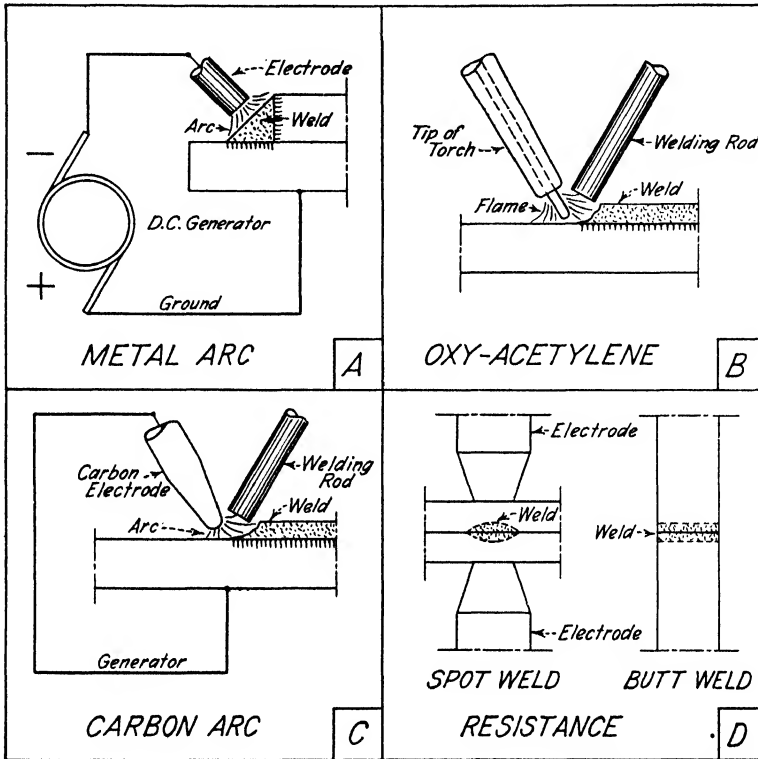

Courtesy of H. M. Priest.

FIG. 223.—Methods of Structural Welding.

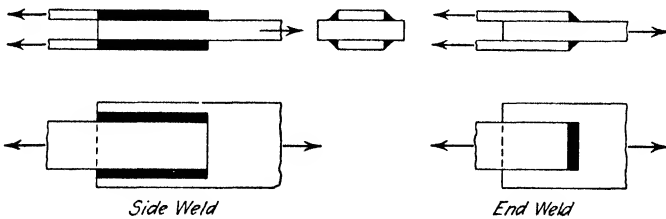

FIG. 224.—Fillet Welds.

trode and is known as the metallic arc method; the other uses a carbon electrode for melting the parts locally as well as the weld-rod, and is known as the carbon arc method.

Oxyacetylene or gas welding is used to some extent; the method makes use of heat derived from the combustion of acetylene gas (or

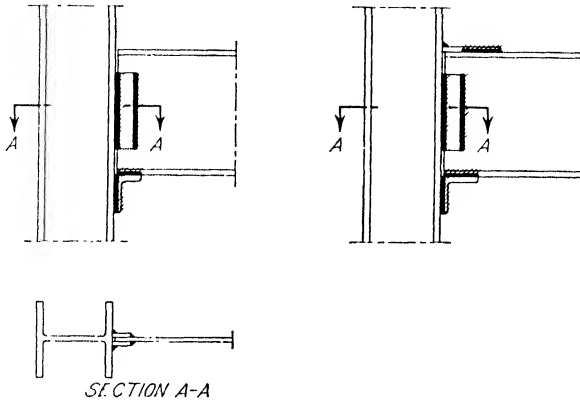

FIG. 225.—Fillet Welds.

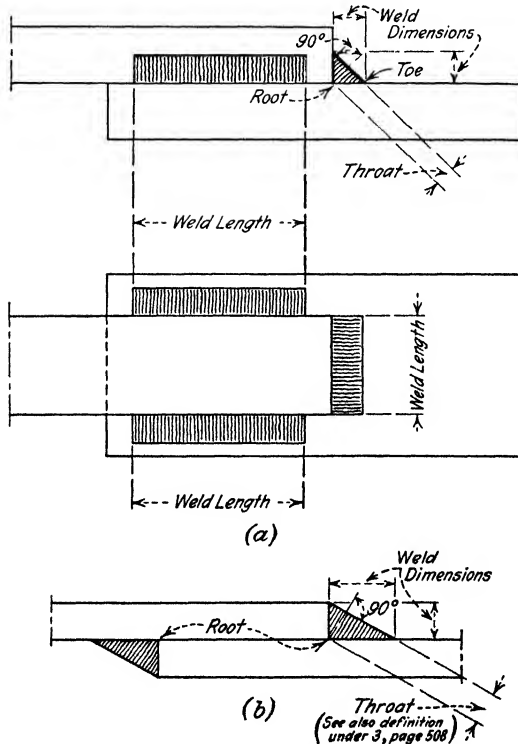

FIG. 226.—Fillet Weld Terms.

some other fuel gas) in a stream of oxygen or air at the tip of a blow-pipe or torch, in place of the electric arc. Gas welding is similar to the carbon arc method in that the flame is used merely to melt locally the parts to be joined and to melt the weld-rod which adds metal to the joint.

The methods of welding just described are illustrated in Fig. 223.*

166. Types of Welded Joints.—Structural welds generally fall in one of two classes: (a) fillet welds, and (b) butt welds.

Fillet welds are illustrated in Figs. 224 and 225, and in Fig. 226 are illustrated the terms commonly used in describing them. Fillet welds

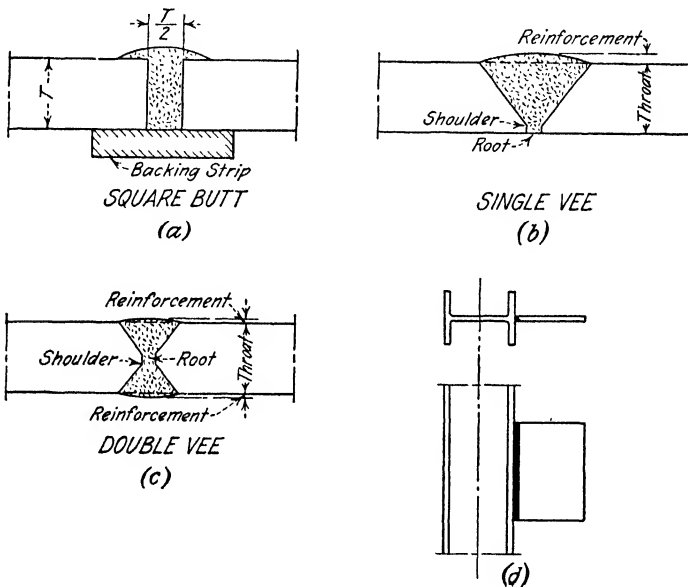

FIG. 227.—Butt Welds.

may be deposited along the sides of the parts to be connected, and are then referred to as **side welds**, or along the ends of the parts and then called **end welds**. Side and end welds are used to some extent in combination although some designers consider this an undesirable practice. †

* Reproduced by permission from a paper "The Practical Design of Welded Steel Structures" by H. M. Priest, *Journal of The American Welding Society*, August, 1933.

† The objection which some engineers have to combining side and end welds is based on the belief that the end welds (owing to smaller elongation in the direction of stress) will resist the major portion of the load and that the side welds will be relatively ineffective until failure of the end welds occurs. That there may be some

Butt welds, as the name implies, are used to join the edges of plates in alignment as illustrated in Fig. 227 (a, b, and c). Butt welds may also be used to join parts at right angles to each other as shown in Fig. 227 (d). The edges to be joined may be prepared for welding by forming single or double vees as illustrated, or they may be joined by an open-square butt weld. The author is indebted to Mr. H. C. Boardman of the Chicago Bridge and

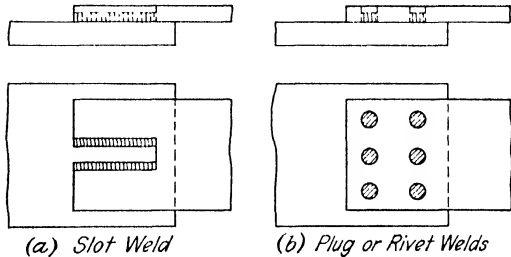

FIG. 228.—Slot Welds and Plug or Rivet Welds.

Iron Works for the information that that organization has found it feasible to weld 3/4-in. plates together with a square butt weld, with

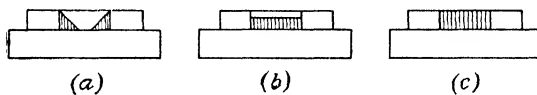

FIG. 229.

no gap between the abutting edges, with one pass on each side using the carbon arc process and adding practically no metal.

In addition to fillet and butt welds structural practice makes some use of slot welds and plug or rivet welds.

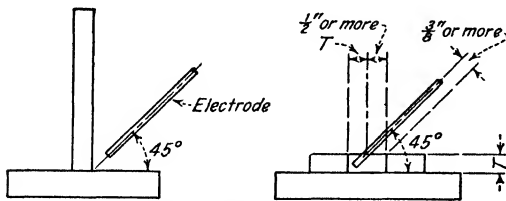

FIG. 230.—Welding Clearances.

These forms are illustrated in Fig. 228, and Fig. 229 shows how weld metal may be deposited in the slots or holes.

167. Welding Clearances and Positions.—In

depositing welds it is considered desirable that the electrode be held at an angle of about 45° with the work. Also it is necessary that there be

basis for the belief is indicated by test results given in the "Report of Structural Steel Welding Committee of the American Bureau of Welding," published by the American Welding Society. The committee reported tests on 105 specimens with side and end welds combined. Of the 105 specimens 23 broke in the main bar and 82 through the welds: "Where fracture took place in the weld, in all four series, the end weld ruptured first, after which the side welds sheared through." Quoted from page 68 of the report.

clearance between the *side* of the electrode and nearby metal of about $1/4$ to $3/8$ in. These requirements place restrictions on the location of welds and width of slots with respect to thickness of metal, which must be kept in mind in designing welded joints. The points mentioned are illustrated in Fig. 230.

In addition to the matter of clearance it is important to remember that the welder should be able to get a clear view of the joint he is welding. The easiest welds are made downward, i.e., on top of a horizontal plane. Vertical and horizontal welding are said to be fairly easy, though not so fast as welding downward on a horizontal surface. Overhead welding is slow and difficult and should be kept to a minimum.

The various types of welds and location terms are illustrated by the sketch shown in Fig. 231.

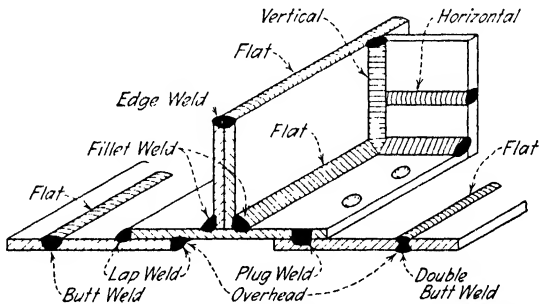

Courtesy of the Lincoln Electric Company.

FIG. 231.—Types of Welds and Location Terms.

168. Strength of Ordinary Welds.—Present design methods assume the strength of a weld to be proportional to its throat area, i.e., the product of the throat width and the length of the weld. (See Fig. 226.) The strength of the weld is then the product of the throat area and the permissible intensity of stress. The "Code for Fusion Welding and Gas Cutting in Building Construction" gives widely accepted allowable intensities of stress which have been established as a result of the experimental investigation of welding sponsored by the American Welding Society. These stresses are quoted at the end of this chapter.

All fillet welds, whether end, side, or combined, are treated as *shear* welds and are designed for a permissible intensity of stress of 11.3 kips per sq. in. of throat area. It would seem that end fillet welds (see Fig. 224) might be classed as tension or compression welds, and the experimental studies referred to indicated that in general end welds are about 35 per cent stronger than side welds, but these studies further indicated the strength of end welds to be more erratic than that of side

welds, and in some cases minimum values for the two types differed by only 8 per cent.*

Butt welds are designed in accordance with the character of the stress to which they may be subjected—shear, tension, or compression.

169. Strength of Shielded Arc Welds.—The intensities of stress given at the end of the chapter are intended for ordinary welding with bare electrodes. Welds made by the shielded arc † process are claimed to have a strength 20 to 50 per cent greater than that of ordinary welds and a ductility from 100 to 200 per cent greater. Some designers allow intensities of stress 20 to 30 per cent greater than those given at the end of the chapter when the welding is done by a shielded arc process.

170. Fillet Welds: Direct Stress.—The design of fillet welding for members in direct stress is very simple in principle. The stress in the part to be attached divided by the safe stress per inch of weld gives the number of inches of fillet weld required to make the connection.

The relation

$$s_w = 8D \text{ kips per in.} \tag{149}$$

in which s_w = the permissible stress per linear inch of fillet weld,

D = the dimension of the fillet,

is very convenient in computing the strength of fillet welds and should be kept in mind. The relation is shown in Fig. 232.

* "Report of Structural Steel Welding Committee of the American Bureau of Welding," page 103.

† Shielded arc welding is a term applied to a process of fusion welding in which the arc is surrounded by, and the molten metal bathed in, hydrogen or other suitable

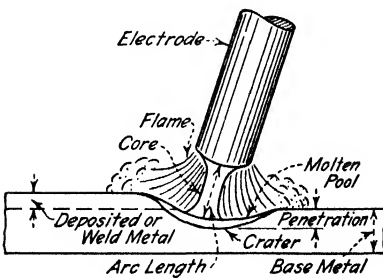

FIG. A.

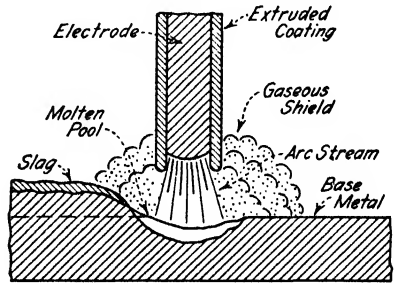

FIG. B.

gases. The gaseous shield for the arc and weld is generally produced by the use of coated electrodes. Figures A and B, taken by permission from the "Procedure Handbook of Arc Welding Design and Practice" by the Lincoln Electric Company, illustrate the difference between ordinary arc welding and shielded arc welding.

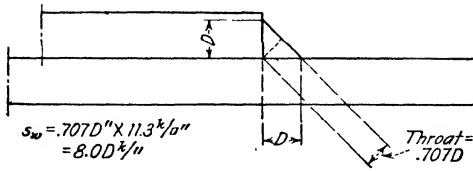
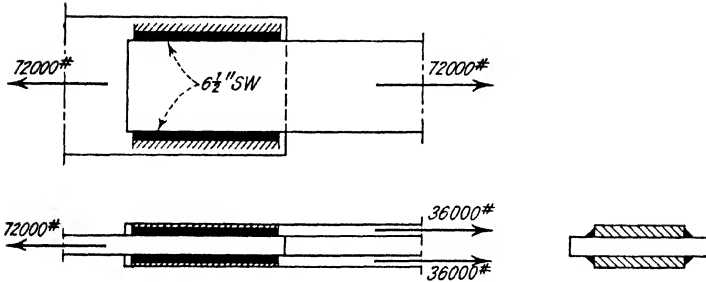

FIG. 232.



$\frac{3}{8} \text{ Fillet Weld } s_w = 8 \times \frac{3}{8} = 3 \frac{1}{2} \text{ lb}$

$\frac{72}{3} = 24 \text{ " of weld } \div 4 = 6 \text{ " for strength}$
 $\frac{1}{2} \text{ " crater}$

$6 \frac{1}{2} \text{ " weld length each side}$

FIG. 233.—Fillet Weld Design.

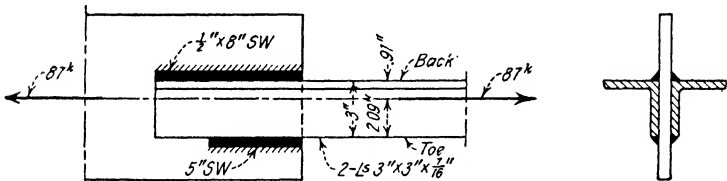

Stress through backs = $\frac{2.09}{3.00} \times 87k = 60.6k$

" " toes = $\frac{.91}{3.00} \times 87k = 26.4k$

$\frac{3}{8} \text{ Fillet: back and toe } s_w = 8 \times \frac{3}{8} = 3 \frac{1}{2} \text{ lb}$

Back $\frac{60.6}{3.0} = 20.2 \text{ "}$

$10.1 \text{ " each L for stress}$
 5 " for crater
 $10.6 \text{ " say } 10 \frac{1}{2} \text{ " for back}$

Toe $\frac{26.4}{3.0} = 8.8 \text{ "}$

$4.4 \text{ " each L for stress}$
 5 " for crater
 $4.9 \text{ " say } 5 \text{ " for toe}$

$\frac{1}{2} \text{ Fillet for back } s_w = 8 \times \frac{1}{2} = 4 \frac{1}{2} \text{ lb}$

Back $\frac{60.6}{4.0} = 15.2 \text{ "}$

$7.6 \text{ " each L for stress.}$
 5 " for crater
 $8.1 \text{ " say } 8 \text{ " of } \frac{1}{2} \text{ Fillet for back}$
 $5 \text{ " " } \frac{3}{8} \text{ " " toe}$

Toe same as before

FIG. 234.—Fillet Weld Design.

The proportioning of fillet welds for two simple cases of direct stress will be found in Figs. 233 and 234. The notation of the welds is in accordance with the report of the Committee on Nomenclature, Definitions, and Symbols of the American Welding Society. The committee recommended a series of symbols and notes for use on drawings of arc-









| ABBREVIATIONS AND IMPORTANT NOTATIONS | | | |
|---|---|--|---|
| <i>SW</i> -Shop Weld <i>FW</i> -Field Weld <i>CW</i> -Continuous Weld Continuous Weld - Designate when length is not given General Note (On Drawgs) - All Fillet Welds $\frac{3}{8}$ " unless noted | | | |
| SYMBOLS | | | |
| WELD | FUNDAMENTAL SYMBOL | METHOD USED FOR SECTIONS | SYMBOL AS USED IN PLAN OR ELEVATION |
| FILLET |  |  |  |
| |  |  |  |
| |  |  |  |
| SYMBOLS FOR CHAIN INTERMITTENT WELDS | | | |
| |  | | |
| BUTT |  | Show section through weld giving necessary information for preparation of the joint, its assembly and welding. | |
| ABBREVIATIONS AND SYMBOLS FOR USE ON DRAWINGS OF BUILDINGS, BRIDGES AND OTHER FRAMED STRUCTURES (ARC AND GAS WELDING) Approved by American Welding Society Nomenclature Committee June 1933 Executive Committee June 1933 | | | |

FIG. 235.

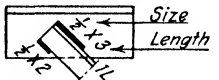
and gas-welded steel structures. The recommendations are reproduced in Fig. 235.

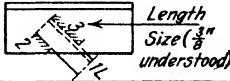
The welding in Figs. 233 and 234 is distributed in each case in accordance with the principle that the centroid of the resisting forces developed by the welds should coincide with the center of gravity of

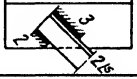
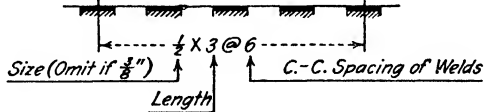
the member. This is obvious in Fig. 233, and a little reflection will show that in Fig. 234 the resisting capacity of the welds on the backs and toes of the angles should be inversely proportional to their distances from the centroid of the angles. A simple and convenient graphical method of partitioning the load between the backs and toes of the angles is shown in Fig. 236 for the member of Fig. 234; it is applicable in any case.

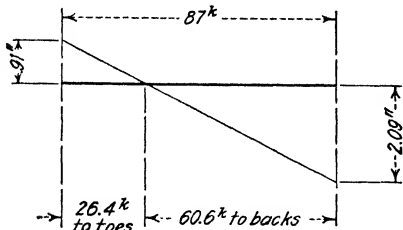

FIG. 236.

171. Fillet Welds: Bending.—A simple case of fillet welds in bending is shown in Fig. 237. Assuming that the bracket plate is not in actual contact with the column flange (contact should not be

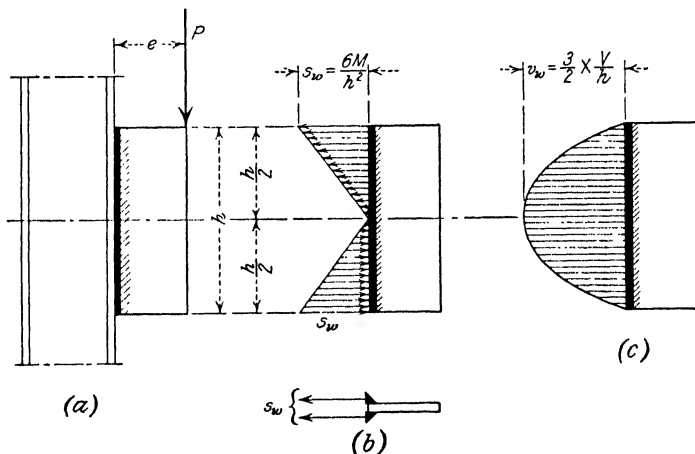

FIG. 237.—Fillet Welds in Bending.

assumed unless positive measures are taken to ensure it) the distribution of bending stress over the height of the welds will be as shown in Fig. 237 (b) if the beam formula is accepted; distribution of shear over the height of the welds will then be as in Fig. 237 (c).* The student

* It is important for the student to see clearly that the distribution of shear shown in Fig. 237 (c) follows as a necessary consequence of statics if the distribution of bending stress is as shown in Fig. 237 (b). It is known, however, that the beam formula as ordinarily stated is not applicable at an abrupt change in cross-section, and that at a section where such a change occurs there will be a concentration of stress on the outer fibers. Since the total tension must still equal the total compression, and since the product of either total tension or total compression and the

should particularly note that the relations (see Fig. 237 [b] and [c])

$$s_w = \frac{6M}{h^2}$$

distance between their centroids must still be equal to the bending moment at the section, we may expect the distribution of bending stress at the section to be some-

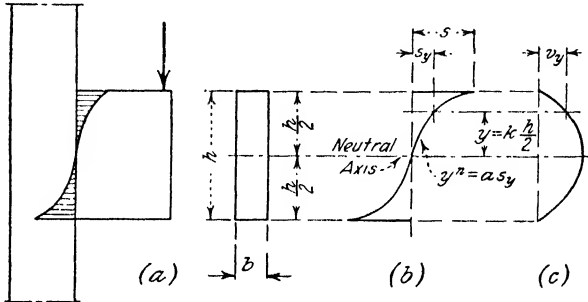

what as shown at (a) in the accompanying figure. Assuming that the equation of the curve of stress distribution may be taken as

$$y^n = a s_y$$

as shown at (b), and adopting the notation of the figure, we may derive, if $M =$ bending moment

$$s_y = k^n 2 (n + 2) \frac{M}{bh^2}$$

When $k = 1$, i.e., $y = h/2$, this becomes

$$s = 2 (n + 2) \frac{M}{bh^2} \tag{a}$$

The accompanying distribution of horizontal shearing stress must be as shown in (c) and may be expressed by

$$v_y = \left(\frac{n + 2}{n + 1} \right) (1 - k^{(n+1)}) \frac{V}{bh}$$

The maximum of course occurs at the neutral axis and is

$$v = \left(\frac{n + 2}{n + 1} \right) \frac{V}{bh} \tag{b}$$

When $n = 1$ the relations (a) and (b) necessarily reduce to the commonly stated formulas for rectangular beams.

The reader will note that as n becomes large the bending stresses are concentrated more and more in the outer fibers and that the distribution of horizontal shear approaches uniformity.

The amount of stress concentration to be expected depends on the ratio of the increased depth to the original depth, and on the ratio of the dimension of the fillet connecting the different depths to the original depth. The matter has been investigated and discussed by applied mathematicians and experimenters, and their

and

$$v_w = \frac{3}{2} \frac{V}{h}$$

give the maximum bending stress and the maximum shearing stress per inch of height. It is assumed for purposes of design that the corresponding intensities of bending stress and shearing stress may be found by dividing these stresses per inch of height by the throat area per inch of height of the welds. This may be illustrated by assuming the following data in Fig. 237:

$$P = 40 \text{ kips}$$

$$e = 6 \text{ in.}$$

$$h = 16 \text{ in.}$$

Then

$$M = 40 \times 6 = 240 \text{ in.-kips}$$

and

$$s_w = \frac{240 \times 6}{16^2} = 5.63 \text{ kips per in. of height}$$

$$v_w = \frac{4.0}{1.6} \times \frac{3}{2} = 3.75 \text{ kips per in. of height}$$

If the welding consists of two $\frac{3}{8}$ -in. fillets the corresponding intensities are then assumed to be

$$\text{Bending stress} = \frac{5.63}{2 \times 0.375 \times 0.707} = 10.6 \text{ kips per sq. in.}$$

$$\text{Shearing stress} = \frac{3.75}{2 \times 0.375 \times 0.707} = 7.1 \text{ kips per sq. in.}$$

conclusions are well summarized in "Advanced Mechanics of Materials," by F. B. Seely, published by John Wiley & Sons.

The character of the material is a significant factor in determining the importance of the stress concentration from the viewpoint of the designer; and the same is true of the character of the load. For ductile material and quiescent loads the stress concentration may be relatively unimportant, but for brittle material, or ductile material under vibrating loads it is likely to be important. The material used by the structural engineer is in general ductile, but deposited weld-metal may lack ductility unless special care (such as the use of coated electrodes) is taken. The author tentatively suggests for welded bracket connections similar to the one in Fig. 237 that $n = 2$ be used for fixed loads, and $n = 3$ or $n = 4$ be used for repeated loads such as would occur if the bracket supports a crane runway girder.

It should be clearly understood that formulas (a) and (b) are not presented as exact solutions (the author does not know how the bending stress is actually distributed in cases such as are considered here) but merely as an approximate method of estimating the stresses at sections of abrupt change. Of course the formulas as given are applicable only to rectangular homogeneous sections.

The preceding paragraph illustrates the *analysis* of stress in welds resisting bending. The *design* process will generally require the calculation of h for a given weld size. For example, assume the same load and eccentricity and calculate h given that the welding is to consist of two 3/8-in. fillets. Then:

$$\text{Moment} = 6 \times 40 = 240 \text{ in.-kips}$$

$$\begin{aligned} \text{Permissible } s_w &= \frac{3}{8} \times 0.707 \times 13.0^* = 3.45 \text{ kips per in. per fillet} \\ &= 6.9 \text{ kips per in. for two fillets} \end{aligned}$$

$$h = \sqrt{\frac{6 \times 240}{6.9}} = 14.5 \text{ in.—say } 15.0 \text{ in.}$$

Similarly for shear:

$$\begin{aligned} \text{Permissible } v_w &= \frac{3}{8} \times 0.707 \times 11.32 = 3 \text{ kips per in. per fillet} \\ &= 6 \text{ kips per in. for two fillets} \end{aligned}$$

$$h = \frac{4.0}{6} \times \frac{3}{2} = 10 \text{ in.}$$

The depth determined by bending is the larger and should be used.

It will be of interest to redesign this connection making use of the method of allowing for stress concentration suggested in the footnote on page 490. Assuming that the curve of stress distribution may be represented by the relation given in the footnote, with $n = 3$, we have

$$sb = \frac{10M}{h^2}$$

and

$$h = \sqrt{\frac{10 \times 240}{6.9}} = 18.7 \text{ in.—say } 19.0 \text{ in.}$$

Investigation for shear will give a shorter length than in the previous solution. From (b) in the footnote

$$vb = \frac{5}{4} \frac{V}{h}$$

Then

$$h = \frac{4.0}{8} \times \frac{5}{4} = 8.67 \text{ in.}$$

* Based on stresses given on page 508 under "Permissible Unit Stresses," "Maximum fiber stresses due to bending shall not exceed the values prescribed above for tension and compression respectively."

In a connection of the kind under discussion the height should be computed on the basis of both shear and moment and the larger height used. If the height is determined by shear the critical intensity will be at the neutral axis. If the height is determined by moment there may be shearing stresses near the top or bottom of the beam (not horizontal) having an intensity greater than that at the neutral axis but they will in all cases be less than the permissible intensity.

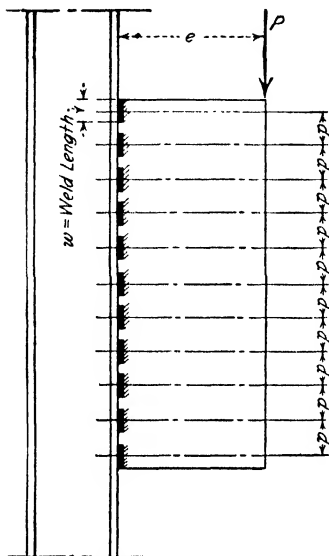

FIG. 238.

In some cases it may be desirable to make a deep bracket with intermittent welds as shown in Fig. 238. It should be clear that the number of weld lengths required may be estimated in the same way as the number of rivets required to resist a given moment. The relation given in Chapter V

$$n = \sqrt{\frac{6M}{W_p} \times \frac{n-1}{n}}$$

may be applied if

n = number of weld lengths in a line;

p = pitch of weld lengths, i.e., distance center to center weld lengths (see Fig. 238);

W = strength of one weld length.

Application of this procedure may be illustrated by assuming the following data in connection with Fig. 238:

$$P = 70 \text{ kips}$$

$$p = 4 \text{ in.}$$

$$e = 2 \text{ ft.}$$

w = weld length = 2 in. actual, $1\frac{1}{2}$ in. effective ($\frac{1}{2}$ in. for crater)

Assume $\frac{1}{2}$ -in. fillet welds on each side of plate.

Then: Moment = $70 \times 2 = 140$ ft.-kips

$$W = \frac{1}{2} \times 0.707 \times 13 \times 2 \times 1\frac{1}{2} = 13.8 \text{ kips}$$

$$n = \sqrt{\frac{140 \times 12 \times 6}{13.8 \times 4} \times \frac{n-1}{n}} = 13$$

172. Welded Connections: Beams and Columns.—The types of connections for beams and columns used for welded construction are illustrated by Figs. 239, 240, and 241 which were taken from a paper by Frank P. McKibben presented before an annual meeting of the

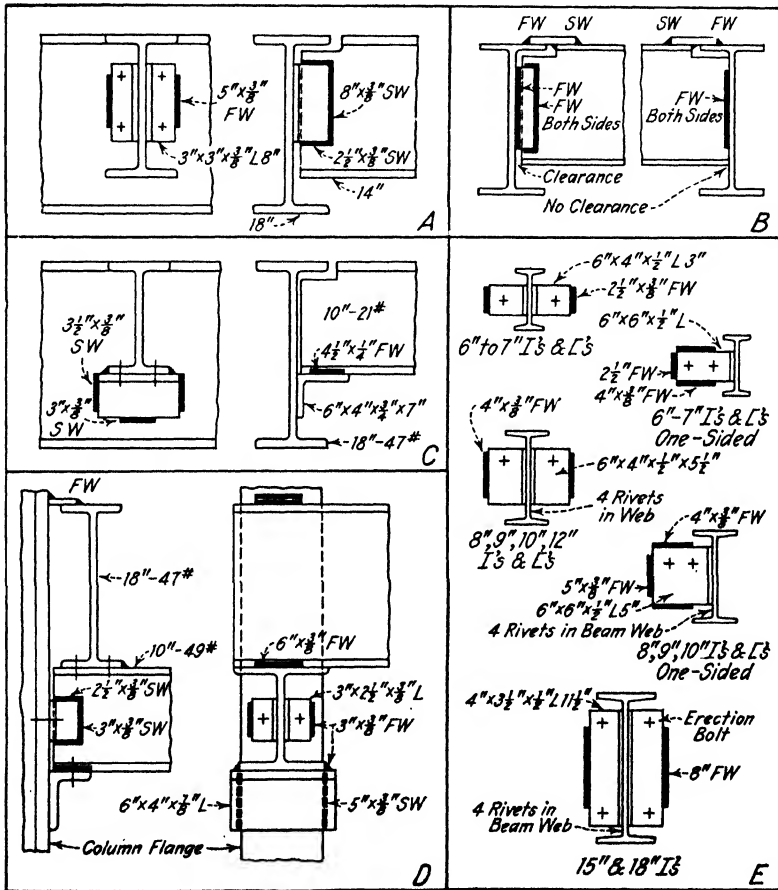

FIG. 239.—Structural Details. Sketches of Connections of Beams to Beams in All-Welded, and in Shop-Riveted, Field-Welded Buildings.

American Welding Society; they are reproduced here through the courtesy of the author and the society. The following comments on the details shown are quoted from the original paper: *

* Journal of the American Welding Society, May and June, 1933.

STRUCTURAL DETAILS FOR BUILDINGS

Typical connections of beams to beams illustrated in Fig. 239 require no milling of beam ends, except perhaps at the right end of that at *B* where two webs are welded together directly. In general, beams are ordered with the usual mill tolerances as shown at left end of *A*.

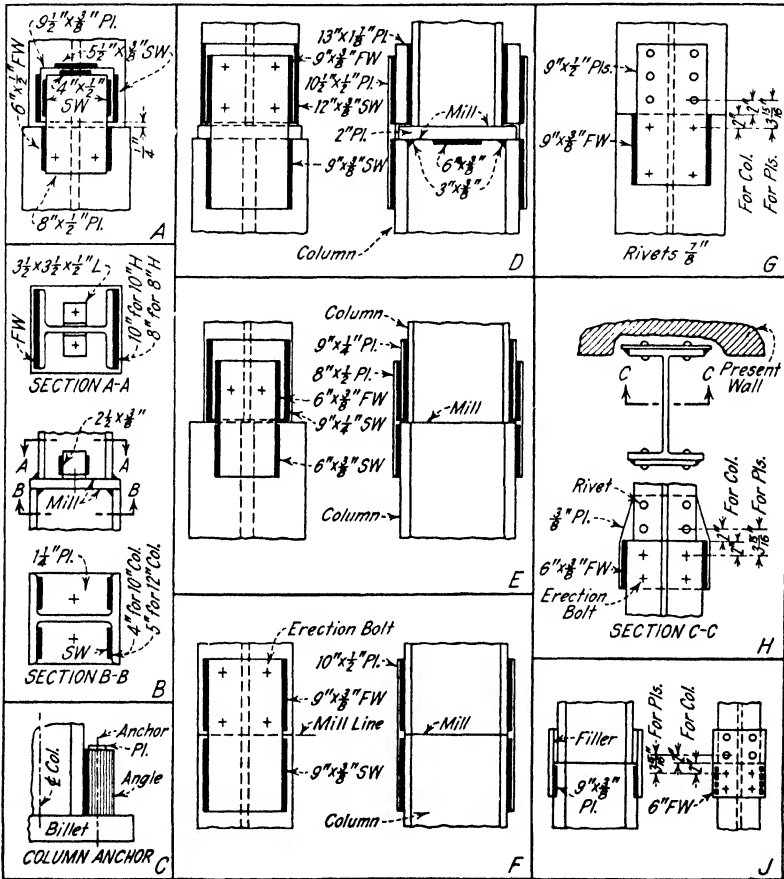

FIG. 240.—Structural Details. Sketches of Column Splices in All-Welded and in Shop-Riveted, Field-Welded Buildings.

In designing bracket angle supports as in *D*, provision must be made for the shear, and for bending in the outstanding leg near the angle fillet, or rather in the vertical leg at the base of angle fillet because the moment is really a maximum there. An interesting but simple study may be made of this by equating the slope of outstanding leg to that of the supported beam.

As a matter of fact, if the angle's outstanding leg and the beam's bottom flange

be welded sufficiently as in C, the state of stress in the outstanding leg is materially altered because it becomes essentially a part of the beam but bending remains in the vertical leg.

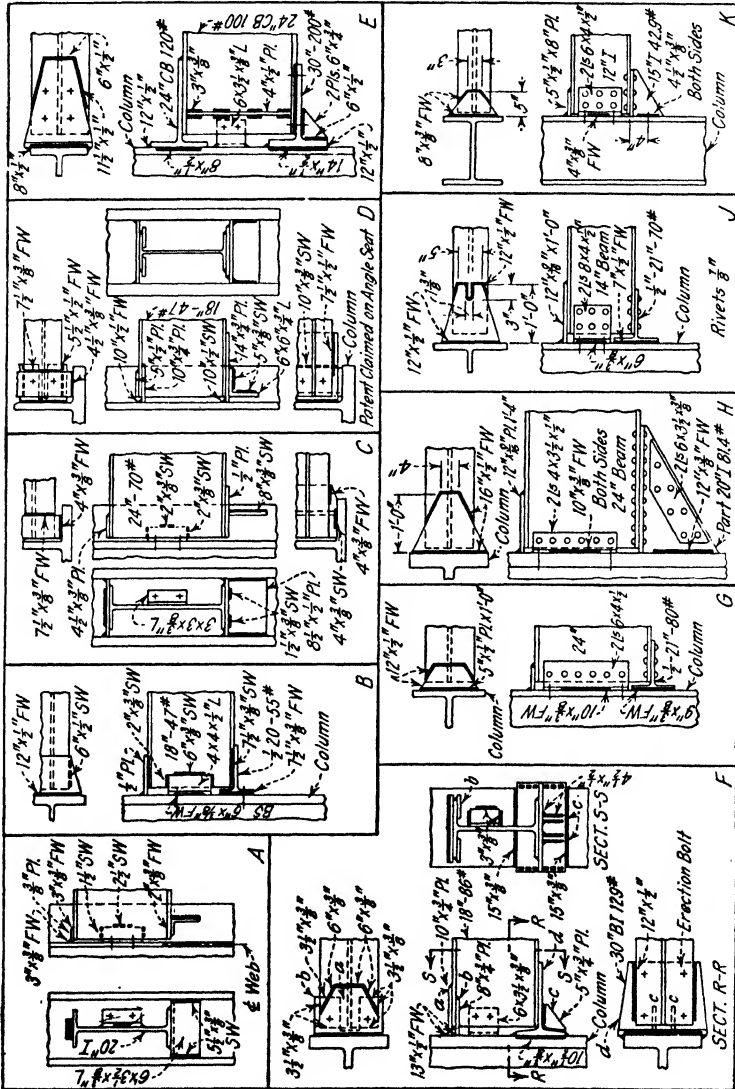

Fig. 241.—Structural Details. Sketches of Connections to Columns in All-Welded, and in Shop-Riveted, Field-Welded Buildings.

Figure 240 illustrates column splices with intervening bearing plate at D between upper and lower column sections of different sizes, also with direct bearing at F for column of similar sizes. Attention is called to the arrangement in upper sketch at

H for simplifying field welding of column splice plates on the rear side of a column located against a masonry wall of an existing building. By using, on the rear flange, a splice plate wider than the flange, the field welding is easily accomplished from the front.

Figure 241 depicts connection of beams to columns for all-welded, as well as for shop-riveted, field-welded buildings, most of which are typical of designs suitable for carrying vertical loads and bending moments. For example, at *E* the "wind" brackets consist of upper and lower tees cut from I beams as commonly used in similar riveted construction. The vertical loads in this case are carried by the lower tee, the outstanding stem of which is strengthened by two 6 in. by $\frac{3}{4}$ in. plate stiffeners. At *F*, two connecting plates are used at the top flange instead of a tee. This sketch also shows plate stiffeners under the lower tee at *C*. In top flange of sketch *J* a slot weld is utilized to increase the length of the weld. Attention is called to the existence of a patent claim on the angle seat supporting the beam between the column flanges at *D*.

Although nearly all building connections shown in Figs. 239, 240, and 241 require erection bolts, it is of interest to state that two patented details, utilizing welded interlocking devices in place of bolts, are available for erection purposes, and are so arranged that holes in beams and columns are largely if not entirely avoided.

In the same paper Professor McKibben gave some valuable data from actual welded buildings; these data are reprinted in the following table.

Through the courtesy of Professor McKibben and the General Electric Company, Figs. 242, 243, 244, and 245 are presented. Figures

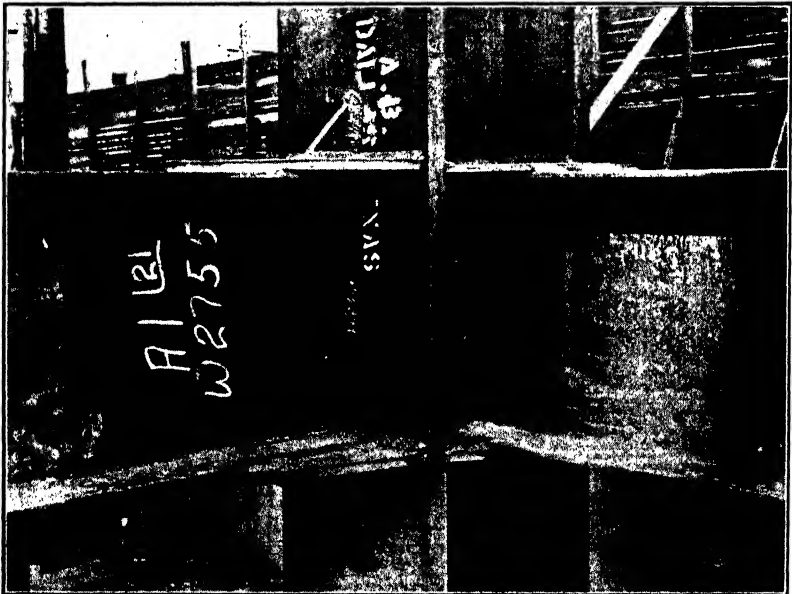

Courtesy of Frank P. McKibben and The General Electric Company.

FIG. 242.—Dallas Power and Light Company Building, Dallas, Texas.

DATA FOR WELDING STEEL BUILDING FRAMES

| | Univ.* of California | | Providence Court House | | Boston City Hospital | | Boston Edison | | Dallas P. & L. Company | | Dallas Gas Company | | Dupont Company | |
|--|----------------------|--|------------------------|--|----------------------|--------|---------------|--------|------------------------|--------|--------------------|--------|----------------|-------|
| | Field | | Field | | Shop | Field | Field | Field | Shop | Field | Shop | Field | Field | Field |
| 1. Electrode melted and wasted, lb | 4,800 | | 1,800 | | | 1,120 | 2,600 | 4,650 | 7,100 | 6,000 | 6,000 | 5,000 | 3,220 | |
| 2. Current used, kw-hr | 10,970 | | 3,810 | | | 4,150 | 6,120 | 9,460 | | 12,200 | 12,200 | 9,990 | 8,395 | |
| 3. Total steel in buildings, tons | 801 | | 811 | | 492 | 492 | 1,314 | 1,170 | 1,215 | 700 | 700 | 1,000 | 1,576 | |
| 4. Welders' time, man-hrs | 1,927 | | 831 | | | 557 | 1,206 | 1,768 | 3,140 | 2,000 | 2,000 | 1,640 | 1,411 | |
| 5. Total length of 3/8 in. fillets, lin. in. | 109,572 | | | | | | 51,921 | 56,415 | 97,500 | 13,200 | 13,200 | 51,600 | 65,400 | |
| 6. Total length of other fillets, lin. in. | | | | | | | 8,593 | 17,842 | 25,400 | 49,800 | 49,800 | 28,200 | | |
| 7. Total length of all fillets, lin. in. | 109,572 | | 54,864 | | 37,138 | 25,509 | 60,514 | 74,257 | 122,900 | 63,000 | 63,000 | 79,800 | 65,400 | |
| 8. Fillets per ton of steel in building, lin. in. | 136.9 | | 67.6 | | 75.5 | 51.9 | 46 | 101.2 | 90 | 90 | 90 | 79.8 | 41.5 | |
| 9. Welders' time per ton of steel in building, man-hrs. | 2.28 | | 1.02 | | | | 0.917 | 2.58 | 2.86 | 2.86 | 2.86 | 1.64 | 0.895 | |
| 10. Current per ton of steel in building, kw-hr. | 13.71 | | 4.7 | | | 8.43 | 4.66 | 8.09 | 17.4 | 17.4 | 17.4 | 9.99 | 5.33 | |
| 11. Electrode melted and wasted per ton of steel in bldg., lb. | 5.99 | | 2.22 | | | 2.27 | 1.98 | 5.84 | 8.57 | 8.57 | 8.57 | 5.0 | 2.04 | |
| 12. Welding machine, months. | 6.92 | | 4.7 | | 3 | 3 | 7.5 | 9.1 | | | | 9.3 | 8.0 | |
| 13. Steel per welding machine, mos. tons. | 116 | | 172.5 | | | 164 | 175 | 128.6 | | | | 107.5 | 197 | |
| 14. Number of welding machines | 10 | | 2 | | | 3 | 4 | 5 | | | | 5 | 4 | |
| 15. Number of stories above basement. | 8 | | 8† | | | 9 | 14 | 19 | | | | 13 | 14 | |

* Field connections for all laterals, including seismic forces, arc-welded. Direct loads carried on shop-riveted connections.

† In tower, 17.

242 and 243 show actual welded connections in the 28-story Dallas Power and Light Company Building at Dallas, Texas; Figs. 244 and 245 show actual welded connections in the 14-story Edison Electric Illuminating Company building at Boston, Massachusetts.

It is important for the student to note that continuity in welded connections may be inevitable unless special care is taken to provide flexibility. For example, in the connection shown in Fig. 246, complete continuity is present and should be designed for. It would be incorrect in this case to design the flange connections for the wind

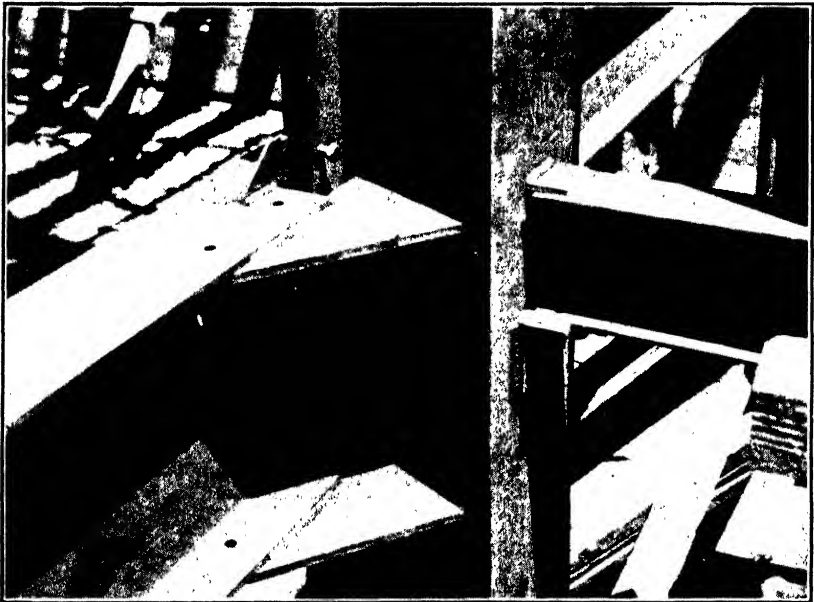

Courtesy of Frank P. McKibben and The General Electric Company.

FIG. 243.—Dallas Power and Light Company Building, Dallas, Texas.

moment only; since complete continuity is present the moments due to both vertical and lateral loads must be provided for. The web connection generally would be designed under the assumption that its sole duty is to resist the end shear. Of course the web connection actually resists some moment but its amount is insignificant in comparison with the total; it may be taken into account, however, and the method of doing so is suggested in Fig. 246 (b). Although the maximum shear per inch of height must be as shown in Fig. 246 (b) *if the beam formula holds* the height h would generally be determined under the assumption that the shear is uniformly distributed along the web con-

nection. Such a design procedure is in a sense consistent with the method by which the working stresses for welds were established, but it is important for the designer to recognize the approximate nature of the procedure. It is essential that there be some provision for supporting such a beam until the welding can be done, and this may be accomplished by some such detail as that shown in Fig. 246 (c).



Courtesy of Frank P. McKibben and The General Electric Company.

FIG. 244.—Edison Electric Illuminating Company Building,
Boston, Massachusetts.

173. Welded Plate Girders.—Plate girders of moderate size may be fabricated by welding the parts together. The general arrangement and connection of the parts may be as indicated in Fig. 247. The proportioning of the section may be carried out by the same methods employed for riveted girders whether the design is made by the approximate flange area method or the more exact moment of inertia method. Or the flange area method may be modified by the procedure discussed in Chapter III, Art. 80, and the accuracy of the design will be com-

parable with that of the moment of inertia method, with considerably less computation. Of course the student will notice that $1/6$ of the web may be considered as flange area in designing by the flange area method, since no holes need be deducted.

The welding of the flanges to the web may be continuous or intermittent; if the former is used the rate of change of the flange stress



Courtesy of Frank P. McKibben and The General Electric Company.

FIG. 245.—Edison Electric Illuminating Company Building,
Boston, Massachusetts.

will determine the minimum size fillet, and if intermittent welding is chosen the pitch for a given weld size and length may be calculated by the same methods used for riveted girders.

When two or more cover plates are needed the added plates may be made wider than the base cover, as in Fig. 248, or narrower as in Fig. 249. If the width of a cover is more than about 20 or 30 times its thickness it

should be connected to the base cover by means of plug or rivet welds as shown in Fig. 248.

Stiffeners may be single flats welded to the web continuously or intermittently. Intermediate stiffeners may be designed and spaced

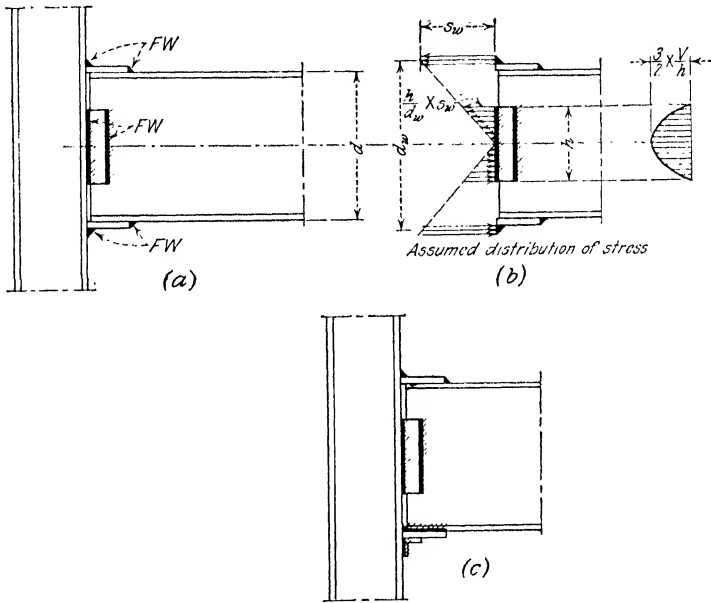

FIG. 246.

by the usual rules. End stiffeners should be designed as columns rather than by bearing on the ends: design by the latter method, though satisfactory for riveted girders, is not suitable when the entire stiffener is

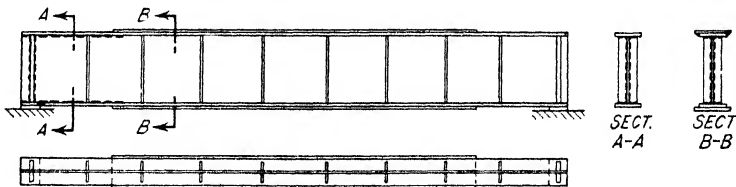

Fig. 247.—Typical Welded Girder.

bearing and does not engage a large mass of additional metal. The length of the column may reasonably be taken as half the depth of the girder, and if the outstanding width of the stiffener flat is not more than

12 times its thickness the radius of gyration may be taken about an axis coincident with the center line of the web. These requirements for end stiffeners are illustrated in Fig. 250; in all but the most exceptional cases compliance with these requirements will result in a design stress for end stiffeners of 15,000 lb. per sq. in. under the A.I.S.C. "Specifications."

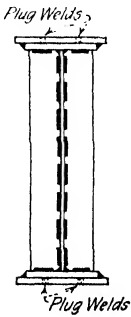

FIG. 248.

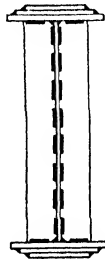

FIG. 249.

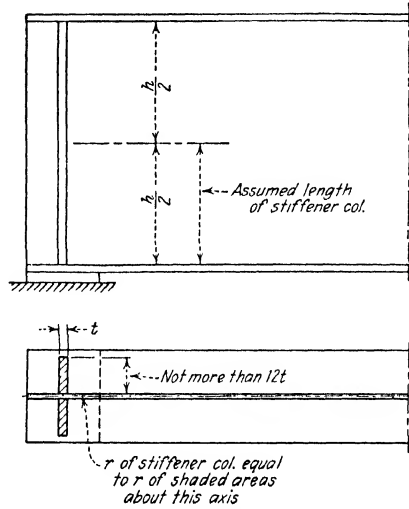

FIG. 250.

Welded crane girders having a cross-section like that shown in Fig. 251 are ideal for cranes and spans of moderate size. The design may be carried out by the same methods used for similar riveted girders.

Calculation Sheet DP22 illustrates the design of a welded crane girder similar to that shown in Fig. 251.

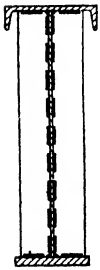

FIG. 251.

174. Welded Trusses.—The discussion of welded trusses in this text will be restricted to moderate-size building trusses. Welded trusses of large capacity may be and have been designed, but the complications and difficulties involved cannot be properly discussed in the limited space of this chapter.

The design of welded trusses differs from the design of riveted trusses in that the selection of shapes and arrangement of joints generally will require more careful study. The ideal toward which the designer of a welded truss works is the elimination of all gusset plates. The attainment of this ideal is often difficult and in many cases requires such sacrifices of convenience in fabrication as to seem not worth while.

The use of T chords made by longitudinal splitting of a wide flange beam, or by building up from two plates, will in some cases make

| | | | | | |
|---|--|------|--------|--------------|--|
| <p><u>Welded Runway Girder</u></p> <p><u>Span 25'-0"</u></p> <p><u>Live Load</u> 1-Whiting 50-Ton O. E.T. Crane</p> <div style="text-align: center;"> </div> <p><u>Dead Load</u></p> <p>Girder = 200 #/ft estimated Rail, etc. = 30 Total = 230 #/ft</p> <div style="display: flex; justify-content: space-between;"> <div style="width: 45%;"> <p><u>Maximum Moment</u></p> <p>L.L. = 722^k</p> <p>Imp. 25% = 181</p> <p>D.L. $.23 \times \frac{25^2}{8} = 18$</p> <p>Total = 921^k</p> <p>$\div 4.48' = 206^k$ @ 18 = 11.44^o net tens. flg.</p> <p>@ 16.67 = 12.35 $\frac{1}{.84} \times \frac{482 \times 7.5}{16.67 \times 4.9} = 10.78$</p> <p style="text-align: center;">23.13^o net comp. flg.</p> </div> <div style="width: 45%;"> <p><u>Lateral Moment</u></p> <p>$.2 \times 50T = 10T$</p> <p>$\frac{10 \times 2}{8} = 2.5^k/\text{wheel}$</p> <p>$\frac{2.5}{45} \times 722 = 40.2^k = 482^{\text{in}}k$</p> <p>$\frac{L}{b} = \frac{25 \times 12}{15} = 20$ $s_r = 16.67^k/\text{in}$</p> </div> <div style="width: 45%;"> <p><u>Maximum Shear</u></p> <p>L.L. = 128^k</p> <p>Imp. 25% = 32</p> <p>D.L. $.23 \times \frac{25}{2} = 3$</p> <p>Total = 163^k</p> <p>@ 12 = 13.6^o gr. web @ 15 = 10.9^o gr. end stiff's. @ 3^k/in = 54.4 lin. inches weld for end stiff's</p> </div> </div> | <p>DP 22</p> <p>Crane Runway Girder</p> <table border="1" style="width: 100%; border-collapse: collapse;"> <tr> <td>1934</td> <td>T.C.S.</td> </tr> <tr> <td colspan="2">Sheet 1 of 1</td> </tr> </table> <div style="text-align: center;"> </div> | 1934 | T.C.S. | Sheet 1 of 1 | |
| 1934 | T.C.S. | | | | |
| Sheet 1 of 1 | | | | | |

Material for 1-Girder*

| | |
|--|--|
| <p>1-Web $54 \times \frac{3}{8} = 20.25^{\text{o}}/\text{gr.}$ $\frac{1}{6} = 3.38^{\text{o}}/\text{in}$</p> <p>1-Top L $15^{\text{o}} @ 50^{\#} = 14.64 - 1.25 = 13.39, + 3.38 = 16.77$</p> <p>1-Top Pl. $14 \times \frac{3}{8} = 7.88 - .98 = 6.90, + 16.77 = 23.67^{\text{o}}/\text{net}$</p> <p>1-Bott. Pl. $13 \times \frac{3}{8} = 8.13 - 0 = 8.13, + 3.38 = 11.51^{\text{o}}/\text{net}$</p> <p>4-End Stiff's. $6 \times \frac{15}{16} = 2 \times 6 \times \frac{15}{16} = 11.25^{\text{o}}/\text{gr. o.s. stiff. legs.}$</p> <p>14-Int. Stiff's. $5 \times \frac{5}{8}$</p> <p>2-Sole Pls. $13 \times \frac{3}{4}$</p> <p>Weld metal + excess, say 1$\frac{1}{2}$% \pm</p> | <p>Pl. excess 2$\frac{1}{2}$% = 45</p> <p>@ 68.9 x 25.5' = 1755*</p> <p>@ 50.0 x 25.5 = 1275</p> <p>@ 26.8 x 25.5 = 685</p> <p>@ 27.6 x 25.5 = 705</p> <p>@ 19.1 x 4.5 = 34.5</p> <p>@ 6.4 x 4.5 = 40.5</p> <p>@ 33.2 x .5 = 35</p> <p style="text-align: center;">= 90</p> <p>Total for 1-Girder = 5340*</p> |
|--|--|

Flange Welding

3" Chain welds - 2 $\frac{1}{2}$ " effective
 $2 \times 2\frac{1}{2} \times 3 = 15^k/\text{weld length}$

$\frac{163}{53.8} = 3.03^k/\text{in}$ approx. rate of change of flg. stress

$\frac{15}{3.03} = 4.95^{\text{in}}$ Say 5" spacing of weld lengths to $\frac{1}{4}$ point.

Shear at Quarter Point = 106^k

$\frac{15 \times 53.8}{106} = 7.6^{\text{in}}$ Say 7" spacing of weld lengths between $\frac{1}{4}$ points.

*The student will do well to study the effect of the correction implied in the footnote on page 180; not only on this girder, but on those designed in DP 11, pages 185 - 188.

possible joint connections without gusset plates. A joint in a truss of this type is shown in Fig. 252. The student will notice that the area of the chord is considerable, rather more than is ordinarily required in a roof truss, and the use of this sort of section may result in waste of metal in the chords if the vertical leg of the T is kept within reasonable limits as to thickness. The thickness of the vertical leg of the T should

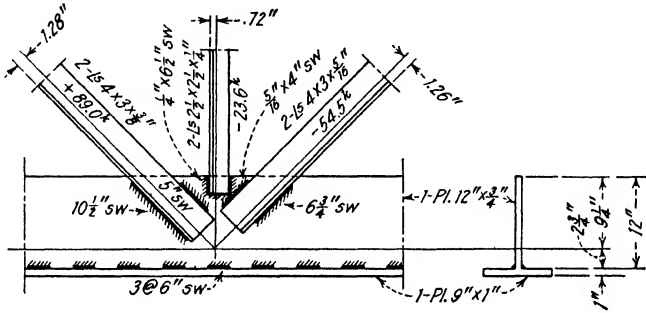

FIG. 252.

never be less than 1/16 of its width and preferably should be not less than 1/14 of the width. A further objection to the T chord is that the width needed for the web connections is likely to be so great as to result in excessive secondary stresses in trusses with the short panels common to roof construction. The Pratt truss may be found more favorable for a welded truss with T chords, and the use of small channels and

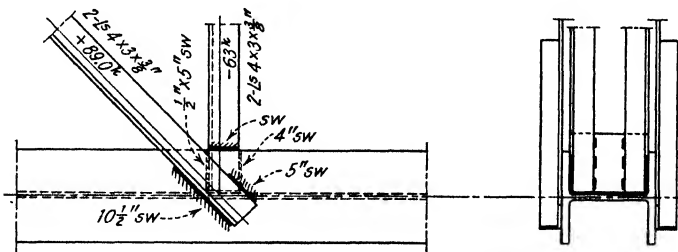

FIG. 253.

rolled T's for the web members may be helpful because of the symmetry of the resulting members.

If the design of a truss using T chords seems to be impracticable it may be possible to use H chords with the web placed in a horizontal position; the use of the Pratt system is almost essential for such construction. If the truss for which an L joint is shown in Fig. 252 is rede-

signed as a Pratt truss using an H chord the corresponding joint may be detailed as in Fig. 253. The truss is now a double-plane truss and the web members must have the two ribs properly connected by batten plates, or batten plates and lacing.

The author thinks that the effort to eliminate gusset plates may be overdone in many cases and suggests that it may be better to design the truss in the ordinary way; if this is done the joint of Fig. 252 may be detailed as in Fig. 254.

The detailing of joints in welded trusses with the members failing to intersect at a common point (by several inches in some cases) and the use of single-angle web and chord members, as has been done in some welded structures, cannot be defended, and justifies the observation that in some cases much of the economy claimed for welded construction is due to design which would not be tolerated in a riveted structure.

The student is referred to the larger treatises devoted exclusively to welding and to the publications of the American Welding Society for further information on design procedure and suggestive details of construction.

175. Stresses in Welds.—

Lack of space makes it impossible to reproduce a complete specification for welded structures, but it seems desirable to give some information on current practice and to

that end there are presented herewith brief abstracts from the "Code for Fusion Welding and Gas Cutting" published by the American Welding Society. These abstracts include some definitions, permissible intensities of stress, and details regarding design and workmanship. At certain points there are interpolated quotations from "Major Provisions of An Arc-Welding Specification" prepared by Frank P. McKibben, and published in *Engineering News-Record* for March 14, 1929.

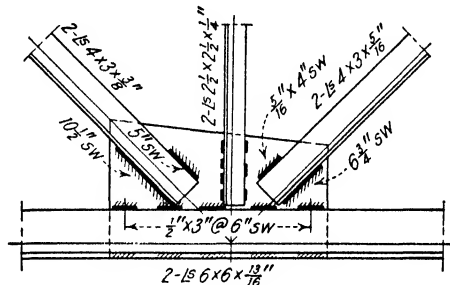

Fig. 254.

DEFINITIONS

The definitions of welding terms, as approved and published by the American Welding Society, shall govern for any welding terms appearing in this code.

For convenience, some of the more common terms have been included herein, and their specific applications under this code are defined as follows:

1. *Fusion Welding*.—The process of joining metal parts in the molten, or molten and vapor states, without the application of mechanical pressure or blows.

Under this code, fusion welding is restricted to the arc and gas welding processes.

2. *Root*.—The zone at the bottom of the cross-sectional space provided to contain a fusion weld.

3. *Throat*.—The minimum thickness of a weld along a straight line passing through the root.

Under this code the throat of a fillet weld shall be the distance along a line from the root to the hypotenuse at right angles thereto, of the largest isosceles right triangle that can be constructed in the cross-section of the fillet weld; and the throat of a butt weld shall be equal to the thickness of the thinner part joined.

4. *Fillet Weld*.—A weld of approximately triangular cross-section, whose throat lies in a plane disposed approximately 45° with respect to the surfaces of the parts joined.

The *size of a fillet weld* shall be expressed in terms of the width in inches of its adjacent fused sides.

5. *Butt Weld*.—A weld whose throat lies in a plane disposed approximately 90° with respect to the surfaces of at least one of the parts joined.

The *size of a butt weld* shall be expressed in terms of its net or unreinforced throat dimension in inches.

6. *Weld Length*.—The length of a weld shall be considered to be the unbroken length of the full cross-section of the weld exclusive of the length of any craters.

7. *Weld Dimensions*.—Under this code the dimensions of a weld shall be expressed in terms of its size and length.

8. *Gas Cutting*.—The process of severing ferrous metals by means of the chemical behavior of oxygen, in the presence of ferrous metals at high temperatures, to produce a kerf or cut of uniform width without burning the edges of the kerf or cut.

PERMISSIBLE UNIT STRESSES

1. Welded joints shall be proportioned so that the loads specified in the Building Code shall not cause stresses therein to exceed the following amounts in pounds per square inch:

| | |
|--|--------|
| Shear on section through throat of weld..... | 11,300 |
| Tension on section through throat of weld..... | 13,000 |
| Compression on section through throat of weld..... | 15,000 |

Maximum fiber stresses due to bending shall not exceed the values prescribed above for tension and compression respectively.

Fillet welds placed transverse to the direction of stress shall be considered as under shear.

2. In designing welded joints adequate provision shall be made for bending stresses due to eccentricity, if any, in the disposition or section of base metal parts.

DESIGN

1. The architect or engineer designing or supervising a welded structure shall be experienced and skilled in such work.

2. *Plate Girders*.—Girders shall be proportioned either by their moments of inertia or by the flange area method. In applying the flange area method to welded girders having no holes in the web, one-sixth of the web area may be considered a part of each flange area.

Stiffeners may be either angles or flat bars, welded to the top and bottom flanges.

and to the web, by continuous or intermittent fillet welds designed to transmit the stresses.

Connection of component parts of flanges to each other and of flanges to web shall be by continuous or intermittent fillet welds designed to transmit the stress.

3. *Beams*.—The use of continuous beams and girders, designed in accordance with accepted engineering principles, shall be permitted provided that their welded connections be designed to transmit the stresses to which they may be subjected.

The connection at the ends of non-continuous beams shall be designed so as to avoid excessive secondary stresses due to bending.

4. *Columns*.—Fillet welds connecting the component parts of a built-up column may be either continuous or intermittent. If intermittent, the length of each weld at the ends of the column shall be equal to the least width of the column. The length of the intervening welds shall be not less than $1\frac{1}{2}$ in., spaced not more than 4 in. in the clear. The size, length, and spacing of the fillet welds shall be such as to provide the same strength, per unit of column length, as the rivets specified elsewhere in the Building Code.

Lattice bars and tie plates, if used, shall be welded so as to secure strengths equal to those of the rivets specified therefor elsewhere in the Building Code.

5. *Butt Joints*.—One or both edges of base metal parts, $\frac{1}{4}$ in. or more in thickness, transmitting stress by means of butt welds shall be beveled. For single and double vee joints, the bevel of each part shall be not less than 30° , thus forming an open space with an angle of not less than 60° . For single and double bevel joints, the bevel shall be not less than 45° .

Before welding, the root edge or face of one part shall be separated from the root edge or face of the other part by the spacing given for butt joints in the "Code for Fusion Welding and Gas Cutting in Building Construction" published by The American Welding Society.

All butt welds shall be reinforced by depositing additional metal on the weld to a height extending beyond the surface of the thinnest part joined. The height of said reinforcement shall be not less than the following percentages of the thickness of the thinnest part joined:—20 per cent for single vee and single bevel butt welds, and $12\frac{1}{2}$ per cent, on each side, for double vee and double bevel butt welds.

6. *General*.—Intermittent welds shall be not less than 2 in. long, exclusive of crater, spaced in the clear not exceeding sixteen times the thickness of the thinnest piece connected, nor more than 4 in. in the clear.

Fillet welds of lengths less than four times their width shall not be figured as part of any connection.

To the calculated length of each weld, $\frac{1}{2}$ in. shall be added to allow for the crater.

WORKMANSHIP

1. Contractors for welded structures shall be required to satisfy the Superintendent of Buildings as to their ability to produce satisfactory welded joints of the forms specified, and with the process (arc or gas), materials and equipment to be used on the proposed work.

2. The quality of welds permitted under this code shall conform to the practice recommended in the "Code for Fusion Welding and Gas Cutting in Building Construction" published by The American Welding Society.

3. Surfaces to be welded shall be free from loose mill scale, rust, paint, or other foreign matter. A thin coat of linseed oil or equivalent, over the surfaces to be

welded, need not be removed. This provision applies both in the case of new structures and where new steel is to be welded to steel in an existing structure.

4. In assembling and during welding, the component parts of a built-up member shall be held by sufficient clamps, or other adequate means, to hold the parts in proper relation for welding.

ERECTION

1. Structural steel parts shall not be painted before they are welded. Parts that are welded in the shop, to be erected by bolts or rivets, shall receive the usual painting after the shop welding is finished. Parts to be field welded shall receive a coat of linseed oil after shop work is completed, and after erection and field welding, they shall receive as many coats of paint as the total number specified elsewhere in the Building Code for shop and field painting.

2. For all welded structures over 30 ft. in height, erection bolts, or equivalent means shall be employed for temporarily supporting the members and for ensuring proper alignment.

APPENDIX A

GENERAL SPECIFICATIONS FOR THE DESIGN OF STEEL RAILWAY BRIDGES

These specifications were taken, in large part, from those prepared by the conference committees of the American Society of Civil Engineers and the American Railway Engineering Association, published in the *Proceedings* of the American Society of Civil Engineers for December, 1929. The author has modified the specifications to suit his own views with respect to allowable intensities of stress, loading, provision for net section, and in some other matters of minor importance.

PART I.—DESIGN AND MANUFACTURE

SECTION A.—PROPOSALS AND DRAWINGS

Definition of Terms.

1. The term "Company" means the Railway Company party to the contract. The term "Engineer" means the Chief Engineer of the Company or his subordinates in authority. The term "Inspector" means the inspector representing the Company. The term "Contractor" means the manufacturing or fabricating contractor party to the contract.

Proposals.

2. Bidders shall submit proposals conforming to the terms in the letter of invitation. The proposals preferably shall be based on plans and specifications furnished by the Company. The plans will show the conditions determining the design of the bridge, the general dimensions, stresses, and typical details.

Invitations requiring the Contractor to furnish the design shall state the general conditions at the site, such as track spacing, character of foundation, presence of old structures, traffic conditions, etc.

Shop Drawings.

3. After the contract has been awarded and before the work is begun, the Contractor shall submit to the Engineer for approval, prints in duplicate of stress sheets and shop drawings, unless such drawings shall have been prepared by the Company.

Shop drawings shall be made on the dull side of the tracing cloth, 24 by 36 in. in size, including margins. The margin at the left end shall be $1\frac{1}{2}$ in. wide, and the other margins $\frac{1}{2}$ in. The title shall be in the lower right-hand corner.

No change shall be made on any approved drawing without the consent of the Engineer, in writing.

The tracings of the drawings shall be the property of, and be delivered to, the Company after the completion of the contract.

4. The Contractor shall be responsible for the correctness of his drawings, and

for shop and field connections, although the drawings may have been approved by the Engineer.

5. Ordering of material by the Contractor prior to the approval of the drawings shall be at his risk.

Drawings to Govern.

6. If the drawings and the specifications differ, the drawings shall govern.

Patented Devices.

7. The Contractor shall protect the Company against claims arising from the use of patented devices or parts proposed by him.

Notice to Engineer.

8. No material shall be rolled nor work done before the Engineer has been notified where the orders have been placed.

SECTION 1.—GENERAL FEATURES OF DESIGN

Materials.

101. Bridges shall be made wholly of structural steel, except where otherwise specified. Rivet steel shall be used for rivets. Castings shall be of steel unless cast iron is specifically authorized by the Engineer.

Types of Bridges.

102. The types of bridges to be used for various span lengths may be as follows:

Rolled beams for spans up to 40 ft.

Plate girders for spans up to 125 ft.

Riveted trusses for spans 100 ft., or longer.

Pin-connected trusses for $\left. \begin{array}{l} \text{single-track spans 250 ft. or longer} \\ \text{double-track spans 200 ft. or longer} \end{array} \right\}$ when specifically authorized by the Engineer.

Spacing of Trusses, Girders, and Stringers.

103. The distance between centers of trusses or girders shall be sufficient to prevent overturning by the specified lateral forces. In no case shall it be less than one-twentieth of the span for trusses, nor one-fifteenth of the span for girders.

The girders of deck spans and the stringers of through spans shall be spaced not less than 6 ft. 6 in. between centers. If four stringers are used under one track they shall be arranged in pairs, each pair symmetrical about a rail.

Depth Ratios.

104. The depth of trusses preferably shall be not less than one-tenth of the span. The depth of plate girders preferably shall be not less than one-twelfth of the span. The depth of rolled beams used as girders and the depth of solid floors preferably shall be not less than one-fifteenth of the spans. If smaller depths are used, the sections shall be so increased that the deflection will not be greater than if these limiting depth ratios were not exceeded.

Clearances.

105. The clearances on straight track shall not be less than those shown in Fig. A-1. On curved track the clearance shall be increased to allow for the over-

any members, such stresses shall be shown on the stress sheet for the members affected.

Dead Loads.

202. In estimating the weight for the purpose of computing dead load stresses, the following unit weights shall be used:

| | |
|--|---------------------|
| Steel | 490 lb. per cu. ft. |
| Concrete..... | 150 " " " " |
| Sand, gravel, and ballast..... | 120 " " " " |
| Asphalt-mastic and bituminous macadam..... | 150 " " " " |
| Granite..... | 170 " " " " |
| Paving bricks..... | 150 " " " " |
| Timber..... | 5 " " ft. B. M. |

The track rails, inside guard rails, and fastenings shall be assumed to weigh 200 lb. per lin. ft. for each track.

Live Load.

203. The live load for each track shall consist of typical engines followed by a uniform train load, according to either class E series, or Class M series, as may be specified by the Engineer. It shall be a multiple of one or the other of the loads with wheel spacings, as shown in Figs. A-2 and A-3.

Loading E-75 or Loading M-65 is recommended for main-line bridges of American railways.

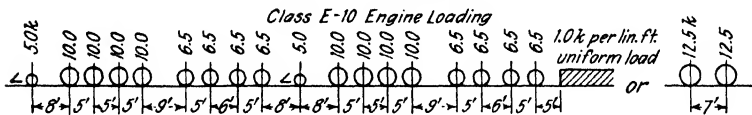

FIG. A-2.

In special locations, where conditions limit the loading to light engines, a lighter loading, as stipulated by the Engineer, may be used, but in no case less than three-fourths of that already recommended; the live load assumed shall be proportional to the loading recommended, with the same wheel spacing.

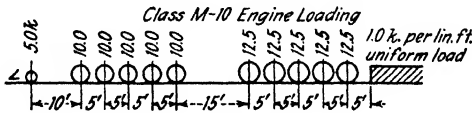

FIG. A-3.

For girders and trusses of spans carrying more than one track, live loads shall be assumed as follows:

For two tracks, full live load.

For three or more tracks, full live load on the two tracks nearest the girder or truss, and 75 per cent of full live load on all other tracks.

Impact.

204. The stresses due to the dynamic effect of the live load shall be added to the maximum computed live load stresses and shall be determined by the formula,

$$I = S \frac{400 - \frac{l}{2}}{400 + l}$$

in which S = maximum computed live load stress for a single track;

I = impact stress, dynamic effect of the live load;

l = length, in feet, of the span which is loaded to produce the live load stress.

For girders and trusses of double-track bridges, the impact shall be taken from the full live load on one track only. The impact shall be only that from the live load on the track nearest the girder or truss.

For bridges with three or more tracks the impact shall be computed from the load on the track which, when loaded, produces the greatest live load stress in the member.

For bridges designed exclusively for electric traction, the impact shall be taken as one-third of that given by the impact formula.

Centrifugal Force.

205. On curves the centrifugal force shall be taken as a percentage of the live load, including impact, and assumed to act 6 ft. above the top of the rail. The percentages to be applied shall be as given in Table A-a.

TABLE A-a

| | | | | | | | | | | | | | | |
|------------------------------------|--------|--------|----|----|----|----|----|----|----|----|----|-----|-----|-----|
| Degree of curve..... | 0° 20' | 0° 40' | 1° | 2° | 3° | 4° | 5° | 6° | 7° | 8° | 9° | 10° | 11° | 12° |
| Speed, in miles per hour..... | 72 | 72 | 72 | 59 | 53 | 46 | 41 | 38 | 35 | 33 | 31 | 29 | 28 | 27 |
| Percentage for centrifugal force.. | 2 | 4 | 6 | 8 | 10 | 10 | 10 | 10 | 10 | 10 | 10 | 10 | 10 | 10 |

Lateral Forces.

206. Wind on Loaded Bridge.

The wind shall be considered as a moving load acting in any horizontal direction. The wind force on the bridge shall be taken at 30 lb. per sq. ft. of:

- (a) one and one-half times the floor system as seen in elevation;
- (b) the projection of all trusses;

but not less than 200 lb. per lin. ft. of loaded chord and 150 lb. per lin. ft. of unloaded chord.

The wind force on the train shall be taken as 300 lb. per lin. ft. on one track, applied 8 ft. above the top of the rail.

207. Wind on Unloaded Bridge.

If a wind force of 50 lb. per sq. ft. of surface as defined in Art. 206, on the unloaded bridge, would produce greater stresses than the combined wind forces specified, those stresses shall be used in the members where such greater stresses occur.

208. Stability of Spans and Towers.

In calculating stability, spans and towers shall be considered as loaded on the

leeward track with empty cars weighing 1200 lb. per lin. ft., and subjected to a wind force of 300 lb. per lin. ft., applied 8 ft. above the top of the rail.

209. Sway of Engines.

The lateral force to provide for the effect of the sway of the engines, in addition to the wind loads specified, shall be a moving concentrated load of 20,000 lb., which may be applied at the base of rail in either horizontal direction at any point of the span.

Longitudinal Force.

210. The longitudinal force resulting from the starting and stopping of trains shall be 20 per cent of the load on the engine drivers, and 5 per cent of the load on the remainder of the train. This force shall be taken on one track only, and shall be assumed to act 6 ft. above the top of the rail.

In bridges where, by reason of continuity of members or frictional resistance, the longitudinal force will be directed largely to the abutments (such as ballasted deck bridges of only three or four spans), the longitudinal force shall be taken as one-half that specified.

Reversal of Stress.

211. Members subject to reversal of stress under the passage of the live load shall be proportioned for the stress requiring the larger section.

The stress for designing the connections for such members shall be determined by obtaining the resultant stress of each kind, tension, and compression, and adding 50 per cent of the smaller stress to each.

Combined Stresses.

212. Members subject to both axial and bending stresses (including bending of posts due to floorbeam deflection) shall be so proportioned that the combined fiber stresses will not exceed the allowed axial stress. In members continuous over panel points, only three-fourths of the bending stress computed as for simple beams shall be added to the axial stress.

213. Members subject to stresses produced by a combination of dead load, live load, impact, and centrifugal force, with either lateral or longitudinal forces, or with bending due to lateral forces, may be proportioned for unit stresses 25 per cent greater than those specified in Art. 301; but the section of the member shall not be less than that required for the combined dead load, live load, impact, and centrifugal force.

Secondary Stresses.

214. Secondary stresses shall be avoided as far as practicable. In trusses without sub-paneling, secondary stresses due to distortion need not be considered in any member the width of which, measured parallel to the plane of flexure, is less than one-tenth of its length. Other secondary stresses shall be considered.

SECTION 3.—UNIT STRESSES

Unit Stresses.

301. The allowable unit stresses to be used in proportioning the parts of a bridge shall be as follows:

(a) Structural and Rivet Steel:

| | Kips per square-inch* |
|---|--|
| Axial tension, net section | 18.0 |
| Tension in extreme fibers of rolled shapes, built sections, and girders, net section | 18.0 |
| Axial compression, gross section | $\frac{18.0}{1 + \frac{l^2}{16,000r^2}}$ |

but not to exceed the value for $l/r = 56$
 in which l = length of the member, in inches;
 r = least radius of gyration of the member, in
 inches.

Compression flanges of plate girders or beams:

| | |
|--|---------------------------|
| when $l/b \leq 10$ | 18.0 |
| when $l/b > 10$ | 18.9 |
| in which l = the length, in inches, of the unsupported flange between lateral connections or knee- braces; | $1 + \frac{l^2}{2000b^2}$ |

b = the flange width, in inches.

l/b shall not exceed 40

| | |
|---|------|
| Tension in extreme fibers of pins | 27.0 |
| Shear in plate girder webs, gross section | 11.2 |
| Shear in power-driven rivets and pins | 13.5 |
| (Rivets driven and bucked by pneumatically or electrically operated hammers are considered power-driven.) | |
| Shear in turned bolts and hand-driven rivets | 11.2 |
| Bearing on power-driven rivets, pins, outstanding legs of stiffener angles, and other steel parts in contact | 27.0 |
| Bearing on turned bolts and hand-driven rivets | 22.4 |
| Bearing on expansion rollers, per linear inch | 0.6d |
| in which, d = diameter of rollers, in inches. | |
| For cast-steel shoes and pedestals, the allowable unit stresses in structural steel shall apply. | |

(b) High-Tension Steel:

For members composed of steel of greater strength than structural grade the allowable stresses may be increased in proportion to the specified minimum yield point of the stronger steel, provided such yield point is not more than 70 per cent of the ultimate strength. In the compression formulas the fractional term of the denominator shall be increased in the same proportion.

(c) Wooden Cross-Ties:

| | |
|--|-----|
| Tension in extreme fibers: | |
| White oak and dense yellow pine | 2.0 |
| Dense Douglas fir | 1.4 |
| White pine, ordinary yellow pine, and spruce | 1.1 |
| The maximum wheel load with 100 per cent impact shall be considered as distributed over three ties. | |

* 1 kip equals 1000 lb.

(d) Masonry:

Bearing pressure:

| | |
|-----------------------------------|------|
| Granite | 0.90 |
| Sandstone and limestone | 0.45 |
| Concrete | 0.67 |

Provision for Overload.

302. Members shall be so proportioned that an increase of live load which will increase the total unit stresses in the chords or flanges 30 per cent will not produce total unit stresses in the other members or details more than 30 per cent greater than the designing stresses.

Effective Bearing Area.

303. The effective bearing area of pins, bolts, and rivets shall be the diameter multiplied by the length in bearing; except that for countersunk rivets, one-half the depth of the countersink shall be omitted.

Effective Diameter of Rivets.

304. In proportioning rivets, the nominal diameter of the rivet shall be used.

Slenderness Ratio.

305. The slenderness ratio (ratio of unsupported length to corresponding radius of gyration) shall not exceed:

- 100 for main compression members.
- 120 for riveted tension members subject to live load reversal of stress.
- 120 for wind and sway bracing.
- 140 for single lacing.
- 200 for double lacing.
- 200 for riveted tension members not subject to live load reversal of stress.

SECTION 4.—DETAILS OF DESIGN

Thickness of Material.

401. The minimum allowable thickness of material shall be $\frac{5}{16}$ in., except for fillers. Gussets shall not be less than $\frac{3}{8}$ in. thick.

Metal subject to marked corrosive influences shall be thicker than otherwise would be required, or else protective measures shall be provided.

Open Details.

402. Details shall be so arranged as to give free access for inspection and painting. Water-pockets shall be avoided.

Eccentric Connections.

403. Eccentric connections shall be avoided if practicable, but, if they are unavoidable, the members shall be so proportioned that the combined fiber stresses will not exceed the allowed axial stress. Members shall be so arranged that their axes intersect in a point.

Compression Members.

404. Compression members shall be so designed that the metal will be concentrated, so far as practicable, in the webs and flanges, and so that the center of gravity of the section will be near the center line of the member.

The thickness of each web shall be not less than one-thirtieth of the distance between the lines of rivets connecting it to the flanges. The thickness of the cover-plates shall be not less than one-fortieth of the greatest distance between adjacent rivet lines.

Outstanding Legs of Angles.

405. The width of the outstanding legs of angles in compression, except those reinforced by plates, shall not exceed the following:

- (a) For stringer flange angles, ten times the thickness.
- (b) For main members carrying axial stress, twelve times the thickness.
- (c) For bracing and other secondary members, fourteen times the thickness.

Rigid Members.

406. The two end panels of the bottom chords at each end of single-track pin-connected bridges, and the hip verticals and members with similar duties in all bridges, shall be rigid.

Strength of Connections.

407. Connections shall have a strength at least equal to the calculated stresses in the members connected. If all the members have excess area all the connections shall be increased in strength, beyond that required by the calculated stresses, in the ratio:

$$\frac{\text{Capacity of member having least excess area}}{\text{Calculated stress in member having least excess area}}$$

Transverse bracing and sway bracing members shall have connections designed for the calculated stresses therein, but no such connection shall have less than three rivets for a single angle member or four rivets for a double angle member.

Net Section.

408. In proportioning tension members the diameter of the rivet holes shall be taken $\frac{1}{8}$ in. larger than the nominal diameter of the rivet.

The net section of riveted tension members shall be the least area found as follows:

- (a) A right section with the holes in that section only deducted.
- (b) A zigzag section with all holes in the zigzag section deducted and the net diagonal distances taken at $\frac{3}{8}$ of their values; except that the area thus found is not to be used if less than a right section with the holes cut by the zigzag section deducted.

Effective Sections of Angles.

409. If angles in tension are connected so that bending cannot occur in any direction, the effective area shall be taken as the net area of the angle.

If angles in tension are connected on one side of gusset plates, provision shall be made for the resulting bending stresses.

Section at Pin Holes.

410. In pin-connected, riveted, tension members the net section beyond the pin hole, parallel to the axis of the member, shall not be less than the net section of the member. The net transverse section through the pin hole shall be at least one-third larger than the net section of the member. Riveted tension members shall be stitch-riveted where necessary, to make a compact member.

Maximum Length of Rivets.

411. If the grip of rivets carrying calculated stress exceeds four and one-half times the diameter, the number of rivets shall be increased at least 1 per cent for each additional $\frac{1}{16}$ in. of grip. If the grip exceeds six times the diameter of the rivet, specially designed rivets shall be used.

Spacing of Rivets.

412. Rivets shall be proportioned by their nominal diameter. They shall be spaced not less than three diameters apart, center to center.

In the direction of stress they shall be spaced not farther apart than sixteen times the thickness of the thinnest plate connected; and at right angles to the direction of stress, not farther apart than thirty times that thickness, except in the cover plates of compression members, where the spacing may be forty times the thickness of the thinnest plate.

When two or more plates are in contact and riveted for compactness, the stitch rivets shall not be farther apart in any direction than twenty-four times the thickness of the thinnest outside plate connected. At the ends of built compression members the pitch of rivets in the direction of stress shall not exceed four times the diameter for a distance one and one-half times the width of the member.

At the edge of a gusset plate the rivets connecting a tension member to the gusset plate shall not be spaced further apart, in a row at right angles to the line of stress, than ten times the nominal diameter of the rivet.

Edge Distance of Rivets.

413. The distance from the center of a rivet to a sheared edge shall not be less than one and three-quarter times the diameter, nor to a rolled or planed edge less than one and one-half times the diameter, except in flanges of beams and channels, where the minimum distance may be one and one-quarter times the diameter.

The distance from the edge of a plate shall not exceed eight times the thickness of the plate.

Size of Rivets in Angles.

414. The diameter of the rivets in angles whose size is determined by calculated stress shall not exceed one-fourth of the width of the leg in which they are driven. In angles whose size is not so determined, 1-in. rivets may be used in $3\frac{1}{2}$ -in. legs, $\frac{7}{8}$ -in. rivets in 3-in. legs, and $\frac{3}{4}$ -in. rivets in $2\frac{1}{2}$ -in. legs.

Compression Splices.

415. Members subject to compression only, if faced for bearing, shall be spliced on four sides sufficiently to hold the abutting parts true to place and to transmit at least 25 per cent of the stress through the splice material. The splice shall be as near the panel point as practicable. Members not faced for bearing shall be fully spliced.

Extra Rivets Through Fillers.

416. If splice plates are not in direct contact with the parts which they connect, rivets shall be used on each side of the joint in excess of the number required for direct contact to the extent of two extra lines for each intervening plate.

If rivets carrying stress pass through fillers, the fillers shall be extended beyond the connected member and the extension secured by enough additional rivets to carry one-half the stress passing through the fillers.

Stay Plates.

417. In compression members the open sides shall be provided with lattice bars and shall have stay plates as near each end as practicable. Stay plates shall be provided at intermediate points where the latticing is interrupted. In main members the length of the end stay plates shall be not less than one and one-quarter times the distance between the lines of rivets connecting them to the outer flanges, and the length of intermediate stay plates shall be not less than three-quarters of that distance. Their thickness shall be not less than one-fiftieth of the same distance.

In tension members composed of shapes the separate segments shall be connected by stay plates, or by stay plates and lattice bars. Stay plates for tension members shall have a length not less than two-thirds of the lengths specified for compression members, and shall be spaced not more than 5 ft. center to center. There shall not be less than three rivets connecting the stay plate to each segment.

Latticing.

418. Lattice bars of compression members shall be so spaced that the l/r of the portion of the flange included between the lattice-bar connections will not be greater than two-thirds of the l/r of the member, and in no case more than 50.

419. The latticing of compression members shall be proportioned to resist a shearing stress normal to the member, not less than that given by the following formulas:

$$V = \frac{P}{100} \left(\frac{1}{50} \frac{L}{r} + \frac{24}{L/r} \right) \quad (1)$$

$$V = \frac{P}{100} \left(\frac{1}{100} \frac{L}{r} + \frac{48}{L/r} \right) \quad (2)$$

in which V = normal shearing stress, in pounds;

P = capacity of the member, in pounds;

L = the length of the member, in inches;

r = the radius of gyration of the member about an axis perpendicular to the plane of the latticing.

Formula (1) shall be used for values of L/r greater than 49, and formula (2) for smaller values of L/r .

420. In compression members with cover plates, the cover plates shall be assumed to take one-half the shear.

421. The diameter of the rivet shall not exceed one-third of the width of the lattice bar. Lattice bars connecting to flanges more than 5 in. wide shall have at least two rivets in each end.

422. The angle between the lattice bars and the axis of the member shall be not less than 45° for double latticing, and 60° for single latticing.

The thickness of lattice bars shall be such that the requirements of Art. 305 are met, taking the length as the distance between rivets connecting them to the member.

Double latticing shall be riveted at intersections.

Reinforcing Plates at Pin Holes.

423. Where necessary to give the required section or bearing area, the section at pin holes shall be reinforced on each segment by plates. One plate on each side shall be as wide as the outstanding flanges will permit. These plates shall contain

enough rivets, and be so connected, to transmit and distribute the bearing pressure uniformly over the full cross-section and to reduce the eccentricity of the segment to a minimum. At least one full-width plate on each segment shall extend to the far edge of the stay plate and the others not less than 6 in. beyond the near edge.

Forked Ends.

424. Forked ends of compression members shall be avoided if practicable. Where forked ends are used, enough pin plates shall be provided to give each jaw the full strength of the compression member. At least one of these plates shall extend to the farthest edge of the stay plates, and the others not less than 6 in. beyond the near edge of the farther stay plate.

Floorbeam Connections.

425. Floorbeams preferably shall be square to the girders or trusses, and shall be riveted directly to the girders or to the posts of the trusses.

End-Connection Angles.

426. Stringers in through spans shall be riveted between the floor beams. The connection angles shall be not less than 4 in. wide and $\frac{1}{2}$ in. finished thickness. Solid floors shall be connected to the girders or trusses by angles not less than $\frac{1}{2}$ in. finished thickness.

Plate Girders.

427. Design.

Plate girders shall be proportioned by the moment of inertia of their net sections, including the compression sides; or by assuming that the flanges are concentrated at their centers of gravity, but not beyond the backs of the flange angles. In the latter case, one-eighth of the gross section of the web, if properly spliced, may be considered as flange section. For girders having unusual forms of section, the moment of inertia method shall be used.

The gross section of the compression flange of a plate girder or a rolled beam shall not be less than the gross section of the tension flange.

428. Flange Plates.

Flanges of plate girders preferably shall be made without cover plates or side plates unless angles of greater section than 6 by 6 in. by $\frac{7}{8}$ in. would otherwise be required.

Flange plates shall be equal in thickness, or shall diminish in thickness from the flange angles outward. No plate shall have a thickness greater than that of the flange angles.

When flange plates are used, at least one plate on each flange shall extend the full length of the girder, and on through bridges, an end and corner cover plate shall be used. Any additional flange plates shall be of such length as to allow two rows of rivets of the regular pitch to be placed at each end of the plate, beyond the theoretical point required, and there shall be a sufficient number of rivets at the ends of each plate to transmit its stress before the theoretical point of the next outside plate is reached.

429. Flange Splices.

Flange members that are spliced shall be covered by extra material equal in section to the member spliced. There shall be enough rivets on each side of the splice to transmit the stress of the parts cut.

Flange angles shall be spliced with angles.

No two members shall be spliced at the same flange cross-section.

430. Web Plates and Web Plate Splices.

The thickness of web plates shall not be less than $1/170$ of the clear distance between flange angles or side plates.

Splices in the webs of plate girders shall be designed for both shear and bending.

431. Flange Rivets.

The flanges of plate girders shall be connected to the web with enough rivets to transfer to the flange section the horizontal shear at any point, combined with any load that is applied directly on the flange. Where ties rest on the flange, one wheel load shall be assumed to be distributed over three ties.

432. Stiffeners.

Stiffener angles shall be placed at end bearings and at points of concentrated load. Such stiffeners shall not be crimped. The outstanding legs shall be proportioned for bearing and shall extend out as nearly as practicable to the edge of the flange angles.

433. Intermediate Stiffeners.

Webs of plate girders shall be stiffened by pairs of angles approximately at distances given by the formula,

$$d = 100t\sqrt{\frac{18,000}{s} - 1}$$

in which d = the clear distance, in inches, between the stiffeners;

t = the thickness, in inches, of the web;

s = the intensity of shearing stress on the gross vertical section, in pounds per square inch, obtained by dividing the sum of the live load shear, impact shear, and the dead load shear, by the gross area of the web,

but the distance shall not exceed (a) 6 ft., or (b) the depth between the flanges.

If the depth between the flanges is less than sixty times the thickness of the web, intermediate stiffeners may be omitted.

The thickness of intermediate stiffeners shall be not less than one-sixteenth of the width of the outstanding legs. The outstanding leg shall reach as near to the edge of the flange angle as practicable. The widths shall not be less than 2 in. plus one-thirtieth of the depth of the web between flanges.

434. Brackets.

The top flanges of through plate girders shall be rigidly braced laterally, at panel points of the bridge, by brackets with web plates. The brackets shall extend to the top of the main girders and shall be as large as the clearance will allow. They shall be attached rigidly to the web plate of the girder and to the top flange of the floor-beam. In solid floors these braces shall be not more than 12 ft. apart.

Lateral Bracing.

435. Bottom lateral bracing shall be provided in all spans except deck plate girder spans less than 50 ft. long. Continuous steel or concrete floors shall be considered as lateral bracing.

Top lateral bracing shall be provided in deck spans, and in through spans having sufficient headroom.

Portal and Sway-Bracing.

436. Through truss spans shall have portal bracing, with knee-braces, as deep as the specified clearance will allow.

Through truss spans shall have sway-bracing at every intermediate panel point if the height of the trusses is enough to allow a depth of 6 ft. or more for the bracing. When the height of the trusses will not allow that depth, the top lateral struts shall be of the same depth as the chord, and shall have knee-braces as large as the clearance will allow.

Deck truss spans shall have sway-bracing at every panel point. The top lateral loads shall be carried to the supports by means of a complete top lateral system in the planes of the top chords and the end posts.

Rigid Bracing.

437. Lateral bracing shall be rigid, with not less than three rivets in each end connection.

When a double system of bracing is used, both systems may be considered effective simultaneously, if the members meet the requirements as both tension and compression members.

Cross Frames.

438. In deck plate girder spans there shall be cross frames at both ends proportioned to resist centrifugal and lateral forces, and intermediate cross frames at intervals not exceeding 18 ft.

Viaduct Towers.

439. Viaduct bents preferably shall be composed of two supporting columns, and towers shall be formed by uniting these bents in pairs.

The towers shall be braced both transversely and longitudinally with a double system of rigid diagonals, and shall have longitudinal and transverse struts at caps and bases and at all intermediate panel points.

In double-track towers, the bracing shall be designed to transmit the longitudinal force to both sides.

Where long spans are supported on short single bents, such bents shall have hinged ends, or else the columns and anchorage shall be proportioned for the bending stresses produced by temperature changes.

The bottom struts of viaduct towers shall be proportioned for the calculated stresses, or for stresses in tension or compression not less than one-fourth the dead load reaction on one pedestal. The column bearings shall be designed to permit expansion and contraction of the tower bracing.

The columns preferably shall have a batter transversely of 1 horizontal to 6 vertical for single-track viaducts, and 1 horizontal to 8 vertical for double-track viaducts.

Eye Bars.

440. The thickness of eye bars shall be not less than 1 in., nor greater than 2 in. The thickness plus $\frac{1}{4}$ in. shall not be less than one-eighth of the width. The section of the head through the center of the pin hole shall exceed that of the body of the bar by at least $37\frac{1}{2}$ per cent. The diameter of the pin shall be not less than three-fourths of the width of the bar.

The form of the head shall be submitted to the Engineer for approval before the bars are made.

Eye Bar Packing.

441. The eye bars of a set shall be symmetrical about the plane of the truss and as nearly parallel as practicable. The inclination of any bar to the plane of the truss

shall not exceed $\frac{1}{16}$ in. to the foot. The bars shall be packed close, held against lateral movement, and so arranged that those in the same panel will not be in contact.

Expansion.

442. Provision shall be made for expansion and contraction of spans at the rate of 1 in. in 100 ft. In spans more than 400 ft. long, provision shall be made for expansion in the floor.

End Bearings.

443. In spans more than 70 ft. long there shall be rollers at one end. Shorter spans shall be arranged to slide on smooth surfaces.

Bearings and ends of spans shall be secured against lateral movement.

Rollers.

444. Expansion rollers shall be not less than 6 in. in diameter. They shall be coupled together with substantial side-bars and geared to the upper and lower plates. The parts shall be so arranged that the rollers can be cleaned readily.

Pedestals and Shoes.

445. Pedestals and shoes preferably shall be made of cast steel. The difference in width between the top and bottom bearing surfaces shall not exceed twice the distance between them. For hinged bearings, the distance shall be measured from the center of the pin. In built pedestals and shoes, the web plates and the angles connecting them to the base plate shall be not less than $\frac{3}{4}$ in. thick. If the size of the pedestal permits, the webs shall be rigidly connected transversely. The minimum thickness of the metal in cast-steel pedestals shall be 1 in. Pedestals and shoes shall be so constructed that the load will be distributed uniformly over the entire bearing surface. Spans more than 70 ft. long shall have hinged bearings at both ends.

Inclined Bearings.

446. For spans on an inclined grade and without hinged bearings, the sole or masonry plates shall be beveled so that the masonry surfaces will be level.

Anchorage for Towers.

447. Anchor bolts for viaduct towers and similar structures shall be designed to engage a mass of masonry the weight of which is at least one and one-half times the uplift.

Anchor bolts for trusses and girders shall not be less than $1\frac{1}{4}$ in. in diameter and extend into the masonry not less than 12 in.

Camber.

448. The length of truss members shall be such that the camber will be equal to the deflection produced by the dead load plus full train load without impact; ordinarily this will be effected by increasing the length of the top chord $1/8$ in. for each 10 ft.

SECTION 5.—WORKMANSHIP

General.

501. The workmanship and finish shall be equal to the best general practice in modern bridge shops. Material at the shops shall be kept clean and protected from the weather as far as practicable.

Straightening.

502. Material shall be straight before being laid off or worked. Straightening shall be done by methods that are not injurious. Sharp kinks or bends shall be cause for rejection.

Shearing.

503. Shearing, chipping, and flame cutting shall be done neatly and accurately. If carrying calculated stress, structural steel exceeding 3/4 in. in thickness, and alloy steel exceeding 1/2 in. in thickness, shall have 1/4 in. of metal planed from the sheared or burned edges. Re-entrant angles shall be filleted before cutting.

Punching and Reaming.

504. Material, forming parts of a member composed of not more than five thicknesses of metal, may be punched 1/16 in. larger than the nominal diameter of the rivets, whenever the thickness (of the metal) is not greater than 3/4 in. for structural steel, or 1/2 in. for alloy steel. When there are more than five thicknesses, or when any of the main material is thicker than 3/4 in. in structural steel, or 1/2 in. in alloy steel, all the holes shall be punched 3/16 in. smaller, and after assembling, reamed 1/16 in. larger, than the nominal diameter of the rivets; except that when the metal is thicker than the diameter of the rivet minus 1/8 in., the holes shall be drilled.

505. The diameter of the die shall not exceed the diameter of the punch by more than 3/32 in. If any holes must be enlarged to admit the rivets, they shall be reamed. Holes must be clean cut, without torn or ragged edges. Poor matching of holes may be cause for rejection.

Reaming after Assembling.

506. Reaming shall be done after the pieces forming a built member are assembled and so firmly bolted together that the surfaces are in close contact. Burrs on the outside surface shall be removed. The pieces shall be taken apart before riveting, if necessary, and any shavings removed. When it is necessary to take the members apart for shipping or handling, the pieces reamed together shall be so marked that they may be re-assembled in the same position in the final setting up. No interchange of reamed parts will be permitted.

Reamed Holes.

507. Reamed holes shall be cylindrical, perpendicular to the member, and not more than 1/16 in. larger than the nominal diameter of the rivets. Reamers preferably shall be directed by mechanical means. Outside burrs shall be removed.

Drilled Holes.

508. Drilled holes shall be 1/16 in. larger than the nominal diameter of the rivet. Burrs on the outside surfaces shall be removed. Drilling shall be accurately done. Poor matching of holes may be cause for rejection.

Reaming and Drilling.

509. Reaming and drilling shall be done with twist drills.

Shop Assembling.

510. The parts of riveted members shall be well pinned and firmly drawn together with bolts before riveting is commenced. The drifting done during assembling shall

be only such as to bring the parts into position and not sufficient to enlarge the holes or distort the metal.

Field Connections.

511. Solid floor sections shall be assembled to the girders or trusses, or to suitable frames, in the shop, and the end connections made to fit.

512. Riveted trusses shall be assembled in the shop to line and fit and the holes for field connections drilled or reamed while so assembled; or these connections may be reamed to proper metal templates so placed as to result in fair holes for the connections. Holes for other field connections, except those in lateral, longitudinal, and sway-bracing, shall be reamed or drilled to a metal template.

Match-Marking.

513. Connecting parts assembled in the shop for the purpose of reaming or drilling holes in field connections shall be match-marked, and a diagram showing such marks shall be furnished the Engineer.

Rivets.

514. The size of rivets called for on the plans shall be the size before heating.

515. Rivet heads shall be of approved shape and of uniform size for the same diameter of rivet. They shall be full, neatly made, concentric with the rivet holes, and in full contact with the surface of the member.

Riveting.

516. Rivets shall be heated uniformly to a light cherry red and driven while hot. They shall be free from slag, scale, and carbon deposit. When driven, they shall completely fill the holes. Loose, burned, or otherwise defective rivets shall be replaced. In removing rivets, care shall be taken not to injure the adjacent metal and, if necessary, they shall be drilled out. Caulking or re-cupping shall not be done.

517. Rivets shall be driven by direct-acting riveters where practicable. The pressure shall be continued after the upsetting has been completed.

518. When rivets are driven with a pneumatic riveting hammer, a pneumatic bucket shall be used for holding up, when practicable.

Field Rivets.

519. Field rivets shall be furnished in excess of the nominal number required to the amount of 15 per cent, plus ten rivets for each size and length.

520. Field rivets shall be free from fins on the under side of the head.

Turned Bolts.

521. Where turned bolts are used to transmit shear, the holes shall be reamed parallel and the bolts shall make a tight fit with the threads entirely outside the holes. A washer not less than 1/4 in. thick shall be used under each nut.

Lacing-Bars.

522. The ends of lacing-bars with single rivets shall be neatly rounded, unless otherwise specified.

Fit of Stiffeners.

523. Stiffeners under the top flanges of deck girders and at all bearing points shall be milled or ground to bear against the flange angles. Other stiffeners must fit

sufficiently tight against the flange angles to exclude water after being painted. Fillers and splice plates shall fit within 1/4 in. at each end.

Web Plates.

524. Web plates of girders which have no cover plates may be 1/8 in. above or below the backs of the top flange angles. Web plates of girders which have cover plates may be 1/2 in. less in width than the distance back to back of flange angles.

525. If web plates are spliced, there shall be not more than 3/8-in. clearance between ends of plates.

Facing Floorbeams, Stringers, and Girders.

526. Floorbeams, stringers, and girders having end connection angles shall be made of exact length. If facing is necessary, the thickness of the end connection angles shall not be reduced more than 1/8 in. at any point.

Finished Members.

527. Finished members shall be true to line and free from twists, bends, and open joints.

Abutting Joints.

528. Joints in compression members and girder flanges, and where so specified on the drawings, in tension members, shall have the abutting surfaces faced and brought to an even bearing. Where joints are not faced, the opening shall not exceed 1/4 in.

Eye Bars.

529. Eye bars shall be straight, true to size, and free from twists, folds in the neck or head, and other defects. The heads shall be made by upsetting, rolling, or forging, and not by welding. The form of the head will be determined by the dies in use at the works where the eye bars are made, if they are satisfactory to the Engineer. The thickness of the head and neck shall not overrun more than 1/16 in.

530. Eye bars that are to be placed side by side in the structure shall be bored so accurately that upon being placed together, pins 1/32 in. less in diameter than the pin holes will pass through the holes at both ends at the same time without driving.

Annealing.

531. Before boring, all eye bars shall be annealed or heat-treated to produce the required physical qualities, and shall be straightened.

532. Other steel which has been partially heated shall be annealed unless it is to be used in minor parts.

Boring Pin Holes.

533. Pin holes shall be bored true to gage, smooth, straight, at right angles with the axis of the member, and parallel with each other, unless otherwise required. The variation from the specified distance from outside to outside of pin holes in tension members, or from inside to inside of pin holes in compression members, shall not exceed 1/32 in. In built-up members the boring shall be done after the member is riveted.

534. The diameter of the pin hole shall not exceed that of the pin by more than 1/50 in. for pins 8 in. or less in diameter, nor 1/32 in. for larger pins.

Pin and Rollers.

535. Pins more than 7 in. in diameter shall be forged and annealed. Pins and rollers shall be turned accurately to gage.

They shall be straight, smooth, and free from flaws.

For pins 9 in. or more in diameter there shall be a 2-in. hole bored longitudinally through the center.

Upset Ends.

536. Bars with screw ends shall be upset so that the section at the root of the thread will be at least 15 per cent greater than in the body of the bar.

Screw-Threads.

537. Screw-threads shall fit the nut-threads. They shall be U. S. Standard, except that for pin ends of diameters greater than $1\frac{3}{8}$ in., they shall be made with six threads to an inch.

Bearing Surfaces Planed.

538. The top and bottom surfaces of base plates and cap plates of columns and pedestals, except surfaces to be in contact with masonry, shall be planed or else hot-straightened. The parts of members in contact with them shall be faced to fit. Connection angles for base plates and cap plates shall be riveted to compression members before the members are faced.

539. Sole plates of plate girders shall have full contact with the girder flanges. Sole plates and masonry plates shall be planed or else hot-straightened. Cast pedestals shall be planed on the surface in contact with steel. The bottom surfaces to rest on masonry shall be rough-finished.

Pilot Nuts.

540. Two pilot nuts and two driving nuts for each size of pin shall be furnished, unless otherwise specified.

Shop Painting.

541. Unless otherwise specified, steel work shall be thoroughly cleaned and given one coat of approved paint, after it has been accepted by the Inspector and before leaving the shop. The paint shall be applied in a workmanlike manner, and well worked into joints and open spaces. Cleaning shall be done with steel brushes, hammers, scrapers, and chisels, or by other equally effective means. Oil, paraffin, and grease shall be removed by the use of benzine or gasoline. Loose dirt shall be brushed off with a dry bristle brush. Surfaces not in contact but inaccessible after assembling shall be painted.

Machined Surfaces.

542. Machined-finished surfaces of steel, except abutting joints and base plates, shall be coated with white lead and tallow applied hot as soon as the surfaces have been finished and accepted by the Inspector.

Facilities for Inspection.

543. The Contractor shall afford the Inspector, without charge, facilities for inspection of materials and workmanship in the shop. The Inspector shall be allowed free access to the necessary parts of the works.

Material Orders and Shipping Statements.

544. The Contractor shall furnish to the Engineer as many copies of material orders and shipping statements as the Engineer may direct. The weights of the individual members shall be shown on the statements.

Notice of Beginning Work.

545. The Contractor shall give ample notice to the Engineer of the beginning of rolling in the mill, and of work in the shop, so that inspection may be provided. No material shall be rolled, nor work done in shop, before the Engineer has been so notified.

Inspector's Authority.

546. The Inspector shall have authority to reject materials or workmanship which do not meet the requirements of these specifications. In case of dispute, the Contractor may appeal to the Engineer, whose decision shall be final.

Rejection.

547. The acceptance of any material or finished members by the Inspector shall not be a bar to their subsequent rejection, if found defective.

Rejected material and workmanship shall be replaced promptly or made good by the Contractor.

SECTION 6.—FULL-SIZE TESTS OF EYE BARS**Eye Bars.**

601. The acceptance of the eye bars shall depend upon the results of full-size tests.

Number of Full-Size Tests.

602. The number and size of the bars to be tested shall be stipulated by the Engineer before the mill order has been placed. The number shall not exceed 5 per cent of the whole number of bars ordered, with a minimum of two bars on small orders.

Selection of Test Bars.

603. The test bars shall be of the same section as the bars to be used in the structure and of the same length, if within the capacity of the testing machine. They shall be selected by the Inspector from the finished bars. Test bars representing bars too long for the testing machine shall be selected from the full-length bar material after the heads on one end have been formed. Then they shall be cut and the second head formed, making a bar of the greatest length that can be tested.

604. The minimum requirements for full-size eye-bar tests shall be as follows:

| | |
|--|--------|
| Yield point, in pounds per square inch | 35,000 |
| Ultimate strength, in pounds per square inch | 65,000 |
| Elongation in 18 ft., percentage | 12 |

The elongation shall be measured in the body of the bar, including the fracture. The fracture shall show a silky or finely granular structure throughout.

Retests.

605. If a bar fails to meet the requirements of Art. 604 two additional bars of the same size and from the same mill heat shall be tested. The bars represented by the test may be re-annealed before the additional bars are tested. If two of the three bars tested fail, the bars of that test and mill heat shall be rejected.

606. A record of the annealing charges showing the bars in each charge and details of the treatment as to temperature and time, shall be furnished to the Engineer.

Payment for Test Bars.

607. Bars tested full-size shall be paid for by the Company at the same rate as the bars accepted, if they meet the requirements of the specifications. Bars which fail to meet these requirements, and bars rejected as a result of tests, shall not be paid for by the Company.

SECTION 7.—WEIGHING AND SHIPPING**Pay Weight.**

701. The payment in pound-price contracts shall be based on the scale weight of the metal in the fabricated structure, including field rivets shipped. The weight of the field paint and cement, if furnished, boxes and barrels used for packing, and material used for staying or supporting members on cars, shall not be included.

Any weight in excess of $1\frac{1}{2}$ per cent more than the computed weight shall not be included.

Variance in Weight.

702. If the scale weight of any member is less than $97\frac{1}{2}$ per cent of the computed weight, it shall be cause for rejection.

Weight of Steel and Iron.

703. The weight of steel shall be assumed as 0.2833 lb. per cu. in. The weight of cast iron shall be assumed as 0.2604 lb. per cu. in.

Computed Weight.

704. The weights of rolled shapes, and of plates up to and including 36 in. in width, shall be computed on the basis of their nominal weights and dimensions, as shown on the approved shop drawings, deducting for copes, cuts, and open holes. For plates more than 36 in. in width, there shall be added to the nominal weight one-half the allowed percentage of over-run in weight given in the American Society for Testing Materials Specifications for Steel for Bridges, Serial Designation: A7.

The weight of the heads of shop-driven rivets shall be included in the computed weight.

The weights of castings shall be computed from the dimensions shown on the approved shop drawings, with 10 per cent added for fillets and over-run.

Weighing.

705. The finished work shall be weighed in the presence of the Inspector, if practicable. The Contractor shall furnish satisfactory scales and do the handling of the material for weighing.

Marking and Shipping.

706. The weight shall be marked on members weighing more than 5 tons. Bolts and rivets of one length and diameter, and loose rivets and washers of each size, shall be packed separately. Pins, other small parts, and small packages of bolts, rivets, washers, and nuts, shall be shipped in boxes, crates, kegs, or barrels, but the gross weight of any package shall not exceed 300 lb. On the outside of each package shall be marked plainly a list and description of the material contained therein.

Loading Long Girders.

707. Long girders shall be so loaded and marked that they will arrive at the bridge site in position for erection without turning.

Shipment of Anchorage Material.

708. Anchor bolts, washers, and other anchorage or grillage materials shall be shipped in time to be built into the masonry.

TABLE A-1

WORKING STRESSES FOR COMPRESSION MEMBERS. $s = \frac{18\,000}{1 + \frac{1}{16\,000} \frac{L^2}{r^2}}$

| <i>L/r</i> | <i>s</i> | <i>L/r</i> | <i>s</i> | <i>L/r</i> | <i>s</i> |
|------------|----------|------------|----------|------------|----------|
| 56 | 15 050 | 95 | 11 510 | 133 | 8 550 |
| 57 | 14 960 | 96 | 11 420 | 134 | 8 480 |
| 58 | 14 870 | 97 | 11 330 | 135 | 8 410 |
| 59 | 14 870 | 98 | 11 250 | 136 | 8 350 |
| 60 | 14 690 | 99 | 11 160 | 137 | 8 280 |
| 61 | 14 600 | 100 | 11 080 | 138 | 8 220 |
| 62 | 14 510 | 101 | 10 990 | 139 | 8 150 |
| 63 | 14 490 | 102 | 10 910 | 140 | 8 090 |
| 64 | 14 330 | 103 | 10 820 | 142 | 7 960 |
| 65 | 14 240 | 104 | 10 740 | 144 | 7 840 |
| 66 | 14 150 | 105 | 10 660 | 146 | 7 720 |
| 67 | 14 060 | 106 | 10 570 | 148 | 7 600 |
| 68 | 13 960 | 107 | 10 490 | 150 | 7 480 |
| 69 | 13 870 | 108 | 10 410 | 152 | 7 360 |
| 70 | 13 780 | 109 | 10 330 | 154 | 7 250 |
| 71 | 13 690 | 110 | 10 250 | 156 | 7 140 |
| 72 | 13 600 | 111 | 10 170 | 158 | 7 030 |
| 73 | 13 500 | 112 | 10 090 | 160 | 6 920 |
| 74 | 13 410 | 113 | 10 010 | 162 | 6 820 |
| 75 | 13 320 | 114 | 9 930 | 164 | 6 710 |
| 76 | 13 230 | 115 | 9 850 | 166 | 6 610 |
| 77 | 13 130 | 116 | 9 780 | 168 | 6 510 |
| 78 | 13 040 | 117 | 9 700 | 170 | 6 410 |
| 79 | 12 950 | 118 | 9 620 | 172 | 6 320 |
| 80 | 12 860 | 119 | 9 550 | 174 | 6 220 |
| 81 | 12 770 | 120 | 9 470 | 176 | 6 130 |
| 82 | 12 670 | 121 | 9 400 | 178 | 6 040 |
| 83 | 12 580 | 122 | 9 330 | 180 | 5 950 |
| 84 | 12 490 | 123 | 9 250 | 182 | 5 860 |
| 85 | 12 400 | 124 | 9 180 | 184 | 5 780 |
| 86 | 12 310 | 125 | 9 110 | 186 | 5 690 |
| 87 | 12 220 | 126 | 9 040 | 188 | 5 610 |
| 88 | 12 130 | 127 | 8 960 | 190 | 5 530 |
| 89 | 12 040 | 128 | 8 890 | 192 | 5 450 |
| 90 | 11 950 | 129 | 8 820 | 194 | 5 370 |
| 91 | 11 860 | 130 | 8 750 | 196 | 5 290 |
| 92 | 11 770 | 131 | 8 680 | 198 | 5 220 |
| 93 | 11 680 | 132 | 8 620 | 200 | 5 140 |
| 94 | 11 600 | | | | |

TABLE A-2

$$\text{VALUES OF IMPACT FACTOR, } I = \frac{400 - \frac{l}{2}}{400 + l}$$

| <i>l</i> | <i>I</i> | <i>l</i> | <i>I</i> | <i>l</i> | <i>I</i> | <i>l</i> | <i>I</i> |
|----------|----------|----------|----------|----------|----------|----------|----------|
| 1 | 0.996 | 39 | 0.867 | 110 | 0.676 | 295 | 0.363 |
| 2 | .993 | 40 | .864 | 115 | .665 | 300 | .357 |
| 3 | .989 | 41 | .861 | 120 | .654 | 310 | .345 |
| 4 | .985 | 42 | .857 | 125 | .643 | 320 | .333 |
| 5 | .981 | 43 | .854 | 130 | .632 | 330 | .322 |
| 6 | .978 | 44 | .851 | 135 | .621 | 340 | .311 |
| 7 | .974 | 45 | .848 | 140 | .611 | 350 | .300 |
| 8 | .971 | 46 | .845 | 145 | .601 | 360 | .289 |
| 9 | .967 | 47 | .842 | 150 | .591 | 370 | .279 |
| 10 | .963 | 48 | .839 | 155 | .581 | 380 | .269 |
| 11 | .960 | 49 | .836 | 160 | .571 | 390 | .259 |
| 12 | .956 | 50 | .833 | 165 | .562 | 400 | .250 |
| 13 | .953 | 52 | .827 | 170 | .553 | 410 | .241 |
| 14 | .949 | 54 | .822 | 175 | .543 | 420 | .231 |
| 15 | .946 | 56 | .816 | 180 | .534 | 430 | .223 |
| 16 | .942 | 58 | .810 | 185 | .526 | 440 | .214 |
| 17 | .939 | 60 | .804 | 190 | .517 | 450 | .206 |
| 18 | .935 | 62 | .799 | 195 | .508 | 460 | .198 |
| 19 | .932 | 64 | .793 | 200 | .500 | 470 | .190 |
| 20 | .929 | 66 | .788 | 205 | .492 | 480 | .182 |
| 21 | .925 | 68 | .782 | 210 | .484 | 490 | .174 |
| 22 | .922 | 70 | .777 | 215 | .476 | 500 | .167 |
| 23 | .918 | 72 | .771 | 220 | .468 | 520 | .152 |
| 24 | .915 | 74 | .766 | 225 | .460 | 540 | .138 |
| 25 | .912 | 76 | .761 | 230 | .452 | 560 | .125 |
| 26 | .908 | 78 | .755 | 235 | .445 | 580 | .112 |
| 27 | .905 | 80 | .750 | 240 | .438 | 600 | .100 |
| 28 | .902 | 82 | .745 | 245 | .430 | 620 | .088 |
| 29 | .899 | 84 | .740 | 250 | .423 | 640 | .077 |
| 30 | .895 | 86 | .735 | 255 | .416 | 660 | .066 |
| 31 | .892 | 88 | .730 | 260 | .409 | 680 | .055 |
| 32 | .889 | 90 | .724 | 265 | .402 | 700 | .045 |
| 33 | .886 | 92 | .720 | 270 | .396 | 720 | .036 |
| 34 | .882 | 94 | .717 | 275 | .389 | 740 | .026 |
| 35 | .879 | 96 | .710 | 280 | .382 | 760 | .017 |
| 36 | .876 | 98 | .708 | 285 | .376 | 780 | .008 |
| 37 | .873 | 100 | .700 | 290 | .370 | 800 | .000 |
| 38 | .870 | 105 | .688 | | | | |

APPENDIX B

GENERAL SPECIFICATIONS FOR THE DESIGN OF STEEL HIGHWAY BRIDGES

In order to save space it has seemed best not to reprint a complete set of specifications for the design of highway bridges. Accordingly these specifications have been arranged for use in conjunction with those printed in Appendix A for the design of railway bridges.

In using these specifications for the design of steel highway bridges it is to be understood that in addition to the requirements printed in this appendix, all articles in the specifications in Appendix A beginning with 301 are operative in controlling the design, except those modified by articles printed in this appendix, and those obviously applicable only to railway bridges.

The requirements printed in this appendix are in general taken from the specifications prepared by representatives of the American Association of State Highway Officials and the American Railway Engineering Association, printed in Bulletin 314, Vol. 30, of the latter organization, for February, 1927.

The clearance diagrams have been modified to more nearly represent the author's views, and minor modifications have been made in some other instances.

SECTION 1.—GENERAL FEATURES OF DESIGN

Materials.

Castings shall be steel or malleable castings, or cast iron. Cast iron shall be used only where specifically authorized by the Engineer.

Phosphor-bronze may be used in expansion bearings.

Width of Roadway and Sidewalk.

102. The width of roadway shall be the clear width measured at right angles to the longitudinal center line of the bridge between the tops of curbs or guard timbers. If there are no curbs or guard timbers, it shall be the clear width inside to inside of the handrails or other guards along the sides of the structure.

The width of the sidewalk shall be the clear width, measured at right angles to the longitudinal center line of the bridge, from the extreme inside portion of the handrail to the face of the curb or guard timber, except that if there is a truss, girder, or parapet wall adjacent to the roadway curb, the width shall be measured to its extreme outside portion.

Clearances.

103. The horizontal clearance shall be the clear width, and the vertical clearance the clear height, available for the passage of vehicular traffic, as shown on the clearance diagrams.

Unless otherwise provided the several parts of the structure shall be constructed to secure the following limiting dimensions or clearances for traffic.

The clearances and width of roadway for two-lane traffic shall be not less than those shown in Fig. B-1. The roadway width shall be increased at least 9 ft. for each additional lane of traffic.

Bridges constructed for the combined use of highway and electric railway traffic shall have clearances not less than those shown in Figs. B-2 and B-3. But the clear width between curbs shall never be less than: (a) for two lanes of traffic—the paved width of highway leading up to the bridge plus 4 ft. (b) For three or more lanes of traffic—the paved width of highway leading up to the bridge plus 3 ft.

In cases involving curved tracks, the horizontal clearances shall be increased an amount corresponding to that required to maintain the specified clearances. If the outer rail is super-elevated, the clearances shall be correspondingly increased.

Curbs.

104. The face of the curb shall be not less than 6 in. and preferably not less than 9 in. from that portion of the railing, truss, or girder nearest the roadway. The curb height shall be not less than 9 in. above the adjacent finished roadway surface, when not otherwise determined, or provided by law.

Concrete curbs shall be designed to resist a lateral force of not less than 500 lb. per lin. ft. of curb, applied at the top of the curb.

Railings.

105. Substantial railings along each side of the bridge shall be provided for the protection of traffic. The top of the railing shall not be less than 3 ft. above the finished surface of the roadway adjacent to the curb, or if on a sidewalk, not less than 3 ft. above the side walk floor.

Railings shall be designed to resist a horizontal force of

not less than 150 lb. per lin. ft. applied at the top of the railing, and a vertical force of not less than 100 lb. per lin. ft.

In general, railings shall be of two classes, as follows: (1) Railings for the protection of pedestrians on bridges in cities and villages. (2) Railings for use on country bridges not subject to general pedestrian traffic.

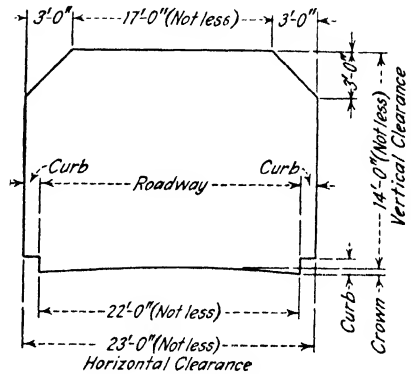

FIG. B-1.

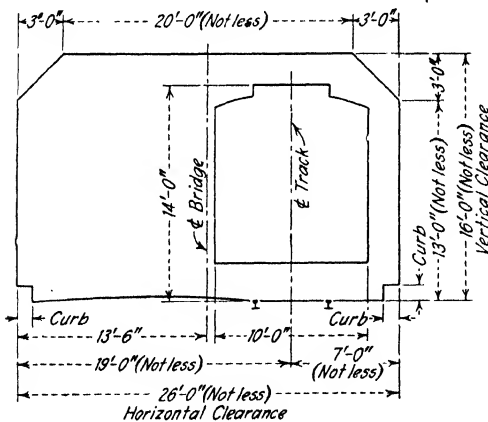

FIG. B-2.

Metal railings of the first class shall consist of an upper and a lower horizontal rail connected by a suitable web. The clear distance between the top of the curb or the sidewalk and the lower rail shall not exceed 6 in. Metal railings of the second class may consist of not less than two lines of horizontal rails of approved section. In each connection of the railing to the posts, truss members, etc., there shall be

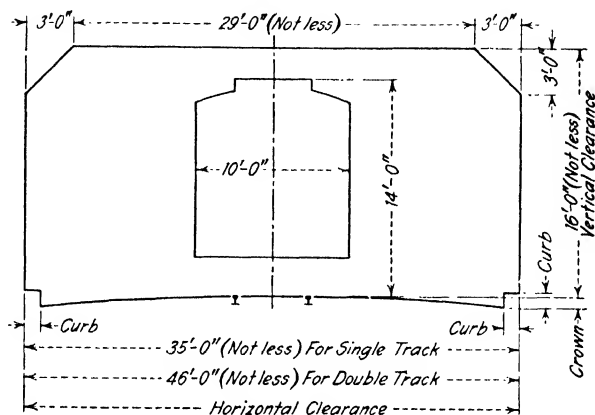

FIG. B-3.

not less than two rivets or bolts. Provision shall be made for movement due to temperature.

Openings in concrete railings of the first class shall be proportioned with due regard to the safety of persons using the structure. Provision shall be made for the expansion and contraction of concrete railings at intervals consistent with the design.

Drainage

106. The transverse drainage of roadways shall be secured by means of a suitable crown in the roadway surface. If necessary, longitudinal drainage shall be secured by means of scuppers, which shall be of sufficient size and number to drain the gutters adequately. If drainage gutters and downspouts are required, the downspouts shall be of cast- or wrought-iron pipe not less than 4 in. in diameter, provided with suitable cleanout fixtures. The details of floor drains shall be such as to prevent the discharge of drainage water against any portion of the structure. Overhanging portions of concrete and timber floors preferably shall be provided with drip beads.

Paved Floors.

107. Pavements other than wood block shall be supported by reinforced-concrete slabs carried on steel or reinforced-concrete floor members. Wood block pavements may be supported by a creosoted plank base.

Blast Protection.

108. On bridges over railroad tracks, metal likely to be injured by locomotive gases shall be protected by concrete. Concrete surfaces less than 20 ft. above the

tracks shall be protected by cast-iron blast plates located over the center line of each track. The plates shall be not less than 3 ft. wide and not less than 3/4 in. thick and so supported that they may be replaced readily. Pockets which will hold locomotive gases shall be avoided if practicable.

Utilities.

109. Where required, provision shall be made for trolley wire supports and poles for lights, and suitable spaces shall be made available for electric conduits, water pipes and gas pipes.

Types of Bridges.

110. The different types of bridges may be used within the following limits, due consideration being given to transportation and erection conditions in selecting the type to be used.

| | |
|--|---------------|
| Rolled beams for spans up to..... | 60 ft. |
| Plate girders for spans..... | 30 to 125 ft. |
| Riveted half-through trusses for spans..... | 45 to 100 ft. |
| Riveted trusses for spans above..... | 100 ft. |
| Pin-connected trusses for exceptionally heavy spans, when specifically authorized by the engineer. | |

Classification of Bridges.

111. The classification of bridges with reference to traffic shall be as follows:

Class AA. Bridges for specially heavy traffic units in locations where the passage of such loads is frequent.

Class A. Bridges for normally heavy traffic units and the occasional passage of specially heavy loads.

Class B. Bridges for light traffic units and the occasional passage of normally heavy loads. Class B bridges should be considered as temporary or semi-temporary structures.

Class C. Bridges for electric railway traffic in addition to highway traffic. The latter may correspond to any one of the classes described above.

SECTION 2.—LOADS

Loads.

201. Structures shall be proportioned for the following loads and forces:

- (a) Dead load.
- (b) Live load.
- (c) Impact or dynamic effect of the live load.
- (d) Lateral forces.
- (e) Other forces, when they exist, as follows: Longitudinal force; centrifugal force; and thermal forces.

Members shall be proportioned for the combination of loads and forces producing the maximum total stress, except as otherwise provided herein.

Upon the stress sheets a diagram of the assumed live loads shall be shown, and the stresses used in design, due to the various loads, shall be shown separately.

Dead Load.

202. The dead load shall consist of the weight of the structure complete, including the roadway, sidewalks, and car tracks, pipes, conduits, cables, and other public utility services.

The snow and ice load is considered to be offset by an accompanying decrease in live load and impact and shall not be included except under special conditions.

In the case of structures having concrete slab floors, an adequate allowance shall be made in the design dead load to provide for the weight of a wearing surface. This allowance will depend upon the type of wearing surface contemplated: it shall be in addition to the weight of any monolithically placed concrete wearing surface, and shall be not less than 15 lb. per sq. ft. of roadway.

The following weights are to be used in computing the dead load:

| | Weight per cubic foot, pounds |
|---|----------------------------------|
| Steel..... | 490 |
| Cast iron..... | 450 |
| Timber (treated or untreated)..... | 60 |
| Concrete: Stone or gravel, plain or reinforced..... | 150 |
| Concrete: Coarse Haydite and sand, plain or reinforced..... | 125 |
| Concrete: All Haydite, plain or reinforced..... | 105 |
| Loose sand and earth..... | 100 |
| Rammed sand or gravel, and ballast..... | 120 |
| Macadam or gravel, rolled..... | 140 |
| Cinder filling..... | 60 |
| Pavement, other than wood block..... | 150 |
| Railway rails and fastenings..... | 150 lb. per lin. ft. of track |

Live Load.

203. The live load shall consist of the weight of the applied moving load of vehicles, cars and pedestrians.

Highway Live Loads.

204. The highway live load on the roadway portion of the bridge shall consist of trains of motor trucks, or equivalent loads, as hereinafter specified. Each loading is designated by the letter H, followed by a numeral indicating the gross weight in tons of the heavier-loaded truck in the train.

Traffic Lanes

205. The truck trains or equivalent loads shall be assumed to occupy traffic lanes, each having a width of 9 ft. corresponding to the standard truck clearance width. Within the curb to curb width of the roadway, the traffic lanes shall be assumed to occupy any position which will produce the maximum stress but which will not involve overlapping of adjacent lanes, nor place the center of the lane nearer than 4 ft. 6 in. to the roadway face of the curb.

Truck.

206. The wheel spacing, weight distribution, and clearance of the trucks used for design purposes shall be as shown in Fig. B-4.

Highway Loading.

207. The highway loading shall be of three classes: namely, H20, H15, and H10, and may be either truck train loadings or equivalent loadings. Loadings H15 and H10 are 75 and 50 per cent, respectively, of loading H20.

(a) **Truck Train Loadings.** The truck train loading shall be as shown in Fig. B-5 and shall be used for loaded lengths of less than 60 ft. It shall consist of one truck of the gross weight indicated by the loading class followed by, or preceded by, or both followed and preceded by, a line of trucks of indefinite length, each of the following or preceding trucks having a gross weight of three-fourths of the gross weight indicated by the loading class.

Trucks in adjacent lanes shall be considered as headed in the same direction.

(b) **Equivalent Loading.** The equivalent loading shall be as shown in Fig. B-6, and shall be used only for loaded lengths of 60 ft. or greater. It shall consist of a uniform load per linear foot of traffic lane combined with a single concentrated load so placed on the span as to produced maximum stress. The concentrated load shall be considered as uniformly distributed across the lane on a line normal to the center line of the lane. For the computation of moments and shears, different concentrated loads shall be used as indicated in Fig. B-6.

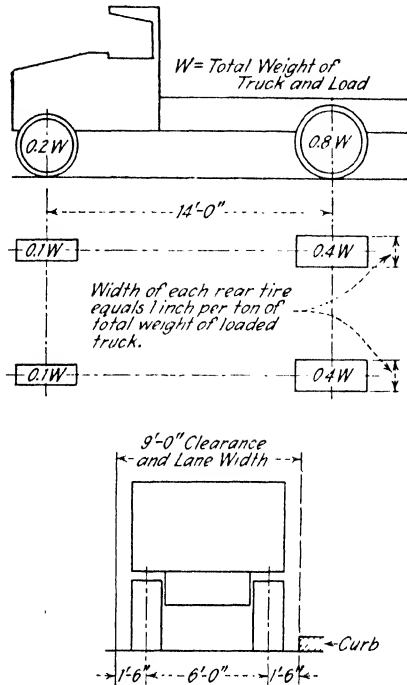

FIG. B-4.

Selection of Loadings.

208. Bridges of the different classes shall be designed for the loadings as follows:

| Class of Bridge | Loading |
|-----------------|---------|
| AA | H20 |
| A | H15 |
| B | H10 |

Application of Loadings.

209. The loadings shall be applied by that one of the following methods which produces the greater maximum stress in the member considered, due allowance being made for the reduced load intensities hereinafter specified for roadways having loaded widths in excess of 18 ft.

(1) Each traffic lane loading shall be considered as a unit, and the number and position of the loaded lanes shall be such as will produce maximum stress.

(2) The roadway shall be considered as loaded over its entire width with a load per foot of width equal to one-ninth of the load of one traffic lane.

Reduction in Load Intensity.

210. If the loaded width of the roadway exceeds 18 ft., the specified loads shall be reduced 1 per cent for each foot of loaded roadway width in excess of 18 ft. with

a maximum reduction of 25 per cent, corresponding to a loaded roadway width of 43 ft. If the loads are lane loads, the loaded width of the roadway shall be the aggregate width of the lanes considered; if the loads are distributed over the entire

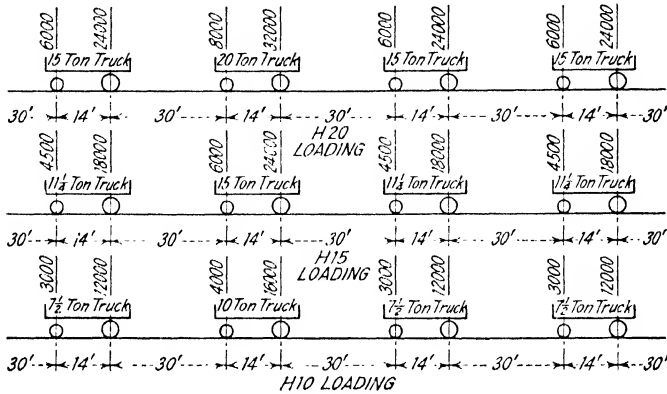

FIG. B-5.

width of the roadway, the loaded width of the roadway shall be the full width of roadway between curbs.

Electric Railway Loading.

211. If highway bridges carry electric railway traffic, the railway loading shall be determined on the basis of the class of traffic which the bridge may be expected to carry. The possibility that the bridge may be required to carry the freight cars of steam railroads shall be given consideration.

When not otherwise specified, the electric railway loading on each track shall be a train of two electric cars followed by, or preceded by, or both followed and preceded by, a uniform load. The cars shall be of one of the classes shown in Fig. B-7. The class is designated by a numeral indicating the total loaded weight of each car. The uniform load per foot of track following or preceding electric cars shall be the uniform load corresponding to the class of highway loading specified (640 lb. per lin. ft. for H20 loading). The electric railway loading shall be assumed to occupy 10 ft. of the roadway width.

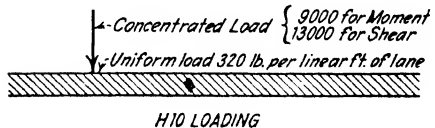
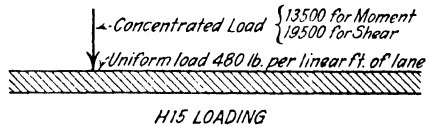
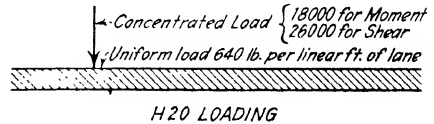

FIG. B-6.

For freight car loading, one of the classes of cars shown in Fig. B-8 may be assumed in the absence of more exact data.

The railway loading used shall be shown on the stress sheets.

212. Highway bridges carrying electric railway traffic shall be designed for the following loading conditions:

(1) The highway loading on any portion of the roadway area including that portion occupied by the railway.

(2) The electric railway loading on the car tracks and the highway loading on the remaining traffic lanes.

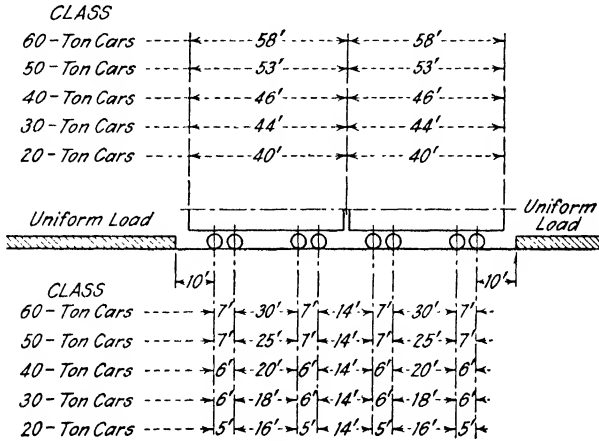

FIG. B-7.

Sidewalk and Foot Bridge Loading.

213. Sidewalk floors, stringers, and their immediate supports shall be designed for a live load of not less than 100 lb. per sq. ft. of sidewalk area.

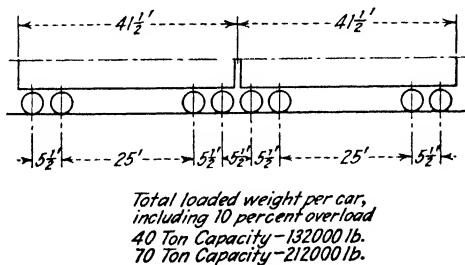

FIG. B-8.

Girders or trusses of bridges with sidewalks shall be designed for a sidewalk live load determined by the following formula:

$$P = \left(40 + \frac{3000}{L} \right) \left(\frac{55 - W}{50} \right)$$

in which P = live load, in pounds per square foot of sidewalk area, but not to exceed 100 lb. per sq. ft.;

L = loaded length of sidewalk, in feet;
 W = width of sidewalk, in feet.

In calculating stresses in structures which support cantilevered sidewalks, the sidewalk shall be considered as fully loaded on only one side of the structure if this condition produces maximum stress.

All parts of foot bridges shall be designed for a live load of not less than 100 lb. per sq. ft.

Impact.

214. Live load stresses, except those due to sidewalk loads and centrifugal, tractive, and wind forces, shall be increased by an allowance for dynamic vibratory, and impact effects.

The amount of this allowance or increment is expressed as a fraction of the live load stress, and for both electric railway and highway loadings shall be determined by the formula:

$$I = \frac{50}{L + 125 \text{ ft.}}$$

in which I = impact fraction;

L = the length, in feet, of the portion of the span which is loaded to produce the maximum stress in the member considered.

Longitudinal Force.

215. Provision shall be made for the effect of a longitudinal force of 10 per cent of the live load on the structure, acting 4 ft. above the floor.

Lateral Forces.

216. (a) The wind force on the structure shall be assumed as a moving horizontal load equal to 30 lb. per sq. ft., on $1\frac{1}{2}$ times the area of the floor system and of deck girders, and on the projected area of all trusses, through girders, and handrails.

(b) The lateral force due to the moving live load and the wind pressure against it shall be considered as acting 6 ft. above the roadway and shall be as follows:

Highway bridges, 200 lb. per lin. ft.

Highway bridges carrying electric railway traffic, 300 lb. per lin. ft.

(c) The total assumed wind force shall be not less than 300 lb. per lin. ft. in the plane of the loaded chord and 150 lb. per lin. ft. in the plane of the unloaded chord on truss spans, and not less than 300 lb. per lin. ft. on girder spans.

(d) In calculating the uplift, due to the foregoing lateral forces, in the posts and anchorages of viaduct towers, highway viaducts shall be considered as loaded on the leeward traffic lane with a uniform load of 400 lb. per lin. ft. of lane, and viaducts carrying electric railway traffic in addition to highway traffic shall be considered as loaded on the leeward track with a uniform load of 800 lb. per lin. ft. of track.

(e) A wind pressure of 50 lb. per sq. ft. on the unloaded structure, applied as specified above in paragraph (a), shall be used if it would produce greater stresses than the combined wind and lateral forces of paragraphs (a) and (b).

Centrifugal Force.

217. If the electric railway track is curved, the structure shall be designed to resist a lateral force equal to 10 per cent of the moving railway loading. This lateral force shall be considered as acting 4 ft. above the top of the rail.

Thermal Forces.

218. Provision shall be made for the stresses (if any) resulting from the following variations in temperature:

Moderate climate, from 0° to 120° F.

Cold climate, from -30° to 120° F.

The rise and fall in temperature shall be figured from an assumed temperature at the time of erection.

DISTRIBUTION OF LOADS**Distribution of Wheel Loads to Stringers and Floorbeams.**

219. *Shear.*—In calculating end shears and end reactions in transverse floorbeams and longitudinal beams and stringers, no lateral or longitudinal distribution of the wheel load shall be assumed.

Bending Moment in Stringers.—In calculating bending moments in longitudinal beams or stringers, no longitudinal distribution of the wheel loads shall be assumed. The lateral distribution shall be determined as follows:

(a) *Interior Stringers.*—Interior stringers shall be proportioned for fractional wheel loads determined in accordance with the following table, except that when the limiting stringer spacings are exceeded, the stringer loads shall be determined by the reactions of the truck wheels, assuming the flooring between stringers to act as a simple beam.

| Kind of floor | Floor designed for one traffic lane | | Floor designed for two or more traffic lanes | |
|---|---|-----------------------------------|--|-----------------------------------|
| | Fraction of a wheel load to each stringer | Limiting stringer spacing in feet | Fraction of a wheel load to each stringer | Limiting stringer spacing in feet |
| Plank | $\frac{S}{4.0}$ | 4.0 | $\frac{S}{3.5}$ | 5.0 |
| Strip 4 in. in thickness or wood block on 4-in. plank sub-floor | $\frac{S}{4.5}$ | 4.5 | $\frac{S}{3.75}$ | 5.5 |
| Strip 6 in. or more in thickness | $\frac{S}{5.0}$ | 5.0 | $\frac{S}{4.0}$ | 6.0 |
| Concrete | $\frac{S}{6.0}$ | 6.0 | $\frac{S}{4.5}$ | 10.0 |

S = spacing of stringers, in feet.

(b) *Outside Stringers.*—The live load supported by outside stringers shall be the reaction of the truck wheels, assuming the flooring to act as a simple beam between stringers.

(c) *Total Capacity of Stringers.*—The combined load capacity of the beams in a panel shall not be less than the total live and dead load in the panel.

Bending Moment in Floorbeams.—In calculating bending moment in floorbeams, no transverse distribution of the wheel loads shall be assumed.

If longitudinal stringers are omitted and the floor is supported directly on the floorbeams, the latter shall be proportioned for a fraction of the wheel loads as indicated in the following table, except that when the limiting floorbeam spacing is exceeded the floorbeam loads shall be determined by the reactions of the truck wheels, assuming the flooring between floorbeams to act as a simple beam.

| Kind of floor | Fraction of wheel loads to each floorbeam | Limiting floorbeam spacing, in feet |
|---|---|-------------------------------------|
| Plank | $\frac{S}{4.0}$ | 4.0 |
| Strip 4 in. in thickness or wood block on 4-in. plank sub-floor | $\frac{S}{4.5}$ | 4.5 |
| Strip 6 in. or more in thickness | $\frac{S}{5.0}$ | 5.0 |
| Concrete | $\frac{S}{6.0}$ | 6.0 |

S = spacing of floorbeams, in feet.

Distribution of Wheel Loads on Concrete Slabs.

220. *Bending Moment.*—In calculating bending stresses due to wheel loads on concrete slabs, no distribution in the direction of the span of the slab shall be assumed. In the direction perpendicular to the span of the slab, the wheel load shall be considered as distributed uniformly over a width of slab which is termed the "effective width" and is obtained from the following formulas, in which

S = span of slab, in feet;

W = width of wheel or tire, in feet;

D = distance, in feet, from the center of the near support to the center of wheel;

E = effective width in feet for *one wheel*.

CASE I. Main Reinforcement Parallel to Direction of Traffic.

$E = 0.7S + W$, in which E shall have a maximum value of 7.0 ft.

When two wheels are so located on a transverse element of the slab that their effective widths overlap, the effective width for each wheel shall be $1/2(E + C)$, in which E is the value determined by the formula above and C is the distance between centers of wheels.

CASE II. Main Reinforcement Perpendicular to Direction of Traffic.

$$E = 0.7 (2D + W).$$

For this case the bending moment on a strip of slab 1 ft. in width shall be determined by placing the wheel loads in the position to produce the maximum bending, assuming no distribution; determining the effective width for each wheel; and assuming the load of each wheel on the 1-ft. strip to be the wheel load divided by its respective effective width.

The design assumption of Case II does not provide for the effect of loads near unsupported edges. Therefore, at the ends of the bridges and at intermediate points where the continuity of the slab is broken, the edges of the slab shall be supported by diaphragms or other suitable means.

Shear.—Slabs designed for bending moment in accordance with the foregoing rules and for the wheel loads contemplated by these specifications may be considered adequate for shear without special reinforcement.

Distribution of Electric Railway Wheel Loads.

221. Electric railway wheel loads shall be assumed to be uniformly distributed longitudinally over a length of 3 ft. In the case of ballasted floors, a lateral distribution of 10 ft. for an axle load shall be assumed.

Reversal of Stress.

222. Members subject to alternate stresses of tension and compression, due to the combination of dead, live, impact, and centrifugal stresses, shall be proportioned for the kind of stress requiring the larger section.

If the alternate stresses occur in succession during the passage of the live load, the larger shall be increased by 50 per cent of the smaller and the connections designed for the resultant stress thus obtained.

Combined Stresses.

223. Members subject to both axial and bending stresses shall be so proportioned that the combined fiber stresses will not exceed the maximum allowable axial stress. In members continuous over panel points, only three-fourths of the bending stress computed as for simple beams shall be added to the maximum axial stress.

224. Members subject to stresses produced by a combination of dead load, live load, impact, and centrifugal force, with either lateral or longitudinal forces, or with bending due to lateral forces, may be proportioned for unit stresses 30 per cent greater than those specified in Art. 301, Appendix A; but the section of the member shall not be less than that required for the combined dead load, live load, impact, and centrifugal force.

Secondary Stresses.

225. Secondary stresses shall be avoided as far as practicable. In trusses without sub-paneling, secondary stresses due to distortions need not be considered in any member the width of which, measured parallel to the plane of flexure, is less than one-tenth of its length. Other secondary stresses shall be considered.

SECTION 3.—UNIT STRESSES

From here on all articles in the specifications for design of railway bridges, given in Appendix A, beginning with 301, are operative except where specifically modified.

Slenderness Ratio.

305. The slenderness ratio (ratio of unsupported length to corresponding radius of gyration) shall not exceed:

- 120 for main compression members
- 140 for riveted tension members subject to live load reversal of stress
- 140 for wind and sway bracing
- 140 for single lacing
- 200 for double lacing
- 200 for riveted tension members not subject to live load reversal of stress

SECTION 4.—DETAILS OF DESIGN**Outstanding Legs of Angles.**

405. The width of outstanding legs of angles in compression, except where reinforced by plates, shall not exceed the following:

- (a) In girder flanges, twelve times the thickness.
- (b) In main members carrying axial stress, twelve times the thickness.
- (c) In bracing and other secondary members, sixteen times the thickness.

Half-Through Truss Spans.

434 (a). The vertical truss members and the floorbeam connections of half-through truss spans shall be proportioned to resist a lateral force, applied at the top chord panel points of the truss, determined by the following equation:

$$R = 150(A + P);$$

R = the lateral force, in pounds;

A = area of cross-section of the chord, in square inches;

P = panel length, in feet.

The necessary resistance may be secured in part by extending one or both of the floorbeam connection angles upward along the inside of the post and by providing a solid web on the post. If outrigger brackets are used they shall be effectively connected to the floorbeam.

APPENDIX C

AMERICAN INSTITUTE OF STEEL CONSTRUCTION

* SPECIFICATION FOR THE DESIGN, FABRICATION, AND ERECTION OF STRUCTURAL STEEL FOR BUILDINGS

AS ADOPTED JUNE 1, 1923, AND REVISED NOVEMBER, 1928, WITH EDITORIAL
REVISION JANUARY, 1934.

FOR BREVITY THIS DOCUMENT IS REFERRED TO IN THIS TEXT AS THE
A.I.S.C. SPECIFICATION

SECTION 1.

This Specification defines the practice adopted by the American Institute of Steel Construction for the design, fabrication, and erection of structural steel for buildings.

SECTION 2. GENERAL.

To obtain a satisfactory structure, the following major requirements must be fulfilled.

- (a) The material used must be suitable, of uniform quality, and without defects affecting the strength or service of the structure.
- (b) Proper loads and conditions must be assumed in the design.
- (c) The unit stresses must be suitable for the material used.
- (d) The workmanship must be good, so that defects or injuries are not produced in the manufacture.
- (e) The computations and design must be properly made so that the unit stresses specified shall not be exceeded, and the structure and its details shall possess the requisite strength and rigidity.

SECTION 3. MATERIAL.

* Structural steel shall conform to the Standard Specifications of the American Society for Testing Materials for Steel for Buildings, Serial Designation A 9 (or, if so specified by the Buyer, for Steel for Bridges, Serial Designation A 7), as amended to date. (Ultimate tensile strength 60000-72000 pounds per square inch.)

SECTION 4. LOADING.

(a) Steel structures shall be designed to sustain the dead weight imposed upon them, including the weight of the steel frame itself, and, in addition, the maximum live load as specified in each particular case. Proper provision shall be made for temporary stresses caused by erection.

* Revised January, 1934.

(b) In cases where live loads have the effect of producing impact or vibration, a proper percentage shall be added to the static live load stresses to provide for such influences, so that the total stress found in any member is an equivalent static stress.

(c) Proper provision shall be made for stresses caused by wind both during erection and after completion of the building. The wind pressure is dependent upon the conditions of exposure, but the allowable stresses specified in Section 5 (f) and (g) are based upon the steel frame being designed to carry a wind pressure of not less than twenty (20) pounds per square foot on the vertical projection of exposed surfaces during erection, and fifteen (15) pounds per square foot on the vertical projection of the finished structure.

(d) Proper provision shall be made to securely fasten the reaction points of all steel construction and transmit the stresses to the foundations of the structure.

SECTION 5. ALLOWABLE STRESSES.

All parts of the structure shall be so proportioned that the sum of the maximum static stresses in pounds per square inch shall not exceed the following:

(a) Tension.

| | |
|--|-------|
| Rolled Steel, on net section | 18000 |
| On the area of the nominal diameter of rivets under the limitations defined in Section 13. | 13500 |

(b) Compression.

Rolled Steel, on short lengths or where lateral deflection is prevented. 18000
 On gross section of columns,

$$\frac{18000}{1 + \frac{l^2}{18000r^2}}$$

with a maximum of 15000
 in which l is the unbraced length of the column, and r is the corresponding least radius of gyration of the section, both in inches.

For main compression members, the ratio l/r shall not exceed 120, and for bracing and other secondary members, 200.

(c) Bending.

On extreme fibers of rolled sections, and built-up sections, net section, if lateral deflection is prevented. 18000

When the unsupported length l exceeds 15 times b , the width of the compression flange, the stress in pounds per square inch in the latter shall not exceed.

$$\frac{20000}{1 + \frac{l^2}{20000b^2}}$$

The laterally unsupported length of beams and girders shall not exceed 40 times b , the width of the compression flange.

On extreme fibers of pins, when the forces are assumed as acting at the center of gravity of the pieces. 27000

***(d) Shearing.**

| | |
|--|-------|
| On pins | 13500 |
| On power-driven rivets | 13500 |
| On turned bolts in reamed holes with a clearance of not more than 1/50 of an inch | 13500 |
| On hand-driven rivets | 10000 |
| On unfinished bolts | 10000 |
| On the gross area of the webs of beams and girders, where h , the clear distance between flanges in inches, is not more than 60 times t , the thickness of the web in inches | 12000 |

On the gross area of the webs of beams and girders if the web is not stiffened where h is more than 60 times t , the greatest average shear per square inch, $\frac{V}{A}$, shall not exceed

$$\frac{18000}{1 + \frac{h^2}{7200t^2}}$$

in which V is the total shear, and A is gross area of web in square inches.

(e) Bearing.

| | Double Shear | Single Shear |
|---|--------------|--------------|
| On pins | 30000 | 24000 |
| On power-driven rivets | 30000 | 24000 |
| On turned bolts in reamed holes | 30000 | 24000 |
| On hand-driven rivets | 20000 | 16000 |
| On unfinished bolts | 20000 | 16000 |
| On expansion rollers per linear inch, 600 times the diameter of the roller in inches. | | |

(f) Combined Stresses.

For combined stresses due to wind and other loads, the permissible working stress may be increased $33\frac{1}{3}$ per cent, provided the section thus found is not less than that required by the dead and live loads alone.

(g) Members Carrying Wind Only.

For members carrying wind stresses only, the permissible working stresses may be increased $33\frac{1}{3}$ per cent.

SECTION 6. SYMMETRICAL MEMBERS.

Sections shall preferably be symmetrical.

SECTION 7. BEAMS AND GIRDERS.

(a) **Rolled beams** shall be proportioned by the moment of inertia of their net section. Plate girders with webs fully spliced for tension and compression shall be so proportioned that the unit stress on the net section does not exceed the stresses specified in Section 5 as determined by the moment of inertia of the net section.

(b) **Plate girder webs** shall have a thickness of not less than 1/160 of the unsupported distance between the flanges.

***(c) Web splices** shall consist of plates on each side of the web capable of transmitting the full stress through the splice connections.

(d) **Stiffeners.** Stiffeners shall be required on the webs of rolled beams and plate girders at the ends, and at points of concentrated loads, and at other points where h , the clear distance between flanges, is greater than $85t\sqrt{18000(A/V)-1}$, in which t is the thickness of the web. When stiffeners are required, the distance in inches between them shall not be greater than $85t\sqrt{18000(A/V)-1}$, or not greater than 6 feet. When h is greater than 60 times t , the thickness of the web of a plate girder, stiffeners shall be required at distances not greater than 6 feet apart. Stiffeners under or over concentrated loads shall be proportioned to distribute such loads into the web.

Plate girder stiffeners shall generally be in pairs, one on each side of the web, and shall have a close bearing against the flange angles at points of concentrated loading; stiffeners over the end bearings shall be on plate fillers. The pitch of rivets in stiffeners shall not exceed 6 inches.

(e) **Flange plates** of all girders shall be limited in width so as not to extend more than 6 inches or more than 12 times the thickness of thinnest plate beyond the outer row of rivets connecting them to the angles.

(f) **Crane runway girders** and the supporting framework shall be proportioned to resist the greatest horizontal stresses caused by the operation of the cranes.

(g) **Rivets** connecting the flanges to the web at points of direct load on the flange between stiffeners shall be proportioned to carry the resultant of the longitudinal and transverse shears.

(h) **Rivets** connecting the flanges to the webs of plate girders and of columns subjected to bending shall be so spaced as to carry the increment of the flange stress between the rivets.

SECTION 8. COLUMN BASES.

(a) Proper provision shall be made to distribute the column loads on the footings and foundations.

*(b) The top surface of all column bases, except rolled steel bearing plates 4 inches or under in thickness, shall be planed for the column bearing.

(c) Column bases shall be set true and level, with full bearing on the masonry, and be properly secured to the footings.

SECTION 9. ECCENTRIC LOADING.

Full provision shall be made for stresses caused by eccentric loads.

SECTION 10. COMBINED STRESSES

(a) Members subject to both direct and bending stresses shall be so proportioned that the greatest combined stresses shall not exceed the allowed limits.

(b) All members and their connections which are subject to stresses of both tension and compression due to the action of live loads shall be designed to sustain stress giving the largest section, with 50 per cent of the smaller stress added to it. If the reversal of stress is due to the action of wind, the member shall be designed for the stress giving the largest section and the connections proportioned for the largest stress.

SECTION 11. ABUTTING JOINTS.

Compression members when faced for bearings shall be spliced sufficiently to hold the connecting members accurately in place. Other joints in riveted work, whether in tension or compression, shall be fully spliced.

SECTION 12. NET SECTIONS.

(a) In calculating tension members, the net section shall be used, and in deducting the rivet holes they shall be taken $\frac{1}{8}$ inch greater in diameter than the nominal diameter of the rivets.

* (b) In pin connected tension members, the net section through the pin hole, transverse to the axis of the member, shall be at least 25 per cent greater than the net section of the member. The net section beyond the pin hole, parallel with the axis of the member, shall be not less than 75 per cent of the net section required through the pin hole.

SECTION 13. RIVETS AND BOLTS.

(a) In proportioning rivets, the nominal diameter of the rivet shall be used.

(b) Rivets carrying calculated stresses, and whose grip exceeds five diameters, shall have their number increased 1 per cent for each additional $\frac{1}{10}$ inch in the rivet grip. Special care shall be used in heating and driving such rivets.

(c) Rivets shall be used for the connections of main members carrying live loads which produce impact, and for connections subject to reversal of stresses.

(d) Finished bolts in reamed holes may be used in shop or field work where it is impracticable to obtain satisfactory power-driven rivets. The finished shank shall be long enough to provide full bearing, and washers used under the nuts to give full grip when turned tight.

Unfinished bolts may be used in shop or field work for connections in small structures used for shelters, and for secondary members of all structures such as purlins, girts, door and window framing, alignment bracing and secondary beams in floor.

(e) The end reaction stresses of trusses, girders, or beams, and the axial stresses of tension or compression members which are carried on rivets, shall have such stresses developed by the shearing and bearing values of the rivets; but where rivets are used for shelf or bracket supports or for connections that also provide rigidity to the structure, the rivets may in addition to their shearing and bearing stresses, carry tension as defined in Section 5 (a).

SECTION 14. RIVET SPACING.

(a) The minimum distance between centers of rivet holes shall be three diameters of the rivet; but the distance shall preferably be not less than $4\frac{1}{2}$ inches for $1\frac{1}{4}$ inch rivets, 4 inches for $1\frac{1}{8}$ inch rivets, $3\frac{1}{2}$ inches for 1 inch rivets, 3 inches for $\frac{7}{8}$ inch rivets, $2\frac{1}{2}$ inches for $\frac{3}{4}$ inch rivets, 2 inches for $\frac{5}{8}$ inch rivets, and $1\frac{3}{4}$ inches for $\frac{1}{2}$ inch rivets. The maximum pitch in the line of stress of compression members composed of plates and shapes shall not exceed 16 times the thinnest outside plate or shape, nor 20 times the thinnest enclosed plate or shape with a maximum of 12 inches, and at right angles to the direction of stress the distance between lines of rivets shall not exceed 30 times the thinnest plate or shape. For angles in built sections with two gage lines, with rivets staggered,

the maximum pitch in the line of stress in each gage line shall not exceed 24 times the thinnest plate with a maximum of 18 inches.

(b) In tension members composed of two angles, a pitch of 3'-6" will be allowed, and in compression members, 2'-0", but the ratio l/r for each angle between rivets shall not be more than $\frac{3}{4}$ of that for the whole member.

(c) The pitch of rivets at the ends of built compression members shall not exceed four diameters of the rivets for a length equal to $1\frac{1}{2}$ times the maximum width of the member.

(d) The minimum distance from the center of any rivet hole to a sheared edge shall be $2\frac{1}{4}$ inches for $1\frac{1}{4}$ inch rivets, 2 inches for $1\frac{3}{8}$ inch rivets, $1\frac{3}{4}$ inches for 1 inch rivets, $1\frac{1}{2}$ inches for $\frac{7}{8}$ inch rivets, $1\frac{1}{4}$ inches for $\frac{3}{4}$ inch rivets, $1\frac{1}{8}$ inches for $\frac{5}{8}$ inch rivets and 1 inch for $\frac{1}{2}$ inch rivets. The maximum distance from any edge shall be 12 times the thickness of the plate, but shall not exceed 6 inches.

SECTION 15. CONNECTIONS.

* (a) Connections carrying calculated stresses, except for lacing, sag bars, or hand rails, shall have not fewer than 2 rivets.

(b) Members meeting at a joint shall have their lines of center of gravity meet at a point if practicable; if not, provision shall be made for any eccentricity.

(c) The rivets at the ends of any member transmitting the stresses into that member should have their centers of gravity in the line of the center of gravity of the member; if not, provision shall be made for the effect of the resulting eccentricity. Pins may be so placed as to counteract the effect of bending due to dead load.

(d) When a beam or girder "A" is connected to another member in such a manner that "A" acts as a continuous or fixed end beam, proper provision shall be made for the bending moments at such a connection.

* (e) Where stress is transmitted from one piece to another, through a loose filler, the number of rivets shall be such as to properly develop the stresses; tight-fitting fillers shall be preferred.

SECTION 16. LATTICE.

(a) The open sides of compression members shall be provided with lattice having tie plates at each end and at intermediate points if the lattice is interrupted. The plates shall be as near the ends as practicable. In main members carrying calculated stresses the end tie plates shall have a length of not less than the distance between the lines of rivets connecting them to the flanges, and intermediate ones of not less than one-half of this distance. The thickness of tie plates shall be not less than one-fiftieth of the distance between the lines of rivets connecting them to the segments of the members, and the rivet pitch shall be not more than four diameters. Tie plates shall be sufficient in size and number to equalize the stress in the parts of the members.

(b) Lattice bars shall have neatly finished ends. The thickness of lattice bars shall be not less than one-fortieth for single lattice and one-sixtieth for double lattice of the distance between end rivets; their minimum width shall be as follows:

For 15" channels, or built sections with $3\frac{1}{2}$ " and 4" angles— $2\frac{1}{4}$ " ($\frac{3}{4}$ " rivets) or $2\frac{1}{2}$ " ($\frac{7}{8}$ " rivets).

For 12", 10", and 9" channels, or built sections with 3" angles— $2\frac{1}{4}$ " ($\frac{3}{4}$ " rivets).

For 8" and 7" channels, or built sections with $2\frac{1}{2}$ " angles—2" ($\frac{5}{8}$ " rivets), or $2\frac{1}{4}$ " ($\frac{3}{4}$ " rivets).

For 6" and 5" channels, or built sections with 2" angles— $1\frac{1}{2}$ " ($\frac{1}{2}$ " rivets), or $1\frac{3}{4}$ " ($\frac{5}{8}$ " rivets).

* (c) The inclination of lattice bars to the axis of the members shall preferably be not less than 45 degrees. When the distance between the rivet lines in the flanges is more than 15 inches, the lattice shall be double and riveted at the inter-section if bars are used, or else shall be made of angles.

(d) Lattice bars shall be so spaced that the ratio l/r of the flange included between their connections shall be not over $\frac{3}{4}$ of that of the member as a whole.

SECTION 17. EXPANSION.

Proper provision shall be made for expansion and contraction.

SECTION 18. MINIMUM THICKNESS.

No steel less than $\frac{5}{16}$ inch thick shall be used for exterior construction, nor less than $\frac{1}{4}$ inch for interior construction, except for linings or fillers and rolled structural sections.

These provisions do not apply to light structures such as skylights, marquees, fire-escapes, light one-story buildings, or light miscellaneous steel work.

For trusses having end reactions of 35000 pounds or over, the gusset plates shall be not less than $\frac{3}{8}$ inch thick.

SECTION 19. ADJUSTABLE MEMBERS.

* The total initial stress in adjustable members shall be assumed as not less than 5000 pounds.

SECTION 20. WORKMANSHIP.

(a) All workmanship shall be equal to the best practice in modern structural shops.

(b) Drifting to enlarge unfair holes shall not be permitted.

(c) The several pieces forming built sections shall be straight and fit close together; and finished members shall be free from twists, bends, or open joints.

(d) Rolled sections, except for minor details, shall not be heated.

(e) Wherever steel castings are used, they shall be properly annealed.

(f) **Punching.** Material may be punched $\frac{1}{16}$ inch larger than the nominal diameter of the rivets, whenever the thickness of the metal is equal to or less than the diameter of the rivets, plus $\frac{1}{8}$ inch. When the metal is thicker than the diameter of the rivet, plus $\frac{1}{8}$ inch, the holes shall be drilled, or sub-punched and reamed.

* (g) Rivets are to be driven hot and, wherever practicable, by power. Rivet heads shall be of hemispherical shape and uniform size throughout the work for the same size rivet, full, neatly finished, and concentric with the holes. Rivets, after driving, shall be tight, completely filling the holes, and with heads in full contact with the surface. Rivets shall be heated uniformly and their temperature before driving should not exceed 1950° F., which is a light yellow color

An air hammer should not be used for driving after the temperature is below 1000° F., which is a blood red color.

*(h) Compression joints depending upon contact bearing shall have the bearing surfaces truly faced and plane after the members are riveted. All other joints shall be cut or dressed true and straight, especially where exposed to view.

(i) The use of a cutting torch is permissible if the metal being cut is not carrying stresses during the operation. The radius of re-entrant flame cut fillets shall be as large as possible, but never less than 1 inch. To determine the net area of members so cut, $\frac{1}{8}$ inch shall be deducted from the flame cut edges. Stresses shall not be transmitted through a flame cut surface.

SECTION 21. PAINTING.

(a) Parts not in contact, but inaccessible after assembling, shall be properly protected by paint. Surfaces to be riveted in contact shall not be painted.

(b) All steel work, except where encased in concrete, shall be thoroughly cleaned and given one coat of acceptable metal protection well worked into the joints and open spaces.

(c) Machine finished surfaces shall be protected against corrosion.

(d) Field painting is a phase of maintenance, but it is important that unless otherwise properly protected, all steel work shall after erection be protected by a field coat of good paint applied by a competent painter.

SECTION 22. ERECTION.

(a) The frame of all steel skeleton buildings shall be carried up true and plumb, and temporary bracing shall be introduced wherever necessary to take care of all loads to which the structure may be subjected, including erection equipment, and the operation of same. Such bracing shall be left in place as long as may be required for safety.

(b) As erection progresses the work shall be securely bolted up to take care of all dead load, wind and erection stresses.

(c) Wherever piles of material, erection equipment, or other loads are carried during erection, proper provision shall be made to take care of stresses resulting from the same.

(d) No riveting shall be done until the structure has been properly aligned.

(e) Rivets driven in the field shall be neated and driven with the same care as those driven in the shop.

SECTION 23. INSPECTION.

(a) Material and workmanship at all times shall be subject to the inspection of experienced engineers representing the purchaser.

(b) Material or workmanship not conforming to the provisions of this Specification shall be rejected at any time defects are found during the progress of the work.

(c) The Contractor furnishing such material or doing such work shall promptly replace the same.

(d) All inspection as far as possible shall be made at the place of manufacture, and the Contractor or Manufacturer shall co-operate with the Inspector permitting access for inspection to all places where work is being done.

INDEX

A

- Actual stresses, compression members, 217
- A.I.S.C. Specifications for building design, 547
- Ammann, O. H., 268
- Appearance of structural members, 203
- Approximate radii of gyration, 421
- Area, compression members, 215
 - net, of tension members, 202
- Arrangement of structural members, 5
- Assumptions in design of girders, 115

B

- Bay length, definition of, 18
- Beam and column framing, bracing for, 22
- Beam bridges, description of, 39
 - definition of, 14
- Beam connections, framed, 272
 - illustrative example, 280
 - seat, 277
 - split-beam, 307
 - standard, 276
 - subject to moment, 299
 - illustrative example, 312
- Beams, bending in two directions, 106
 - definition of, 9
 - holes in flanges, 100
 - limited deflection, 112
 - selection of, by maximum moment tables, 66
 - by safe load tables, 66
 - by section modulus, 63
 - illustrative example, 66
 - web strength of, diagonal buckling, 80
 - illustrative examples, 94
 - shear, 78
 - vertical buckling, 84
 - vertical compression, 88
 - with cover plates, 102
 - without lateral support, 70

- Bending, compression members, 220
 - effect of deflection, 223
- tension members, 203
 - effect of deflection, 204
- Bent, bracing for, with knee braces, 26
 - without knee braces, 28
 - definition of, 18
- Bishop, C. T., 61
- Boardman, H. C., 485
- Braced bay, definition of, 18
- Bracing, bent with knee braces, 26
 - bent without knee braces, 28
 - bridge girders, 442
 - bridge trusses, 440
 - flat roof buildings, 31
 - for beam and column building, 22
 - for industrial buildings, 26
 - weight of, 375
- Bridge decks, typical sections, 428, 429, 430
- Bridges, classification of, 37
 - contrasted layouts, 439
 - dead load, 428
 - design of floorbeams, 449
 - design of layout, 436
 - design of stringers, 448
 - design of trusses, 452
 - bracing, 458
 - compression chords, 456
 - tension chords, 452
 - web members, 457
 - economic proportions, 440
 - economic span length, 437
 - girder spans, bracing for, 442
 - design of, 442
 - highway, specifications for design, 534
 - weight of, 430
 - illustrative design, 460
 - impact on, 424
 - live loads for, 422
 - railway, specifications for design, 511
 - weight of, 431
 - truss spans, design of, 446

Bridge trusses, depth of, 440
 Hudson's formula for weight of, 434
 slope of diagonals, 441
 Buildings, data on welding, 499
 floor framing, estimating weight of, 376
 industrial, bracing for, 26
 illustrative designs, 396
 roof loads for, 367
 specifications for design, 547
 Building trusses, depth of, 388
 formula for weight, 374
 Burr, William H., 213

C

Center of gravity of plate girder flanges, 420
 Chord splices, double-plane trusses, 351-366
 single-plane trusses, 334-340
 Column formulas, Rankin-Gordon, 213
 straight line, 213
 Columns (*see also* Compression members)
 actual stresses in, 217
 cut-off, definition of, 16
 loaded at two levels, 233
 illustrative example, 236
 shear in, 244
 Compression members, actual stresses, 217
 area required, 215
 convenient relations, 219
 definition of, 12
 design of, 212
 illustrative example, 228
 economical proportions, 218
 latticing for, common rules, 241
 illustrative example, 244, 260
 maximum spacing of, 255
 limiting thicknesses, 218
 proportioning, 214
 safe load tables, 227
 slenderness ratio, crane columns, 395
 influence on design, 215, 390, 457
 limiting values, 518, 546, 548
 subject to bending, 220
 effect of deflection, 223
 suitability of common types, 199
 typical sections of, 13, 199

Conklin, C. D., 61
 Connections, beam, framed, 272
 illustrative example, 280
 seat, 277
 standard, 276
 pin, 261, 268
 riveted, effect of initial tension, 296
 general, 263
 initial tension, 295
 methods of failure, 266
 principles of design, 270
 split-beam, 307
 subject to moment, 285
 rivets in shear, 285
 rivets in tension, 291
 types of, 261
 welded, beams and columns, 495
 for trusses, 504
 Cover plates, determination of length, 124
 for girder bridges, 444
 envelope curve for, 445
 Crane columns, 393
 Cross, Hardy, 396
 Cross frames for girder bridges, 42
 proportions of, 443
 spacing of, 442
 Cut-off columns, definition of, 16

D

Dead load, definition, 3
 estimates of, 4
 Dencer, F. W., 61
 Depth, of bridge trusses, 440
 of building trusses, 388
 Detailing, importance of, 60
 Determination of stresses, 5
 Double-plane truss, connections, 346-366
 definition of, 21
 stresses in gussets, 349
 tension splices, 351, 355
 Drawings, design, 62
 layout, 62
 shop, 62
 stress sheet, 61
 Dryden, Hugh L., 371
 Duchemin, Colonel, 370

- E**
- Eccentric connections, riveting for, 285
- Economic depth for plate girders, 189
- Economic proportions for bridges, 440
for compression members, 218
- Economic span length for bridges, 437
- Eiffel, G., 371
- Envelope curve for cover plate length, 446
- F**
- Fish, Gilbert D., 481
- Fleming, Robins, 369
- Floorbeams, design, 448
estimating weight of, 376
narrow flanges desirable, 450
- Floor loads, dead, 376
live, 375
- Framing, weight of, for floors, 376
- Functional design, definition of, 1
relation to structural, 3
- G**
- Girder bridges, description of, 39
design of, 442
- Girder connections to resist moment, 299
- Girders, *see* Plate girders
- Gowen, Sumner, 445
- Gusset plates, stresses, in double-plane truss, 349
in single-plane truss, 340-342
- H**
- Hill, George C., 371
- Hoover, Herbert, 375
- Hudson, C. W., 88
- Hudson's 100/3 formula, 434
- I**
- Impact, 4, 424, 515, 542, 548
- Industrial buildings, bracing for, 26
weight of, 375
framing for, 17
illustrative designs, 396
- J**
- Johnson, Thomas H., 213
- K**
- Ketchum, M. S., 61, 176, 480
- Kunz, F. C., 445
- L**
- Lap splice, 356
- Lateral bracing for girder bridges, 443
- Length of cover plates, 124
algebraic determination, 129
graphical determination, 128
parabolic determination, 126
- Live loads, *see* Loads
- Loads, bridges, dead, 428
live, 422
crane, 379
dead, definition of, 3
floor, dead, 376
live, 375
definition of, 4
roof, 367
wall, 379
- Lug angles, 344-345
- M**
- Maximum stresses in columns, 217
- McKay, R. F., 271
- McKibben, Frank P., 495, 498, 507
- Modern truss types, 52
- N**
- Net section, 320
calculation of, 322
definition, 322
diagrams, 325, 326, 327
tension members, 202
- O**
- Oliver, W. A., 295
- P**
- Pitch of rivets, plate girder flanges, 137
- Plate girders, center of gravity of flanges, 420
definition, 10
design assumptions, 115
design of, illustrative examples, 123, 158
design of flanges, approximate method, 116

- Plate girders, design of flanges, author's modified method, 178
 moment of inertia, 168
 net section, 122
 proportioning, 122
 design of web, 116
 economic depth, 189
 effective depth, 121
 estimating weight of, 378
 flange splices, 142, 153
 length of cover plates, 124
 algebraic determination, 129
 graphical determination, 128
 parabolic determination, 124
 railway, Szlapka's formula for weight of, 431
 rivet pitch, 137
 vertical loads, 140
 typical cross sections, 10
 web reinforcement for, 166
 illustrative example, 168
 web splices, type A, 143
 type B, 145
 type C, 146
 web stiffeners, 129
 bearing, design of, 130
 riveting of, 132
 intermediate, design of, 133
 spacing of, 133
 web thickness, 121
 welded, 501
 without lateral support, 180
 illustrative example, 184
 subject to lateral loads, 180
- Priest, H. M., 482
- Proportioning, some factors in, 6
- Purlins, definition of, 17
 design of, 381
 sag rods for, 382
 weights of, 374
- R
- Radii of gyration, table of approximate values, 421
- Riveted connections, double-plane**
 trusses, 346-366
 compression splices, 364
 tension splices, 351, 355
 effect of initial tension, 296
 general, 263
- Riveted connections, initial tension in, 295
 method of failure, 266
 principles of design, 270
 single-plane trusses, 329-345
 chord splices, 334-340
 lug angles, 344-345
 stresses in gusset plates, 340-342
 subject to moment, rivets in shear, 285
 rivets in tension, 291
- Rivet pitch, plate girder flanges, 137
- Roof framing, weight of, 374
- Roofing, weights of, 373
- Roof loads, equivalent snow and wind, 369
 snow, 368
 wind, 369
- Roof trusses, compression diagonals, 390
 design of, 386
 formula for weight of, 374
 pitch and depth illustrated, 387
 proportioning, 389
 slope of diagonals, 389
- S
- Safe load tables, use of, beams, 66
 compression members, 227
- Sag rods, 383
- Salmon, E. H., 212
- Single-plane trusses, chord splices, 334-340
 connections, 329-345
 lug angles, use of, 344-345
 stresses in gusset plates, 340-342
 definition of, 20
- Slenderness ratio, crane columns, 395
 influence on design, 215, 390
 bridge trusses, 457
 limiting values, 518, 546, 548
- Span, economic, for bridges, 437
- Spandrel beam, definition of, 15
- Specifications for design, buildings, 547
 highway bridges, 534
 railway bridges, 511
- Splices, compression members, double-plane trusses, 364
 girder flanges, 153
 girder webs, 143, 145, 146

- Splices, lap or shingle, 356
 tension member, double-plane
 trusses, 351, 355
 single-plane trusses, 334-340
- Split-beam connections, 307
 illustrative example, 312
- Stanton, Thomas E., 372
- Statics, importance of training in, 6
- Stresses, actual in columns, 217
 gusset plates, double-plane trusses,
 349
 single-plane trusses, 340-342
- Stringer, definition of, 43
 design of, 448
- Structural design, definition of, 1
 four parts in, 3
 relation to functional, 3
 some points in, 2
- Structural members, appearance of,
 203
 arrangement of, 5
 fundamental forms, 9
- Suction, leeward side of structures,
 371, 372
- Swain, George Fillmore, 212, 369
- Symbols for welding, 489
- Szlapka, Peter L., 9-L formula, 431
- T
- Tension members, batten plates for,
 238
 definition of, 11
 design, 201
 illustrative example, 210
 net section, 202, 322
 splices, heavy double-plane, 355
 ordinary double-plane, 351
 single-plane, 334-340
 subject to bending, 203
 effect of deflection, 204
 suitability of common types, 196
 typical sections of, 12, 196
- Traction frames, 459
- Trestles, description of, 48
- Truss bridges, general description, 51
 modern types, 52
- Truss connections, double-plane, 346-
 366
 chord splices, 351, 355
 stresses in gusset plates, 349
- Truss connections, single-plane, 329-
 345
 chord splices, 334-340
 stresses in gusset plates, 340-342
 single-plane trusses, lug angles, use
 of, 344-345
- Trusses, bridge, depth of, 440
 design of, 448, 452
 economic proportions, 440
 economic span, 437
 Hudson's formula for weight of, 434
 building, depth of, 388
 design of, 386
 formula for weight, 374
 double-plane, definition of, 21
 single-plane, definition of, 20
 slope of diagonals, 389, 441
 welded, 504
- V
- Vacuum, leeward side of buildings, 371
 372
- Velocity pressure, true and indicated
 wind speed, 372
- Viaducts, *see* Trestles
- W
- Waddell, J. A. L., 364, 431, 436
- Walls, weight of, 579
- Watson, Wilbur J., 371
- Web reinforcement, for beams, 79
 for girders, 166
- Web splices for girders, type A, 143
 type B, 145
 type C, 146
- Web stiffeners for girders, bearing, de-
 sign of, 130
 riveting of, 132
 intermediate, design of, 133
 spacing of, 133
- Web strength of beams, diagonal buck-
 ling, 80
 illustrative examples, 94
 shear, 78
 vertical buckling, 84
 vertical compression, 88
- Weight, of bridge trusses, Hudson's
 formula for, 434
 of building trusses, formula for, 374
 of railway girders, Szlapka's formula
 for, 431

- Welded connections, beams and columns, 495
trusses, 504
- Welded joints, types of, 484
- Welded plate girders, 501
- Welded steel buildings, data on, 499
- Welded trusses, 504
- Welding, clearances, 485
methods of, 481
permissible stresses for, 508
symbols and notation for, 489
- Welds, fillet, bending stress, 490
direct stress, 487
definition of terms, 484, 507
strength of ordinary, 486
strength of shielded arc, 487
- Wilson, W. M., 295
- Wind pressure, Florida and Gulf of Mexico, 372
inclined surfaces, 370
normal surfaces, 369
velocity, 372

This pocket contains Plates II to X, inclusive.

Plate I is printed on page 401.

