

BIRLA CENTRAL LIBRARY

PLANT (RAJASTHAN)

612.015

Call No.

M 697

Accession No.

41759

Acc. No. 4.1759

ISSUE LABEL

Not later than the latest date stamped below.

74

A TEXTBOOK OF
BIOCHEMISTRY

A TEXTBOOK OF BIOCHEMISTRY

BY

PHILIP H. MITCHELL, Ph.D.

Professor of Biology, Emeritus

Brown University

Second Edition
Third Impression

New York

Toronto

London

McGRAW-HILL BOOK COMPANY, INC.

1950

A TEXTBOOK OF BIOCHEMISTRY

Copyright, 1946, 1950 by the McGraw-Hill Book Company, Inc. Printed in the United States of America. All rights reserved. This book, or parts thereof, may not be reproduced in any form without permission of the publishers.

*Dedicated to the memory
of
my two inspiring teachers*

RUSSELL H. CHITTENDEN

and

LAFAYETTE B. MENDEL

**Dr. Chittenden, pioneer of Biochemistry
in America, distinguished researcher, and
born leader of men.**

**Dr. Mendel, extraordinarily gifted in the
art of clear exposition, one of the few who
turned the attention of the chemical
world to the importance of correct
nutrition for human welfare.**

PREFACE TO THE SECOND EDITION

The large number of researches reported every year in the field of biochemistry include many discoveries which a student of the subject needs to know. Seemingly established ideas become obsolete or in need of revision. New techniques are developed and permit the presentation of data for drawing clearer generalizations or for making entirely new ones. During the period between the first and second editions of this book, biochemical discoveries and advances have appeared at a steadily accelerating pace. The time is fully ripe for a second edition.

It is impossible to include all of the interesting or even all of the significant discoveries within the pages of a text of limited size. The author has tried to select those matters which are most important to the student taking a first course in biochemistry.

While all chapters of the book have been revised, the biggest changes include developments in regard to the materials of life, the carbohydrates, lipids, proteins, and especially the vitamins. The kinetics of enzyme action have been drastically revised and somewhat extended. The most important changes are, perhaps, those relating to intermediary metabolism, a story now rapidly unfolding. As would be expected, the treatment of hormones required much revision, and chemotherapy, of course, required considerable extension because of new developments.

While it is too much to hope that the selection of new material will avoid all criticism, an earnest effort has been made to include the truly significant and fundamental advances.

PHILIP. H. MITCHELL

PROVIDENCE, R. I.
June, 1950

PREFACE TO THE FIRST EDITION

The central theme and the chief goal of biochemical study is an explanation of metabolism—the real chemistry of life. While the chemistry of foods and of dead tissues is helpful corollary material, the essentials are the reactions of living protoplasm. Accordingly, emphasis in this text has been given and major space allotted to such subjects as the constitution and activity of enzymes, the intermediary reactions of anabolism and catabolism, and the vital significance of hormones and vitamins. Chapters I, III, IV, and V are more descriptive and are designed to give a working knowledge of the chief materials of living matter, but most of the remainder of the book deals with the chemistry of life itself.

This book will be found to place emphasis upon nutrition. Correct nutrition is part of the basis of human welfare. To build a structure of health for mankind four main parts are required in the foundations: Good heredity, training in the best mental habits, protection against infections, and optimum nutrition. Over the first two of these, neither the world in general nor the medical profession in particular has found very effective ways of exercising control. What little biochemistry can contribute to the science of heredity is suggested but not systematically treated in this book. With regard to combating infection, some space has been given to the chemistry of immunity and chemotherapy. But the chief present-day mission of biochemistry would seem to be the establishment of nutrition as a science rather than leaving it as one of the arts.

This mission has not been fully recognized in the past by the medical world. The practitioner, always under pressure to accomplish a succession of "patching" jobs, is of course aware that many of the "patchings" would have been unnecessary or more satisfactorily accomplished had his patients been in sound health; but he has not been in a position to do much about it. Since 1911 when Funk announced the vitamin hypothesis, biochemists have worked steadily and at an accelerating rate to build a foundation of "Newer Knowledge of Nutrition," as McCollum aptly calls it. The foundation is already sound enough for use as the base of a superstructure of applied nutrition. Its use in so-called "preventive medicine" is rapidly growing; its extension can hardly be foretold now but will doubtless appear in improved agronomy, crop control, food processing and marketing, and, above all, in education of medical men,

nutritionists, and others who carry the responsibility for promotion of human welfare. The pattern of the new structure is already discernible in the work of the Food and Nutrition Board of The National Research Council, in the activities of the American Medical Association, and in the deliberations of the Hot Springs Conference of 1944.

But the only satisfactory foundation of good nutrition is one which uses as building stones a knowledge of metabolism along with food chemistry and the studies of nutritional status and of empirical determinations of minimal or optimal food requirements. This text therefore attempts to suggest the relation between metabolism and nutrition. The functioning of oxidative enzymes is viewed as much as is now possible in the light of vitamin and mineral requirements. The interconversion of foodstuffs in metabolism is related to the study of the balanced diet. Other similar connections will appear to the reader.

While it may seem logical to the student mind to approach biochemistry from the anatomic point of view, treating each organ system of the body in its turn, there are also advantages in viewing the material from the standpoint of systematic organic chemistry or from that of physiological function. No slavish adherence to any one of these approaches has been preserved in preparation of this text. Each of the three has been followed as it seemed to contribute to clarity. The physiological viewpoint predominates.

Up until recent years any textbook of biochemistry contained, with good reason, much material on elementary physical chemistry: Osmotic pressure, dissociation of acids, bases, and salts, measurement and significance of pH, the nature of the colloidal state, the theory and use of polariscope and spectroscope, etc. Some knowledge of these matters is as necessary a part of the mental equipment of the student of biochemistry as are introductory and organic chemistry. Teachers of biochemistry long ago assumed that general chemistry (including organic) was prerequisite for biochemistry and, in the opinion of the author, elementary physical chemistry should now be similarly regarded. It is surely requisite for any modern treatment of introductory and organic chemistry and its inclusion in such courses appears to be regular pedagogical practice in modernized departments of chemistry. There is no more reason why the teacher of biochemistry should be required to devote a considerable part of the time available for a course to giving students the essentials of physical chemistry than of organic chemistry. In this belief discussions of physicochemical matters are reduced to mere "refresher" statements, thus conserving space for more of the important matters of biochemistry. References to sources of information regarding elementary physical chemistry are included for the use of students who need them. One

aspect of the use of physical chemistry in biochemistry, a study of redox potential, has been included because of its fundamental importance in biochemistry and because it is not apt to be considered in prerequisite courses.

This book does not attempt any systematic treatment of clinical or pathological biochemistry. In many cases, such as in the regulation of the acid-base balance and of the blood-sugar level, the normal functioning is illuminated by a study of the abnormal. Whenever this is the case, the phenomena are described at some length. Many of the abnormal or pathological states encountered by the physician and the biochemist in a clinical laboratory must be explored as byways. This book attempts to lead only along the highways. The omission seems justifiable. Inclusion of a wealth of detail is confusing to the student who is gaining a first view of a field of knowledge and, as this book is designed for a first course in biochemistry, a limitation upon its scope seems advisable. Further work in clinical chemistry is apt to be pursued while using one or more of the several excellent manuals available; and if the worker is well grounded in the essentials, the details fit into the right place in his mental picture.

The amount of space and the emphasis given to the different aspects of a subject are determined with some difficulty by the textbook writer. To him the newer discoveries are fresh and exciting while the longer established facts and theories seem relatively drab and less important. He must bear in mind, however, that, to the student just entering the field, the older work is as significant as it was when new. The author has made an earnest effort to maintain a helpful balance both in emphasis upon and in allotment of space to the established body of biochemical knowledge and the newer knowledge of biochemistry.

To give credit to all investigators overloads a textbook, which by its very nature cannot be a reference work, and yet the names of some investigators are so associated with certain work—names of pioneers in certain fields and of discoverers of certain techniques—that they acquire a substantive meaning and are an almost indispensable part of the student's vocabulary. Names which, in the author's judgment, are in this class have been included. Fallibility of judgment in this matter is only too probable. The author begs indulgence for his errors, particularly those of omission. A partial atonement is attempted in the references to the literature.

PHILIP H. MITCHELL

PROVIDENCE, R. I.
February, 1946

CONTENTS

	Page
PREFACE TO THE SECOND EDITION	vii
PREFACE TO THE FIRST EDITION	ix
AN INTRODUCTION TO BIOCHEMICAL LITERATURE	xv
CHAPTER I	
CARBOHYDRATES	1
CHAPTER II	
PHOTOSYNTHESIS	46
CHAPTER III	
FATS AND RELATED SUBSTANCES	64
CHAPTER IV	
PROTEINS AND AMINO ACIDS	95
CHAPTER V	
NUCLEOPROTEINS AND NUCLEIC ACIDS	141
CHAPTER VI	
THE VITAMINS	153
CHAPTER VII	
ENZYMES	220
CHAPTER VIII	
<u>DIGESTION</u>	<u>252</u>
CHAPTER IX	
<u>ABSORPTION AND DETOXICATION</u>	<u>277</u>
CHAPTER X	
<u>BLOOD AND LYMPH</u>	<u>291</u>
CHAPTER XI	
CHEMISTRY OF RESPIRATION AND ACID-BASE REGULATION	331

	PAGE
	CHAPTER XII
BIOLOGICAL OXIDATION	355
	CHAPTER XIII
CALORIMETRY AND ENERGY METABOLISM	387
	CHAPTER XIV
CARBOHYDRATE METABOLISM	414
	CHAPTER XV
METABOLISM OF THE LIPIDS	447
	CHAPTER XVI
<u>PROTEIN METABOLISM</u>	475
	CHAPTER XVII
URINE	519
	CHAPTER XVIII
COMPOSITION OF FOODS: DIETETICS	542
	CHAPTER XIX
THE CHEMISTRY OF ANIMAL TISSUES	572
	CHAPTER XX
CHEMISTRY OF THE HORMONES	591
	CHAPTER XXI
CHEMOTHERAPY	642
AUTHOR INDEX	663
SUBJECT INDEX	675

AN INTRODUCTION TO BIOCHEMICAL LITERATURE

Biochemistry is an intricate subject. Dealing as it does with the chemistry of living matter—the most intricate chemical mechanism in existence—and attempting to decipher the chemical structure of molecules that are among the largest and most complex in nature, biochemistry requires a synthesis of all branches of chemistry and many allied subdivisions of science in the devising of methods for new discoveries. For reasons most of which are obvious, chemists and students of the medical and allied sciences often find their interests turning to biochemistry. The number of research workers in this field is thus very large and shows a marked tendency to increase.

Because of its intricacy and the large number of its productive workers, biochemistry presents a body of literature entirely beyond the possibility of complete mastery by any one reader. Even the researcher entirely devoted to biochemical pursuits can scarcely hope to know in its original form the literature other than that closely allied to his own research.

In this situation the usefulness of summaries, in the form of monographs and reviews prepared by those who are experts in the fields that they describe, becomes apparent.

The following lists indicate such summaries together with a list of the more prominent of the journals that publish the original reports of biochemical research. It cannot be too strongly impressed upon the student of this or any other subdivision of science that, while summaries may be indispensable, some use of the original reports as prepared by the investigators themselves affords a view clearer and better than any obtainable except that resulting from actual observation and experiment.

The books and journals listed are not intended as a complete guide to biochemical literature. They include the works which are apt to be useful to the student. Other books and journals will be cited among the references given at the ends of the chapters.

BACKGROUND LITERATURE

“Organic Chemistry: An Advanced Treatise.” Henry Gilman, Editor-in-chief. Vols. I and II. 2d ed., New York, 1943.

“Physical Chemistry for Premedical Students.” J. P. Amsden. 2d ed., New York, 1950.

“The Determination of Hydrogen Ions.” W. M. Clark. 3d ed., Baltimore, 1928.

"The Physical Properties of Colloidal Solutions." E. F. Burton. 3d ed., New York, 1938.

"The Development of Physiological Chemistry in the United States." R. H. Chittenden. New York, 1930.

MONOGRAPHS IN BIOCHEMISTRY

The following are arranged in the order of the chapters in this book. Only one title is listed under each subject. The selections are those which seem to be more especially useful. Others are listed among the references accompanying each chapter.

"The Carbohydrates." E. F. Armstrong and K. F. Armstrong. 5th ed., New York, 1934.

"Plant Physiology." Presents a helpful treatment of photosynthesis. E. C. Miller. 2d ed., New York, 1938.

"The Biochemistry of the Fatty Acids and the Lipids." W. R. Bloor. New York, 1943.

"Lecithin and Allied Substances, the Lipins." H. Maclean and I. S. Maclean. New York, 1927.

"Chemistry of Natural Products Related to Phenanthrene." L. F. Fieser and M. Fieser. 3d ed. New York, 1949.

"Chemistry of the Amino Acids and Proteins." Edited by C. L. A. Schmidt, and written by eighteen specialists. 2d ed., Springfield, Ill., 1944.

"Nucleic Acids." P. A. T. Levene and L. W. Bass. New York, 1931.

"Chemistry and Physiology of the Vitamins." H. R. Rosenberg. New York, 1942.

"Chemistry and Methods of Enzymes." J. B. Sumner and G. F. Somers. 2d ed., New York, 1947.

"Human Gastric Function." Deals with control of digestive secretion. S. Wolf and H. G. Wolff, New York, 1943.

"Absorption from the Intestine." F. Verzar. New York, 1936.

"Handbook of Hematology." Edited by H. Downey. Deals with various aspects of blood morphology and chemistry written by a number of specialists. Vols. I-IV. New York, 1938.

"Respiration." J. S. Haldane. New Haven, 1928.

"Mechanisms of Biological Oxidation." D. E. Green. Cambridge, England, 1941.

"Basal Metabolism in Health and Disease." E. F. DuBois. Philadelphia, 1936.

"The Metabolism of Living Tissue." E. Holmes. Cambridge, England, 1937.

For the chemistry of urine consult Chaps. XXVII-XXXII in "Practical Physiological Chemistry." P. B. Hawk, B. L. Oser and W. H. Summerson. 12th ed., Philadelphia, 1947.

"Chemistry of Food and Nutrition." H. C. Sherman. 7th ed., New York, 1947.

"The Newer Knowledge of Nutrition." E. V. McCollum, E. Orent-Keiles, and H. G. Day. 5th ed., New York, 1939.

REVIEW PUBLICATIONS

Review journals and annuals are a great aid in finding the current reports of advance in a large and complex field. While most of them present the views and theories of the individual writers, others are little

more than annotated bibliographies. The following list of publications includes those which are most helpful to the biochemist.

- Annual Review of Biochemistry.* Vol. 1, 1932–Vol. 18, 1949.
Physiological Reviews. Vol. 1, 1921–Vol. 30, 1950.
Nutrition Reviews. Vol. 1, 1942–1943–Vol. 8, 1950.
Nutrition Abstracts and Reviews. Vol. 1, 1931–Vol. 18, 1949.
Advances in Enzymology. Vol. 1, 1941–Vol. 9, 1949.
Vitamins and Hormones: Advances in Research and Applications. Vol. 1, 1943–Vol. 7, 1949.
Advances in Protein Chemistry. Vol. 1, 1945–Vol. 5, 1949.
Advances in Carbohydrate Chemistry. Vol. 1, 1946–Vol. 4, 1949.

In addition to review publications, abstract journals are of use to the biochemist. They include *Chemical Abstracts* and *Biological Abstracts*.

THE CHIEF BIOCHEMICAL JOURNALS

The following list includes only the journals that are primarily or largely devoted to reports of biochemical research. It is to be noted that the later volumes of the *Journal of Physiology* and of the *American Journal of Physiology* devote a smaller proportion of space to biochemistry than was inclined to be the case before separate biochemical journals were published in English. Many journals not here listed, especially the *Journal of the American Chemical Society*, publish a considerable proportion of the important biochemical research. The following are listed in the order of their establishment:

- Zeitschrift für physiologische Chemie*, also called *Hoppe-Seyler's Zeitschrift (Z. physiol. Chem.)* Vol. 1, 1877–Vol. 284, 1949.
Journal of Physiology (J. Physiol.) Vol. 1, 1878–Vol. 111, 1950.
American Journal of Physiology (Am. J. Physiol.) Vol. 1, 1898–Vol. 160, 1950.
Journal of Biological Chemistry (J. Biol. Chem.) Vol. 1, 1905–Vol. 183, 1950.
Biochemical Journal (Biochem. J.) Vol. 1, 1906–Vol. 46, 1950.
Biochemische Zeitschrift (Biochem. Z.) Vol. 1, 1906–Vol. 320, 1949.
Journal of Laboratory and Clinical Medicine (J. Lab. Clin. Med.) Vol. 1, 1915–Vol. 35, 1950.
Endocrinology. Vol. 1, 1917–Vol. 46, 1950.
Archives of Biochemistry (Arch. Biochem.) Vol. 1, 1924–Vol. 25, 1950.
Journal of Nutrition (J. Nutrition) Vol. 1, 1928–Vol. 40, 1950.

CHAPTER I

CARBOHYDRATES

The carbohydrates may be roughly divided into monosaccharide sugars, disaccharide sugars, the higher sugars, and the polysaccharides.

Sugars are included among the indispensable materials of life, functioning both as structural material for the synthesis of protoplasmic and intercellular substances and in an important way as a readily available fuel for vital oxidations. Sugars are the first physiological product of photosynthesis, which is an obviously fundamental process of vital chemistry considered as a whole. These facts, together with some practical considerations, make the sugars a logical starting point in biochemistry.

Carbohydrates Defined. The name carbohydrate was brought into use under the impression that all members of the group were composed of the elements carbon, hydrogen, and oxygen, with the last two in the same proportion as in H_2O . This is true for the majority of them, *e.g.*, glucose, $C_6H_{12}O_6$, and sucrose, $C_{12}H_{22}O_{11}$; but it is not true for all of the group, even for some which are quite typical in their carbohydrate characteristics, *e.g.*, rhamnose, $C_6H_{12}O_5$; also some obviously carbohydrate substances contain nitrogen, as in the case of glucosamine, or other exceptional elements.

The carbohydrates are properly defined as the aldehyde and ketone derivatives of the higher or polyhydric alcohols. Recalling the characteristic atomic groupings of aldehydes, ketones, and polyhydric alcohols, one sees that the following molecular formulas represent simple carbohydrates:

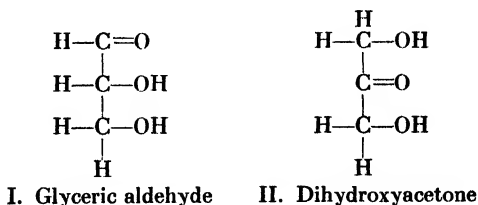

Both are derivatives of the trihydric alcohol, glycerol, $CH_2OH \cdot CHO \cdot CH_2OH$, I, an aldehyde and II, a ketone. Both arise during the processes of carbohydrate utilization in plants and animals. Though not found in abundance, they are nearly typical in their carbohydrate

properties and a mixture containing both of them is often called *glycerose*, the suffix *-ose* signifying that it is a sugar. More typical examples of carbohydrate structure are found in the case of glucose and fructose, which are among the best known and most frequently occurring sugars. Their abbreviated formulas may be represented thus:

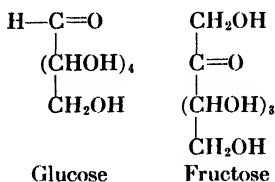

Glucose is thus shown as the aldehyde and fructose as the ketone derivative of a hexahydric alcohol. It is *sorbitol*, $\text{CH}_2\text{OH}\cdot(\text{CHOH})_4\cdot\text{CH}_2\text{OH}$, occurring naturally in certain fruits, *e.g.*, the berries of the mountain ash, and produced artificially by several methods. One of these methods, the reduction of glucose or fructose, is to be expected upon recalling the well-known relationship:

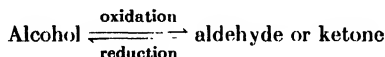

General Relations among the Carbohydrates. The more complex carbohydrates are condensations (dehydrated polymers) of the simple sugars. Naming the latter *monosaccharides*, we designate the others as *disaccharides*, *trisaccharides*, *tetrasaccharides*, and *polysaccharides*.

Hydrolysis is the process most frequently used to indicate the relations of the more complex carbohydrates to monosaccharides. In some cases water alone, even at room temperature, may cause hydrolysis. For example, sucrose kept several weeks at room temperature in water solution will be appreciably hydrolyzed into two monosaccharides, glucose and fructose. Superheated steam is sometimes used, but in most procedures hydrolysis is effected by the aid of a catalyst. Dilute acid or alkali and enzymes, biocatalysts, are the chief agents of hydrolysis. Thus the hydrolysis of sucrose is rapidly brought about by boiling in 3 per cent H_2SO_4 or by the action at 37°C . of aqueous solutions of the enzyme *sucrase*, prepared by extracting the intestinal mucosa. Other enzymes, each more or less specific in its action, similarly catalyze the hydrolysis of other carbohydrates.

MONOSACCHARIDES

Monosaccharides are the final end products of simple, uncomplicated hydrolysis of the other carbohydrates. The reverse process, *dehydration*

synthesis, appears to explain the origin of higher carbohydrates in nature. There is every reason to assume that the monosaccharide atomic groupings exist preformed in the higher carbohydrates. The definition of carbohydrates is thus applicable to all of them, even though some of the characteristic aldehyde, ketone, or alcohol groups may be present only potentially, being masked in many dehydrated polymers.

The Subdivision of the Monosaccharides. The natural monosaccharides may be classified as *dioses*, *trioses*, *tetroses*, *pentoses*, *hexoses*, and *heptoses*, according to the number of C atoms in the molecule.¹ Higher members of the series, *e.g.*, *octoses* and *nonoses*, have been prepared synthetically but have not been described as occurring in nature. The only possible diose is glycollic aldehyde, $\text{CHO}\cdot\text{CH}_2\text{OH}$, which has no asymmetric C atom² and is thus without the optical activity which is regarded as a characteristic property of sugars. The other members of the series may exist in both aldehyde and ketone forms so that each group could be subdivided accordingly. Thus we have *aldopentoses*, *ketopentoses*, *aldohexoses*, *ketohexoses*, *etc.* Pentoses and hexoses are the most prominent and abundant natural monosaccharides.

Stereoisomerism among the Monosaccharides. Individual monosaccharides are characterized by the specific stereoisomeric arrangement around their asymmetric C atoms. The following method of writing the formulas shows the occurrence of asymmetric C atoms, indicated by asterisks.

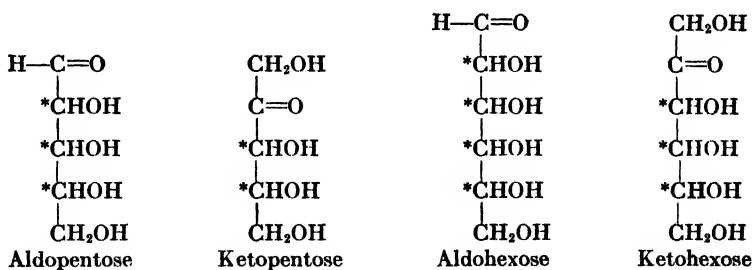

An aldotriose has one asymmetric C atom. The one possible ketotriose has no asymmetric C atom and accordingly is not usually designated as a sugar but is called dihydroxyacetone. An aldotetrose has 2 asymmetric C atoms; a ketotetrose, 1; an aldopentose has 3, a keto-

¹ The older classification was based on the number of O atoms. Thus rhamnose, $\text{CHO}\cdot(\text{CHOH})_4\cdot\text{CH}_3$, was termed a methyl pentose, but it is produced artificially by the indirect substitution of H for an $-\text{OH}$ group of a hexose and so is better characterized as a desoxyhexose (hexose minus oxygen).

² An asymmetric C atom is one attached to 4 different atoms or groups and is the cause of optical activity, the rotation of the plane of polarized light.

pentose, 2; etc. Any asymmetric C atom can exist in either of two arrangements. In either case it contributes definitely to the distinctive properties of the entire molecule. Of the properties affected, optical activity is the one most readily and accurately measured. In one orientation a given asymmetric group tends to rotate the plane of polarized light to the right, the *dextro* effect, and in the other to the left, the *levo* effect. In any one type of sugar, *e.g.*, the aldohexoses, each asymmetric C atom may be oriented so as to exert either effect. This is the basis of the well-known Le Bel-van't Hoff rule that the number of stereoisomers of a given organic arrangement is 2^n where n represents the number of asymmetric C atoms. Thus there are 16 possible aldohexoses (4 asymmetric C atoms) and although most of them have not been obtained from any natural source, all of them are producible by artificial synthesis and their stereoisometric configuration can be established.

↙ The relationships between the stereoisomers of monosaccharides are clearly indicated by the results of those artificial syntheses by which the various modifications are built up from simpler sugars. One of the oldest and most useful methods is that of *cyanhydrin synthesis*. An aldose or a ketose combines with HCN to form a cyanhydrin.

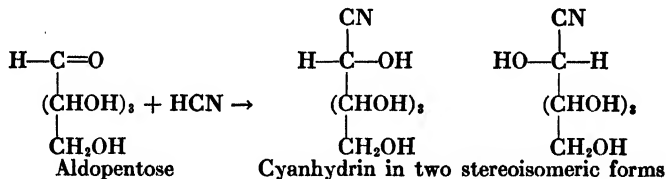

The reaction involves the formation of a new asymmetric C atom. If the chances are equal, such products are mixtures of equal parts of the two resulting stereoisomers although in this particular type of synthesis one of the isomers usually tends to predominate. The cyanhydrins (also called "nitriles") hydrolyze to form acids containing one more carbon atom than the sugar serving as the starting point.

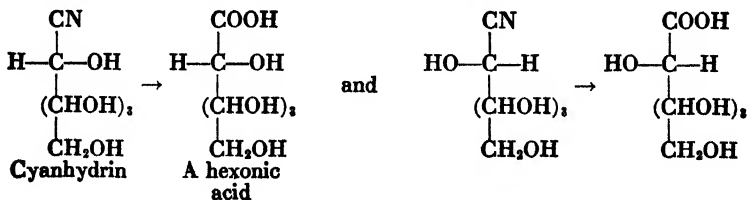

These acids may be reduced to the corresponding sugars [$\text{COOH}-(\text{CHOH})_4\text{CH}_2\text{OH} \rightarrow \text{CHO}-(\text{CHOH})_4\text{CH}_2\text{OH}$] so that two aldohexoses

are formed from an aldopentose. The two aldotrioses, D-glycero- and L-glycero-, might be regarded as the starting point for a systematic building up of all the monosaccharides. The syntheses involved have been actually demonstrated. The results, schematically summarized, are shown for aldose monosaccharides derivable from D-glycero-.

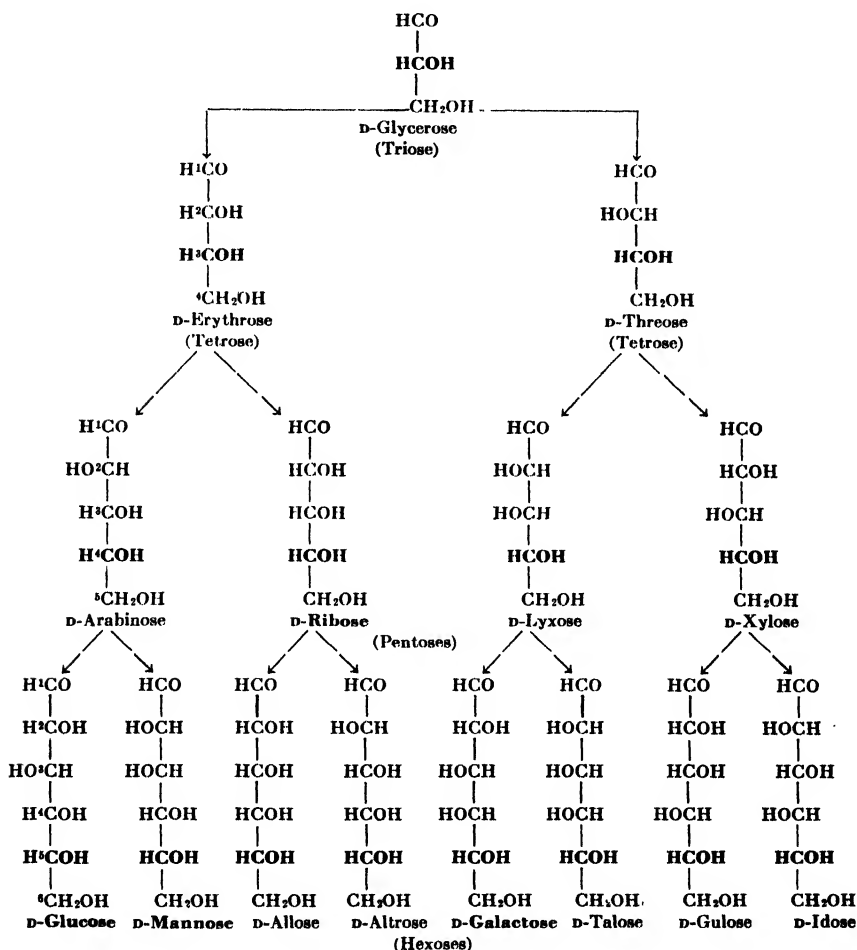

The series might be continued, the next group being the 16 possible aldoheptoses. The asymmetric C atom of D-glycero- is represented in the scheme as having the same configuration as that shown for each of the corresponding asymmetric groups (number 3 in tetroses, 4 in

pentoses, 5 in hexoses).¹ The common names of physiologically important sugars are shown in bold type.

A series of 14 other aldose monosaccharides, to be regarded as derivable from L-glycerose

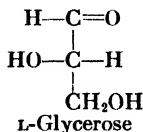

could be similarly represented. Each sugar in the series would have the configuration of the penultimate C atom represented as HO--C--H. Each of these sugars would be an "optical mate" or optical antipode of the corresponding sugar in the scheme as shown. In other words, each one would have its stereoisometric configuration the mirror image of that of its antipode. All of these sugars are producible by artificial synthesis but, except for L-arabinose, obtainable by hydrolysis of a number of natural carbohydrates, members of the L-series are rarely found.

These two series are conventionally written with the prefixes D- or L- to indicate their relation, respectively, to D-glycerose and L-glycerose. It must be clearly understood: *These prefixes do not primarily indicate the direction of the rotation of the plane of polarized light* although their use arose historically from the terms *dextro-* and *levo-*.²

The ketoses are obtainable by suitable transformation of the corresponding aldoses (p. 16) so that the stereoisomeric relations as outlined apply to all the monosaccharides. The prefixed letter is also used with the same significance for the ketoses as for the aldoses. The value of this convention is well illustrated in the case of D-glucose and D-fructose. They are readily interconvertible, yield the same products in certain reactions (p. 16), and are both related to D-sorbitol, to which either may be

¹ A shorthand notation often used is as follows:

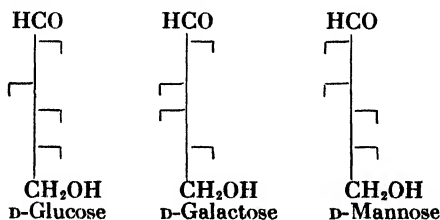

² The use of the prefixes D- and L- (small Roman capitals) is preferable for indicating stereoisomeric configuration. The use of *d-* and *l-* (small italics) for this purpose, as formerly practiced, seems to be losing favor. The latter prefixes are reserved, in some publications, for indicating the direction of rotation. A useful convention indicates both configuration and direction of rotation. Thus, D-(+)- shows D configuration and dextrorotation, while D-(-)- shows D configuration and levorotation.

reduced although fructose also yields D-mannitol because the newly formed asymmetric group at C atom 2 may assume either configuration.

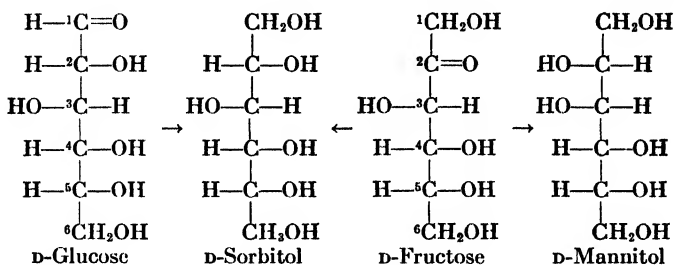

Specific rotation is comparative rotatory power and may be defined as the rotation (expressed in angular degrees) which the pure substance would show when 1 g. of it is dissolved in water, made up to a volume of 1 ml., and observed in a polariscope tube 1 dcm. long. Unless otherwise indicated, it is assumed that the specific rotation is measured by the use of plane-polarized, pure sodium light. It is also assumed, unless otherwise indicated, that the measurements are made at approximately 20°C. The symbol $(\alpha)_D$ is then used to represent specific rotation. If polarized light of some other wave length is used or if some other temperature prevails, the symbol is appropriately modified. Thus $(\alpha)_{546}^{90}$ indicates specific rotation at 90°C., observed with plane-polarized light of wave length 546 m μ . Actual observations are converted to

values for specific rotation by use of the formula, $(\alpha)_D = \frac{\alpha}{w \times l}$ in which α is the rotation actually observed in angular degrees, w is the weight in grams of the pure substance dissolved in 1 ml. of the observed solution, and l is the length of the tube in decimeters. Dextrorotation is commonly indicated by the + sign, levorotation by the - sign. For sugars of known identity whose solutions contain no other optically active substance or only those for which due allowance can be made, the formula is very useful for practical quantitative measurements. If $(\alpha)_D$ is known and α and l are measured, w or $100 \times w$ (per cent of the sugar solution) can be obtained. Thus the polariscope is of great practical as well as theoretical value in sugar chemistry.

Mutarotation. The monosaccharide formulas, as so far presented, are unable to account for a number of the properties of sugars. One of the discrepancies is the phenomenon of mutarotation or changing rotation. When a monosaccharide is dissolved in water and observed polariscopically as soon afterward as possible, its specific rotation is different from that observed later. This was described in the case of glucose as far back as 1846 by Dubrunfaut; but in spite of many attempts

to form a theory to explain the phenomenon, no satisfactory theory was possible until recent years. A helpful discovery appeared in 1896 when Tauret succeeded in obtaining a modified form of glucose. Using ordinary pure glucose, for which $(\alpha)_D$ of the freshly prepared solution is approximately $+111^\circ$, he dissolved it in boiling pyridine. When it cooled he obtained crystals of a form of glucose, now designated as β -D-glucose,

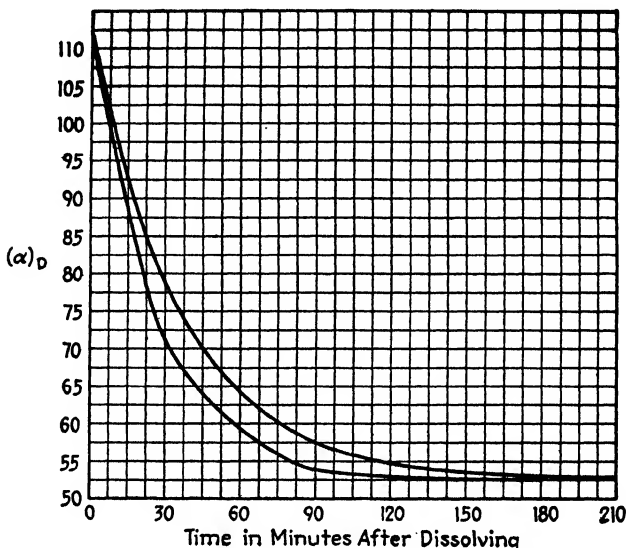

FIG. 1. Mutarotation of α -D-glucose. During the experiment represented by the upper curve the temperature was lower than that prevailing during the one represented by the lower curve. Extrapolation to zero time suggests that the initial specific rotation was approximately $+111^\circ$. Equilibrium is reached at approximately $+52.5^\circ$.

which showed $(\alpha)_D = +19^\circ$ (approximately) in freshly prepared aqueous solution. This form can also be obtained by crystallizing glucose from warm water, above 70°C . The other form, α -D-glucose, is usually crystallized from methanol. Both forms show mutarotation, the α -form decreasing, the β -form increasing in specific rotation until, at equilibrium, $(\alpha)_D = 52.5^\circ$ in either case. The rate of the change at room temperature in pure water is indicated in Fig. 1 but is hastened by rise of temperature and is quite sensitive to the effect of the H ion activity of the solution. Slight alkalinity, such as that obtained by adding a little NH_4OH , brings the specific rotation of α -D-glucose to $+52.5^\circ$ in a few minutes.

Mutarotation has been observed in the case of many sugars. All the monosaccharides show this phenomenon, as do also the disaccha-

rides, except those which do not show the presence of any free aldehyde or ketone group.

It seemed difficult to account for mutarotation effects without postulating the presence of an asymmetric C atom in addition to those already described. But its behavior and location in the sugar molecule were not clearly demonstrated until the study of certain derivatives of sugars had developed.

Methyl Glucosides. Among the sugar derivatives whose study was especially elucidative for the theory of sugar structure, methyl glucosides early assumed prominence. If a solution of a sugar in boiling methanol is treated with 0.5 per cent hydrogen chloride to serve as a catalyst, the product no longer shows aldehyde or ketone properties and is found to have a methyl group substituted for a hydrogen atom. Such substitution products are known as "glycosides" (p. 42), including pentosides, hexosides, etc. The specific product obtained with methanol and glucose is methyl glucoside. The reaction, a dehydration synthesis, may be written thus:

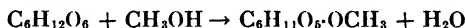

From the products of this reaction, Emil Fischer (1893) succeeded in isolating two stereoisomers, the α - and β -forms, with different specific rotations but showing mutarotation at a relatively slow rate. These and other properties of the isomers eventually led to the formulation of their structure, which may be represented thus:

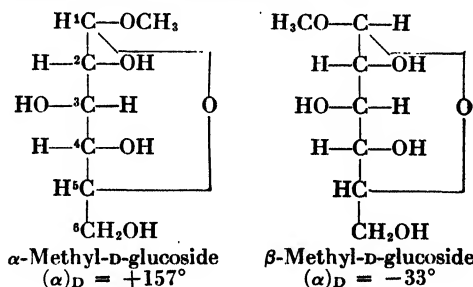

It is seen that C atom 1 is asymmetric and is oriented differently in the α - and β -forms. The C atom concerned is part of a ring structure. As shown here the ring is a six-membered one composed of an oxygen atom and 5 carbon atoms. It may be called an "amylenoxide" ring. Other ring formations are possible. They might be the three-membered ethylene oxide ring, the four-membered propylene ring, or the five-membered butylene ring. The six-membered one as shown above is by far the most probable. This becomes quite apparent upon setting up a three-dimensional model using C atoms of the conventional pattern.

One finds that the C atoms can fall into such a position that the first and the fifth ones are in a close spatial relation. This suggests that they could be tied together by an oxygen atom. Six-membered rings composed wholly or chiefly of C atoms are relatively stable. Nevertheless, the possibility of other ring formations cannot be excluded. Indeed, the methylation process, if carried out at room temperature, results in the production of methyl glucosides for which indirect evidence obtained by study of their derivatives indicates the structure

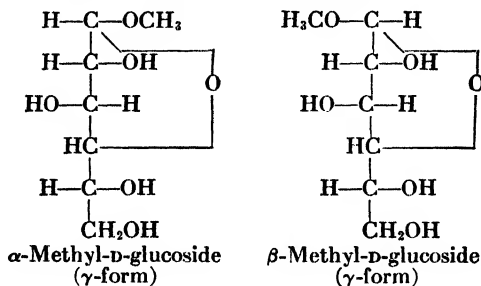

These forms are relatively unstable and on long standing or on heating above 66°C . are converted into the six-membered ring forms. For this reason they have not been isolated as the free sugars.

The Ring Structures of Sugar Molecules. The ring structures of relatively high stability, for which there is good evidence in the case of the glycosides, appear to correspond to similar though more mutable forms in sugar molecules. Sugars are readily obtained from methyl glycosides by hydrolysis and vary in their properties according to the specific glycoside hydrolyzed. Thus, from α -methyl-D-glucoside, for which $(\alpha)_D = +157^\circ$, one obtains α -D-glucose, $(\alpha)_D = +111^\circ$ (initially), while β -methyl-D-glucoside, $(\alpha)_D = -33^\circ$, yields β -D-glucose of initial specific rotation $+19^\circ$.

Haworth (1929) suggested that the two forms of rings that have been clearly indicated as occurring in the sugars and the glycosides be so designated as to indicate their relationship to the simplest organic compounds with corresponding ring structures. They are *pyran* and *furan*.

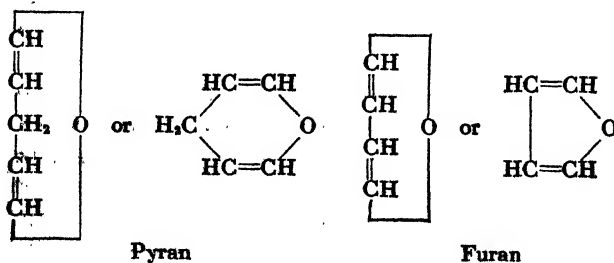

According to this scheme, the four forms of glucose corresponding to the four methyl glucosides presented above would be:

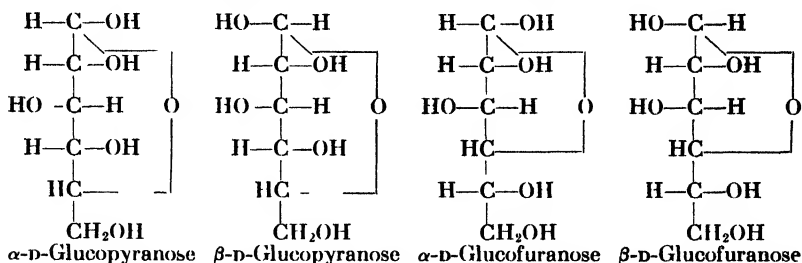

They may also be represented in cyclic form, thus conforming to the conventional manner of showing heterocyclic structures.

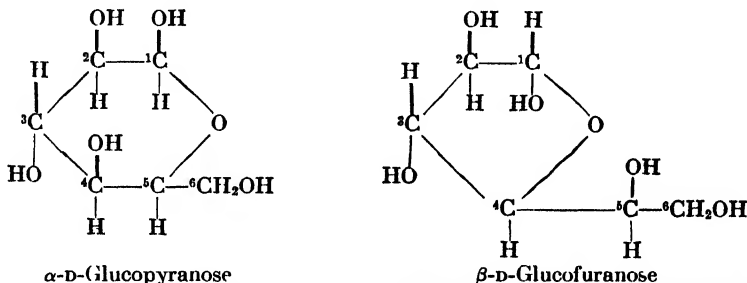

Heavy and light lines connected to asymmetric C atoms suggest projection of attached bonds above and below the plane of the paper, respectively.

Ketoses show the same evidence of ring formation as do the aldoses. Thus we have: α-D-fructopyranose, β-D-fructopyranose, α-D-fructofuranose, and β-D-fructofuranose.

The mutability of the monosaccharide molecular structure is sufficiently pronounced to suggest that ring forms other than pyranose and furanose may arise. They may be prepared as glucosides by means of suitable syntheses, but the corresponding sugars when liberated by hydrolysis may be too unstable to permit a study of their characteristics. All tend to mutate to the pyranose form. Even the furanoses which occur in natural glucosidic compounds tend to do so when freed by hydrolysis.

The Theory of Mutarotation. The chief process occurring while mutarotation progresses to equilibrium appears to be the change of the α-form to the β-form or vice versa. The chemical mechanism involved is not clear but is assumed to be the opening up of the ring structure to the free aldehyde or ketone condition. Further assuming this to be reversible, the process is represented thus:

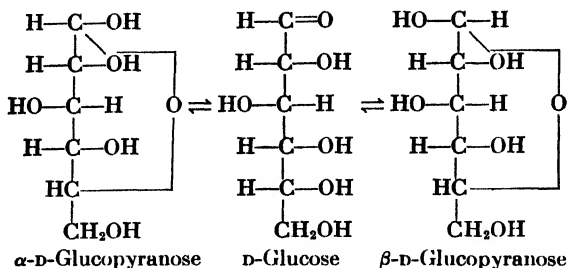

At equilibrium, when $(\alpha)_D = +52.5^\circ$, these four changes are proceeding at such relative rates that approximately 37 per cent appears to be in the α -form and 63 per cent in the β -form.

This theory may be applied with suitable modifications to explain the nature of mutarotation of any sugar. The specific rotations of the α - and

TABLE 1.—VALUES FOR SPECIFIC ROTATION¹ OF MUTAROTATING SUGARS

Sugar	α -Form	At equilibrium	β -Form
	angular degrees	angular degrees	angular degrees
Monosaccharides:			
D-Glucose.....	+111.0	+ 52.5	+ 19.0
D-Fructose.....	- 21.0	- 92.0	-133.5
D-Mannose.....	+ 34.0	+ 14.6	- 17.0
D-Galactose.....	+144.0	+ 80.5	+ 52.0
L-Rhamnose.....	- 7.7	+ 8.9	+ 54.0
D-Arabinose.....	- 54.0	-105.0	-175.0
L-Arabinose.....	+105.0
D-Xylose.....	+ 92.0	+ 19.0	- 20.0
Disaccharides:			
Lactose.....	+ 90.0	+ 55.3	+ 35.0
Maltose.....	+168.0	+136.0	+118.0
Cellobiose.....	+ 72.0	+ 35.0	+ 16.0
Melibiose.....	+179.0	+142.5	+124.0
Gentiobiose.....	+ 39.0	+ 9.6	- 11.0

¹ The values are for solutions of less than 10 per cent at approximately 20°C. Values for α - and β -forms are obtained by extrapolation and therefore subject to considerable uncertainty. Values not obtained by actual observation, but calculated from other data, are shown in italics.

β -forms and of the equilibrium mixtures are given in Table 1 for a number of sugars of physiological interest, including some disaccharides.

That some of the sugar in a solution is in the free aldehyde or ketone form seems probable because sugars actually give reactions involving oxidations or reductions such as aldehydes and ketones afford. On the other hand, sugars do not oxidize as rapidly as might perhaps be expected if any large proportion of their molecules were present as free aldehydes

or ketones. It is clear that, with the α - and β -ring forms in equilibrium with the "open" form, all of the sugar is *potentially* aldehydic or ketonic.

The Characteristic Reactions of Monosaccharides. The relationships of the monosaccharides to each other as indicated by methods of synthesis (p. 4) afford some evidence of their molecular structure. A brief summary of some of the most important other evidence will be given here.

An aldose heated with a concentrated solution of HI loses all of its oxygen and is converted into an iodo compound. Thus glucose yields iodoheptane, $C_6H_{13}I$, which is a derivative of *normal* hexane. This reaction proves that the chain of C atoms of the sugar is not branched.

Polyhydric Alcohol Reactions. The sugars readily form alcoholates with metallic hydroxides. To a mild degree, then, a sugar has acid properties in the form of replaceable hydrogen. Apparently more than one of the —OH groups can behave in this way. The relative tendency to dissociate as an acid is, as would be expected, very low. Expressed in the conventional way as pK values (log of reciprocal of the dissociation constant), the first and second dissociation constants for some sugars are represented as follows:

	pK ₁	pK ₂
Glucose.....	12.00	13.85
Fructose.....	11.08	13.24
Sucrose.....	12.00	13.52

Such values indicate that sugars behave as acids only in distinctly alkaline solutions. Attempts to measure a third dissociation constant meet with serious difficulty because sugars are markedly unstable in alkaline solution.

Further evidence of the presence of the alcohol groupings is seen in the *formation of sugar esters*. Like simple carbinols, the sugars esterify with both organic and inorganic acids. In the case of acetic acid (acetylation), for example, the synthesis may be carried out by treating the sugar with acetyl chloride, $CH_3CO\cdot Cl$, in cold pyridine which neutralizes the HCl set free. The reaction is

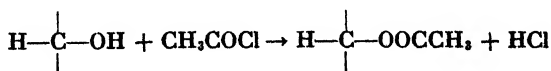

The total number of acetyl groups which can be introduced by complete esterification of the sugar is a measure of the number of —OH groups in

its molecule. Thus glucose can form a pentaacetate, arabinose a tetra acetate, etc.

Another reaction involving the alcoholic properties of sugars is *ether formation*. The production of the glycosides as described above might be regarded as an example inasmuch as the alkyl group is attached by the ether linkage. But the glycosides differ from typical ethers in that they are readily hydrolyzed. Starting with glycosides, however, the true sugar ethers (resistant to hydrolysis) can be formed by use of suitable reagents. One of them introduced by Purdie and Irvine (1903) is an alkyl iodide in the presence of silver oxide. The reaction is essentially

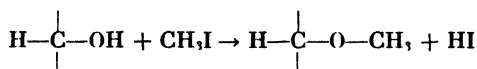

Thus tetramethyl-methyl glucoside, trimethyl-methyl fructoside, and the corresponding polyethers of other sugars have been synthesized. Again a measure of the total number of —OH groups is obtained.

Aldehydic and Ketonic Reactions. In addition to the cyanhydrin reaction and the reductions and the oxidations described above, a number of other reactions are dependent upon and give evidence for the aldehyde or ketone structure of sugars.

The reactions which are perhaps most frequently used as a quick test for the majority of sugars are those involving the reduction of metallic hydroxides. There are many modifications. The oldest employs CuSO_4 in a solution of KOH . It is sometimes called **Trommer's test**. If an excess of copper be avoided, all of it will be reduced upon boiling with a reducing sugar to the red cuprous oxide, Cu_2O , the sugar being oxidized. In the more familiar and long used **Fehling's test**, sodium potassium tartrate is dissolved in KOH solution to which CuSO_4 is added. The copper is thus prevented from forming black cupric oxide, CuO , so that smaller concentrations of sugar are detectable than in **Trommer's test**. A further improvement, **Benedict's test**, employs Na_2CO_3 instead of KOH and sodium citrate instead of the tartrate. This permits the detection of relatively small amounts of sugar. Ammoniacal copper solutions are sometimes used. Metallic hydroxides other than copper are employed in some tests, e.g., bismuth in the **Nylander-Almen test** and silver in ammoniacal solution in the familiar general test for aldehydes. The reduction of metallic salts even in acid solution can be effected by sugars to some extent. In **Barfoed's test** copper acetate in dilute acid shows reduction to Cu_2O with monosaccharide sugars after some 30 sec. boiling, but with reducing disaccharides only after boiling several minutes to permit hydrolysis of the disaccharide.

The reaction with phenylhydrazine, known as the osazone test, is widely used. The yellow osazones produced are readily crystallized into forms which in several cases serve to identify the sugar. The reagent used may be the free base, phenylhydrazine, with acetic acid or phenylhydrazine hydrochloride, $C_6H_5 \cdot NH \cdot NH_2 \cdot HCl$, with sodium acetate. In either case the reaction goes on in acid solution and best at pH about 5. The reaction occurs in two stages, (1) formation of phenylhydrazone and (2) formation of phenylosazone. The first reaction can be demonstrated by keeping the solution at room temperature. In the case of glucose, the reaction is

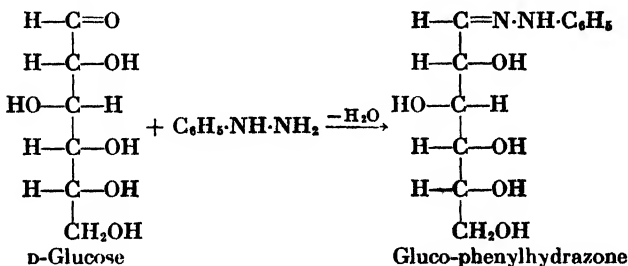

The phenylhydrazone probably has a cyclic structure since its solutions in ethanol-water mixture or in pyridine show mutarotation.

The reaction tends to proceed further with excess of the reagent and especially at higher temperatures. It is usually done at 100°C. The phenylhydrazone reacting at boiling temperature with 2 mols of phenylhydrazine forms aniline, ammonia, and the osazone

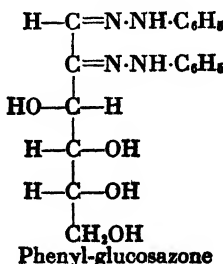

Glucosazone is so slightly soluble that it crystallizes at 100°C from concentrated solutions and at lower temperatures from quite dilute ones. It is claimed that 5 mg. glucose in 10 ml. will form a detectable amount of osazone crystals. Other sugars yield osazones which are more soluble but nevertheless crystallize out with sufficient ease to facilitate their detection. After the osazone has been recrystallized, the melting point, which is characteristic for each osazone, may be taken.

Glucose, fructose, and mannose yield the *same* osazone, *glucosazone*. The condensation with phenylhydrazine masks the atomic groupings distinctive for these three sugars. Confirmatory of this relationship and of the aldehyde and ketone structure is the *interconversion* of these three sugars in solutions of weak alkalinity, such as that furnished by $\text{Ba}(\text{OH})_2$ or $\text{Ca}(\text{OH})_2$. Starting with α - and β -glucose in equilibrium, the alkalinity results in a slow falling off of specific rotation, which in about 24 hr. may decrease until the solution has no rotatory power. This is due to the levorotation of fructose formed from some of the glucose and counteracting its dextrorotation. But mannose also appears in low concentration. This reaction is believed to be due to a reversible enolization between the groups at C atoms 1 and 2.

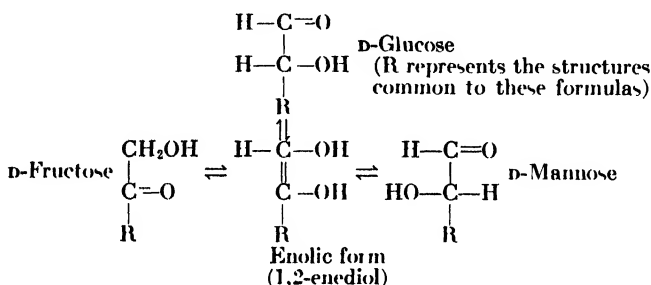

Oxidation of Monosaccharides. Under conditions of mild oxidation of sugar in alkaline solution, sugar acids are produced. The latter reaction is illustrated in the case of glucose by the formation of D-gluconic acid under mild oxidation with bromine water.

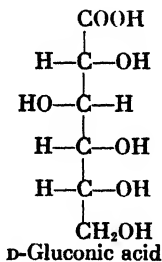

Like all similar sugar acids, it dehydrates in solution to form a ring structure known as a "lactone," which, in the case of D-gluconic acid, has been shown to exist as either a furanose-like or a pyranose-like structure.

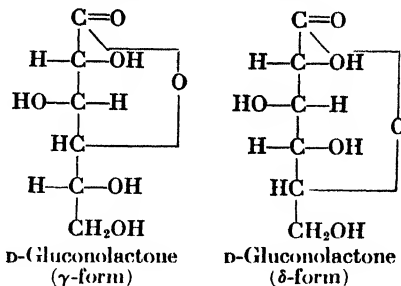

By varying the conditions of oxidation, other sugar acids may arise. With HNO_3 not only the aldehyde group but also the primary alcohol group at C atom 6 is changed to a carboxyl. Thus D-glucose yields saccharic acid and D-galactose forms mucic acid. The latter, because of its low solubility, crystallizes out readily and so affords a useful test for galactose.

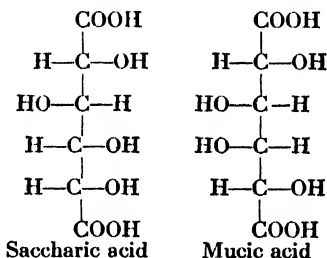

The uronic acids are biologically the most important of the sugar acids. Glucuronic acid is produced by reduction of the lactone of saccharic acid, using sodium amalgam and dilute H_2SO_4 .

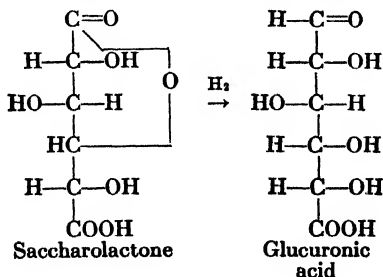

A number of uronic acids have been described as occurring in nature, but glucuronic acid is the one most frequently found, usually as a unit structure of polysaccharides and other complex biological materials. It is found in urine as glucuronates.

In warm alkaline solution exposed to air, many oxidation products of smaller molecular weight are formed. From D-glucose, for example,

a large number of acids may be obtained. They include carbon dioxide, formic acid, glycolic acid ($\text{CH}_2\text{OH}\cdot\text{COOH}$), oxalic acid ($\text{COOH}\cdot\text{COOH}$), DL-glyceric acid ($\text{COOH}\cdot\text{CHOH}\cdot\text{CH}_2\text{OH}$), four different stereoisomeric trihydroxybutyric acids [$\text{COOH}\cdot(\text{CHOH})_2\cdot\text{CH}_2\text{OH}$], eight tetrahydroxyvaleric acids [$\text{COOH}\cdot(\text{CHOH})_3\cdot\text{CH}_2\text{OH}$], and some others.

Desoxysugars. Sugars containing fewer O than C atoms are known as desoxysugars or desoses. Their study has assumed prominence because they are obtained by the hydrolysis of certain biologically important substances. A desoxyribose, for example, is thus shown to be a component group of some nucleic acids from various sources. Although it had long been known that nucleic acids yield sugar upon hydrolysis and although it had been possible to identify the sugar from typical plant nucleic acids as the pentose D-ribose, many attempts to discover the nature of the sugar from typical animal nucleic acids were inconclusive until Levene (1929) showed that it was 2-desoxy-D-ribose.

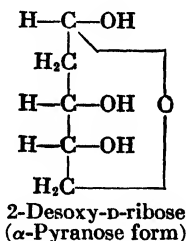

The properties of the 2-desoxysugars are similar to those of the common sugars, but they do not form osazones owing to the lack of an alcohol or carbonyl grouping at C atom 2. The formation of *levulinic acid*, $\text{CH}_3\cdot\text{CO}\cdot\text{CH}_2\cdot\text{CH}_2\cdot\text{COOH}$, upon treatment with mineral acid, a reaction given by hexoses but not by simple pentoses, is obtained with 2-desoxyribose.

Sugars of another type, the 6-desoxysugars, occur in nature. Their structure, represented by that of L-rhamnose, 6-desoxymannose, has been established by reduction of the iodo-derivative. In principle, the reaction may be shown thus:

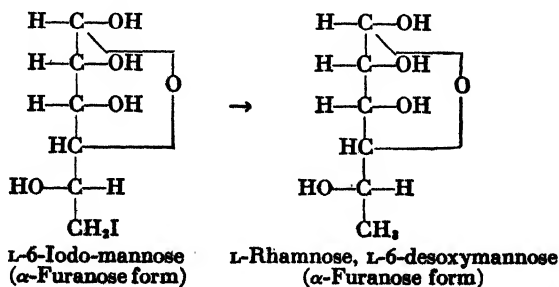

The 6-desoxyhexoses were formerly known as *methyl pentoses*, but their derivation and properties have led to their characterization as *desoses*. L-Rhamnose is obtained by the hydrolysis of a number of plant glycosides and also from di- and trisaccharides.

The Amino Sugars. Sugars containing the amino group, $-\text{NH}_2$, are widely distributed in nature. Only two, **D-glucosamine** and **D-galactosamine**, are definitely identified from natural sources although several others have been prepared synthetically.

Glucosamine is obtained as one of the hydrolysis products from a number of proteins, but the most abundant source is chitin, the chief material of crustacean exoskeletons, hence the older name of this sugar, *chitosamine*. Its reactions and also its artificial synthesis lead to the structural formula

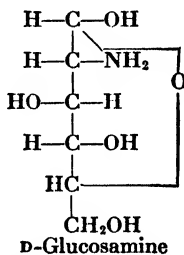

D-Glucosamine
2-Amino-D-glucopyranose
(Shown in the α -form)

It is usually separated as the hydrochloride after the hydrolysis of the protein or chitin yielding it. It readily forms "salts" with mineral acids because of the amino group. The hydrochloride exhibits mutarotation. It gives the usual sugar reduction tests and has a sweet taste with a somewhat bitter aftertaste. It can be converted into either glucose or mannose. Another amino sugar, apparently D-galactosamine, is derived from chondromucoid, a protein of cartilage.

Occurrence of Monosaccharides in Nature. Of the many monosaccharides known to the organic chemist, only two, D-glucose and D-fructose, have been clearly shown to exist free, as such, in the normal tissues or fluids of animals although other sugars arise as the result of the action of certain bacteria in suitable media. Other natural monosaccharides are obtained by hydrolysis of more complex substances.

Glucose is the sugar of blood and other animal fluids and is readily taken up by tissue cells. It is also present in many fruit juices. In corn and potatoes its concentration in proportion to starch varies with the degree of ripening and with temperature and light. It is probably produced in all green plants although its conversion into starch, cellulose, and other plant products may prevent its presence in readily detectable concentration. Fructose is found in a number of fruit juices and with

other sugars in honey. An abundant source of both glucose and fructose is the disaccharide sucrose which readily hydrolyzes to yield 1 mol of each.

Sources of combined monosaccharides are indicated in Table 2 which includes the known, naturally occurring ones with the exception of a few rare sugars of plant origin.

DISACCHARIDES

Most of the disaccharides are sugars of the general formula $C_{12}H_{22}O_{11}$. This means that they hydrolyze to yield 2 mols of hexoses. Sucrose hydrolyzes to D-glucose and D-fructose; lactose, to D-glucose and D-galactose; maltose, to 2 mols of D-glucose.

More than one disaccharide may be built from the same constituent monosaccharides. This would be puzzling were it not for knowledge of the varying forms which a monosaccharide molecule can take and of the different ways in which they can eliminate the components of water so as to join together. There are, for example, at least six different natural disaccharides which, upon hydrolysis, yield 2 mols of D-glucose; yet all are distinguishable by their properties, optical, chemical, and physiological.

A few disaccharides, obtainable from the incomplete hydrolysis of more complex biological substances, such as glycosides, yield 1 or 2 mols of a pentose, xylose, or arabinose.

Lactose. Milk sugar, constituting about 4.8 per cent of cow's milk and about 6 per cent of human milk, is easily prepared by crystallization from the protein-free filtrates of milk. It responds to the reduction tests, forms a characteristic osazone, lactosazone, and yields mucic acid when heated with nitric acid. It is dextrorotatory and shows mutarotation (p. 12). One of its constituent monosaccharides must have a potentially free aldehyde group which can be oxidized, form addition products with phenylhydrazine, and change between α - and β -forms. The accepted structure based upon indirect evidence may be represented as

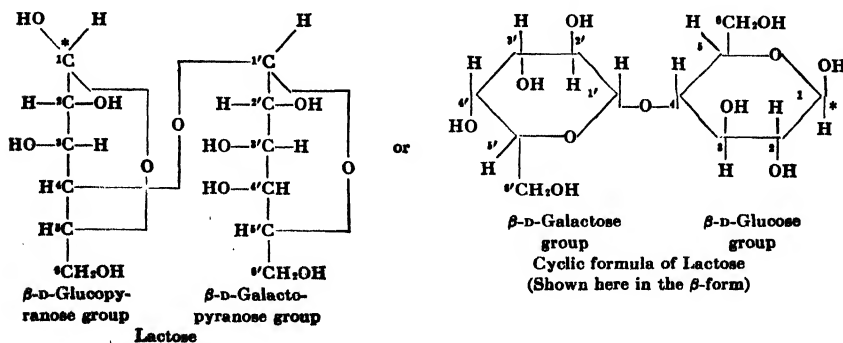
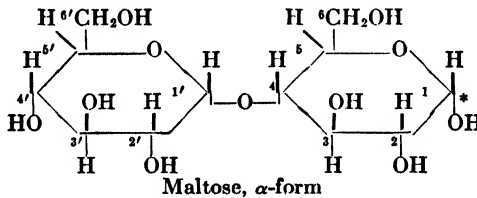

TABLE 2.—NATURALLY OCCURRING MONOSACCHARIDES AND THEIR SOURCES
 Sugar Source Yielding the Sugar Upon Hydrolysis

Trioses:	
D-Glycerose	Not separated as such but both are identified as phosphoric acid esters in yeast and muscle
Dihydroxyacetone	
Aldopentoses:	
D-Arabinose	Some constituent of tubercle bacilli; the glucoside barbaraloin
L-Arabinose	Gum arabic, cherry, and similar tree gums containing polysaccharides, the so-called "arabans"; pentosans of bran, seed, etc.; the disaccharide vicianose
D-Xylose	Pentosans, the so-called "xylans" of wood gums, oat hulls, cotton-seed hulls, corncobs, straw, and bamboo
D-Ribose	Nucleic acid of yeast and wheat germ; other nucleic acids; riboflavin (vitamin B ₂) as ribityl
2-Desoxy-D-ribose	Thymus nucleic acid and certain of its derivatives and related substances, other nucleic acids
Aldohexoses:	
D-Glucose	Starch; cellulose; glycogen; many plant glucosides; several di-, tri-, and tetrasaccharides
D-Galactose	Lactose; the trisaccharide raffinose, the tetrasaccharide stachyose, a number of plant glycosides, galactolipins of nervous tissue, agar-agar and similar so-called "galactans"
D-Mannose	The so-called "mannosans" of plants as in the ivory nut of the tagua palm, cellulose-like complexes of white spruce, strophanthus glycosides
L-Rhamnose	The disaccharides rutinose and strophanthobiose, the trisaccharides robinose and rhamninose, a number of glucosides from various plant sources
D-Isorhamnose	Purgic acid, the glycoside chinovin
D-Rhodoese, (D-fucose, 6-desoxy-D-galactose)	The glycosides convovulin and jalopin
L-Fucose (6-desoxy-D-galactose)	Gum tragacanth; a so-called "fucosan" of the seaweed Japanese Nori
Digitalose (6-desoxy-3-methyl-D-galactose)	
Digitoxose (2,6-didesoxy-D-allose or altrose)	A glycoside of <i>Strophanthus</i>
Digitoxose (2,6-didesoxy-D-allose or altrose)	Digitalis glycosides
Ketoheptoses:	
D-Fructose	The levulan (fructosan) inulin of the storage parts of the Compositae, sucrose, the trisaccharides, raffinose, melezitose, and gentianose
L-Sorbitose	Juice of fruits containing D-sorbitol after oxidation by <i>B. zylinum</i>
Amino aldohexoses:	
D-Galactosamine	Chondroitin-H ₂ SO ₄ from mucoids of certain animal tissues
D-Glucosamine	Chitin of the arthropod exoskeleton, mucin of saliva, etc.
Ketoheptoses:	
D-Mannoketoheptose	Avocado pear, <i>Persea gratissima</i>
Perseulose (probably L-galactoketoheptose)	Juice of avocado after its alcohol persitol (from reduction of D-mannoketoheptose) is oxidized by <i>B. zylinum</i>
Sedoheptose	Some constituent of the stonecrop, <i>Sedum spectabile</i>

Inspection of these formulas will show that they so represent lactose that its descriptive name could be β -D-pyranogalactosido-1-4- β -D-glucopyranose. The grouping around the carbon atom indicated by an asterisk is the potentially free aldehydic one which accounts for mutarotation.

Maltose. The best and most abundant source of maltose is starch when subjected to hydrolysis by the enzyme *amylase*. The latter occurs in various plant and animal products. But maltose is the structural unit of a large number of biological materials of plant origin. It does not appear to occur free in nature except in so far as it is liberated by enzymes, as, for example, in malted grain and in the animal digestive system. Maltose is a reducing sugar which forms a characteristic osazone, maltosazone, and shows mutarotation. Like lactose, then, its constituent monosaccharides are so linked as to leave a potentially free aldehydic group. Its structure is represented as



It is thus indicated as α -D-pyranoglucosido-1-4-D-glucopyranose. The part of the molecule which can mutate to give the α - and β -forms is indicated by an asterisk.

Cellobiose. From purified cellulose, such as filter paper or absorbent cotton, a disaccharide formerly called *cellose*, now known as *cellobiose*, has been prepared. Although not found in nature it has especial interest because of its relationship to cellulose. It would seem to be a structural unit or "building stone" of cellulose in the same sense that maltose is a unit of the starch molecule.

The properties of cellobiose are very similar to those of maltose: Reducing power, osazone formation, mutarotation, hydrolysis to yield 2 mols of D-glucose. Moreover, it possesses a 4-1 glucosidic linkage. Yet its melting point and specific rotation are distinctly different from those of maltose.

An explanation of the difference between maltose and cellobiose is found in the nature of the glucosidic linkage. Cellobiose is not hydrolyzed by the enzyme *maltase* of yeast but is by the glucosidase, commonly called *emulsin*, of almonds; for maltose, the results are the reverse of those for cellobiose. The two enzymes are characterized by their specific ability to hydrolyze glucosides, maltase acting, for example, on α -methyl-D-glucoside and emulsin on β -methyl-D-glucoside. In fact

only an enzyme known to be specific for α -D-glucosidic hydrolysis can split maltose and only one for the β -D-glucosidic hydrolysis can split cellobiose. The case is comparable to that of the enzymatic splitting of lactose, which cannot be hydrolyzed by an α -galactosidase but is split by the galactosidase derived from the fungus kephir and shown to be a β -galactosidase.

Inspection of the formulas for lactose and maltose shows how these observations are taken into account. The configuration at the C atom 1' of the galactose group is trans to that of C atom 2' and is thus shown as the reverse of the corresponding configuration in maltose. The formula for cellobiose is therefore represented as follows:

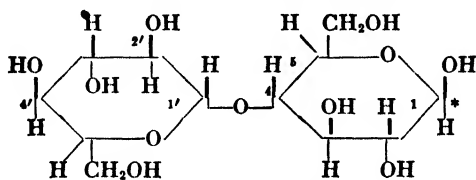

Cellobiose, β -form

(α - and β -forms are due to mutation at the C atom indicated by an asterisk.)

One may note that in comparison with the maltose formula the aldehydic pyranose ring is identical; but the glucosidic pyranose ring, the one printed at the left, is shown as though the corresponding part of the maltose structure were rotated through 180° on an axis passing through C atoms 1' and 4' and in the plane of the paper. The resulting isomerism differs from that due to the potentially aldehydic group which permits both maltose and cellobiose to exist in two forms.

Other Reducing Disaccharides. The entire group of disaccharides might be divided into reducing sugars (which have a free or potentially free aldehydic group) and the nonreducing ones in which any such groups are bound.

Of reducing disaccharides some differ from the ones described above by having C atom 6 instead of C atom 4 taking part in the glucosidic linkage. One of them is *gentiobiose*. It occurs in the form of a trisaccharide *gentianose* in various species of gentians. It is liberated from the trisaccharide by mild hydrolysis. It hydrolyzes to yield 2 mols of glucose. It is split by emulsin and is thus shown to have the β -glucosidic configuration as in lactose and cellobiose. Except for a characteristic melting point and specific rotation, gentiobiose has properties very similar to those of maltose.

Another similar disaccharide is also obtained by mild hydrolysis of the trisaccharide *raffinose*, usually prepared from the sugar beet but obtainable from many plants. This disaccharide is named **melibiose**.

It has been shown to have, like gentiobiose, the 6-1 linkage, but upon hydrolysis it yields 1 mol each of galactose and glucose. The galactosidic linkage has the α -configuration.

A disaccharide known as **isomaltose** has been the subject of some controversy. It was thought to arise during the action of maltose-splitting enzymes upon maltose but was later claimed to result from the action of amylase on starch. It is believed to be a glucose α -glucoside but to have the 1-6 rather than the 1-4 linkage. **Isolactose** and **isocellobiose** are also imperfectly characterized.

A disaccharide called **turanose** is apparently a glucosido-fructose. It is obtained by the partial hydrolysis of the trisaccharide *melizitose*, which occurs in the exudation from young branches of the larch tree. Turanose is of interest because it yields glucose and fructose upon hydrolysis as does the familiar sucrose, but it differs from sucrose in being a reducing sugar, forming an osazone, and exhibiting mutarotation.

Sucrose. The most familiar of all the sugars is sucrose (saccharose, cane sugar, beet sugar, etc.). Although widespread in nature in fruit juices and plant saps, its accumulation in amounts suitable for commercial preparation is more restricted. It is clearly the most important of sugars industrially, not even excepting glucose. Although very soluble, it readily crystallizes, and this together with some of its other properties makes its purification relatively easy. Its function in plants appears to be that of a readily transported reserve food.

While the breakdown of starch *in vitro* leads to maltose or glucose, the corresponding process in some living systems tends to form sucrose chiefly. A probable explanation is found in the action of certain enzymes in the reversible phosphorylation reactions, starch \rightleftharpoons glucose-1-phosphate, and glucose-1-phosphate \rightleftharpoons sucrose. Phosphorylation seems to be indispensable in sucrose synthesis in plants. Glucose-1-phosphate can be used in the cell for many purposes. It is thus apparent that starch and sucrose are complementary reservoirs of carbohydrate readily available for fuel and other uses.

The outstanding property of sucrose is its failure to give reduction tests, indicating its stability in the presence of mild oxidizing agents. It forms no osazone but hydrolyzes readily to yield glucose and fructose so that glucosazone appears when sucrose is used in the phenylhydrazine reaction. The constituent monosaccharides are so joined in the sucrose molecule that their respective aldehyde and ketone groups are not free to react.

Sucrose, which shows no mutarotation, has a specific rotation of $+66.5^\circ$. After hydrolysis the value is -20° . The process is therefore termed "inversion," and the resulting mixture of equal parts of glucose

and fructose is called **invert sugar**. Even the enzyme sucrase, from either plant or animal sources, is often called invertase. The hydrolysis of sucrose may be represented thus:

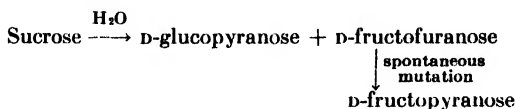

Sucrose appears to be α -D-pyranoglucosido-1-2-D-fructofuranose:

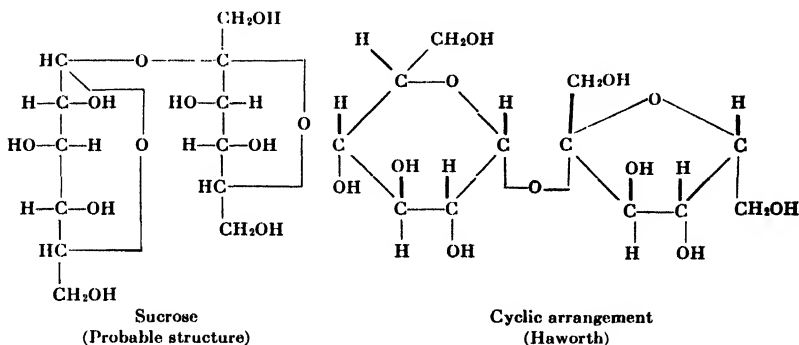

Trehalose. In addition to sucrose, another nonreducing natural disaccharide, trehalose, has been described. It is widely distributed in fungi and certain seaweeds. Its failure to give reduction tests indicates that it has no free aldehyde or ketone group. This is confirmed by failure to form an osazone and lack of mutarotation. On hydrolysis it yields 2 mols of glucose.

TRISACCHARIDES AND TETRASACCHARIDES

Some trisaccharides occur in nature in glycosidic union with various noncarbohydrate substances. From these plant glycosides, mild hydrolysis can set the trisaccharide free. Other trisaccharides occur in the free state in certain plant products.

Raffinose. This carbohydrate, also called "melitose" or "mellitriose," is the best known of the trisaccharides. Although widespread in nature, it is obtainable in quantity from few sources, *e.g.*, sugar beets, cotton seed, and the so-called "Australian manna."

It has no reducing power and does not show mutarotation. Its complete hydrolysis in acid solution yields one equivalent each of fructose, glucose, and galactose. Hydrolysis under the influence of the enzyme emulsin forms galactose and sucrose; but hydrolysis with sucrase (yeast) yields fructose and melibiose. These results lead to the following formulation of the raffinose structure:

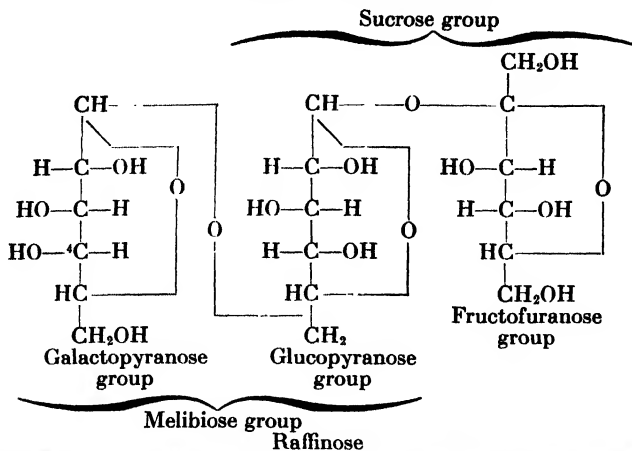

Gentianose. Gentianose is found in gentian roots. Its properties in general resemble those of raffinose, *i.e.*, it is nonreducing, shows no mutarotation, and forms no osazone. Its complete hydrolysis in acid solution yields 1 mol of fructose and 2 of glucose. Hydrolysis under the influence of emulsin yields glucose and sucrose; but with sucrase, fructose and gentiobiose are obtained. Its structure resembles that of raffinose except that it has a glucose group in place of galactose.

Other Trisaccharides. A trisaccharide named **melezitose** is obtained from an exudate, the so-called "manna," of the Douglas fir and the larch. Some other trisaccharides are of interest as natural sources of rhamnose. They include **rhamnino**, from certain glycosides. It yields 1 mol of galactose and 2 of rhamnose. Another is **robinose** from the glycoside robinine. It also yields 1 mol of galactose and 2 of rhamnose. Several trisaccharides have been described as products of the incomplete hydrolysis of higher carbohydrates.

Stachyose. A tetrasaccharide obtained from the tubers of *Stachys tubrifera* is a sweet sugar named stachyose. Other names for it are **mannotetrose** and **lupeose**. Other sources for it are some of the lupins, the "manna" of the ash tree, the twigs of white jasmine, and a few other plant structures. Its complete hydrolysis in dilute H_2SO_4 yields one equivalent each of fructose and glucose and two of galactose.

IDENTIFYING PROPERTIES OF SUGARS

Aside from the sharp division into reducing and nonreducing types, the sugars have many properties in common.

Comparative Sweetness. One naturally thinks of the sweet taste as characteristic of sugars, and this property does distinguish them

from all of the polysaccharides. The latter are tasteless. It is not a distinctive property. Many substances having no chemical relationship to carbohydrates have a sweet taste. Moreover, the sugars themselves vary widely as to their relative sweetness. Table 3 presents data as to the comparative sweetness of a number of sugars.

TABLE 3.—COMPARATIVE SWEETNESS OF SUGARS¹

Sugar	Relative Sweetness, Sucrose = 100
Fructose.....	173.3
Synthetic invert sugar.....	130
Invert sugar obtained by invertase.....	127.4
Glucose.....	74.3
Xylose.....	40
Maltose.....	32.5
Rhamnose.....	32.5
Galactose.....	32.1
Raffinose.....	22.6
Lactose.....	16

¹ Results based on determination of the average concentration of each sugar just detectable as sweet by 20 different subjects. (Biester, Wood, and Waklin, 1925.) For results by newer methods, see A. T. Cameron, Report 9, Sugar Research Foundation, Inc., New York, 1947.

The rarer sugars are variously reported as "faintly sweet," "quite sweet," etc., but quantitative data are not available.

Fermentability. The ability of any one organism to cause alcoholic fermentation of a sugar is more or less specific. The standard fermenting agent, bread or beer yeast, readily ferments glucose, fructose, maltose, and sucrose. It ferments mannose slowly and galactose very slowly. It appears to be unable to ferment any other monosaccharides. The fermentation of maltose and sucrose seems to involve a preliminary hydrolysis to their constituent monosaccharides. Yeasts are provided with enzymes specific for this purpose, and the failure to ferment other disaccharides and the tri- and tetrasaccharides may be attributable to the inability of the yeast to hydrolyze them. Ethanol and CO₂ are the chief products of yeast fermentation. Another alcoholic ferment is the substance known as "kefir grains," obtained from an Asiatic fungus. It readily causes the fermentation of lactose. It is the agent used in producing the fermented milk known as *koumyss*.

In addition to alcoholic fermentation, the acid type is also studied in connection with sugar chemistry. Although acids are produced to some extent along with other by-products in all types of fermentation, even the alcoholic kind, they are the predominant products in the case of a number of bacterial fermentations.

The α -Naphthol Reaction. A general test for carbohydrates is the **Molisch reaction**. All carbohydrates and all compounds containing a

carbohydrate grouping in the molecule respond positively. A few drops of a 5 per cent solution of α -naphthol in alcohol are added to the solution to be tested, which is then stratified upon concentrated H_2SO_4 . A reddish-violet color appears at the zone of contact. The reaction is due to the liberation of furfural

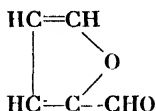

A furfural derivative is produced in some cases. Condensation with α -naphthol produces the color.

Special Tests for Sugars. To distinguish the sugars from one another the reduction tests (p. 14), the phenylhydrazine reaction (p. 15), the behavior with fermenting agents (p. 27), and the optical activity are of much aid; but certain special tests afford additional information sufficient in most cases for identification of the sugar.

The phloroglucinol-HCl test is a general reaction for pentoses; it is sometimes called the *Tollens reaction*. The sugar solution is treated with an equal volume of HCl which has been saturated with phloroglucinol (1,3,5-trihydroxybenzene). The mixture is kept at $100^\circ C.$, and in the presence of pentoses a cherry-red color develops. Galactose and glucuronic acid also respond similarly. The color given by galactose, however, has an absorption spectrum different from that given by pentoses. The test does not differentiate glucuronic acid. A modification of this reaction is the basis of quantitative methods for determining pentoses by the weight of the phloroglucinol compound formed.

The resorcinol-HCl reaction, known as *Seliwanoff's test*, is specific for ketohexoses. It is commonly used to detect fructose. The sugar solution is treated with about five volumes of a reagent containing 12 per cent HCl and 0.05 per cent resorcinol (*meta*-dihydroxybenzene). The mixture is kept at $100^\circ C.$, and a red color develops in the case of fructose. If a sufficient amount of the sugar is present, a brown precipitate forms. Its solution in ethanol has a brilliant red color. The reaction is due to the formation of hydroxymethylfurfural which, condensing with resorcinol, produces the red substance. The interconvertibility of glucose and fructose causes the former to yield at least some red color upon prolonged heating with the reagent.

The mucic acid test is given by galactose. Heated with HNO_3 , this sugar yields mucic acid (p. 17), which separates upon standing at room temperature as a white precipitate, sometimes in crystalline form. Any higher carbohydrate or glucoside yielding galactose may respond to the test. It is sometimes used to identify lactose in urine.

Determination of the *melling point* and the *specific rotation* are obviously very useful for complete identification of a sugar.

THE POLYSACCHARIDES

The classification of the polysaccharides is not very satisfactory because information regarding their structure is incomplete. A provisional classification is based upon the products of their hydrolysis. Thus there are hexosans and pentosans, which could be regarded as made up, respectively, of dehydrated polymers of hexoses and pentoses. These main groups may in turn be subdivided according to the individual sugars obtained upon hydrolysis. Thus we speak of glucosans, fructosans, arabans, xylans, etc. This scheme is satisfactory for some carbohydrates which hydrolyze to yield exclusively one monosaccharide. But polysaccharides may yield more than one monosaccharide and in some cases other products which are not sugars. Such substances are sometimes called "mixed polysaccharides."

Starch. Starch is abundant in many kinds of plants. It is laid down in the cells of the storage parts (roots, tubers, seeds, nuts, fruits) of all green plants with the exception of a few (such as the *Compositae*) which store a similar carbohydrate, inulin. Starches are also found in the leaves of many plants during and just after exposure to light. The disappearance of starch from leaf cells in the dark is only one instance of the reversibility of the starch-formation process in plants. Starch is deposited in the cells containing it in the form of distinct granules, the starch grains. Their form and structure are sufficiently characteristic for each plant species to be of real aid in the identification of the source of starch-containing materials and other commercial products of plant origin.

The composition of starch grains is somewhat complex. The chief constituents are amylose and amylopectin. Amylose might be thought of as the true starch. It is a widely distributed component of starches, and is the material which gives the typical blue color with iodine, while amylopectin gives a pale violet. The proportion of amylose to amylopectin varies in starches from different sources. The difference between amylose and amylopectin seems to be due (p. 31) to differences in molecular structure. Some kinds of starch grains appear to contain a small amount of hemicellulose (p. 36) in addition to the usual constituents. Starch grains always yield a small proportion of ash (0.2 to 0.4 per cent).

Disruption of the grains results from heating in the presence of water. The temperature required varies somewhat with starch from different sources but is in a range from about 64 to 71°C. In boiling water dis-

ruption is complete and rapid. The product is starch paste. Although the natural starch grains have a high specific gravity so that they settle out of water suspensions rapidly, starch paste separates into starchy and starch-free strata rather slowly. Pure amylose and the so-called "soluble starch," obtained by heating starch grains in the presence of a weak organic acid or dilute HCl, form clear and permanent solutions in water. The starch from the paste or the solution is easily precipitated out by the addition of alcohol.

The hydrolysis of starch goes on rapidly in boiling dilute mineral acid, slowly in boiling dilute organic acid. Enzymes called "amylases," such as salivary and pancreatic amylases and malt diastase, rapidly hydrolyze starch in neutral or near neutral solution. The product of enzyme hydrolysis is maltose and that of acid hydrolysis is glucose. The yield of glucose is so nearly quantitative that starch may justifiably be regarded as a glucosan. Part of the glucose may be in the form of a monophosphate.

The most familiar reaction of starch is the formation of the blue so-called *starch iodide* in the presence of Lugol's solution. The blue compound will not form, or if already formed will dissociate to a colorless condition, in the presence of alcohol, in an alkaline reaction, or at temperatures above about 60°C.

The molecular structure of starch has been intensively investigated. The liberation of maltose in the presence of an amylase would indicate that maltose is the unit or "building stone" of starch in somewhat the same sense that glucose is the unit of maltose. Enzymatic partial hydrolysis of starch yields various dextrans. A general scheme based on this fact may be represented as follows:

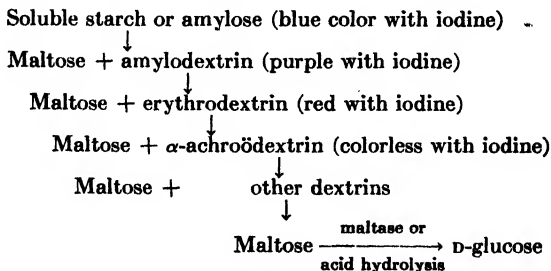

This scheme does not necessarily represent the chemical reactions as they may actually occur but merely indicates the probable course of hydrolysis. The older interpretation of the results of partial hydrolysis represented the starch molecule as a long chain of maltose units breakable at various indeterminate points. Later views were based upon the idea that relatively small molecules could form aggregates of varying

size due to auxiliary molecular valencies or coordinate valencies. This idea is perhaps helpful in explaining the behavior of starch paste; but in any case there must be large starch molecules, the structure of which is determined by typical chemical valencies. Modern views tend to the theory of an arrangement of chains of maltose groups attached to a "nucleus" which might itself be a chain of maltose groups or a closed ring structure consisting of several maltose groups or maltose and glucose units. The structure of the chainlike groups seems already clearly established and is that of glucopyranose units linked by the α -form of glucosidic union as in maltose. A part of the chain is shown thus:

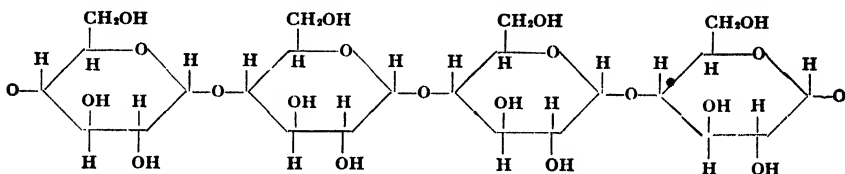

Some investigators reserve the name amylose to apply only to such "straight-chain," *i.e.*, unbranched, structures and consider that "amylopectins" are the "branched-chain" components of starch. Prepared by some methods, amylose shows X-ray diffraction patterns (p. 32) that are interpreted as evidence that its chain is arranged in a helical coil. Such a molecule is relatively compact rather than threadlike in shape.

Cellulose. The most abundant of all plant constituents, cellulose has been the object of much research in connection with its commercial utilization. It is the chief product of growth in plants. Cellulose, like starch, cannot be defined at present in any strictly chemical sense. It occurs as a complex in plant structures from which its separation may or may not alter its chemical nature. It is the remainder after the harder parts of plant materials have been subjected to extraction so as to remove all soluble and easily hydrolyzable substances. The materials commonly used as the starting point for cellulose investigations are absorbent cotton and high-quality paper, such as thoroughly extracted filter paper. Woody structures contain much material besides true cellulose, *e.g.*, the lignins, the hemicelluloses, and some other materials.

The properties of cellulose are not very striking. It gives no color reaction with iodine and is not soluble in any of the ordinary laboratory solvents. It does go into solution, perhaps by forming some soluble combination, in Schweitzer's reagent, a solution of copper hydroxide in strong ammonia. Another similar reagent is zinc chloride in strong HCl. Viscose is prepared by treatment of cellulose with NaOH and CS₂ and is the source of much of the artificial silk of commerce. "Mercerized" cotton is prepared by treatment with 10 per cent NaOH. "Vegetable

parchment" is made by treating a high-grade paper with H_2SO_4 (about 70 per cent). Nitrocellulose is produced by the action of strong HNO_3 in the presence of concentrated H_2SO_4 . Cellulose is not hydrolyzed by boiling dilute acid, but after preliminary treatment with concentrated H_2SO_4

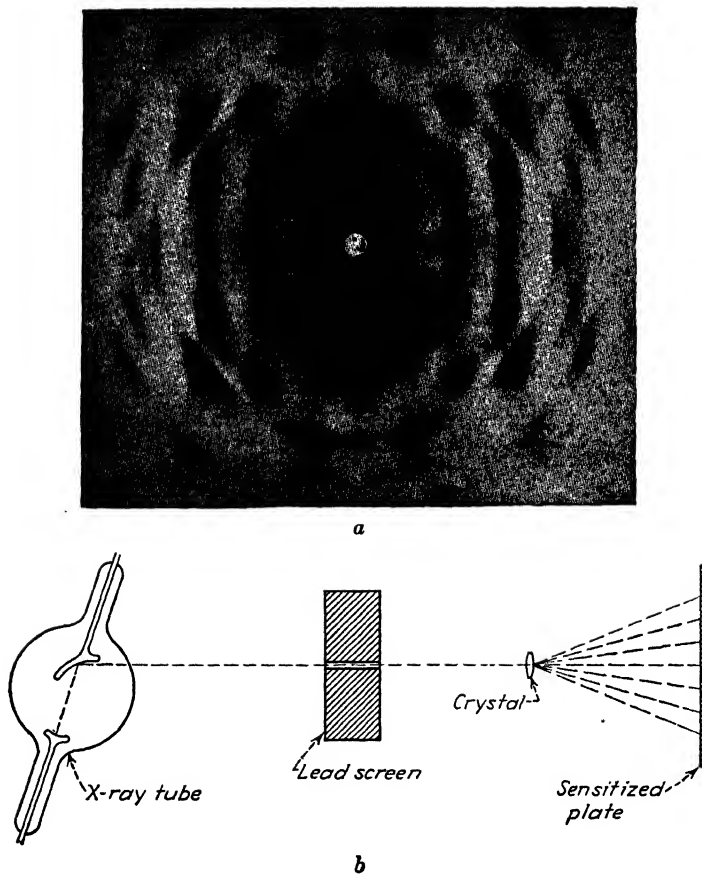

FIG. 2. X-ray diffraction pattern of cellulose. From the diffraction patterns as shown at *a*, the "crystal" lattice of the material can be computed. *b*, diagram of the arrangement of the apparatus.

and subsequent dilution with water, prolonged boiling causes the complete hydrolysis of cellulose to glucose.

Cellulose Structure. Incomplete hydrolysis yields substances which are molecular fragments. Some of them have been crystallized. They include di-, tri-, and tetrasaccharides. Cellobiose, equivalent in some cases to as much as 50 per cent of the cellulose, has been obtained. Allowing for losses, it amounts to more than that. Haworth and

Machemer (1932) obtained evidence of a minimum chain length of 100 to 200 glucose units in the cellulose molecule. Staudinger and Husemann (1937) considered that the cellulose molecule has more than 1,000, perhaps 2,000, glucose units. It is very likely that the natural cellulose molecules are of varying length and any measurements possess only statistical value. Not only chemical methods but physical ones (viscosity and osmotic-pressure measurements of cellulose solutions) yield results which vary widely according to the preliminary treatment of the cellulose.

X-ray Studies of Cellulose. The cellulose structure is better suited than are some biological materials for X-ray spectrographic examination. The photographic record shows a pattern of spots (Fig. 2) which are due to the diffraction of X rays by regularly repeated atomic arrangements constituting a pattern or "space lattice" in the crystalloid molecules.

Sponsler and Dore (1926), though not the first to demonstrate that cellulose possesses a crystallike structure, made an extensive study of its X-ray diffraction. Most of the observations were on ramie (from *Boehmeria nivea*). The measurements indicated a space lattice of *glucopyranose units* in long chains of regular arrangement. Measurements of certain spacings in the molecule disagreed with what would be expected if the glucose units were linked as in cellobiose, so that Sponsler and Dore favored the theory of a different linkage and suggested that cellobiose is an artifact produced during acetolysis (simultaneous acetylation and hydrolysis) employed in the splitting of cellulose.

Later X-ray studies of cellulose included observations upon the thin wall of large (macro) cells of *Valonia* (Preston and Astbury, 1937) and *Halicystis* (Sisson, 1938). The cellulose wall of a single cell can be used for X-ray spectrographic examination. Results indicate that the "crystallites" of cellulose vary even in closely contiguous areas of the cell but show evidence of definite arrangement of long chains of glucose units.

Molecular formulas for cellulose can hardly be more than conjectural at present. Those most frequently proposed assume the cellobiose linkage

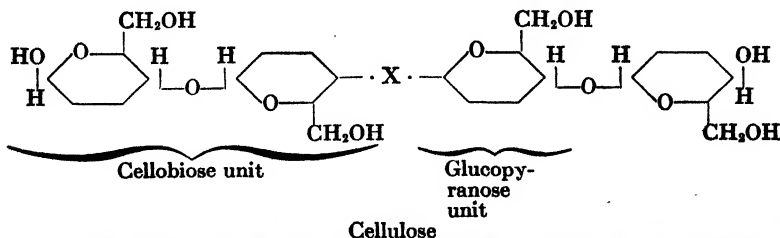

The formula shows glucopyranose units arranged in cellobiose grouping. X represents an indefinite number of other glucopyranose units which, according to Staudinger, might be as many as 2,000. Stereoisometric configurations, where not shown, are assumed to be those of glucopyranose.

Glycogen. Glycogen is the storage carbohydrate for animals as starch is for plants. Its behavior in the animal body will be discussed more fully in connection with carbohydrate metabolism (Chap. XIV). Although glycogen is found more or less in all animal tissues, it is most abundant in the liver. It may amount to 12 per cent of the weight of the rabbit liver after a rich carbohydrate intake, but the liver content is subject to great variation. Muscles are next in their glycogen content. Apparently all of the active cells of the animal body contain at least some glycogen. The stores of glycogen in cold-blooded animals are sometimes surprisingly large. The oyster, for example, after a summer of abundant feeding, may yield as much as 38 per cent of the dry weight of the tissues as glycogen. Glycogen is not commonly found in tissues of green plants, but its preparation from kernels of golden bantam corn has been reported. It also occurs in the yeast cell and may be present in traces in other microorganisms.

The properties of glycogen sharply distinguish it from other polysaccharides. It is extracted from tissues by cold water only with difficulty, but it is freely soluble in warm water and remains dissolved upon cooling. Its solutions are opalescent. It gives a red iodine reaction with Lugol's solution. The iodine test, suitably modified, is used to identify it *in situ* histologically. Glycogen is easily hydrolyzed in dilute acid solution to give a nearly quantitative yield of glucose. Amylases also hydrolyze it to glucose. Its most striking feature is its resistance to the action of alkalis. Glycogen-containing materials may be heated at about 100°C. in 30 per cent KOH during several hours until oxidative destruction of proteins, fats, and all organic substances except glycogen appears to be complete. The glycogen remains apparently unaltered. From this mixture or from its water solutions, glycogen is readily precipitated by alcohol. It can be repeatedly redissolved in alkali and precipitated by alcohol until it attains what appears to be a high degree of purity. Glycogen is one of the few polysaccharides obtained in what may be considered chemical purity.

The molecular structure of glycogen has been investigated by methods comparable to those employed for starch. It shows a very high molecular weight, e.g. 6 million, but its value varies according to the source and the method of preparation. Methylation studies indicate a chain of glucose units, 12 to 18 in number. These groupings, however, probably represent side chains detached from the large macromolecule by the process of chemical manipulation. Probably, as in the case of starch, a large number of chains branch off from a "nucleus" of the molecule, or from other chains. The linkage between glucopyranose units appears to be the α -type, as in starch, since amylases attack glycogen.

It is surprising that compounds so similar in constitution that they

hydrolyze to yield the same building material, namely, glucose units, should possess properties so different as are those of amylose, amylopectin, cellulose, and glycogen. A solution of this mystery has long been sought, and although the answer is not yet entirely clear, a striking fact may be regarded as furnishing at least part of the explanation. This is the *difference in branching of the chains of glucose units*, varying all the way from the very long unbranched chains in cellulose (thus favoring its occurrence in nature as long fibers) up to the elaborately branched construction of the globular-shaped glycogen molecule with its relatively short chains of which the numerous end groups are free to enter into chemical reactions. It is noticeable that cellulose is almost chemically inert in the life of the plant, serving for protection and support. Glycogen, on the other hand, is outstandingly active in the metabolism of any cell that contains it. The end groups are readily broken off for distribution and use as glucose and are as readily replaced on the glycogen molecule when cellular conditions favor carbohydrate storage.

A **galactogen**, comparable to glycogen, has been prepared from the protein gland of the snail, *Helix pomatia*. Schulbach and Loop (1937) have separated it from accompanying glycogen by forming a copper complex and further purified it by the use of diastase which it resists. In 0.1*N* H₂SO₄ it hydrolyzes to give a nearly quantitative yield of galactose. A galactogen of mammalian origin was isolated (Wolfson *et al.*, 1947) from lung tissue, shown to differ in its properties from the snail preparation, and reported to yield no sugar other than galactose upon hydrolysis.

Inulin. Inulin is a substance resembling starch in properties and function, being a storage carbohydrate accumulated in the tubers and roots of many plants, especially the dahlia, artichoke, dandelion, burdock, and chicory. Inulin seems to be more particularly characteristic of the *Compositae*.

Its properties include ready solubility in warm water, somewhat sparing solubility in cold water, and precipitability by alcohol. It gives no color reaction with iodine. It is not hydrolyzed by enzymes of vertebrate tissues, but it is split by inulase prepared from plant sources. It is usually stated that inulin has no reducing power, but all preparations commonly available give at least a slight reduction of Fehling's solution. Whether this is due to a few end groups of the monosaccharide chains of the inulin molecule or to partial hydrolysis of the inulin during its preparation is difficult to say. Inulin is easily hydrolyzed. In boiling water it shows a progressive increase in reducing power with corresponding changes in rotatory power. It is rapidly hydrolyzed in acid solutions, giving a quantitative yield of D-fructose.

Fructosans other than inulin have been prepared from several plant

sources and, like glucosans, have distinctive properties, indicating that fructose may polymerize in more than one way.

Hemicelluloses. Accompanying cellulose in the leafy and woody structures of plants and to some extent in nuts, seeds, etc., there are miscellaneous carbohydrates called hemicelluloses. Actually they are not related to cellulose in chemical structure nor do they resemble it in chemical and physical properties. The hemicelluloses are ill-defined. Hemicelluloses are regarded as those polysaccharide-like materials accompanying cellulose but differing from it in being hydrolyzed by dilute boiling acid and in yielding various sugars or sugars plus uronic acids. Armstrong suggests that hemicelluloses "always contain sugar acids of the uronic type," but some preparations described as hemicelluloses apparently yield no uronic acid.

Hemicellulose is prepared from plant materials after they have been extracted to remove pectin and various substances which are comparatively soluble. The hemicellulose is then dissolved in dilute (about 4 per cent) NaOH, and from this extract certain hemicelluloses may be precipitated by merely acidifying. Others require the addition of alcohol for their precipitation. Hemicelluloses requiring alcohol rather than mere acidification for precipitation appear to be of the "mixed" type. They yield D-galactose, L-arabinose, and D-galacturonic acid in some cases; others may yield D-glucose, D-xylose, and D-glucuronic acid.

The biochemistry of the hemicelluloses is obviously in an undeveloped stage. The name "hemicellulose" may be no longer useful when plant chemistry becomes further advanced.

Vegetable Gums and Mucilages. Large yields of substances which are chemically related to hemicelluloses and are, indeed, sometimes classed with them may be obtained from the gums and mucilages. Gum arabic (acacia gum) has long been a familiar substance in commerce and in the laboratory. It is freely soluble in water. It occurs as the calcium or calcium-magnesium salt of arabic acid. The acid groups are presumably those of glucuronic acid. Upon hydrolysis, it yields a considerable amount of L-arabinose with smaller amounts of rhamnose, D-galactose, and D-glucuronic acid.

The gums from plum, cherry, and other fruit trees, the gums from various conifers, and other vegetable gums are also composed largely of substances which, like gum arabic, are "mixed" polysaccharides. They appear, in general, to be salts of uronic acids in dehydrated union with sugar groups.

The vegetable mucilages include such substances as **agar-agar**, prepared from Asiatic seaweeds, and **carrageenin**, a polysaccharide isolated from Irish moss. Many algae yield materials of this type. One of their

characteristic properties is the gelation upon cooling of their solutions made in warm water. Both agar-agar and carrageenin have been shown to be sulfuric acid esters, the ester group of which is a complex polysaccharide. They exist in nature as the Na, K, Mg, Ca, or other salts, *i.e.*, as sulfates. The polysaccharide material is sometimes called a galactan. Agar-agar yields 20 to 28 per cent and carrageenin 31 to 34 per cent of galactose.

Mannosans. Ivory nut meal, which is made by grinding the endosperm of nuts from a South American palm, the tague tree, yields mannosans. The endosperm, "vegetable ivory," is so hard that it is sometimes used to make buttons. The meal is first extracted to remove soluble materials, and the residue is treated with 5 to 10 per cent NaOH which dissolves a mannosan which Klages called "mannan A." From the faintly acidified solution it is precipitated by methanol. Another similar carbohydrate, known as "mannan B," is dissolved as an alkaline copper complex from which it is set free by acetic acid and precipitated by methanol. Other mannosans have been prepared. They appear to differ in the grouping of the mannose units. Some of the so-called "mannans" hydrolyze to yield some sugar other than mannose, such as glucose.

Pentosans. The polysaccharides containing pentose groups are also apt to be of the "mixed" variety. "Xylans" and "arabans" have been described in a number of cases, but further investigation has shown that their building blocks include something other than merely xylose or arabinose.

The so-called "xylans" are very widespread in woody or other hard parts of plants. Some of these structures may give high yields of xylose; *e.g.*, beechwood yields the equivalent of 16 per cent and wheat straw, 25 per cent. But there seems to be no proof that plants contain any preformed substance which could hydrolyze to yield only xylose.

A similar argument may be presented regarding arabinose. The case of gum arabic (p. 36) is one example inasmuch as its large yield of L-arabinose is accompanied by other sugars and D-glucuronic acid. Another example is seen in the case of a polysaccharide prepared from larch wood and consisting chiefly of galactose but yielding 14 to 15 per cent of arabinose.

The occurrence of pentose groups in association with hexoses and uronic acid groups is in agreement with a theory, long held to be very probable, which assumes that the pentoses arise in nature from the hexoses. Glucose and galactose are oxidized in plants to glucuronic and galacturonic acids, and these, in turn, may be decarboxylated to yield the corresponding pentoses, D-xylose and L-arabinose.

The Pectic Substances. Material that seems to serve primarily as cement between the cells of plant tissues contains the pectic substances. Many names have been assigned to different preparations of them, but authoritative opinion regards them all as classifiable into four types, *protopectin*, *pectin*, *pectic acid*, and *pectinic acid*. All are colloidal substances of high molecular weight with a fundamental structural unit that is composed of a long chain of *galacturonic acid* residues, probably hundreds of them, united by glycosidic linkage. The link has been shown, in some cases at least, to be 1-4 as it is in maltose, starch, and many other carbohydrates. This leaves the carboxyl group of galacturonic acid residues free to be esterified, and some of them are found to be methyl esters so that methanol is freed by hydrolysis. But in addition to galacturonic acid and methanol, hydrolysis products of the pectic substances include galactose, arabinose, xylose, and acetic acid. Not all of these have been obtained from the pectic substances of all plants. For example, acetic acid was not found among breakdown products of apple, tomato, or lemon pectin.

Protopectin is so named in the belief that it is the mother substance of all pectic substances. It occurs in the thickening of cell walls of parenchyma. There is some confusion in ideas regarding the pectic substances of the middle lamella, *i.e.*, the cementing substances between cells of these tissues. Some writers appear to include them under protopectin, but all recent investigators agree that the cell-wall material and the middle-lamellar material differ in structure and properties. Some writers call the cell-wall material pectose and the middle-lamellar material pectin; but others call them, respectively, protopectin and pectose of middle lamella. Both of these materials are insoluble in water but can be transformed into soluble materials by enzymes occurring in macerated tissue.

Pectin is formed from protopectin by the action of the enzyme *protopectinase* or by partial acid hydrolysis and is a water-soluble, alcohol-precipitable substance. It is the useful constituent of the commercial products used in making jellies, jams, and marmalades. It gives the gelling property to natural fruit juices. In order to gel, pectin requires sugar (sucrose is generally used) in concentration of 65 to 70 per cent and acid present in concentration that gives a pH of 2.8 to 3.5. In laboratory tests, tartaric or citric acid may be used; in ordinary jelly making, the fruit acids are depended on. The amount of pectin required in proportion to the sugar used varies according to the source and the method of preparing the pectin. It is standardized in terms of the number of pounds of sucrose which one pound of pectin can set, under controlled conditions, into a gel of standard properties. Commercial preparations of pectin are made from various sources. The waste (skins and cores) of apples

have been used. But the source that seems to be of especial value is the peel of citrus fruits. The albedo (white part of the peel) is a rich source, and lemon culls and peels afford one of the favored starting points for commercial preparations.

Pectinic acids and *pectic acids* arise from the further breakdown of pectin through the action of an enzyme called pectase or by other hydrolyses. Methanol is liberated during this process, a deesterification. Pectinic acid is partially deesterified, and pectic acid is presumably a completely deesterified product. The latter is water-insoluble and separates in a gelatinous mass when solutions of its sodium salt are acidified. Both pectinic and pectic acids form gelatinous precipitates when converted to the calcium salt.

The place of sugars in the complex of pectic substances in the natural state is still under debate. There is no question but that pectic substances, prepared in certain ways, yield sugars. For example, the pectic material from flax is reported to yield the following components:

	Per Cent
Galacturonic acid.....	61.2
Methoxy groups.....	4.1
Acetic acid groups.....	8.6
L-Arabinose.....	10.9
D-Galactose.....	13.9
L-Xylose.....	10.9

Preparations from many sources yield arabinose and galactose, presumably resulting from something corresponding to araban and galactan. But a large part of the sugar-yielding material can be removed from pectic preparations by mere physical processes, *e.g.*, redissolving and reprecipitating by alcohol. This observation has led to the opinion that the sugar-yielding material is held to the polygalacturonic acid chain by secondary valence only. It is reported, however, by some investigators that, when pectin is deesterified by an enzyme rather than by acid hydrolysis, the sugar-yielding groups are retained in the resulting pectinic acid. This suggests that they are united to the galacturonic acid structures by primary rather than secondary valence. The structure of pectic substances requires further study.

Lignin. The lignins are a large group of complex substances occurring abundantly in the woody parts of plants. Much of the research upon lignin has been done with material derived from spruce and other woods that are the more important sources for manufacture of paper pulp. Lignins are by no means confined, however, to typical woody tissue. Difficulty in the progress of lignin chemistry has been due in part to failure to find any satisfactory solvents. No reagent capable of

freely dissolving lignin without probability of altering its chemical nature appears to be available. Another difficulty is the result of the natural occurrence of the lignins in union with hemicellulose and other carbohydrates from which separation has not been obtained by the use of enzymes but only by acid hydrolysis which probably alters the lignin. It is the removal of lignin, along with hemicelluloses, etc., which necessitates the "cooking" process as the first step in preparation of commercial wood cellulose.

Freundenberg suggests a scheme to represent the fundamentals of the chemical nature of lignin. He regards it as made up of substances resulting from etherification and condensation (dehydration synthesis) of such unit structures as

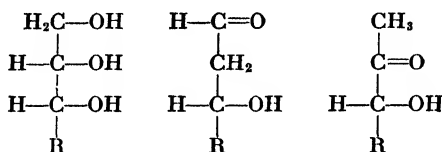

where R represents a grouping of which important representatives are

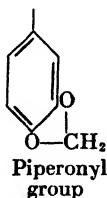
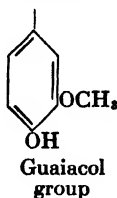

The first three of these formulas indicate the relation of lignin to glycerol, to an aldose, and to a ketose. The last three formulas indicate the presence of the benzene ring in modifications, of which these are but examples.

Immunological Polysaccharides. Polysaccharides which give specific immune reactions have been prepared from bacterial cultures. Either the whole culture or merely the bacteria-free filtrate can be used as the source. Their specific character is shown by the formation of precipitates with blood serum of specifically immunized animals. For example, the substance from a pneumococcus culture can be diluted 6×10^6 times and still yield a precipitate with antipneumococcus serum but even in high concentration give no precipitate with other sera. Discovered first in pneumococcus, immunological polysaccharides were later shown to arise in cultures of many types of bacteria. For each type, even closely related ones, the polysaccharides are quite specific. Some at least of the purified polysaccharides are not themselves antigenic; *i.e.*, they do not arouse the production of antibodies upon injection into animals. According to Morgan there is evidence in support of the

theory that attributes specific immunological properties of a complete bacterial antigen to a polysaccharide constituent but attributes antigenicity (ability to arouse immunity) to a combination of the polysaccharide with some other substance, probably a protein.

An interesting product of incomplete hydrolysis studied by Heidelberger and others is called an "aldobionic acid." It is apparently a glucuronic acid linked through its reducing group to glucose. The latter has a free reducing group. There is reason to believe that its structure probably is

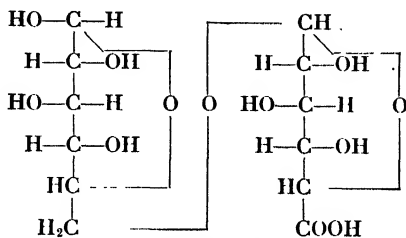

Aldobionic acid
(Shown here as D-glucuronosido-6-β-D-glucopyranose)

Similar "aldobiuronic acids" belonging to the large group of "cellobiuronic acids" have been prepared from cultures of other kinds of bacteria. A specific type I pneumococcus polysaccharide yields D-galacturonic acid. Sugars obtained from *Mycobacterium tuberculosis* polysaccharides include D-arabinose, D-galactose, D-mannose, and D-glucosamine. These sugars have also been found as constituent groups in other bacterial polysaccharides. Studies of the structure of immunopolysaccharides, though developing rapidly, are still comparatively new. A pneumococcus type III polysaccharide is reported to consist of chains of cellobiuronic acid units, having the 1-4 linkage, joined to each other by a 1-3 linkage. Thus, -glucose-1-3-glucuronic acid-1-4-glucose-1-3-glucuronic acid would be present.

In order to account for the presence of acetyl groups and of nitrogen in some of these polysaccharides, the suggestion of the presence of acetylated amino sugar groups in their molecules appears to be a promising theory.

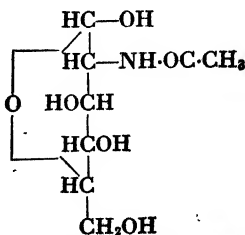

N-Acetyl-amino hexose

It is even possible that all of the nitrogen of some specific immunopolysaccharides may occur in this form, although in the polysaccharide from type I pneumococcus, about half of the N is recognizable as free amino, $-\text{NH}_2$, groups.

Immunopolysaccharides are obviously complex. Some of the pneumococcus polysaccharides in purified form yielded evidence of molecular weights from 140,000 to 500,000.

In view of the discovery that specific pneumococcal polysaccharides may be used as vaccines, the study of compounds of this type has acquired much interest. A review by Haworth and Stacey calls attention to the fact that work in this field "abolished the older view that proteins were the only significant immunizing antigens and introduced a new biological concept, namely, that of the powerful determinative influence of carbohydrate residues in the immunogenic sense."

Glycosides. The methyl glucosides (p. 9) are type forms of a large number of plant products. They were long known as glucosides because many of them, probably the majority, yield glucose upon hydrolysis. But inasmuch as any sugar having a free or potentially free aldehyde group can form a compound of this type, it seems better to use the generic term glycoside and to restrict the use of the name glucoside to those containing the glucose group. From natural glycosides of plants the following sugars, in addition to glucose, have been obtained: D-Galactose, D-mannose, D-fructose, D-arabinose, L-arabinose, D-ribose, L-xylose, D-rhamnose, and several other desoxysugars. Some glycosides hydrolyze to yield more than one kind of sugar. Uronic acids (especially glucuronic acid) occur in glycosidic unions. Several rare sugars are found only in glycosides.

Plant glycosides occur in unnumbered variety. Armstrong, describing some 125 different ones, writes of them as only the "better known" glycosides and agrees with Wheldale in the opinion that when data regarding the chemical constitution and the natural distribution of glycosides in plants are more nearly complete, they might afford a purely chemical basis for differentiation of plant species.

The substances in addition to sugars obtained by hydrolysis are called **aglycones**. They include a wide variety of organic compounds. Among them are phenols, alcohols, aldehydes, organic acids, derivatives of coumarin, of anthraquinone, of flavone, of anthocyan, and many others. Some glycosides or the plant preparations containing them are in everyday use. Many flavoring substances, such as mustard and horseradish, derive their taste in part from glycosides. A number of important drugs are glycosides, *e.g.*, those derived from digitalis. Phlorizin from the bark and roots of apple, cherry, pear, and plum trees is a

drug having a marked effect upon the kidney so as to cause sugar excretion (glycosuria).

The diversity of glycoside structures is suggested by even the small number of examples given in Table 4.

TABLE 4.—EXAMPLES OF GLYCOSIDES

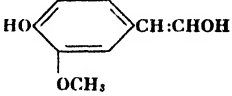
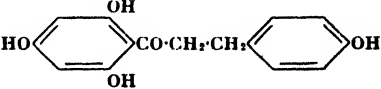
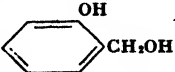
Name	Source	Hydrolysis products	Aglycone structure
Amygdaline	Seeds of bitter almond	2 Glucose + D-mandelonitrile	$C_6H_5-CH(OH)-CN$
Arbutin	Leaves of arbutus and other plants	Glucose + hydroquinone	
Coniferin	Bark of fir tree	Glucose + coniferol	
Digitonin	Leaves of <i>Digitalis purpurea</i> (foxglove)	4 Galactose + xylose + digitogenin	A sterid (see p. 86)
Digitoxin	Leaves of <i>Digitalis purpurea</i> (foxglove)	3 Digitoxose + digitogenin	A sterid (see p. 86)
Digoxin	Leaves of <i>Digitalis lanata</i>	3 Digitoxose + digoxigenin	A sterid (see p. 86)
Phlorizin	Bark of certain fruit trees	Glucose + phloritin	
Quercitrin	Bark of oak	Rhamnose + quercetin	$C_6H_5 \begin{cases} O-C-C_6H_5(OH)_2 \\ \\ CO-C-OH \end{cases}$ A flavonol (see Chap. VI)
Rutin	Many plant sources	Glucose + rhamnose + quercetin	See Chap. VI
Salicin	Bark of aspen and willow trees	Glucose + saligenin	
Sinigrin	Black mustard seed	Glucose + allyl isothiocyanate + $KHSO_4$	$CH_2=CH-CH_2-SCN$

REFERENCES

In this and other lists of references given at the end of each chapter the textbooks, monographs, and review articles are chosen not only because of their content but also because they provide copious references to journal articles and monographs which present reports of original investigations.

An authoritative monograph is E. F. Armstrong and K. F. Armstrong, "The Carbohydrates," 5th ed., New York, 1934. The subject is presented from the theoretical point of view in "Organic Chemistry: An Advanced Treatise," edited by H. Gilman, Vol. II, Chap. 16, "Carbohydrates I" by M. L. Wolfrom; Chap. 17, "Carbohydrates II" by A. L. Raymond; Chap. 18, "Carbohydrates III" by E. Heuser.

"Chemistry of the Carbohydrates" by W. W. Pigman and R. M. Goepf, Jr., New York, 1948, is a complete and authoritative treatise.

The stereoisomerism of sugars is explained by W. N. Haworth, "The Constitution of Sugars," New York, 1929, and is given in more detail in "The Collected Papers of C. S. Hudson" edited by R. M. Hann and N. K. Richtmyer, New York, Vol. I, 1946, and Vol. II, 1948.

The chemistry of starch is presented by J. A. Radley, "Starch and Its Derivatives," New York, 1940. For other aspects, see E. T. Reichert, "The Differentiation and Specificity of the Starches in Relation to Genera and Species," *Carnegie Inst. Wash., Pub.* 173, 1913.

For cellulose, see A. G. Norman, "Biochemistry of Cellulose, Lignin, etc.," London, 1937.

The glycosides are treated in detail by E. F. Armstrong and K. F. Armstrong, "The Glycosides," London, 1931.

X-ray studies of polysaccharides are presented by G. L. Clark, "Applied X-rays," 3d ed., New York, 1940.

"Advances in Carbohydrate Chemistry" edited by W. W. Pigman and M. L. Wolfrom, New York, published annually since 1945, contains many useful essays.

Analytical methods are given by C. A. Browne and F. W. Zerban, "Physical and Chemical Methods of Sugar Analysis," New York, 1941.

With regard to stereoisomerism, the discovery of asymmetry and its general significance is presented in a fascinating account in Chap. II of "The Life of Pasteur" by R. Vallery-Radot, transl. by Devonshire, New York, 1902. A modern treatment by R. L. Shriner, Roger Adams, and C. S. Marvel is presented in Chap. III of "Organic Chemistry," edited by H. Gilman, New York, 1938. Note also Hudson, C. S., Historical Aspects of Emil Fischer's Fundamental Conventions for Writing Stereoformulas in a Plane, *Advances in Carbohydrate Chem.*, 3, 1, 1948.

Among helpful reviews are the following:

ARMSTRONG, E. F., Chemistry of the Carbohydrates and the Glycosides, *Ann. Rev. Biochem.*, 7, 51, 1938.

ASTBURY, W. T., X-ray Studies of the Structure of Compounds of Biological Interest, *Ann. Rev. Biochem.*, 8, 113, 1939.

FREUDENBERG, K., Polysaccharides and Lignin, *Ann. Rev. Biochem.*, 8, 81, 1939.

HASSID, W. Z., The Chemistry of the Carbohydrates, *Ann. Rev. Biochem.*, 13, 59, 1944.

HAWORTH, W. N., and HIRST, E. L., The Chemistry of the Carbohydrates and the Glucosides, *Ann. Rev. Biochem.*, 6, 99, 1937.

HAWORTH, W. N., and STACEY, M., The Chemistry of the Immunopolysaccharides, *Ann. Rev. Biochem.*, 17, 97, 1948.

MEYER, K. H., The Chemistry of Glycogen, *Advances in Enzymol.*, 3, 109, 1943.

NORMAN, A. G., Chemistry of the Carbohydrates and Glycosides, *Ann. Rev. Biochem.*, 10, 65, 1941.

PEAT, S., Plant Carbohydrates, *Ann. Rev. Biochem.*, 15, 75, 1946.

PRINS, D. A., and JEANLOZ, R. W., Chemistry of the Carbohydrates, *Ann. Rev. Biochem.*, 17, 67, 1948.

Some papers bearing upon the molecular structure of representative carbohydrates are listed:

AVERY, J., HAWORTH, W. N., and HIRST, E. L., The Constitution of the Disaccharides. XV. Sucrose, *J. Chem. Soc.*, 129, 2308, 1927.

BACON, J. S. D., BALDWIN, E., and BELL, D. J., The Magnitude of the "Unit Chains" of Liver Glycogen of Rabbits Supplied with Glucose, Fructose, and Sucrose, *Biochem. J.*, 38, 198, 1944.

BALLS, A. K., and SCHWIMMER, S., Digestion of Raw Starch, *J. Biol. Chem.*, 156, 203, 1944.

BUSTON, H. W., Observations on the Nature, Distribution and Development of Certain Cell-wall Constituents of Plants, *Biochem. J.*, 29, 196, 1935.

HASSID, W. Z., BAKER, E. E., and MCCREARY, R. M., An Immunologically Active Polysaccharide Produced by *Coccidioides Immitis* Rixford and Gilchrist, *J. Biol. Chem.*, 149, 303, 1943.

HAWORTH, W. N., HIRST, E. L., and RUELL, D. A., The Constitution of Raffinose, *J. Chem. Soc.*, 123, 3125, 1923.

HAWORTH, W. N., and LONG, C. W., The Constitution of the Disaccharides. XII. Lactose, *J. Chem. Soc.*, 113, 544, 1927.

HAWORTH, W. N., LONG, C. W., and PLANT, J. H. G., The Constitution of the Disaccharides. XVI. Cellobiose, *J. Chem. Soc.*, 119, 2809, 1927.

- HAWORTH, W. N., and PEAT, S., The Constitution of the Disaccharides. XI. Maltose, *J. Chem. Soc.*, 115, 3094, 1926.
- HAWORTH, W. N., RAISTRICK, H., and STACY, M., The Molecular Structure of Galactocarolose Produced from Glucose by *Penicillium Charlesii* (G. Smith), *Biochem. J.*, 31, 640, 1937.
- HOTCHKISS, R. D., and GOEBEL, W. F., The Synthesis of the Heptaacetyl Methyl Ester of Gentiobiuronic Acid, *Science*, 83, 353, 1936.
- HUDSON, C. S., Relations between Rotatory Power and Structure in the Sugar Group, *Bur. Standards Bull.*, 21, 241, 1926.
- HUDSON, C. S., and PACSU, E., Crystalline Turanose, *Science*, 69, 278, 1929.
- LEVENE, P. A., and KREIDER, L. C., On the Structure of Pectin Polygalacturonic Acid, *Science*, 85, 610, 1937.
- MORGAN, W. T. J., The Preparation and Properties of a Specific Polysaccharide from *B. Dysenteriae* (Shiga), *Biochem. J.*, 30, 909, 1936.
- NORTHROP, J. H., and NELSON, J. M., The Phosphoric Acid in Starch, *J. Am. Chem. Soc.*, 38, 472, 1916.
- PERCIVAL, E. G. V., SOMERVILLE, J. C., and FORBES, I. A., Isolation of an Anhydro-sugar Derivate from Agar, *Nature*, 142, 797, 1938.
- RITTER, D. M., PENNINGTON, D. E., OLLEMAN, E. D., WRIGHT, K. A., and EVANS, T. F., Constitution of Gymnosperm Lignin, *Science*, 107, 20, 1948.
- WOLFROM, M. L., et al, A Galactogen from Beef Lung, *Arch. Biochem.*, 14, 1, 1947.

CHAPTER II

PHOTOSYNTHESIS

That CO_2 and H_2O with no physiological fuel value are used in the synthesis of carbohydrates which have high fuel value is of itself a sufficiently interesting and significant fact to warrant intensive study; but in view of the additional fact that in practically no other way is solar radiation in the form of visible light trapped and made available for life and other terrestrial processes, the significance, both theoretical and practical, of photosynthesis becomes apparent.

Photosynthesis as a Potential Source of Energy. Coal and mineral oil are used at so rapid a rate by modern civilization that what required millions of years to produce will probably be exhausted in a few centuries. This has raised the question as to whether or not intensive agriculture could produce from the soil enough plant products to substitute for the coal and oil of present-day requirements. Biologists, engineers, and economists furnish data for use in estimations of the amount of energy which the crops of forest and field might be made to yield and the amount required for commercial and domestic use. Spoehr (1926) has summarized such calculations which indicate that, even if the plant products were obtained in the most efficient yields per acre that are now possible and were used in the most economical way, the energy obtainable under conditions prevailing in the United States would fall far short of present requirements. It has been estimated that even under the most luxuriant conditions of growth, plants seldom, if ever, trap more than 3 per cent of the solar energy falling upon them. It is no wonder, then, that both the engineer and the biochemist, looking to the future when coal and oil supplies shall have become deficient, have tried to solve the riddle of photosynthesis in the hope that some improvement upon nature's efficiency in the utilization of solar energy might be devised.

In a review of certain aspects of photosynthesis, Strain (1944) makes the significant statement:

Of the thousands of scientific workers throughout the world, not more than a few score are engaged in studies of the special reactions by which plants capture sunlight and synthesize the complex carbon compounds required as foods by all other organisms. It is not surprising that, today, so little is known regarding

the specific steps involved in this complex, vital process. "Freedom from want," as measured by an adequate food supply, is an ideal based upon syntheses that remain unknown to scientists and politicians alike. In the future, advantages will accrue to the peoples most adept at the production, modification, and utilization of carbonaceous vegetable matter.

Chlorophyll and Carotenoids. Chlorophyll, the abundant green pigment of plants, is commonly stated to be the agent of photosynthesis. Chlorophyll is indispensable, as is indicated by many observations. One of them is the fact that in mottled leaves photosynthesis occurs in the green patches but not in white or yellow ones. Chlorophyll really consists of at least two substances, chlorophyll *a* and chlorophyll *b*, and is accompanied by yellow pigments, collectively called *carotenoids*. The latter include the carotenes (or carotins) and the xanthophylls. The carotenes are so named because carrots are an especially abundant source of the type member of the group. The yellow pigments are not commonly apparent in most of the green parts of plants because the vivid green of the more abundant chlorophyll hides them. But the close association of the three types of pigment in plant cells suggests that there might be some interdependence in their functioning.

Chloroplasts. The green and yellow pigments are located in the cell structure known as a chloroplast. The latter is a relatively dense aggregate of varying but always small diameter (3 to 10 μ , rarely as much as 25 μ in the longest diameter) and is regarded as a specialized plastid. In young, growing cells of embryonic tissue or etiolated (white or yellow) leaves, the chloroplasts may be colorless; but, as green color develops, the chlorophyll is deposited in or upon the chloroplasts. The arrangement of the chlorophyll is somewhat variable in different plants, but in any case there seems to be a concentration of chlorophyll in the form of minute disks, the *grana*, in the protein-rich stroma, the central portion of the chloroplast being often rich in starch, especially during active photosynthesis.

Properties of Chlorophyll. Although chlorophyll, once separated from the other leaf constituents, is readily soluble in acetone and some other organic solvents, it is not thus removed from dry leaf powder. When, however, a little water is added to the acetone, the chlorophyll dissolves freely. This and other contributory evidence might be taken to indicate that chlorophyll does not exist in the chloroplast in a "free" state but combined, presumably with protein or with fatlike compounds or both. Chlorophyll in a living cell exists in a highly "organized" state, intimately associated with many protoplasmic constituents, and should therefore be expected to function in a manner quite different from that observed in a mere solution of separated chlorophyll. It is

hardly surprising, then, that many experiments designed to bring about photosynthesis by means of chlorophyll in an artificial medium have consistently failed to produce any good imitation of the natural process.

The distinguishing solubilities of two kinds of chlorophyll are shown in the following table.

TABLE 5.—SOLUBILITIES OF CHLOROPHYLL *a* AND *b*

	Ether and absolute ethanol	Cold methanol	Petroleum ether
Chlorophyll <i>a</i>	Easily	Slightly	Difficultly
Chlorophyll <i>b</i>	Less easily than <i>a</i>	Very slightly	Insoluble

Both are soluble in acetone, chloroform, carbon disulfide, benzol, and 95 per cent ethanol, the *a* form being slightly more soluble than the *b*.

Structure of Chlorophyll. Prolonged and intense research has established the molecular structure of the chlorophylls. Much of the work was done by Willstätter and his associates, but Conant and his coworkers have made important contributions as have a considerable number of other investigators. The formula shown here is that given by Fischer and Wenderoth (1939), somewhat modified as the result of further investigation.

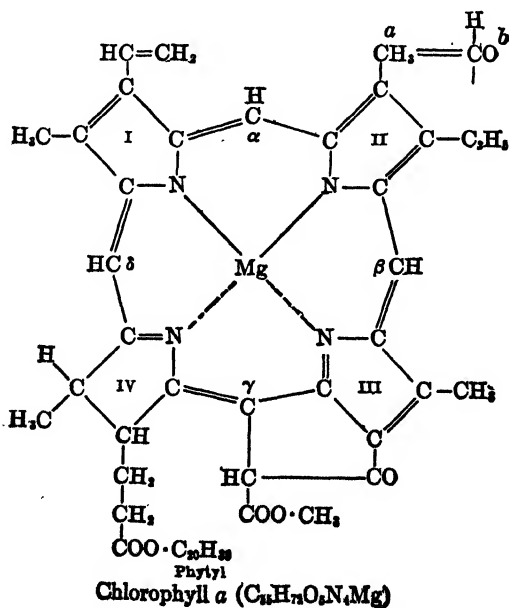

The change of the methyl group (*a*) to the aldehyde group (*b*) represents the oxidation of chlorophyll *a* to chlorophyll *b*. The position of the primary and secondary valence bonds between Mg and N atoms and the consequent location of the double bonds in the ring structures are believed to be subject to resonance. If so, the double bonds are not fixed and their positions as shown indicate only one of a number of possible arrangements.

The formula shows four pyrrole and similar groups, *e.g.*,

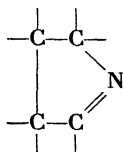

all united by C atoms (α , β , γ , δ) and bearing side chains of varying complexity. One of the groups, shown at III, is condensed with a side chain to form a five-membered C ring. The most complex side chain is composed of a propionic acid group united by an ester linkage to the phytyl group which can readily be hydrolyzed from chlorophyll to yield the unsaturated primary alcohol, phytol, $C_{20}H_{39}OH$.

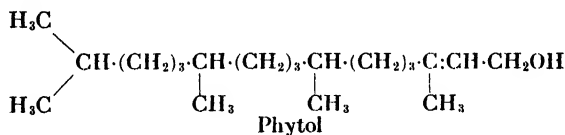

The one atom of Mg is represented in accord with the fact that pure chlorophyll yields an ash containing only MgO in amount indicating Mg as composing approximately 2.7 per cent of chlorophyll (theoretical, 2.69 for chlorophyll *a* and 2.65 for chlorophyll *b*). The Mg atom is represented as attached to N atoms partly by "primary" and partly by "secondary" valence. No Mg ion is formed by electrolytic dissociation of chlorophyll in solution, so that chlorophyll is not an organic salt of Mg. The Mg is easily removed by treatment with acid, but the Mg-containing complex in the molecule is relatively stable toward alkalis. The arrangement of the four rings (I to IV) and connecting C atoms (α , β , γ , δ) is the same as that occurring in heme, a constituent of hemoglobin (see Chap. X). Heme, however, has Fe in the place of Mg and also differs from chlorophyll in some of the side chains.

The chlorophyll preparations obtained from many different kinds of plants, both terrestrial and aquatic, show only minor differences in composition and properties.

The absorption spectra of chlorophyll afford a useful method for its observation and study. They may be seen by the usual method of spectroscopic observation of white light after passing it through a known thickness of a solution containing a known concentration of chlorophyll. The spectra may also be observed while passing the light through a leaf or other chlorophyll-containing structure in the natural state, if sufficiently transparent. In the latter case the spectrum differs markedly from those obtained with pure chlorophyll *a* or chlorophyll *b*. This is due to the presence of the two chlorophylls and the two kinds of yellow

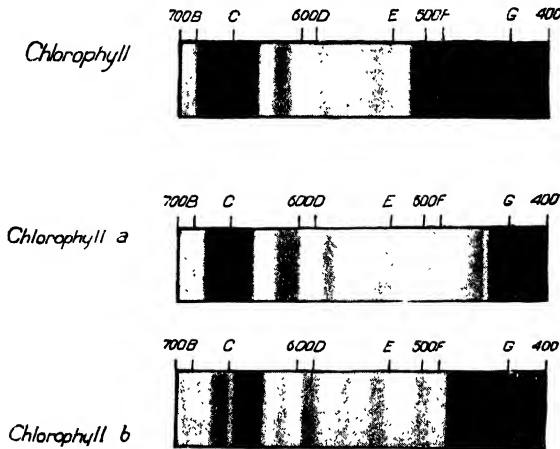

FIG. 3. Absorption spectra of different preparations of chlorophyll. Wave lengths are shown in $m\mu$. (From E. C. Miller, "Plant Physiology," 2d ed., New York, 1938.)

pigments in close association in the natural chloroplast. The spectra shown in Fig. 3 will indicate the differences. The spectrographic analysis presented in Fig. 4 demonstrates more clearly the relative absorption of light of different wave lengths by each form of chlorophyll. The wave lengths (about 655 to 687 $m\mu$) which are in the red part of the spectrum and which are in the region of a dark absorption band of chlorophyll *a* are more effective in stimulating photosynthesis than are wave lengths of other parts of the spectrum. There seems to be a tendency, however, toward diminishing photosynthetic effectiveness with decrease in wave length of the incident light, even when the intensity and the total energy content of the light are taken into account. It appears, indeed, that the blue-violet light, which is in the part of the spectrum where the absorption by chlorophyll is strongest, is not very effective and in some experiments has been observed to cause less photosynthetic activity per unit of light energy than green light, which is only slightly absorbed. The significance of this unexpected result is difficult to explain. Dangeard

(1927) found that the *amount of growth* of certain algae in light from various parts of the spectrum was related to the intensity of absorption by chlorophyll. Moreover, there is evidence that green plants thrive better in white light than they do in any colored light.

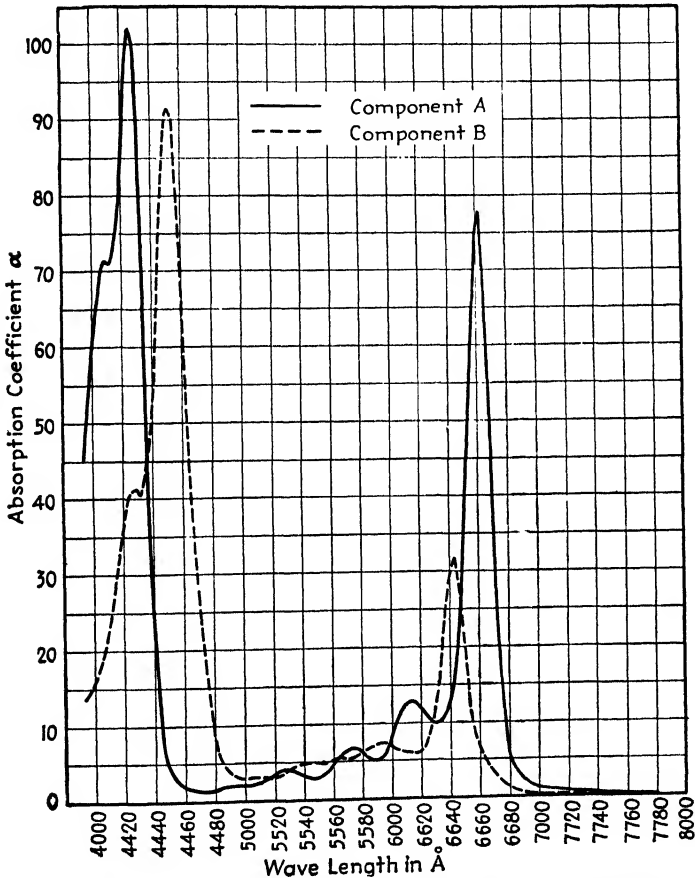
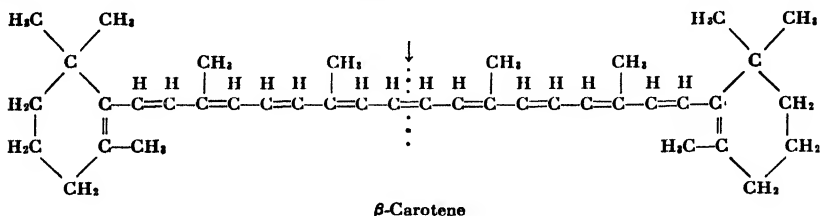

FIG. 4. Spectrographic curves showing light absorption by chlorophyll A (solid line) and chlorophyll B (dotted line). Abscissas are Ångstrom units; ordinates, relative light absorption. (From F. P. Zscheile, Jr., *Cold Spring Harbor Symp. Quant. Biol.*, 3, 111, 1935.)

The Chloroplast Yellow Pigments. Carotene, which, like the other carotenoids and the chlorophylls, is soluble in fats and in fat solvents, is a highly unsaturated hydrocarbon, $C_{40}H_{56}$. It occurs in at least four forms, of which two are α -carotene and β -carotene. The formula of the latter is represented thus:



It has two groups consisting of methylated cyclohexene structures which are united by a C-atom chain having alternately single and double bonds. At the point in the formula indicated by an arrow the molecule may be split and, taking on two equivalents of H_2O , yields 2 molecules of vitamin A.

α -Carotene has the same empirical formula, $\text{C}_{40}\text{H}_{56}$, but is believed to differ from the β -form in having a different arrangement of the unsaturated bond of one of the cyclic groups, thus:

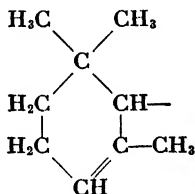

A γ -carotene, also $\text{C}_{40}\text{H}_{56}$, has been described. It apparently contains the group represented as

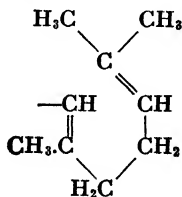

The carotenes show absorption spectra useful in their identification.

The **xanthophylls** are closely related to the carotenes. A formula of one of the leaf xanthophylls, **lutein**, represents it as the dihydroxy derivative of α -carotene.

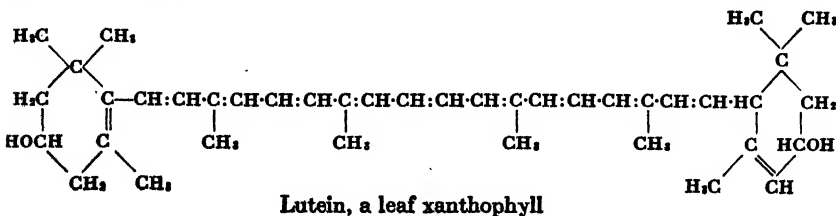

At least 15 different xanthophylls have been recognized as occurring in plants. Some plants contain more than one kind.

Stratographic Analysis. Satisfactory separation of the different chlorophylls, carotenes, and xanthophylls, so as to isolate them, is somewhat difficult. The best method so far found is stratographic analysis, also called "chromatographic adsorption." The pigments, extracted from the plant material and taken up in a suitable solvent (*e.g.*, ethanol), are percolated slowly through a tall column of an adsorbent (*e.g.*, magnesia or sucrose). When the choice of a solvent and the adsorbing material is correctly made, a preferential adsorption occurs. Consequently the column takes on a stratified appearance, layers of green, yellow, or orange being formed. The pigment which is most readily adsorbed colors the uppermost layer and so on to the lowest stratum which contains the least adsorbable pigment. The middle part of each stratum may contain only one pigment. It can be eluted from the adsorbing material by a properly chosen solvent.

Stratographic analysis is used for separation of a number of biological materials. The method is applicable even to approximately quantitative uses since the relative depth of each stratum tends to vary directly with the amount of the pigment which it contains. The suitably chosen solvent may be allowed to flow dropwise or very slowly down through the column or down the strip of paper when paper serves as adsorbent. This further separates the zones and may actually, in some cases, permit isolation of one or more compounds in a zone or in separate zones. After the adsorption process is complete, the glass tube containing the adsorbent may be cut in pieces corresponding to the colored zones. Colorless compounds after stratification on paper may be treated with reagents which develop color so as to permit separation and quantitative estimation.

The Photosynthetic Reaction Summarized. The outstanding fact known about photosynthesis is that CO_2 and H_2O are utilized in the formation of carbohydrate and O_2 is liberated.

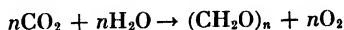

It obviously involves the reduction of CO_2 . Several of the numerous theories proposed assume that the first step is the formation of a chlorophyll- CO_2 complex. Even this simple assumption has been hard to prove or to disprove. It is true that the rate of CO_2 absorption by leaves is sufficiently rapid, even in the presence of a low tension of the gas, to indicate that CO_2 combines with something in the plant cell. Part of the combining power has been attributed to the proteins and part of it to the formation of carbonates or more especially of bicar-

bonates. If the chlorophyll-CO₂ complex is formed, it must be of a temporary nature.

The need for H₂O is apparent in view of the marked interference with photosynthesis by water deprivation. Photosynthesis in leaves is stopped or greatly inhibited at or before the "wilting point." The significance of H₂O is further indicated in experiments reported by Curry and Trelease (1935), who found that photosynthesis in the green alga *Chlorella* was reduced to about 0.4 per cent of its normal rate when 99.9 per cent deuterium oxide was substituted for ordinary water.

The Baeyer Formaldehyde Theory. The first product formed is not surely established. As far back as 1870, Baeyer suggested that formaldehyde might be the first product.

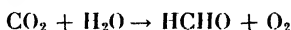

In spite of many vicissitudes and many attempts either to prove or to disprove it, this theory remains after three-quarters of a century as a mere hypothesis.

Formaldehyde in extremely low concentration is toxic to plants. For example, the water plant *Elodea canadensis* has been found by Paechnatz (1937) to show toxic effects of HCHO when its concentration is 0.001 per cent or even less. This objection is met by the supposition that formaldehyde is so rapidly polymerized into carbohydrate that it never reaches a toxic concentration in the plant cell. If formaldehyde is an intermediary product, one would expect that sufficiently low concentrations of it when supplied to the plant in the surrounding water or air could be utilized for carbohydrate synthesis and that this should be possible even in the dark. Experiments have been attempted in an effort to prove this, but results have been conflicting. One of the positive results was that reported by Sabalitschka and Weidling (1926), who found increased carbohydrate concentration in *Elodea* leaves, both in the light and in the dark but especially in the dark, when the surrounding water contained HCHO. The apparent synthesis increased with the concentration of HCHO up to an optimum at about 0.024 per cent and then fell off. Paechnatz found, however, on repeating this work, that the plant cells were in a more or less moribund condition and certainly did not retain, in the presence of more than 0.001 per cent HCHO, all normal physiological properties of *Elodea* cells. The analytical results indicated that the plants lost in their total solid material while the formaldehyde exerted some sort of a "sparing" effect upon the carbohydrate as though preventing it from being oxidized. The depressing effect of the formaldehyde upon oxidation (CO₂ production) was observed even in low concentrations of HCHO.

Another test of the formaldehyde theory would be the detection of HCHO as actually present, at least in minute traces, in plants while carrying on photosynthesis. Here again the evidence is conflicting. The reagent called "dimedon" (dimethylhydroxyresorcinol) is said to be capable of detecting formaldehyde in 0.001 per cent concentration, and Klein and Werner reported on its use in demonstrating the production of HCHO by *Elodea* in the light but not in the dark. Barton-Wright and Pratt found, however, that HCHO was also produced in the culture media from the action of light upon CO₂ and bicarbonates independently of any photosynthetic activity of the plant. Other work in which formaldehyde is distilled from green plant material has led to equally uncertain interpretations. The failure of an unequivocal detection of HCHO in the presence of active photosynthesis is regarded by Baly (1922) and others as evidence for the theory that HCHO, *as such*, is not actually produced during photosynthesis but occurs in a highly reactive form designated as "activated formaldehyde" which is supposed to be rapidly changed to sugar and cannot be detected.

A third type of research is the study of the condensation of HCHO into carbohydrate. It has long been known (Butlerow, 1861) that HCHO in alkaline solution gives rise to sugars and sugarlike compounds. The mixture obtained is sometimes called *formose*. Nef reports on formose as being made up of about equal proportions of pentoses and hexoses, the latter including both aldo- and keto-forms. The aldohexoses included DL-glucose and DL-galactose. In view of the fact that the alkalinity of solutions in which HCHO condenses to sugars is greater than that to be expected in plant cells, one can hardly feel that these reactions throw much light on the mechanism of the natural synthesis of carbohydrate in plants.

The Energy Requirements in Photosynthesis. Based upon the energy content of D-glucose and assuming that it is representative of the carbohydrates produced, the photosynthetic reaction might be summarized thus:

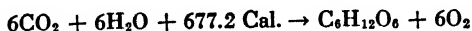

where Cal. stands for kilogram calories and 677.2 Cal. (heat of combustion of glucose) represents the energy which must be absorbed in the form of radiant energy in the production of 1 gram molecule of sugar. The number of quanta (energy units) utilized in forming the first product of the photosynthetic reaction has been extensively investigated in the hope of elucidating the true nature of that reaction. One method is the one-sided exposure of leaves or aquatic plant cultures to light of known intensity while measuring the radiation which penetrates to the

other side and is thus unabsorbed. The difference between the intensity of the incident light and that unabsorbed permits computation of the energy trapped by the plants, and this value may be compared with the rate of photosynthesis simultaneously measured.

This and all similar methods are subject to serious experimental difficulties and errors, most of which tend to make the energy requirements appear too high. In general, therefore, the measurements yielding the lowest values (highest efficiency) are to be given especial weight. On this basis, it would seem that 4 to 6 quanta are required in the utilization of 1 molecule of CO_2 or liberation of 1 molecule of O_2 . Some investigators find that the minimum is more than 6 quanta. It must be recalled, however, that the actual energy content per quantum varies with the frequency. One quantum = $h\nu$, where h is Planck's constant (6.55×10^{-27}) and ν is the frequency. Thus shorter waves (higher frequency) deliver quanta of higher energy value. Data in Table 6 will serve to illustrate this statement. The figures in the last column are obtained by multiplying the $h\nu$ (quantum) values by the factor (2.386×10^{-8}), which converts ergs to calories, and by 6.06×10^{23} , Avogadro's number. The resulting Q values, expressed as kilogram calories, represent in each case the amount of energy that would be available if 1 quantum were utilized by each molecule of 1 gram equivalent (892 g.) of chlorophyll.

TABLE 6.—ENERGY EQUIVALENTS OF LIGHT OF VISIBLE WAVE LENGTHS

Wave length	Frequency per sec.	Approximate location in spectrum	Quantum value, $h\nu$	$Q = Nh\nu$
m μ	$\gamma \times 10^{14}$	region	ergs $\times 10^{-12}$	Cal.
750	4.00	Extreme red	2.62	37.80
700	4.29	Middle of red	2.81	40.62
656	4.58	C line (Fraunhofer)	3.00	43.48
590	5.08	Orange-yellow	3.33	48.06
490	6.12	Green-blue	4.01	57.88
455	6.60	Blue-violet	4.32	62.33
395	7.59	Extreme violet	4.97	71.80

If formaldehyde, of which the heat of combustion is about 150 Cal., be regarded as the first product of the photosynthetic reaction, it is clearly seen that, for that portion of the spectrum in the red region which is most markedly absorbed by chlorophyll and is especially effective in photosynthesis, no less than 4 quanta would be required. Only when the frequency is as great as that of the blue and violet light is the energy value such that 2 quanta might suffice. If merely 1 quantum were to be utilized, this could be possible only in the case of ultraviolet rays

(200 $m\mu$ or less). This conclusion would seem at first thought to be valuable evidence in favor of the formaldehyde theory inasmuch as the reduction of 1 gram molecule of CO_2 in photosynthesis in red light appears to require 4 quanta per molecule. But one must be cautious in drawing this deduction because conditions in the neighborhood of the chloroplast are complicated by many factors. One of them is the ever-present oxidative metabolism of the protoplasm. If O_2 is withdrawn or if oxidation is checked by any of a number of respiratory poisons, photosynthesis is inhibited. Any variation in the cellular oxidation rate might add to the uncertainties of computation of the photosynthetic rate as influenced by light alone.

The Photosynthetic Ratio. When the O_2 evolved and the CO_2 assimilated are both determined simultaneously during photosynthesis, the ratio O_2/CO_2 can be estimated. It is known as the photosynthetic ratio. Many uncertainties are involved in its determination, as is evident upon noting that both the O_2 evolution and the CO_2 assimilation must be corrected in order to make allowance for cell oxidations. Corrections are made from measurements of the gaseous exchange of the plant in the dark on the assumption that this value represents oxidation in the light.

Some of the most carefully determined values are those obtained by Willstätter and his school. These workers are apparently convinced that *the ratio is unity* and any apparent deviations from unity are to be accounted for by technical difficulties or by lag in measurements. If this conclusion is correct, it furnishes substantial evidence in favor of the theory that the fundamental photosynthetic reaction is

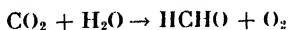

The Effect of Varying CO_2 Tension and Light Intensity. Although plants can carry on photosynthesis at surprisingly low CO_2 tensions and, indeed, the vast majority of land plants have CO_2 available only at the usual level of the average atmospheric content (0.03 to 0.04 per cent), the rate of photosynthesis can be markedly increased by higher CO_2 tensions. The curves shown in Fig. 5 will illustrate the effect. The values used were obtained with aquatic plants, and the CO_2 was furnished by KHCO_3 ; but quite similar curves are obtained by the use of land plants with CO_2 content of the air varied from 0.03 to 0.24 per cent. Photosynthesis speeds up with increased abundance of CO_2 but not in a linear relationship because at high CO_2 tensions light intensity becomes a limiting factor. Only when the intensity of illumination is sufficiently great is the photosynthetic rate proportional to the CO_2 tension and then only over a limited range of values. The effect of heightened CO_2 tension reaches a maximum beyond which further

increases may even depress the rate, due no doubt to the toxic effect of high concentrations of CO_2 .

The corresponding experiments in which light intensity is varied while keeping the CO_2 tension constant yield similar results. The rate of photosynthesis increases with the intensity but only to level out at a value determined by the limiting effect of the CO_2 tension. As could be inferred from the previous discussion, the effects of varying the light

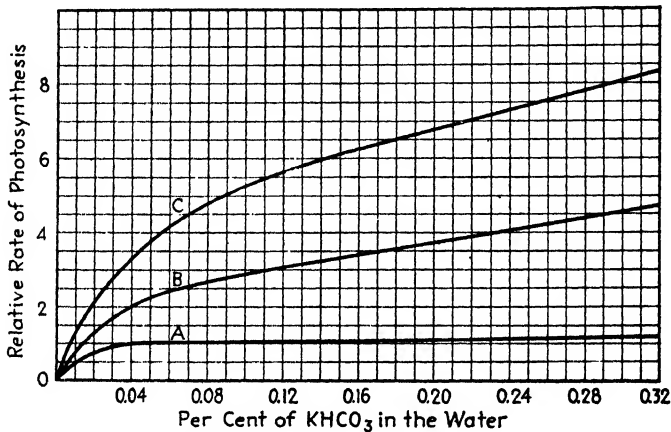

FIG. 5. The effect of varying CO_2 supply upon the rate of photosynthesis. The rate was measured by determinations of O_2 liberated by aquatic plants. CO_2 was supplied by varying concentrations of KHCO_3 . Results shown in curve A were obtained with a low intensity of light; for those in curve B, illumination was three times as intense as for curve A; in curve C, nine times as intense as for curve A. (After Harder.)

intensity are noticeably modified by the wave lengths of the light; but even when ordinary sunlight is used, the effect of increasing intensity reaches a maximum beyond which further increases have a depressing effect although the CO_2 concentration may be fairly high.

The Temperature Effect. The rate of photosynthesis varies with temperature in a complex manner. With optimum illumination and CO_2 tension, the rate is increased by rise of temperature in a regular manner as are all chemical processes, being at least doubled by a rise of 10°C . ($Q_{10} = 2$). With illumination at sufficiently low intensity, the rate of photosynthesis appears to be *independent of temperature*. Low light intensity sets the pace for the entire process. In a complex chain of interdependent reactions, such as must be involved in the photosynthetic process, the slowest "link in the chain" determines the rate. With intermediate degrees of light intensity, the effect of temperature is intermediate and the Q_{10} values vary between 1 and 2. Such results are obtainable, however, only in ranges of temperature which do not

exceed about 31 to 35°C. When the temperature rises to 40°C. or higher, the photosynthetic rate is depressed even though the temperature does not become sufficiently high to kill the plant. This may be regarded as evidence that one or more enzymatic processes are involved in the chain of photosynthetic reactions. Such a temperature effect is characteristic of enzyme action.

The Dark Reaction. When a green plant is exposed to *intermittent* lighting, the amount of carbohydrate produced by photosynthesis may exceed that resulting from *continuous* illumination with the same intensity and total duration of lighting. This indicates that some part of the photosynthetic process consists of a reaction or reactions which can go on in the dark but at so slow a rate as to set the limit of the rate of the process as a whole. It is sometimes called the Blackman reaction. One of the fruitful methods for its investigation consists in observing the rate of photosynthesis under intermittent light flashes of known intensity at regular and known intervals. Using such a method, Emerson and Arnold (1932) found that the photochemical part of the synthesis could occur in as short a time as 0.01 msec. (msec. = 0.001 second) whereas the dark reaction required a time of the order of 40 msec. at 25°C. The latter is obviously the pace setter of photosynthesis except under conditions of very low light intensity.

The Carbohydrates Formed. The carbohydrates produced by photosynthesis include simple and complex sugars and polysaccharides. The nature of the sugar formed as the first product can only be conjectured. Among the suggestions that have been put forward are glycollic aldehyde (a compound with 2 C atoms), trioses (3 C atoms), glucose (6 C atoms), and fructose (6 C atoms).

We may speak of the initial part of the synthesis as the "fixation" of CO₂, followed by or accompanied simultaneously by what is commonly spoken of as "reduction" of CO₂. In short, assimilation of CO₂ involves an energizing (reducing) reaction. Of course the actual source of the energy introduced is sunlight, but an indirect utilization of energy has attracted some attention. It is of interest because it shows analogies between metabolism in plants and in animals. The experiments involved were possible because of the use of isotopic C atoms which, having radioactivity, may be detected in any compound containing them. They serve as labels of compounds. It had been known for some years that, during the course of vital oxidation in mammalian muscle and in yeast, CO₂ may be taken up and combined with certain acids arising as partial oxidation products. For example, pyruvic acid combines with CO₂ to form oxaloacetic acid.

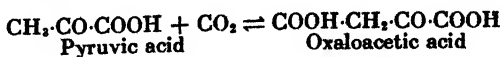

Such reactions occur in spite of the fact that the series of oxidative reactions, of which they are a part and which constitute the tricarboxylic acid cycle (see Chap. XII), produce the net effect of liberated CO_2 , i.e., it exceeds what may be taken up. A number of investigators have showed the assimilation of CO_2 containing radioactive C during photosynthesis. Its assimilation into acids and other intermediary products of oxidation is reported by Calvin and Benson (1948). They used two kinds of green algae, *Chlorella* and *Scenedesmus*, which were exposed to CO_2 containing the isotope C^{14} . They found that both of these plants took up the labeled C^{14}O_2 in such a way that C^{14} could be found in various fractions separated from the plant substance. The fractions contained some of the compounds, occurring in the tricarboxylic acid cycle, and others which arise by means of reactions that go concurrently with those of the cycle.

Of particular interest was the isolation and identification of phosphoglyceric acid. This arises in the course of normal metabolism in both plants and animals by oxidation of triose phosphate which arises from the splitting of a hexose phosphate. This led to the theory that some of the reactions by which hexose is formed in photosynthesis are the same reactions by which hexose is normally destroyed but operating in reverse.

Confirmatory evidence has been obtained by other isotope experiments, devised and used for the study of carbohydrate synthesis in animals but also used in studies of photosynthesis. These experiments not only detect isotopic C in the synthesized carbohydrates but also show which of their C atoms are the radioactive ones. Starch or glycogen of the tissue is hydrolyzed and the resulting glucose, together with any free glucose present, is fermented in one of the available methods by *Lactobacillus casei* to form lactic acid. The latter is oxidized with KMnO_4 to acetaldehyde and CO_2 , and the aldehyde is further broken down to iodoform and formic acid. Radioactive atoms, marked with an asterisk, are traced during these reactions as shown in the following scheme:

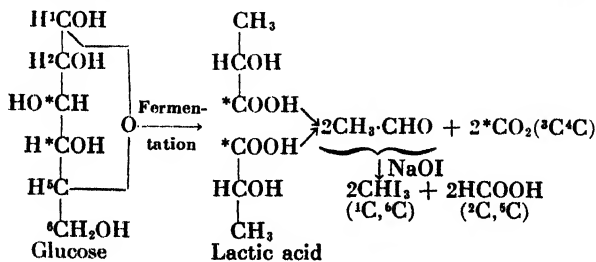

These results, showing all the radioactive C atoms traceable to positions 3 and 4 of glucose were obtained when NaH^*CO_3 was injected into

rats which were simultaneously fed glucose. The animals were killed $3\frac{1}{2}$ hr. after feeding, the livers taken immediately, and the glycogen in them prepared and tested. The outcome of this and similar experiments shows that, in animals, carbohydrate synthesis may be due to a process which is essentially the reverse of the breakdown reactions by which hexose yields trioses and the latter may yield pyruvic acid or lactic acid under some circumstances (see glycolysis, Chap. XIV). The essential fact in connection with the present argument is the apparent participation of trioses in the synthesis of other carbohydrates.

A number of investigators have used similar techniques for the study of photosynthesis. Such experiments have been more frequently and successfully done since the relatively stable isotope C^{14} has been available. In addition to experiments with green algae, plants have been exposed to an atmosphere containing $C^{14}O_2$ during photosynthesis and then examined to trace the isotope. Some of these experiments are shown in Table 7.

TABLE 7.—DISTRIBUTION OF RADIOACTIVE CARBON IN SUGAR MOLECULES AFTER PHOTOSYNTHESIS

Nature of experiment	Relative amounts of C^{14} found in		
	$^3C, ^4C$ position	$^2C, ^3C$ position	$^1C, ^4C$ position
Algae, in dark after previous illumination.....	75-90		
Barley shoots, photosynthesizing 1 hr. in $C^{14}O_2$	61	24	15
Same 2 hr.	37	36	27

Such results give further weight to the theory that photosynthesis involves chemical reactions proceeding through the triose stage; but they further indicate that the initial carbohydrate formed is so apt to be altered by complex metabolic reactions, breaking apart and reconstituting sugar molecules, that labeled C atoms, originally placed in the 3C and 4C positions, tend to become uniformly distributed through the molecule.

One should note, as has been pointed out by active researchers in this field, that these results obtained by newer techniques and indicating that a triose (probably triose phosphate) is the first carbohydrate formed leave unsolved the fundamental problem of how CO_2 is actually reduced (energized) in photosynthesis. The idea that sucrose might be the initial product, since it tends to accumulate during photosynthesis in the leaves of some species, has given way to the opinion that it is formed secondarily from the hexoses and is, for such plants, the chief form in which carbohydrate is translocated. Starch, in leaves which form it, is only a temporary

storage material, serving to remove from activity the sugar formed in excess of what is removed by translocation or oxidation.

Wohl (1937) has proposed an interesting theory which suggests that hexoses might be not only the first carbohydrate formed but the first definite compound produced by photosynthesis. His ideas are based on the complex constitution of the chlorophyll-bearing granum and its environment. The behavior of the chlorophyll affords evidence, as mentioned above, that it is in combination with protein. With the aid of an underlying protein molecular pattern, holding a number of chlorophyll groups in one giant molecule, it might be possible, according to Wohl's suggestion, for the hexose molecule to arise in one uninterrupted process. This would do away with the formaldehyde theory, long a thorn in the side of biochemists. Incidentally, it would require less energy than if HCHO were an intermediary product. Six molecular equivalents of HCHO contain about 900 Cal. while one of glucose has only 677 Cal. Further research, including elucidation of the properties of the hypothetical protein-chlorophyll complex, will be required before this theory can gain a footing.

Possible Interaction of Chloroplast Pigments. Baly, Heilbron, and their coworkers have been proponents of a theory summarized by Baly (1935). It takes account of the close association of chlorophylls and carotenoids in the chloroplast. It can be given in abbreviated form. A photochemical reaction, involving oxidation of chlorophyll *a* to chlorophyll *b*, is assumed to occur thus:

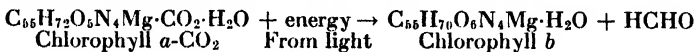

This might be followed by the regeneration of chlorophyll *a* from the *b* form through simultaneous oxidation of carotene to xanthophyll.

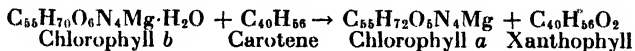

The subsequent reduction of xanthophyll to carotene would permit, indirectly, the liberation of O₂ as it regularly occurs in photosynthesis. The reactions involved in restoration of chlorophyll *a* would thus constitute the dark reaction.

This theory, if substantiated, would give significance to a striking fact: namely, chlorophyll *a*, chlorophyll *b*, carotenes, and xanthophylls occur together closely packed into the chloroplast of every green plant.

Photosynthesis as Related to Other Plant Syntheses. While carbohydrates are the immediate result of photosynthetic activity, other syntheses are indirectly dependent upon this process. The formation of protein in the plant is deficient or otherwise abnormal if photosynthesis is interfered with through defective nutrition or lighting. Just how

photosynthesis is related to protein synthesis is uncertain. Heilbron (1923) offered a suggestion. He agrees with Baly that formaldehyde, if produced during photosynthesis, must be in an "activated" form and finds that, presumably because it is in this condition, it reacts with nitrates or nitrites (important sources of nitrogen for plant synthesis of protein) to yield formhydroxamic acid, $\begin{array}{c} \text{H} \\ \diagup \\ \text{C}=\text{NOH} \\ \diagdown \\ \text{HO} \end{array}$, which might be a starting point for protein synthesis.

Carbohydrates are readily transformed into fats in both plants and animals. Photosynthesis is thus preliminary to synthesis of fats which comprise an important part of the storage material of some plants.

REFERENCES

- A useful exposition of photosynthesis and related subjects will be found in "Plant Physiology," E. C. Miller, 2d ed., New York, 1938.
- "Photosynthesis in Plants," edited by J. Franck and W. E. Loomis, Ames, Iowa, 1949, written by 30 authors, reflects the present-day confusion of ideas regarding the chemical mechanisms of photosynthesis but is exceptionally authoritative.
- Other aspects of plant synthesis are presented in "Protein Metabolism in the Plant," A. C. Chibnall, New Haven, 1939.
- The chemistry of chlorophyll is to be found in "Investigations on Chlorophyll. Methods and Results," R. Willstätter and A. Stoll, transl. by F. W. Shertz and A. R. Mertz, Lancaster, Pa., 1928.
- The following reviews are recommended:
- EMERSON, R., Photosynthesis, *Ann. Rev. Biochem.*, 6, 535, 1937.
- GAFFRON, H., Chemical Aspects of Photosynthesis, *Ann. Rev. Biochem.*, 8, 483, 1939.
- JOHNSTON, E. S., and MYERS, J. E., Photosynthesis, *Ann. Rev. Biochem.*, 12, 473, 1943.
- KAMEN, M. D., "Radioactive Tracers in Biology," New York, 1947; and *Ann. Rev. Biochem.*, 16, 631, 1947.
- STRAIN, H. H., Chloroplast Pigments, *Ann. Rev. Biochem.*, 13, 591, 1944.
- WASSINK, E. C., Photosynthesis, *Ann. Rev. Biochem.*, 17, 559, 1948.
- Papers of especial interest are:
- BALY, E. C. C., Photosynthesis, *Nature*, 109, 344, 1922.
- BALY, E. C. C., The Kinetics of Photosynthesis, *Proc. Roy. Soc.*, B117, 218, 1935.
- BARTON-WRIGHT, E. C., and PRATT, M. C., Studies in Photosynthesis. I. The Formaldehyde Hypothesis, *Biochem. J.*, 24, 1210, 1930.
- CALVIN, M., and BENSON, A. A., The Path of Carbon in Photosynthesis, *Science*, 107, 476, 1948.
- CURRY, J., and TRELEASE, S. F., Influence of Deuterium Oxide on the Rate of Photosynthesis, *Science*, 82, 18, 1935.
- DANGEARD, P. A., Recherches sur l'assimilation chlorophyllicane et les questions qui s'y rattachent, *Botaniste*, 19, 1-397; *Biol. Abst.*, 3, 474, 1927.
- EMERSON, R., The Effect of Intense Light on the Assimilating Mechanism of Green Plants, (*Cold Spring Harbor Symposia. Quant. Biol.*, 3, 128, 1935.
- EMERSON, R., and ARNOLD, W., A Separation of the Reactions in Photosynthesis by Means of Intermittent Light, *J. Gen. Physiol.*, 15, 391; 16, 191, 1932.
- FISCHER, H., and BREITNER, S., Vergleichende Oxydation des Chlorophyllids und einiger Abkömmlinge, *Ann. Chem.*, 522, 151, 1936.
- HEILBRON, I. M., Photosynthesis of Plant Products, *Nature*, 111, 502, 1923.
- PAECHNATZ, G., Zur Frage der Assimilation von Formaldehyd durch die grüne Pflanze, *Z. Bot.*, 32, 161, 1937.
- SHERMAN, W. C., Chromatographic Identification and Biological Evaluation of Carotene from Mature Soybeans (and Yellow Maize), *Food Research*, 5, 13, 1940.
- STEPKA, W., BENSON, A. A., and CALVIN, M., The Path of Carbon in Photosynthesis: II. Amino Acids, *Science*, 108, 304, 1948.
- WARBURG, O., and NAGELEIN, E., Über die Einfluss der Wellenlänge auf den Energieumsatz bei der Kohlensäureassimilation, *Z. physiol. Chem.*, 106, 191, 1923.
- WOHL, K., Theory of Assimilation, *Z. physik. Chem.*, B37, 105, 1937.

CHAPTER III

FATS AND RELATED SUBSTANCES

Fats are defined as the triglycerides of the fatty acids. They are esters of glycerol, $C_3H_5(OH)_3$; the type formula, therefore, is $C_3H_5(OOCR)_3$, where R represents the alkyl radical of some fatty acid or of two or three different fatty acids. This definition applies to what may be called the *true fats*, sometimes called *neutral fats*. But the term fats has been variously used. In casual laboratory parlance and in the popular sense, it seems to include any substance having physical properties like those of the fats, *i.e.*, immiscible with water or nearly so, soluble in ether and similar "fat solvents," and having a greasy or oily texture. The results of proximate biochemical analysis often include values for "fat content" when ether-soluble substance is really meant. We shall confine the use of the word "fat" to materials as defined above.

Classification. Several schemes for an orderly system of naming and defining the various ether-soluble substances of plant and animal structures have been introduced. No one system seems to have been uniformly adopted by biochemists. The scheme suggested by Bloor (1925) has much in its favor and is the one presented here. Some modifications have been introduced to conform to the results of newer researches.

In this classification the fats and related substances are termed **lipids** or **lipides**. They are defined as those substances which are (1) insoluble or nearly insoluble in water but soluble in such fat solvents as ether and chloroform; (2) fatty acids or compounds related to fatty acids as esters, either actually or potentially; and (3) utilizable by living organisms. The third of these characteristics excludes the mineral oils.

LIPIDS

- I. **Simple lipids**, esters of fatty acids with various alcohols.
 1. Fats, glycerol esters.
 2. Waxes, esters of alcohols other than glycerol.
- II. **Compound lipids**, esters of fatty acids containing groups in addition to those derived from alcohols and fatty acids.
 1. Phospholipids, substituted fats, and related compounds containing the phosphoric acid group and a nitrogenous group.
 - a. Lecithins, having a choline residue as the nitrogenous group attached to a phosphoric acid group substituted in a fat molecule.
 - b. Cephalins, having an aminoethyl alcohol residue as the nitrogenous group attached to a phosphoric acid group substituted in a fat molecule.

- c. Plasmalogens, similar to cephalins, but having an acetal structure so that aldehydes are obtained by hydrolysis.
 - d. Sphingomyelins, characterized by yielding sphingol but not glycerol upon hydrolysis and also yielding a fatty acid, choline, and phosphoric acid.
 - 2. Galactolipids (cerebrosides), characterized by yielding the sugar galactose upon hydrolysis and also yielding sphingol and a fatty acid.
 - 3. Other (ill-defined) compound lipids, such as sulfur-containing lipids, lipositols, etc.
- III. Derived lipids, obtained by hydrolysis of lipids as defined above or otherwise derived from them.
1. Fatty acids.
 2. Sterids, including sterols (solid alcohols) and some of the steroids, a heterogeneous group, some of which do not form fatty acid esters.
 3. Fatty aldehydes, reduction products of fatty acids.
 4. Alcohols other than sterols, the so-called "fatty alcohols," products of further reduction of fatty acids.
 5. Glyceryl ethers.

This classification in schematic form is •

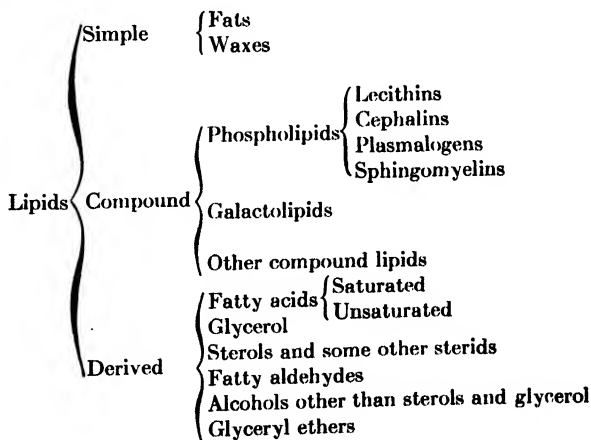

The Fatty Acids. Acids obtained by hydrolysis of fats include several types of which the chief are the *saturated* and the *unsaturated*. Of the saturated fatty acids the largest and most important subgroup is that of the acetic or normal type. They are of the so-called "straight-chain" structure with type formula, $C_nH_{2n+1}\cdot COOH$.

Acetic	$CH_3\cdot COOH$	Rarely, if ever, found in typical fats
Butyric	$CH_3(CH_2)_2\cdot COOH$	Obtained in low yield from certain fats, especially butter
Caproic (Hexanoic)	$CH_3(CH_2)_4\cdot COOH$	
Caprylic (Octanoic)	$CH_3(CH_2)_6\cdot COOH$	Obtained in small yields from many fats but more abundantly from some of plant origin
Capric (Decanoic)	$CH_3(CH_2)_8\cdot COOH$	

Lauric (Dodecanoic)	$\text{CH}_3(\text{CH}_2)_{10}\text{COOH}$	Named from its abundance in fats of the <i>Lauraceae</i> (laurels)
Myristic (Tetradecanoic)	$\text{CH}_3(\text{CH}_2)_{12}\text{COOH}$	
Palmitic	$\text{CH}_3(\text{CH}_2)_{14}\text{COOH}$	Most abundant and widespread of the acids of this series
Stearic	$\text{CH}_3(\text{CH}_2)_{16}\text{COOH}$	
Arachidic (Eicosanoic)	$\text{CH}_3(\text{CH}_2)_{18}\text{COOH}$	Named from its occurrence in peanut oil
Behenic	$\text{CH}_3(\text{CH}_2)_{20}\text{COOH}$	Found in oil of ben
Lignoceric	$\text{CH}_3(\text{CH}_2)_{22}\text{COOH}$	Occurs chiefly in compound lipids
Melissic	$\text{CH}_3(\text{C}_6\text{H}_5)_{28}\text{COOH}$	Found in beeswax

Fatty acids of this type but of still higher molecular weight have been reported as occurring in waxes. The higher members of the series, containing more than 20 C atoms, are not characteristically found in true fats but occur in other lipids, especially waxes. Palmitic and stearic acids are the most abundant of the acids of this series in the fats of both plants and animals, but lauric, myristic, and arachidic acids are widely distributed.

It will be noticed that all the members of the series as shown have an even number of C atoms. This is indeed the general rule for all natural fatty acids. Certain of them, alleged to contain an odd number of C atoms, have later been found to consist of mixtures of two or more with an even number of C atoms. The difficulties of quantitative separation are considerable.

The tendency to produce fatty acids with an even number of C atoms is due in part to the fact that the process of fat synthesis in plants and animals involves a progressive building up of the fatty acid carbon chains by the addition of two links at a time. Each fatty acid molecule which serves as the starting point for the synthesis of a more complex one is carried through reactions which add two units to its carbon chain. Moreover, when fatty acids are destroyed by physiological oxidation, the point of attack is commonly at the β -carbon atom resulting in the elimination of 2 C atoms from the chain and producing a new fatty acid containing 2 less C atoms than its precursor. The process is illustrated in the case of palmitic acid thus:

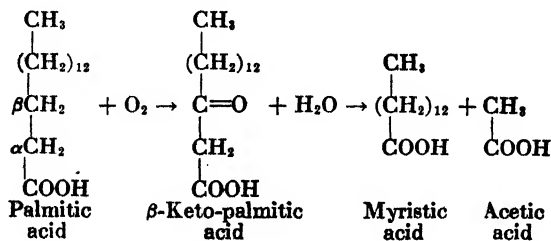

There are also saturated fatty acids having branched chains of C atoms. Examples are

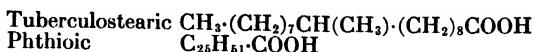

They have been obtained from *Mycobacterium tuberculosis*.

Acids of the unsaturated type constitute a second series of important fatty acids. The degree of unsaturation varies. Some have one double bond so that the type formula is $\text{C}_n\text{H}_{2n-1}\text{COOH}$. They may be designated as *-enoic* acids. Some have two double bonds ($\text{C}_n\text{H}_{2n-3}\text{COOH}$) and are the *-dienoic* acids, etc. The important ones are listed as follows:

UNSATURATED FATTY ACIDS

1. Oleic acid series ($\text{C}_n\text{H}_{2n-1}\text{COOH}$)

Crotonic	$\text{CH}_3 \cdot \text{CH} : \text{CH} \cdot \text{COOH}$	Croton oil
Palmitoleic	$\text{CH}_3 \cdot (\text{CH}_2)_5 \cdot \text{CH} : \text{CH} \cdot (\text{CH}_2)_7 \cdot \text{COOH}$	Vegetable and animal oils and fats
Oleic	$\text{CH}_3 \cdot (\text{CH}_2)_7 \cdot \text{CH} : \text{CH} \cdot (\text{CH}_2)_7 \cdot \text{COOH}$	
Erucic	$\text{CH}_3 \cdot (\text{CH}_2)_7 \cdot \text{CH} : \text{CH} \cdot (\text{CH}_2)_{11} \cdot \text{COOH}$	Rapeseed and nasturtium seed oil, etc.

2. Linoleic (linolic) acid series ($\text{C}_n\text{H}_{2n-3}\text{COOH}$)

Linoleic	$\text{CH}_3 \cdot (\text{CH}_2)_4 \cdot \text{CH} : \text{CH} \cdot \text{CH}_2 \cdot \text{CH} : \text{CH} \cdot (\text{CH}_2)_7 \cdot \text{COOH}$	Linseed oil and various plant and animal fats
----------	---	---

Isomers of linoleic acid probably occur.

3. Linolenic acid series ($\text{C}_n\text{H}_{2n-5}\text{COOH}$)

Linolenic	$\text{CH}_3 \cdot \text{CH}_2 \cdot \text{CH} : \text{CH} \cdot \text{CH}_2 \cdot \text{CH} : \text{CH} \cdot \text{CH}_2 \cdot \text{CH} : \text{CH} \cdot (\text{CH}_2)_7 \cdot \text{COOH}$	With linoleic
Elaeostearic	$\text{CH}_3 \cdot (\text{CH}_2)_3 \cdot \text{CH} : \text{CH} \cdot \text{CH} : \text{CH} \cdot \text{CH} : \text{CH} \cdot (\text{CH}_2)_7 \cdot \text{COOH}$	Tung oil

(Probable formula)

Other isomers of linolenic acid probably occur.

4. Four double-bond series ($\text{C}_n\text{H}_{2n-7}\text{COOH}$)

Arachidonic	$\text{C}_{19}\text{H}_{31} \cdot \text{COOH}$	Lecithin, cephalin
-------------	--	--------------------

5. Five double-bond series ($\text{C}_n\text{H}_{2n-9}\text{COOH}$)

Clupanodonic	$\text{C}_{21}\text{H}_{33} \cdot \text{COOH}$	Sardine oil
--------------	--	-------------

In addition to the saturated and the unsaturated fatty acids others of less regular structure occur exceptionally. Some are hydroxy acids containing one —OH group. They include the saturated *cerebronic acid*, $\text{C}_{24}\text{H}_{48}\text{O}_3$, derived from a galactolipid and *ricinoic acid*, $\text{C}_{18}\text{H}_{34}\text{O}_3$, from castor oil. *Japanic acid*, $\text{C}_{22}\text{H}_{42}\text{O}_4$, from japan wax and a few others are saturated fatty acids with two —OH groups.

Chaulmoogric acid, $C_{18}H_{32}O_2$, and *hydnocarpic acid*, $C_{16}H_{28}O_2$, and their homologues from chaulmoogra oil are cyclic acids. Chaulmoogric acid has been assigned the formula

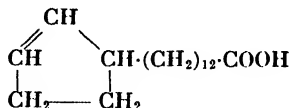

The structure and properties of these acids have attracted attention because of the use of chaulmoogra oil or chaulmoogric acid in the treatment of leprosy.

Properties of the Fatty Acids. The lower members of the normal saturated series are volatile and water-soluble, but the higher members

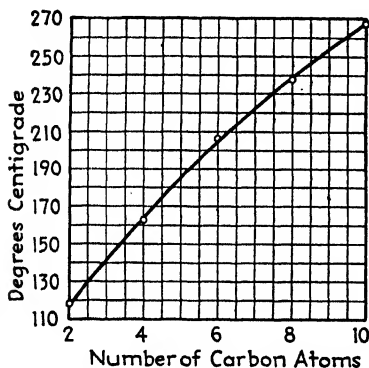

FIG. 6. Boiling points of fatty acids of the acetic-acid series. Higher members of the series tend to decompose without definite boiling points.

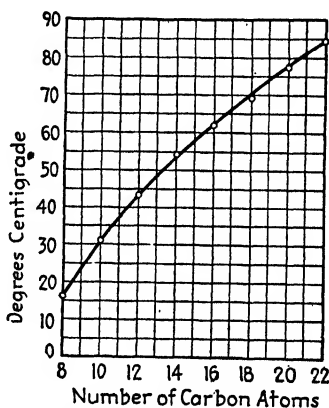

FIG. 7. Melting points as recorded for natural fatty acids of intermediate molecular weight. Those of lower molecular weight are liquids at room temperatures. Data for those containing more than 22° C atoms are less precise than for those indicated in the curve.

of the series are of low volatility (diminishing with rise in molecular weight) and are practically water-insoluble. The comparative volatility is indicated for the lower members of the series by the boiling points (Fig. 6); the higher ones decompose without actually boiling. The "texture" (comparative hardness at room temperature), of which the melting point is a fair index (Fig. 7), also varies with the molecular weight.

The unsaturated fatty acids, however, are all water-insoluble, non-volatile, and of oily texture, in fact are oils at room temperature. In

general, the greater the degree of unsaturation, the lower are the melting point and solidifying temperature.

Isomerism of the unsaturated fatty acids has been extensively studied. In oleic acid, the double bond is believed to be at the middle of the C atom chain. Its ozonide breaks down to yield the following three products: Nonyl aldehyde, $\text{CH}_3(\text{CH}_2)_7\text{CHO}$; nonylic acid, $\text{CH}_3(\text{CH}_2)_7\text{COOH}$; and azelaic acid, $\text{COOH}\cdot(\text{CH}_2)_7\text{COOH}$. These fragments, each containing 9 C atoms, indicate that, since oxidation occurs at the unsaturated bond, the latter is between the ninth and tenth C atoms of oleic acid. According to the modern system of nomenclature (p. 67) it is called Δ^9 -octadecenoic acid. Isomers with the unsaturated bonds in other positions have been synthesized artificially. The natural oleic acid has the cis arrangement, thus:

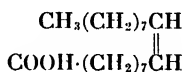

This detail has been established by a study of its physical properties, *e.g.*, the molecular equivalents required to produce a monomolecular film on a water surface of known area. The trans isomer

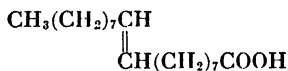

is **elaidic acid**. Its occurrence in nature does not seem to have been demonstrated, but it is used (Chap. XV) as a tracer to follow the deposit of food fatty acid in animal tissues. Another isomer, **vaccenic acid**, *trans*-octadecen-11-oic acid, is found in relatively high amounts in summer butter (4 to 5 per cent), less abundant in winter butter, and in small amounts in various animal and vegetable fats. It has attracted attention because it is reported to have a growth-stimulating effect for rats.

Similar studies of isomerism among the more highly unsaturated fatty acids, especially the linoleic series, have been made. Linoleic acid as it commonly occurs in nature has double bonds between the ninth and tenth and between the twelfth and thirteenth C atoms. It is therefore called $\Delta^{9,12}$ -octadecadienoic acid. Of the possible arrangements around these bonds, at least two occur. They are

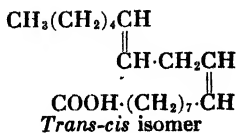
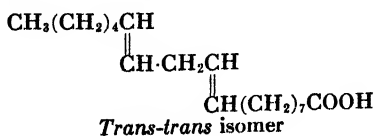

There is some evidence that the cis and trans isomerism of these acids has physiological significance. The trans acids, for example, are more

effective as bacteriolytic agents than are the cis forms and are also better protein precipitants.

The location of double bonds in the C atom chain of the physiologically important fatty acid **arachidonic** seems to be established (Arcus and Smedley-Maclean, 1943) as shown below.

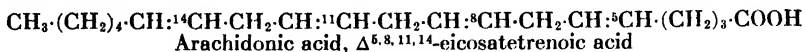

It will be noticed that the double bonds are so placed that two single-bonded arrangements are between them. This seems to be generally true among the naturally occurring unsaturated fatty acids. The physiological significance of this tendency is unknown. It is in contrast to the arrangement in those highly unsaturated hydrocarbons (p. 52) which have alternating double and single bonds. One notes that, with four double bonds, 16 (2^n) stereoisomers of arachidonic acid are theoretically possible. The stereoisomerism of the natural form is not established.

Indispensable Fatty Acids. Burr (1930) advanced the idea that certain "essential fatty acids" were indispensable for good growth and nutrition. Further investigations have established this idea and shown that the acids required are of the unsaturated type. Those which, in purified form, can make good the deficiency are linoleic, linolenic, and arachidonic acids. Any one of these can more or less completely meet the requirements without the others although linoleic acid appears to be the most effective. In some experiments arachidonic acid proved to be equally good.

The effects of this deficiency have been observed chiefly in rats. In addition to growth failure, the best quantitative measure of the deficiency, the symptoms include skin effects (dermatitis) with scaliness, rough fur, and much dandruff (Fig. 8). There is excessive water drinking. But the important effects are more deeply seated. They include kidney lesions, histological abnormalities in a number of tissues, including the ovary, and reproductive failure. In late stages bloody urine (hematuria) is often noted. If the deficiency is prolonged, it may be fatal. Autopsy shows severe kidney damage.

The amount required in the diet is not large. Apparently some 20 to 40 mg. of linoleic acid per rat per day is sufficient. The requirement tends to vary directly with the fat content of the food. Good lactation in rats requires 100 mg. per day. Lard is one of the best sources of linoleic acid, which varies from 7 to 15 per cent in different samples. The food oils of vegetable origin, although rich in unsaturated fatty acids, are not so rich in the indispensable ones as might be expected. Corn oil, however,

is a good source. Cod-liver oil is not curative. The relatively small amount of the requirement for these fatty acids suggests that they have a vitamin-like effect. They appear to be necessary as "building stones" for vital architecture and are also required in the production of the mobile (blood-transportable) lipids. It has been shown that an adequate supply of indispensable fatty acids may "spare" (decrease the quantitative requirement) but not replace certain vitamins, especially those the lack of which can cause skin disease (dermatitis), and conversely, vitamin

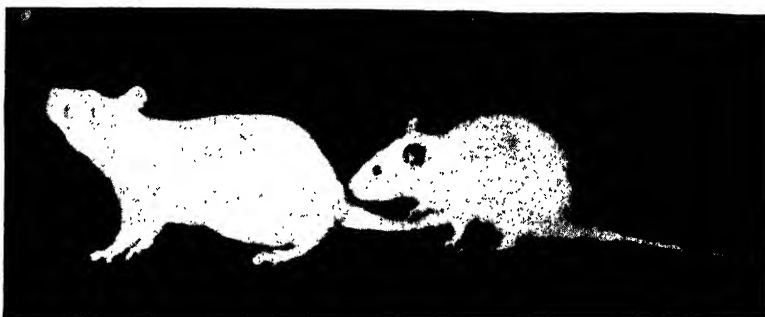

FIG. 8. Rat dermatitis and growth failure due to lack of essential fatty acids. The rats are female litter mates. The one on the left was on a normal diet (control); the other received a fat-free diet. Note stunting, rough coat, and dermatitis on tail, ears, and paws. (From G. O. Burr, "On the Necessity of Fats in the Diet," in "Chemistry and Medicine," University of Minnesota Press, 1940.)

B₆ and vitamin E can spare linoleic acid. While not strictly indispensable, neutral fat fed in suitable proportion to other foods is found to favor a rapid growth rate and some other aspects of optimal nutrition. The human requirement for indispensable fatty acids is not definitely known. Their curative effects in eczema have been observed in some cases though they are not invariable.

Fatty Aldehydes and Alcohols. Fatty acids may be reduced to yield what are called fatty aldehydes and fatty alcohols. The aldehydes occur in union with other groups in certain compound lipids (p. 83), but histological tests suggest that they may also be free in some cells. The fatty alcohols, however, have been prepared from a number of natural sources, both plant and animal. They occur as esters in waxes and in certain oils and are set free by hydrolysis in alkaline solution (saponification). They are then found mixed with the nonsaponifiable matter which is chiefly sterids. The typical fatty alcohols are solids at room temperature. They include cetyl alcohol, C₁₆H₃₃CH₂OH, and similar saturated alcohols. Unsaturated ones have been found in mammalian bone-marrow fat and in fish-liver oils. Representatives are oleyl alcohol,

$C_{17}H_{33}CH_2OH$, and selachyl alcohol, a dihydric alcohol. Fish-liver oils contain substances called "glyceryl ethers," in which an $-OH$ group of glycerol is substituted by union, through ether linkage, with an alkyl group derived from a fatty acid. These compounds are individually named alcohols, such as chimyl alcohol, batyl alcohol, and selachyl alcohol. The latter, $C_{18}H_{35}O \cdot C_3H_5(OH)_2$, from shark liver, contains the group related to oleic acid.

Glycerol. Fats being glycerides, their hydrolysis yields glycerol, $C_3H_5(OH)_3$, also called "glycerin," which is a by-product of soap manufacture and is also liberated by the enzymatic digestion of fats. Glycerol is freely soluble in water and ethanol but almost insoluble in ether. It can be dehydrated at high temperatures, especially in the presence of a dehydrating agent, such as $KHSO_4$, to yield acrolein, the irritating odor of which is readily detected.

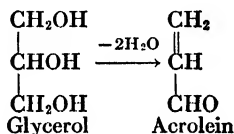

Acrolein production is a useful test for glycerol either free or in combination in fats and other lipids. Glycerol, mixed with borax to form a bead, gives a green flame test (glycerol borate) when heated on a platinum wire.

Natural Fats as Mixtures. Fats as found in plants and animals are more or less complex mixtures. This is shown by study of the fatty acids. In some cases one fatty acid may predominate, as in olive oil, which yields oleic acid amounting to more than 80 per cent of the total fatty acids. Bayberry wax and japan wax yield palmitic acid in similar large amounts. Butter fat, on the other hand, yields a long row of fatty acids as indicated in Table 8.

While it is possible in some cases to prove the existence of triglycerides, such as *triolein*, $C_3H_5(OOCC_{17}H_{33})_3$, or *tripalmitin*, $C_3H_5(OOCC_{15}H_{31})_3$, many neutral fats, perhaps the majority, are found to be the so-called *mixed glycerides*. Examples of mixed glycerides would be

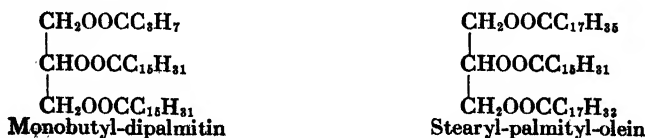

Inasmuch as the relative positions of the fatty acid radicals can be

varied in a mixed glyceride, isomerism is possible. Isomers have been prepared by artificial synthesis and their properties studied.

TABLE 8.—FATTY ACID CONTENT OF BUTTER

Acid	Fatty acids	Equivalent triglycerides
	Per cent ¹	Per cent
Dioxystearic.....	1.00	1.04
Oleic.....	32.50	33.95
Stearic.....	1.83	1.91
Palmitic.....	38.61	40.51
Myristic.....	9.89	10.44
Lauric.....	2.57	2.73
Capric.....	0.32	0.34
Caprylic.....	0.49	0.53
Caproic.....	2.09	2.32
Butyric.....	5.45	6.23
Total.....	94.75	100.00

¹ It is not certain that the values given represent complete separation of fatty acids. Those occurring in very low concentration are not listed.

Saponification. Although fats are comparatively resistant to hydrolysis in acid solution, they are readily hydrolyzed in alkaline solution. The process is called "saponification" because the products include soap. A typical reaction, the saponification of triolein with NaOH, yielding the soap, sodium oleate, and glycerol, may be written thus:

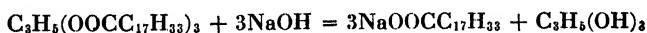

A soap may be defined as the metallic salt of a higher fatty acid. Inasmuch as fatty acid in esterified form in any compound can yield a soap, the saponification process may be applied to compound lipids as well as to neutral fats.

Saponification can be effected in a mixture of melted fat and alkaline water, but is usually carried out in hot alcohol, which facilitates the process.

The soaps of the alkali metals are soluble. Those of the alkali-earth metals are almost insoluble in water. This is the explanation of the curdy precipitate which forms when soap is used in "hard water" containing salts of Ca and Mg such as the carbonates and chlorides. Soaps of the heavy metals, *e.g.*, lead, are water-insoluble; but lead oleate, an important ingredient of adhesive plaster, is ether-soluble. Of the commercial soaps the so-called "hard" soaps are predominatingly sodium soaps while "soft" soaps are chiefly those of potassium.

Soaps may be "salted out" from aqueous solution by addition of neutral salts, such as sodium chloride. This process is doubtless facilitated by the tendency of soaps to form sizable aggregates, colloidal particles, in cold solution.

Emulsions. A dispersal of fats, usually in the form of oils, so that fine droplets are suspended in a watery medium, is the common type of emulsion, but other types occur. Semisolid fat may be dispersed in water, or watery droplets may be dispersed in fat. The latter form is a butterlike emulsion. Although an oil vigorously shaken with water is dispersed in droplets fine enough to diffract light in the manner which gives the creamy appearance characteristic of emulsions, the dispersion thus obtained is only temporary. Complete separation into aqueous and oily layers rapidly follows the cessation of shaking. A stable emulsion is obtainable only when an emulsifier or stabilizer is present. Effective emulsifiers include soaps, proteins, soluble polysaccharides, bile salts, and a number of other substances. In order to act as an emulsifier, a substance must be able to cause a marked change in surface-tension conditions at the interface between the two phases, the oily and the watery. Anything which lowers the surface tension of water at its air surface will, in general, have the same effect at the water-oil interface so that the surface tension-lowering effect as commonly measured becomes a rough index of the emulsifying property of a given substance. One can picture the lowering of surface tension of water in contact with oil as permitting the water to flow around or to "wet" oil droplets, thus preventing them from coalescing to larger drops which would eventually separate into an oily layer because of the lower specific gravity of fat in comparison with that of water.

The emulsifying action of soaps affords an interesting case which has been given special study. A striking demonstration is obtained by contrasting the emulsification in an alkaline solution of neutral oil, *e.g.*, pure olive oil, with that of the same oil containing fatty acid, either rancid oil or oil containing a low concentration of added oleic acid. In the first case, prolonged shaking is required to produce an emulsion and even then it is an imperfect one; but with the acid-containing oil a slight agitation is sufficient to produce a finely dispersed and stable emulsion. The stability of the emulsion of neutral oil is limited by the small amount of soap formed by shaking in alkaline solution at room temperature. But free fatty acid readily forms soap under these conditions, and thus the emulsion is stabilized. One may picture, at the oil-water interface, the formation of a film of soap molecules acting as a "cement substance" between oil and water. The polar end of the soap molecule, the NaOOC -group, is strongly attracted toward water and is, indeed, responsible for

the solubility of soap in water. The long C chain, a nonpolar group, which in the case of oleic acid is the $C_{17}H_{33}$ — group, is more strongly attracted toward the oil than toward the water. As a result each soap molecule forming at the interface is oriented so that the surface of an oil droplet has a structure which may be represented as shown in Fig. 9.

The action of soaps as emulsifiers has further attracted attention because of the so-called "reversal effect." If a calcium soap, instead of a sodium soap, is produced in an experiment similar to the one just described, the resulting emulsion will take the form of aqueous droplets

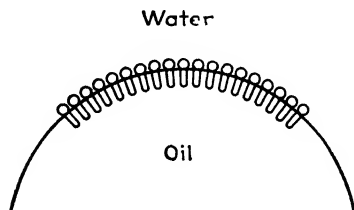

FIG. 9. Suggests the orientation of soap molecules at the interface between oil and water. The metallic part (Na or K) of the soap is represented by circles and the fatty acid part by bars.

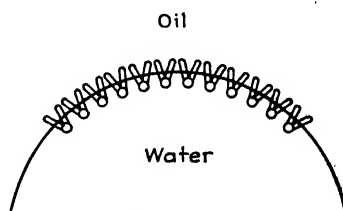

FIG. 10. Suggests that the shape of soap molecules may be effective in determining the form of an emulsion which they stabilize. Soaps of a divalent metal, e.g., Ca, would be wedge-shaped and might thus affect the bending of the film at an oil-water interface.

dispersed in oil, an emulsion resembling butter rather than cream. Bancroft, a pioneer investigator of this phenomenon, interpreted his observations as indicating that sodium soaps lower the surface tension of water sufficiently to enable it to emulsify fat, while calcium soaps lower the surface tension of oil to a degree enabling it to emulsify water. When the proportion of calcium soap to sodium soap is varied, as in experiments where an oleic acid-containing oil comes in contact with solutions containing varying proportions of NaOH and $CaCl_2$, the nature of the resulting emulsion depends upon whether sodium or calcium soap predominates. It is possible to produce a balanced condition in which the "antagonistic effects" of the two kinds of soap neutralize each other so that no stable emulsion is formed. Other divalent metallic ions, such as those of magnesium, tend to act like calcium; and other monovalent ions, such as those of potassium, behave like sodium.

The shape of the oriented film at the oil-water interface may be pictured in the case of the divalent soaps as shown in Fig. 10.

The shape of molecules of soaps of divalent metals (roughly wedge-like) may be regarded as influencing the curvature of the oil-water inter-

face so as to determine the nature of the emulsion. If this supposition is correct, the relative solubility of the two types of soap in oil and in water may not be the determining factor.

Physiologically, the balanced relations between monovalent ions (especially Na and K) and divalent ions (especially Ca and Mg) are found to be of prime importance in vital phenomena. Disturbances in the balanced relation may produce profound physiological changes, such as those in membrane permeability, in excitability, etc. At the pH generally prevailing in living tissues any free fatty acid could hardly be expected to be in the form of soap. The physiologist is, therefore, uncertain regarding the theory that some of the dramatic effects of disturbing the physiologically balanced relations between monovalent and divalent metallic ions and especially their "antagonistic effects" may be due to reversible changes in the character of protoplasmic emulsions involving different orientations of soap molecules.

The action of emulsifiers other than soap has been less extensively investigated, but much evidence is available to indicate that such substances are in the form of ultramicroscopically thin films at oil-water interfaces and thus act as stabilizers of emulsions.

Hydrogenation. Unsaturated fatty acids or fats containing them can be made to take up hydrogen at their double bonds. The process, known as hydrogenation, is of considerable commercial importance. Vegetable oils such as cottonseed oil, peanut oil, etc., are thus converted into soft, semisolid fats which serve as lard substitutes. A catalyst is required. Powdered metallic nickel has long been in use for this purpose, but other catalysts are available. Hydrogenation as carried on for commercial purposes is far from complete. There is a marked tendency for the more highly unsaturated fatty acids, such as those of the linolenic and linoleic series, to be partly hydrogenated before the less unsaturated ones, such as oleic acid, are changed.

Rancidity. A tendency of fats to become rancid is noticed during prolonged storage. Rancidity is often marked by disagreeable odors. The chemical processes involved are of several types. The simplest is the liberation of fatty acid by enzyme action as sometimes happens in butter. If butyric acid is set free, its odor is noticeable. A more complex type of rancidity is that due to molds, such as *aspergillus*, which may cause the formation of ketones. But the most prevalent and practically important type is oxidative rancidity in which the fats are oxidized by atmospheric oxygen.

Various conditions affect the rate of development of oxidative rancidity. High temperatures, a small amount of moisture, and light accelerate the process. A number of metals catalyze the process. Oils kept

in contact with lead or copper rapidly become rancid. Removal of oxygen delays rancidity. Antioxidants are used. They are substances, such as certain polyphenols and hydroquinones, which prevent the attack of O_2 upon the double bond of unsaturated fatty acids. Similar antioxidant effects are important in animal metabolism.

Analytical Methods Applied to Fats. Inasmuch as the exact analysis of natural fats is extraordinarily laborious and time consuming, their characterization ordinarily depends upon the measurement of certain physical and chemical properties. The physical ones include melting point, temperature of solidification (congealing point), and refractive index. The following chemical determinations are commonly included in fat analysis.

1. *The acid value*, a measure of free fatty acid, is defined as the milligrams of KOH required to neutralize the free fatty acid of 1 g. of fat.

2. *The saponification number*, a rough measure of the average molecular weight of the constituents of a fat, is defined as the milligrams of KOH required to saponify 1 g. of fat. It is determined by titration of the remaining excess of alkali after saponifying a weighed quantity of fat in standard alcoholic KOH. The relationship of the result to the molecular weight is indicated in Table 9.

TABLE 9.—SAPONIFICATION NUMBERS OF PURE TRIGLYCERIDES

Triglyceride	Molecular weight	Saponification numbers
Butyrin.....	302.2	557.0
Decanoin.....	554.4	303.6
Myristin.....	722.7	233.0
Palmitin.....	806.8	208.6
Stearin.....	890.9	188.9
Olein.....	884.8	190.2
Linolein.....	878.8	191.5

3. *The Reichert-Meissl number*, a measure of the volatile fatty acid content of a fat, is defined as the number of cubic centimeters of 0.1N KOH required to neutralize the soluble, volatile fatty acids obtained from 5 g. of fat. After saponification of the fat, the material is acidified and distilled with steam. The distillate is titrated, giving a measure of fatty acids of low molecular weight, chiefly butyric, caproic, and decanoic acids. The high Reichert-Meissl number of butter is important in identifying it and in detecting its adulteration.

4. *The iodine number*, a measure of the degree of unsaturation, is defined as the grams of iodine absorbed by 100 g. of fat. A weighed

amount of the fat dissolved in CCl_4 is treated with a measured volume (excess) of a standardized solution of iodine in glacial acetic acid. A "halogenating agent" to facilitate the reaction is also used. One method (Hanus) employs iodine bromide; another (Wijs), iodine chloride; and a third (Yasuda) uses pyridine sulfate dibromide. The reaction is permitted to come to equilibrium (1 to 2 hr.) at room temperature in the dark. The excess iodine, not taken up by unsaturated bonds of the fat, is then titrated in the presence of KI solution by the familiar iodometric method using standard thiosulfate. That the iodine absorbing power of unsaturated fatty acids tends to vary according to the degree of unsaturation is indicated by the following values:

Fatty Acid	Iodine Number
Oleic.....	89.93
Linoleic.....	181.16
Linolenic.....	273.7

5. *The acetyl number*, a measure of the $-\text{OH}$ groups, is defined as the milligrams of KOH required to neutralize the acetic acid obtained by saponification of 1 g. of fat after it has been acetylated. Acetylation is produced by heating the fat with acetic anhydride, thus causing the acetyl groups to substitute for the free $-\text{OH}$ groups of the fatty acids. Castor oil with a high acetyl number (about 146), due to its ricinoleic acid (p. 67), is in contrast to most vegetable and animal oils with lower acetyl values (2.5 to about 20) inasmuch as hydroxy fatty acids are not abundant in most fats.

Results of these analytical measurements on some common fats and oils as shown in Table 10 will indicate the variability of the natural products and the possibilities for identification of the source of the fat by means of the results.

Nonsaponifiable Matter. Natural fats, including oils, contain varying amounts of material (Table 11) which retains its solubility in ether after saponification. As soaps are not ether-soluble, the "nonsaponifiable fraction" is readily separated from them by extraction with ether. It contains the sterols, certain of the fat-soluble pigments of plants and animals, and the fat-soluble steroid vitamins and hormones.

Drying Oils. Oils which are rich in highly unsaturated fatty acid undergo autoxidation, *i.e.*, are spontaneously oxidized by atmospheric oxygen at ordinary temperatures. The product is a hard and waterproof substance. This is the basis of the "drying" or hardening of paints and shellacs and of the hardening of oilcloth and linoleum. Tung oil, from the seeds of the tung tree (*Aleurites fordii*) and allied species, is the most powerful "drying" oil known. It has come into considerable use in the

TABLE 10.—ANALYTICAL DATA FOR REPRESENTATIVE FATS AND OILS

	Solidifying point, °C.	Saponification value	Iodine value	Acid value	Reichert-Meißl number
Beef tallow.....	31 to 38	196-200	35.4-42.3	0.25	
Butterfat.....	19 to 24.5	210-230	26-28	0.45-35.4	17.0-34.5
Castor oil.....	-12 turbid; -17 to -18 solid	175-183	84	0.12-0.8	1.4
Chaulmoogra oil, U.S.P.....	25	196-213	98-104		
Cod-liver oil.....	-3	171-189	137-166	5.6	0.2
Corn oil.....	-10 to -20	187-193	111-128	1.37-2.02	4.3
Cottonseed oil.....	12 to -13	194-196	103-111.3	0.6-0.9	0.95
Human fat.....	15	193.3-199	64	0.25-0.55
Lard.....	27.1 to 29.9	195-203	47-66.5	0.5-0.8	
Linseed oil.....	-19 to -27	188-195	175-202	1-3.5	0.95
Mutton tallow.....	36 to 41	195-196	48-61	1.7-14	
Olive oil.....	2 turbid; -6 solid	185-196	79-88	0.3-1.0	0.6-1.5
Peanut oil.....	3	186-194	88-98	0.8	0.4
Soybean oil.....	-10 to -16	189-193.5	122-134		
Tung oil.....	2 to 3	190-197	163-171	2	0.35

TABLE 11.—THE UNSAPONIFIABLE MATTER OF SOME REPRESENTATIVE FATS

Fat	Unsaponifiable Matter, per Cent
Butterfat.....	0.3-0.45
Castor oil.....	0.6
Cod-liver oil.....	0.54-2.68
Corn oil.....	1.5-2.8
Lard.....	1.1-1.6
Linseed oil.....	0.4-1.2
Olive oil.....	0.4-1.0
Peanut oil.....	0.5-0.9
Sperm oil.....	39.0-42.0
Tung oil.....	0.4-0.8
Wool fat.....	39.0-44.0

place of linseed oil, formerly the chief "drying" oil of commerce. Tung oil is especially rich in its yield of highly unsaturated fatty acids such as those of the linolenic series.

PHOSPHOLIPIDS

Thudichum (1829-1901), who did the major part of the pioneer work of investigation of phospholipids, called these products "phosphatides," and this name is still in use as well as the newer one. All of them contain

phosphorus and nitrogen, but while most of them have a P:N ratio of 1:1, in one subgroup, the sphingomyelins, this ratio is 1:2.

Lecithins. If the ether extract of cellular material of either plants or animals is treated with acetone, a white waxy precipitate of phospholipids is obtained. It is sometimes called "crude lecithin," as it is usually the starting point for preparation of lecithins, but it is really a complex mixture. The purification of lecithin is an intricate and laborious process. It is difficult to get rid of other compound lipids and especially the other phospholipids. It is necessary also to avoid exposure to air because lecithin is autoxidizable. Either crude or pure lecithin, white when first precipitated, is perceptibly yellowed as a result of oxidation within a few minutes of exposure. After a few days it acquires a dark reddish-brown color. Purification processes may be carried on in an atmosphere of nitrogen.

The tissue serving as a source of lecithin is dried *in vacuo* and extracted with alcohol and ether. Ether alone does not remove all the lecithin, presumably because of its failure to break up certain lecithin-protein complexes. After precipitation by acetone, further separation can be effected in several ways, one of which is the preparation of the cadmium chloride salt of lecithin. Liberation from this salt is brought about by ammonia.

The behavior of lecithin toward water is peculiar. It is readily dispersed so as to give the appearance of an emulsion. But the dispersed masses, observed microscopically, may have an irregular shape described as "myelin forms" rather than a globular shape.

The hydrolysis of lecithin by $\text{Ba}(\text{OH})_2$ yields barium soaps, barium glycerophosphate, and choline. The latter is oxyethyl-trimethylammonium hydroxide.

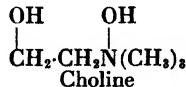

Results of this hydrolysis and other data, including artificial synthesis, lead to the following formulas for lecithin:

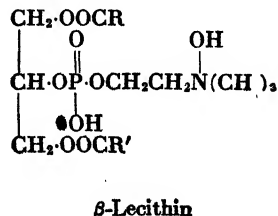
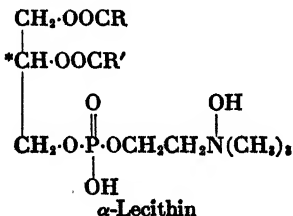

In these formulas R and R' represent fatty acid radicals which may be

the same or different in a lecithin molecule. The α - and β -forms differ in their physical properties, *e.g.*, optical activity. It will be noticed that the β -form could be symmetrical and optically inactive. Natural lecithins, like fats, are complex mixtures yielding various fatty acids, both saturated and unsaturated. The claim, made at one time, that every lecithin contained at least one unsaturated fatty acid, seems to have been disproved. Only a few specimens of lecithin have been isolated as chemical individuals. One prepared by Levene was shown to be stearyl- α -lecithin. The fatty acids having 18 C atoms seem to predominate among those derived from the lecithins of animal tissues, although some with longer C chains have been identified, and palmitic acid with 16 C atoms is frequently found. The proportion of saturated to unsaturated fatty acid as measured by the iodine number tends to be relatively constant in the lecithins derived from any one animal organ.

The lecithins are *amphoteric* which means that they can react both as acids and as bases. The phosphoric acid group has one replaceable hydrogen, and the choline group can dissociate as a base. Choline is a rather strong base so that the basic properties of lecithin predominate over its acidic properties. The isoelectric point (pH at which it migrates neither toward anode nor cathode) is probably about 6.7 in the case of pure lecithin in its natural state.

Choline has considerable physiological significance as a regulator of fat metabolism. It is found that animals on a diet deficient in choline-containing substances tend to accumulate neutral fat in the liver, and excess of choline produces the opposite effect, *i.e.*, a lowering of the store of liver neutral fat. A derivative of choline, acetylcholine, has attracted attention as one of the "chemical transmitters" concerned in the transfer of the process of excitation from certain nerve endings to adjacent structures. It has not been shown, however, that lecithin or other choline-containing phospholipids are the immediate precursors of acetylcholine.

Lysolecithins. Phospholipids can be broken down by certain enzymes so that the fatty acid is split off. An enzyme, one of the lecithinases, found in certain venoms (bee and cobra) specifically removes only the unsaturated fatty acid group of lecithins producing what are called "lysolecithins."

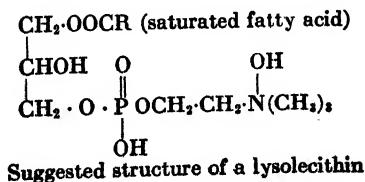

Lysolecithins and lysocephalins are powerfully toxic. They cause rapid destruction of red blood corpuscles (hemolysis), but they can combine with one molecular equivalent of cholesterol (p. 89) to produce substances which do not cause hemolysis.

Cephalins. Closely associated with lecithins are the cephalins, also called "kephalins." They are characterized by having, instead of a choline group, the β -aminoethyl alcohol (ethanolamine) group.

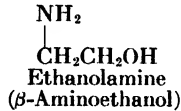

Based upon the results of saponification and other data, the structure of cephalins is given as

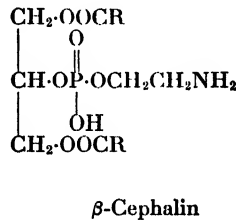
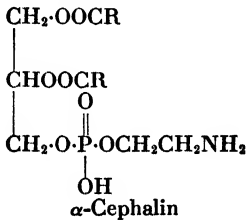

As in the case of lecithins, the cephalins differ from each other in regard to the fatty acid groups, saturated and unsaturated, built into their molecules. Also like lecithins, the natural cephalins are complex mixtures. All of their properties so closely resemble those of the lecithins that separation is difficult. A method of separation depends upon the fact that cephalins are practically insoluble in ethanol at 60°C . while lecithins are comparatively soluble. A special function probably due to cephalins is that of counteracting anticoagulants of blood (Chap. X) so as to instigate the process of blood clotting. Cephalin-protein complexes are believed to act in a similar manner.

Cephalin-like Phospholipids. The cephalin-like phospholipids of brain are reported (Folch, 1942, 1943) to include compounds which yield **inositol** and the amino acid (Chap. IV) **serine** among the products of their hydrolysis. These preparations are related to cephalins because they yield fatty acid, phosphoric acid, glycerol, and ethanolamine; but how serine and inositol are related is not yet clear. The occurrence of inositol in association with a lipid is of interest because, as will be shown in later chapters, inositol has certain regulative effects on lipid metabolism. Inositol, also called **inosite**, is widely distributed in plants and animals. It is a cyclic hexahydric alcohol.

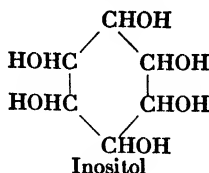

The name **lipositol** was proposed by Folch and Woolley for inositol phospholipids, and Woolley reports on the preparation of lipositol from a plant source, soybean oil. The material, in seemingly isolated form, contained 16 per cent of inositol. From both animal and vegetable sources, diphosphoinositides have been prepared.

Plasmalogens. Another type of phospholipid closely related to lecithins and cephalins are the plasmalogens. Like cephalins, they yield, upon hydrolysis, ethanolaminic and glycerophosphoric acid but differ from other phosphatides in yielding aldehydes rather than fatty acids. Both α - and β -forms have been recognized. Feulgen, who with coworkers has done the pioneer investigation of these substances, has suggested the following formula for a representative α -plasmalogen:

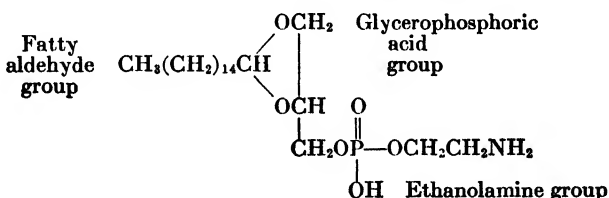

Sphingomyelins. The sphingomyelins differ from other phospholipids in that no glycerol group is present. The products of hydrolysis are sphingol, a fatty acid, phosphoric acid, and choline. **Sphingol**, also called **sphingosine**, is a complex alcohol bearing an amino group. Its structure appears (1942) to be $\text{CH}_3 \cdot (\text{CH}_2)_{12} \cdot \text{CH} : \text{CH} \cdot \text{CHOH} \cdot \text{CHNH}_2 \cdot \text{CH}_2\text{OH}$. The preponderance of available evidence indicates that it is joined to a fatty acid residue in sphingomyelin through the amino group rather than by an ester linkage. A probable formula for sphingomyelin is

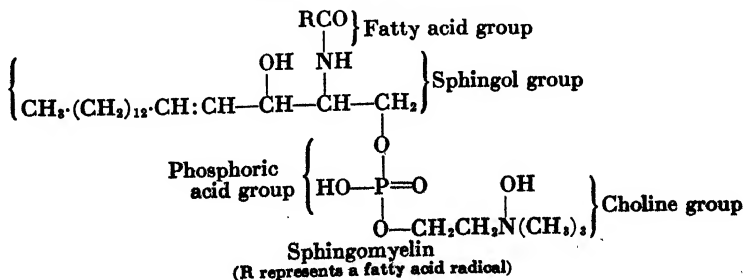

A specimen of sphingomyelin, isolated in a degree of purity permitting identification of the fatty acid, yielded *lignoceric acid*. Another gave what was believed to be *hydroxystearic acid*.

While the sphingomyelins are like the other phospholipids in being insoluble in acetone and cold ethanol, they differ in being nearly insoluble in cold ether. The preparation of sphingomyelin depends in part upon this difference. Suitable solvents include warm ether, chloroform, pyridine, and glacial acetic acid. Sphingomyelins are relatively stable compounds, not autoxidizable. They have been found in brain, lung, spleen, kidney, liver, egg yolk, and in smaller amounts in blood and muscle. In spite of this wide distribution, nothing definite is known of their physiological significance.

The relative abundance of phospholipid in animal tissues is indicated in Table 12. Such results vary considerably even in the same tissue of a

TABLE 12.—PHOSPHOLIPID CONTENT OF ANIMAL TISSUES¹

Tissue	Beef tissues (Blood)	Rabbit tissues (Nerking)
Spinal cord.....	11.16
Brain.....	4.58	3.86
Liver.....	3.06	1.07
Bone marrow.....	2.71
Adrenal gland.....	2.39
Pancreas.....	1.86	
Heart muscle.....	1.64	1.60
Kidney.....	1.62	1.34
Lung.....	1.25	1.52
Skeletal muscle.....	0.42-1.06	0.60
Blood.....	0.14

¹ Figures are per cent of moist tissue and indicate "crude lecithin," a mixture of phospholipids.

given species. The variations are due in part to the lack of precise methods of determination and also, probably, to actual variation with metabolism. This matter will be discussed further in Chap. XV.

Folch-Pi (Folch) and Sperry note that the separation of different phospholipids depends upon solubilities which are greatly modified by small amounts of impurities. They suggest, therefore, that characteristic, identifiable atomic groupings would afford a better basis for classification than does solubility and propose to subdivide phospholipids thus: (1) Phosphoglycerides, (2) phosphoinositides, and (3) phosphosphingosides. It would seem that newly discovered phospholipids might fit into such a scheme.

GALACTOLIPIDS

The galactolipids, formerly called **cerebrosides** and also termed "cerebro-galactosides," are found, as the name cerebroside implies, in nervous tissue more abundantly than elsewhere. Hydrolysis by acid liberates one equivalent each of *fatty acid*, *sphingol*, and the sugar *galactose*. Individual galactolipids are characterized by the kind of fatty acid built into the molecule. Although soluble in certain fat solvents (hot ethanol, hot acetone, and pyridine) the galactolipids are practically insoluble in ether even when warm. Detailed information regarding the union of constituent groups is lacking, but some evidence is available. Partial hydrolysis yields **pyscosin**, the galactoside of sphingol, and this indicates that the arrangement is in the order

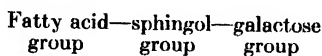

Fatty acids found in separated (more or less purified) galactolipids are the saturated, normal *lignoceric acid*, $C_{23}H_{47}COOH$, of **kerasin**; *cerebronic acid*, believed to be hydroxy-lignoceric acid, of **cerebron**, also called **phrenosin**; *nervonic acid*, believed to be the unsaturated homologue of lignoceric acid and to have the formula $C_{23}H_{45}COOH$, of **nervon**; and *oxynervonic acid*, apparently the hydroxy derivative of nervonic acid, of **oxynervon**. Some evidence for the existence of other fatty acids in galactolipids has been presented, but the nature of these and even of the four listed above is not well established.

Galactolipids are widely distributed in animal organs and have even been found in some plant structures, but only nervous tissue yields them in amounts large enough for satisfactory isolation. Kerasin and cerebron appear to compose at least 2 per cent of fresh brain tissue—more than 8 per cent of the solid matter. Although this suggests some especial function in nerve activity, nothing is definitely established regarding their physiological significance.

Cerebrosides of spleen are reported (Klenk and collaborators) to contain glucose as well as galactose, and cerebroside accumulations in the spleen in Gaucher's disease are reported to contain considerable glucose.

Klenk and coworkers have isolated brain cerebrosides which they regard as a new type and have named **gangliosides**. Their distinguishing features are (1) their content of a special fatty acid, called "neuraminic acid," and (2) their yield of more than one equivalent of galactose. They form clear colloidal solutions with water, are readily soluble in mixtures of chloroform or benzene with ethanol, and are insoluble in ether, acetone, and ethyl acetate. They contain no amino nitrogen. They are levorotatory.

STERIDS

Sterid chemistry began with investigation of the sterols (solid alcohols), which are complex substances of fairly high molecular weight. They occur, free or as esters or in both forms, in all structures of plants and animals and in blood and some other animal fluids. The longest known and most thoroughly studied example is cholesterol, $C_{27}H_{46}OH$, so named because of its abundance in bile, from which it too often crystallizes to form gallstones. A number of other sterols have been described as occurring in plants and animals. They have been subjected to intensive research in recent decades along with other related substances which are also of exceptional physiological interest, *viz.*, the bile acids, the vitamins D (preventing rickets), the sex hormones (both male and female), and some others. The numerous and heterogeneous compounds related to sterols may be referred to as steroids. The entire group, including sterols, is referred to as the sterids (solid lipids) in recognition of the fact that they are typically waxlike solids with high melting points.

Structure. The difficulties involved in elucidation of the complex molecular structure of sterids and its relation to their physiological properties can scarcely be appreciated except by the student of the historical development of research in this field. The account is too extended to be included here (see references, p. 93). Many investigators in Canada, England, France, Germany, Japan, Switzerland, and the United States have made important contributions. A monumental and truly fundamental task was the establishment of the molecular structure of cholesterol, begun by Windaus in 1901, and assisted by discoveries of many investigators, but not completed until 1932 when Rosenheim and King solved the problem of the ring framework of the bile acids and enabled Windaus and Wieland to use the results in establishing the cholesterol formula.

Both sterols and steroids are built upon the same structural framework or nucleus of the molecule. It is sometimes erroneously referred to as the "phenanthrene nucleus," which it does resemble, but is more correctly described as a *cyclopentanoperhydrophenanthrene* structure. The carbon atoms and the ring formations of the sterid nucleus are numbered thus:

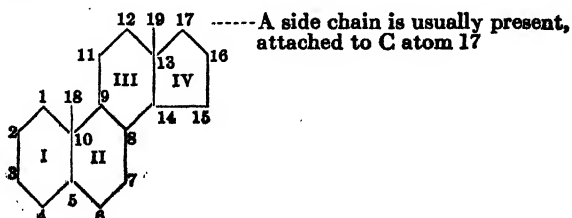

In this nucleus, ring IV is the cyclopentano part and rings I, II, and III constitute the perhydrophenanthrene portion. Being hydrogenated, they differ from phenanthrene, which is a similar condensation of three *benzene* rings. A methyl group is usually present at position 18 and regularly at 19. A side chain, attached at position 17, occurs in most sterids.

Sterids differ structurally in the following respects:

1. The methyl group at position 18: It is missing from estrogenic (causing sexual receptivity) female hormones and is modified in the D group of vitamins.

2. The presence or absence of a side chain at position 17: It is lacking in estrogenic hormones, in androgenic (producing maleness) hormones, and in one of the hormones of the adrenal cortex.

3. The structure of the side chain at C atom 17 when present: The number of C atoms in it varies from 2 to 10. The branching of the carbon chain, the number and position of unsaturated bonds, and the presence of substituent groups also introduce variations.

4. The presence or absence of one or more hydroxyl and/or carbonyl (keto) groups: They are usually at positions 3 or 17 but may be at other positions, including 7, 11, 12, 14, and 16. If the compound has one or more *hydroxyl* groups and no carbonyl or carboxyl groups, it is a *sterol* and its specific name terminates in *-ol*. If it has one or more carbonyl or carboxyl groups, it is regarded as a steroid. In many cases the specific name of the compound is given in recognition of carbonyl groups and accordingly terminates in *-one*. This is especially the case when physiological activity of the compound is dependent upon the presence of the ketone group. Thus testosterone, a male hormone from the testis, is so designated although it is a 3-keto-17-hydroxy compound.

5. The presence or absence of double bonds between carbon atoms (degree of hydrogen saturation) and location of double bonds when present: Some sterids, *e.g.*, the estrogenic hormones (estradiol and estrone) have such an arrangement of unsaturated bonds that ring I of the nucleus is a benzene ring and a few sterids, *e.g.*, equilenin from horse urine, have both rings I and II of the benzene type. The number and location of double bonds markedly affect chemical and physiological properties.

6. The stereoisomeric configuration at a carbon atom to which the hydroxyl group is attached: The —OH group at position 3, for example, may be either *cis* or *trans* to the methyl group at position 18. When it is *trans* the compound is usually named with the prefix *epi-*, *e.g.*, *epicoprosterol*.

7. The stereoisomeric arrangement of the rings with respect to each other: This may be illustrated in the case of ring I. Thus if one assumes

TABLE 13.—A CLASSIFICATION OF STERIDS

"Parent" substance	Orientation at C ₅ —C ₁₀	Side chain attached to C ₁₇	Examples
Estrane (C ₁₈ H ₃₀)	cis	None (also lacks—CH ₃ at position 18)	Estrogenic hormones and related substances in urine
Androstane (C ₁₉ H ₃₂)	trans	None	Androgenic hormones and related compounds (mostly urinary)
Pregnane (C ₂₁ H ₃₆)	cis	— ²⁰ CH ₂ . ²¹ CH ₃	Progesterone (pregnancy hormone) and most of adrenal cortex hormones
Allopregnane (C ₂₁ H ₃₆)	trans	— ²⁰ CH ₂ . ²¹ CH ₃	Allopregnandiol of urine
Cholane (C ₂₄ H ₄₂)	cis	— ²⁰ CH. ²² CH ₂ . ²³ CH ₂ . ²⁴ CH ₃ ²¹ CH ₃	Cholic acid of bile and related compounds
Cholestane (C ₂₇ H ₄₈)	trans	— ²⁰ CH. ²² CH ₂ . ²³ CH ₂ . ²⁴ CH ₂ . ²⁵ CH. ²⁷ CH ₃ ²¹ CH ₃ ²⁶ CH ₃	Cholesterol and related compounds; vitamin D ₂
Coprostone (C ₂₇ H ₄₈)	cis	Same as for cholestane	Coprosterol of feces
Ergostane (C ₂₈ H ₅₀)	trans	— ²⁰ CH. ²² CH ₂ . ²³ CH ₂ . ²⁴ CH. ²⁶ CH. ²⁸ CH ₃ ²¹ CH ₃ ²⁵ CH ₂ . ²⁷ CH ₃	Ergosterol from many sources; calciferol (vitamin D ₂)
Sitostane (C ₂₉ H ₅₂) also called stigmastane	trans	— ²⁰ CH. ²² CH ₂ . ²³ CH ₂ . ²⁴ CH. ²⁷ CH. ²⁹ CH ₃ ²¹ CH ₃ ²⁵ CH ₂ . ²⁸ CH ₂ ²⁶ CH ₃	Sitosterols and stigmasterols of plant oils

that the orientation of rings II, III, and IV remains fixed (as it regularly does in natural sterids) the adjustment of ring I to ring II could be either a cis or a trans form depending upon the orientation along the line between carbon atoms 5 and 10.

The latter variation is one of the significant ways in which the naturally occurring sterids differ. It determines in part some of their physiological

properties. This is hardly surprising in view of the marked change of shape of the molecule when this arrangement is altered. Because of these prominent effects the terms *cis* and *trans*, as applied to descriptive names of sterids, are often used to refer only to the stereoisomerism between rings I and II. The estrogenic and some other female hormones, cholic acid from bile, and several hormones of the adrenal cortex are thus said to be *cis* sterids, while the male hormones, several adrenal hormones, cholesterol (also a number of its derivatives), ergosterol, the D vitamins, various plant sterols, and some other sterids are *trans* forms.

Classification. While sterids are loosely classified according to physiological action (sex hormones, steroid vitamins, etc.), a systematic classification is made according to the nature of the side chain at position 17. Each sterid is thus regarded as a derivative of a "parent" substance which is the hydrocarbon obtained or theoretically obtainable when the sterid is completely reduced. The individual members of each group differ among themselves in the number and position of unsaturated bonds and in the number and position of substituent groups (hydroxyl, carbonyl, and carboxyl). The classification is shown in Table 13.

In addition to the tabulated classes other sterids are known. One group of pharmacological interest includes the aglycones (p. 42) of the cardiac glycosides derived from digitalis and other plants. These sterids have not been thoroughly investigated; but specific therapeutic effects upon the heart are shown, in some cases at least, to be determined by the structure of the side chain of the sterid aglycone.

Further discussions of certain sterids will be deferred (see Chaps. VI, VIII, XV, and XX). Only the sterols will be taken up here.

Cholesterol. The structural formula of cholesterol is

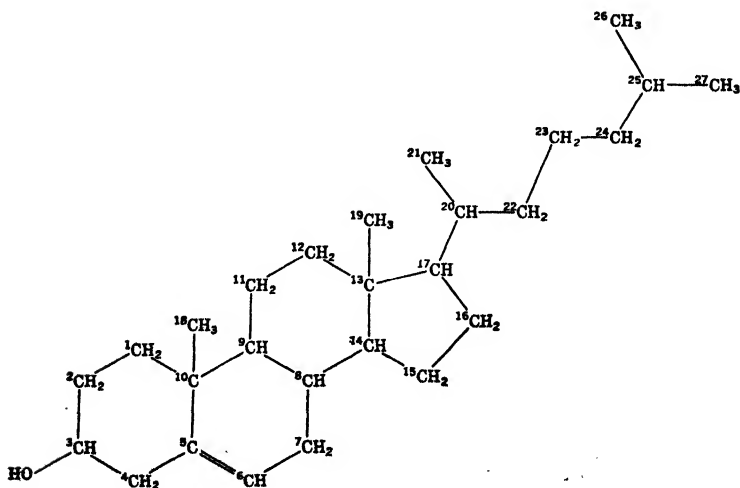

Cholesterol gives a number of characteristic color reactions when subjected to certain procedures, *e.g.*, (1) a cherry-red with a greenish fluorescence when its chloroform solution is treated with concentrated sulfuric acid (Salkowski test); (2) a violet color changing to bluish green when its chloroform solution is treated with a few drops of acetic anhydride and then with concentrated sulfuric acid (Liebermann-Burchard test); (3) a violet color of the dried residue when solid cholesterol is moistened with concentrated hydrochloric acid containing ferric chloride and the resulting mixture is evaporated to dryness (Schiff test). From its alcohol-acetone solution free cholesterol is precipitated by digitonin, but cholesterol esters are not. Digitonin is one of the digitalis glycosides, and its specific configuration permits combination with free cholesterol and with other natural sterols in the free state (not esterified).

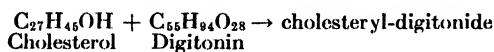

The configuration at C₃ influences the reaction. For example, dihydrocholesterol, 3-hydroxycholestane, is precipitated but epidihydrocholesterol and epicholesterol (synthetic products) are not precipitated.

This reaction is the basis of a method for quantitative estimation of cholesterol. If total cholesterol, rather than free cholesterol, is to be determined, the analysis must be preceded by saponification in mildly alkaline solution so as to set cholesterol free from its esters. Although such estimations reveal the presence of cholesterol in all animal tissues and fluids, they show it to be more abundant in nervous tissue and in the adrenal gland than elsewhere. Many determinations on the human brain show an average content of about 2.7 per cent of cholesterol in the fresh, undried tissue of the whole brain. Its amount is variable in different specimens of bile, normally about 0.1 per cent; but in bile from a gall bladder, as much as 4.7 per cent has been found. In blood and in tissues other than nervous, a small amount, less than 0.1 per cent, is found. When extracted from animal tissues, cholesterol usually contains some 1 to 3 per cent of **dihydrocholesterol**, also called **cholestanol**, a saturated sterid, 3-hydroxycholestane. In some cases, tissue cholesterol may be accompanied by small amounts of **7-dehydrocholesterol**, 3-hydroxy- $\Delta^{5-6,7-8}$ -cholestadiene, and **oxycholesterol**, 3,4-dihydroxy- Δ^{5-6} -cholestene. The occurrence of these three compounds suggests that they are products of partial reduction and partial oxidation of cholesterol in the tissues. This is probably true, but the metabolic history of cholesterol (its origin, intermediary reactions, and destruction) has not yet been clearly deciphered. This matter will be treated further in Chap. XV.

As stated in connection with unsaponifiable matter (p. 78) cholesterol

and all sterols (also many steroids) occur in nature associated with fats. They are extracted by fat solvents of which many different ones are used. Cholesterol and all typical sterols are insoluble in water and aqueous solutions; but in the form of esters and in protein complexes, they are slightly soluble.

Cholesterol readily crystallizes from ether to form waxy, rhomboidal plates (Fig. 11), but its complete purification by crystallization is impractical because it forms mixed crystals with other sterols which are associated with it in tissues. A number of methods have been used to separate sterols. One of them depends upon the different solubilities of the brominated forms from which, after isolation, the sterol can be regenerated by treatment with zinc and acetic acid or other means. Another method utilizes the differing solubilities of the digitonides from which the sterol may be released by treatment with pyridine.

Cholesterol is levorotatory, $(\alpha)_D = -38.8^\circ$. Its melting point is 150°C .

Coprosterol, $\text{C}_{27}\text{H}_{47}\text{OH}$, in feces results from bacterial reduction of cholesterol. The double bond between C atoms 5 and 6 is hydrogenated, thus forming a saturated compound. This reduction, however, is not a simple one but involves a reorientation of the cholesterol trans structure to the cis form which characterizes coprosterol and other coprostane derivatives. This is probably accomplished by a partial oxidation which precedes reduction.

Ergosterol. The structural formula of ergosterol is

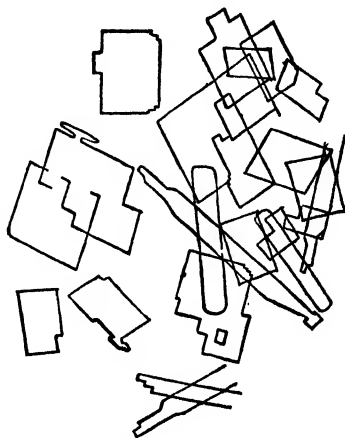
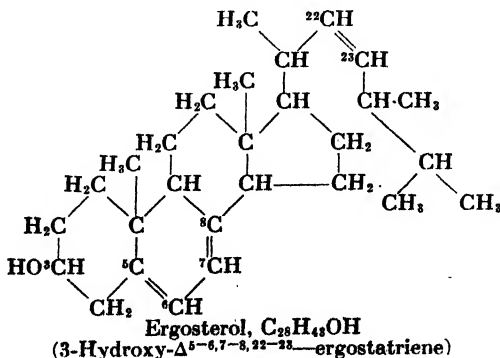

FIG. 11. Cholesterol crystals.

This sterol got its name because it was first discovered in ergot, a fungus, growing on plants, especially rye. It has been an attractive object of research since it was shown (1931) to be the substance in sterol preparations which yields vitamin D₂ (calciferol) when exposed to ultraviolet irradiation. While ergosterol is the chief sterol of fungi and yeast, it occurs in small amounts, along with other sterols, in many plant structures. Its wide distribution is indicated by the large number of food materials which can acquire at least some vitamin D potency (prevent or cure rickets) upon suitable ultraviolet irradiation. Details will be considered in Chap. VI. The small amounts believed to occur in some animal tissues, *e.g.*, 0.5 per cent of sterols of skin, are not determined chemically but are said to be recognizable by spectrophotometric analysis. Absorption in the ultraviolet spectral region (240 to 300 $m\mu$) is characteristic. The changes in absorption resulting from various intensities and durations of ultraviolet irradiation are used to follow the progress of the consequent molecular transformations which give rise to a number of substances, including calciferol. A significant source of an antirachitic substance is dehydrocholesterol (p. 90) of animal tissues. It yields vitamin D₃ upon ultraviolet irradiation.

Having three double bonds, ergosterol has a relatively high iodine number (199). It is levorotatory, $(\alpha)_D = -133^\circ$. It melts at 163°C.

Zymosterol, accompanying ergosterol in yeast, is dextrorotatory, $(\alpha)_D = 47.3^\circ$, and melts at 110°C.

Other Sterols. The term "phytosterols" (plant sterols) has been used to refer to various compounds occurring in plants and either proved or believed to be sterols. Only a few of them are well characterized.

Stigmasterol obtained from the oil of the calabar bean (*Physostigma venosum*) is 3-hydroxy- $\Delta^{5-6,22-23}$ -sitostadiene (Table 13); $(\alpha)_D = -45^\circ$; m.p., 170°C. It may be widely distributed in plants, but besides Calabar bean oil, only soybean oil has been found to yield sufficient amounts for preparation.

The **sitosterols**, probably the chief sterols of most plants, are also derivatives of sitostane in some cases, at least. They are prepared from plant oils. Several preparations have been shown to be mixtures of sterols. Having nearly the same solubilities, they have not been separated as pure substances in all cases. Their structures are not completely determined.

Other phytosterols, some belonging in the ergostane group, some in the sitostane group, and some not yet characterized, have specific names. They include **cinchol** from cinchona bark, **spinasterol** from spinach, **fucosterol** from marine rockweed (*Fucus vesiculosus*), **brassicasterol** from oil of rapeseed (*Brassica napus*), and a number of others.

Wool fat, very high in unsaponifiable matter, yields a sterid-like preparation long known as "ischolesterol." From it two substances, named **agnosterol** and **lanosterol**, were prepared (1930) in near purity. Agnosterol has two, and lanosterol has three double bonds. But the evidence now available indicates that the nuclear skeleton of the molecule contains five ring structures, relating these substances to picene rather than to phenanthrene. Strictly speaking, therefore, they are not sterids.

REFERENCES

Monographs dealing with more general aspects of lipid chemistry are: "The Biochemistry of the Fatty Acids," W. R. Bloor, New York, 1943; "The Biochemistry of the Lipids," H. B. Bull, New York, 1937, and "The Chemical Constitution of Natural Fats," T. P. Hilditch, London, 2d. ed., 1947.

The phospholipids are described in "Lecithin and Allied Substances. The Lipins," H. Maclean and I. S. Maclean, New York, 1927.

Sterols and other sterids are given an especially useful treatment in "Natural Products Related to Phenanthrene," I. F. Fieser and M. Fieser, 3d ed., New York, 1949. "The Chemistry of the Sterids," H. Sobotka, Baltimore, 1938, contains a 320-page catalogue which classifies and characterizes these very numerous compounds and also provides a bibliography of some 1,300 references.

The chapter on sterols and related compounds by W. H. Strain in Vol. II of "Organic Chemistry," edited by Gilman, covers the subject very broadly and is especially helpful in the treatment of the stereochemistry of these substances.

A standard work on the methods of preparing and analyzing lipids is "The Chemical Technology and Analysis of Oils, Fats and Waxes," J. Lewkowitzsch, 6th ed., New York, 1921.

Recommended reviews are:

ANDERSON, R. J., The Chemistry of the Lipoids of Tubercle Bacilli, *Physiol. Rev.*, **12**, 166, 1932.

BROWN, J. B., The Chemistry of the Lipids, *Ann. Rev. Biochem.*, **13**, 93, 1944; and **15**, 93, 1946.

CROWFOOT, DOROTHY, X-ray Crystallography and Sterol Structure, *Vitamins and Hormones*, **2**, 409, 1944.

FOLCH-PI, J., and SPERRY, W. M., Chemistry of the Lipids, *Ann. Rev. Biochem.*, **17**, 147, 1948.

HEILBRON, I. M., and JONES, E. R. H., The Chemistry of the Sterols, *Ann. Rev. Biochem.*, **9**, 135, 1940.

LONGENECKER, H. E., and DAUBERT, B. F., The Chemistry of the Lipids, *Ann. Rev. Biochem.*, **14**, 113, 1945.

RUGH, W. L., The Chemistry of the Steroids, *Ann. Rev. Biochem.*, **14**, 225, 1945.

SHOPPEE, C. W., The Chemistry of the Steroids, *Ann. Rev. Biochem.*, **11**, 103, 1942.

SOBOTKA, H., and BLOCH, E., The Steroids, *Ann. Rev. Biochem.*, **12**, 45, 1943.

Some papers dealing with special aspects of lipid chemistry are listed:

ARCUS, C. L., and SMEDLEY-MACLEAN, I., Structure of Arachidonic and Linoleic Acids, *Biochem. J.*, **37**, 1, 1943.

BOSWORTH, A. W., and BROWN, J. B., Isolation and Identification of Some Hitherto Unreported Fatty Acids in Butter Fat, *J. Biol. Chem.*, **103**, 115, 1933.

BOSWORTH, A. W., and SIBSON, E. W., Arachidonic Acid in Butter Fat, *J. Biol. Chem.*, **107**, 489, 1934.

BROWN, J. B., and FRANKEL, J., Studies on the Chemistry of the Fatty Acids III. The Properties of Linoleic Acids, *J. Am. Chem. Soc.*, **60**, 54, 1938.

BROWN, J. B., and SHELDON, C. C., The Occurrence of Highly Unsaturated Fatty Acids in the Oils of Some Common Fowls and in Animal Fats, *J. Am. Chem. Soc.*, **56**, 2149, 1934.

BURR, G. O., BROWN, J. B., KASS, J. P., and LUNDBERG, W. O., Comparative Curative Values of Unsaturated Fatty Acids in Fat Deficiency, *Proc. Soc. Exptl. Biol. Med.*, **44**, 242, 1940.

BURR, G. O., BURR, M. M., and MILLER, E. S., On the Fatty Acids Essential to Nutrition. III, *J. Biol. Chem.*, **97**, 1, 1932.

BUSHELL, W. J., and HILDITCH, T. P., Course of Hydrogenation in Mixtures of Mixed Glycerides, *J. Chem. Soc.*, (1937) 1767, *Chem. Abstracts*, **32**, 1129, 1937.

ECKSTEIN, H. C., The Linoleic and Linolenic Acid Contents of Butter Fat, *J. Biol. Chem.*, **103**, 135, 1929.

GREEN, T. G., and HILDITCH, T. P., Some Further Observations on the Occurrence of an Octadecadienoic Acid in Cow Butter Fats, *Biochem. J.*, **29**, 1564, 1935.

GUNDE, B. G., and HILDITCH, T. P., Mixed Unsaturated Glycerides and Liquid Seed Fats, *J. Soc. Chem. Ind.*, **59**, 47; *Chem. Abstracts*, **34**, 4291, 1940.

- HILDITCH, T. P., ICHAPORIA, M. B., and JASPERSON, H., Progressive Hydrogenation of Groundnut (Peanut) and Sesame Oils, *J. Soc. Chem. Ind.*, 57, 363; *Chem. Abstracts*, 33, 1528, 1938.
- HILDITCH, T. P., and LONGENECKER, H. E., Further Determination and Characterization of the Component Acids of Butter Fat, *J. Biol. Chem.*, 122, 497, 1938.
- RIEMENSCHNEIDER, R. W., ELLIS, N. R., and TITUS, H. W., The Fat Acids in the Lecithin and Glyceride Fractions of Egg Yolk, *J. Biol. Chem.*, 126, 255, 1938.
- SNIDER, R. H., and BLOOR, W. R., Fatty Acids of Liver Lecithin, *J. Biol. Chem.*, 99, 555, 1933.
- WOOLLEY, D. W., Isolation and Partial Determination of Structure of Soy Bean Lipositol, a New Inositol-containing Phospholipid, *J. Biol. Chem.*, 147, 581, 1943.
- WURSTER, O. H., Hydrogenation of Fats, *Ind. Eng. Chem.*, 32, 1193, 1940.

CHAPTER IV

PROTEINS AND AMINO ACIDS

The name "protein" was proposed by Mulder (1839) to indicate certain fundamental compounds which he believed to be basic constituents of protoplasmic materials. The name comes from a Greek word signifying "that which is of first or prime importance." Although the modern conception of the nature of proteins differs somewhat from that of Mulder, the name is still appropriate in that proteins are of prime importance in biochemistry. They occur in all protoplasmic material and indeed are the most abundant solids present. They also occur in extracellular matter. Proteins are indispensable components of the food of animals. They were, indeed, the first food materials for which it was definitely established that their absence from the diet was fatal to animals. Moreover, the metabolism of protein goes on continuously in all living things. Verworn long ago suggested that living matter might even be defined as the material in which protein metabolism occurs.

Proteins are characterized by extreme complexity and usually have a high molecular weight, 35,000 and upward. Some proteins are estimated to have molecular weights expressed in millions.

The structure of proteins is known to be such that their hydrolysis yields amino acids. Protein research extending over more than a century has made this fact increasingly evident ever since Braconnot showed in 1820 that hydrolysis of the familiar protein gelatin yielded the amino acid glycine.

Proteins in Relation to Amino Acids. Any type of hydrolysis, not complicated by oxidation or other destructive reactions, liberates amino acids from all proteins. Some proteins yield products other than amino acids, as will be shown in connection with the classification of proteins; but in any case the bulk of the protein molecule appears to be composed of amino acid residues so united by *dehydration synthesis* that amino acids are freed upon hydrolysis. Examples of the hydrolytic methods used in the study of protein are (1) boiling with H_2SO_4 , approximately 35 per cent; (2) boiling with HCl , 5 to 10 per cent; (3) action of digestive juices such as pancreatic juice. In view of the fact that a given protein subjected to any of these or some other methods of hydrolysis yields the same assortment of amino acids, the conclusion may be

drawn that the amino acid residues exist preformed in the protein molecule. Therefore a description of amino acids becomes necessary as a preliminary to the study of proteins. Emil Fischer, one of the leading pioneers in protein chemistry, called amino acids the "building stones" of the proteins. The relationship is obviously analogous to that between the monosaccharides and polysaccharides.

Amino Acids. The amino acids obtained from protein are typically of the α -form. The amino group, $-\text{NH}_2$, is attached to the carbon atom next to the carboxyl group, $-\text{COOH}$. The type formula is

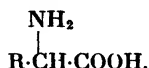

Two amino acids, proline and hydroxyproline, are exceptions. But the exceptions are more apparent than real in that their imino group, $-\text{NH}-$, is attached to the α -carbon atom in each case, and good evidence is available that in the case of proline, at least, its transformation into an α -amino acid occurs in metabolism. Some of the more important data regarding the amino acids are summarized in Table 14. A survey of the structural formulas presented there will indicate the common tendency among the amino acids to show a relationship to alanine so that the majority could be represented by the type formula

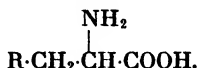

The symbol R in this case stands for a wide variety of atomic groupings, some aliphatic, some aromatic, some heterocyclic.

The history of the discovery of amino acids covers a long period of time, as is indicated in column 4 of the table. In several cases the amino acid was known to chemists before its relationship to the proteins was recognized. In several cases isolation and description preceded the establishment of the molecular structure and the artificial synthesis by considerable periods of time. The names and dates shown in the table merely indicate discovery in the sense of isolation and in only a few cases the establishment of structure. Amino acid research has met with many difficulties, of which not the least is satisfactory separation of pure amino acids from the complex hydrolysate of a protein.

Some 40 or more amino acids have been described as occurring in nature, and many more have been artificially synthesized. In view of the facts that the substituent amino group may be attached to a carbon atom other than the α -carbon and that two or more amino groups may be present, the theoretically possible number of amino acids is practically

TABLE 14.—AMINO ACIDS ACKNOWLEDGED TO BE “BUILDING STONES” OF PROTEINS

Common name	Systematic name	Structural formula	Discoverer and date
Glycine (glycocoll)	Aminoacetic acid	$\begin{array}{c} \text{NH}_2 \\ \\ \text{HCH-COOH} \end{array}$	Braconnot 1820
Alanine	α -Aminopropionic acid	$\begin{array}{c} \text{NH}_2 \\ \\ \text{CH}_2\text{CHCOOH} \end{array}$	Strecker 1850
Valine	α -Amino-isovaleric acid	$\begin{array}{c} \text{H}_3\text{C} \quad \text{NH}_2 \\ \quad \\ \text{CH}_2\text{CHCHCOOH} \end{array}$	Gorup-Besanez 1856
Leucine	α -Amino-isocaproic acid	$\begin{array}{c} \text{H}_3\text{C} \quad \text{NH}_2 \\ \quad \\ \text{CH}_2\text{CHCH}_2\text{CHCOOH} \end{array}$	Proust 1819
Isoleucine	α -Amino- β -ethyl- β -methyl-propionic acid	$\begin{array}{c} \text{H}_3\text{C} \quad \text{NH}_2 \\ \quad \\ \text{CH}_2\text{CHCH}_2\text{CHCOOH} \\ \\ \text{H}_3\text{C} \end{array}$	F. Ehrlich 1903
Serine	α -Amino- β -hydroxy-propionic acid	$\begin{array}{c} \text{OH} \quad \text{NH}_2 \\ \quad \\ \text{CH}_2\text{CHCOOH} \end{array}$	Cramer 1865
Threonine	α -Amino- β -hydroxy- <i>n</i> -butyric acid	$\begin{array}{c} \text{NH}_2 \\ \\ \text{CH}_2\text{CHCHCOOH} \\ \\ \text{OH} \end{array}$	Schryver and Buston, 1925; Rose <i>et al.</i> 1935
Phenylalanine	α -Amino- β -phenyl-propionic acid	$\begin{array}{c} \text{NH}_2 \\ \\ \text{C}_6\text{H}_5\text{CH}_2\text{CHCOOH} \end{array}$	Schulze and Barbieri 1879
Tyrosine	α -Amino- β -(<i>p</i> -hydroxyphenyl) propionic acid	$\begin{array}{c} \text{NH}_2 \\ \\ \text{HO-C}_6\text{H}_4\text{CH}_2\text{CHCOOH} \end{array}$	Lohig 1846
Iodogorgonic acid	3,5-Diiodotyrosine	$\begin{array}{c} \text{NH}_2 \\ \\ \text{HO-C}_6\text{H}_3(\text{I})_2\text{CH}_2\text{CHCOOH} \end{array}$	Drechsel 1896
Thyroixine	β -3,5-Diiodo-4-(3',5'-diiodo-4-hydroxy) phenyl- α -aminopropionic acid	$\begin{array}{c} \text{NH}_2 \\ \\ \text{HO-C}_6\text{H}_3(\text{I})_2\text{O-C}_6\text{H}_3(\text{I})_2\text{CH}_2\text{CHCOOH} \end{array}$	Kendall 1915
Tryptophan	α -Amino- β -indol-propionic acid	$\begin{array}{c} \text{NH}_2 \\ \\ \text{C}_8\text{H}_7\text{NH-CH}_2\text{CHCOOH} \end{array}$	Hopkins and Cole 1901

TABLE 14.—AMINO ACIDS ACKNOWLEDGED TO BE “BUILDING STONES” OF PROTEINS
(Continued)

Common name	Systematic name	Structural formula	Discoverer and date
Proline	Pyrrolidine- α -carboxylic acid	$\begin{array}{c} \text{H}_2\text{C} - \text{CH}_2 \\ \quad \\ \text{H}_2\text{C} \quad \text{CH} \text{COOH} \\ \diagdown \quad / \\ \text{NH} \end{array}$	E. Fischer 1901
Hydroxyproline	γ -Hydroxypyrrolidine- α -carboxylic acid	$\begin{array}{c} \text{HO}-\text{CH}-\text{CH}_2 \\ \quad \\ \text{H}_2\text{C} \quad \text{CH} \text{COOH} \\ \diagdown \quad / \\ \text{NH} \end{array}$	E. Fischer 1901
Cystine	Di-(α -amino- β -thiopropionic) acid	$\begin{array}{c} \text{H}_2\text{C}-\text{S}-\text{S}-\text{CH}_2 \\ \quad \quad \\ \text{HC}-\text{NH}_2 \quad \text{HC}-\text{NH}_2 \\ \quad \quad \\ \text{COOH} \quad \text{COOH} \end{array}$	Wollaston 1810
Methionine	α -Amino- γ -methylthiol- n -butyric acid	$\begin{array}{c} \text{NH}_2 \\ \\ \text{H}_3\text{C}-\text{S}-\text{CH}_2 \text{CH}_2 \text{CH} \text{COOH} \end{array}$	Mueller 1922
Aspartic acid	Aminosuccinic acid	$\begin{array}{c} \text{NH}_2 \\ \\ \text{COOH} \text{CH}_2 \text{CH} \text{COOH} \end{array}$	Plisson 1827
Glutamic acid	α -Aminoglutaric acid	$\begin{array}{c} \text{NH}_2 \\ \\ \text{COOH} (\text{CH}_2)_2 \text{CH} \text{COOH} \end{array}$	Ritthausen 1866
Hydroxyglutamic acid	α -Amino- β -hydroxyglutaric acid	$\begin{array}{c} \text{OH} \text{NH}_2 \\ \quad \\ \text{COOH}-\text{CH}_2-\text{CH} \text{CH} \text{COOH} \end{array}$	Dakin 1918
Lysine	α - ϵ -Diaminocaproic acid	$\begin{array}{c} \text{NH}_2 \quad \text{NH}_2 \\ \quad \quad \\ \text{CH}_2 (\text{CH}_2)_4 \text{CH} \text{COOH} \end{array}$	Drechsel 1889
Hydroxylysine	α - ϵ -Diamino- β -hydroxy- n -caproic acid	$\begin{array}{c} \text{NH}_2 \quad \text{OH} \text{NH}_2 \\ \quad \quad \\ \text{CH}_2 (\text{CH}_2)_4 \text{CH}-\text{CH}-\text{COOH} \end{array}$	Schryver <i>et al.</i> 1925
Arginine	α -Amino- δ -guanidine- n -valeric acid	$\begin{array}{c} \text{NH}_2 \\ \\ \text{C}=\text{NH} \quad \text{NH}_2 \\ \quad \quad \\ \text{HN}-\text{CH}_2 (\text{CH}_2)_3 \text{CH}-\text{COOH} \end{array}$	Schulze and Steiger 1886
Histidine	α -Amino- β -imidazolpropionic acid	$\begin{array}{c} \text{N} \quad \text{CH} \quad \text{NH}_2 \\ // \quad \quad \\ \text{HC} \quad \text{C}-\text{CH}_2 \text{CH}-\text{COOH} \\ \diagdown \quad / \\ \text{NH} \end{array}$	Kossel 1896 Hedin 1896

unlimited. Nevertheless only 23 amino acids have been unequivocally accepted as common “building stones” of the proteins although some others have been reported as present in protein hydrolysates. Conservatism suggests that confirmation of such discoveries is advisable. Data regarding “unconfirmed” amino acids and some other physiologically

TABLE 15.—AMINO ACIDS NOT DEFINITELY ESTABLISHED AS PROTEIN “BUILDING STONES”

Common name	Systematic name	Structural formula	Discoverer and date	Source
Amino butyric acid	α -Amino-n-butyric acid	$\begin{array}{c} \text{NH}_2 \\ \\ \text{CH}_2 \text{ CH}_2 \text{ CH COOH} \end{array}$	Schützenberger and Bourgeois 1875	Reported as present in alkaline hydrolysate of silk
Canavanine	α -Amino- γ -guanidinoxy-n-butyric acid	$\begin{array}{c} \text{NH}_2 \\ \\ \text{HN}-\text{C} \\ \qquad \qquad \\ \text{HN}-\text{O}-\text{(CH}_2\text{)}_2 \text{ CH COOH} \end{array}$	Kitagawa and Monobe 1933	Soybean meal, jack bean meal
Citrulline	α -Amino- δ -carbamino-valeric acid	$\begin{array}{c} \text{NH}_2 \\ \\ \text{C}-\text{O} \quad \text{NH}_2 \\ \qquad \qquad \\ \text{HN}-\text{(CH}_2\text{)}_3 \text{ CH COOH} \end{array}$	Wada 1930	Plant and animal tissues, but may arise from arginine
Homocystine	Di-(α -amino- γ -thiobutyric) acid	$\begin{array}{c} \text{H}_2\text{C}-\text{S}-\text{S}-\text{CH}_2 \\ \qquad \qquad \\ \text{H}_2\text{C} \qquad \qquad \text{CH}_2 \\ \qquad \qquad \\ \text{HC}-\text{NH}_2 \quad \text{HC}-\text{NH}_2 \\ \qquad \qquad \\ \text{COOH} \qquad \text{COOH} \end{array}$	Butz and du Vigneaud 1932	Believed to arise in metabolism of methionine, not found in protein
Djenkolic acid	A homologue of homocystine	<p>(probable formula)</p> $\begin{array}{c} \text{H}_2\text{C}-\text{S}-\text{CH}_2-\text{S}-\text{CH}_2 \\ \qquad \qquad \\ \text{H}_2\text{C} \qquad \qquad \text{CH}_2 \\ \qquad \qquad \\ \text{HCNH}_2 \quad \text{HCNH}_2 \\ \qquad \qquad \\ \text{COOH} \qquad \text{COOH} \end{array}$	Van Veen and Hyman 1935	Djenkol nuts, urine; not yet isolated from a pure protein
Lanthionine	A thioether of alanine	$\begin{array}{c} \text{CH}_2-\text{S}-\text{CH}_2 \\ \qquad \qquad \\ \text{HCNH}_2 \quad \text{HCNH}_2 \\ \qquad \qquad \\ \text{COOH} \qquad \text{COOH} \end{array}$	Jones <i>et al.</i> 1941	Wool after alkali treatment
Dibromotyrosine	3,5-Dibromotyrosine		Mörner 1907	Horny skeleton of certain corals, probably a “building stone” of special proteins
Dihydroxyphenylalanine (“Dopa”)	α -Amino- β -3,4-dihydroxyphenylpropionic acid		Torquati 1913	Pods and sprouts of peas and beans

TABLE 15.—AMINO ACIDS¹ NOT DEFINITELY ESTABLISHED AS PROTEIN “BUILDING STONES” (Continued)

Common name	Systematic name	Structural formula	Discoverer and date	Source
Hydroxy-valine	α -Amino- β -hydroxy-isovaleric acid	(probable formula) $\begin{array}{c} \text{OHNH}_2 \\ \\ \text{H}_3\text{C} \diagdown \text{C} \text{---} \text{CH COOH} \\ \\ \text{H}_3\text{C} \end{array}$	Schryver and Buston 1925	Proteins of oats and corn
Norvaline	α -Amino- <i>n</i> -valeric acid	$\begin{array}{c} \text{NH}_2 \\ \\ \text{CH}_2(\text{CH}_2)_2\text{CH-COOH} \end{array}$	Abderhalden <i>et al.</i> 1930	Globin, casein, protein of horns
Norleucine (caprine)	α -Amino- <i>n</i> -caproic acid	$\begin{array}{c} \text{NH}_2 \\ \\ \text{CH}_2(\text{CH}_2)_4\text{CH COOH} \end{array}$	Thudichum 1901	Not found in proteins
Ornithine	α - δ -Diaminovaleric acid	$\begin{array}{c} \text{NH}_2 \quad \text{NH}_2 \\ \quad \quad \\ \text{CH}_2(\text{CH}_2)_3\text{CH-COOH} \end{array}$	Jaffé 1877	Animal tissues; not found in proteins

¹ Other naturally occurring amino acids have been described. Among them are the sulfur-containing ones, cysteine (α -amino- β -thiolpropionic acid) and its homologue, homocysteine. They arise from cystine and homocystine, respectively, but there is no conclusive evidence that they occur preformed in proteins. At least 12 others are alleged to have been found in nature, but neither their relationship to proteins nor their chemical constitution is established.

important ones which do not appear to be protein constituents are presented in Table 15.

Classification of the Amino Acids. According to their molecular structure amino acids may be grouped in several ways. The following is a convenient classification.

- I. Monoamino-monocarboxylic—including the first 12 amino acids shown in Table 14 and also methionine.
- II. Monoamino-dicarboxylic—including aspartic acid, glutamic acid, and hydroxyglutamic acid.
- III. Diamino-monocarboxylic—including lysine and arginine. Histidine is sometimes included in this subgroup. Tryptophan has a nitrogen atom in its indole group but does not behave like a diamino acid.
- IV. Diamino-dicarboxylic—cystine.
- V. Heterocyclic—proline, hydroxyproline, histidine, and tryptophan.

One notes that cystine and methionine are sulfur-containing amino acids. An —OH group occurs in seven as follows: Serine, threonine, tyrosine, iodogorgoic acid, thyroxine, hydroxyproline, and hydroxyglutamic acid. The benzene ring is present in phenylalanine and with substituted groups in four others. While nitrogen occurs in most cases as the amino group, the imino group, —NH—, is present in five amino acids, and histidine contains tertiary nitrogen.

Cystine is peculiar. While designated as a diamino-dicarboxylic acid, it readily reduces to cysteine, HS-CH₂-CHNH₂-COOH, α-amino-β-thiolpropionic acid, which belongs in group I.

Certain properties of the individual amino acids are implicitly indicated by this classification. Thus amino acids containing two carboxyl groups are predominantly acidic in behavior while the diamino acids are noticeably basic.

General Reactions of Amino Acids. Possessing both the carboxyl and the amino group, amino acids are amphoteric. Their chemical behavior is correspondingly complex.

1. *Salt formation* occurs with both acids and bases. For example, they react with HCl to form hydrochlorides of the type formula

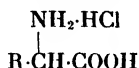

They react with NaOH to form sodium salts of the type formula

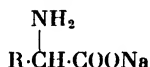

Corresponding salts are formed with other acids and bases.

2. *Esterification* is brought about with alcohols. With ethanol and hydrogen chloride, esters are formed of the type

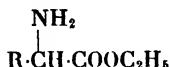

3. *The nitrous acid reaction* causes the amino group to liberate nitrogen.

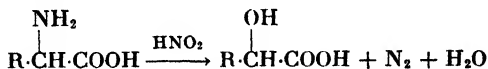

This reaction is not given by proline and hydroxyproline nor is it given by the imino group in general. The reaction serves, indeed, as a means of detection and measurement of free amino groups in proteins as well as in amino acids. Use of the Van Slyke method for quantitative measurement of nitrogen evolved in this reaction affords helpful information regarding the free amino groups of proteins.

4. *Formaldehyde reacts* so as to mask the amino group. The products are not surely known. Some of those suggested are indicated.

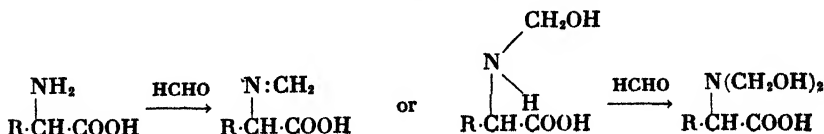

In the masked condition, what was previously an amino group has lost its basic properties. An amino acid or a protein thus treated still permits dissociation (p. 108) of the potentially acidic carboxyl group or groups. It thus becomes possible to titrate with standard alkali and obtain a satisfactory measure of free carboxyl groups.

As will be shown later, amino acids are united in the protein molecule so that the amino group of one is united with the carboxyl group of another (eliminating a molecule of water) to give the union $-\text{NH}-\text{CO}-$. Hydrolysis by any agent opens up these links so that an increase in free amino and free carboxyl groups occurs as hydrolysis progresses. On this account either the *nitrous acid reaction* or the *formol titration* (reaction 4), as Sørensen, its discoverer, named it, may be used to follow the progress of protein hydrolysis in the presence of acids or during the course of enzymatic digestion.

5. *Methylation* may produce compounds of the types

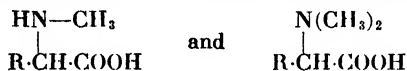

6. *The amino group may be acetylated* by the action of acetyl chloride or acetic anhydride. This gives compounds of the type

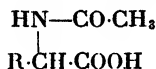

7. *Acyl halides may be formed* in the usual manner provided the amino group has been previously protected by being, for example, acetylated. This results in compounds of the type

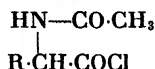

The masking group, $-\text{CO}-\text{CH}_3$, may be removed by the action of HCl.

8. *Formation of primary amines* can be brought about by heating with barium hydroxide. The carboxyl group being disrupted to form CO_2 , compounds are formed of the type



9. *Dehydration* causes amino acids to unite with each other in a ring formation known as the "diketopiperazine ring." In the case of glycine the reaction may be represented as

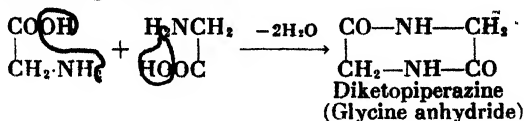

Hydrolysis by heating in the presence of dilute acid opens up the diketopiperazine ring to produce compounds belonging to the group known as peptides. Thus in the case of glycine anhydride the peptide glycyglycine is formed.

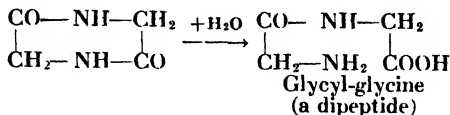

The peptides (p. 121) may be formed by the union of two or more amino acids and are accordingly named dipeptides, tripeptides, polypeptides, etc.

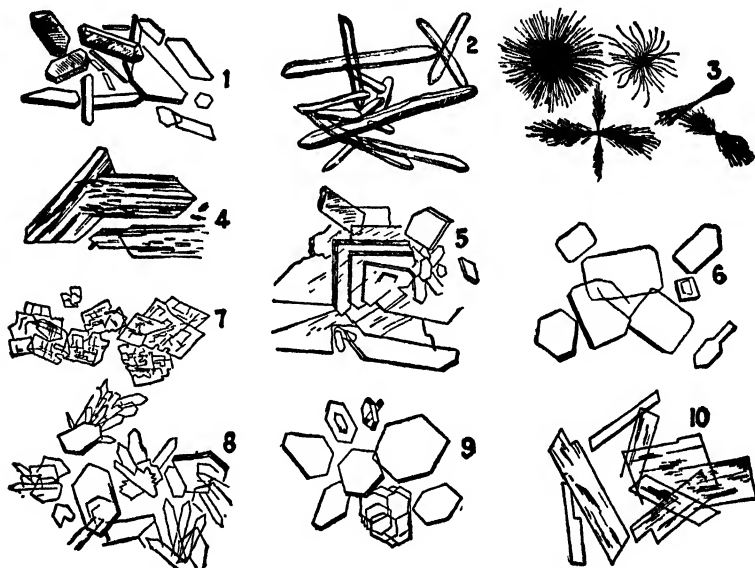

FIG. 12. Crystalline forms of amino acids. Microscopic appearance of: 1, Glycine; 2, glycine ethyl ester hydrochloride; 3, tyrosine; 4, glutamic acid; 5, aspartic acid; 6, serine; 7, phenylalanine; 8, leucine; 9, cystine; 10, copper salt of proline.

Crystalline forms of some amino acids and their compounds are shown in Fig. 12.

Optical Activity. All the amino acids except glycine contain one or more ~~asymmetric carbon~~ asymmetric carbon atoms and therefore show optical activity. Prefixed letters D- or L-, as formerly used for naturally occurring amino acids, were intended to indicate the steric configuration rather than the observed direction of rotation. A more recent convention employs symbols which indicate both the configuration and the direction of

rotation. Thus D-(+) indicates D-configuration and dextrorotation. The actually observed rotatory power of an amino acid is markedly affected by various factors which influence the degree and the nature of the electrolytic dissociation of the amino acid. Among these factors are the concentration of the amino acid itself, the pH of its solution, the

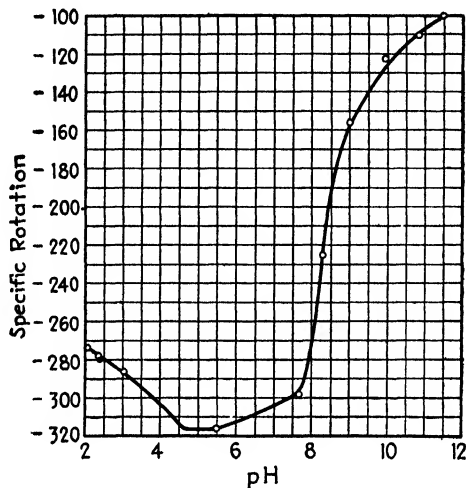

FIG. 13. The specific rotation of cysteine as affected by the pH of the solution. Data of Pirie for 0.0083M solution at 20°C. Cysteine is isoelectric at pH of approximately 5.6.

nature of the solvent, the presence of other electrolytes, and the temperature. The effects of varying conditions are so large that any statement regarding the specific rotation of an amino acid has little meaning unless accompanied by a statement of the conditions prevailing in the solution. In the case of L-histidine, for example, the widely varying results shown in Table 16 have been recorded.

TABLE 16.—SPECIFIC ROTATION OF L-HISTIDINE

Concentration and solvent	Temperature	(α) _D	Observers
	°C.	Ang. degrees	
0.05M in water.....	20	-39.3	Lutz and Jirgensons
0.05M (1 mol histidine + 10 mols HCl).....	20	+11.1	Lutz and Jirgensons
2.2 per cent in water.....	20	-39.7	Abderhalden and Weil
2.3 per cent in water.....	20	-37.9	F. Ehrlich
3.1 per cent in 1N HCl.....	18	+ 9.6	Fischer and Cone

The changes in $(\alpha)_D$ as related to pH are shown for cysteine in Fig. 13. Similar relations are found with proteins as indicated in Fig. 14.

The amino acids have been prepared in most cases in the D-form, in the L-form, and in the inactive DL-form. The third or racemic condition is the one tending to arise as a result of artificial synthesis.

A number of the natural amino acids derived from hydrolysis of proteins have long been designated as D-forms. One finds D-alanine, D-valine, D-isoleucine, D-norleucine, D-glutamic acid, D-hydroxyglutamic

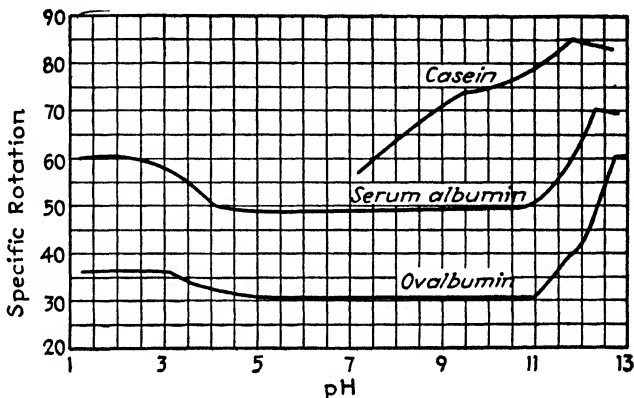

FIG. 14. The specific rotation of proteins as affected by the pH of the solution. The serum albumin was observed at 20°C., casein and ovalbumin at 25°C. (Data of Almquist and Greenberg.)

acid, and D-arginine represented in the literature as the natural forms. It has recently been shown that natural alanine is related to L(+)-lactic acid. Alanine therefore has the configuration conventionally designated as the L-form. Indeed, it now seems altogether probable that all the amino acids as they occur preformed in the protein molecule have the same configuration around the α -carbon atom, namely, the L-form. The configuration around an asymmetric carbon atom other than the α -carbon is not necessarily such as to be designated the L-form. Threonine, for example, has the configuration of the β -carbon atom which relates it to the sugar D(-)-threose. It was on this account that Rose and his coworkers chose the name "threonine" after discovering and establishing the structure of this amino acid.

Some amino acids are subject to steric inversion in metabolism; e.g., D(+)-leucine appears to be converted to L(-)-leucine. Racemic forms, DL-, may arise during the manipulation incidental to protein hydrolysis and separation of amino acids from the hydrolysates. Separation of the optical antipodes from the racemic mixture is extremely difficult, so that either form is apt to be contaminated by the other in the final preparation.

The animal body is provided with an enzyme system specific for the metabolism of D-amino acids in addition to the enzyme systems which metabolize the L-forms.

Nutritional Significance of Amino Acids. Although proteins were distinguished almost from the beginnings of biochemistry as being indispensable for animal nutrition, it was not until the second decade of the present century that the amino acids derived from protein digestion

TABLE 17.—AMINO ACID YIELDS FROM REPRESENTATIVE PROTEINS

	Egg albumin	Lactalbumin	Serum albumin	Serum globulin	Edestin (hemp)	Glutenin (wheat)	Gliadin (wheat)	Zein (maize)	Keratin (wool)	Fibroin (silk)	Gelatin	Salmine (salmon sperm)	Casein (cow's milk)	Vitellin (egg yolk)	Insulin (cryst.)	Pepsin (cryst.)
Glycine.....	0.0	0.4	0.0	3.5	3.8	0.9	0.0	0.0	0.6	40.5	25.5	0.5	1.1		
Alanine.....	2.2	2.4	2.7	2.2	3.6	4.7	2.0	9.8	4.4	25.0	8.7	1.9	0.2		
Valine.....	2.5	3.3	6.3	0.2	3.4	1.9	2.8	0.0	4.3	7.9	2.4		
Leucine and iso-leucine.....	10.7	14.0	20.0	18.7	14.5	6.0	6.6	25.0	11.5	2.5	7.1	9.7	11.0	30.0	
Phenylalanine..	5.1	1.3	3.1	3.8	3.1	2.0	2.4	7.6	11.5	1.4	3.0	2.8	+	
Tyrosine.....	4.2	2.0	4.7	6.7	4.6	4.5	3.4	5.9	4.8	11.0	0.0	6.6	5.0	12.2	10.3
Tryptophan...	1.3	2.7	0.5	2.3	2.5	1.7	1.1	0.2	1.8	0.0	2.2	2.5	2.2
Threonine.....	1.5	3.6	2.7	
Glutamic acid..	14.0	12.9	7.7	8.2	19.2	25.7	43.7	31.3	12.9	5.8	21.8	12.2	30.0	18.6
Hydroxyglu-tamic acid...	1.4	10.0	1.8	2.4	2.5	0.0	10.5	
Apartic acid..	6.1	9.3	3.1	2.5	10.2	2.0	0.8	1.8	2.3	3.4	4.1	0.5	6.8
Proline.....	4.2	3.8	1.0	2.8	4.1	4.2	13.2	9.0	4.4	1.0	9.5	11.0	9.0	4.0	+	
Hydroxyproline	14.1	0.2	
Serine.....	1.8	0.6	0.3	0.7	1.0	2.9	13.6	0.4	7.8	5.0	3.6	
Cystine.....	1.3	4.3	6.1	1.0	1.0	1.8	0.8	13.1	0.2	0.3	1.2	12.2	1.4
Methionine....	4.6	2.6	2.1	2.1	2.3	3.4	0.0(?)	
Arginine.....	5.2	3.0	4.8	5.2	15.8	4.7	2.9	1.8	7.8	0.7	8.2	87.4	3.8	7.8	3.2	2.7
Histidine.....	1.4	2.1	1.2	0.9	2.2	1.8	1.5	0.8	0.7	0.1	1.0	2.5	1.2	8.0	0.1
Lysine.....	6.4	8.8	6.9	6.2	2.2	1.9	0.6	0.0	2.3	0.3	5.9	6.0	5.4	2.2	2.1
Ammonia.....	1.4	1.3	2.3	4.0	5.2	3.6	0.4	2.3	1.7	8.8

were proved to be the actual indispensable nutritive requirements. It is now apparent that proteins are almost completely, if not entirely, hydrolyzed to their constituent amino acids during digestion. The yields of amino acids from individual proteins vary both qualitatively and quantitatively (see Table 17). This explains the long-established fact that certain individual proteins or even certain combinations of different proteins will not sustain life in man or laboratory mammals although nonprotein dietary requirements are adequately supplied. The problem resolves itself into the following question: Which amino acids are indispensable for animal nutrition and how much of each one is

required? The problem may also be stated as follows: Which amino acids cannot be synthesized from other substances available in the tissues of animals? Research designed to solve this problem has been prolonged and complex. Decisive results were practically precluded until the nutritional requirements of animals for all nonprotein materials, such as inorganic elements and vitamins, had been established. The work of Rose and his associates eventually afforded decisive results. Protein-free diets containing the necessary carbohydrates and fats with supplements of all the known nonprotein requisites were fed with added amino acids of satisfactory purity. It was thus possible, by omitting any one or more of the amino acids which are protein "building stones," to find which were the indispensable ones. Young rats were used in these researches, and the criterion of satisfactory nutrition was the maintenance of the normal rate of growth. The amino acids found to be indispensable in the sense that their lack caused growth failure, were

Arginine	Phenylalanine
Valine	Tryptophan
Leucine	Methionine
Isoleucine	Lysine
Threonine	Histidine

These results were surprising in certain respects. Previous experiments had seemed to indicate that proteins lacking tyrosine would not sustain life, but Rose found that tyrosine could be omitted provided sufficient phenylalanine were fed. Tyrosine could, to a limited extent, replace phenylalanine, provided the latter was not reduced in the diet below the requisite minimum. The obvious conclusion is that the rat can produce tyrosine from phenylalanine but is unable to carry on the reverse process. Cystine had also been regarded as indispensable but appeared to be entirely dispensable, according to these experiments, provided a sufficient amount of methionine were fed. It is highly probable that cystine as used in previous experimentation was contaminated with methionine. Complete separation of these two amino acids is difficult, but Rose and his associates employed synthetic preparations of unequivocal purity. Experiments with arginine yielded unique results. Diets lacking it would maintain growth only at a diminished rate. Apparently the rat, although able to produce some arginine, cannot synthesize enough of it for growth.

Other amino acid "building stones" were found to be dispensable in the sense that any or all of them could be omitted from the food mixtures without change in the rate of growth of the rats. These amino acids included

Glycine	Hydroxyglutamic acid
Alanine	Proline
Serine	Hydroxyproline
Norleucine	Citrulline
Aspartic acid	Tyrosine
Glutamic acid	Cystine

The experiments as conducted by Rose *et al.* yielded another unexpected result. A mixture of 19 amino acids (accepted protein "building stones" previously known) failed to sustain rat growth in contrast to the hydrolysate of casein, the familiar protein of milk. Evidently casein supplied some amino acid not previously recognized. This led to the discovery of threonine which, added to the other indispensable amino acids, made the diet adequate for rat growth.

One should be cautious about applying results obtained with rats to the nutrition of man. The labor and expense involved in the preparation of pure amino acids in quantity sufficient for the requirements of men has limited the use of this method in the study of human nutrition. Rose and Rice report that the amino acid requirements for the dog are the same as those for the rat. It has been shown by Almquist and associates, however, that glycine is indispensable for the growth of chicks. Arginine has also been shown by Elvehjem, Hart, and associates to be essential for the growth of the chick although citrulline can be substituted for arginine in the chick's food. Glutamic acid and cystine are also indispensable, while tyrosine is essential under certain conditions. It is obvious that the chick's requirements differ from those of the rat and the dog.

Mere maintenance of life with no greater loss of nitrogen in the excreta than is present in the food proteins is distinctly a different matter from maintenance of normal growth rate. Some work indicates that the only amino acids necessary for mere maintenance of the adult rat are valine, isoleucine, norleucine, threonine, tryptophan, methionine, and either phenylalanine or tyrosine. This matter will be considered again in the chapter on protein metabolism.

Electrolytic Dissociation of Amino Acids. All amino acids are ampholytes, a convenient term signifying "amphoteric electrolytes." They may also be termed "amphiprotic substances" thus recognizing that, like acids, they may donate a proton and also, like bases, may accept a proton. They are, however, comparatively weak. They can dissociate as acids only in the presence of a hydrogen-ion activity less than some critical value and conversely can dissociate as bases only in the presence of sufficiently low hydroxyl-ion activity. Their dissociation is, in short, determined by the pH of their solutions. At some critical pH value an amino acid must behave as though it were dissociated neither as

an acid nor as a base. In other words, it will not migrate, under the influence of a constant current passing through its solution, either to the anode or to the cathode. Under these circumstances, however, it is not necessarily true that the amino acid bears no electric charge but whatever negative charge is present must be balanced by a positive charge. An amino acid fulfilling these conditions is said to be at the isoelectric point.

This point is usually given in terms of the pH of the solution in which the isoelectric condition occurs. The isoelectric point may also be expressed

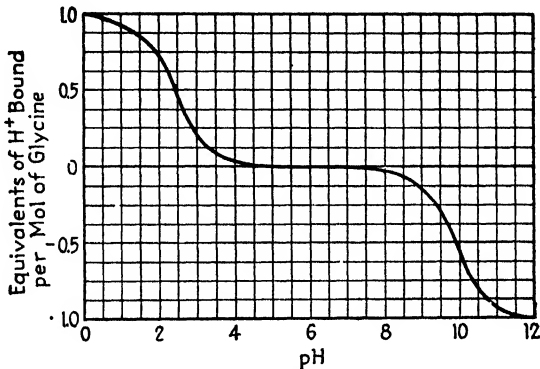

FIG. 15. Dissociation curve of glycine. Based on measurements taken by Sørensen at 18°C. and with total ionic strength of solution 0.1M.

by a symbol corresponding to pH, pK, etc. This symbol is pI' . It is defined for a simple amino acid by the equation

$$pI' = \frac{1}{2}(pK'_1 + pK'_2)$$

where pK'_1 and pK'_2 are the logarithms of the reciprocals of the first and second dissociation constants of the amino acids. These dissociation constants are a measure, as in the case of all electrolytes, of the relative dissociating power of the acidic and basic groups. Thus in the case of glycine pK'_1 is 2.404 and pK'_2 is 9.842, according to measurements made by Sørensen. This is equivalent to stating that in a solution of pH 2.404 (under conditions of temperature, ionic strength, etc., prevailing in Sørensen's measurements) glycine is half dissociated as an acid while in a solution of pH 9.842 glycine is half dissociated as a base. At some intermediate pH value glycine must behave neither as an acid nor a base. In the case of the amino acids this isoelectric condition covers a more or less extended range and might therefore be referred to as an isoelectric zone rather than as an isoelectric point. The curve shown in Fig. 15 illustrates the dissociation of glycine graphically. The level part of the curve indicates the isoelectric zone; the mid-point of this zone corresponds to

the pI' value (6.1) which is numerically equal to the corresponding pH on the scale of abscissas. In Fig. 16 the corresponding but more complex curve for the diamino acid histidine and in Fig. 17 the curve for the dicarboxylic aspartic acid are shown.

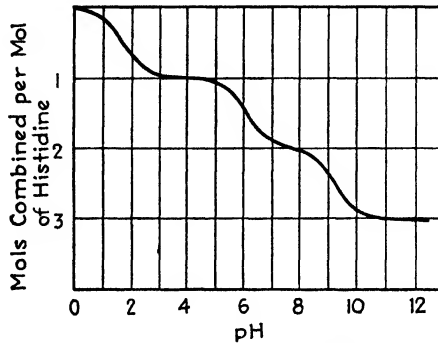

FIG. 16. Dissociation curve of histidine. The ordinates are equivalents of H^+ removed from one mol of the cation of the histidine. (Measurements made by J. P. Greenstein.)

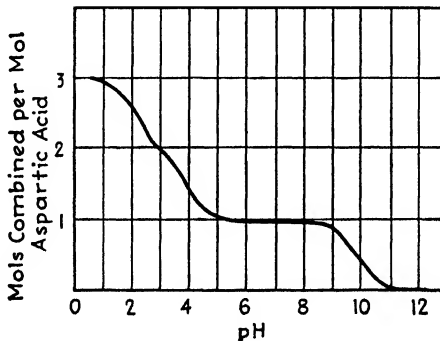
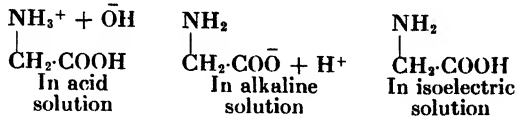

FIG. 17. Dissociation curve of aspartic acid. The ordinates are equivalents of H^+ bound by 1 mol of the anion of aspartic acid. (Measurements made by J. P. Greenstein.)

Dissociation constants and isoelectric points for some amino acids are given in Table 18.

The Zwitter-ion Theory. Earlier ideas regarding the dissociation of amino acids assumed that they dissociated in acid solutions as bases but in alkaline solutions as acids. In the isoelectric solution they were assumed to be undissociated. These three conditions could be represented in the case of glycine as follows:



Starting with pure glycine in water, the addition of HCl on the one hand or of NaOH on the other gives reactions which could be shown as



A study of the curve shown in Fig. 15 will indicate that the dissociation of either the amino or the carboxyl group tends toward completion in the

TABLE 18.—APPARENT DISSOCIATION CONSTANTS OF AMINO ACIDS

Amino acid	pK ₁ '	pK ₂ '	pK ₃ '	Approximate isoelectric points
Glycine.....	2.42	9.71	6.1
Alanine.....	2.36	9.72	6.1
Valine.....	2.32	9.62	6.0
Isoleucine.....	2.36	9.68	6.0
Proline.....	2.00	10.60	6.3
Glutamic acid.....	2.19	4.25	9.66	3.2
Aspartic acid.....	1.88	3.65	9.60	3.0
Arginine.....	2.02	9.04	12.48	10.8
Lysine.....	2.18	8.95	10.53	9.7
Histidine.....	1.82	6.00	9.17	7.6

isoelectric zone, and there is no reason to assume that either group fails to dissociate in the isoelectric condition. There is considerable other evidence that both groups can dissociate in the isoelectric condition. One other proof is found in the contrast between the titration behavior of an amino acid in water and in formaldehyde solution. As previously explained (p. 101), formaldehyde masks the amino group so that its basic properties are obliterated. Under these conditions its titration with sodium hydroxide proceeds as in the case of any weak organic acid and yields a titration curve similar to that of acetic acid. Titration of glycine in water gives an entirely different result. Titration curves of an intermediate character are obtained when the concentration of formaldehyde is insufficient to mask all of the amino groups. In Fig. 18 these effects are illustrated. It will be noticed that the presence or absence of formaldehyde has no effect on the titration of glycine with HCl.

The modern explanation of the amphoteric behavior of the amino

acids is known as the *zwitter-ion theory*, which assumes that in the isoelectric condition it is dissociated both as an acid and as a base. The only reason it does not appear to be an electrically charged ion is that it bears equal or approximately equal positive and negative charges. One might assume that these opposite charges would cause the isoelectric amino acid to close up in a ring formation, but the chemical and the physicochemical behavior of amino acids indicate ampholyte properties which are best explained by the zwitter-ion theory. The dipolar zwitter ion may also be called an *amphion*.

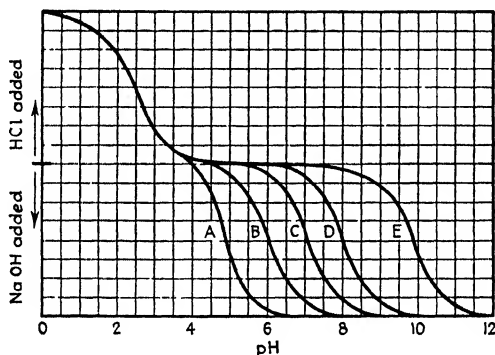

FIG. 18. Titration curve of glycine in the presence of different concentrations of formaldehyde. Curve A with 32 per cent of HCHO, curve B with 8 per cent, curve C with 2 per cent, and curve D with 0.5 per cent. Curve E is the titration of glycine without addition of HCHO. The addition of HCl gives the same curve irrespective of the concentration of HCHO. (From data of Birch and Harris.)

The dissociation of proteins, although more complex than that of amino acids because a large number of dissociating groups are involved, is similar in principle.

Separation of Amino Acids from Protein Hydrolysates. Many difficulties have been encountered in efforts to determine quantitatively each of the numerous amino acids set free in the hydrolysis of proteins. The properties of most of the amino acids are so nearly alike that their complete separation is extremely difficult. Earlier work resulted in incomplete separations of the less soluble amino acids tyrosine and cystine by means of fractional crystallization. Early in the present century Fischer introduced the method of fractional distillation of the ethyl esters of amino acids. This afforded some advantage in that the amino acids themselves are not sufficiently volatile for distillation. Esters were obtained by suspending the hydrolyzed amino acids in absolute ethanol and treating with hydrogen chloride gas. The resulting ethyl ester

hydrochlorides were freed from hydrochloric acid and the esters extracted with ether, dried, and distilled *in vacuo*. The distillation effected no complete separations. Each fraction included several esters, and each ester occurred in more than one fraction. Further distillations and the use of other methods of separation were thus required. Fischer himself apparently intended the method for qualitative use, but it has afforded some nearly quantitative results.

Extraction of the aqueous solutions of amino acids with butyl alcohol, a method developed by Dakin, has been useful in separating the mono-amino-monocarboxylic forms and proline, which are more soluble in butyl alcohol than in water, from the other amino acids.

The electrical transport method has been employed for a partial separation of amino acids. If the pH of the solution is properly chosen, amino acids which are predominantly acidic migrate toward the anode while the basic amino acids move toward the cathode.

In addition to these and some other general methods, special determinations suitable for individual amino acids have been devised. Saturation of a protein hydrolysate with hydrogen chloride causes the nearly quantitative separation of glutamic acid hydrochloride in crystalline form. Similarly, glycine hydrochloride ethyl ester can be very largely crystallized out of a complex mixture. Arginine has been successfully precipitated by flavianic acid (1-naphthol-2,4-dinitro-7-sulfonic acid). All the basic amino acids may be precipitated by phosphotungstic acid, while the dicarboxylic acids can be precipitated as the barium salts. The copper salts of amino acids differ in their solubility in water, and the water-soluble ones may be further separated by taking advantage of their differing solubilities in methanol. Colorimetric methods have been developed for quantitative determinations of some amino acids and have been used successfully for tyrosine and tryptophan. Tryptophan has also been determined by methods which make use of the insolubility of its mercury salt.

Microbiological assay methods have developed into convenient tools. They depend upon the use of a microorganism that cannot synthesize for itself the particular amino acid to be determined. For some of these methods, certain selected strains belonging to the *Lactobacillus* group are used. A strain of *Streptococcus fecalis* has been used for valine and threonine. In some cases, mutant strains of the mold *Neurospora crassa* have been selected or developed under X-ray treatment for use in such measurements. In practice, a culture medium containing all the required nutrients except the amino acid to be measured is devised by means of preliminary tests. To it a known amount of a solution containing the amino acid is added in each of a series of culture tubes inoculated with

the organism. The rate of growth is then measured in some appropriate way, *e.g.*, by increase in turbidity of the culture, in each tube and is compared with the rate in each of a similar series containing known and graduated amounts of the pure amino acid.

The stratographic method (p. 53) has been adapted to the separation and quantitative estimation of amino acids in a protein hydrolysate. Paper chromatography, in which filter paper is the adsorbent for separation of amino acids was introduced by Consden *et al.* (1944). It was adapted for quantitative work by Block (1948) on the assumption that, after development of a specific color reaction with the adsorbed amino acid, its amount is proportional to the density of the color times the area of the spot on the paper.

Present-day methods employ combinations of those outlined above and some others, but even the most elaborate combination cannot ensure that all the amino acids in the hydrolysate of any protein are determined in a satisfactorily quantitative way.

Yields of Amino Acids from Proteins. Selected results of analyses of the hydrolysates of some representative proteins are presented in Table 15. The values shown in the case of some of the proteins are not results of a single analysis but are compilations of values obtained in different laboratories. Inspection of the table shows that an albumin yields amino acids in quantities more closely resembling the yields from other albumins than those from proteins of other types. One may say, in general, that proteins of the same class, especially those from similar natural origins, tend to show similarities in their amino acid components. For example, zein of corn and gliadin of wheat, which belong to the same class of proteins and occur in seed grains, resemble each other in their amino acid yields. One also notices that some proteins are entirely lacking in certain amino acids. Thus gelatin lacks several amino acids. Some proteins are characterized by strikingly large yields of some one or more of the amino acids. Gliadin yields 43 per cent of glutamic acid, and salmin yields 87 per cent of arginine.

The amino acids shown as derived from some proteins add up to more than 100 per cent. This is due to the fact that no account is taken of the water which enters into the reactions hydrolyzing proteins. In most cases the totals fall far short of 100 per cent. This is explained in large measure by the defects of the analyses in a quantitative sense. The extent to which this is due to incompleteness of knowledge about all amino acids can only be conjectured, but it is entirely possible that more amino acids remain to be discovered. Another difficulty is possible contamination of supposedly purified proteins by moisture. There seems to be no satisfactory criterion for showing the difference between

loss of adhering moisture and loss of structural water during processes of drying proteins.

Preparation and Purification of Proteins. Separation of proteins from natural fluids and tissues in a crude or slightly contaminated state presents no difficulties, but the tendency of proteins to combine with each other and with many other substances, both organic and inorganic, makes the preparation of really pure proteins extremely difficult. The problem is further complicated by the lack of satisfactory criteria of protein purity. Many of the usual criteria for organic compounds are not applicable to proteins. They have no melting points. Elementary analysis in the case of large and complex molecules, such as those of proteins, are not satisfactory because a small, unavoidable experimental error is equivalent to a large error when the molecular weight is very large. Inasmuch as some proteins may be crystallized, one might possibly suppose that the crystalline structure would be of some use, but not all proteins have been crystallized, and even those which are obtained in crystalline form may be recrystallized many times under certain circumstances without attaining constancy of composition. Even when constancy is attained, the resulting preparation may, in some cases, contain more than one protein.

Modern methods for testing the purity of supposedly isolated proteins include several physical methods. One of them is observation by optical means of the sharpness of the boundary between the supernatant solvent and the protein solution and other aspects of the behavior of the boundary during the progressive movement of protein molecules as produced by high-speed whirling in an ultracentrifuge. Centrifugal force, many times that of gravity, is exerted so that protein molecules migrate through the solvent. If proteins of different molecular weights are present, zones of differing optical density will appear in the centrifuge tube while a single protein tends to give a sharp boundary line. It is observed on photographs, which are usually made with ultraviolet rays passing through the solution in a quartz cell. The results are used both as a test of purity and for determination of the molecular weight of the protein.

Another method tests the migration of the protein under the influence of the constant current (electrophoresis) under known conditions of pH of the solution. The Tiselius form of electrophoresis apparatus (Fig. 19) is widely used. The container for the protein solution may be fitted with quartz windows through which ultraviolet photographs may be obtained for determination of the direction (anodal or cathodal) and of the rate of migration of the protein and the character of the boundary between the protein solution and a supernatant KCl solution. Obser-

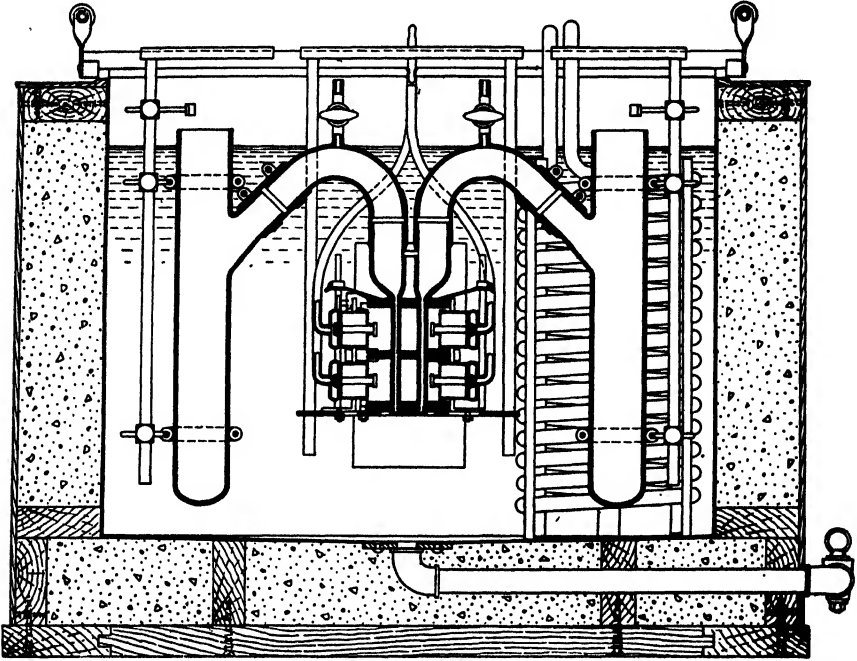

a

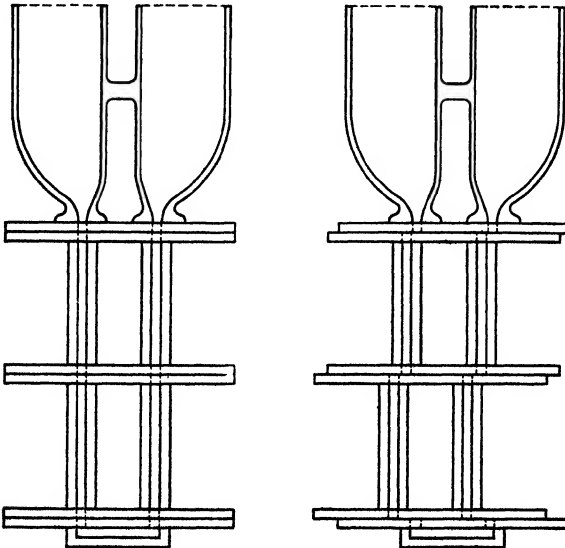

b

For caption see opposite page.

vations by this method are used to calculate the isoelectric point and the molecular weight and to judge the purity of the protein. The method is also used to separate proteins from each other.

Another criterion of purity is the solubility curve obtained by a series of tests measuring the amount of the protein dissolved when varying amounts of the purified preparation are thoroughly shaken with uniform volumes of the same solvent. If the protein is pure, the curve which plots the amount dissolved against the amount of the protein used should rise to the point of saturation of the solution and then become perfectly flat, thus indicating only two phases in the mixture. According to these criteria, some of the proteins isolated in recent years are believed to be of satisfactory purity. A great advance in protein-purification methods resulted from knowledge of the isoelectric conditions. Loeb (1921) pointed out that proteins show a minimum of combining power at the isoelectric point and also minimum solubility (see Fig. 21). Some proteins are insoluble at the isoelectric point, and all of them are precipitated more nearly completely by suitable reagents when in the isoelectric condition than under other circumstances. Modern methods of protein purification usually employ isoelectric precipitation. When two or more proteins having approximately the same isoelectric point occur together in nature, isoelectric precipitation must be supplemented by other procedures. Crystallization of a protein is usually carried out at its isoelectric point.

Dialysis has long been used for the separation of proteins. The method is, in brief, to place the protein solution in a container provided with a semipermeable membrane which prevents protein diffusion but allows smaller molecules and ions to pass. The container is surrounded by water or some solution adjusted to the desired pH and if frequently changed will rid the protein solution of diffusible contaminants. *Electrodialysis* is a further improvement. In this case a constant current passes

FIG. 19. The Tiselius electrophoresis apparatus. In *a* the entire apparatus, except for electrical connections, is shown immersed in a constant-temperature bath surrounded by an insulating box. Observations may be taken at low temperatures (about 4°C.) to minimize the disturbance due to convection. The temperature-regulating coils are shown at the right. The symmetrically placed large tubes with curving side arms serve to hold the electrolyte solution into which are inserted electrodes (not shown here) connected to a source of a constant electric current. The U tube for holding the solution of a substance (*e.g.*, protein) of which the electrophoretic migration is to be observed is shown in the center. Its detail is shown in *b*. In this form of the apparatus, the solution can be separated after electrophoresis into different fractions by the use of sliding plates (note bottom of *b*). (From A. Tiselius, *The Harvey Lectures*, 35, 37, 1939-1940.)

between electrodes so placed outside of the dialyzing membranes that diffusible ions are efficiently removed from the protein solution.

A number of *precipitation reactions* are used. All proteins are easily precipitated by alcohol at their isoelectric points. If this reaction can be carried out without altering the protein (denaturation), the method is very helpful. *Salting-out procedures* are also widely used. Neutral salts cause the protein, especially when at its isoelectric point, to separate unchanged from the solution. Among the salts more often used for this purpose are ammonium sulfate, magnesium sulfate, and sodium chloride. Some proteins require complete saturation of their solutions with the salt, while others are precipitated at lower concentrations. This affords a valuable method for the separation of certain types of proteins. Picric acid is sometimes used to precipitate proteins, the picric acid being subsequently removed by ether after it is set free from the protein picrate by acid. *Phosphotungstic acid* is another protein precipitant sometimes used. It can be removed from the precipitate suspended in water by the use of barium hydroxide.

The actual preparation of some representative proteins will illustrate the practical application of the above and some other methods.

Edestin, a protein of the globulin type, is extracted from ground hemp seed by 5 per cent NaCl solution at 50 to 60°C., filtered, and slowly cooled. Edestin crystallizes out and after several recrystallizations may be freed from sodium chloride by dialysis against distilled water. The material is dehydrated by washing with alcohol and ether. Some other vegetable globulins may be prepared by this method, which depends upon the principle that, while such proteins are fairly soluble in warm, dilute NaCl solution, they separate out when the solution is cooled.

Gliadin, one of the prolamins, is prepared from wheat flour. Mixed with a little water, the flour is made into a dough, which is repeatedly kneaded with water until the wheat starch grains are washed away. The gluten remaining is extracted with warm 70 per cent alcohol which dissolves prolamins. After filtering, the extract is concentrated *in vacuo* below 50°C. to a syrup which is poured into five volumes of a 1 per cent NaCl solution. This precipitates gliadin. It is removed, dissolved in 70 per cent alcohol, and cooled to about 8°C. On standing at low temperature the gliadin separates out. After being again dissolved in 70 per cent alcohol and reprecipitated by cooling, final purification is attained by pouring the concentrated alcohol-containing gliadin syrup into a 1 per cent LiCl solution. The latter process is repeated, the gliadin finally precipitated by absolute alcohol, dehydrated by several treatments with absolute alcohol and ether, and dried *in vacuo*.

Casein, the chief protein of milk, is prepared by isoelectric precipitation. Skimmed milk is treated with sufficient 0.05N HCl, with rapid stirring, to bring the mixture to pH 4.6. The resulting precipitate is washed repeatedly with distilled water by decantation and is then dissolved by the addition of sufficient 0.1N NaOH to bring the mixture to pH 6.3. After the solution is filtered, casein is again precipitated by HCl and the process of dissolving and reprecipitating may be repeated several times. The final precipitate, washed free from chlorides with distilled water, is dehydrated by alcohol and ether.

Ovalbumin is obtained from the white of egg. Separated from the yolks, the white is treated with an equal volume of saturated ammonium sulfate solution. This precipitates egg globulin but leaves the albumin in solution. After filtering, the solution is treated with more ammonium sulfate until the albumin just begins to show signs of being precipitated (salted out) by faint cloudiness of the solution. It is then adjusted to pH 4.8, the isoelectric point of albumin, by adding acetic acid. When the solution is allowed to stand in the refrigerator, albumin crystallizes. Several recrystallizations from acidified ammonium sulfate solution are required to remove contaminating proteins. The crystals are finally washed with acidified ammonium sulfate solution and freed from electrolytes by dialysis.

The *protamines* combined with nucleic acid occur as nucleoproteins in the heads of spermatozoa. Ripe fish sperm is used as the source. From salmon sperm, *salmin* is obtained; from herring sperm, *clupein*; and from sturgeon sperm, *sturin*. A suspension of sperm in water is strained, and the fluid is treated with acetic acid, which precipitates nucleoprotein. It is dehydrated with alcohol and ether. The dried material is extracted with 1 per cent H_2SO_4 which breaks down the nucleoprotein to protamin and nucleic acid and dissolves the protamin as the sulfate, leaving nucleic acid undissolved. The filtered extract is treated with alcohol to precipitate protamin sulfate, which may be further purified by reprecipitation from aqueous solution with alcohol. A further step to get rid of traces of nucleic acid is precipitation of protamin picrate. Picric acid is removed by treatment with H_2SO_4 and extraction with ether. Protamin sulfate is again precipitated with alcohol. The protamin may be freed from the sulfate group by the use of barium hydroxide.

The Classification of Proteins. Entirely satisfactory criteria for classification of such complex compounds as proteins are not available. It would be an advantage to classify them strictly on the basis of their chemical constitution; but in the present state of incompleteness of protein chemistry, it is convenient to group them partly according to their constitution and partly according to their properties. Some proteins show behavior which places them on the border line between certain well-defined groups, so that different biochemists do not always agree as to complete classifications. The system adopted by the American Society of Biological Chemists, slightly modified to include some advantageous features of the system approved by the British Medical Association, is given here.

Three main groups are distinguished as follows:

- A. Simple proteins
- B. Compound proteins
- C. Derived proteins

A. The Simple Proteins. Compounds occurring in nature and yielding on hydrolysis chiefly α -amino acids or their immediate derivatives.

1. *Albumins*—soluble in water and neutral salt solutions, coagulable by heat, salted out by saturation with ammonium sulfate but not by saturation with sodium chloride except in the presence of acid, give all protein color and precipitation tests and usually lack none of the indispensable amino acids among their hydrolysis products; examples are ovalbumin from white of egg and serum albumin from blood plasma.

2. *Globulins*—insoluble in pure water and very dilute salt solutions, soluble in 1 per cent or slightly stronger solutions of neutral salts, coagulable by heat, salted out by half saturation with ammonium sulfate and by complete saturation with sodium chloride, give all protein color and precipitation tests and usually lack none of the indispensable amino acids among their decomposition products; examples are *ovoglobulin* from white of egg, *serum globulin* from blood plasma, *edestin* from hempseed, many globulins similar to *edestin* from other seeds and nuts, and *myosin* from meat.

3. *Glutelins*—insoluble in water or neutral salt solutions but soluble in very dilute acids or alkalis, assume a sticky, tenacious, gel-like condition upon imbibition of water as in dough-making, coagulable by heat, show no conspicuous lack of any amino acid; examples are *glutenin* from wheat and *oryzenin* from rice.

4. *Prolamines*—insoluble in all watery solutions but soluble in 60 to 80 per cent alcohol, not heat-coagulable, contain the largest amounts of proline found in any proteins, amounting to 10 per cent or more of the molecule, also the largest amount of glutamic acid found in any proteins, amounting to 43 per cent in one case; examples are *gliadin* from wheat, *hordein* from barley, *secalin* from rye, *zein* from maize, and others from various seeds.

5. *Albuminoids* or *scleroproteins*—insoluble in all reagents which do not decompose them, digested slowly and with difficulty, if at all, by all gastrointestinal enzymes, tend to yield a disproportionately large amount of simpler amino acids such as glycine, and are deficient or entirely lacking in one or more of the more complex amino acids such as tyrosine and tryptophan; examples are *keratin* from epidermis, horns, hair, wool, nails, and other skin appendages; *collagen* from bones, tendons, and other connective tissues; and *fibroin* of silk.

6. *Histones*—soluble in water and dilute acid solutions, insoluble in ammonia, soluble in sodium or potassium hydroxide, not coagulated by heat, predominantly basic in character and yield comparatively large amounts of diamino acids, occur in nature as components of compound proteins; examples are *globin* (denatured) of hemoglobin from blood and *histones* of nucleoproteins from various plant and animal tissues.

7. *Prolamines*—simple proteins of comparatively low molecular weight, soluble in water, dilute acids, and alkalis (including ammonia), not coagulated by heat, so predominantly basic that their watery solutions are alkaline to litmus, combine with large proportions of acid but have only a slight combining power for alkalis, composed largely of diamino acids, especially arginine, occur in combination with nucleic acid in the heads of spermatozoa; examples are *salmiin* from salmon sperm, *sturin* from sturgeon sperm, *clupein* from herring sperm, and several others that have been prepared from various kinds of fish sperm.

B. The Compound Proteins. Substances occurring in nature and yielding on hydrolysis, in addition to α -amino acids, some nonprotein group, sometimes called the **prosthetic group**.

1. *Nucleoproteins*—yield nucleic acid, occur most abundantly in cell nuclei but not confined to them, are generally combinations of a histone with nucleic acid; examples are *thymus nucleoprotein* and *yeast nucleoprotein*.

2. *Chromoproteins* or *hemoglobins*—colored proteins, composed of a histone united to a color group containing a metal, include the respiratory pigment proteins of blood; examples are *hemoglobin* from blood and *hemocyanin* from invertebrate blood.

3. *Glycoproteins*—yield sugarlike substances as the prosthetic group; examples are *mucin* from saliva and *mucoïd* from connective tissues.

4. *Lecithoproteins*—yield *lecithin* (phosphorized fat) as the prosthetic group,

have not been sufficiently studied to make certain whether they actually occur in nature or are formed during the process of their preparation from various plant and animal substances, for example, in egg yolk.

5. *Lipoproteins*—yield fatty acid as the prosthetic group and, like lecithoproteins, have not been definitely proved to occur in nature but may exist in all plant and animal tissue.

6. *Phosphoproteins*—sometimes classed as simple proteins since no organic prosthetic group has been identified, break down to yield phosphoric acid which has been regarded as the prosthetic group, are predominantly acid in character, important in nutrition of growing animals; examples are casein from milk and ovovitellin from egg yolk.

C. Derived Proteins. Proteins obtained by partial hydrolysis or denaturation of natural proteins. Some of them are intermediary products of protein hydrolysis. The group also includes the slightly modified (probably not hydrolyzed) proteins obtained by heat coagulation and the synthetic substances called peptides.

1. *Coagulated proteins* - produced by heat or alcohol coagulation, which is apparently a process of dehydration; insoluble in all reagents which do not decompose them.

2. *Metaproteins* or *infraproteins*—produced by brief action of dilute acids or alkalis on natural proteins at temperatures below boiling; examples are proteins formed by action of dilute acid on certain globulins at room temperature, alkali metaprotein formed by action of dilute NaOH or KOH on natural proteins at 30 to 60°C., and acid metaprotein formed by action of dilute acid on natural proteins at 30 to 60°C.

3. *Proteoses*—produced by action of dilute acids or protein-digesting enzymes when hydrolysis is permitted to go beyond the metaprotein stage; divided into primary and secondary proteoses; the primary proteoses are salted out by half saturation with ammonium sulfate and are precipitated by nitric acid and by picric acid, while secondary proteoses are salted out only by complete saturation with ammonium sulfate and are not precipitated by nitric or picric acid. The secondary proteoses have a smaller molecular weight than primary proteoses and represent a more advanced stage in the hydrolytic cleavage of natural proteins. Proteoses are not coagulable by heat. Many of them are powerfully toxic when injected into animals. An example is albumose from albumin.

4. *Peptones*—produced by action of dilute acids or protein-digesting enzymes when hydrolysis is permitted to go beyond the proteose stage; cannot be salted out by ammonium sulfate or any other salt; are not precipitated by nitric acid or picric acid, have a molecular weight small in comparison with natural proteins, and in complexity and general chemical behavior resemble very closely the artificially synthesized polypeptides, which may, indeed, be defined as peptones of known molecular structure.

The more important data regarding the simple proteins are summarized in Table 19.

Synthesis of Peptides. The preparation of a dipeptide from a diketopiperazine (amino acid anhydride) has been described (p. 103). This is a general method for the preparation of many dipeptides involving only one amino acid but has serious limitations. When two different amino acids are joined in a diketopiperazine ring, it is difficult to control the point at which a subsequent hydrolysis will open the ring. Consequently, a mixture of two dipeptides may arise. For example, the

anhydride of leucine and glycine would yield leucyl-glycine and glycyl-leucine. A strictly quantitative separation presents great difficulties.

Another method starts with the monochloro derivative of an acid

TABLE 19.—REVIEW OF SIMPLE PROTEINS—SUMMARY OF MORE IMPORTANT DATA

Class	Characteristic solubilities	Heat coagulation	"Salting-out" behavior	Predominant reaction	Hydrolysis yields	Examples
1. Albumins . . .	Sol. in water	+	By saturation with $(\text{NH}_4)_2\text{SO}_4$ or with NaCl and acetic acid	Slightly more acidic than basic	Nearly all amino acids	Ovalbumin, serum albumin
2. Globulins . . .	Insol. in water, sol. in dilute salt solutions	+	½ saturation with $(\text{NH}_4)_2\text{SO}_4$ or saturation with NaCl	About equally acidic and basic	Nearly all amino acids	Ovoglobulin, edestin, serum globulin
3. Glutelins . . .	Insol. in nearly neutral solutions, sol. in acid or alkali	+	Can be salted out of acid solutions	About equally acidic and basic	Nearly all amino acids	Glutenin, oryzenin
4. Prolamins . . .	Sol. in 70–80% alcohol	–		More acidic than basic	Much glutamic acid	Gliadin, hordein, zein
5. Albuminoids.	Insol. in all reagents except ones which decompose them				Predominantly the simpler amino acids	Keratin, elastin, collagen, fibroin
6. Histones . . .	Sol. in water, insol. in dilute ammonia	–	Similar to albumins	Quite basic	Large amounts of histidine and lysine	Globin
7. Protamins . . .	Very soluble	–	Similar to albumins	Very basic	Large amounts of arginine	Salmin, sturin, scombrin

chloride which, reacting with an amino acid, forms a peptide linkage. The reaction is illustrated thus:

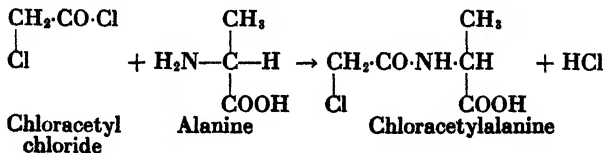

Treating the product of this reaction with ammonia yields a dipeptide.

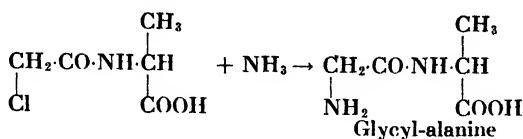

Starting with the corresponding halogen-propionyl chloride, a dipeptide containing the alanyl grouping would be obtained. Similarly, the halogen derivatives of other acid chlorides may be employed and, as they may be combined with any one of certain amino acids, a wide variety of dipeptides may be synthesized. Moreover, the method can be extended for the preparation of tripeptides and even polypeptides although limitations in the extension of the method are encountered. An example of a tetrapeptide is

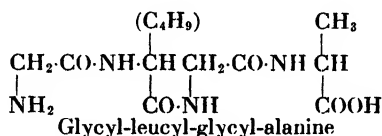

An especially useful method was developed by Bergmann and associates. They found that an acid chloride of an amino acid could be prepared if the amino group were suitably "masked." For this purpose they chose the carbobenzyloxy group. It is obtained from a derivative produced in the reaction

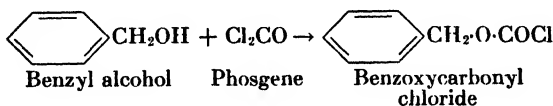

The product of this reaction, on treatment with an amino acid, produces a derivative of the type

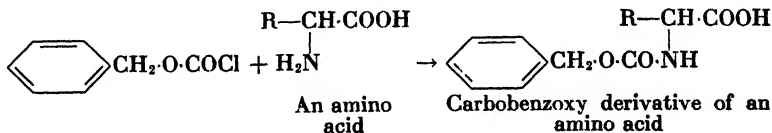

which, by the action of phosphorus pentachloride, can be changed into the corresponding acid chloride; and this, reacting with an amino acid, yields a compound having the peptide linkage.

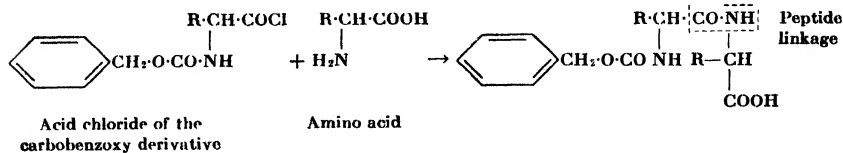

This compound reacting with hydrogen in the presence of colloidal platinum yields a peptide, the carbobenzoxy group being eliminated with the formation of CO_2 and toluene.

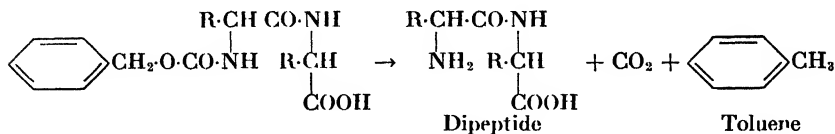

This method affords an advantage in that hydrolysis is not used in the final stage, thus avoiding a tendency to hydrolytic cleavage of the dipeptide itself. Another advantage is that the method prevents the racemization of the amino acids so that the resulting dipeptides retain the stereoisomeric configuration of natural products. The method may be extended for the synthesis of more complex peptides.

By these and some other methods, peptides constituting an extended list have been synthesized. One of Emil Fischer's products contained a chain of 18 amino acid residues, namely, L-leucyl-tricylgyl-leucyl-triglycyl-leucyl-octaglycyl-glycine. Other polypeptides of approximately equal or even greater complexity have been prepared. Their behavior resembles that of proteins in certain respects. They are nondiffusible through parchment paper, give some of the protein color reactions, and may be thrown out of solution by some of the typical protein precipitants.

Nitrogen Distribution in Proteins. Useful information is obtained by the quantitative determination of the different types of nitrogen found in proteins.

1. The amide nitrogen, presumably because of the acid-amide grouping of aspartic and glutamic acid residues in the protein, can be determined by the amount of ammonia set free when the protein hydrolysate is boiled with $\text{Ca}(\text{OH})_2$.

2. The so-called "humin nitrogen" is that present in a black precipitate which forms during the determination of the amide nitrogen. It is filtered off and subjected to a nitrogen determination. Its significance for protein composition is not explained satisfactorily, but its amount varies widely in different proteins.

3. If another aliquot portion of a protein hydrolysate is treated with phosphotungstic acid, the basic amino acids and cystine are precipitated. The determination of sulfur permits calculation of cystine in the precipi-

tate, and another portion of it boiled with NaOH gives off ammonia in proportion to the arginine present, while still another portion subjected to nitrous acid treatment for determination of amino nitrogen (p. 101) permits the calculation of other basic amino acids by difference.

4. Monoamino nitrogen and the other nitrogen of the monoamino acids are calculated from the nitrous acid reaction and the determination of total nitrogen in the filtrate from the phosphotungstic acid precipitate.

Results of such analyses are shown for some representative proteins in Table 20.

TABLE 20.—NITROGEN DISTRIBUTION IN REPRESENTATIVE PROTEINS
Values are per cent of the total nitrogen of the protein

Proteins	Amide N	Humin N	Cys-tine N	Argi-nine N	Histi-dine N	Lysine N	Mono-amino N	Mono-non-amino N	Total meas-ured
Casein.....	10.27	1.28	0.20	7.41	6.21	10.30	55.81	7.13	98.6
Hemoglobin...	5.24	3.60	0.0	7.70	12.70	10.90	57.00	2.90	100.0
Gelatin.....	2.25	0.07	0.0	14.70	4.48	6.32	55.80	14.90	98.5
Edestin.....	9.99	1.98	1.49	27.05	5.75	3.86	47.55	1.70	99.4
Gliadin.....	25.52	0.86	1.25	5.71	5.20	0.75	51.98	8.50	99.8

Protein Color Reactions. A number of color tests more or less characteristic of proteins and, in some cases, given by the amino acids are frequently used.

The *biuret test* gives a color varying from pink-lavender to purple, according to the nature of the protein, when its solution or a suspension of insoluble protein is treated with an excess of KOH and a small amount of dilute CuSO₄ solution. Several modifications of the procedure, such as the use of "biuret paper" or the "biuret reagent," have been devised. Any excess of copper produces the dark-blue color of Cu(OH)₂, which hides the color due to proteins. Ammonium ions and magnesium salts also interfere with the reaction. The test derives its name from the fact that it is given by biuret. This is obtained by heating dry urea.

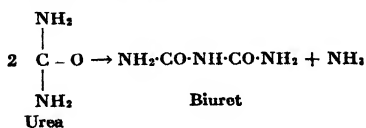

The color is due in this case to the formation of a complex represented by Schiff as

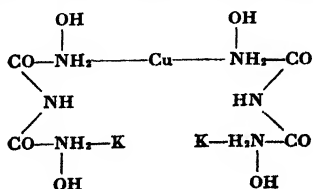

The significance of the fact that all proteins respond to the biuret test is that it gives confirmatory evidence of the peptide structure of the protein molecule. While a number of compounds of varying structure give a positive biuret test, conspicuous among them are the polypeptides. Any of them formed by the union of four or more amino acids respond to the test.

Millon's test is given by the majority of proteins when the solution or a suspension of insoluble protein is boiled with a small amount of Millon's reagent. The latter is prepared by dissolving metallic mercury in excess of nitric acid and diluting with two volumes of water. The protein, if in solution, is precipitated and when boiled takes on a brick-red color. The reaction is due to the phenol grouping present in tyrosine residues of the protein. Proteins which lack tyrosine as a "building stone" do not give any color in this reaction. Tyrosine gives a brilliant red color (Hoffman's test), and phenol responds without even heating.

The glyoxylic acid test (Hopkins-Cole reaction) is given by most proteins. The solution is treated with a small amount of a solution containing a salt of glyoxylic acid. For Benedict's modification of this reagent a suspension of powdered magnesium in distilled water is treated under cooling with an excess of saturated oxalic acid solution and the mixture is filtered to remove magnesium oxalate. The filtrate is acidified with acetic acid and diluted. The mixture of protein solution and glyoxylate is stratified above concentrated H_2SO_4 . A positive reaction is the formation of a violet ring at the zone of contact. The reaction is due to the presence of the indole group in the tryptophan residues of the protein. Proteins lacking tryptophan give no color in this reaction.

The Liebermann reaction also involves tryptophan. Proteins containing it give a violet or bluish color in the presence of HCl if the protein has been previously treated with alcohol and ether. It is believed that contamination of the ether with glyoxylic acid is responsible for the positive result.

The xanthoproteic test is frequently used. Nearly all proteins respond positively to it. Treatment with an excess of concentrated nitric acid gives a yellow solution, which is cooled and then treated with an ammonium hydroxide solution, which is stratified above the nitric acid. A brilliant orange color appears at the zone of contact and may be accompanied by a white precipitate. The test is due to the presence of the benzene ring in the protein molecule and is therefore given by phenylalanine, tyrosine, and tryptophan.

The ninhydrin reaction is given by all proteins and typical amino acids and, indeed, by all compounds containing at least one free amino group and one free carboxyl group. Ninhydrin is triketohydrindene hydrate

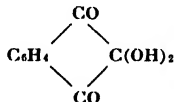

A positive result is a blue color which develops on boiling. The color is intensified by the presence of a low concentration of pyridine. Proline and hydroxyproline do not give the test, and histidine after some delay develops a red color. The reaction is highly sensitive. Glycine, for example, gives the reaction in a 1:10,000 dilution.

Other color reactions are given by certain amino acids only when in the free state but not when united as in the protein molecule. Among them are the following: (1) Mörner's test for tyrosine, which consists in the development of a green color on boiling with H_2SO_4 containing formaldehyde; (2) Piria's test, in which tyrosine dissolved in

concentrated H_2SO_4 is diluted, neutralized with BaCO_3 , filtered, and treated with FeCl_3 to develop a violet color; (3) the Folin and Looney test, in which tyrosine gives a blue color in alkaline solution with a special reagent prepared by the use of sodium tungstate, phosphomolybdic acid, and phosphoric acid. Although the specificity of this reaction for tyrosine is not established, it can be used as the basis of a quantitative determination of tyrosine from isolated proteins; (4) the aldehyde reactions of tryptophan, in one of which a red-violet color is obtained with *p*-dimethylaminobenzaldehyde in H_2SO_4 ; (5) a color reaction of tryptophan, upon which Kraus's method for quantitative determination is based, employing an acetic acid solution of vanillin and concentrated HCl and developing a violet color; (6) Sullivan's test for cystine, with sodium- β -naphthoquinone-4-sulfonate developing a red color in the presence of alkali; (7) a color reaction of arginine (Sakaguchi), using α -naphthol and NaOBr . A number of other color reactions have been described for specific amino acids but the above are perhaps the ones most widely used.

Other General Reactions of Proteins. Among the reactions common to all or to the majority of proteins are the following:

Reactions with concentrated mineral acids are complex. Most protein solutions of 1 per cent or greater concentration form heavy precipitates upon the addition of relatively small amounts of acid, but with further amounts of acid the resulting changes in hydrogen-ion activity produce complex results, which include dissolving of the protein and its hydrolysis.

Reactions with concentrated alkalis do not involve precipitation but cause hydrolysis and oxidative decomposition.

Reactions with salts of heavy metals precipitate proteins under some conditions of hydrogen-ion activity, temperature, etc. Mercuric chloride and silver nitrate yield heavy precipitates which do not redissolve in excess of the reagent. The same is true of some other salts of heavy metals. Copper sulfate and ferric chloride are examples of metallic salts which precipitate proteins but cause re-solution of the precipitate with excess of the reagent. These salts are subject to hydrolytic dissociation, so that when present in excess, they produce an acidity sufficient to cause re-solution.

Precipitation by alkaloidal reagents is widely used in protein chemistry. Alkaloidal reagents, an ill-defined group, include trichloroacetic acid, tannic acid, phosphotungstic acid, phosphomolybdic acid, and potassiummercuric iodide. Apparently the precipitates formed are protein salts of the acidic component of the reagent. On this account, complete precipitation is attained only when the reaction occurs in a solution having its pH on the acid side of the isoelectric point of the protein.

Precipitation by alcohol occurs with all proteins but is satisfactory only when the protein is at its isoelectric point. Precipitation can occur in solutions which are not at the isoelectric point, but relatively high concentrations of alcohol are required and complete precipitation is not assured.

Heat coagulation occurs in the case of a considerable number of proteins. The temperature at which coagulation occurs varies with different proteins, covering a range from about 38°C to about 75°C. Although it was once tacitly assumed that proteins could be identified by determination of the coagulation temperature, it is now clearly evident that this value varies widely with the conditions prevailing in the protein solution. Both the temperature of coagulation and the completeness of the process are dependent upon the presence of ions other than those of proteins, and the effects are especially sensitive to the pH of the solution. All proteins are noncoagulable in solutions of pH sufficiently differing from the isoelectric point in either the acid or the alkaline direction. The more nearly the solution approaches the isoelectric point, the more completely the protein coagulates. At the isoelectric point any coagulable protein is completely precipitated by heating. The nature of the coagulation process is not clearly understood. Some evidence points to a dehydration of the protein molecule as the probable explanation. In any case, a coagulated protein is, as is commonly said, "denatured." It differs from the natural protein in several ways, of which the most striking is its insolubility in all solvents except those which cause its hydrolytic or other decomposition.

Proteins, however, may be denatured by heating under circumstances which do not cause coagulation. An obvious demonstration of this is obtained by heating such a protein as egg albumin in either an acid or alkaline solution. Although no coagulation occurs, the albumin, naturally soluble at its isoelectric point, is now transformed into what is known as a *metaprotein*, which is insoluble at its isoelectric point. It flocculates when brought to the isoelectric pH, but this is unlike a coagulum in that it readily redissolves without hydrolysis when the pH of the suspending solution is changed in either direction from the isoelectric value. Other less obvious denaturation changes occur under the influence of exposure to prolonged action, at room temperature, of dilute acids or alkalis, of the action of mild heating, of prolonged exposure to alcohol, or of X-ray or ultraviolet irradiation. The protein molecule is an unstable structure, highly sensitive to many environmental forces.

Combining Power of Proteins. The amphoteric character of proteins must be taken into account in estimating the power of proteins to combine with acids or bases. This is analogous to the behavior of amino acids. Proteins have free —COOH groups. Some of them are provided by aspartic and glutamic acid residues, and any chain of amino acid groups united in a peptide grouping could have a free carboxyl group at the end of the chain. Similar reasoning accounts for the presence of free —NH_2 groups, most of them being supplied by the diamino acid

residues of the protein. The combining powers vary, therefore, with the structure of the protein and with the pH of its solution.

Earlier protein investigators attempted to account for the complex behavior of proteins by assuming that adsorption occurred upon the surfaces of the large protein molecules or molecular aggregates. Owing chiefly to the pioneer work of Loeb (1920-1922) the relation of protein

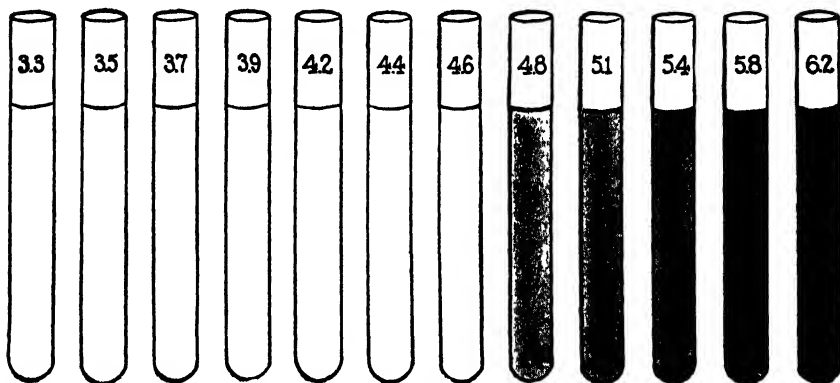

FIG. 20. Experiment to demonstrate that proteins combine with a base only when in a condition less acid than the isoelectric point. Twelve portions of powdered gelatin, suspended in cold solutions of differing pH were all treated in a dark room with M/64 AgNO_3 and later washed with cold water to remove the silver not in combination with gelatin. The gelatin preparations were then liquefied by warming and made up to 1 per cent solutions. The pH was then determined in each case and the solutions, poured into test tubes, were exposed to light. In about half an hour each gelatin preparation of pH 4.8 or more became dark, showing the presence of silver; while those of pH 4.7 or less remained permanently free from evidence of the presence of silver although exposed to light for more than a year. The pH values of the gelatin solutions are shown on the test tubes. (*J. Loeb, "Proteins and the Theory of Colloidal Behavior."*)

reactions to pH was greatly clarified. He showed that if the pH of a protein solution is controlled, the amount of an acid or a base combining with it is predictable, follows the law of definite proportions, and is, in fact, stoichiometric. Loeb obtained satisfactory proof that proteins combine with bases only when the solution has a pH on the alkaline side of the isoelectric point and combine with acids only when the solution has a pH on the acid side of the isoelectric point. The results are illustrated in Figs. 20 and 21. Figure 21 also shows the tendency of many properties of a protein to be at a minimum when the protein is in the isoelectric condition.

Proteins combine with other proteins, and the molecules of an individual protein appear to combine with each other. Large protein com-

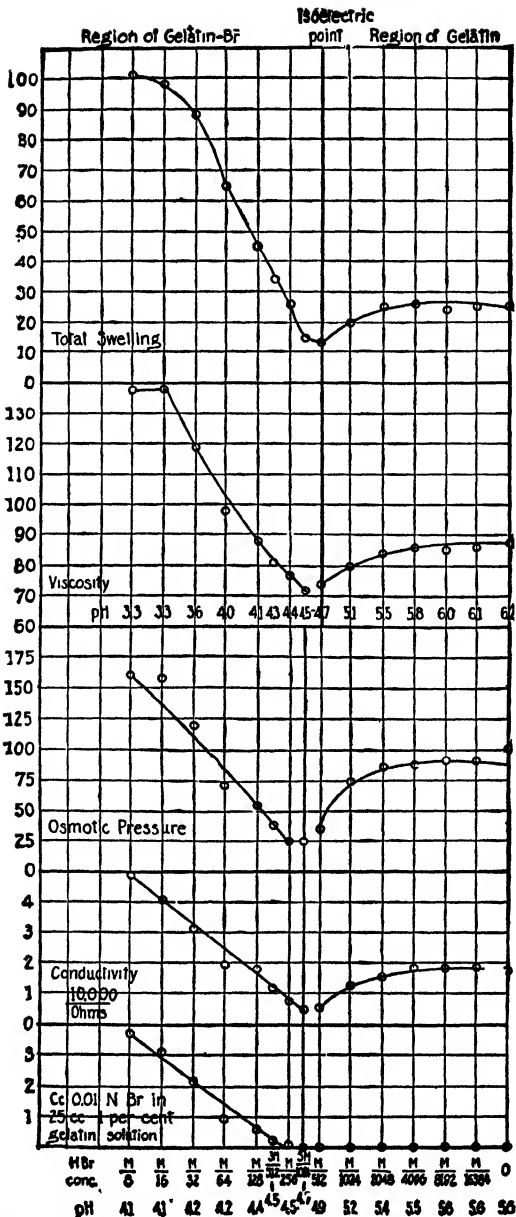

FIG. 21. Curves showing that the following physico-chemical properties: imbibition of water (swelling), viscosity, osmotic pressure, and electrical conductivity of a protein (gelatin in this case) are at a minimum at the isoelectric point. The graph at the bottom shows that the protein combines with Br, representative of anions, only on the more acid side of the isoelectric point. (*J. Loeb, "Proteins and the Theory of Colloidal Behavior."*)

plexes may thus arise. Proteins also combine with organic substances so numerous and varied as to constitute an indefinitely long list. Among them are various plant and animal pigments, carbohydrate substances, fatty acids, compound lipids, certain vitamins, and some of the hormones.

The significance of protein-combining power can hardly be exaggerated. It has been the basis of much biological theory. Some physiologists have gone so far as to assume that nearly all the components of active protoplasm are in the form of protein complexes.

Molecular Weight of Proteins. The usual methods for determination of molecular weights of organic compounds can yield only rough

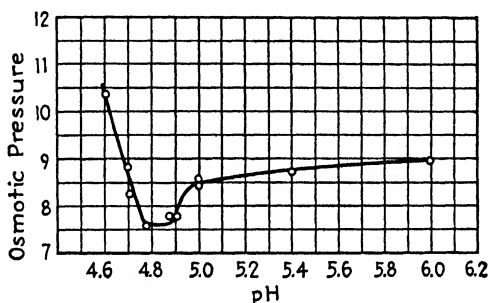

Fig. 22. Osmotic pressure of casein as influenced by the pH of its solution. Ordinates are osmotic pressure in centimeters of water per unit of casein concentration. Osmotic pressure is at a minimum in the isoelectric zone. See also the curve for the osmotic pressure of gelatin as shown in Fig. 21. (Curve drawn from data of Burk and Greenberg.)

approximations when applied to substances so complex as the proteins. The use of quantitative analysis has been attempted. One of the most successful of such attempts will serve to illustrate. Hemoglobin of blood contains iron, for which accurate methods of quantitative determination are available and show the average content of iron to be 0.33 per cent. This would indicate that hemoglobin has a minimal molecular weight of approximately 16,670, assuming that hemoglobin contains only 1 atom of iron in the molecule. Actually, however, physical properties, such as osmotic pressure, indicate a much higher molecular weight for this protein, in some cases four times the minimal value.

Osmotic-pressure measurements, however, can give results that are only approximate and are apt to be misleading unless they are interpreted with caution. The protein solutions used must be of relatively low molar concentration because of the high molecular weight, so that the unavoidable observational error of even the best methods produces a relatively large error in the computed molecular weight. Moreover, protein osmotic pressure is enormously influenced by the pH of the solu-

tion and by the presence of other electrolytes, and the degree of hydration of proteins in aqueous solutions is not satisfactorily determined. The osmotic behavior of proteins is indicated in Figs. 22 and 23.

Freezing-point determinations by the so-called "cryoscopic method" have been widely used in studies of protein osmotic pressures, but results are not sufficiently precise for satisfactory molecular-weight computations.

The ultracentrifuge method developed by Svedberg has proved to be the most efficient tool yet devised for protein molecular-weight estimation. The principles involved were outlined (p. 115) in connection

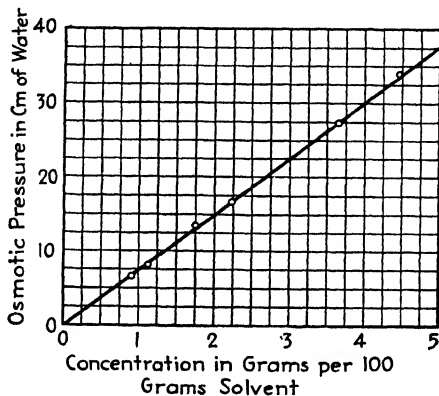

FIG. 23. Osmotic pressure of casein in relation to its concentration. All measurements made under isoelectric conditions (pH 4.78 to 4.92). The straight-line relationship here shown was found only when the concentration of casein was corrected for the effect of solvation. Solvent, 6.66*M* urea. (Data from Burk and Greenberg.)

with criteria of purity. Svedberg's improved oil turbine operates at speeds of 5,000 to 80,000 revolutions per minute (r.p.m.). At 75,000 r.p.m. the centrifugal force is equivalent to 400,000 times the force of gravity. As the sedimentation rate is proportional to the molecular weight the latter may be computed.

Some of the results obtained by the use of Svedberg's method are summarized in Table 21. Relatively few proteins have been prepared in such purity and stability as to show sedimentation behavior indicating only one molecular species of definite weight. All proteins show instability of molecular weight at pH values not within a range which includes the isoelectric point. Some examples, as observed by Svedberg and his coworkers, showing varying molecular weight in proteins, which might once have been regarded as chemical individuals, are given in Table 22. Homologous proteins, *e.g.*, erythrocrucorin and hemocyanin from the blood of various invertebrates, may vary widely in molecular weight.

Svedberg's measurements have led him to suggest that many natural

TABLE 21.—MOLECULAR WEIGHTS OF PROTEINS AS MEASURED BY THE ULTRA-CENTRIFUGE

Protein	Source	pH region of stability	Mol. wt. from sedimentation velocity	Mol. wt. from sedimentation equilibrium
Erythrocrucorin.....	<i>Lampetra</i> blood		18,300	19,000
Erythrocrucorin.....	<i>Area</i> blood			33,600
Erythrocrucorin.....	<i>Chironomus</i> blood			31,400
Lactoglobulin.....	Cow's milk	1.0-9.0	33,900	37,800
Pepsin (cryst.).....	Pig's stomach		35,500	39,200
Insulin (cryst.).....	Pig's pancreas	4.5-7.0		35,100
Bence-Jones protein.....	Human urine	3.5-7.5		35,000
Ovalbumin.....	Hen's egg	4.0-9.0	43,800	40,500
Hemoglobin.....	Human blood		63,000	
Hemoglobin.....	Horse blood	6.0-9.0	69,000	68,000
Serum globulin.....	Horse blood	4.0-9.0	67,100	66,900
Edestin.....	Hempseed	3.5-9.7	303,000	
Excelsin.....	Brazil nuts	5.5-10.0	291,000	
Amandin.....	Almonds	4.3-10.0	329,000	
Hemocyanin.....	<i>Palinurus</i> blood		446,000	460,000
Hemocyanin.....	<i>Nephrop</i> blood		766,000	
Hemocyanin.....	<i>Homarus</i> blood		752,000	784,000
Erythrocrucorin.....	<i>Planorbis</i> blood		1,634,000	1,539,000
Hemocyanin.....	<i>Octopus</i> blood		2,785,000	
Hemocyanin.....	<i>Eledone</i> blood		2,791,000	
Erythrocrucorin.....	<i>Lumbricus</i> blood	2.6-10.0	3,190,000	2,946,000
Hemocyanin.....	<i>Helix</i> blood		6,630,000	6,706,000
Hemocyanin.....	<i>Buceyon</i> blood		9,660,000	

TABLE 22.—MOLECULAR WEIGHT DISTRIBUTION FOR SOME PROTEINS OF NONUNI-FORM MOLECULAR WEIGHT

Protein	Source	Molecular weight of chief components
Lactalbumin.....	Cow's milk	12,000-25,000
Gelatin.....	Cartilage	10,000-100,000
Casein.....	Cow's milk	75,000-375,000
Myoglobin.....	Muscle	16,000 34,000 68,000
Pomelin.....	Orange seeds	17,000 210,000 320,000
Pseudoglobulin.....	Blood serum	50,000-100,000
Yellow oxidizing enzyme.....	Yeast	28,000-95,000
Mosaic disease virus.....	Tobacco with mosaic disease	15×10^6 to 20×10^6

proteins occur in units of molecular weight of about 36,400, or of one-half that value, or some multiple of it. Proteins of especially high molecular weight might similarly be regarded as comprising units of about 400,000. In either case these units are regarded as combining reversibly, the extent of the polymerization being dependent upon concentration, pH, temperature, and other physicochemical conditions. That such reversible combinations of protein units actually occur seems highly probable, but the idea that the unit is of fairly uniform size for a considerable number of natural proteins is not substantiated. Molecular-weight determinations on imperfectly isolated proteins may yield only the average value of a mixture of particles of different sizes.

Molecular Structure. Although not the only theory proposed, the idea that proteins are essentially polypeptides of high molecular weight is the oldest and still the most satisfactory theory. The amino acid residues appear to be joined by the peptide linkage to form long chains. The theory was proposed almost simultaneously by Hofmeister and by Fischer (1902). A diagrammatic representation may be shown thus:

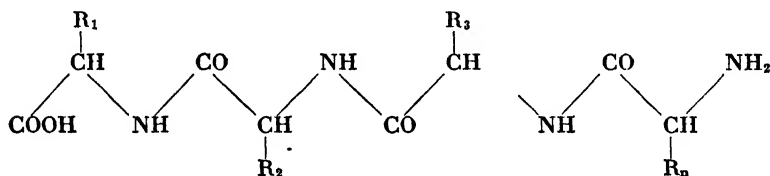

Peptide linkage is shown at three points only, but the actual length of the chain may be indefinitely extended. Satisfactory estimates of the number in any one uncomplicated chain are not available because there may be side chains or looping of chains.

The formula as here shown makes no attempt to indicate to scale the relative spacing between atoms or the angles between adjacent bonds. Both of these have been determined, however, with a rather high degree of precision by the study of the X-ray diffraction patterns of proteins and polypeptides. Such values are useful in the development of a theory of the probable structure of natural proteins. Scale atom models, such as those constructed by Neurath (Fig. 24), are also helpful in gaining a mental picture of the protein structure.

R_1 , R_2 , etc. represent the parts of amino acid residues not otherwise shown in the formula. They may vary in complexity from 1 hydrogen atom of the glycyl group to relatively large groups such as that of the tryptophan residue. If all amino acids of proteins are of the α -type and the L-configuration, as now seems to be true, the chains resulting from their linkage must possess a standard, symmetrical, repetitive pattern of

carbon and nitrogen atoms constituting the main continuous grouping, the "vertebral column" of the molecule. The points of attachment of side chains by peptide linkage can be at the free —COOH groups of dicarboxylic amino acids or at the free —NH_2 groups of diamino acids. Similar side-chain attachments might occur at the —OH groups of tyrosine and the hydroxyamino acids.

The actual dimensions of natural protein particles can be estimated. In the case of the largest ones, virus particles and bacteriophages (Chap.

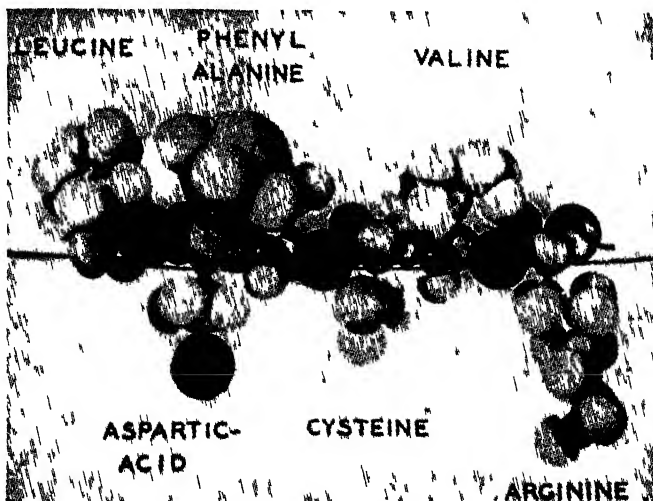
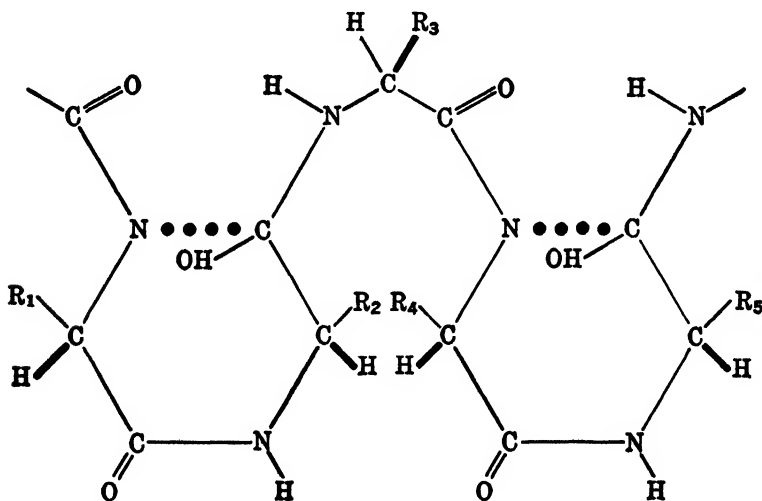

FIG. 24. An atom scale model of a hexapeptide. It indicates the arrangement of the main chain of C and N atoms (see p 134) and the alternating arrangement of groups, R_1 , R_2 , etc each of which characterizes a specific amino acid residue (*J. Neuroth, J Phys. Chem., 44, 296, 1940*)

V), the electron microscope, magnifying some 20,000 times or more, can be used to obtain photographs. Another ingenious method employs X-ray bombardment of bacteriophage solutions with graduated dosages of irradiation. This is followed by observations of the proportion of phage particles still living after each "dosage" as compared with those in the original solution. The principle involved is that the larger the particle size, the greater the chances of "hits" by a given X-ray bombardment. The proportion thus destroyed, or its inverse, the particles remaining viable, can be related, through a formula developed by Lea, to the average diameter of the particles. They are thus shown to vary from about $8 \text{ m}\mu$ (Coli dysentery phages) to about $120 \text{ m}\mu$ (Subtilis phage) in average diameter. These values are roughly in agreement with those computed from other measurements.

The long chains of amino acids may, in some protein molecules, extend roughly parallel to each other. Possible cross linkings that have been suggested for such cases are represented in Fig. 25.

X-ray studies, especially those of Astbury who investigated a number of proteins, mostly of the fibrous type such as keratin of hair and wool, have yielded information regarding the spacing (repetitive) of the atoms. Astbury describes two types of keratin, the α - and the β -type. The latter appears to be the fully extended polypeptide chain and is observed in stretched hair, becoming a completely β -type form when the hair is stretched until its length is increased 60 per cent. The α -type, observed in unstretched fibers, shows X-ray diffraction patterns which indicate atomic spacings explainable on the basis of the folding of polypeptide chains. The atomic arrangement in the folded structure is still undetermined. One theory, widely discussed, assumes that the chain folds so as to produce hexagonal rings, which are represented thus:



In this scheme the rings are formed by a lactim-lactam arrangement as indicated in the diagram by dotted lines. The stereoisomeric arrangement at asymmetric C atoms is suggested by heavy bond lines to indicate an atom or group supposed to project up from the plane of the paper. It is seen that the alternating arrangement of the groups R_1 , R_2 , etc., is now interfered with so that, as indicated at R_2 , R_4 , they may occur in the same plane in close crowding. Neurath investigated this structure by the use of scaled atomic models and concluded that, unless unreasonable distortions of bond angles are assumed, the hexagonal foldings are too condensed to afford sufficient space for amino acid residues other

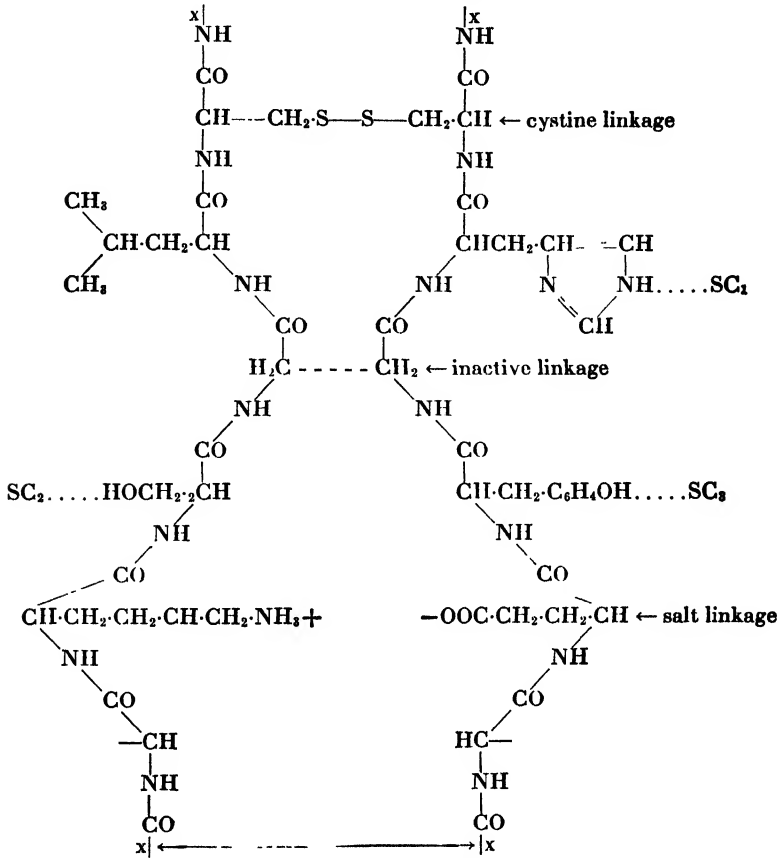

Distance, 9.6 to 11.5 Å; average, 10 Å

FIG. 25. Scheme arranged by R. J. Block to indicate possible cross links between parallel chains of amino acid residues joined in each chain by peptide linkage. The diagram illustrates the grid for β -keratin, *e.g.*, in stretched hair. The α -form would be derived from this by folding the paper into a series of regular folds that would leave the side chains still parallel to the plane of the paper.

Reading from the top down, the left-hand chain represents the residues of cysteine, leucine, glycine, valine, lysine, and an unidentified amino acid; similarly, the chain on the right represents cysteine, histidine, glycine, tyrosine, glutamic acid, and an unidentified residue. The two cysteine residues are joined to form cystine. Points of possible attachments of side chains are suggested at SC₁, SC₂, and SC₃. Indefinite continuation of the chains is suggested at points marked x. The intervals indicated in Ångströms are those deduced from measurements of X-ray diffraction patterns.

The variation in the distance between the parallel main chains is caused by differences in the type of linkage, *e.g.*, the salt bond between the ϵ -amino group of lysine and the γ -carboxyl group of glutamic acid is pictured as spreading the chains further apart than the -S-S linkage of two cysteyl residues. (After R. J. Block, "Chemistry of the Amino Acids and Proteins," Charles C Thomas, Springfield, Ill.)

than those of glycine and alanine. Neurath raises the following question: May a contracted form of polypeptide chain be a spiral shape which would still maintain the alternate orientation of amino acid residues?

Huggins finds that the ribbonlike structure represented by the above formula when constructed to scale (maintaining suitable bond angles) "cannot be plane but must be folded. One plausible type of folding, agreeing with the X-ray data, makes the chain a spiral." Such spiral chains could be expected to align themselves in layers.

But many proteins are not fibrous. They have more or less globular-shaped molecules. They may vary from rod shapes, detected by behavior toward polarized light, through ellipsoidal forms, whose asymmetry may be measured by diffusion rates and other methods, to roughly spherical forms. Efforts to conceive an arrangement of amino acid residues in such forms have been made, but here, as in Astbury's suggestion of folded chains, hexagonal patterns that have been suggested seem not to allow sufficient space for placement of the residues. Such a "cyclol" arrangement as proposed by Wrinch may be indicated thus:

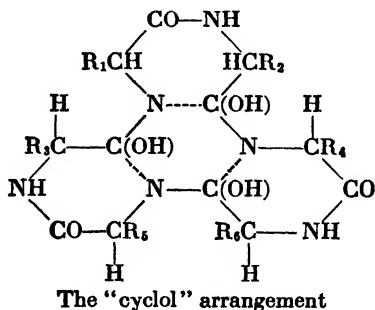

It shows three diketopiperazine rings united by lactam-lactim arrangements.

If it were sufficiently extended, folded up, and the "edges" united, the cyclol arrangement would form a polyhedral cage consisting of a lacelike "cyclol" fabric. While provocative of much interest and discussion, this idea cannot be regarded as a satisfactory theory unless the spaces afforded in the hexagonal rings can be shown to accommodate the amino acid residues.

Another aspect of protein structure which has been widely considered is the possibility that some, at least, of the amino acid residues tend to occur at regularly repeated intervals along a given peptide chain. This idea, advanced especially by Bergmann, is based on analyses of protein hydrolysates tending to show that specific amino acid groups occur in the protein molecule in simple, whole-number ratios. Thus, with hemo-

globin of cattle, amino acid determinations in the hydrolysate and molecular-weight estimations for the protein led Niemann to conclude that the protein could be regarded as containing the following:

Total Number of Amino	
Acid Groups	576 = 2 × 288
Arginine groups	12
Lysine groups	36
Histidine groups	32
Aspartic acid groups	32
Glutamic acid groups	16
Tyrosine groups	12
Proline groups	12
Cysteine groups	3

Similar conclusions were drawn from the data obtained with a number of other proteins. Such regularity is most easily explained as due to a "pattern" in which specific amino acid groups occur at regularly repeated intervals (frequencies) along a chain or a potential chain of peptide links. Thus every sixteenth link (576/36) would be a lysine residue and 15 other residues would be interposed. Similarly, tyrosine residues would occur with a frequency of 18 (576/12) and 47 other residues be interposed.

This theory seems to gain support in that it agrees with that of Svedberg (p. 134) which assumes that proteins tend to occur as multiples of certain unit sizes. A fundamental unit would appear to contain 288 amino acid residues or a multiple of 288 in agreement with Bergmann's findings.

It has been pointed out by several commentators that quantitative determination of the amino acid content of proteins is not as precise as would be required fully to substantiate Bergmann's hypothesis. It is also notable that 288 is an especially convenient number to serve as the total of amino acid residues because it has more whole-number divisions than any smaller number. In the case of gelatin the apparent frequency (as estimated from analyses) for occurrence of glycine and proline residues is such as to result in a conflict, so that every twenty-first position along the chain would be claimed for both of these residues. Obviously, the idea of a regular pattern of amino acid arrangements cannot yet be regarded as having convincing proof. It may have a limited application in the case of the arrangement of some of the amino acid residues of some proteins.

REFERENCES

The standard and most important reference book on this subject is "The Chemistry of the Amino Acids and Proteins," edited by C. L. A. Schmidt and written by 18 specialists in particular aspects of protein chemistry, 2d ed., Springfield, Ill., 1944.

Helpful monographs dealing with a part of this subject are "The Biochemistry of the Amino Acids" by H. H. Mitchell and T. S. Hamilton, New York, 1929, and "The Amino Acid Composition of Proteins and Foods" by R. J. Block and D. Bolling, Springfield, Ill., 1945.

"Advances in Protein Chemistry" edited by M. L. Anson and J. T. Edsall, New York, published annually since 1944, presents helpful reviews.

As an introduction to the use of physical chemistry in the study of proteins, see "Physical Chemistry for Students of Biology and Medicine" by D. I. Hitchcock, 3d ed., Springfield, Ill., 1940.

Review articles are as follows:

- BERGMANN, M., The Structure of Proteins in Relation to Biological Problems, *Chem. Rev.*, **22**, 423, 1938.
- BRAND, E., and EDSALL, J. T., The Chemistry of the Proteins and Amino Acids, *Ann. Rev. Biochem.*, **16**, 223, 1947.
- COHN, E. J., Proteins as Chemical Substances and as Biological Components, Harvey Lectures, Series **34**, 124, 1939.
- COHN, E. J., Some Physical-chemical Characteristics of Protein Molecules, *Chem. Rev.*, **24**, 203, 1939.
- EDSALL, J. T., The Chemistry of the Proteins and Amino Acids, *Ann. Rev. Biochem.*, **11**, 151, 1942.
- HEWITT, L. F., The Chemistry of the Proteins and Amino Acids, *Ann. Rev. Biochem.*, **12**, 81, 1943.
- HITCHCOCK, D. I., The Chemistry of Amino Acids and Proteins, *Ann. Rev. Biochem.*, **9**, 173, 1940.
- HUGGINS, M. L., X-ray Studies of the Structure of Compounds of Biochemical Interest, *Ann. Rev. Biochem.*, **11**, 27, 1942.
- KEKWICK, R. A., and MCFARLANE, A. S., The Chemistry of the Proteins and Amino Acids, *Ann. Rev. Biochem.*, **12**, 93, 1943.
- PEDERSEN, K. O., The Chemistry of the Proteins and Amino Acids, *Ann. Rev. Biochem.*, **17**, 169, 1948.
- ROSE, W. C., The Nutritive Significance of the Amino Acids, *Physiol. Rev.*, **18**, 109, 1938.
- SNELL, E. E., The Microbiological Assay of Amino Acids, *Advances in Protein Chem.*, **2**, 85, 1945.
- A few of the enormous number of papers on research in this field are selected.
- ASTBURY, W. T., X-ray Studies of Protein Structure, *Cold Spring Harbor Symposia Quant. Biol.*, **2**, 15, 1934.
- BERG, C. P., and ROSE, W. C., Tryptophane and Growth, I, *J. Biol. Chem.*, **82**, 479, 1929.
- BERG, C. P., ROSE, W. C., and MARVEL, C. S., Tryptophane and Growth, II, III, *J. Biol. Chem.*, **85**, 207, 219, 1929.
- BERGMANN, M., Synthesis and Degradation of Proteins in the Laboratory and in Metabolism, *Science*, **79**, 439, 1934.
- BERGMANN, M., and NIEMANN, C., Newer Biological Aspects of Protein Chemistry, *Science*, **86**, 187, 1937.
- BOLLING, D., SOBER, H. A., and BLOCK, R. J., Quantitative Separation and Determination of Small Amounts of Histidine and Tyrosine Employing Paper Chromatography, *Fed. Proc.*, **8**, 185, 1949.
- BUNNEY, W. E., and ROSE, W. C., Growth upon Diets Practically Devoid of Arginine, with Some Observations upon the Relation of Glutamic and Aspartic Acids to Nutrition, *J. Biol. Chem.*, **76**, 521, 1928.
- CARPENTER, D. C., Splitting the CONH Linkage by Means of Ultraviolet Light, *J. Am. Chem. Soc.*, **62**, 289, 1940.
- CONDEN, R., GORDON, A. H., and MARTIN, A. J. P., Qualitative Analysis of Proteins: A Partition Chromatographic Method Using Paper, *Biochem. J.*, **38**, 224, 1944.
- HEWITT, L. F., The Polysaccharide Content and Reducing Power of Proteins and Their Digest Products, *Biochem. J.*, **32**, 1554, 1938.
- GREENSTEIN, J. P., Sulfhydryl Groups in Proteins, I, *J. Biol. Chem.*, **125**, 501, 1938.
- SCULL, C. W., and ROSE, W. C., Relation of the Arginine Content of the Diet to the Increments in Tissue Arginine during Growth, *J. Biol. Chem.*, **89**, 109, 1930.
- ST. JULIAN, R. R., and ROSE, W. C., The Relation of the Dicarboxylic Amino Acids to Nutrition, *J. Biol. Chem.*, **98**, 439, 1932.
- TOENNIES, G., A Map of the Natural Amino Acids, *Science*, **97**, 492, 1943.
- TOWN, B. W., The Separation of Amino Acids by Means of Their Copper Salts. 3. The Hydrolysis of Gliadin. An Investigation of the Dicarboxylate Fraction, Including the Isolation of *n*-Glutamic Acid as an Hydrolysis Product, *Biochem. J.*, **35**, 417, 1931.
- WOMACK, M., KEMMERER, K. S., and ROSE, W. C., The Relation of Cystine and Methionine to Growth, *J. Biol. Chem.*, **121**, 403, 1937.
- WRINCH, D. M., Structure of Pepsin, *Phil. Mag.*, **24**, 940, 1937.
- YOUNG, E. G., On the Separation and Characterization of the Proteins of Egg White, *J. Biol. Chem.*, **120**, 1, 1937.

CHAPTER V

NUCLEOPROTEINS AND NUCLEIC ACIDS

Although rather unstable and easily hydrolyzed, nucleoproteins appear to exist as such in all cells. They may be regarded as protein nucleates, unions of a simple protein with nucleic acid, analogous to similar unions with inorganic acids. While the simple proteins involved appear to include albumins, histones, and protamines, other proteins might, theoretically, function in forming nucleates.

One of the early researches on nucleoproteins, reported by Miescher in 1897, was an investigation of the sperm of the Rhine salmon at Basle. As the fish near the spawning region, large quantities of milt can be expressed from the males. It consists chiefly of spermatozoa, the heads of which are very largely composed of protamine nucleate. Miescher was able to separate the two constituents and was thus the discoverer of both protamines and nucleic acids.

The relation between protein and nucleic acid is sometimes represented by the following hypothetical scheme suggested by the pioneer work of Miescher, of Kossel, and of others.

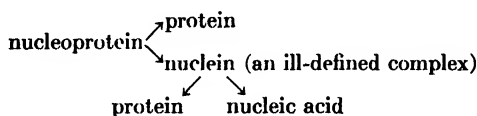

Distribution and Types of Nucleic Acids. The names nucleoprotein and nucleic acid imply that these compounds occur in the nucleus. While abundant in nuclei, they also occur in cytoplasm. They are found in all typical cells of both plants and animals. Earlier work led to the idea that nucleic acids derived from plants were characterized by yielding ribose upon hydrolysis, while those of animal origin yielded desoxyribose. Yeast nucleic acid and triticonucleic acid (wheat) were shown to be ribose compounds, and thymonucleic acid (thymus gland) was found to be a desoxyribose derivative. More recent work shows that the distinction thus indicated is not universal. Desoxyribose has been obtained from nucleic acid of yeast-cell nuclei and ribose from a pancreas nucleic acid. Feulgen suggested that possibly the nucleic acids from the nucleus tend to be of the desoxyribose type, while those of cytoplasm have the

ribose-containing structure generally preponderating. Later work has tended to confirm this idea. In any case, division of nucleic acids into plant and animal types is no longer valid; provisional classification as ribose and desoxyribose types is useful.

Nucleoproteins are far more abundant in tissues possessing large nuclei in closely packed cells than in tissues with less prominent nuclei. Thus, glandular tissues (thymus, liver, pancreas, etc.) are rich sources, as are spermatozoa and other structures with large nuclei; muscle is a very poor source.

Properties of Nucleoproteins. Nucleoproteins are predominantly acidic and are readily soluble in alkaline solution in which they form salts with alkalis; they are precipitated by acetic acid but dissolve in dilute HCl. They give the ordinary protein color tests and precipitation reactions and are not heat-coagulable.

Nucleoprotein may be prepared from yeast which has been ground in the presence of a mixture of ether and water to destroy the cells. Treatment with an excess of 0.4 per cent NaOH for about 24 hr. at room temperature dissolves the protein. After the solution is filtered, the cautious addition of dilute HCl to the point of maximum precipitation separates nucleoprotein. From animal tissues, such as the thymus gland, nucleoprotein is extracted with 1MNaCl solution and precipitated by dilution with water.

Properties of Nucleic Acids. Nucleic acids are only slightly soluble in cold water, more readily soluble in hot water, and easily soluble in dilute alkaline solutions with the formation of an alkali salt. They are precipitated by HCl, and yeast nucleic acid is precipitated by an excess of acetic acid. They are insoluble in alcohol and are precipitated in the form of their salts with alkali earth metals and heavy metals. Thymus nucleic acid in the form of its sodium salt in approximately neutral solution sets to a stiff jelly upon cooling. Yeast nucleic acid does not show this property.

Yeast nucleic acid is prepared by grinding compressed yeast with a dilute solution of KOH, which is added slowly until the ground-up paste is faintly alkaline to litmus. After an excess of saturated picric acid solution has been added and the solution filtered, nucleic acid is precipitated by HCl. The nucleic acid is freed from adhering picric acid by dissolving in dilute KOH, filtering, acidifying with acetic acid, and precipitating with a large excess of ethanol.

Nucleic acids of animal tissues are extracted with 5 per cent NaCl solution and deproteinized by various procedures; the nucleic acid is precipitated from a faintly acid protein-free filtrate by an excess of ethanol.

Products of Nucleic Acid Hydrolysis. The nucleic acids are best characterized by the products of their acid or enzymatic hydrolysis. From the two best known ones, the products are

	Yeast Nucleic Acid	Thymus Nucleic Acid
Purine Bases } Guanine	Adenine	Adenine
Pyrimidine Bases } Cytosine	Guanine	Guanine
	Uracil	Cytosine
		Thymine
Sugars	β -D-Ribofuranose	β -2-Desoxy-D-Ribofuranose
Acid	Phosphoric acid	Phosphoric acid

Hydrolysis in boiling dilute acid readily liberates one-half of the phosphoric acid, the other half only very slowly. The sugars produced were described in Chap. I. They are believed to occur in nucleic acids in the tautomeric forms shown thus:

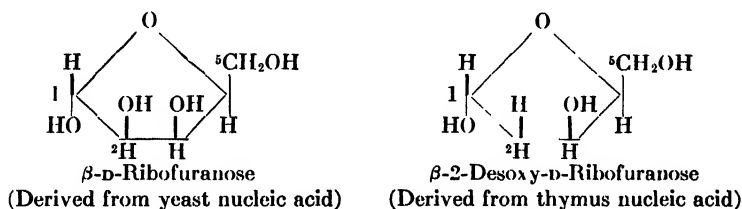

The Purine Bases. A large group of compounds occurring both free and in combination in plant and animal tissues are known as purine bases. They are regarded as derivatives of purine.

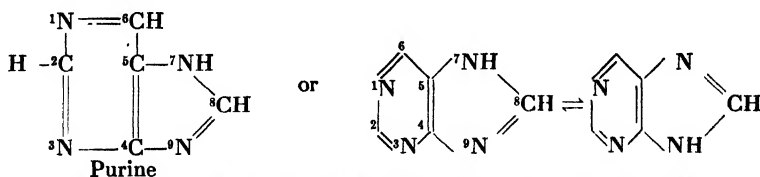

(The older type of formula, at left, is giving way to the cyclic arrangement, shown here in tautomeric forms.)

Nucleic acids in their natural state contain residues of two amino-purines, **adenine** and **guanine**.

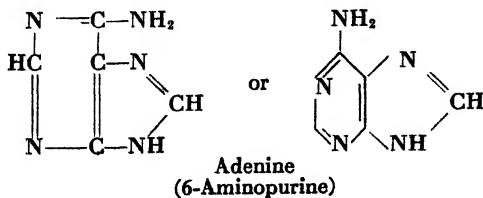

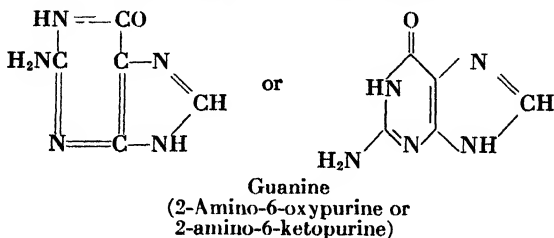

Closely related to these and arising from them by deamination in animal tissues are the two oxypurines, **hypoxanthine** and **xanthine**.

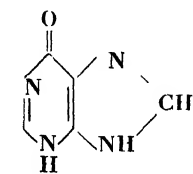

Hypoxanthine
(6-Oxypurine or
6-ketopurine)

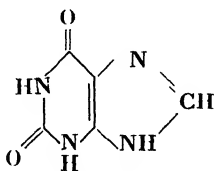

Xanthine
(2,6-Dioxypurine or
2,6-diketopurine)

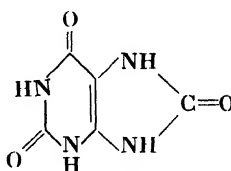

Uric acid
(2,6,8-Trioxypurine or
2,6,8-triketopurine)

Hypoxanthine readily oxidizes to xanthine and the latter to uric acid. The origin of uric acid in mammals (Chap. XVI) is due chiefly to the catabolism of nucleic acids.

The purine bases and uric acid may be precipitated as their silver salts from ammoniacal solution or as the copper salts in the presence of sodium bisulphite. Free guanine may be separated from the hydrolysis products of nucleic acid by addition of strong ammonia. Filtered off and dissolved in boiling 5 per cent HCl, guanine forms, upon cooling, needle-shaped crystals of its hydrochloride. Adenine may be precipitated as its difficultly soluble picrate, which forms clusters of yellow threadlike crystals. Guanine treated with HNO_3 gives a yellow compound which turns purple (murexide test) upon addition of KOH or NH_4OH . Adenine does not respond to this test.

The Pyrimidine Bases. A considerable number of bases from plant and animal tissues are derivatives of pyrimidine

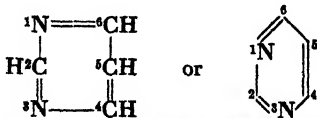

(Shown in two conventional methods of writing the formula)

The three bases obtained from nucleic acids are

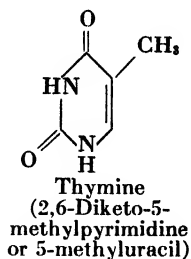
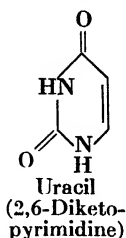
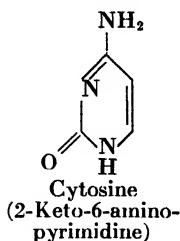

Cytosine and uracil yield dialuric acid (2,4,6-triketo-5-hydroxypyrimidine or 5-hydroxybarbituric acid) upon treatment with bromine. Dialuric acid gives a purple color (Wheeler and Johnson test) in the presence of an excess of $\text{Ba}(\text{OH})_2$. Thymine, however, yields decomposition products which include acetol, $\text{CH}_3\text{CO}\cdot\text{CH}_2\text{OH}$. After the acetol is distilled off, it can be detected by a blue color reaction developed under suitable conditions with *o*-aminobenzaldehyde.

Nucleotides and Nucleosides. The researches of Jones at Johns Hopkins and of Levene at the Rockefeller Institute were especially helpful in showing the nature of the constituent groups of the nucleic acids. Hydrolysis of the acids was studied in both laboratories. By the use of ammonia at 110 to 122°C., yeast nucleic acid is split into relatively large fragments called mononucleotides, which may easily be separated because of their different precipitability by alcohol. Four nucleotides are obtained. Their names and the products of their complete hydrolysis are shown below.

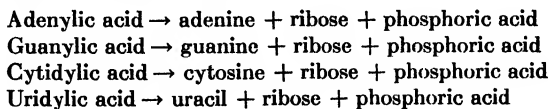

The probable structure of these nucleotides is shown thus:

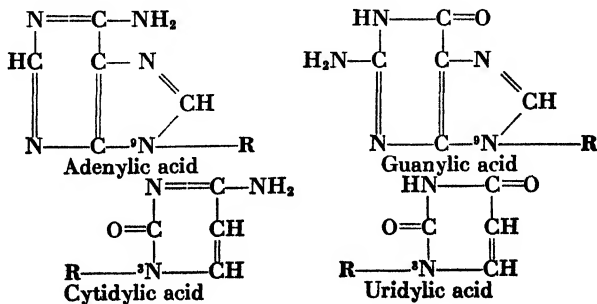

For the nucleotides obtained from yeast nucleic acid **R** is represented thus:

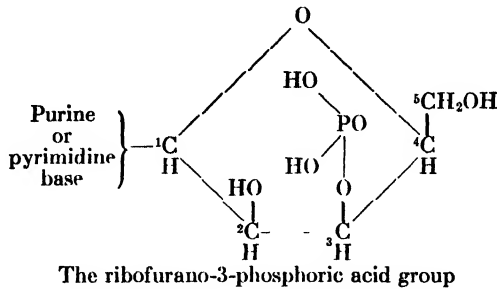

With the exception of guanylic acid, which is found free in nature (liver, spleen, pancreas, yeast), this form of nucleotide having the phosphoric acid group at position 3 has been obtained only by hydrolysis of nucleic acids.

Other isomeric nucleotides occur. They have the phosphoric acid group at position 5. The adenylic acid and certain related nucleotides (to be discussed in Chap. XIV) as found in muscle have the structure

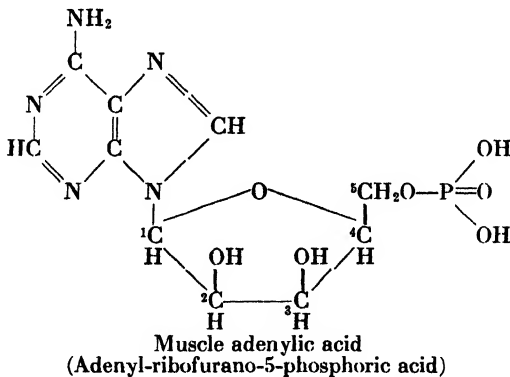

Pyrimidine mononucleotides have been obtained only as the phosphoric acid forms prepared from hydrolysis products of nucleic acids.

The desoxyribose nucleic acids, though not so thoroughly investigated, are analogous to the ribose type. They differ, of course, in the sugar which they yield when hydrolyzed and also differ in that the desoxyribose type (*e.g.*, thymus nucleic acid) yields the pyrimidine bases *cytosine* and *thymine* while the ribose type yields cytosine and uracil. The purine bases *adenine* and *guanine* are the same in both types.

Each nucleotide is represented as a compound of base-ribose-phosphoric acid. The arrangement in this order is based upon the fact that

while certain enzymes (phosphatases) are able to split a nucleotide to produce phosphoric acid without splitting the other constituents, other enzymes (nucleotidases) split off the base, leaving ribose-phosphoric acid intact.

The base-sugar combinations are glycosides known as nucleosides. They have been prepared from the hydrolysis products of nucleic acids or nucleotides, and some of them have been obtained from tissue extracts. According to the nature of the base and the sugar, they may be classified as follows:

Ribose Nucleosides	2-Desoxyribose Nucleosides
Adenosine	Adenine desoxyriboside
Guanosine	Guanine desoxyriboside
Cytosine riboside (Cytidine)	Cytosine desoxyriboside
Uracil riboside (Uridine)	Thymine desoxyriboside

As shown in the formulas for nucleotides, ribose is in the furanose form. This has been established by studies of the methyl and other derivatives of the sugar. The phosphate group is attached at the C₃ atom of ribose. This was shown by Levene and Harris by reducing ribose phosphoric acid. The resulting ribityl phosphoric acid was found optically inactive, showing that the phosphate group must be symmetrically placed. While this is proved for purine nucleotides, it is only inferred for the pyrimidine types.

The four possible desoxyribosides, derivable from thymus nucleic acid, were obtained by Klein. Although the ordinary methods of acid or alkali hydrolysis are not suitable for this purpose, he was able to obtain the result through enzyme action. By inhibiting nucleotidase and deaminase of intestinal mucosa, the remaining enzyme action was permitted to liberate nucleosides without further hydrolysis.

The attachment of sugar to position 3 of the *pyrimidine* base as represented in the above formulas seems to be established beyond question for both ribo- and desoxyribonucleotides. The *purine* base might have the attachment at position 7 or 9. The latter is more probable as shown by the ultraviolet absorption spectra, which resemble those of 9-substituted artificial products and do not resemble those of 7-substituted ones.

Deamination. Adenine and guanine are changed by the enzymes **adenase** and **guanase** of animal tissues to hypoxanthine and xanthine, respectively. Although the process of deamination appears to be identical, the two enzymes are specific and have a different distribution in animal organs.

Similarly, both nucleotides and nucleosides may be deaminated.

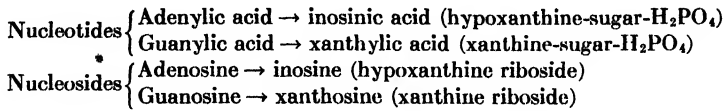

Inosinic acid was prepared from meat extract by Liebig as early as 1847, but its chemical nature was not established until more than 60 years later. In the meantime a substance known as "carnine" had been prepared from meat extracts and shown to yield hypoxanthine and a sugar when hydrolyzed. Carnine eventually proved to be inosine.

The other deaminated nucleotides and nucleosides apparently do not accumulate in tissues, but the occurrence of the enzymes which could produce them indicate that they are probably formed.

Structure of Nucleic Acid. Yeast nucleic acid is often spoken of as a "tetranucleotide." The use of this name is based on the analysis of its hydrolysis products and on molecular-weight determinations of the material as ordinarily prepared. The molecular weight is found to vary in some preparations from slightly more than 1,300 to about 1,700. The sum of the four constituent nucleotides is 1,357. But other nucleic acid preparations show higher values. Yeast nucleic acid itself shows some properties indicating that it may exist in a polymerized form. Among others, the so-called "allonucleic acid," the pentose nucleic acid obtained from pancreas, is said to have a molecular weight of about 3,000; and the molecular weight of thymus nucleic acid, measured by viscosity methods or by the ultracentrifuge, may show values of the order of 500,000 or 1,000,000 or more. However, even thymus nucleic acid after subsection to some of the procedures used for its purification may be obtained in a form having some properties suggesting that it could be a tetranucleotide.

The possible structure of a hypothetical tetranucleotide, a possible nucleic acid building block, has been extensively studied. A formula proposed by Levene (1929) seemed to be supported by considerable evidence; but later work has failed to substantiate it, and reviewers of this subject, writing between 1945 and 1948, find that proofs of the existence of a definite tetranucleotide unit are not satisfactory. Assuming that the compounds of high molecular weight can depolymerize to yield those of smaller weight, a fortuitous combination of fragments containing approximately equal parts of four different nucleotides might be obtained. Such a result, however, can hardly serve as proof of a definite tetranucleotide structure. The status of this problem recalls the similar uncertainty

regarding a repetitive pattern of amino acids (p. 138) as suggested in the Bergmann hypothesis of protein structure.

The Significance of Nucleic Acid in Chromosomes. The long, stringlike structures of certain chromosomes suggest molecular aggregates. As is well recognized in genetics, the genes of any one chromosome tend to remain together during the processes of cell division. This might be attributable to large protein-chain molecules. More recent work suggests that the nucleic acid, which is also a part of the chromosomal apparatus, might be the continuous structure to which proteins are attached as side chains. The very large molecular weight of some nucleic acids and especially of desoxyribonucleic acids, when prepared from separated cell nuclei in something like their native state, suggests that they can exist in chains of indefinite length.

Astbury investigated thymus nucleic acid by means of X-ray photographs and found that thin films of stretched nucleic acid gave evidence of spacings along the fiber axis of about 3.3 Å, "which is almost identical with that of a fully extended polypeptide chain system such as β -keratin (p. 136) or β -myosin." Studies of this and other spacings indicated by the photographs led to the suggestion that there might be a close succession of more or less flat aggregates standing out perpendicularly from the long axis of the nucleic acid molecule so as to form a relatively rigid structure. If each of the flat units were a tetranucleotide, there might be some 2,000 or more of them strung along like flat beads on a chain. Future efforts to explain the chemistry of mitosis and other cellular activities involving chromosomes will probably include a study of the peculiar and interesting properties of the nucleic acids.

Nucleotides Having Special Functions. A number of nucleotides which are not combined in nucleic acids exist in tissues and have special functions. Adenylic acid, adenosine diphosphate, and adenosine triphosphate have been found in both plant and animal cells. They function in the chemical utilization of sugars and will be discussed (Chap. XIV) in connection with carbohydrate metabolism.

Another type known as the pyridine nucleotides contains nicotinamide, one of the vitamins, as a constituent group. Still others have thiamine or riboflavin. These three types of vitamin-containing nucleotides function as parts of oxidizing enzyme systems of protoplasm and will be described (Chap. XII) in connection with bio-oxidation.

Viruses (Vira). Many communicable diseases of plants, animals, and man are transmitted by means of infectious agents which are invisible under the microscope and pass through bacteria-retaining filters. Such agents are called *filtrable viruses*. The term is somewhat misleading because some infective agents generally called "viruses" exist in particles

large enough to be microscopically visible and are retained by certain bacterial filters. The virus which causes the tobacco mosaic disease (mottled diseased spots in the leaves) has been investigated biochemically with especially notable results. From diseased tobacco plants Stanley (1935) prepared a crystalline protein which had the disease-producing activity of the virus.

Preparation of a virus so as to retain its activity requires rapid work at low temperature because the virus tends to be easily denatured. The methods used include adsorption and subsequent elution. Stanley used celite (a diatomaceous earth) in acid condition and eluted with an alkaline solution. In some cases protein-destroying enzymes can be used to get rid of adhering proteins without destroying the virus. Salting-out methods and other precipitation procedures are used. The tobacco mosaic virus and other viruses which have been obtained in purified form are **nucleoproteins**. They give the usual protein color tests and yield nucleic acid which can be separated and identified. The yield of nucleic acid varies in different preparations even when they are made from the same source. The type of nucleic acid obtained from viruses producing plant diseases appears to be similar to yeast nucleic acid inasmuch as the hydrolysis products include pentose. Some viruses causing animal diseases appear to be more like thymus nucleoprotein. The nucleic acid may not always be an indispensable part of the protein molecule in order that it may show virus activity. At any rate, some active preparations which were very low in phosphorus content have been obtained. The binding between protein and nucleic acid varies in firmness in different viruses. From the tobacco mosaic virus it is split off by very mild hydrolysis; but in the virus which produces the bushy stunting disease in some plants, such as tomatoes, the binding is firm. The proportion of nucleic acid to the total nucleoprotein varies in different viruses from about 10 per cent to about 40 per cent.

The amino acid content of virus proteins has been studied. The tobacco mosaic virus yields arginine, lysine, aspartic and glutamic acids, phenylalanine, tyrosine, tryptophan, cystine (or cysteine), leucine, proline, and serine. Efforts to find glycine, alanine, and histidine have failed.

The size of virus particles is estimated in various ways. These include ultracentrifugation, ultrafiltration, electrophoresis, and other physical methods. One of the interesting methods is the study of photographs made with the electron microscope. This apparatus, using electromagnetic focusing of a beam of electrons, magnifies 20,000 to 100,000 times. The photographs reveal virus particles of varying sizes and shapes. Some are small (diameter 8 to 12 $m\mu$) and may be nearly

spherical in shape. Some, including the tobacco mosaic virus, are rod shaped with a cross section about 15 $m\mu$ in diameter and a length of about 330 $m\mu$.

The molecular-weight estimations reveal a wide range of results. This is true even for different preparations of the same virus. Some values recorded for tobacco mosaic virus are in the range 26 to 50×10^6 . Values obtained with other viruses are both smaller and larger than those included in this range. All active viruses, however, have molecular weights recorded in millions.

Polymerization, as suggested by observations on size and molecular weight, is probably possible for the viruses in general. Apparently they can exist as aggregates of different sizes without necessarily losing virus activity. This recalls the similar behavior of nucleic acids.

The internal structure of the virus particle has been studied in photographs of the X-ray diffraction patterns which they produce. The results suggest that the virus particle is highly organized in a manner analogous to the patterned arrangement of atoms in a crystal.

Bacteriophage. Substances which cause destruction of bacteria or, as one might say, diseases of bacteria, are called the *bacteriophages*. They are classified with the viruses and have similar properties. A purified bacteriophage prepared by Northrop from killed cultures of staphylococcus had the properties of a nucleoprotein.

Is a Virus a Living Organism? A virus is on the border line between what is commonly thought of as a nonliving protein molecule and what is accepted as a living organism, a small bacterium. One of the common criteria for deciding whether or not a thing is alive is the ability to grow and reproduce. The virus grows in a suitable host. This is proved by infecting a plant with a minute amount of purified virus and finding that the plant becomes completely diseased. The virus can then be obtained in the usual quantity found in diseased plants. But no means have yet been devised for growth of the virus on a nonliving medium. One may think, then, of a virus as highly organized matter which is not an organism capable of growth and reproduction *independent* of typically living organisms. Because they stand on the border line between the living and the nonliving their biochemistry is of peculiar interest.

REFERENCES

An exhaustive treatment of the structural chemistry and properties of nucleic acids is found in "Nucleic Acids" by P. A. T. Levene and L. W. Bass, New York, 1931.

A less extensive but very useful summary is Chap. XI, "The Chemistry of Pyrimidines, Purines and Nucleic Acids" by T. B. Johnson in "Organic Chemistry," edited by H. Gilman, New York, 1938.

Several aspects of the subject are presented by various investigators in *Cold Spring Harbor Symposia Quant. Biol.*, 12, 1-279, 1947.

Among useful reviews are the following:

- ALLEN, F. W., The Biochemistry of the Nucleic Acids, Purines, and Pyrimidines, *Ann. Rev. Biochem.*, **10**, 221, 1941.
- BEARD, J. N., Chemical, Physical and Morphological Properties of Animal Viruses, *Physiol. Rev.*, **28**, 349, 1948.
- CHARGAFF, E., and VISCHER, E., Nucleoproteins, Nucleic Acids, and Related Substances, *Ann. Rev. Biochem.*, **17**, 201, 1948.
- DELBRÜCK, M., Bacterial Viruses (Bacteriophages), *Advances in Enzymol.*, **2**, 1, 1942.
- GULLAND, J. M., BARKER, G. R., and JORDAN, D. O., The Chemistry of the Nucleic Acids and Nucleoproteins, *Ann. Rev. Biochem.*, **14**, 175, 1945.
- HOAGLAND, C. L., The Chemistry of Viruses, *Ann. Rev. Biochem.*, **12**, 615, 1943.
- LORING, H. S., The Biochemistry of the Nucleic Acids, Purines and Pyrimidines, *Ann. Rev. Biochem.*, **13**, 295, 1944.
- MARTON, L., The Electron Microscope in Biology, *Ann. Rev. Biochem.*, **12**, 587, 1943.
- MIRSKY, A. E., Chromosomes and Nucleoproteins, *Advances in Enzymol.*, **3**, 1, 1943.
- PIRIE, N. W., The Viruses, *Ann. Rev. Biochem.*, **15**, 573, 1946.
- STANLEY, W. M., The Biochemistry of Viruses, *Ann. Rev. Biochem.*, **9**, 545, 1940.
- TIPTON, R. S., The Chemistry of the Nucleic Acids, *Advances in Carbohydrate Chem.*, **1**, 193, 1945.
- Some papers which indicate the trends of recent work in this field are listed.
- BAWDEN, F. C., and PIRIE, N. W., Methods for the Purification of Tomato Bushy Stunt and Tobacco Mosaic Viruses, *Biochem. J.*, **37**, 66, 1943.
- BARNES, F. W., JR., and SCHOENHEIMER, R., On the Biological Synthesis of Purines and Pyrimidines, *J. Biol. Chem.*, **151**, 123, 1943.
- BRADY, T. G., Isolation of Adenine-desoxyriboside from Thymusnucleic Acid, *Biochem. J.*, **35**, 855, 1941.
- BUELL, M. V., A New Method for the Isolation of Crystalline Adenine Nucleotides, *J. Biol. Chem.*, **150**, 389, 1943.
- DAVIDSON, J. N., and WAYMOUTH, C., Factors Influencing the Nucleoprotein Content of Fibroblasts Growing in Vitro, *Biochem. J.*, **37**, 271, 1943.
- DAVIDSON, J. N., and WAYMOUTH, C., Ribonucleic Acids and Nucleotides in Embryonic and Adult Tissue, *Biochem. J.*, **38**, 39, 1944.
- DOUNCE, A. L., The Desoxyribo-nucleic Acid Content of Isolated Nuclei of Tumor Cells, *J. Biol. Chem.*, **151**, 235, 1943.
- KLECZKOWSKI, A., Combination of Potato Virus X and Tobacco Mosaic Virus with Pepsin and Trypsin, *Biochem. J.*, **38**, 160, 1944.
- KNIGHT, C. A., Nucleoproteins and Virus Activity, *Cold Spring Harbor Symposia Quant. Biol.*, **12**, 115, 1947.
- KUNITZ, M., Isolation from Beef Pancreas of a Crystalline Protein Possessing Ribonuclease Activity, *Science*, **90**, 112, 1939.
- LAUFFER, M. A., The Sedimentation Rate of the Infectious Principle of Tobacco Mosaic Virus, *J. Biol. Chem.*, **151**, 627, 1943.
- LEVENE, P. A., MIKESKA, L. A., and MORI, T., On the Carbohydrate of Thymonucleic Acid, *J. Biol. Chem.*, **85**, 785, 1930.
- LORING, H. S., and CARPENTER, F. H., The Isolation of Mononucleotides after Hydrolysis of Ribonucleic Acid by Crystalline Ribonuclease, *J. Biol. Chem.*, **150**, 381, 1943.
- STACEY *et al.*, Chemistry of the Feulgen and Dische Nuclear Reactions, *Nature*, **157**, 740, 1946.
- STANLEY, W. M., Virus Achievement and Promise, *Am. Scientist*, **36**, 59, 1948.

CHAPTER VI

THE VITAMINS

Traditionally, the food requirements of man and of domestic and laboratory animals were supposed to be met by proteins, fats, carbohydrates, and inorganic salts. That other food substances were indispensable was long suspected though difficult of proof. Diseases of obscure origin such as scurvy, beriberi, and pellagra, now known to be due to dietary deficiencies, were not easily proved to be caused by faulty diet. Delay in recognition of the nature of deficiency diseases was due in part to the preoccupation of the medical world with bacterial and other parasitic invasions as the cause of disease and in part to the fact that substances, the lack of which caused disease, were required in such minute amounts and occurred in foods in such faint traces that they were overlooked by dietitians and food chemists.

While intimations of food deficiencies as the cause of scurvy and beriberi and a few other diseases were not lacking in earlier literature, experiments of Hopkins, reported in 1912, gave one of the earliest laboratory proofs of the theory. He showed that young rats could not be made to grow satisfactorily on a diet composed of the *known milk constituents* in a purified condition, while the addition of even small amounts of *whole, natural milk* to the synthetic diet could restore the growth rate to normal.

Some earlier work by Eijkman also pointed to dietary deficiencies. He showed that hens fed chiefly on white or polished rice developed a paralysis which could be cured by feeding the rice polishings which contained the cortex and the germ of the grains. Funk, in a series of papers (1911-1912), showed that a substance which occurred in rice polishings in small amounts and which he obtained in concentrated or nearly purified form could cure paralysis in birds and was apparently the missing factor required in the cure of human beriberi. Funk stated what was then called the vitamin hypothesis: *Certain diseases result from the absence of an indispensable dietary factor.* He proposed to call any such disease an **avitaminosis**. He chose the name "vitamine" for his beriberi-preventing substance because it appeared to be an *amine* and was necessary for *life*. While these attributes are not common, as Funk himself later realized, to all the substances of this type, biochemists agreed to use

the term with a changed spelling, **vitamin**, with a tacit understanding that when the chemical nature of any vitamin became established a more suitable name could be applied.

A vitamin is an organic compound required preformed in the diet of one or more species of animals, but only in amounts too small to be of significance as a direct source of energy for vital processes. This definition obviously lacks precision but is based on the following facts:

1. While any of the major foods of animals may be replaced wholly or largely by other foods, a vitamin requirement for a given species is indispensable for its normal functioning and generally for life itself.

2. While the daily consumption of food of a nonvitamin character is conventionally computed as grams or kilograms or as calories per unit of body weight, a vitamin intake is in micrograms or at most milligrams per unit of body weight.

3. While food in general—protein, fat, carbohydrate—is used wholly or in part as fuel for energy liberation, vitamins appear to be used exclusively for the construction of vital machinery such as the biocatalysts.

Vitamins cannot be defined as members of any one group or of a few groups of organic compounds but are widely divergent in chemical constitution. Neither can vitamins be defined, as yet, in terms of some one type of physiological function which they fulfill. While some of them have been shown to function catalytically as parts of enzyme systems, this is not known to be true of all of them.

How Many Vitamins are Known? The total number of vitamins and vitaminlike substances cannot be stated at present. For some, the evidence is incomplete; in other cases, two supposed dietary requirements have been differently characterized in different laboratories but later shown to be, in all probability, identical; in some cases a supposed single dietary requirement has appeared, in the light of more extended experiments, to consist of more than one factor.

Further complications arise in listing the vitamins. A number of substances, long familiar to biochemists as occurring in animals, have been found more recently to be indispensable in the diet. A requisite for some animals may not be a dietary essential for other species, not necessarily because it is unimportant but because it can be synthesized in the body or by the bacterial flora of the intestine and need not, therefore, be supplied preformed in the food.

If one counts separately each of the several known substances included in such group designations as vitamins A, vitamins D, etc., and also includes other indispensable food constituents not ordinarily classed as vitamins, the list mounts up to 40 or more requisites for mammalian and avian diets without the inclusion of some of the supposed vitamins, the

evidence for the existence of which is relatively incomplete. But, in spite of this bewildering array, it is significant, as pointed out by R. R. Williams, that only six of the vitamins are so apt to be deficient in *human* diets that the corresponding avitaminoses have assumed significance in food technology, in medicine and sociology, and in national economy. They are

Vitamin	Corresponding Avitaminosis
Thiamine.....	Beriberi
Ascorbic acid.....	Scurvy
Vitamin D.....	Rickets
Nicotinic acid (niacin).....	Pellagra
Vitamin A.....	Xerophthalmia
Riboflavin.....	"Ariboflavinosis"

It is quite possible, however, that future developments in the science of human nutrition may add to this list. Folic acid or some related compounds serving as a preventative of certain forms of sprue may be added in the near future.

Alphabetic and Other Names. The convention of designating vitamins by letters of the alphabet has brought such names as vitamin A, vitamin B, etc., into familiar everyday use, but such designations have become confusing, partly because of the multiple nature of several vitamins once regarded as single substances and partly because of the various meanings that have come to be associated with the same alphabetic designation. Newer names, free from equivocal meaning because they refer to pure crystalline substances of known constitution, are less familiar. It therefore seems useful to present Table 23, which compares alphabetic designations and other names which have had or now have considerable usage.

Some of the vitamins have not had a letter of the alphabet definitely assigned to them. They include

Inositol

Niacin (nicotinic acid) and niacinamide (nicotinic acid amide, nicotinamide)

p-Aminobenzoic acid

Pantothenic acid

They are generally regarded as belonging in the B group, and it is possible that pantothenic acid may prove to be identical with what was formerly called vitamin B₅, while niacin has a distribution in foods and properties not inconsistent with the suggestion that it might be what has been called vitamin B₃. There is some doubt that *p*-aminobenzoic acid is a vitamin in the sense of being strictly indispensable to any animal species.

TABLE 23.—COMPARISON OF NAMES OF VITAMINS

Alphabetic designation	Name seemingly favored in current usage	Other designations which have been or are now used	Comments
A	Activated carotenoids	Fat-soluble A factor, anti-xerophthalmic vitamin, growth-promoting factor, antiinfective vitamin, axerophthol	Now believed to occur in two forms, A ₁ and A ₂ , A ₁ predominating in land forms and marine fishes, A ₂ in fresh-water fishes
A ₁	Activated β -carotene		
A ₂	Vitamin A ₂		
B	B complex	Water-soluble B factor, anti-beriberi vitamin	Now regarded as including some 10 or more food factors
B ₁	Thiamine	Aneurin, oryzamin	The true beriberi preventive
B ₂	Riboflavin	Vitamin G, lactoflavin, oboflavin, hepatoflavin	Sometimes named according to source, milk, egg, or liver
B ₃	Vitamin B ₃	Williams-Waterman factor, bird weight-maintenance factor	Possibly identical with pantothenic acid
B ₄	Vitamin B ₄	Reader factor, antiparalysis factor for rats	Said to be replaceable by a mixture of arginine and glycine
B ₅	Vitamin B ₅	Peters factor, pigeon weight-maintenance factor	May be identical with nicotinic acid
B ₆	Pyridoxine	Filtrate factor I, adermin, antiacrodynia factor	Certain writers have referred to this as factor H
B ₇	Vitamin B ₇	Vitamin I	Said to be preventive of certain digestive disorders in birds
B ₈	Vitamin B ₈	Adenine and adenylic acid	Vitamin action not clearly proved
C	Ascorbic acid	Antiscorbutic vitamin, cevetamic acid, hexuronic acid	The scurvy-preventing vitamin
D	Vitamins D	Antirachitic vitamins, antiricketic vitamins, rachitosterols	The number of different substances having vitamin D activity is unknown
D ₂	Calciferol		
D ₃	Activated 7-dehydrocholesterol		

TABLE 23.—COMPARISON OF NAMES OF VITAMINS (Continued)

Alphabetic designation	Name seemingly favored in current usage	Other designations which have been or are now used	Comments
E	Vitamins E	α -Tocopherol, other tocopherols, antisterility vitamins	The number of different substances having vitamin E activity is unknown
F		Indispensable fatty acids have been called the F factor	There seems to be no general agreement as to use of the term "vitamin F"
G	Riboflavin	Vitamin B ₂	Vitamin G has been used to refer to B ₂ + B ₆
H	Biotin	Vitamin H has been used to mean what is now B ₆	H has also been used to refer to an antianemic factor
I		Vitamin B ₇	See vitamin B ₇
J		Antipneumonia factor	Not yet well established
K	Vitamins K	Antihemorrhagic factor, Koagulations factor	A considerable and unknown number of substances have vitamin K activity
L L ₁ L ₂	Vitamins L Vitamin L ₁ Vitamin L ₂	Lactation vitamins Lactation factor from liver Lactation factor from yeast	Evidence indicates that these vitamins are distinct entities, but they have not been characterized chemically or extensively studied
M	Vitamins B ₉ or the folic acid group	Anticytopenia factor for monkeys (see p. 183) now believed to be pteroylglutamic acid or a related compound	This vitamin exists in several different forms and has complex functions
P	Vitamin P	Permeability vitamin, capillary antifrability vitamin	Although numerous investigations of this factor have been reported, it is not well characterized chemically and its need, as distinct from that for ascorbic acid, has been questioned by some writers

Vitaminlike Substances. The list of compounds, long known to be present in living tissues and derived from foods but now regarded as meeting specific nutritive requirements, is already a long one. It includes

Choline, sometimes listed as one of the B vitamins although other compounds yielding the methyl group can be substituted for it in the diet.

Chondroitin, possibly replaceable in the diet by certain sugars or sugar acids.

Three indispensable fatty acids, any one of which can substitute more or less completely for the others (see Chap. III).

Ten or more indispensable amino acids (see Chap. IV).

Adenine and adenylic acid may belong in the list.

These compounds appear to be utilized in animal metabolism so as to be sources of energy liberation, as are the usual carbohydrate, lipid, and amino acid products of animal digestion. On this account objection to their inclusion among the vitamins, as now generally defined, is well taken. Nevertheless, the specific nutritive needs which they can meet and the relatively small quantity required for successful nutrition give them a vitaminlike character. Rosenberg suggests that nutrients which thus fill a dual role, *i.e.*, meet a specific need for vital building material and the general one for fuel substance, be given the provisional name **vitagens**.

The vitamins may be roughly classified as

I. Water-soluble, including all of the B group, thiamine, riboflavin, nicotinic acid, nicotinamide, pyridoxine, pantothenic acid, inositol, and probably others, some of which are not yet well characterized; biotin is also water-soluble and although its older name is vitamin H, it might well be included in the B group; choline and *p*-aminobenzoic acid are sometimes included in the B group; other water-soluble vitamins are ascorbic acid (vitamin C) and vitamin P.

II. Fat-soluble, including vitamins A, vitamins D, vitamins E, and vitamins K.

A condensed summary of the more important properties of the better known vitamins is presented in Table 24.

The B Group of Vitamins. A discussion of the individual vitamins begins logically with what is now called the "B group." The first well-characterized vitamin, the one for which Funk coined the name, proved to be one of this group. The first proof that vitamins other than Funk's antiberiberi substance existed was reported by McCollum and Davis (1913) who showed that a young rat requires for normal growth something found in fats and also a water-soluble factor which they spoke of as "water-soluble B." The latter was shown in various laboratories to have a distribution in foods and a physiological effect similar to the antiberiberi substance. McCollum's designation and that of Funk came to be united in the name "vitamin B." There was much evidence, however, that it was not the only water-soluble vitamin. The incidence

of beriberi uncomplicated by pellagra, in China, India, and other parts of the Far East suggested that if pellagra were a dietary-deficiency disease it must be prevented and cured by something other than the so-called "vitamin B." Likewise, cases of pellagra without typical beriberi symptoms furnished additional evidence that the two diseases were of different origin. During 10 years or more, pellagra studies were based upon theories other than the vitamin hypothesis; but by 1926, Goldberger, of the U.S. Public Health Service, was convinced that pellagra was an avitaminosis. While the required vitamin appeared to have essentially the same distribution in foods as the beriberi-preventing substance, its separate identity could not be established until it was shown that yeast, one of the most abundant and commonly used sources of vitamin B, lost its curative power for beriberi after it had been autoclaved at high temperature but still contained a heat-stable substance which could prevent pellagra. For a time the antiberiberi vitamin was designated as B₁ and the pellagra preventative as B₂. The latter was also called vitamin G by American writers.

It soon became clear, however, that more than one heat-resistant factor was present in yeast. Indeed, water-soluble vitamins tending to have a distribution in natural foodstuffs similar to that of vitamin B₁ were found to be more numerous than had been at first suspected. The following scheme will serve to summarize certain phases of the development of knowledge regarding the so-called "B group."

Vitamin B, first regarded as the antiberiberi factor, later shown to comprise other factors, especially a more heat-stable one of pellagra-preventive value.

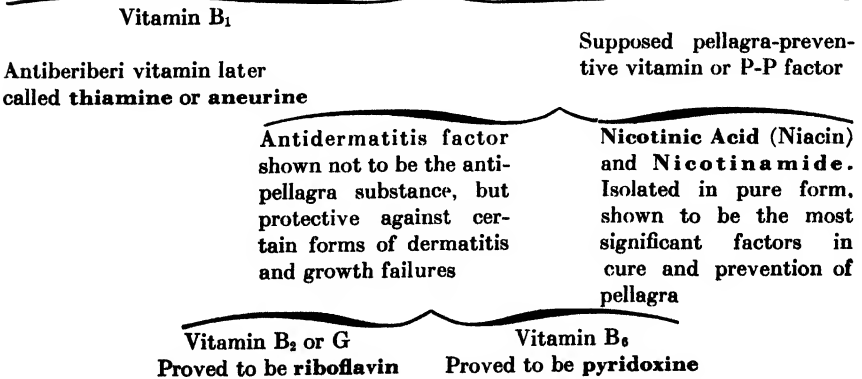

Thiamine. Chinese records indicate that beriberi occurred as far back as 2600 B.C., but the first description of the disease in medical literature was given by Dutch physicians in the East Indies in the

TABLE 24.—A SUMMARY OF OUTSTANDING DATA REGARDING THE VITAMINS

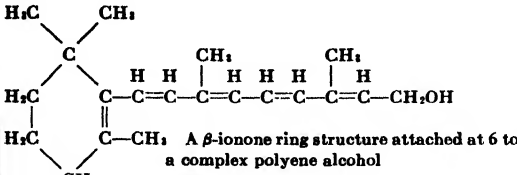
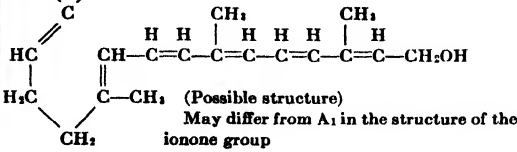
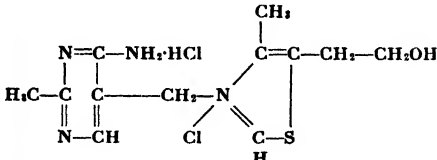
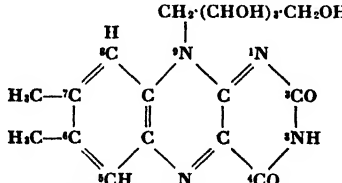
Vitamin	Chemical constitution	Chief associated avitaminoses
<p data-bbox="157 359 178 375">A₁</p> <p data-bbox="157 550 178 566">A₂</p>	<div style="text-align: center;">  <p data-bbox="383 391 739 438">A β-ionone ring structure attached at 6 to a complex polyene alcohol</p> </div> <div style="text-align: center;">  <p data-bbox="383 590 739 646">(Possible structure) May differ from A₁ in the structure of the ionone group</p> </div>	<p data-bbox="760 271 952 391">Dry eye condition (xerophthalmia), due to failure of certain secretions, leading to eye infections and sometimes to blindness</p> <p data-bbox="760 391 952 454">Night blindness (nyctalopia, incorrectly called "hemeralopia")</p> <p data-bbox="760 454 952 718">Failure to maintain various special forms of epithelium (epithelial metaplasia), leading to keratinization and serious failures of glandular structures, including genital and urinary organs. These failures are often associated with increased susceptibility to infections</p>
<p data-bbox="125 821 207 837">Thiamine</p>	<div style="text-align: center;">  <p data-bbox="218 925 739 989">2,5-dimethyl-6-aminopyrimidine ("pyrimin" group) combined with 4-methyl-5-hydroxyethyl thiazole, shown here as the chloride-hydrochloride</p> </div>	<p data-bbox="755 758 952 885">Beriberi with associated symptoms, but this disease is apt to be complicated by partial deficiencies of others of the B vitamins</p> <p data-bbox="755 885 952 965">Polyneuritis, involving paralysis, corresponding in animals to human beriberi</p> <p data-bbox="755 965 952 1029">Slow heart rate (bradycardia) and other heart symptoms</p>
<p data-bbox="136 1093 193 1133">Ribo- flavin</p>	<div style="text-align: center;">  <p data-bbox="313 1244 654 1268">6,7-Dimethyl-9-(p-ribityl)-isoalloxazine</p> </div>	<p data-bbox="755 1053 952 1181">No distinct avitaminosis but various forms of dermatitis are due to its lack, in man sore lips (cheilosis) and other facial sores</p> <p data-bbox="755 1181 952 1284">Vascularization of the cornea is an important symptom and may be followed by cataract and blindness</p> <p data-bbox="755 1284 952 1348">In chicks, "curled toe" paralysis may involve the sciatic nerve</p> <p data-bbox="755 1348 952 1476">A sudden collapse, after prolonged deprivation, leads quickly to death from what may be termed "ariboflavino-sis"</p>

WHICH HAVE BEEN PREPARED IN PURE CRYSTALLINE FORM

Animals sensitive to lack	Chemical and physical properties	Theory of the nature of physiological action
Man and all laboratory and domestic animals tested	<p>Related to carotenoid pigments in that β-carotene contains two atomic groups similar to vitamin A, while other carotenes and carotenoids contain one such group; vitamins A are colorless. With antimony trichloride, give a blue color measured colorimetrically or determined by the characteristic absorption spectra, A₁ maximum at 620 mμ, A₂ maximum at 693 mμ.</p> <p>Soluble in fats and fat solvents and occur in the fats and oils of plants and animals</p> <p>Esterify with various acids, including bile acids, which may thus aid in absorption of the vitamin from the intestine</p> <p>Crystallizes from methanol in pale yellow plates, m.p., 8°C.</p> <p>Easily oxidized (autoxidizable) but are stable in the absence of O₂. Destroyed by ultraviolet light</p>	<p>There is no accepted theory of its action in most tissues; but in the retina of land vertebrates, most marine teleosts, and some invertebrates, A₁ is involved in a chemical cycle so as to be required for the restoration of rhodopsin after bleaching by light. A₂ functions similarly with the photosensitive porphyropsin of fresh-water and anadromous teleosts. While A₁ and A₂ occur together in both retina and other tissues, one or the other predominates as indicated above</p> <p>Can be stored in the liver mostly as esters and appear to favor the storage of fat in the body</p> <p>Degenerative changes, especially in epithelium, during their lack suggest that they are required for normal protoplasmic synthesis</p>
Birds are especially sensitive, but apparently all animals require thiamine	<p>Soluble in water and alcohol, insoluble in ether and similar solvents</p> <p>Relatively heat-stable but subject to both hydrolytic and oxidative destruction in alkaline solution</p> <p>Crystallizes in colorless needles, m.p., 229-231°C.</p> <p>Gives a number of color reactions, several of which have been used for its quantitative determination</p>	<p>Is required as a part of the prosthetic group of the coenzyme of carboxylase so that its lack blocks the activity of this enzyme and results in failure of carbohydrate metabolism and in the accumulation of pyruvic acid in blood and tissues</p>
Rats, dogs, and chickens have been observed extensively, but probably all animals require it	<p>Slightly soluble in water and ethanol, very soluble in alkaline solution, insoluble in ether, etc.</p> <p>Yellow color and shows greenish fluorescence</p> <p>Crystallizes in fine needlelike clusters which melt at 282°C. with decomposition</p> <p>Adsorbed on fuller's earth, eluted by pyridine and dilute ammonia</p> <p>Relatively heat-stable but easily destroyed by light</p> <p>Characteristic absorption spectrum with maxima at 220-225, 267-269, 366-372, and 445-446 mμ</p> <p>Fluorescence in suitably filtered light from mercury-vapor lamp of fluorophotometer may be used for quantitative measurement</p>	<p>Is required as one component for the synthesis of the "yellow enzyme," a flavoprotein complex, indispensable in normal biological oxidation in animals and many plants</p>

TABLE 24.—A SUMMARY OF OUTSTANDING DATA REGARDING THE VITAMINS

Vitamin	Chemical constitution	Chief associated avitaminoses
<p>Niacin (nicotinic acid) and niacinamide (nicotinic acid amide)</p>	<div style="display: flex; justify-content: space-around; align-items: center;"> <div style="text-align: center;"> $\begin{array}{c} \text{CH} \\ // \quad \backslash \\ \text{HC} \quad \text{C}-\text{COOH} \\ \quad // \\ \text{HC} \quad \text{CH} \\ \\ \text{N} \end{array}$ <p>Pyridine-β-carboxylic acid</p> </div> <div style="text-align: center;"> $\begin{array}{c} \text{CH} \\ // \quad \backslash \\ \text{HC} \quad \text{C}-\text{CONH}_2 \\ \quad // \\ \text{HC} \quad \text{CH} \\ \\ \text{N} \end{array}$ <p>Nicotinamide</p> </div> </div>	<p>Pellagra, with its attendant symptoms, some of which are probably due to deficiency of other vitamins, especially thiamine and riboflavin</p> <p>"Black tongue" disease of dogs. Pellagra-like condition in pigs</p>
<p>Pyridoxine</p>	<div style="text-align: center;"> $\begin{array}{c} \text{CH}_2\text{OH} \\ \\ \text{C} \\ // \quad \backslash \\ \text{HO}-\text{C} \quad \text{C}-\text{CH}_2\text{OH} \\ \quad // \\ \text{H}_3\text{C}-\text{C} \quad \text{CH} \\ \\ \text{N} \end{array}$ <p>2-Methyl-3-hydroxy-4,5-dihydroxymethyl-pyridine also occurs as the aldehyde, pyridoxal, and the amide, pyridoxamine</p> </div>	<p>No distinct avitaminosis, but a form of rat dermatitis (acrodynia) appears to be a characteristic symptom</p> <p>A form of anemia occurs in dogs</p> <p>Fits resembling epilepsy have been observed in dogs, rats, and pigs</p>
<p>Pantothenic acid</p>	<div style="text-align: center;"> $\begin{array}{c} \text{CH}_2\text{OH} \\ \\ \text{HO}-\text{CH}_2-\text{C}-\text{CH} \quad \text{CO}-\text{NH} \\ \quad \\ \text{CH}_3 \quad \text{CH}_2\text{CH}_2\text{COOH} \end{array}$ <p>α-Hydroxy-β,β-dimethyl-γ-hydroxybutyric acid united by peptide linkage with β-aminopropionic acid. Only the dextrorotatory form is biologically active</p> </div>	<p>No distinct avitaminosis, but special forms of dermatitis in rats, chicks, and man have been cured by this vitamin</p> <p>Hemorrhagic lesions of the adrenal cortex have been attributed to its lack.</p> <p>Premature graying of hair (achromotrichia) in rats and other animals have been corrected by it. Reproductive failure of rats, due to resorption of embryos</p>
<p>Choline</p>	<div style="text-align: center;"> $\begin{array}{c} \text{C}_2\text{H}_5\text{OH} \\ \diagup \quad \diagdown \\ \text{N} \equiv (\text{CH}_3)_3 \\ \diagdown \quad \diagup \\ \text{OH} \end{array}$ <p>Trimethyl-hydroxyethyl-ammonium hydroxide</p> </div>	<p>Marked abnormalities of fat metabolism, involving excessive fat deposits in the liver</p> <p>Hemorrhagic kidney degeneration</p> <p>Slipped tendon or hock disease (perosis) in chicks, also caused by other deficiencies</p>

WHICH HAVE BEEN PREPARED IN PURE CRYSTALLINE FORM (Continued)

Animals sensitive to lack	Chemical and physical properties	Theory of the nature of physiological action
Man, dog and pig are known to require it; rats, sheep, and chicks do not seem to need it	<p>Nicotinic acid is soluble in water and ethanol; crystallizes in needles; m.p. 235.5–236.5°C.; is heat-stable even at autoclave temperature; gives with 2,4-dinitrochlorobenzene a compound which has a red color when dissolved in alcoholic KOH; also gives a yellow color with CNBr in the presence of any one of several amines</p> <p>Nicotinamide is more soluble in ether and benzene than is nicotinic acid; crystallizes in needles; m.p., 129°C.; gives both of the above color tests</p>	Are required to furnish one component of pyridine nucleotides, which are utilized in the tissues in the synthesis of "coenzymes I and II." The latter function with specific dehydrogenases in biological oxidations
Rats have been chiefly observed but birds, dogs, and pigs are known to require it. Man probably requires it	<p>Water-soluble, colorless compound</p> <p>Crystallizes in white platelets; m.p. 160°C.</p> <p>Relatively heat-stable in both acidic and alkaline solutions and can be sublimed</p> <p>Probably occurs in nature as a part of a protein complex</p> <p>Forms salts; the HCl salt is generally used</p>	Claimed (Birch) to be concerned with the metabolism of fatty acids; there is some evidence that it might aid in the synthesis of fat from protein, also some evidence that it might be important in the production of hemoglobin; serves as part of enzymes important in glutamic acid metabolism
Rats, chicks, pigs, and man are known to require it. Dogs and foxes also appear to need it	<p>A pale-yellow viscous oil; very soluble in water and hygroscopic; slightly soluble in ether and amyl alcohol; almost insoluble in benzene and chloroform; sensitive to destructive action of heat, acids, and alkalies; dextro-rotatory; $(\alpha)_D = 37.5^\circ$</p> <p>Generally used as its Ca salt, which is water-soluble, has a slightly bitter taste, and forms microcrystals; m.p. 198–200°C.; $(\alpha)_D = +24.3^\circ$</p>	The lack of it leads to such morphological abnormalities of all tissues that the functioning of pantothenic acid in the general anabolism of protoplasm is clearly indicated. It is known to serve as part of an enzyme system that functions in acetylation reactions, such as the formation of acetylcholine
Rats and birds are known to require it; man probably does	<p>A colorless, viscid liquid; alkaline; water-soluble and strongly hygroscopic; insoluble in ether, etc.</p> <p>Adsorbed on charcoal (norit)</p> <p>Forms salts with acids and absorbs CO₂</p> <p>Forms a characteristic platinum chloride which crystallizes in plates (C₂H₁₄NO)₂PtCl₆</p>	<p>Promotes the production of phospholipids and prevents accumulation of neutral fat in the liver</p> <p>Functions in the conversion of homocystine to methionine</p> <p>Probably aids in the synthesis of creatine in the tissues</p>

TABLE 24.—A SUMMARY OF OUTSTANDING DATA REGARDING THE VITAMINS

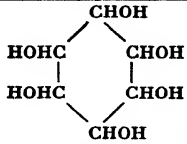
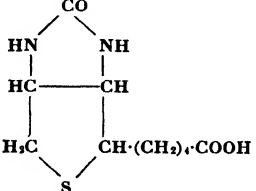
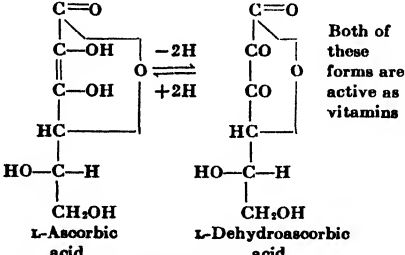
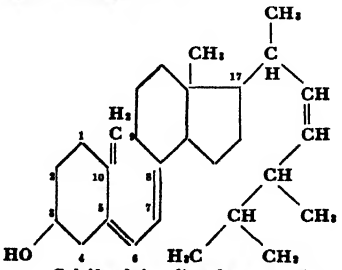
Vitamin	Chemical constitution	Chief associated avitaminoses
Inositol (Inosite)	 <p style="text-align: center;">Hexahydrocyclohexane</p> <p>Of the several isomeric forms, the so-called "mesoinositol" (optically inactive) has especially effective physiological properties</p>	<p>A special type of fatty liver, with much cholesterol, in rats</p> <p>Loss of hair, forming bald spots (alopecia) and dermatitis in mice</p> <p>"Spectacled eye" in rats but this may also be due to other deficiencies</p> <p>Hemorrhagic degeneration of the adrenal gland</p>
Biotin	 <p>A cyclic urea derivative containing S in thio-ether linkage and having the <i>n</i>-valeric acid group attached to the C atom α to the S atom</p>	<p>A characteristic form of dermatitis, often with "spectacled eye" and accompanied by marked growth failure, in rats. The deficiency is fatal</p> <p>Chicks also show a specific dermatitis with inflammation of eyelids</p> <p>Dogs show paralysis</p> <p>For symptoms in man see p. 182</p>
Ascorbic acid	 <p style="text-align: center;">Both of these forms are active as vitamins</p>	Scurvy with its associated symptoms
Vitamins D	<p>One of the active forms of vitamin D</p>  <p style="text-align: center;">Calciferol, irradiated ergosterol (Vitamin D₂)</p>	Rickets with its associated symptoms

WHICH HAVE BEEN PREPARED IN PURE CRYSTALLINE FORM (Continued)

Animals sensitive to lack	Chemical and physical properties	Theory of the nature of physiological action
Rats and mice are known to require it; man probably does	Soluble in water, insoluble in alcohol and ether Tastes sweet but is nonreducing Forms octahedral crystals; m.p. 225–226°C. Occurs in plants generally as a phosphate, the calcium-magnesium salt of which is phytin; occurs as part of a larger complex in animal tissues	The nature of its physiological action is not yet determined. But, like the longer studied members of the B group, it seems to be necessary for optimum growth (rat and chick). It is curative for certain kinds of fatty livers
Rats and chicks have been chiefly observed, but probably all animals require it	Soluble in water and ethanol; nearly insoluble in chloroform, ether, and petroleum ether Relatively heat-stable and resistant to both acids and alkalis Amphoteric; isoelectric zone at pH 3-3.5 Optically active, $(\alpha)_D = +92^\circ$, as prepared from liver Adsorbed on charcoal (norit) Forms crystals, m.p. 230–232°C.; forms crystalline methyl ester, m.p. 166–167°C. Is inactivated, physiologically, by "avidin," one of uncooked egg-white proteins	Functions as a coenzyme (coenzyme R) in the respiration of certain bacteria in the root nodules of leguminous plants. Any similar functioning in animals can only be conjectural and has not been proved but is probable Different forms of biotin have been prepared from natural sources, and by in vitro treatment, e.g., desthiobiotin, but do not have the full vitamin potency of biotin. Aids in fixation of CO ₂ (see p. 183)
Guinea pigs are especially sensitive, man almost equally so; rats, cattle, chickens, and some other species can synthesize it	Soluble in water and alcohols; insoluble in ether, chloroform, and similar fat solvents Tastes slightly sour and shows acidic properties; pK ₁ , 4.17; pK ₂ , 11.57 Optically active, $(\alpha)_D = +24^\circ$. D-Ascorbic acid is not antiscorbutic Shows an absorption spectrum in the ultraviolet with a maximum at 265 m μ Crystallizes in white plates, m.p. 190–192°C. Readily oxidizes and can be titrated by means of its reducing power	Although able to function as a redox system in H ₂ transport and although depleted animal tissues show lowered O ₂ uptake, no specific role of ascorbic acid in cellular oxidation has been established. It does have specific effects on some enzymes in vitro
Probably required by all animals, but requirement is lowered when Ca and P of the diet are supplied in optimum amount	Soluble in fats and fat solvents, insoluble in water, and so occur only in fatty tissues; liver oils are the only rich sources Produced by action of ultraviolet light on certain natural sterols, the provitamins D, and thus may be formed in the skin under bright sunshine or other source of ultraviolet light Show an absorption spectrum in the ultraviolet with a maximum at 265 m μ Form crystals, m.p. 115°C. (D ₂); m.p. 82–83°C. (D ₃) Optically active, $(\alpha)_D = +82.6^\circ$ (D ₂ in acetone); $(\alpha)_D = +83.3^\circ$ (D ₃ in acetone) Readily form esters and also addition compounds, especially with other sterols Vitamin D ₂ is thermolabile	The manner in which they function to facilitate bone calcification is not determined Are said to improve intestinal absorption of Ca and P, but they may function in a phosphorylating enzyme system

TABLE 24.—A SUMMARY OF OUTSTANDING DATA REGARDING THE VITAMINS

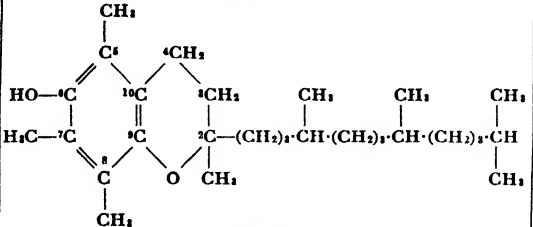
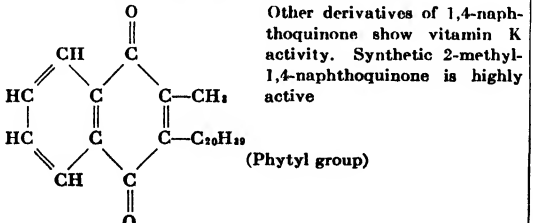
Vitamin	Chemical constitution	Chief associated avitaminoses
Vitamin E	<p>One of the four known forms of vitamin E</p>  <p style="text-align: center;">α-Tocopherol (5,7,8-Trimethyl-tocol, a chroman derivative)</p>	<p>Reproductive failure, marked in the female by stillbirths or resorption of the fetus <i>in utero</i> and in the male by irreversible degeneration of the spermatogenic tissue</p> <p>Extreme muscular dystrophy may result from its lack</p>
Vitamins K	<p>One of the active forms of vitamin K</p>  <p style="text-align: center;">Vitamin K₁, a natural form (2-methyl-3-phytyl-1,4-naphthoquinone)</p> <p>Other derivatives of 1,4-naphthoquinone show vitamin K activity. Synthetic 2-methyl-1,4-naphthoquinone is highly active</p> <p style="text-align: right;">(Phytyl group)</p>	<p>Prolonged coagulation time of the blood, sometimes causing severe or even fatal hemorrhage, is the result of lowered prothrombin (a protein required for blood clotting) content of the blood. Vitamin K is useful in newborn infants, in cases of hemorrhagic jaundice, and in some surgical cases</p>

seventeenth century. A turning point in thought regarding this disease followed its eradication in the Japanese navy in 1882 as a result of a mere change in diet. Eijkman (1890) described the production in birds of experimental polyneuritis resembling the chief symptom of beriberi, and in 1901 Grijns definitely stated the deficiency theory of the origin of the disease. It was not, however, until 1911, when Funk stated his vitamin hypothesis, that beriberi was widely recognized as an avitaminosis. In 1926, Jansen and Donath obtained what was then called vitamin B₁ in pure crystalline condition. This work was accomplished in the same laboratory in Java where Eijkman had done his significant experiments. The artificial synthesis, accomplished by Williams and his coworkers in 1936, led to the modern use of the name *thiamine*, which is suggestive of its chemical constitution (see Table 24).

Occurrence. Of known vitamins, thiamine is one of the most widely distributed in nature. Nearly all structures of plants and animals seem to contain at least traces. Fats and fatty tissues are either entirely

WHICH HAVE BEEN PREPARED IN PURE CRYSTALLINE FORM. (Continued)

Animals sensitive to lack	Chemical and physical properties	Theory of the nature of physiological action
Probably needed by most animals; goats may be an exception Its significance in failures of human reproduction is not established	Soluble in fats and fat solvents, insoluble in water, and occur in the non-saponifiable fraction of fats The free vitamins are oils, but some of their esters have been crystallized Relatively heat resistant, not destroyed by steam at 180°C. or by dry heat 24 hr. at 97°C. Relatively resistant to both acids and alkalis Are slowly destroyed by ultraviolet light Although resistant to oxidation, may be oxidized in the presence of FeCl ₂	The nature of the profound effects of lack of vitamins E upon the morphology of certain tissues (muscle, testis, fetal tissue) is not clear. The suggestion that these vitamins may have a role in the regulation of oxidation has been offered
Chicks have been most widely used in its study and are highly sensitive to its lack, but it may be required by all animals	Vitamins K ₁ and K ₂ are fat soluble, but some of the compounds (both natural and artificial) having vitamin K activity, are water soluble, e.g., phthiocol prepared from tubercle bacilli Vitamin K ₁ as prepared from alfalfa is a yellow, viscid oil, m.p., -20°C., but K ₂ is a yellow crystalline solid, m.p., 54°C. A number of other active substances have been crystallized Absorption bands of the ultraviolet spectra have been useful in identifying different forms of vitamin K A number of color reactions have been described	Promote the production of prothrombin, which is necessary for blood clotting, and is formed in the liver. The chemical and physiological mechanism involved is not known

lacking or conspicuously low in this, a water-soluble vitamin. The content of foodstuffs has been reckoned in various units. One which attained considerable prominence was the *international unit*, based upon a certain standard concentrated preparation of the vitamin. The present and preferable usage is to express the content of the vitamin as the actual quantity of thiamine. According to what appear to be the best estimates available, one international unit is equivalent to $3\frac{1}{2}$ micrograms (1 microgram, usually written 1 γ , is 0.001 mg.) of pure thiamine (300 I.U. = 1 mg. thiamine). Table 25 shows the content of representative foods as measured by one of the bioassay methods.

The table indicates that relatively few foods are really rich sources of thiamine. Of these the cereals are prominent, but processes of refinement in milling of flour so nearly eliminate the vitamin that a significant problem in human nutrition arises. This has led to the proposal from government sources in various countries and from students of nutrition that flour should either be made from whole or nearly whole grains or

that it should be fortified by the addition of thiamine. It has also been proposed that dried yeast, an excellent source of the vitamin, should be mixed with flour or that extra quantities of yeast should be used in bread mixing. Vitamin enrichment of foods will be discussed more fully in connection with dietetics (Chap. XVIII).

Although meats have come to be regarded popularly as an important source of thiamine, only pork and internal organs (liver and kidney) contain amounts comparable to those found in the cereals. Most of the

TABLE 25.—THIAMINE CONTENT OF REPRESENTATIVE FOODS
Measured by the rat bradycardia method

Food	I. U. per gram	Micrograms per gram
Barley germ.....	14.0	47
Rye germ.....	7.5	23
Wheat germ, crude.....	5.9-18.8	19.5-62
Whole wheat.....	2.3-3.4	7.6-11
Wheat bran.....	1.3	4.3
Rice bran.....	5.6-7.6	18.5-25
Oatmeal.....	3.3	10.9
Pork muscle.....	3.2	10.6
Ham.....	2.2	7.3
Liver and kidney.....	1.5-1.9	5.0-6.3
Lean beef and mutton.....	0.5-0.6	1.7-2.0
Nuts.....	0.8-2.0	2.6-6.6
Fish.....	0.3-0.6	1.0-2.0
Fresh fruits and vegetables.....	0.3-0.6	1.0-2.0

meats, including beef muscle, are fair but not rich sources, and the same is true of fish.

Human Requirements. Although the requirements of laboratory animals for thiamine have been determined with considerable accuracy, the requirement for man is not easily determined. Conclusions are based mostly upon statistical evidence. A difficulty arises in deciding whether the minimum supply necessary to prevent obvious symptoms of deficiency is slightly less than the optimum supply or much less. From animal experimentation as well as from observations on human beings it is obvious that the requirement is varied by at least four kinds of factors: (1) Growth, pregnancy, and lactation, (2) body weight, (3) the total food intake measured in Calories and especially the carbohydrate intake, (4) the previous history of the individual with respect to partial depletion of thiamine. Other factors, such as efficiency of absorption from the intestines and the bacterial flora of the intestine, though less significant, may also be concerned.

Cowgill, after an extended study of the diets of experimental animals and of human beings, proposed the formula

$$\frac{\text{Thiamine daily requirement}}{\text{Calorie intake}} = K \times \text{body weight}$$

where K is constant for a given species. For man the formula may be written so as to show the daily requirement in milligrams.

$$\text{Thiamine} = 4.7 \times 10^{-6} \times \text{weight in kilos} \times \text{Calorie intake}$$

Thus a man of 70 kilos eating 3000 Cal. per day would require 0.99 mg. of thiamine daily. This represents only the minimum need and, as Cowgill and others have suggested, the optimum is probably larger.

Chemistry. The original paper by Williams and Cline (1936) should be consulted for the steps involved in the synthesis and the establishment of the thiamine formula. Synthetic production has made thiamine available in quantity for experimental use, for human nutrition, and for agricultural purposes. It is used as a growth stimulant for plants.

Thiamine is relatively heat-stable, but it suffers oxidative destruction at a rate dependent upon the pH of its solutions. At pH 1, it suffers very little, if any, destruction during boiling. At pH 7, it is more rapidly destroyed although 60 per cent of it may remain after 4 hr. of boiling. In distinctly alkaline solutions it is rapidly destroyed even at temperatures well below boiling. It dissociates electrolytically as a base. Its adsorption on fuller's earth, charcoal, and other adsorbents has been widely used in its separation and purification from natural sources. Its color reactions have been investigated. Some of them have been the bases of proposed methods for its quantitative colorimetric determination. One of them described by Prebluda and McCollum (1939) uses alkaline diazotised *p*-aminoacetanilide and *p*-aminoacetophenone to obtain a red color. Color reactions offer promise of development into suitable quantitative methods. Such a chemical determination would be useful as a substitute for the time-consuming biological methods. Kirch and Bergeim (1942) devised another promising colorimetric method.

Bioassays. Bioassay methods for the determination of thiamine are typical of those for measurement of other vitamins. Some of the biological methods employed are listed below.

1. The cure of avian neuritis is one of the oldest methods. The bird, usually a pigeon, is brought to an advanced stage of general paralysis (Fig. 26) on a thiamine-free diet. The amount of material of unknown thiamine content which must be fed to restore muscular control then becomes a measure of its thiamine content. The method has serious

limitations because the responses of individual birds show considerable variation.

2. The rat-growth method uses the amount necessary to maintain a certain average growth rate in young rats of standard age and previous history. This method is unsatisfactory chiefly because it is not specific. Any of a large number of dietary deficiencies is apt to cause growth failure so that the planning of the basal diet to which the thiamine-containing material is to be added presents some difficulty.

3. The growth of microorganisms, including a number of species of bacteria and yeasts, has been the basis of numerous methods. All of

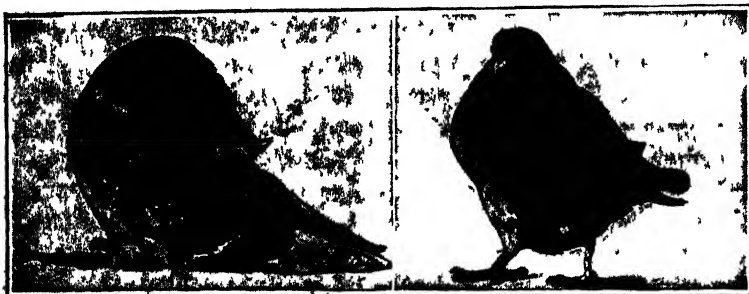

FIG. 26. Polyneuritis cured by thiamine. The picture on the left shows a pigeon in an advanced stage of paralysis due to a diet deficient in thiamine. The other picture shows the same bird 3 hr after the administration of 4 mg of Funk's yeast vitamin preparation (C. Funk, "The Vitamins," Williams & Wilkins Company)

them suffer from the defect of not being specific tests for thiamine (see p. 113).

4. The rat bradycardia method has proved to be most satisfactory. On a diet lacking thiamine, the normal heart rate (500 to 550 per minute) is slowed (bradycardia) to about 350 per minute in the rat. The amount of thiamine which must be administered to restore the normal rate, accurately observed by the electrocardiograph, shows so small a variation among individual rats that a satisfactory assay method becomes possible. When average results with a sufficiently large number of animals (40 to 50) are taken, the method appears to be accurate within 5 per cent.

5. The rate of the uptake of O_2 by slices of the brain tissue from animals in advanced stages of thiamine deficiency is increased in proportion to thiamine added to the tissue. An assay method based upon this principle is called the *calatorulin test* by Peters.

Physiological Action. The symptoms of thiamine avitaminosis afford some clues to its physiological action. The most noticeable symptom is paralysis, beginning usually with leg muscles. In birds, failure of muscles which control the position of the head is noticeable. In human beriberi,

two different types of syndromes are described: "wet" beriberi with extensive edema and the "dry" type marked by emaciation (Fig. 27). The differences, though not satisfactorily explained, are probably due to variations in the deficiency of nutritive factors other than thiamine. Digestive disturbances frequently accompany beriberi and are often marked by diminished muscular activity of the stomach and intestines. Loss of appetite, though not always occurring in beriberi, is quite general in laboratory animals deprived of thiamine. Heart abnormalities, especially bradycardia, are invariably present in late stages in both man and animals and are probably the immediate cause of death. Even in advanced stages of beriberi the heart symptoms are cured promptly by large intravenous doses of thiamine.

Nerve degeneration observed at autopsy after death from beriberi or in thiamine-deficient animals was once regarded as the direct effect of lack of thiamine. More recent work indicates that a diet adequate in all essentials except thiamine does not result in nerve degeneration. Another long-known fact indicated that the paralysis observed in thiamine

deficiency was not due primarily to an actual morphological degeneration of the nerves. Paralysis so severe that the experimental animal is almost totally helpless responds so quickly to a single injection of thiamine that the animal can hold up its head within 15 min. and appears nearly normal within 1 to 3 hr. Obviously, nerve regeneration could not account for so rapid a response. The cause of the paralysis is now sought in terms of altered metabolism in nervous tissue.

The fundamental action of thiamine is in furthering the synthesis of **co-carboxylase**. An apoenzyme, **carboxylase** catalyzes the oxidation of pyruvic acid but requires a coenzyme of which thiamine in the form of its phosphate is a constituent group. The inability of the animal organism to synthesize thiamine and the continuous loss of thiamine explains its indispensability. Pyruvic acid, normally present in blood



FIG. 27. Beriberi of the "dry" type. Shows atrophy of the legs and characteristic position of the foot. (After Bälz and Miura.)

in a concentration less than 3 mg. per cent, increases to about double the normal concentration during mild thiamine avitaminosis and shows a four- or fivefold increase in acute beriberi. Pyruvic acid shows similar increases in the cerebrospinal fluid and in the urine. Injection of thiamine rapidly restores pyruvic acid concentrations to normal. Pyruvic acid is an intermediate product of carbohydrate metabolism. Its oxidation is indispensable if carbohydrate is to be utilized in the normal manner. Correspondingly, animals on a high carbohydrate diet show especially severe symptoms in thiamine deficiency; most of them can be relieved to a considerable degree when the food carbohydrate is replaced by an isocaloric (equivalent in fuel value) intake of fat.

Thiamine and pyrimin (see formula, Table 24) are regularly excreted in urine. The urine content may be proportional to the intake, about 5 to 8 per cent of the latter. The excretion of less than 30 γ per day is indicative of a suboptimal supply of thiamine, especially so when the administration of a 1-mg. dose of thiamine is followed by the excretion in the urine of only about 60 γ because the tissues, presumably depleted, absorb most of the thiamine.

Riboflavin. A yellow pigment, prepared from milk whey and eventually named "lactoflavin," has long been known, but its relationship to the vitamins was only recently established. Another pigment, described by Warburg and his coworkers in 1932, was shown to be widely distributed and came to be known as "Warburg's yellow enzyme." In the meantime, yellow substances having the same greenish fluorescence as lactoflavin were prepared from a number of sources: liver (hepato-flavin), egg white (ovoflavin), etc. In 1933 several investigators showed independently that these widely distributed flavins were apparently identical in nutritive value with what had come to be called "vitamin B₂" or "vitamin G." The colored component of the yellow enzyme, set free from its natural complex, was shown in Warburg's laboratory to be a flavin. Subsequent investigations proved that it was of the same nature as the well-known flavins and like them could supply the missing factor in a diet deficient in vitamin B₂. Its reactions and its artificial synthesis (1935) led to the name *riboflavin*, which replaces the terms "vitamin B₂" and "vitamin G."

Occurrence. Riboflavin, like the yellow enzyme of which it is a constituent, is widely distributed in both plants and animals, but the amount present varies widely. It may be determined by a microbioassay method. Sherman and Bourquin suggested a unit based upon the requirement of young rats. Estimates as to the amount of pure riboflavin corresponding to a Sherman-Bourquin unit vary somewhat. Booher reports that 3 γ

of pure crystalline riboflavin are equivalent to 1 unit. The values in Table 26 show the results of bioassays in different laboratories.

Liver, the germ of grains, yeast, and the green leaf parts of plants are rich sources of riboflavin. It is apparently synthesized in green leaves. Eggs, lean meat, and milk and other dairy products are also important sources, while root vegetables and fruits are useful though less important sources.

Animal Requirements. For rats and some other laboratory animals the requirement of riboflavin is fairly well established. The Sherman-

TABLE 26.—RIBOFLAVIN CONTENT OF REPRESENTATIVE FOODS

Food	Sherman-Bourquin units per 100 g.	Approximate equivalent ¹ in mg. per 100 g.
Liver.....	800-1200	2.4 -3.60
Yeast, dry.....	750-2500	2.25-7.50
Wheat germ.....	150- 404	0.45-1.20
Kale.....	150- 300	0.45-0.90
Spinach.....	100- 175	0.3 -0.53
Eggs.....	99- 150	0.3 -0.45
Beef, lean.....	90- 150	0.27-0.45
White of egg.....	60- 120	0.18-0.36
Whole wheat.....	48- 124	0.14-0.37
Cheese.....	44- 288	0.13-0.86
Whole milk.....	34- 100	0.10-0.30
Carrots.....	30- 75	0.09-0.23
Bananas.....	26- 50	0.08-0.15
Turnips.....	17- 50	0.07-0.15
Potatoes.....	15- 31	0.05-0.09
Oranges.....	15- 65	0.05-0.19
Apples.....	10- 43	0.03-0.13

¹ Based on results of Booher indicating that 1 S-B unit is equivalent to 0.003 mg. of crystalline riboflavin.

Bourquin unit is defined as the amount required daily for sustaining a growth of 3 g. per day in "standard" young rats. In the case of man, however, the requirement is not well established. It has been estimated from the riboflavin content of the diets of healthy persons as about 600 S-B units (about 1.8 mg.) for an adult; but there is some evidence that the requirement varies (see Table 67) with growth, activity, and body weight. Clinicians suggest that patients with certain ocular lesions or cheilosis (Table 24) should be studied with respect to adequacy of riboflavin in the diet.

Chemistry. Riboflavin may be prepared as salts of certain metals, e.g., silver and thallium. It is heat-stable in acid, neutral, or slightly alkaline solutions but is rapidly destroyed by strong alkali. It is destroyed by exposure to light and especially to ultraviolet light. Losses of riboflavin during the processing and cooking of foods can be reduced to a minimum by protection from light. It is levorotatory, $(\alpha)_D = -114^\circ$, but is named "D-riboflavin" because of the configuration of the ribityl group.

Physiological Action. The so-called "rat pellagra" was at one time thought to be a syndrome caused by lack of vitamin B₂. But in the



FIG. 28. Riboflavin deficiency in the rat. (From Research Laboratories, S. M. A. Corporation, Chagrin Falls, Ohio.)

light of further research some, at least, of these symptoms were shown to be the result of lack of other members of the B group, especially B₆. The symptoms of ariboflavinosis (Fig. 28) and the nature of its physiological action are summarized in Table 24.

Nicotinic Acid and Nicotinamide. It is now an established fact that pellagra cannot be prevented or cured without the use of nicotinic acid or its amide. A diet deficient in these factors, however, is apt also to be deficient in others of the B group of vitamins. On this account, the relationship of pellagra to nicotinic acid could not be shown during some two decades of study of pellagra and, indeed, could be established only when the other B vitamins important in human nutrition were known. In 1937, a number of investigators showed independently that, while some of the symptoms of pellagra could be alleviated by a diet adequate in all known requirements save nicotinic acid, complete cures

were obtained when this vitamin was fed. The corresponding avitaminosis in dogs, known as the "black-tongue" disease, responds equally well to this treatment. The names **niacin** and **niacinamide** have come into use to designate the vitamin in its two forms.

The *symptoms of pellagra* are most noticeably those affecting the skin. Indeed, the name *pellagra* comes from the Italian, meaning "rough skin." Beginning with erythema, serious and characteristic lesions gradually develop. They are rough and hard, have sharply defined edges, and are almost always bilaterally symmetrical. Among the parts

TABLE 27.—NICOTINIC ACID CONTENT OF SOME FOODS OF ANIMAL ORIGIN

Food	Nicotinic acid, mg/100 g. fresh tissue (not dried or cooked)	
	Bioassay (dogs)	Chemical method
Liver (beef, veal, lamb, pork).....	22.5-46	13.2-29.8
Kidney (beef, pork).....	15.5-17.8	6.4-10.5
Heart (beef, veal, pork).....	4.9- 8.0	7.0-10.6
Ham.....	8.8-10.4	5.6- 8.4
Muscle (beef, veal, lamb, pork, chicken)	3.8-18.0	6.1- 9.1
Fish (cod, salmon).....	2.3- 7.4

of the body most frequently affected are the backs of the hands, the forearms, and the neck. There are also digestive symptoms, which include ulcers in the intestine, especially in the colon, gingivitis, diarrhea, and frequently nausea and vomiting. There are also nervous symptoms, including insomnia and severe headaches. Death claims a very high proportion of pellagra victims. Dietetic treatment is not always effective when the disease is in an advanced stage.

The occurrence of nicotinic acid is fairly widespread in common foods so that only a somewhat peculiar and monotonous diet can be pellagra-producing. Some of the mountaineers and other "poor whites" and both white and Negro share-croppers in our southern states are the groups which show the highest incidence of pellagra in this country. Their diet is characteristically composed of corn meal and some white flour, both cooked without yeast, salt pork (scraps), and very little fresh meats, fish, fruits, vegetables, eggs, or milk or other dairy products. The predominance of corn in such diets is significant. It is conspicuously low in niacin and tryptophan content as compared to other cereals.

The values in Table 27 are selected from extensive data reported by Waisman and Elvehjem and show that meats, especially liver and

kidney, are rich sources of nicotinic acid. Yeast seems to be the only other food comparatively rich. The relatively high values reported in bioassays, using dogs, may be due to physiological effects caused by substances other than nicotinic acid. While determinations on foods other than meats are less completely reported in the literature, evidence is clearly shown that wheat germ, green leafy foods, peanuts, and possibly other nuts are good preventatives of pellagra, while milk and skim-milk products, eggs, peas, and beans are also fairly useful but less effective as preventatives.

The minimal and the optimal requirements of man for nicotinic acid are not definitely known (see Chap. XVIII). In the treatment of pellagra, daily doses ranging from 50 to 500 mg. have been used. The requirement for monkeys is apparently about 5 mg. per day. In some animals, *e.g.*, sheep and cattle, the synthesis of nicotinic acid appears to be brought about by intestinal bacteria.

Though the modern use of nicotinic acid in the treatment of pellagra has cut the mortality from this disease almost to the disappearing point in treated cases, it affords no real solution of the pellagra problem. Only an improved diet made possible

by economic betterment and dietetic education can be really effective. The pellagra-producing diet is deficient in a number of dietary essentials besides nicotinic acid.

The physiological action of nicotinic acid is better understood than is the case with most of the vitamins. It functions as an indispensable component of substances generally known as **coenzymes**, which are required in all plant and animal cells carrying on carbohydrate oxidation. These coenzymes are necessary for the action of the large group of enzymes called **dehydrogenases**. They will be described in a later chapter dealing with biological oxidation.

Pyridoxine. Goldberger and Lillie (1926) described a characteristic rat dermatitis for which the name "acrodynia" (Fig. 29) came to be accepted. At one time the condition was known as "rat pellagra,"



FIG. 29. Pyridoxine-deficient rat. (Research Laboratories, S.M.A. Corporation, Chagrin Falls, Ohio.)

but this term has been abandoned. About 12 years later György showed that this disease was a specific avitaminosis and proposed that the curative substance should be termed vitamin B₆. Investigation of this substance made rapid advances during 1938 and 1939, when it was isolated from food sources in several laboratories, its chemical nature established, and its artificial synthesis accomplished. Its structure and properties are given in Table 24.

The symptoms of its lack have been observed chiefly in the rat. They include acrodynia, which affects chiefly the paws, mouth, tail, ears, and nose and has a characteristic accompaniment of edema. Another symptom is growth failure. Other mammals show, in addition to the rat symptoms, seizures similar to epilepsy accompanied by a type of degeneration in muscles and in the spinal cord. In birds the symptoms are less characteristic but include growth failures. So far as man is concerned no specific avitaminosis has been attributed to a lack of this vitamin, but beneficial effects of treatment with pyridoxine have been recorded for patients suffering from a number of diseases. These include pellagra, muscular degeneration (dystrophy), certain forms of epilepsy, and pernicious anemia.

The determination of pyridoxine may be made by chemical analyses and bioassays. Of the chemical methods the one that appears to be most useful is that depending upon the colorimetric measurement of the blue color developed when a pyridoxine-containing solution, buffered with veronal to pH 7.6, is treated with a butanol solution of 2,6-dichloroquinone chloroimide. Probably the best of the several bioassays is the rat acrodynia test. This can be made either by measuring the amount required to prevent the symptom or by finding the curative dose. György defines 1 rat unit as "the daily requirement for prevention or cure of the avitaminosis" and finds that it is equivalent to 10 γ of pure pyridoxine.

The distribution of this vitamin is very widespread in both animal and plant tissues. While quantitative determinations are not available for many foods, it is clear that yeast and seeds (e.g., wheat and corn) are excellent sources. Liver is a good source, and milk, eggs, and green leaf foods contain smaller but significant amounts.

This vitamin is found in a free state to only a limited extent. About three-fourths of it appears to be bound up in some complex in the tissues containing it. The combination is known in many cases to contain protein from which pyridoxine is liberated by heat or hydrolysis. Pyridoxal and pyridoxamine occur largely as phosphates, usually in proteins. The term vitamin B₆ is used to refer to the three forms collectively.

The requirement of this vitamin is not known for human beings. Save for the fact that it is found in the urine only after a large dose has been

given but is not detectable otherwise, we have, indeed, no good clue pointing to the retention and therefore presumably to the utilization of this vitamin in man. The requirement of the rat (10 γ per day) was indicated above. Chicks appear to need as much as 30 γ per day. Sheep and cattle do not appear to require this vitamin because, apparently, it is synthesized by the bacteria of their digestive systems.

Its physiological action has been widely investigated. In its absence metabolism becomes abnormal in several ways, but more particularly with respect to amino acids. Oser writes that knowledge of its functioning seems "to justify regarding this vitamin as occupying a position in protein metabolism comparable to that of thiamine in carbohydrate metabolism." Specifically, pyridoxal and pyridoxamine, as phosphates, serve as coenzymes in transamination which, as will be shown in Chap. XVI, is an important part of protein metabolism. In certain bacteria, pyridoxal phosphate acts as though it were the coenzyme of tyrosine decarboxylase (Chap. VIII). So far as mammals are concerned, experiments reported by Lepkovsky and coworkers indicate that pyridoxine deficiency causes abnormality in the metabolism of tryptophan (Chap. XVI) in rats and swine. Products of incomplete metabolism of tryptophan appear in the urine.

Pantothenic Acid. A specific type of skin disease, a dermatitis first described in chicks and shown to be curable by liver extract, was later compared to a specific form of dermatitis in rats. While the latter could also be cured by liver, it was found impossible to relieve it by the use of thiamine, riboflavin, pyridoxine, or nicotinic acid. At about this time (1938) R. J. Williams and his coworkers established the chemical nature of the substance which they named pantothenic acid because it occurs in all life. They were studying more particularly the requirements of yeast, the growth of which is stimulated by pantothenic acid. This substance being available in pure form, it was possible to demonstrate, as was done in several laboratories, that pantothenic acid was identical with the factor which could cure the specific dermatitis of chickens and of rats. The artificial synthesis of pantothenic acid, making it available for more extended and precise investigations, was accomplished independently in several laboratories in 1940.

It is striking, that while all the amino acids used as protein building stones are of the α -variety, the amino acid portion of pantothenic acid is β -alanine. Its origin in certain bacteria appears to be decarboxylation of aspartic acid.

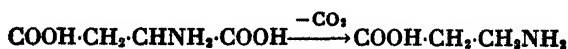

The symptoms of pantothenic acid deficiency in chicks include a characteristic dermatitis around the eyes, near the beaks, and between the toes. There is also retarded and rough feathering. In late stages degeneration occurs in the spinal cord, and certain forms of liver damage are found at autopsy. In hens a poor egg-laying performance is noted. In rats and mice there is retarded growth and a premature graying or whitening (Fig 30) of the hair (achromotrichia). This symptom has also been studied in foxes. There is considerable controversy as to the



FIG 30 Nutritional achromotrichia due to pantothenic acid deficiency. Of the two rats (litter mates shown at the age of 90 days) originally having dark fur, the one at the left was kept from weaning time on a diet that included 100 γ of pantothenic acid daily, meanwhile, the one at the right was kept on a diet differing only in that it lacked pantothenic acid. Practically complete achromotrichia resulted. (Research Laboratories, S M A Corporation, Chagrin Falls, Ohio)

nature of the deficiency causing achromotrichia, but most investigators agree that pantothenic acid is important in its prevention and cure. In rats certain forms of internal hemorrhage, notably in the adrenal glands, have been described. The rat dermatitis sometimes takes the form called the "spectacled-eye" condition. A ring of hairless, inflamed skin around the eyes suggests the appearance of spectacles. The same symptom appears in rats on diets deficient in either biotin or inositol.

In human beings the effects of lack of this vitamin have not been studied satisfactorily. It has been found, however, that an abnormally low content of pantothenic acid occurs in the blood of persons suffering from certain deficiency diseases, including beriberi, pellagra, and ariboflavinosis.

The quantitative determination of pantothenic acid depends chiefly upon its effects in furthering the growth of microorganisms. Several species of

bacteria have been used, but probably the most sensitive and widely used method is that which follows the increase in the growth rate of yeast as a result of adding pantothenic acid-containing material to the culture medium. It is claimed that as little as one part in two billion parts of culture medium can be measured. Other bioassay methods are based on the effect upon the growth curve of young rats or chicks and, in some methods, upon the prevention or cure of the specific chick dermatitis. It appears that chicks require 140 γ daily to provide for maximum growth.

The distribution of pantothenic acid is widespread. It is found, as its name implies, in every living thing so far observed. But from the standpoint of planning adequate rations, one has to take account of the fact that only a few foods, including yeast, liver, and egg yolk, are very rich sources.

The physiological action seems to be connected with vital processes that involve acetylation. Lipman and his associates have described a substance which they call **coenzyme A**. It is required for one type of pyruvic acid oxidation. This process is believed to begin by oxidative decarboxylation, setting free an acetyl group, thus:

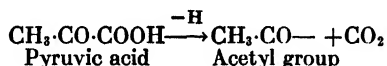

The acetyl group appears to be utilized in the tricarboxylic acid oxidation cycle (Chap. XII). It is also probable that the acetyl group is utilized in the physiologically significant production of acetylcholine (p. 81). Acetylation processes are, as indicated by these two examples, sufficiently prominent in vital phenomena to make the operation of coenzyme A highly significant. Lipman *et al.* have evidence to show that pantothenic acid is required for its construction.

Choline. There is some question as to whether choline ought to be called a vitamin. The case is somewhat analogous to that of arginine. It will be recalled that while the animal body can synthesize some of this amino acid it does not succeed in producing enough for all needs. Similarly, with choline a synthesis occurs, but, as will be shown in Chap. XV, additional choline must be furnished in the diet under some conditions. The main facts regarding the chemistry and physiological action of choline are summarized in Table 24. Details of its probable origin and its utilization and destruction will be considered (Chap. XV) in connection with fat metabolism. As a constituent group of some of the phospholipids, choline plays an indispensable role in their synthesis.

Inositol. Like nicotinic acid and choline, inositol has long been known as a constituent of plant and animal tissues. Recognition of its

indispensability is comparatively recent. The discovery (1939) that it could be prepared in quantity from the precipitate obtained by adding lime to "steep water," which is a by-product of the manufacture of corn-starch, has made inositol readily available for experimental study. Its chemical and physiological properties are summarized in Table 24. Its role in connection with phospholipids (lipositol, etc.) was suggested in Chap. III. One aspect of its behavior is shown in Table 59 in connection with fat metabolism.

Biotin. It has been known since the beginning of the present century that yeast requires for optimum growth something which is widely distributed in plant and animal tissues. Wildiers (1901) named this "bios." Fulmer and others showed (1923) that bios consists of more than one substance and soon after this Lucas succeeded in separating two fractions which he called "bios I" and "bios II." Bios I is now believed to be inositol, and bios II was shown by Kögl (1935) to contain as one of its components what is now called biotin. In the meantime a curious phenomenon had been observed in rats and other animals. When all or a considerable part of the protein of the diet is supplied by raw (uncooked) egg white, there arises a combination of symptoms which came to be known as the *egg-white injury*. It has been extensively studied in a number of laboratories. Boas (1927) showed for experimental animals and György (1931) showed for man the need of an anti-egg-white-injury factor which György named **vitamin H**. György and his coworkers furnished proof (1940) of the identity of vitamin H with biotin. Through the work of György, du Vigneaud, and their coworkers, the chemical nature of biotin was extensively explored, and du Vigneaud was successful in preparing it by artificial synthesis (see Table 24). There is evidence that biotin is identical with a substance known as "coenzyme R," which has long been studied as a growth and respiration factor for many strains of bacteria found in the root nodules of leguminous plants and enabling them to fix atmospheric nitrogen.

The symptoms of biotin deficiency can be observed in an animal on a biotin-free diet, but the deficiency is more frequently attained as a result of feeding a diet in which uncooked egg white is the chief or only protein. Rats show a specific form of dermatitis marked by scaliness and shedding of the scales (desquamation), but the spectacled-eye condition is also, as in some other deficiencies, apt to appear. There is a marked loss of weight, leading to extreme emaciation and death. In chicks the characteristic symptoms are also those of a specific dermatitis. In man, the deficiency has been demonstrated when 30 per cent of the calories of the diet were furnished in the form of raw egg white.

The symptoms include marked pallor, desquamation (scaling off of the skin), noticeable susceptibility to fatigue, muscle pains, heart distress, and loss of appetite (anorexia.) All the symptoms can be made to disappear by administration of biotin. In medical practice some successes have been reported in biotin treatment of common pimples (*acne vulgaris*) and of boils.

The egg-white injury is now known to be due to the inactivation of biotin by one of the egg albumins which, because of this effect, has been named **avidin**. It has been obtained in pure form and shown to combine with biotin in stoichiometric proportions. In this combined form the biotin is no longer diffusible and appears to be unavailable to the animal. Avidin or egg white which has been heated (2 min. at 100°C.) cannot inactivate biotin so that even a soft-boiled egg is not dangerous.

Although this is the best studied case of vitamin inactivation by another food substance, it is not the only known one. A form of deficiency disease, Chastek paralysis, has arisen on fox farms and appears to result from inactivation of thiamine when uncooked fish constitutes a considerable part of the foxes' food. An enzyme found in carp hydrolyzes thiamine. Other vitamin inactivations will be described in connection with vitamins A and E.

The quantitative determination of biotin has so far depended upon bioassays. The growth rate of a number of different species of bacteria or of specific strains of yeast can be used as the method of measurement. The prevention and cure of the egg-white injury in rats is the basis of another type of bioassay.

The distribution of biotin is very widespread in the tissues of both plants and animals. Among foods of animal origin, liver, kidney, and egg yolk are the richest sources. Milk is a somewhat poorer source. Vegetables, nuts, and cereals are important sources. While a part of the biotin in foods is in a free, soluble state, the major part of it is bound up in a complex from which it can be freed only by a drastic hydrolysis with mineral acid or by the prolonged action of proteolytic enzymes such as trypsin.

The requirement for biotin has to be met from dietary sources for all animals so far investigated. The human requirement is estimated as 50 rat units of biotin per day, when given subcutaneously, and some three to five times as much when eaten as food. This amounts to approximately 2 to 10 γ of the pure methyl ester of biotin.

The physiological action has been only partially investigated. It is known that biotin, like other vitamins of the B group, functions in the make-up of an enzyme system. It operates in reversible decarboxylation of oxaloacetic acid.

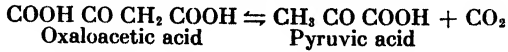

This reaction, moving from right to left, is one of the few ways in which living things can assimilate CO_2 (p. 59). Partly on this account and partly because the reaction is one of the cogs in the vital mechanism (tricarboxylic acid cycle) for oxidation of pyruvic acid and the closely related lactic acid, this reaction is of general interest. Biotin is also said to affect the synthesis of oleic acid.

para-Aminobenzoic Acid. Some recent investigators include *p*-aminobenzoic acid (PAB) in the list of B vitamins. Under some experimental conditions, the correction of premature graying of hair (achromotrichia) in rats has been strikingly demonstrated when this compound, widely distributed in plant and animal tissues, is added to synthetic diets. Evidence has been presented by Martin (1942) indicating that this is only an indirect effect and results from the action of PAB on the bacterial flora of the intestine so as to make pantothenic acid more readily available to the animal. It is reported to be of aid in the treatment of Rocky Mountain spotted fever and other rickettsial diseases.

Pteroylglutamic Acid (PGA) and Related Compounds: The Folic Acid Group: Vitamins B₉. Preparations were described (Mitchell, Snell, and Williams, 1941) as containing something required for the growth of certain bacteria, *e.g.*, *Streptococcus lactis R*, and differing from previously known food substances. As it was made from leaves and had acidic properties, it was called **folic acid**. A number of other preparations, described between 1938 and 1943, seemed to be related chemically and in certain of their physiological effects to folic acid. Among names applied to such preparations were vitamin M (p. 157), vitamin B₉, vitamin B₁₀, vitamin B₁₁, factor U, yeast norit eluate factor, and *Lactobacillus casei* factor. Confusion in naming and describing these factors began to clear away when (1946) a group of 16 cooperating chemists succeeded in the artificial synthesis of what has been called synthetic folic acid or synthetic *L. casei* factor but which they named **pteroylglutamic acid** (PGA). Its formula is

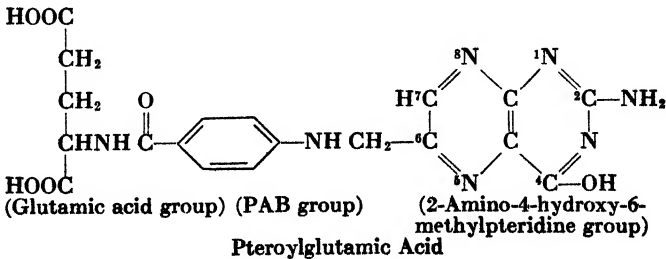

It contains a *p*-aminobenzoic acid group attached by a peptide link to glutamic acid and also attached to a pteridine derivative. The pteridines are widespread in nature, occurring mostly in animal pigments, *e.g.*, xanthopterin found in the integument of certain insects and in urine. One notes that the atomic grouping of the pteridines resembles that of purines but that one more C atom is present in the ring framework which is a condensation of a pyrimidine and a pyrazine ring.

The various incompletely characterized vitamins of what one might call the folic acid group or the vitamins B₉ all seem to be built on much the same plan in that they contain pterioic acid,

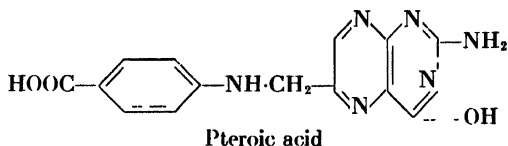

which lacks a glutamic acid group and is a pteridyl-*p*-aminobenzoic acid. It is itself a growth stimulant for some organisms, *e.g.*, *Streptococcus fecalis* R, which apparently can use it together with glutamic acid to synthesize PGA. Many organisms, including chicks and rats, cannot do this. Pterioic acid, however, is an artificial synthetic product. The naturally occurring variations of PGA do not generally lack the glutamic acid group. Some contain more than one. Two that have been prepared from natural sources, **pteroyltriglutamic acid** and **pteroylheptaglutamic acid**, contain three and seven glutamic acid groups, respectively. The former has been called the fermentation *L. casei* factor, the latter vitamin B₉ conjugate. It seems probable that a considerable number of these glutamic acid peptides, having a pterioic acid group attached, exist in nature. Collectively, they may be termed PGA conjugates. Not all the vitamins of this type, however, are such conjugates. One form, the "SLR factor," which can replace PGA in sustaining growth of *S. lactis* R and some other streptococcus strains, is a compound of pterioic and formic acids.

Neither folic acid nor the majority of preparations related to it have been sufficiently studied in pure form to be characterized chemically. Even the best folic acid preparations are probably mixtures although the most potent component is PGA. Of the conjugate forms an almost infinite variety would be theoretically possible. The following skeletal formulas represent isomeres of pteroyltriglutamic acid that could exist.

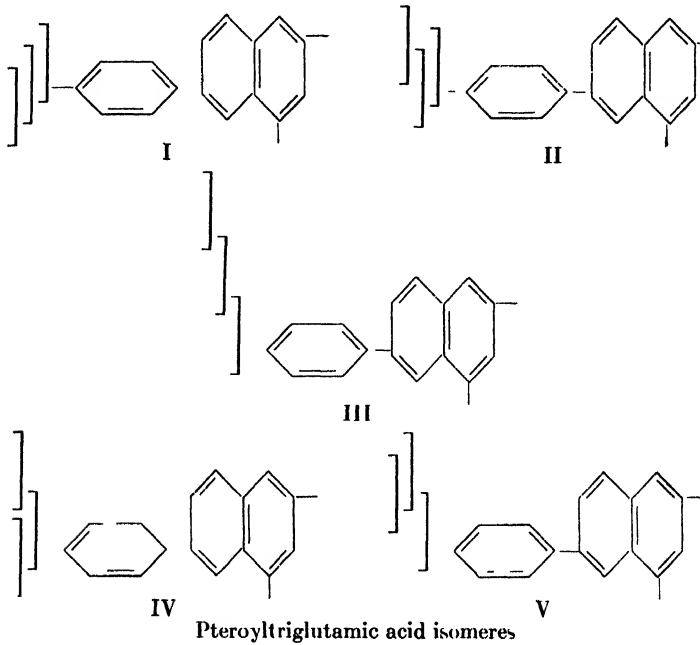

Formula III represents a synthetic product, "teropterin," which has vitamin properties. It was also obtained as a natural product of bacterial fermentation.

The conjugate forms of vitamin B₆ can be split so as to liberate PGA as tested by microbiological assay. The splitting is produced by an enzyme prepared from various animal organs and a few plant tissues. It is called **vitamin B₆ conjugase**.

Symptoms due to lack of vitamins B₆ are, in the main, failures in satisfactory hemopoiesis (production of blood and especially of blood cells) in short, an anemia. A form of anemia in monkeys characterized by a greatly reduced blood cell count, **cytopenia**, was perhaps the first noted deficiency indicating need for this vitamin. Yeast and liver extracts were found to be curative or preventive. The active substance was called **vitamin M**. Later it was found to be required by chicks for growth and prevention of anemia. Its curative action in certain kinds of human anemia was shown (1945) by success in treatment of **sprue** and now seems well established. While **sprue** has complex symptoms, including glossitis (inflammation of the tongue), diarrhea, and extreme prostration, its chief and perhaps primary disturbance is a form of severe anemia. The considerable number of cases of **sprue** which have been reported as

cured or at least much relieved by PGA seems to justify the belief that the disease is due primarily to lack of this vitamin although the sprue-producing diet probably has other deficiencies. Pteroyltriglutamic and pteroylheptaglutamic acid are also reported to relieve sprue and to cause the excretion in urine of small amounts of PGA. It thus seems probable that the human body has vitamin B₁₂ conjugase and can utilize various forms of the vitamin.

The distribution of vitamin B₁₂ can be reported only in an approximate way because the microorganisms, growth rates of which are observed in assays, vary as to their growth response to the conjugates. But it is reported (1947) that fresh, very green, leafy vegetables and liver are highest; other green vegetables, cauliflower, and kidney are high; beef, veal, and breakfast cereals made from wheat are medium; root vegetables, tomatoes, cucumbers, pale green vegetables, bananas, pork, ham, lamb, cheese, milk, breakfast cereals made from rice and corn, and many canned foods are low in content of the vitamin. Results of these assays were reported as "folic acid content." There seems to be a correspondence between folic acid content and chlorophyll content of plants. People of localities where sprue is prevalent make considerable use of foods, *e.g.*, rice, corn meal, and sweet potatoes, that are reported to be deficient in "folic acid content." Storage at room temperature diminishes the amount although at refrigerator temperatures and in frozen foods loss is much less.

The physiological action of PGA aids in an unexplored way in the processes of blood cell production. This complex function requires so many different things in the diet, in addition to factors of internal origin, that disturbances leading to anemia are of many and varied kinds (see p. 157 and Chap. X). One must keep in mind the fact that no vitamin or other food essential can entirely cure a type of anemia, *e.g.*, Addisonian pernicious anemia, that is a pathological failure and not due to a dietary deficiency. Nor is PGA very helpful in anemias due to deficiency in iron, copper, cobalt, indispensable amino acids, or any dietary essential other than PGA. One possible exception is the pyrimidine base, **thymine**. It is reported to lower the requirement for PGA in some organisms including the human. This suggests that thymine is not always synthesized in adequate amounts and takes some part in metabolic processes involving PGA.

The human requirement is unknown. In treatment of sprue and other forms of nutritional macrocytic anemias, patients have been given doses of PGA varying from 5 mg. to about 20 mg. per day over periods of one to several weeks. Probably such curative doses are greatly in excess of the normal requirement.

Ascorbic Acid. The long history of scurvy and its devastating effects upon the human race and the story of the early use of fresh fruits and vegetables in combating this scourge are too well known to need retelling. It was not until the beginning of the present century, however, that a number of investigators, and especially Holst and Frölich, showed that guinea pigs could suffer from a disease which seemed to be the equivalent of human scurvy. Its occurrence as a result of faulty diet marked it as an avitaminosis. By 1925 a number of investigators had obtained concentrated preparations of the nearly pure vitamin from lemon juice and from cabbage. Szent-Györgyi (1928) obtained a purified compound which, because of its properties, he named *hexuronic acid* (p. 17). It was obtained from adrenal glands and also from oranges and cabbage. In the same laboratory and in a number of others it was soon shown that hexuronic acid was identical with the active principle of the antiscorbutic preparations which had been previously studied, and in 1933 Reichstein and his coworkers in Switzerland and Haworth and his coworkers in England succeeded independently in the artificial synthesis of the vitamin to which the name "ascorbic acid" was given.

The symptoms of scurvy include extravasations of blood appearing as red spots under the skin and forming hidden bleeding places in any of the internal organs or the muscles and particularly in periosteum of the large bones. Bleeding and soreness of the gums, accompanied by marked decay of the teeth, with consequent prurient infections of the mouth, constitute one of the most prominent symptoms. The teeth are very apt to fall out. Another particularly noticeable feature is the extreme soreness of the joints so that movement or even touching of the joints is very painful. Accompanying this condition is a noticeable change in the ends of the bones, which become very fragile and easily broken. Swellings on the ribs, similar to those which are characteristic of rickets, also occur. X-ray pictures of the bones, especially of the joints, give one of the surest means of diagnosis of the disease since the changes that occur in them are distinguishable from those due to other diseases—even rickets. The digestion is markedly impaired. Constipation, followed by diarrhea, is usual. The heart is often badly affected, showing hypertrophy and, later, degenerative changes which often cause sudden death of the victim at a time when the disease does not appear to be progressing rapidly.

The determination of ascorbic acid has been done by a number of chemical methods. They depend in general upon the properties of this vitamin which enable it to be readily reduced or oxidized. One method which is widely used oxidizes ascorbic acid with 2,6-dichlorophenol-

indophenol. The end point of the titration is reached when a standard solution of the indophenol reagent has been reduced to a colorless condition and added in slight excess to give a pink color. Unfortunately, neither this nor the other reduction methods which have been described are entirely specific for ascorbic acid, so that other interfering substances must either be eliminated or taken into account in the calculation. These methods also fail to measure ascorbic acid when it is not free but in the combined form, **ascorbigen**. A number of colorimetric methods have been employed.

Bioassays, although much more time-consuming and less convenient than chemical determinations, are still the most reliable for measurement of ascorbic acid. Guinea pigs seem to be the susceptible laboratory animals. On a scurvy-producing diet they develop marked symptoms in 15 to 21 days. The amount of material required for a standard cure compared with a known amount of pure ascorbic acid can furnish the data for computing the result of the assay. The distribution of vitamin C in fruits and vegetables is well known even to the general public. Some quantitative results for representative foods are shown in Table 28.

While nearly all plant tissues contain at least some ascorbic acid, the high content of the citrus fruits has long attracted attention. In general, the decreasing order of abundance is lemons, limes, oranges, and grapefruit, but there is considerable variation in the same kind of fruit in accordance with the manner of its ripening and the time of storage. Less familiar to the general public is the fact that all green leaf salads are important sources of ascorbic acid. Watercress is reported to be especially rich in this vitamin. Paprika and rose hips are very high, but the West Indian cherry may contain as much as 3 per cent of the edible portion. Animal tissues are conspicuously deficient, although small amounts are derived from all fresh meats, and liver is a fairly good source. Curiously enough, the highest concentration of ascorbic acid that has been found in animals is in the adrenal gland. This fact, though without significance for dietetics, may prove to be of considerable interest when or if the physiological action of ascorbic acid can be explained.

The requirements for ascorbic acid are peculiar in that the majority of animals so far tested do not need it in the diet at all. First shown for the rat, it was later found that many other laboratory and domestic animals and a number of wild animals that have been tested can synthesize vitamin C. The precursor used for this synthesis is not yet determined although it has been shown that a number of sugars and especially mannose can increase the ascorbic acid content of surviving slices of certain tissues. Only man, the other primates, and the guinea pig have been shown to require ascorbic acid preformed in the diet.

Guinea pigs require about 2 mg. daily. The optimal supply for human adults has been variously estimated as 50 to 100 mg. per day. The low content of this vitamin in cow's milk and especially in pasteurized milk (ascorbic acid being highly susceptible to oxidative destruction) makes it important to include orange juice, tomato juice, or other good sources of ascorbic acid in the diet of infants and children.

TABLE 28.—ASCORBIC ACID CONTENT OF REPRESENTATIVE FOODS¹

Fruits	Mg. per 100 g.	Vegetables	Mg. per 100 g.	Dairy Products	Mg. per 100 g.
Apples.....	2-5	Asparagus.....	40	Milk, cow's, raw.	2
Apples, dried....	0	Beans, green.....	10	Milk, pasteurized	0-1
Apricots.....	1	Beets.....	5	Cheese.....	0
Apricots, dried...	8	Beet leaves.....	35	Butter.....	0
Bananas.....	8	Broccoli.....	50		
Blackberries....	3	Brussels sprouts...	50	Meats	
Blueberries.....	4-10	Cabbage, green....	40	Beef, lean, cooked	Trace
Cantaloup.....	40	Carrots.....	3	Chicken, cooked.	Trace
Cherries.....	8	Cauliflower.....	30	Liver, beef,	
Figs, dried.....	0	Celery.....	5	cooked.....	10
Grape juice.....	Trace	Corn, sweet.....	10	Fish, fresh,	
Grapefruit juice.	40	Endive.....	10	cooked.....	Trace
Lemon juice.....	60	Kale.....	50		
Lime juice.....	30	Lettuce, green....	10	Miscellaneous	
Orange juice.....	50	Lettuce, head.....	5	Beer.....	0
Peaches.....	7	Onion.....	10	Grain, dried	
Pears.....	3	Parsley.....	175	(flour).....	0
Pineapple.....	25	Peas, green.....	15	Seeds, dried....	0
Plums.....	2	Peppers, green....	180	Eggs.....	0
Prunes, dried....	0	Peppers, ripe red...	230	Jelly.....	0
Raisins.....	0	Potatoes, new....	15	Nuts.....	0
Strawberries....	50	Spinach.....	60	Wine.....	0
Tomatoes.....	25-30	Turnips.....	30	Yeast.....	0
Watermelon.....	15	Watercress.....	50		

¹ The values shown are approximate averages of results obtained by different methods and analysts. In many cases the ascorbic acid content may be less than here shown as a result of cooking or of storage without protection from oxygen of the air. The seven items in heavy type probably constitute the chief sources of ascorbic acid in American foods.

The physiological action of ascorbic acid still remains to be explained. Many types of investigation suggest theories. The ease with which this vitamin enters into reversible oxidation and reduction suggests that it should be a part of some enzyme system active in biological oxidation, but only in plants, *e.g.*, in barley, has the functioning of ascorbic acid as a definite part of a specific enzyme system been demonstrated. It seems, however, that the relative state of oxidation in which the reaction

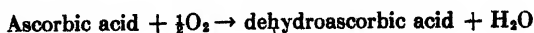

exists momentarily in a cell influences so many oxidations directly and other vital reactions indirectly that one may think of ascorbic acid as a general utility tool. Oxidation to dehydroascorbic acid occurs in many kinds of plant tissues under the influence of a specific enzyme, **ascorbic acid oxidase**. The reverse process requires a more complex system. Although corresponding oxidation-reduction processes apparently occur in animals, the reactions appear to involve complex conditions not fully explained (See Chap. XII).

Specific effects of ascorbic acid are (1) its *action in metabolism of tyrosine*, the side chain of which is not oxidized normally in ascorbic acid deficiency; (2) *antioxidant effects* exerted in several ways, e.g., checking of the rapidity of oxidative destruction of the powerful hormone, epinephrine, and checking the oxidative discoloration of fruits and vegetables when their cells are exposed to air by cutting; and (3) *effects resembling peroxidase action*. Peroxidases (Chap. XII) are enzymes that accelerate oxidation with the aid of peroxide formed in a concurrent oxidation. It is reported that ascorbic acid, in the presence of Cu and Fe salts and aided by peroxide, causes the oxidation of phenolic compounds.

A more general effect is its use in animals to aid in resisting stresses and strains. Thus during exposure to extreme cold or burning of the skin or severe wounding, the high concentration of ascorbic acid in the adrenal gland (p. 188) at first decreases markedly and then increases. Also a rich supply of ascorbic acid is reported to aid in good recovery from burns and wounds. The suggestion is that ascorbic acid aids processes that manufacture certain of the adrenal hormones known to be useful under emergency conditions.

Another general effect is the influence of ascorbic acid on the production and maintenance of normal connective tissue. It is found that the toughness, elasticity, and rate of restoration of the tissues in wounds show deficiencies in ascorbic acid deprivation but are improved by adequate supplies of the vitamin. Ascorbic acid is necessary for synthesis of collagen and formation of the reticulum. The normal concentration of ascorbic acid in human blood varies somewhat and can often be increased by liberal intake. Excretion in the urine is relatively small, but when the blood level reaches what is called the saturation point (1 mg. per 100 ml. of blood) excretion in the urine becomes proportional to any further intake of the vitamin. This indicates that storage of ascorbic acid is definitely limited. On the other hand, it has been shown that human adults on a strictly scorbutic diet may show no symptoms of scurvy for as much as 120 days, so that there must be some reserves to fall back upon. In rats on an ascorbic acid-free diet the livers are found to contain considerable

amounts of ascorbic acid. This does not necessarily prove that synthesis, in addition to mere storage, occurs in the liver.

Vitamin P. Szent-Györgyi and his coworkers (1936) found that something in addition to ascorbic acid was needed to control internal hemorrhage in man. Like ascorbic acid, it is abundant in citrus fruits, but it is of a different chemical nature and, unlike ascorbic acid, is less abundant in the juice than in the peel. They made a highly concentrated preparation and showed that it contained **flavonones**. Not all subsequent investigators have been able to confirm these Hungarian workers, so that some doubt has been cast upon the reality of this so-called "vitamin P." Scarborough (1939-1940) in England and Kugelmass (1940) and others in this country have reported on its effective action in the cure of subcutaneous bleeding in patients who were not benefited in this respect by ascorbic acid. The Hungarian investigators reported (1941) that even the rat, a completely scurvy-resistant animal, can be made to develop deficiency symptoms curable by vitamin P. It would seem, therefore, that the preponderance of evidence favors the existence of vitamin P as a separate entity, distinct from ascorbic acid. Some foods, *e.g.*, cauliflower, are rich in ascorbic acid and lack vitamin P, while others, *e.g.*, grapes, are very low in ascorbic acid and rich in vitamin P.

The concentrated flavonone-containing preparation made by the Hungarian investigators was named **citrin**, since it came from citrus fruits. Scarborough reported (1945), however, that "citrin" did not show physiological effects identical with those of cruder vitamin P preparations. He regarded "citrin" as a crystalline complex of flavonone derivatives which resembles a pure substance.

Another preparation, having vitamin P activity, is called **rutin** (p. 43). It is a flavonol glycoside reported to have the following structure:

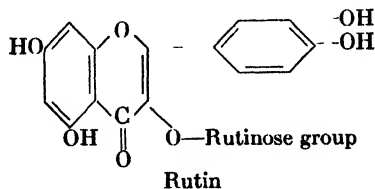

Rutinose, furnishing the sugar group, is a disaccharide of rhamnose and glucose. Rutin, sometimes prepared from cured tobacco leaves, has been found in much higher concentration in green buckwheat plants. Its clinical use is reported on but not yet established. **Hesperidin**, is

another flavonol glycoside made from vitamin P concentrates. It is a rhamnoside.

Symptoms of vitamin P deficiency are primarily an increased fragility of capillary walls. This leads to rupture and internal bleeding, especially beneath the skin. As an increased capillary permeability tends to accompany fragility, the name "permeability vitamin" or vitamin P came into use. The tendency to capillary rupture has long been regarded as a symptom of ascorbic acid deficiency, but it now appears doubtful that ascorbic acid without vitamin P can prevent or cure this trouble.

The bioassay of vitamin P may be carried out on guinea pigs. One of the well-known scorbutic diets (*e.g.*, oats and hay) together with pure ascorbic acid is fed and capillary fragility is quantitatively measured by pressure or suction. After this symptom has developed, the relative concentration of vitamin P in a food can be estimated from the amount of it required to restore normal capillary resistance.

The distribution of vitamin P in natural foodstuffs resembles that of ascorbic acid to a degree sufficient to ensure, in all probability, that any diet adequate for prevention of scurvy would not lack vitamin P. High concentration in grapes, grape juice, and wine has been recorded. Leaves of many plants are known to be good sources.

Isotelic Substances. Some of the water-soluble vitamins (niacin and ascorbic acid) and all of the fat-soluble ones owe their physiological action to the occurrence in the molecule of a certain strategic grouping of atoms. Other atomic groupings in the molecule may vary more or less without destroying the peculiar vitamin properties of the compound. R. J. Williams has suggested the use of the convenient term "isotels" or "isotelic vitamins" (Greek, *iso*-, "same" and *telos*, "purpose") to designate such a similar group. It will be found (Chap. XX) that certain hormones also exist in modified forms which have the same or nearly the same function. For example, the androgenic (causing maleness) and the estrogenic (arousing sexual receptivity in the female) hormones include a number of substances in each group, so that there are isotelic hormones.

Study of the differences and similarities in molecular structure of isotelic substances is of interest because it may afford clues as to the nature of their physiological functioning. In some cases isotels are isomers, but in a considerable number of cases, it is demonstrable that of two isomers which are enantiomorphs (one dextro- and the other levorotatory) one shows full physiological activity and the other none or nearly none. This is true, for example, of the two optical forms of ascorbic acid and of the hormone epinephrine. This means that the steric shape of a molecule may determine specific physiological action

as well as general (p. 89) nutritive value. It seems to be established that, when a specific function is attributable to an atomic grouping which contains centers of asymmetry, their steric configuration cannot be altered without profound change or even complete loss of physiological potency.

The fat-soluble vitamins in any isotelic group differ, as will appear in the following paragraphs, in respect to the structure of side chains and have in common a ring structure or "nucleus" of the molecule. For the A vitamins it is the β -ionone ring; for the D group, the modified sterid ring structure; and for the vitamins E, the chroman ring system. The K group is perhaps an exception in that the 1,4-naphthoquinone ring system, common to the natural vitamins K, may be varied in some synthetic products without complete loss of vitamin activity. Yet, as is suggested by in vitro reactions of the substitutes, they may be convertible in vivo to the structure of the natural isotels.

Vitamin A. There is some confusion in the literature regarding the A group, the longest known of the fat-soluble vitamins. This is due partly to the complexity of the physiological functioning of this group and partly to the inclusion in it, by implication at least, of substances belonging in the group of carotenes and carotenoids (p. 51), which are not really vitamins in the strict sense. Comparing the formula of vitamin A₁ shown in Table 24 with that of carotene (p. 52), one sees that 1 mol of β -carotene plus 2H₂O seems to be equivalent to 2 mols of vitamin A₁. Actually, however, when fed to rats, β -carotene is reported to have potency of only half that of an equal amount of pure vitamin A. Similarly, the hydrolytic cleavage of either α - or γ -carotene would yield, theoretically, 1 mol of the vitamin and one of a closely similar, though physiologically inactive, substance. But here again the actual vitamin potency as measured is much less than that calculated. At least six other carotenoids, among a larger number which have been considered, are regarded as possible sources of vitamin A. Such substances are properly termed **provitamins A**. A number of isomeres of vitamin A are known. One of the naturally occurring ones, called neovitamin A, is reported to be present in considerable amounts in most fish-liver oils.

The history of the A group begins with the recognition by McCollum and Davis and simultaneously by Mendel and Osborne of the existence of something in fatty foods which is an indispensable factor for growth and is even necessary for life itself. These and other investigators studied the symptoms developed by the use of diets deficient in what was then called the "fat-soluble A factor." Xerophthalmia, the dry-eye condition with its accompanying infection and tendency to blindness,

attracted so much attention that the vitamin was often called the "anti-xerophthalmic substance." Steenbock and his coworkers (1919-1920) were among the first to recognize that the carotenoids showed vitamin A activity and were obtainable from fish-liver oils, rich sources of the vita-

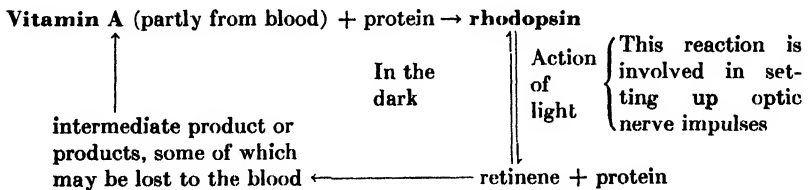

FIG 31. The need of vitamin A. The dogs in 1 and 2 show prostration and severe xerophthalmia as a result of a diet deficient in vitamin A. The dog in 3 is one of the same animals shown in 1 and 2 after being treated for 10 days with 20 cc. of cod liver oil daily in addition to the previous diet. (From Steenbock, Nelson, and Hart, *Am. J. Physiol.*, 1921.)

min. Steenbock suggested that carotene might be identical with vitamin A. This idea was in dispute for some years. Indeed, a number of yellow oils were shown to be without vitamin A potency. By 1930, however, the fact that carotene in its *natural* state could replace vitamin A was established. When the artificial synthesis of vitamin A was accomplished (1937), its structural relationship to carotene became obvious.

The symptoms of vitamin A deficiency are summarized in Table 24. The most conspicuous one is the condition of the eyes (Fig. 31), sometimes

resulting in total blindness if the deficiency is not so complete as to be fatal before the eye disease has run its course. The blindness is the result of more than one effect but includes an opaque condition of the cornea which, once attained, cannot be cured by feeding any quantity of vitamin A. The symptom attracting particular attention since about 1934 is night blindness, which is regarded by some investigators as the first symptom to appear on a vitamin A-deficient diet. Mammalian vision in dim light (night vision) is physiologically different from daylight vision. In the former, the retinal rods are the photosensitive elements, but in bright light the cones are also functional, affording vision of details in sharp focus and giving color vision. Functioning of the rods requires the photosensitive pigment **rhodopsin**, also called *visual purple*. It is bleached by the action of light and restored in darkness. This cycle involves vitamin A. The substance formed from visual purple under the action of light is a yellow pigment called **retinene**. It is one of the carotenoids and, according to Wald, can be converted into vitamin A, which in turn is required for the regeneration of rhodopsin, but somewhere in this cycle of reactions something appears to be lost from the retina inasmuch as a continuous supply of vitamin A must be brought to the eye in the blood stream in order to maintain good vision in dim light. The pigments involved in this cycle and the vitamin A appear to function while in combination with protein material. A schematic representation of this theory may be given as follows:



This cycle appears in a variant form in fresh-water fishes (see Table 24). In them **vitamin A₂** replaces A₁ and is recognized by its characteristic absorption maxima as measured with the spectrograph. The corresponding photosensitive pigment, **porphyropsin**, functions in the place of rhodopsin. While A₂ clearly resembles A₁ the exact molecular structure is still in doubt (see Table 24). The retinas of some salt-water fishes yield compounds with light-absorbing characteristics that differ from both A₁ and A₂ so that the existence of still other vitamins A has been postulated.

The most general symptom of avitaminosis A is the change which occurs in the composition and structure of various epithelial tissues and which might be concerned with the alleged susceptibility of vitamin A-deficient animals to infection.

The determination of vitamin A by chemical analysis is not very satisfactory. The most widely used and perhaps the best method is the one which depends upon the Carr-Price reaction. Antimony trichloride added to a chloroform solution of vitamin A develops a blue color, the intensity of which is proportional to the concentration of the vitamin and can be measured in a colorimeter or with the spectrophotometer. Unfortunately the blue color fades, so that the technique of its measurement is somewhat difficult. Moreover, the test is not entirely specific for vitamin A. By the use of the spectrophotometer, carotene, vitamin A₁, and vitamin A₂ can be separately determined. The maximum absorption for carotene is at a wave length of 590 m μ ; for vitamin A₁, at 620 m μ ; and for A₂, at 693 m μ . The blue color developed by carotene persists, while that due to the vitamin fades in a few minutes. Vitamin A may also be measured directly by spectrophotometric methods.

Bioassay methods, however, are still relied upon for the measurement of vitamin A. Young rats are used. Fed on a standard basal vitamin A-free diet, their growth rate declines, and when growth practically ceases, the food to be tested is added to the diet. The amount of the food required to restore the average growth rate to normal in a group of rats indicates the concentration of vitamin A in the food under assay, provided all other requisites for growth are supplied in the basal diet. The growth rate of the test animals is compared with that of controls receiving a known amount of β -carotene added to the basal diet. The standard international unit (I.U.) is equivalent to 0.6 γ of pure β -carotene. Another bioassay method depends upon the appearance of cornified epithelium in the vaginas of spayed rats fed the standard vitamin A-free diet and the measurement of the amount of vitamin A-containing food which must be given to cause a rapid disappearance of this symptom.

The distribution of vitamin A is determined in part by its property of being fat-soluble. The amount found in some representative foods is shown in Table 29.

While fish-liver oils are apt to be conspicuously rich in vitamin A, all green-leaf salads are important sources. Butter and cheese are also significant. The yellow vegetables, carrots, yams, sweet potatoes, yellow turnips, etc., are useful provitamin sources. Of meats, liver is the best. The values given for foods are really vitamin A equivalents and include vitamins A and provitamins A. In the case of most foods the latter predominate.

The requirements for vitamin A have to be met from dietary sources for all animals so far tested with the exception of some insects. The quantitative requirement is not easily evaluated because the conversion of carotenoids into vitamin A and the effectiveness of absorption of both of

them in the intestine vary with species and even in the same individual. In some animals as much as 50 to 70 per cent of carotene fed may be excreted unchanged in the feces. Human adults appear to absorb (on the average) about 50 per cent of the carotene of the food. The ability

TABLE 29.—VITAMIN A CONTENT OF SOME REPRESENTATIVE FOODS
 Values given are in terms of international units (I.U. equivalent to 0.6 γ β -carotene) but, based chiefly on bioassays, include both vitamin A and provitamin A

Food	I.U. per 100 g.	Food	I.U. per 100 g.
Fish-liver Oils, variable so that values are only approximate		Vegetables	
Haddock.....	6,500	Olive (canned, ripe)....	150-300
Cod.....	60,000	Peas (green).....	1,400
Mackerel.....	3,000,000	Peppers (green).....	1,300
White sea bass.....	5,000,000	Peppers (red).....	7,700
Tuna.....	6,500,000	Potatoes (white).....	70
Swordfish.....	25,000,000	Potatoes (sweet, yellow)	7,000
Black sea bass.....	60,000,000	Spinach.....	35,000
Meats, etc.		Dairy Products, etc.	
Beef liver.....	1,250-16,300	Butter.....	1,600-5,000
Calf liver.....	7,000-34,000	Cheese.....	1,700-5,000
Pig liver.....	8,000-11,000	Cream (20 per cent fat)	1,000
Sheep liver.....	10,000-27,000	Milk (whole, average market).....	230
Lamb liver.....	5,000-11,000	Milk (from cows on green pasture).....	2,800
Chicken liver.....	600	Eggs (whites).....	None
Kidney.....	1,000	Eggs (yolks).....	4,200
Lean beef.....	50-100	Fruits	
Vegetables		Apples.....	100
Asparagus (fresh, green)	900	Apricots (fresh).....	7,500
Beans (green, snap)....	1,400	Apricots (dried, commercial).....	9,800
Broccoli (green leaf)...	42,000	Banana.....	380
Cabbage (partly green).	70	Cranberries.....	30
Carrot (mature).....	7,500	Dates (dried, commercial).....	200
Celery (green stalks)...	2,000	Figs (dried, commercial)	50
Corn (dried, white)....	None	Grapefruit.....	None
Corn (dried, yellow)....	800	Lemon juice.....	None
Dandelion greens.....	35,000	Orange juice.....	100
Lettuce (green).....	5,600	Raisins.....	100
Lettuce (bleached, iceberg).....	175	Watermelon.....	130
Olive (canned, green)...	350		

to convert the provitamin into the active substance is known to be much better in the rat than it is in pigs, cows, or sheep. Another uncertainty arises from lack of knowledge about the conversion process (see p. 193). The ability of the animal to store vitamin A affords another variable, and

the rate of depletion of the reserve, which is mostly in the liver, also varies with species. Moreover, the requirement for vitamin A appears to be affected by the supply of vitamin E. At any rate, rats are depleted of vitamin A, when it is deficient in the diet, with especial rapidity if the supply of vitamin E is also deficient and the potency of A is increased by an adequate supply of E.

Another factor is the possibility of food interference. Apparently, the presence of excessive amounts of heated fats in the diet can so lower the availability of vitamin A as to produce an actual deficiency.

Among the provisional standards, one based upon careful studies of human adults indicates that 2,500 I.U. per day of vitamin A or 5,000 I.U. of β -carotene are sufficient. This is equivalent to $1\frac{1}{2}$ mg. of the vitamin or 3 mg. of carotene. But the optimal intake is probably larger. The need for vitamin A in the food is certainly increased during lactation. A nursing mother may have an output of vitamin A in the milk as high as 1.8 mg. per day. While the vitamin A content of cow's milk is not as high as that of human milk, it has been observed that a liberal supply of vitamin A in the fodder may be followed by a 10 per cent increase in milk production with some increase in the fat content and the vitamin A in the milk. Requirements during pregnancy are also high, though apparently not as high as during lactation.

The physiological action of vitamin A, aside from its role in the regeneration of visual purple, is not clear. Its general action in the prevention or cure of degenerative changes in epithelial cells, including the reticulo-endothelial system, suggests that it is in some way concerned in the vital architecture of cells. One of its functions for glandular epithelium is the prevention or cure of a form of degeneration of gonadal tissue, especially that of the ovary. Vitamin A is therefore required for successful reproduction.

The conversion of the various carotenes and carotenoids into vitamin A probably occurs in the intestinal wall of the rat. Of several lines of evidence to indicate this, perhaps the most striking is that rats may die from vitamin A deficiency although generous quantities of carotenes are injected into the blood stream. In other species this may not be true; at least benefits are reported to follow carotene injections into vitamin A-deficient children. It seems probable that both vitamin A and carotene circulate in the blood plasma in combination with serum albumin.

Vitamins D. Although it is now well known as the "sunshine vitamin" which cures rickets, vitamin D was not easily proved to be a necessary food factor. Cod-liver oil, to be sure, was early shown to aid in the cure of this disease, and the incidence of rickets was correlated with a deficiency of sunshine in 1890. Hopkins (1906) seems to have

been the first to suggest that rickets might be a deficiency disease, and Funk included it in his list of supposed avitaminoses. But Mellanby (1919) actually showed that puppies with rickets were cured by a diet rich in animal fats. During the next 3 years, work in many laboratories paved the way to an understanding of rickets by solving some preliminary problems. One of these was the difficulty in finding a diet that would surely produce experimental rickets. If the food furnishes adequate amounts of calcium and phosphorus and these in correct proportion to each other, typical rickets cannot be produced nor will any of its symptoms arise from a mere deficiency of vitamin D in the diet unless the diet is used for a long time. Another difficulty was the lack of a quantitative method for measuring the progressive changes during rickets. Both of these difficulties were overcome. Diets free from animal fats but high in calcium and low in phosphorus unfailingly produce rickets in any species of mammal or bird kept out of sunshine or other sources of ultraviolet light.

To follow the progress of rickets the line test was developed. For this, young rats of a standardized previous history are generally used. At any stage of the disease or during the progress of its cure, the animals are killed and the long bones dissected out. The ulna, radius, and tibia are useful for the test. The bone is split lengthwise, immersed briefly in 3 per cent AgNO_3 , washed in water, and exposed to bright light. A black deposit of metallic silver appears in the epiphyseal region (Fig. 32) and is proportional to the degree of calcification. In extreme rickets no silver will appear in the epiphysis, but when healing has begun the calcium deposits are so located that the corresponding silver stain appears along a distinct line. The completeness and width of the line are proportional to the degree of healing and can be used as a quantitative measure of the amount of vitamin D added to the ricketogenic diet.

The progress of rickets and its cure may also be observed by the use of X-ray photographs of the bones. The interpretation of the photographs, revealing various degrees of density in the epiphyses, is somewhat difficult; but this method is the only quantitative one applicable to human subjects and is employed for the diagnosis of rickets and the measure of effectiveness of cures in children. The decline of the rate of growth registered in the weight curve furnishes additional evidence.

Preliminary problems having been solved, the proof that rickets is an avitaminosis, curable by cod-liver oil, was soon established through the work of several groups of investigators.

In 1924 the startling discovery that irradiation of foods by ultraviolet light could give them antiricketic potency was made by Steenbock and his coworkers and independently by Hess. This was especially interesting

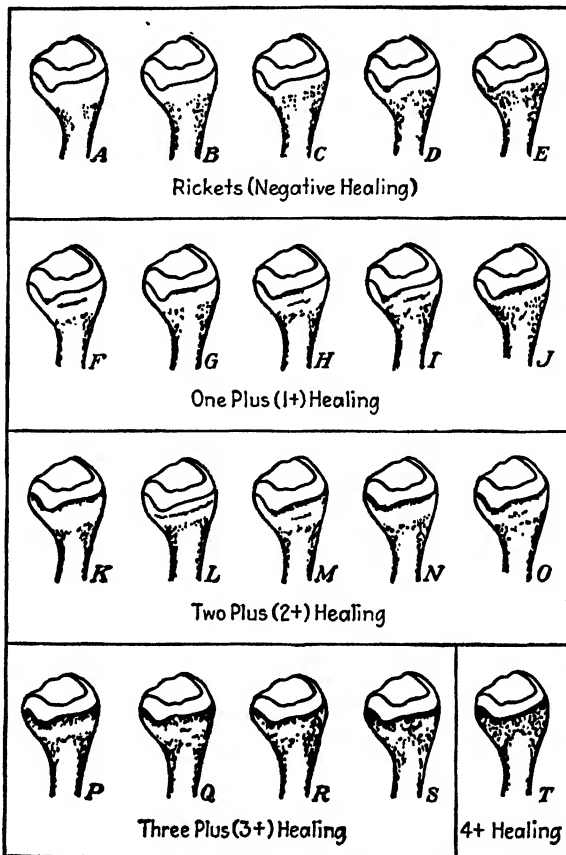

FIG. 32. Sketches to indicate the relative appearance of the "line test" in rats. The test is performed by exposing longitudinally sectioned halves of the proximal end of the tibia in 3 per cent AgNO_3 solution to intense light. The resulting silver stain is viewed under a low-power microscope. Upon the calcified areas, silver phosphate is formed and reduced to black silver. Sketches *A* to *E* show the results in rickets, *D* and *E* being less severe than *A* and *B*. *F* to *S* show varying degrees of healing as produced by antiricketic foods. *T* shows complete healing. (From Bills, Honeywell, Wirick, and Nussmeier, *J. Biol. Chem.*, 90, 619, 1931.)

in connection with the previously known fact that children who play in bright sunshine and animals exposed to it do not have rickets and if they have acquired this affliction sunshine is a good cure. The effectiveness of sunshine had been shown experimentally for ricketic rats by Hess and Unger (1921). In 1925 McCollum, convinced that the antiricketic substance was a food factor distinct from vitamin A and all others, proposed that it be called vitamin D.

Sterols obtained from the nonsaponifiable fraction of food fats were shown to contain the substance which ultraviolet light converts into the vitamin, and in 1927 reports from three different laboratories pointed to **ergosterol** as one of the provitamins. A few years later, isolation of pure vitamin D was followed by the establishment of its molecular structure. In the period 1930–1938, the work of many investigators, European, English, and American, showed that several (an as yet undetermined number) substances have antiricketic activity although their relative potency is not the same when tested on different species. What is highly potent in the rat may not be correspondingly effective for chicks or babies.

The symptoms of rickets include, in addition to growth failures and deficiency in bone calcification, an increased excretion of calcium in urine and feces, so that a relatively high proportion of the intake fails to be retained in the body. Corresponding to defective calcification, there is a lowered ash content of the bones, calcium phosphate being especially low. There is a decreased concentration of phosphorus-containing compounds in the blood, and this is accompanied by a lowering of what may be called diffusible calcium compounds (as distinct from calcium-protein complexes), so that the concentration of calcium phosphate available for ready deposition in the bones is decreased.

The aftereffects of rickets, even when the avitaminosis is duly corrected, are serious. Among them are misshapen bones (*e.g.*, bowlegs), epiphyseal enlargements such as knock-knees and beading of the ribs (the so-called “ricketic rosary”), faulty and retarded development of the teeth resulting in overcrowding and excessive tendency to dental caries, and respiratory disturbances resulting from chest deformity (“pigeon breast”). Many cases of difficulty in childbirth appear to be due to pelvic deformities resulting from rickets during girlhood. Adequate provision against even a mild D-avitaminosis is important as surely as is the prevention of obvious rickets.

The determination of vitamin D in foods can be done by spectroscopic methods and by chemical analysis but not very satisfactorily. Bioassays are found to be more reliable. Rats are generally used, and the method is that which employs the line test as described above. Chicks are sometimes used, and the determination of the weight of the bone ash or its content of calcium and phosphorus becomes the criterion for the degree of healing in response to the food under assay.

The distribution of vitamin D is unique in that it is not found in as many foods as are the other vitamins. No significant amount of it has ever been surely detected in any foods of plant origin, although it can be developed in them from their provitamins by suitable irradiation. One

would suppose that sunshine could do this in field and garden, and it does apparently happen during the curing of hay, but the result is not predictable. Fish-liver oils are the chief source of the vitamin. Cod-liver oil is regarded as the standard one, but there is much variation in the vitamin D content in the oil from different fishes. Values shown in Table 30 will illustrate the range. Noting that cod-liver oil has about 100 I.U. per gram, one sees that tuna fish-liver oil may be 400 times as potent. The origin of vitamin D in fish livers is problematic. Attempts

TABLE 30.—CONCENTRATION OF VITAMIN D IN OILS AND FOODS

Source	International Units per Gram
Fish-liver oils:	
Tuna.....	10,000-40,000
Sea bass.....	5,000
Rockfish.....	1,000-1,500
Chinook salmon.....	1,300
Halibut.....	1,200
Mackerel.....	750
Turbot.....	260
Cod.....	100
Pollack.....	50
Haddock.....	10
Sturgeon.....	None
Other sources:	
Liver of beef, pig, chicken.....	0.1-0.7
Salmon (muscle).....	2.3-8.0
Beefsteak.....	0.1

to prove that it results from mere storage in the liver of the vitamin D in the food consumed by the fish have not been successful. Meats and especially liver are not inconsiderable sources of vitamin D, and fish muscle, especially salmon, is a very fair source.

The activation of provitamins D by the action of ultraviolet irradiation has been elucidated by Windaus and his coworkers. The products which are formed, successively, during the conversion have been studied and in most cases isolated. Their properties and molecular structure have been determined. The process is irreversible. The activation of ergosterol has been especially studied and may be represented thus:

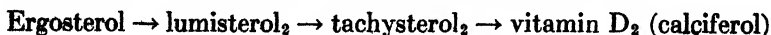

Further irradiation leads to destruction of the vitamin with the formation of toxisterol and suprasterols. This last fact explains the prevalence at one time of the idea that artificial vitamin D was toxic. Improperly controlled irradiation may result in the formation of toxisterol which, as the name implies, is distinctly toxic. The timing and

the intensity of irradiation must be carefully controlled to obtain the maximum production of the vitamin free from undue contamination. The wave length of the light used for irradiation is also important. Only a narrow band in the ultraviolet (Fig. 33) is effective.

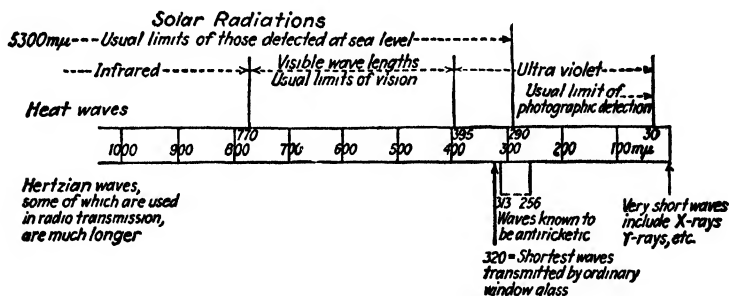
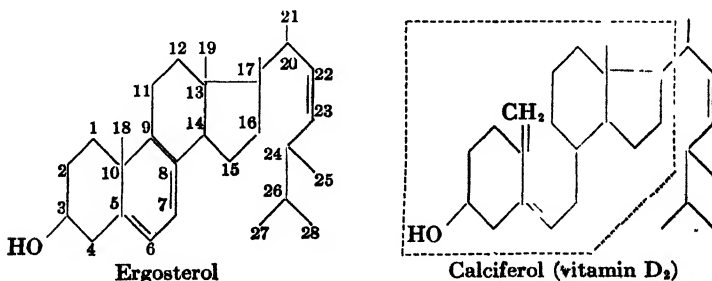

FIG. 33. The relation of antiricketic rays to other radiations. The antiricketic part of the solar spectrum is a rather narrow band in the extreme violet and the ultraviolet regions. The most effective wave lengths are from 280 to 300 μ . Unfortunately, these are so largely absorbed by the atmosphere during the major part of the year that, at sea level, only summer sunshine gives good protection against rickets. Ultraviolet rays of sunshine are absorbed by ordinary glass, and, on this account, windows of quartz or of special glass that transmits ultraviolet light are used for solaria.

Chemical Specificity. Comparison of structural formulas for ergosterol (p. 91) and calciferol suggests the nature of the activation process. In abbreviated form they are



There is no difference in the side chain attached at C₁₇ nor in the alcohol group at C₃. The unsaturated bonds at 5-6 and 7-8 are identical. The peculiarity of the activated form is in the opening up of the ring structure at 9-10 and the presence of a methylene group at C₁₈ rather than a methyl group attached to the ring at C₁₀. All forms of vitamin D so far recognized contain the group shown inside dotted lines in the formula for calciferol. Upon this structure, therefore, the specificity

of vitamin D activity seems to depend. Differences occur only in the structure of the side chain attached to C₁₇. Known members of the group are

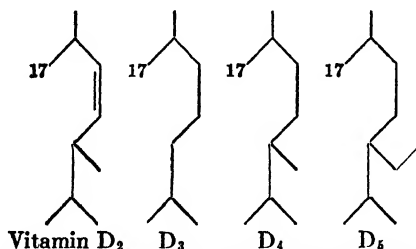

Structure believed to characterize the side chain of each of the vitamins D which have been described. The "active" group is not shown. Its C₁₇ atom is the point of attachment of the side chain.

There is no substance properly called vitamin D₁. What was once so designated turned out to be a mixture of lumisterol and calciferol. Other vitamins D, in addition to those listed, are postulated; but their chemistry and physiological action have not been established.

The production of vitamin D in animals by the action of light, though extensively studied, presents further problems for investigations. The skin of man and other mammals contains provitamins D in concentration exceeding that of other tissues. Activation probably occurs on or very near the surface of the skin. It has been repeatedly shown that vitamin D can be absorbed through the skin when applied in the form of oily solution or skin creams. The effectiveness of sunshine in preventing rickets in birds in spite of their feathers is not entirely explained, although it has been shown experimentally that ultraviolet irradiation of the feet affords protection from rickets. It is also somewhat puzzling that fur-bearing animals are protected by sunshine. It is alleged that cats, when prevented from licking their fur, may show symptoms of rickets.

The requirement for vitamin D cannot be definitely stated because it depends upon the calcium-phosphorus ratio in the diet and the relative exposure to sunshine or artificial sources of ultraviolet light. Only ultraviolet is effective, and the amount reaching the earth's surface is curtailed by cloud, fog, dust, and other atmospheric interferences. Sunshine affords so little ultraviolet light in winter as to be without significance. Ordinary glass is opaque to these rays. Indoor sunbaths are valuable only if quartz or an especially chosen type of glass is used for the window panes. Irradiation with quartz-mercury vapor lamps or other artificial sources of ultraviolet light is effective. Determination of the requirement is further complicated by species differences in responding to the several forms of vitamin D. For human infants and

children, certain recommendations have been made. They vary all the way from 400 to 1,500 I.U. per day. An international unit is equivalent to 0.0257 γ of calciferol when tested on rats.

The physiological action by which this vitamin favors the deposition of calcium phosphate in bones and otherwise regulates the disposition of this mineral in tissues and body fluids is incompletely explored. One of its important functions in some animals, at least, is to favor the absorption of calcium and phosphorus of the food from the intestine. No definite connection with any activity of an enzyme system has been established in the same sense that it has been for thiamine and niacin.

Vitamins E. Although it had been known that a deficient supply of any vitamin might interfere with reproduction, a more specific vitamin effect was demonstrated (1922) by Evans and Bishop. They showed that a synthetic diet, containing supplements to provide the previously known vitamins, caused reproductive failures. They recognized this condition as a specific avitaminosis and named the required substance vitamin E. They showed it to be present in wheat-germ oil, and Evans and his coworkers later demonstrated its presence in the nonsaponifiable fraction. Its value in the prevention and cure of muscular dystrophy in animals was also demonstrated in Evans' laboratory, and Evans, Emerson, and Emerson (1936) isolated pure compounds with vitamin E activity (α - and β -tocopherols). The artificial synthesis was accomplished by Karrer and his associates (1938) in Switzerland. According to their suggestion, the four known vitamins E, α -, β -, γ -, and δ -tocopherol, would be designated, respectively, as 5,7,8-trimethyltolcol, 5,8-dimethyltolcol, 7,8-dimethyltolcol, and 8-methyltolcol (see Table 24).

The symptoms of vitamin E deficiency are peculiar. While most avitaminoses are fatal when the deficiency is practically complete and sufficiently prolonged, adult animals, fed on a supposedly vitamin E-free diet, may actually have an approximately normal span of life and may even raise one or a few litters. In due time, however, the reproductive organs are affected. In the testis the germinal epithelium degenerates, and if this change progresses beyond initial stages, it is irreversible. Feeding vitamin E cannot repair the damage. In the female, there is first a tendency to stillbirths and later to resorption of the young *in utero* and consequently complete sterility. Yet the ovary is still functional, ovulation occurs, and the animal, mated to a normal male, can become pregnant. The condition can be cured by vitamin E.

Extreme and prolonged deprivation brings on degenerative changes in muscle (dystrophy). This is accompanied by a proportionately large increase in urinary excretion of creatine, which is normally retained in

muscle. Nerve degeneration, especially in the spinal cord, may occur and even lead to a form of partial paralysis. Convulsions may set in, and if this occurs the avitaminosis is fatal.

The quantitative determination of vitamin E can be made by spectroscopic or by colorimetric methods. But as they are applicable only to the separated vitamin and losses are thus involved, such methods have not yet superseded the time-consuming bioassays. The rat-fertility test is generally used. In one of the methods, female virgin rats are put on a vitamin E-free diet during growth so that the body is depleted of stored vitamin. The food to be assayed is then added to the basal diet and the effects on fertility and other aspects of reproduction are compared with those of standard α -tocopherol.

An international unit ("fertility dose") is the amount which, given by mouth daily, is just sufficient to cause the birth of at least one living young for each of 50 per cent of females previously found sterile because of uterine absorption. An I.U. is approximately equivalent to 2.5 mg. of α -tocopherol.

The distribution of vitamin E is distinctly more widespread and in greater abundance in plant than in animal tissues. The best sources are certain vegetable oils and especially wheat-germ oil. The oil from other seed germs, including cottonseed and rice, are fair sources. Olive oil and peanut oil yield little or none. Green leaf foods are fair sources. Lettuce, alfalfa, and tea leaves have been so designated. Foods of animal origin are only meager sources. Liver may in some cases, but not always, be a fair source; fish-liver oils, though generally rich in other fat-soluble vitamins, are only poor sources of vitamin E.

The physiological action is probably not exerted upon reproductive processes directly but affects them indirectly through a more generalized action. One general effect, widely studied, is antioxidation which checks the rate of oxidative destruction of important metabolites. For example, vitamins E spare and potentiate vitamins A and carotenes. The amount of A required to sustain good health is decreased, the potency of a given amount of A or provitamins A is increased, and the storage of A is increased and prolonged by inclusion of tocopherols in the diet. Another example is the increased effectiveness (lowered minimal requirement) of indispensable fatty acids (p. 70) resulting from generous supplies of vitamins E. This appears to be due to restraint of an otherwise too rapid oxidation of unsaturated fatty acids. Correspondingly, some fats, e.g., lard, have keeping quality, i.e., lowered tendency to oxidative rancidity (p. 76), roughly proportional to the content of natural tocopherols.

Supplementary feeding of tocopherols to cows is reported to increase

the amount of milk produced and its fat content. Herbivora consume an abundance of tocopherols when the germ part of grain and the green leaf part of forage are available.

There is thus much circumstantial evidence of the functioning of the tocopherols in an oxidation-reduction system. But the first product obtained by in vitro oxidation is a quinone which, though reducible, does not go back to the original structure.

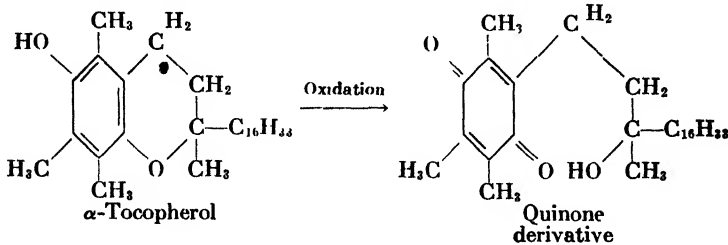

This fails to confirm the idea that vitamins E are part of a *reversible* oxidation-reduction enzyme system; but Michaelis and Wollman found (1949) that, at very low temperature, α -tocopherol can be converted to an orange-colored semiquinone. This is the result of a one-step rather than a two-step oxidation and is reversible. It is therefore suggested that, in this way and in a protein complex, the tocopherols might possibly function as parts of a reversible oxidation-reduction system as do various other vitamins. An oxidation product with some, although relatively low, antisterility potency has been isolated (Boyer, 1949) from products of the reaction of ferric ions with α -tocopherol.

An interesting report (Vogelsang and Shute, 1946) suggests that a generous supply of tocopherols may be beneficial to patients with congestive heart disease and the anginal syndrome. It has also been reported that animals on a vitamin E-free ration may die suddenly of heart failure. Normal heart tissue has a relatively high tocopherol content. It should be recalled that cardiac disorders result from deficiency of other vitamins, *e.g.*, thiamine and ascorbic acid. Such effects and those of vitamins E are exerted by action upon oxidative mechanisms of the heart.

The requirement for females appears to be larger (perhaps as much as tenfold) than it is for males. A male rat might remain fertile with no more than 0.25 mg. of α -tocopherol per day. The requirement for prevention of muscular dystrophy is reported to be less than that for maintaining fertility. The human requirement is still undetermined. While physicians, European, English, and American, have reported success in treatment with wheat-germ oil of women who have repeatedly had abortions or stillbirths, yet so many unsuccessful tests have also been

reported and the possible causes of human reproductive failure are so numerous that the medical world has not accepted the idea that human sterility actually results from avitaminosis E. The value of vitamin E as a curative for some cases of muscular dystrophy seems to be more widely accepted. Human requirements for this vitamin cannot be stated quantitatively. Doses as high as 6 mg. of α -tocopherol per day have been used. Food interference may be a cause of an apparent deficiency. Cod-liver oil is said to reduce the availability of α -tocopherol.

Vitamins K. Dam and his associates (1929) in Copenhagen reported that chicks on a synthetic diet had subcutaneous and intramuscular hemorrhages. This seemed to be a specific avitaminosis and Dam (1934) suggested that the required factor be called vitamin K, using the initial letter of the term "Koagulations Vitamin." Later work in the Copenhagen laboratory showed that the vitamin was required to maintain or to restore the concentration of blood prothrombin which is one of the substances participating in blood coagulation. The usefulness of the vitamin in maintaining the clotting power of human blood was shown by several groups of investigators. In 1939, the Danish workers, in collaboration with Swiss investigators in Karrer's laboratory, isolated pure vitamin K, and Doisy and his associates in St. Louis prepared pure vitamin K₂. In the same year, artificial synthesis of the vitamin was accomplished in three different laboratories.

The rapidity of the advance of knowledge of vitamin K demonstrates the improvement of techniques in vitamin investigation. Within five years after it was recognized as a vitamin its chemistry and physiology were advanced almost as much as had been the case for vitamin B₁ during more than a quarter of a century. The speed of progress in the study of pyridoxine affords a similar example. Both the physiologist and the chemist now possess vitamin-research "tools" not available to earlier investigators. Not the least of these is the purified state in which more than a dozen vitamins can be used so that a "basal diet," which is composed of foods of known composition, can be fed. To this, natural foods or their extracts can be added in order to study their specific effects on any symptoms which appear to be avitaminotic.

Chemical Specificity. The formula of vitamin K₁ (p. 166) shows it to be a substituted naphthoquinone. Another naturally occurring member of the group, vitamin K₂, has a similar constitution but differs as to the group attached at position 3 to the naphthoquinone structure. Some 60 or more synthetic naphthoquinone derivatives have been tested for vitamin-K activity. Many of them proved to be more or less potent. The simple 2-methyl-1,4-naphthoquinone itself is at least three times as potent

as the natural forms. Other compounds, including various quinones and hydroquinones, have been found to be active. It thus appears that the effective atomic grouping may be something producible in the organism from a number of precursors; but until the physiological action of the vitamin is known in more detail no conclusions can be drawn.

Quantitative determinations can be made by a number of chemical methods depending upon color reactions. In one of them the material is treated with 2,4-dinitrophenylhydrazine in 2N HCl and warmed; then NH_4OH is added to develop a green color which is stable and is proportional to the amount of quinones present.

The bioassay method is still in demand. It depends upon the measurement of clotting time. Day-old chicks are placed on a vitamin K-free diet. In about 15 days they show a prolonged clotting time, which may be an hour or more, in contrast to the normal 4 to 6 min. The material to be tested is then fed or injected, and the blood-clotting time is determined 16 or 18 hr. later. One of the pure preparations of the vitamins K, similarly administered, is used as a standard.

The distribution of natural vitamin K is for the most part confined to plants and microorganisms, although pork liver is reported to be a useful source. Green-leaf foods are the best sources. Spinach, cabbage, cauliflower, and alfalfa are known to be rich; but vitamin K occurs also in tomatoes, soybeans, and some other foods. Fruits and cereals are only poor sources. Bacteria have been shown in the case of a number of species to contain substances with vitamin-K activity. One of these, phthiacol (2-methyl-3-hydroxy-1,4-naphthoquinone), prepared from cultures of human tubercle bacilli, has mild vitamin-K potency. Bacteria of the human intestine produce at least a part of the vitamins K needed by man.

The requirement for vitamin K has been studied more particularly in chicks, but other birds, rats, mice, rabbits, dogs, and human beings are also known to require it. The quantitative requirement for man is unknown. Deficiencies are not apt to occur under normal conditions. In obstructive jaundice or in any condition which prevents a free flow of bile into the intestine, delayed blood clotting is generally observed. The difficulty seems to be due to the need for bile salts to aid in absorption of vitamin K from the intestine. The clinical use of vitamin K, injected or fed together with bile salts, has been widely adopted to relieve this symptom. Another clinical application, emphasized in modern medicine, is the feeding of vitamin K to expectant mothers during the month preceding childbirth in order to check undue hemorrhage in both mother and child. The vitamin may also be administered to the newborn infant.

The *physiological action of vitamin K* is understood only in so far as it has been shown to be necessary for the production of prothrombin in the liver. The mechanism involved, though conjectured, is unknown.

Incompletely Identified Vitamins. It seemed at one time that probably all the nutritional requirements of the rat had been identified because rats had been maintained through two or three generations on "synthetic" diets, *i.e.*, mixtures of purified proteins, fats, carbohydrates, salts, and vitamins. It had never been demonstrated, however, that such diets produced a growth rate as rapid as that observed with an adequate, natural diet. It is now realized (1949) that we still have a somewhat incomplete picture of the nutritive needs of even the rat, although it has been used for nutritional investigations more extensively than has any other animal. One puzzling feature is that some experimental animals, including rats, grow faster and show some other signs of better nutrition when proteins of animal origin replace those of vegetable origin in the diet. This suggests that an unidentified food factor, provisionally called "the animal protein factor," is thus supplied. All available evidence tends to indicate that it is not any of the known amino acids.

There is evidence for the existence of a number of what we may call incompletely identified vitamins. The type of experiment that supplies the evidence is illustrated by a report from Richardson, Hogan, and Karrasch. Day-old chicks were placed on a ration composed of purified casein, starch, lard, inorganic salts, cellulose, and gelatin mixed in suitable proportions to meet nutritional needs. The proteins yield the required amino acids, lard is a good source of indispensable fatty acids, and the salt mixture contained every inorganic element known to be required by chicks. To this mixture, 13 vitamins in pure form were added as follows:

Vitamins per 100 g. of Ration

Vitamin A.....	6000 I.U.
Vitamin D.....	850 I.U.
Thiamine.....	0.8 mg.
Riboflavin.....	1.6 mg.
Pyridoxine.....	1.2 mg.
Calcium pantothenate.....	2.0 mg.
Choline.....	400.0 mg.
Inositol.....	100.0 mg.
<i>p</i> -Aminobenzoic acid.....	30.0 mg.
Nicotinic acid.....	1.0 mg.
2-Methyl-1,4-naphthoquinone.....	1.0 mg.
α -Tocopherol.....	8.0 mg.
Biotin.....	2 γ per chick per day

Of the well-established vitamins, ascorbic acid was omitted, but the chick synthesizes this for itself. In spite of this array of vitamins and

vitamin-like substances, the birds grew at a subnormal rate and showed inability to walk and perch normally because of loosening of leg tissues permitting slipped tendons. This symptom, called **perosis** or "hock disease," is known to appear during deficiency of either choline or manganese; but both of these were shown to be adequately supplied. The missing requirement could be furnished by a water extract of liver and could be adsorbed from the extract, at pH 1, by fuller's earth and eluted by 0.2*N* ammonia. It was prepared in concentrated form. It has been designated as the "antiperosis vitamin" or **vitamin B_p**.

An attempt to list "unidentified vitamins" is not satisfactory. With hundreds of vitamin-research reports appearing monthly, anything written on the subject may need revision before it can be printed. The list may shorten because items are transferred to the group of established vitamins. The list may shorten in another way. Thus the items vitamin H, bios II-b, anti-egg-white-injury factor, Elvehjem's factor W, vitamin B_w, Marshall's factor S, coenzyme R, and possibly some others all appear to be identical and are now designated by the one name, biotin. An equally long list of names (p. 183) is now replaced by PGA and its conjugates. Similar instances may be noted upon examination of Table 23, which also includes the incompletely identified factors vitamin J and vitamins L. Others are discussed briefly in the following paragraphs.

The Grass-juice Factor. In order to maintain the optimal rate of growth in rats, Elvehjem, Hart, and their associates at Wisconsin found that winter milk (cow) was inferior to summer milk. The missing factor in winter milk could be supplied by grass or by the juice pressed out of fresh grass and clarified in a centrifuge. Guinea pigs were found to be even more sensitive than rats to the effects of lack of this factor. Extended observations at Wisconsin and in other laboratories clearly indicate that this so-called "grass-juice" factor is something distinct from any of the known vitamins. It has been found in a considerable number of plant foods, clover, peas, cabbage, spinach, and others. Animal tissues, even liver, are very poor sources. It can be destroyed by heat and by oxidation.

Factor T. A fat-soluble substance has been postulated by Schiff and Hirschberger, who find evidence that it is required for maintenance of the normal number of blood platelets in rats and human beings. This substance, called "factor T," was found in sesame oil and in egg yolks but not in cod-liver oil or olive oil.

Streptogenin. A growth factor, discovered (1941) by Woolley, was named streptogenin because it was required for the growth of certain types of streptococci. It is also required for *Lactobacillus casei* and some other microorganisms. Woolley also showed (1946) that it was necessary for

mice in order that they attain a normal growth rate; while Womack and Rose (1946) demonstrated a similar requirement in rats. The chief source of it is certain proteins, *e.g.*, casein, which if fed in either crude or purified form or after digestion by trypsin supply strepogenin; but if the protein is hydrolyzed by either acids or alkalies, it completely loses strepogenin value, both for microorganisms and for animals. Inasmuch as proteins of the highest purity have been used in such experiments, it is believed that strepogenin is not a contaminant that is removed by acid or alkali treatment, but is a fragment of the protein molecule released by trypsin or normal digestive processes but split by acid or alkaline hydrolysis. These observations and the physical and chemical properties of strepogenin have led to the tentative conclusion that it is a peptide. It would seem to be of relatively low molecular weight (300 to 500) judging from its diffusion behavior. It might be a tripeptide.

The so-called "factor S," reported (1940) by a group of investigators at Cornell to be indispensable for the chick, is now regarded by them as probably identical with strepogenin. On diets lacking it chicks fail to grow, become anemic, show a general weakening, and usually die before they are 8 weeks old. The Cornell group reported that factor-S potency (assayed on chicks) of yeast, fish meal, and casein is so closely correlated with strepogenin content (microbiological assay) as to suggest that strepogenin and factor S are identical.

The animal protein factor (APF) is reported to be required by hens to maintain good egg-laying and to ensure hatchability of the eggs. The Cornell investigators find that the requirements for rapid growth of *L. casei* during the first 16 hr. of incubation include not only strepogenin but also glutathione (see Chap. XII) and a factor contained in certain animal products and having properties which suggest that is the factor required by hens. It differs chemically from strepogenin although its occurrence is very similar. When tested in several ways, growth of rats and of chicks, microbiological assays, and effects on mice, APF appears to have the same effects as vitamin B₁₂ (p. 213), and some of their chemical and physical properties strongly indicate that they may be identical.

If it should be established that strepogenin and possibly other nutritive essentials are peptides, some basic biochemical ideas will need revision. During about a third of a century it has been believed that animals and microorganisms required proteins as nutrients only in order to obtain the necessary amino acids as building stones for vital syntheses. Current disclosures suggest that the protoplasm may need to have some of these nutritive units in a form more complex than that of free, completely hydrolyzed amino acids.

Vaccenic acid, an isomer of oleic acid, but having its double bond between ^{11}C and ^{12}C , appears to be (Boer *et al.*, 1946) the chief, if not the only, component of a fraction separated from summer butter and capable of causing a faster growth rate in rats than is obtained when winter butter or certain vegetable oils are substituted for summer butter. It is probably better to regard vaccenic acid as a newly recognized member of the group of indispensable fatty acids (p. 70) rather than as a vitamin.

The guinea-pig antistiffness factor was reported (Wulzen and Bahrs, 1941) to be present in raw (unheated) whole milk and in green leaves. When guinea pigs are on a diet composed of milk and the supplements which make good its long-known deficiencies, they grow well and show no abnormalities at autopsy, but when the milk has been heated (pasteurized) or when skim milk is substituted for whole milk, the animals show a deficiency characterized at first by stiffness of the limbs and also later by emaciation and weakness. If the diet is not corrected, it is fatal. At autopsy, the muscles show peculiar calcification and are found to be abnormally high in their content of free phosphates and are low in the phosphate-liberating enzyme, alkaline phosphatase. While the symptoms somewhat resemble the muscular dystrophy due to lack of tocopherols, the condition is quite distinct, is not relieved by vitamins E, and is not accompanied by excretion of creatine in urine as is the dystrophy of avitaminosis E. The antistiffness factor was isolated (Van Wagten-donk and Wulzen) from several natural sources. It seems to be concerned with the metabolism of adenylic acid (p. 146) and its important derivatives. The method of preparing it from natural sources indicates that it is a sterid, and it is reported that the acetic ester of ergostanol (see Table 13) is about as potent as a crystalline preparation of the factor made from a vegetable source.

Later work by a Cornell group (Smith *et al.*, 1949) did not show significant curative power for ergosteryl acetate and also failed to show that the tissue calcification is a part of the same syndrome as the stiffness. They did confirm the existence of an antistiffness factor. Reports from several laboratories suggest that it is a sterid.

*Vitamins B₁₂ and B₁₄*¹ have been recently discovered and investigated. Both are concerned in the processes of hemopoiesis although they may also have more general functions. As explained (p. 183) PGA is helpful for certain types of nutritional anemia but not for pernicious anemias. It has been known since 1926 (see Chap. X) that something obtainable

¹ The term vitamin B₁₂ is applied by Novac and Hauge to a substance prepared in concentrated form from several sources, including liver extract, and favoring rapid growth of chicks.

from normal liver was corrective for pernicious anemia of the macrocytic type (small number of red cells of abnormally large average size). A highly concentrated and possibly purified crystalline preparation was obtained (Rickes *et al.*, 1948) from liver extracts and named vitamin B₁₂. At about the same time an apparently identical preparation was made in England (Smith, 1948). The potency of the vitamin is easily tested by its effect on the growth of *Lactobacillus lactis* Dorner (LLD) and expressed in so-called "LLD units." The purified crystals were found to be effective (causing one-half the maximal growth rate) when present in the culture medium to give 1.3 parts in 100 billion parts (1.3×10^{-5} $\mu\text{g}/\text{ml}$ of medium). Tested clinically on suitably chosen patients, it was also spectacularly potent. One patient showed a definite hematopoietic response to one intramuscular injection of 3 γ (0.000003 g.) of the pure preparation. It would seem that such minute quantities could give biochemical effects only by a catalytic action. Commercial preparations of concentrated liver extracts have long been dispensed for use in pernicious anemia. When seven samples of them from four different producers were assayed microbiologically, it was found that the number of LLD units in each was roughly proportional to their potency as tested in clinical use.

Preparation of B₁₂ from liver is an expensive process. Fortunately, however, it can be obtained from cultures of the mold *Streptomyces griseus*. Commercial preparations from this source are dispensed under the name "cobione."

A significant property of B₁₂ is its content of cobalt, found to be present in both the American and the English preparations. The substance crystallizes in small red needles. The color seems inseparable from potency and is apparently proportional to the Co content. The Co is found in the ash along with P in ratio Co:P = 1:3. It contains N but no S. On the basis of one atom of Co per molecule, the minimal molecular weight would be some 1,500 to 1,600. The presence of Co helps to solve a problem that has been before the biochemical world since 1937. It was then shown (Underwood) that Co was indispensable in the food for prevention of certain diseases of domestic animals, especially sheep, marked by a severe anemia. Discovery of vitamin B₁₂ opens the way to an explanation of the mechanism of the Co effect.

Vitamin B₁₂ may prove to be of real practical value. A case (1948) in clinical literature reports a remarkable use of it. PGA, at first helpful, had lost its effectiveness for the patient who later responded to liver-extract preparations but acquired a sensitivity to them so that they could not safely be used. The patient responded favorably, however, to vitamin B₁₂.

TABLE 31.—DATA PERTAINING TO HYPERVITAMINOSIS

Vitamin	Animals observed	Approximate ratio, toxic dose physiological intake	Hypervitaminosis symptoms
A	Rats	10,000	Growth failure, hemorrhage, abnormal fragility of bones
Thiamine	Dogs Rats Mice	70,000 5,000 30,000	No hypervitaminosis observed, ratio is that of lethal to therapeutic dose; poor lactation in 3rd generation of rats on thiamine-rich diet is prevented by Mn feeding
Riboflavin	Mice	Nontoxic ¹	A dosage 5,000 times the apparent daily requirement caused no symptoms
Pyridoxine	Rats, dogs, and monkeys Cats	Nontoxic ¹	No symptoms when dosage exceeds 1,000 times the physiological one Convulsions and nervous symptoms
Nicotinic acid	Dogs Man	More than 8,000 Very large	Prolonged high dosage is lethal Itching and burning skin sensations
Pantothenic acid	Man Rat	Nontoxic More than 20,000	Intravenous injections of 100 mg. caused no reactions
Inositol	Mice and rats	Very large	No toxic level of intake has been reached
Ascorbic acid	Guinea pigs Man	Nontoxic ¹	No hypervitaminosis at very high levels Mild diuresis
D	Rats Dogs and man	2,000 2,000	Digestive disorders, loss of weight, inflammation of kidneys, high blood calcium, and Ca deposits in tissues
E	Rats, dogs, and cats	Nontoxic	No symptoms when 1 or 2 g. were fed daily during 2 months
K ₁ and K ₂ , natural forms	Mice	Nontoxic	No serious effects when 25 g. per kg. were administered
Vitamin K substitutes such as 2-methyl-1,4-naphthoquinone	Dogs, rabbits, and man	Unknown, the physiological intake not determined	Vomiting, porphyrinuria, occasionally albuminuria

¹ Nontoxic in the sense that the toxic dose has not been attained.

Vitamin B₁₄ (Norris and Majnarich, 1949) has been isolated from urine in crystalline form and shows a stimulating effect upon the rate of proliferation of cells in a suspension of beef bone marrow. The substance is cobalt-free and distinctly different from vitamin B₁₂. As the authors suggest it may be more in the nature of a hormone than a vitamin and represents some part of the chemical mechanisms required for the com-

pletion of the hemopoietic process. The substance appears to be very potent. Maximal effects (a six- or sevenfold increase in red-cell production) were found when 1 part of the preparation was present in 10 billion parts of culture medium. In rats made anemic by sulfathiazole, one injection of 0.01 mg. was effective in relieving the anemia. The possible function of this substance will be discussed in connection with anemias (Chap. X).

Hypervitaminosis. Although vitamins are indispensable, they can, like any other metabolite, disturb the steady state of physiological processes if present in sufficiently high concentration in body tissues and fluids. A toxic level might be found for a vitamin as well as for any other dietary requirement or for a foreign substance. This fact has led some writers to deplore the prevalence of inexpensive vitamin concentrates on the market since the uninstructed might use them in physiological excess. Such a condition constitutes a hypervitaminosis and has been observed for a number of vitamins in laboratory animals. This danger, while certainly worthy of careful consideration, seems possible of undue exaggeration inasmuch as the "margin of safety" between *physiological* intake and the *toxic* level is wide in the case of each vitamin for which hypervitaminosis has been studied (Table 31). A lethal dose has not been found for the majority of the vitamins and they may, indeed, be classed pharmacologically as nontoxic.

REFERENCES

- So many useful books on vitamins are available that a selection is difficult. A standard and authoritative treatment will be found in "The Newer Knowledge of Nutrition" by E. V. McCollum, E. Orent-Keiles, and H. G. Day, 5th ed., New York, 1939.
- A more detailed treatment is to be found in "Chemistry and Physiology of the Vitamins" by H. R. Rosenberg, New York, 1942.
- Three monographs dealing with the avitaminoses are
- EDDY, W. H., and DALLDORF, G., "The Avitaminoses," Baltimore, 1941.
- HARRIS, L. J., "Vitamins and Vitamin Deficiencies," London, 1938.
- Hess, A. F., "Scurvy Past and Present," New York, 1920.
- An especially useful volume is the collection of reprints of authoritative treatments of many aspects of vitamin chemistry and physiology taken from the Journal of the American Medical Association and published as "The Vitamins: A Symposium," Chicago, 1939.
- Two specialized monographs are "Vitamin E. A Symposium," New York, 1940, and "Vitamin K," by H. R. Butt and A. M. Snell, Philadelphia, 1941.
- Among many reviews the following are selected:
- ALMQUIST, H. J., Vitamin K, *Physiol. Rev.*, 21, 194, 1941.
- ANSBACHER, S., Para-Aminobenzoic Acid—Experimental and Clinical Studies, *Vitamins and Hormones*, 2, 215, 1944.
- BEST, C. H., and RIDOUT, J. H., Choline as a Dietary Factor, *Ann. Rev. Biochem.*, 8, 349, 1939.
- DAM, H., Fat-soluble Vitamins, *Ann. Rev. Biochem.*, 9, 353, 1940.
- DUTCHER, R. A., and GUERRANT, N. B., The Vitamins, *Ann. Rev. Biochem.*, 15, 273, 1946.
- ELVEHEIM, C. A., Present Status of the Vitamin B Complex, *Am. Scientist*, 32, 25, 1944.
- EMBREE, N. D., Fat-soluble Vitamins, *Ann. Rev. Biochem.*, 16, 323, 1947.
- FROST, D. G., The Relation of Nutritional Deficiencies to Graying, *Physiol. Rev.*, 28, 368, 1948.
- HILLBRON, I. M., JONES, W. E., and BACHARACH, A. L., The Chemistry and Physiology of Vitamin A, *Vitamins and Hormones*, 2, 155, 1944.
- HECHT, S., The Chemistry of Visual Substances, *Ann. Rev. Biochem.*, 11, 465, 1942.

- HERTZ, R., Biotin and the Avidinbiotin Complex, *Physiol. Rev.*, **26**, 479, 1946.
- HICKMAN, K., Fat-soluble Vitamins, *Ann. Rev. Biochem.*, **12**, 353, 1943.
- JUKES, T. H., and STOKSTAD, E. L. R., Pteroylglutamic Acid and Related Compounds, *Physiol. Rev.*, **28**, 51, 1948.
- KING, C. G., Vitamin C, Ascorbic Acid, *Physiol. Rev.*, **16**, 238, 1936.
- LOOPBOUROW, J. R., Physical Methods for the Identification and Assay of Vitamins and Hormones, *Vitamins and Hormones*, **1**, 109, 1943.
- MELVILLE, D. B., The Chemistry of Biotin, *Vitamins and Hormones*, **2**, 29, 1944.
- NORRIS, L. C., and HEUSER, G. F., Water-soluble Vitamins, *Ann. Rev. Biochem.*, **14**, 469, 1945.
- OSER, B. L., The Vitamins, *Ann. Rev. Biochem.*, **17**, 381, 1948.
- PAPPENHEIMER, A. N., Muscular Disorders Associated with Deficiency of Vitamin E, *Physiol. Rev.*, **23**, 37, 1943.
- SNELL, E. E., Growth Factors for Microorganisms, *Ann. Rev. Biochem.*, **15**, 375, 1946.
- SNELL, E. E., Use of Microorganisms for Assay of Vitamins, *Physiol. Rev.*, **28**, 255, 1948.
- SPIES, T. D., The Use of Pteroylglutamic Acid (Liver *L. casei* Factor, Folic Acid) in Clinical Studies, *Ann. Rev. Biochem.*, **16**, 387, 1947.
- SPIES, T. D., Clinical Aspects of Vitamins, *Ann. Rev. Biochem.*, **17**, 449, 1948.
- WALD, GEORGE, The Photoreceptor Function of the Carotenoids and Vitamins A, *Vitamins and Hormones*, **1**, 195, 1943.
- WILLIAMS, R. J., Water-soluble Vitamins, *Ann. Rev. Biochem.*, **12**, 305, 1943.
- WOOLLEY, D. W., Water-soluble Vitamins, *Ann. Rev. Biochem.*, **16**, 359, 1947.
- The following are selected from the wealth of papers on vitamin research:
- ABBASY, M. A., *et al.*, Vitamin C and Infection, Diagnosis of Vitamin C Subnutrition by Urine Analysis, *Lancet*, **233**, 177, 181, 1937.
- ANDERSON, H. D., ELVEHEM, C. A., and GONCE, J. E., JR., Vitamin E Deficiency in Dogs, *Proc. Soc. Exptl. Biol. Med.*, **42**, 750, 1939.
- ANGIER, R. B., *et al.*, The Structure and Synthesis of the Liver *L. casei* Factor, *Science*, **103**, 667, 1946.
- ASENJO, C. F., and DE GUZMÁN, A. R. F., The High Ascorbic Acid Content of the West Indian Cherry, *Science*, **103**, 219, 1946.
- BAUMANN, C. A., RÜSING, B. M., and STEENBOCK, H., The Absorption and Storage of Vitamin A in the Rat, *J. Biol. Chem.*, **107**, 705, 1934.
- BAXTER, J. G., and ROBESON, C. D., Crystalline Vitamin A Palmitate and Vitamin A Alcohol, *Science*, **92**, 203, 1940.
- BERGEL, F., JACOB, A., TODD, A. R., and WORK, T. S., Vitamin E: Structure of β -Tocopherol, *Nature*, **141**, 646, 1938; *Nutr. Abs. & Rev.*, **8**, 358, 1938.
- BESSEY, O. A., and KING, C. G., The Distribution of Vitamin C in Plant and Animal Tissues and Its Determination, *J. Biol. Chem.*, **103**, 687, 1933.
- BESSEY, O. A., and WOLBACH, S. B., Vascularization of the Cornea of the Rat in Riboflavin Deficiency, *J. Exptl. Med.*, **69**, 1, 1939.
- BICKNELL, F., Vitamin E in the Treatment of Muscular Dystrophies and Nervous Diseases, *Lancet*, **237**, 10, 1940.
- BILLS, C. E., HONEYWELL, E. M., WIRICK, A. M., and NUSSMEIER, M., A Critique of the Line Test for Vitamin D, *J. Biol. Chem.*, **90**, 619, 1931.
- BINKLEY, S. B., MCKEE, R. W., THAYER, S. A., and DOISY, E. A., The Isolation of Vitamin K, *J. Biol. Chem.*, **130**, 219, 1939.
- BIRCH, T. W., and HARRIS, L. J., Bradycardia in the Vitamin B-deficient Rat and Its Use in Vitamin B₁ Determinations, *Biochem. J.*, **28**, 602, 1934.
- BOER, J., JANSEN, B. C. P., and KENTIE, A., The Role of Vaccenic Acid in Nutrition, *Nature*, **158**, 201, 1946.
- COX, C. J., Crystallized Vitamin C and Hexuronic Acid, *Science*, **86**, 540, 1937.
- DARBY, W. J., JONES, E., and JOHNSON, H. C., The Use of Synthetic *L. casei* Factor in the Treatment of Sprue, *Science*, **103**, 108, 1946.
- DU VIGNEAUD, V., MELVILLE, D. B., GYÖRGY, P., and ROSE, C., On the Identity of Vitamin H with Biotin, *Science*, **92**, 62, 1940.
- EAKIN, R. E., MCKINLEY, W. A., and WILLIAMS, R. J., Egg-white Injury in Chicks and Its Relationship to a Deficiency of Vitamin H (biotin), *Science*, **92**, 224, 1940.
- EMERSON, O. H., The Structure of Beta and Gamma Tocopherols, *J. Am. Chem. Soc.*, **60**, 1741, 1938.
- EVANS, H. M., EMERSON, O. H., and EMERSON, G. A., The Isolation from Wheat Germ Oil of an Alcohol, α -Tocopherol, Having the Properties of Vitamin E, *J. Biol. Chem.*, **113**, 319, 1936.
- FARBER, S., *et al.*, The Action of Pteroylglutamic Conjugates on Man, *Science*, **106**, 619, 1947.
- FIESER, L. F., The Synthesis of Vitamin K, *Science*, **91**, 31, 1940.
- FOOTS, P. J., HELMER, O. M., LEPKOVSKY, S., and JUKES, T. H., Treatment of Pellagra with Nicotinic Acid, *Proc. Soc. Exptl. Biol. Med.*, **37**, 405, 1937.

- GOLDSMITH, G. A., and ELLINGER, G. F., Ascorbic Acid in Blood and Urine after Oral Administration of a Test Dose of Vitamin C, *Arch. Internal Med.*, 63, 531, 1939; *Chem. Abs.*, 33, 4298, 1939.
- GOODHART, R., and SINCLAIR, H. M., Deficiency of Vitamin B in Man as Determined by the Blood Cocarboxylase, *J. Biol. Chem.*, 132, 11, 1940.
- GYÖRGY, P., and POLING, C. E., Pantothenic Acid and Nutritional Achromotrichia in Rats, *Science*, 92, 202, 1940.
- HAMAN, R. W., and STEENBOCK, H., The Antirachitic Effectiveness of Vitamin D from Various Sources, *J. Biol. Chem.*, 114, 505, 1936.
- HAWKINS, W. W., and BARSKY, J., An Experiment on Human Vitamin B₁ Deprivation, *Science*, 108, 284, 1948.
- HECHT, S., and MANDELBAUM, J., Dark Adaptation and Experimental Human Vitamin A Deficiency, *Am. J. Physiol.*, 130, 651, 1940.
- HEILBRON, I. M., JONES, R. N., SAMANT, K. M., and SPRING, F. S., The Constitution of Calciferol, *J. Chem. Soc.*, 1936, 905, 1936.
- HOLMES, H. N., and CORBET, R. E., The Isolation of Crystalline Vitamin A, *J. Am. Chem. Soc.*, 59, 2042, 1937.
- KARRER, P., and EPPRECHT, A., A General Method of Preparing 2-methyl-3-alkyl-naphthoquinones. Constitution and Vitamin K Activity, *Nutr. Abs. & Rev.*, 10, 62, 1940.
- KARRER, P., and JENSEN, K. A., Structural Specificity for Vitamin E Activity, *Helv. Chim. Acta*, 21, 1622, 1940; *Chem. Abs.*, 33, 2183, 1938.
- KARRER, P., and RUEGGER, A., Synthesis of Vitamin A, *Helv. Chim. Acta*, 23, 284, 1940; *Chem. Abs.*, 34, 5418, 1940.
- KIDDER, G. W., and FULLER, R. C., III, The Growth Response of *Tetrahymena geleii* W to Folic Acid and to the *Streptococcus lactis* R Factor, *Science*, 104, 160, 1946.
- KOHLER, G. O., ELVEHJEM, C. A., and HART, E. B., The Relation of the "Grass Juice Factor" to Guinea Pig Nutrition, *J. Nutrition*, 15, 445, 1938.
- LARDY, H. A., POTTER, R. L., and ELVEHJEM, C. A., The Role of Biotin in Bicarbonate Utilization by Bacteria, *J. Biol. Chem.*, 169, 451, 1947.
- LIPSCHITZ, M. A., POTTER, VAN R., and ELVEHJEM, C. A., The Relation of Vitamin B₁ to Cocarboxylase, *Biochem. J.*, 32, 474, 1938.
- LUCKEY, T. D., MOORE, P. R., ELVEHJEM, C. A., and HART, E. B., The Activity of Synthetic Folic Acid in Purified Rations for the Chick, *Science*, 103, 682, 1946.
- MACKENZIE, C. G., and MCCOLLUM, E. V., The Cure of Nutritional Distrophy in the Rabbit by Alphatocopherol and Its Effect on Creatine Metabolism, *J. Nutrition*, 19, 345, 1940.
- MITCHELL, H. K., SNELL, E. E., and WILLIAMS, R. J., The Concentration of "Folic Acid," *J. Am. Chem. Soc.*, 63, 2284, 1941.
- MOORE, T., The Vitamin A Reserve of the Adult Human Being in Health and Disease, *Biochem. J.*, 31, 155, 1937.
- MUNRO, H. N., LAZARUS, S., and BELL, G. H., The Value of Capillary Strength Tests in the Diagnosis of Vitamin C and Vitamin P Deficiency in Man, *Nutr. Abs. & Rev.*, 17, 291, 1947.
- NORRIS, E. R., and MAJNARICH, J. J., Vitamin B₁₂ and Cell Proliferation, *Science*, 109, 32-35, 1949.
- OSBORNE, T. B., and MENDEL, L. B., Ophthalmia as a Symptom of Dietary Deficiency, *Am. J. Physiol.*, 69, 543, 1924.
- RANDLE, S. B., SOBER, H. A., and KOHLER, G. O., The Distribution of the "Grass Juice Factor" in Plant and Animal Materials, *J. Nutrition*, 20, 459, 1940.
- RICKES, E. L., BRINK, N. G., KONIUSZY, F. R., WOOD, T. R., and FOLKERS, K., Crystalline Vitamin B₁₂, *Science*, 107, 396, 1948.
- RICKES, E. L., *et al.*, Vitamin B₁₂, a Cobalt Complex, *Science*, 108, 134, 1948.
- ROSS, L. E., VAN WAGTENDONK, W. J., and WULZEN, R., Evidence for a Sterid Compound in Cane Juice Possessing Antistiffness Activity, *Proc. Soc. Exptl. Biol. Med.*, 71, 281, 1949.
- SCARBOROUGH, H., Vitamin P, *Biochem. J.*, 33, 1400, 1939.
- SCARBOROUGH, H., Nutritional Deficiency of Vitamin K in Man, *Lancet*, 1940 I, 1080; *J. Am. Med. Assoc.*, 115, 491, 1940.
- SEIMOTORI, N., EMERSON, G. A., and EVANS, H. M., The Prevention of Nutritional Muscular Dystrophy in Guinea-pigs with Vitamin E, *J. Nutrition*, 19, 547, 1940.
- SHORE, M. S., Activity of Vitamin B₁₂ for the Growth of *Lactobacillus lactis*, *Science*, 107, 397, 1948.
- SMITH, S. E., WILLIAMS, S. A., BAUER, A. C., and MAYNARD, L. A., The Wrist Stiffness Syndrome in Guinea Pigs, *J. Nutrition*, 38, 87, 1949.
- SPIES, T. D., SUAREZ, R. M., SUAREZ, R. M. JR., and HERNANDEZ-MORALES, F., The Therapeutic Effect of Folic Acid in Tropical Sprue, *Science*, 104, 75, 1946.
- STILLER, E. T., HARRIS, S. A., FINKELSTEIN, J., KERBSTETZ, J. C., and FOLKERS, K., The Total Synthesis of Pure Pantothenic Acid, *J. Am. Chem. Soc.*, 62, 1785, 1940.

- SYDENSTRICKER, V. P., GEESLIN, L. E., TEMPLETON, C. M., and WEAVER, J. W., Riboflavin Deficiency in Human Subjects, *J. Am. Med. Assoc.*, 113, 1697, 1939.
- SYDENSTRICKER, V. P., SEBRELL, W. H., CLECKLEY, H. M., and KRUSE, H. D., The Ocular Manifestations of Ariboflavinosis, *J. Am. Med. Assoc.*, 114, 2437, 1940.
- TOTTER, J. R., MIMS, V., and DAY, P. L., Further Studies on the Relationship between Xanthopterin, Folic Acid and Vitamin M, *Science*, 100, 223, 1944.
- VOGELANG, A., and SHUTE, E. V., Effect of Vitamin E in Coronary Heart Disease, *Nature*, 157, 772 1946.
- WADDELL, W. W., JR., and GUERRY, D., Effect of Vitamin K on the Clotting Time of the Prothrombin and the Blood with Special Reference to Unnatural Bleeding of the Newly Born, *J. Am. Med. Assoc.*, 112, 2259, 1939.
- WALD, G., Carotenoids and the Visual Cycle, *J. Gen. Physiol.*, 19, 351, 1935.
- WALD, G., The Distribution of Vitamin A₁ and A₂, *J. Gen. Physiol.*, 22, 391, 1939.
- WEST, R., Activity of Vitamin B₁₂ in Addisonian Pernicious Anemia, *Science*, 107, 398, 1948.
- WILLIAMS, R. J., and MAJOR, R. T., Structure of Panthothenic Acid, *Science*, 91, 246, 1940.
- WILLIAMS, R. R., and CLINE, J. K., Synthesis of Vitamin B₁, *J. Am. Chem. Soc.*, 58, 1504, 1936.
- WOOLLEY, D. W., Some Correlations of Growth-promoting Powers of Proteins with Their Strepogenin Content, *J. Biol. Chem.*, 162, 383, 1946.
- WOMACK, M., and ROSE, W. C., Evidence for the Existence of an Unidentified Growth Stimulant in Proteins, *J. Biol. Chem.*, 162, 735, 1946.
- WRIGHT, L. D., and WELCH, A. D., The Production of Folic Acid by Rat Liver in Vitro, *Science*, 98, 179, 1943.
- WULZEN, R., and BARRS, A. M., Effects of Milk Diets on Guinea Pigs, *Am. J. Physiol.*, 133, 500, 1941

CHAPTER VII

ENZYMES

Many of the chemical reactions occurring in living matter or under its influence require, *in vitro*, higher temperatures or other more intense energies than are compatible with life. For example, the hydrolysis of polysaccharides or of proteins by the use of acid requires boiling temperature and a toxic degree of acidity. Yet in the digestive system or in cells these reactions occur readily. The cell reagents which make this possible are the enzymes. Just as catalysts can facilitate reactions in nonliving systems, so enzymes, the catalysts of living matter, make biochemical reactions possible.

The early history of knowledge about enzymes was bound up with the study of fermentation. Fermentation processes as brought about by yeast and bacteria attracted attention and were naturally compared with digestive processes in the stomach and intestines. In view of certain similarities thus observed, the action of microorganisms was said to be due to organized ferments while digestive and similar changes were attributed to unorganized ferments. The term "ferments" is still often used, especially by German writers, in the same sense as "enzymes." The latter word, introduced by Kühne in 1878, means "in yeast" and was intended to refer to any substances produced by living cells and influencing reactions in ways comparable to the effects of the hypothetical yeast material which caused fermentation. That such a material is a distinct entity able to cause the fermentation of sugar to $\text{CO}_2 + \text{H}_2\text{O}$ without the presence of any living yeast cells was not actually proved until 1897, when Buchner overcame the difficulties which had previously interfered with the success of this significant experiment. Separation of the enzyme from yeast was attained by grinding the cells with sharp sand and subjecting them to high-pressure filtration. The "yeast juice" thus obtained was free from any microscopically visible structures yet could cause very rapid fermentation of sugar. Buchner gave the name "zymase" to the enzyme thus indicated to be a yeast constituent. It is now regarded as a mixture of several enzymes. His discovery did away with the old distinction between organized and unorganized ferments but revealed a distinction between two types of enzymes: Those easily separated from other cellular material, the *lyoenzymes* or *extracellular*

enzymes; and those not easily separated, the *desmoenzymes* or *intracellular enzymes*.

A more modern name, **biocatalyst**, suggested by Bayliss, though in good usage, seems to make little headway in replacing the familiar name *enzyme*.

Types of Enzymes. Any given enzyme tends to be a catalyst for a specific chemical reaction. We may thus group enzymes roughly according to the nature of the catalyzed reaction. Two large groups are the hydrolyzing enzymes and those concerned with oxidation and reduction. A number of enzymes do not belong in either of these groups. They include transferring enzymes and isomerizing enzymes.

Nomenclature. Enzymes are named in general by adding the suffix *-ase* to a root word chosen to indicate the functioning of the enzyme. In the majority of cases this word is derived from the substrate. The substrate is the compound or class of compounds, some reaction of which is catalyzed by the enzyme. Thus, sucrose is the substrate of sucrase; protein, of proteinase (protease); starch (*amylum*), of amylase. Enzymes are also designated according to the nature of the catalyzed reaction. Thus, hydrolases affect hydrolysis, oxidases catalyze oxidation, deaminases split out an amino group, mutases cause molecular internal rearrangement, etc.

Enzymes investigated before the modern convention was adopted are still called by older names, such as pepsin, rennin, trypsin, papain, ptyalin, etc.

Classification of Enzymes. Although not entirely satisfactory, a grouping of enzymes according to the nature of the substrate and of the catalyzed reaction affords a useful survey.

1. Proteinases, hydrolysis of proteins
 2. Peptidases, hydrolysis of peptides
 3. Deaminases, splitting off the amino group
 4. Esterases, hydrolysis of esters
 - a. Lipases, splitting of fats
 - b. Phosphatases, hydrolysis of esters of phosphoric acid
 - c. Other esterases, hydrolysis of various esters
 5. Carbohydrases, hydrolysis of carbohydrates
 - a. Amylases, hydrolysis of starch, glycogen, and dextrin
 - b. Specific carbohydrases, *e.g.*, inulase, cellulase, etc.
 - c. Glucosidases, more or less specific for hydrolysis of glucosides and disaccharides (p. 22), *e.g.*, α - and β -glucosidases, such as maltase and emulsin; the specific enzymes, such as sucrase (invertase), etc.
 6. Enzymes concerned with oxidation and reduction: The complex behavior of these enzymes and the different degrees of specificity among them make their arrangement in subgroups somewhat peculiar. They will be described and grouped in Chap. XII.
- } These enzymes break the C—N linkage

7. Enzymes catalyzing specific types of reactions, *e.g.*, *fumarase*, changing fumaric acid, $\begin{array}{c} \text{CH-COOH} \\ | \\ \text{CH-COOH} \end{array}$, to malic acid, $\begin{array}{c} \text{CHOH-COOH} \\ | \\ \text{CH}_2\text{-COOH} \end{array}$; *carboxylase*, catalyzing the liberation of CO_2 from the carboxyl group; *carbonic anhydrase*, catalyzing the liberation of CO_2 from carbonic acid or carbonates; and a number of other miscellaneous enzymes.

Properties of Enzymes. Enzymes are generally investigated by observing the catalytic action of extracts of cells or of fractions precipitated from such extracts or from enzyme-containing secretions. It is thus found that enzymes are soluble in water, in dilute salt solutions, in mixtures of alcohol and water or of glycerol and water, are insoluble in sufficiently high concentration of alcohol, are salted out of aqueous solutions by neutral salts, and are precipitated by the majority of protein precipitants. One may say, in brief, that enzymes are proteins. Like all proteins, they show colloidal behavior; they cannot pass through dialyzing membranes and are precipitated by agents commonly used to throw down material in the colloidal state. They migrate to anode or cathode or to neither when an electric current passes through their solutions, and the movement, as in the case of all proteins, is determined by the pH of the solutions. They are thus shown to dissociate as ampholytes and to exhibit an isoelectric condition.

Purification and Crystallization. If use is made of the solubility, salting-out, and precipitation properties used in the separation of proteins, enzymes may be prepared in highly concentrated form. In the case of some of them, purification has led to crystallization in what appears to be chemical purity or a close approach to it.

The procedure used by Northrop and Kunitz in making pure crystalline trypsin and chymotrypsin will serve to illustrate some of the methods of separation although the method varies for each enzyme preparation.

Beef pancreas, used within 1 hr. after slaughter of the animals, is immersed in cold 0.25*N* H_2SO_4 . Later the tissue is drained, minced, and suspended 24 hr. in two volumes of 0.25*N* H_2SO_4 at 5°C. It is then strained through cloth. The acid extract is treated with solid $(\text{NH}_4)_2\text{SO}_4$ to 0.4 saturation to precipitate extraneous protein, which is filtered off and discarded. The filtrate is brought to 0.7 saturation with solid $(\text{NH}_4)_2\text{SO}_4$ and held 2 days at 5°C. The enzymes are salted out in this fraction which is filtered off and dissolved in water. The fractionation with $(\text{NH}_4)_2\text{SO}_4$ is repeated. The precipitate is dissolved in 0.25 saturated $(\text{NH}_4)_2\text{SO}_4$, adjusted to pH 5, and held 2 days at 25°C. Crystals of chymotrypsinogen separate. The filtrate contains trypsinogen. After a number of recrystallizations chymotrypsinogen is dissolved in 0.2*N* H_2SO_4 , adjusted to pH 7.6, and treated with a trace of trypsin,



FIG. 34 Chymotrypsin crystals. (*M. Kunitz and J. H. Northrop, J. Gen. Physiol.*, 18, 433, 1934)



FIG. 35. Trypsin crystals. (*M. Kunitz and J. H. Northrop, J. Gen. Physiol.*, 19, 991, 1935.)

which converts chymotrypsinogen to the active chymotrypsin during 2 days at 5°C. The solution of the active enzyme is adjusted to pH 4.0 and salted out in 0.7 saturated $(\text{NH}_4)_2\text{SO}_4$. The resulting amorphous precipitate is dissolved in 0.01*N* H_2SO_4 , retained at 25°C. for 24 hr., during which time crystals of chymotrypsin form.

The filtrate from the chymotrypsinogen crystals is refractionated with $(\text{NH}_4)_2\text{SO}_4$, and the material salted out in 0.7 saturated $(\text{NH}_4)_2\text{SO}_4$



FIG 36. Pepsin crystals. (J. H. Northrop, *Harvey Lectures*, 1934-1935)

is washed with saturated MgSO_4 , dissolved in 0.4*M* borate solution at pH 9.0, cooled to 5°C., and made 0.5 saturated with MgSO_4 . Upon standing some days at 5°C., crystals of trypsinogen form. After being washed with MgSO_4 solution, they are dissolved in 0.02*N* H_2SO_4 , made 0.5 saturated with MgSO_4 , buffered with 0.4*M* borate at pH 9, and retained at 5°C. Crystals of trypsin form after addition of a minute amount of trypsin-containing material. Conversion of trypsinogen to trypsin is autocatalytic, *i.e.*, catalyzed by trypsin itself.

The form of the crystals of chymotrypsin, trypsin, and pepsin is shown in Figs. 34 to 36.

Enzymes which have been obtained in crystalline forms are listed in Table 30.

Chemical Nature of Enzymes. Enzyme properties are those of proteins, and the crystalline enzyme preparations of the highest purity

attained are proteins, in some cases pure proteins. The natural conclusion is that enzymes are proteins. This idea has been questioned. A number of enzyme preparations practically separated from extraneous matter have been reported as failing to give any protein color reactions even though the enzyme activity was high. But, as Northrop and others have shown, the specific catalytic activity of a purified enzyme can be demonstrated when it is present in a concentration too low to show protein color tests. This is not unique inasmuch as catalysts in general

TABLE 32.—CRYSTALLINE ENZYMES

Enzyme	Investigator	Date
Urease.....	Sumner	1926
Pepsin ¹	Northrop	1930
Trypsin ¹	Northrop and Kunitz	1932
Chymotrypsin ¹	Northrop and Kunitz	1933
Flavoprotein (a respiratory enzyme).....	Theorell	1934
Carboxypeptidase.....	Anson	1935
Catalase.....	Sumner and Dounce	1937
Ficin (from <i>Ficus latex</i>).....	Walti	1938
Ascorbic acid oxidase.....	Tadokoro and Takasugi	1939
Papain.....	Balls and Lineweaver	1939
Ribonuclease.....	Kunitz	1939
Lactic dehydrogenase.....	Straub	1940
Phosphorylase.....	Green, Cori, and Cori	1942

¹ Also obtained as the crystalline zymogens, pepsinogen, trypsinogen, and chymotrypsinogen.

Others obtained in crystalline form are amylase, carbonic anhydrase, carboxylase, alcohol dehydrogenase, lecithinase, and tyrosinase. The list, growing slowly during a decade, is now increasing rapidly as application of the already developed techniques becomes more widespread. Northrop's "Crystalline Enzymes" (1948 edition) lists 39.

can act in what might be called infinitesimally small amounts, and as all protein color tests fail at some low but known concentration.

It is also pointed out that the catalytic enzyme effect may be due to some material accompanying the protein, possibly adsorbed upon it or perhaps constituting one substituent group (prosthetic group) or a "side chain" of the main protein molecule. For some enzymes this is doubtless true, and the active or prosthetic group can be reversibly separated as a nonprotein substance. The remaining protein has no enzyme activity and is reactivated only by restoring the prosthetic group. The latter, however, is also inactive by itself, so that even here *the enzyme appears actually to be a protein although a compound one*. The nature of the enzymes with prosthetic groups will be discussed in a later chapter. They are the ones concerned with bio-oxidation.

Most of the enzymes obtained in crystalline form are simple proteins. Some of them, including trypsin and chymotrypsin, afford evidence of being isolated, chemically pure, individual substances (p. 115). Moreover, certain chemical treatments such as hydrolysis or denaturation, which progressively destroy the protein structure, are accompanied by a parallel progressive decrease in enzyme activity. Neither this nor any other available evidence proves conclusively that the entire protein molecule is directly concerned in the catalytic effect and, as will be shown in discussing enzyme specificity, certain groupings of the protein molecule appear to confer catalytic activity.

A number of enzymes obtained in highly concentrated or isolated forms have been shown to contain some metallic element, and in some of these cases enzymatic activity is known to depend upon the presence of the metal. Metal-containing proteins are not uncommon in nature, and in view of the effectiveness of metals as inorganic catalysts, their presence in biocatalysts is of interest. Enzymes which appear to be metal-containing are listed as follows:

Iron-containing:

- Peroxidase, breaks down peroxides with formation of "active" oxygen
- Cytochrome oxidase, causes oxidation of reduced cytochrome (see Chap. XII)
- Catalase, liberates molecular O_2 from H_2O_2
- A number of others probably contain Fe

Copper-containing:

- Polyphenol oxidase, catalyzing a number of oxidations
- Tyrosinase, might be identical with polyphenol oxidase
- Laccase, a phenol oxidase
- Ascorbic acid oxidase probably contains Cu

Manganese-containing:

- Arginase, splits arginine to urea and ornithine, is activated by Mn^{++} ions as are also certain esterases
- An enzyme required for ascorbic acid synthesis in liver seems to require Mn

Vanadium-containing:

- An enzyme catalyzing oxidation of phospholipids in liver

Zinc-containing:

- Carbonic anhydrase of erythrocytes
- Peptidase of yeast

Magnesium-containing:

- Carboxylase, oxidizing pyruvic acid

Calcium-containing:

- Enzymes concerned with coagulation of blood require Ca which may be a part of the enzyme

Cobalt-containing:

- Vitamin B_{12} , containing Co, seems to have a catalytic function

Specificity. All enzymes are restricted to the catalysis of a specific reaction or type of reaction. Some may cause the hydrolysis of a large

group of substrates of similar structure, *e.g.*, pepsin hydrolyzes all soluble native proteins; others are active with a few substrates, *e.g.*, salivary amylase hydrolyzes starch, glycogen, and dextrin but has no effect on other similar carbohydrates; some enzymes, while active with a number of substrates, are known to be specific for a given stereoisomeric structure of the substrate, *e.g.*, the α - and β -glucosidases (p. 22); a few enzymes appear to be constructed for catalyzing a specific reaction of one substrate, *e.g.*, urease catalyzes the breakdown of urea to NH_3 and CO_2 . Of a considerable number of similar compounds which might be possible substrates for urease, all fail to be attacked. It is clear that the specificity of enzymes is a relative matter.

The nature of enzyme specificity was epitomized by Emil Fischer in what is called the "lock and key" theory: An enzyme to be effective must fit the molecule of the substrate somewhat as a key fits into a lock. Some enzymes appear to be "master keys" in that they can fit into a considerable number of substrates possessing certain similarities of atomic grouping in their molecules.

A case which has been investigated in exceptional detail is that of the specificity of dipeptidase of mammalian pancreas or intestine. This enzyme is regarded as catalyzing the hydrolysis of dipeptides. The latter in the form of synthetic compounds of known structure, either free or in the form of derivatives, were tested to determine whether or not they could serve as substrate for the enzyme. It was found that

1. Only the natural stereoisomer could be hydrolyzed; thus glycyl-L-leucine could be split but not glycyl-D-leucine;

2. The imino, $-\text{NH}-$, and the amino, $-\text{NH}_2$, groups cannot have alkyl or acetyl or other substituent groups in the place of the hydrogen;

3. The hydrogen of the α -carbon atom must not be substituted in either amino acid residue;

4. The free carboxyl group, $-\text{COOH}$, may be esterified without causing interference, thus indicating that this group is not a point of attack by the enzyme.

Bergmann, who with his coworkers was a leading investigator in this field, summarizes these results in the manner indicated in Fig. 37. Even if Bergmann's theory of this particular mechanism should require future modification, it serves admirably to illustrate the general theory of the "lock and key" relationship.

The specifications for substrate vulnerability differ in the case of different enzymes. Thus Bergmann has shown that dipeptides, in order to be split by crystalline pepsin, must have a free carboxyl group although this is not required for splitting by dipeptidase.

The Effect of Varying the Enzyme Concentration. With a highly purified enzyme, the initial rate of the catalyzed reaction is directly proportional to the enzyme concentration over a fairly wide range (Fig. 38). This cannot be shown with incompletely purified

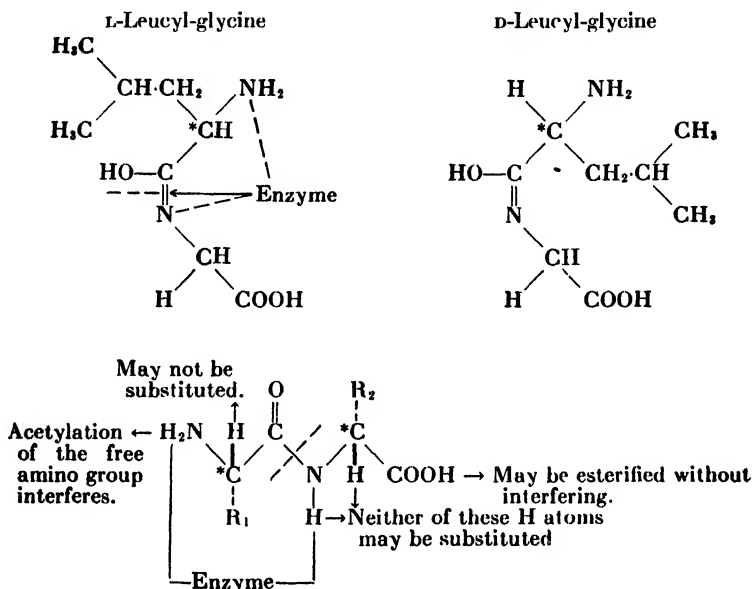

Fig. 37. Scheme to illustrate Bergmann's results of studies of the specificity of a dipeptidase. The asymmetric C atoms indicated by asterisks are represented as oriented so that the parts of the amino acid residues not shown (R_1 and R_2) are cis to each other. This leaves the corresponding H atoms on the same side of the main plane of the $-\text{CO}-\text{CH}-\text{NH}-\text{CO}-$ chain and, owing to the small size of the H atoms, permits a relatively close approach (a "fit") between the enzyme and the substrate. In order that cleavage by hydrolysis shall occur at the point indicated by a dotted line, the enzyme-substrate combination must form, and this appears to involve the amino and imino groups of the substrate since substitution upon them interferes with hydrolysis.

The formulas of L-leucyl-glycine and D-leucyl-glycine (equalized forms) serve to indicate the "fit" of the enzyme on the natural form.

enzymes as Northrop demonstrated in the case of proteases because of the presence of inhibitors (Fig. 39). The latter are, in general, interfering proteins which can combine either with the enzyme or the substrate. Even with purified enzyme preparations the proportionality must eventually fail because the concentration of the substrate becomes a limiting factor. In advanced stages of the enzyme action the accumulation of the products may block the reaction. This may happen even in a

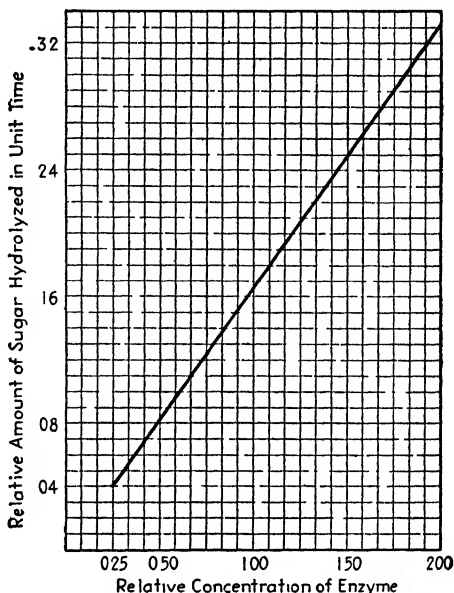

FIG. 38. The effect of increase in concentration of the enzyme upon the initial rate of the reaction. The enzyme sucrase hydrolyzes sucrose so that the amount of the sugar changed during the first 15 minutes of the reaction is directly proportional to the concentration of the enzyme. The initial concentration of the sugar was the same in all measurements. (Data of Hudson.)

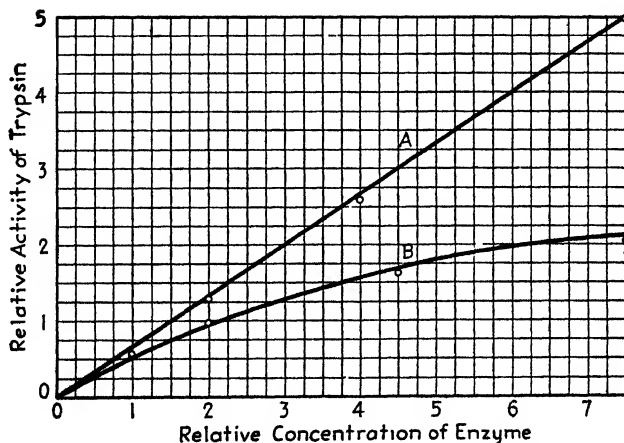

FIG. 39. The effect of inhibitor on the activity-concentration curve of trypsin. Curve A represents the effect of varying the concentration of pure trypsin. Curve B represents the effect of varying the concentration of a mixture of trypsin and inhibitor but keeping the ratio of enzyme and inhibitor constant. (After Northrop.)

comparatively early stage. The effects of inhibitors could account for an older concept known as the Schütz rule: The rate of the reaction is proportional to the square root of the enzyme concentration. This rule is

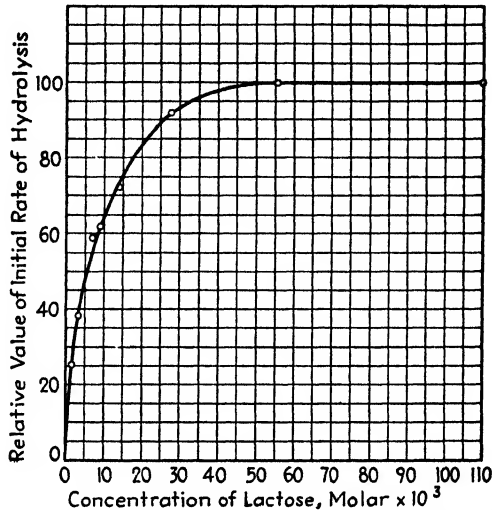

FIG. 40. The effect of substrate concentration on the initial rate of enzyme action. (Data of Lineweaver and Burk.)

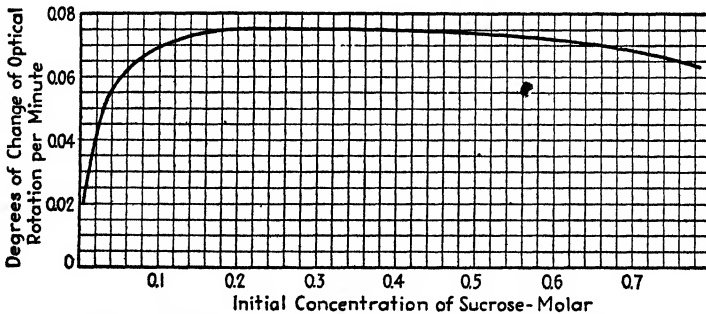

FIG. 41. The effect of substrate concentration on the activity of the enzyme, sucrose. The first part of the curve follows the same course as that of Fig. 40 (lactase) but sufficiently high concentration of the substrate causes the rate to fall off somewhat. (Data from experiments of Michaelis and Menten.)

demonstrated to hold within certain limits of enzyme concentration of pepsin in a crude state.

Substrate Concentration Effects. Holding the concentration of the enzyme and all other conditions constant except the concentration of the substrate, it is found that the initial rate of the reaction increases

with rise in substrate concentration up to a certain maximum (Table 33 and Fig. 40) but that with higher substrate concentrations no further increase in the rate is obtained. This is apparently due to the limitation of the rate of formation of the enzyme-substrate complex, which reaches a maximum determined by the concentration of the enzyme and thus becomes the limiting factor for the rate of the process. At sufficiently high concentrations the rate may be actually diminished (Fig. 41).

The pH Effect. The hydrogen-ion activity of its medium affects every enzyme. Extreme acidity or alkalinity causes irreversible destruc-

TABLE 33.—EFFECT OF CONCENTRATION OF SUBSTRATE ON INITIAL RATE OF ENZYME ACTION

(Data of Lineweaver and Burk on lactase)

Lactose concentration, molar	Lactose hydrolyzed in 4 hr., mg.	Relative rate, per cent
0.002	6.0	25
0.0035	9.3	38
0.007	14.4	59
0.009	15.0	62
0.014	17.5	72
0.028	22.5	92
0.056	24.4	100
0.110	24.3	100

tion. Exposure to lesser degrees of acidity or alkalinity may cause reversible inactivation in the case of some enzymes. For every enzyme there is an optimal pH at which the enzyme exhibits its maximal activity. In most cases the optimum is not sharply defined and might perhaps be designated as an "optimal zone." The effect is illustrated in Fig. 42. The pronounced contrast in the optimal pH zones of pepsin and of trypsin is shown in Fig. 43.

The explanation of the pH optimum is sought in the electrolytic dissociation of proteins. There is evidence, in the case of some purified enzymes, that their optimal pH does not differ greatly from their own isoelectric points or isoelectric zones, but the correspondence is not close in the case of all enzymes. Michaelis and coworkers found evidence indicating that invertase (sucrase) showed maximum activity when its behavior (see p. 110) as acid or as base was minimal. For crystalline pepsin and trypsin this is also true in a general way, although the effect of the enzyme dissociation is somewhat overshadowed by that of the substrate dissociation. It will be seen in Fig. 43 that the dissociation

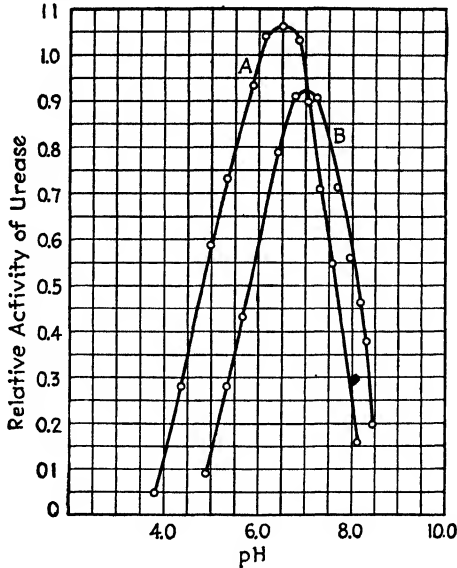

FIG. 42. Activity of the enzyme, urease, as affected by pH. A 2.5 per cent solution of urea was acted on by the urease preparation at differing pH, regulated in measurements for curve A by the use of $M/3$ citrate buffer and for curve B by the use of $M/8$ phosphate buffer. The activity in citrate buffer is slightly higher and the optimum pH (6.5) slightly lower than in phosphate buffer. In the latter the pH optimum is 6.9. (These curves are drawn from experiments reported by Howell and Sumner.)

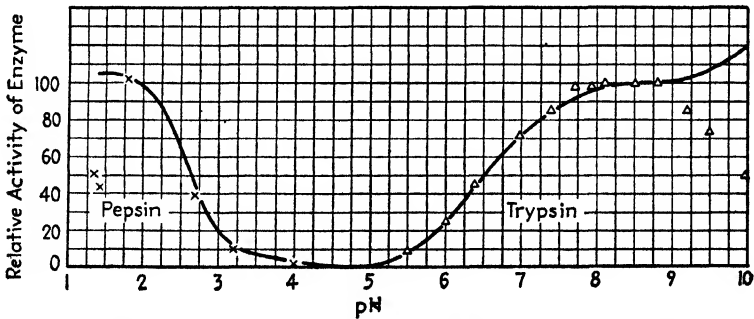

FIG. 43. The effect of pH upon the activity of pepsin and trypsin with casein as substrate. The curve represents the relative dissociation of casein—as cation at pH values below its isoelectric point (about 4.8) and as anion on the other side of the isoelectric point. Points marked X show relative activity of pepsin; those indicated by triangles show relative activity of trypsin. The enzyme activity is proportional to the dissociation of the substrate except when the pH is too low for good peptic activity or too high for good tryptic activity. The pH optimum for protease activity may vary with different substrates and the corresponding differences in the dissociation curves of the substrate proteins help to explain this fact. (Data used in this figure are taken from experiments reported by Northrop.)

of the substrate *casein* as cation when digested by pepsin or as anion when digested by trypsin rises to a maximum in the zone where the rate of digestion is maximal. On account of these complexities, the optimum pH for a proteinase may differ with the character of the substrate. Thus, the optimum for pepsin, acting on casein, is pH 1.5 (approximately) but, acting on gelatin, is about pH 3.0.

TABLE 34.—OPTIMUM pH VALUES FOR ACTIVITY OF REPRESENTATIVE ENZYMES¹

Enzyme	Optimum pH
Amylase, salivary, acetate buffer	5.6
phosphate buffer	6.5
Pancreatic	6.8-7.0
Malt	4.4-5.2
Catalase, liver	7.0
β -Glucosidase	5.0
Lactase, dog intestine	5.4-6.0
Calf intestine	5.0
Yeast	7.0
Lipase, pancreatic	8.0
Castor oil plant	4.7
Maltase, intestine	6.1-6.8
Yeast	6.7-7.2
Papain from fruit of the papaw (<i>Carica papaya</i>)	About 5.5 (active, 4-7)
Pepsin, albumin as substrate	1.5
Casein as substrate	1.8
Hemoglobin as substrate	2.2
Phosphatase, bone	8.4
Plasma	9.0
Plants	3.4-6.0
Sucrase, intestine	6.8
Yeast	4.5
Trypsin	8.0
Urease, citrate buffer	6.5
phosphate buffer	6.9

¹ The data show that the optimum varies not only with the character of the enzyme, but also with the source, with the electrolyte used as buffer, and with the kind of substrate.

The optimum pH values of some representative enzymes are shown in Table 34.

Temperature Effects. An enzyme-catalyzed reaction tends to be increased in rate by rise in temperature, as is any chemical reaction. At abnormally low temperatures the enzyme effect is greatly retarded, practically disappears at 0°C., and becomes nil when the enzyme is in a frozen condition. One of the accepted methods for observing the temperature effect is measurement of the rate of the chemical reaction at two temperatures separated by an interval of 10°C. This gives the van't Hoff relationship known as the "temperature coefficient" or the "Q₁₀" value. A more general relationship was formulated by Arrhenius.

His equation may be written

$$\frac{d \ln k}{dT} = \frac{\mu}{RT^2}$$

where μ is the temperature characteristic and will be in calorie units if R , the gas constant, is given its numerical value in terms of calories per gram molecule per degree. Thus evaluated, $R = 1.98$, or approximately 2 calories.

The integrated equation is

$$k = Ce^{-\frac{\mu}{RT}}$$

but changed into logarithmic form and rearranged, it becomes

$$\ln k = C - \mu \frac{1}{RT}$$

It is written in this form in order to show that it is the equation of a straight line such that, if the log of the velocity be plotted against the reciprocal of the absolute temperature, the slope of the line is determined by μ . But as C (integration constant) is unknown, it is necessary, in order to find μ , to use the equation in another form. One integrates the Arrhenius equation between limits. Thus integrating between T_1 and T_2 one obtains

$$\frac{\text{Rate at } T_2}{\text{Rate at } T_1} = e^{\frac{\mu}{R}\left(\frac{1}{T_1} - \frac{1}{T_2}\right)}$$

or, in logarithmic form and with R substituted by its numerical value, 2

$$\ln (\text{rate at } T_2) - \ln (\text{rate at } T_1) = \frac{\mu}{2} \left(\frac{1}{T_1} - \frac{1}{T_2} \right)$$

from which μ can be found by measuring the rates at known temperatures.

The temperature characteristics or critical-energy increments as measured for certain enzymes are shown in Table 35. They may be thought of as the relative degrees to which the enzyme molecules have to be energized to render them active.

The effect of the enzyme is, as with catalysts in general, to lower the critical-energy increment for the reaction. Thus the decomposition of H_2O_2 in water alone shows a μ value of 18,000 cal.; catalyzed by the iodide ion, $\mu = 13,500$ cal.; with colloidal platinum, $\mu = 11,700$ cal.; and in the presence of catalase, an enzyme specific for this reaction, the μ value varies in different temperature ranges and with different H_2O_2 concentration but may be as low as 2100 cal. Another example is that

of sucrose inversion which, catalyzed by acid (H ion), has a μ value of 25,500 cal. but in the presence of the enzyme *sucrase* μ is approximately 9000 cal. These are merely quantitative statements of the simple fact that catalysts, including enzymes, facilitate chemical reactions so that they occur at lower temperatures (lower energy levels) than would otherwise be the case.

The protein characteristics of an enzyme, however, render it heat-sensitive, so that with rise in temperature two processes are affected:

TABLE 35.—ENERGY OF ACTIVATION OF SOME ENZYMES
(Taken from papers by W. J. Crozier and by I. W. Sizer)

Enzyme	Energy of activation (μ) cal.	Comment
Sucrase, yeast.....	10,700	Below 13 or 17°C.
	8,300	Above 13 or 17°C.
Sucrase, malt.....	13,000	
Urease, soybean.....	11,700 or 8,700	μ differs with medium
Urease, <i>Proteus vulgaris</i>	14,400, 11,700 or 8,700	μ differs with previous history of the culture
Xanthine and aldehyde dehydrogenase of milk	21,000, 18,000, 16,000 or 13,000	μ differs with the temperature range and nature of substrate
Anaerobic dehydrogenase of <i>E. coli</i> ...	25,000, 21,200, 19,400 or 15,000	μ differs with the concentration of the enzyme and nature of the substrate
Lipase, castor bean.....	16,700	Triacetin as substrate
Succinic dehydrogenase of bacteria...	16,700	Using methylene blue as H ₂ acceptor

(1) Speeding up of the reaction, involving enzyme activation, and (2) destruction of the enzyme because of its denaturation. Nearly all enzymes are inactivated by boiling. Prolonged heating at temperatures ranging from 40 to 60°C. or a shorter period at 80°C. destroys nearly all enzymes, while at 100°C. enzymes are inactivated almost instantaneously. Heat inactivation has been shown to be reversible for trypsin and to a more limited extent for pepsin (Northrop). But for some enzymes the process seems to be irreversible. Because of the antagonistic effects produced by rise of temperature there is an optimum for enzyme activity. For enzymes of animal origin this is at or near body temperature, 37 to 40°C. Some vegetable enzymes have higher optima. Papain from the fruit of the papaw shows an optimum at about 65°C.

The optimal temperature is not a fixed value but varies according to experimental conditions. Thus when the enzyme concentration is comparatively low and the time of observation of comparable tests at varying

temperatures is correspondingly prolonged, the apparent optimum is lower than it is when the reaction time is relatively brief. The longer the time, the greater is the opportunity for destructive denaturation of the enzyme.

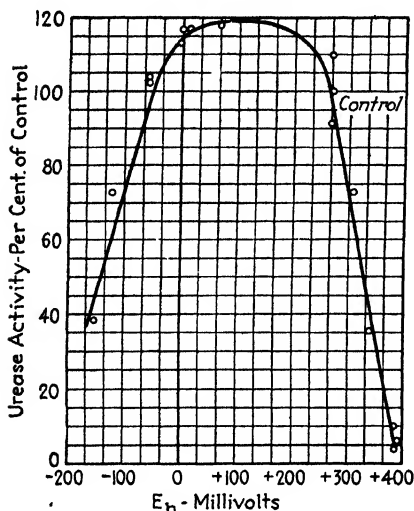

FIG. 44. The effect of oxidation and reduction on the activity of the enzyme, urease. For the experiments that are represented by points on the left side of the bell-shaped curve, reduction was caused by the presence of Na_2S in the following concentrations: 0.05, 0.025, 0.0012, 0.0005, and 0.00025M. Evidence from other experiments indicated that the effect of Na_2S was due to its action as a reductant rather than to destructive action upon the enzyme. For the points on the right side of the curve oxidation was produced by the presence of KMnO_4 in the following concentrations: 0.000006, 0.000012, 0.000019, 0.000025, 0.00004, 0.00005, and 0.0001M. There may possibly have been some destructive action of KMnO_4 upon the enzyme in addition to its depressant action as an oxidant. The abscissas represent electrometric measurements of oxidation-reduction potential. For further explanation see Chap. XII.) (After Sizer and Tytell.)

regular effects, as shown in Fig. 44, were obtained. It should be noted that this effect is independent of that of the pH, which was maintained constant by the same buffer during all measurements. The

The Effects of Oxidation and Reduction. For a number of enzymes it has been shown that the activity is influenced by the presence of oxidizing reagents (oxidants) or of reducing substances (reductants). The relative oxidative effect existing in a solution may be regarded as the comparative electron pressure or electron tension. It is measurable by connecting a bright platinum electrode and a standard indifferent electrode (e.g., a calomel electrode) with the solution and with a potentiometer. The measurement expressed in volts is the redox potential. Its measurement and significance will be discussed more fully in connection with bio-oxidation, for which the enzymes involved are intimately concerned with redox potentials.

In the case of urease, however, the redox effect has been clearly demonstrated by Sizer. He found that impure preparations of urease showed no clean-cut effects of oxidants and reductants. The interference due to the impurities, of which extraneous protein was probably important, protected the enzyme to a greater or less degree. But with pure recrystallized urease

bell-shaped curve obtained reveals marked inhibition of the enzyme by excessive reduction or oxidation and shows that a certain redox potential affords optimum activity. In this case it is at about +150 millivolts when referred to the normal H_2 electrode as zero potential (the E_h value). The suggestion offered in explanation of this effect is that the sulfur-containing groups of the enzyme molecule are in some way concerned in its activity, and their change from the oxidized condition ($R-S-S-R$) to the reduced condition ($R-SH$ $HS-R$) is required for at least a certain proportion of these groups. Sizer measured the redox potential in the interior of the jack bean (the source of the urease preparation) after soaking in water, removing the seed coat, and insertion of electrodes. He found $E_h = +190$ mv., which is near enough to the optimum for the crystalline urease to suggest that the oxidation-reduction effects are significant in the functioning of the enzyme in the cell. Of scores of enzymes tested for their behavior to reagents which affect the sulfhydryl ($-SH$) groups, only a minority (about 25 per cent) appeared to be without sensitivity to such effects. The majority would seem to be sulfhydryl enzymes.

The Effects of Light and Other Radiant Energy. In general, enzymes tend to be inactivated by light. In some cases the initial effect is activation. Red and green light are reported to be effective in activation of salivary amylase. The destruction or inactivating effect of ultraviolet light is especially marked, although the initial effect of small doses may be activation for some enzymes. This is in agreement with the general action of ultraviolet on living matter which is notably sensitive to overdosage of ultraviolet light. Proteins are destroyed or at least denatured by it. In the case of crystalline pepsin the quantitative relations between ultraviolet irradiation and enzyme inactivation were investigated by Northrop, and a further study by Gates showed that the ultraviolet absorption spectrum of pepsin revealed an absorption band between 240 and 275 $m\mu$, which is the region especially effective for inactivation. The β - and γ -rays of radium emanations are likewise powerful in the inactivation of pepsin and probably of other enzymes. Other radiant energies, *e.g.*, X rays, produce effects which vary with different enzymes although in the case of some of them, no effect is produced.

Enzymes as Catalysts. A catalyst increases the rate of a reaction without itself permanently being altered or combined with the reaction products. On this account, a catalyst should be able to function indefinitely so far as the effects of the catalyzed reaction upon it are concerned. A true catalyst, while affecting the velocity, does not change the equilibrium of the reaction.

Enzymes, although actually fulfilling these criteria, do not appear

to do so. After renewed supplies of the substrate have been added and the enzyme is employed during a sufficient length of time, its activity diminishes and finally disappears. The explanation, however, is found in the instability of the enzyme. Like all proteins, enzymes are subject to denaturation by various means and especially by hydrolytic cleavage. In some cases, an enzyme has been shown to retain its catalytic power longer while functioning with repeated renewals of substrate than while merely maintained in aqueous solution at the same pH and temperature but without substrate. An inorganic catalyst, even one so simple as colloidal platinum, may also be rendered ineffective by some reaction other than the one it catalyzes. One case is the adsorption of protein upon the surfaces of the platinum. One speaks of such effects as "poisoning of the catalyst." Many protein precipitants or denaturing agents similarly "poison" enzymes, while proteins which accompany enzymes in tissue extracts often inactivate the enzyme, apparently by combining with it. Moreover, a number of enzymes of various types have been shown to be destroyed by proteases, and proteases themselves are no exception but are subject to proteolytic destruction by other proteases.

The equilibrium of some enzyme-catalyzed reactions appears to be shifted to the point of completion of the reaction. This may be accounted for by changes in the products of the reaction. A good example is the mutation of the monosaccharide molecules set free by the hydrolysis of sucrose (p. 25). Fructofuranose, supposedly an initial product of the hydrolysis, does not remain as a part of the reacting system, so that no reverse effect (synthesis of sucrose) should be expected and an equilibrium short of complete hydrolysis is theoretically impossible. The same result follows the use of an inorganic catalyst (H ions) when sucrose is hydrolyzed by acid. In the case of other enzymes, notably certain esterases, no interfering side reaction or spontaneous change occurs, and the equilibrium of the catalyzed reaction is found to be dependent upon the same conditions which would determine it in the absence of the enzyme.

Kinetics of Enzyme Action. We may assume that enzyme action begins with the formation of an enzyme-substrate complex. Evidence for this is derived from study of the effects of varying the concentration of enzyme or substrate and from specificity studies and other experiments. While such an intermediate compound has not been isolated and identified, objective evidence for its existence has been offered in one case at least. Keilin reported that the enzyme peroxidase, which causes certain oxidations to occur in the presence of H_2O_2 , unites with it. The peroxidase is an Fe-containing substance with a characteristic absorption spectrum, having four dark bands; but when H_2O_2 is added to its solution, there is a marked change in the spectrum, which now has two bands

in new locations. The change is completed when the H_2O_2 added is equivalent to the Fe. of the enzyme. Another Fe-containing enzyme, catalase, was reported by Stern to show a corresponding effect with its substrate, H_2O_2 ; but some doubt is thrown on the result because of possible impurity of the enzyme.

Further evidence of the reality of the enzyme-substrate combination is found in *enzyme-blocking phenomena*. When a compound of molecular constitution, resembling the structure of a substrate in some significant way, is added to an enzyme solution, the enzyme may become inactive toward its normal substrate. Thus there seems to be competitive inhibition of the enzyme. The phenomenon is significant because it apparently occurs *in vivo* as well as *in vitro*. A good example is the action of malonate on succinic acid dehydrogenase, an enzyme of general protoplasmic utility (Chap. XII), catalyzing the reversible reaction in which succinate (succinic acid, $\text{COOH}\cdot\text{CH}_2\cdot\text{CH}_2\cdot\text{COOH}$) loses H_2 to form fumarate (fumaric acid, $\text{COOH}\cdot\text{CH}\cdot\text{CH}\cdot\text{COOH}$). The reaction is blocked in the presence of malonate (malonic acid, $\text{COOH}\cdot\text{CH}_2\cdot\text{COOH}$) the structure of which appears to enable it to form a relatively stable union with the enzyme, successfully competing with the normal substrates so as to inhibit (block) the enzyme.

So many cases of this type of behavior are known that one feels inclined to believe that some blocking substance could be found to compete with the substrate or substrates of the majority of enzymes. The fundamental theory of the nature of chemotherapy (Chap. XXI) is based essentially on this belief. The curative chemotherapeutic agent is assumed to block some essential process in the protoplasm of an invading microorganism so as to weaken it beyond viability.

After the enzyme-substrate complex is formed, the further progress of the reaction might be characterized in either of two ways.

1. A monomolecular reaction (breaking down of the substrate molecule).

2. A reaction in which the rate is proportional to the concentration of the enzyme-substrate compound (a theory proposed by Michaelis).

Consider the first case. The equation which describes the rate of a monomolecular reaction is

$$K = \frac{1}{t} \ln \frac{a}{a-x} \quad \text{or} \quad t = \frac{1}{K} \ln \frac{a}{a-x}$$

where K is the velocity constant, a is the original concentration of the reacting substance, and x is the amount changed in time t . If the time intervals are plotted against the $\log a/a-x$, the resulting curve for a monomolecular reaction is a straight line of which the slope is $1/K$. Data

from some experiments reported by Cajori on the action of intestinal lactase will serve to illustrate (Table 36 and Fig. 45). The process follows

TABLE 36.—KINETICS OF ENZYME ACTION
(Data of Cajori on hydrolysis of lactose by intestinal lactase of the dog)

Time, hr.	Lactose hydrolyzed (x), per cent	$\log \frac{a}{a-x}$	$K = \frac{1}{t} \log \frac{100}{100-x}$
1	4.0	0.018	0.0180
2	8.3	0.037	0.0185
3	12.3	0.057	0.0190
5	19.5	0.094	0.0188
7	25.5	0.128	0.0183
23.5	62.5	0.426	0.0181

the course of a monomolecular reaction during the first 5 hr. but deviates slightly from it during later stages.

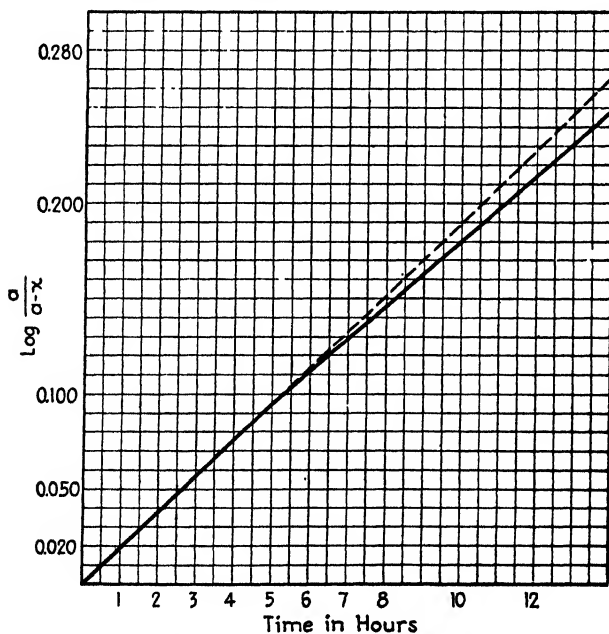
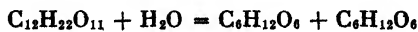

FIG. 45. Curve to show the kinetics of the hydrolysis of lactose by lactase. Explanations in the text. (After Cajori.)

The reaction



is represented as bimolecular; but one component, water, is present in

such large excess that its molar concentration does not change significantly during the hydrolysis and may be regarded as a constant.

The similar behavior of a reaction with an inorganic catalyst, the hydrolysis of sucrose in the presence of H ions, is shown (Fig. 46). Deviation from a straight line in Fig. 45 may be regarded as due to the effect of accumulation of products of the reaction. It has been shown, for example, that the initial velocity of sucrase action may be greatly

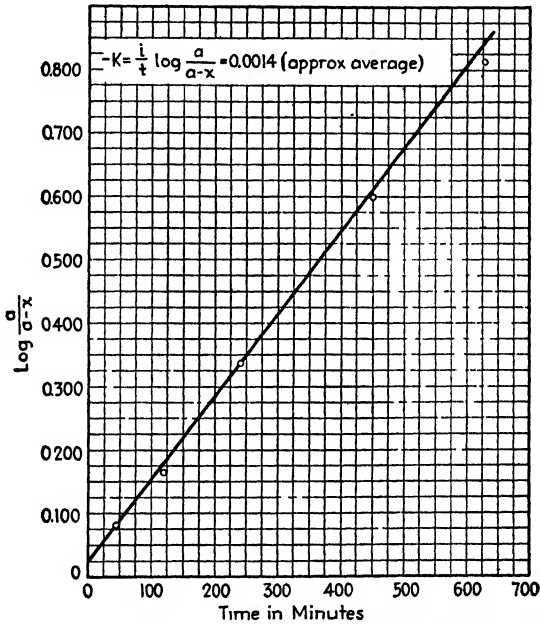

FIG. 46. The reaction course of the inversion of sucrose catalyzed by H ions. The curve represents the equation: $t = \frac{1}{K} \log \frac{a}{a-x}$. (Data from experiments by Wilhelm.)

decreased by adding glucose or fructose to the solution of the substrate, sucrose. When 2 per cent sucrose solution contains 8 per cent β -D-glucose, the reaction velocity is only about one-third of that found with sucrose alone. Addition of α -D-glucose or of D-fructose produces similar though less marked decreases. Under the conditions surrounding the action of an enzyme in nature, e.g., in a living cell or in the digestive organs, reaction products may be removed from the reacting system. They might diffuse out of a cell or be utilized in its metabolism and are absorbed from the intestine into the circulation.

The second possibility, that the reaction rate is determined by the concentration of an enzyme-substrate compound, is difficult to prove. It seems to be the most logical assumption and has been widely accepted

but not universally. The researches of Michaelis and Menten and others afford data in support of the theory. It is impossible, however, to be sure that the observed relationships involving numerous factors are determined by the concentration of the enzyme-substrate compound or merely by the rate at which the products of substrate breakdown diffuse away from the enzyme molecules. The latter rate would yield the simple

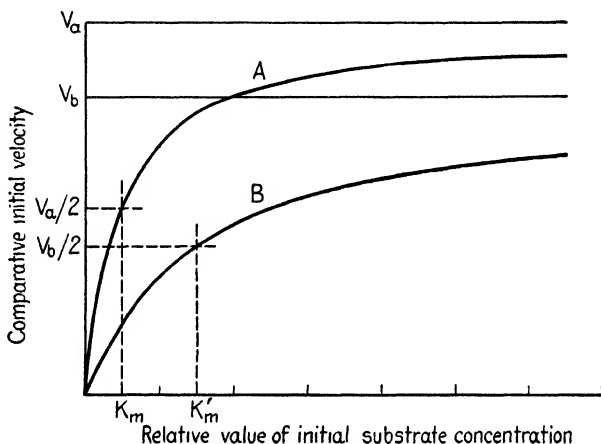

FIG. 47. Graph to illustrate the significance of the Michaelis constant. V_a and V_b are the limiting values for the velocity of an enzyme-catalyzed reaction using the same enzyme but different substrates for the two reaction curves, A and B, respectively. The same concentration of the same enzyme and all other factors, save the nature of the substrate, are assumed to be the same in the two sets of measurements. Setting $v = V/2$, the corresponding abscissa is a graphic measure of K_m for each reaction. Note the larger value of K_m , *i.e.*, smaller reaction velocity, in reaction *b*. The suggestion is that K_m is determined by the relative affinity of the enzyme for the substrate. (After Baldwin.)

monomolecular reaction curve. The two explanations are supplementary rather than mutually exclusive.

The second possibility is summarized in the Michaelis equation

$$v = \frac{Vx}{x + K_m}$$

in which v is the initial velocity of the enzyme-catalyzed reaction, V is the limiting velocity attainable when the concentration of the substrate is sufficient to "saturate" the enzyme, x is the concentration of the substrate, and K_m is the **Michaelis constant**, a quantitative index tending to vary inversely with the relative activity of the enzyme.

The derivation of this equation is based on the simple assumptions that the enzyme combines with the substrate and that the velocity of the

resulting catalyzed reaction is proportional to the effective concentration of the enzyme-substrate complex.

In testing this equation, values of x may be chosen in a series of tests in which all conditions except substrate concentration are held constant.

Values of v for relatively short time intervals are determined. Plotting a curve (v as ordinate, x as abscissa) one obtains a rectangular hyperbola from which the value of V can be computed if it is not practically attained (Fig. 40) and measured. The fact that the equation fits actual observations argues for the correctness of its basic assumptions. The Michaelis constant can be obtained by determination of the value of x when $v = V/2$. Substituting $V/2$ for v in the Michaelis equation, $V/2 = Vx/x + K_m$ and $2x = x + K_m$, or $x = K_m$. This is shown graphically in Fig. 47. An evaluation of K_m is sometimes instructive. If, for example, a given enzyme operates upon different substrates at different rates, one may find K_m for each case (Fig. 47) and compare the values. From them one obtains a quantitative measure of the effectiveness of the enzyme and gains the impression that the Michaelis constant is a measure of the relative tendency of the enzyme to combine with its substrate.

The course of the same reaction may vary considerably when catalyzed by different enzymes. A case investigated by Sherman and his coworkers will serve to illustrate. From barley malt two amylases may be separated by fractional salting out with $(\text{NH}_4)_2\text{SO}_4$ and fractional precipitation with alcohol. They are called α - and β -amylase. The latter liberates maltose from starch much more rapidly than does the α -amylase but is less effective in causing the disappearance of starch (Fig. 48). One may say α -amylase is dextrinogenic, β -amylase is maltogenic. This does not

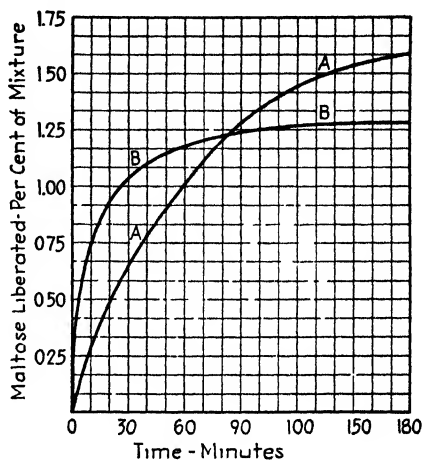

FIG. 48 Hydrolysis of starch by α - and β -amylase from barley malt. Curve A shows the course of the reaction with α -amylase, curve B with β -amylase. The latter causes a relatively rapid liberation of maltose during the first hour; but even after 3 hr., the starch still reacted blue with iodine in spite of the action of β -amylase. The α -amylase, though initially causing maltose liberation at a comparatively slow rate, produces a more profound hydrolysis of starch. (From experiments reported by Caldwell and Doebbeling.)

The course of the same reaction may vary considerably when catalyzed by different enzymes. A case investigated by Sherman and his coworkers will serve to illustrate. From barley malt two amylases may be separated by fractional salting out with $(\text{NH}_4)_2\text{SO}_4$ and fractional precipitation with alcohol. They are called α - and β -amylase. The latter liberates maltose from starch much more rapidly than does the α -amylase but is less effective in causing the disappearance of starch (Fig. 48). One may say α -amylase is dextrinogenic, β -amylase is maltogenic. This does not

appear to be explained as a mere difference in the Michaelis constant for the two enzymes but is probably due to a difference in the point of attack. It is probable that the α -amylase attacks starch at the 1-6 links between glucopyranose units, *i.e.*, where branching of chains occurs (p. 31), while the β -amylase attacks 1-4 links between glucopyranose units as they occur in "straight-chain" formation in pure amylose. Corresponding differences in the course of proteolysis by gastric or pancreatic enzymes (Chap. VIII) are recognized.

Actual Velocity of Enzyme Action. Turnover Numbers. In the case of some enzymes, prepared in pure form and of known molecular weight, it is possible in an *in vitro* experiment, under controlled conditions, to measure the number of molecular equivalents of substrate transformed per unit time. This yields the so-called "turnover number" for the enzyme. In some cases, surprising rapidity is found. Thus the enzyme catalase, which catalyzes the reaction, $2\text{H}_2\text{O}_2 \rightarrow 2\text{H}_2\text{O} + \text{O}_2$, is reported to break down 2,500,000 molecules of hydrogen peroxide per minute per molecule of enzyme at 0°C. This rate, however, is exceptional. Other enzymes, studied in this way, show turnover numbers (mols of substrate changed per mol of enzyme per minute) of 1,000 to 20,000 at room or body temperature.

Reversibility. According to the law of mass action a biocatalyst, like any catalyst, should affect a chemical reaction as it proceeds in either direction. This was implied in the statement that enzymes do not change the equilibrium of a reaction. A considerable number of enzymes, however, appear to direct one-way traffic only. This may be due, as suggested above, to mutations and other "side reactions" and to physical conditions which operate to lower the concentration of the initial reaction products. But for some enzymes, reversibility is readily demonstrated. Some of the earliest experiments to yield a clean-cut result were devised by Kastle and Loevenhart, who showed that certain esterases may catalyze the synthesis as well as the hydrolysis of the ester. Similar results have been obtained with lipases (Fig. 49). Under comparable conditions, the equilibrium attained in the presence of the enzyme is the same whether it acts on the ester or its split products.

The reversibility of carbohydrases has been tested by a number of investigators. Under the right circumstances, a small amount of a disaccharide has been detected (p. 24), but usually the presence of the specific disaccharide hydrolyzed by the enzyme has not been proved. Polysaccharides have been synthesized (see Chap. XIV) in artificially arranged enzyme systems.

The reversibility of proteinases is also difficult to demonstrate. Pepsin was investigated by Danielewski and by Wasteneys and Borsook. The

products of prolonged peptic hydrolysis of certain proteins were greatly concentrated, treated with freshly added pepsin, and allowed to stand for some time. Substances possessing certain protein characteristics and known as **plasteins** were obtained. Collier has similarly investigated the action of papain on concentrated pepsin or papain digests of egg albumin. He also obtained plasteins and showed that the synthesis or

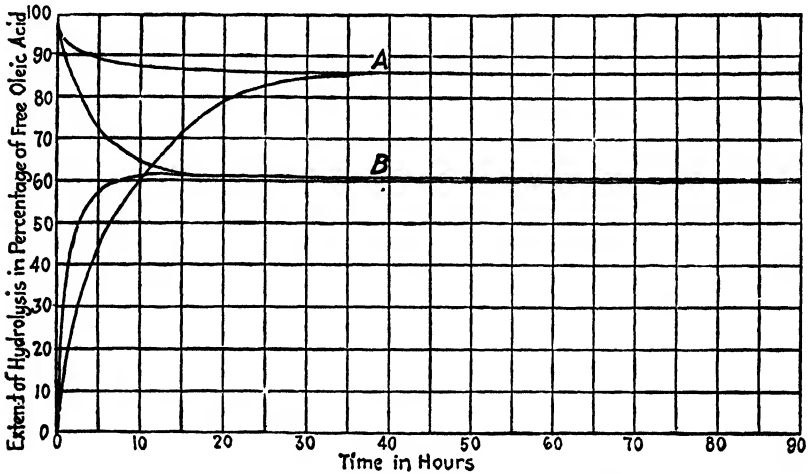

FIG. 49. The reversible action of lipase and the influence of the concentration of water upon the equilibrium of the reaction. The pair of curves that show attainment of equilibrium at *A* represent the synthesis (upper curve of pair) and hydrolysis (lower curve) of fat under the influence of pancreatic lipase when the reacting mixture contains 9 mols of water to 1 of fat. The pair of curves shown at *B* represents the corresponding results when the reacting mixture contains 3 mols of water to 1 of fat. With the smaller concentration of water, hydrolysis, as measured by the free fatty acid present, is less complete and synthesis more pronounced when equilibrium is reached. (After *Armstrong and Gosney*.)

the hydrolysis of the plastein through the action of the enzyme parallels the disappearance of free amino acids (*e.g.*, tyrosine) or their liberation. This and other evidence seems to prove that the plastein forms reversibly from its own split products. Studies with the ultracentrifuge, however, reveal that the plastein is a mixture of substances of varying molecular weight. Even after it was partially purified by dialysis, it showed no approach toward homogeneity. While the ultracentrifuge indicated the presence of some molecular species approaching the size of natural proteins, the major part of the material appeared to have molecular weights less than 1,000. One can hardly say that reversal of protease action has produced, *in vitro*, the original substrate.

There is ample evidence from studies of intermediary metabolism that intracellular enzymes do function in a reversible manner, but the conditions necessary for this effect are not easily produced in artificial systems. One of these conditions in the case of hydrolases is a low concentration of water so as to favor dehydration synthesis. It is possible to test this *in vitro* by experiments such as the one reported by Armstrong and Gosney (Fig. 49). A mechanism by which a lowered concentration of free water molecules at some localized point is attained within a living cell can only be conjectured but might conceivably exist.

Zymogens and Enzyme Activation. Extracts of tissues may show no active enzyme when first prepared. For example, extracts of gastric glands contain no pepsin but do contain a protein which Northrop and his coworkers have obtained in pure crystalline form and which is called **pepsinogen** ("mother of pepsin"). This and similar substances are called *zymogens* or *proenzymes*. Pepsinogen becomes active pepsin through mere exposure to acid comparable to that of the gastric juice. But when a small amount of pepsin in active form is present, it hastens the activation of the remaining pepsinogen to pepsin. This is called **autocatalysis**. The activation process involves splitting from pepsinogen of a masking (inhibiting) group which has the properties of a polypeptide of molecular weight about 5,000. Pepsin itself is a much larger molecule, above 35,000. The pancreatic proteases, trypsin and chymotrypsin, are activated in a slightly different way. When pure pancreatic juice is obtained from a cannula inserted into the pancreatic duct, it shows no proteolytic activity. It does contain, however, the zymogens **trypsinogen** and **chymotrypsinogen**. Both of these may also be obtained from extracts of the pancreas (p. 222) and may be crystallized in pure form. Their activation can be accomplished in several ways, some of which involve proteolytic enzyme action. Trypsin can activate trypsinogen so that the presence of a mere trace of the active enzyme in pancreatic juice or in solutions of trypsinogen causes rapid activation. Trypsin also activates chymotrypsinogen to form chymotrypsin. The activation of digestive enzymes will be discussed in more detail in Chap. VIII. The production of zymogens rather than active enzymes in the secreting cells appears to be a natural protection against self-digestion (autolysis).

Enzymes show what appears to be an activation due to the presence of certain inorganic salts. The mechanism of such an effect is still obscure. The activation by adjustment of the pH of the medium has already been discussed, as has that by the use of oxidants or reductants.

It is clear that a protein which serves as an enzyme can function only when in a certain state and functions at its maximum only when its

labile form is brought into a condition for which the specifications are quite particular.

Coenzymes. Some enzymes consist of a protein and a nonprotein component so associated that the latter could be regarded as the prosthetic group of a compound protein. Pioneer investigators of this type of biocatalyst called the protein part an "enzyme" and the nonprotein part a "coenzyme"; but later work has shown that while the protein part confers specificity for attack upon the substrate and is inactivated by heat, thus exhibiting two of the properties of enzymes, it is not catalytically active except when in combination with the nonprotein component. Accordingly, the protein part is now called an "apoenzyme" (Greek, *-apo*, "from" or "off") thus implying that it is only a part of an enzyme. The nonprotein part is still called the "coenzyme." The active combination of the two parts is spoken of as an "enzyme system" or an "activated enzyme." The union between the two components is easily dissociable in some cases. Dialysis, permitting the comparatively small molecules of the coenzyme to pass through the dialyzing membrane, may separate them. Some are in firmer union so that mild hydrolysis may be required to separate them. All the known apoenzyme-coenzyme systems function directly or indirectly in biological oxidation. Their chemistry will therefore be discussed (Chap. XII) in that connection.

None of the hydrolases have been shown to be composed of apoenzyme and coenzyme. They appear to be simple proteins.

Adjuvants. Some enzymes, *e.g.*, certain amylases of both plant and animal origin, appear to require inorganic ions furnished by neutral salts in order to show optimum activity. The anion has been found to be more important as an adjuvant for these amylases than the cation. The Cl ion is the most effective one for activation of pancreatic amylase. Some amylases appear to be unaffected by ions of inorganic salts. The nature of the effect is not clearly demonstrated. One might suppose that the effective ion causes the enzyme to assume an especially active form. Such an effect would be analogous to that of optimum pH of the medium.

Some enzymes which are activated by a metallic ion, for example, arginase activated (p. 226) by Mn^{++} , are believed to form a saltlike combination with the activating ion. A similar activation of certain esterases by Mn^{++} has been shown to be nonspecific in the sense that other divalent cations (Ca^{++} , Mg^{++}) are also adjuvants.

The activating effects of substances which affect oxidation-reduction have already been discussed (p. 236).

Another type of enzyme adjuvant is found in the case of bile salts, which greatly facilitate the action of lipases in the intestine. The effect is due in part to the ability of bile salts to emulsify fats and also to the

facilitation (see Chap. VIII) of fatty acid absorption through the intestinal wall.

Antienzymes. The presence of enzyme inhibitors in tissue extracts and in digestive secretions was brought out in connection with activation of enzymes. The inhibitors are proteins, so far as is now known. They appear to combine with the enzyme protein in such a way as to mask its catalytically active groups and might be thought of as antienzymes. But more typical antienzymes have been discovered. Extracts of the tapeworm added to active trypsin solutions reversibly inactivate the enzyme. Presumably the tapeworm, living in a medium containing proteases, is protected by its inhibitors. By analogy, living tissues in general might be expected to contain similar inhibitors, but attempts to demonstrate them in extracts of intestinal lining cells have not been successful. It is true, however, that blood and tissue extracts show nonspecific, slightly inhibitory effects on proteases. All living cells are less rapidly attacked by proteolytic enzymes than are the proteins of the dead cells. It is not known definitely that proteins occur upon the actual surface of the cell; the possibility that protoplasmic surface membranes may be the protective mechanism, checking the entrance of disruptive enzymes into the cell, cannot be excluded.

Strictly speaking, the term *antienzymes* should not be applied to normally occurring proteins derived from tissues or secretions and inhibiting enzymes by combining with them. The term might better be reserved for substances which arise through an immune reaction. Theoretically, any protein foreign to the blood and tissues should, when injected, arouse the immunity mechanism to produce a specific antibody. Plant enzymes are seemingly foreign proteins, but attempts to produce enzyme inhibitors or inactivating antibodies by injecting gradually increasing doses of enzymes of plant origin have not always been entirely successful. In the case of urease, which is highly toxic when injected into animals, gradually increasing doses may be administered so as to build up considerable immunity. A specific antiurease can be demonstrated in the blood. Some similar results have been obtained with other enzymes foreign to the animal body.

Enzymes in Protoplasm. The far-reaching significance of biocatalysts raises the question as to whether or not all metabolic reactions in cells are dependent upon them. No categorical answer can be given, and a considerable number of vital chemical reactions for which no specific enzyme has been identified appear to occur. In view of the rapid progress of the study of biocatalysts during recent years with the discovery of numerous enzymes, apoenzymes, and coenzymes, long postulated but not revealed by earlier work, one hesitates to set a limit to the

number of possible cellular enzymes. The close interdependence of metabolic reactions, occurring in linked cycles to be described in later chapters, suggests that even a reaction which might occur in protoplasm without the aid of a specific enzyme could be governed by an enzyme that catalyzed a linked reaction.

One aspect of certain intracellular reactions presents a difficult problem. They appear to be definitely localized in the cell. Thus, glycogen formation in liver cells results in its deposition in microscopic granules, suggesting that glycogen synthesis from sugar is highly delimited. This is but one instance of many which might be cited. The idea is thus suggested that intracellular enzymes are not free to diffuse through protoplasm. Moreover, the reversible action of such enzymes presents peculiar and as yet unsolved problems. So little is known of the mechanism of biological synthesis that the subject may be regarded as an almost unexplored field where discoveries are only beginning to be made.

Autolysis. A living cell in good physiological condition appears to synthesize its protoplasmic constituents at such a rate as to compensate approximately for decomposition processes of oxidation and hydrolysis or, briefly stated, *anabolism balances catabolism*. The cell tends to maintain a "steady state" which is called **homeostasis**. During cell growth or recovery from certain injuries, synthesis (anabolism) actually predominates. But under conditions of malnutrition and during some other diseases there is a "wasting away" of the tissues as destructive processes predominate. Muscular dystrophy during lack of vitamin E affords a striking example. A similar process may occur even under physiological conditions as, for example, the involution of the mammary gland after lactation ceases.

After death of the cells, however, the self-destruction of their substance is inevitable. If macerated tissue is suspended in water containing a suitable antiseptic such as toluene or chloroform to prevent growth of microorganisms while permitting enzyme action, a process of autolysis sets in, slowly at first but accelerated after the first day or so. Eventually nearly all the protein of the tissue is dissolved with hydrolysis. The enzymes which catalyze the process are free in only minute amounts during the early stages; but by a process which may involve autocatalysis (self-activation) but surely involves change to optimum pH they increase to a maximum. These proteolytic enzymes are known as **cathepsins** and include proteinases, resembling either pepsin or trypsin, and peptidases. The rate at which different stages of protein breakdown appear is sufficiently characteristic for a given type of tissue to furnish what Bradley, a leading investigator in this field, refers to as "a pattern of

autolysis." Liver, kidney, and most glandular tissues show greater catheptic action than do muscles or connective tissues.

Practical Applications of Enzyme Chemistry. In the industries, enzymes are employed in the preparation of cotton and other fibers for weaving and in the finishing of cloth. The industries dependent upon fermentation, alcohol manufacture, brewing, wine making, etc., are closely dependent upon knowledge of enzyme action for their efficiency. There are many other industrial applications.

In clinical chemistry, enzyme studies also find practical application. One of the oldest is the examination of gastric contents withdrawn by stomach tube for diagnosis of certain digestive disturbances. In more recent years, duodenal contents have been sampled by the use of a tube passing through the stomach. This permits diagnostic tests for pancreatic and other enzymes in the intestine.

The determination of blood-plasma phosphatase activity has come to be an important diagnostic tool. Phosphatase increases during bone diseases (rickets, osteomalacia, etc.) and is roughly proportional to the severity of the disease. This enzyme also increases in the blood during certain types of jaundice, in arthritis, and in tuberculosis. Red blood cells are said to have increased phosphatase activity in cancer patients.

The catatorulin test on brain slices of animals for bioassay of thiamine (p. 170) is another practical use of an enzyme reaction. Others have been devised.

REFERENCES

Among numerous monographs on this subject, "Chemistry and Methods of Enzymes" by J.B. Sumner and G. F. Somers, New York, 2d ed 1947, will be found very useful as a concise summary of the properties of many enzymes of all known types. Its bibliography includes over 1,400 references.

"The Chemistry and Technology of Enzymes," by H. Tauber, New York, 1949, covers the subject from the standpoint of biochemistry and industrial chemistry.

"Crystalline Enzymes" by J. H. Northrop, New York, 2d ed. 1948, discusses an important aspect of enzyme isolation.

A series of volumes, "Advances in Enzymology," edited by F. F. Nord and C. H. Werkman, have been published annually since 1941. They contain useful summaries of research on enzymes and related subjects of biochemistry.

"Dynamic Aspects of Biochemistry" by E. Baldwin, Cambridge, England, and New York, 1947, gives an extraordinarily interesting account of the nature and action of enzymes and their functioning in metabolism.

Some selected review articles are listed.

BALLS, A. K., Proteolytic Enzymes, *Ann. Rev. Biochem.*, 9, 43, 1940.

BERGMANN, M., Proteins and Proteolytic Enzymes, *Harey Lectures, Series 31*, 36, 1936.

BERGMANN, M., and FRUTON, J. S., Proteolytic Enzymes, *Ann. Rev. Biochem.*, 10, 31, 1941.

FRUTON, J. S., Proteolytic Enzymes, *Ann. Rev. Biochem.*, 16, 35, 1947.

GRÖNBERG, D. M., and WINNICK, T., Enzymes that Hydrolyze the Carbon-Nitrogen Bond: Proteinases, Peptidases, and Amidases, *Ann. Rev. Biochem.*, 14, 31, 1945.

LINDERSTRÖM-LANG, K., Proteolytic Enzymes, *Ann. Rev. Biochem.*, 3, 37, 1939.

MYRBÄCK, K., Nonproteolytic Enzymes, *Ann. Rev. Biochem.*, 8, 59, 1939.

SIZER, I. W., Effects of Temperature on Enzyme Kinetics, *Advances in Enzymol.*, 3, 35, 1943.

SUMNER, J. B., Nonoxidative Enzymes, *Ann. Rev. Biochem.*, 17, 35, 1948.

WALDSCHMIDT-LEITZ, E., The Mode of Action and Differentiation of Proteolytic Enzymes, *Physiol. Rev.*, 11, 358, 1931.

- WASTENEYS, H., and BORSOOK, H., The Enzymatic Synthesis of Protein, *Physiol. Rev.*, 10, 110, 1930.
- A few of the research reports which give an insight into some of the methods of enzyme research are the following:
- BERGMANN, M., FRUTON, J. S., and POLLOK, H., The Specificity of Trypsin, *J. Biol. Chem.*, 127, 643, 1939.
- CALDWELL, M. L., BOOHER, L. E., and SHERMAN, H. C., Crystalline Amylase, *Science*, 74, 37, 1931.
- CALVERY, H. O., HERRIOTT, R. M., and NORTHROP, J. H., The Determination of Some Amino Acids in Crystalline Pepsin, *J. Biol. Chem.*, 113, 11, 1936.
- CHANGE, B., The Properties of the Enzyme-substrate Compounds of Horse-radish and Lacto-peroxidase, *Science*, 109, 204, 1949.
- FRUTON, J. S. BERGMANN, M., and ANSLOW, W. P., JR., The Specificity of Pepsin, *J. Biol. Chem.*, 127, 627, 1939.
- HERRIOTT, R. M., Isolation, Crystallization and Properties of Swine Pepsinogen, *J. Gen. Physiol.*, 21, 501, 1938.
- KUNITZ, M., and NORTHROP, J. H., Isolation from Beef Pancreas of Crystalline Trypsinogen, Trypsin, a Trypsin Inhibitor, and an Inhibitor-trypsin Compound, *J. Gen. Physiol.*, 19, 991, 1936.
- MORRELL, C. A., BORSOOK, H., and WASTENEYS, H., Influence of the Backward Reaction in the Peptic Hydrolysis of Albumin, *J. Gen. Physiol.*, 8, 601, 1927.
- NORTHROP, J. H., The Mechanism of the Influence of Acids and Alkalies on the Digestion of Proteins by Pepsin or Trypsin, *J. Gen. Physiol.*, 5, 263, 1922.
- NORTHROP, J. H., Chemical Nature and Mode of Formation of Pepsin, Trypsin, and Bacteriophage, *Science*, 86, 479, 1937.
- SIZER, I. W., Sucrose Inversion by Bakers' Yeast as a Function of Temperature, *J. Gen. Physiol.* 21, 695, 1938.
- SIZER, I. W., The Activation Energy of Urea Hydrolysis Catalyzed by Soybean Urease, *J. Biol. Chem.*, 132, 209, 1940.
- SIZER, I. W., Temperature Activation of the Urease-urea System Using Urease of *Proteus Vulgaris*, *J. Bacteriol.*, 41, 511, 1941.
- SIZER, I. W., and TYTELL, A. A., The Activity of Crystalline Urease as a Function of Oxidation-reduction Potential, *J. Biol. Chem.*, 138, 631, 1941.
- SUMNER, J. B., Isolation and Crystallization of the Enzyme Urease, *J. Biol. Chem.*, 69, 435, 1926.
- SUMNER, J. B., and HAND, D. R., Crystalline Urease. II, *J. Biol. Chem.*, 76, 149, 1928.
- SUMNER, J. B., KIRK, J. S., and HOWELL, S. F., The Digestion and Inactivation of Crystalline Urease by Pepsin and by Papain, *J. Biol. Chem.*, 98, 543, 1932.

CHAPTER VIII

DIGESTION

Digestion is a necessary preliminary to the assimilation of food by animals. Even the protozoa are provided with a mechanism, the food vacuole, serving as a digestive organ. The physiology and chemistry of digestion has been studied for many species but more nearly completely in the case of man and some other mammals. Only salts, water, monosaccharides, and a few other organic compounds of small molecular weight, such as vitamins and purines, are consumed by higher animals in a form suitable for use. Digestion is an especially necessary process for food proteins which are highly toxic when injected. Most of the food carbohydrate is not utilizable until it is hydrolyzed to its constituent monosaccharides. Even those food fats which are seemingly identical with body-storage fats need to be split for absorption in the intestine. The chemistry of digestion in animals is primarily the activity of hydrolyzing enzymes, especially the proteases, carbohydrases, and lipases. The following account will deal mostly with digestion in the human alimentary tract.

SALIVARY DIGESTION

Salivary secretion by three pairs of glands, the parotid, submaxillary, and sublingual glands, is under nervous control. This fact is established by electrical excitation of the nerves connected with the glands and by the result of severing these nerves, namely, permanent cessation of secretory action, a total "paralysis" of the gland. The stimuli, acting reflexly, include the taste, odor, and sight of food and many other conditioned or psychic reflex effects. Dryness of the oral membranes and mechanical stimuli, especially those resulting from chewing, are effective. The only chemical stimuli known are abnormal ones resulting from the presence of certain drugs, *e.g.*, pilocarpine, in the circulation.

The number of effective stimuli is so large that the amount of saliva is considerable. Estimates vary but agree in placing the volume at more than a liter per day, probably averaging 1,500 ml. in 24 hr. in the human adult. Most of it is produced while eating, but a slower rate of secretion is maintained at other times almost uninterruptedly.

Composition of Saliva. Saliva is a dilute secretion containing about 99.5 per cent of water. The average of a large number of deter-

minations is reported to be 99.42 per cent. Complexity of the nervous control of secretion results in considerable variation, a larger volume of more watery saliva being generally produced by dry, hard substances in the mouth than by moist, softer foods. Of the small amount of solids, nearly three-fourths is protein, chiefly the glycoprotein mucin, which gives saliva its high viscosity. Other organic substances include traces of phospholipids and of such waste products as urea and uric acid. Ammonium salts are found in traces. Inorganic salts include the chlorides, phosphates, and bicarbonates of sodium, potassium, and calcium and amount to about 0.2 per cent or less. Saliva may serve as a vehicle for excretion of foreign substances. The common experience of a bitter taste following the injection of morphine is due to excretion by the salivary glands. Many drugs can similarly "leak" through into the saliva. Alcohol appears in saliva in nearly direct proportion to its concentration in blood. While its medicolegal validity has not been generally accepted, determination of alcohol in saliva is proposed in order to avoid the inconvenience of taking a blood sample when chemical evidence of recent ingestion of alcohol is required.

While the inorganic salts of the saliva tend to reflect those of blood serum, the correspondence is not complete. Some of the experiments on record show a tendency to a higher concentration of K^+ , Ca^{++} , and HCO_3^- in saliva than in serum.

The pH of saliva is variable even in the same subject. A series of over 600 specimens from 228 normal persons reported by Starr showed a range from 5.75 to 7.05 in pH values although a majority of the results fell within a narrower range, 6.35 to 6.85. Values as high as 7.9 are reported. It seems to be established that high values result from exposure of saliva to air before testing. This permits escape of CO_2 and raises the pH value. Collected directly from the salivary ducts, saliva is on the acid side of neutral nearly all of the time. During rapid secretion of HCl by the gastric glands saliva may be temporarily alkaline.

The saliva of many persons contains a low concentration of potassium thiocyanate (KSCN), which was at one time correlated with smoking but is now regarded as due to liver and kidney detoxication of traces of cyanides derived from plant foods.

The salivary constituents which contribute to the formation of "tartar" on the teeth are chiefly calcium phosphate and bicarbonate. Loss of CO_2 from the saliva causes their precipitation. Food particles and bacterial residues tend to be entrapped in the precipitate.

Dental Caries. Decay of the teeth is so common that every effort to find any contributory cause is important. The theory generally held is that acid fermentation of food particles clinging in pits and

fissures of the teeth and between them is the cause of decay. The fermentation acids are supposed to attack the surface enamel and then the underlying dentin. In view of this theory, the ability of saliva to neutralize acids has been studied in attempts to show that this is protective against caries. Statistically, there is some evidence that people who are highly susceptible to tooth decay secrete saliva with less acid-neutralizing power, on the average, than is found in the case of those with sound teeth. But, on the whole, the results are not convincing and some of the evidence suggests that a tendency to a more acid saliva follows rather than precedes tooth decay.

The modern trend of research in this field is toward the study of faulty diet as a predisposing cause of susceptibility to this and other dental defects. Diet during the period of tooth formation is of unquestionable importance, although there is probably some effect of diet at all periods of life. Especially important is an adequate supply of Ca and P. This is to be expected inasmuch as calcium phosphate is the chief constituent of both enamel and dentin. But an equally great significance is attached by most investigators to adequacy in the supply of vitamin D. Its importance, especially during childhood, seems to be as well established as could be expected when statistical data have to be used for proof. But sound teeth are not necessarily assured by adequate supplies of Ca, P, and vitamin D. One of the factors involved is the health of the gingival tissues which requires, among other things, an adequate supply of ascorbic acid. The vexing problems relating to dental health are far from being solved.

✓ **Salivary Amylase.** The only significant enzymatic effect of saliva is starch hydrolysis. The enzyme long known as **ptyalin** breaks down dextrans and glycogen as well as starch. It has not been obtained in purified condition. The course of its activity was described (p. 30). The optimum pH zone is 6.6 to 6.8. The presence of the Cl ion enhances its activity, and when dialyzed until salt-free, it is inactive. It is highly susceptible to acidity, being rapidly destroyed at pH 4 or less. This indicates a sharp limitation of its activity after it reaches the stomach, where acidity of the gastric juice destroys it. Starches eaten with the last course of a full meal may continue to be hydrolyzed by admixed saliva until the acid of the gastric juice has entirely permeated the food mass in the stomach.⁶⁷

The comparative amylase activity of human saliva is determined by the use of several methods. One that is frequently used measures the time required to reach the stage where a given amount of starch has been digested until it just fails to show a blue color with iodine. This stage is called the achromic point. Even when all conditions (quality

and quantity of starch, concentration of saliva, pH, concentration and kind of buffer, electrolyte concentration, and temperature) are duly standardized and maintained constant, wide variations are observed. Some individuals show practically no amylase activity. Even in the same person it shows considerable variability though generally less than between individuals.

Maltase is assumed to occur in saliva to account for the small amounts of glucose which have been detected in salivary digests. The alleged occurrence of other weakly active enzymes, sucrase, protease, etc., in saliva has not been substantiated and is probably explained, in some cases, by bacteria of the mouth.

Functions of Saliva. The chemical aspect of salivary digestion is not impressive. Amylases of the intestine are adequate for starch digestion. Carnivorous and herbivorous animals, so far as tested, are not found to have significant amounts of salivary amylase. The solvent and lubricating powers of saliva are more important. The dog which bolts its food with comparatively little mastication affords a good example of the lubricating effect of saliva.

GASTRIC DIGESTION

Secretion of gastric juice by the large number of small glands in the gastric mucosa is largely, but not entirely, under nervous control. This is demonstrable by the use of an experimental opening (fistula) in the stomach, permitting quantitative collection of gastric juice. The reflexes which arouse salivary secretion are equally potent for gastric secretion. The gastric glands are of the two following types: (1) Those having a single layer of secreting cells (the chief cells), and (2) those having large cells (the parietal cells) outside the layer of chief cells and able to deliver their product through minute canaliculi directly into the lumen of the gland. From the lumen, the mixed product of the two types of cells flows into the stomach.

Methods of Studying Gastric Digestion. Gastric contents (a mixture of food, saliva, and gastric juice) may be obtained by emptying the stomach of a recently killed animal or by the use of a stomach pump. Material thus obtained is useful for some observations but does not show the composition of gastric juice. For this purpose, the best method makes use of the gastric fistula.

The first gastric fistula came about accidentally in the famous case of Alexis St. Martin. He was wounded by the accidental discharge of a shotgun. The wound involved the front of the abdomen and the stomach. In the process of healing, the stomach wound became attached to the abdomen so that a permanent opening from the outside of the body

into the stomach cavity was established after the wound was healed. A fold in the mucous lining of the stomach lay in such a position that it formed a flap or valve inside of the fistula. This enabled the stomach to retain food. Recovery was complete, and the patient was in good health. Dr. Beaumont, his attending physician, published in 1828 a unique account of this case and his numerous observations on it. The important physiological outcome was the development of an operative method for making the gastric fistula. There have been only a few cases of the gastric fistula operation on human beings. One observed by Carlson was necessitated because of occlusion of the esophagus.

For the most part, gastric fistulas have been made on dogs. Heidenhain largely developed the experimental technique, but the operation was particularly elaborated for the study of gastric secretion by Pavlov. He devised a method by which the stomach was left in a condition to carry on its functions as usual but a smaller part was made into an "accessory" stomach. This smaller sac was provided with a permanent fistula. The division of the stomach was made by a longitudinal cut running parallel to the main blood and nerve supplies of the stomach. In this way, the nutritive condition and the nervous control of both portions of the operated stomach were left in normal functional condition. While food was being digested in the main part of the stomach, normal gastric juice was produced also in the "accessory" stomach. This juice, uncontaminated by food material, could be collected at the fistula.

"Artificial gastric juice," as it is usually called, is suitable for the experimental study of the action of stomach enzymes. This preparation is made by extracting the ground-up mucous lining of the stomach of a recently killed animal. For this extraction, several different solvents are suitable: 0.4 per cent HCl, water, glycerol, mixtures of water and glycerol, or mixtures of water and alcohol. The extract made with dilute HCl can be treated with an excess of alcohol so as to form a precipitate which contains the gastric enzymes. Dehydrated by further treatment with pure alcohol, this precipitate constitutes one of the forms of commercial pepsin used for medicinal purposes. A solution of this material in dilute HCl is an effective artificial gastric juice. Dilute alcoholic extracts of the mucosa of the fourth stomach of the calf are used as commercial "rennet" for culinary preparation of clotted milk.

The stomach pump in its modern forms, as designed by Rehfuss and by Ryle (Fig. 50), has made the collection of gastric contents relatively simple. The tube may be left in place for many hours, and samples may be collected at suitable intervals. After removal of residual matter the gastric juice secreted in response to "psychic" stimuli or to other stimuli which do not involve the swallowing of food may be obtained in fairly

pure form. The secretion after injection of histamine (p. 260) may also be obtained.

Composition of Gastric Juice. Supposedly pure gastric juice obtained from the Pavlov "accessory" stomach is clear, slightly viscid, and pale yellow in color. The HCl concentration varies from about 0.2 to 0.5 per cent. The average of the supposedly most normal specimens from the dog is 0.4 per cent. Probably human gastric juice has about the same acidity. All available evidence indicates that the parietal cells are the sole source of HCl.

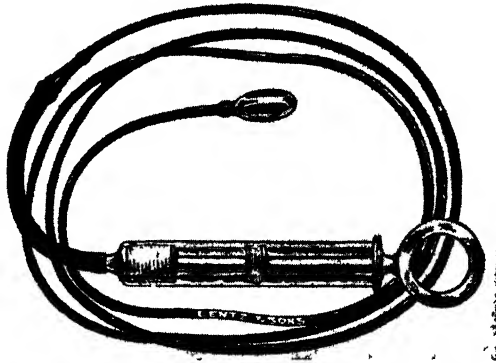

FIG. 50. Rehfuss stomach tube. The perforated capsule at the end of the tube permits withdrawal of gastric contents without occlusion of the opening by the mucosa.

The gastric juice contains mucin-like proteins (mucus), inorganic salts, and enzymes. The mucus is produced by small glands in the gastric lining. It probably functions as a protection for the mucosa against the action of pepsin-HCl. The enzymes include **pepsin** (gastric protease), **rennin** (milk-coagulating enzyme), and **gastric lipase**. Rennin has been definitely identified only in the fourth stomach of the calf.

The water content of gastric juice is variable. Some specimens contain about 97 per cent, but those regarded as most nearly normal for the dog have about 99.5 per cent of water.

The Origin of HCl. As actually produced by the parietal cells before mixing with other components of gastric juice, HCl may be, according to Hollander, 0.17*N* or about 0.61 per cent. This would be approximately isotonic with blood serum. The pH would be about 0.9. Such an acidity, extremely toxic to any living cells and entirely beyond the range of pH values existing in protoplasm, must require a special physiological mechanism for its production. In efforts to identify it many theories have been explored. The most plausible one suggests

that the reaction is essentially an interchange of ions between H_2CO_3 and NaCl .

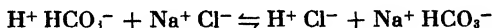

Under ordinary conditions, this reaction drives so forcibly from right to left that the equilibrium concentration of HCl is extremely low. But many kinds of evidence, such as the interdependence between the CO_2 concentration of the blood and the rate of HCl secretion, point to the value of this theory. The best evidence is provided by the behavior of the enzyme **carbonic anhydrase**. Its presence on the surfaces of red corpuscles has afforded an explanation of the shift of HCl from serum to corpuscles (Chap. XI), and if it were present on the parietal cells of gastric glands it could be functional in HCl production. It catalyzes the reaction



and, in the presence of H_2CO_3 and NaCl , can favor the production of HCl , provided the latter is removed from the reacting system. Davenport (1939) investigated the occurrence of carbonic anhydrase in gastric glands. Pieces were cut out of gastric mucosa in numerous areas, so chosen that the number of parietal cells included varied from none to a maximum. The enzyme activity in splitting CO_2 from NaHCO_3 was determined quantitatively, and results were compared with the number of parietal cells determined by actual count in histological sections. No anhydrase was found in the chief cells, but in material containing parietal cells the enzyme activity was directly proportional to their number. If, as seems probable, carbonic anhydrase plays a role in HCl production, the requisite concentration of carbonic acid might be attained partly by withdrawal of bicarbonate from blood and partly by a high rate of oxidation in the parietal cell producing CO_2 and acids from metabolites.

Gastric Proteolysis. Hydrolysis of proteins is the chief digestive change in the stomach. Pepsinogen (p. 246) produced in the chief cells is activated to pepsin upon contact with HCl from parietal cells. Activation can occur at any pH below 6, and at an intermediate acidity (pH 4.6) the process is autocatalytic in the sense that a small amount of pepsin formed hastens the activation of the remaining pepsinogen, (p. 246). It seems that the $-\text{OH}$ groups of the tyrosine residues of pepsin have some especial significance in its functioning. When pepsin is treated with ketene ($\text{CH}_2:\text{CO}$) under suitably controlled conditions, acetylation takes place at the phenolic $-\text{OH}$ groups so as to mask them. The further the acetylation process is carried, the less is the specific activity of pepsin as a proteinase. While pepsin has been shown to cause the liberation of

amino acids from its substrate protein, especially during prolonged action, it seems normally to carry proteolysis only to the stage of proteoses and peptones, which are relatively large fragments of the food protein molecule. The optimum pH zone is about 1.8 to 2.0 (p. 233). The mineral acids, HCl, HNO₃, H₂SO₄, and H₃PO₄, and even some organic acids, oxalic and citric, are found to be equally effective *at the same pH* in furthering peptic digestion of various proteins.

Rennin. This enzyme, also called **chymosin** and, commercially, **rennet**, causes coagulation of milk. The advantage of this is the prevention in the young mammal of too rapid passage of milk from the stomach so as to interfere with orderly digestion in the intestine. The long controversy as to the separate identity of pepsin and rennin seems now to be settled. Both coagulate milk and, indeed, all proteases are apparently able to coagulate milk. After Northrop prepared crystalline pepsin and Tauber and Kleiner prepared calves' rennin free from pepsin, the different characteristics of the two enzymes were clearly established. They have different isoelectric points (rennin, about 5.4 and pepsin, 2.7) and differ in composition. Rennin appears to contain more sulfur than pepsin. They also differ in activity. Rennin may have some six times the milk-coagulating power of pepsin. The coagulating reaction has been variously explained but appears to involve something equivalent to a partial hydrolysis of the chief protein of milk. To distinguish between the native and coagulated protein the former may be called caseinogen and the latter casein. Some writers prefer to call the natural one "casein" and the coagulated one "paracasein." The fact that acid alone clots milk, as in the case of lactic acid produced by bacteria in souring of milk, is accounted for by the natural occurrence of caseinogen as the Ca salt which is soluble while free caseinogen is insoluble at its isoelectric point. Acid sufficient to bring milk to this point, pH 4.7, reversibly precipitates caseinogen. Rennin action, however, irreversibly changes caseinogen to casein (paracasein) which is soluble in dilute acid except in the form of its Ca salt which precipitates to form the clot. In the absence of Ca ions (as after adding oxalate) rennin causes no clot but so changes caseinogen that subsequent addition of CaCl₂ causes instantaneous clotting. Rennin, like pepsin, occurs as a zymogen which is activated by acid at pH 5 or less.

Gastric Lipase. The fat-splitting action of the gastric juice is not very marked. Finely emulsified fats, such as cream, may undergo a very partial hydrolysis into glycerol and fatty acids. But the acid condition of the stomach contents prevents any considerable change of this sort. Even when gastric juice is rendered alkaline, its fat-splitting power is meager. Some experimenters have even contended that the

stomach produces no lipase and the mild fat-splitting powers of the gastric contents are due entirely to a lipase which gets into the stomach by regurgitation of intestinal contents through the pylorus. Any marked lipase action is undoubtedly due to an enzyme derived from this source. But the demonstration of a mild lipolytic action in extracts of the gastric mucosa renders highly probable the commonly accepted view that the gastric glands do produce a trace of lipase.

Gastrin. Although the nervous control of gastric secretion is prominent, there is also a chemical (hormonal) control. Chemical excitants of glands are sometimes called *secretagogues*. While most foods are not gastric secretagogues, certain ones, such as meat and meat extracts, do call forth secretion of gastric juice. Edkins (1905) was able to show that this was not a direct effect but was due to action of the secretagogues on the lining of the pyloric portion of the stomach so that it produced the active substance. This, circulating in the blood, arouses the gastric glands and is thus shown to be a hormone. It is called "gastric secretin" or *gastrin*. Ivy and his coworkers have shown that some gastrin preparations yield **histamine**.

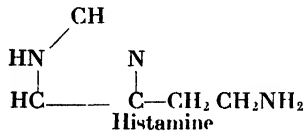

This, a well-known amine derived from histidine (p. 274), is potent in causing secretion of juice in the stomach. It is widely used for this purpose in experimental physiology and clinical studies. Subcutaneous injection of as little as 10 γ per kg. of body weight is sufficient to cause a copious flow of juice which in man or dog reaches its maximum in 30 to 45 min. after injection. The juice formed is so nearly free of constituents of gastric juice other than HCl that it would seem as though histamine stimulated only the parietal cells. Other preparations having gastrin activity will be considered in Chap. XX.

Gastric Analysis. In order to obtain gastric contents for examination and analysis in the diagnosis of digestive abnormalities, several methods are used to stimulate the flow of gastric juice. Various test meals have been devised. A simple one consists of bread and weak tea. Chopped lean beef, broiled, is used when a more complete excitation of gastric secretion is desired. A thin oatmeal gruel is frequently used. When it is especially important to observe the secretion of hydrochloric acid, histamine injections may be employed.

Preceding the stimulus for gastric secretion, the gastric contents (residuum) are removed by stomach pump to serve for control observa-

tion. In modern practice small gastric samples are removed subsequent to the stimulus at 15- or 30-min. intervals. This permits determination of the relative and maximum rates of gastric secretion and the time relations which vary in different types of gastric disturbances.

Details of analytical methods are to be found in clinical manuals. Microscopic examination is undertaken to look for evidences of cancer or other abnormal growths or for bleeding. Total acidity is determined because a number of gastric disturbances involve deficiency in secretion of HCl. When this is extreme it is called **achlorhydria**. Free acidity and combined acidity are measured. The latter is chiefly due to protein hydrochlorides. In the place of these various acidity titrations more modern procedure may substitute the determination of the pH, which is best accomplished with the glass electrode. In any case, acidity measurements are required in order to determine whether optimum conditions for peptic activity are present. In case of low acidity, tests for lactic acid as evidence of bacterial fermentations are made. Qualitative or quantitative measurements of peptic activity are usually undertaken. The rare condition of failure to secrete pepsin is called **apepsia**. For evidence of regurgitation of intestinal contents into the stomach, tests for bile constituents may be made. Using the successive samples, the rate of secretion of acid and the rate of emptying the stomach may be determined. Both of these rates vary not only pathologically but among normal individuals.

Gastric analysis is supplemented in modern practice by X-ray observations to determine gastric motility, which is perhaps as likely to be at fault in cases of gastric disturbance as is the secretory function.

PANCREATIC DIGESTION

The product of gastric digestion in form ready to pass from the stomach through the pylorus is called **chyme**. It is commonly described as having the consistency of a thick pea soup. Some constituents are in solution, some in suspension. It usually contains some free HCl and a somewhat larger concentration of combined HCl. Digestible proteins, including all except albuminoids, are in various stages of partial hydrolysis, proteoses and peptones predominating. The carbohydrates comprise incompletely digested starch, dextrans, and sugars, and fragments of cellulose, which is indigestible. Emulsified food fats, such as cream, remain emulsified and to some extent other food fats have become partly emulsified.

Intermittent relaxation of the pyloric sphincter, controlled chiefly by a localized nervous mechanism, normally ensures a gradual paying out, bit by bit, of the chyme into the duodenum, so that the small intestine

is able to move its contents along its narrow lumen without local congestion. As each gush of chyme enters the duodenum, an answering flow of bile and pancreatic juice is normally produced. As the pancreatic and bile ducts open into the intestine at a point only a few inches beyond the pylorus, their juices are mixed with chyme immediately after it leaves the stomach. This neutralizes chyme acidity and normally makes the duodenal contents alkaline.

Digestion in the intestine involves the interaction of three agents, pancreatic juice, bile, and intestinal juice. Although their effects are exerted upon food materials by simultaneous and interdependent activity, it is convenient to describe their effects separately.

The Control of Pancreatic Secretion. The stimulus activating the pancreas to secrete is chiefly chemical. Early experiments indicated this in that the flow of juice from a pancreatic fistula followed the introduction of chyme or HCl into the duodenum. Such experiments might be taken to indicate that acidity provided the stimulus for a reflex nervous effect, but this idea is precluded by observation of the effectiveness of acid after all nervous connections to the pancreas have been severed. The actual mechanism was discovered by Bayliss and Starling (1904). They showed that when the mucous lining of the duodenum of a recently killed animal is extracted with dilute HCl, neutralized, filtered, and sterilized, and is then injected into the circulation of a dog with a pancreatic fistula, a flow of pancreatic juice proportional to the amount of extract injected is obtained. This discovery preceded the work of Edkins on gastric secretin and was, indeed, the first discovery of typical chemical control of secretion. Bayliss and Starling suggested that a definite substance, produced in the intestinal epithelium under the influence of HCl, is carried by the blood to the pancreas and excites its secretory activity. They proposed to call this substance **pancreatic secretin**. They also suggested that the now widely used term "hormone" be applied to any such "chemical messenger."

Pancreatic secretin has been extensively investigated, but its chemical structure is not yet established. Hammarsten and Ivy obtained it in the form of a crystalline picrolonate. Its properties (Chap. XX) are those of a polypeptide. It is not produced in parts of the intestine other than the duodenum.

Another active substance, called **pancreozymin** by its discoverers, Harper and Raper (1943), is prepared from the intestinal tissues but not found in the mucosa. It increases the production of enzymes by the pancreas without increasing the volume of pancreatic juice formed. It is regarded as a hormone acting upon the enzyme-producing function of the pancreas. If this is correct it is of interest as confirmatory to the

general theory of secretion. This assumes that the manufacture of the specific products of a gland may go on in its cells while they seem to be at rest and that the outflow from the gland to the duct is a specialized process having its own mechanism of control. In the pancreas, pancreozymin seems to stimulate the production processes while secretin stimulates the outflow.

Although nervous excitation of pancreatic secretion cannot be entirely excluded, it must be of minor importance if it occurs at all.

Composition of Pancreatic Juice. As obtained from a fistula, uncontaminated pancreatic juice is a thin, watery fluid closely resembling saliva. Its composition is variable, and there is no assurance that fistula juice is representative of that produced under physiological conditions. The average water content is 98.7 per cent, and the solids include albumin, globulin, noncoagulable protein, other organic compounds, and inorganic salts. The latter have so large a proportion of NaHCO_3 that it, together with some alkaline phosphates, renders the juice distinctly alkaline, pH 7.5 to 8.0, with occasional specimens even more alkaline.

Pancreatic juice obtained from a cannula in such a way as to avoid contact with wounded tissues or blood or the intestinal lining, is practically devoid of any proteolytic or lipolytic activity. It contains certain enzymes and the zymogens of others. Their number, "versatility," and high activity in intestinal digestion make pancreatic juice an important and indispensable digestive agent. The following enzymes have been identified in activated pancreatic juice: Trypsin, chymotrypsin, carboxypeptidase, amylopsin (amylase), and steapsin (lipase). Lactase and maltase have been reported to be present in some cases, but for the most part, the splitting of disaccharides is due to enzymes of the intestinal juice.

Activation of Pancreatic Proteases. Trypsinogen and chymotrypsinogen probably enter the duodenum under normal conditions without being activated, but even a slight contact with intestinal mucosa is sufficient to start activation which is rapidly completed. Experiments designed to obtain inactive pancreatic juice from a fistula may result in getting an active one. The activating effect is attributed to an intestinal enzyme called enterokinase, at least so far as trypsin is concerned. Pure crystalline trypsinogen and chymotrypsinogen, as prepared from pancreatic tissue by Northrop's methods, are easily activated. Enterokinase produces some active trypsin, and this by autocatalysis activates more trypsin, which also activates chymotrypsin.

Pancreatic Enzymes. The idea long prevalent that trypsin could completely hydrolyze proteins to amino acids has now been abandoned. Purified trypsin, isolated from other enzymes, splits proteins only to

the proteose-peptone stage. The complete process requires a group of intestinal and pancreatic enzymes of which at least three are pancreatic. There is some evidence of the existence of a fourth one in pancreatic juice. Two, trypsin and chymotrypsin, can attack food proteins. They differ, according to Northrop, in that chymotrypsin is much the more active in coagulating milk. Both of them, however, can hydrolyze proteins, but they may not attack the same linkages in the protein molecule. When acting on casein, chymotrypsin following previous action of trypsin, or trypsin following chymotrypsin, increases the degree of hydrolysis. The optimum pH zone (8.0 to 9.0) is the same for both enzymes.

The existence of an enzyme known as **erepsin** was postulated to account for the fact that certain extracts of intestinal mucosa, without hydrolyzing effects on food proteins, could split proteoses, peptones, and peptides. The erepsin effect is now known to be due to a group of enzymes, each of which is specific for certain substrates. One of them has been identified in pancreatic juice. It is **carboxypeptidase**, which, as the name indicates, disrupts peptides by attack at the end of the amino acid chain where the free —COOH group is placed.

The chief carbohydrase of pancreatic juice is usually known by its older name **amyllopsin** but is also called "pancreatic amylase." It was prepared (1931) in the form of a crystalline protein by Caldwell, Booher, and Sherman. It shows activity in dilutions exceeding $1:10^8$ and may digest as much as 4×10^6 times its weight of starch. Unlike salivary amylase, it even attacks raw (uncooked) starch grains. Experiments on human subjects show that raw starch of corn and wheat may, under some conditions, be entirely digested and raw potato starch to the extent of 80 per cent. The optimum pH for amyllopsin is about 7.1. The course of the hydrolysis of starch does not differ significantly from that due to ptyalin.

A lipase known as **steapsin** is present in an inactive form (prolipase) in pancreatic juice. Its activation in the intestine has not been fully explained. In test-tube experiments it may be activated by boiled extracts of pancreas, an effect which Rosenheim (1910) attributed to a coenzyme. But the effect is not specific and may be imitated by the use of blood serum or even by lead salts. In the intestine the bile salts appear to be the effective activators. Steapsin splits the neutral fats which are triglycerides of the higher fatty acids.

Pancreatic juice also contains a **cholesterol esterase** which catalyzes the reversible reaction, $\text{cholesterol} + \text{fatty acid} \rightleftharpoons \text{cholesterol ester}$, and a **lecithinase** which liberates fatty acids from phospholipids and is distinct from other lipases.

DIGESTIVE ACTION DUE TO THE INTESTINAL MUCOSA

The enormous number of glands (glands of Brunner and Lieberkühn glands) occurring in the intestinal mucosa secrete intestinal juice. Mucous glands are also functional, resembling those in the stomach. The control of the rate of secretion of intestinal juice, although probably hormonal (Chap. XX), has not been satisfactorily explained. The juice as obtained from a fistula may or may not be representative of that normally secreted but is not rich in the intestinal enzymes. These have more generally been studied in extracts of intestinal mucosa. The prevalent view is that intestinal enzymes, although operating in the secreted juice, are also effective on the surfaces or in the protoplasm of the lining cells of the intestine. Linderstrøm-Lang and Holter (1940) found that various poly- and dipeptidases were present in greater abundance at a depth of 0.5 to 1.0 mm. below the surface of intestinal mucosa than at the surface or at greater depths. Intestinal juice is alkaline but less so in fistula samples from the upper than from the lower part of the intestine.

Peptidases. Polypeptidases of both the carboxy- and the amino-type have been found in intestinal extracts. These are called exopeptidases since they operate with the aid of the terminal (exo-) $-\text{COOH}$ and $-\text{NH}_2$ groups of the peptide. There are also endopeptidases which attack the substrate at some point not near the end of a peptide chain. Dipeptidases (p. 228) have been extensively studied.

The elaborate chemical mechanisms of animals for hydrolyzing proteins and protein molecular fragments might seem, a priori, to be an unnecessary provision of nature. But modern knowledge of the specific attack of different enzymes upon different peptide unions in the protein molecule makes this mechanism seem to be necessary from the viewpoint of natural adaptation. The prevalent idea that proteins are almost completely if not entirely converted into amino acids before absorption into the blood is supported by study of the intestinal proteases.

Carbohydrases. Although weak activity of intestinal extracts in hydrolyzing starch has been reported, more interest centers on the sugar-splitting enzymes. **Sucrase** and **maltase** are probably produced throughout the length of the small intestine. **Lactase**, in the pig, is found chiefly in the mucosa of the duodenum and tends to be more abundant in the young mammal than in the adult. Its occurrence in intestinal juice has not been satisfactorily demonstrated. Optimum pH zones are: For sucrase, 5 to 7; for maltase, 5.8 to 6.2; for lactase, 5.4 to 6.0.

Phosphatase and Nucleases. An enzyme called "phosphatase," which splits phosphoric acid from certain organic phosphates, including hexose phosphates, glycerophosphate, and the nucleotides, is obtained

from intestinal mucosa. The optimum pH is about 8.6. Nucleotides (Chap. V) are set free from nucleic acid by the intestinal enzyme called **polynucleotidase**. There are probably specific forms of this enzyme. One of them, prepared from pancreas in crystalline and practically pure form by Kunitz, is called **ribonuclease**. It is specific for splitting ribonucleic acid (not desoxyribonucleic acid) into its constituents mononucleotides without liberation of phosphoric acid. It is not shown that this enzyme is present in the intestine although it seems probable that this reaction occurs there. The similar splitting of desoxyribonucleic acid (p. 147) has been demonstrated, using intestinal mucosa. Of the nucleotides thus liberated, the purine type are split by **nucleosidase** to liberate adenine, guanine, and pentose. No enzyme cleaving pyrimidine nucleosides has been found in the intestine although they do occur in certain other tissues.

A schematic summary of the liberation of nucleic acid and its digestive hydrolysis follows:

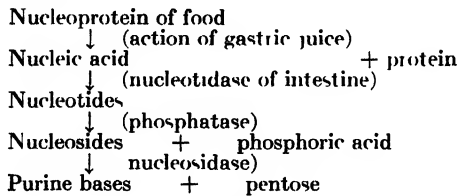

BILE

The liver, the largest single organ in the animal body, has manifold functions. Most of them will be discussed in connection with metabolism. One outstanding function is the secretion of bile. While this is a continuous process, the rate of secretion as measured by the outflow from a biliary fistula is varied. Chemical stimulants may include secretin from the intestine. Its effect upon bile secretion is, however, very small in comparison with its effect on the pancreas, and its direct effect upon liver cells is questioned. A high protein diet, especially meat, has been associated with increased bile production. The most important chemical factor appears to be the presence of bile salts. Secreted by liver cells and excreted into the small intestine in solution in bile, these salts are normally reabsorbed through the intestinal wall and carried by the portal blood directly back to the liver. Here they are almost completely taken up by the liver cells and added to newly formed salts for further use in the bile. This affords a localized circulation of the bile salts. When this is interrupted by the withdrawal of bile through a fistula, bile secretion diminishes but is noticeably increased upon introduction of bile salts into the intestine. Sluggishness of secretion of bile is successfully treated by feeding bile salts.

The amount of bile formed can be only estimated. Observations have been made upon human patients and upon experimental animals with biliary fistulas, but the flow of bile thus measured is probably less than under normal conditions. It is estimated to be in excess of a liter per day in the normal human adult.

Composition of Bile. As it moves from the liver through the hepatic duct, bile is distinctly different from the fluid found in the gall bladder. So far as anatomical observations are concerned, it appears as

TABLE 37—ANALYSES OF BILE

	Averages of 3 analyses of fistula bile from liver	Averages of 4 analyses of bile from bladder
	per cent	per cent
Water	97 13	86 00
Bile salts	1 55	8 20
Mucin and pigments	0 19	2 25
Cholesterol	0 12	2 17
Fat, including lecithin	0 06	0 66
Inorganic salts	0 72	0 78

though the bile, when not flowing into the intestine, merely backs up into the gall bladder for storage. This idea is inadequate. The gall bladder's total capacity in man is only about 3 per cent of the daily secretion. Operative removal of the gall bladder (cholecystectomy) because of gallstones or infection does not noticeably affect digestion in most subjects. Some mammals, including the rat, horse, and some species of deer, do not have a gall bladder. Furthermore, bladder bile, as obtained from recently slaughtered animals (pigs or cattle), may contain as much as 18 per cent of solids, is high in viscosity, and is usually cloudy. Hepatic bile has about 3 per cent of solids and is relatively fluid and transparent. Comparison of quantitative analyses of the two kinds of bile (see Table 37) suggests that water is absorbed in the bladder and that some materials, especially cholesterol and mucus, are added. No enzymes except phosphatase have been found in bile. Bile is alkaline (pH 7.7 to 8.6), largely because of the bile salts.

Bile Salts. A specific product of liver secretion, the bile salts are characteristic components of bile. They are chiefly the Na and to a lesser extent the K salts of taurocholic and glycocholic acids. They are obtained in crystalline form by mixing ether with an alcoholic extract of desiccated bile. They are soluble in water and ethanol and insoluble in ether. They are distinctly alkaline. They yield precipitates of their

free acids when their solutions are acidified with mineral acid. They have a remarkable power of lowering the surface tension of water. This property enables them to emulsify fats, so that bile is an effective emulsifier. Bile salts dissolve fatty acids and water-insoluble soaps. The solvent power is greater when the bile salts are accompanied by cholesterol.

Glycocholic acid, heated with 5 per cent HCl, hydrolyzes to cholic acid and the amino acid glycine. Taurocholic acid, similarly treated, yields cholic acid and taurine. Taurine, aminoethylsulfonic acid, is related to the amino acids cystine and cysteine. In vitro, this relation is shown by the following reactions:

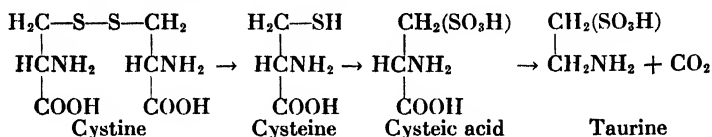

Cystine is probably the precursor of taurine in the liver, but the intermediate compound has not been identified. An enzyme, occurring in liver, specifically decarboxylates cysteic acid to form taurine.

Cholic acid, $\text{C}_{26}\text{H}_{48}\text{O}_6\cdot\text{COOH}$, is a specific product of liver cells. Its structural relation to cholesterol (p. 89) is indicated by its formula

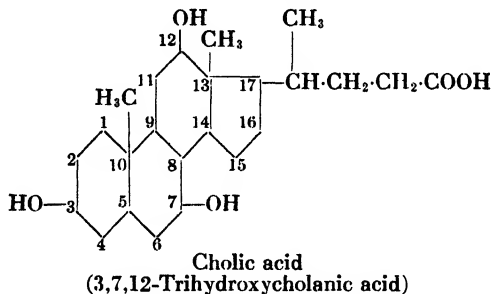

If, as is assumed but not proved, cholesterol is the mother substance of cholic acid, it would have to be reduced at the 5-6 double bond and oxidized in the side chain and at other points. Other related acids, desoxycholic (3,12-dihydroxycholic), chenodesoxycholic (3,7-dihydroxycholic), and lithocholic (3-hydroxycholic), have been obtained from the corresponding glycine or taurine derivatives as found in bile of various species of animals but in concentrations less than those of glycocholic and taurocholic acids. Cholic acid is joined to glycine or taurine by a $-\text{CO}\cdot\text{NH}-$ link, a molecule of H_2O being eliminated from the $-\text{COOH}$ of cholic acid and the $-\text{NH}_2$ group of the other component.

Bile salts entering the general circulation, as happens in obstructive jaundice, are toxic. They diminish the surface tension at the limiting

membrane of red corpuscles and some other kinds of cells. In sufficient concentration they are a solvent for cell surface lipids, and this effect may be sufficient to cause cytolysis. When injected into experimental animals, bile salts cause circulatory depression, muscular spasms, and other severe symptoms and may be lethal. When bile salts are present in the blood in significant amount, they appear in the urine (Chap. XVII).

Bile Pigments. The chief pigments determining the color of bile are bilirubin, $C_{33}H_{36}O_6N_4$, and biliverdin, $C_{33}H_{34}O_6N_4$. Biliverdin is formed from bilirubin in vitro by mild oxidation, and the other less abundant pigments of bile are closely related to these two. Bile pigments are waste products arising from the breakdown of hemoglobin in the liver. The iron-porphyrin group of this and related proteins is the precursor, but unlike these porphyrins, bile pigments have their pyrrole groups in open chain formation rather than in a closed ring and do not contain a metallic element.

The probable formula of bilirubin is

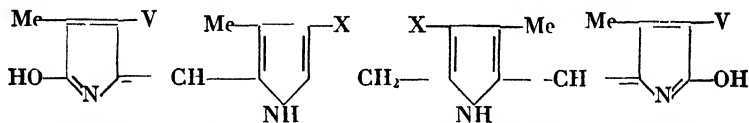

V represents the vinyl group, $-\text{CH}=\text{CH}_2$, X a propionic acid residue, $-\text{CH}_2\text{CH}_2\text{COOH}$

Green bile, such as that of the rabbit, has biliverdin as the predominant pigment; reddish bile, normally found in the ox, pig, and man, has bilirubin as the chief pigment. Bile-pigment derivatives, especially stercobilin formed by bacterial action in the intestine, account chiefly for the color of feces. Some of these substances are absorbed from the intestine and appear among the pigments of normal urine. They include urobilinogen and urobilin.

The bile pigments are slightly soluble in water and insoluble in ether. Bilirubin is soluble in chloroform while biliverdin is not. The latter is soluble in ethanol. Bilirubin readily crystallizes from its chloroform solutions.

Bile pigments give a number of color reactions. One that is frequently used is in *Gmelin's test*. Urine or other material to be tested for the presence of bile is stratified above concentrated HNO_3 . Bands of various colors formed by oxidation of bile pigments appear above the contact zone. This and similar tests are used in diagnostic urine examination.

Control of the Flow of Bile. While the secretion of bile is continuous, the outflow into the intestine is usually intermittent. It is

determined by (1) the opening and closing of the small ring-shaped muscle, sphincter of Oddi, at the duodenal end of the common bile duct, (2) the pressures exerted upon the duct by muscles of the intestinal wall, and (3) relative pressure of the bile in the duct and in the gall bladder. The latter has a thin muscle layer in its walls and is apparently able to function by relaxation or contraction as a pressure regulator. Ivy and his coworkers have investigated a possible chemical mechanism of gall-bladder control. They conclude that a hormone, called **cholecystokinin**, is produced in the duodenum when acid enters it and can cause gall-bladder contraction in the dog, cat, and guinea pig, but not in the rabbit.

Functions of the Bile. The main usefulness of bile is in the digestion and absorption of fats. The bile salts are efficient emulsifiers and, unless emulsified, fats are not well digested. Moreover, bile salts have a remarkable solvent action on fatty acids and aid in their absorption from the intestine. It is probable that in the absence of bile an oily film of undigested fat can so coat food particles as to interfere with the activity of proteases and amylases. When bile is excluded from the intestine, as by drainage through a fistula or by obstructive jaundice, there is a marked increase in the amounts of undigested food in the feces. Fat in the feces may be as much as 90 per cent or more of that in the food although about 95 per cent normally disappears under conditions of good digestion. The solvent power of the bile for cholesterol and other sterols and steroids appears to be essential for their absorption from the intestine. This matter will be referred to again in the following chapter.

The role of the bile as an aid in neutralizing HCl of the chyme is important, although quantitatively it is probably less important than are the pancreatic and intestinal juices.

Bile has a mild laxative effect and, by aiding in food utilization, tends to diminish the amount of material subject to putrefaction in the lower intestine.

As a vehicle of excretion, bile is of considerable significance. Bile pigments and cholesterol (present in free form or as its esters) are the main waste substances. There is no explanation of why the synthesis of cholesterol should markedly exceed the body's needs. The possibility that cholesterol of the food provides an important part of the excess has not been excluded. But its excretion is almost entirely via the bile. Free cholesterol is insoluble in aqueous media. It is held in solution in bile by the bile salts, but failure to retain all of it in solution frequently results in the formation of gallstones (biliary calculi). The majority are composed chiefly of crystalline cholesterol with some admixture of bile pigments and inorganic matter. The presence of small amounts of phospholipids, chiefly lecithin, in bile is unexplained.

Certain inorganic wastes are excreted in bile. Metals, such as Cu, Zn, and a few others, have been shown to take this pathway after they have been removed from the blood by the liver. The presence of Ca and Mg in bile might be regarded as due to excretion, but their reabsorption from the intestine is possible.

INTESTINAL FERMENTATION AND PUTREFACTION

Microorganisms have a favorable growth medium in the intestine. Owing to the tendency of gastric HCl to sterilize gastric contents, relatively few bacteria or yeasts escape into the duodenum. Under normal conditions the duodenal contents are nearly sterile, but in the lower part of the small intestine and especially in the colon, the bacterial flora are very abundant. The alkalinity of the duodenal contents gives way to a tendency to slight acidity in the ileum as a result of acid fermentations. The feces are commonly neutral or faintly alkaline.

Gaseous Fermentation. Intestinal bacteria produce gases. The chief ones are CO_2 , CH_4 , H_2 , N_2 , and H_2S . The proportions of these gases vary with the nature of the diet and the type of intestinal flora predominating. The chief source of CO_2 and CH_4 is carbohydrate fermentation, although these gases also result from other fermentations. The chief source of N_2 and H_2S is the putrefaction of proteins and their hydrolysis products. Ammonia is also formed but not as a gas. It combines with fermentation and other acids. Some of the N_2 is derived from air swallowed with food. Much of the gas produced in the intestine does not pass out through the rectum but is absorbed into the blood. This permits the toxic gas H_2S to gain access to the tissues.

Cellulose Utilization. The animal digestive system has no provision for hydrolysis of cellulose, yet this substance composes a considerable part of the food of some species. Bacteria attack cellulose forming soluble carbohydrate. Studies on herbivores, especially the goat, show that a large proportion of food cellulose is utilized. It would entirely escape digestion but for the action of bacteria in the digestive system. The digestive organs in such animals, especially in those with a large cecum, provide for comparatively long retention of food, thus favoring more cellulose fermentation than occurs in other animals. Cellulose is utilized only to a small and undetermined extent in man. Aside from the effect on cellulose and the production of vitamins, there is no evidence that intestinal bacteria are of use to animals. Even herbivores (guinea pigs) have been reared on sterile foods while maintained in an aseptic environment after aseptic Caesarean delivery. They were satisfactorily nourished for a short time without the aid of bacteria.

Putrefaction. The fermentative action of many species of bacteria upon proteins and their split products produces putrid odors and is called

“putrefaction.” Bacterial enzymes are to some extent extracellular and can thus decompose proteins of the medium. Some of the products may be identical with those formed by animal proteases, *i.e.*, proteoses, peptones, and amino acids. But amino acids and other nitrogenous compounds tend to be decomposed. Some of the resulting substances are referred to as **ptomaines**. This is an ill-defined term and might well be reserved for the especially toxic products. The fragments (aporphegmas) of amino acids are produced in general by one or both of two types of reactions, deamination by deaminating enzymes and decarboxylation by decarboxylases. The metabolism of amino acids in animal organs generally involves deamination before decarboxylation, but bacterial action is often in the reverse order. Some of the resulting amines are relatively toxic for animals and are significant components of putrefaction products.

Bacterial deaminations and decarboxylations are shown for each of the amino acids which yield characteristic products.

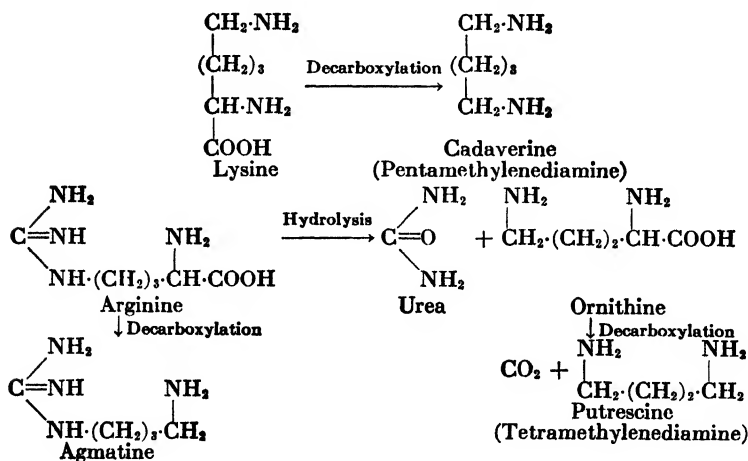

Cadavarine and putrescine are so named because they were discovered in putrefying flesh.

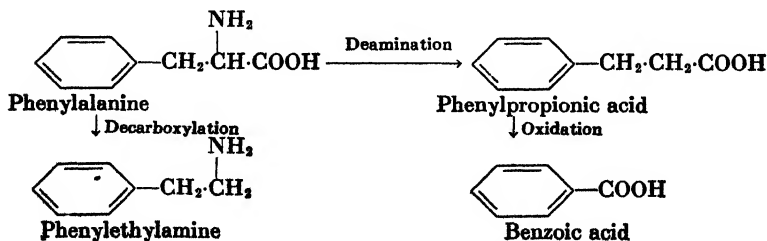

Bacterial action in the intestine is probably a normal source of some of the benzoic acid appearing in urine (p. 287) as hippuric acid.

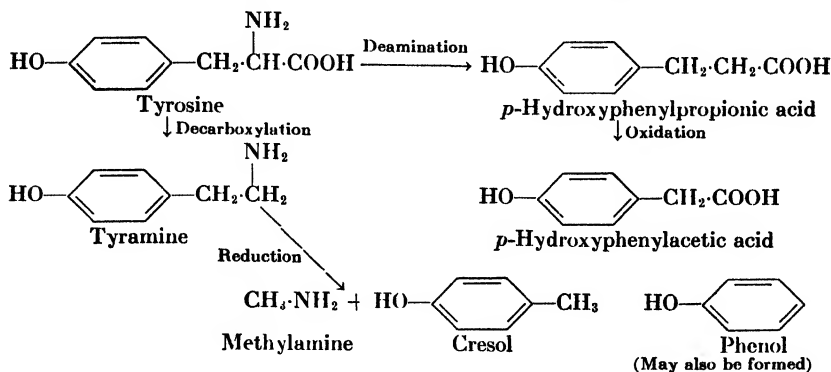

Tyramine has marked physiological action in raising blood pressure, but is detoxified in the liver.

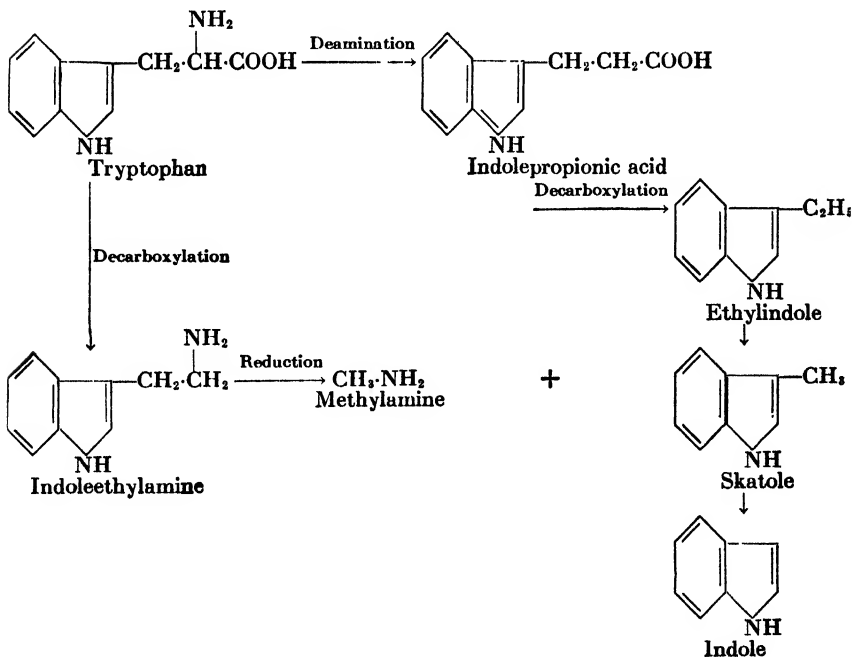

Indole and skatole are the substances chiefly responsible for the characteristic odor of feces. An enzyme, tryptophanase, occurring in *Escherichia coli* bacteria and known to make use of pyridoxal phosphate

in its coenzyme, breaks down tryptophan into indole, pyruvic acid, and ammonia.

Histamine has marked physiological effects in lowering blood pressure and may be (p. 260) a hormone. If histamine is produced in the intestine, it is apparently destroyed before it is absorbed into the blood.

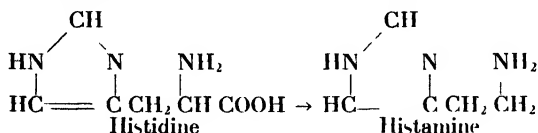

Cystine, its reduction product cysteine, and probably methionine can yield ethyl mercaptan, $\text{CH}_3\text{CH}_2\text{SH}$, methyl mercaptan, CH_3SH , and H_2S .

Bacterial decomposition of lecithin may yield choline and related toxic amine derivatives

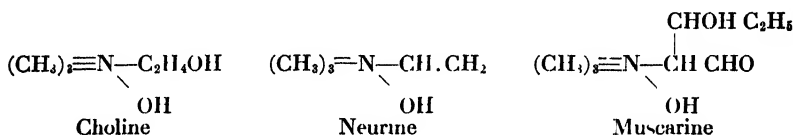

DIGESTION IN THE LARGE INTESTINE

The colon does not produce a juice of marked digestive powers. Weakly active enzymes have been reported to be present in extracts of the mucosa of the large intestine, but the chief secretion is mucus. Absorption of water overbalances secretion, so that the contents normally become less watery and more nearly solid before entering the rectum. A major part of fermentation and putrefaction processes may occur in the colon.

Feces. Under most conditions 20 to 30 per cent of the solids of fecal matter consists of bacteria, mostly dead. They are killed by products of their own activity. Other fecal matter includes mucus, substances derived from bile and other digestive juices, and undigested food residues. The last named include keratin, tougher fibers of connective tissues of meat, cellulose fragments, and starch grains. In addition, some truly excretory substances are present, notably the salts of Ca, Fe, and other metals, excreted via bile or intestinal glands. The usually small amount of ether-soluble material of feces contains some 30 per cent of nonsaponifiable matter. It includes **coprosterol** and small amounts of its isomer **cholestanol**, produced by the action of bacteria on cholesterol. Certain plant sterols and products of bacterial action on them are also found.

Microscopic examination shows sloughed-off cells from the linings of the alimentary tract normally and, pathologically, blood, pus, parasites, and parasite products. Aside from bacteriological examination, the chief diagnostic information derived from the study of feces is that obtained by microscopic examination.

The amount of feces varies so widely with the character of the diet, especially with the amount of indigestible matter (roughage) included, that no general figure can be given as the average amount. The results of a considerable number of determinations upon normal, healthy adults, as reported by Hawk, was approximately 100 g. per day.

REFERENCES

Among monographs dealing with this subject are "Introduction to Gastro-enterology" by W. C. Alvarez, New York, 1940, and "The Stomach and Duodenum" by G. B. Eusterman and D. C. Balfour, Philadelphia, 1935.

Two books which deal with special phases of digestion are "Physiological Chemistry of Bile" by H. Sobotka, Baltimore, 1937, and "Absorption from the Intestine" by F. Verzar and E. J. MacDougall, New York, 1936.

Some works which deal with the relationship of intestinal conditions to auto-intoxication are "Therapeutic Problem in Bowel Obstruction" by O. H. Waugensteen, Springfield, Ill., 1937; and "Lactobacillus Acidophilus and Its Therapeutic Application" by L. F. Rettger, M. N. Levy, L. Weinstein, and J. E. Weiss, New Haven, 1935.

The investigation of gastric digestion by means of gastric fistulas in men is described in connection with the first case on record in Dr. W. Beaumont's famous little work, "Experiments and Observations on the Gastric Juice and the Physiology of Digestion," Plattsburg, New York, 1833. More recent similar cases are described in "The Control of Hunger in Health and Disease" by A. J. Carlson, Chicago, 1916; and "Human Gastric Function" by S. Wolf and H. G. Wolff, New York, 1943.

An understanding of the motor functions of digestion is helpful in the study of its chemistry. This matter is admirably treated in W. B. Cannon's "The Mechanical Factors of Digestion," New York, 1911.

Among numerous available reviews, the following are selected:

- ALVAREZ, W. C., Intestinal Autotoxication, *Physiol. Rev.*, 4, 352, 1924.
 BARKIN, B. P., The Digestive Work of the Stomach, *Physiol. Rev.*, 8, 365, 1928.
 BEST, C. H., and MCHENRY, E. W., Histamine, *Physiol. Rev.*, 11, 371, 1931.
 BRADLEY, H. C., Gastric Digestion—A Survey, *Yale. J. Biol. Med.*, 4, 399, 1932.
 FLOREY, H. W., *et al.*, The Secretions of the Intestine, *Physiol. Rev.*, 21, 36, 1941.
 GARRY, R. C., The Movements of the Large Intestine, *Physiol. Rev.*, 14, 103, 1934.
 HERRIN, R. C., The Digestive System, *Ann. Rev. Physiol.*, 5, 157, 1943.
 IVY, A. C., The Role of Hormones in Digestion, *Physiol. Rev.*, 10, 282, 1930.
 IVY, A. C., The Physiology of the Gall Bladder, *Physiol. Rev.*, 14, 1, 1934.
 IVY, A. C., and GRAY, J. S., The Digestive System, *Ann. Rev. Physiol.*, 1, 235, 1939.
 JOSEPHSON, B., The Circulation of the Bile Acids in Connection with Their Production, Conjugation and Excretion, *Physiol. Rev.*, 21, 463, 1941.
 MAGEE, H. E., The Role of the Small Intestine in Nutrition, *Physiol. Rev.*, 10, 473, 1930.
 MURLIN, J. R., The Emptying Mechanism of the Stomach (a review), *J. Nutrition*, 2, 311, 1930.
 NORTROP, J. H., Isolation and Properties of Pepsin and Trypsin, *The Harvey Lectures*, Series 30, 229, 1935-1936.
 NORTROP, J. H., The Formation of Enzymes, *Physiol. Rev.*, 17, 144, 1937.
 NORTROP, J. H., and HERRIOTT, R. M., Chemistry of the Crystalline Enzymes, *Ann. Rev. Biochem.*, 7, 37, 1938.
 QUIGLEY, J. P., The Digestive System, *Ann. Rev. Physiol.*, 2, 45, 1940.
 SLUTZKY, B., and ANDERSON, A. C., Digestive System, *Ann. Rev. Physiol.*, 6, 225, 1944.
 STILL, E. U., Secretin, *Physiol. Rev.*, 11, 328, 1931.
 THOMAS, J. E., The Digestive System, *Ann. Rev. Physiol.*, 3, 233, 1941.
 THOMAS, J. E., and FRIEDMAN, M. H. F., Digestive System, *Ann. Rev. Physiol.*, 11, 103, 1949.
 VAN LIEBE, E. J., The Digestive System, *Ann. Rev. Physiol.*, 4, 273, 1942.

- WHIPPLE, G. H., The Origin and Significance of the Constituents of the Bile, *Physiol. Rev.*, **2**, 440, 1922.
Some papers which will serve to indicate certain of the trends of research in digestion are listed.
- BLOOMFIELD, A. L., Psychic Gastric Secretion in Man, *Am. J. Digest. Diseases*, **7**, 205, 1940.
- GLICK, D., and KING, C. G., Relationships between the Activation of Pancreatic Lipase and the Surface Effects of the Compounds Involved: The Mechanism of Inhibition and Activation, *J. Biol. Chem.*, **97**, 675, 1932.
- HOLLANDER, F., The Components of the Gastric Secretion, *Am. J. Digest. Diseases*, **3**, 651, 1936.
- IVY, A. C., Internal Secretions of the Gastro-intestinal Tract, *J. Am. Med. Assoc.*, **117**, 1013, 1941.
- KRASNOW, F., Composition of Saliva, *Dental Cosmos*, **78**, 301, 1936.
- PORTER, J. R., and RETTGER, L. F., Influence of Diet on the Distribution of Bacteria in the Stomach, Small Intestine, and Cecum of the White Rat, *J. Infect. Diseases*, **66**, 104, 1940.
- SHAY, H., *et al.*, Gastric Anacidity, *Am. J. Digest. Diseases*, **8**, 115, 1941.
- SMITH, E. L., and BERGMANN, M., The Peptidases of Intestinal Mucosa, *J. Biol. Chem.*, **153**, 627, 1944.
- TAUBER, H., and KLEINER, I. S., Studies on Rennin. I, The Purification of Rennin and Its Separation from Pepsin, *J. Biol. Chem.*, **96**, 745, 1932.
- TORREY, J. C., The Regulation of the Intestinal Flora of Dogs Through Diet, *J. Med. Research*, **39**, 415, 1919.

CHAPTER IX

ABSORPTION AND DETOXICATION

Absorption of digestion products into the blood and lymph is a necessary preliminary to the distribution of nutrients to the various tissues. It does not occur to any significant extent in the stomach. This is proved by experiments upon animals after the operation of making a duodenal fistula. In such animals the chyme can be collected quantitatively and its composition compared with that of the food ingested. The material recovered in the chyme is thus found to contain protein slightly in excess of that eaten because of the addition of gastric secretions. The total carbohydrate and fat content is roughly equivalent to that of the food. Only alcohol and a few other nontypical foods, such as pepper, mustard, and other condiments, appear to be absorbed from the stomach. When they are absorbed, an accompanying absorption of ordinary food substances may also occur to a slight extent. Inorganic salts are not absorbed unless present in unusually high concentration, 3 per cent or more. Water is not ordinarily absorbed in the stomach. The entire subject, however, is controversial owing to criticisms of the methods used. A recent review (Karel, 1948) suggests that absorption from the stomach is more significant than usually supposed.

The small intestine is the chief absorbing organ. Its lining epithelium is adapted to this function. Its great length furnishes an extensive absorbing field. Its area is particularly large because of the enormous number of small projections, the villi, which occur in the lining. They are especially adapted to serve as absorbing organs.

Paths of Absorption. Materials taken up from the small intestine can leave it by way of two paths. (1) The path by way of the blood vessels includes the capillaries in the walls of the intestine and especially those in the villi, the mesenteric veins, and the portal vein. Any absorbed material taking this path is bound to pass through the liver before it enters the general circulation of the body. This fact is significant in that the liver is able to modify the concentration and the chemical structure of the absorbed materials to fit them for optimum functioning in the nourishment of other tissues. (2) The path by way of the lymphatics includes the lymph vessels of the intestine, the large lacteal vessels, and the thoracic duct. Materials taking this path reach the blood indirectly as the thoracic duct empties into the venous system

near the heart. The material which leaves the intestine by way of the lacteals is called **chyle**.

Absorption of Water. The amount of water removed from the small intestine is not sufficient to cause any noticeable decrease in the fluidity of the intestinal contents. In general, the material passing through the ileocecal valve into the large intestine has about the same consistency as the chyme. This is not due to any lack of absorption of water from the small intestine but results from the copious secretions which, pouring into the intestine, add water to the contents sufficient to compensate for that absorbed. Absorption of water in the large intestine is more easily noticeable and is sufficient in most species of mammals, under ordinary conditions, to cause the formation of semisolid or even hard feces.

Protein Absorption. As suggested in the previous chapter, protein digestion yields amino acids to the blood. Older views regarded the soluble and diffusible proteoses and peptones as suitable for absorption; the modern view is that even if they are absorbed, they are so changed by the various peptidases in the intestinal wall that amino acids are the chief substances, resulting from protein digestion, that actually circulate in the blood. Analyses to determine the quantity of amino acids in the blood at suitable intervals show a distinct increase during the digestion of a protein-rich meal. The amino acids do not leave the intestine in significant amounts by way of the lacteal system. This is proved in experiments on dogs with a thoracic duct fistula. The lymph collected from the fistula does not contain any increased amount of amino acid nitrogen as a result of protein digestion.

Absorption of protein molecular fragments larger than amino acids cannot be definitely excluded. One notes the passage of secretin, believed to be a polypeptide, into the blood. The phenomena of food allergy raise further questions. An allergic person may be sensitive to certain foreign proteins which should presumably be hydrolyzed in the digestive system. If digestion were complete, only amino acids, to which the body is not allergic, should reach the blood. How are the profound and sometimes fatal effects of food allergy produced upon organs remote from the digestive system unless specific proteins or protein-like substances are absorbed? While there is no definite answer to this question, Vaughan, in a recent review, suggests that proteins or protein fragments might be absorbed in the allergic persons. If this should prove to be true, it would not show that the same thing happens in the normal digestive system. (See p. 212.)

Absorption of Carbohydrate. The digestion of carbohydrates yields monosaccharides to the blood. Glucose is the normal sugar of

the blood in all animals. It is distinctly increased in the blood of the portal vein during digestion of carbohydrate food. Other monosaccharides are also absorbed, although quantitative measurements of the small amounts normally present in the blood have not been extensively made. The necessity of hydrolysis of colloidal polysaccharides to fit them for absorption is obvious, but the hydrolysis of the soluble and diffusible disaccharides also occurs. Maltase, lactase, and sucrase of the small intestine tend to ensure the hydrolysis of disaccharides. The resulting monosaccharides are more effectively used in animal tissues than are other carbohydrates.

The rate of absorption of different monosaccharides appears to be very different although their molecular size and their penetrability through artificial membranes are essentially the same. Cori reports from experiments on rats, to which sugars were given by stomach tube, that the relative rates of absorption were

D-Galactose	110	D-Mannose	19
D-Glucose	100	L-Xylose	15
D-Fructose	43	L-Arabinose	9

Thus galactose and glucose are taken up so much more rapidly than some other sugars that a special mechanism for their absorption might be inferred to be present. A theory that is plausible, although supported by incomplete evidence, suggests that a phosphorylation process is involved. If so, it would be analogous to a similar process which occurs (see Chap. XIV) in the kidney. A specific phosphatase of absorbing cells could convert the sugar to its phosphoric acid ester and thus facilitate its rapid absorption.

Monosaccharides other than glucose tend to be converted into glycogen in the liver. Glycogen (p. 34) is composed of glucose units. The extent to which the transformation into glucose occurs during the process of intestinal absorption, rather than in the liver, is not known.

Sugars other than monosaccharides are absorbed if present in the intestine in sufficiently high concentration. If sucrose, for example, is eaten in large amounts, it may be detectable in the blood and in the urine. Similar experiments have been done with other sugars.

The portal blood conveys sugars away from the intestine. The lymphatic path conveys, at most, a very small proportion of the absorbed sugars.

Absorption of Fat. Glycerol and fatty acids compose a significant part of the material absorbed as the result of fat digestion. This follows from the presence of active lipase and efficient emulsifiers in the intestine. Soaps are probably present but rarely and then in rather small amounts.

Soaps of the higher fatty acids do not exist as such except at a pH of 9 or more, and this degree of alkalinity is not apt to occur and then only in limited portions of the upper intestine. The extent to which fats may be absorbed without hydrolysis has been debated for decades and is still unsettled. The earlier view that the finely emulsified fat in lacteals represented food fats, mostly unchanged during digestion and absorption, gave way to a theory which went to the other extreme and assumed that all fat was hydrolyzed before it was absorbed although it was promptly resynthesized into neutral fat in the very cells which absorbed it. This theory was based chiefly upon histological evidence. Food fats stained with the red dye Sudan III cannot be found in the free borders of absorbing cells nor can droplets of emulsified fat be seen there even when abundantly present in the deeper parts of these cells.

A review of the matter by Frazer (1940) calls attention to the fact that fat is absorbed in parts of the cat intestine where no lipolytic action can be demonstrated and that opportunity for lipase activity in all parts of the intestine is more limited than was formerly assumed. He concludes, that, while lipolysis undoubtedly occurs, its necessity as a preliminary to absorption has not been proved. Unhydrolyzed fat that may be absorbed is very finely, perhaps molecularly, dispersed. The free fatty acid obtainable from rat intestinal mucosa is reported to show no increase as an accompaniment to fat absorption.

In order that fat shall be dispersed finely enough to be absorbed, very efficient emulsifiers are required. Frazer and his coworkers report that the emulsification resulting from the combined action of bile salts, free fatty acids, and monoglycerides (the latter arising from partial splitting of neutral fats by lipase) is adequate to permit the emulsion of remaining unsplit, neutral fat to an absorbable fineness.

The pathway of absorption is chiefly through the lacteal-thoracic duct system. This is shown by experiments upon animals, usually dogs, with a fistula in the thoracic duct. After the digestion of food containing a known amount of fat, part of it can be found in the thoracic lymph, but sometimes only 17 per cent (after feeding cream) and apparently never more than about 60 per cent. The disposal of the remainder is still in question. Part of it goes into the portal blood, and some may be ingested by leucocytes which are abundantly present in the tissues of the intestinal wall. Some of the free fatty acid is believed to be used in the synthesis of phospholipids in the intestine, although this process goes on more prominently in the liver. As previously stated (p. 270), bile salts are an important factor in rendering free fatty acids soluble and absorbable. Frazer presents evidence indicating that the unhy-

dolyzed, merely dispersed fat takes the lacteal pathway while products of fat hydrolysis may be disposed of in other ways.

Absorption of Other Lipids. Phospholipids in general and lecithins in particular, the latter having been specifically studied, may be hydrolyzed before absorption. The resynthesis of lecithin in the intestinal wall has been demonstrated.

Cholesterol appears to be absorbed in two forms: (1) In a soluble complex with bile salts, (2) as cholesteryl esters formed with higher fatty acids. These esters are soluble, occur regularly in blood serum, and have also been found in chyle. The esterification can occur in the intestine.

Sitosterol, a mixture of plant sterols, is poorly absorbed if at all. This is surprising because the sitosterols are closely related structurally to cholesterol. Ergosterol is also poorly absorbed. Certain other sterids (*e.g.*, the hormones *lestosterone* and *progesterone*) are reported, when given in large doses, to be absorbed rapidly from the rat intestine.

Absorption of Vitamins. Protein or other complexes of food vitamins are apparently hydrolyzed so that the vitamins are absorbed in free or at least in simple form, such as phosphate or other esters. The fat-soluble vitamins are known, in some cases, to be dependent upon the presence of bile for adequate absorption. The facilities in animal tissues for storage of vitamins are limited, but are more apparent in the liver than in any other organ. Even the liver shows marked limitations in this respect. Water-soluble vitamins fed in excess are not entirely stored but tend to appear in the urine either as such or as metabolized products. Excess intake may fail of complete absorption, especially in the case of fat-soluble vitamins.

Thiamine may be absorbed either free or phosphorylated. Although a phosphatase of the pig duodenal mucosa can phosphorylate thiamine, as shown by Tauber (1937), yet thiamine of blood serum appears to be in the free form. A major part of the blood thiamine is in some combined form in the corpuscles. Its conversion into cocarboxylase (p. 171) must occur in tissue cells. Liver, kidney, muscle, brain, and nucleated blood cells are known to be able to make this synthesis.

Riboflavin in the complex form found in some raw vegetables and seeds is reported to fail to be absorbed in the rat intestine but may be completely absorbed in the form it takes in cooked foods. Riboflavin is probably absorbed in phosphorylated form. Glycerol extracts and other preparations of intestinal mucosa catalyze this synthesis. Verzar and Laszt showed that when this mechanism is disturbed, as happens after iodo-acetate poisoning or after adrenalectomy, riboflavin fails to

be utilized by the rat, but the symptoms of ariboflavinosis disappear when riboflavin phosphate is substituted for riboflavin in the diet.

Niacin (nicotinic acid) and nicotinamide are absorbed from the intestine. Presumably the pyridinoproteins of food are digested, but the extent to which the free pyridine nucleotides (p. 149) are hydrolyzed before absorption is not determined. Blood serum is said to contain niacin rather than pyridine nucleotides. Much of the blood niacin is in the corpuscles.

Pyridoxine is rapidly absorbed but fails to be taken up from the intestine when bound to protein. Lantz found in rat-feeding experiments that the pyridoxine of cooked foods was well utilized.

Pantothenic acid is probably absorbed in free form. There is some evidence that when in combined form in foods, it is less well utilized.

Biotin is freely absorbed. Its bound form, occurring in foods, is well utilized, suggesting that it is hydrolyzed by digestion. Destruction or inactivation of biotin can occur in the alimentary tract. In addition to the effect of avidin (p. 182), utilization by bacteria and possibly other interferences may operate. The requirement of biotin when fed is said to be some five times that needed when injected.

Vitamins A and the provitamins (p. 193) are absorbed as such. Carotene can be absorbed in colloidal suspension in water. Vitamin A is fed experimentally in foods or in solution in an oil. If mineral oil is the solvent or if this oil accompanies the feeding of vitamin A in other solvents, marked interference with absorption of the vitamin may result. Of digestible fats, those higher in unsaturated fatty acids are more favorable to the absorption of the vitamin. Neither vitamins A nor carotenes are well absorbed in mammals in the absence of bile or lipase. In obstructive jaundice, for example, there may be a failure in the absorption of the vitamin and the provitamin, especially the latter.

Vitamins D are absorbed in free form. When fed as esters which resist hydrolysis, they fail to be utilized. Like vitamins A, their absorption is poor in the presence of mineral oils, is facilitated by moderate amounts of digestible fat, and cannot be satisfactory in the absence of bile. Feeding of vitamin D to an animal with a biliary fistula does not result in good absorption except when bile salts are fed. The provitamin ergosterol is not well absorbed, although after activation (p. 202) by irradiation to calciferol it is absorbed.

Vitamins E and K are also dependent upon bile salts for adequate absorption. Vitamin E appears to be less available to the body when injected than when fed. This suggests that some favorable modification occurs during digestion or absorption.

The absorption of other vitamins and vitaminlike substances, in so far as investigated, presents no peculiar problems.

1) **The Nature of the Absorption Process.** The physiologists of the nineteenth century attempted to explain absorption upon the basis of diffusion in accordance with the laws of osmotic pressure. Later work showed that these laws, in so far as they are now known, cannot explain absorption. Certain inorganic salts and other soluble and diffusible substances are taken up from the intestine at entirely different rates as measured by their disappearance from tied-off loops of the intestine. This is true even when the substances are present in the intestine in equimolar concentration so that they exert equal osmotic pressure. Moreover, some of the blood serum of an animal is absorbed from a loop of its own intestine. Presumably the serum has the same osmotic pressure as the cell contents, and many of the serum constituents exert the same osmotic pressure as do the same constituents in the cells.

One must bear in mind the fact that the absorbing surfaces of the intestine are made up of living cells. The absorption process is therefore of the same character as the processes involving cell permeability. This is a complex problem of general physiology not to be attacked by the methods of biochemistry alone. When the problems of cell permeability are solved, the peculiarities of intestinal absorption may be explained.

DETOXICATION

If everything absorbed from the alimentary tract circulated freely without being altered chemically or regulated as to concentration in body fluids, mammalian functioning as we now know it would be impossible. It is well to recall the general concept of toxicity (p. 216) as a relative matter. The regulation of the concentration of nutrients in the blood will be discussed in connection with metabolism. The remainder of this chapter deals with chemical alteration of substances which are toxic in so low a concentration that, in spite of rapid excretion, their presence in the fluids and tissues of the body would be inimical to physiological conditions. Metabolic processes which make them comparatively harmless are called "detoxication."

Under ordinary conditions the chief substances absorbed from the intestine and requiring detoxication are products of intestinal putrefaction. Some individuals maintain intense putrefaction in the colon, as shown by the condition of the feces and by urine analysis, over considerable periods of time and yet show no apparent ill effects. They appear to be able to detoxify the absorbed products adequately.

It should be added, however, that the apparent effects of excessive

intestinal putrefaction, which are familiar and are commonly known by the term "auto-intoxication," are generally experienced. Obviously, it would be difficult to prove that any individual entirely escapes depression of health, regarded in its broader physiological sense, under these conditions even when the excessive amounts of putrefactive products appear to be effectively detoxicated.

The problem of explaining auto-intoxication has not been solved. There is even much doubt that the toxic effect of putrefactive products upon metabolism is the actual cause of the depressed feelings (head-ache, fatigue, etc.) which often accompany constipation. Quite similar symptoms are said to follow any plugging of the lower bowel, as by a wad of cotton introduced through the rectum. It is reported that the accompanying rise of blood pressure occurs in the dog within 4 min. after inserting the cotton plug and continues until its removal. This suggests that a nervous effect is aroused by local pressures or irritations and causes the symptoms to appear irrespective of toxic effects. Alvarez has suggested that cases in which the difficulty is due to stoppage of the colon and which are promptly relieved by a bowel movement are not auto-intoxication in a biochemical sense but are essentially effects of nervous reflexes.

In addition to putrefactive products, certain foreign substances are subject to detoxication. Some are drugs, some are components of foods infrequently used by man, and a few are of fairly common occurrence in foods.

The important detoxication mechanisms may be classified as (1) oxidation, (2) reduction, and (3) conjugation. In the last named, the toxic substance is joined with some physiological compound to produce a substance relatively safe for blood transport and kidney excretion.

Although the liver is able to bear the brunt of the work of detoxication and is the seat of the more important metabolic processes involved, the kidneys and possibly some other tissues play a more or less active part. Reduction due to intestinal bacteria might be regarded as a detoxication mechanism.

Oxidative Detoxication. Oxidation is a prominent feature of the detoxifying process. Even the substances detoxified by conjugation are also partly oxidized in many cases. Generally speaking, aliphatic compounds and the aliphatic side chains of aromatic compounds are more readily oxidized than are the aromatic substances. Thus alcohols, aldehydes, and organic acids of the aliphatic type are quite readily oxidized irrespective of whether they are absorbed from the intestine or are formed as intermediate products of the metabolism of carbohydrate, protein, or fat. Toxic diamines, such as cadaverine and putrescine, may be destroyed by oxidation which is probably due to the enzyme **diamine**

oxidase found in animal tissues. Even aromatic groups are readily oxidized when they are a part of an amino acid molecule. Phenylalanine and tyrosine are utilized in ways (Chap. XVI) which can involve oxidation. Moreover, a foreign aromatic compound may undergo some oxidation. Thus, benzene appears to yield some muconic acid

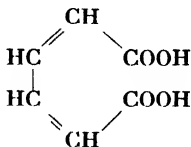

although part of the benzene is merely oxidized to phenol. Simple derivatives of benzene (toluene, ethylbenzene, benzaldehyde, and benzyl alcohol) may be oxidized to benzoic acid; while phenylethyl alcohol yields phenylacetic acid. More complex derivatives, such as *m*-xylene, $\text{C}_6\text{H}_4(\text{CH}_3)_2$, and symmetrical trimethylbenzene, may have only one of the side groups oxidized to a carboxyl group.

Aromatic amines are only partly oxidized, in contrast to aliphatic amines, which are completely oxidized. Benzyl amine, $\text{C}_6\text{H}_5\cdot\text{CH}_2\cdot\text{NH}_2$, oxidizes to benzoic acid; and aniline, $\text{C}_6\text{H}_5\cdot\text{NH}_2$, to *p*-aminophenol. Acetanilide, $\text{C}_6\text{H}_5\cdot\text{NH}\cdot\text{OC}\cdot\text{CH}_3$ ("acetylated aniline"), oxidizes in a similar way to form *p*-acetylaminophenol in the human body although forming *p*-aminophenol in the rabbit.

More complex ring structures, such as the heterocyclic ring of indole and skatole and the condensed ring structures of anthracene and cyclopentanoperhydrophenanthrene rings (p. 86) of vitamins D and the sex hormones, tend to oxidize by the formation of —OH groups at certain positions.

In general, the oxidation products of aromatic and other compounds with ring structures undergo further stages in detoxication. They are combined with some other group, as will be explained in connection with conjugation.

Detoxication Involving Reduction. Although less prominent than oxidation, reduction may take a minor part in detoxifying processes. The possibility of such action by intestinal bacteria was mentioned, but reduction also occurs in the animal tissues. A well-established case is that of picric acid, which is reduced to picramic acid.

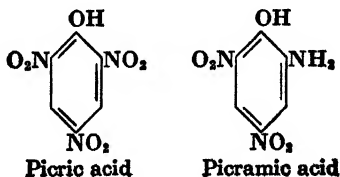

Similarly, *p*-nitrophenol reduces to *p*-aminophenol and the $-\text{NO}_2$ group of aromatic derivatives generally tends to be reduced to an amino group. This process may be accompanied, however, by oxidation. Thus nitrobenzene forms *p*-aminophenol, and *p*-nitrobenzaldehyde produces *p*-aminobenzoic acid.

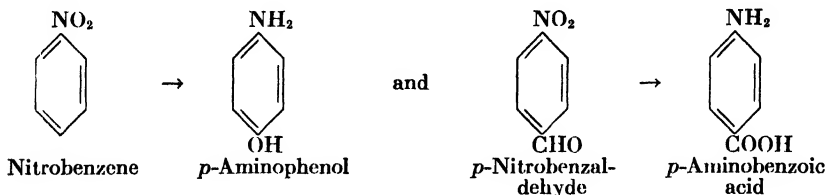

Conjugation with Sulfuric Acid. A conspicuous feature of detoxication is conjugation of the toxic substance to form an ester or otherwise to effect a dehydration synthesis. The longest known and perhaps the most frequently observed of the esterifying processes is the formation of ethereal sulfates. The process is well illustrated in the case of indole. Its putrefactive formation (p. 273) from tryptophan leads to its absorption. It is oxidized in the liver to indoxyl, conjugated with H_2SO_4 , and excreted in the urine chiefly as the potassium salt known as **indican**.

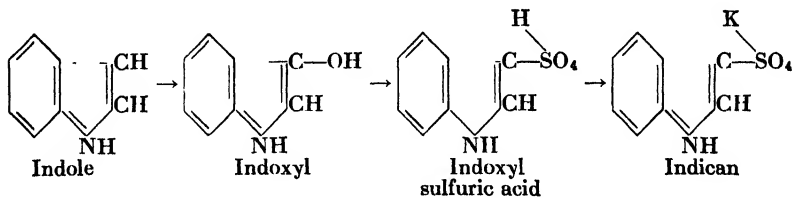

Skatole behaves in a similar way, forming skatoxyl and the corresponding ethereal sulfate. Many other ethereal sulfates are probably formed. Not many have been identified in blood or urine but one, at least, is known, *i.e.*, phenol potassium sulfate. Some phenol may escape into the urine unchanged, especially when an excessive amount is present.

The major part of the sulfate of the animal body is formed by oxidation of the sulfur of cystine and methionine.

The quantity of ethereal sulfate in human urine is variable and amounts to some 40 to 100 mg. of S in a 24-hr. urine collection. As this represents about 5 to 16 per cent of the total S excreted, it is clear that a significant part of the oxidized sulfur of the body may be utilized, under some circumstances, in detoxication.

Glucuronic Acid Conjugation. A number of substances, including some which also conjugate with H_2SO_4 , can be detoxified by conjugation with glucuronic acid. This, the prototype of the uronic acids (p. 17), arises through a special form of oxidation. In spite of the tendency of the body to utilize carbohydrate by means of the complex oxidative reactions which eventually yield CO_2 and H_2O , the special oxidation which yields glucuronic acid occurs regularly. The limit of the amount which can be produced has not been determined, but the total excretion of glucuronic acid in human urine, although variable, is normally not more than 50 mg. per day. The adaptation of the glucuronic acid-producing mechanism to detoxication is shown by the large increase in excretion of conjugated glucuronates which follows the administration of certain drugs (chloral hydrate, camphor, menthol, morphine) and some other foreign substances, such as borneol and turpentine. Such substances when detoxified appear as glucuronates in the urine.

Some of the substances which are detoxified by glucuronate conjugation are also handled in other ways. Thus phenol is partly detoxified as the glucuronate but also appears in urine as an ethereal sulfate. Benzoic acid is conjugated with glucuronic acid and also with glycine. Other similar cases have been described. The form of conjugation is indicated by the following examples:

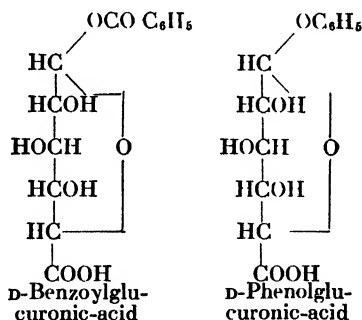

As the second formula indicates, conjugation may be of the glucosidic type rather than an esterification such as occurs in the first formula.

Detoxication by Glycine and Other Amino Compounds. The formation of hippuric acid, so named because of its abundance in horse urine, is a long-known type of detoxication. The compound is benzoylglycine, $C_6H_5 \cdot CO \cdot NH \cdot CH_2 \cdot COOH$, and represents detoxified benzoic acid. Its comparatively high concentration in herbivore urine is due mainly to the presence of benzoic acid-yielding substances in certain kinds of fodder. In man, its formation results partly from the benzoic acid produced by intestinal bacteria and partly from that in foods.

The modern use of benzoates as a food preservative tends to increase the intake of benzoic acid. This practice is legalized because, physiologically, it has been shown that the ability of the human body to detoxify benzoic acid is practically unlimited. Some of the glycine required for this purpose is derived directly from food proteins and some from the conversion of various amino acids to glycine.

Salicylic acid, *o*-hydroxybenzoic acid, an important drug, nicotinic acid, and *p*-hydroxybenzoic acid are, to some degree, detoxified by a similar conjugation with glycine. Thus excess of niacin in the animal body may appear in the urine as nicotinuric acid, a compound closely analogous to hippuric acid.

In chickens a similar type of detoxication makes use of **ornithine** (p. 100). This diamino acid, derived from arginine, combines with two equivalents of benzoic or phenylacetic acid. The conjugation forms the —CO·NH— linkage as it does in hippuric acid production. A similar link is formed with phenylacetic acid in the detoxication which produces phenylacetylglutamine in man and the chimpanzee. It is notable that a given substance may be detoxified by conjugation with different amino compounds in different species of animals.

Detoxication by means of the amino acid **cysteine** has been observed. The result is a mercapturic acid which appears in the urine. Part of a dose of bromobenzene is combined in the dog with cysteine and acetic acid thus:

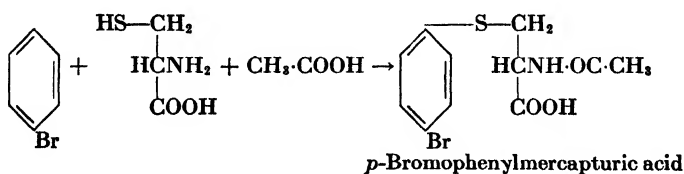

Some of the bromobenzene is oxidized to phenol and excreted as the ethereal sulfate and the conjugated glucuronate. Chlorobenzene and iodobenzene may also be detoxified, in part, by forming the corresponding phenylmercapturic acids.

It has been found that, in rabbits, naphthalene may be similarly detoxified, forming

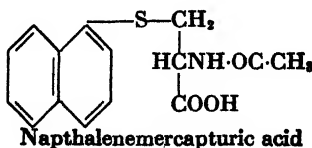

Other condensed ring compounds, *e.g.*, anthracene and phenanthrene, are said to be detoxified in a similar way.

The peptide **glutathione** (p. 383), which is widely distributed in animal tissues, is composed of three amino acids, glycine, cystine (reducing to cysteine), and glutamic acid, which are the three known to function generally in detoxication. There is only indirect evidence that glutathione might be the source of the amino acids thus used, but Harrow and his associates have offered the interesting suggestion that this might be a function of glutathione.

Acetylation. One example of the utility of acetic acid was given in the case of the formation of mercapuric acids. Acetic acid is used in other ways to detoxicate by acetylation. Thus, *p*-aminobenzoic may be converted to *p*-acetylaminobenzoic acid. Sulfanilamide (*p*-aminobenzenesulfonamide), which is widely used in chemotherapy to combat certain infections, may be largely acetylated in the human body, appearing in the urine as *p*-acetylaminobenzenesulfonamide.

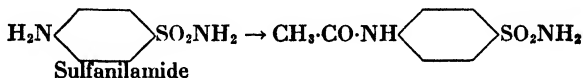

REFERENCES

"Absorption from the Intestine," by F. Verzar and E. J. MacDougall, New York, 1936, gives a general view of this subject.

"Detoxication Mechanisms" by R. T. Williams, New York, 1949, is authoritative.

To a considerable extent, reviewers of the biochemistry of absorption and detoxication have included these subjects in the treatment of various phases of metabolism. On this account some helpful material will be found among the references given with Chaps. XIV-XVI. Some more specific reviews are listed.

HARROW, B., and SHERWIN, C. P., Detoxication Mechanisms, *Ann. Rev. Biochem.*, 4, 263, 1935.

KAREL, L., Gastric Absorption, *Physiol. Rev.*, 28, 433, 1948.

MAGEE, H. E., The Role of the Small Intestine in Nutrition, *Physiol. Rev.*, 10, 473, 1930.

QUICK, A. J., Detoxication Mechanisms, *Ann. Rev. Biochem.*, 6, 291, 1937.

STEKOL, J. A., Detoxication Mechanisms, *Ann. Rev. Biochem.*, 10, 265, 1941.

Some representative papers are listed.

ANCHEL, M., and SCHOENHEIMER, R., Further Studies in Coprosterol Formation. The Use of Compounds Containing Labile Deuterium for Biological Experiments, *J. Biol. Chem.*, 125, 23, 1938.

BARNES, R. H., MILLER, E. S., and BURR, G. O., Fat Absorption in Essential Fatty Acid Deficiency, *J. Biol. Chem.*, 140, 773, 1941.

BECK, L. V., Organic Phosphate and "Fructose" in Rat Intestinal Mucosa, as Affected by Glucose and by Phlorhizin, *J. Biol. Chem.*, 143, 403, 1942.

BOLTON, C., and WRIGHT, G. P., The Absorption of Amino Acids and Their Distribution in the Body Fluids, *J. Physiol.*, 89, 269, 1937.

BOURNE, M. C., and YOUNG, L., The Metabolism of Naphthalene in Rabbits, *Biochem. J.*, 28, 803, 1934.

COFFEY, R. J., MANN, F. C., and BOLLMAN, J. L., The Effect of the Exclusion of Bile on the Absorption of Foodstuffs, *Am. J. Digest. Diseases*, 7, 143, 1940.

DEUEL, H. J., JR., HALLMAN, L., and REIFMAN, A., The Rate of Absorption of Various Fatty Acids by the Rat, *J. Nutrition*, 21, 373, 1941.

DI SOMMA, A. A., The Constitution of Conjugated Phenolphthalein Formed in the Animal Body, *J. Biol. Chem.*, 133, 277, 1940.

DUTCHER, R. A., HARRIS, P. L., HARTZLER, E. R., and GUERRANT, N. B., The Assimilation of Carotene and Vitamin A in the Presence of Mineral Oil, *J. Nutrition*, 8, 269, 1934.

- FLYNN, J. E., and WARNER, E. D., Prothrombin Levels and Synthetic Vitamin K in Obstructive Jaundice of Rats, *Proc. Soc. Exptl. Biol. Med.*, **43**, 190, 1940.
- GRAY, E. LEB., MORGAREIDGE, K., and CAWLEY, J. D., Intestinal Absorption of Vitamin A in the Normal Rat, *J. Nutrition*, **20**, 67, 1940.
- GREAVES, J. D., and SCHMIDT, C. L. A., The Role Played by Bile in the Absorption of Vitamin D in the Rat, *J. Biol. Chem.*, **102**, 101, 1933.
- HARROW, B., MAZUR, A., and SHERWIN, C. P., Studies in Acetylation. The Fate of *p*-Aminobenzoic Acid in the Rabbit, *J. Biol. Chem.*, **102**, 35, 1933.
- HARROW, B., CHAMELIN, I. M., and MAZUR, A., Possible Role of Glutathione as a Detoxifying Agent, *Proc. Soc. Exptl. Biol. Med.*, **37**, 271, 1937.
- KRATZER, F. H., Amino Acid Absorption and Utilization in the Chick, *J. Biol. Chem.*, **153**, 237, 1944.
- LITTLE, J. M., and ROBINSON, C. S., The Transportation of Absorbed Lipids, *Am. J. Physiol.*, **134**, 773, 1941.
- ROSENHEIM, O. and WEBSTER, T. A., A Dietary Factor Concerned in Coprosterol Formation, *Biochem. J.*, **35**, 920, 1941.
- ROWNTREE, J. I., The Effect of the Use of Mineral Oil upon the Absorption of Vitamin A, *J. Nutrition*, **3**, 345, 1931.
- SELYE, H., Role of Bile in Absorption of Steroids, *Endocrinology*, **32**, 279, 1942.
- STEKOL, J. A., Glutathione in Relation to Growth of Rats on a Low Casein Diet Which Contained Bromobenzene and Naphthalene, *J. Biol. Chem.*, **127**, 131, 1939.
- WAGREICH, H., BERNSTEIN, A., PADER, M., and HARROW, B., Detoxication of Borneol by Glucuronic Acid in Humans, *Proc. Soc. Exptl. Biol. Med.*, **46**, 582, 1941.
- WEST, H. D., Evidence for the Detoxication of Diphenyl through a Sulfur Mechanism, *Proc. Soc. Exptl. Biol. Med.*, **43**, 373, 1940.
- ZBARSKY, S. H., and YOUNG, L., Mercapturic Acids. II. The Formation of *l*-Phenylmercapturic Acid from Phenyl-*l*-cysteine, in Vivo, *J. Biol. Chem.*, **151**, 217, 1943.

CHAPTER X

BLOOD AND LYMPH

The rapid circulation of blood enables it to be the chief medium for (1) distribution of nutrients to the various tissues, (2) the collection of waste materials of cells, (3) the delivery of solid wastes to the kidneys for excretion, and (4) the transfer of O_2 and CO_2 between lungs and tissues. These are only the more obvious functions of the blood. They also include (5) the important role of acting as an aid to the buffering of the acids and bases of the body, (6) the distribution and radiation of heat, (7) the part played by the blood in regulating the osmotic pressure of tissues and fluids, and (8) the distribution of hormones, immune substances, etc.

The blood is not the locale of any significant metabolic reactions. Neither hydrolytic nor oxidative enzymes of vigorous activity are found in the fluid part of blood, the **plasma**, and those occurring in the formed elements of blood, the **corpuscles**, are relatively feeble in red corpuscles, the **erythrocytes**. Even in the white corpuscles, the **leucocytes**, which, being nucleated, are typical cells, metabolism is quantitatively insignificant because leucocytes compose so small a proportion of the active cells of the body. The third kind of formed elements, **platelets** or **thrombocytes**, are not known to carry on any typical metabolic reactions.

General Characteristics of Blood. Separated by centrifuging, the corpuscles amount to about 45 per cent of the volume of human blood, the plasma about 55 per cent. But these values are subject to considerable variation even in normal, healthy persons. The corpuscle volume varies from about 41 to about 46 per cent. There is also a species variation. In the rabbit, for example, the corpuscles are about 27 per cent of the blood volume. The erythrocytes so outnumber other formed elements of the blood that the latter constitute only about 0.2 per cent of the volume of the corpuscles.

The specific gravity in man is variable (1.041 to 1.067), and the average normal value has been estimated as not less than 1.055 or more than 1.060. It varies with age and with sex, tends to diminish after meals, and to increase during exercise. There is a diurnal variation, decreasing somewhat during the day and rising during sleep. The

average shows so much variation between individuals that a value normal for one person may be an index of a pathological condition in another. The corpuscles have a higher specific gravity than plasma, so that in shed blood prevented from coagulating, the corpuscles settle to the lower layers. White corpuscles are lighter than the red ones and, when abnormally abundant in blood, may even be sufficiently segregated during sedimentation to form a visible layer, the "buffy coat" above the red corpuscles.

The total solids are variable. The following values (approximate) serve to indicate the normal range in human blood.

	Total Solids, Per Cent
Whole blood.....	19-23
Plasma.....	7-8.7
Corpuscles.....	36-42

The osmotic pressure is normally regulated so as to be maintained within a relatively narrow range of variation. Measured by the lowering of the freezing point of water (cryoscopic method), $\Delta = -0.537^{\circ}\text{C}$. as an average value for normal human blood. This is approximately equivalent in osmotic pressure to 0.9 per cent NaCl, which is sometimes used for intravenous injection. The osmotic pressure of human serum averages a little less, $\Delta = -0.526^{\circ}$. Ringer's solution is an improvement over NaCl solution because it has less tendency to disturb the balanced relations between the inorganic cations of body fluids and tissues. Mammalian Ringer solution may be made up as follows:

	Per Cent
NaCl.....	0.90
CaCl ₂	0.026
KCl.....	0.03

Other formulas are sometimes used. The Ringer-Locke and the Tyrode solutions contain the following:

	Locke	Tyrode
	Per cent	Per cent
NaCl.....	0.90	0.80
CaCl ₂	0.048	0.02
KCl.....	0.042	0.02
NaHCO ₃	0.01-0.03	0.10
Glucose.....	0.10-0.20	0.10
MgCl ₂	0.01
NaH ₂ PO ₄	0.005

and are saturated with O₂ gas at atmospheric pressure. A Ringer solution for use with the frog heart contains the following:

	Per Cent
NaCl.....	0.65
CaCl ₂	0.012
KCl.....	0.014
NaHCO ₃	0.02

The blood content of certain inorganic constituents is given in Table 38.

Plasma and Serum. The fluid part of blood in its natural condition is called plasma; the fluid part of blood after it has gone through the processes of coagulation is called serum. While the composition of these two fluids is similar, serum lacks certain of the substances required for coagulation (clotting). Of these the most prominent, quantitatively, is the protein **fibrinogen**, which is lacking in serum, having been changed to the insoluble protein **fibrin** of the clot. Serum is also characterized

TABLE 38.—MAJOR INORGANIC CONSTITUENTS OF BLOOD

Values are in milligrams per cent and indicate the usual range of results of analyses of human blood

	Sodium	Potas- sium	Cal- cium	Magne- sium	Chloride	Inorganic phosphate	Sulfate
Whole blood . . .	165-200	200-210	5-6	4-4.6	<u>200-295</u>	6-20	1-3
Plasma (serum) ..	300-345	18- 22	10-10.6	2.5-3	<u>350-380</u>	16-20	1-1.8
Corpuscles	20- 23	100-120	0-0.5	6-7.8	(See p. 342)	Very low	

by its content of certain materials liberated in excess during coagulation. Of these the most notable is the protein **thrombin**, usually regarded as an enzyme. The material concerned in coagulation and the chemistry of the process are described more fully below (p. 296).

Plasma may be obtained by centrifuging freshly drawn blood if clotting is prevented in some way, *e.g.*, by chilling the blood. Serum may be obtained in several ways. If blood is permitted to clot and stand for about 24 hr., the clot shrinks and serum is squeezed out. Blood may be vigorously stirred during the time that clotting processes are occurring so that the thready masses of fibrin are collected on the stirring rod and removed. The remaining material is **defibrinated blood**, which cannot clot. Serum may be separated from it by sedimentation of corpuscles and removal of the supernatant serum or by use of the centrifuge.

While plasma or serum may be prepared with sufficient care to render it free from corpuscles and platelets, it is not necessarily free from other microscopically visible particles. They are known as **chylomicrons**

and consist of minute droplets of highly dispersed fat. Their number varies according to the recency of ingestion of fat-containing food and other circumstances influencing the amount of fat in the circulation.

The Serum Proteins. Serum albumin and serum globulin compose the major part of the solids of serum. Although their concentration is somewhat variable, the following percentage values may be regarded as representative.

	Total protein	Serum albumin	Serum globulin
	Per cent	Per cent	Per cent
Dog.....	5.5	3.2	2.3
Horse.....	7.3	3.1	4.2
Pig.....	7.4	2.6	4.8
Man.....	7.2	5.0	2.2

Serum Globulins. Serum proteins are separated by salting-out methods. The globulin fraction is precipitated completely by (1) saturation with $MgSO_4$ or (2) half saturation with $(NH_4)_2SO_4$. It can be further fractionated to yield the two commonly recognized forms of serum globulin, **euglobulin** and **pseudoglobulin**. Neither of these can be said to have been shown to be a chemical individual. Slight variations in the methods of separation and purification yield products with differing properties. The euglobulin is commonly defined as the fraction thrown out by (1) saturating its solution with $NaCl$, (2) making the solution half saturated with $MgSO_4$, or (3) one-third saturated with $(NH_4)_2SO_4$. The pseudoglobulin is regarded as the part of the globulin fraction which (1) is not salted out by $NaCl$, (2) is salted out by saturation with $MgSO_4$, or (3) by half saturation with $(NH_4)_2SO_4$. The two globulin types are also differentiated by solubility of pseudoglobulin in water and insolubility of euglobulin. Repeated fractionation of the globulins followed by dialysis results in the formation of what appear to be further fractions, so that the number of globulins thus obtainable is a debatable question. It has been suggested by Svedberg that the circulating blood might contain only one serum globulin and that even the two main fractions are artifacts resulting from salting out or other manipulations.

The globulins are separable by electrophoresis using the Tiselius method (p. 115), which yields what are called the α -, β -, and γ -globulins with isoelectric points, respectively, 5.1, 5.6, and 6.0.

The fractional separation of serum globulins has been intensively investigated because of their importance in immunochemistry. In general, the antibodies (p. 320), such as antitoxins, precipitins, agglutinins,

etc., are associated with the serum globulins and are prepared in comparatively concentrated form by separation of one or another of the globulin fractions with which the desired antibody tends to be more closely associated.

Serum Albumins. The protein of serum which is not salted out by saturation with $MgSO_4$ or half saturation with $(NH_4)_2SO_4$ is called "serum albumin." Much evidence points to the probability that the albumin fraction, like the globulin one, consists of more than one protein. Perhaps the best evidence is that different albumin preparations from serum can behave differently as antigens in immune reactions.

Serum albumins differ only slightly in their general properties from egg albumin. The differences include a higher levorotatory power for serum albumin, less tendency to be rendered insoluble by alcohol, and greater solubility of the precipitate formed with concentrated HCl in excess of the reagent.

The ratio of the concentration of serum albumin to that of serum globulin varies in different mammals from about 0.6:1 in the pig to about 3:1 in the rabbit. In man the ratio is about 2:1 but shows considerable variation even in the same individual. A striking preponderance of serum globulin has been demonstrated in some cold-blooded animals.

Origin. The production of serum proteins has been studied by use of a method known as **plasmapheresis**. The animal, usually a dog, is bled daily. The withdrawn blood is centrifuged to separate corpuscles which, suspended in Ringer-Locke solution, are restored to the circulation. In this way the animal is deprived of part of the plasma proteins without being made anemic. Conditions favorable to regeneration of the depleted protein may then be studied. Experimental diets show that the most effective food for good regeneration is blood plasma itself, given either fresh or dried. Of foods tested, the next in efficiency is liver, while spleen, heart muscle, and casein are less effective. These experiments, carried on chiefly by Whipple and his associates, indicate that food proteins of animal origin tend to favor production of serum albumin, while some of the cereal and other plant proteins (*e.g.*, rice and potato) seem to favor globulin synthesis. Regeneration occurs in the fasting animal until protein reserves are used up. Liver yields an important part of the reserve store.

The organs which carry on the synthesis of the serum proteins are not completely identified. All the evidence points to the liver as the chief site. Weighty evidence would be obtained by failure of regeneration of the serum proteins in an animal deprived of the liver (hepatectomized). The survival of the animal after this operation is not long enough, however, to permit entirely satisfactory comparison between its performance

in protein synthesis and that of the control (unoperated) subject. The more rapid synthesis of another of the plasma proteins, fibrinogen, has been shown to occur in the liver. This might be regarded as favoring the theory that the liver also synthesizes serum proteins. Other organs and tissues cannot yet be excluded. This matter will be discussed further in Chap. XVI.

Function. The serum proteins are functional as aids in the buffering mechanism of the blood. Proteins, being ampholytes, can combine with either acids or bases. At the pH of blood, the serum proteins are at least partly in the form of their sodium or other metallic salts and can thus serve to neutralize acid formed by oxidative metabolism. Quantitatively this function is overshadowed by the other effective mechanisms (Chap. XI) for regulation of acid-base balance of blood.

Serum proteins are important in regulation of the water balance between blood and tissues. Proteins tend to be retained within the blood vessels, thus exerting what is called the "colloid osmotic pressure" of the blood. This is valuable in preventing an undue loss of fluid from the blood to the tissues (edema). Plasmapheresis, if it reduces the plasma proteins below 3 per cent in the dog, can cause edema. Clinical observations show that low serum protein values, *more especially low serum albumin values*, accompany various forms of edema in man. Concentrated solutions (25 per cent) of serum albumin are injected to raise the "colloid osmotic pressure" and thus increase the blood volume when it is lowered by hemorrhage or in wound shock.

The serum proteins appear to be a part of the reserve protein of the body in the sense that they can be utilized to some extent when food protein is deficient. It has been shown that the protein requirements of a fasting animal can be met by the injection of homologous blood serum, thus maintaining the animal in nitrogen equilibrium (urinary N equal to the N of the injected protein). It appears, however, that the injected serum protein is not utilized in the same way as are the amino acids resulting from digestion of food proteins. The difference is shown in phlorizinized dogs (p. 42), which do not excrete glucose and N in the urine in correspondence with injected serum as they do in response to eating protein.

Coagulation. The importance of the clotting process is apparent when one notes the danger from excessive hemorrhage in hemophilia. This is the abnormal hereditary condition in which the clotting process is defective. Even delayed clotting in certain diseases, such as jaundice and some other diseases involving the liver, may result in excessive loss of blood from even a small wound. Normally the clotting time, the interval between the moment the blood leaves the circulation and the

moment when it ceases to be fluid, is less than 5 min. The average time for normal, healthy persons has been variously estimated but is difficult to determine because it varies so much according to the amount of blood lost, the extent of its exposure to wounded tissue, and the method of estimating the clotting time. By any of the methods commonly used a clotting time in excess of 10 min. may be regarded as abnormally long.

Although the nature of the clotting process is not entirely explained, a theory proposed by Howell seems to account for the majority of the phenomena observed.

The theory, in brief, is as follows: The materials necessary for clotting are all present in the circulating blood but are prevented from reacting by an anticoagulating substance. After blood is shed or otherwise exposed to abnormal conditions the following reactions occur:

1. Thromboplastin is released by disintegrating platelets, the thrombocytes, and from cells of wounded tissues.

2. Thromboplastin reacts with a complex of prothrombin and anti-prothrombin so as to liberate prothrombin.

3. Prothrombin is activated to thrombin by a process which requires the presence of Ca ions.

4. Active thrombin causes the soluble protein *fibrinogen* to change into the threadlike, crystalline, insoluble protein *fibrin*. The three-dimensional intricate network of fibrin threads, entrapping the corpuscles, constitutes the clot.

In schematic form

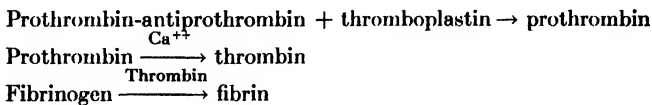

Fibrinogen is a protein resembling globulins. It can be prepared from freshly drawn blood. That of the horse is sometimes used because, if cooled immediately after collection, it clots relatively slowly. Other means of preventing clotting, such as addition of oxalates, may be used. Plasma is obtained by centrifuging and is treated with an equal volume of saturated NaCl solution. This precipitates fibrinogen contaminated by other plasma proteins. Redissolved in 3 per cent NaCl and reprecipitated repeatedly, it is obtained in a state of purity suitable for investigation. While it is insoluble in water, it differs from the typical globulins in that it requires only half saturation with NaCl rather than complete saturation to salt it out. Dissolved in dilute salt solution it gives a clear, colorless preparation which does not clot spontaneously. It readily clots, however, upon the addition of thrombin in the form of blood serum or the extract of a blood clot. If observed while in the process of forma-

tion of the clot, fibrin is visible in the field of the ultramicroscope (Fig. 51) as fine, threadlike crystals.

Thrombin is generally considered to be an enzyme, but its functioning in a typically catalytic manner has not been demonstrated unequivocally. It could act, according to evidence from some investigations, by combining with fibrinogen to produce fibrin. Indeed, the nature of the change when fibrinogen becomes fibrin is not known. It might be a mild hydrolysis or some other form of denaturation. A theory (Baumberger, 1941) that the change involves the formation of -S-S- links in fibrin from the -SH groups of fibrinogen has plausibility. There is evidence to



FIG. 51. The ultramicroscopic appearance of fibrin, showing crystal-like form. (After Howell.)

show that conversion of prothrombin to thrombin involves an enzyme. This idea has appeared recurrently and in varying forms ever since the writings of Morawitz (1905) who called the activating factor thrombokinase. Ferguson, a recent investigator of blood clotting, finds (1943) that plasma contains a zymogen which becomes activated during the clotting process and is found in serum as an active protease. It

so closely resembles trypsin that it has been called **trypsin-like** but is clearly not trypsin, and other names, *e.g.*, **plasmin**, have been given for it. Operating in connection with Ca ions and thromboplastin, plasmin appears to be a part of the system that converts prothrombin to thrombin. Seegers believes that a plasma globulin (A α globulin) becomes activated and then hastens the conversion of prothrombin to thrombin.

Thrombin is prepared by extraction with 8 per cent NaCl solution of fibrin which has been previously extracted with water and with ether. The material dissolved by 8 per cent NaCl is highly active in clotting solutions of purified fibrinogen. Active thrombin can also be prepared by precipitating serum proteins with an excess of alcohol (about 20 volumes), drying the precipitate, and extracting it with water. The latter method permits one to demonstrate the difference between prothrombin and thrombin. If one uses plasma or whole, unclotted blood rather than serum for precipitation by alcohol, water extracts of the resulting precipitate contain little or no thrombin. They cannot change fibrinogen to fibrin and are regarded as containing prothrombin rather than thrombin. The conversion to active thrombin requires Ca ions.

This is shown by the observation that blood treated with oxalate to precipitate Ca or treated with citrate to suppress Ca ionization does not clot. Yet Ca ions are not required for the conversion of fibrinogen to fibrin since this occurs in the absence of Ca ions. The inference is that Ca^{++} is required for thrombin activation. Ca-free thrombin has been prepared, however, in active form. It clots fibrinogen thus showing that the reaction, fibrinogen $\xrightarrow{\text{thrombin}}$ fibrin, does not require Ca.

Thrombin is a protein. It is soluble in water, not coagulated by boiling, is salted out by half saturation with $(\text{NH}_4)_2\text{SO}_4$, is precipitated by an excess of ethanol, and does not become insoluble after exposure of a week or more to the precipitating alcohol. Its preparations give the usual protein color tests, responding especially to those which are due to the presence of tryptophan residues.

The properties of prothrombin have not been so well determined. It is believed to be a pseudoglobulin of the glycoprotein type. Its relative concentration in blood, the "prothrombin level," is estimated by Quick's method or by the method of Ware and Seegers. Clear, non-clotting plasma is obtained by centrifuging blood which has been treated with oxalate immediately after withdrawal from a vein. The oxalated plasma is treated with an excess of a thromboplastic preparation and then with CaCl_2 sufficient to produce optimal concentration of Ca ions. If the blood has a normal amount of prothrombin, clotting occurs promptly. If the prothrombin level is low, clotting is delayed, and from the prolonging of the clotting time, the relative "prothrombin level" may be estimated. In man, prothrombin is usually present in the blood in amounts sufficient to avoid serious danger from hemorrhage; but when it is decreased to about 30 per cent of the normal, the level is regarded as dangerously low.

The origin of prothrombin in the liver and the dependence of this synthesis upon vitamin K were discussed in a previous chapter (p. 208). A likely cause of prothrombin deficiency in man is interference with the free flow of bile which is necessary (p. 282) for effective absorption of vitamin K from the intestine. Obstructive jaundice is frequently accompanied by a lowered prothrombin level and danger from hemorrhage. Certain diseases and poisons which produce liver damage prevent the synthesis of normal amounts of prothrombin.

One of these poisons has attracted much attention because of its importance in animal husbandry. A bleeding disease was traced to the eating of spoiled clover hay from silos, and the causative agent was shown to be a derivative of coumarin which has a structure related to that of the naphthoquinones (p. 166). It apparently interferes with the functioning

of vitamin K in the liver synthesis of prothrombin. The resulting lowered prothrombin level of the blood may be fatal. The synthetic compound dicoumarol has been used clinically to check the spread of intravascular clotting (p. 301) in cases of thrombosis.

Antiprothrombin. Prothrombin is normally maintained in an inactive form in the circulating blood by means of an inhibitor, an antiprothrombin. It was discovered by Howell. Inasmuch as the liver is a good source from which to make concentrated and possibly pure preparations of this substance, it has been named **heparin**. It is water-soluble and thermostable. It is apparently synthesized by the mast cells which occur in connective tissue and especially in the walls of the liver blood vessels. Although extensively investigated, the chemical constitution of heparin is not completely established. Most of the investigators who have studied it, especially Jorpes, have obtained evidence showing that it contains the D-glucuronic acid and D-glucosamine residues and sulfuric acid in an ester form. It is thus shown to be closely akin to chondroitin sulfuric acid (see Chap. XIX). Although it is antiprothrombic in the sense that it tends to prevent the conversion of prothrombin to thrombin, it can also show antithrombic action in the presence of a cofactor which is found in the albumin fraction of serum proteins. Heparin is very potent. As little as 1 mg. can prevent the coagulation of 100 ml. or more of freshly shed blood. It is said to be unable to prevent activation of *purified* prothrombin by Ca ions in the presence of highly purified fibrinogen and thromboplastin. Ferguson suggests that natural anticoagulants are inhibitors of plasmin.

Antithrombins which tend specifically to prevent thrombin itself from showing activity are known. Blood-sucking animals, such as leeches and ticks, produce antithrombins. A long-known preparation is made from an extract of the salivary glands of the medicinal leech, *Hirudo medicinalis*, and is known as **hirudin**. It has been widely used in transfusion and other physiological experiments requiring some means of preventing coagulation. Hirudin has the properties of a protease. A very low concentration of a similar antithrombic substance is found in normal blood. Presumably it tends to prevent intravascular clotting.

Thromboplastin. The rapid disintegration of platelets, thrombocytes, in shed blood and the comparatively prolonged clotting time of the blood of animals which, like the frog, are deficient in platelets, suggest that some substance set free from the platelets is an instigator of the clotting process. The well-known fact that blood which comes in contact with the dying cells of a wound clots more rapidly than does blood which is received directly from a blood vessel into a test tube suggests the idea that any dying cell may give off something that can hasten clotting.

This is shown strikingly in blood from birds, reptiles, and fishes. If prevented from coming into contact with wounded tissues, clotting time, normally measured in minutes, may be hours or even days. Addition of suitable tissue extracts to such bloods causes rapid clotting. These ideas are substantiated by other observations. It is claimed that when the clotting process is observed under the microscope, fibrin crystals are seen to form more abundantly near the disintegrating platelets than elsewhere. Material extracted from crushed tissue by ether is potent in hastening coagulation.

The substance which instigates clotting has been variously named: "Thrombokinase," "zymoplastic substance," "cytozyme," etc., but the term "thromboplastin," suggested by Howell, is appropriate and does not suggest that the substance is an enzyme or an enzyme activator. The available evidence does not indicate that it operates in either of those ways.

Cephalin (p. 82), obtained from any tissue, is reported by some investigators to act as thromboplastin, but this is disputed by other workers. In any case there is the probability that other compounds may act similarly. There is evidence that cephalin-protein complexes may thus serve.

The function of thromboplastin, according to Howell's theory, is to liberate prothrombin from its inactive combination with the antiprothrombin *heparin*.

Thrombosis, or intravascular clotting, is serious and may be fatal. Its normal prevention suggests that at least a small concentration of something which has an antithrombic action may be present in blood. Platelets probably disintegrate regularly so that some small amount of thrombin should be formed. Under certain abnormal conditions, such as injury to blood-vessel walls, abnormal agglutination (clumping) of corpuscles or platelets, presence of gas bubbles or other foreign substances in blood, etc., the amount of thromboplastin set free is sufficient to cause a clot. If it lodges in a small artery, arteriole, or capillary before it has been dissolved, it may cause a localized stoppage of the circulation. If this occurs in the brain or in the heart, it may even be fatal.

Delayed clotting may, under some circumstances, be an equally serious threat to life. The use of vitamin K preparations, fed or injected, has already been mentioned. Other means for facilitating coagulation include (1) the use of bandages impregnated with cephalin or cephalin-containing extracts; (2) the application of warmth, which hastens the reactions of clotting; (3) irrigation of wounds with solutions containing active thrombin. The last-named method is reported to be a genuine aid in saving the lives of wounded soldiers and is especially effective when the

thrombin solution is soaked up in a spongy mass of fibrin, called "fibrin foam," and applied to the wound. The simplest method is the application of fibrous material, such as surgical dressing. The foreign material hastens platelet disintegration. The deficiency in hemophilia appears to be a lack of a plasma factor required for liberation of thromboplastin from platelets.

Erythrocytes. The structure of the human red corpuscle is relatively simple, as it is a nonnucleated, highly specialized cell. It has the form of a biconcave disk but is flexible and may even assume a cup shape. Its size is variable, but the average has been given as 7.7μ in diameter. More recent measurements (Ponder) give the average as 8.8μ and the range as 7.5 to 9.5μ . It is essentially a tiny sac containing a very concentrated solution of the red Fe-containing protein, hemoglobin.

The number is commonly given as averaging 5,000,000 per cubic millimeter, but variations are considerable and are due to sex (men have more than women), individual variations, mode of living, condition of nutrition, and disease. It is lowered in anemia in its many forms and is increased in a few diseases. It varies with age, being greatest in the fetus and infant. There is a diurnal variation with a tendency to diminish after meals. In women the number is affected by the sex cycle and by pregnancy, increasing during menstruation and decreasing in pregnancy.

The effect of altitude is of peculiar interest. It can be imitated by the lowering of atmospheric pressure in an experimental chamber. The relation between pressure and the number of corpuscles is shown in Fig. 52. The same effect is obtained by lowering the O_2 tension without change in pressure. It is thus shown to be a natural compensatory mechanism for providing sufficient oxygen to the tissues under conditions of its deficiency. The steadily maintained increase in blood corpuscles of men and animals living at high altitudes has been frequently observed. At 4,000 meters, for example, the count may be as high as 7,000,000 or 8,000,000 and in a few cases even higher. It is one of the most important aspects of acclimatization to mountain life. A sudden change in altitude, such as in an airplane flight, has been observed to cause a marked increase in the red cell count, but the effect is too rapid to be the result of increased red cell production. It is apparently due to physical and physico-chemical conditions: Mobilization of corpuscles from previously sluggish capillaries, contraction of the spleen, decreased plasma volume following migration of water to the tissues, etc.

Formation and Destruction. The production of erythrocytes, "hemopoiesis," is due to specialized cells in what are called hemopoietic tissues. In the adult mammal under normal conditions hemopoiesis occurs only

in bone marrow, but in embryos, both liver and spleen are also hemopoietic and may resume this function under some pathological conditions. Pathology affords evidence that lymph nodes may also produce red cells.

The biochemical aspects of red cell production have been investigated by feeding experiments. Rats and dogs have been especially observed. On an iron-free or iron-poor diet, *e.g.*, milk, anemia is produced. The restoration of normal hemoglobin content can then be studied in relation

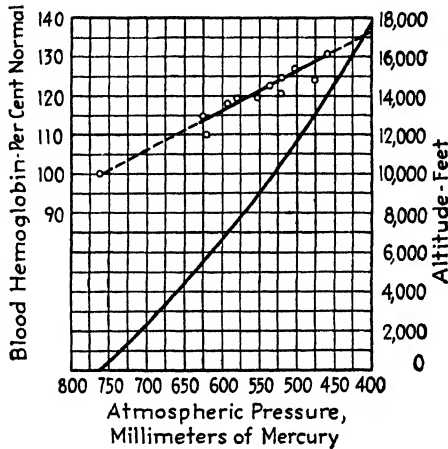

FIG. 52. The effect of altitude on the hemoglobin content of the blood. Abscissas are atmospheric pressures. The curve shows the relation of atmospheric pressure to altitude (ordinates at the right). The relative hemoglobin content of the blood of men residing at various altitudes is indicated by the plotted points (see ordinates at the left). The hemoglobin at sea level is taken as 100 per cent. It will be seen that at a pressure of 625 mm. of Hg, which corresponds to an altitude of about 5,500 feet, hemoglobin is increased some 10 to 15 per cent with a roughly corresponding increase in erythrocytes. A further increase occurs at higher altitudes, tending to be proportional to the decrease in atmospheric pressure. (After Fitzgerald.)

to food. Addition of Fe alone is not adequate. Supplemented by small amounts (about 0.2 mg. per kg. of body weight per day) of copper, the iron causes good hemoglobin production and cure of the dietetic anemia if other food requirements are adequate. Small amounts of cobalt (2 mg. per kg. per day) are reported to stimulate red cell production in the dog.

Another method used by Whipple and his associates is the study of dogs after their blood-hemoglobin level has been reduced to about 50 per cent of the normal by hemorrhages at suitable intervals during about 3 months. Restoration of the hemoglobin level can then be observed with the use of experimental diets. The relative values of the more effective foods are indicated by the following table.

Food	Daily intake	Hemoglobin formed during 2 weeks
	g.	g.
Liver (pork)	300	93
Spleen (pork)	300	82
Kidney (pork)	300	69
Gizzard (chicken)	200-300	60 or more
Heart (beef)	300	49
Muscle (from several sources)	300	10-40

Some fruits, *e.g.*, apricots, peaches, prunes, were also found to be fairly effective though less so than the animal tissues which contain iron-protein complexes. Some fruits, a number of vegetables, and all grains and dairy products lacked any marked potency. The dog is not well fitted for utilization of vegetable foods, which may be useful for blood production in some animals. Even a protein-free diet (sugar and water) was found to permit the dog to synthesize some hemoglobin (30 g. or more in 2 weeks), and when supplemented by inorganic iron the amount produced was about doubled. This shows that body stores of protein, such as those of muscle, may be used to supply the amino acids required for the synthesis. Attention has been drawn to the requirement for lysine for hemoglobin synthesis. Deaminated casein in which lysine has been altered does not support blood production in the dog. The most efficient food source of protein is globin, or hemoglobin itself. They surpass even the liver proteins.

The iron held in readiness for the process of hemoglobin production is believed to be in the form of an Fe-containing protein named **ferritin**. In separated form (from intestinal mucosa, liver, spleen, or bone marrow) it is a dark-brown substance which may contain Fe up to as much as 23 per cent of its weight. It is ferric iron and is stored in the form of colloidal particles of insoluble iron phosphate held by a relatively large nondiffusible protein molecule called apoferritin. Ferritin appears to be formed in the intestinal mucosa as iron is absorbed from digestion products; but in the blood stream, ferritin is not found and the mobile iron appears to be carried as a ferric salt of globulin. When ferritin yields iron for hemopoiesis, the iron changes from ferric to ferrous and at the same time apoferritin may yield (Granick, 1946) something used for the synthesis of the protein part, globin, of hemoglobin.

In addition to the actively hemopoietic tissue, other organs, gastric mucosa and liver, are functionally concerned in erythrocyte production. Evidence for this is derived from studies of the anemias (p. 316).

Erythrocytes disintegrate continually. The destruction is carried

on mainly by the Kupffer cells of the liver. Located in the walls of liver blood vessels they engulf and, as it were, digest corpuscles. This process occurs more or less in reticulo-endothelial tissue of other parts of the circulation. As a result of corpuscle disintegration bile pigments, among other things, are formed. The amount of bile-pigment production has been the basis of estimations of the rate of erythrocyte destruction. Other methods are used. The results of computations vary over a wide range, some of them being so high as to indicate that the average length of life of a corpuscle is no more than 8 to 10 days. Other estimations would make it as much as 120 days. There is probably considerable variation under varying conditions.

Composition. Erythrocytes in the mature stage are composed almost entirely of hemoglobin, water, and stroma. Hemoglobin normally constitutes 32 to 35 per cent of the fresh weight and 90 to 95 per cent of the dry weight. This is a concentration so high in comparison with known solutions of proteins as to suggest that the hemoglobin may not all be in true solution. Stroma may be obtained, after addition of water in amount sufficient to destroy (hemolyze) the corpuscles, by centrifuging and is found to be rich in lecithin and cholesterol. These compounds constitute some 20 per cent or more of the dry weight. Other components include inorganic material and protein. The protein has been called **stromatin**. Its properties distinguish it from hemoglobin, the serum globulins, and fibrinogen. Its isoelectric point (5.5 according to Jorpes) and its yield of certain of the amino acids serve to characterize it. The stroma, formerly thought to be an envelope or outer membrane of the erythrocyte, is now generally regarded as constituting an internal meshwork as well as an envelope.

Hemolysis. Any process by which hemoglobin escapes from red corpuscles is called "hemolysis." This definition differs somewhat from the older usage of the word to imply complete disruption of erythrocytes. When the erythrocytes are nearly or completely destroyed, blood becomes transparent and has a clear, brilliant red color which, suggesting "lake" pigments, led to the term **laking** as synonymous with hemolysis. The conditions causing hemolysis include: (1) Lowering the osmotic pressure of the plasma; (2) addition of fat solvents, such as ether or chloroform, which dissolve stroma lipids; (3) presence of bile salts which dissolve cholesterol; (4) addition of soaps of the higher fatty acids; (5) action of saponin or sapotoxin; (6) high alkalinity; (7) action of various toxins such as those of snake venom and various bacterial products; (8) introduction of a foreign serum which contains what is called a "natural hemolysin" for the red cells of the particular kind of blood under examination, *e.g.*, dog serum, hemolytic for rabbit corpuscles; (9) action of

what are called "immune hemolysins"; (10) pressure effects, such as are caused by alternate freezing and thawing, which destroy the cells mechanically. It is clear that the erythrocyte is a highly sensitive structure, easily disrupted by relatively slight environmental changes or by foreign reagents. While this is more or less true of every kind of cell, fragility and sensitiveness are prominent characteristics of the red cells and are easily observed because of the tendency of hemoglobin to escape from the cell after any slight injury.

Some of the agents of hemolysis, such as fat solvents, soaps, and alkalis, appear to hemolyze because of solvent or chemical action on stroma material. Others operate in ways which demand further description.

Osmotic Effects. The surface of the erythrocyte has the properties of a semipermeable membrane and has been extensively investigated from the standpoint of the general physiology of cell permeability. Red corpuscles of most species of animals show differential permeability between the very similar ions Na^+ and K^+ , being much more permeable to K^+ than to Na^+ , so that potassium is accumulated in the cell even though sodium is the more concentrated of these ions in plasma. The following values for rabbit blood will serve to illustrate.

	Potassium	Sodium
	per cent	per cent
Corpuscles.....	0.52	0.00
Plasma.....	0.026	0.44

Thus potassium is 20 times as concentrated in such corpuscles as in plasma, while sodium is practically excluded. The erythrocytes of all species exhibit a differential permeability toward anions and cations, being more permeable to anions. So far as the movement of water in and out of the cell (osmosis) is concerned, red cells are distinctly permeable. There is even a response to changes incident to each normal circulatory movement. Water shifts from plasma to corpuscles as the blood changes from arterial to venous and in the reverse direction as the blood is arterIALIZED in the pulmonary circulation.

The water content of human corpuscles normally varies from 57 to 64 per cent, and retention of hemoglobin within them is maintained under these conditions. Addition of water to blood causes hemolysis. The amount of water required in human blood for hemolysis to begin is normally that sufficient to make the osmotic pressure of the surrounding plasma or serum approximately equal to that of 0.05M NaCl solution.

The amount and rate of hemolysis rapidly increase with further additions of water up to the point where osmotic pressure is equivalent to 0.03*M* NaCl. Some of the corpuscles, however, may fail to hemolyze until a still greater dilution is attained. Blood or separated corpuscles mixed with a solution having the same osmotic pressure as plasma will not show hemolysis. Such a solution is 0.9 per cent NaCl for mammalian blood or 0.7 per cent NaCl for frog blood and is an *isotonic* or *isosmotic solution*. It is often referred to as "normal saline" or "physiological salt solution" (p. 292). NaCl is more suitable than any other single solute for preparation of an isotonic solution because it is comparatively innocuous for erythrocytes and, being present in mammalian plasma in concentration of about 0.56 per cent, actually furnishes some 60 per cent of the total osmotic pressure of plasma under normal conditions. Any solution of osmotic pressure less than that of plasma may be called *hypotonic*. Even when it differs so little as to cause no visible hemolysis, the effects are discernible by suitably delicate measurements. One method employs the hematocrit. Blood, together with a solution to be tested for its osmotic effects, is placed in a specially designed centrifuge tube having an accurately graduated part at the bottom. After the blood is whirled until the corpuscles are packed into the graduated portion, their volume can be read and compared with that of a control consisting of an equal amount of blood diluted with serum or a solution known to be isosmotic. Another method depends upon the comparison of light transmission through the treated and the untreated blood.

Hemolysis apparently occurs without actual disruption of the corpuscles. On this account the older idea that hemolysis in hypotonic solutions consists of the bursting of cells because of internal pressure of water taken in by osmosis has given way to the theory that hemolysis is a change in permeability or other conditions necessary for retention of hemoglobin.

Clinically, the comparative resistance of erythrocytes to hemolysis by hypotonic solutions (the fragility test) may be measured. Diminished resistance accompanies hemolytic jaundice. Increased resistance has been observed in certain types of anemia.

When corpuscles are surrounded by a solution of osmotic pressure higher than that of normal plasma, a *hypertonic* or *hyperosmotic* solution, their water content decreases so that the volume shrinks. If the shrinkage is sufficient to give them a wrinkled appearance when seen under the microscope, they are called **crenated corpuscles**.

Hemolysins. In general, the blood of any species of animal tends to be more or less hemolytic for the corpuscles of any other species. This is attributed to what are called natural hemolysins, which include not

only those of foreign blood but also those derived from bacteria and other foreign organisms, the snake venoms, etc. Examples of normal hemolytic effects of blood are the destruction of rabbit corpuscles by human blood or dog blood. A striking case is that of the eel, the serum of which is highly hemolytic for all mammalian bloods. As little as 0.04 ml. of eel serum given intravenously to a rabbit can cause hemolysis accompanied by bloody urine (hemoglobinuria). The escape of hemoglobin through the kidney, which normally retains blood proteins, shows damage to kidney cells and illustrates the fact that hemolysins are but one type of a larger class of substances, the **cytolysins** or **cytotoxins**, destructive for cells.

There are also immune hemolysins. An example is the hemolysin developed immunologically in the guinea pig for rabbit corpuscles toward which normal guinea pig blood is not perceptibly hemolytic. But after a suitable number of injections of a guinea pig with rabbit blood or rabbit corpuscles, the treated animal's serum becomes specifically hemolytic for rabbit corpuscles.

Hemoglobin. The concentration of hemoglobin in whole blood is commonly measured by some modification of colorimetric procedure applied to a suitably diluted laked sample. The normal average for the human adult has been assigned various values from about 14 to about 16 per cent. It probably exceeds 15 per cent. The value 15.6 per cent is widely used. Inasmuch as hemoglobin estimations for diagnostic purposes are frequently reported in terms of per cent of normal, the analyst is restricted in making comparisons. The variation of the so-called "average" or "normal" value is due in part to the variation in the number of erythrocytes and also to variation in their hemoglobin content. The latter, estimated in terms of **the color index** is the following ratio:

$$\frac{\text{Hemoglobin content taken as per cent of normal content}}{\text{Number of corpuscles computed as per cent of normal number}}$$

which indicates the relative abundance of hemoglobin per cell.

This ratio is useful in distinguishing between certain varieties of anemias, tending to be high in the primary types, such as pernicious anemia, and low in the secondary types and in nutritional anemia.

Other indices in use clinically are **the volume index**, which is chiefly varied by the relative water content of the cells,

$$\frac{\text{Volume of packed cells computed as per cent of the normal volume}}{\text{Number of corpuscles computed as per cent of the normal number}}$$

and the **saturation index**, which is another index of hemoglobin content,

$$\frac{\text{Hemoglobin content computed as per cent of the normal content}}{\text{Volume of packed cells computed as per cent of the normal volume}}$$

Hemoglobin is a compound protein and is easily hydrolyzed in dilute

acid to yield the histone **globin** and the prosthetic group **heme** formerly called **hematin**. Heme is most easily obtained in the form of its HCl salt called **hematin**. Blood, dried on a microscope slide, is treated with glacial acetic acid and a little NaCl, heated until the acetic acid boils, and then cooled slowly. Hemin crystallizes in chocolate-colored rhombic plates (Fig. 53). The structure of hemin has been established by various studies, including artificial synthesis. The formula (see chlorophyll, p. 48) is

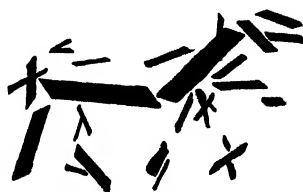
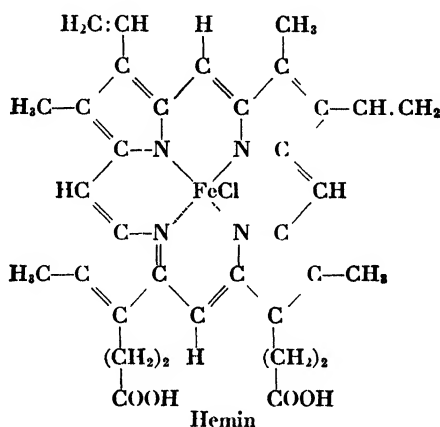
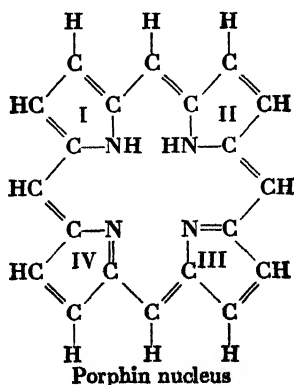

FIG. 53. Hemin crystals.



The pyrrole-containing nucleus, called "porphin," occurs in so many compounds of biological interest (chlorophyll, hemoglobin, myoglobin, iron-containing protein enzymes, cytochromes, etc.) that its investigation has assumed importance. It may be represented as



The form occurring in hemin is known as protoporphyrin to distinguish it from other isomeric forms found in nature. One may further distinguish between ferroprotoporphyrin (ferrous iron) and ferriprotoporphyrin (ferric iron). Thus hemin is ferriprotoporphyrin chloride.

The four pyrrole groups, so united by the intervening C atoms as to constitute a ring with single or double bonds between the C and N atoms, are the framework upon which the various natural and artificial derivatives are built by addition of side chains and by other modifications. It will be noted that hemin has four methyl and two vinyl groups and two residues of propionic acid as side chains. The position of the Fe atom is the strategic feature of the structure. It is represented as attached to the N atoms partly by ordinary and partly by secondary valences. It probably exists in resonance. It is not oxidized but remains in the *ferrous* condition when hemoglobin takes up oxygen to form oxyhemoglobin.

The method of union between heme and globin is unknown but clearly has functional significance. Some observations afford clues as to the nature of the union. The behavior of the iron atom toward oxygen and other properties of the iron-containing group differ, when in combination with globin, from the properties of free heme. Also the absorption spectra of hemoglobin and oxyhemoglobin differ from those of heme and reduced heme. There is some evidence to indicate that heme is attached, through its Fe atom, to globin in such a way as to involve the imidazole group of histidine in globin and to permit this group to participate in resonance around the Fe atom.

The Fe atom of hemoglobin and of some of the closely related compounds is in the ferrous state. It may therefore be represented as having two primary valences (utilized for holding the rings of the porphin nucleus) and four secondary or residual valences, of which only two are required for nuclear attachment. There are thus two secondary valences remaining for other attachments. The manner in which they are utilized in hemoglobin and some of its derivatives is postulated as shown in three of the following formulas. The fourth shows ferric iron, which is present in some Fe-porphin proteins.

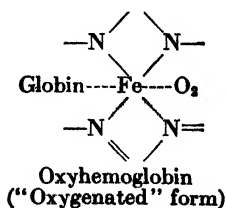
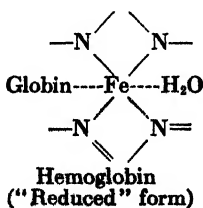

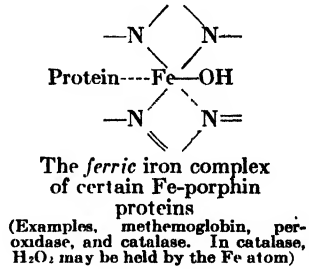
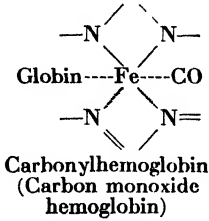

It should be noted that, in these porphin complexes in either the ferrous or ferric state, the primary valence bonds of the Fe atom are not necessarily fixed but probably resonate as is also probable for the bonds of the Mg atom in the similar porphin structure (p. 48) of chlorophyll.

Some of the compounds related to hemoglobin arise by cleavage, by oxidation-reduction reactions of the Fe-porphin group, and by denaturation of the globin. The relations of certain of the products to each other are indicated in the following diagram modified from a similar one by Keilin.

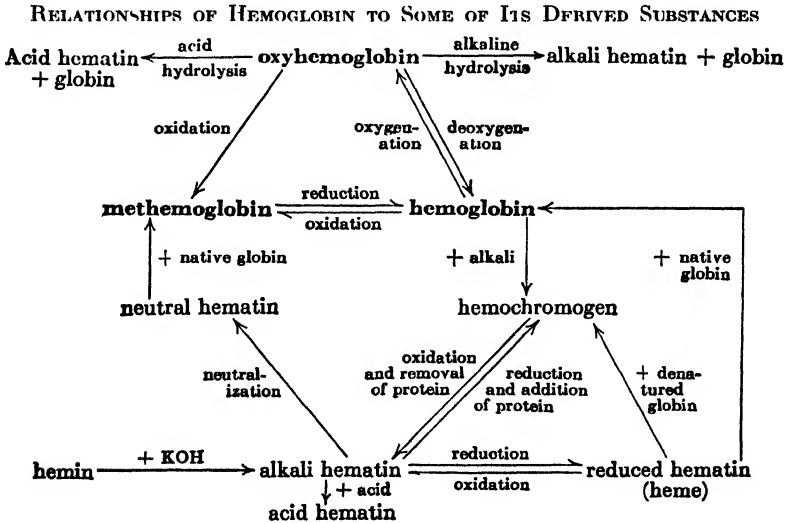

Crystallization. Hemoglobin may be crystallized from the blood of certain species (dog, cat, guinea pig, rat, and horse) by merely laking with ether and permitting the laked blood to stand in a cold place. In the case of other species, special procedures are required. Sketches of some of the forms obtained are shown in Fig. 54. The work of a number

of investigators, chiefly Reichert, has revealed species relationships in the crystallographic forms of hemoglobin.

Absorption Spectra. Solutions of hemoglobin or any of its various compounds or solutions of any of the majority of its decomposition products absorb light of specific wave lengths so that each of these substances may be identified by the use of the spectroscope. Some of the absorption spectra frequently observed for this purpose are indicated in Fig. 55.

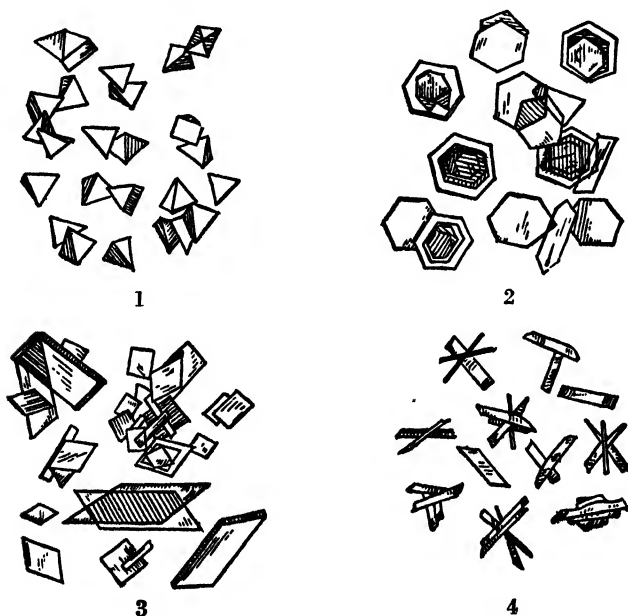

FIG. 54. Sketches to indicate the forms of hemoglobin crystals as obtained from blood of different species: 1, guinea pig; 2, squirrel; 3, horse; 4, rat. (After Reichert.)

The concentration of the material under observation and the thickness of the layer of solution through which light passes before entering the spectroscope must be controlled in order to obtain the spectra in definitely characteristic form. The width and to some extent the position of the absorption bands on the spectrum may be used as a rough quantitative index.

The *molecular weight* of hemoglobin (p. 131) is probably about 64,000 in the case of some mammalian hemoglobins.

The *amino acids* obtained by hydrolysis of globin tend to resemble those derived from the albumins, but leucine, isoleucine, and histidine are found in relatively high yields and glutamic acid is low as in some other histones. The exceptionally high content of histidine (more than 8 per cent) is notable.

The function of hemoglobin is primarily that of O_2 transport, but it is also significantly useful in buffering acidity which could otherwise affect the pH of blood during CO_2 transport. Each of these functions will be discussed.

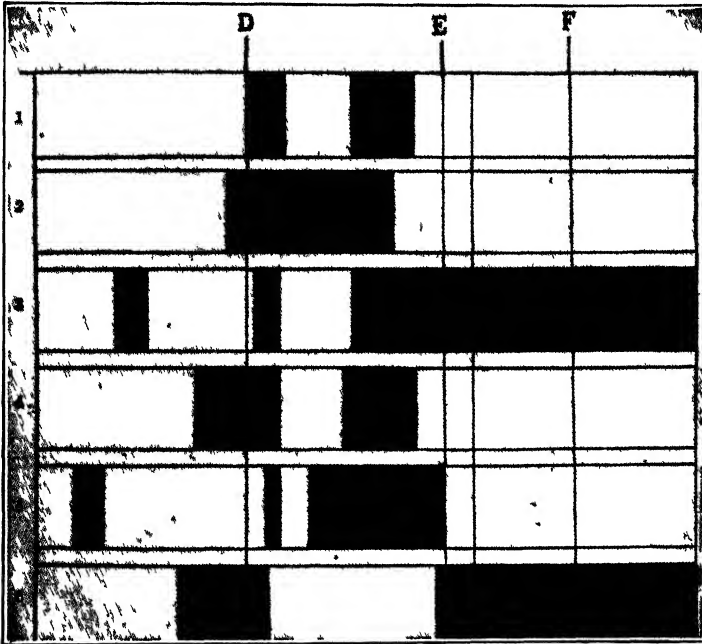
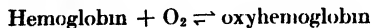

FIG. 55. Absorption spectra of hemoglobin and its derivatives 1, oxyhemoglobin; 2, hemoglobin in the presence of a reducing agent, 3, methemoglobin in neutral solution; 4, methemoglobin in alkaline solution, 5, hematin in acid solution, 6, hematin in alkaline solution. Fraunhofer lines are shown as points of reference (After Ziemke and Muller.)

Reactions of Hemoglobin with Various Gases. The reaction



moves to the right in the lung capillaries and in the reverse direction in the general systemic capillaries. The nature of the reaction is indicated by the curve in Fig. 56, which shows the variation in per cent saturation of hemoglobin with O_2 as affected by changes in O_2 tension. The graph shows certain remarkable adaptations of hemoglobin to its function in O_2 transport. (1) The degree to which it takes up O_2 is only slightly lowered (96 to 90 per cent saturation) by decreasing the O_2 tension from 100 mm. Hg (maximum O_2 tension in the lungs at 1 atmosphere pressure) to 70 mm. Hg (O_2 tension of air at an elevation of 10,000 ft.). Hemoglo-

bin is thus shown to be highly efficient in taking up O_2 even under varying conditions. (2) As O_2 tension is progressively decreased the curve falls more steeply, so that O_2 is shown to be given off freely under conditions prevailing in the systemic capillaries. This reaction will be discussed more fully in connection with the chemistry of respiration.

Union of hemoglobin with O_2 is appropriately called **oxygenation**. It is not an oxidation in the ordinary sense. The Fe atoms, although

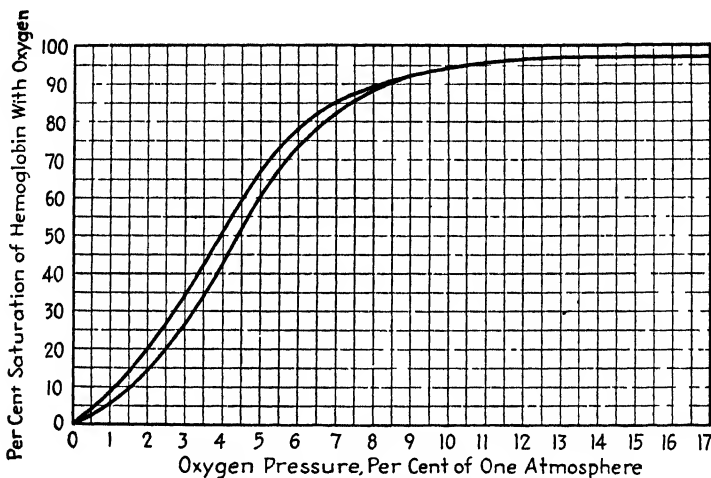
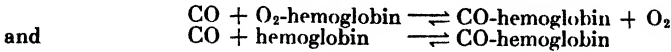

FIG. 56. Dissociation curves of oxyhemoglobin. The upper curve shows results for two adult men when the measurements were made *in vitro* with the blood in the presence of CO_2 at 40 mm. of Hg partial pressure. The lower curve, which shows a still higher efficiency in giving off O_2 at lowered O_2 pressure, represents the blood of the same persons when the oxyhemoglobin dissociation was measured within the body. The difference may be regarded as due to the slightly higher CO_2 tension in venous blood as compared with that prevailing during the *in vitro* measurements. (After J. S. Haldane.)

involved in the uptake of O_2 , do not change from the ferrous to the ferric condition. Hemoglobin may be actually oxidized, however, by a number of *in vitro* oxidants, *e.g.*, potassium ferricyanide. The product is known as **methemoglobin**, and its iron is in the ferric condition. It has a brown color and a characteristic spectrum (Fig. 55). It may arise *in vivo* after the administration of any of a number of drugs and poisons. Some of them are as follows: Acetanilide, aniline, chlorates, ferricyanides, hydroquinone, nitrophenols, phenacetin, sulfanilamide drugs, sulfonal, and trional. Methemoglobin cannot serve in O_2 transport.

Hemoglobin combines with carbon monoxide to form the cherry-red **carbon monoxide hemoglobin**, also called **carboxylhemoglobin**,

which does not readily dissociate but is a relatively stable compound as compared with oxyhemoglobin. One may say that the reactions



attain equilibrium at a high concentration of CO-hemoglobin. The CO attaches to the hemoglobin, apparently involving the Fe atom in such a way as nearly to prevent the formation of oxyhemoglobin. Van Slyke found that the tendency of hemoglobin in hemolyzed human blood to take up CO was about 210 times as great as the tendency to combine with O₂. The oxygenation of blood is thus interfered with, so that asphyxiation occurs as soon as the O₂-combining capacity of the blood is reduced below a critical level. This is the primary cause of death from inhalation of any CO-containing gas such as illuminating gas, coal gas, motor-exhaust gases, etc. The comparative stability of CO-hemoglobin results in cumulative effects, so that even intermittent breathing of air contaminated with CO may cause serious poisoning or fatal effects. Prolonged breathing of air containing 0.1 per cent of CO causes acute symptoms, and not more than 0.02 per cent can be tolerated for any sustained period without toxic effects. Even this low concentration may cause headache after 5 or 6 hr. exposure.

Spectroscopic examination of blood affords proof of CO poisoning as the cause of death. The characteristic absorption spectrum of CO-hemoglobin is obtained, and addition of a reducing agent, *e.g.*, ammonium ferrous tartrate in what is known as "Stokes' solution," to the sample does not change the spectrum. Such a reducing reagent, added to normal blood or to blood containing a relatively low concentration of CO-hemoglobin, would cause the absorption spectrum of hemoglobin to appear. Low concentrations of CO-hemoglobin are detected and estimated diagnostically by chemical analysis.

The reaction of hemoglobin with nitric oxide, NO, is similar to that with CO, but the resulting compound is even more stable than CO-hemoglobin and is regarded (Anson and Mirsky) as NO-methemoglobin.

The reaction of hemoglobin with CO₂, although extensively investigated, is still under debate. Obviously, carbonic acid can react with the potassium salt of hemoglobin, which is present in the corpuscle, to form KHCO₃, and this reaction appears to occur. But it has also been suggested that amino groups of hemoglobin may react reversibly with CO₂ to form a carbamino compound

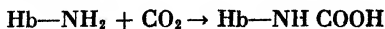

The functioning of red corpuscles in relation to CO₂-transport in blood will be described more fully in connection with respiration.

The Anemias. Any condition in which the hemoglobin content of the blood is lower than normal is called *anemia*. Many types are recognized according to their origin (etiology). Thus there are those due to (1) excessive loss of blood, (2) excessive destruction of erythrocytes, or (3) disorders in erythrocyte production. Nutritional anemias and pernicious anemia are of the third type. Anemias might also be classified according to the nature of the change in the blood as (1) *macrocytic*, having a conspicuous number of the larger erythrocytes; (2) *microcytic*, with the smaller erythrocytes predominating; and (3) *normocytic*, without significant change in the relative numbers of the corpuscles of differing size. The anemias are further characterized according to variations in the relative numbers of reticulocytes or other immature corpuscles present. The blood indices (p. 308) are useful in distinguishing the different types of anemia.

Aspects of nutritional anemia were discussed (p. 303) in connection with the formation of red cells.

Pernicious anemia is significant because of the high incidence of death among its victims. It is of especial biochemical interest because of the associated physiological disturbances which throw light upon the biochemistry of normal hemopoiesis. Minot and Murphy (1926) demonstrated the remarkable effectiveness of liver in the relief of pernicious anemia of the macrocytic type. Feeding of liver, and especially raw liver, or the feeding or injection of certain liver extracts afforded dramatic improvement in the condition of the patients along with a striking increase in hemopoiesis. From about the third to about the seventh day of treatment there is a large increase of reticulocytes, which then progressively decrease to something like a normal number while mature erythrocytes increase and may even approximate the average number for healthy persons. While this suggests the importance of the liver for erythrocyte production, other observations indicate that it is only a storage organ for the required material. It had long been known that pernicious anemia is associated with severe gastric disturbance, achlorhydria, aepsia, and, indeed, a general malfunctioning of the gastric glands. The question of whether or not this was a cause of the anemia was successfully investigated by Whipple and his associates. Having shown that neither the administration of meat nor of normal human gastric juice to the patient afforded any relief, they found that *when both meat and normal human gastric juice were fed*, obvious improvement followed. Further investigation showed that factors necessary for correction of pernicious anemia are of two kinds: (1) *Extrinsic*, provided by meat and a number of other foods (yeast, liver, rice polishings, eggs, milk, and possibly tomatoes and spinach) and (2) *intrinsic*, produced by the gastric mucosa,

especially in the pyloric region, but later shown to be also derivable from the duodenal mucosa. The intrinsic factor has been shown not to be identical with any of the following enzymes: Pepsin, rennin, lipase, trypsin, or erepsin. Yet it shows the enzyme-like property of thermolability, being destroyed at 70 to 80°C. The name *hemopoietin* has been suggested for it. It appears to be required to activate the extrinsic factor. The resulting product has been termed *ventriculin* since it can be obtained in active form from the mucosa of the ventriculum. In vitro activation of the extrinsic factor so as to form the substance relieving pernicious anemia is successful when beef is treated with normal gastric juice at pH 5 or 7 but not when the mixture is at pH 1.8 or 2.5. Evidently the concentration of HCl optimum for peptic activity interferes with the production of ventriculin. The occurrence of the extrinsic factor in natural foods resembles that of certain of the B group of vitamins, and this adds weight to the obvious suggestion that the extrinsic factor is one or more of the compounds included in or related to the folic acid group (p. 183), such compounds as PGA or its conjugates, or some other pteroyl derivatives. The functioning of the so-called "vitamin B₁₂" in the cure of anemia would seem to be catalytic since it is curative in minute amounts and contains the catalytically active cobalt. The importance of adequate supplies of thiamine and riboflavin in treatment of pernicious anemia has been demonstrated. But they are apparently required in addition to the extrinsic factor. Sprue (p. 185) seems to involve a dietary deficiency of the extrinsic factor.

The theory deducible from these observations may be stated as follows: An unidentified food factor, interacting with an enzyme-like product (hemopoietin) of the pyloric and duodenal mucosa, forms a substance (ventriculin) which is absorbed into the blood, is stored in the liver, and is necessary for normal hemopoiesis. The failure to produce hemopoietin or some abnormality in its reaction with the extrinsic factor is the primary cause of pernicious anemia. It is tempting to conclude that the preparation called "vitamin B₁₄" (p. 215) is the long-sought ventriculin. But, as its discoverers suggest, such a conclusion is still premature. The origin of pernicious anemia is unknown, but there is some evidence to suggest that it is hereditary.

The erythrocytes in pernicious anemia show a marked increase in permeability to glucose, an abnormality which disappears after treatment with liver preparations. This and some other observations suggest that the active principle is required for the formation of stroma of normal structure. If this is true, it is in contrast to the dietary-deficiency anemias which, in general, are characterized by abnormalities in the synthesis of either the globin or the heme portion of hemoglobin or both.

Although this discussion does not attempt any complete description of medical aspects of the extensive subject of the anemias, enough has been presented to indicate clearly that the number, the chemical composition, and the structure of erythrocytes are in a state of dynamic equilibrium which can be disturbed by so many kinds of changing conditions that anemia, in its multitude of variations, may be symptomatic of a large number of adverse circumstances.

Polycythemias. Abnormally high erythrocyte content of blood is termed *polycythemia* and tends to be parallel to heightened hemoglobin content (hyperhemoglobinemia). In some cases the increase is more apparent than real, being due to a lowered plasma volume. In other cases it is merely symptomatic of a temporary condition, such as (1) violent exercise, (2) partial asphyxia, (3) decreased O₂ tension (p. 302), (4) abnormally high rate of oxidative metabolism as in overactivity of the thyroid, or (5) any of a number of other conditions involving either increase in the O₂ requirement or decrease in available O₂ supply (anoxia).

Polycythemia vera appears to be a primary disturbance rather than a symptom. It is accompanied by increased blood volume and shows no causal relation to general anoxia, although localized interference with the O₂ supply of hemopoietic tissues of the bone marrow may be involved. Red cell counts are recorded as 6,000,000 to 11,000,000 per cubic millimeter. Biochemically, the disturbance is characterized by a low color index (p. 308), a high basal metabolic rate (Chap. XIII), a relatively high bilirubin content of blood, and increased amounts of urobilinogen in the urine. The last two of these conditions reflect excessive catabolism of hemoglobin.

Leucocytes. White blood corpuscles are less abundant than red ones. The average number under normal conditions is about 7,000 per cubic millimeter, but may vary from about 4,000 to about 10,000. The tendency of leucocytes to adhere to capillary walls and to aggregate in lymph nodes and certain other localities lowers the number of those to be found in a blood sample taken by skin puncture. Exercise, however, mobilizes the white corpuscles and results in higher counts. Pathologically the leucocyte count may be abnormally low (leucopenia) or excessively high (leucocytosis). Leucocytosis generally accompanies infection and appears to be one aspect of the mechanisms of defense.

There are two main types of white blood cells, **granulocytes**, which have cytoplasmic granules and are sometimes called the "true leucocytes," and the **lymphocytes**. The latter are globular in shape with relatively clear cytoplasm and show less amoeboid motion than do the majority of granulocytes. In mammals (postnatal) lymphocytes are generally formed in the lymph nodes and in the spleen and only to a

small extent in bone marrow; granulocytes originate chiefly in the hemopoietic tissues of bone marrow. In the embryo, and even in the adult under pathological conditions, liver, spleen, and lymph nodes assume more general blood-producing functions.

Both types of white corpuscles include numerous subtypes distinguished by the cytologist and the pathologist according to size, protoplasmic structure, motility, and staining properties. Inasmuch as marked variation in the relative abundance of some of the subtypes accompanies certain pathological conditions, differential counts of stained cells in blood smears, giving what is called the "blood picture," afford useful diagnostic information.

Normally, the relatively large amoeboid reticulocytes with complex nuclei, called **polymorphonuclear leucocytes**, are the most abundant (65 ± 5 per cent of all leucocytes), while typical lymphocytes compose 30 ± 10 per cent. Other types which are subgroups of the main ones are found in relatively small numbers.

The chemical composition of leucocytes is fairly typical of undifferentiated animal cells. The proteins include albumins, globulins, and nucleoprotein. The carbohydrate, very low in concentration, is chiefly glycogen. Of the lipids, about one-half is phospholipid, but the amount is variable, generally decreasing during the course of an infectious disease but rising again during recovery. Cholesterol esters show a tendency to accumulate in leucocytes during infection.

Biochemical Aspects of Phagocytosis. The engulfing and destruction (phagocytosis) of bacteria and other foreign substances is accomplished by the polymorphonuclear leucocytes and involves amoeboid motion. The latter is influenced by the pH of the medium. When the medium is slightly on the acid side of neutral, the cells show a chemotactic response, moving from a less to a more acid region. The phagocytes are also positively chemotactic toward a substance called **leucotoxin** which appears to be liberated by injured tissues. It has been prepared in crystalline form from tissue exudates. Certain amino acids, nucleic acid, and foreign proteins are said to have a similar directive effect upon the movement of phagocytes. In order to gain access to a wounded or an infected area or to carry on some other of their functions, phagocytes must leave the blood vessels in adequate numbers. This is accomplished by **diapedesis**. The phagocytes "crawl" through interstices between the thin mosaic cells of capillary walls. The theory to explain this process suggests that intercellular substance of capillary walls changes from gel to sol under localized influence of the leucocyte adhering to the capillary wall. The gel-sol change seems to be reversible, inasmuch as the capillary is not necessarily disrupted by diapedesis.

Having gained access to an infected area, phagocytes function during the further development of inflammation, engulfing both bacteria and tissue debris. Carbonic, lactic, and other acids forming during inflammation develop a local acidosis (pH about 7.2 or less as compared with about 7.35 in normal tissue fluids). This facilitates the further influx of phagocytes by chemotaxis until the acidity reaches a pH of about 6.7. At this point the polymorphonuclear leucocytes are adversely affected and decrease in number. They are replaced by the **macrophages**, comparatively large cells which originate chiefly from the reticulo-endothelium, are more resistant to mild acidity, and continue the phagocytic processes in the inflamed area.

The macrophages are important for phagocytosis when bacteria invade the blood (septicemia), in which case the macrophages operate to a considerable extent in their original location, the linings of the general systemic vessels and other reticulo-endothelial tissues such as those of liver, spleen, and lymph nodes.

Phagocytic action upon bacteria is markedly influenced by what are called **opsonins** (from Greek, signifying "to prepare food"). Opsonins of the plasma are specific for the bacteria which arouse their production and so alter the surfaces of the bacteria as to increase the chances of their being phagocytized. Production of opsonins is one aspect of the defense mechanism of the body. The **opsonic index** is the ratio of the number of bacteria phagocytized by leucocytes in the presence of a sample of a patient's serum to the number phagocytized in normal serum.

Immune Substances of Serum. In addition to opsonins, a number of other substances are produced by the defense mechanisms of immunity. Anything which can arouse the production of an immune substance may be called an **antigen**. Antigens include bacteria, molds, protozoa, certain toxins, and foreign proteins in general. While foreign proteins, either free or in an invading organism or in a cell fragment, are the chief antigens, the possibility that certain polysaccharides (p. 40) may serve as antigens cannot be ruled out.

The specific substances produced in response to an immune reaction are called **antibodies**. While they are extractable from tissues of the immunized animal, they are also found to be prominent in blood plasma or serum. The antibodies are probably proteins; at least one may say that no antibody has been found free from protein. They are concentrated in the globulin fraction of serum. Pauling suggests that antibodies differ from normal serum globulins only in that "the end parts of the globulin polypeptide chain . . . assume configurations complementary to surface regions of the antigen." This suggestion is in agreement with the results of Pauling's experiments in which a specific antibody was

formed *in vitro* by the action of a pneumococcus antigen upon a purified serum globulin from beef blood at 57°C. for a period of 14 days.

Antibodies include (1) *agglutinins*, which are specific in causing the clumping together of the kind of cells (corpuscles, bacteria, etc.) that served as antigen; (2) *hemolysins* and other *cytolysins* (p. 308); (3) *precipitins*, which form precipitates specifically (p. 325) with the foreign antigenic protein; and (4) *antitoxins*, which specifically counteract the toxicity of certain pathogenic organisms, *e.g.*, diphtheria antitoxin.

The extent to which these names of antibodies, usually spoken of as though they belonged in separate categories, are really overlapping terms is not clear. One notes, for example, that an opsonin may be an agglutinin and all forms of agglutinins might be regarded as precipitins inasmuch as they cause cells to adhere to each other by a reaction that may be comparable to protein flocculation. Also it has been shown (Northrop, 1942) that a purified crystalline protein preparation of diphtheria antitoxin is a precipitin for diphtheria toxin.

The Complement. In order that a reaction may occur between an immune substance (a cytolysin) and its antigen, an additional factor occurring in blood plasma is generally necessary. It is known as the "complement" or "alexin." It has the properties of a complex globulin to which albumin and lipid components appear, in some cases at least, to be attached. It is nonspecific. Its concentration in plasma has not been shown to be increased by the process of immunization. It gives no perceptible specific reaction with the antigen except in the presence of the antibody or after the latter has acted upon the antigen. When the antibody thus acts as an antigen sensitizer, it is generally called the **amboceptor**. When the antigen-amboceptor-complement complex is formed, the *complement fixation* thus occurring is not perceptibly reversible. Since the complement is not specific but can react with any antigen-antibody combination, the fixation of the complement can be used as the basis of the well-known Wassermann reaction for detection of syphilis. The patient's serum is heated to destroy its complement and is mixed with an alcoholic extract of an animal tissue, such as beef heart, containing a "lipid antigen." A standard amount of complement, in the form of guinea pig fresh serum, is also added. After opportunity for the formation of antibody-antigen complex, the mixture is treated with a preparation of washed red blood corpuscles, usually from sheep, and serum containing a specific hemolysin for the corpuscles, *e.g.*, serum of a rabbit immunized to sheep cells. If the serum is from a syphilitic, the resulting antibody-antigen complex will cause complete fixation of the guinea pig serum complement so that no hemolysis of the sheep corpuscles occurs.

Allergic Reactions. An allergy is a form of **anaphylaxis**, a condition in which the organism has become hypersensitive to the presence of foreign proteins or proteinlike material. The theory suggesting that certain fragments of foreign protein molecules may be absorbed through mucous membranes and thus produce a food allergy was considered (p. 278) in connection with protein absorption. Among the many food proteins for which allergy has been detected, those of egg, milk, shellfish, and wheat are perhaps the ones most frequently found to be causative factors or **allergens**.

Similar to food allergies are those which involve, primarily, the mucous membranes of the respiratory tract. They include "hay fever," which is hypersensitivity to proteins of specific pollens, also "horse fever," "cat fever," etc., which are hypersensitiveness to specific proteins of dandruff or dust from fur or feathers. Other similar sensitivities are known.

The skin allergies also appear to be of a similar nature as in the case of the frequently noticed sensitivity of the human skin to wool. Marked reactions taking the form of skin disturbances (urticaria, eczema, or certain forms of edema) may be important symptoms in food allergic reactions or in other types of hypersensitivity.

True anaphylaxis is set up in a laboratory animal by a single injection of material containing foreign protein. If no further injection is given during some 3 weeks, the animal develops a hypersensitiveness which is specific for the protein used, so that if it is injected or otherwise administered the animal suffers anaphylactic shock, the severity of which is determined by the degree of anaphylaxis established and the amount of the foreign protein, the allergen, given on the second occasion. Instead of developing immunity by the formation of a *protective* antibody, the anaphylactic animal has developed a *sensitizing* antibody, sometimes called an **anaphylactin**. This, according to current theories, can react with its specific allergen in such a way as to cause the liberation in body tissues and fluids of an **anaphylatoxin**. This toxin closely resembles histamine (p. 274) and may, in some cases at least, actually be histamine. The more prominent symptoms of anaphylactic shock, *e.g.* lowered blood pressure, convulsive breathing (threatening or causing fatal asphyxia), disturbances in protein metabolism, certain changes in blood chemistry, and violent contractions of muscles of bronchioles, uterus, stomach, intestines, and bladder, may be produced by injection of histamine. The liberation of anaphylatoxin occurs in different degree in the different organs of the body. There is evidence from experiments with excised tissues to suggest that these differences are due to differential absorption of the allergen by the tissues.

Both true anaphylaxis and the allergies may be combated and at

least temporarily abolished by a desensitization process in which the sensitizing substance (allergen) is injected, in amounts too small to produce serious anaphylactic or anaphylactoid reactions, at intervals of some 3 to 7 days over a considerable period of time, the dosage being gradually increased until a temporary immunity is produced.

Haptens. A large group of substances, called *haptens*, can combine with proteins so as to behave like a prosthetic group which modifies the immunological behavior of the protein. Substances which operate as haptens include the immune polysaccharides (p. 40), some lipids, and a considerable number of drugs and other chemical reagents. The same hapten may unite with a whole group of antigens, which will then show a dominant specificity due to the hapten. While the members of such a group will not be immunologically identical and will be distinguishable by certain aspects of their behavior, they will show a marked similarity in some respects. Specificity of an antigen toward its antibody is a relative matter, for while the reaction (agglutination, lysis, etc.) may occur at very high dilutions of the antibody when reacting with its specific antigen, a similar reaction may occur when the antibody, in comparatively concentrated form, is added to a related antigen. Antigens may be related in this sense because of similar structure of the typically protein part of the molecule. For example, the serum proteins of man are more closely related to those of the anthropoid apes than to those of other species. But especially interesting and readily detectable antigen relationships result from hapten behavior. A simple case is that of iodized proteins. Treated with iodine, they acquire diiodotyrosine groups and possibly other iodine-containing groups and take on antigenic properties attributable to them. While the antigenic characteristics of the original proteins may still render them distinguishable from each other, they nevertheless show dominant antigenic properties which are very similar. An illustration of this among natural proteins is found in the behavior of the iodine-containing protein of thyroid glands. It is called thyroglobulin (Chap. XX) and when prepared from the glands of different species shows marked immunological similarities. Some natural proteins seem to owe their antigenic similarities to the presence of a hapten which is believed to be a lipid.

The blood grouping which characterizes human individuals involves haptens. This grouping is more or less familiar to everyone because it has to be taken into account in order to avoid dangerous agglutination of corpuscles in blood transfusion. Human corpuscles are of four main types when classified according to their behavior toward agglutinins. The groups are referred to as O, A, B, and AB. Their differences are regarded as due to their differing content in cell surfaces of two polysac-

charide haptens, A and B. They are inherited as dominant Mendelian characters. Agglutination which may occur upon mixing blood of different individuals, as in transfusion, involves plasma antibodies called "iso-agglutinins," which are inherited as Mendelian recessive characters. It is because of its hereditary origin that blood grouping can sometimes be used to prove nonpaternity.

The Rh Blood Factor. Human bloods may also be grouped according to agglutinative behavior which involves a specific immune reaction. The phenomena, though previously studied in animals, were first shown to have significance for human serology when Landsteiner and Wiener (1940) published their work on a newly recognized agglutigen. It was named the Rh factor because it was discovered by the use of rhesus monkey blood serving as antigen when injected into rabbits. The rabbits acquire an agglutinin for rhesus blood cells. But human beings (about 86 per cent of the white population) react positively to the Rh antiserum while some 14 per cent give no reaction. This variation is due to heredity. An individual reacts Rh positive if inheriting either one or two (Rh) genes. The gene behaves as a Mendelian dominant. An individual reacts Rh negative only if homozygous recessive (rh, rh).

Further studies have shown that the human blood proteins (agglutinogens) which react with Rh antiserum are at least five in number, and as they may occur in different combinations there are seven or more Rh blood types in addition to the Rh negative type. The total number of types and the mechanism of heredity which causes their differences are still under investigation.

The practical significance of these discoveries has become clear in a number of ways. One of them is the fatal hemolytic reaction which sometimes occurs when a woman is given a blood transfusion from a donor whose blood is entirely compatible according to the older and established blood-grouping tests. Such cases are reported almost always to be women who have at some time been pregnant. The explanation is that the fetus, conceived by an Rh positive father and an Rh negative mother, gave off to the mother's blood an antigen which aroused in her the production of the Rh agglutinin. It is now believed that many cases of miscarriages, stillbirths, and especially cases of erythroblastosis fetalis (a serious and often fatal disease of the fetus with an abnormal proportion of colorless cells in the blood and few erythrocytes) are due to the presence of the Rh agglutinin or some similar immune substance produced in the mother by an Rh antigen from the fetus. Although erythroblastosis is apt to occur when the mother is Rh negative and the fetus, because of inheritance from the father, is Rh positive, it is not an invariable result. The explanation of this anomaly is not yet clarified.

It would be good eugenic practice to spread the information regarding the Rh factor and to offer medical advice against the marriage of an Rh negative woman with an Rh positive man. Haldane and other writers have presented the desirability of eugenic education.

The Detection of Blood. Identification of blood for medicolegal purposes and also its detection in gastric samples, in exudates, and in urine and feces for diagnostic purposes assumes importance.

The hemin test (p. 309) is particularly useful. A modification, known as "Nippe's test," employs a solution of KCl, KBr, and KI in glacial acetic acid and is more reliable than the original test.

The guaiac test is sometimes used. An extract containing a small amount of blood is treated with a few drops of an alcoholic solution of gum guaiac or guaiaconic acid and then with hydrogen peroxide. A blue color due to oxidation of guaiaconic acid is obtained in the presence of blood.

The benzidine test is more sensitive than the guaiac test. The blood-containing aqueous solution is treated with a saturated solution of benzidine (*p*-diamino-diphenyl, $\text{H}_2\text{N}-\text{C}_6\text{H}_4-\text{C}_6\text{H}_4-\text{NH}_2$) in glacial acetic acid. H_2O_2 is then added, and a brilliant blue or greenish-blue oxidation product of benzidine forms in the presence of blood. The test is said to detect blood in a dilution of $1:5 \times 10^6$.

Spectroscopic examination for identification of the absorption bands (p. 313) of oxyhemoglobin or other derivatives of hemoglobin is often used.

The only available method for determination of the species of blood, *e.g.*, to distinguish human from any other blood, is an immunological one. It is sometimes called the *Bordet test*. A laboratory animal, usually a rabbit, is repeatedly injected with gradually increasing doses of blood of known species. Eventually the animal develops a precipitin which may be found in its serum and is more or less specific for the blood serving as antigen. It does not differentiate human blood from that of anthropoid apes, but human blood would not be confused with any other bloods. The reaction is so exceedingly delicate that a minute blood stain may be tested. The precipitin reaction is also useful for identification of the source of the majority of proteins. For example, a rabbit immunized to the proteins of horse meat yields serum which will precipitate the protein of extracts of horse muscle but would give no reaction with beef or pork proteins.

Diagnostic Blood Analysis. The development of analytical methods, especially those utilizing small amounts of blood, has greatly increased the availability of blood chemistry for recognition of changes in blood composition accompanying pathological and other abnormal conditions.

Data assembled in Table 39, compiled by Hawk and Bergeim, will serve to indicate the chief applications of blood analyses to the problems of diagnosis.

Space limitations preclude an adequate description of the analytical methods employed. They will be found in laboratory manuals. Some of them will be outlined in later chapters.

This table does not include many of the substances which occur in the blood in low concentration. Some of them are nitrogen-containing compounds and are thus represented by the undetermined nitrogen. Others are products of incomplete oxidation and are thus intermediary products of metabolism as are lactic acid, acetoacetic acid, and β -hydroxybutyric acid. Others are vitamins for which analytical data are not as complete as they are for ascorbic acid. Many hormones circulate in the blood. Iodine of the blood is largely representative of one of them, the thyroid hormone. Other hormones have been assayed in blood, but the presence of some can only be inferred from their effects upon specific functions. If the normal and abnormal variations in the concentration of all blood constituents (nutrients, waste products, substances representative of intermediary processes of metabolism, hormones, immune substances, inorganic constituents, etc.) could be known, the biochemist would have a picture highly informative regarding chemical processes in living cells in health and disease. In short, the blood composition tends to reflect tissue metabolism, which is not satisfactorily shown, in general, by analysis of dead tissues. It is not surprising, therefore, that much research has been directed to the development of blood analytical methods. Other types of methods for the study of metabolism will be considered in Chap. XIV.

Lymph. The chemical composition of lymph is qualitatively similar to that of plasma but differs quantitatively. The concentration of proteins is lower, while the concentration of certain waste products and other diffusible metabolites tends to be higher in lymph than in plasma. This is due in part to the origin of lymph. It is to a considerable extent an exudate from the blood. One should also bear in mind the fact that lymph is in actual contact with rapidly metabolizing tissue cells and thus is their immediate source of nutrients and the recipient of waste products diffusing out from the cells. Huxley's time-honored metaphor, "Lymph may be regarded as a sort of middleman between the blood on the one hand and the tissues on the other," epitomizes the lymph functions.

The composition of lymph in comparison with that of plasma is indicated by data in Table 40 taken from Heim's analysis of samples from the dog under physiological and healthy conditions.

One notes that proteins are the most abundant solids of lymph, as they

TABLE 39.—COMPOSITION OF HUMAN BLOOD
(Hawk and Bergeim, "Practical Physiological Chemistry," The Blakiston Company, Philadelphia, 1937.)

Constituent	Normal range, mg. per 100 cc. ¹	Pathological conditions in which increases (unless otherwise noted) may be encountered
Total solids, per cent.	19-23	Anhydremia. Low in hydremic plethora and anemia
Total proteins (serum), per cent.	6.5-8.2	See above. Low in nephritis with edema (nephrosis)
Albumin (serum), per cent.	4.6-6.7	Low in nephrosis
Globulin (serum), per cent.	1.2-2.3	Nephrosis, anaphylactic conditions, malignancy infections, muscular activity
Fibrinogen (plasma), per cent.	0.3-0.6	Pneumonia, infectious. Low in cirrhosis of liver, chloroform or phosphorus poisoning, typhoid fever
Hemoglobin, per cent (Haden)	15.6	Polycythemia. Low in primary and secondary anemia, chlorosis
Iron, as Fe.	52	See Hemoglobin
Copper	0.05-0.25	
Total nitrogen, per cent.	3.0-3.7	Varies chiefly with proteins (albumin, globulin, hemoglobin)
Nonprotein N.	25-35	Nephritis, eclampsia, etc. See Urea N
Urea N.	10-15	Chronic and acute nephritis, metallic poisoning, cardiac failure, intestinal or prostatic obstruction, some infectious diseases. Relatively low in nephrosis.
Uric acid.	2-3.5	Nephritis, gout, arthritis, eclampsia
Creatinine.	1-2	Nephritis
Creatine.	3-7	Terminal nephritis
Amino-acid N.	5-8	Leukemia, acute yellow atrophy of the liver, severe nephritis
Ammonia N.	0.1-0.2	Terminal interstitial nephritis
Undetermined N.	4-18	Eclampsia
Glucose.	70-100	Diabetes, pregnancy, severe nephritis
Total fatty acids.	290-420	Diabetes, nephritis
Cholesterol.	150-190	Diabetes, nephritis, nephrosis, biliary obstruction, pregnancy. Low in pernicious anemia
Lipide phosphorus (lecithin)	12-14	Diabetes, nephritis, pregnancy. In anemia, low in plasma, high in cells
Total acetone bodies (as acetone)	0.8-5.0	Diabetes
Acetone + acetoacetic acid (as acetone)	0.3-2.0	Diabetes
β-Hydroxybutyric acid (as acetone)	0.5-3.0	Diabetes
Bilirubin.	0.1-0.25	Biliary obstruction, hemolytic anemias. Low in secondary anemia
CO ₂ capacity (plasma), vol. per cent.	55-75 ²	Respiratory diseases, tetany. Low in diabetes, nephritis
CO ₂ content (arterial blood), vol. per cent	45-55 ²	Respiratory diseases, tetany. Low in diabetes, nephritis
CO ₂ content (venous blood), vol. per cent	50-60 ²	Respiratory diseases, tetany. Low in diabetes, nephritis
O ₂ capacity, vol. per cent.	16-24 ²	Polycythemia, anhydremia. Low in cardiac and respiratory diseases, anemia
O ₂ content (arterial blood), vol. per cent.	15-23 ²	Polycythemia, anhydremia. Low in cardiac and respiratory diseases, anemia
O ₂ content (venous blood), vol. per cent	10-18 ²	Polycythemia, anhydremia. Low in cardiac and respiratory diseases, anemia
Ascorbic acid.	0.8-2.4	Low in scurvy
Lactic acid.	5-20	Exercise, eclampsia
Phenols (free)	1-2	Intestinal obstruction, pernicious anemia, nephritis
Chlorides as NaCl.	450-500	Nephritis, cardiac conditions, prostatic obstruction, eclampsia, anemia. Low in diabetes, fever and pneumonia
Sulfates, inorganic as S (serum)	0.9-1.1	Nephritis
Phosphorus, inorganic as P (plasma)	3-4	Nephritis. Low in rickets. Normal values 1-2 mg. higher in children
Calcium (serum)	9-11.5	Low in infantile tetany, severe nephritis, parathyroidectomy
Magnesium (serum)	1-3	No changes noted in disease
Sodium (serum)	330	Low in cases of alkali deficit
Potassium (serum)	16-22	Pneumonia, acute infections, occasionally in uremia
Iodine, γ per 100 cc.	8-15	Hyperthyroidism. Low in cretinism

¹ Figures express concentration in milligrams per 100 cc. of whole blood unless otherwise indicated in first column.

² Figures represent weighted averages of the observations of several investigators.

are of plasma, but only about half as concentrated. The proteins, so far as they have been studied individually, are the same ones found in plasma. Those entering into the clotting process, though present, are

TABLE 40.—BLOOD PLASMA AND CERVICAL LYMPH OF THE NORMAL DOG COMPARED AS TO CONCENTRATIONS OF CERTAIN CONSTITUENTS

The values given are in milligrams per 100 ml. except for protein, which is given in per cent

Constituent	Plasma		Lymph		Ratio lymph conc. plasma conc.	No. of dogs used
	Av.	Range	Av.	Range		
Protein.....	6.18	5.54- 7.23	3.32	1.38- 4.57	0.54	16
Nonprotein N....	32.6	21.1 - 46.0	34.8	19.8 - 45.4	1.07	10
Urea.....	21.7	17.9 - 28.0	23.5	19.8 - 33.0	1.07	7
Creatinine.....	1.37	1.22- 1.54	1.40	1.28- 1.49	1.03	7
Sugar.....	123.0	112.0 -143.0	132.0	107.0 -144.0	1.08	16
Amino acids.....	4.9	4.84	0.99	1
Chlorides.....	678.0	649.0 -721.0	711.0	690.0 -730.0	1.05	7
Total P.....	22.0	18.3 - 26.1	11.8	10.2 - 13.7	0.54	6
Inorganic P.....	5.6	4.4 - 6.9	5.9	4.7 - 7.3	1.05	3
Calcium.....	11.7	10.85- 12.95	9.84	8.93- 10.84	0.84	11

not sufficiently concentrated to produce as firm a clot in lymph as in blood.

REFERENCES

An excellent treatment of the structure and general chemistry of the blood is given in W. H. Howell's "Textbook of Physiology," Sec. IV, pp. 407-476, 14th ed., Philadelphia, 1940.

An extensive work on histology, chemistry, physiology, and pathology of blood is "Handbook of Hematology," edited by H. Downey, 4 volumes, New York, 1938.

Two monographs dealing with special phases are: V. Menkin, "Dynamics of Inflammation," New York, 1940; and F. Schiff and W. C. Boyd, "Blood Grouping Technic," New York, 1942.

A large number of reviews are available. Some dealing with general aspects of blood, including coagulation, are listed.

AUSTIN, J. H., Blood: Physiology of Formed Elements and Plasma; Blood Clotting, *Ann. Rev. Physiol.*, 1, 297, 1939.

BRUNER, H. D., Blood, *Ann. Rev. Physiol.*, 5, 181, 1943.

CHARGAFF, E., The Coagulation of Blood, *Advances in Enzymol.*, 5, 31, 1945.

FERGUSON, J. H., Blood Coagulation, Thrombosis and Hemorrhagic Disorders, *Ann. Rev. Physiol.*, 8, 231, 1946.

HOWELL, W. H., Theories of Blood Coagulation, *Physiol. Rev.*, 15, 435, 1935.

QUICK, A. J., Blood, *Ann. Rev. Physiol.*, 6, 295, 1944.

QUICK, A. J., The Anticoagulants Effective *In Vivo* with Special Reference to Heparin and Dicumarol, *Physiol. Rev.*, 24, 297, 1944.

SEEGERS, W. H., and WARE, A. G., Recent Advances in our Knowledge of Prothrombin, *Am. J. Clin. Path.*, 19, 41, 1949.

SMITH, H. P., and FLYNN, J. E., The Coagulation of Blood, *Ann. Rev. Physiol.*, 10, 417, 1948.

Reviews dealing with hemopoiesis and related subjects are as follows:

GRANICK, S., Ferritin: Its Properties and Significance for Iron Metabolism, *Chem. Revs.*, 38, 379, 1947.

HANN, P. F., The Use of Radioactive Isotopes in the Study of Iron and Hemoglobin Metabolism and the Physiology of the Erythrocyte, *Advances Biol. Med. Phys.*, 1, 288, 1948.

- HAYDEN, R. L., Classification and Differential Diagnosis of the Anemias, *J. Am. Med. Assoc.*, **104**, 706-1935.
- LEDERER, E., Biochemistry of the Natural Pigments, *Ann. Rev. Biochem.*, **17**, 495, 1948.
- MINOT, G. R., and STRAUSS, M. B., Physiology of Anti-pernicious Anemia Material, *Vitamins and Hormones*, **1**, 269, 1943.
- RICH, A. R., The Formation of Bile Pigment, *Physiol. Rev.*, **5**, 182, 1925.
- ROBSCHT-ROBBINS, F. S., The Regeneration of Hemoglobin and Erythrocytes, *Physiol. Rev.*, **9**, 666, 1929.
- Reviews of certain aspects of immune chemistry include the following:
- HEIDELBERGER, M., Chemical Aspects of the Precipitin and Agglutinin Reactions, *Chem. Rev.*, **24**, 323, 1939.
- LONGCOPE, W. T., Anti-anaphylaxis and Desensitization, *Physiol. Rev.*, **3**, 240, 1923.
- MCCUTCHEON, M., Chemotaxis in Leukocytes, *Physiol. Rev.*, **26**, 319, 1946.
- MARRACK, J. R., Immunochemistry, *Ann. Rev. Biochem.*, **11**, 629, 1942.
- MUDD, S., MCCUTCHEON, M., and LUCKE, B., Phagocytosis, *Physiol. Rev.*, **14**, 210, 1934.
- PAULING, L., CAMPBELL, D. H., and PRESSMAN, D., The Nature of the Forces between Antigen and Antibody and of the Precipitation Reaction, *Physiol. Rev.*, **23**, 203, 1943.
- CHASE, M. W., and LANDSTEINER, K., Immunochemistry, *Ann. Rev. Biochem.*, **8**, 579, 1939.
- DRAGTEDIT, C. A., Anaphylaxis, *Physiol. Rev.*, **21**, 563, 1941.
- FELDBERG, W., Histamine and Anaphylaxis, *Ann. Rev. Physiol.*, **3**, 671, 1941.
- STRANDSKOV, H. H., Physiological Aspects of Human Genetics, Five Human Blood Characteristics, *Physiol. Rev.*, **24**, 445, 1944.
- Other reviews are listed.
- MYERS, V. C., and MUNTWYLER, E., Clinical Applications of Biochemistry, *Ann. Rev. Biochem.*, **9**, 303, 1940.
- STURGIS, C. C. and BYTHELL, F. H., Quantitative and Qualitative Variations in Normal Leukocytes, *Physiol. Rev.*, **23**, 279, 1943.
- Among many research papers available, a few are selected.
- ALT, H. L., The Relation of Growth and Nutrition to the Reticuloocyte Level in the Young Rat, *J. Nutrition*, **16**, 597, 1938.
- BAUMBERGER, J. P., Some Evidence in Support of a Sulfhydryl Mechanism of Blood Clotting, *Am. J. Physiol.*, **133**, 206, 1941.
- BROCK, J. F., The Relation between Hypochromic Anemias and Iron Deficiency, *Brit. Med. J.*, **1**, 314, 1937; *Nutr. Abs. & Rev.*, **7**, 208, 1937.
- CASTLE, W. B., and HAM, T. H., Observations on the Etiologic Relationship of Achylia Gastrica to Pernicious Anemia. V. Further Evidence for the Essential Participation of Extrinsic Factor in Hematopoietic Responses to Mixtures of Beef Muscle and Gastric Juice and to Hog Stomach Mucosa, *J. Am. Med. Assoc.*, **107**, 1456, 1936.
- CHARGAFF, E., BENDICH, A., and COHLN, S. S., The Thromboplastic Protein Structure, Properties, Disintegration, *J. Biol. Chem.*, **156**, 161, 1944.
- COHN, E. J., MINOT, G. R., *et al.*, The Nature of the Material in Liver Effective in Pernicious Anemia, *J. Biol. Chem.*, **77**, 325, 1928.
- DAFT, F. S., ROBSCHT-ROBBINS, F. S., and WHIPPLE, G. H., New-formed Hemoglobin and Protein Catabolism in the Anemic Dog, *J. Biol. Chem.*, **108**, 487, 1935.
- DAKIN, H. D., and WEST, R., Observations on the Chemical Nature of a Hematopoietic Substance Occurring in Liver, *J. Biol. Chem.*, **109**, 489, 1935.
- DAM, H., and GLAVIND, J., Determination of Prothrombin, *J. Am. Med. Assoc.*, **115**, 149, 1940.
- ELVEHJEM, C. A., DUCKLES, D., and MENDENHALL, D. R., Iron Versus Iron and Copper in the Treatment of Anemia in Infants, *Am. J. Diseases Children*, **53**, 785, 1937.
- FERGUSON, J. H., A New Blood-clotting Theory, *Science*, **97**, 319, 1943.
- FROST, D. V., POTTER, V. R., ELVEHJEM, C. A., and HART, E. B., Iron and Copper Versus Liver in the Treatment of Hemorrhagic Anemia in Dogs on Milk Diets, *J. Nutrition*, **19**, 207, 1940.
- HERBERT, D., A Simple Colorimetric Method for the Estimation of Haemolysis and Its Application to the Study of Streptolysin, *Biochem. J.*, **35**, 1116, 1941.
- HORECKER, B. L., and BRACKETT, F. S., A Rapid Spectrophotometric Method for the Determination of Methemoglobin and Carboxylhemoglobin in Blood, *J. Biol. Chem.*, **152**, 669, 1944.
- KUIZENGA, M. H., and SPAULDING, L. B., The Preparation of the Highly Active Barium Salt of Heparin and Its Fractionation into Two Chemically and Biologically Different Constituents, *J. Biol. Chem.*, **148**, 641, 1943.
- MACINTOSH, F. C., A Method for Estimating the Potency of Heparin Preparations, *Biochem. J.*, **35**, 770, 1941.
- MILSTONE, J. H., Prothrombokinase and the Three Stages of Blood Coagulation, *Science*, **106**, 546, 1947.

- RAMSAY, W. N. M., and STEWART, C. P., The Analysis of Blood Phospholipins, *Biochem. J.*, **35**, 39, 1941.
- REINHARDT, W. O., FISHLER, M. C., and CHAIKOFF, I. L., The Circulation of Plasma Phospholipids: Their Transport to Thoracic Duct Lymph, *J. Biol. Chem.*, **152**, 79, 1944.
- ROSE, M. S., VAHLTEICH, E. McC., and MACLEOD, G., Factors in Food Influencing Hemoglobin Regeneration. III. Eggs in Comparison with Whole Wheat, Prepared Bran, Oatmeal, Beef Liver, and Beef Muscle, *J. Biol. Chem.*, **104**, 217, 1934.
- ROSS, W. F., The Heme-globin Linkage of Hemoglobin. I, II, *J. Biol. Chem.*, **127**, 169, 179, 1939.
- SCHULTZE, M. O., and ELVEHJEM, C. A., The Relation of Iron and Copper to the Reticulocyte Response in Anemic Rats, *J. Biol. Chem.*, **102**, 357, 1933.
- SEEGERS, W. H., Prothrombin and Fibrinolysin, *Science*, **103**, 461, 1946.
- WARE, A. G., GUEST, M. M., and SEEGERS, W. H., Plasma Accelerator Factor and Purified Prothrombin Activation, *Science*, **106**, 41, 1947.
- WARE, A. G., and SEEGERS, W. H., Two-stage Procedure for the Quantitative Determination of Prothrombin, *Am. J. Clin. Path.*, **19**, 471, 1949.
- WEECH, A. A., and GOETTSCHE, E., Dietary Protein and the Regeneration of Serum Albumin. III. The Potency Values of Egg White, Beef Liver, and Gelatin, *Johns Hopkins Hosp. Bull.* **64**, 425, 1939.
- WIENER, A. S., Distribution and Heredity of Variants of the Rh Type, *Science*, **98**, 182, 1943.

CHAPTER XI

CHEMISTRY OF RESPIRATION AND ACID-BASE REGULATION

Respiration, considered as the gaseous exchange between an organism and its environment, may be conveniently studied in connection with higher animals under the subdivisions (1) *external respiration*, the gaseous exchange between the blood and the air, and (2) *internal respiration*, the gaseous exchange between the blood and the tissues. External respiration includes the physiology of breathing, which is mostly outside of the province of biochemistry. Internal respiration in its broadest sense includes bio-oxidation (Chap. XII) inasmuch as it utilizes O_2 and yields CO_2 , the chief gases involved in the respiratory exchange. But the problems more directly concerned in the chemistry of respiration are those investigated by study of the blood and include the following:

1. The oxygenation of blood in the lungs and the outgo of O_2 from blood to tissues, *i.e.*, the study of the nature of O_2 transport.

2. The similar problems of CO_2 transport.

3. The regulation of the blood hydrogen-ion activity so that it is not disturbed by the intake of considerable amounts of CO_2 and other potentially acid products of bio-oxidation as blood becomes venous in the systemic circulation.

4. The chemical and physicochemical changes in blood as affected by the respiratory exchanges.

Gases of the Air and the Blood. Analyses of inspired and expired air show that during ordinary rates of breathing the human body reduces the oxygen of the air by a little less than 5 per cent and raises the CO_2 by about 4.3 per cent. These figures vary with species and in the same individual under different circumstances. The average values as shown in Table 41 are representative. Nitrogen of the air behaves as an inert gas toward the animal body. The same is true of the rare gases, such as argon, helium, neon, and krypton, which are not determined in physiological analyses but are merely measured with the nitrogen. Carbon dioxide is added to the air in the lungs in an amount less than the oxygen withdrawn. This is due to the fact that some of the oxygen utilized for physiological oxidations constantly goes to form water, a part of which is excreted by the breathing.

In the lungs blood changes from the venous to the arterial condition. The over-all change is summarized by the results of analyses of the gases removable by the use of a vacuum from samples of arterial and venous blood.

In the method of Van Slyke and Stadie, lactic acid is added to the blood sample to ensure liberation of CO_2 and potassium ferricyanide to aid in liberating O_2 . The results are usually expressed as volumes per

TABLE 41.—GASES OF INSPIRED AND EXPIRED AIR
Values are in per cent by volume

	N_2	O_2	CO_2
Inspired air	79	20.96	0.04
Expired air	79	16.02	4.38
Difference	0.0	-4.91	+4.31

cent (ml. of gas from 100 ml. of blood) as shown in Table 42. The values given are averages of analyses by Harrop on blood of normal men. They should be regarded as merely representative. They differ from those reported by other observers. Results depend upon the condition of the subject and the location of the blood vessel from which the sample is taken.

TABLE 42.—GASES OF BLOOD AND ALVEOLAR AIR

	O_2	O_2	CO_2	CO_2	N_2
	vol. %	tension mm. Hg	vol. %	tension mm. Hg	
Arterial blood	20	100	38	35	1.7
Venous blood	12	37.6	45	42.6	1.7
Alveolar air		100		35	

For comparison, representative values of O_2 and CO_2 tension in arterial and venous blood and in the air of the lung air sacs (alveoli) are included in Table 42. The tension of any one of the gases composing a mixture, it will be recalled, is its partial pressure, *i.e.*, that part of the total pressure exerted by the mixture which is due to the given gas. Thus in the atmosphere at sea level (760 mm. Hg) O_2 , composing 20 per cent of the air, has a tension of 152 mm. Hg. In alveolar air O_2 is at a lower tension.

Similarly, a gas in a liquid exerts a partial pressure or tension. It is measured by finding what concentration of that gas, in an atmosphere to which the liquid is exposed, causes no change in the concentration of the

same gas in the liquid. Inasmuch as any gas diffuses from a region where its partial pressure (tension) is higher to one of lower tension, the movement of O_2 from alveolar air to venous blood and of CO_2 in the reverse direction is assured, as inspection of the values in Table 42 indicates.

It will be noticed that the nitrogen, although it is the most abundant of the gases of the air, is present in low and equal concentration in both arterial and venous blood. The figure given, 1.7 volumes per cent, includes minute concentrations of the rare atmospheric gases. Nitrogen appears to be merely dissolved in blood in concentration determined by its partial pressure in the air and, together with the rare gases, is physiologically inert.

Oxygen Transport. The reaction between hemoglobin and oxygen (p. 313) is chiefly responsible for oxygenation of blood. This is clearly indicated by comparing the O_2 -absorbing capacity of plasma with that of whole blood. Plasma, if quite free from hemoglobin, takes up O_2 by merely dissolving it. The concentration thus attained is estimated to be about 0.2 to 0.3 volume per cent for plasma in contact with alveolar air. Whole blood, on the other hand, can take up some 20 volumes per cent under the same conditions, so that the reaction forming oxyhemoglobin may be said to increase O_2 uptake by blood nearly a hundredfold.

While the O_2 capacity of mammalian blood is surprisingly high, that of other vertebrates is lower. The average capacity is estimated (Baldwin) as 18.5 volumes per cent in birds, 12 in amphibia, and 9 volumes per cent in fishes and reptiles. Animals, such as the gastropods, cephalopods, and crustaceans, which utilize the blue Cu-containing protein **hemocyanin** as the O_2 -transporting respiratory pigment, have relatively low O_2 capacities (2 to 8 volumes per cent).

Hemoglobin, under the conditions prevailing in blood, shows special adaptations to efficiency of O_2 transport. One aspect of this was shown (p. 314 and Fig. 56) in the effect of O_2 tension on the equilibrium of the reaction

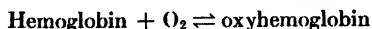

The presence of electrolytes and probably the arrangement of hemoglobin in corpuscles affords a further advantage to O_2 transport. Laked blood, dialyzed to deplete diffusible electrolytes, gives a different oxyhemoglobin dissociation curve (Fig. 57) from that obtained with whole blood.

The effect of CO_2 on the oxygen-dissociation curve (Fig. 58) is even more striking. When the CO_2 tension is as high as that prevailing in blood, corresponding to some 35 to 40 volumes per cent, the steepness

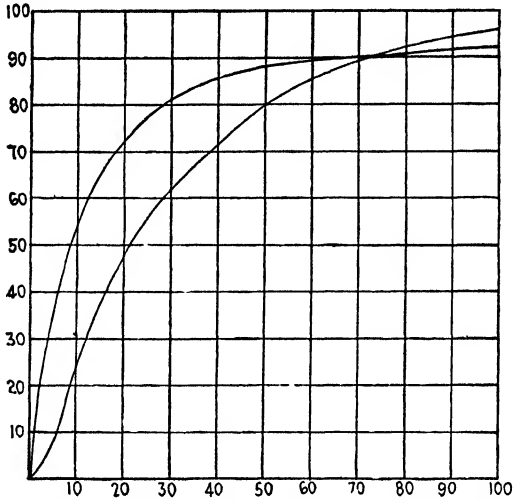

FIG 57 The effect of electrolytes on the dissociation curve of oxyhemoglobin. Abscissas are tensions of O_2 in the surrounding air (expressed in millimeters of mercury), ordinates are percentages of saturation of hemoglobin with oxygen. The upper curve is for hemoglobin in the absence of salts, that is, after its solution has been dialyzed; the lower one is for hemoglobin in the presence of blood salts. (After Barcroft and Roberts.)

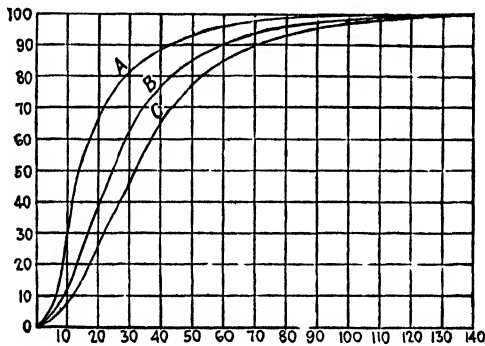

FIG 58 The effect of CO_2 on the dissociation curve of oxyhemoglobin. Abscissas are O_2 tensions, ordinates percentage saturation of hemoglobin with oxygen. A, curve obtained in the presence of CO_2 at 5 mm Hg tension; B, at 20 mm Hg tension; C, at 40 mm Hg tension. (After Bohr.)

of the oxygen-dissociation curve is such as to indicate efficiency of the liberation of O_2 when its tension falls to about 30 mm. Hg, a tension which might occur in the lymph surrounding systemic capillaries. The effect of increase in CO_2 tension on O_2 liberation is useful in adaptation of respiration to exercise when more O_2 is required and more CO_2 produced. The curves shown in Fig. 58 indicate this.

Blood does not become 100 per cent saturated with O_2 in the lungs but probably attains, normally, some 95 to 98 per cent of saturation. The O_2 uptake occurs at a high rate, probably in not more than 1 sec., the estimated time for the passage of a corpuscle through a lung capillary. Such efficiency is possible partly because of the rapidity of the reaction of hemoglobin with oxygen and partly because of the small size of corpuscles and their shape, affording relatively much surface in proportion to the volume and thus facilitating O_2 diffusion into corpuscles. Oxygen given off from the tissues, on the other hand, is not normally more than that which reduces the blood to some 55 per cent of saturation under resting conditions, so that a considerable "margin of safety" is available in O_2 supply for emergency conditions.

Transport of Carbon Dioxide. Carbon dioxide is carried in the blood in several forms. Some of it exists as dissolved CO_2 and theoretically there must be a very low concentration of H_2CO_3 . For the most part, however, carbonic acid forms bicarbonates in the blood and tends to dissociate to yield the HCO_3 ion. The blood is not sufficiently alkaline to form any appreciable amount of carbonates or CO_3 ions. Several types of measurement give results that agree in indicating that of the "bound" CO_2 , carbonic acid and bicarbonates do not account for the entire amount. The remainder has been called (Roughton) the x-bound CO_2 . A considerable part of it is in the form of the carbamino compound (p. 315) formed with proteins, especially with hemoglobin, which seems to be better adapted to this reaction than are other blood proteins. But the x-bound CO_2 appears to include another contingent which Roughton designates as the y-bound CO_2 . While its nature is not established, it might well be the bicarbonate salts of proteins, especially hemoglobin bicarbonate. Listed, the forms of CO_2 are

- A. Free CO_2
- B. Bound CO_2 , including
 1. H_2CO_3
 2. $-HCO_3$ ions
 3. Carbamino compounds
 4. The hypothetical y-bound CO_2

The relative amounts of the more important of these forms in blood are approximately indicated by the figures in Table 43 based on analytical data of Stadie and O'Brien. The values are only representative ones and would vary somewhat with changing conditions, such as amount of exercise. The hypothetical y-bound CO_2 and the minute concentration of H_2CO_3 are disregarded in these computations.

It is obvious that the major part of the CO_2 is in the form of plasma

bicarbonate, chiefly that of Na with some K. In the corpuscles K is the chief base (p. 342) and thus balances most of the bicarbonate which is in the cells. In the case here shown, the extra load of CO₂ which is carried by the venous blood is 3.9 volumes per cent (52.1 - 48.2), and of this, 2.4 volumes per cent (38.1 - 35.7) or 61.4 per cent of the load is carried by the plasma, leaving 38.6 per cent to be carried by the corpuscles.

The transport of CO₂ in the carbamino form appears to be far more important for physiological efficiency of the respiratory cycle than its

TABLE 43.—PARTITION OF CO₂ IN PLASMA AND CELLS OF BLOOD
Values are expressed in volumes per cent at 38°C.

	Arterial			Venous		
	Whole blood	Plasma	Corpuscles	Whole blood	Plasma	Corpuscles
Free CO ₂	2.4	1.6	0.8	2.7	1.8	0.9
CO ₂ as bicarbonate.....	42.9	33.1	9.8	45.7	35.2	10.5
Bound CO ₂ , other than bicarbonate.....	2.9	1.0	1.9	3.7	1.1	2.6
Total CO ₂	48.2	35.7	12.5	52.1	38.1	14.0

actual amount would seem to indicate. This conclusion is drawn from the relatively high rate of the reversible reaction

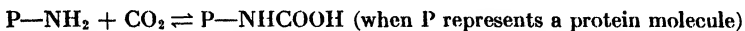

This is an important aid in attaining the necessary speed of CO₂ outgo from blood in the lungs and of its intake in the other tissues. Ferguson and Roughton calculated that "Of the *difference* in CO₂ content between average *arterial* whole blood and *venous* blood in man, 15 to 20 per cent at least is due to the difference in carbamino-bound CO₂."

It is well to bear in mind that by far the major part of the CO₂ in venous blood is not eliminated in the lungs while the blood is being arterialized. More than 90 per cent of it is normally retained, and the CO₂ tension of arterial blood is nearly as high as that of venous blood. This condition is a part of the natural adaptation of the mammalian respiratory system to respond in rate and depth of breathing movements to CO₂ content of the blood. The respiratory center in the medulla which exerts nervous control of respiration is highly responsive to changes in the CO₂ tension of its blood supply from the carotid artery. Indeed, a fall of CO₂ tension below a critical level (about 19 to 24 mm. Hg), a condition named **acapnia** (from the Greek, signifying "without smoke"), causes complete cessation of respiratory movements (apnea).

This is the basis of the recommendation to use air containing about 5 per cent of CO_2 when a pulmotor is employed to restore respiration to a partially asphyxiated person.

Carbonic Anhydrase. It is a well-established fact that attainment of equilibrium in the reactions



is very slow, too slow, in fact, to account for the evolution of CO_2 from the blood of lung capillaries into the alveolar air during the 1 sec. of time that is available for the process. Nevertheless, some 70 per cent of the CO_2 given off in the lungs comes from bicarbonates of the blood. The physicochemical anomaly thus presented could not be explained until the discovery of the enzyme *carbonic anhydrase* which catalyzes the liberation of CO_2 . Henriques (1928) was the chief pioneer in its discovery. He showed that the escape of CO_2 from blood plasma or serum was much slower than from whole blood or corpuscles. This suggested the presence of an enzyme in the corpuscles. Many other investigators have developed its study. It has been obtained in highly concentrated form having activity 2,000 times that of whole blood. It has the properties of a protein and is regarded as a zinc-containing one (p. 226). It is definitely inhibited by those reagents, such as cyanides, which are known to "poison" metal-containing protein enzymes. It is distinct from all other known enzymes of blood and also differs from hemoglobin although it tends to associate itself with hemoglobin when the latter crystallizes. While highly concentrated in erythrocytes, it has not been found in plasma in amounts more than could be accounted for by the slight amount of hemolysis which occurs during the preparation of plasma. This enzyme is not widespread. Aside from small amounts in muscle, pancreas, and spermatozoa, and the significant concentrations in parietal cells of the stomach (p. 258), it is reported to be either absent or present in mere traces in the numerous other animal tissues and fluids that have been investigated.

Its importance in respiration is indicated by Roughton's estimate that without it only about one-hundredth of the CO_2 evolved from bicarbonates in the lung would have opportunity to escape. Its functioning in the uptake of CO_2 will be considered (p. 342) in connection with blood buffering.

Of the CO_2 liberated in the lungs, it is estimated (Roughton) that in the case of a resting man, the blood sources are approximately

Bicarbonates, 70 per cent

Preformed, dissolved CO_2 , 10 per cent

CO_2 , bound, mostly as carbamino compounds, 20 per cent .

The "Steady State": Homeostasis. Animals are provided with complex regulatory mechanisms reacting so as to correct any condition tending toward a change in a physical state or in the concentration of a substance. This results in a "steady state" with small variations confined to a narrow range. One recognizes that physiological processes are in a state of dynamic equilibrium, continually in flux, but always tending toward a state of equilibrium. This condition was termed homeostasis by Cannon. Claude Bernard was one of the first physiologists to recognize this fundamental generalization. The more highly developed an animal is in the scale of evolution, the larger the number and the sensitiveness of these dynamic equilibria which may be recognized. Examples of physical states are regulated body temperature (Chap. XIII) and osmotic pressure (Chap. X). Examples of chemical regulation are found in the concentration of serum proteins, of the substances concerned with blood coagulation, of the number and composition of corpuscles, and of the distribution of electrolytes between blood and the tissues. An especially elaborate and complex chemical regulation is the one controlling the concentration of sugar in the blood (Chap. XIV). A peculiarly interesting and significant regulatory mechanism controls the hydrogen-ion activity of the blood and the tissues. It will be discussed in the following paragraphs.

Buffers of the Blood. Although H_2CO_3 is a weak acid, the large amount of it entering the blood in the systemic capillaries plus the considerable amounts of other potentially acid products of cellular metabolism would disturb the regulated acid-base balance of the blood were it not for the buffering mechanisms which normally maintain the blood in its slightly alkaline condition. Actually the pH of venous blood differs from that of the arterial by only about 0.01 to 0.03 of a pH unit. Representative values might be as follows: Arterial blood, pH 7.35; venous blood, pH 7.33.

The buffers of the blood include the plasma proteins, hemoglobin, oxyhemoglobin, the bicarbonates, and the inorganic phosphates. It will be recalled that many reversibly reacting systems which involve H or OH ions can operate within a restricted range of pH values of the medium so as largely to suppress changes in hydrogen-ion activity which would otherwise result upon addition of acids or bases. Any system acting thus is a buffer. Among the important buffering systems are those involving the salts of "weak" acids with "strong" bases. Phosphates and bicarbonates are of this type.

In the case of phosphates, the chief reaction involved is



The blood acid phosphate is chiefly NaH_2PO_4 which can dissociate thus

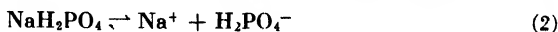

The blood basic phosphate is chiefly Na_2HPO_4 which can dissociate thus



The blood therefore contains the ions H_2PO_4^- and HPO_4^- . Any tendency to increase in H-ion activity disturbs the equilibrium between them in reaction (1) but increases the concentration of H_2PO_4^- ions without much change in concentration of H ions. Similarly, any tendency to increase in OH ions results mostly in their neutralization by the H ions furnished by further dissociation of H_2PO_4 in reaction (1). This system operates in the pH range 5.8 to 8 (approximate) with maximum efficiency at about 6.8 and is thus effective under the conditions prevailing in blood. The low concentration of phosphates makes them quantitatively less important than some of the other buffers.

The bicarbonate system is similar. The chief reaction involved within the pH range of blood is



The main source of bicarbonate ions is the reaction

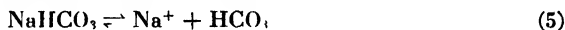

Any tendency to increase in H-ion activity tends to cause a shift from right toward left in reaction (4).

Blood proteins, in general, function as blood buffers by virtue of the form in which they tend to exist in plasma and corpuscles, namely, the salts of weakly dissociating protein-carboxyl groups with blood bases, *e.g.*, Na salts of plasma proteins and K salts of hemoglobin. Such a buffering system functions in a reaction which may be shown thus:

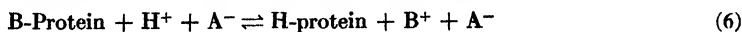

where "B-protein" represents the protein salt and A^- the anion of an acid. The buffering effect is due to the low dissociative power of the protein acidic groups.

The relative efficiency of any buffering system is determined in part by the ratio of the concentrations of the components of the system. The ratios of importance in regulation of the blood pH are

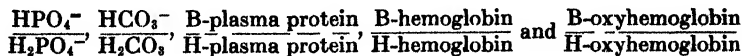

Hemoglobin in reduced form and oxygenated hemoglobin require separate treatment (p. 343).

The significance of these ratios is explained in accordance with the nature of electrolytic dissociation of acids and bases.

Dissociation of an acid (HA), it should be recalled, reaches dynamic equilibrium, according to the law of mass action, when

$$k_1(\text{HA}) = k_2[(\text{H}^+) \times (\text{A}^-)] \quad (7)$$

where k_1 and k_2 are the velocity constants of dissociation and association, respectively, and the symbol “()” indicates activity which for approximate purposes may be regarded as equivalent to concentration.

Rearranging (7)

$$\frac{(\text{H}^+) \times (\text{A}^-)}{(\text{HA})} = \frac{k_1}{k_2} = K_a \quad (8)$$

where K_a represents, by definition, the *dissociation constant* of the acid.

In a system containing a “weak” acid and its salt with a “strong” base, the latter dissociates so much more than does the acid that nearly all the anions concerned are furnished by the salt. In the case of the blood buffers this is significant in enhancing their ability to counteract acids by moving reaction (7) toward the left, thus decreasing (H^+) .

Writing (8) in logarithmic form, we have

$$\log k_a = \log (\text{H}^+) + \log (\text{A}^-) - \log (\text{HA}) \quad (9)$$

and, when rearranged with change of signs,

$$-\log k_a = -\log (\text{H}^+) + \log \frac{(\text{HA})}{(\text{A}^-)} \quad (10)$$

or

$$\text{p}K_a = \text{pH} + \log \frac{(\text{HA})}{(\text{A}^-)} \quad (11)$$

since, by definition, $\text{p}K_a = -\log K_a$ and $\text{pH} = -\log(\text{H}^+)$.

Writing (11) thus:

$$\text{pH} = \text{p}K_a - \log \frac{(\text{HA})}{(\text{A}^-)} \quad \text{or} \quad \text{pH} = \text{p}K_a + \log \frac{(\text{A}^-)}{(\text{HA})} \quad (12)$$

it becomes obvious that the effect of a buffer system (“weak” acid + its salt with a “strong” base) upon the pH of a solution containing it is dependent upon two factors: (1) The dissociation constant of the acid and (2) the ratio of the concentration of undissociated buffer to the concentration of its anions. The expression (12), known as the **Henderson-Hasselbach equation**, is useful in many ways.

When $(\text{HA}) = (\text{A}^-)$ the ratio is unity and, since $\log 1 = 0$, the last term of (12) disappears and $\text{pH} = \text{p}K_a$.

It can be shown mathematically that when $\text{pH} = \text{pK}_a$ the buffering system has maximum efficiency, but this deduction is clearly demonstrated by a simple titration (Fig. 59) which reveals the relatively small

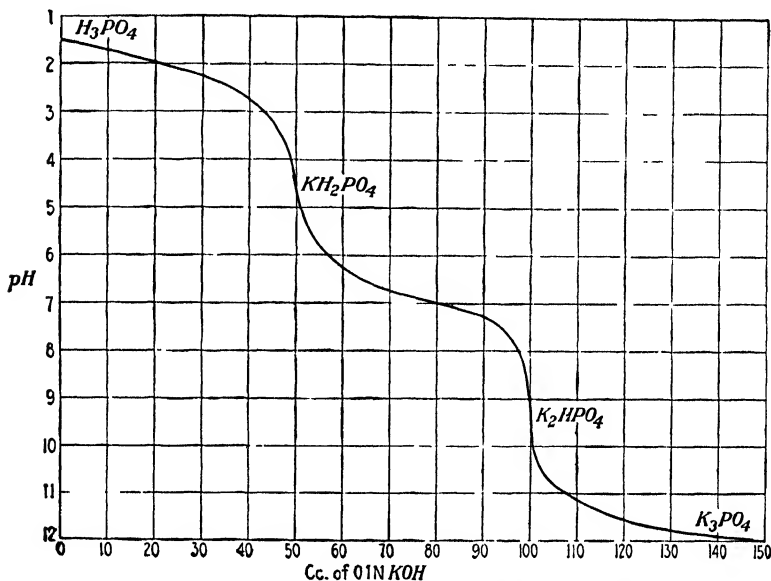

Fig. 59. Titration curve of phosphoric acid, showing its buffering effects. Abscissas are cubic centimeters of 0.1N KOH added to 50 cc. of 0.1 M phosphoric acid. Gradual changes in the resulting pH values are followed by sudden changes as each of the first two dissociating hydrogen ions is neutralized. In the range of pH values from about 5.8 to about 8.0, the combined action of monobasic and dibasic phosphates affords a buffering effect. (After W. M. Clark.)

changes in pH resulting from additions of acid or base when $\text{pH} = \text{pK}_a$ and the ratio (HA):(A⁻) is 1:1.

The pK_a values of the chief buffering systems of blood are shown below:

	pK_a
B-Hemoglobin:H-hemoglobin.....	7.3
B-Oxyhemoglobin:H-oxyhemoglobin.....	6.7
$\text{HPO}_4^-:\text{H}_2\text{PO}_4^-$	6.8
$\text{HCO}_3^-:\text{H}_2\text{CO}_3$	6.1

It is seen that the hemoglobin system (pK_a nearly equal to blood pH) operates at comparatively high efficiency. It is also seen, however, that as any tendency toward acidosis develops the phosphate and bicarbonate systems tend to be increasingly effective as buffers. This may be regarded as a natural adaptation significantly useful in protection against the fatal effects of acidosis.

Buffering Due to Erythrocytes: The Chloride Shift. It is easily demonstrated that the buffering power of whole blood greatly exceeds that of plasma or serum. One of the first clues obtained in efforts to explain this observation was the change of the concentration of chlorides in plasma and erythrocytes as an accompaniment to changes in CO₂ tension. If a blood specimen is divided in two parts and one is exposed to an atmosphere of low CO₂ content while the other is similarly exposed to one of high CO₂ content, it will be found that subsequently the centrifuged corpuscles of the blood exposed to much CO₂ contain a concentration of chlorides higher than that of the corpuscles of the other blood sample. Analyses show that the extra chloride is taken in from the plasma. The process is reversible, so that exposure of the blood to low CO₂ tension causes chloride to go out of the erythrocytes into the plasma. No corresponding transfer of bases occurs. Indeed, some corpuscles are almost (p. 306) cation impermeable. The reaction involved would seem to be between H₂CO₃ and NaCl and to cause the liberation of HCl which then migrated into corpuscles.

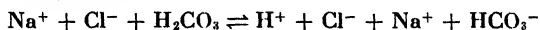

Actually, however, the familiar fact is that addition of CO₂ to a solution of NaCl does not produce any noticeable amount of HCl. The above reaction drives forcibly from right to left. Moreover, the reaction

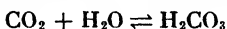

is a sluggish one and, uncatalyzed, attains equilibrium more slowly than would be required to enable it to be effective during the passage of a corpuscle through a capillary. The apparent discrepancy is explained as follows: CO₂ readily goes in or out of cells, including erythrocytes, so that the excess CO₂ coming from the tissues into the blood rapidly diffuses from plasma into corpuscles. Once inside, it encounters carbonic anhydrase (p. 337), abundant in erythrocytes, absent from plasma. Production of H₂CO₃ is catalytically hastened. It reacts with bases of the corpuscles to form bicarbonates, *e.g.*, KHCO₃, which readily dissociate to form the HCO₃⁻ ion. Now, as is well known to general physiologists, the corpuscle is more permeable to anions than to cations, and this may account, in part, for the exchange of Cl⁻ from plasma for HCO₃⁻ of corpuscles. But another phenomenon is also probably important. It is known in general physiology as "ion exchange." It would seem as though some ions may be held in a strategic manner at or in the surface membranes of cells and are thus enabled to exchange with certain ions of the surrounding medium with extraordinary facility. At any rate, HCO₃⁻ exchanges with Cl⁻.

Inside the corpuscles, HCl and H₂CO₃ are neutralized by bases, chiefly K, furnished largely by hemoglobin and oxyhemoglobin and to some

extent by the cell phosphates, chiefly, however, by hemoglobin. The buffering capacity of the proteins and phosphates is sufficient to prevent any significant change in the pH of erythrocytes.

In the lung capillaries (p. 337) all these reactions move in reverse order as compared with the changes in systemic capillaries.

Buffering Due to Hemoglobin and Oxyhemoglobin. The readily reversible reaction

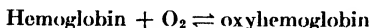

is significant in CO₂ transport. The explanation of this might be the relative strength of hemoglobin and oxyhemoglobin dissociation as acids. Hemoglobin is significantly weaker in this respect and should therefore be a better buffer than oxyhemoglobin.

The extent to which this effect is due merely to the lesser dissociative power of hemoglobin as such or to this plus the effect of the formation of the carbamino compound of hemoglobin is not yet determined. In any case the loss of O₂ affords an important aid to the blood-buffering systems in the transport of CO₂ without much change in the blood pH. This is known as an isohydric change.

Recalling the effect of CO₂ on the oxyhemoglobin dissociation curve (Fig. 58), one sees that the loss of O₂ from the blood to the tissues and the simultaneous intake of CO₂ are mutually assisting processes. An equally effective mutual reinforcement occurs in the lung capillaries. The uptake of O₂ aids in driving CO₂ out of the blood because the oxyhemoglobin thus formed is more strongly dissociated as an acid than is hemoglobin while the loss of CO₂ in the lungs facilitates a more nearly complete saturation of hemoglobin with O₂.

Relative Buffering by the Different Systems. The corpuscles assisted by the chloride shift and the loss of O₂, occurring simultaneously with the accession of CO₂, are able to assume the major role in preventing acidification of blood as it becomes venous.

TABLE 44 — APPROXIMATE CO₂-CARRYING POWER OF BUFFERS IN OXYGENATED BLOOD

Buffer	CO ₂ -carrying power of separate buffers between pH 7.35 and 7.25	Proportion of CO ₂ -carrying power
	vol. per cent	per cent of total
Bicarbonate.....	0.5	5
Plasma protein.....	1.0	11
Cell phosphate.....	2.0	22
Oxyhemoglobin-hemoglobin.....	5.8	62

An approximate estimate (Van Slyke) of the relative buffering power of the more important blood systems is presented by the data in Table 44, which is based on their carrying power for CO_2 within the normal physiological range of pH values.

Such data indicate that approximately 75 per cent of the CO_2 taken up by the circulating blood may be carried in the corpuscles. Aided by the loss of O_2 , a still larger proportion, probably more than 85 per cent of the total buffering effect in the respiratory cycle, is due to the corpuscles.

The Blood pH and the Alkali Reserve. Inasmuch as the acid-neutralizing power of the corpuscles is largely utilized in carrying the excess of CO_2 in venous blood over that in arterial, the larger part of the blood alkali and other acid-neutralizing material which is present in the plasma is available for maintenance of the faint alkalinity of blood, due chiefly to NaHCO_3 . This and the other buffers (plasma proteins, phosphates, amino acids, and a few other buffers of minor importance) are available for stabilizing the blood pH during excess production of CO_2 and for neutralizing nonvolatile acid products of metabolism (lactic, pyruvic, citric, and other acids).

This "reservoir" of acid-neutralizing substances is known as the plasma alkali reserve. It affords an indispensable protection against the threat of acidosis.

The buffering power of the alkali reserve is sufficiently effective to allow very little lowering of the blood pH even when, as in the extreme case of diabetes, so much nonvolatile acid has entered the blood from the tissues that the onset of acidosis is imminent. Measurement of the pH of plasma or whole blood is relatively simple because of the modern use of the glass electrode, but the results are not easily interpreted. For diagnostic purposes, therefore, it is more useful to measure the alkali reserve than to determine the blood pH.

Measurement of the alkali reserve is usually done by a method which, in principle, depends upon the determination of the CO_2 -combining power of the blood plasma. For details a laboratory manual must be consulted. The method in outline is as follows:

1. Take the blood sample from the patient's vein under conditions which prevent coagulation (keeping the sample under paraffin oil and adding oxalate).

2. Separate the plasma by centrifuging.

3. Expose the plasma to an atmosphere containing a sufficient concentration of CO_2 to permit saturation of the sample. Air forced out of the human lungs at the end of an expiration (alveolar air) is frequently used.

4. Introduce a small, accurately measured portion of CO₂-treated plasma into the vacuum chamber of the Van Slyke apparatus.

5. Add H₂SO₄ sufficient to liberate all bound CO₂.

6. In an attenuated vacuum, with shaking, remove CO₂ from the liquid to the gaseous phase.

7. Measure the gas in the graduated portion of the vacuum chamber under atmospheric pressure. The gas thus found, corrected for the small amount remaining in the liquid and reduced to standard conditions of temperature and pressure (0°C. and 760 mm. Hg), is the CO₂ capacity of the plasma used. Results are usually expressed in volumes per cent. This measurement is equivalent to a determination of the alkali reserve.

Methods employing other principles are available. One of them is the estimation of the alkali tolerance of the patient. Successive, measured portions of NaHCO₃ are taken by mouth until the urine becomes alkaline. The amount of NaHCO₃ required tends to be inversely proportional to the alkali reserve and thus permits an approximate estimate of the latter. Another method depends upon gas analysis of the alveolar air from the patient's lungs in order to determine its CO₂ tension. This value decreases in a roughly proportional way with the fall of the alkali reserve because the latter is chiefly NaHCO₃, so that its decrease causes a lowering of the concentration of CO₂ in the lung spaces. Still another method employs the determination of ammonia in the urine. As the alkali reserve becomes depleted there is less base available in the form of alkali metal (chiefly Na, partly K) to neutralize nonvolatile acid products of metabolism, and NH₄ ions are increasingly used for this purpose at the expense of urea formation. Ammonium salts are therefore excreted by the kidney at a rate the excess of which above normal is a rough index of the depletion of the alkali reserve.

The manner in which results of these different measurements vary under normal conditions and in mild, moderate, and severe acidosis is shown in Table 45, compiled by Van Slyke.

Acidosis and Alkalosis. The word acidosis in its broadest sense should be regarded as signifying any pathological condition due to an excessive proportion of acid in the fluids or tissues or both. In a more restricted sense, it might be regarded as a tendency for the blood to become acid. Actually, however, the blood in the living mammal never becomes acid. If the blood pH (normal range 7.5 to 7.3) reaches 7 (the neutral point) the accompanying disturbances are fatal unless very promptly relieved. Acidosis may result from overproduction of acid, as is usually the case, or from an alkali deficit. But the acid may be compensated by alkali excess, and an alkali deficit may be compensated by

TABLE 45.—SIGNIFICANCE OF MEASUREMENTS OF THE ALKALI RESERVE BY DIRECT AND INDIRECT METHODS
(D. D. Van Slyke, *J. Biol. Chem.*, 32, 271, 1918)

Condition of subject	Corresponding results of indirect tests for acidosis					
	Actual bicarbonate reserve. Plasma bicarbonate CO ₂ reduced to 0°, 760 mm. vol. per cent	24-hr. excretion of 0.1 N acid + NH ₃	Carbon dioxide of alveolar air		Sodium bicarbonate required to turn urine alkaline	
Normal resting adult Extreme limits of bicarbonate reserve Mild acidosis, no pronounced symptoms Moderate to severe acidosis. Symptoms may be apparent Severe acidosis Symptoms of acid intoxication	80-53	(a) Cc. per kg. (b) Approximate cc. per 60 kg. person	(a) Mm. tension (b) Approximate per cent	Reliability in diabetes	(a) G. per kg. ¹ (b) Approximate g. for a 60 kg. person	Reliability in diabetes
	53-40	(a) 0-27 (b) 0-1600	(a) 53-35 mm. (b) 6.8-4.7 per cent	Good	(a) 0-0.5 (b) 0-30	May indicate acidosis in its absence May indicate much more acidosis than is present
	40-30	(a) 27-65 (b) 1600-4000	(a) 35-27 mm. (b) 4.7-3.6 per cent	Good	(a) 0.5-0.8 (b) 30-50	
Below 30	(a) 65-100 (b) 4000-6000 (a) Over 100 (b) Over 6000	(a) 27-20 mm. (b) 3.6-2.7 per cent	Liabile to considerable error in either direction	(a) 0.8-1.1 (b) 50-65 (a) Over 1.1 (b) Over 65		

¹ The values in this column may also be used as an index of the amount of NaHCO₃ required to restore the alkali reserve to a normal value when acidosis is of the severity indicated in the first column.

decreased CO_2 . It is therefore necessary to take both of these factors into account in defining acidosis as "a condition due to the accumulation of actually or potentially acid substances when the rate of their production or absorption exceeds the rate of their elimination, which condition becomes abnormal (acidosis) when it has either lowered the blood pH or decreased its alkali reserve below the extreme normal limits."

Alkalosis, correspondingly, signifies any tendency to an abnormally high proportion of alkali in the fluids and tissues and may result from its abnormal accumulation or from excessive loss of acid.

It is difficult to select any specific ranges of blood pH values which satisfactorily delimit either acidosis or alkalosis; but one may say that, in general, a blood pH less than 7.25 is an index of serious acidosis, while pH values higher than 7.50 mark alkalosis. One should note, however, that milder forms of either acidosis or alkalosis may be regarded as present, potentially at least, although the blood pH is within the normal range. As the blood pH approaches 7.0, the most striking danger signal of acidosis, **coma**, sets in. When the blood pH is approximately 7.8, the corresponding danger signal of alkalosis, **tetany**, is apt to appear.

Inasmuch as carbonic acid and its accompanying bicarbonate are the most responsively variable acid and base of the blood, it is possible to define and roughly to delimit the various forms of acidosis and alkalosis in terms of the concentration of these two variables. It may also be shown that the relation between the concentration of bicarbonates in the plasma and the pH of the plasma, as influenced by the CO_2 content, is such that measurement of the pH alone does not reveal the true state of the blood. A high pH (7.5 to 7.8) may be due to either an excess of alkali (as after excessive vomiting and consequent loss of HCl) or to a deficit of CO_2 (as after rapid breathing while at rest). Similarly, a low pH (7.3 to 7.1) may be due to excess of CO_2 (as in pneumonia when respiration is interfered with) or to a bicarbonate deficit (as in true acidosis when the alkali reserve has been drawn upon to neutralize nonvolatile acids). Moreover, and this is especially significant in diagnosis, the pH may be within the normal range (7.5 to 7.3) when the alkali reserve is dangerously depleted but compensation has occurred by loss of CO_2 or by neutralization of nonvolatile acids with ammonia and rapid elimination by the kidneys. The relationships between bicarbonate concentration and pH of the plasma are shown in Fig. 60. The areas delimited by the plotted curves correspond (Van Slyke) to the physiological and the pathological or abnormal conditions indicated upon the areas. These conditions are characterized in Table 46.

Electrolyte and Gas Equilibria. In the complex and easily disturbed state of dynamic equilibrium which exists in body fluids and espe-

cially in the blood, variable concentrations of many substances are involved. A change in the activity of any one of them not only disturbs the equilibrium of the chemical reactions and physical states immediately concerned but may also affect the equilibrium of a considerable number of others indirectly concerned. For example, the chloride shift and the

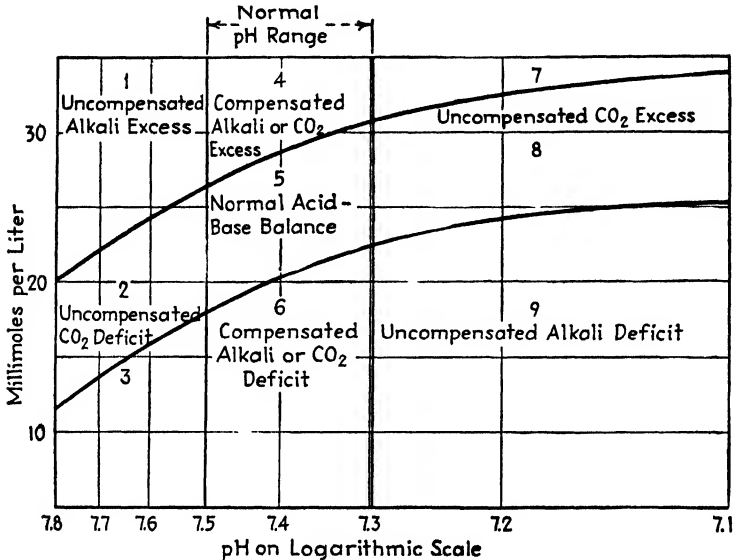

FIG. 60. The relation between the bicarbonate concentration and the pH of oxalated plasma or serum. The ordinates (millimols of bicarbonate) could be changed to CO₂-combining power. (One millinol BHC₃ = 2.24 volumes per cent of bicarbonate CO₂.) The two curves as drawn are for oxygenated plasma and would be parallel but slightly higher for venous plasma. The normal pH values would also be moved about 0.02 to the right for venous plasma. If whole blood were used rather than plasma, all ordinates would be lowered by about 4 millimols per liter, since bicarbonate concentration is lower in whole blood than in plasma.

The two curves as drawn are chosen so as to delimit the range of normal values in area 5. The significance of points having coordinates that place them outside of this area is explained in more detail in Table 46 than is here indicated.

accompanying movements of other electrolytes change the relative osmotic pressures of plasma and corpuscles and thus cause movement of H₂O from plasma to corpuscles during the course of the blood through the general circulation but in the reverse direction as the blood becomes arterialized in the lungs. In a similar way any change in electrolyte concentrations exerts effects upon water distribution among the components of the blood and also between the blood and the tissues. The complex relations between O₂ tension and CO₂ tension are not only inter-

TABLE 46.—SIGNIFICANCE OF THE BLOOD ACID-BASE RELATIONS SHOWN IN FIG. 60

Disturbed state of the acid-base relations indicated by areas of Fig. 60	Abnormal or pathological conditions causing the disturbed state	Physiological mechanism tending to restore the disturbed state to normal
1. Uncompensated alkali excess with high pH because alkali increases without a proportional rise in CO ₂	High dosage with alkali (<i>e.g.</i> , NaHCO ₃); excessive vomiting or loss of HCl by stomach pump; X-ray or radium overdosage	Lowered lung ventilation increasing blood CO ₂ ; increased secretion of alkaline urine
2-3. Uncompensated CO₂ deficit with high pH because of excessive loss of CO ₂	Hyperpnea (excessive breathing, voluntary or induced by O ₂ scarcity as at high altitude); fever; hot baths	Kidney compensation by excretion of alkaline or less acid urine; less NH ₃ used to neutralize acid
4. Compensated alkali or CO₂ excess with pH in the normal range because increases are proportional	Alkali excess from high intake of NaHCO ₃ when it is slowly absorbed CO ₂ excess from defective excretion as in emphysema of the lungs	Retention of CO ₂ Retention of bicarbonate
6. Compensated alkali or CO₂ deficit with pH in the normal range because decreases are proportional	Alkali deficit from acid overproduction, as in ketosis, or faulty elimination, as in nephritis CO ₂ deficit from over ventilation of lungs	Increased elimination of CO ₂ by greater lung ventilation Kidney compensation as for 2 and 3
7-8. Uncompensated CO₂ excess with pH low because alkali does not increase	Under ventilation of lungs as in pneumonia (obstruction to breathing) or in morphine narcosis (depressed activity of respiratory center); re-breathing of air; cardiac decompensation	Increased lung ventilation, use of NH ₃ to neutralize acids, elimination of more acid urine and possibly a shift of acid from blood to tissues
9. Uncompensated alkali deficit with low pH because alkali reserve is depleted	Acute stage of acidosis due to nephritis or to diabetes; deep ether anesthesia; some types of heart disease; eclampsia (violent convulsion)	Increased lung ventilation, increased elimination of acid in urine, and increased use of NH ₃ to neutralize acids

dependent (p. 343) but of such a character as to be markedly influenced by electrolyte concentrations, especially by Cl^- , HCO_3^- , and H^+ , although others are also involved.

The changes in the blood occurring during a respiratory cycle may be considered without reference to those changes due to intestinal absorption, tissue metabolism, kidney function, etc.; but even so delimited, the number of interdependent variables to be accounted for in a complete mathematical treatment of the physical chemistry of respiration is large. This statement becomes more striking upon noting the following list of the more important ones selected by L. J. Henderson for treatment in his book, "Blood, A Study in General Physiology."

1. The O_2 tension of the blood
2. The concentration of O_2 as oxyhemoglobin
3. The total CO_2 of the blood
4. The free CO_2 of the blood
5. The pH of the plasma
6. The pH of the corpuscles
7. Concentration of base bound by plasma proteins
8. Concentration of base bound by cell proteins
9. Bicarbonate concentration in the plasma
10. Bicarbonate concentration in the cells
11. Plasma Cl concentration
12. Concentration of Cl in the cells
13. The percentage of the total blood Cl or HCO_3^- ions in the cells
14. The volume of the cells
15. The percentage of H_2O in the cells

The Chemistry of Nervous Regulation of Respiration. The automatic discharge of nerve impulses from the respiratory center for control of breathing movements and the operation of reflexes upon the respiratory center are matters of physiology rather than biochemistry. But the interrelations between the activity of the respiratory center and the chemical composition of the blood are of such significance in the regulation of the acid-base balance that it requires a discussion at this point.

Three of the variables of blood have been studied in relation to respiration, *i.e.*, the O_2 tension, the CO_2 tension, and the pH. While the activity of the respiratory center is governed by variations in all three, responses are far more sensitive to CO_2 tension and pH changes than to the O_2 tension. Experiments upon human subjects have shown that moderate reduction in the O_2 supply by breathing air containing 10 to 11 per cent of O_2 , in place of ordinary air which contains nearly twice as much O_2 , has only a barely perceptible effect in increasing the total ventilation of the lungs (liters of air breathed per minute) which, being dependent upon

both the rate and the depth of breathing, reflects the activity of the respiratory center. Only when the O₂ content of the respired air is reduced to a point (7 to 8 per cent) where noticeable effects of O₂ deprivation such as blueness of the skin (cyanosis) appear is the effect upon respiration very marked. Even then the increased lung ventilations observed, in the case of a resting person who is not producing any excess of CO₂, may be no more than 23 to 45 per cent above normal. Unconsciousness, a "black-out" as it is popularly called, from the effect of lowered O₂ tension (anoxemia) in the brain arteries, often occurs with little or no warning in the form of panting (dyspnea). This constitutes a

TABLE 47.—THE EFFECT UPON RESPIRATION OF THE CO₂ CONTENT OF THE AIR

Gas breathed		Volume breathed
O ₂ content	CO ₂ content	
per cent	per cent	liters per minute
20(air)	0.01(air)	7.43
20.2	0.95	9.06
18.06	2.97	11.33
18.43	11.5	32.46

serious menace to the aviator at high altitudes. It is because of this threat that the aviator dons the O₂ mask *before* attaining altitudes of dangerously low O₂ pressure.

Effects of increased CO₂ tension are indicated by observations (Zuntz) on the human subject as shown in Table 47.

Thus an increase of CO₂ in the respired air to a level (11.5 per cent) which, though high, is not seriously toxic, may increase respiration more than fourfold. This effect tends to keep the CO₂ tension of the blood and the alveolar air within a relatively narrow range of variation. Thus Haldane found that, when the CO₂ concentration of the alveolar air increases by as little as 0.2 volumes per cent as a result of exercise, lung ventilation may be doubled.

Inasmuch as changes in CO₂ tension can alter pH of the blood, it is natural to suppose that the latter variable might be the chief governor of the respiratory center. There are, indeed, experiments on record in which the pH of the arterial blood was lowered by addition of lactic acid with little or no change in the CO₂ tension. Such experiments indicate that, when the blood alkalinity is decreased by about 0.01 of a pH unit, respiration is noticeably increased, and a change of 0.012 has been found to double the lung ventilation. There seems to be more difficulty in

demonstrating a parallelism between blood pH and the respiratory rate. The comparatively rapid penetration of CO_2 into cells may account for its peculiar effectiveness as compared with other acids, such as lactic, although other possible explanations cannot be excluded.

The CO_2 effect may be an indirect one rather than being due to the action of the blood which supplies the center. There is evidence that the effects of the CO_2 tension and even of the pH of the blood might be exerted reflexly. There is also evidence to show that the pH inside of the cells constituting the center, or more especially the intercellular CO_2 tension, is more significant than is the corresponding value in the carotid blood. The latter possibility is in agreement with observations which show that, when a relatively high O_2 tension in the blood accompanies a heightened CO_2 tension, the effect of the latter upon respiration is partly canceled, presumably because oxidation in the protoplasm of the cells is sustained at such a rate that no accumulation of potentially acid products of incomplete oxidation occurs in the protoplasm. The relative effectiveness of the blood pH and of the intracellular CO_2 tension (or pH) is still somewhat debatable.

The significance of the adjustment of lung ventilation to the CO_2 tension of the blood is obvious. It enables the lungs to get rid of excess CO_2 formed in response to muscular activity or as a result of any heightened metabolism. CO_2 being the chief potentially acid product of metabolism, respiration is also an important regulative influence upon the acid-base balance of the body as a whole and of the blood in particular.

Kidney Functioning in Acid-Base Regulation. Although respiration is well adjusted to rid the blood of the volatile CO_2 , other potentially acid products of metabolism are in most cases nonvolatile. Their elimination is chiefly through the kidneys. Oxidation of the sulphur-containing amino acids forms H_2SO_4 , and metabolism of the phosphoproteins and phospholipids yields H_3PO_4 . Obviously these acids do not exist free in the body fluids but are neutralized by buffers. The resulting sulfates and phosphates are secreted into the urine at a rate so adjusted, normally, to their concentration in the blood as to prevent acidosis or depletion of the alkali reserve. The kidney tends to excrete more acid phosphate, BH_2PO_4 , than basic phosphate, B_2HPO_4 , although basic phosphates have the higher concentration in blood. This aids in protecting the alkali reserve and is a part of the explanation of the tendency of urine to be acid most of the time. The urine also carries away some bicarbonate and CO_2 .

Organic acids, such as those which are intermediary products of bio-oxidation, tend to be oxidized to $\text{CO}_2 + \text{H}_2\text{O}$, and the resulting carbonic acid is excreted chiefly by the lungs. But this form of disposal is

not always complete. Particularly in the case of lactic acid, some may escape from muscles during excessive activity. A part of the lactic acid in the blood is excreted in the urine as lactates. Acetoacetic acid, $\text{CH}_3\cdot\text{CO}\cdot\text{CH}_2\cdot\text{COOH}$, and β -hydroxybutyric acid, $\text{CH}_3\cdot\text{CHOH}\cdot\text{CH}_2\cdot\text{COOH}$, may appear in considerable quantities during defective conditions of oxidation, especially in diabetes. These two acids may be sufficient in amount to overcome the acid-base balance in the blood and cause acidosis. Any tendency to accumulation of nonvolatile organic acids is met by the use of ammonia to spare the alkali reserve (Na and K) of the blood (p. 345). Ammonium salts thus increase in the urine, although in severe stages of acidosis free organic acids may be excreted. A probable immediate source of ammonia is glutamine, $\text{COOH}\cdot\text{CH}_2\cdot\text{CH}_2\cdot\text{CHNH}_2\cdot\text{CONH}_2$. Its acid amide group, together with the corresponding group of asparagine (acid amide of aspartic acid), constitute a reservoir, so to speak, of body nitrogen. It can be replenished from other amino acids and is available for various uses, including ammonia production.

The kidney also responds to any tendency toward alkalosis by secreting an alkaline urine.

REFERENCES

- This subject is covered in a broad and comprehensive way in J. S. Haldane's book "Respiration," New Haven, 1922.
- A similar and more recent treatment is "Respiration" by J. S. Haldane and J. G. Priestly, New Haven, 1935.
- A difficult and intricate aspect of the subject is presented in "Blood, A Study in General Physiology" by L. J. Henderson, New Haven, 1928.
- The general physiologist will be interested in "Comparative Physiology of Respiratory Mechanisms" by A. Krogh, Philadelphia, 1941.
- Some useful reviews are listed below.
- BERNTHAL, T., Respiration, *Ann. Rev. Physiol.*, 6, 155, 1944.
- GEMMILL, C. L., The Respiratory System, *Ann. Rev. Physiol.*, 5, 123, 1943.
- GESELL, R., Respiration and its Adjustments, *Ann. Rev. Physiol.*, 1, 185, 1939.
- GESELL, R., The Chemical Regulation of Respiration, *Physiol. Rev.*, 5, 551, 1925.
- HENDERSON, L. J., Physiological Regulation of the Acid-base Balance of the Blood and some Related Functions, *Physiol. Rev.*, 5, 131, 1925.
- JOHNSON, R. E., FORBES, W. H., DILL, D. B., and HENDERSON, L. J., Respiration, *Ann. Rev. Physiol.*, 2, 21, 1940.
- MONGE, C., Chronic Mountain Sickness, *Physiol. Rev.*, 23, 166, 1943.
- PI-SUNER, A., The Regulation of the Respiratory Movements by Peripheral Chemo-receptors, *Physiol. Rev.*, 27, 1, 1947.
- PITTS, R. F., Organization of the Respiratory Center, *Physiol. Rev.*, 26, 609, 1946.
- ROUGHTON, F. J. W., Recent Work on Carbon Dioxide Transport by the Blood, *Physiol. Rev.*, 15, 241, 1935.
- SCHMIDT, C. F., and COMROE, J. H., JR., Respiration, *Ann. Rev. Physiol.*, 3, 151, 1941.
- SENDROY, J., JR., Acid-Base Metabolism, *Ann. Rev. Biochem.*, 7, 231, 1938.
- Some papers selected from many dealing with the acid-base balance are as follows:
- BISCHOFF, F., SANSUM, W. D., LONG, M. L., and DEWAR, M. M., The Effect of Acid Ash and Alkaline Ash Foodstuffs on the Acid-Base Equilibrium of Man, *J. Nutrition*, 7, 51, 1934.
- BLATHERWICK, N. R., and LONG, M. L., Studies of Urinary Acidity. I. Some Effects of Drinking Large Amounts of Orange Juice and Sour Milk, *J. Biol. Chem.*, 53, 103, 1922.
- BLATHERWICK, N. R., and LONG, M. L., Studies of Urinary Acidity. II. The Increased Acidity Produced by Eating Prunes and Cranberries, *J. Biol. Chem.*, 57, 815, 1923.

- CLAFF, C. L., and SWENSON, O., Micro Glass Electrode Technique for Determination of Hydrogen Ion Activity of Blood and Other Biological Fluids, *J. Biol. Chem.*, 152, 519, 1944.
- CULLEN, G. E., and EARLE, I. P., Studies of the Acid-Base Condition of Blood. II. Physiological Changes in Acid-Base Condition Throughout the Day, *J. Biol. Chem.*, 83, 545, 1929.
- EARLE, I. P., and CULLEN, G. E., Studies of the Acid-Base condition of Blood. I. Normal Variation in pH and Carbon Dioxide Content of Blood Sera, *J. Biol. Chem.*, 83, 539, 1929.
- HASTINGS, A. B., and EISELE, C. W., Diurnal Variations in the Acid-Base Balance, *Proc. Soc. Exptl. Biol. Med.*, 43, 308, 1940.
- HASTINGS, A. B., VAN SLYKE, D. D. *et al.*, The Acid Properties of Reduced and Oxygenated Hemoglobin, *J. Biol. Chem.*, 60, 89, 1924.
- KENYON, F., WILSON, C. A., and MACY, I. G., Daily Fluctuations in Urinary pH, *Arch. Pediatrics*, 51, 490, 1934.
- ROUGHTON, F. J. W., and SCHOLANDER, P. F., Micro Gasometric Estimation of the Blood Gases, *J. Biol. Chem.*, 148, 541, 551, 573, 1943.
- VAN SLYKE, D. D., HASTINGS, A. B., HEIDELBERGER, M., and NEILL, J. M., The Alkali-binding and Buffer Values of Oxyhemoglobin and Reduced Hemoglobin, *J. Biol. Chem.*, 54, 481, 1922.

CHAPTER XII

BIOLOGICAL OXIDATION

Oxidation is the chief means for liberation of energy for life processes. All other sources of energy for life are practically negligible. Historically, attempts to explain the chemical mechanism of bio-oxidation had to take into account the fact that the foodstuffs utilized, while able to burn in a flame, would not unite with oxygen at any temperature compatible with life. Earlier ideas, therefore, assumed that oxygen had to be activated in some way so that it would behave like "nascent oxygen" or possibly like H_2O_2 , which possesses heightened oxidizing powers. Later ideas emphasized the so-called "activation of hydrogen," which, as Wieland suggested, might be removed from food substances in a form enabling it to combine with oxygen. Activation of oxygen or of hydrogen represented vague views to which no definite chemical meaning became attached.

The modern view of typical cases of biological oxidation is that enzymes catalyze the transfer of H_2 from a fuel food (the metabolite) to another substance able to combine with hydrogen, known as "a hydrogen acceptor." This in turn gives up hydrogen to a further acceptor which may be O_2 itself, forming H_2O or H_2O_2 , or some other acceptor. This process may go on through an indefinite number of steps, each involving hydrogen transfer. Each one, however, permits the liberation of some energy. Barron has likened the process to the flow of water through a canal provided with locks, each one of which would represent an oxidative reaction releasing energy. Such a release, occurring step by step rather than in bursts, which would waste energy in the form of heat, is in accord with the obvious fact that bio-oxidation is always under control. It differs from oxidation in a fire which tends to increase to a conflagration. The flow of water through a series of locks is also under control. This analogy is helpful for a beginner in the study of bio-oxidation. The long chain of chemical reactions which may intervene between a metabolite, *e.g.*, sugar, and its final oxidation products, CO_2 and H_2O , is not a mere puzzling accident of nature but is the result of natural adaptation affording real physiological advantage. One must remember, however, that the final outflow from a canal and through each lock must be maintained if blocking of the flow is to be avoided. Imagine a canal with a terminal dam higher than the water level of the supplying lake. No flow could be

maintained. Similarly, if the union of hydrogen with oxygen in the cell is blocked, the entire series of hydrogen transfers tends to come to a stop.

There is a tendency, perhaps, to think of bio-oxidation as analogous to the burning of carbon as in coal. The biological fuels, sugars, fats, etc., are indeed carbon-rich compounds; but they are also hydrogen-rich, and the *typical* cellular oxidation processes consist of stripping hydrogen away and transferring it from one acceptor to another until it finally unites with oxygen, while carbon remains in the dehydrogenated residues and eventually becomes carboxyl groups, $-\text{COOH}$. For the latter process oxygen is usually derived from H_2O and not from O_2 . The $-\text{COOH}$ group is changed to CO_2 by suitable enzymes.

The oxidation of carbon so as to involve H_2O is also a feature of certain simple oxidations. The reaction

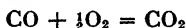

appears, on first view, to be quite simple; but actually the two gases mixed dry do not unite even at high temperature. A mere trace of moisture can facilitate the reaction, producing formic acid as an intermediate.

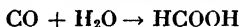

The further course of the reaction appears to be

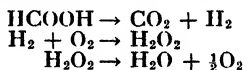

The water, while entering the reaction, reappears and thus functions in a catalytic way.

Types of Oxidation. The chemical reactions which are oxidative involve one or more of the following types:

1. Loss of an electron, *e.g.*,

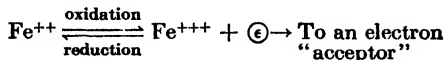

2. Loss of hydrogen, *e.g.*,

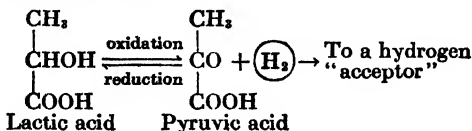

3. Gain of oxygen, *e.g.*,



4. Addition of water with loss of hydrogen

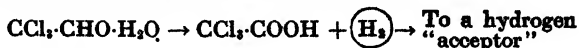

The fourth type is essentially a combination of the second and third. Wherever hydrogen or an electron escapes, an acceptor must be pro-

vided. In both of these cases the net result is essentially the same although the mechanism involved is different. Cellular oxidations include all four types, but the second, loss of hydrogen, is most frequently observed.

Reversible Redox Systems. The requirement for an acceptor may be stated in another way, as follows: If something is oxidized, something else must be reduced. The oxidized material is a reductant, the reduced material, an oxidant. Two substances which thus react reversibly with each other constitute a simple oxidation-reduction system, also called a "redox system." Thus a ferric salt and a ferrous salt may compose a redox system. Many biological materials afford similar systems. Oxidizing enzymes are of this type. Thus, the flavin group (p. 367) of the enzymes which are flavoproteins is reversibly oxidized or reduced so that the two resulting forms constitute a redox system. An example of a different type is ascorbic acid-dehydroascorbic acid (for formulas see p. 164). It should be understood that, although such a redox system is reversible, the reaction between the two components need not necessarily occur. Thus, mixing of ascorbic acid in the oxidized and reduced forms causes no change at a measurable rate; but in the presence of a specific enzyme, hydrogen transfer from the reduced to the oxidized component may occur. Even here, however, the reaction proceeds to an equilibrium rather than to completion unless it is coupled with another oxidizing reaction.

Redox Potential. Although not always apparent, electron transfer is involved in oxidation. Any solution containing a redox system may therefore be regarded as able to constitute the liquid part of one-half of a galvanic cell. If the system is an active one, it can affect the electrical potential of an electrode in contact with the solution.

The oxidant will tend to remove electrons from the electrode while the reductant will tend to give up electrons to it. The net effect of these two tendencies will cause the electrode to assume a potential which can be measured under the right conditions. The potential assumed will be determined by the nature of the redox system in the solution. The greater the tendency of the oxidant to receive electrons, the greater is its oxidizing power exerted upon the reductant and the more its tendency to draw the negatively charged electrons from the electrode. Consequently, the electrode assumes a less negative or a more positive potential than it would show in the presence of a weaker oxidant. The relative tendency for electron transfer to occur provides what may be called the "electron pressure" of the system. In order to measure it a complete electrical circuit is established as in any galvanic cell. A suitable liquid junction is established between the solution containing the redox system and another solution provided with its own electrode. The latter solu-

tion must constitute an electrically active system, and its electrode must assume a known and dependable potential. If now the proper wiring connections are made between the two electrodes and through a potentiometer, the difference in potential between the electrodes can be observed. Potentials due to the electrodes themselves must not interfere with the measurement. To this end, an "indifferent" electrode such as clean, bright platinum or gold is used in the solution containing the redox system, and a calomel electrode in a KCl solution of constant and known concentration is usually employed as the other "half-cell" in the circuit. The potential of the KCl-calomel system is known, and its value, subtracted from the potential of the completed galvanic cell, gives the potential (in volts) due to the redox system.

The E_h Scale. It is necessary to have some standard of reference upon which a scale of comparative values of redox potentials can be set up. For an analogy, consider electrostatic potentials. Any body so connected to earth (grounded) that it has the same potential as the earth is said to have zero potential. Higher potentials are positive, and lower ones are negative. So, in the case of redox potentials, a zero value is chosen. It is *the potential of the normal H_2 electrode*. This may be defined as the potential assumed by a colloidal platinum (or palladium) electrode saturated with pure H_2 gas at 1 atmosphere of pressure and immersed in a solution normal in hydrogen ions, $(H^+) = 1$ ($pH = 0$). Any redox system having a potential higher than that of the normal hydrogen electrode is positive, and one having a lower potential is negative. A redox potential could be measured *theoretically* by immersing a suitable electrode in a solution containing an active redox system, connecting it through a potentiometer to a normal H_2 electrode, and bridging the two half-cells thus formed by a KCl salt bridge, which will not of itself set up a potential or disturb that due to the electrodes. *Practically*, however, it is convenient to substitute for the normal H_2 electrode a more stable one, such as the calomel electrode, which, having been standardized with respect to the normal H_2 electrode, may be used as a "reference" electrode. From the measured potential of this completed galvanic cell, the potential due to the effect of a redox system upon the electrode in its solution may be calculated. The resulting value is denoted by the symbol " E_h ." Upon a scale of E_h values, ranging both on the positive and the negative side of zero, the redox potential of any measured redox system may be placed. The significance of the comparisons thus obtained will be considered presently.

E_h Values as Related to Redox Systems. The fundamental relation between the redox potential of an active system and its condition when measured is derived from a thermodynamic consideration of the free-energy transfer involved and is expressed thus:

$$E_h = E_0 + \frac{RT}{nF} \ln \frac{[\text{oxidant}]}{[\text{reductant}]}$$

where E_0 is a constant, characteristic of a given redox system and varying with different systems; R is the universal gas constant in electrical units; T is the absolute temperature; n is the valence change (number of electrons) involved in the transfer; F is the faraday, 96,500 coulombs; while $\ln [\text{oxidant}]/[\text{reductant}]$ signifies the use of the natural logarithm of the ratio of the concentration of oxidant (the component of the system which is more reduced and is thus able to cause oxidation) to the concentration of reductant (the more oxidized component). Theoretically, activities rather than concentrations are involved, but activity values are not known for most redox systems. The resulting inaccuracy is generally negligible. The derivation of this equation may be found in works on physical chemistry.¹

The ratio $[\text{oxidant}]/[\text{reductant}]$ can be computed from the E_h value if E_0 is known. One way of determining the latter for a given system is to measure E_h when the ratio is experimentally fixed. Thus, one may take measured amounts of purified preparations of the oxidant and reductant (e.g., Fe^{++} and Fe^{+++} salts) and dissolve both of them in the same solution. When they are present in equimolar concentration, the ratio is unity and the logarithm of the ratio is zero, so that the last term of the equation disappears and

$$E_h = E_0$$

The value E_0 , expressed in volts, is characteristic for any given redox system. It is the value which would be found if the system contained equal concentrations of its two components in a solution with $\text{pH} = 0$ and were measured against a standard H_2 electrode in a solution normal in hydrogen ions. From the equation it is clear that E_h values rise with increase of the ratio $[\text{oxidant}]/[\text{reductant}]$ and fall with its decrease (Fig. 61).

When redox potential is measured with the system at some pH other than zero and the pH of the solution affects the potential, the observed E_0 value (when the ratio $\frac{[\text{oxidant}]}{[\text{reductant}]} = 1$) is indicated by the symbol E'_0 . In any case the given voltages are on a scale of which 0 is the potential of the normal H_2 electrode.

The choice of the H_2 electrode as the reference one for redox potentials is advantageous. In some cases, including many biological systems, the activity of hydrogen ions is directly or indirectly involved in the oxidation-reduction reaction. Consequently, redox potential is markedly

¹ A useful treatment of the subject is given by B. Cohen in Chap. XIX of "A Textbook of Biochemistry," edited by Harrow and Sherwin, Philadelphia, 1935.

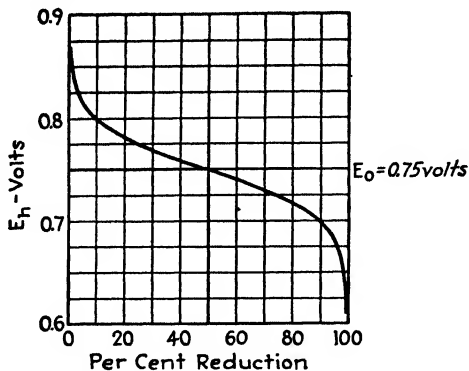

FIG. 61. The relation between E_h values and the degree of reduction or oxidation of a redox system. The system shown is the ferric-ferrous one with $E_0 = 0.75$. The reaction involved may be represented as: $\text{Fe}^{+++} + e = \text{Fe}^{++}$. (After W. M. Clark, using measurements of Peters.)

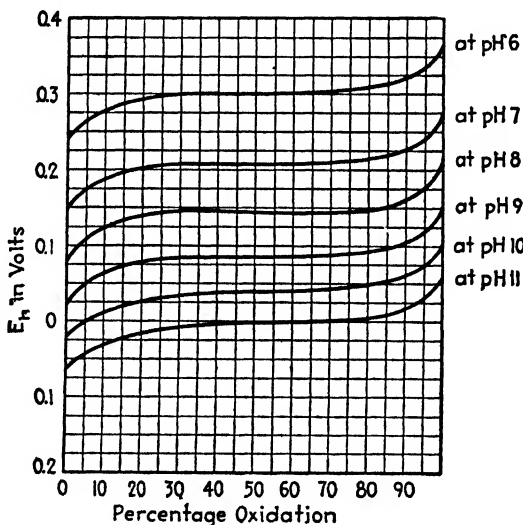

FIG. 62. Curves to show the relation between potential, pH, and degree of oxidation of a reversible oxidation-reduction system, *viz.*, the indophenol system. The E_0' values may be taken as the ordinates of the points where the curves cross the line corresponding to 50 per cent oxidation. (Curves drawn from similar ones by Cohen, Gibbs, and Clark.)

influenced in such systems by the pH of the solution (Figs. 62 and 63). There are redox systems (*e.g.*, ferrocyanide-ferricyanide) which are indifferent to (H^+).

The Significance of Redox Potential. If any given redox system is able to produce oxidation in another system, the given one must have

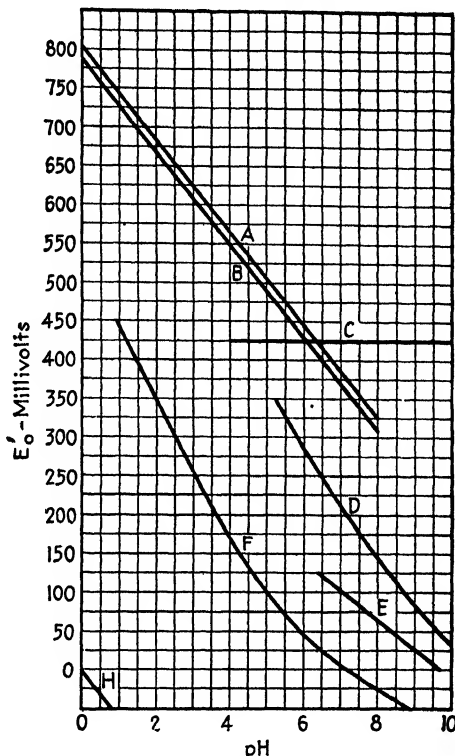

FIG. 63. The effect of pH upon the E'_0 values of some oxidation-reduction systems of biochemical interest. A, the system of which the hormone, epinephrine (adrenine),

is the reductant. Its formula is $\text{HO} \begin{array}{c} \text{HO} \\ \diagdown \quad \diagup \\ \text{C}_6\text{H}_3 \\ \diagup \quad \diagdown \\ \text{HO} \end{array} \text{CHOH-CH}_2\text{-NH CH}_3$. B, the system

of which the reductant is catechol, $\text{HO} \begin{array}{c} \text{HO} \\ \diagdown \quad \diagup \\ \text{C}_6\text{H}_4 \\ \diagup \quad \diagdown \\ \text{HO} \end{array}$. This curve is parallel to curve A,

as are those of a number of systems of which the reductant is structurally similar to catechol. C, the ferricyanide-ferrocyanide system, which is not affected by pH. D, the system of which the reductant is 2,6-dichlorophenol indophenol, a dye used as a redox indicator in biochemical investigation. E, methemoglobin system. F, methylene blue-leucomethylene blue system, used as a redox indicator in biochemical investigation. H, a small part of the curve of the H_2 electrode potential, shown for comparison.

While a straight-line relationship between E'_0 values and pH may be found over a limited range, this is not true over a wider range, as is indicated in curves D and F. When curves A and B are further extended beyond pH 8, more complex curves are obtained. (After Ball and Chen.)

the higher redox potential. This follows from thermodynamic reasoning and is practically demonstrable. Suppose it is necessary to know whether alcohol can be oxidized to aldehyde or aldehyde reduced to alcohol under the influence of an enzyme of a cell. The apoenzyme, a specific protein, operates in conjunction with a coenzyme, which in this case is diphosphopyridine nucleotide (p. 365). The two redox systems are (1) $\frac{[\text{alcohol}]}{[\text{aldehyde}]}$ and (2) $\frac{[\text{reduced pyridine nucleotide}]}{[\text{oxidized pyridine nucleotide}]}$. The approximate E'_0 values, at 30°C. and pH 7, are (1) -0.20 and (2) -0.29 volt. System (2), having the lower potential, may be oxidized at the expense of system (1), and in the yeast cell, as shown by Warburg and Euler, alcohol may be formed from aldehyde. It must be understood that this reaction cannot proceed to any significant extent unless coupled with another which is tending to reduce the pyridine nucleotide. Each link of the chain of coupled oxidation reductions which may occur in protoplasm is related to its neighboring links according to the relative redox potentials. System $C \rightleftharpoons D$ of relatively high potential, so reacting that its oxidized component may serve as H_2 acceptor from system $E \rightleftharpoons F$ of lower potential, is in turn oxidized by system $A \rightleftharpoons B$ of potential higher than that of $C \rightleftharpoons D$. The enzymes and the hydrogen acceptors and electron acceptors of a cell may provide as many as six steps in the transfer of H_2 from a substrate to O_2 . A scheme modified from a similar one by Ball and representing the theoretical arrangement of these systems as they appear to operate in cells is shown in Fig. 64. It is based in part upon well-established fact and in part upon hypothesis. The place of cytochrome *b* in the scheme is not well established. Until its properties are known and certain other features of this scheme are precisely studied, it must be regarded as provisional. Many bio-oxidations are more direct, involving less complex chains of reactions.

Classes of Enzymes Concerned in Bio-oxidation. Oxidizing enzymes might be classified (1) according to the nature of their substrates, *e.g.*, the glycolytic enzymes, oxidizing sugars, the 4-carbon acid enzymes, oxidizing succinic acid and related acids, etc.; or (2) according to the prosthetic group, sometimes called the "coenzyme" (p. 247). The latter scheme does not completely classify the oxidizing enzymes because the prosthetic groups of some of them are unknown. Probably some of them have no such group. Nevertheless, the scheme is useful for the biochemist.

It must be emphasized that each of the scores of different enzymes which may be arranged in this classification includes two components. They are the prosthetic group which is identical or at least similar for an entire class, and a protein which is unique and quite specific for each

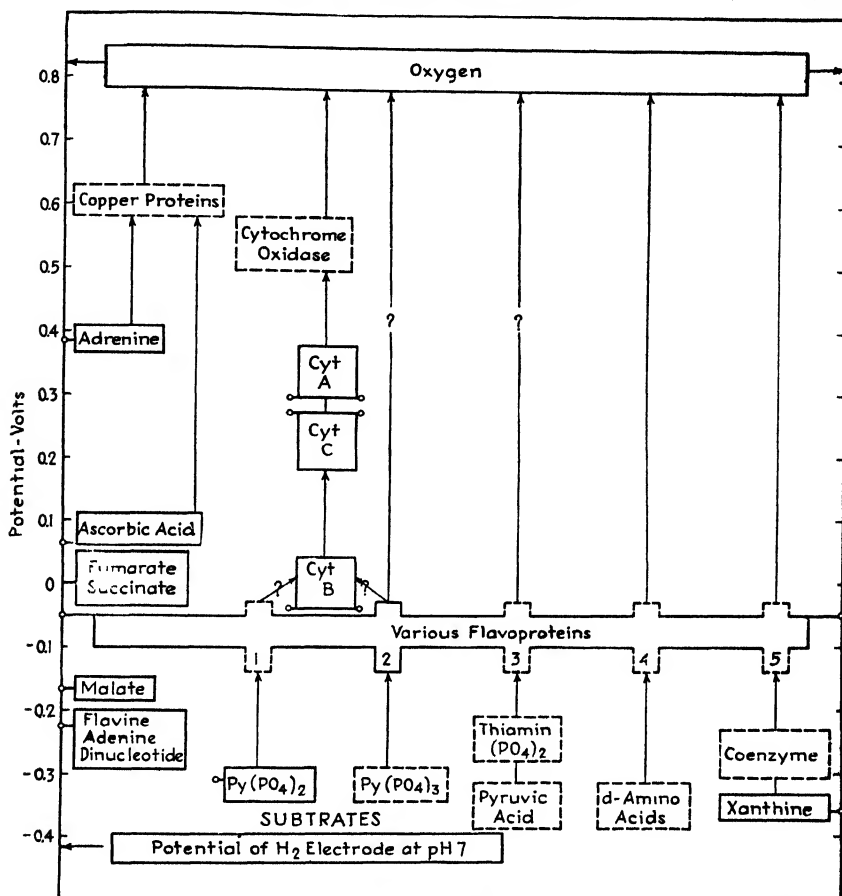

FIG. 61. The approximate levels of the redox potentials of some of the systems concerned in biological oxidation. The potentials indicated are those at pH 7. Where dotted lines surround the name of a component of a system, the corresponding potential is only approximately known or is merely inferred. The place of cytochrome B (Cyt B) is suggested but with question marks. Cytochrome A (Cyt A) and cytochrome C (Cyt C) are indicated as functioning with the aid of cytochrome oxidase. Of five complex systems here indicated, two (4 and 5) are represented as having the flavoprotein enzyme reacting with oxygen. It is seen that flavin adenine dinucleotide is at a level differing from that of the flavoproteins of which it is a part in the functioning enzyme systems. It may also be found eventually that the diphosphopyridine [Py(PO₄)₂] and the triphosphopyridine nucleotides [Py(PO₄)₃] should be placed at a level differing from that here indicated when they are in functional combination with a specific protein.

In oxidations employing the cytochrome system, nearly two-thirds of the energy gap between substrates and oxygen is bridged by the iron-porphyrin proteins.

The connection of the fumarate-succinate system, representing a part of the succinic acid cycle, with any complete oxidative chain is not here indicated. Szent-Györgyi has suggested that it may serve as a connecting link between a flavoprotein system on the one hand and the cytochrome system on the other.

The ideas represented in this diagram will be found useful in reviewing data contained in Tables 45 and 46 and in the text pp. 332-340. (This diagram is based on a similar one by E. G. Ball.)

enzyme. Even the enzymes acting upon the same substrate, but obtained from different sources, appear to have specific protein components.

The types of enzymes are listed with their prosthetic groups where known.

A. Pyridinoprotein enzymes

1. Diphosphopyridinoproteins, diphospho-pyridine-adenine nucleotide (coenzyme I)
2. Triphosphopyridinoproteins, triphospho-pyridine-adenine nucleotide (coenzyme II)

B. Flavoprotein enzymes

1. Flavine-adenine-dinucleotide proteins, flavine-adenine-dinucleotide
2. Flavine-mononucleotide proteins, flavine phosphoric acid
3. Other flavoproteins, flavine-adenine-dinucleotide with one or more unknown groups

C. The cytochromes, not called enzymes because they operate as electron acceptors rather than as catalysts for specific substrates, but grouped in this scheme because they play an important role in bio-oxidation and because their structure resembles that of oxidizing enzymes

D. Iron-porphyrin-protein enzymes, one or more Fe porphyrin groups of unknown constitution

1. Cytochrome oxidases, catalyzing the oxidation of cytochromes by O_2 (not definitely known to be Fe proteins)
2. Peroxidases, catalyzing the oxidation of various substrates by H_2O_2
3. Catalases, catalyzing the reaction, $2H_2O_2 \rightarrow 2H_2O + O_2$,

E. Copper-protein enzymes

1. Polyphenol oxidases, specific proteins catalyzing the oxidation of phenols,

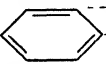
such as catechol, , but catalytically active only when in

the form of the Cu salt, Cu behaving like a prosthetic group

2. Monophenol oxidases, similar to polyphenol oxidases
3. Laccase, a polyphenol oxidase from the latex of the lacquer tree, requiring Cu for its activity but apparently containing another, unidentified, prosthetic group
4. Ascorbic acid oxidase, probably a Cu proteinate

F. Zinc-protein enzyme, carbonic anhydrase, prepared from red blood corpuscles, catalyzing the reaction, $H_2CO_3 \rightleftharpoons CO_2 + H_2O$

G. Thiaminoprotein enzymes, thiamine pyrophosphate

1. Carboxylase (yeast), catalyzing the oxidation of pyruvic acid, $CH_3-CO-COOH$, to $CO_2 + CH_3-CHO$
2. Carboxylase (bacteria), catalyzing the oxidation of pyruvic acid to $CO_2 + CH_3-COOH$
3. Carboxylase (animal tissues), catalyzing the oxidation of pyruvic acid to products not yet determined

H. Cytochrome-reducing dehydrogenases, having no known prosthetic group but using the cytochromes as acceptors e.g., succinic dehydrogenase (p. 376)

Other oxidizing enzymes, not classified in this scheme, include some which catalyze reactions involving O_2 or H_2O and some involving other oxidative mechanisms. Some of them are postulated to have a prosthetic

group which, as in groups *A*, *B*, and *G* in the above list, contains a residue of a vitamin molecule. Thus (1) pyridoxal phosphate, a derivative of pyridoxine (vitamin B_6), (2) some unidentified substance containing biotin (vitamin *H*), and (3) another that uses pantothenic acid (also a member of the *B* group of vitamins) all seem to function in biological oxidation in ways which suggest that they are prosthetic groups of oxidizing enzymes. Any classification of oxidizing enzymes must be regarded as provisional. The rapid advances in this field of biochemistry during the past decade suggest that a more satisfactory classification may be made in the near future.

The number of oxidizing enzymes already investigated is so large that space limitations preclude the description of more than certain representative ones. The role of these enzymes as they act together in the complex drama of bio-oxidation will be somewhat clearer after the study of metabolism (Chaps. XIV to XVI). But it still seems as though the more that is seen of this drama, the more "the plot thickens."

The Pyridinoprotein Enzymes. The general nature of the action of these enzymes is indicated by the behavior of their prosthetic groups. As they are reduced, the substrate is oxidized—usually dehydrogenated. The chemical mechanism, so far as now known, appears to be the same for coenzymes I and II and is shown together with their structural formulas, as follows:

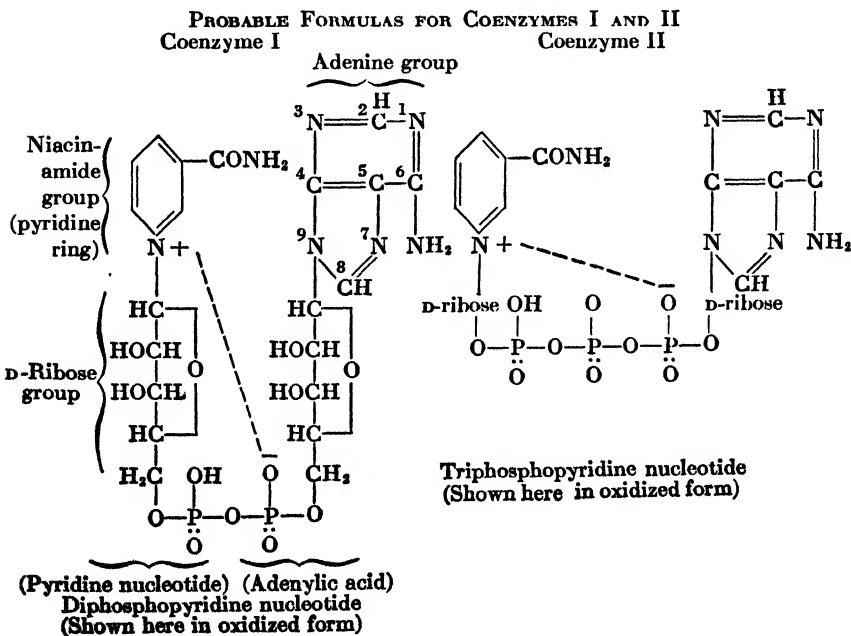

The reversible oxidation-reduction appears to involve the N of the pyridine ring, thus:

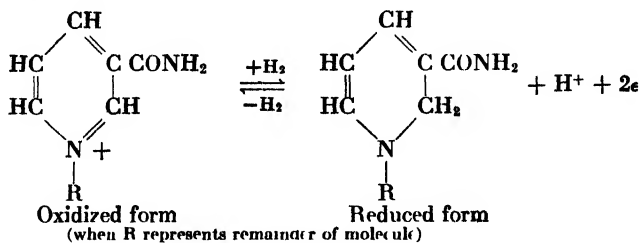

Some investigators write of the enzyme or the apoenzyme and its coenzyme; others use the term "pyridinoprotein enzyme." Similar confusion is encountered in the nomenclature of other types of oxidizing enzymes.

The reversible reactions, the equilibria of which are dynamically involved in the activity of such an enzyme, include the following:

1. Substrate \rightleftharpoons dehydrogenated oxidation product
2. Prosthetic group (oxidized) \rightleftharpoons prosthetic group (reduced)
3. Complete enzyme system \rightleftharpoons coenzyme + protein

In addition, some reaction moving so as to reoxidize the reduced form of the prosthetic group is necessary if the substrate is to be oxidized to any significant extent. An illustration of such a coupling of reactions is seen in the behavior of coenzyme I when, in yeast, it acts as H_2 acceptor so that triose is oxidized to glyceric acid, but it also acts simultaneously as H_2 donor so that aldehyde is reduced to alcohol. The coenzyme thus serves two reactions catalyzed by two different enzymes. This particular case is interesting because the coenzyme behavior can be neatly demonstrated spectroscopically. When reduced the coenzyme complex shows a definite absorption band which disappears upon oxidation. If now a solution containing triose phosphate is treated with its dehydrogenase (containing coenzyme I), the absorption band of the spectrum darkens, but upon adding alcohol dehydrogenase the band promptly fades out. The actual coupling involved is more complex than here shown because phosphorylating enzymes, governing the transfer of phosphoric acid groups from phosphate donors to triose phosphate, are indispensable and actually energize the reaction as it occurs in protoplasm. Such interdependent reactions are of fundamental biological importance and will be discussed further in connection with carbohydrate metabolism in animals. We shall find that essentially the same reactions occur and, as studied in muscles, differ only in that the end effect is reduction of pyruvic acid to lactic acid rather than of aldehyde to alcohol.

Another reaction is also probably involved, namely, reversible synthesis of the "coenzyme" from the products of its hydrolytic cleavage. Incompleteness of the resynthesis would account for the need of renewed supplies of those vitamins which are components of oxidative enzymes.

The fact that the protein part of each of these enzymes is specific for the substrate indicates that a protein-substrate compound forms as a preliminary to transfer of hydrogen from substrate to prosthetic group. Similar reasoning applies to all oxidizing enzymes, and the kinetics of their action furnish additional evidence of formation of an enzyme-substrate complex.

Some pyridinoprotein enzymes selected from those which have been well studied are listed in Table 48 together with their substrates.

Not all dehydrogenases are pyridinoproteins. Other types are those which can react with flavins or with cytochromes to cause hydrogen transfer.

The Flavoprotein Enzymes. Enzymes having isoalloxazine nucleotide (also called "riboflavin phosphate" or the "phosphate of vitamin B₂") have been under intensive investigation since 1932, when Warburg and Christian announced the discovery in yeast of an oxidative catalyst which they called the **yellow enzyme**. It proved to be a complex of specific protein and a nucleotide, serving as the prosthetic group or coenzyme, which Warburg called **cozymase**. It is now called "isoalloxazine mononucleotide." Krebs and, later, Warburg and Christian investigated another enzyme of similar type, **D-amino acid oxidase** of the kidney. This was found to employ a more complex prosthetic group, isoalloxazine-adenine-dinucleotide, formerly called "cozymase II." A crude preparation from heart muscle of a flavoprotein enzyme in an insoluble form is called **diaphorase**. The structures of both nucleotides and the probable nature of the oxidation-reduction change are shown below.

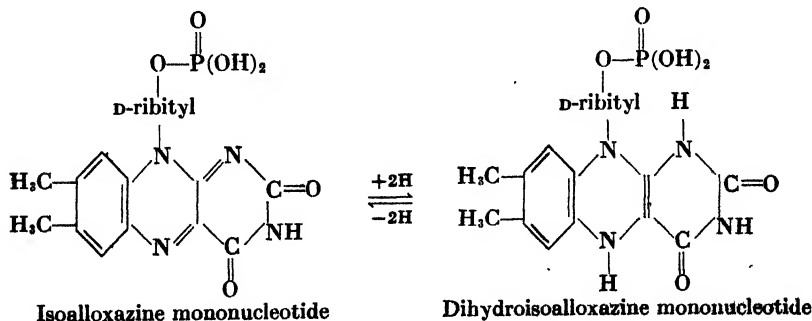

TABLE 48.—REPRESENTATIVE PYRIDINOPROTEIN ENZYMES¹

Enzyme	Substrate system		Occurrence
	Less oxidized component	More oxidized component	
1. Lactic acid dehydrogenase	L(+)-Lactic acid, CH ₃ :CHOH:COOH, or lactates	Pyruvic acid CH ₃ :CO:COOH, or pyruvates + (H ₂)	Most animal tissues, rich in heart muscle
2. Malic acid dehydrogenase	L(+)-Malic acid, CHOH:COOH, or malates CH ₂ :COOH	Oxaloacetic acid, CO ₂ :COOH, or oxalacetates, + (H ₂) CH ₂ :COOH	Most animal tissues, rich in heart muscle
3. Alcohol enzyme of yeast	Ethanol, CH ₃ :CH ₂ :OH, or other simple aliphatic alcohols	Acetaldehyde, CH ₃ :CHO, or corresponding aldehydes + (H ₂)	In yeast this enzyme acts aerobically so as to oxidize alcohol, but anaerobically so as to form it from aldehyde
4. Alcohol enzyme of animal tissues	Ethanol, or other simple aliphatic alcohols	Acetaldehyde or corresponding aldehydes	Prepared from liver but probably occurs in other tissues
5. Triose-phosphoric dehydrogenase	3-Phosphoglyceraldehyde (glycerose-3-phosphate), CHO CHOH + H ₂ PO ₄ H ₂ C-O-P(OH) ₂ O	1,3-Diphosphoglyceric acid, O-P(OH) ₂ C=O + (H ₂) CHOH H ₂ C-O-P(OH) ₂ O	The specific protein has been prepared in crystalline form from baker's yeast. Also found in other yeasts, in bacteria, and in brain, muscle, and intestine
6. β-Hydroxybutyric dehydrogenase	L(-)-β-Hydroxybutyric acid, CH ₃ :CHOH:CH ₂ :COOH, or its salts	Acetoacetic acid, or acetoacetates, CH ₃ :CO:CH ₂ :COOH, + (H ₂)	Heart, kidney, and liver tissue
7. Hexose-monophosphoric dehydrogenase	Glucose-6-phosphate, O O-P(OH) ₂ CH ₂ :(CHOH) ₄ :CHO, + H ₂ O	6-Phosphogluconic acid, O O-P(OH) ₂ CH ₂ :(CHOH) ₄ :COOH, or phosphogluconates, + (H ₂)	Prepared from yeast and from erythrocytes; is probably widespread

TABLE 48.—REPRESENTATIVE PYRIDINOPROTEIN ENZYMES.¹ (Continued)

Enzyme	Substrate system		Occurrence
	Less oxidized component	More oxidized component	
8. Phosphogluconic acid dehydrogenase	6-Phosphogluconic acid, $\begin{array}{c} \text{O} \\ \parallel \\ \text{O}-\text{P}(\text{OH})_2 \\ \\ \text{CH}_2(\text{CHOH})+\text{COOH}, \text{ or phosphogluconates} \end{array}$	6-Phosphoketohexonate $\begin{array}{c} \text{O} \\ \parallel \\ \text{O}-\text{P}(\text{OH})_2 \\ \\ \text{CH}_2(\text{CHOH})+\text{CO-COOH} \end{array} + \text{H}^+$	Yeast and animal tissues
9. Isocitric acid dehydrogenase	Isocitric acid $\begin{array}{c} \text{H} \\ \\ \text{HOOC-C-CH}_2\text{-COOH} \\ \\ \text{CHOH-COOH}, \text{ or} \\ \text{isocitrates arising through enzymatic} \\ \text{transformation of citrate in cells} \end{array}$	α -Keto- β -carboxyglutaric acid, $\begin{array}{c} \text{H} \\ \\ \text{HOOC-C-CH}_2\text{-COOH}, \text{ or its salts} + \text{H}^+ \\ \\ \text{CO-COOH} \end{array}$ This spontaneously changes to α -keto-glutaric acid + CO ₂ , making the reaction irreversible.	Widely distributed in animal tissues; the best preparations made from heart muscle
10. Glucose-oxidizing dehydrogenase	D-Glucose, $\text{CH}_2\text{OH}:(\text{CHOH})+\text{CHO} + \text{H}_2\text{O}$	D-Gluconic acid, or gluconates, $\text{CH}_2\text{OH}(\text{CHOH})+\text{COOH} + \text{H}^+$	Prepared from liver; can function with either coenzyme I or II
11. Glutamic acid dehydrogenase	γ (+)-Glutamic acid, or glutamates, $\text{HOOC}:(\text{CH}_2)_2$ $\begin{array}{c} \\ \text{CHNH}_2\text{-COOH} + \text{H}_2\text{O} \end{array}$	α -Ketoglutamic acid, or its salts, $\text{HOOC}:(\text{CH}_2)_2 + \text{NH}_4 + \text{H}^+$ $\begin{array}{c} \\ \text{CO-COOH} \end{array}$	As prepared from higher plants, these enzymes utilize coenzyme I; from yeast, coenzyme II; but from liver, both coenzymes

¹ Those numbered 1-6 are diposphopyridinoproteins, utilizing coenzyme I; 7-9 are triphosphopyridinoproteins, using coenzyme II; number 10 is apparently nonspecific, utilizing either coenzyme; number 11 occurs in both forms. Circles surrounding hydrogen in the equation indicate that it is taken up by the coenzyme acting as hydrogen "acceptor."

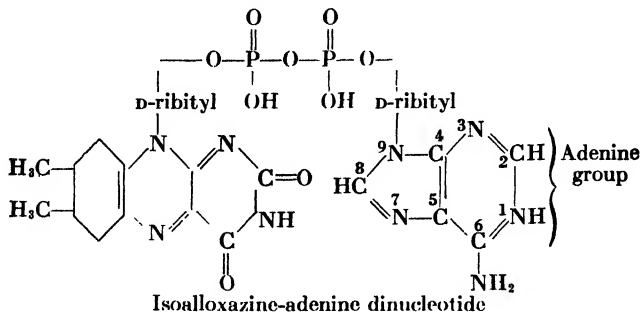

The reversible reaction is believed to occur stepwise in two stages, involving the transfer of one hydrogen atom and one electron in each stage. This is in accord with the general theory of such oxidation-reduction changes as developed by Michaelis from a study of quinones, semiquinones, and hydroquinones. It might be called the free-radical theory. In this particular case the intermediate structure, corresponding to the "free radical," can be easily recognized because it is red (the oxidized form is yellow and the reduced form, colorless) and it shows a specific absorption spectrum.

Riboflavin (p. 160) in both the free and the nucleotide form is autooxidizable. It can be oxidized when in the reduced form by atmospheric O_2 . One might expect, therefore, that the flavoprotein enzymes would also react with O_2 . This is actually found to be true of some of them, but others require an intermediary redox system for their reversible functioning, *e.g.*, the cytochrome system.

In addition to the two coenzymes described, at least two others exist. Both are apparently flavin derivatives, but their structure is incompletely explored.

The majority of the flavoprotein enzymes so far investigated can interact with one or both of the pyridine nucleotides, the latter being oxidized while the flavine is reduced.

For the flavoprotein enzymes listed in Table 49, redox systems which can reduce them (column 2) and others which can oxidize them (column 3) are indicated. Where the naturally operative redox system has not been recognized, dyes, such as methylene blue which can operate, are indicated. Methylene blue, colorless in reduced form, is a useful redox indicator. Being reversibly oxidized, it affords a redox system, and the intensity of the blue color is an index of the extent to which it is oxidized. Many other dyes are used as similar redox indicators in physiological studies.

Cytochromes. Iron-porphyrin proteins are important and widespread in biological materials. Hemoglobin of blood, myoglobin of

muscle, and similar "respiratory proteins" are the longest known and most thoroughly studied. But beginning with the work of Keilin (1925), investigations in his laboratory at Cambridge, in Theorell's laboratory at Stockholm, and in many other laboratories have clearly

TABLE 49.—FLAVOPROTEIN ENZYMES

The prosthetic group of the first two in the list is riboflavin phosphate; of the others, it is isoalloxazine-adenine dinucleotide.

Name	Reducing systems	Oxidizing systems	Source
"Yellow enzyme" of Warburg and Christian	Di- and triphosphopyridine nucleotides	Oxygen at high tension, the system operating at protoplasmic O ₂ tension is unknown	Yeast
Cytochrome-c reductase	Triphosphopyridine nucleotide	Cytochrome c; O ₂ is only slowly effective	Yeast
"Yellow enzyme" of Haas	Diphosphopyridine nucleotide	Oxygen much less effective than with the "Warburg-Christian" enzyme. Methylene blue is effective	Yeast
"Yellow enzyme" of Straub	Di- and triphosphopyridine nucleotide	Methylene blue; O ₂ is only slowly effective; some cellular redox system, intermediary between this enzyme and O ₂ , is postulated	Heart muscle; but some form of flavo-protein enzyme appears to occur in all animal tissues
Xanthine oxidase	Hypoxanthine-xanthine-uric acid; aldehydes-acids; diphosphopyridine nucleotide	Oxygen	Milk; liver and probably other animal tissues
D-Amino acid oxidase	D-Amino acids and α-keto acids	Oxygen	Kidney, liver, and intestine

shown that the cytochromes also play a significant role in bio-oxidation. It is now believed that one or more of them can be found in every cell which respire aerobically and that nearly all the respiratory activity of such a cell depends upon them. The latter conclusion is based chiefly upon study of the effect of certain respiratory inhibitors, such as KCN, which can combine with iron of an iron-porphyrin protein in such a way as to interfere with its reversible oxidation-reduction. Cyanides, in

concentration too low to kill the cell, greatly inhibit its power to take up O_2 .

The porphyrin nucleus was described in connection with chlorophyll (p. 48); its relation to the iron atom was discussed in connection with hemoglobins (p. 309). So far as cytochromes are concerned, the iron-porphyrin (prosthetic) group is found to be similar to but not identical with the corresponding group of hemoglobin. This is established by both chemical and spectrographic evidence. The functioning of the iron in these two types of compounds is, however, distinctly different. Hemoglobins show no change of valence of the iron atom as an accompaniment to the taking on and giving off of O_2 and function so as to convey O_2 from the lungs to the other tissues. Cytochromes show a reversible valence change of the iron atom (ferric \rightleftharpoons ferrous), do not take on or give off O_2 , and function catalytically in the union of hydrogen and oxygen.

The beginner in the study of bio-oxidation might be puzzled by the fact that cytochrome, though not combining in the ordinary sense with either hydrogen or oxygen, is nevertheless functional in causing their oxidative union. Cytochrome in the reduced (ferrous) condition is reoxidized to the ferric condition by O_2 under the influence of certain specific enzymes such as cytochrome oxidase. The entire cytochrome system, including the oxidase, may be thought of as "activating" oxygen so that it combines with hydrogen. Where does the hydrogen come from? Any redox system, *e.g.*, flavoprotein-reduced flavoprotein, which can reduce cytochrome can thereby give off hydrogen. The reaction in its essentials may be represented thus:

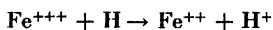

The cytochrome iron atom gains an electron and a hydrogen ion is freed to combine with oxygen as the electron is transferred through the cytochrome system. The latter acts as an "electron carrier," roughly analogous to a conducting wire connecting the two halves of a galvanic cell so as to permit an oxidative reaction to occur when electrical connection is completed.

Three cytochromes, known as cytochromes *a*, *b*, and *c*, are recognized by their characteristic absorption spectra, which exhibit only faint bands in the oxidized condition but are sharply visible when the cytochromes are in the presence of a sufficiently effective reductant, such as hydro-sulfite. A fourth cytochrome, called cytochrome *a₃*, associated with cytochrome *a* in heart muscle, was described by Keilin and Hartree. They note that some but not all of its properties resemble those of cytochrome oxidase. They are not convinced that the two are identical and suggest that *a* and *a₃* might be interconvertible. The maximum

absorption for each of the three principal, visible bands (α , β , and γ) of the reduced cytochromes of heart muscle are given in wave lengths $m\mu$ as follows:

	α	β	γ
	$m\mu$	$m\mu$	$m\mu$
Cytochrome <i>a</i>	605	513 (ρ)	452
Cytochrome <i>a</i> ₃	600	ρ	448
Cytochrome <i>b</i>	564	530	432
Cytochrome <i>c</i>	550	521	415

Cytochrome *c* is the only one which has been isolated in a form sufficiently pure for satisfactory chemical investigation. Reports of the preparation from heart muscle of a solution free from cytochromes other than *a* and *a*₃ have appeared. There are similar claims for cytochrome *b*. Even cytochrome *c*, the most stable and probably the most abundant of the cytochromes, is obtainable in only small amounts. From a kilogram of heart muscle, Keilin and Hartree obtained 0.165 g.

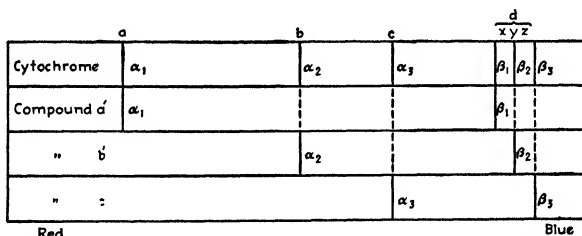

FIG. 65. Scheme to show the location in the spectrum of the chief absorption bands of different cytochromes. (After Meldrum.)

as a dark red protein containing 0.34 per cent of iron. Theorell and Akesson report on what appeared to be a more highly purified product having 0.43 per cent of iron, suggesting a minimal molecular weight of about 13,000. The cytochromes found in certain bacteria and plants appear to be unique in that they have absorption spectra that are not identical with those of animal cytochromes. In addition to the four of yeast and animal cells, at least six others have been described. The location of the absorption bands for components of a typical cytochrome preparation is indicated in Fig. 65.

It should be emphasized that reduced cytochrome *c* is not oxidized by exposure to oxygen except in solutions so acid or so alkaline as to be entirely outside the range of pH values which could occur in living cells. There is no evidence that any of the cytochromes are autoxidizable in the cell. Some activating system, such as cytochrome oxidase, is

required and is present in protoplasm. The change as it actually occurs in living cells can be observed spectroscopically in a suspension of yeast cells under the microscope. On deprivation of air the spectrum of reduced cytochrome *c* becomes visible but fades when the yeast is well exposed to oxygen. These changes can be repeated indefinitely. Keilin was also able to see the same effect in the wing muscle of the bee moth, *Galleria mellonella*. The wings were made translucent by removal of the scales and the living moth fixed to a microscope slide. The wing muscle was observed with a microspectroscope. Oxygen depletion due to muscular contraction or deprivation of air caused the spectrum of reduced cytochrome *c* to appear but it disappeared upon reoxidation.

Cytochrome Oxidase. This enzyme specifically catalyzes the oxidation of cytochromes by molecular oxygen. It has been commonly grouped with iron-porphyrin protein enzymes. There seem to be no experiments on record to prove that it contains iron. Its behavior toward CO indicates that it contains either iron or copper. It was at one time confused with polyphenol oxidase, which it resembles, and which is now known to be a Cu-containing enzyme. The restorative action of Cu fed to rats suffering from anemia due to faulty diet is accompanied by rapid increase in the cytochrome oxidase content of the rat tissues. Cytochrome oxidase is thought to be identical with what was formerly called **indophenol oxidase**. Its activity is shown by use of the Nadi reagent, a mixture of α -naphthol and dimethyl-*p*-phenylene diamine, which in the presence of the enzyme forms indophenol blue. Preparations represented by the two names are believed to contain the same enzyme because they have the same occurrence in nature, are inhibited by the same treatments, and oxidize cytochrome in the same way.

No success has been attained in attempts to prepare the isolated enzyme. It is associated in tissue extracts with insoluble particles from which the enzyme has not been dissolved in pure form.

The rate of the oxidation of cytochromes by this enzyme is nearly independent of the partial pressure of O₂ over a considerable range of values. This indicates the effectiveness of the enzyme in causing oxidation in a cell at the relatively low O₂ tensions commonly prevailing in protoplasm.

Cytochrome oxidase has been known as "Warburg's respiratory enzyme." He postulated its existence because of the behavior of the cytochromes (not oxidized by O₂ in solutions but readily oxidized in tissues) before the enzyme was studied in cell-free preparations containing no cytochrome.

Peroxidase. This enzyme, an iron-porphyrin protein, catalyzes the oxidation of a number of substrates by the oxygen liberated simul-

taneously from H_2O_2 . The only other peroxides which can replace H_2O_2 are monosubstituted organic ones, *e.g.*, monoethyl hydrogen peroxide, $\text{C}_2\text{H}_5\text{O}\cdot\text{OH}$. The decomposition of H_2O_2 under the influence of the enzyme seems to occur only when coupled with the oxidation of a metabolite. Among the latter are adrenaline, ascorbic acid, histidine, tryptophan, tyrosine, *p*-cresol, and a number of dyes. The distinctive feature of peroxidase is its inability to utilize molecular O_2 , using only the oxygen of a peroxide.

The distribution of peroxidase is widespread in plant tissues. Potatoes and horse-radish are especially rich and useful sources of it. In animal tissues it has been recognized in the spleen but is probably absent from most organs. Its significance for animal oxidations is questioned. Leucocytes, however, contain a green-colored verdoperoxidase. Agner isolated it from pus cells of empyemic fluid. It was shown to contain 0.1 per cent of iron and 0.001 per cent of copper. Other iron-porphyrin proteins of animal tissues, *e.g.*, hemoglobin, show at least some peroxidase-like action. They are able to oxidize some of the dyes which are substrates for peroxidase with the aid of H_2O_2 .

Theorell has isolated crystalline peroxidase from the horse-radish and obtained it in a probably pure condition from milk. It has a brownish color. There seems no doubt of its iron-porphyrin character, inasmuch as the activity of its preparations is proportional to their iron-porphyrin content, which is 1.48 per cent of the crystalline protein.

Catalase. Although this enzyme has been investigated more extensively than have any other oxidizing enzymes, its role in bio-oxidation is still only hypothetical. It catalyzes the reaction



Unlike peroxidase, catalase operates independently upon H_2O_2 , requires no other coupled reaction, and liberates inactive molecular O_2 . No substrate normally oxidized by catalase is known. Yet this enzyme appears to occur more commonly than any other one known to biochemists. No tissue that is "active" physiologically has been found to lack it, and its abundance in any tissue is roughly proportional to the oxidative rate. Thus the highly active embryonic tissues are higher in catalase than are the corresponding less active adult tissues. Other similar contrasts have been described.

One reason for the extensiveness of catalase studies is the fact that the method used is simple and accurate. A solution of H_2O_2 , properly buffered, is treated with the tissue or its extract or with the purified enzyme and the O_2 evolved is measured at suitable time intervals.

Catalase has been a favorite material for study of the kinetics of enzyme action.

Crystalline catalase prepared from liver by Sumner and Dounce shows evidence of being an isolated pure protein of molecular weight about 250,000. The iron content varies in different preparations. The purest ones are said to be free from copper. It is extremely active. Even at 0°C., 1 molecule decomposes about 440,000 molecules of H₂O₂ per second. Catalase shows a characteristic absorption spectrum which undergoes no visible change in the presence of H₂O₂. This unexpected result is probably due to the short life of the enzyme-substrate compound. The Fe-containing groups appear to be of more than one kind. Sumner and Dounce showed that beef liver catalase contains four such groups, some of which are decomposed by acidifying catalase to yield a ferric salt and biliverdin. One out of four of them is susceptible to conversion by HCl into bile pigment, according to Lemberg. Laskowski and Sumner found that beef erythrocyte catalase contains four heme groups but no group decomposable into iron and biliverdin.

Catalase has been called the "scavenger enzyme." One of its functions appear to be the protection of cells against any possible accumulation of H₂O₂, which is a by-product of a number of bio-oxidations and is highly toxic. But in some cells, namely, erythrocytes and certain kinds of bacteria, catalase is not always an efficient protector against peroxide poisoning. Moreover, Keilin and Hartree have shown that, in vitro, catalase, instead of destroying H₂O₂, may actually use it when in low concentration in furthering the oxidation of alcohol. The normal function of catalase is still in doubt.

Cytochrome-reducing Dehydrogenases. A number of enzymes cause the dehydrogenation of their substrates, using the cytochrome system without any other hydrogen acceptor. So far, no prosthetic group has been discovered for them. Among these enzymes are α -glycerophosphoric acid dehydrogenase, succinic acid dehydrogenase, and one of the lactic acid dehydrogenases.

As an example, the action of the succinic dehydrogenase, which apparently occurs in all animal tissues, may be cited.

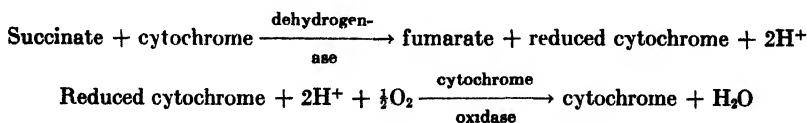

Thiaminoprotein Enzymes. A type of enzyme which is widely distributed has the prosthetic group in the form of thiamine pyrophosphate

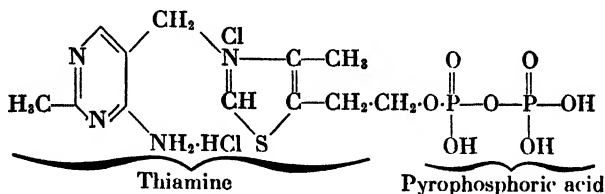

The outstanding reaction catalyzed by these enzymes is the breakdown of pyruvic acid. Causing decarboxylation, the enzymes are called **carboxylases**, and the prosthetic group is known as **co-carboxylase**. The existence of a special type of enzyme for this reaction is of interest in view of the central role played by pyruvic acid in metabolism. It and

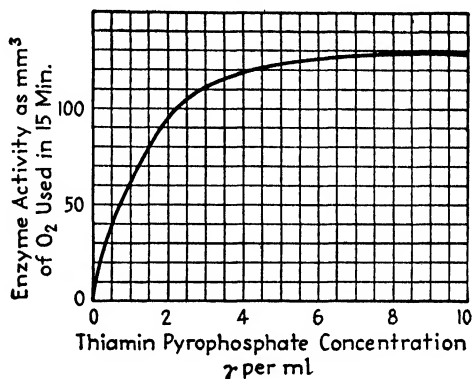
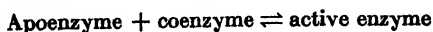

FIG. 66. The effect of the concentration of thiamine pyrophosphate upon the activity of pyruvic acid oxidase. These results of Lipmann's were used by him to calculate the dissociation constant of the compound of co-carboxylase (thiamine pyrophosphate) with the apoenzyme (protein) of carboxylase (pyruvic acid oxidase). The dissociation constant was found to be intermediate between those reported from Warburg's laboratory for *D*-amino acid oxidase (a flavine-adenine-protein) and alcohol dehydrogenase (a diphosphopyridine protein). (After F. Lipmann, *Cold Spring Harbor Symposia on Quant. Biol.*, 7, 248, 1939.)

similar α -keto acids can arise as a result of so many oxidative reactions (Chap. XVI) that their disposal assumes prime importance. The disturbances associated with accumulation of pyruvic acid in the blood and tissues were discussed in connection with thiamine. The effectiveness of the prosthetic group is indicated in Fig. 66.

Such measurements are probably indicative of the comparative concentration of a vitamin, in this case thiamine, which must be maintained in a tissue if the enzyme of which it is a component is to operate normally. In the reaction



the firmer the union (the lower the dissociation constant of the enzyme complex), the lower is the concentration of the coenzyme required in the cell to keep the enzyme concentration at an effective level. The concentration of a coenzyme may be related in some cases to the dietary requirements for a vitamin.

Both Mn and Mg salts, when added to *in vitro* mixtures of enzyme, coenzyme, and substrate, markedly increase the activity. Mn is the more effective, as little as 10 γ of Mn added to a mixture containing 3 γ of cocarboxylase causing a fivefold increase in activity. The role of these divalent ions has not been explained but seems to be an indispensable one. Green suggests that the metal may be required to bind the prosthetic group to the protein. A concentrated preparation of the enzyme from yeast contained 0.13 per cent of Mg. Other divalent ions, Fe, Ca, Cd, Zn, and Co, have some activating effect although less than that of Mn and Mg.

The catalyzed reaction as observed with yeast preparations probably is

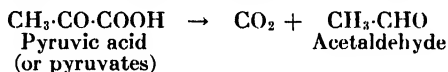

Similar decarboxylation is catalyzed by this enzyme with α -ketobutyric acid, $\text{CH}_3\cdot\text{CH}_2\cdot\text{CO}\cdot\text{COOH}$, α -ketovaleric acid, $\text{CH}_3\cdot(\text{CH}_2)_3\cdot\text{CO}\cdot\text{COOH}$, or other similar acids as substrate. These reactions should not be confused with *oxidative* decarboxylation, involving a different enzyme system (p. 382) and requiring oxygen. Pyruvic acid yields acetic acid in this case.

Preparations of this enzyme from bacteria (*B. delbruckii*) are, however, practically inactive on pyruvic acid except in the presence of flavine-adenine-dinucleotide. Apparently a coupled reaction involving oxidation of acetaldehyde to acetic acid is required. The net result may be shown thus:

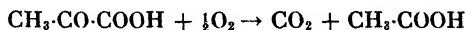

The thiaminoprotein enzymes of animal organs have been studied chiefly in normal and avitaminotic brain tissue. A preparation of the protein component is active on pyruvic acid after addition of diphosphothiamine, Mg or Mn, adenylic acid, phosphate, and fumarate. The fumarate, easily reduced to succinate, seems to be required to further a reaction coupled to the decarboxylation of pyruvic acid. The enzyme of brain tissue thus resembles the bacterial one rather than the yeast preparation. Studies on surviving tissue slices from various animal organs show the widespread distribution of carboxylase and indicate that the oxidation product formed is acetic acid.

This enzyme functions in several ways other than decarboxylation of α -keto acids. Some of them involve syntheses. It appears, for example, that the enzyme can catalyze the formation, through acetaldehyde as intermediate, of acetylmethylcarbinol from pyruvic acid.

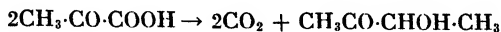

Other reactions involve the fixation of CO_2 . It has been demonstrated that the enzyme furthers the formation of α -ketoglutaric acid, $\text{COOH}\cdot\text{CH}_2\cdot\text{CH}_2\cdot\text{CO}\cdot\text{COOH}$, from pyruvic acid and carbonic acid.

The mechanism, although extensively investigated, has not been clarified. Most of the theories assume that the initial reaction produces oxaloacetic acid.

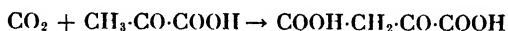

If this is the first product it must have only fleeting existence, as it is not detectable; but addition of oxaloacetate without pyruvate to the enzymatically active system yields various products, including α -ketoglutaric acid. The matter will be considered further in connection with the tri-carboxylic acid cycle.

The Mutase Effect. A number of enzymes can so operate upon a redox system that the same substrate is both oxidized and reduced simultaneously. The process is known as the mutase effect. An example is **aldehyde mutase**, which is obtainable from many sources but has been observed chiefly in milk and liver. It is believed to be a flavoprotein enzyme. With acetaldehyde as substrate both ethanol and acetic acid are formed.



The energy made available by the oxidation of one molecule of substrate is utilized in reducing another. Some other aldehydes behave similarly with this enzyme.

Mutase effects are produced by other enzymes. One of them obtained from liver is a pyridinoprotein. As the prosthetic group, coenzyme I, is oxidized and reduced, aldehyde is both reduced and oxidized.

Miscellaneous Oxidases. A considerable number of oxidizing enzymes extracted from animal, plant, or bacterial cells remain unclassified. Prosthetic groups, if present, are unknown. Acceptors operating with them are known in only a few cases. Among them is **amine oxidase** which catalyzes the destruction of a considerable number of amines by O_2 with the production of ammonia and H_2O_2 . This enzyme is apparently protective in animals against toxic amines formed by intestinal putrefactions.

Another unclassified enzyme is **uricase**, which oxidatively destroys uric acid with the formation of allantoin, CO_2 , and H_2O_2 . This enzyme may be an iron-porphyrin protein. It will be discussed more fully in connection with uric acid metabolism (Chap. XVI).

An unclassified enzyme, **glucose oxidase** of molds, causes the oxidation of glucose to gluconic acid. A similar enzyme, found in the liver and catalyzing the same reaction, is a pyridinoprotein.

Lactic acid dehydrogenase of certain bacteria is also of unknown structure and catalyzes a reaction ($\text{lactate} \rightleftharpoons \text{pyruvate}$) which in animal bodies is known to be catalyzed by a pyridinoprotein.

A number of enzymes specific for reactions of certain amino acids are in the unclassified group.

The Tricarboxylic Cycle. Based partly on studies with tissue extracts and partly on experiments with intact organisms, a postulation of a chain of oxidation-reduction reactions, called the "succinic acid cycle," was made (1937) by Szent-Györgyi and his coworkers. Succinic acid and other related 4-carbon acids seem to function reversibly in the oxidation of pyruvic acid and therefore in the oxidation of the several metabolites which yield it. A more complex series of reactions, known as the "citric acid cycle," was proposed (1937) by Krebs and his associates. Although many observations led to these postulations, one outstanding reaction was weighty in framing them, namely, the production of considerable amounts of α -ketoglutaric acid when pyruvates were added to certain cultures or to crushed-muscle preparations. The group of interrelated reactions is now called "the tricarboxylic acid cycle" because three of the components formed in it are tricarboxylic acids and a fourth one (citric acid) may also arise. One way of representing the cycle is shown in Fig. 67.

This scheme is based chiefly on work with muscle tissues, especially the pigeon breast muscle. There is direct or indirect evidence for the existence of all the enzymes required for the reactions here indicated. They are listed in Table 50 which also includes references to vitamins participating in the reactions. The pyruvic acid, which is represented as entering the cycle in two different ways, *i.e.*, either with or without the direct formation of oxaloacetic acid, is produced in a number of metabolic reactions such as deamination of alanine and decarboxylation of oxaloacetic acid (Fig. 67); but the major part of it is usually produced by carbohydrate oxidation via triose phosphates (see Chap. XIV). Pyruvic acid itself as actually fed into this "metabolic mill wheel" is probably phosphorylated and after being decarboxylated ($-\text{CO}_2$), the remaining fragment (probably the acetyl group, $\text{CH}_3\cdot\text{CO}$) may also be in combination with phosphoric acid. Although most of the reactions

in the cycle occur reversibly, two of them, the decarboxylation of pyruvic acid (1) and of α -ketoglutaric acid (6) are believed to be irreversible. If this is true, it accounts for the fact that, as is actually observed, the movement of the entire chemical mechanism is normally in the clockwise

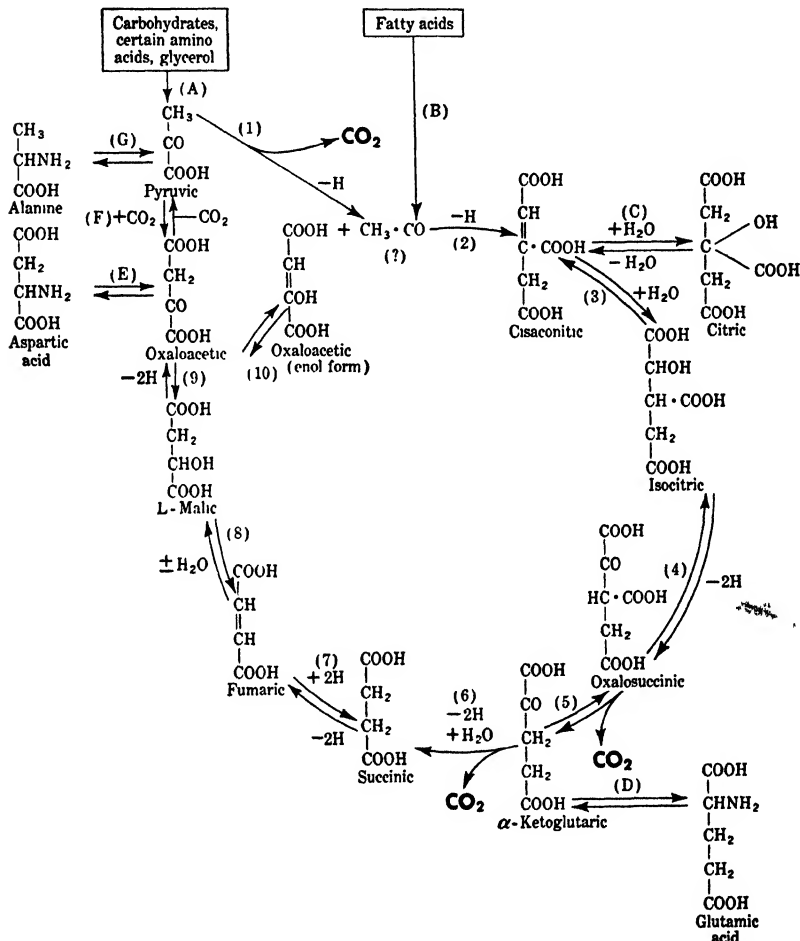

FIG. 67. The tricarboxylic acid cycle. Explanation in text; details regarding reactions in Table 50.

direction as represented in Fig. 67. The fact that Krebs, in describing his earlier discoveries in the field, referred to the reactions as the "citric acid cycle" was due to the circumstance that under some experimental conditions citric acid may accumulate and also to the observation that when citric acid is added to a suitable mixture the formation of α -keto-

glutaric acid may be increased. When the experimental conditions for observing this cycle are such that they represent the natural conditions relatively well, citric acid is not detected. But if added to the system, citric acid is oxidized by it. These ideas are shown schematically

TABLE 50.—DATA REGARDING ENZYMES AND COENZYMES OPERATING IN THE TRICARBOXYLIC CYCLE

Reactions as indicated in Fig. 67	Enzymes, where known	Coenzymes, where operative, and vitamins involved
(1)	Oxidative decarboxylase, not well studied in animal tissues	Coenzyme I (niacin) and diphosphothiamine with ATP required
(2)	Believed to be "citrogenase"	Pantothenic acid seems to be required either for reaction (1) or for (2)
(3)	Aconitase	
(4)	Isocitric dehydrogenase	Coenzyme II (niacin)
(5)	Oxalosuccinic decarboxylase	
(6)	An oxidative decarboxylase system, probably acts with phosphorylation, using ATP	Probably requires both thiamino- and pyridinoprotein enzymes
(7)	Succinic dehydrogenase	No coenzyme, but uses $-S-S- \rightleftharpoons -SH$ groups
(8)	Fumarase	
(9)	Malic dehydrogenase	Coenzyme I (niacin)
(10)	Seems to need no enzyme	
(A)	Enzymes involved in glycolysis	See Chap. XIV
(B)	Enzymes for fat oxidation	See Chap. XV
(C)	Aconitase	
(D)	Transaminase	See Chap. XVI
	Glutamic dehydrogenase	Coenzyme I (niacin)
(E)	Transaminase	See Chap. XVI
(F)	Oxalacetic carboxylase	Seems to need biotin
(G)	Transaminase	See Chap. XVI

(Fig. 67) by placing the reaction between cisaconitic and citric acids outside the cycle.

Observing the complex reactions that constitute this cycle, one may easily lose sight of the simple fact that it is the machine for carrying on the oxidation of pyruvic acid:

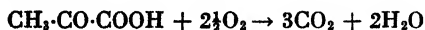

At three points CO_2 is given off, and at each of five places a pair of H atoms is stripped out; but as three pairs are taken up in the form of H_2O molecules, the net loss is $2H_2$, which are combined with oxygen with the

aid of enzyme systems that are not part of the cycle. Thus the net effect of one turn of this metabolic mill wheel is the oxidation of one molecule of pyruvic acid according to the above formulation. For simplicity, the compounds concerned are spoken of as acids. Actually of course, at the pH prevailing in protoplasm or in the presence of buffers used in test-tube experiments, these acids are not present as such but as salts; so that we are really dealing with pyruvates, citrates, succinates, malates, etc. It is also well to bear in mind the fact that only minute (catalytic) amounts of the compounds in the cycle are needed.

In addition to the oxidation of pyruvic acid, any compound which appears in the cycle itself, *e.g.*, acetates, oxaloacetates, etc., can also be oxidized by it. Such compounds arise during metabolism of amino acids, fatty acids, and carbohydrates, so that the tricarboxylic acid cycle is the prime mechanism of many cellular oxidations. Some of the paths through which other metabolites pour their products into the cycle are indicated in Fig. 67. More will be considered in Chap. XVI.

The description of the cycle was modified many times between 1937 and 1948. One hesitates even now to say that it is nearly complete. The chief uncertainty at the present time is with regard to reaction (1), by which pyruvic acid may enter the cycle.

Glutathione. Hopkins described a substance known as "glutathione," which can function as a hydrogen acceptor. It has been prepared in pure form from tissue extracts and has been artificially synthesized. In reduced form it is a tripeptide of glycine, cysteine, and glutamic acid.

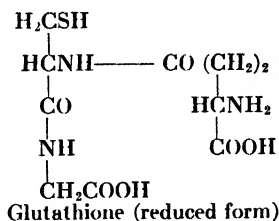

It oxidizes by loss of hydrogen from the —SH group ($\text{R—SH} + \text{R—SH} \rightleftharpoons \text{RS—SR}$). It is widely distributed, occurring in so many kinds of animal and plant tissues and microorganisms that one is inclined to assume that it is a universal constituent of active cells. It is detected in its reduced form by Mörner's sensitive test for cysteine, giving a brilliant purple color with sodium nitroprusside. As cysteine or other —SH compounds which can give the color appear to be absent from tissues, the test has been used for glutathione. Its low concentration (0.01 to 0.02 per cent) suggests that it functions in a catalytic manner.

It is suggested by Hopkins that the redox system glutathione-reduced glutathione is related to the dehydroascorbic acid-ascorbic acid system. In a study of the ascorbic acid oxidase prepared from cabbage or cauliflower he found that the oxidation of ascorbic acid in the presence of O_2 and the enzyme is inhibited by the presence of glutathione as though dehydroascorbic acid could act as H_2 acceptor in the oxidation of reduced glutathione. A possible function of glutathione was suggested (p. 289) in connection with detoxication.

The Significance of Phosphoric Acid. The prominence of the phosphoric acid group, either in its simpler form or as pyrophosphoric acid, in bio-oxidation is impressive. The oxidizing enzymes of the pyridino-, the flavo-, and the thiaminoprotein types contain phosphoric acid in their prosthetic groups. Moreover, a large number of oxidative or hydrolytic mechanisms by which carbohydrates and lipids are utilized in metabolism operate upon the metabolites while they are in the form of phosphoric acid derivatives, such as hexose monophosphate, hexose diphosphate, phosphopyruvic acid, lecithins, other phospholipids, etc. The general utility of phosphoric acid (phosphates) is especially notable in connection with metabolism (Chaps. XIV to XVI). F. Lipmann, in an extended review of this matter, has called attention to the energy-rich character of the phosphate bond when it exists in certain forms, including pyrophosphate and triphosphate groups (see p. 417).

Summary. Bio-oxidation is the subtitle of the drama of life. It is the central theme of every physiological story. It is characteristic and cannot be closely imitated in nonliving systems. It is one process which must go on if life is sustained, and its failure is the infallible sign of death.

In spite of all that is known about bio-oxidation, it is a drama of which the plot is still unsolved. The biochemist is a stagehand. His position in the wings has enabled him to get acquainted with some of the actors (enzymes), to see the properties (foodstuffs) going on the stage, to catch snatches of conversation and hear stage effects (activity of certain enzymes) during the play, and to know that the play goes to a successful conclusion (growth, maintenance, production of heat and work, excretion of H_2O , CO_2 , and other waste products) unless there are missing (malnutrition) some of the stage properties or unless hoodlums (invading organisms) interfere. But how the plot works out he does not know. One guess is worth considering as a tentative explanation of a part of the problem. It is fairly apparent that cellular enzymes are not generally in haphazard positions but are definitely oriented in protoplasmic organization, as are the members of a chorus or a ballet on the stage, so that they can perform as a unit. This guess is based partly on the orderly sequence of oxidation-reduction reactions proceeding as a unit, although

involving many enzymes, and partly on the well-known effects of injury. Slight mechanical injuries may depress the oxidation in a cell and severe ones abolish it. Incidentally, the converse is also true. Depressed oxidation, as in oxygen deprivation, causes cytological disorganization, reversible in early stages, but eventually fatal. Pursuing the allegory a little further, the cell is not only the stage but is the training school, producing the actors, and the shop, producing the stage setting. The cell synthesizes its enzymes and its protoplasmic materials.

In résumé of what is known of bio-oxidation the following list gives the known types of cellular oxidizing systems:

1. Metallo-protein enzyme systems reacting directly with oxygen
2. Flavoprotein enzymes reacting directly with oxygen
3. Flavoprotein enzymes reacting through the cytochrome system with oxygen
4. Pyridinoprotein enzymes reacting through a flavoprotein system with oxygen
5. Pyridinoprotein enzymes reacting through a flavoprotein enzyme system which in turn reacts through the cytochrome system with oxygen
6. Dehydrogenases reacting through the cytochrome system with oxygen.

REFERENCES

An especially useful, concise description of oxidative enzymes with a clear exposition of their significance is found in "Mechanisms of Biological Oxidations" by D. E. Green, Cambridge, England, 1940, New York, 1941.

Much helpful material on bio-oxidation may be gleaned from "Perspectives in Biochemistry" by J. Needham and D. E. Green, New York, 1937.

Some very illuminating papers are included in "A Symposium on Respiratory Enzymes," Madison, Wisconsin, 1942.

Reviews include the following:

ANSON, M. L., and MINSKY, A. E., Hemoglobin and the Heme Pigments and Cellular Respiration, *Physiol. Rev.*, 10, 506, 1930.

BALL, E. G., Biological Oxidations and Reductions, *Ann. Rev. Biochem.*, 11, 1, 1942.

BARRON, E. S. G., Cellular Oxidation Systems, *Physiol. Rev.*, 19, 184, 1939.

BARRON, E. S. G., Biological Oxidations and Reductions, *Ann. Rev. Biochem.*, 10, 1, 1941.

ELLIOTT, K. A. C., Biological Oxidations and Reductions, *Ann. Rev. Biochem.*, 15, 1, 1946.

EVANS, E. A., JR., Pyruvate Oxidation and the Citric Acid Cycle, *Biol. Symposia*, 5, 159, 1941.

GREEN, D. E., and STUMPF, P. K., Biological Oxidations and Reductions, *Ann. Rev. Biochem.*, 13, 1, 1944.

HOGNESS, T. R., Oxidation Catalysts, *Biol. Symposia*, 5, 119, 1941.

LARDY, H. A., and ELVEHJEM, C. A., Biological Oxidations and Reductions, *Ann. Rev. Biochem.*, 14, 1, 1945.

LIPMANN, F., Biological Oxidations and Reductions, *Ann. Rev. Biochem.*, 12, 1, 1943.

MICHAELIS, L., Biological Oxidation and Reductions, *Ann. Rev. Biochem.*, 16, 1, 1947.

STERN, K. G., Biological Oxidations and Reductions, *Ann. Rev. Biochem.*, 9, 1, 1940.

TAUBER, H., Nonproteolytic Enzymes, *Ann. Rev. Biochem.*, 10, 47, 1941.

THEORELL, H., Nonproteolytic Enzymes, *Ann. Rev. Biochem.*, 9, 663, 1940.

WEIL-MALHERBE, H., Biological Oxidations and Reductions, *Ann. Rev. Biochem.*, 17, 1, 1948.

The following papers serve to illustrate a number of methods in the investigation of representative types of oxidative enzymes:

AGNER, K., Verdoperoxidase, *Advances in Enzymol.*, 3, 137, 1943.

AXELROD, A. E., SOBER, H. A., and ELVEHJEM, C. A., Reduction of the *d*-Amino-acid Oxidase Content of Rat Tissues in Riboflavin Deficiency, *Nature*, 144, 670, and *J. Biol. Chem.*, 134, 749, 1939, 1940.

- BALL, E. G., and RAMSDELL, P. A., The Catalytic Action of Milk Flavoprotein in the Oxidation of Reduced Diphosphopyridine Nucleotide (cozymase), *J. Biol. Chem.*, **131**, 767, 1939.
- BAWN, C. E. H., and GARNER, W. E., Coupling of Phosphorylation and Oxidation Processes, *Nature*, **157**, 659, 1946.
- BORSOOK, H., The Oxidation-Reduction Potential of Coenzyme I, *J. Biol. Chem.*, **133**, 629, 1940.
- HAAS, E., Cytochrome Oxidase, *J. Biol. Chem.*, **148**, 481, 1943.
- HAAS, E., Separation of Cytochrome Oxidase into Two Components, *J. Biol. Chem.*, **152**, 695, 1944.
- KEKWICK, R. A., and PEDERSON, K. O., Some Physico-chemical Characteristics of the Yellow Respiratory Enzyme, *Biochem. J.*, **30**, 2201, 1936.
- KLEIN, J. R., and KOHN, H. J., The Synthesis of Flavin-adenine Dinucleotide from Riboflavin by Human Blood Cells in vitro and in vivo, *J. Biol. Chem.*, **136**, 177, 1940.
- LIPMANN, F., Flavin Component of the Pyruvic Acid Oxidation System, *Nature*, **143**, 436, 1939.
- LIPMANN, F., Metabolic Generation and Utilization of Phosphate Bond Energy, *Advances in Enzymol.* **1**, 99, 1941.
- MRIKLEJOHN, G. T., and STEWART, C. P., Ascorbic Acid Oxidase from Cucumber, *Biochem. J.*, **35**, 755, 1941.
- NICOLET, B. H., The Structure of Glutathione, *J. Biol. Chem.*, **88**, 389, 1930.
- OCHOA, S., and ROSSITER, R. J., Flavin-adenine-dinucleotide in Tissues of Rats on Diet Deficient in Flavin, *Nature*, **144**, 787, 1939.
- PUCHER, G. W., SHERMAN, C. C., and VICKERY, H. B., A Method to Determine Small Amounts of Citric Acid in Biological Material, *J. Biol. Chem.*, **113**, 235, 1936.
- THEORELL, H., The Protein Component of the Yellow Enzyme and its Coupling with Lacto-flavin-phosphoric Acid, *Biochem. Ztschr.*, **290**, 293, 1937; *Chem. Abstracts*, **31**, 5394, 1937.
- SCHULTZE, M. O., The Effect of Deficiencies of Copper and Iron on the Cytochrome Oxidase of Rat Tissues, *J. Biol. Chem.*, **129**, 729, 1939.
- SMITH, E. L., and STOTZ, E., Solubilization and Purification of Cytochrome Oxidase, *Fed. Proc.*, **9**, 230, 1950.
- WAINIO, W. W., COOPERSTEIN, S. J., KOLLEN, S., and EICHEL, B., Cytochrome Oxidase, *Science*, **106**, 471, 1947.

CHAPTER XIII

CALORIMETRY AND ENERGY METABOLISM

The fuel requirements of the animal body must be met by an adequate intake of oxidizable food. The requirement is measured in Calories,¹ and its determination together with the measurement of the fuel value of food may be termed "calorimetry." The actual number of Calories required per day is widely variable, being determined by the needs for (1) maintenance of the organization of cells and tissues, (2) growth and repair, (3) maintenance of body temperature, (4) production of secretions, and (5) nervous and muscular activities. All these physiological processes are accompanied by and dependent upon biological oxidation, the main source of energy liberated in living matter. It is often true that during a limited time the organism is not in energy balance, showing a deficit during periods of starvation or subnutrition or a plus balance during abundant feeding when growth, recovery, or fattening is in progress. But in the long run and during the major part of normal adult life, the animal body may exhibit a perfect energy balance, so that the calorie value of the food intake is just equal to the total energy liberated in the form of heat, mechanical work, and electrical energy. Obviously, the determination of the calorie requirement is an important aspect of nutrition and dietetics.

The Heat of Combustion of Foods. The energy obtainable by oxidation of organic compounds, including foodstuffs, can be measured by several methods. One of them employs the bomb calorimeter (Fig. 68). A weighed amount of the material of which the energy is to be measured is placed in a suitable crucible and enclosed in a tightly sealed steel bomb, which is lined with platinum or gold-plated copper. The bomb is provided with a valve through which O₂ can be introduced under suitable pressure, *e.g.*, 20 atmospheres, and is immersed in a water-filled chamber, which is insulated to prevent heat loss. The material in the crucible is ignited by an electric arc, and the resultant rise of temperature of the water surrounding the bomb is observed, using a sensitive differential thermometer. The water is stirred throughout the period

¹ The Calorie as referred to in the biochemistry of nutrition is the large Calorie (kilocalorie) or the amount of heat required to raise the temperature of 1 kg. of water through 1°C., or, more strictly defined, from 15°C. to 16°C.

of observation. A small electric motor drives the stirring apparatus. The weight of water used, which must be definitely known and expressed in kilograms, is multiplied by the rise in temperature expressed in degrees

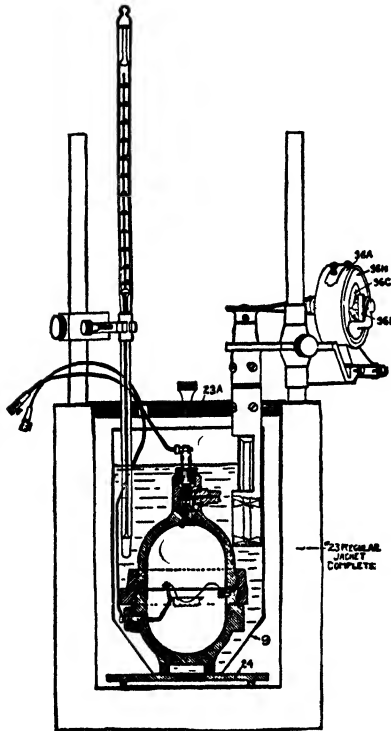

FIG. 68. Bomb calorimeter. The steel bomb is shown in sectional view. The crucible, with electrical connections for making an arc, is supported in the center of the bomb. The water that surrounds the bomb is kept in motion by a stirring device actuated by a small motor (36A-F). The bulb of a delicate thermometer is immersed in the water. The jacket and cover that form the outside container are constructed so as to afford heat insulation. (As supplied by the Emerson Apparatus Company.)

amount of energy when completely oxidized. A theoretical calculation shows that, if all the nitrogen of the metabolized protein left the body in the form of urea, the resultant loss in availability of the potential

centigrade to obtain the result in Calories. Certain corrections for heat generated by the electric current, etc., must be applied. The apparatus may be standardized by the combustion of a known amount of some substance, e.g., ethanol, of satisfactory purity and known heat value.

The values obtained in the case of some substances of physiological interest are shown in Table 51.

The caloric values of the carbohydrates, fats, and proteins used as human food all show considerable variation among themselves. It has become customary, however, to use weighted average values for each of the three classes of foods in computing the fuel value of a mixed food for which chemical analysis has shown the content of carbohydrate, fat, and protein. These average fuel values are as follows:

Carbohydrate.....	4.10 Cal. per g.
Fat.....	9.45 Cal. per g.
Protein.....	5.65 Cal. per g.

Protein fuel value actually available in the body is less than the protein heat of combustion. A large portion of the protein utilized is converted into urinary products which are incompletely oxidized. As shown in Table 51, urea and creatinine can yield a considerable

energy of the protein would be about 0.9 Cal. per g. of protein. Actually, however, some of the excreted products of protein breakdown (creatinine, uric acid, etc.) have caloric values higher than that of urea so that estimates based on studies of the calories consumed as protein and the corresponding caloric values of the urinary products have led to the conclusion that about 1.3 Cal. per g. of protein should be the average allowance for incomplete oxidation in protein metabolism, reducing the figure 5.65 to 4.35 Cal. per g.

TABLE 51.—HEATS OF COMBUSTION OF ORGANIC SUBSTANCES

Substance	Calories per Gram	Substance	Calories per Gram
Carbohydrates:		Proteins:	
Glucose	3.75	Edestin	5.64
Sucrose	3.96	Gliadin	5.74
Starch	4.23	Casein	5.85
Glycogen	4.22	Albumin	5.80
Fats:		Gelatin	
Animal body fat	9.60	Animal waste products:	
Butterfat	9.30	Creatinine	4.58
Olive oil	9.00	Urea	2.53

In calculating the fuel values of food, however, an allowance for incompleteness of absorption from the intestine must be made. Approximate averages, as obtained by analyses of the food and the feces during the use of a mixed diet, are as follows:

Carbohydrates	98 per cent absorbed, 2 per cent lost
Fats	95 per cent absorbed, 5 per cent lost
Protein	92 per cent absorbed, 8 per cent lost

After these allowances are made, the average fuel values *actually available in human nutrition* are given approximately as follows:

Carbohydrates	(4.1 × 0.98)	4 Cal. per g.
Fats	(9.45 × 0.95)	9 Cal. per g.
Protein	(4.35 × 0.92)	4 Cal. per g.

These caloric values are the Atwater and Bryant factors for calculating fuel values of food from the results of chemical analysis and are probably more suitable for use in human dietetics than the somewhat higher factors previously proposed by Rubner.

The dietitian does not ordinarily calculate the caloric values of any food to be used in a diet but makes use rather of the extensive data already available and published by governmental and other laboratories. The data include values for food as marketed and as prepared for the table and are conventionally expressed as Calories per unit of weight or as the

TABLE 52.—CALORIE VALUES OF REPRESENTATIVE FOODS¹

Food	Fuel value	100-Calorie
	per 100 g.	portion
	cal.	g.
Foods of high caloric value:		
Oil, vegetable salad oil.....	900	11
Butter.....	733	14
Bacon, fat.....	712	14
Bacon, broiled, drained.....	599	17
Almonds.....	640	16
Cashew nuts.....	609	16
Foods of medium caloric value:		
Sausage.....	416	24
Ham, medium fat.....	340	29
Crackers, plain soda.....	416	24
Corn flakes.....	359	28
Bread, white commercial.....	261	38
Beef, medium fat.....	290	35
Beef, lean, round.....	150	66
Cheese, American, "Cheddar".....	393	25
Cheese, cottage.....	101	99
Milk, condensed, sweetened.....	327	31
Ice cream, plain.....	214	47
Raisins.....	298	34
Maple sirup.....	256	39
Eggs.....	158	64
Corn, fresh, sweet.....	108	93
Baked beans without pork.....	103	97
Foods of low caloric value:		
Bananas.....	98	102
Apples.....	64	156
Oranges.....	50	199
Milk, fresh whole.....	69	145
Potatoes.....	85	117
Beets, fresh.....	46	219
Carrots.....	45	224
Cabbage.....	29	346
Asparagus.....	26	384
Spinach.....	25	400
Celery.....	22	455
Lettuce.....	18	550

¹ Values are computed for the edible portion.

weight of the 100-Cal. portion. Representative data are presented in Table 52.

It will be noticed that foods of high caloric value (small 100-Cal. portions) are those low in water content (*e.g.*, nuts) and high in fat (*e.g.*, butter and salad oil) while low caloric values characterize foods of high water content.

Animal Heat Production and Respiratory Exchange. Energy liberation is nearly the same thing as oxidative metabolism in the animal body inasmuch as oxidative reactions are almost the only sources of free energy. Oxidative metabolism is, in turn, well reflected by the respiratory exchange so that one may speak of the latter as representative of energy metabolism. The total amount of energy liberated is not readily calculated since some of it is utilized for endothermal reactions involving the synthesis of protoplasmic materials. The net free energy can be calculated as heat plus mechanical work and is practically equivalent to the energy of bio-oxidation.

Although other methods are used there are two chief ones commonly employed for the measurement of energy metabolism.

1. Direct calorimetry, which is the determination of the heat production plus the mechanical work, the sum being expressed in Calories. To obtain the caloric value of the mechanical work one multiplies the measured work by the mechanical equivalent of heat. A factor in general use for this conversion is

$$426.5 \text{ kilogram-meters} = 1 \text{ kilogram-calorie}$$

2. Indirect calorimetry is carried out by measurement of the respiratory exchange, *i.e.*, O₂ used and CO₂ produced. Indirect calorimetry must be accompanied by determination of urinary nitrogen, as will be explained presently. These two methods will now be described in turn.

The Animal Calorimeter: Direct Calorimetry. The apparatus used for measurement of the energy transformations of an animal is a calorimeter. The modern type is exemplified by the Atwater-Rosa-Benedict form (Fig. 69) designed for use in experiments on man. This is the most nearly completely equipped type. It measures, simultaneously, the respiratory exchange and the heat production of the subject of the experiment. The main part of the apparatus is a chamber which can be hermetically sealed. Its size depends upon whether the subject is to lie still or is to be permitted to move about during the experiment. Smaller calorimeters are constructed for experiments on animals.

For the purpose of measuring the respiratory exchange and to ventilate the air of the chamber, an inlet and an outlet are provided. A circulation of air is maintained through the chamber and a connecting system

of closed tubes and containers. A suitable air blower is included in the circuit to maintain air movement. The air enters the chamber after being dried and warmed. As it leaves the chamber, it is forced through sulfuric acid in order to remove the moisture evaporated from the sub-

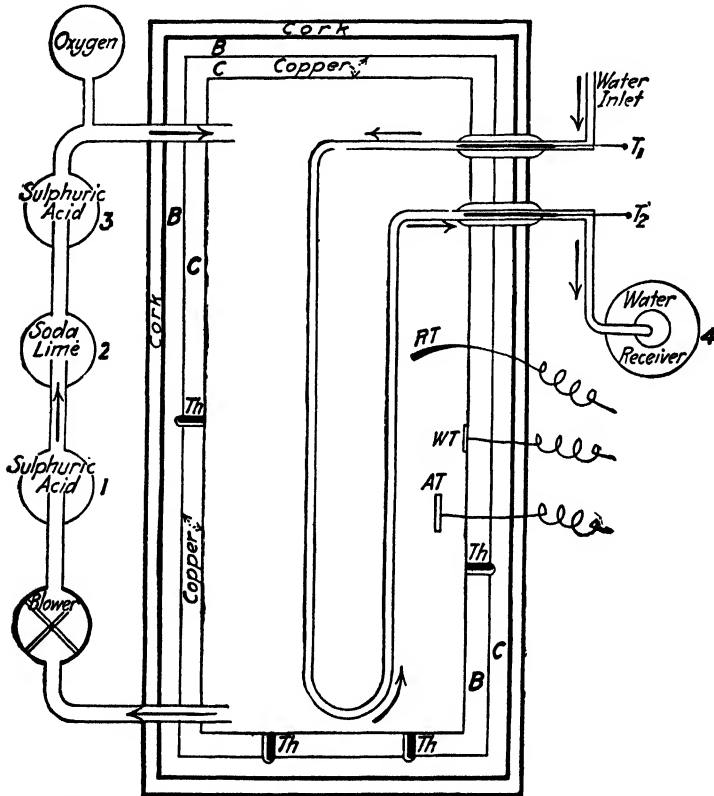

FIG. 69. Diagrammatic plan of respiration calorimeter, Atwater-Rosa-Benedict type. Absorbers at 1, 2, and 3. B and C, dead-air spaces. Th, thermocouple. T_1 and T_2 , thermometers for water as it enters and leaves the chamber. RT, rectal thermometer. WT, wall thermometer. AT, air thermometer. (After G. Lusk.)

ject. The acid is held in "absorbers" which can be weighed at the beginning and the end of the experiment. Their gain in weight shows the amount of water evaporated from the respiratory passages and the skin. After leaving the sulfuric acid the air is forced through containers filled with soda lime, which absorbs CO_2 . The water which evaporates from these containers is absorbed by sulfuric acid between them and the air inlet of the chamber. By weighing these soda lime and sulfuric acid containers before and after the experiment, their combined increase in

weight is measured. It permits computation of the CO_2 produced by the subject of the experiment. Oxygen utilization, which tends to deplete the supply in the air circulating through the apparatus, is compensated for by additions of this gas from a tank of compressed oxygen. The latter is so arranged that the diminished pressure due to oxygen utilization automatically admits oxygen from the tank to replace that used. The loss of weight of the tank during the progress of the experiment gives the amount of oxygen used, provided due allowance is made for any change in the O_2 concentration of the system, for changes in its temperature, and for barometric changes. The composition of the air in the chamber is determined, analytically, from fair samples pumped out at the beginning and the end of the experiment. The temperature and pressure of the air in the chamber are also taken at these two times. By these various appliances, the apparatus permits the measurement of the H_2O and CO_2 given off and of the O_2 used during the time of observation. This is, in many cases, 1 hr., but in certain experiments the subject remains in the calorimeter during longer periods. Experiments lasting 10 days are on record. Food is passed in through a porthole with inner and outer airtight doors. The excreta are similarly removed.

The calorimeter also permits the measurement of heat production. For this purpose a flow of water is maintained through a coil of copper pipes suspended from the roof of the chamber. The water as it enters the coils is at a constant, controlled temperature, lower than that of the air of the chamber. Consequently, it absorbs the heat evolved by the occupant, acting in a way that is just the opposite of the action of an ordinary hot-water heating system. The water which flows out of the coil is collected in a tank, which is weighed at the beginning and the end of the experiment. Thus the amount of water which flows through is known. Electrical conductivity apparatus is attached to the water pipes at the points where they enter and leave the chamber. This permits frequent and very accurate recording of the water temperature at these points. From the data (volume of water passing through and average temperature at entrance and exit points) the heat evolved by the subject can be computed, with certain corrections described below, for any period of the experiment or for its entire duration.

Obviously, loss of heat by radiation from the chamber must be prevented. In experiments upon very small animals, this object is attained by the use of a Dewar flask with its surrounding vacuum which provides heat insulation. But in a large calorimeter, such as is used for human experiments, the vacuum-insulation principle is not practical. Instead, heat insulation is secured in part by the structure of the chamber. It has three walls separated by dead-air spaces which entirely surround the

chamber. The outermost of the three walls is especially constructed with cork interlining so as to afford heat insulation. The final attainment of heat insulation is reached by a device which depends upon the principle that heat does not radiate between bodies of the same temperature. The two inner walls are made of copper. An electrical thermocouple registers any minute temperature differences between them. An electrical heating system applied to the outer copper wall is regulated so as to keep the temperature of this wall the same as that of the inner one. Thus, heat loss through the walls of the chamber is effectively prevented and all heat given off by the occupant must be conveyed away from the chamber by the air and water currents. The air entering the chamber is warmed to the temperature which prevails within so that it is not itself warmed by the body heat of the subject.

A large part of the heat provided by the body is used in evaporation of water from the respiratory passages and the skin. Because of the high latent heat of water, a quarter or more of all the heat produced by the body is taken up as latent heat during evaporation. The actual amount can be reckoned from the quantity of water which is removed by the outgoing air. This quantity is determined by weighing the water absorbers and, as the latent heat of water is a well-established constant, the heat removed by evaporated water is satisfactorily computed.

Certain other corrections must also be taken into account. These include the temperature of the air in the chamber at the beginning and end of the experiment and the body temperature of the subject at the beginning and end. Both of these temperatures are obtained by means of electrical resistance thermometers which can be read outside the chamber. One thermometer is suspended in the air of the chamber; the other is inserted in the rectum of the subject. Inasmuch as the specific heats of air and of the animal body are approximately known, the readings of these thermometers permit the computation of any heat diminution or heat storage that may occur in the air or in the body of the subject during the experiment.

The Respiratory Quotient. The ratio of the CO_2 produced during a given time to the O_2 utilized simultaneously is known as the respiratory quotient (RQ). The gases are measured as volumes and corrected for temperature and barometric pressure. Thus the formula is

$$\text{RQ} = \frac{\text{liters of CO}_2 \text{ produced}}{\text{liters of O}_2 \text{ used}}$$

Some difficulty arises in view of the variability in the rate of excretion of CO_2 . Part of the CO_2 produced during a given period may fail to be measured. An excessive CO_2 output may also occur under some circum-

stances, such as rapid respiration or increased lactic acid concentration in the blood. Because of this, short periods for measurement of RQ values are often unsatisfactory. Over comparatively long periods, the possible error has less proportional significance. With either shorter or longer periods, corrections may be applied to the CO₂ measurements if gas analyses are made of the blood to determine its CO₂ content at the beginning and end of the period.

Values for the RQ are used in attempts to determine the proportional amounts of carbohydrate, fat, and protein undergoing oxidation. Suppose carbohydrate were the only substance being oxidized and its oxidation to CO₂ + H₂O were complete, we would have in the case of glucose

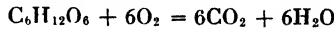

Recalling that all gases in equimolar amounts occupy the same volume at standard temperature and pressure, one sees that the ratio

$$\frac{\text{Liters of CO}_2 \text{ produced}}{\text{Liters of O}_2 \text{ used}} = \frac{6}{6} = 1 = \text{RQ}$$

Accordingly it is assumed that the more nearly an RQ value approaches unity, the more carbohydrate utilization is predominant in metabolism. Practically all carbohydrates would yield the same result in computations since they contain hydrogen and oxygen in proportion to form water, so that the oxygen used in complete oxidation is proportional to the C atoms.

In a similar way the theoretical RQ may be computed for a fat. In the case of tristearin, we have

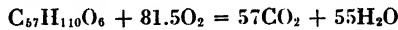

$$\text{RQ} = \frac{57}{81.5} = 0.699$$

Corresponding computations give

RQ for tripalmitin	0.703
RQ for triolein.....	0.713
RQ for "mixed" body fat.	0.713

The average value of the RQ for fat is commonly assumed to be 0.71.

Computation of a theoretical RQ for proteins is more complex because their oxidation is less predictable and yields a complex mixture of intermediate and final products. The method used in the computation will be explained in the next section (p. 396). The values thus obtained are 0.80 to 0.82. Protein is constantly utilized at a rate determined chiefly by the amount of protein ingested, but the rates of utilization of fat or carbohydrate are subject to comparatively rapid fluctuation. In general, one assumes that RQ values between 0.71 and 0.80 signify a high rate of

fat utilization, while values between 0.82 and 1.00 are indicative of carbohydrate oxidation.

RQ values larger than 1.00 or less than 0.70 have been observed and are explained on the basis of the conversion of carbohydrate to fat and of fat to carbohydrate, respectively. Thus during the fattening of geese with excessive food high in carbohydrate, an RQ of 1.38 was observed by Bleibtreu. Similar values are reported for hibernating animals during the period just prior to hibernation. But when the oxygen-poor fat is being converted to oxygen-rich carbohydrate during hibernation, an RQ less than 0.70 may be obtained.

Considerable caution should be used in the interpretation of RQ values obtained for isolated organs or tissues or for intact animals over a short period of observation. This is due not only to the interconversion processes between the major foodstuffs but also to variability in the intermediate products of metabolism. Thus, as Soskin has pointed out, pyruvic acid, $\text{CH}_3\text{CO}\cdot\text{COOH}$, an important intermediate compound in bio-oxidation of carbohydrate, may enter into a large number of metabolic reactions. For some of them the theoretical RQ may be zero as in its transformation into the amino acid alanine. For other reactions the RQ is as high as 2.00, *e.g.*, in its conversion to acetoacetic acid, $\text{CH}_3\text{CO}\cdot\text{CH}_2\cdot\text{COOH}$. Intermediate values are computed for other reactions which are also known to occur. A misinterpretation of RQ values was used to support the erroneous conclusion, long held, that carbohydrate was not oxidized by the diabetic organism. This matter will be discussed further in the next chapter. It is sufficient to state here that low RQ values (about 0.70) in diabetes are now regarded as due to excessive conversion of amino acids and fats to sugar rather than to a complete failure to oxidize carbohydrate. Nevertheless, the assumption is still made, whether rightly or wrongly, that when metabolism of the entire body rather than that of an isolated organ is measured during a period of hours rather than minutes the RQ is indicative of the nature of the food oxidized. Under normal conditions, the human body in health frequently yields RQ values between 0.80 and 0.93, which confirms the idea, supported by other evidence, that carbohydrate, fat, and protein tend to be utilized simultaneously, although in variable proportions.

Indirect Calorimetry. Calorimeters, especially those suitable for human subjects, are not available in many laboratories. But energy metabolism can be measured indirectly without the use of a calorimeter because certain relationships between the respiratory exchange and the energy liberation have been established by simultaneous measurements of both. The data required for indirect calorimetry are (1) CO_2 produced, (2) O_2 consumed, and (3) the urinary nitrogen for the period during which

CO₂ and O₂ were measured. The computations involved depend upon estimation of the actual amounts of protein, fat, and carbohydrate oxidized and are shown by a specific example.

Consider the following data for 24-hr. measurements on a normal person:

CO ₂ eliminated.....	306 liters
O ₂ consumed.....	360 liters
Total nitrogen of urine.....	11 g.

It is first necessary to estimate the protein metabolism, assuming¹ that 1 g. of nitrogen is representative of 6.25 g. of protein and requires, on the average, 5.92 liters of O₂ and yields 4.75 liters of CO₂ in oxidative metabolism. Thus elimination of 11 g. of urinary nitrogen shows

52.25 liters CO ₂ (11 × 4.75) due to protein oxidation
65.12 liters O ₂ (11 × 5.92) used in protein oxidation

Subtracting these values from the totals shows

253.8 liters CO ₂ due to fat and carbohydrate
294.9 liters O ₂ used for fat and carbohydrate

The *nonprotein* RQ thus becomes

$$\frac{\text{CO}_2 \text{ due to fat and carbohydrate}}{\text{O}_2 \text{ used for fat and carbohydrate}} = \frac{253.8}{294.9} = 0.86$$

A given nonprotein RQ corresponds, theoretically, to the utilization of one and only one proportion of carbohydrate to fat. The calculations of these proportions have been made (Table 53) and show that a non-protein RQ of 0.86 corresponds to oxidation of 0.622 g. of carbohydrate and 0.249 g. of fat with liberation of 4.875 Cal. when 1 liter of oxygen is used. Thus, it is found for the 24 hr., that

Fat oxidized.....	73.43 g. (0.249 × 294.9)
Carbohydrate oxidized.....	183.43 g. (0.622 × 294.9)
Protein oxidized.....	68.75 g. (6.25 × 11 g. of urinary N)

From these values the energy liberated may be computed thus:

	Cal.
From fat.....	73.43 × 9.45 = 694
From carbohydrate.....	183.43 × 4.10 = 752
From protein.....	68.75 × 4.35 = 299
Total for 24 hr.....	1745

¹ These assumptions were deduced (Loewy) from the average elemental composition of protein. Subtraction of the amount of each of the protein elements (C, H, O, N, and S) found in urine and feces from the corresponding amounts in the ingested protein shows the residue of these elements involved in protein oxidation. From such remainders, one may calculate the O₂ used and the CO₂ produced in protein oxidation and compute the protein RQ.

TABLE 53.—CALCULATED AMOUNTS OF CARBOHYDRATE AND FAT CONSUMED DURING THE UTILIZATION OF 1 LITER OF O₂ AS RELATED TO OBSERVED VALUES OF THE NONPROTEIN RQ

(Values are based upon calculations by Zuntz and Shumberg, modified by Lusk and by McClendon)

Nonprotein RQ	Equivalents of 1 liter of O ₂ used		
	Carbohydrate	Fat	Energy
	g.	g.	Cal.
0.707	0.000	0.502	4.686
0.71	0.016	0.497	4.690
0.72	0.055	0.482	4.702
0.73	0.094	0.465	4.714
0.74	0.134	0.450	4.727
0.75	0.173	0.433	4.739
0.76	0.213	0.417	4.751
0.77	0.254	0.400	4.764
0.78	0.294	0.384	4.776
0.79	0.334	0.368	4.788
0.80	0.375	0.350	4.801
0.81	0.415	0.331	4.813
0.82	0.456	0.317	4.825
0.83	0.498	0.301	4.838
0.84	0.539	0.284	4.850
0.85	0.580	0.267	4.862
0.86	0.622	0.249	4.875
0.87	0.666	0.232	4.887
0.88	0.708	0.215	4.899
0.89	0.741	0.197	4.911
0.90	0.793	0.180	4.924
0.91	0.836	0.162	4.936
0.92	0.878	0.145	4.948
0.93	0.922	0.127	4.961
0.94	0.966	0.109	4.973
0.95	1.010	0.091	4.985
0.96	1.053	0.073	4.998
0.97	1.098	0.055	5.010
0.98	1.142	0.036	5.022
0.99	1.185	0.018	5.035
1.00	1.232	0.000	5.047

Indirect calorimetry has an advantage over the direct method. The subject is not confined to a metabolism chamber but may be engaged in any form of activity during the measurement. The apparatus required for quantitative determination of O₂ used and CO₂ produced may be in portable form in a holder strapped to the back, so that if the urine is col-

lected quantitatively, the subject may even engage in mountain climbing or other outdoor activities.

Basal Metabolism. The oxidative metabolism which occurs without influence of food or muscular work is the basal metabolism. The conditions under which it can be measured include fasting for some 14 to 18 hr. and no muscular activity for approximately half an hour. The body is then in the basal condition. One might compare it to a furnace with the fire banked and dampened. The metabolism under these conditions is that required for body maintenance, but it is peculiar in that a steady state of dynamic equilibrium prevails with a comparatively predictable concentration of carbohydrate, amino acids, and fats in the blood and tissues in the form readily available for oxidation. These special equilibrium conditions do not prevail except during the limited period of about 14 to about 18 hr. after the last preceding meal. Basal metabolism is not equivalent to minimal metabolism (mere maintenance of life), as is shown by the fact that during sleep the oxidative rate is generally a little lower than the basal one.

The basal metabolic rate (BMR) may be measured as the per cent of variation of the basal metabolism from the expected or normal value. For example, suppose the measurement on a given subject shows a basal metabolism of 52.5 Cal. per hr. while established values for persons of the same sex, age, weight and height is 50 Cal. per hr. The difference (2.5 Cal.) is 5 per cent in excess of the expected value. Thus the BMR is plus 5 per cent.

Basal metabolism is usually measured by a determination of the oxygen consumption alone. The reason for this is that under these special conditions the body is oxidizing carbohydrate, fat, and protein in amounts which are physiologically predetermined and can be depended upon to vary only within relatively narrow limits. This is demonstrated by the comparative constancy of the RQ for subjects in the basal condition, which is in the neighborhood of 0.82. It is therefore possible to convert the value for O_2 consumption into the corresponding value for calories liberated without knowing the other data of indirect calorimetry (CO_2 production and urinary nitrogen). A factor generally used for this conversion is

1 liter of O_2 consumed is equivalent to 4.825 Cal.

which corresponds to an RQ of 0.82 as shown by actual calorimetry, both direct and indirect.

Measurement of the BMR. Use of BMR values has become extended because of their importance in diagnosis of disturbances of metabolism. Apparatus designed, for the most part, after that devised

by Benedict is readily available. Details of its construction and use are to be found in pamphlets accompanying each type of instrument, but the nature of the procedure may be briefly outlined. The subject, having taken no food since the preceding evening, comes to the laboratory before breakfast with minimum expenditure of energy, lies in *complete muscular and nervous repose* during about 30 min. and then breathes pure O_2 from a spirometer through a facial mask or similar device. As the expired air returns to the spirometer through an efficient CO_2 absorber and the entire closed gaseous system is kept saturated with water vapor, O_2 consumption is measured by the progressive decrease in the volume of O_2 in the spirometer. The measurement is continued during a convenient interval, which in one form of apparatus is 8 min.¹

It is not usually necessary to translate the O_2 consumption into Calorie values. The result may be merely expressed as milliliters of O_2 used per minute after the observed value has been corrected for temperature and barometric pressure. Such values permit comparisons to be made with the normal or "expected" values. The latter are available in tabulated form and, while they are based in general on averages as actually obtained on supposedly normal human subjects, the figures are modified to some extent in conformity with theoretical considerations of the effect of weight, height, and surface area of the body upon the BMR.

Factors Affecting the Basal Metabolism. The total oxidative metabolism under basal and all conditions might well be dependent, theoretically, upon the amount of the active protoplasmic mass of the body, although the protoplasmic mass can only be estimated. Such meager evidence as is available favors this theory first proposed by Rubner.

Relation to Surface Area. Rubner also proposed another theory which states that *the basal metabolism is proportional to the surface area*. This law appears to apply fairly well to warm-blooded homoiothermic animals. Constancy of body temperature is maintained against loss of heat by radiation and evaporation from the body surface, so that a relationship between heat production (basal metabolism) and surface area is not surprising.

The relationship has been satisfactorily established for human subjects, but its applicability to experimental animals is only approximately demonstrated because it is difficult to keep them sufficiently quiet for a basal measurement or to have activity strictly comparable in a series of measurements. Such investigations, however, have shown that the BM is not proportional to body weight. Indeed, smaller animals have

¹ This is the BMR apparatus or "metabolimeter" from the Sanborn Company of Cambridge, Mass.

higher metabolic rates per kilogram of body weight than larger ones. This is explained, in part, by the smaller proportion of bone, connective tissue, and other structures with low metabolic activity in the smaller animal, but is due chiefly to the relation between size and surface area.

In any two bodies of similar shape but different size, the surface of the smaller one is larger in proportion to its size than is that of the larger body. Of two spheres, one with twice the diameter of the other, the

TABLE 54.—CALORIES LIBERATED PER DAY (VOIT)

	Body weight	Metabolism per kg. of body weight	Metabolism per sq. m. of body surface
	Kg.	Cal.	Cal.
Horse.....	441.0	11.3	948
Pig.....	128.0	19.1	1,078
Man.....	64.3	32.1	1,042
Dog.....	15.2	51.5	1,039
Rabbit.....	2.3	75.1	776
Goose.....	3.5	66.7	969
Fowl.....	2.0	71.0	943
Mouse.....	0.018	212.0	1,188
Rabbit (without ears).....	2.3	75.1	917
Average.....	1,000

smaller one has only one-eighth the volume, but has one-fourth as much surface as the other. In bodies composed of material of the same specific gravity, their weights are proportional to their volumes, so that the weight of the smaller of two such similar bodies is less in proportion to that of the larger one than is its surface. Thus, of two animals of the same shape but one having one-eighth of the weight of the other, the smaller one has one-fourth of the surface of the other. For example, suppose two dogs to be of the same age and general shape but of breeds that so differ in size that one dog weighs 1 kg. and the other 8 kg. Their surfaces will be found to be in the proportion of 1:4 though their weights are as 1:8. The body surfaces of the two are proportional to the cube roots of the squares of their weights ($\sqrt[3]{1^2}:\sqrt[3]{8^2} = 1:4$). In any given species of animal, the actual surface can be computed from the weight, provided a constant factor peculiar to the species, relating weight to surface, be known. This constant allows for peculiarities in animal shape, such as long limbs or large ears. If s is the surface, k the constant, and w the weight, then

$$s = k \sqrt[3]{w^2}$$

The determination of the constant can be made only by actual comparison

between the weight and the measured surface of an animal. Table 54 contains data, calculated by E. Voit, which show that, although metabolism *per unit of body surface* in animals of different size is variable, the metabolism per unit of weight varies more widely. Not all these figures represent strictly basal metabolism, but all were obtained with resting animals and are comparable. They serve to show that warm-blooded animals produce about 1000 Cal. per day per sq. m. of body surface.

Benedict, after extended studies of basal metabolism of numerous species of homoiothermic animals, including human subjects, concluded (1938) that basal metabolism is not really proportional to the surface area even though it is more nearly so than it is to body weight. He further suggests that the older attempts to find a law of uniformity of basal metabolism might well give way to efforts to explain the differences.

In the case of man, empirical formulas for the estimation of body surface have been proposed by a number of investigators. The formula given by Brody, Comfort, and Mathews (1928) is

$$A = W^{0.53} \times H^{0.40} \times C$$

or in logarithmic form

$$\log A = 0.53 \log W + 0.40 \log H + \log C$$

where A is the surface area in square centimeters W , is the weight in kilograms, H is the height in centimeters, and C is a constant equal to 240.

A nomogram prepared by Boothby and Sandiford (Fig. 70) also shows the relation between surface area and weight and height.

Although not very accurately predictable, the basal metabolism can be approximately calculated, as shown by DuBois, for normal individuals. He found, for example, that measurements on a large number of adult men, not over fifty years of age, averaged 39.7 Cal. per hr. per sq. m. of body surface and that 86 per cent of all cases were within 10 per cent of the average. Computed for 24 hr., the value is 953 Cal. per sq. m. per day, about 9 per cent less than the older value (1042) reported by Voit (p. 401).

The Effect of Age. The above values apply to young adults and middle-aged persons only. The basal metabolism of children, involving growth, the rate of which is not constant, shows complex deviations. Data compiled by Rose are shown in Table 55. A sharp rise during infancy gives way to a fall during childhood. It is to be noted that not only the growth rate *per se* is involved but the period of sex development at puberty is also reflected in the basal metabolism, so that it shows a slower rate of decline or may even rise in boys during the period twelve to fifteen and in girls ten to thirteen years of age.

During the period of life from about twenty to about fifty years of age, the basal metabolism remains nearly constant (Fig. 71), showing only a slight decline, but during later years a somewhat greater, progressive

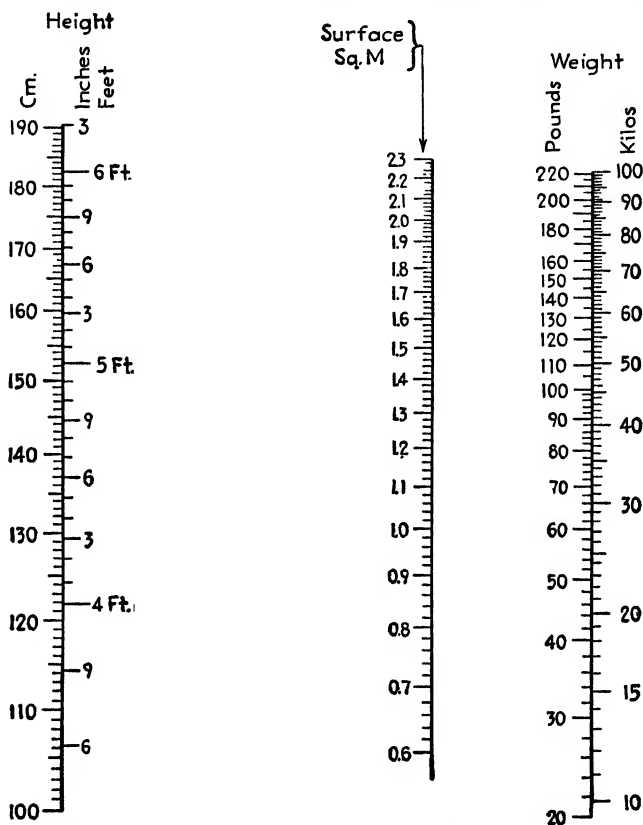

FIG. 70. Nomogram for estimation of the body surface area. A straight line is drawn from a point on the left-hand scale, corresponding to the person's height, to a point on the right-hand scale, corresponding to the weight. The line crosses the intermediate scale at a point corresponding to the body area in square meters. The nomogram is based on the DuBois formula for body surface area. (*Peters and Van Slyke, "Quantitative Clinical Chemistry," Williams and Wilkins Company.*)

decline occurs. Standard data for persons sixty years and over are comparatively meager.

The Influence of Sex. In general, the basal metabolism is larger per kilogram of body weight or per square meter of body surface for men than for women. That this is due to a direct effect of sex (action of male hormones as contrasted with that of female hormones) is not demonstrated. One must consider indirect effects of sex involving a difference

in structure and texture of tissues. The sex allowance to be made in computing the "normal" or expected value of the basal metabolism varies at different ages. This is indicated in Fig. 71.

TABLE 55.—BASAL METABOLISM OF CHILDREN
(Data compiled by M. S. Rose)

Age	Cal. per sq. m. per hr.	
Premature infants.....	25	
Birth to 2 weeks.....	25.5-29.2	
	Boys	Girls
3 months.....	38.7	36.2
6 months.....	43.3	41.2
9 months.....	46.6	45.8
12 months.....	47.5	46.2
15 months.....	48.1	46.4
18 months.....	48.3	45.8
21 months.....	48.0	45.7
2 years.....	47.9	45.4
3 years.....	47.1	43.3
4 years.....	45.8	42.5
5 years.....	44.5	41.6
6 years.....	43.7	41.2
7 years.....	42.9	40.4
8 years.....	42.1	40.0
9 years.....	41.6	39.5
10 years.....	40.8	37.1
11 years.....	38.9	37.5-41.4
12 years.....	38.5-51.5	38.2-42.4
13 years.....	38.5-46.5	37.4-41.0
14 years.....	37.3-44.3	36.6-40.8
15 years.....	45.3	31.0-34.6
16 years.....	44.7	31.0-32.3
17 years.....	43.7	32.3
18 years.....	42.0	32.2

Effect of Climatic Conditions. Measurements of the basal metabolism of people living in tropical or subtropical regions show average values about 10 per cent or even 20 per cent below those for comparable persons in temperate zones. An effect of the changing seasons has not been established by all of the observers who have looked for it. Several reports, however, indicate some tendency toward higher metabolism in cold weather than in hot weather.

Effects of Diet and of Starvation. A diet furnishing a subnormal amount of nourishment was shown by Benedict, in the case of 12 college students, to lower basal metabolism about 18 per cent as an accompani-

ment to an average decrease of 12 per cent in body weight. Chronic subnutrition in adults, as reflected by underweight, is generally found to be associated with a low BMR. In underweight children, however, Blunt found a heightened BMR *per kilogram of body weight*. Variations in the

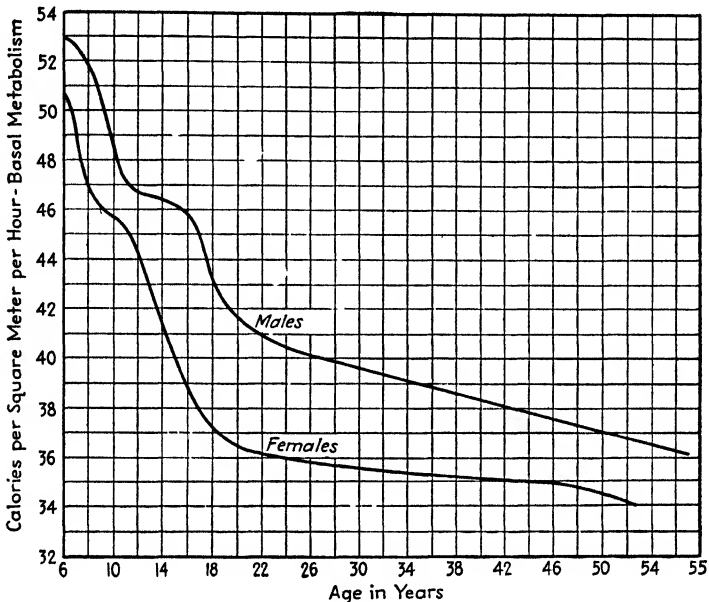

FIG. 71. The effect of age on basal metabolism. The great drop in the first part of the curve accompanies the decrease in the growth rate. The bend in this part of the curve accompanies the onset of puberty. The smoothness of the curve is the result of averaging a large number of measurements and should not be used to set up any rigid standard since some ± 10 per cent must be allowed to cover individual variations due to diet and other conditions of living but not necessarily signifying any abnormality in the metabolic rate.

The data used for these curves, which are not in agreement with the data presented in Table 51, are taken from Boothby, Berkson, and Dunn, *Am. J. Physiol.*, 116, 468, 1936.

quality of the diet, *mild* vitamin deficiencies, etc., have not been shown to exert marked effects on the BMR.

Starvation is accompanied by a considerable decrease in the basal metabolism. This is illustrated by the results of measurements shown in Fig. 72. It will be noticed that recovery of basal metabolism after the end of the fasting period required about 3 weeks.

Effect of Internal Secretions and Disease. The action of the thyroid hormone on the BMR is striking. This matter as well as similar effects of other internal secretions will be discussed more fully in Chap. XX; but

inasmuch as BMR measurements are especially useful for diagnosis of thyroid disturbances, it is to be noted in this connection that a lowered functioning of the thyroid (hypothyroid condition) may decrease the BMR by as much as 25 per cent and occasionally more. Correspondingly, an overactive thyroid (hyperthyroid condition) increases the BMR, sometimes as much as 40 per cent above normal.

The anterior pituitary may also cause disturbance of the BMR. The effect may be exerted indirectly through the influence of the thyrotrophic hormone of the anterior pituitary upon the activity of the thyroid.

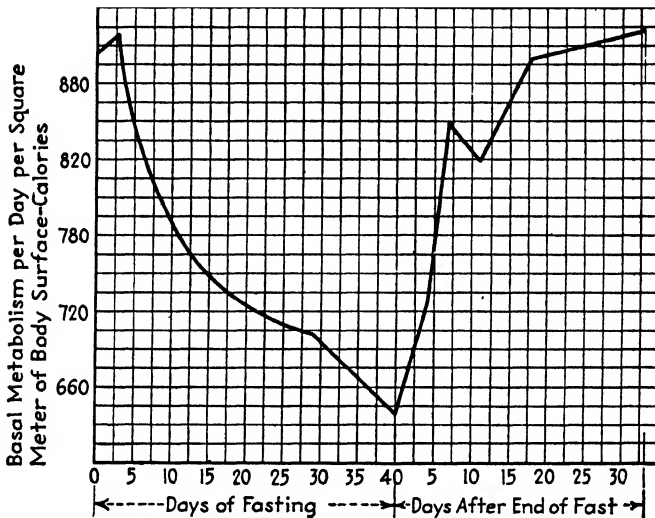

FIG. 72. The effect of fasting and of realimentation on basal metabolism. (From data obtained by G. Lusk.)

Direct effects of pituitary hormones upon metabolism are also known and may influence the BMR. The internal secretions of the adrenal cortex are regarded as stimulators of metabolism inasmuch as a minus BMR is more or less characteristic of Addison's disease, which involves lowered activity of the adrenal gland. Metabolism is also lowered in some cases of diabetes and may be restored to normal by insulin treatment.

Disease not primarily involving a disturbance in internal secretion may also affect metabolism. The high metabolic rate during fever from any cause is the obvious accompaniment of a heightened rate of heat liberation.

"Normal" Variations of Basal Metabolism. In view of the many conditions affecting basal metabolism, it is not surprising that persons in apparently normal health show considerable variation in BMR even when the measurement has been corrected for age and sex and is expressed

as Calories per square meter of body surface. It is generally conceded, however, that the so-called "normal" variations are within ± 10 per cent of the mean value for comparable individuals. Smaller variations cannot usually be considered to have diagnostic significance. So far as the observational error is concerned, careful technique eliminates large errors, so that measurements on a given individual are often reproducible to within ± 2 per cent. Some difficulty, however, arises from uncertainties in application of the formulas for computing the surface area of the body.

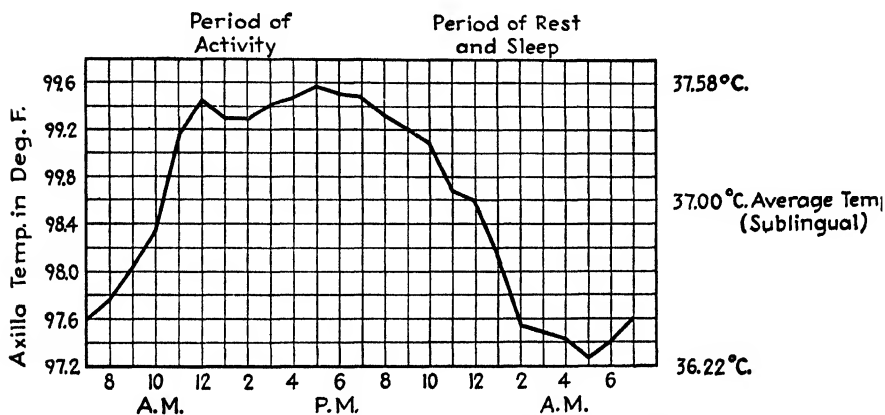

Fig. 73. Diurnal variations of body temperature.

Regulation of Body Temperature. Description of the complex "thermostating" mechanism of a homiothermic animal, such as man, belongs largely in the field of physical physiology rather than in chemical physiology. The operation of the temperature-regulating center, which is probably also able to affect the rate of heat production in the body (thermogenic effect), is a matter of complex reflex activities involving regulation of the rate of heat production on the one hand and of the rate of heat loss on the other. Heat production is regulated by increase or decrease in muscle tensions, by shivering, and possibly by more subtle effects upon the rate of oxidative metabolism. Heat loss is regulated by a highly complicated mechanism affecting the rate and depth of respiration, the activity of the sweat glands, and the rate of the circulation and the relative distribution (changes in the relative flow to surface regions) of the blood.

The elaborations of physiological regulation of temperature include a diurnal variation with a rise during the active daytime hours and a fall during the night. The diurnal range of body temperature rarely exceeds 1.35°C . (2.4°F). Representative values are shown in the curve of Fig. 73.

When the daily rhythm of activity changes, as in traveling to the opposite side of the earth or in changing from day work to night work, there is a time lag of a few days in the complete readjustments of oxidative rates and consequent rhythm of body temperature changes.

The relative effectiveness of the different mechanisms by which heat escapes from the body is indicated by the following values (Vierordt), which may be regarded as representative.

	Cal.	Per cent of total
With urine and feces.....	48	1.3
By warming of expired air.....	84	3.5
Evaporation from lungs.....	182	7.2
Evaporation from skin.....	364	14.5
Radiation and conduction from skin.....	1792	73.0
Total daily loss.....	2170	99.5

It will be seen that evaporation and radiation dispose of the major part of the heat. Clothing checks but does not prevent heat loss.

The Effect of Food: Specific Dynamic Action. The mere ingestion of food raises the metabolic rate. While this is true of all foods there is a more pronounced effect of protein when fed alone or, more specifically, of amino acids, than of other foods. Carbohydrates and especially sugars (because of their rapid absorption from the intestine) are distinctly effective. Fats are more slowly absorbed and distributed and partly on this account show less marked effects in raising the metabolic rate. This tendency to increase the oxidative rate is called the specific dynamic action of food. It is not due to the heightened activity of the digestive system. The effect is not produced by feeding noncalorigenic foods, such as cellulose and meat extracts, although such materials do stimulate the gastrointestinal musculature to heightened activity. The effect, moreover, is readily obtained by intravenous injection of amino acids and sugars, which thus are enabled to stimulate tissue metabolism directly. It is as though the nutrients increased the rate of oxidative metabolism by mass action as in ordinary *in vitro* reactions. Foods not only do increase the metabolism above the basal level but may actually cause liberation of energy in excess of that supplied by the food. Thus Rubner reported that protein food equivalent to 100 Cal. caused the liberation of 130 Cal. in excess of basal. Similar though sometimes smaller values are reported by other investigators. Lusk, in studies on dogs, found, as an average, that food equivalent to 100 Cal. in the form of sugar raised basal metabolism by 106 Cal., in the form of fat by 104

Cal., and in the form of protein by about 130 Cal. It is agreed by most investigators in this field that, as Lusk's results indicate, the specific dynamic action of fat is somewhat less than that of carbohydrate, and for protein (amino acids) the net effect is distinctly larger than for other foods.

The modern theory, as formulated by Lusk and supported by others, is that, while fat ingestion stimulates metabolism merely by increase in available fuel for oxidation, carbohydrate intake also increases a number of calorigenic intermediate reactions in addition to those of typical oxidation; but excess of fat and carbohydrate is largely stored as reserve fuel rather than oxidized. Amino acids, in contrast, are not stored as reserve protein to any great extent. Becoming available in heightened concentration, they increase the rate at which they are deaminated (p. 486) and *also increase other metabolic activities*. These include the formation of urea in the liver and its excretion, together with other protein waste products, by the kidney. It is estimated that the production and excretion of protein end products, chiefly urea, may account for about half of the extra calories liberated as a result of protein feeding.

All specific dynamic effects, however, are reported by E. B. Forbes and associates (1944) to be greatly modified when a food mixture rather than a single foodstuff is fed. The result is not the sum of the effects of the several nutrients. In experiments on rabbits, separately determined specific dynamic effects for protein, sugar, and fat were, respectively, 32, 20, and 16 per cent of their energy values. But in combination, the effect was less than the sum of the separate effects. The most striking result was that found for a combination of protein and fat which was 54 per cent less than the dynamic effect calculated from the separate effects of the two foods. Similar though smaller decreases were observed with other combinations. As suggested by *Nutrition Reviews*, "There is probably no one value for the dynamic effect of protein, fat, and carbohydrate, the dynamic value of each depending on the amount of the other two being simultaneously metabolized."

The practical significance of the specific dynamic effect is the following: The calculation of the calorie equivalent of a diet required for maintenance must allow for this effect and provide calories somewhat in excess of those needed for basal metabolism and for muscular activity. DuBois has estimated that, on an ordinary diet, 6 per cent of the basal metabolism is probably adequate. Benedict suggested 10 per cent to provide a safe margin.

The Effect of Muscular Work. The most variable factor in energy metabolism is muscular activity. Even when at rest and as nearly relaxed as possible, muscles liberate a considerable part of the body heat. This is due to the proportionately large amount of the body's

active protoplasm contained in muscle. But when at work, muscles liberate energy at a rate so high that the total metabolism per day may be increased to three times that of basal metabolism or even higher, as in the case of a farmer or a lumberman. Such a worker may metabolize more than 6000 Cal. per day. The muscular activity involved in sitting quietly, as while reading, may so increase metabolism that, in the case of a person with a maintenance metabolism (asleep) of about 65 Cal. per hr.,

TABLE 56.—EXPENDITURE OF ENERGY DURING ACTIVITY¹

Activity	Cal. per Hr.
Reclining, relaxed.....	76
Sitting quietly.....	100
Sitting, reading.....	105
Standing, relaxed.....	107
Standing, at attention.....	115
Sewing by hand.....	111
Knitting steadily.....	116
Light activity, as in dressing.....	118
Typewriting.....	140
Kitchen work, as in dishwashing.....	144
Sweeping.....	169
Light athletic exercise.....	170
More strenuous exercise.....	290-320
Heavy exercise, <i>e.g.</i> , swimming.....	400-500
Walking slowly on level.....	200
Faster walking (3.75 miles per hr.).....	300
Running (5.3 miles per hr.).....	570
Walking down stairs.....	365
Sawing wood.....	480
Running in a race.....	600
Fast stair climbing.....	1100

¹ Computations are those made for a man of 70 kg. with a minimal metabolic rate of 65 Cal. per hr. The values given are approximate averages.

energy liberation becomes about 100 Cal. per hr. During light exercise, such as walking, it might be about 170; at work, such as carpentry, it might be about 240; during heavy work, as in running a race, it might be 600; and during strenuous exercise, as in walking swiftly up stairs, it might be 1100 Cal. per hr. In the last case metabolism would be 17 times as much as the minimum.

The energy expenditures involved in human activities—household, industrial, athletic, etc.—have been extensively measured both by direct and by indirect calorimetry. Some representative values are shown in Table 56.

The energy expenditure involved in mental activity appears to be considerable but is probably more apparent than real. That it is actually due to increased oxidation in the brain has never been unequivocally

proved. So much increased tension in skeletal muscles accompanies mental activity that the resultant increase in oxidation accounts for a major part of the increase in O_2 utilization. When a supposed increase in mental effort, such as working on problems of mental arithmetic, is accompanied by voluntary muscular relaxation, the change in O_2 uptake is so small as to be regarded by some commentators as within the range of observational error. In any case, the increase of metabolism in the brain must be very small.

The Daily Caloric Requirement. It is possible to compute the total calories needed by an individual during any day for which the nature and amount of activity are known so that the corresponding fuel requirements may be estimated with reasonable certainty. An example, using the DuBois formula for basal metabolism in the case of a young man (twenty to thirty years of age) of sedentary habits, weight 70 kg., height 168 cm., and surface area 1.8 sq. m., is shown.

Requirements	Cal.
Basal metabolism ($39.7 \times 1.8 \times 24$).....	1715
Specific dynamic effect (10 per cent of basal, a generous allowance)	172
Metabolism due to reading 2 hr. (8 per cent of basal)	11
Metabolism due to sedentary activity 12 hr. (29 per cent of basal).....	249
Metabolism due to mild exercise 2 hr (estimate).	320
Total	<u>2467</u>

Computations such as these have led to the commonly accepted standard allowance of about 2500 Cal. per day for the average fuel requirement of a sedentary man. Obviously, the requirement varies widely with the amount of muscular activity. An extreme case is that of a bicycle rider, whose total metabolism during a 6-day race increased to about 10,000 Cal. per day. Other causes of variability, age, sex, body build, etc., were discussed in connection with basal metabolism.

Because of the variability of requirements, attempts to establish standard caloric allowances are not very satisfactory. Standards may be regarded as rough indices rather than as definite fixed values. The same individual, pursuing the same habits of living and using a diet which does not change *qualitatively* in any way known to be significant, may establish himself at *quantitatively* different levels of food intake and maintain the body weight at a higher or lower level, corresponding roughly to the food intake, but practically constant at each level. Thus increased food intake is shown to be possible within certain limits without progressive fattening. This fact clearly suggests that a standard dietary allowance of calories which is estimated to be adequate and which is sufficient to maintain body weight is not *necessarily* the optimum allowance. One

recognizes the "thin-man" type, the "well-rounded" figure, the "fat-man" type, etc. The "standard" for one type may not be standard for another. While emaciation and obesity are obviously disadvantageous, any definite decision as to what is optimum weight in proportion to height is difficult to make in the light of available knowledge. There is much to suggest that the optimum may be different for individuals of the same height but of different "build." Some of the best studies of this problem are based on the statistics of life insurance companies. Monographs on nutrition should be consulted for details, but one may say by way of summary that obvious underweight (below average for given sex, height, and age) is an unfavorable condition in persons under twenty-five years of age. Up to about thirty-five, a moderate degree of overweight is not unfavorable, but at later periods of life and especially in middle-aged and older people, overweight is associated with an increasingly high death rate and with failure to maintain good health. With most individuals any conscious regulation of the total food consumption is apt to be the result of fashion, fad, or finance rather than of physiological principles.

Nevertheless, the practical, everyday method for judging the adequacy of the caloric intake is to watch the body weight, increasing or decreasing the total amount of a suitable mixed diet of an adult so as to maintain weight at a chosen level. In children the allowance per unit of body weight or surface area is larger than for adults in order to allow for the energy requirement of growth. In addition, children are apt to be comparatively active with a correspondingly increased need for food. Even basal metabolism is at a relatively high level. DuBois found, for example, that boys twelve to thirteen years old maintained a basal metabolism (see Fig. 71) about 25 per cent higher per square meter of body surface than that of adults.

Considerable increases in caloric requirements during pregnancy and lactation need to be met. In pregnancy the basal metabolism, computed per unit of body weight, is little if any higher than normal, but when the increased weight is considered, the total amount of food needed is distinctly increased. During lactation, milk production involves a considerable expenditure of energy. It has been reckoned, for example, that a moderately active woman who would ordinarily require some 2100 to 2300 Cal. should receive 2800 to 3000 Cal. per day during lactation.

REFERENCES

A standard monograph on this subject is "Basal Metabolism in Health and Disease" by E. F. DuBois, Philadelphia, 1936.

Although representing older concepts, the book which for some decades was indispensable to the student of this subject is "The Science of Nutrition" by the late Graham Lusk, 4th ed., Philadelphia, 1928. It is still highly profitable reading.

For a description of calorimeter construction, see "A Respiration Calorimeter with Appliances for

the Direct Determination of Oxygen" by W. O. Atwater and F. G. Benedict, *Carnegie Inst. Wash. Pub.* 42, 1905. Also, "A Comparison of Methods for Determining the Respiratory Exchange of Man," same series, *Pub.* 216, 1915.

Actual results will be found in publications from the Office of Experiment Stations, *U.S. Dept. Agr., Bull.* 63, 69, 109, 136, and 175.

A useful treatment of the subject is found in F. G. Benedict's "Vital Energetics: A Study in Comparative Basal Metabolism," *Carnegie Inst. Wash. Pub.* 503, 1938.

Reviews of more recent works in this field are listed.

BOOTHBY, W. M., and PAULSON, D. L., Energy Metabolism, *Ann. Rev. Physiol.*, 2, 169, 1940.

BURTON, A. C., Temperature Regulation, *Ann. Rev. Physiol.*, 1, 109, 1939.

CARPENTER, T. M., Energy Metabolism, *Ann. Rev. Physiol.*, 6, 131, 1944.

DEIGHTON, T., Physical Factors in Body Temperature Maintenance and Heat Elimination, *Physiol. Rev.*, 13, 427, 1933.

FORBES, E. B., and VORIS, L., Energy Metabolism, *Ann. Rev. Physiol.*, 5, 105, 1943.

HERRINGTON, L. P., and GAGGE, A. P., Temperature Regulation, *Ann. Rev. Physiol.*, 5, 295, 1943.

KLEIBER, M., Energy Metabolism, *Ann. Rev. Physiol.*, 6, 123, 1944.

KLEIBER, M., Body Size and Metabolic Rate, *Physiol. Rev.*, 27, 511, 1947.

MURLIN, J. R., Energy Metabolism, *Ann. Rev. Physiol.*, 1, 131, 1939.

RICHARDSON, H. B., The Respiratory Quotient, *Physiol. Rev.*, 9, 61, 1929.

SCOTT, J. C., and BAZETT, H. C., Temperature Regulation, *Ann. Rev. Physiol.*, 6, 107, 1944.

WILHELMJ, C. M., The Specific Dynamic Action of Food, *Physiol. Rev.*, 15, 202, 1935.

A few papers representative of this type of research are as follows:

ATWATER, W. O., and SNELL, J. F., A Bomb Calorimeter and Method of Its Use, *J. Am. Chem. Soc.*, 25, 659, 1903.

BENEDICT, F. G., and CARPENTER, T. M., The Influence of Muscular and Mental Work on Metabolism and the Efficiency of the Human Body as a Machine, *Office of Experiment Stations, U.S. Dept. Agr., Bull.* 208, 1909.

BENEDICT, F. G., and FOX, E. L., A Method for the Determination of the Energy Values of Foods and Excreta, *J. Biol. Chem.*, 66, 783, 1925.

BENEDICT, F. G., and MURSCHAUSER, H., Energy Transformations during Horizontal Walking, *Carnegie Inst. Wash. Pub.* 231, 1915.

BENEDICT, F. G., and PARMENTER, H. S., The Energy Metabolism of Women while Ascending or Descending Stairs, *Am. J. Physiol.*, 84, 675, 1928.

BOOTHBY, W. M., BERKSON, J., and DUNN, H. L., Studies of the Energy Metabolism of Normal Individuals. A Standard for Basal Metabolism with a Nomogram for Clinical Application, *Am. J. Physiol.*, 116, 468, 1936.

CANZANELLI, A., GUILD, R., and RAPPORT, D., The Use of Ethyl Alcohol as a Fuel in Muscular Exercise, *Am. J. Physiol.*, 110, 416, 1934.

HENDERSON, Y., and HAGGARD, H. W., The Maximum of Human Power and Its Fuel, *Am. J. Physiol.*, 72, 220, 1925.

MCCAY, C. M., MAYNARD, L. A., SPERLING, G., and BARNES, L. L., Retarded Growth, Life Span, Ultimate Body Size, and Age Changes in the Albino Rat after Feeding Diets Restricted in Calories, *J. Nutrition*, 18, 1, 1939.

MORRISON, P. R., and PEARSON, O. P., The Metabolism of a Very Small Mammal, *Science*, 104, 287, 1946.

SELTZER, C. C., Body Build and Oxygen Metabolism at Rest and during Exercise, *Am. J. Physiol.*, 129, 1, 1940.

SMITH, H. M., Energy Requirements for Grade and Level Walking, *Carnegie Inst. Wash. Pub.* 309, 1922.

SMITH, H. M., and DOOLITTLE, D. B., Energy Expenditure of Women during Horizontal Walking at Different Speeds, *J. Biol. Chem.*, 65, 665, 1925.

STEINHAUS, A. H., Studies on the Influence of Physical Work on the Basal Metabolism, *Am. J. Physiol.*, 76, 184, 1926.

CHAPTER XIV

CARBOHYDRATE METABOLISM

The chemical changes occurring in animal or plant tissues are sometimes referred to as "intermediary metabolism" in contrast to the "over-all" changes observed by determination of food composition, respiratory exchange, and urine composition, which indicate only the beginning and the end of metabolism. The obstacles to the study of intermediary metabolism can scarcely be appreciated by the novice in biochemistry. They are due largely to the sensitiveness of living matter. Many methods used in ordinary chemistry destroy or so modify protoplasm that its behavior throws little or no light upon its real physiological reactions. The approach to problems of intermediary metabolism must generally be an indirect one.

Methods. Among the types of methods developed during recent decades, the following four are worthy of special note: (1) Blood analysis, (2) observations on more or less isolated enzyme systems, (3) the use of slices of tissues cut from organs of a recently killed animal, and (4) experiments with tagged atoms or molecules detectable because of radioactivity or other isotopic characteristics. The uses of each of these four methods will be outlined.

In *blood analysis*, development of microchemical methods has made it possible to determine the concentration of a number of blood constituents in a sample so small (*e.g.*, 5 ml.) that blood may be drawn at frequent intervals (*e.g.*, 15 min.), thus permitting the observer to study fluctuation in the concentration of glucose, lactic acid, pyruvic acid, amino acids, creatine, etc., in blood. Such observations often afford helpful clues to the nature of metabolic changes in tissues. Especially useful information may be obtained when the arterial blood entering an organ and the venous blood leaving it are both sampled at suitable intervals.

The preparation of cellular enzymes from tissue extracts may require special and ingenious methods in order to obtain the enzyme in pure form, or at least free from certain other enzymes, and yet preserve its physiological activity. Such methods have been extensively developed in recent years and have shown the nature of some cellular enzyme systems, *e.g.*, specific proteins, coenzyme or prosthetic group, and activators or

inhibitors. This matter was presented in Chaps. VII and XII. When such an enzyme system is obtained, it affords opportunity to discover its substrates and the products of its activity and to study the kinetics of the reaction. One must bear in mind, however, that an isolated enzyme system need not necessarily behave in the same way that it does in living protoplasm.

The use of fresh tissue slices, while furnishing help in some problems, e.g., the catatorulin test (p. 170), has limitations because some protoplasmic enzyme systems rapidly lose activity after separation of the organ from the circulation. The solution in which cell survival is to be maintained long enough for observations must be made with some care. The tissue slices must be thin enough (0.3 mm. is satisfactory in many experiments) to permit easy diffusion of gases and nutrients between cells and medium.

Radioactive isotopes of C, N, P, Na, K, Cl, I, and some other elements, incorporated in the molecules of compounds which are fed or injected, can be readily traced because the radiations of such tagged atoms may be detected by sensitive apparatus such as the Geiger or Geiger-Müller counter. After administration of the isotope-containing material its distribution in blood and tissues of the experimental animal may be followed by use of the detector, and compounds isolated from the tissues will be shown, if radioactive, to be intermediary metabolic products of the material administered. As will appear in this and subsequent chapters, a wealth of information has been obtained by this method.

A similar method employs *deuterium*, which is "heavy hydrogen," or hydrogen with an atomic weight of 2(D). While ordinary H_2O when hydrolyzed yields hydrogen which contains only about 0.02 per cent of deuterium, heavy water, D_2O , can be prepared so nearly free of H_2O that its hydrolysis yields D_2 of purity sufficient for use in physiological experiments. Incorporated by artificial synthesis into foods that are fed or injected, the deuterium can be traced by analysis of tissues or specific compounds separated from the carcass. Complete oxidation of the separated material yields water, the density of which is an index of its deuterium content. Deuterium thus serves as a tracer so that its disposal in metabolism can be followed to yield valuable information. Tritium (T), hydrogen of atomic weight 3, is now available because of its production in the atomic pile and will be of importance in biochemical studies. A number of other isotopes which afford certain advantages for research have also become available because of the atomic pile. Before its advent, the majority of isotopes were produced only by bombardments caused by a cyclotron. This limited the kinds and the amounts of isotopes produced compared with what are now available.

The Chief Materials of Carbohydrate Metabolism. In the mammal, and, indeed, in all vertebrates, relatively few carbohydrates are metabolized. Under most physiological conditions monosaccharides are the only carbohydrates normally absorbed from the intestine. Glucose, fructose, and galactose are the chief ones. Some others, including pentoses, may be present in smaller amounts.

Some conversion to sugar phosphate (phosphorylation) probably occurs in the intestinal wall during absorption. The evidence for this assumption is mostly indirect, although a small amount of sugar phosphate has been actually isolated from the intestinal mucosa of the rat and was found to increase slightly during glucose absorption. The concentration present in the mucosa at any one time might be expected to remain low because of a rapid turnover, dephosphorylation speedily following phosphorylation.

Glycogen is formed largely from glucose but indirectly from other sources in animal tissues and plays an important role in metabolism.

Certain of the trioses (p. 21) are intermediate products of sugar utilization. Carbohydrate metabolism is intricately interrelated with that of fats and proteins. The glycerol part of fats is readily converted to carbohydrate and the fatty acid part is possibly convertible, although complex intermediary changes which are not thoroughly demonstrated would be required. The reverse process, conversion of carbohydrate to fat, occurs on a high caloric diet and possibly under other conditions.

A number of amino acids are convertible to glucose in animals, while some of the intermediary products of carbohydrate metabolism can be used for the synthesis (Chap. XVI) of certain amino acids.

Interconversion of carbohydrates, in addition to the transformation of various food carbohydrates into glycogen, occurs in animal tissues as well as in plants. The chief carbohydrate substances formed in animals, from other carbohydrates are galactose, glucosamine, galactosamine, and glucuronic acid (hexoses and related compounds), and the pentoses D-ribose and deoxyribose. Important materials utilized in the syntheses are glucose, trioses, and lactic acid. In the mammary gland, for example, active lactation involves lactose production, which requires the synthesis of galactose. It is formed chiefly at the expense of glucose with triose derivatives as intermediates. Under certain conditions involving nervous disturbance, lactic acid may be used for the synthesis. Aside from the mammary gland, animal organs appear to be unable to form lactose. Lactose of the food thus becomes a probable source of galactose for the formation of galactolipids in the growing mammal and adds one more item to the list of uses of milk in nutrition.

Phosphorus-containing Compounds Reacting with Carbohydrates. Certain compounds which are phosphates or contain the

phosphate group yield phosphoric acid for use in many reactions in intermediary metabolism. Carbohydrate reactions especially are intricately interwoven with those which involve these phosphorus-containing substances inasmuch as the main processes of carbohydrate metabolism require phosphorylation and dephosphorylation, thus completing what is commonly called *the phosphate cycle*. It is highly significant that some of the compounds which "donate" the phosphoric acid group for the purpose of phosphorylating something are pyrophosphates. The pyrophosphoric acid structure

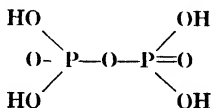

results from the application of much heat (energy) to phosphoric acid and, correspondingly, has what is now called (Lipmann, 1943, see p. 384) the high-energy phosphate bond represented by a convenient symbol (∞) as suggested by Lipmann. Its importance can be demonstrated by experiments which cause the hydrolytic cleavage of one of these bonds. This liberates 10,000 cal. or more, in some cases as much as 12,000 cal. per g. mol. of phosphate set free. But when an ordinary bond, as in a simple phosphate ester, is similarly split, only about 2,000 cal. are liberated. Another interesting fact is that when a high-energy phosphate bond is broken under physiological conditions, which cause transfer of the phosphoric acid group from a donor to an acceptor, there is no appreciable loss of energy. This sudden upsurge of energy in the newly formed acceptor-phosphate compound often energizes a reaction that, apparently, would not otherwise occur.

Maintenance of a reserve store of high-energy phosphate bonds is dependent on sustained oxidative activity. When glucose or some other of the readily oxidized metabolites is consumed, a part of the energy thus liberated is used to synthesize adenosine triphosphate (ATP) and phosphocreatine. While ATP is indispensable as a quick acting, almost explosively rapid energizer, phosphocreatine contains, after all, the main store of ∞ in most tissues.

The chief compounds serving as phosphate donors and phosphate acceptors in the phosphate cycle are phosphocreatine and certain nucleotides. Some account of these must be given as a preliminary to the discussion of carbohydrate metabolism.

Phosphocreatine. Creatine of meat and meat extracts is a well-known substance, the most abundant of the so-called *meat extractives*, which include a long list of the nonprotein organic compounds of meat.

But after Folin had demonstrated that creatine in the free state was practically absent from resting muscle which had been frozen in the living state and extracted before the hydrolyses accompanying death could occur, it became clear that creatine existed in a combined form in the living tissue. Inasmuch as the phosphate group was liberated along with creatine, the combined form was named phosphagen, a term now discarded in view of the fact that the phosphate group is also liberated in muscle from substances other than the creatine complex. The complex was eventually isolated (Fiske and Subbarow, 1929) and shown to be phosphocreatine.

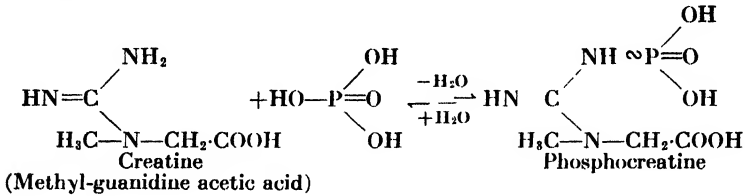

The synthesis of phosphocreatine and its hydrolysis to liberate creatine and phosphoric acid occurs readily in muscle. The properties of creatine and its origin and disposal in the body will be described in later chapters.

Phosphoarginine in invertebrate tissues functions in the same way as does phosphocreatine in the vertebrate.

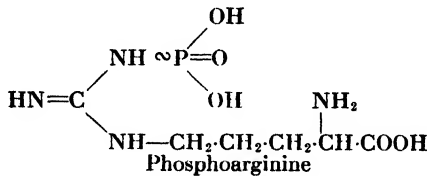

Adenylic acid (AMP), one of the nucleotides (p. 146), is another muscle substance containing the phosphoric acid group. Its structure is given as

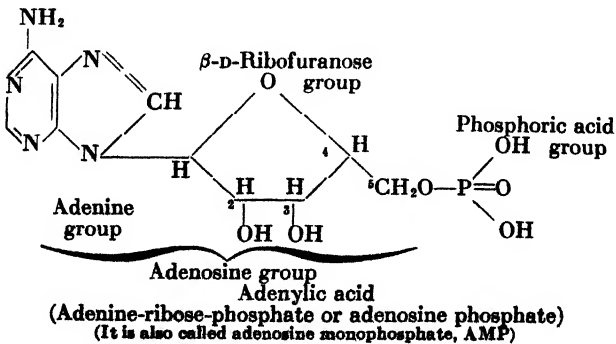

Closely related to adenylic acid is *inosinic acid*, hypoxanthyl-ribose-phosphoric acid, formed by deamination of adenylic acid under the influence of a deaminase.

Adenosine triphosphate is an important source of phosphoric acid groups for participation in metabolism. It may be regarded as adenylic acid condensed with pyrophosphoric acid and is represented as

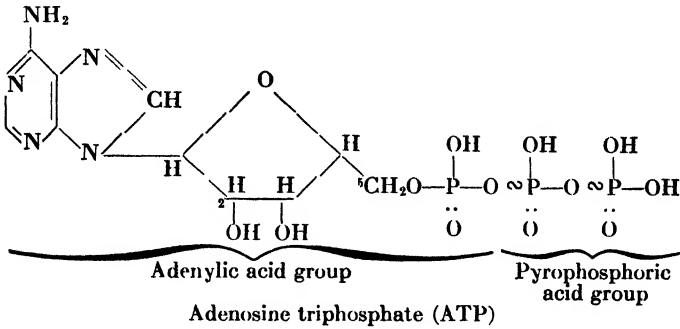

Liberation of phosphoric acid converts this substance to adenylic acid (Lohmann, 1929), a reaction greatly accelerated during muscular activity. Resynthesis of adenosine triphosphate readily occurs in the living muscle and also appears to occur in fresh muscle juice to which adenylic acid is added. Adenosine triphosphate is isolated as its barium salt.

Adenosine diphosphate, formed as an intermediate between adenylic acid and adenosine triphosphate, is adenosine pyrophosphate. The latter term is also used to refer to a mixture of adenosine di- and triphosphate.

Phosphatases. Any enzyme which catalyzes the hydrolytic liberation of phosphoric acid from an organic or an inorganic compound is a phosphatase. Many are known. Those which operate in the hydrolysis and resynthesis of adenosine triphosphate (ATP) and adenosine diphosphate (ADP) appear (Kalckar, 1944) to be specific.

Muscle extracts and preparations of the muscle protein **myosin** contain adenosinetriphosphatase (ATPase) specific for the reaction

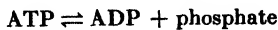

But the same enzyme in the presence of myokinase (p. 423) catalyzes the reaction



Liver extract, in contrast, contains the enzyme for the reaction which seems to be

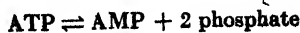

Potato extracts (albumin-containing fraction) show a similar enzyme which is also found to catalyze the reaction

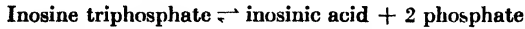

The fact that myosin in a supposedly purified state shows phosphatase activity has led to the suggestion that it is itself the enzyme, but the possibility that it carries the enzyme adsorbed upon its molecules has not been conclusively disproved. In any case, the observation is of interest inasmuch as shortening of the rod-shaped molecules containing myosin is regarded as the mechanism of muscular contraction, and the sudden release of energy by splitting of ATP is one of the first chemical reactions, if not the first, to occur when muscle is excited for contraction.

Glycogenesis. The process of glycogen synthesis is called glycogenesis. Its occurrence in the liver was first demonstrated by Claude Bernard, and his extensive researches (1848-1857) revealed the importance of glycogenesis in the regulation of animal carbohydrate metabolism. *It enables the animal to maintain a reservoir of stored carbohydrate in the form of glycogen and also is important in that it is a part of the process for transformation of certain carbohydrates and other materials into forms of especial usefulness in metabolism.*

Glycogen is also formed in tissues other than liver. The most important of them are skeletal and heart muscle, although visceral muscle, blood, lymph, certain skin tissues, and kidney contain low concentrations. A small and variable amount of glycogen (less than 0.1 per cent) is reported to be present in brain tissue. But on the whole it seems that nerve cells maintain no effective reserve store of carbohydrate. They are strikingly dependent upon a steady supply of blood glucose. Disturbances of nerve functioning are among the first symptoms to appear when blood glucose concentration falls below the physiological level.

The chief material for glycogen formation is glucose. Glycogen is constructed from α -D-glucopyranose groups. But glycogenesis involves the use of many kinds of glycogen formers. Fructose was found by Cori to be utilized at a more rapid rate than glucose for glycogenesis *in liver* although the difference was slight. Experiments (Cori and Shine, 1936) with liver slices suggest the relative availability of some of the glycogen formers. Regarding fructose as 100, the following values were found:

Trioses	{ Dihydroxyacetone, $\text{CH}_2\text{OH CO CH}_2\text{OH}$	71
	{ Glyceric aldehyde, $\text{CH}_2\text{OH}\cdot\text{CHOH CHO}$	58
Trihydric alcohols	{ α -Glycerophosphate, $\text{CH}_2\text{OH CHOH CH}_2\text{O}(\text{H}_2\text{PO}_3)$	56
	{ β -Glycerophosphate, $\text{CH}_2\text{OH CHO}(\text{H}_2\text{PO}_3) \text{CH}_2\text{OH}$.	31
	{ Glycerol, $\text{CH}_2\text{OH}\cdot\text{CHOH CH}_2\text{OH}$	30
Hexoses	{ Galactose, $\text{CH}_2\text{OH}\cdot(\text{CHOH})_4 \text{CHO}$	20
	{ Mannose, $\text{CH}_2\text{OH}(\text{CHOH})_4\text{-CHO}$	9

Other significant glycogen formers, related chemically or by metabolic processes to the 3- and 6-carbon compounds listed above, are lactic acid, $\text{CH}_3\text{-CHOH}\cdot\text{COOH}$; pyruvic acid, $\text{CH}_3\text{-CO}\cdot\text{COOH}$; methyl glyoxal, also called pyruvic aldehyde, CH_3COCHO ; and citric acid, $\text{COOH}\cdot\text{CH}_2\text{-C(OH)(COOH)\cdot CH}_2\text{-COOH}$.

The utilization of lactic acid has been tested by experiments in which rats were fed lactic acid having the C atom of the carboxyl group radioactive (C^{11}). The liver glycogen formed was sufficient to account for 30 per cent of the lactic acid, but the radioactivity of the glycogen was equivalent to only 1.6 per cent of the C^{11} . This indicates that the carbon chain of lactic acid is disrupted before its use in glycogenesis. Confirmatory evidence was obtained in experiments using C^{11} in the form of bicarbonate, which was injected while ordinary lactic acid was fed to fasting rats. The resultant liver glycogen contained significant amounts (0.3 to 1.1 per cent) of C^{11} . The theory of CO_2 utilization for animal syntheses was presented in connection with bio-oxidation (p. 379), and these experiments give new evidence in its support. The formation of glucose from inositol (p. 161) has also been shown by the use of deuterium as a label.

Amino acids serving as glycogen formers include glycine, alanine, serine, valine, cystine, aspartic acid, glutamic acid, hydroxy-glutamic acid, arginine, proline, and histidine. A detailed account of the processes involved will be given in Chap. XVI. Some confusion has arisen in regard to some of these amino acids. This is due, in part, to the different behavior of stereoisomers. The naturally occurring L(-)-histidine, for example, is a much better glycogen former than is the D(+)-histidine or even the DL-histidine. In contrast, racemic alanine (DL-form) is reported to be as good a glycogen former as is the natural L(+)-alanine. Some experiments indicate that D-alanine is more effective than the natural form. In the case of D(+)-valine, D(-)-valine, and DL-valine, the different forms appear to be nearly equal in ability to yield glucose in phlorizinized dogs.

The use of phlorizin (a glucoside, p. 43) is common in experiments to detect the transformation of various foodstuffs into glucose. The drug, given subcutaneously, interferes with a number of metabolic processes, one of which is the kidney mechanism for retention of blood glucose. It thus permits glucose to appear in the urine so that the sugar-forming tendency of substances fed or injected may be tested in a quantitative, or at least comparative way by the determination of the resulting urinary glucose.

Gluconeogenesis is the term used to refer to the formation of glucose from noncarbohydrate material, such as fats and amino acids. While the

glucose thus formed is potentially available for glycogenesis, one must be cautious in interpreting gluconeogenesis as surely leading to glycogenesis. Much of our knowledge regarding gluconeogenesis is derived from experiments on phlorizinized animals, animals with experimental diabetes, or on human diabetic subjects. In such abnormal conditions sugar production is probably very different quantitatively from the same process under normal conditions. Moreover, the intermediate chemical reactions in the process

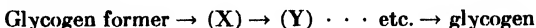

are not known in all cases. The available evidence indicates (p. 423) that phosphorylation is an intermediate step. The glycogen former is apparently converted into a derivative of phosphoric acid before it becomes glycogen. α -D-glucopyrano-1-phosphate (p. 437) is probably the immediate precursor of glycogen. The tacit opinion seems to be that glycogen formers are converted into glucose, but direct proof is lacking.

Glycogenesis in muscle differs in some respects from glycogenesis in liver. In the first place, the main source of muscle glycogen is blood glucose, although there is resynthesis of glycogen from the products of its own partial breakdown in the muscle. Muscle is dependent upon the liver for steady maintenance of a supply of glucose. When muscle glycogen tends to be depleted during sustained muscular activity and glucose is not being adequately supplied by intestinal absorption, liver glycogen is "paid out" (mobilized) as blood glucose, thus providing for restoration of muscle glycogen. Furthermore, glycogenesis in muscle is more directly dependent upon the pancreatic hormone, insulin, than it is in liver. An animal deprived of its pancreas (depancreatized, pancreatectomized) adds little or no glycogen to its muscle store when given glucose alone, but when insulin is injected shortly before the glucose is given, muscle glycogen does increase. Even in a normal animal the injection of insulin tends to increase muscle glycogenesis. No corresponding direct effects of insulin upon liver glycogenesis are found. It is claimed, however (Bouckaert and de Duve, 1947), that when the blood-sugar concentration and certain other conditions are maintained constant more glucose "disappears" in the liver during the action of insulin than at other times, although some of the sugar is probably used in formation of fat and certain amino acids rather than for glycogen production. The functioning of insulin will be considered further (p. 431) in connection with diabetes.

The enzymes operating in glycogenesis have been studied by means of *in vitro* experiments using purified substrates and extracted (in some cases purified) enzymes. With glucose-1-phosphate as the substrate,

enzyme preparations containing **phosphorylase** from liver, heart, or brain yield a polysaccharide showing typical glycogen properties, namely, resistance to the action of strong alkali, solubility in water, stability when kept at low temperature, and a reddish color reaction with iodine. But when the same synthesis is attempted with the use of muscle phosphorylase, the product is very similar to starch. It gives a blue color with iodine, is poorly soluble in water, and gives X-ray diffraction patterns closely resembling those of potato starch.

Another enzyme, **phosphoglucomutase**, which occurs in every plant and animal tissue in which phosphorylase has been found, catalyzes the reaction

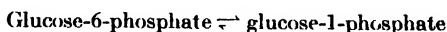

A third enzyme, known as **hexokinase**, is also involved. This name was first applied (Meyerhof) to a yeast product, and the analogous muscle enzyme was named (Ahlgren) glycomutin. A similar enzyme was prepared (Ochoa) from brain tissue. There now seems to be a tendency to call any such enzyme, hexokinase. Its activity is described as an activation of glucose so as to facilitate its combination with phosphoric acid. The only purified preparations of this enzyme so far obtained have been made from yeast, but it probably occurs in animal tissues. The source of the phosphoric acid group which reacts with glucose is adenosine triphosphate. Hexokinase may well be called a "transferring enzyme." Under its influence a phosphoric acid group is transferred from ATP to a hexose which may be either glucose or fructose.

A summary of the reactions leading from glucose to polysaccharide is given in the following scheme, modified from the similar one of Colowick and Sutherland:

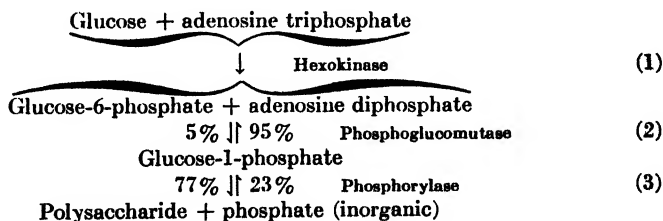

The percentage values given for the reversible reactions (2) and (3) indicate the equilibrium states. The pronounced tendency of reaction (2) to go toward the formation of glucose-6-phosphate (95 per cent of the latter in the equilibrium mixture of the two phosphates) presents difficulty in obtaining any considerable yield of polysaccharide in the test tube. This difficulty is met by including barium acetate in the reaction

mixture, so that inorganic phosphate freed in reaction (3) is rendered nonreactive by precipitation as barium phosphate.

In these *in vitro* syntheses a small amount (*e.g.*, 1 to 5 mg. per cent) of a polysaccharide such as glycogen or starch has to be added to the reaction mixture to "prime" the reaction. One must admit, therefore, that a polysaccharide synthesis without the aid of an *in vivo* process (in addition to production of the necessary enzymes) has not yet been attained.

The transformation of glycogen to glucose (see glycogenolysis) involves certain of the same enzymes acting reversibly in the same reactions.

The reactions of glycogenesis are more or less typical of the processes of synthesis of polysaccharides in general. A scheme (Stettien, 1947) summarizes the results of a number of recent studies in this field.

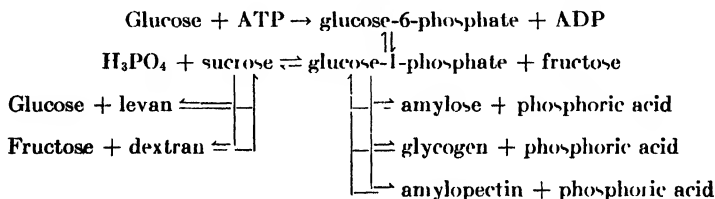

The degree of complexity in these reactions suggests that one needs to be on guard against the tendency to oversimplify the view of a metabolic process which might be represented by so simple a formulation as

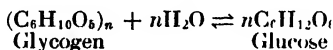

Glycogenolysis and Glycolysis. The breakdown of glycogen to form glucose is called glycogenolysis. It is to be distinguished from glycolysis, a term used to indicate the breakdown of glycogen and related carbohydrates in processes which normally accompany the liberation of energy. An enzyme, glycogenase, also called a "diastase," was formerly said to catalyze glycogenolysis in the liver, but it now seems clear that phosphorylating enzymes are concerned, as they are in glycogenesis.

According to Cori, glycogenolysis in the liver proceeds thus:

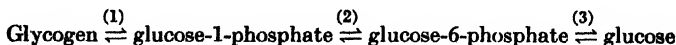

The enzymes are (1) phosphorylase, (2) glyco-phosphomutase, and (3) phosphatase. Cori points out that glycogen is unique as a substrate. Its phosphorylation requires little or no energy and can therefore occur directly with inorganic phosphate. Reaction (3) does not occur in muscle. The enzyme catalyzing the reaction in liver appears to be specific for glucose-6-phosphate. While glycogenolysis in liver yields

glucose as the chief and possibly the only product, glycolysis *in muscle* yields lactic acid as the main product.

Indeed, glycolysis is sometimes narrowly defined as the process by which 1 molecule of a hexose or its equivalent group in glycogen yields 2 molecules of lactic acid. While glycolysis probably occurs in various actively metabolizing animal tissues, it has been intensively studied (p. 435) only in muscle. Liver glycogenolysis will be discussed further in connection with regulation of blood-sugar concentration.

Glycogen, Glucose, and Lactic Acid Determinations. The quantitative analyses most frequently done for study of carbohydrate metabolism are outlined here.

Glycogen determination is generally made by the Pflüger method. It depends, in principle, upon the resistance of tissue glycogen to the action of alkalis. A weighed amount of tissue is mixed with an equal volume of 60 per cent KOH and heated over steam until proteins, sugars, and, indeed, most of the organic compounds have been hydrolyzed and some of them partially oxidized. The mixture is filtered, and glycogen is precipitated with alcohol, filtered off, dissolved in water, and hydrolyzed by boiling in dilute HCl. The resulting glucose is determined by any of the numerous methods available. The amount of glucose multiplied by the factor 0.92 gives the amount of glycogen. As glycogenolysis is rapid in dead tissues, the sample must be analyzed immediately after killing the animal or, better, frozen *in situ* in the anesthetized (amytal) animal before excision.

Glucose determination in tissues is generally made by some type of reduction method. The blood or the tissue extract must first be freed from protein which is precipitated by various methods, *e.g.*, as phosphotungstate compounds, as copper proteinates, or as the trichloroacetates. The ability of the protein-free tissue extract to reduce copper under a set of controlled conditions as, *e.g.*, in Benedict's quantitative, copper-containing solution, may be the basis of the measurement. Among the especially sensitive types of methods for determination of small amounts of reducing substances, such as glucose, are the various modifications of the Hagedorn Jensen procedure in which reduction of potassium ferricyanide is measured under standard conditions. Colorimetric methods for microdetermination, *e.g.*, measurement of intensity of color produced by reduction of picramic acid (Folin method), are also available.

Lactic acid determination may be done by oxidation to acetaldehyde, which is distilled off into a measured excess of a solution of sodium bisulfite, which forms an addition product with acetaldehyde. The remaining uncombined bisulfite is titrated with iodine (back titration),

thus permitting calculation of the combined amount and its equivalent in lactic acid.

The Lactic Acid Cycle. Using the above methods, it has been possible to study the intricate relations between the three predominant materials of carbohydrate metabolism in animals. The liver glycogen store, "paid out" in the form of blood glucose at a rate so regulated as to maintain a nearly constant blood-glucose concentration, assists in the regulation of the glycogen content of muscle. While resting or in mild activity, the muscles carry on glycolysis at a rate sufficiently low to permit disposal of the lactic acid formed without the aid of any mechanism

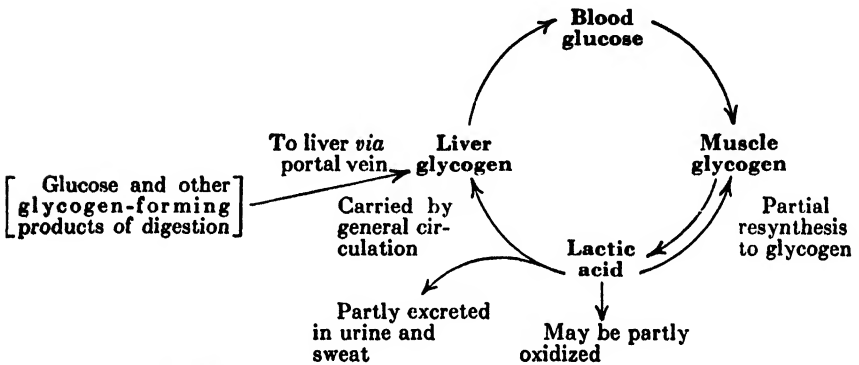

FIG. 74. The lactic acid cycle, as suggested by Cori and Cori. Blood glucose is derived only in part from liver glycogen. It also includes glucose derived from intestinal absorption or from gluconeogenesis.

outside the muscle. But when lactic acid is formed in relatively high concentration, as it is during vigorous muscular work, some of it escapes into the blood. A small proportion of it (during exhausting muscular work, a larger proportion) may escape into the urine. A major part of the blood lactic acid, however, is conserved by the liver, which converts it into glycogen. Knowledge of this process, though studied by a number of investigators, was especially developed by Cori and Cori. The relations may be summarized (Fig. 74) in what is called the lactic acid cycle.

Regulation of the Blood-sugar Level. As implied in connection with glycogenesis and glycogenolysis, the concentration of glucose in blood is regulated. The maintenance of a "steady state," so that glucose concentration in the blood varies only within restricted limits, is one of the more complex cases of homeostasis (p. 338). The elaborate physiological mechanisms involved are so numerous and intricate that they are only partially understood although extensively investigated. It is even difficult to list all the mechanisms concerned inasmuch as

some of them have an indirect yet significant effect. One might classify them as mass action (due to relative concentrations of glucose and related substances), nervous mechanisms, and hormonal action. A number of the better known of these mechanisms will be discussed. Blood-glucose concentration, or what may be called the blood-sugar level, is normally maintained in man between 70 and 100 mg. per 100 ml. of blood. This comparatively steady state is maintained in spite of the various processes tending to increase or decrease the blood glucose concentration, such as the following:

- Processes
Increasing Blood Glucose
1. Absorption from intestine
 2. Glycogenolysis in liver
 3. Gluconeogenesis in liver

- Processes
Decreasing Blood Glucose
1. Absorption into all tissues
 2. Glycogenesis, chiefly in liver and muscle
 3. Various syntheses such as fat production
 4. Glycolysis
 5. Excretion of glucose

Some variability in the blood-sugar level is found among different individuals and even in the same individual at different times so that there is room for difference of opinion as to what are "normal" limits. A value for the lower limit might be 55 mg. per cent so that any lower concentration could be regarded as abnormally low, a **hypoglycemia**. A value for the upper limit is sometimes set at 120 mg. per cent with the assumption that any higher concentration is a **hyperglycemia**.

The limit below which physiological processes cannot go on normally is rather closely defined. At about 45 mg. per cent, muscular tremors and various nervous symptoms occur, and coma with complete anesthesia (hypoglycemic shock) soon follows. Unless the tendency to lowering of the blood-sugar level is checked, death follows promptly. Hypoglycemia is commonly brought about experimentally by injection of a sufficient dose of insulin, as in the procedure for bioassay of insulin potency in rabbits, and is then called *insulin shock*.

The upper limit compatible with physiological existence is not sharply defined. Diabetics and laboratory animals with experimental diabetes (pancreatectomized) may exist indefinitely under mild insulin dosage with an obvious and variable hyperglycemia, having blood glucose concentrations, for example, varying between 160 and 200 mg. per cent or about twice as high as the normal values. Values as high as 1,200 mg. per cent (1.2 per cent) have been observed in late stages of diabetes although there is no unequivocal evidence that death is due to *direct* effects of hyperglycemia rather than to abnormalities of bio-oxidation, of which hyperglycemia is more an effect than a cause. Undoubtedly, hyperglycemia is more or less toxic and is contributory to diabetic

symptoms, but the minimal lethal dose of glucose must produce a blood glucose concentration higher than is apt to be attained in diabetes.

Kidney excretion of glucose into the urine, **glucosuria**, is the device which affords a measure of protection against hyperglycemia. The urine-secretory mechanism involves restoration to the blood, through the kidney tubules, of a part of the glucose which is present in the filtrate formed in the kidney glomeruli. This is probably accomplished with the aid of reversible phosphorylation of glucose in the tubule cells. Glucose is one of a number of substances which may be said to have a **kidney threshold**. This is defined as a critical blood concentration, above which complete restoration to the blood fails and the substance "spills over" into the urine. The normal human kidney threshold for glucose is somewhat variable even in the same individual but is roughly delimited as 160 to 200 mg. per cent, with high frequency at about 170 mg. per cent. It rises in diabetes. It is lowered in some forms of kidney disturbance, giving what is called a "renal glucosuria" even though, as is usually the case, the blood-sugar level is normal. This matter will be referred to again in connection with sugar tolerance.

An effect of the nervous system on the blood-sugar level was first described by Claude Bernard, who showed that puncture of the medulla in the region between the levels of origin of the vagus and auditory nerves causes a pronounced glucosuria provided the liver contains a store of glycogen to furnish glucose to the blood. The operation is called *la piqûre* and the resulting condition, "puncture diabetes." Similar effects can be obtained by electrical stimulation of sympathetic nerves leading to the liver or, by what amounts to much the same thing, the injection of adrenine (epinephrine) or excitation of adrenal secretion. Adrenine tends to increase glycogenolysis, thus raising the blood-sugar level.

These effects of the adreno-sympathetic system may account for certain forms of temporary glucosuria. It is often found, for example, that glucosuria follows intense emotion or excitement, especially when not accompanied by muscular activity sufficient to keep the blood-sugar level below the renal threshold. Thus urine-sugar tests made after a football game on a number of subjects showed a higher incidence of temporary glucosuria among student spectators than among the players. As many as 15 per cent of men tested immediately after writing an examination have been found to show temporary glucosuria. Whether or not nervous effects on sugar metabolism are contributory to diabetes is debatable. The claim has been made that persons leading lives of "high nervous tension" are more apt to develop diabetes than are those leading a more placid life, but no conclusive evidence is presented.

Glucose-tolerance Tests. While the presence or absence of glucosuria is a convenient test for the effectiveness of the blood-sugar-regulating mechanism, it does not furnish as much or as useful information as does the simultaneous determination of both blood and urine sugar. Particularly useful information for detection of mild forms of diabetes can be obtained by use of what is called the "glucose-tolerance test." A known amount of glucose (*e.g.*, 1.5 g. per kg. of body weight) is given by mouth, usually before breakfast. Glucose determinations are made on a control sample of blood removed just before beginning the experiment

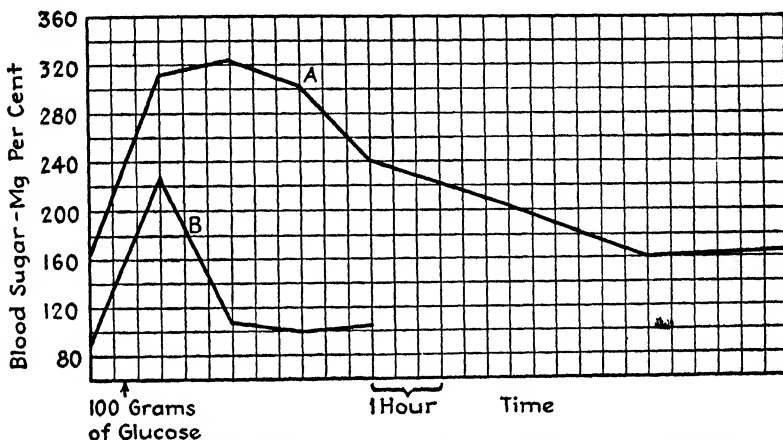

FIG. 75 Results of glucose-tolerance tests: A, diabetic; B, nondiabetic.

and on subsequent samples taken at suitable intervals (*e.g.*, hourly). Plotting the blood-glucose concentration values as ordinates and time as abscissas, one obtains a curve indicative of the blood-sugar regulative function. The contrast between the normal and the diabetic subject is indicated by the curves of Fig. 75. Determination of sugar which may appear in the urine generally accompanies the blood-sugar determinations.

The interpretation of the curve obtained in the glucose-tolerance test does not depend entirely upon the height to which the blood-sugar level rises; it is even more dependent upon the time relations. In the normal person the taking of 1 g. of glucose per kg. of body weight increases blood sugar to about 150 mg. per cent during the first hour, but it returns to the normal value of about 100 mg. per cent in less than 2 hr. In the diabetic, however, the heightened blood-sugar level reaches its peak later (after about 2 hr.), is more persistent, and may not return to the value which prevailed before taking the sugar for 8 hr. or even longer. Such a curve is indicative of diabetes or some form of disturbance in carbohydrate

metabolism even when significant amounts of glucose do not appear in the urine because of a heightened kidney threshold. One practical way of evaluating the sugar-tolerance curve is to compute the hyperglycemic index. This is

$$\frac{\text{Blood-glucose level after 2 hr.} - \text{fasting level}}{\text{Maximum level} - \text{fasting level}} \times 100$$

The index is approximately zero for normal individuals but rises progressively with aggravation of any of those conditions, such as diabetes, which delay the disposal of excess of blood sugar.

Hormones Affecting Carbohydrate Metabolism. While the products of internal secretion (Chap. XX), the hormones, exert their effects in some cases upon physiological mechanisms such as nerve endings, most of the hormones affect the course of chemical reactions involved in metabolism of carbohydrates, fats, and proteins. But the number and the complexity of hormonal effects upon carbohydrate metabolism are outstanding. Works dealing specifically with the subject of endocrinology and metabolism should be consulted for details. Only the major effects will be outlined here.

1. *Adrenine* (adrenaline, epinephrine) tends to increase glycogenolysis in the liver and in muscles. It may have other effects on carbohydrate metabolism but they are not well established.

2. *Insulin* tends to increase deposition of glycogen in muscle (p. 422), but the corresponding effect in the liver is not clearly demonstrable. The rapid depletion of blood glucose after insulin injection and the hyperglycemia resulting from insulin deficiency suggest that insulin is in some way concerned with utilization of glucose. The chemical mechanism involved, however, appears to be complex. It will be discussed in connection with diabetes.

3. *Hormones of the anterior pituitary* include those which affect carbohydrate metabolism by means of increased gluconeogenesis in the liver and others which exert indirect effects through their action upon various endocrine organs. The so-called "diabetogenic" and "ketogenic" hormones (p. 433) may have a more direct action.

4. *Hormones of the adrenal cortex* include an unknown number of active principles. Some of them (Chap. XX) exert marked effects upon carbohydrate metabolism. Animals (rats, cats, dogs) deprived of the adrenals (adrenalectomized) die after the operation within a few days or, at the most, in about 3 weeks unless corrective treatment is given. One form of successful treatment is the injection of extracts of adrenal cortex. Some degree of success may be attained by injection of certain purified compounds obtainable from the adrenal cortex. Among them are certain ones which affect carbohydrate metabolism. The effects of

adrenalectomy include low glycogen content of the liver, a tendency to a lowered blood-sugar level, and slight glucosuria. It is reported for the rat, however, that glucosuria does not occur if the animal is partly depancreatized as well as adrenalectomized. This suggests some interaction or antagonistic effect of insulin and a cortical hormone. The most effective of the cortical hormones in this respect is 17-hydroxy-11-dehydrocorticosterone.

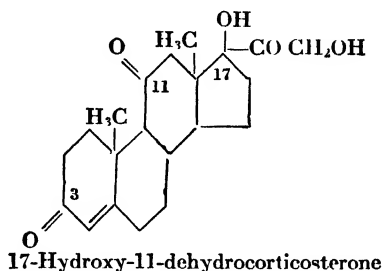

This substance can cause marked glucosuria in partly depancreatized rats or even in normal rats.

There is considerable evidence to indicate that some one or more of the adrenal cortical hormones may be necessary for the processes of phosphorylation and therefore for the normal course of carbohydrate utilization. This matter will be considered further in Chap. XX.

5. *The thyroid hormone*, thyroxine, is a powerful stimulant of bio-oxidation in general and therefore tends to increase utilization of carbohydrate. In addition, thyroid apparently stimulates gluconeogenesis from protein.

Diabetes. The chief characteristic of the all too prevalent disease diabetes is an obviously abnormal course of carbohydrate metabolism with hyperglycemia and glucosuria. There is also a tendency to incompleteness of oxidation of fatty acids so that their intermediary products of metabolism, acetoacetic acid, $\text{CH}_3\cdot\text{CO}\cdot\text{CH}_2\cdot\text{COOH}$, β -hydroxybutyric acid, $\text{CH}_3\cdot\text{CHOH}\cdot\text{CH}_2\cdot\text{COOH}$, and acetone, $\text{CH}_3\cdot\text{CO}\cdot\text{CH}_3$, collectively referred to as *acetone bodies*, *acetone substances*, or *ketone substances*, may accumulate in the blood (ketonemia) and appear in the urine (ketonuria). The behavior of the diabetic organism has been extensively studied, not only for its pathology but also in the hope of explaining the physiology of carbohydrate metabolism.

Modern ideas regarding the cause of diabetes may be said to begin with the classic experiments of von Mering and Minkowski (1889), who found that after complete extirpation of the pancreas (pancreatectomy) the animal had intense experimental diabetes during the time (2 to 4 weeks) that it survived the operation. Hyperglycemia and glucosuria

persist even when the pancreatectomized animal consumes no carbohydrate food, so that gluconeogenesis is shown to be a prominent feature of diabetes.

Any condition which permits survival of the islet tissue (islands of Langerhans) of the pancreas, even though other tissues (acini which secrete pancreatic juice) degenerate, prevents the onset of the experimental diabetes. Thus, ligation or blocking of the pancreatic duct or pancreatectomy, when a portion of the pancreas (about one-fourth or more) is transplanted into a new location, can cause atrophy of the acini. But if there is functional survival of the islet tissues, these operations do not cause experimental diabetes. These and other observations clearly point to a loss of function of the islands of Langerhans as the cause of "pancreatic" diabetes and indicate that the normal product of their internal secretion, insulin, is necessary to prevent diabetes. The elaborate capillary blood supply of the islands is further suggestive of their ability to function as endocrine glands. Pathological degeneration of islet tissue has been observed in some but not all cases at autopsy after death from diabetes.

Insulin was finally proved to be an active carbohydrate-metabolizing hormone by the celebrated work of Banting, Best, and Macleod (1921), although previous work had indicated its probable existence. They, however, prepared an active extract of pancreas which, injected into a normal or a diabetic subject, lowered the blood-sugar level. They and their coworkers, including Collip, also laid the foundations of knowledge of the solubilities and other properties of insulin so that it was eventually possible to prepare it in highly purified form. The properties underlying its preparation include its solubility in alcohol up to about 80 per cent, its stability in acid solutions, formation of a difficultly soluble picrate, insolubility in pyridine, salting out by $(\text{NH}_4)_2\text{SO}_4$, and precipitability at its isoelectric point, 5.35. Abel and his coworkers (1926) prepared insulin in crystalline form. Starting with an already partially purified preparation, they precipitated insulin with pyridine, redissolved in acetic acid buffered with brucine acetate, and by addition of ammonia caused the precipitation of crystalline insulin at its isoelectric point. A number of modifications of this method have been described. Insulin may be recrystallized from various buffer solutions, but the organic buffers, e.g., brucine or digitonin, seem preferable.

Crystalline insulin is a protein with about 0.52 per cent of zinc. Its properties and composition will be described in more detail in Chap. XX.

Although insulin deficiency is obvious in both experimental and human diabetes and injection of insulin can correct the diabetic abnormalities of carbohydrate metabolism, insulin is not the only hormone involved in diabetes. Houssay and his coworkers made the striking

discovery that after extirpation of the pituitary (hypophysectomy) subsequent pancreatectomy causes none of the typical diabetic symptoms. The average survival period is distinctly prolonged as compared with that after simple pancreatectomy, no typical hyperglycemia or glucosuria occurs, and ketonuria is absent. The operations may be done in the reverse order; pancreatectomy, causing experimental diabetes, is followed by hypophysectomy, which alleviates the diabetic symptoms. Moreover, as Houssay and others have shown, hypophysectomized animals are especially sensitive to insulin. A dosage that would cause a moderate lowering of the blood-sugar level in a normal or a pancreatectomized animal may produce a marked hypoglycemia in the hypophysectomized animal and may even lower the blood sugar to the level of the fatal hypoglycemic shock. These and other effects of the pituitary upon carbohydrate metabolism may be attributed to the anterior lobe, which is the source of the hormones involved.

One of them is the so-called **diabetogenic hormone**. This can produce diabetic symptoms even in normal animals; F. G. Young showed that the repeated injection of massive doses of an anterior pituitary extract produced *permanent* diabetes in dogs. It was also found that degenerative changes of certain of the islet cells and a lowered insulin content of the pancreas followed the production of such a "pituitary diabetes." This suggests that the pituitary hormone injections cause overactivity of the islet cells, even to the point of exhausting them. This idea is substantiated by observations of a temporary fall in blood-sugar level immediately after injection of the pituitary hormone. "Pituitary diabetes" has been produced in the rabbit as well as in the dog, but attempts to produce it in the rat, the mouse, or the cat failed.

A **ketogenic hormone**, also called the "fat-metabolizing" hormone, is assumed to be formed in the anterior pituitary and to stimulate the rate of fatty acid metabolism. Certain extracts of the anterior pituitary, when injected into rats on a fat-rich diet, can cause ketonemia and ketonuria without any rise in the blood-sugar level. This indicates that the hormone involved is distinct from the diabetogenic one.

One must conclude that the deficiency or the lack of insulin in the diabetic condition results in a disturbance of the normally balanced relationships between insulin and the pituitary hormones so that the latter, by stimulation of gluconeogenesis and fat metabolism, are enabled to bring on hyperglycemia and glucosuria together with ketonemia and ketonuria.

The Physiological Action of Insulin. It would seem, and was at one time assumed, that insulin is necessary for the utilization of carbohydrate, especially of glucose, so that the fundamental disturbance of metabolism in the diabetic condition would be failure to use glucose. Much work by many investigators has not shown complete failure.

While it is true that certain tissues, *e.g.*, the heat muscle, show a quantitative impairment in power to utilize glucose in the diabetic condition as compared with the normal, yet, as a number of investigators, notably Soskin and his associates, have shown, "the diabetic animal at its characteristically hyperglycemic level utilizes as much or more sugar than the normal animal at its normal blood sugar level." The theory that insulin is indispensable for glucose utilization must be discarded.

As previously indicated (p. 422) one function of insulin is facilitation (increase in speed) of glycogenesis in muscle, but even this activity is not indispensable and does not apply in the same sense to liver glycogenesis.

What, then, is the fundamental effect of insulin? No simple answer to this question has been found. Soskin proposed a theory which may be stated thus: Glycogenesis and glycogenolysis, the chief regulators of the blood-sugar level, *normally* respond to changes in the level in a way which indicates that there is a critical concentration of blood glucose which might be called the **liver threshold**. Any higher concentration of glucose favors glycogenesis and a lower one, glycogenolysis. Gluconeogenesis in the liver is similarly regulated. This tends to conserve the body's carbohydrate supply. De Duve and his associates are also convinced that the concentration of glucose is a determining condition in its utilization. But the *diabetic* organism, deficient in or lacking insulin, shows a disturbance in this threshold so that neither the glycogen function nor gluconeogenesis is under control. In spite of hyperglycemia, glycogenolysis and glucose production from amino acids and fats waste the available fuels, which "spill out" into the urine as glucose and acetone bodies. According to this point of view, the chief function of insulin is to maintain the normal liver threshold, thus enabling this organ to regulate carbohydrate metabolism. Soskin compares this regulation to that of a thermostat for a furnace. Rise of room temperature shuts off the furnace and conserves its fuel. Correspondingly, rise of blood-sugar level (analogous to increased temperature) in the normal animal shuts off glycogenolysis and gluconeogenesis in the liver. Seemingly, lack or deficiency of insulin interferes with this regulation.

A more specific function of insulin is described by Cori and associates. They report that preparations of the muscle enzyme **hexokinase** (p. 423), which so activates glucose that it can be phosphorylated, are inhibited by addition of certain extracts of the anterior pituitary gland. The active pituitary principle is described as a labile protein and might be the blood-sugar-raising principle operative in diabetes. But when insulin is added along with the pituitary principle, the inhibitory effect of the latter is overcome so that hexokinase activity is normal. Insulin, then, blocks off inhibition due to the pituitary substance although, in its absence, insulin is without effect upon an already activated hexokinase.

The adrenal cortex seems also to be concerned in these reactions. Certain cortical preparations are found to reinforce the inhibition due to the pituitary substance, but this effect is also blocked by insulin. It thus appears that insulin is required if normal rates of phosphorylation of glucose are to prevail, and since phosphorylation is the first step in the processes by which glucose is chiefly used, its importance is obvious. These reactions have not been shown to explain the role of insulin in activity of the liver. Moreover, this activating mechanism can be only a partial explanation anyway, because (see p. 433) an animal without an anterior pituitary, presumably free from this kinase-blocking principle, is extraordinarily sensitive to insulin. Nevertheless, the hexokinase-activating action of insulin is interesting and is reported by several investigators to operate *in vivo* as well as *in vitro*. Insulin causes a lowering of the concentration of blood amino acids as though it favored protein synthesis in the tissues.

Summary of Blood-sugar-level Regulation. The rate at which a number of chemical mechanisms of the body operate is dependent upon the blood-sugar level, which, in turn, rises or falls responsively. The chief relationships thus involved are summarized in Fig. 76. This scheme does not include the intricate relationships between hormonal effects and blood-sugar levels.

Glycolysis in Muscle. Modern studies clearly indicate that glycogen, not glucose, is the carbohydrate actually used in muscle. Conversion of the blood glucose to glycogen (p. 423) is only partly understood. Glycogenolysis as it occurs in liver does not take place in muscle, which seems to lack the kind of phosphatase catalyzing the reaction,

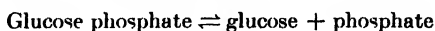

Muscle carbohydrates, other than glycogen, exist as the phosphoric acid esters of hexoses and trioses. They have been studied chiefly as the intermediary products of metabolism in muscle and yeast. Glycolysis in muscle and fermentation in yeast show many similarities but differ in that lactic acid production is characteristic in muscle and ethanol production in yeast.

Knowledge of details of carbohydrate breakdown in yeast developed early because of the use of enzyme-containing press juice (p. 220), but intimate knowledge of carbohydrate metabolism in muscles did not develop until after Meyerhof devised (1925) a method for preparing a suitable muscle extract. An anesthetized animal is cooled to 0°C., its muscles are removed without crushing, and continuously maintained at low temperature, not much above 0°C., the muscle is finely minced and extracted with cold water or isotonic KCl solution. Low temperature is required to avoid denaturation and consequent insolubility of cellular

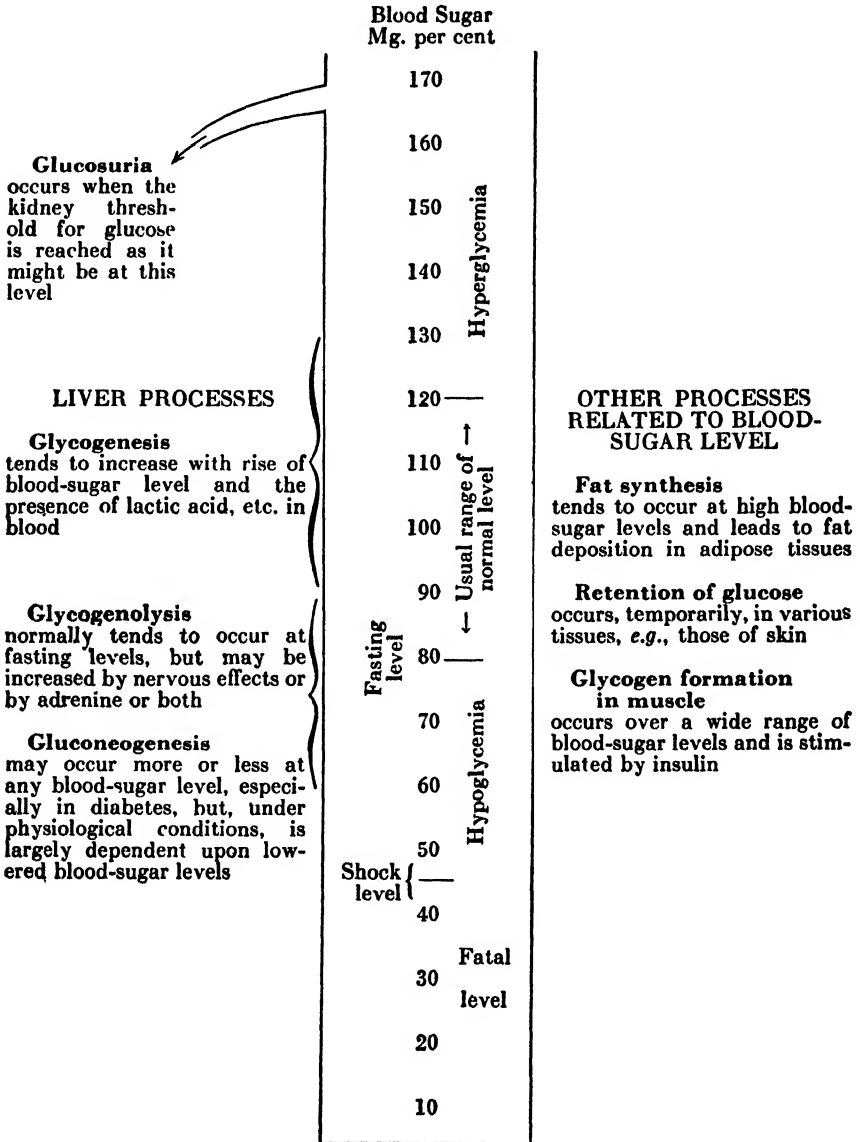

FIG. 76. Blood-sugar levels as related to various physiological processes. The relationships as shown here are those usually found but would not necessarily hold true for all cases.

proteins. Strained and centrifuged, a clear viscous solution is obtained. It has all the enzymes required for conversion of glycogen to lactic acid, including those which break down phosphocreatine and ATP.

The extract may be used for different types of experimentation. For example, it may be dialyzed so as to remove the coenzymes of some of its enzyme systems. Upon addition of the right coenzyme, the activity of such a system is restored, and thus the nature of its coenzyme may be determined. When it is activated, its substrates may be identified and the kinetics of its action may be studied together with its dependence upon concurrent reactions. Such an extract may be the starting point for concentration or isolation of enzymes.

The extracts do not take up oxygen. Respiration does not occur. This fact is believed to be due, in part at least, to the lack in the extract of cytochrome oxidase for which suitable solvents have not been found. It remains with the tissue debris. Other respiratory catalysts may also be lacking in the extract. Study of the uncomplicated glycolytic process may be carried on, therefore, without the necessity of excluding air. Whatever oxidation accompanies glycolysis requires no oxygen. Indeed, the entire process of *glycolysis is anaerobic*.

Besides respiration, another process of muscle metabolism also fails to occur, namely, activation of glucose for conversion to glycogen. Hexokinase (p. 423) is not present in active form. When, therefore, glycogen of the extract is used up, further glycolysis cannot be observed without addition of more glycogen.

During initial stages of glycogen breakdown, however, phosphorylation occurs under the influence of the enzyme *phosphorylase*. It has been found in extracts of liver, brain, heart, skeletal muscle, and yeast. Glycogen breakdown occurs in a chain of reactions. The first product appears to be glucose-1-phosphate. A postulated representation of the reaction is

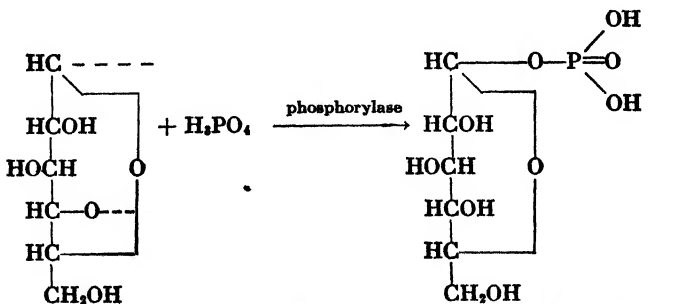

The probable α -D-glucopyranose unit of glycogen is shown here with dotted lines to indicate its union (1-4) with other units.

α -D-Glucopyranose-1-phosphate

The phosphoric acid groups required for this reaction may come from the breakdown of adenosine triphosphate although free inorganic phosphate from phosphocreatine is at least indirectly involved. In muscle poisoned with iodo-acetate, initial reactions of glycolysis go on until phosphocreatine ceases to be hydrolyzed. But the adenine nucleotides are especially functional. This is shown by experiments in which extracts of various cells (liver, heart, skeletal muscle, brain, and yeast) are dialyzed until phosphates and adenylic acid are removed. The extract is then found to have lost its power to break down glycogen and regains it only when *both phosphates and adenylic acid* are restored to it. Adenylic acid is required because it functions in the reaction

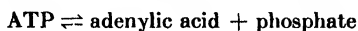

which is "linked" to phosphorylation. The latter can proceed because the product, glucose-1-phosphate, is changed reversibly to glucose-6-phosphate under the influence of another enzyme, *phosphoglucumutase*. Magnesium or manganese ions accelerate this reaction. Using crystalline preparations of the enzyme, maximal activity occurs only in the presence of optimal but catalytic amounts of glucose-1-6-diphosphate, suggesting that it is an intermediary product in the reaction. A third enzyme, *oxoisomerase*, reversibly catalyzes the conversion of glucose-6-phosphate to fructose-6-phosphate. These two phosphates are also named, respectively, the "Robison-Embden ester" and the "Neuberg ester" in recognition of their discoverers. The term "Robison-Embden ester" is sometimes used to refer to the equilibrium mixture of glucose and fructose monophosphates. The transformations may be shown thus:

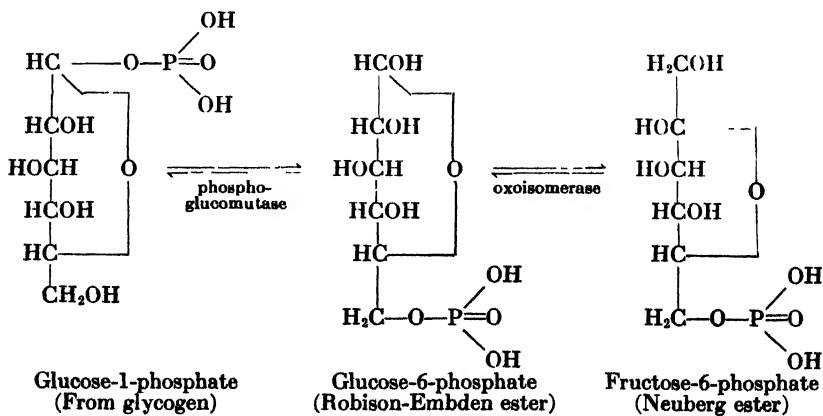

Both glucose and fructose esters are normally found in extracts of muscle, but the glucose esters are in higher concentration than is the

fructose ester. Together they amount to approximately 125 mg. per 100 g. of muscle.

The iodo-acetate effect in muscle, first shown by Lundsgaard and later studied by others, has been helpful in the study of muscle glycolysis. An animal injected with a suitable dose of the sodium salt of iodo-acetic acid, $\text{CH}_2\text{I}\cdot\text{COOH}$, fails to form lactic acid during muscular contraction. Although the ability of the muscle to contract under these conditions is limited, its contractile responses to stimuli are sufficient to correspond to the production of readily measurable amounts of lactic acid in unpoisoned muscle. These observations indicate that lactic acid formation is not a prerequisite for muscular contraction but is in some way linked with recovery after contraction. There is, however, no apparent interference with the formation of the sugar phosphate esters and, accompanying this process, the splitting of phosphocreatine to form creatine and phosphoric acid occurs in direct proportion to the amount of contraction of the muscle.

Fructose Diphosphate. The hexose *monophosphates* of muscle are still further phosphorylated to form fructose *diphosphate*, also called the Harden-Young ester. It is unstable and probably has only a fleeting existence in normal muscle. When, however, the muscle is poisoned by administration of fluorides, lactic acid production is inhibited, as it is in iodo-acetate poisoning; but in the fluoride-treated muscle the breakdown of fructose diphosphate is also inhibited so that it accumulates in amount sufficient for detection. Presumably it is formed from the Neuberg ester, α -D-fructofurano-6-phosphoric acid, but its formation is in equilibrium with the Robison-Embden ester. A probable formulation of its structure represents it thus:

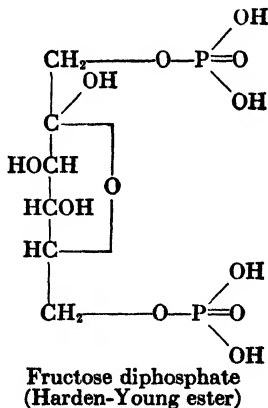

Its production is catalyzed by a specific enzyme, **phosphofructo-**

kinase, which like hexokinase (p. 123) is a transferring enzyme and moves a phosphoric acid group from ATP to fructose-6-phosphate to form the diphosphate. Mixed with muscle extract, purified fructose diphosphate can be converted to lactic acid as readily as is glycogen. Adenosine triphosphate can supply the necessary phosphoric acid groups for conversion of fructose monophosphate to the diphosphate. The furanose structure, which fructose readily assumes, appears to be of significance in nature because, as suggested by W. O. James, it is readily phosphorylated.

Summary of Phosphorylation Reactions. The chemical mechanisms of glycolysis so far described constitute only the preliminary part of the process, namely, phosphorylation. In résumé, the reactions and the enzymes which are now believed to be involved are

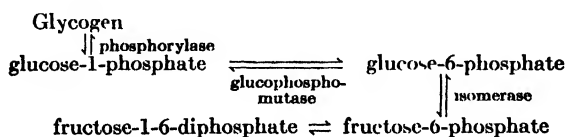

Lactic Acid Production. The actual cleavage of carbohydrate is assumed to begin with the splitting of fructose-1-6-diphosphate (Harden-Young ester), although the possibility of cleavage of hexose monophates cannot be definitely excluded. The reaction which seems most probable would yield two triose phosphates and is represented thus:

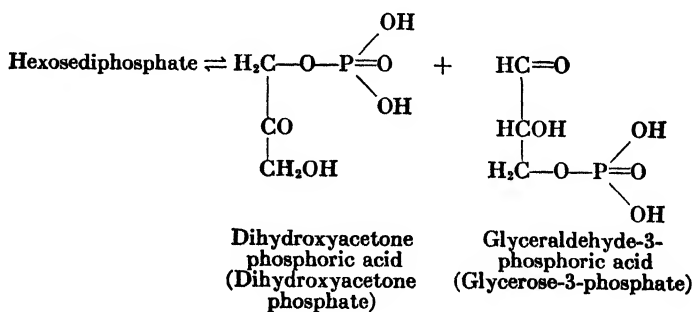

An enzyme for catalysis of this reaction has been identified. It is called *aldolase* and was found by Meyerhof and Lohmann in extracts of muscle and yeast. It has been separated in pure, or nearly pure, crystalline form. As prepared in Cori's laboratory from rabbit or rat muscle it had the properties of a longer known protein, myogen A.

The further changes involving the two triose phosphates are formulated in accordance with the evidence now available. Dihydroxyacetone phosphate changes to glycerose-3-phosphate in a reversible reaction

catalyzed specifically by **phosphotriose isomerase**. The glycerose-3-phosphate may be converted into 1-3-diphosphate but, in any case, is subjected to the action of a **triosephosphate dehydrogenase**, an enzyme that has been prepared in crystalline form in several laboratories. Its net effect is as shown in (1). If a second phosphoric acid group is involved, it is transferred to ADP to form ATP. Reaction (1) being an oxidation liberates energy. Reaction (2) is catalyzed by **phosphoglyceromutase**.

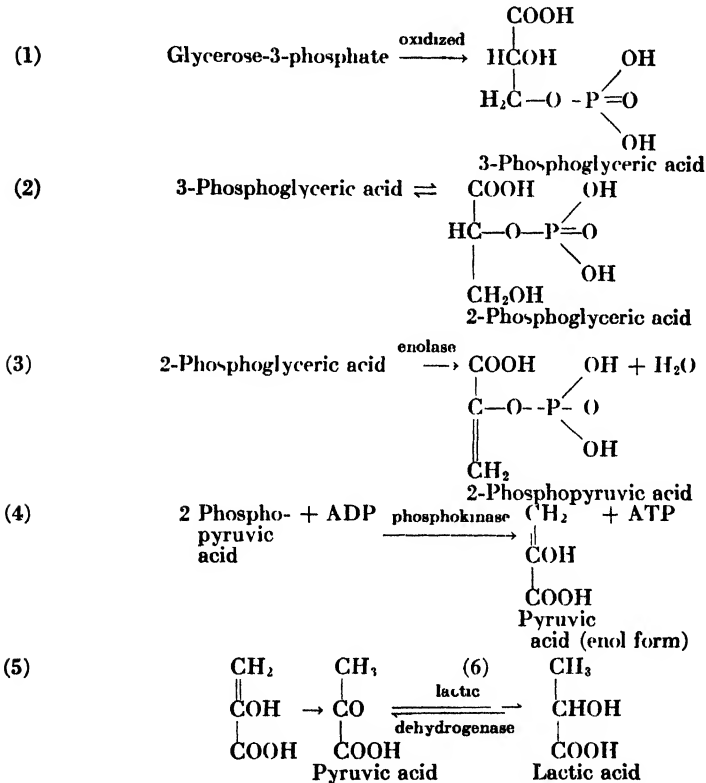

Reaction (5) probably occurs spontaneously. Reaction (6) is coupled with reaction (1). The H atoms set free in the latter are taken up by coenzyme I (diphosphopyridine nucleotide). This is the coenzyme common to both enzymes concerned (see Table 48) and therefore can pass along the H atoms, under the influence of lactic dehydrogenase, to reduce pyruvic acid to lactic acid.

Lactic acid as formed in glycolysis is largely resynthesized to muscle glycogen. Most investigators in this field are agreed that about 80 per

cent of it is thus used in frog muscle. The fate of the remainder is not definitely known, but the natural inference is that it is oxidized, except in so far as it is removed by the circulation. According to the Coris, lactic acid in mammalian muscle *in situ* tends to be completely removed from muscle to blood, transported to the liver (lactic acid cycle) for reconversion to carbohydrate. One should note, moreover, that older ideas about production of comparatively large amounts of lactic acid in muscle were colored by results of analyses of excised muscle stimulated to give many contractions. It is now clear that a muscle *in situ* with a good circulation of well-oxygenated blood may do much work without exceeding the oxygen requirement simultaneously supplied to it. Under these conditions, the concentration of lactic acid attained in the muscle is low indeed, practically negligible.

Energy Liberation in Glycolysis. Glycolysis does not liberate energy sufficient for sustained muscular contraction and heat liberation. Several of the glycolytic reversible reactions are, in their net effect, thermoneutral. Thus hydrolysis of phosphocreatine liberates 10 to 12 Cal. per gram-molecular equivalent, but its resynthesis at the expense of adenine triphosphate hydrolysis is endothermal and uses 10 to 12 Cal. The complete glycolytic reactions by which two equivalents of lactic acid may be formed from one glucose equivalent are calculated to liberate only about 36 Cal. This is in contrast to the complete oxidation of one mol of glucose to CO_2 and H_2O which would liberate some 675 to 680 Cal. Reaction (1), oxidation to form glyceric acid, is the only exothermic change in glycolysis. This reaction may be so coupled (p. 441) that it occurs without need of oxygen while pyruvic acid is reduced to lactic acid. Thus glycolysis can occur in the absence of O_2 (anaerobic conditions such as immersion in N_2 gas) and a muscle is enabled to do a limited amount of work in emergencies that deplete it of O_2 . Glycolysis thus has a unique significance. Indeed, it seems generally true that cells which are well stocked with glycogen survive limited periods of O_2 deprivation more successfully than do other cells.

An illustration of the advantage thus afforded is seen in the conditions arising during extreme muscular exertion. A man may carry on muscular work with such an expenditure of energy that the oxygen supply to the muscles, in spite of the accompanying deep and rapid breathing and increased heart action, is so inadequate that he goes into "oxygen debt" to the extent of 10 liters of O_2 or, in extreme cases, even more than that and requires nearly an hour for complete repayment of the "oxygen debt" to the muscles. The "promissory note" which represents the "oxygen debt" in the muscle is the accumulated lactic acid. It can be disposed of within the body only at the expense of bio-oxidation. Even the lactic acid cycle (p. 426) requires O_2 for its complete operation.

During relatively mild exercise the O_2 uptake in the muscle may be increased to an extent sufficient to check lactic acid accumulation at a level which, though higher than in resting muscle, is not progressive and is reflected in a constant lactic acid concentration in the blood. This gives the "steady state" such as prevails when a runner in a long-distance race at moderate speed attains his "second wind."

The heart, as well as the skeletal muscle, derives advantage from the use of the anaerobic glycolytic process. A perfused heart can actually beat for some time in the absence of O_2 , provided the perfusion fluid is maintained alkaline and the heart glycogen store is not exhausted. It operates under these conditions at the expense of glycolysis. When the glycogen is exhausted, the heartbeat ceases but can be revived if glucose is immediately provided.

Carbohydrate Oxidation. As implied above, part of the lactic acid arising from glycolysis is supposed to be oxidized in muscle to supply the normal aerobic liberation of energy necessary to resynthesize glycogen, to liberate the main part of the heat developed in muscle, and to restore the muscle to its resting state. It is not yet clear, however, that some 20 per cent of the lactic acid (that portion not used for glycogen resynthesis) is oxidized. There is indeed no complete proof as to what is oxidized as muscle fuel. Decision rests upon measurement of the RQ, which for normally metabolizing muscle is 1. But lactic acid, $C_3H_6O_3$, or trioses, $C_3H_6O_3$, or hexoses, $C_6H_{12}O_6$, would all give this result in complete oxidation. Lactic acid is constantly available. Even in resting muscle it amounts to about 20 mg. per cent. In any case the fuel would appear to be oxidized to pyruvic acid and then to enter the tricarboxylic acid cycle involving the usual oxidative mechanisms as they occur in living cells. It will be recalled that most of the investigations of these cycles were carried on with the use of muscle extracts. Recalling that not only carbohydrates, but also glycerol, fatty acids, and certain amino acids may contribute compounds which can serve as "grist to the tricarboxylic acid mill," it is not strange that investigations have yielded results which do not clearly determine the nature of muscle fuel. The matter will be discussed further in the next chapter.

Other forms of carbohydrate oxidation occur. Glucose may be oxidized to gluconic acid, $CH_2OH \cdot (CHOH)_4 \cdot COOH$, which can be completely oxidized. The formation of glucuronic and other uronic acids (p. 17) followed by pentose production is another path of oxidation.

Fermentation of Carbohydrate. Yeast contains enzymes which operate in ways which resemble muscle glycolysis. Starting with glycogen, the phosphorylation processes are identical and so apparently are the initial stages of hexose cleavage, forming triose phosphates. The difference, however, is in the later stages. Pyruvic acid, instead of being

converted to lactic acid, is decarboxylated, producing acetaldehyde, and this reduces to ethanol by a dismutation with triose phosphate, forming phosphoglyceric acid [see reaction (1), p. 441].



Fermentation, like glycolysis, is inhibited by iodo-acetate which does not prevent phosphorylation. Alcoholic fermentation is essentially an anaerobic process and is thus able to exhibit what is known as the "Pasteur effect," namely, the inhibition of fermentation when anaerobic conditions are replaced by an abundant O₂ supply. As Pasteur showed, yeasts grow more rapidly under aerobic conditions than under anaerobic ones but produce more alcohol in the anaerobic state.

Fat Formation from Carbohydrate. The fact that a carbohydrate-rich diet may cause fat accumulation is a matter of common knowledge. Quantitative proof is available. Pigs have been maintained on a ration containing limited amounts of fat and protein. Determination of the total fat of the carcass showed amounts so large as to be accounted for only by conversion of the carbohydrate of the food to fat. Cow's milk contains fat far in excess of an amount that could be supplied by the food fat and sometimes sufficient to indicate the daily synthesis of 250 g. or more of fat from carbohydrate. Some other examples were given (p. 396) in connection with RQ measurements.

Experiments have also been done (Schoenheimer) with deuterium. Mice on a diet practically devoid of fat were given "heavy water," D₂O. The body fat, which could have been formed only by the use of carbohydrate, contained deuterium which, increasing during the early part of the experiment, was later maintained in steady concentration in the fats. The mice meanwhile showed no significant changes in weight. Thus fat appeared to be used in oxidative metabolism while it was also being synthesized. This suggests that the conversion of carbohydrate to fat is not, at least in the mouse, a mechanism for mere food storage but is a part of the normal course of metabolism. It also indicates that water is utilized in the conversion of carbohydrate to fat. The chemical changes involved in the conversion are not entirely demonstrated. Production of the glycerol part of the fat molecule presents little difficulty since triose phosphate can change to α -glycerophosphate, CH₂OH-CHOH-CH₂OPO₃H₂, which hydrolyzes to yield glycerol and H₃PO₄. The chemical mechanism for fatty acid production is more conjectural. An attractive theory suggests that pyruvic acid is decarboxylated in a reaction for which carboxylase (p. 378) is the appropriate enzyme and forms acetaldehyde.

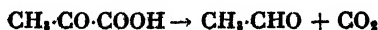

This might well be followed by an aldol condensation, a reaction well known *in vitro*.



Thus a four-carbon compound is formed. Similar condensations might be assumed to extend the carbon chains to the length found in natural fatty acids. A series of oxidations and reductions are postulated to account for the conversion of the condensation product to the fatty acid. It is in these reactions that water would be utilized. It has been found in experiments with deuterium that the higher fatty alcohols (p. 71) of the tissues contain comparatively large amounts of deuterium. This may indicate that they are intermediate compounds in fat synthesis. It is also possible (see p. 450) that glycogen production followed by glycolysis could be part of the process of converting sugar to fat.

A number of experiments indicate that carbohydrate conversion to fat can occur only when the diet includes adequate supplies of thiamine, riboflavin, and pantothenic acid and that, of these, thiamine is particularly important. The thiamine requirement suggests (p. 378) that decarboxylation of α -keto acids, *e.g.*, pyruvic \rightarrow acetaldehyde, is involved.

REFERENCES

Most of the monographs dealing with this subject are not specifically devoted to carbohydrate metabolism, which is inextricably interwoven with other metabolic reactions. Useful background reading is "The Metabolism of Living Tissue" by E. Holmes, Cambridge, England, 1937.

An illuminating review of the fundamental work of Claude Bernard will be found in Garrison's "History of Medicine," Philadelphia, 1929. An exhaustive bibliography of Bernard's work is given in "Bernard, Creador de la Medicina Científica" by Jose J. Izquierdo, Mexico City, 1942.

Much helpful material is found in the book by E. P. Joslin and others, "Treatment of Diabetes Mellitus," 7th ed., Philadelphia, 1940.

A helpful summary of the complex subject of glycolysis is given by C. F. Cori in a paper on the phosphorylation of carbohydrate in "Symposium on Respiratory Enzymes," University of Wisconsin Press, 1942. In the same symposium, see O. Meyerhof, "Oxidoreductions in Carbohydrate Breakdown."

"Advances in Biological and Medical Physics" edited by J. H. Lawrence and J. G. Hamilton, New York, Vol. I, 1948, and Vol. II, 1949, give information and bibliographies on study of intermediary metabolism by use of isotopes.

Reviews covering most of the many phases of this subject are listed:

- BOUCKAERT, J. P., and DE DUVE, C., The Action of Insulin, *Physiol. Rev.*, **27**, 39, 1947.
- CHAIKOFF, I. L., Carbohydrate Metabolism, *Ann. Rev. Biochem.*, **5**, 205, 1936.
- CORI, C. F., and CORI, G. T., Carbohydrate Metabolism, *Ann. Rev. Biochem.*, **15**, 193, 1946.
- DORFMAN, A., Pathways of Glycolysis, *Physiol. Rev.*, **23**, 124, 1943.
- DEUEL, H. J., JR., Metabolism of Fructose and Galactose, *Physiol. Rev.*, **16**, 173, 1936.
- DEUEL, H. J., JR., Carbohydrate Metabolism, *Ann. Rev. Biochem.*, **12**, 135, 1943.
- EVANS, E. A., JR., Carbohydrate Metabolism, *Ann. Rev. Biochem.*, **13**, 187, 1944.
- FISCHER, H. O. L., Chemical and Biological Relationships between Hexoses and Inositols, *Harvey Lectures*, **40**, 156, 1944-1945.
- KAMEN, M. D., Use of Isotopes in Biochemical Research: Fundamental Aspects, *Ann. Rev. Biochem.*, **16**, 631, 1947.
- KREBS, H. A., The Intermediary Stages in the Biological Oxidation of Carbohydrate, *Advances in Enzymol.*, **3**, 191, 1943.
- LOHMANN, K., Chemistry and Metabolism of the Compounds of Phosphorus, *Ann. Rev. Biochem.*, **7**, 125, 1938.
- LUNDSGAARD, E., The Biochemistry of Muscle, *Ann. Rev. Biochem.*, **7**, 377, 1938.
- MANN, T., and LUTWAK-MANN, C., Non-oxidative Enzymes, *Ann. Rev. Biochem.*, **13**, 25, 1944.
- MILLIKAN, G. A., The Chemistry of Muscle, *Ann. Rev. Biochem.*, **11**, 497, 1942.

- NORD, F. F., Mechanism of Alcoholic Fermentation, *Chem Rev.*, **26**, 423, 1940.
- OOSTON, A. G., and SMITHIES, O., Some Thermodynamic and Kinetic Aspects of Metabolic Phosphorylation, *Physiol. Rev.*, **28**, 283, 1948.
- RUSSELL, J. A., Relation of Anterior Hypophysis to Carbohydrate Metabolism, *Physiol. Rev.*, **18**, 1, 1938.
- SCHOENHEIMER, R., and RITTENBERG, D., The Study of Intermediary Metabolism with the Aid of Isotopes, *Physiol. Rev.*, **20**, 218, 1940.
- SOMOGYI, M., Carbohydrate Metabolism, *Ann. Rev. Biochem.*, **11**, 217, 1942
- SOSKIN, S., The Blood Sugar: Its Origin, Regulation and Utilization, *Physiol. Rev.*, **21**, 140, 1941.
- STETTEN, JR., D., Carbohydrate Metabolism, *Ann. Rev. Biochem.*, **16**, 125, 1947.
- UMBREIT, W. W. Phosphorus Compound, *Ann. Rev. Biochem.*, **16**, 105, 1947.
- VENNESLAND, B., Carbohydrate Metabolism, *Ann. Rev. Biochem.*, **17**, 227, 1948.
- YOUNG, F. G., The Pituitary Gland and Carbohydrate Metabolism *Endocrinology*, **26**, 345, 1940.
- The following papers are selected to show methods and trends of investigation in this field:
- ABEL, J. J., *et al.*, Crystalline Insulin, *J. Pharmacol.*, **31**, 65, 1927, **32**, 367, 387, 397, 1928.
- BECK, L. V., Glucose Phosphate in Rat Mucosa, *J. Biol. Chem.*, **143**, 403, 1942.
- BUCHANAN, J. M., HASTINGS, A. B., and NESBITT, F. B., Glycogen Formation in Liver, *J. Biol. Chem.*, **150**, 413, 1943.
- CHESLER, A., and HIMWICH, H. E., Glycogen Content of Various Parts of the Central Nervous System of Dogs and Cats, *Federation Proc.*, **2**, 6, 1943.
- COLOWICK, S. P., and SUTHERLAND, E. W., Polysaccharide Synthesis with Purified Enzymes, *J. Biol. Chem.*, **144**, 423, 1942.
- CORI, G. T., and CORI, C. F., Kinetics of the Enzymic Synthesis of Glycogen from Glucose-1-phosphate, *J. Biol. Chem.*, **135**, 733, 1940.
- CORI, C. F., CORI, G. T., and GREEN, A. A., Crystalline Muscle Phosphorylase III Kinetics, *J. Biol. Chem.*, **151**, 39, 1943.
- DOHAN, F. C., and LUKENS, F. D. W., Lesions of the Pancreatic Islets Produced in Cats by Administration of Glucose, *Science*, **105**, 183, 1947.
- DUBOIS, K. P., and POTTER, V. R., Activation of the Adenosinetriphosphatase System by Acetylcholine, *J. Biol. Chem.*, **148**, 451, 1943.
- GOMORI, G., Hexosediphosphatase, *J. Biol. Chem.*, **148**, 139, 1943.
- GOOD, C. A., KRAMER, H., and SOMOGYI, M., Glycogen Determination, *J. Biol. Chem.*, **100**, 485, 1933.
- GREEN, D. E., and STUMPF, P. K., Starch Synthesis with the Use of Phosphorylase (Potato), *J. Biol. Chem.*, **142**, 355, 1942.
- HASSID, W. Z., CORI, G. T., and MCCREADY, R. M., Constitution of the Polysaccharide Synthesized by the Action of Crystalline Muscle Phosphorylase, *J. Biol. Chem.*, **148**, 89, 1943.
- JOHNSON, R. E., and BARGER, A. N., A Simplified Estimation of Lactate in Muscle, *Biochem. J.*, **35**, 538, 1941.
- KALCKAR, H. M., Adenylpyrophosphatase and Myokinase, *J. Biol. Chem.*, **153**, 355, 1944.
- SCHUCK, C., Urinary Excretion of Citric Acid, *J. Nutrition*, **7**, 679, 1934.
- SHAFFER, P. A., and SOMOGYI, M., Blood Sugar Determination, *J. Biol. Chem.*, **100**, 695, 1933.
- SHERMAN, C. C., MENDEL, L. B., SMITH, A. H., and TOOTHILL, M. C., The Metabolism of Orally Administered Citric Acid, *J. Biol. Chem.*, **113**, 265, 1936.
- SNOW, G. A., and ZILVA, S. S., The Action of *l*-Ascorbic Acid on the in Vitro Respiration of Liver Tissue from Guinea-pigs on a Restricted Diet, *Biochem. J.*, **35**, 787, 1941.
- STEWART, C. P., and THOMPSON, J. C., The Conversion of Laevulose and Fatty Acid into Glucose, *Biochem. J.*, **35**, 245, 1941.
- WOOD, H. G., LIFSON, N., and LORFER, V., The Position of Fixed Carbon in Glucose from Rat Liver Glycogen, *J. Biol. Chem.*, **159**, 475, 1945.

CHAPTER XV

METABOLISM OF THE LIPIDS

Intestinal absorption of fats is still not satisfactorily explained. It doubtless involves some metabolic changes including resynthesis of fat from the absorbed products of its hydrolysis. The rate of resynthesis may be slower than was formerly supposed. Reiser (1942) reported that no triglyceride was found in the intestinal mucosa of the fasting pig although 2.5 per cent of the dried tissue was free fatty acid. This value was about doubled 5 hr. after feeding 300 g. of oil, and even under these conditions, the triglyceride was low in concentration. There is good evidence to show that lipids are largely in protein combination, and this might explain in part the failure (p. 280) of fats to show histological staining in parts of the absorbing cells.

The extent to which fats are reversibly converted to phospholipids in the absorbing cells is not known although it apparently occurs. Also the proportional distribution of the absorbed fat between the lacteals, the portal blood, and other paths of absorption is not yet worked out.

The Blood Lipids. The blood contains the following types of lipids:

1. Neutral fat (triglycerides)
2. Phospholipids (lecithins, cephalins, and sphingomyelins, in decreasing order of concentration)
3. Cholesterol (free and as esters)
4. Other sterids (including certain vitamins and hormones in minute concentration)
5. Fatty acids (probably present in combination with proteins)

The relative amounts of lipids of blood plasma are shown for seven species in Table 57, which also indicates the variability of the analytical results.

The least variable results are those for total lipid and the most variable are those for neutral fat, which may constitute as little as one-fourth or nearly as much as one-half of the total lipid. The sum of the neutral fat, cholesteryl esters, and phospholipids is about 80 per cent of the total.

The erythrocytes tend to be lower in neutral fat and cholesteryl esters than is plasma but higher in free cholesterol and phospholipids.

Average values of each of the blood-lipid fractions are higher in adults than in children and in the latter are higher than in newborn infants.

The theory that fats are mobilized from the storage organs and transported in the circulation in the form of phospholipids was formulated chiefly by Bloor in 1916. Later, the idea that cholesteryl esters served as a similar vehicle for transport of fatty acids was added. Both of these substances are more soluble in plasma than is neutral fat. The latter, however, is always present in blood under normal circumstances so that the necessity for its conversion to a more soluble form is not apparent. The matter of fat mobilization and transport and the variability in the proportions of blood lipids to each other will be discussed further in connection with liver functions.

TABLE 57.—BLOOD LIPIDS—NORMAL PLASMA LIPIDS ESTIMATED BY OXIDATIVE MICROMETHODS

(Boyd, *J. Biol. Chem.*, 143, 131, 1912)

Mean and standard deviations of lipid values in fasting, oxalated plasma¹
(Expressed as mg. per 100 ml. of blood plasma)

	Guinea pig	Albino rat	Rabbit	Cow	Cat	Cockerel	Man
Number tested.	10	116	89	3	27	22	118
Total lipid	169 ± 34	230 ± 31	243 ± 89	318 ± 51	376 ± 110	520 ± 85	530 ± 74
Neutral fat	73 ± 33	85 ± 30	105 ± 50	105 ± 39	108 ± 65	225 ± 77	142 ± 60
Total fatty acids	116 ± 29	152 ± 23	169 ± 66	202 ± 55	228 ± 82	361 ± 74	316 ± 85
Total cholesterol	32 ± 5	52 ± 12	45 ± 18	110 ± 32	93 ± 24	100 ± 23	152 ± 24
Cholesterol esters	21 ± 4	31 ± 10	23 ± 12	73 ± 15	63 ± 23	66 ± 19	106 ± 25
Free cholesterol.	11 ± 2	21 ± 8	22 ± 13	37 ± 15	30 ± 10	34 ± 9	46 ± 8
Phospholipids . .	51 ± 12	83 ± 24	78 ± 33	84 ± 21	132 ± 53	155 ± 34	165 ± 28

¹ All values are for healthy adults, either males or nonpregnant females.

The rise in blood lipids after a fat-rich meal is appreciable but comparatively slow. It may be detected after 1 to 3 hr., reaches its maximum after 5 or 6 hr., and may not subside to the fasting value until about 9 hr. after eating. A marked rise in blood lipids due to any cause is called **lipemia** and if due to a fat-rich meal is "alimentary lipemia." A considerable part, 15 per cent or more, of the increase after eating is found to be phospholipids and cholesteryl esters. This fact has been used in support of Bloor's theory of transport. Nevertheless, the major part of the extra blood lipids is neutral fat.

The very finely emulsified droplets of fat in blood are called **chylomicrons**. Sometimes they are sufficiently abundant to give blood serum a milky appearance known as **lactescence**. Under almost all circumstances they are small, not more than 1 μ in diameter.

Fat Storage. The liver, chief organ for maintaining a carbohydrate reserve, is not quantitatively as important for fat storage as are the adipose tissues, the *fat depots*. Of these the fatty subcutaneous layer, the *panniculus adiposus*, is apt to contain a large part of the stored fat, but there are other important depots, *e.g.*, intermuscular connective tissue, omentum, mesentery, and connective tissues around various organs, such as heart and kidney. The lipids in the active tissues of organs are considerable in amount, especially in nervous tissue, but are chiefly functional and used as reserve fuel only in extreme deprivation.

TABLE 58.—THE COMPONENT, FATTY ACIDS OF HUMAN DEPOT FAT
(Cramer, D. L., and Brown, J. B., *J. Biol. Chem.*, 151, 427, 1943)
Five specimens from autopsy of persons dying from causes not likely to affect fat
(Values are per cent of fatty acids)

Fatty acids	Average value	Range
Lauric.....	0.5 ¹	0.1- 0.9
Myristic.....	3.5	2.6- 5.9
Tetradecenoic.....	0.4	0.2- 0.6
Palmitic.....	25.0	24 -25.7
Hexadecenoic.....	6.4	5 - 7.6
Stearic.....	7.0	5.2- 8.4
Octadecenoic (oleic).....	15.9	44.8-46.9
Octadecadienoic (linoleic).....	9.6	8.2-11.0
Arachidonic.....	0.66	0.3- 1.0
Other C ₂₀ acids.....	1.2	0.3- 2.2

¹ Results of three analyses only.

A storage organ severed from its connection with the central nervous system (denervated) tends to have an influx of glycogen followed by an increase in its store of fat. Conversely, during starvation, denervated adipose tissue is depleted only after prolonged hunger.

The composition of depot fat shows an obvious tendency to a uniformity in the proportions of its constituent fatty acids. There is therefore an approach toward characteristic physical and chemical properties of the body fat of any one species. One notes, *e.g.*, the relative hardness and higher melting point of mutton fat as compared with lard. The relative constancy of human fat is indicated by the limited range of values for the fatty acid content as shown in Table 58.

Relative constancy of composition is evident, however, only under certain conditions such as the use of an adequate and uniform diet. It is much more apparent when the depot fats are formed by synthesis from food carbohydrate than when they result largely from mere deposition of

ingested fat. When fats which differ from those of the body are fed in abundance, the depot fats can be made to vary (Table 10) over a wide range of values for hardness, melting point, iodine number, etc. This fact has a practical application in animal husbandry. Pigs are given foods of which the fats will produce lard of maximum commercial value, neither too hard nor too soft to meet popular demands.

The relative tendencies toward deposition of fat unchanged and toward modification during the process of storage have been successfully studied by the use of tracers. Two of the methods used are (1) feeding fats containing elaidic acid and (2) feeding artificially hardened (hydrogenated) fats produced by introducing deuterium into the fatty acids of food oils. By both methods it has been amply demonstrated that food fatty acids may appear in depot fats largely unaltered. This is true, however, only for fatty acids of higher molecular weight, those containing more than 10 C atoms. Those of smaller molecular size are apparently consumed although fragments from them may be used in the reconstruction of depot fatty acids.

The constant state of flux (p. 444) in depot fats is a surprising revelation of newer investigations in fat metabolism. The low O_2 uptake of adipose tissue and its comparative constancy in amount when the caloric intake is constant would suggest, as was formerly supposed, that fat in depots remains inert and reenters the "metabolic mill" only when required to make good a food deficit. Not only the deuterium experiments described in Chap. XIV but other evidence, such as changing composition of depot fats without change in body weight, emphasize the truth of the newer idea of the constant, active participation of fat-storage mechanisms in metabolic processes.

Adipose tissue is shown by chemical and histological tests to contain glycogen. Under some conditions, for example, when previously fasted rats are fed a carbohydrate-rich diet, the amount may be considerable. Enzymes of adipose tissue can phosphorylate glycogen. Glycogenolysis leading to fat synthesis may therefore occur in fat-storage cells. Surviving slices of glycogen-rich adipose tissue show a higher RQ than is found for the fasting animal. This indicates that adipose tissue can convert glycogen to fatty acids.

Fat Formation from Protein. While, as we have seen, fat production from carbohydrate is easily demonstrated, its production from protein has long been a debatable matter so far as the higher animals are concerned. Though long ago demonstrated in some lower forms, *e.g.*, in fly maggots and in the silkworm, this conversion was not clearly demonstrated for a mammal until 1939 when Longenecker, using rats

which had been fasted until they had lost 25 per cent of the body weight, fed them on a diet composed largely of casein with only traces of lipids. He found that of the weight which they regained, 36 per cent was fat. It was very similar in composition to that formed during the use of a carbohydrate-rich diet. These experiments have been confirmed. The transformation of protein to fat cannot be observed, however, unless the diet contains adequate amounts of pyridoxine which is probably needed for the change from protein to carbohydrate or to some intermediary products of carbohydrate metabolism which seem to be the real material for fat production.

Because of the facility with which fat is synthesized from other foods, animals can subsist on diets which appear to be entirely devoid of lipids except for very small amounts of the indispensable fatty acids (p. 70), linoleic and arachidonic. It has been found in several laboratories, however, that the growth rate and several other aspects of good nutrition are favored by inclusion of neutral fat in the diet. While a fat-free diet must be adequate in all its minerals and vitamins, the demand for *thiamine* is especially notable. It is required for adequate metabolism of carbohydrate.

Obesity. Many theories have been proposed to explain obesity in terms of faulty metabolism, but all of them have failed to stand the test of experimental demonstration. Metabolism is normal and obesity is due to excess of energy intake as food above energy expenditure in work and heat liberation. The obese individual merely has an excessive appetite. The food consumption may be excessive only in the sense that muscular activity is comparatively small, or it may be due to environmental factors, such as mere boredom. But the most interesting and important causes are of endocrine origin. Castration usually but not unfailingly leads to obesity as a result of lowered activity without a corresponding decrease of food consumption. Removal of the pituitary is apt to be followed by obesity for the same reason. Several forms of pituitary deficiency are associated with peculiar types of obesity, but the abnormality is in the distribution of fat rather than in its metabolism. It would be expected that a hypothyroid condition, by depressing (p. 421). oxidation, would cause obesity and this is often the case; but in many patients the appetite is also depressed and in them obesity is not a symptom. A few cases of extreme hyperinsulinism (overproduction of insulin) result in hypoglycemia sufficiently severe and prolonged to lead to obesity from excessive food intake in response to lowered blood sugar. Excessive appetite can be aroused in experimental animals by certain injuries to the brain in the hypothalamic region. The gaps in

our knowledge of the physiological cause of appetite are considerable. A lowered blood-sugar level would seem to be one stimulus to arouse the sense of appetite, but it can hardly be the only one.

It is usually found that persons on a reducing diet, so calculated as to supply energy far below its expenditure, fail to lose weight at first.

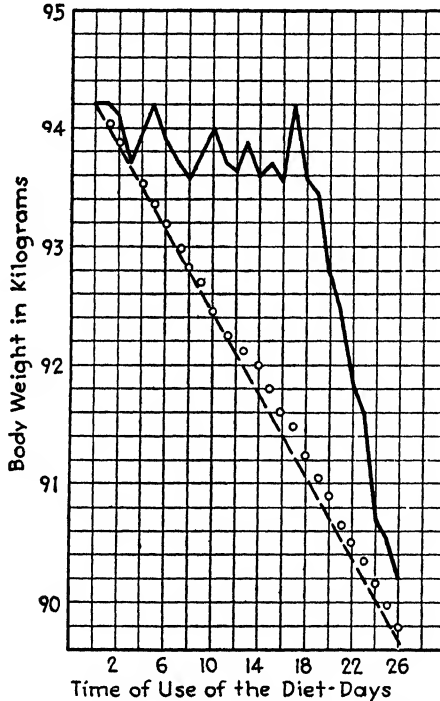

FIG. 77. Relation of water balance to body weight during use of a reducing diet. The observed body weights are shown by the upper curve. The dash line indicates the weight loss as calculated from the caloric deficiency of the diet. The circles show the observed weight corrected for water retention. (After L. H. Newburgh.)

With slight fluctuations the weight is maintained 8 to 10 days or even longer. The would-be reducer may be thus discouraged from persisting on the diet. If he does persist, however, a sudden and rapid decrease brings the weight down to that predicted by calculation of the excess of energy expenditure over intake. This suggests that water temporarily replaces the fat given up by the storage depots but is rapidly lost later on. Studies of the water balance during the first days of use of a restricted diet prove this (Fig. 77) to be the fact.

This phenomenon, however, is not characteristic of fat metabolism alone. It occurs in thin people and in experimental animals (rats and

mice) having very small fat reserves at the beginning of the experiment. After death from starvation the muscle substance is abnormally high in water content with a marked decrease in protein. It is found, however, that water retention on a restricted diet tends to be decreased by protein food with a generous supply of thiamine.

Phospholipids of Animal Tissues. The rate of uptake of phospholipid by tissues from the blood is fairly rapid. A temporary increase in plasma phospholipids occurs during alimentary lipemia but is relatively less than the increase in total lipids, and not all of the increase can be traced to intestinal absorption of the phospholipids of the food. Phospholipid tagged with radiophosphorus has been shown to leave the blood stream after injection at a rate such that its blood level falls to half value in less than 2 hr. A considerable part of it (about one-third) is found in liver.

The amounts of phospholipids in the various organs, although variable, are more or less characteristic of their component tissues. Thus white matter of nervous tissue is so abundantly supplied that the spinal cord and the *white* matter of brain are top ranking with a phospholipid content of about 9 per cent or more, computed as lecithin. The gray matter of brain is next in abundance, about 4 per cent; bone marrow is also abundantly supplied, averaging about 2.8 per cent with larger amounts in infants. Liver, kidney, adrenals, pancreas, and testes commonly contain 2 to 2.6 per cent, heart and lung tissues about 1.5 per cent. Spleen, mucosa of digestive organs, muscle, skin, and osseous tissues contain only 1 per cent or less. Values for blood are given in Table 57. Tissue lymph contains less, on the average, than blood plasma. Egg yolk is a rich source of phospholipid.

Any attempt to deduce the physiological role of phospholipids from their distribution in tissues would be premature. One notes, however, that while relatively inert structures such as osseous and dermal tissues tend to be low in phospholipid content, nervous tissue, which can function normally only in the presence of high O_2 tension, is high in phospholipids. Certain organs (liver and kidney) which show a high metabolic rate are comparatively rich in phospholipid.

The relative proportions of the three main kinds of phospholipids, lecithins, cephalins, and sphingomyelins, as found in tissues have been only partially investigated. In *human blood* the ratio, lecithins:cephalins:sphingomyelins is about 5:4:1, but some cellular structures show quite different ratios. Thus *erythrocytes* have a ratio approximately 3:1:1. In *platelets* about 65 per cent of the phospholipid is cephalin. In *liver* the phospholipids are normally made up of some 55 per cent lecithin and 40 per cent cephalin with only a small proportion of sphingomyelin.

The proportions, however, are variable, changes in lecithin being especially prominent. It is reported that the blood *plasma* of certain mammals, including man, appears to contain only a very low concentration of cephalin inasmuch as the choline content of the plasma phospholipids is found to be substantially equivalent to the P content. This would mean that lecithins and sphingomyelins compose the plasma phospholipids while the blood cephalin must be almost entirely in corpuscles and platelets. In *nervous tissue* a relatively large proportion of the phospholipid is cephalin and sphingomyelin.

The distribution of sphingomyelin was observed (Hunter, 1942) in cat tissues. Brain had the highest content, 1.75 ± 0.19 per cent of the wet weight; lung tissue was next, 0.69 ± 0.12 per cent; then, in decreasing order, kidney, spleen, intestinal mucosa, liver, intestinal muscle, heart muscle, and skeletal muscle. The skeletal muscle had 0.075 per cent. No correlation between the total phospholipid and the sphingomyelin content was observed. This specialized distribution and relative constancy of tissue sphingomyelins is of interest as suggesting that they have specialized functions.

Liver Functioning in Lipid Metabolism. The role of the liver in fat metabolism is no less important than it is in carbohydrate metabolism. In both cases it is an important transformer, converting food into useful forms. There is a marked contrast, however, between these two types of functioning. For carbohydrates the liver is the chief storage depot of the reserve supply; but for fat the liver is not *normally* an accumulator and tends to keep its fat content (3 to 8 per cent) relatively uniform, under conditions of good health and adequate diet, no matter how much fat is piled up in adipose tissues.

In addition to the protein, fat, and carbohydrate interconversions already described, lipid transformations which occur in liver include the following:

1. Phosphorylation of neutral fats to produce phospholipids
2. Cholesterol production and its esterification with fatty acids
3. Desaturation of fatty acids
4. Transformations of fatty acids, shortening or lengthening the carbon chains
5. Various other metabolic changes including oxidation of fatty acids and glycerol

Aside from cholesterol production, these various changes are not characteristic of liver alone; yet, while they do occur in other tissues, they are conspicuous in the liver.

The phosphorylation process probably takes place freely in liver, but

quantitative measurement of its rate is not feasible because of the variable rates of exchange of both neutral fats and phospholipids between blood and liver tissue. The phospholipids normally contain more of the fatty acids of the liver than do the neutral fats. Chaikoff *et al.* (1943) injected Na_2HPO_4 containing radioactive phosphorus (P^{32}) into normal and hepatectomized dogs and sought for the radiophosphorus in the phospholipids of the blood and tissues. The results indicated that practically all the *blood* phospholipid was formed in the liver. Phospholipid was formed in the small intestine and in the kidney, but these organs contributed no significant amounts to the blood.

Cholesterol production was discussed (p. 270) in connection with bile secretion.

Desaturation has been observed by the use of fatty acids containing deuterium. Deuteriostearic acid and deuteriopalmic acid, when fed to animals, have been partly recovered in the body fats as deuteriopalmoleic and deuteriooleic acids. Both desaturation and saturation of fatty acids go on continually in the body. A considerable but undetermined amount of these changes occurs in the liver. The theory that desaturation is a necessary preliminary to oxidation has not been substantiated; but, *in vitro*, unsaturated fatty acids are more readily oxidized than are saturated ones. There are evidently certain limitations in facilities for desaturation inasmuch as the indispensable fatty acids, linoleic (Δ^9 12-octadecadienoic) and arachidonic ($\Delta^{5,8,11,14}$ -eicosatetraenoic), cannot be produced in experimental animals.

Fatty Livers. The tendency of the liver to maintain a "steady state" with respect to its lipid content frequently gives way to a tendency to accumulate lipids. The process is referred to as fatty degeneration or as fatty infiltration. Neither term is satisfactorily descriptive because both abnormal production in and excessive uptake by the liver may be involved. Delayed output of lipids from the liver may also be a factor. The excess lipid may be predominantly composed of neutral fats, phospholipids, or cholesterol in widely varying proportions. There are so many different pathological and dietary disturbances which may give rise to fatty livers that a complete description of all of them cannot be given here. A provisional listing of a number of types of fatty livers of physiological interest is shown in Table 59. Some tentative deductions regarding lipid metabolism may be drawn from the data given in this table.

Certain poisons interfere with the ability of the liver to get rid of neutral fats. This might be due in part to checking of the formation of the relatively transportable lecithins inasmuch as feeding choline, a

lecithin component, hastens the liver defatting process after the poisoning. Desaturation of fatty acid may also be inhibited as shown by lowered iodine number.

Excessive fat may overload the liver; but conditions which speed up certain liver processes, namely, choline feeding to stimulate lecithin formation and high protein feeding to stimulate general metabolism, more or less counteract the excess of fat.

TABLE 59.—SOME TYPES OF FATTY LIVERS OF SIGNIFICANCE IN LIPID METABOLISM

Causative condition	Liver lipids characteristically accumulated	Dietary or other corrective measures
Phosphorus poisoning	High neutral fat or relatively low iodine number	Choline feeding but only after cessation of poisoning
Carbon tetrachloride poisoning	High neutral fat of relatively low iodine number	Choline feeding but only after cessation of poisoning
Excessively fat-rich, protein-poor diet	High neutral fat	Choline and much casein in the diet
Carbohydrate-rich, thiamine-rich, and choline-free diet	High neutral fat with low cholesterol and cholesteryl esters	Choline feeding
Excessive liver feeding or, what is probably equivalent, a cholesterol-rich diet	High cholesterol	"Lipoic" feeding but not choline feeding
Pancreatectomy with insulin treatment	High neutral fat, high cholesteryl esters	Choline feeding plus "lipoic" or methionine feeding
Diabetes, when food carbohydrate and insulin treatment are inadequate	High neutral fat	Adequate carbohydrate feeding with insulin treatment
Excessive cystine in a diet low in choline	Tendency to high neutral fat	Feeding methionine or methionine-rich proteins

High fat production in the liver from carbohydrate requires a generous supply of thiamine but can be checked by feeding choline to stimulate lecithin formation.

Cholesterol accumulation in the liver results from conditions which may be distinctly different from those causing fat accumulation. Cholesterol accumulation is more effectively inhibited by the so-called "lipoic" than by choline. Both of these substances will be discussed in connection with the lipotropic effect.

While protein feeding in general shows a tendency to prevent fatty livers, certain of the protein amino acids, namely, cystine and methionine, show peculiar effects.

Cirrhosis of the liver, an excessive development of fibrous connective tissue, results from a number of causes such as alcoholism, syphilis, and prolonged malarial fever. While there is no correlation between fatty livers and the degree of cirrhosis, it appears that diets which aggravate cirrhosis will eventually produce fatty livers.

The Lipotropic Effect. It has long been known that depancreatized dogs, maintained with insulin injections, develop fatty livers on a diet which is fairly high in sugar and only moderately supplied with protein. The liver accumulates neutral fat and cholesteryl esters but becomes nearly normal (Hershey) when lecithin is added to the same diet. It was later demonstrated (Best, 1935) that choline produces the same result as lecithin. That choline favors lecithin production was indicated by Chaikoff's experiments, which, using radiophosphorus (P^{32}) as a tracer, showed that choline feeding increased the rate of phospholipid production in the liver.

A substance which can thus check an abnormality in lipid metabolism is said to exert a lipotropic effect. Certain compounds related to choline function in the same way. One of them is betaine, which is about one half as effective as choline. A comparison of the formulas shows that both are provided with three methyl groups. Ethanolamine, which bears the same relation to cephalin as does choline to lecithin, lacks methyl groups. Neither cephalin nor ethanolamine is lipotropic.

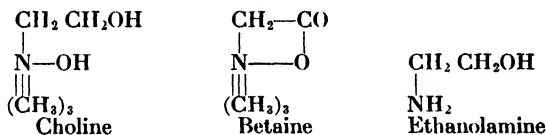

Similar lipotropic effects are exerted by proteins, but they are less potent than choline so that some 30 per cent of the diet must be protein if satisfactory effects are to be obtained. Some experiments indicate that only 0.0065 g. of choline is as effective as 1 g. of casein. The latter is the most potent of the proteins tested. Other proteins in decreasing order of potency are ovalbumin, beef proteins, blood fibrin, wheat gliadin, gelatin, and corn zein. Theories of the nature of this protein effect are complex and must include stimulation of liver metabolism and specific effects of individual amino acids. But one aspect of the problem is outstanding, namely, the action of methionine. This amino acid, $\text{H}_3\text{C}-\text{S}-\text{CH}_2\cdot\text{CH}_2\cdot\text{CHNH}_2\cdot\text{COOH}$, can furnish the labile $-\text{CH}_3$ group for metabolic reactions and in this respect is like choline and betaine. Actually methionine aids in the synthesis of choline as is shown by isotopic experiments. Du Vigneaud fed methionine containing deuterium in the methyl group to young rats maintained on a choline-

methionine-free diet and found choline isolated from the tissues had a high deuterium content. Methionine is lipotropic when fed in pure form. The amount of it required is some 5 to 8 times as much as the choline which could give a similar lipotropic effect. The action of dietary proteins is due, in part at least, to their content of methionine. But the metabolic reactions involved are complicated by the contra effects of other sulfur-containing amino acids. Thus addition to the diet of cystine or homocystine in pure form or of proteins with a high cystine content decreases the effectiveness of lipotropic substances in the diet. Still other factors seem to be involved since the ratio of methionine to cystine in proteins has only a very imperfect relation to their comparative lipotropic action. One may surmise, however, that there is a "competition" among various metabolites for the methyl groups which are some of the building materials needed for synthesis of various metabolites including that of lecithin in the liver. A deficiency in lecithin production tends to cause fatty livers. Other complex transfers of methyl groups (transmethylation) will be discussed (Chap. XVI) in connection with the metabolism of creatine.

Hormones can exert rather direct effects (Chap. XX) on fat metabolism. One of them prepared from the cortex of the adrenal gland deserves mention here because it acts upon fat deposition. In its absence (adrenalectomized animals) the fat content of the liver is lowered, and this result is attributed to a lowered rate of fat production. The fat of adipose tissue is also diminished, as is its glycogen content. Administration of the hormone in separated, more or less purified form causes increase in deposition of liver fat in adrenalectomized animals. As this can occur when the animal is starved, the natural inference is that the hormone functions in the production of fat rather than in its deposition alone.

The "Lipocaic" Effect. One of the first lipotropic effects to be discovered was the action of raw pancreas or its alcoholic extracts when fed to an insulin-treated depancreatized dog on a fatty-liver-producing diet. This led to the deduction that pancreatic tissues produce, in addition to insulin, another hormone which, acting on fat metabolism, was given the provisional name, "lipocaic." After it had been shown that lecithin or, more specifically, choline could give similar effects, the existence of lipocaic seemed questionable. Further studies by a number of investigators, among whom Dragstedt and Chaikoff are prominent, indicate that the lipocaic effect is different from that of choline. While the latter is potent in checking accumulation of neutral fat in the liver, it does not so effectively counteract the tendency to accumulate cholesterol and cholesteryl esters (Table 59) during the use of certain diets. **But feeding raw pancreas or its extracts may counteract the cholesterol**

disturbance. That this result is not due to choline is shown by the effectiveness of a pancreatic extract so prepared that it does not contain lecithin or choline. Also preparations from tissues other than pancreas may be relatively high in choline but fail to show the typical lipocaic effect.

It now seems clear that the missing substance referred to as "lipocaic" is not a pancreatic hormone but is something set free from food proteins by the action of pancreatic enzymes. It was noted that only extracts of *raw* pancreas (enzymatically active) were curative and shown further that fully digested casein could substitute for lipocaic. Moreover administration of a small amount of pancreatic juice to a depancreatized dog prevents fatty liver. The curative effects of predigested casein are found to be proportional to its methionine content.

The Metabolism of Glycerol. It is commonly assumed that an initial step in the utilization of fats is the hydrolysis to glycerol and fatty acids. Glycerol is metabolized through phosphorylation. Its action as a glycogen former was discussed. In phlorizinized animals it is almost quantitatively recovered in the urine as glucose, on the assumption that two molecular equivalents of glycerol yield one of glucose. The appearance of partially oxidized forms of glycerol during glycolysis was shown. A later stage of its oxidation might be pyruvic acid, which would be eventually oxidized to CO_2 and H_2O .

Knoop's Theory of the β -Oxidation of Fatty Acids. The intermediate stages in the breakdown of the long carbon chains of fatty acid molecules are difficult to follow, and even now the nature of the process is a controversial matter.

Modern ideas on the subject date from 1904, when Knoop reported significant experiments which led him to form a theory. He took advantage of the fact that, while "open-chain" compounds tend to be oxidized in the animal body, those containing the benzene ring may partially escape and appear in the urine in some modified form. Thus benzoic acid appears in part (p. 287) as hippuric acid and phenylacetic acid as phenaceturic acid.

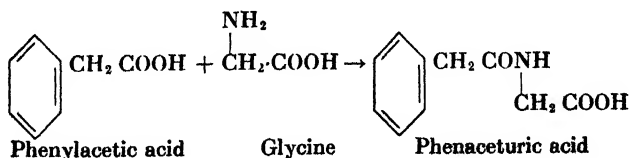

Knoop fed various fatty acids combined by artificial synthesis with the phenyl group and found that fatty acids with an even number of

carbon atoms resulted in excretion of phenacetic acid and those with an odd number of carbon atoms yielded hippuric acid. Thus:

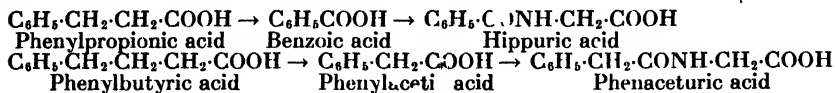

Similar results were obtained with higher fatty acids both saturated and unsaturated. The results led Knoop to formulate what is called the " β -oxidation theory." It will be recalled that this postulate is invoked (p. 66) to explain in part the striking observation that only fatty acids with an even number of carbon atoms appear in natural fats. This fact and also Knoop's results have a rational explanation in the idea that the degradation of the fatty acid molecule proceeds stepwise by the oxidative removal of 2 carbon atoms in each step because the oxidative process attacks the β -carbon atom.

Illustrated by oxidation of caproic acid, the reactions could be summarized thus:

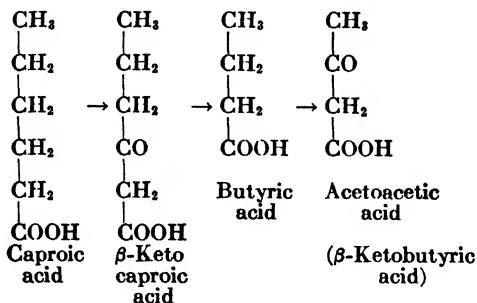

Good evidence of the removal of a two-carbon fragment was furnished (Schoenheimer and Rittenberg) by experiments in which mice fed with deuterium-containing stearic acid were found to have deuterium in the palmitic acid isolated from their tissues. Similarly, deuterium in palmitic acid of food has been found in lauric and myristic acids of tissues.

The intermediate stages of each successive oxidation process have not been deciphered, but might include dehydrogenation to form an unsaturated double bond between the α - and β -carbon atoms followed by hydration and further dehydrogenation. The probability that the keto acid is produced is reinforced by the work of Dakin (1908), who showed that H_2O_2 in a neutral medium can mildly oxidize a fatty acid to form its β -keto derivative.

The cleavage fragment containing 2 C atoms is commonly assumed to be acetic acid, but only indirect evidence supports the assumption.

The well-established fact that acetoacetic acid, β -ketobutyric acid, is

an intermediary product in fatty acid catabolism favors Knoop's theory.

Theories Supplemental to Knoop's. While evidence accumulating since 1904 gives ever stronger support to Knoop's theory, certain supplementary suggestions have appeared. One of them is the idea that the oxidation of the fatty acid need not be stepwise but could occur simultaneously at alternate $-\text{CH}_2-$ groups and is referred to as *the multiple alternate oxidation theory*. The postulate is based partly on the observation that fatty acids when incompletely oxidized in tissues may yield more acetoacetic acid than the unmodified Knoop theory would account for. According to the latter, 1 molecule of a fatty acid, having a long carbon chain, should yield not more than 1 molecule of acetoacetic acid and no more than a short-chain fatty acid. But this expectation is not realized under some circumstances. Among various experiments of this sort are those of Jowett and Quastel (1935), who found that surviving liver slices could form more acetoacetic acid from C_8 , C_{10} , or C_{12} fatty acids than from equivalent amounts of butyric acid (C_4).

The situation is complicated, however, by the idea that acetoacetic acid may be formed in the cell by condensation of 2 molecules of acetic acid. Swendseid and coworkers (1942) offer excellent proof that ketone substances arise in this way. We have, therefore, what is called the *β -oxidation-condensation theory*, which assumes that the two-carbon fragments, split from fatty acids by β -oxidation, are either acetic acid or something convertible to acetic acid, which is condensed to acetoacetic acid.

Krebs and Johnston present a slightly different theory. They suggest that acetoacetic acid is synthesized from acetic and pyruvic acids inasmuch as they found that the intermediary compound, acetopyruvic acid, was ketogenic in fasting rats. The synthesis would be

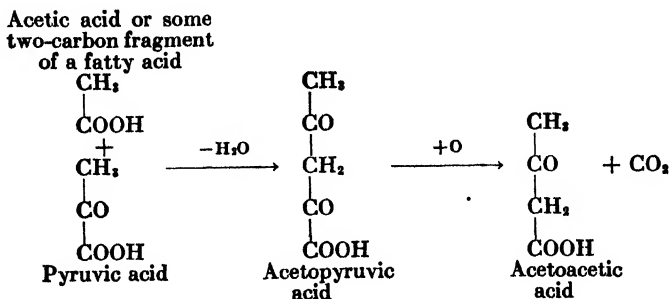

Weinhouse, Medes, and Floyd (1944) report that surviving slices of rat liver yield evidence of synthesis of ketones. They used *n*-octanoic (caprylic) acid containing 5.5 per cent of radioactive carbon (C^{18}) in the

carboxyl group. Obviously, removal of a two-carbon fragment from the fatty acid by β -oxidation would leave no radioactive carbon to appear in acetoacetic acid according to the unmodified Knoop theory. They found, however, that the acetone which was produced in the liver slices by decarboxylation of acetoacetic acid contained considerable amounts of C^{13} , nearly equivalent to that calculated according to the condensation theory. Work by other investigators has confirmed the theory. While it would seem to make the mechanism of multiple alternate oxidation superfluous, it does not disprove its occurrence.

It has become highly probable, through the work of various investigators, that the two-carbon fragment removed from the fatty acid may be oxidized in the tricarboxylic acid cycle. Although the extent to which this occurs without a preliminary conversion to acetoacetic acid is not yet known, several authorities (*e.g.*, Chaikoff) have expressed the belief that production of acetoacetic acid "is not in the main path of oxidation of fatty acids." According to this view, acetoacetic acid arises when fatty acid breakdown is too rapid to permit the immediate and complete oxidation of the fragments.

The ω -oxidation theory has been advanced as another modification. According to this idea oxidation may begin at the CH_3 - group, which is the terminal or ω group of the fatty acid. This would lead to the formation of a dicarboxylic acid and would permit β -oxidation to set in at both ends of the long fatty acid chain. So much evidence tending to show that this can occur in living cells *under some circumstances* has been accumulated that one cannot overlook the theory. Carter, reviewing the evidence, concluded (1941) that the ω -oxidation mechanism "is not a general pathway of fatty acid oxidation but is an emergency mechanism called into play when there is no other method of disposal or when normal processes are overtaxed by the feeding of overwhelming doses."

Ketogenesis and Antiketogenesis. It is commonly agreed that acetoacetic acid is the parent substance of the other ketone bodies, accumulation of which (p. 431) causes ketonemia and ketonuria. Relations between the three ketone substances may be shown schematically.

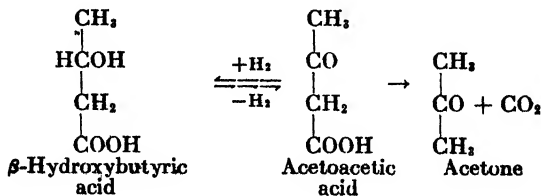

The reversible oxidation-reduction involving acetoacetic and β -hydroxybutyric acids causes these two substances to exist in an equilibrium for

which the position is determined by the relative redox potential of the tissues. The reaction forming acetone appears to be one which is not reversible in the body.

The production of ketone substances is called **ketogenesis**, and excessive production or an accumulation of them is called **ketosis**. It is by far the most frequent cause of acidosis.

Ketosis occurs when carbohydrate and lipid metabolism is disturbed in any of a number of ways, *e.g.*, in diabetes, in starvation, during defective cellular oxidation, and during carbohydrate deprivation. While the ketone substances arise for the most part from fatty acids, ketosis is generally the result of some kind of disturbance in carbohydrate metabolism; the most effective antiketogenic measures for correction of ketosis include those procedures which tend to increase the utilization of carbohydrate, *e.g.*, insulin injection with carbohydrate food for the diabetic and mere ingestion of sugar for the nondiabetic.

After the discovery by Shaffer (1921) that the oxidation in vitro of acetoacetic acid by H_2O_2 in an alkaline solution was markedly accelerated by addition of glucose, there arose a widely accepted theory that cellular oxidation of fatty acid could be normal only when carbohydrate was simultaneously oxidized. This was in agreement with the then prevalent belief that the diabetic organism could not oxidize much carbohydrate and thus might be expected to show ketosis, as it actually does. The accumulation of ketone substances was regarded as due to a lowered ability of the tissues to oxidize acetoacetic acid but was supposed to be counteracted by a so-called "ketolytic action" of carbohydrate. These ideas, however, have given way to the opinion that ketosis results from any condition in which fatty acids are broken down in metabolism at so rapid a rate that the resulting acetoacetic acid cannot be oxidized fast enough to prevent ketosis. The newer theory suggests that carbohydrate checks ketosis by its fat-sparing action rather than by its fat-oxidizing power. One may say that *carbohydrate is antiketogenic rather than being ketolytic*. The tendency to believe that it really is antiketogenic has been strengthened by study of the tricarboxylic cycle. It now seems probable that a two-carbon fragment formed by fatty acid oxidation reacts with pyruvic acid (Fig. 67) to enter the cycle and thus be oxidized rather than synthesized into acetoacetic acid. Inasmuch as the chief part of the pyruvic acid normally arises from carbohydrate breakdown, with only a smaller part coming from amino acids, it seems reasonable to expect that an increase in pyruvic acid production, resulting from carbohydrate feeding, would tend to sweep more of the two-carbon fragments into the cycle and thus diminish the amount of acetoacetic acid formed.

The newer theory is in agreement with the modern concept of insulin

action. It also affords an explanation of the origin of ketosis from causes other than diabetes. Thus in starvation the liver depleted of glycogen attacks fats excessively. Ketosis occurring during the use of a carbohydrate-free diet is the result of a similar situation. The fat-metabolizing hormone of the anterior pituitary, when not checked by adequate functioning of insulin, stimulates rapid breakdown of fatty acids and causes ketosis. Still further support for the newer theory is seen in the fact that depancreatized dogs given an intravenous injection of glucose *without insulin* show a pronounced decrease in ketonemia and ketonuria. It is also reported that human subjects on a ketogenic diet show a decrease in the blood ketone substances during exercise, suggesting that acetoacetic acid is used for muscular work.

The liver is the chief organ for production of acetoacetic acid. Jowett and Quastel used surviving slices of organs in a medium containing butyric acid and found some ketogenesis in kidney, spleen, testis, and brain, but liver produced 10 to 40 times as much as other tissues. This again emphasizes the pace-setting role of the liver in fat metabolism.

The oxidation of acetoacetic acid is quantitatively not so prominent in liver as in other organs, especially muscles, but seems to be a normal process for all tissues at all times. Acetoacetic acid is apparently a normal constituent of blood and is usually found in very low concentration in urine. Only when the liver, not having sufficient carbohydrate available to maintain regular activity of the "metabolic mill," is forced to metabolize fatty acids at an abnormally high rate is ketogenesis sufficient to cause ketonemia and ketonuria. It seems probable (Lehninger, 1945) that phosphorylation of fatty acids by ATP is necessary before they are oxidized.

The extent to which energy liberation from fat depends upon oxidation of acetoacetic acid is not yet determined nor are the intermediary reactions leading to CO_2 and H_2O known. One hypothesis suggests that acetoacetate is oxidized by use of the tricarboxylic acid cycle. The formation of citric acid, when acetoacetate is added to tissue slices of kidney or heart, has been reported. Under certain circumstances the recovered citrate was sufficient to account for 80 per cent of the added acetoacetate. The liver did not cause this reaction. Its failure to do so accords with its known deficiency in oxidizing acetoacetic acid. Breusch has isolated from muscle, kidney, and brain an enzyme **citrogenase** which catalyzes citric acid production from oxaloacetic and β -keto acids including acetoacetic. It has been shown that kidney extracts, to which acetoacetic acid labeled with C^{13} is added, produce α -ketoglutaric acid containing the isotope.

It is reported (Price and Rittenberg, 1949) that C^{14} used to label

acetone fed to rats appears in acetyl groups and in cholesterol, bone carbonate, glycogen, and in glutamic and certain other amino acids of the carcass. It was also found in fatty acids. It is, in short, metabolized as is acetic acid.

Ketogenic-Antiketogenic Ratios. Ketogenesis in the liver may be sufficient to cause ketonemia and ketonuria even in the healthy organism. In general this occurs when the food is very rich in fat, low in or free from carbohydrate, and only moderately supplied with protein. High protein feeding tends to prevent ketogenesis because of gluconeogenesis from certain amino acids. There is what is called a ketogenic-antiketogenic ratio.

$$\frac{K}{A} = \frac{\text{ketogenic material of food}}{\text{antiketogenic material of food}}$$

Ketogenic material includes the fatty acids of food lipids and certain of the protein amino acids (leucine, isoleucine, phenylalanine, and tyrosine) which appear to be ketogenic. The antiketogenic material includes nearly all of the glucose equivalent of the food carbohydrate plus the glycerol of the fat and those amino acids (p. 493) which can serve as material for gluconeogenesis. When the ratio K/A exceeds a critical value, ketosis begins to appear. One may say that the threshold for ketosis has been crossed so that the liver "spills out" ketone substances more rapidly than they are being oxidized by other tissues. But the critical ratio (ketosis threshold) varies in different animals. It is distinctly higher in dogs and cats than in rats and primates. Human beings show a relatively low threshold. Children and women, however, are much more susceptible to ketosis than are adult men. Even comparable individuals show variability. There appears to be an adaptability in this respect so that a diet, at first ketogenic, becomes gradually more tolerable if persisted in. Apparently the Eskimo race is thus adapted. Their diet is normally very high in fat and almost carbohydrate-free. Yet they are reported to show no ketonuria. The threshold of ketosis is relatively low in the diabetic and in experimentally diabetic animals.

Elaborate methods and complex formulas for the calculation of ketogenic-antiketogenic ratios of diets have been devised. While their use has led to a more rational dietary treatment of diabetics than formerly prevailed, the lack of predictability of the value of the ketosis threshold makes these calculations of little general applicability.

Endocrine Effects upon Ketogenesis. All the hormones which affect metabolism may be directly or indirectly involved in ketogenesis. Thyroxine and adrenine favor ketogenesis probably because the glycolysis which they stimulate depletes the system of carbohydrate. Insulin, antiketogenic, and anterior pituitary hormone, ketogenic, are

antagonistic inasmuch as both act upon the regulation of metabolism in the liver. Removal of the pituitary significantly decreases the acetoacetic acid-producing power of surviving liver slices of the rat. Hormones of the adrenal cortex are said to be ketogenic in a way that resembles the action of the anterior pituitary; but this matter is controversial. Some investigators are unable to find any influence of the adrenal cortex upon ketosis.

Vitamin Effects upon Fat Metabolism. The peculiar relation of thiamine to the production of fatty livers was described above. Other specific effects of vitamins upon fat metabolism have been described. Inositol is regarded as similar to lipocic in some respects, tending to counteract fatty livers. Thus it is required for an optimum effect in clearing fatty livers by choline although pyridoxine and linoleic acid are also important. In fact it now seems to be established that linoleic acid is indispensable for the *complete* clearing of fatty livers. Although arachidonic acid is just as effective as linoleic acid in making a diet, otherwise complete, satisfactory for reproduction and lactation, only linoleic acid meets the fatty acid requirement for liver metabolism and for the complete cure of deficiency symptoms in the skin. When growth failure, due to lack of thiamine, pyridoxine, or pantothenic acid, is corrected by feeding the experimentally deficient vitamin, the renewed growth is reported to be accompanied by a large, sometimes sevenfold increase in body fat. A diet deficient in pantothenic acid may cause a lowering by as much as 50 per cent of the total blood lipids of dogs with the production of extremely fat livers. The riboflavin requirement of the dog is not affected by a change in the fat content of the diet although rats show increased need of this vitamin on a fat-rich diet.

The usefulness of vitamin E in the rabbit is interfered with by cod-liver oil. Muscular dystrophy, similar to that produced on a diet lacking vitamin E, occurs when considerable doses of cod-liver oil are administered even though the supply of the vitamin is adequate. When cod-liver oil is mixed with the diet *in vitro*, vitamin E is destroyed. Probably the same thing occurs in the intestine.

Dihydroxystearic acid similarly destroys vitamin K as tested on rats, but in this case the destructive effect is overcome and the blood coagulation is restored to normal by the feeding of larger doses of vitamin K.

Phospholipid Metabolism. Conversion of fat to phospholipids for purposes of mobilization and transport (p. 448) has been studied during a third of a century. Evidence both for and against this idea still accumulates. That the process is at least a part of the mechanism for moving fats into and out of cells, such as those of the intestinal mucosa and the liver, seems very probable. Its significance for the liver was

presented in connection with the lipotropic effect. Other tissues probably employ this mechanism, but its relative importance is not clear.

Phosphorylation of fats as a necessary preliminary to their oxidation is widely discussed, but evidence for it is unconfirmed.

The enzymes activating the anabolic and catabolic reactions of phospholipids include the nonspecific phosphatase of the pancreatic juice and choline esterase of the intestinal juice and the intestinal mucosa. Specific lecithinases have also been described. The reactions catalyzed by these enzymes are indicated in the following scheme of the postulated course of the hydrolysis of lecithin:

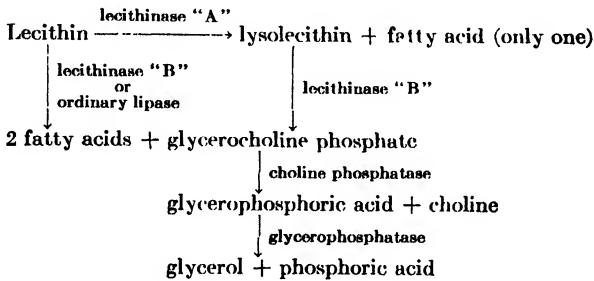

That such a breakdown may occur in various organs is indicated by the detection of lysolecithin (p. 81) and other fragments of lecithin molecules in various tissues. α -Glycerolphosphorylcholine has been isolated from incubated beef pancreas. The corresponding enzymes have also been detected. Lecithinase "A" (phosphodiesterase) and lecithinase "B" (phosphomonoesterase) occur in some tissues. Choline phosphatase, which liberates choline from either lecithins or lysolecithins, is found in comparative abundance in liver, intestine, kidney, spleen, and pancreas, and in smaller amounts in other tissues. Phosphatases are widely distributed.

It should be noted that glycerophosphoric acid is an intermediary compound in both phospholipid and carbohydrate metabolism. Some evidence is available to indicate that carbohydrate may thus contribute to phospholipid synthesis, but attempts to detect the reverse process, sugar production from phospholipids, gave negative results in the diabetic dog.

Synthesis of phospholipids in liver, intestine, and kidney was shown (p. 281) by the use of radioactive *inorganic* phosphates. But synthesis employing *organic* phosphates may occur in many, perhaps all tissues, although proof is incomplete. While lecithin synthesis is a prominent feature of phospholipid formation in liver and intestine, cephalin synthesis

is reported to occur more readily in the brain than in the liver. The phospholipids of egg yolk are synthesized in the liver of the hen.

Phospholipids in all cells occur largely in combination with proteins. This is the accepted explanation of the fact that ether extraction of a tissue yields only a part of its phospholipids. Alcohol treatment, preliminary to ether extraction, gives much larger yields and from some tissues the complete yield of lipids is obtained only after digestion by protease. Phospholipids are transported in blood largely in the form of protein complexes.

Choline Metabolism. Production of choline groups for synthesis of lecithins and, presumably, of sphingomyelins as related to transmethylation was discussed in connection with the lipotropic effect of methionine. But in addition to methyl groups, choline synthesis requires the ethanolamine group. It appears to be produced in the body by a synthesis which employs the amino acid glycine and is used in the formation of tissue cephalins. Stetten's experiments (1941) employing isotopic nitrogen (N^{15}) show that ethanolamine is also used in the synthesis of choline of the other phospholipids. Ethanolamine containing N^{15} was fed to rats. Examination of tissue phosphatides showed that at least 28 per cent of their ethanolamine had been replaced by the isotopic compound after only three days. Its conversion to choline was shown by the presence of isotopic nitrogen representing 11 per cent of the choline of the phospholipids.

Choline, intravenously injected, is rapidly removed from the blood by the tissues. A small amount of choline is excreted in bile and in sweat. Urine removes only a few milligrams per day. It also contains a trace of trimethyl amine, $N\equiv(CH_3)_3$. Inasmuch as the latter can be formed *in vitro* by the action of alkali upon choline, excretion of trimethyl amine suggests that this reaction may occur in the body.

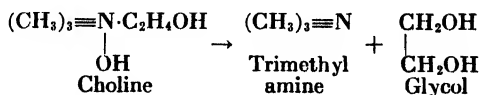

The enzyme, **choline oxidase**, of the liver, however, catalyzes the production of betaine aldehyde from choline.

The action of acetylcholine as a chemical transmitter (p. 81) for the nerve impulse has attracted much attention to this choline derivative. Details regarding its action will be found in works on the physiology of the nervous system and on pharmacology. The metabolic reactions by which it is produced during the passage of nerve impulses have not been fully explained, but experiments with surviving tissue slices and certain tissue extracts suggest that acetoacetic acid is the source of the acetyl

group and that the synthesis is dependent upon vigorous oxidation. Rapid destruction of acetylcholine by action of the enzyme **choline esterase** has been extensively investigated. The enzyme is widely distributed, but its concentration is highly specialized. Its relative activity as measured at any delimited location is used as an index of the extent to which acetylcholine functions there as a chemical transmitter. Use of this index is in agreement with the available data on the concentrations of acetylcholine found. Moreover, muscle paralyzed by denervation shows depletion of the esterase. The hydrolysis may be represented thus:

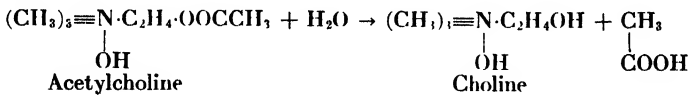

The hydrolysis is inhibited by the drug **eserine**, also called **physostigmine**. This effect is utilized in the investigation of the production and physiological action of acetylcholine, which may reach a detectable concentration in the presence of eserine. The optimal pH for the enzyme is 8.4. Its activity is favored by calcium, magnesium, and manganese ions but inhibited by an increase in potassium-ion concentration. Such a temporary increase has been detected after the passage of nerve impulses through a structure, such as a sympathetic ganglion, that has a large number of synapses where acetylcholine functions as nerve transmitter. Removal of acetylcholine by action of choline esterase is a part of the recovery process after transmission of a nerve impulse.

The chemical mechanism for production of acetylcholine has not been identified. Apparently it is not the hydrolysis acting in reverse. An enzyme called **choline acetylase**, found in muscle and brain tissue but not in kidney or liver, catalyzes acetylcholine production. To the muscle extract, a coenzyme of unidentified nature, eserine, K and Mg ions, ATP, and a source of choline must be added to demonstrate production of acetylcholine. While the coenzyme for this particular reaction is unknown, a corresponding one, coenzyme A (p. 180) using *pantothenic acid*, is operative in certain acetylation reactions. The need for ATP suggests that, as in so many other reactions, a phosphorylation is involved. It is quite conceivable that acetylphosphoric acid is united to choline in the synthesis, the phosphoric acid being taken up by ADP.

Other aspects of the utilization of choline will be described (Chap. XVI) in connection with the metabolism of certain amino acids.

Metabolism of Cerebrosides. The formation, destruction, and physiological functions of the galactolipids (cerebrosides) have not been extensively investigated. Their high concentration in the brain (1 to

2 per cent) and especially in white matter seems significant. Together with cephalins and sphingomyelins they constitute a large part of the material of myelin sheaths of nerves. Galactolipid increases in all nervous tissues during growth and development. As this is without any corresponding supply in the food, synthesis must occur in the body. The use of galactose for this purpose (p. 416) has been noted. Hydrolysis to liberate sphingol has been demonstrated by the appearance of sphingol in the urine of dogs after feeding them cerebrosides. Injected sphingol is excreted in the urine.

Metabolism of Cholesterol. Foods contain some cholesterol. Estimates of its amount in a normal mixed diet of an adult suggest that it is less than 1 g. per day. Of common foods, egg yolk is the richest source, containing about 1.7 per cent cholesterol, but most animal fats and oils, including milk fat, are fair sources. The majority of vegetables and fruits contain only a few milligrams per cent of sterols, and these are phytosterols which are not well absorbed from the intestine. Some of the food cholesterol is in the form of esters which are hydrolyzed by cholesterase of pancreatic and intestinal juices. The use of bile salts in cholesterol absorption was discussed in Chap. IX. Some reverse action of cholesterase can occur during absorption, and this helps to account for the presence of cholesteryl esters in the blood. Esterification occurs chiefly, however, in the liver although cholesterase has been detected in blood plasma. The fatty acids identified in blood cholesteryl esters include oleic, linoleic, stearic, and palmitic.

Synthesis. Cholesterol of the food is not sufficient to account for the amounts found in animal organs. Synthesis undoubtedly occurs. In the human infant cholesterol may increase by as much as 25 mg. per day in the brain alone. But considerable amounts are present in all nervous and glandular tissues with smaller concentrations in muscles. The total sterols of the adult human body are estimated to amount to some 50 g., of which approximately 98 per cent is cholesterol. The liver is the chief site of its synthesis.

That the process is not a simple one is indicated by the fact that mice receiving heavy water produce cholesterol containing deuterium. This recalls the similar participation (p. 444) of water in fat synthesis from carbohydrate. About half of the hydrogen atoms of cholesterol are thus shown to come from water. The other half appears to be derivable almost entirely from acetic acid (acetate). This is shown by feeding deuterium-containing acetate to rats or by adding it to surviving liver slices. Moreover, when the acetate is tagged with isotopic carbon (C^{13}), confirmation is obtained since about half of the C atoms in newly formed cholesterol are C^{13} . Using acetate doubly tagged, $CD_3C^{13}OOH$, gives

further confirmation of the large participation of acetate in cholesterol synthesis. Both D and C¹³ are found in the side chain and also in the sterid nucleus so that small molecules (H₂O and CH₃-COOH) are utilized in the synthesis of all parts of the complex cholesterol molecule. Many substances, notably the fatty acids, can produce acetate in cellular metabolism. Correspondingly, such substances contribute to cholesterol synthesis. But tagging experiments show that fatty acids contribute only by furnishing acetate and are not themselves intermediate stages in the transformation of acetate to cholesterol. The rate of the synthesis in mice is relatively high on a cholesterol-poor diet, is slower on a diet containing a moderate cholesterol supply, and is counteracted by destruction of cholesterol when it is fed in large amounts. Thus the liver is shown to act as a regulator of cholesterol metabolism. Production of fatty livers (Table 59) by high cholesterol feeding indicates, however, that the regulative power can be overtaxed. Even the overflow of excess cholesterol from the liver into the bile (p. 270) is not a sufficient corrective in all cases. Indeed, much of this cholesterol is reabsorbed from the intestine.

Utilization. Cholesterol is so widely distributed in animal tissues (p. 90) that biochemists have long referred to it as the "ubiquitous cholesterol." Its omnipresence is an index of its use for many different purposes but also corresponds to the fact that it renders a fundamental service in all animal cells. This is its participation in the formation of protoplasmic surface films which are known to contain cholesterol. A more specific use is as the material from which certain of the sterid hormones are formed. It decreases in the adrenal cortex when that tissue is stimulated to produce hormones. It is known to be a forerunner of progesterone from the ovaries. It may be the parent substance of other sex hormones. In a modified form, 7-dehydrocholesterol, it serves as provitamin (p. 204) of vitamin D₃.

The Use of Fats for Energy Liberation. The oxidation of fats to CO₂ and H₂O for the liberation of energy cannot be doubted even though, as stated above, the intermediary reactions are not explained. The value of the respiratory quotient may fall during muscular work to a level indicative of fat oxidation. This is more apt to occur when the liver is depleted of glycogen. Further evidence is found in the fact that the concentration of fat in the venous blood leaving a working muscle is less than that of the arterial blood entering it. Ketosis may arise in men doing maximal work on a carbohydrate-poor diet. A slight lipemia may arise in *fasting* men during performance of muscular work but can be prevented if they eat glucose just before the working period. These various observations indicate that carbohydrate is preferentially used

when a sufficient supply of it is available, but fat can be used efficiently as the chief source of energy during prolonged periods of muscular work of moderate intensity. Several investigators have reported, however, that exercise so as to test the maximum working capacity leads to exhaustion much sooner on a fat-rich, carbohydrate-poor diet than on a carbohydrate-rich diet. Of foods used to restore working capacity after exhaustion, sugar is more quickly and more completely effective than any other food.

Computations based on values for the nonprotein RQ (p. 398) suggest that ordinarily about one-fourth of the daily energy expenditure is at the expense of fat, but under some conditions, starvation or carbohydrate depletion, fat may furnish more than 80 per cent of the energy. The high energy content of fats, more than 9 Cal. per g., enables them to serve as a useful, compact, storage fuel. Nevertheless, the good nutritive condition of animals on a diet practically devoid of fat shows the facility with which the animal economy can use substitutes for food fat. It is probable that improvement in growth and reproductive performance follows the inclusion in the diet of fat in excess of that required to furnish the indispensable fatty acids.

The uses of lipids for purposes other than fuel requirements include utilization as "building stones" of vital architectural structures, such as mitochondria and cell membranes. Descriptions of such types of functioning will be found in works on general physiology and chemical embryology. From the viewpoint of biochemistry it is strikingly significant that even after death from starvation, when the store of neutral fat has been subjected to extreme demands, the body of an animal still contains significant amounts of lipid. In mice the fatty acids may amount to as much as 23 per cent of the solid matter of the carcass, and in chickens still higher values, 25 per cent, have been reported. Nearly all of the fatty acids, however, are in compound lipids rather than in neutral fats. This emphasizes the importance of phospholipids, cerebrosides, and sterol esters as indispensable protoplasmic material. Such lipids are referred to as the *element constant* in contrast to mere storage fat, the *element variable*. Recent work with isotopes suggest that even the *element constant* is subject to exchange, replacement, and other metabolic reactions, although such fluctuations are more pronounced in the depot fats.

REFERENCES

A monographic treatment of some aspects of this subject is "Obesity and Leanness" by H. R. Rony, Philadelphia, 1940.

The modern trend of research in this field is shown in "The Dynamic State of Body Constituents" by R. Schoenheimer, Cambridge, Mass., 1942.

Very helpful material is found in vol. 5, Biological Symposia, 1941.

Among a wealth of reviews, old and new, the following are listed:

- ALLES, G. A., The Physiological Significance of Choline Derivatives, *Physiol. Rev.*, **14**, 276, 1934.
- BARNES, R. H., and MACKEY, E. M., Fat Metabolism, *Ann. Rev. Biochem.*, **13**, 211, 1944.
- BEST, C. H., and LUCAS, C. C., Choline-chemistry and Significance as a Dietary Factor, *Vitamins and Hormones*, **1**, 1, 1943.
- BEST, C. H., and RIDOUT, J. H., Choline as a Dietary Factor, *Ann. Rev. Biochem.*, **8**, 349, 1939.
- BILLS, C. E., Physiology of the Sterols, *Physiol. Rev.*, **15**, 1, 1935.
- BLOCH, K., The Metabolism of Acetic Acid in Animal Tissues, *Physiol. Rev.*, **27**, 574, 1947.
- BLOOR, W. R., Fat Transport in the Animal Body, *Physiol. Rev.*, **19**, 557, 1939.
- BROWN, G. L., Transmission at Nerve Endings by Acetylcholine, *Physiol. Rev.*, **17**, 485, 1937.
- BURR, G. O., and BARNES, R. H., Fat Metabolism, *Ann. Rev. Biochem.*, **12**, 157, 1943.
- BURR, G. O., and BARNES, R. H., Non-calorie Functions of Dietary Fats, *Physiol. Rev.*, **23**, 256, 1943.
- CHAIKOFF, I. L., and ENTENMAN, C., Lipid Metabolism, *Ann. Rev. Biochem.*, **17**, 253, 1948.
- CHAIKOFF, I. L., and ZILVERSMIT, D. B., Radioactive Phosphorus: Its Application to the Study of Phospholipid Metabolism, *Advances in Biol. Med. Phys.*, **1**, 322, 1948.
- CHARGAFF, E., Fat Metabolism, *Ann. Rev. Biochem.*, **11**, 235, 1942.
- CONN, J. W., Obesity: Etiological Aspects, *Physiol. Rev.*, **24**, 31, 1944.
- DANN, M., Interconversion of Lipids and Carbohydrates, *Yale J. Biol. Med.*, **5**, 359, 1933.
- DRAGSTEDT, L. R., The Present Status of Lipocaic, *J. Am. Med. Assoc.*, **114**, 29, 1940.
- ECCLES, J. C., Synaptic and Neuromuscular Transmission, *Physiol. Rev.*, **17**, 538, 1937.
- McHENRY, E. W., and CORNETT, M. L., The Role of Vitamins in the Anabolism of Fat, *Vitamins and Hormones*, **2**, 1, 1944.
- McHENRY, E. W., and PATTERSON, J. M., Lipotropic Factors, *Physiol. Rev.*, **24**, 128, 1944.
- NEWBURGH, L. H., Obesity. Energy Metabolism, *Physiol. Rev.*, **21**, 18, 1941.
- PISKUR, M. M., and SCHULTZ, H. W., The Chemistry and Metabolism of the Lipids, *Ann. Rev. Biochem.*, **16**, 79, 1947.
- SINCLAIR, R. G., The Physiology of the Phospholipids, *Physiol. Rev.*, **14**, 351, 1934.
- STADIE, W. C., Fat Metabolism, *Ann. Rev. Biochem.*, **15**, 219, 1946.
- WITZEMANN, E. J., A Unified Hypothesis of the Reciprocal Integration of Carbohydrate and Fat Catabolism, *Advances in Enzymol.*, **2**, 265, 1943.
- The following papers are selected to afford insight into the chief methods of investigation and the trends of theories of lipid metabolism:
- ANDERSON, W. E., and MENDEL, L. B., The Relation of Diet to the Quality of Fat Produced in the Animal Body, *J. Biol. Chem.*, **76**, 729, 1928.
- BEST, C. H., LUCAS, C. C., PATTERSON, J. M., and RIDOUT, J. H., The Lipotropic Properties of Inositol, *Science*, **103**, 12, 1946.
- BHATTACHARYA, R., and HILDITCH, T. P., The Body Fats of the Pig. I. Influence of Ingested Fat on the Component Fatty Acids, *Biochem. J.*, **25**, 1954, 1931.
- BLOCH, K., and RITTENBERG, D., An Estimation of Acetic Formation in the Rat, *J. Biol. Chem.*, **159**, 45, 1945.
- BLOOR, W. R., Diet and the Blood Lipids. II. The Effect of Occasional Overfeeding on the Post-absorptive Level, *J. Biol. Chem.*, **103**, 699, 1933.
- BLOOR, W. R., and SNIDER, R. H., Phospholipid Content and Activity in Muscle, *J. Biol. Chem.*, **107**, 459, 1934.
- BONDY, P. K., and WILHELMI, A. E., Influence of Pituitary and Adrenal Glands on Ketone Body Production by Rat Liver Slices, *Federation Proc.*, **8**, 185, 1949.
- BOYD, E. M., Species Variation in Normal Plasma Lipids, *J. Biol. Chem.*, **143**, 131, 1942.
- BROWN, W. R., HANSEN, A. E., BURR, G. O., and McQUARRIE, I., Effects of Prolonged Use of Extremely Low-fat Diet on an Adult Human Subject, *J. Nutrition*, **16**, 511, 1938.
- BOXER, G. E., and STETTEN, DEW., JR., The Effect of Dietary Choline upon the Rate of Turnover of Phosphatide Choline, *J. Biol. Chem.*, **153**, 617, 1944.
- BUTTS, J. S., CUTLER, C. H., HALLMAN, L., and DEUEL, H. J., JR., Quantitative Studies on β -Oxidation, *J. Biol. Chem.*, **109**, 597, 1935.
- CAHEN, R. L., and SALTER, W. T., Urinary 17-Ketosteroids in Metabolism. I. Standardized Chemical Estimation, *J. Biol. Chem.*, **152**, 489, 1944.
- ECKSTEIN, H. C., The Influence of Diet on the Body Fat of the White Rat, *J. Biol. Chem.*, **81**, 613, 1929.
- ELLIS, N. R., and ZELLER, J. H., The Influence of a Ration Low in Fat upon the Composition of the Body Fat of Hogs, *J. Biol. Chem.*, **89**, 185, 1930.
- FISHLER, M. C., ENTENMAN, C., MONTGOMERY, M. L., and CHAIKOFF, I. L., The Site of Formation of Plasma Phospholipids, *J. Biol. Chem.*, **150**, 47, 1943.
- FULTON, J. F., and NACHMANSOHN, D., Acetylcholine and the Physiology of the Nervous System, *Science*, **97**, 569, 1943.
- GAVIN, G., PATTERSON, J. M., and McHENRY, E. W., Comparison of the Lipotropic Effects of Choline, Inositol, and Lipocaic in Rats, *J. Biol. Chem.*, **148**, 275, 1943.

- GRIFFITH, W. H., Choline Metabolism. IV. The Relation of the Age, Weight and Sex of Young Rats to the Occurrence of Hemorrhagic Degeneration on a Low Choline Diet, *J. Nutrition*, **19**, 437, 1940.
- GRIFFITH, W. H., Nutritional Importance of Choline, *J. Nutrition*, **22**, 239, 1941.
- HANDLER, P., and BERNHEIM, F., The Effect of Choline Deficiency on the Fat Content of Regenerated Liver, *J. Biol. Chem.*, **148**, 649, 1943.
- HILDITCH, T. P., LEA, C. H., and PEDELTY, W. H., The Influence of Low and High Planes of Nutrition on the Composition and Synthesis of Fat in the Pig, *Biochem. J.*, **33**, 493, 1939.
- HILDITCH, T. P., and PEDELTY, W. H., Sheep Body Fats. I. Component Acids of Fats from Animals Fed on High and Low Planes of Nutrition, *Biochem. J.*, **35**, 932, 1941.
- LEHNINGER, A. L., The Metabolism of Acetopyruvic Acid, *J. Biol. Chem.*, **148**, 393, 1943.
- LEHNINGER, A. L., On the Activation of Fatty Acid Oxidation, *J. Biol. Chem.*, **161**, 437, 1945.
- MARENZI, A. D., and CARDINI, C. E., Phospholipids and Choline of Human Plasma, *J. Biol. Chem.*, **147**, 371, 1943.
- PERLMAN, I., and CHAIKOFF, I. L., Radioactive Phosphorus as an Indicator of Phospholipid Metabolism. VII. The Influence of Cholesterol upon Phospholipid Turnover in the Liver, *J. Biol. Chem.*, **128**, 735, 1939.
- PRICE, T. D., and RITTENBERG, D., Metabolism of Acetone, *Federation Proc.*, **8**, 238, 1949.
- REISER, R., Lipids of Duodenal Mucosa of Swine during Absorption of Fat, *J. Biol. Chem.*, **143**, 109, 1942.
- SCHOENHEIMER, R., and RITTENBERG, D., Study of Fat in the Body by Use of Fatty Acids Containing Deuterium, *J. Biol. Chem.*, **111**, 163; **113**, 505; **114**, 381, 1935-1936.
- SMYTH, D. H., The Rate and Site of Acetate Metabolism in the Body, *J. Physiol.*, **105**, 299, 1947.
- STETTEN, DEW., JR., and GRAIL, G. F., The Rates of Replacement of Depot and Liver Fatty Acids in Mice, *J. Biol. Chem.*, **148**, 509, 1943.
- STETTEN, DEW., JR., and SCHOENHEIMER, R., The Conversion of Palmitic Acid into Stearic and Palmitoleic Acids in Rats, *J. Biol. Chem.*, **133**, 329, 1940.
- SWENDESID, M. E., BARNES, R. II., HEMINGWAY, A., and NIER, A. D., Condensation of Acetic Acid to Acetoacetic, *J. Biol. Chem.*, **142**, 47, 1942.
- TORDA, C., and WOLFF, H. C., Acetylcholine Synthesis, *Science*, **103**, 645, 1946.
- TREADWELL, C. R., TIDWELL, H. C., and GAST, J. H., The Relationship of Methionine to Fatty Liver Production and Growth, *J. Biol. Chem.*, **156**, 237, 1944.
- VAN HEYNINGEN, W. E., RITTENBERG, D., and SCHOENHEIMER, R., The Preparation of Fatty Acids Containing Deuterium, *J. Biol. Chem.*, **125**, 495, 1938.
- WEINHOUSE, S., MEDES, G., and FLOYD, N. F., The Mechanism of Fatty Acid Oxidation, *J. Biol. Chem.*, **153**, 689, 1944.

CHAPTER XVI

PROTEIN METABOLISM

The outstanding feature of protein digestion and absorption is the tendency to complete hydrolysis of food proteins so that, with only minor exceptions, amino acids are the actual nutritive units derived from the simple proteins. That the hydrolysis is not quite complete in every respect would seem to be a suitable inference from studies of streptogenin and the animal protein factor (p. 212).

The properties of the end products and certain of the intermediary products of protein metabolism will be described in Chap. XVII.

Amino Acids of Blood and Tissues. Amino acid concentration in blood rises during protein digestion but becomes higher in portal than in systemic blood. The liver removes significant amounts of amino acids. The free amino acids, measured in terms of amino acid nitrogen, in liver rise shortly after protein feeding and may be almost doubled as compared with the average value (45 mg. per cent) for livers of fasting animals. The rise in the systemic blood level is transient because all tissues avidly take up amino acids. As observed in muscle, the uptake is smaller and occurs later than in liver.

No simple equilibrium of the diffusion of amino acids is set up between the blood and active protoplasm because amino acids react with cell proteins, combining with them or replacing amino acids previously in protein combination. When amino acids containing isotopic nitrogen (N^{15}) as a tracer are fed, they are rapidly incorporated into the proteins of all cells at rates which vary in different tissues. The isotopic nitrogen is found in the isolated proteins, and this is true irrespective of whether the animal has been receiving a protein-rich or a protein-poor diet. The exchange process is attributed to the activity of cellular proteases, called **cathepsins**, which catalyze hydrolysis, and, presumably, synthesis of cell proteins. Amino acids are thus conceived to be in dynamic equilibrium with cell proteins. This concept is helpful in explaining some otherwise puzzling features of protein metabolism for, as will appear later, accumulating evidence indicates that amino acids may not necessarily be utilized as such but may so react in metabolism as to suggest that they are first incorporated into proteins.

Owing to the dynamic equilibrium, the rise of blood and tissue con-

centration of free amino acids after protein digestion is followed by a tendency to subside toward the fasting level. Nevertheless, oxidative metabolism is meanwhile speeded up as shown (p. 408) by the specific dynamic effect.

Nitrogen Equilibrium. The adult mammal often shows such a balanced condition in protein metabolism that the nitrogen intake, which represents almost exactly the food protein, is equal to the nitrogen output in feces, urine, and sweat. The body is then in nitrogen equilibrium. This state cannot occur during growth because of synthesis of new tissue protein. The same is true during recovery from starvation or the effects of certain kinds of disease or of malnutrition. In such cases the body exhibits what is called a "plus nitrogen balance," a retention of protein material. Conversely, starvation, defective protein nutrition, and all "wasting" diseases cause a minus nitrogen balance, a loss of body protein.

Nutritional investigations have regularly employed the principle that a negative nitrogen balance means inadequate protein nutrition. Assuming that all nonprotein dietary requirements are being adequately supplied, the smallest intake of proteins or of amino acids that permits the establishment of nitrogen equilibrium is regarded as the minimal protein requirement.

The fact that nitrogen equilibrium can occur led to the drawing of a sharp distinction formerly made between the metabolism of protein and that of carbohydrate or fat. It was said that protein served primarily as protoplasmic building material, only secondarily as fuel for energy liberation, and not at all for accumulation of a fuel reserve. Fats and carbohydrates were regarded as the primary fuels and the materials for reserve storage. Some of the facts given in the two preceding chapters show the need of modifying such concepts. Carbohydrates and certain of the lipids serve as protoplasmic building material while the interconversion of all the major foodstuffs (fats \rightleftharpoons carbohydrates \rightleftharpoons protein) indicates the inaccuracy of the older distinctions. Further limitation of them is required to accord with recent discoveries.

Limited Storage of Protein. There has long been a tendency for physiologists to think of the main mass of body protein as a fixed part of the machinery of life. Called the *morphic protein*, it was supposed to be synthesized during growth or recovery from disease but to be subject to only a small amount of catabolism, "wear and tear," in the healthy adult. This would be analogous to the slight wearing of cylinders and pistons in a gasoline motor. Unlike the motor, however, vital machinery was assumed to repair itself by means of a small amount of anabolism.

This minimum turnover was referred to as endogenous metabolism of protein and was supposed to include only the chemical changes involving proteins actually incorporated into protoplasm. In contrast, the turnover of amino acids in excess of those required to make good the "wear and tear" was called *exogenous protein metabolism*. It now seems, however, that no sharp line of demarcation between these two aspects of metabolism can be drawn. Apparently all or nearly all of the amino acids metabolized behave in the endogenous way, combining with protoplasmic proteins and exchanging with previously incorporated amino acid groups. This is only another instance of the tendency of living matter to be continuously in flux.

Nevertheless, the fact of nitrogen equilibrium must be taken into account. Clearly some regulative mechanism prevents the accumulation of protein reserves comparable to that of glycogen in liver or to the practically unlimited storage of fat. But within limits protein does accumulate. This is evidenced by the lag in excretion of the extra nitrogen when an animal's protein intake is increased. While nitrogen equilibrium is eventually established at the new higher level, it is not reached during several days and meanwhile a plus nitrogen balance prevails.

For the human subject an experiment by von Norden affords an illustration. A person in nitrogen equilibrium on a diet furnishing 90 g. of protein per day changed to a diet containing 131 g. of protein but with no change in the total Calories. During the next 4 days the observed plus nitrogen balances were equivalent to the retention of 38 g. of protein. Only after 5 days was nitrogen equilibrium attained at the new level.

In similar experiments on laboratory animals an increase in the weight of the liver, the intestinal tissues, and the kidneys is found, and chemical analyses show these organs to have a heightened protein content. During the period following a sharp decrease in protein intake, a corresponding loss of accumulated tissue protein occurs.

The extra protein of liver, intestine, and kidney may be thought of as the "labile" protein, the first to be consumed when food protein is inadequate for any reason. This is especially true of liver, which in the rat may lose 20 per cent of its protein during a 2-day fast. Other protein accumulation occurs in blood plasma and, in a certain sense, in erythrocytes when their number or their protein content increases. The plasma protein may be regarded as a reserve, less "labile" than that of the liver. But, in starvation or subminimal protein feeding, still further reserves may be called upon. These are the muscle proteins. Not

ordinarily diminished during mild protein deficiency, they constitute, so to speak, a last-ditch defense. During advanced stages of starvation they may lose some 60 per cent of their protein.

Accumulated proteins do not differ qualitatively, so far as now known, from the proteins of body fluids and tissues. Use of the terms "reserve" protein or "labile" protein is not intended to imply any failure of incorporation into normal protein structure. Experiments using N^{15} as a tracer afford evidence, according to Schoenheimer, that most of the proteins of animal tissues so constantly undergo breakdown and reconstruction that the proteins of one organ are built at the expense of those of another.

Protein Conservation. The tendency to conserve protein is shown by the low excretion of nitrogen during the first day of starvation while glycogen is still available. When it is depleted by the second or third day of fasting, nitrogen excretion markedly increases owing to greater catabolism of proteins. Further conservation is seen during more advanced stages of fasting when the total nitrogen of the urine reaches what is called the "starvation level." From this point (about 2 weeks after beginning the fast) until death from starvation approaches, a small and fairly constant nitrogen excretion prevails. As the fatal end nears, protein conservation breaks down and a marked increase in urinary nitrogen precedes death. Perhaps a better picture of conservation is seen in experiments with a protein-free diet. It is illustrated by the curve of Fig. 78 based on an experiment by Deuel.

Further evidence of conservation is seen in what is called *protein-sparing action*. On a subminimal-protein diet, on a protein-free diet, or during starvation the loss of body protein, as reflected in a negative nitrogen balance, can be diminished by addition of carbohydrate to the food. Moderate amounts of fat show a similar action although larger amounts of fat may actually aggravate the negative nitrogen balance.

Recent work has shown that the protein-sparing effect can be detected in a well-nourished animal as well as in a starving one. Dogs in nitrogen equilibrium show a retention of nitrogen when extra glucose is fed along with protein. When the extra glucose feeding ceases, the stored nitrogen is gradually excreted. This indicates that even the "labile" protein as well as fat (p. 471) tends to be held in reserve when a *luxus* supply of sugar is available to keep the "metabolic mill" well supplied with carbohydrate. It also demonstrates that protein can be utilized for storage as well as for replacement of "wear and tear."

Protein Synthesis in Animals. The artificial synthesis of polypeptides as described in Chap. IV throws little light on protein synthesis in living things. A nearer approach is the synthesis of plasteins (p. 245)

by the action of proteases upon the amino acids of protein digests. While such experiments actually demonstrate reversibility of enzymatic proteolysis, the resulting plasteins do not closely resemble natural proteins. Moreover, the conditions favorable to these syntheses are not such as would be expected to occur in living matter. Synthesis of highly specific

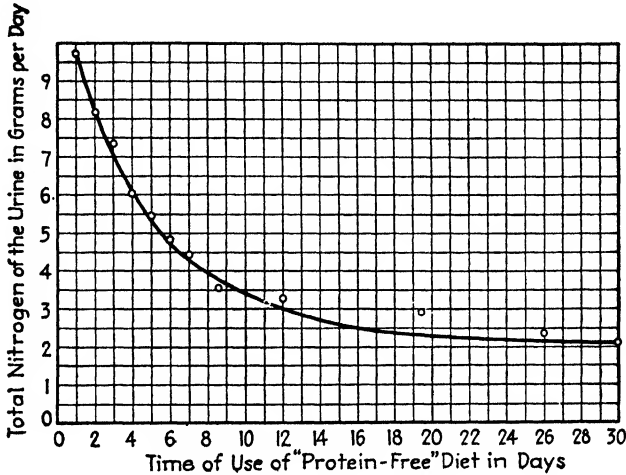

FIG. 78. Curve to suggest the tendency of the body to conserve protein. In the experiment here graphed from results reported by Deuel *et al.* (1928) the diet (starch, sugar, orange juice, lettuce, cod-liver oil, and purified salts) contained 0.24 to 0.51 g. of N per day and only part of this represented protein. Thus the diet was nearly protein free. The Calories, mostly in the form of carbohydrate, averaged about 1800 Cal. per day.

On the first day of the experiment the total N of the urine (9.73 g.) included 7.42 g. of urea N or 76.2 per cent of the total N. On the thirtieth day the total N (2.10 g.) contained only 1.14 g. of urea N or 54.3 per cent. Certain of the other urinary substances, *e.g.*, creatinine and uric acid, remained practically constant throughout the experiment. The metabolic reactions leading to urea excretion diminish both absolutely and relatively when there is need of protein conservation.

proteins in protoplasm appears to be possible only when its enzymes and its architectural components are definitely organized. Protein synthesis involves elimination of H₂O as amino acids are joined together, and this process requires energy. It must, therefore, be accompanied in the cell by some linked reaction capable of making the necessary energy available. This is possible as long as protoplasmic organization is maintained. Most synthetic processes, including protein synthesis, end abruptly after any kind of disorganization occurs to an irreversible extent. Hydrolytic and disruptive reactions then predominate.

The rate of protein synthesis of blood plasma proteins (p. 295) can reach a maximum, under optimal dietary conditions, of about 0.4 g. per kg. of

body weight per day in the plasmapheretic dog. Similar results are obtained in treatment of hypoproteinemia in human nephrotic patients. Plasmapheresis experiments with dogs suggest that the synthesis may be sufficient to represent a complete regeneration of the normal amount of plasma protein in 1 week. This is possible, however, only when the dog is well supplied with food proteins of adequate nutritive value.

The important demand is for the indispensable amino acids, as is indicated by stimulation of protein regeneration and the maintenance of nitrogen equilibrium in a plasmapheretic dog when a mixture of all of them is injected or fed. Completely digested casein, a nutritively adequate protein, is similarly effective provided the hydrolysis is so done as to avoid losses of tryptophan. When certain of the indispensable amino acids are omitted from the mixture, a marked decrease in plasma protein production follows within a week.

Conditions other than amino acid deficiency can also inhibit synthesis. Hepatectomy or almost any injury to the liver is especially inhibitory. Infections, kidney disease, and injections of gum arabic (acacia) are also reported to decrease the rate of synthesis. Plasma proteins are utilized in cellular metabolism. Injections of homologous serum or plasma into fasting animals can maintain nitrogen equilibrium with satisfactory nutritive condition and no apparent depletion of any tissue proteins. This suggests that plasma proteins are constantly used and regenerated. Fibrinogen appears to be used in tissue syntheses more rapidly than are other plasma proteins. There is a correspondingly high rate of its continuous synthesis in the liver. It has been estimated that as much as 6 g. may be used and replaced daily in an adult man. This could be more than one-third of the total fibrinogen in the blood.

The chief organ for synthesis of plasma protein is the liver. Intestinal tissues probably are responsible for production of some of the globulins.

So rapid is the rate of protein anabolism and catabolism in liver and intestinal mucosa that, as Schoenheimer's work with isotopes indicates, more than half of the protein in these organs is broken down and resynthesized in 10 days. The rate of turnover in muscle is slower. In nervous and reproductive tissues it may be slow indeed, judging from their tendency to retain protein during starvation.

Hemoglobin production was discussed in Chap. X. Synthesis of other cellular proteins has scarcely been investigated except by the isotopic experiments mentioned above.

Bergmann and his associates have demonstrated enzymatic synthesis *in vitro* of compounds having the peptide linkage, *e.g.*, benzoyl-L-leucyl-L-leucyl anilide, $C_6H_5CO \cdot NH \cdot CH(C_4H_9)CO - NH \cdot CH \cdot (C_4H_9)CO - NH \cdot$

C₆H₅. The enzymes used were papain (p. 235), bromelin (the proteolytic enzyme of pineapple), and cathepsin prepared from liver. The optimal pH (4.7) for synthesis by papain is not very different from that reported (5.5) for its optimal hydrolytic effect. All three enzymes showed activation by HCN or by compounds containing the —SH group. This suggests that the catalysis is affected (p. 237) by redox potential as are many enzymatic processes.

Biological Synthesis of Amino Acids. For the indispensable amino acids, animals are dependent upon plants as the direct or indirect

TABLE 60.—MINIMAL CONTENT OF INDISPENSABLE AMINO ACIDS REQUIRED FOR GROWTH OF THE RAT¹

	Required in the Diet, per Cent
Basic amino acids:	
Arginine	0.2
Lysine	1.0
Histidine	0.4
“Branched chain” amino acids:	
Valine	0.7
Leucine	0.9
Isoleucine	0.5
Cyclic amino acids:	
Phenylalanine	0.7
Tryptophan	0.2
Other amino acids:	
Methionine	0.6
Threonine	0.6
Total	5.8

¹ The values are estimates made by Rose from the results of numerous experiments.

source. The dispensable amino acids are producible by the animal economy. This is shown by the fact that when the rat is maintained on a protein-free diet with a mixture of the indispensable amino acids as the only source of nitrogen (except for the minute amounts in vitamin supplements), growth is normal and the body proteins contain the usual complement of all the amino acid “building stones.” The relative amounts of the indispensable amino acids required for the rat are indicated in Table 60.

The relative smallness of the arginine requirement is explained by the fact that the mammal can synthesize some of it. The low requirement for tryptophan might be correlated with the small amount of this amino acid in most tissue proteins.

Nine of the amino acids shown to be indispensable for the rat are also required by the mouse (Bauer and Berg, 1943); the addition of a tenth

one, arginine, which favors a more rapid growth in the rat, showed no effect on the growth rate of the mouse. Feeding all 10 amino acids, however, did not afford maximal growth rates in mice. This suggests that one or more other amino acids may fail to be adequately synthesized in this species. The special requirements of the chick (p. 108) include glycine and either arginine or citrulline.

Prolonged experiments covering the growth period of large mammals are lacking because the necessary amounts of purified amino acids have

TABLE 61.—MINIMAL AND RECOMMENDED INTAKES OF INDISPENSABLE AMINO ACIDS FOR NORMAL MEN WHEN SOURCES OF NITROGEN FOR SYNTHESIZING DISPENSABLES ARE ADEQUATE
(Strictly *tentative* values)

Amino acid	Minimal daily requirement	Recommended daily intake	Number of subjects tested
	g.	g.	
L-Tryptophan	0.25	0.5	31 ¹
L-Phenylalanine	1.10	2.2	22
L-Lysine	0.80	1.6	27
L-Threonine	0.50	1.0	19
L-Valine	0.80	1.6	23
L-Methionine	1.10	2.2	13
L-Leucine	1.10	2.2	8
L-Isoleucine	0.70	1.4	8

¹ All these subjects have been kept in balance on 0.3 g. or less.

not been available. But adult dogs have been maintained in nitrogen equilibrium (Rose and Rice, 1939) with the nine indispensable amino acids entirely replacing food protein. Experiments on plasmapheretic dogs (p. 295) also indicate that these are the only amino acids which cannot be synthesized in the dog.

Adult human subjects were maintained in nitrogen equilibrium (Rose *et al.*) when more than 95 per cent of the food nitrogen was supplied by a mixture of the nine indispensables plus arginine. Either histidine or arginine could be omitted without causing a negative nitrogen balance, but omission of one or more of the other eight caused nitrogen loss. Nitrogen equilibrium was promptly restored when the missing amino acid was added to the food.

A more detailed report (Rose, 1949) gives quantitative results for the eight indispensables as shown in Table 61.

It is reported (Holt *et al.*) that, while adult men could be maintained

in nitrogen equilibrium on a diet deficient in arginine, spermatogenesis appeared to be interfered with inasmuch as spermatozoa production decreased to about one-tenth of the normal number. This suggests that arginine, required in large amounts (p. 106) for production of the protamins of sperm, can be diverted from the testis for use by other tissues during a deficiency of supply. Clearly, arginine, although synthesized, is not produced in animals in amounts sufficient to afford complete independence from outside sources.

Utilization of ammonia in amino acid synthesis has long been inferred from the fact that ammonium salts can "spare" a certain part of the protein required in the diet for nitrogen equilibrium. More recent reports from Schoenheimer and his coworkers afford clear proof. Rats were fed ammonium citrate containing isotopic nitrogen, N^{15} . From the carcasses amino acids were isolated. N^{15} was found in glycine, proline, aspartic acid, glutamic acid, histidine, and arginine. Lysine was also isolated but contained no N^{15} . Its metabolism (p. 502) is peculiar.

Water is also utilized somewhere in the chain of synthetic reactions. This is indicated by the presence of deuterium in amino acids isolated from the bodies of animals fed heavy water.

Production of glycine deserves especial note because of the large amounts which can be formed. This is demonstrable by feeding benzoic acid. Its coupling with glycine in detoxication (p. 287), producing hippuric acid, permits estimation of the extent of glycine synthesis by determination of the hippuric acid excretion. At the maximum rate a man can synthesize 9 mg. per hr. per kg. of body weight. This would be equivalent to the production of 15 g. per day in a man of 70 kg. The nitrogen output would be 2.8 g. per day in glycine alone. This is over 35 per cent of the total nitrogen metabolized (7.7 g. per day) in men receiving what Chittenden regarded as adequate protein nutrition for an athlete of 70 kg. It is more than 50 per cent of the urinary nitrogen of men on the minimum protein intake affording nitrogen equilibrium.

Most of the amino groups of the glycine come from the other amino acids. This is indicated by the result of feeding glycine tagged with N^{15} . Only a small amount of the isotopic nitrogen appears in the hippuric acid excreted. The major part of its glycine comes, apparently, from protein. As already suggested, free amino acids, *e.g.*, glycine, may not enter into certain metabolic reactions as readily as do those combined with proteins.

Transamination. The amino groups of amino acids tend to be in a state of constant flux, shifting from one carbon framework to another by processes which involve a complex series of intermediary reactions. This shifting is called "transamination." It is best demonstrated by

the use of isotopes. N^{15} present in the amino group of an amino acid which is fed or injected is traced in the amino groups of other amino acids isolated from the hydrolysis products of body proteins. Transamination occurs prominently in the proteins of liver and blood plasma but has also been recognized in those of brain, heart, kidney, and muscle. More than 30 per cent of isotopic nitrogen of glycine, leucine, and tyrosine has been detected in transaminated forms. These three and six others, alanine, proline, arginine, histidine, aspartic acid, and glutamic acid, are known to be active in transamination. Some amino acids do not enter into transamination reactions. This is true of lysine, α - ϵ -diaminocaproic acid, which can be broken down in metabolism but fails to be regenerated from its products. Ornithine α - δ -diaminopropionic acid, which arises in animals by hydrolysis of arginine, also fails to be active in transamination. Arginine itself undergoes transamination in the amidine group, $NH=C-$, but in neither the α -amino group nor in the imino



group, which becomes the δ -amino group of ornithine. This was proved by hydrolyzing the isolated isotope-containing arginine to form ornithine and urea and finding N^{15} in urea but none in the ornithine.

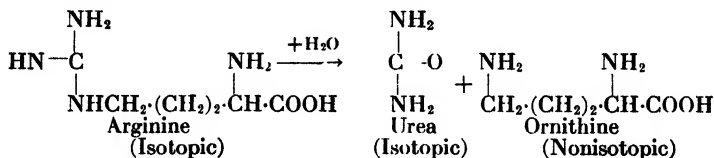

Histidine, on the other hand, acquires isotopic nitrogen in the α -amino group and not in its imidazole nucleus. This was proved by converting the isolated isotope-containing histidine into imidazolelactic acid which contained no N^{15} .

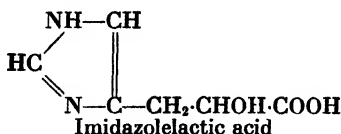

The three basic amino acids, lysine, arginine, and histidine, are thus shown to behave quite differently in transamination. The differences may be compared with the animal's need for them. Lysine appears to fill its indispensable function as an entire unit. Arginine, more plastic, is indispensable only in the sense that the body cannot always produce enough of it. Histidine would appear to be indispensable because the chain of carbon and nitrogen atoms composing its framework is not

formed in animals. But its α -amino group is exchanged as in most amino acids. One may note in this connection that while leucine and isoleucine are indispensable norleucine is not. Here again it is specifically constructed carbon chains which the animal fails to synthesize while the "straight" chain of norleucine, also occurring in caproic acid and in lysine, is readily available.

In sharp contrast to the limited participation of the basic amino acids in transamination are the outstanding reactivities of the dicarboxylic aspartic and glutamic acids. They "accept" and "donate" more isotopic nitrogen than do other amino acids of the tissue proteins. Glutamic acid is especially active. In this connection it is significant that tissue proteins give large yields of aspartic and glutamic acids. The total amino acids of the rat carcass include 12 per cent of aspartic acid and 13 per cent of glutamic acid. Incidentally, glutamic acid is probably supplied in larger quantity by the food of the majority of the human race than is any other amino acid. This is due to the liberal use of cereals, the chief proteins of which (p. 106) are the glutamic acid-rich prolamins. Glutamic acid occupies a strategic place (p. 496) in certain metabolic reactions.

The presence of the enzyme **glutamic acid transaminase**, widespread in plant and animal tissues, explains the exceptional significance of glutamic acid in transamination. The mechanism of the reaction is such that glutamic acid acts as a donor of $-\text{NH}_2$ groups and its deaminated product, α -ketoglutaric acid, acts as an acceptor of $-\text{NH}_2$ groups, provided the specific transaminase is present. This idea is presented diagrammatically in the scheme of Fig. 79. The corresponding **aspartic acid transaminase** is widespread in plants but probably occurs in animals also.

Transaminase preparations made from animal tissues contain vitamin B₆, and the tissues of animals that have been on a diet deficient in this vitamin show greatly reduced transaminase activity. It is restored by addition of pyridoxal phosphate or pyridoxamine phosphate. Most of the concentrated preparations of the enzyme are reported to contain pyridoxal phosphate although pyridoxamine phosphate has been found in a few cases. Schlenk and Fisher, who isolated the enzyme, suggest that the following scheme could represent the transfer of amino groups:

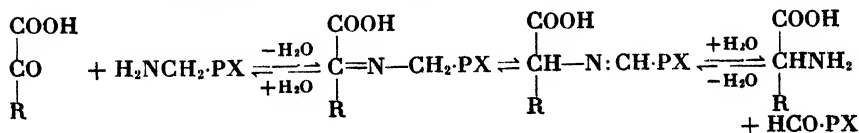

In the scheme R represents the part of an organic acid not otherwise

shown and PX represents the part not otherwise shown of the enzyme system, namely, the prosthetic group (vitamin B₆ phosphate) and apoenzyme. The reactions are postulated upon the idea that, in the prosthetic group, a reversible change of pyridoxamine to pyridoxal can occur, aided by dehydration and hydration. The complete operation of the system would be represented if one inserted these reactions into the scheme of Fig. 79 in place of the words, pyridoxal \rightleftharpoons pyridoxamine.

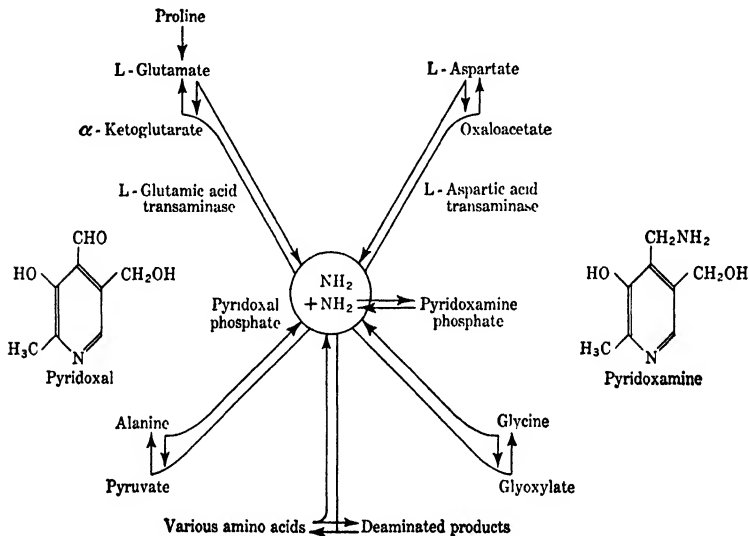

FIG. 79. Scheme to suggest relationships that seem to be involved in transamination. See explanation in text. The circle, enclosing NH_2 , suggests a pool of amino groups, to which various reactions can contribute (inward-pointing arrows) and from which $-\text{NH}_2$ groups can be accepted (outward-directed arrows).

It is not yet clear why glutamic acid should be so intimately involved, but its dicarboxylic structure seems to be significant in view of the tendency of aspartic acid to be transaminated and of the fact that some transaminase preparations appear to be able to use aspartic acid in place of glutamic. That all transaminase reactions must necessarily utilize a dicarboxylic amino acid would be difficult either to prove or to disprove.

Deamination. Removal of the α -amino group by an oxidation which converts the amino acid into an α -keto or an α -hydroxy acid, usually the former, is called deamination. It is a prominent feature of protein metabolism and, for the majority of the amino acids, is the first step in their utilization. Deamination may, theoretically, precede transamination. This suggests that deamination might occur while the amino acid is still incorporated as a unit "building stone" of a living

protein. Most of the work on deamination, however, has dealt with the process as it applies to free amino acids.

One experimental method employs surviving tissue slices which are placed in the Warburg apparatus with a suitably buffered solution of an amino acid. The rate of uptake of O_2 by the system is measured, and in some cases the keto acid produced has been isolated. Another method employs purified enzyme preparations with an amino acid as substrate.

The reaction occurs in two steps: (1) dehydrogenation requiring a suitable oxidative system and (2) hydration with loss of NH_3 .

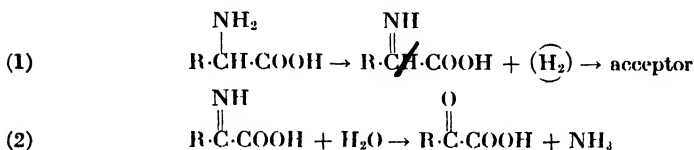

Thus alanine yields pyruvic acid. The latter may be reduced to lactic acid, which does not appear, however, to be a primary product. Similarly, glutamic acid forms α -ketoglutaric acid, histidine yields α -keto- β -imidazolelactic acid, etc. Deamination in metabolism, forming keto acids, differs from that occurring with HNO_2 (p. 101), which forms hydroxy acids.

The place of α -ketoglutaric acid and of oxaloacetic acid in the tricarboxylic acid cycle (p. 381) together with their participation in transamination makes them of peculiar interest in deamination. Although the *transamination* process is not itself oxidative, the removal of some of its participating compounds (α -ketoglutaric and oxaloacetic acids) by oxidation in the tricarboxylic cycle enables *transamination* to effect *deamination* of all those amino acids which transaminate and might even do so, theoretically, to an extent exceeding the action of specific deaminases.

The reversibility of deamination *in vivo* is of course implied in the facts of transamination. Further evidence is found in the successful substitution of α -ketonic or α -hydroxy acids for indispensable amino acids of the food. Thus leucine, isoleucine, valine, methionine, phenylalanine, or tryptophan can be omitted, provided the diet contains the corresponding keto or hydroxy acid, yet no nutritive failure is observed. Somewhat similar but less successful results are obtained with substitution of imidazolelactic acid for histidine. Lysine, however, cannot be replaced by its deaminated product. This corresponds to its failure to participate in transamination.

Reversibility of deamination is also shown by the substitution of unnatural stereoisomeres for the natural L-forms of indispensable amino

acids. This has been shown in rats with histidine, methionine, phenylalanine, and tryptophan. Cystine, when used to "spare" the minimum requirement for methionine, can be the L-, the D-, or the DL-form. The ability of the animal tissues thus to remodel the stereoisomeric arrangement around the α -carbon atom of amino acids may be a general one, applying to the majority of the amino acids. Here again, however, lysine is exceptional. No substitution of the unnatural enantiomorph for L-lysine can afford good nutrition. The same is reported for the branched-chain amino acids, valine, leucine, and isoleucine. Threonine must also be supplied in its natural form, and the specifications apply to the indispensable D-configuration of the CHOH group at the β -carbon atom

Enzymes which catalyze deamination are (1) **L-amino acid oxidase**, (2) **D-amino acid oxidase**, and (3) **glycine oxidase**.

The first has been isolated from kidney and liver. With the natural L-form of an amino acid as substrate, it utilizes molecular oxygen and requires a hydrogen acceptor. Under anaerobic conditions with catalase present, it forms one molecular equivalent of NH_3 and one of a keto acid for each gram atom of oxygen used. Without catalase, H_2O_2 accumulates and less NH_3 is produced. Under aerobic conditions without catalase, one molecular equivalent of H_2O_2 is formed for each gram atom of oxygen consumed. L-Amino acid oxidase does not act with the unnatural D-amino acids nor with β -alanine as substrate. It shows little or no action with dicarboxylic amino acids, diamino acids, threonine, serine, or glycine.

The D-amino acid oxidase is widely distributed in animal tissues, but kidney is the richest source and liver next. It is a flavoprotein enzyme (see Table 49, p. 371). It is specific for D-amino acids and appears to act upon them rapidly. When they are fed to animals the resulting urea excretion increases more promptly than it does in comparable experiments with the L-forms. It seems pretty well established that some D-forms, after being deaminated, are converted to L-forms.

Glycine oxidase is also obtained from liver and kidney and is a flavo-protein enzyme. Glycine, which is not acted on by the other two oxidases, is a substrate. The products are glyoxylic acid and NH_3 . Methylamine and glyoxylic acid are formed when sarcosine (p. 506) is the substrate.

Urea Production. As a result of deamination the chief nitrogenous end product of protein metabolism is urea. Theories of its formation were formerly based on the result of perfusing the liver with blood or a perfusion solution to which $(\text{NH}_4)_2\text{CO}_3$ had been added. The resulting

increase of the output of urea from the liver led to the assumption that it was formed in metabolism by union of the NH_3 , set free by deamination, with the CO_2 produced by other oxidations. Modern work with isotopes shows that both tagged NH_3 and tagged CO_2 may appear in urea. While the idea of such a synthesis is in the main correct, the chemical mechanism is not simple. The occurrence in liver, in kidney, and in spleen of an enzyme called **arginase** has long been known. It catalyzes the hydrolysis of arginine to form ornithine and urea.

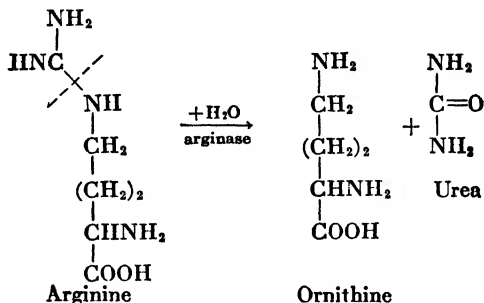

Using surviving slices of liver, Krebs and others have shown that the reaction is greatly accelerated by addition of ornithine or of citrulline to the reaction mixture. Citrulline is known to be formed in liver from ornithine.

The buffer used with liver slices is a bicarbonate solution containing CO_2 . When replaced by a phosphate buffer of the same pH, urea production is almost completely stopped. This has been interpreted as signifying that CO_2 unites with ornithine to form an intermediary compound, δ -carbamino-ornithine, which, reacting with NH_3 , forms citrulline. The latter, reacting with another equivalent of NH_3 , forms arginine. Thus a cycle of reactions is postulated and may be represented as shown in Fig. 80.

For each complete cycle one equivalent of CO_2 and two of NH_3 are taken up and one of urea is thrown off. Actually, however, the cycle does not run so as to be independent of other reactions. Some ornithine is removed, deaminated, and oxidized thus leaving the cycle. Some of the urea nitrogen represents the breakdown of arginine of the food rather than the ammonia derived from other amino acids. Arginine of tissues may be similarly used. It is found, indeed, that the NH_3 disappearing in an experiment with liver slices is less than two equivalents for one of urea produced.

Intermediary reactions leading from ornithine to citrulline have been extensively studied. Experiments have been reported (Cohen and asso-

ciates, 1948) to show that glutamic acid acts as acceptor for CO_2 and NH_3 to form an intermediary compound which reacts with ornithine to form citrulline. Production of the intermediary compound requires energy which must be supplied by concurrent oxidation. The conversion of citrulline to arginine (change of $\text{C}=\text{O}$ to $\text{C}=\text{NH}$) involves what is called transimination. Cohen and Hayano find that it seems to be

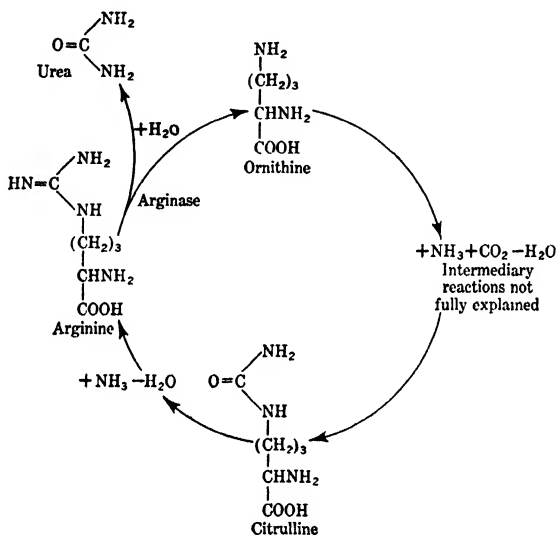

Fig. 80. The cycle of reactions producing urea.

associated with a high-energy phosphate donor system and to require the presence of glutamic acid.

Several objections to this theory have been raised. One of the most serious is the failure of the liver to form arginine from citrulline at an easily measurable rate. Kidney tissues (slices of the cortex), however, can effect this synthesis rapidly when citrulline and glutamic acid are provided. The suggestion has been made that citrulline formed in liver is changed to arginine in the kidney and then utilized by the liver for urea production. The rate at which arginine becomes available in the liver seems, indeed, to be the limiting factor in the speed of urea production. This is inferred from experiments with rat-liver slices in which added NH_3 and CO_2 , in the presence of lactate, are converted to urea at rates which can be accelerated by addition of either ornithine or citrulline, or both, but the effect of the two together never exceeds the maximal effect of either one alone. This suggests that the reaction,

ornithine \rightarrow citrulline, occurs readily in liver while the reaction, citrulline \rightarrow arginine, is limited in some way.

Another objection arises from thermodynamics. The energy content of urea is larger than that of the NH_3 and CO_2 equivalents.



The required energy must be derived from oxidation. Its coupling to the ornithine-arginine cycle is not entirely clear, but the addition of glutamates or the closely related glutamine, of pyruvate or lactate, or of some other easily oxidizable substrate to the solution used with liver slices is necessary for sustained urea production. Ways in which the cycle could be coupled to the tricarboxylic acid oxidative cycle are indicated in Fig. 81 (p. 492).

Good support for the theory is furnished by comparative biochemistry. Those animals (mammals, turtles, amphibians, and elasmobranch fishes) which have the enzyme arginase in the liver excrete urea as the chief end product of protein metabolism. Others (birds, snakes, and lizards), which do not have arginase, excrete uric acid as the chief end product.

Although the fact of the ornithine-arginine cycle seems to be established, some of its details remain to be clarified. It is apparently the most important mechanism for urea production, but others may exist. It is reported, *e.g.*, that urea may arise in the absence of ornithine from NH_3 and CO_2 in the presence of glutamine or asparagine, the acid amides of glutamic and aspartic acids.

The liver is the chief organ for urea production. Krebs tested 17 different tissues and found significant urea production only with liver slices. Numerous experiments on perfusion of organs lead to the same conclusion. Hepatectomy in dogs causes a decline in the blood-urea level during the short period of survival. Formation of small amounts of urea in the kidney and possibly in other organs cannot be excluded even in mammals. In elasmobranchs arginase is widely distributed, urea is present in comparatively high concentration in all tissues and fluids and its production is assumed to be widespread in these fishes.

Urea, once formed, might be supposed to be surely excreted, and this was tacitly assumed to be the case until experiments with isotopes proved the contrary to be true. Block (1946) showed that when urea, containing N^{15} , was administered some of the N^{15} appeared as NH_3 and some even appeared in tissue proteins, although the major part of it was recovered, as would be expected, in urinary urea. Correspondingly it was found (Leifer, Roth, and Hempelmann, 1948) that when urea, labeled by C^{14} , was injected into mice a considerable proportion of it appeared as CO_2 of urine and expired air.

Gluconeogenesis from Amino Acids. A number of amino acids serve as material for glycogen formation or for gluconeogenesis. As previously explained, the maximal extent to which any of them can form

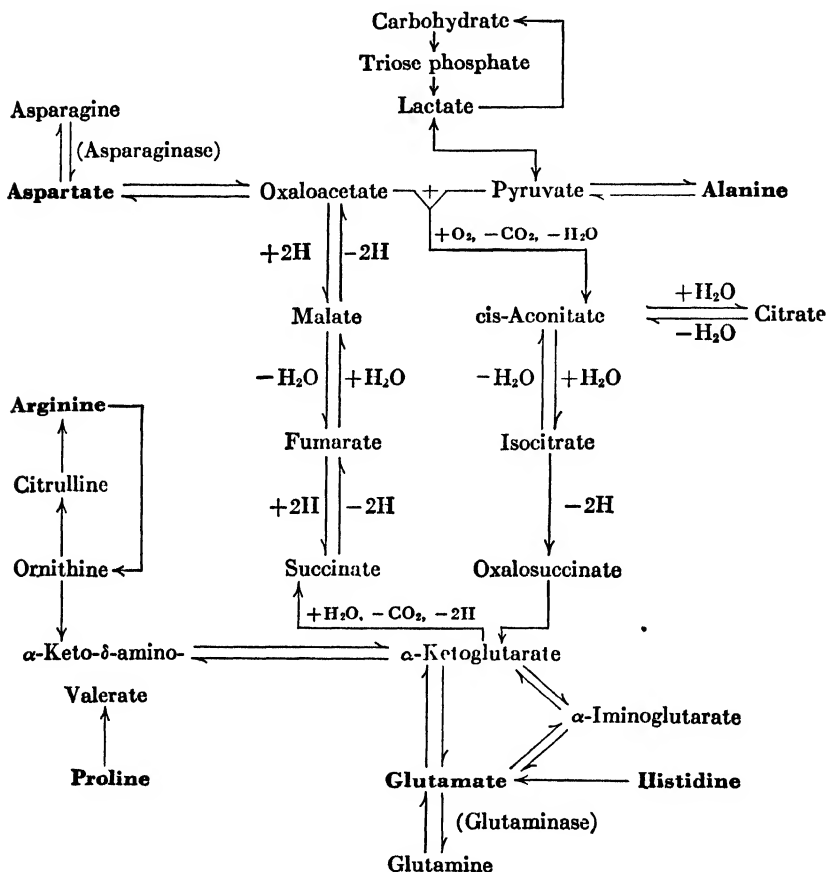

FIG. 81. Scheme to indicate the entrance of six of the protein amino acids and some related compounds into the tricarboxylic acid cycle. The cycle is shown in the form given by E. A. Evans, Jr., *Ann. Rev. Biochem.*, 13, 193, 1944. The scheme on p. 381 may be consulted for the formulas of the acids arising in the cycle.

glucose under *normal* circumstances is only conjectured. Such measurements are made in the diabetic or otherwise glycosuric animal.

In the phlorizinized dog, Lusk showed that glucose excretion in urine may be equivalent to about 58 per cent of the protein metabolized, and this was true whether the dog was fed on lean meat or was starved. The extent of transformation to glucose is estimated by use of the so-called *G/N* or *D/N* ratio, where *G* or *D* represents the urinary glucose (dextrose),

and *N*, the total nitrogen of the urine. When the ratio is 3.65:1, as in the extreme case, we find, assuming muscle protein to average 16 per cent in *N* content, that the glucose formed is 58 per cent (16×3.65) of the protein catabolized.

Lusk and others have studied the conversion of individual amino acids to glucose. The majority are glucose formers although they vary as to the quantitative yield. Exceptional ones which do not yield sugar are leucine and isoleucine, which have branched carbon chains, and

TABLE 62.—COMPARATIVE AVAILABILITY OF AMINO ACIDS FOR SUGAR PRODUCTION IN THE DIABETIC ORGANISM

Good glucose formers	Limited glucose formers	Nonglucogenic amino acids
Glycine	Arginine	Leucine
Alanine	Citrulline	Isoleucine
Serine	Ornithine	Lysine
Norleucine	Histidine	Phenylalanine
Proline	Threonine ¹	Tyrosine
Oxyproline	Valine	
Cystine		
Cysteine		
Aspartic acid		
Glutamic acid		
Hydroxyglutamic acid		

¹ Threonine is glucogenic probably only in so far as it contributes to cystine formation.

phenylalanine and tyrosine, which have the benzene ring in the molecule. Of the basic amino acids, lysine is again exceptional. It forms no glucose. Arginine, citrulline, and histidine appear to be glucogenic only in so far as they yield pyruvic acid or some other component of the oxidative cycles. The dicarboxylic amino acids are similarly limited as to the maximal yield. Glutamic acid, for example, cannot produce glucose in excess of the equivalent of 3 of its 5 carbon atoms. The dicarboxylic acids are apt to approach their maximal theoretical yield, probably because of their close connections (see Fig. 81) with the tricarboxylic acid cycle.

A summary of relative glucogenic potentialities of amino acids is given in Table 62.

Glucose production from individual, purified proteins has also been studied. When fed as the only protein in the diet of pholorizinized animals, the proteins yield *G/N* ratios in the urine showing glucose formation proportional to the content of glucogenic amino acids in each protein.

The *G/N* ratio in diabetes tends to increase with the severity of the diabetic condition. This accords with the modern theory (p. 432) that diabetes involves an exaggerated gluconeogenesis. It has been found that when the *G/N* ratio reaches 2.8, the fatal end of diabetes threatens.

Ketogenesis from Amino Acids. It seems to be generally agreed that lysine, phenylalanine, and tyrosine are ketogenic. Others reported to be so are valine, leucine, and isoleucine. There is some question, however, whether those of the latter group are ketogenic if they are the natural L-forms; but all three of them and some others, in the racemic DL-form, are more or less ketogenic when fed to rats on a protein-free diet.

Much of the work on this matter has been in the form of perfusion experiments or of work with tissue slices. The extent to which any of the amino acids produce acetoacetic acid in the healthy intact animal on a complete and balanced diet remains to be determined. The missing information is one of the reasons for uncertainty and variability of ketogenic-antiketogenic ratios (p. 465) and of the ketogenic threshold.

The intermediary reactions by which an amino acid yields the ketone substances are not clearly understood and apparently differ for the individual amino acids concerned. Some of the postulated chemical mechanisms will be shown later.

Glycine. While glycine is synthesized in the mammal, it must be supplied in the food of the chick. Its use in detoxication has been described (p. 287). Other specific uses include production of glycocholic acid of bile and the formation of the tripeptide glutathione (p. 383). Glycine containing N^{15} is traced into glutathione isolated from the liver. Isotopic NH_3 is similarly traced. In both cases the incorporation of the tagged nitrogen is much more rapid than it is in proteins. It appears that half of the glycine and glutamic acid in the glutathione can be replaced within 4 hr. Another function of glycine will be shown in connection with creatine metabolism.

The existence of a specific deaminizing enzyme (p. 488) for glycine further emphasizes its unique behavior in metabolism. Glycine enters into transamination extensively.

Leucine, Isoleucine, and Norleucine. These three isomers behave alike in so far as they are deaminated by L-amino acid oxidase. They differ as shown above in that the branched chain ones are indispensable, the straight chained norleucine is not.

When leucine, probably in its D-form, is ketogenic, its deaminated product, α -keto isocaproic acid, could be converted, theoretically, to isovaleric acid and demethylated to yield the ketone substances. These hypothetical reactions would be

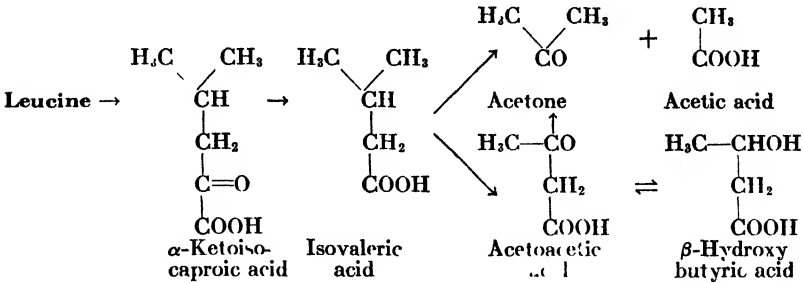

Metabolism of isoleucine is also unsolved. That of norleucine appears to follow the common pattern of deamination and oxidation.

Proline and Hydroxyproline. The similarity of the structures of these two amino acids suggests that they are similarly metabolized, but more definite and complete information is available for proline than for hydroxyproline. Both are oxidized by liver tissue, but proline appears to be destroyed more rapidly by kidney than by liver. The outstanding facts are that proline is convertible to α -ketoglutaric acid + NH_3 and that, with excess of NH_3 , glutamine arises. A scheme to indicate possible courses of these reactions is

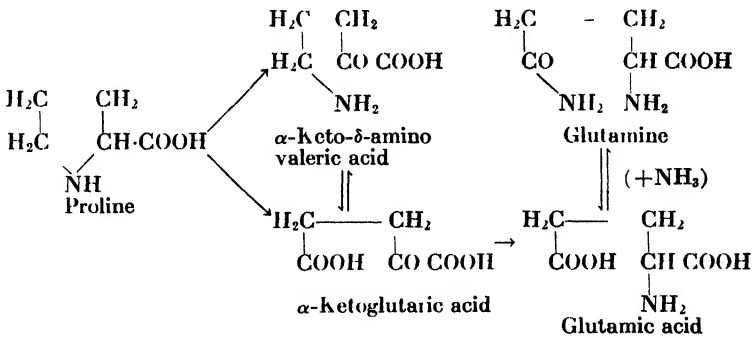

The possibility that glutamic acid itself is the first product of oxidation of proline cannot be excluded. But in any case the significant thing is the opening of the pyrrolidine ring of proline. An enzyme catalyzing this reaction is called **proline oxidase**. It has been prepared from kidney.

Aspartic and Glutamic Acids. The fact that these dicarboxylic acids are not apparently deaminated by L-amino acid oxidase suggests that some other specific deaminating mechanism is provided in animals. The process seems to occur with especial facility. This is deduced from the lively participation of these acids, and especially of glutamic acid

(p. 485), in transamination. Dicarboxylic acids play a significant role in protein metabolism. Possible functions in bridging between polypeptide chains of the protein molecule (Fig. 25, p. 137) and in forming inner ring structures have been suggested.

The synthesis which renders these amino acids dispensable in animal diets may be dependent upon the tricarboxylic acid cycle. Pyruvic acid and CO_2 are utilized (p. 381) in the formation of α -ketoglutaric acid which, aminated, gives glutamic acid. The amination of oxaloacetic acid, another member of the same cycle, forms aspartic acid. The strategic place of glutamic acid or, more specifically, of its partial oxidation product, α -ketoglutaric acid, in metabolism is such that it is the funnel of the hopper by which a number of metabolites can be poured into the "metabolic mill" (Fig. 81) to be oxidized or enabled to take part in interconversions.

It has been suggested that the reactions, glutamine \rightleftharpoons glutamate \rightleftharpoons α -ketoglutarate, may serve to maintain the concentration of α -ketoglutarate that is optimal for operation of the tricarboxylic cycle. This seems especially probable for brain which has a high concentration of glutamic acid.

Both asparagine and glutamine serve as "reservoirs" of nitrogen to be drawn upon for various purposes.

Serine. This amino acid is not obtained in conspicuously high yield from any food protein, and the amount of it participating in animal metabolism is relatively small. It appears, however, to be unique, with the possible exception of threonine, which also has an $-\text{OH}$ group, in its metabolic behavior. It can be deaminated anaerobically, *i.e.*, without simultaneous oxidation. It uses its own oxygen to get rid of hydrogen. The reactions might theoretically be as follows:

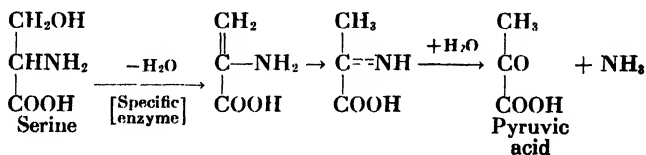

The specific enzyme has not been extensively investigated. It occurs in liver. It may be provisionally called "serine deaminase." Formation of pyruvic acid accounts for the fact that serine is a good glucose former.

Studies of the fate of isotope-labeled serine have shown (Shemin, 1946) that it is directly convertible to glycine in rats and guinea pigs. Apparently the β -group ($-\text{CH}_2\text{OH}$) can be ripped off because both the C and the N of its other groups appear in the glycine. It has a special relation (p. 501) to the metabolism of cysteine.

Phenylalanine and Tyrosine. The fact that phenylalanine is indispensable while tyrosine is not indicates that the oxidation by which tyrosine is produced is irreversible in the animal body. When phenylalanine tagged with deuterium is fed, tyrosine isolated from liver proteins contains deuterium. Both are deaminated by L-amino acid oxidase and take part in transamination.

Some of the information upon which theories of the metabolism of these two amino acids are based is derived from study of urinary compounds excreted by patients having certain "inborn errors of metabolism." They are

"Errors of Metabolism"	Accompanying Urinary Compounds
Alcaptonuria	Homogentisic acid
Phenylketonuria	Phenylpyruvic acid
Tyrosinosis	<i>p</i> -Hydroxyphenylpyruvic acid

The first two are said to be inherited as Mendelian recessive characters. Homogentisic acid is

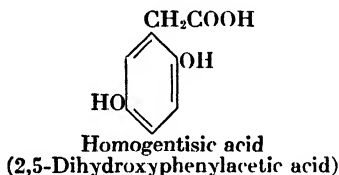

It is autoxidizable, forming black products, so that the urine darkens or turns black on exposure to air. The reaction is hastened by making the urine alkaline.

The output is increased when either phenylalanine or tyrosine is fed to the patient. This suggests that it might be a normal intermediary compound which fails to be disposed of by the alcaptonuria. This idea seems the more probable inasmuch as prolonged feeding of phenylalanine to rats may cause homogentisic acid to appear in their urine. Moreover, feeding of tyrosine to guinea pigs or to normal human subjects on a diet deficient in ascorbic acid causes the excretion of homogentisic and *p*-hydroxyphenylpyruvic acids. They disappear from the urine when ascorbic acid is added to the food. But this vitamin has no corrective action upon an alcaptonuric.

These observations lead to the following hypothetical scheme:

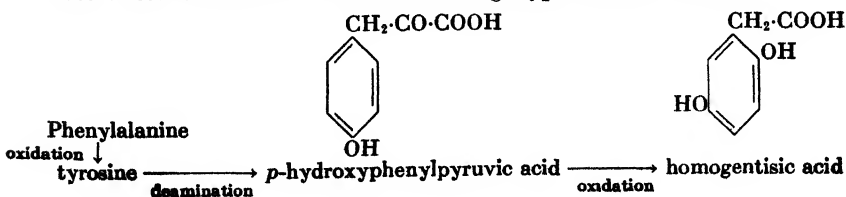

Phenylketonuria occurs in patients having a form of imbecility called "phenylpyruvic oligophrenia." Phenylalanine and phenyllactic acid are also found in the urine together with phenylpyruvic acid. Feeding phenylalanine to such a patient increased the excretion of phenylpyruvic acid, but no other amino acids tried, not even tyrosine, gave this effect. It has also been found that rats on a thiamine-deficient diet may excrete phenylpyruvic acid when large amounts of phenylalanine are fed. Thiamine prevents this condition. Recalling that thiamine is a part of the enzyme carboxylase, required in brain tissue for oxidation of pyruvic acid, one may surmise that phenylketonuric patients have a defect in the activity of this or some similar enzyme so that phenylpyruvic acid, which might be a normal intermediary in phenylalanine metabolism, fails to be further oxidized.

These observations suggest that phenylalanine may be metabolized without conversion to tyrosine.

Tyrosinosis is a very rare disease. Only a few cases have been described. Its chief symptom is the excretion in urine of *p*-hydroxyphenylpyruvic acid. It is increased by feeding tyrosine and is then accompanied by appearance of tyrosine and *p*-hydroxyphenyllactic acid in the urine. This suggests that in these patients the oxidative processes which might proceed normally through homogentisic acid are blocked.

Ketogenesis affords more evidence. Normal liver slices can produce acetoacetic acid from phenylalanine but not from phenylpyruvic acid. But the latter is thus converted by kidney slices. This leads to the following scheme:

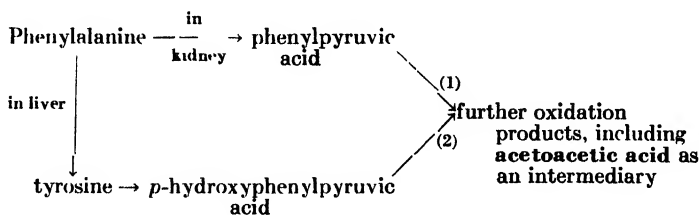

The process appears to be blocked at (1) in phenylketonuria, at (2) in tyrosinosis, and at some further stage of oxidation in alkaptonuria.

The reactions by which phenylalanine and tyrosine yield acetoacetic acid can only be conjectured. They may involve an oxidative opening of the benzene ring. Aromatic compounds of urine are much too small in amount to explain the quantity of these amino acids catabolized. But production of acetic acid by oxidation of the side chain and subsequent conversion to acetoacetic acid does not seem to have been disproved.

Another type of oxidative process may attack tyrosine. It is converted under the action of **tyrosinase** (found in potatoes, in fungi, and in some invertebrates) into the black pigment called **melanin**. Melanin occurs in hair and skin of mammals. In albinism, a recessive Mendelian characteristic, the normal formation of tissue melanins is inhibited. Melanin is a prominent constituent of melanosarcomas and may even appear in the urine of patients with such sarcomas.

The reactions forming melanin are not fully understood but are believed to begin with the oxidation of the tyrosine ring to form dopa, 3,4-dihydroxyphenylalanine. Further oxidation with ring formation could yield an indole derivative

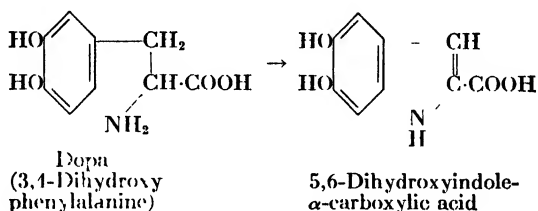

This is converted to melanin, the structure of which is unknown. An enzyme, dopase, found in melanoblasts, can hasten melanin formation.

The role of tyrosine in synthesis of certain hormones will be discussed in Chap. XX.

Tryptophan. Successful substitution of indolepyruvic acid (p. 487) or of D-tryptophan for the otherwise indispensable L-tryptophan has been mentioned as an index of the ready deamination and reamination of this amino acid.

The metabolic disposal of its heterocyclic ring has been studied, as in the case of tyrosine, by observing supposedly intermediary compounds in urine. Some animals (dog, rabbit, guinea pig, but not man or the cat) excrete kynurenic acid. Some urines contain the related kynurenine, which is also detected in tryptophan-containing media acted on by surviving slices of liver. Feeding or injecting kynurenine increases kynurenic acid excretion, as do both tryptophan and indolepyruvic acid. These findings suggest that tryptophan may undergo an oxidative attack upon the indole group. But the first oxidative step might be deamination of the α-amino group, forming indolepyruvic acid.

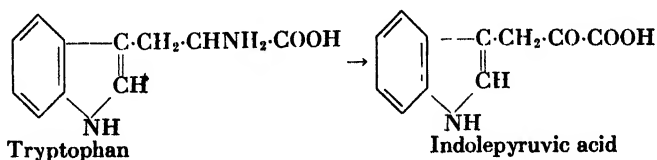

This could be so oxidized as to open the ring and, by a series of oxidations and reductions, form kynurenic acid. But the latter might be formed by reactions which produced kynurenine as an intermediary compound. In this case the first oxidative attack would be upon the indole ring rather than upon the side chain.

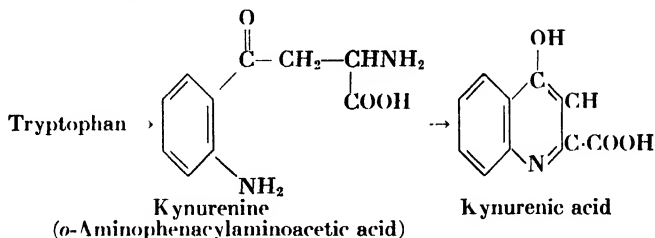

The intermediary reactions involved in kynurenic acid production would seem to be complex. Theories about them are still in a formative state. It is not even certain that kynurenic acid is a normal and necessary stage in tryptophan metabolism. Its disposal by further oxidation has not been studied but must occur inasmuch as kynurenic acid fed to man does not appear in the urine. The reactions forming it are not reversible as is shown by failure of either kynurenine or kynurenic acid to serve as substitutes for tryptophan in the diet.

Some of the urine pigments, both normal and exceptional ones, appear to be formed from kynurenine or kynurenic acid.

The intestinal bacteria *Escherichia coli* may be extracted to yield an enzyme called tryptophanase, which is separated by dialysis into an apoenzyme and a coenzyme. The latter appears to contain pyridoxal phosphate. The reaction with tryptophan does not require oxygen and breaks down the substrate to yield indole, pyruvic acid, and NH_3 . A somewhat similar enzyme found in the mold *Neurospora* can synthesize tryptophan from indole and serine.

Tryptophan is reported to exert lipotropic effects and, unlike certain other lipotropic amino acids, can correct both the fat and the cholesterol types of fatty livers.

A unique effect of dietary deficiency of tryptophan is observed in rats, which develop eye cataracts different from those caused by certain other abnormal diets (riboflavin deficiency, excessive galactose feeding, etc.). Dietary studies indicate that tryptophan and nicotinic acid show a mutually sparing action.

The Sulfur-containing Amino Acids. Cystine, cysteine, homocystine, and methionine have a sufficient number of interrelations in metabolism to warrant a combined discussion of them. All yield the sulfate group when completely oxidized in the body.

Their interrelations are not entirely established but appear to include those indicated in the following scheme:

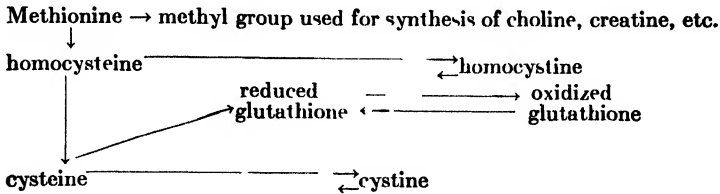

While any of these compounds may so undergo oxidation as to yield the sulfate group directly or indirectly, some unoxidized sulfur in the so-called "neutral sulfur" compounds is found in urine.

Conversion of homocysteine to cysteine is probably not direct. This is inferred from experiments with surviving liver slices, which convert homocysteine to cysteine *in the presence of serine*. This suggests that these two amino acids unite with elimination of H_2O to form *cystathionine*, $COOH \cdot CHNH_2 \cdot CH_2 \cdot CH_2S - CH_2 \cdot CHNH_2 \cdot COOH$, and this hydrolyzes to yield homoserine and cysteine. The over-all process, converting methionine to cystine, is inferred from the satisfactory growth of rats receiving no sulfur except that of methionine. Further evidence has been obtained by feeding methionine containing isotopic sulfur (S^{36}). Cystine isolated from the tissue proteins contained S^{36} . The reverse process, forming methionine, is ruled out by the nutritive failure caused by cystine-rich, methionine-free diets. Cystine, however, can "spare" methionine so that its minimum requirement for good nutrition is reduced. But this is true of the natural L-form only. The D-form cannot aid, as reported by Du Vigneaud, in supporting good growth as does L-cystine. Thus the animal appears unable to deaminate and reaminate cystine so as to produce the natural form. This failure is surprising when contrasted with the behavior of certain indispensable amino acids (methionine, tryptophan, and leucine) of which transformation from D- to L-forms has been recognized. Surprisingly, it is reported (Jones, Caldwell, and Horn, 1948) that both L-lanthionine (see Table 15) and DL-lanthionine can cause resumption of growth in rats stunted by use of a diet insufficient in its content of methionine and cystine.

Cystinuria, another hereditary "inborn error of metabolism," has afforded some information. Adult cystinurics appear to be in good health, and sometimes the only symptom is the presence in urine of excessive amounts of cystine. As much as 1.8 g. per day has been reported in contrast to the normal excretion of less than 0.1 g. It may crystallize from the urine in characteristic hexagonal plates. In children serious trouble may arise due to deposits of cystine, especially in the

kidneys. The curious thing about this condition is that cystine, when fed, is largely metabolized in the normal way so that most of its sulfur appears in the urine as extra sulfate. Cystine in the form of glutathione is similarly utilized. These puzzling results are not clearly explained. Some experiments suggest that the urinary cystine may come from methionine or cysteine. When either of them is fed, cystine excretion may increase but methionine is not always reported to give this result, especially when a high-protein diet accompanies methionine feeding. The urinary cystine must come from a precursor other than the free cystine of the blood. Some cystinurics, indeed, excrete an unidentified substance which liberates cystine after the urine is voided.

Methionine is reported to yield α -amino butyric acid thus accounting for the finding of this compound (see Table 15) in animal tissues although it is not found in protein hydrolysates. This report implies that the methylthiol group, $-\text{S}-\text{CH}_3$, is capable of being oxidized separately and this has been found to be true by the use of an isotope label.

Specific uses of the sulfur-containing amino acids are listed below.

1. Methionine supplies methyl groups (p. 508) for choline production and for creatine synthesis (p. 506).

2. Cystine, or probably cysteine, is used (p. 268) for synthesis of taurine although methionine, via cysteine, can also serve.

3. Cysteine, possibly cystine also, is employed in the synthesis of glutathione.

4. Cystine is an important constituent of insulin.

5. Cysteine can activate a number of proteolytic enzymes.

6. Cystine is an abundant component of the protein of hair.

Experiments on rats have shown poor hair growth on diets low in cystine.

The metabolic importance of the $-\text{SH}$ group furnished by these amino acids may be inferred from experiments in which L-cystine, DL-methionine, or DL-homocystine can stimulate the growth of young rats after the weight increase has been checked by feeding iodo-acetate. The latter could so combine with $-\text{SH}$ groups as to mask and inactivate them so that an extra supply of these amino acids would be required to overcome the iodo-acetate effect.

It has been found that serine, $\text{CH}_2\text{OH}\cdot\text{CHNH}_2\cdot\text{COOH}$, tagged by N^{15} , when fed to rats, results in a very high content of N^{15} in the cystine isolated from the tissue proteins. Thus there seems to be transamination from serine to cystine, and it may even exceed the transfer of $-\text{NH}_2$ groups from serine to glutamic acid, but it need not be transamination inasmuch as serine acquires sulfur (p. 501) from homocysteine and then becomes cysteine which changes to cystine.

Lysine. Nothing definite regarding the metabolism of lysine is known beyond the facts already stated, namely, it is indispensable, does

explained in preceding sections of this chapter. Additional data show the relations of asparagine and glutamine to the amino acids of which they are the acid amides. The enzymes **asparaginase** and **glutaminase**, not previously mentioned, are placed in the scheme to indicate their functioning. Both occur in the liver.

Recalling that pyruvic acid, participating in the tricarboxylic acid cycle, may arise from several amino acids in addition to alanine and may, through lactic acid, give rise to glycogen, one sees that the glyco- genic and gluconeogenic functions of amino acids are apparent.

Creatine and Creatinine Metabolism. Creatine and creatinine are not protein amino acids, but their metabolism is described here inas- much as protein amino acids contribute to their synthesis in the body. Creatine is methyl guanidine acetic acid, and creatinine is its anhydride.

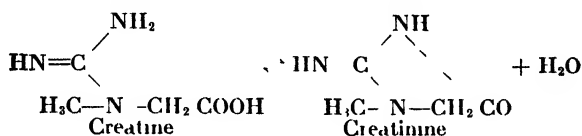

Creatine boiled with HCl yields creatinine. To some extent the reverse reaction occurs, reaching an equilibrium in solutions made mildly alkaline as with Ca(OH)₂. In the body, creatine is converted to creatinine, but the process is irreversible.

The importance of the reaction

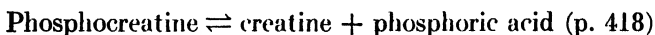

was shown in connection with glycolysis. Although observed chiefly in muscle, this reaction is perhaps functional in the carbohydrate metabo- lism of other vertebrate tissues.

The creatine content of the white matter of nervous tissue and of glandular tissues, including liver, is relatively low (10 to 75 mg. per cent) as compared with that of striated muscle (400 to 600 mg. per cent). Gray matter of nervous tissue, testis, and cardiac and nonstriated muscle are intermediate in their creatine content. It has been shown that certain tissues (kidney, spleen, and liver) which are low in creatine are also exceptionally low in creatinine content. The ratio of creatine: creatinine is lower than in muscle. This might mean that such glands rapidly convert creatine to creatinine, which is removed and excreted.

Creatine accumulates in tissues up to a certain point. This is shown by feeding creatine. When amounts larger than that ordinarily present in food are eaten by man or experimental animals, it need not necessarily appear in the urine as either creatine or creatinine. Much of it, some- times all of it, disappears. It is apparently utilized in the synthesis of

phosphocreatine. But when this synthesis, after prolonged feeding or heavy dosage of creatine, approaches a "saturation" point, creatinine begins gradually to increase in the urine and some creatine also appears. Creatinine when fed is mostly excreted unchanged.

The creatinine normally excreted (1 to 2.5 g. per day) is second only to urea among the nitrogen-containing compounds of mammalian urine. On diets free from creatine and creatinine, the amount is remarkably constant for an adult individual. It is not changed by increase or decrease of protein in the food nor by muscular exercise. Its formation from creatine was long disputed because of the "hiding away" of ingested creatine but is now established by the use of isotopes. Feeding of creatine containing N^{15} causes the appearance of the isotope in creatinine of the urine. Still further proof is obtained by feeding isotopic creatine during a considerable time followed by a creatine-free diet period. Creatinine of the urine is then found to have the same content of N^{15} as does creatine isolated from the animal's tissues. Failure of the reverse process to occur *in vivo* is shown by the results of feeding isotopic creatinine. It is excreted as fed, and no N^{15} appears in creatine.

The synthesis of creatine *in vivo* was long investigated without results. Its relation to arginine, which also has the guanidine group, suggests this amino acid as the source. But attempts to increase creatine formation or creatinine excretion by feeding arginine yielded somewhat equivocal results. The problem was solved by use of isotopic tracers. Creatine synthesis includes several steps, all of which have been fairly well established. Glycine, reacting with arginine, undergoes in the kidney a process which may be called transamidination. The amidine group of arginine is transferred to glycine so as to form glycoyamine (guanidine acetic acid). This is converted to creatine by acquisition of a methyl group (transmethylation) usually derived from methionine but also obtainable from other methyl donors (p. 508). In schematic form

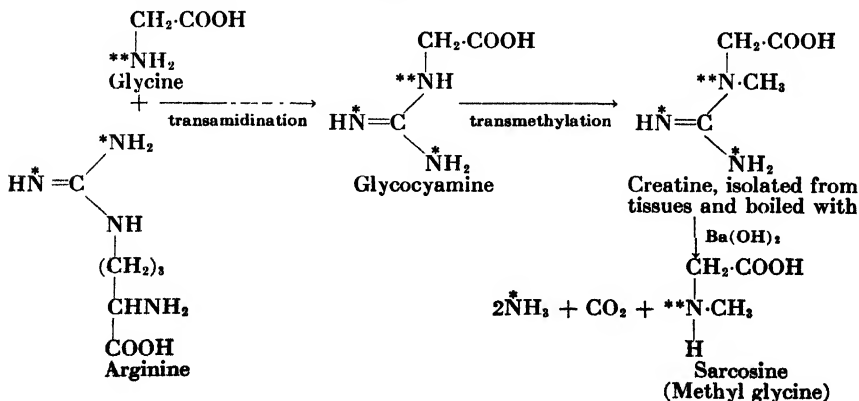

Crucial experiments in support of this scheme (Block and Schoenheimer) included feeding of glycine and arginine with one or the other tagged by N^{16} . Creatine was isolated from the tissues. It was broken down by boiling with $Ba(OH)_2$ to yield sarcosine, NH_3 , and CO_2 . If the N^{16} was originally in glycine, it appeared in the sarcosine; if in the amidine group of arginine, it appeared in the NH_3 . This is indicated by a corresponding labeling of N atoms in the scheme.

Creatinuria. The urine of healthy, normal adults usually contains only small amounts of creatine and is sometimes without any measurable amount of it. When the creatine content is significant the condition is called creatinuria. It occurs during growth, in starvation, in fevers, in diabetes, and during the use of a carbohydrate-free diet. While the fundamental nature of this peculiarity is not clear, one notes that conditions tending to deplete the liver store of glycogen or any disturbance in carbohydrate metabolism may cause creatinuria. This suggests that complete retention of creatine depends upon rapid restoration of the phosphocreatine complex after creatine is liberated in muscular contraction and that this restoration is dependent upon vigorous, normal carbohydrate metabolism.

Transmethylation. The transfer of methyl groups in synthesis of creatine is but one of a number of similar processes known as "transmethylation." Other examples are donation of the methyl group of methionine (p. 457) or of betaine for the synthesis of choline. Choline can give the methyl group to homocysteine to form methionine. Here again the transfers were shown by isotope experiments, largely the work of Du Vigneaud and his associates. Tagged choline or methionine was prepared by artificial synthesis in which deuterium as a $-CD_3$ group was introduced in place of $-CH_3$. Methyl groups donated by choline may be used in certain detoxication processes (Wilson and Leduc, 1949). The more important reactions in metabolism involving transmethylation are presented in Fig. 82.

Prosthetic Groups of Compound Proteins. The types of compound proteins as defined in Chap. IV are not always clearly delimited, because of the tendency of many biological materials to form readily dissociable complexes with proteins. The complex might be regarded as a compound protein or as a mere association. An instance of this was described in connection with certain oxidative enzymes of which one may say that a specific protein is the apoenzyme and another substance, usually a nucleotide, is the coenzyme; but one may also think of the two as being in union as a compound protein of which the nucleotide is the prosthetic group. Many similar cases are known. Most vitamins and hormones, the pigments forming certain of the chromoproteins, the fatty acids, and other lipids, especially cholesterol and the phospholipids, have

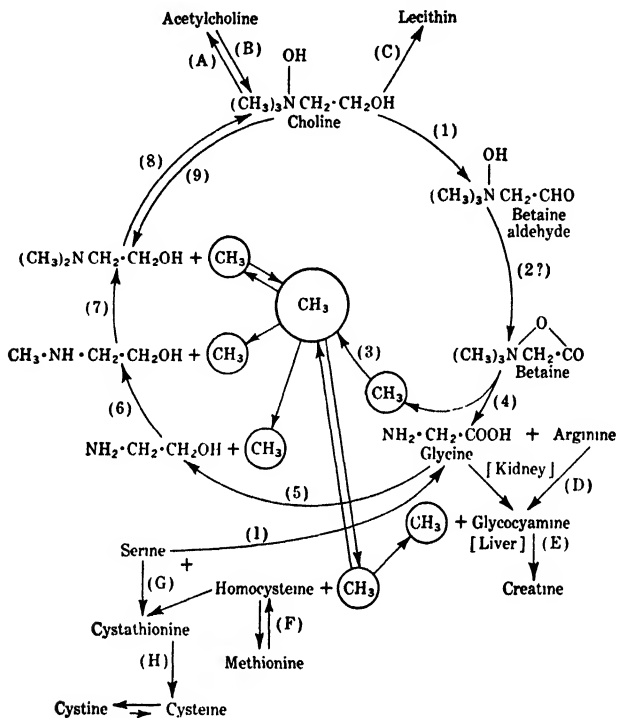

FIG. 82. Scheme to indicate metabolic reactions related to transmethylation. A methyl group in the center suggests the idea of a transference of methyl groups from donors, as shown by three entering arrows, to acceptors, as shown by four outgoing arrows. While the scheme gives primarily a picture of choline metabolism and of the significant contribution of methionine, a number of related reactions previously described in the text are also included. The various reactions represented by numbers or letters are commented upon as follows:

- (1) Oxidation by choline oxidase of liver (p. 468) produces betaine aldehyde.
- (2) Production of betaine by the same enzyme system is inferred from indirect evidence but not definitely proved.
- (3) Betaine, tagged with deuterium and administered to rats, is found to yield methyl groups for nutritive requirements.
- (4) Betaine, labeled with N^{15} and fed to rats, leads to production of glycine rich in N^{15} .
- (5) Conversion of glycine to ethanolamine is proved by feeding glycine, labeled with N^{15} , to rats and finding N^{15} in cephalin of tissues.
- (6), (7), and (8) Methylation of ethanolamine (p. 468) in three steps is rendered highly probable by administration of deuterium-labeled monomethylethanolamine or dimethylethanolamine and finding deuterium in the methyl groups of choline.
- (9) Evidence for this reaction is indirect and is the fact that choline, but *not* dimethylethanolamine, can furnish the necessary methyl groups for promot-

For remainder of caption see opposite page.

been mentioned in previous chapters as existing both in the free state and in protein combination in foods and living materials.

The metabolism of amino acids, showing their tendency to be incorporated in proteins while they are undergoing metabolic reactions, may well be regarded as having general significance. It is indeed probable that very many metabolites are part of a protein complex at the time they are metabolized.

In another and more restricted sense the importance of protoplasmic proteins is apparent. The specific part of each enzyme is protein. All enzymes so far studied behave as though they combined with the substrate. In this sense, then, each metabolite undergoing an enzymatic reaction is in protein combination.

There are six commonly recognized subgroups of compound proteins. For one of them, chromoproteins, the metabolism of a representative member, hemoglobin, was outlined in Chap. X; some data on the behavior of other metalloproteins were given in Chap. XII. The three subgroups—glycoproteins, lecithoproteins, and lipoproteins—will not be given a discussion beyond what has been presented along with the metabolism of carbohydrates and lipids. Much detailed information is available but is beyond the scope of this book. Of the subgroup phosphoproteins, metabolism studies have revealed little that is distinctive beyond appreciation of their high nutritive value in supplying a useful assortment of amino acids and the phosphate group important in many phases of metabolism.

Metabolism of nucleoproteins has been widely investigated and requires discussion at this point. Anabolism and catabolism of the protein components, such as protamins, globins, and albumins occurring in nucleoproteins, may be regarded as essentially like the corresponding processes for all simple proteins. Metabolism of nucleic acid involves distinctive reactions. Its digestion in the intestine (p. 266) by combined effects of several enzymes leads to the absorption of inorganic phosphate, ribose, deoxyribose, purines, pyrimidines, and nucleosides. It is reported that purine nucleosides are absorbed more rapidly than are guanine and adenine. To some extent purines may be destroyed by bacteria of the lower intestine.

ing the growth of rats on a diet low in methionine but supplemented with homocysteine.

- (A) Catalyzed by choline acetylase (p. 469).
- (B) Catalyzed by choline esterase (p. 469).
- (C) Occurs in liver and intestine (p. 467).
- (D), (E) See p. 506.
- (F), (G), (H) See p. 501.
- (I) See p. 496.

The purines and pyrimidines will be discussed separately.

Purine Metabolism. The purines metabolized daily by man ordinarily represent only 1 to 3 per cent of the total nitrogen excreted. To a considerable extent this is a strictly endogenous process. Purines can be synthesized *de novo* in the mammal as is proved by the formation of nucleic acid, nucleotides, etc., during growth while the only food is milk which contains no purine or at the most a mere trace. Similarly, the developing bird performs the same syntheses in the egg, which is purine free. But purine metabolism is also partly exogenous. Foods containing purines are mostly those of animal origin. In general, structures provided with large and numerous nuclei, *e.g.*, thymus (sweetbread), pancreas, liver, and kidney, are the richer sources. Sweetbread, the richest of all, has 0.8 to 0.9 per cent of purines. Lean meat (muscle), poultry, and fish are low in purines. Foods of animal origin yield guanine, adenine, xanthine, hypoxanthine, and their complexes. Tea, maté, coffee, chocolate, and cocoa, the widely used beverage materials, yield the methylpurines, caffeine, theophylline, and theobromine. Dry tea leaves, for example, may contain more than 2 per cent although in tea a considerable part of the purine is the nonmethylated adenine. The dry coffee bean contains on the average about 1.2 per cent of purine computed as caffeine.

Synthesis of purines utilizes protein. In Miescher's classic experiments (p. 141), sperm production in the male salmon was found to be at the expense of muscle protein. The fish take no food during the up-river migration but produce large amounts of milt while the muscles become depleted. Which amino acids specifically serve for synthesis of the purine groups of nucleic acid is not certain. Histidine has been suggested as one. Feeding histidine or proteins that are above average in their content of histidine to dogs is reported to increase the urinary output of the oxidation products of purines. The excretion of uric acid by rats decreases when the diet is deficient in histidine and arginine. To some extent synthesis of purine-containing compounds in animals employs purines of food. Thus when adenine, tagged with N^{15} , is fed, some N^{15} is found in the nucleic acids and in ATP isolated from the carcass; but the amount is a surprisingly small part of that fed. When the corresponding experiment is done with labeled guanine, very little N^{15} , almost none, is found in nucleic acid. By isotope experiments, it was shown that N^{15} in the adenine fed is detected in guanine and isotopic guanine feeding leads to the detection of N^{15} in ATP. These findings, if confirmed, would show the interconversion of adenine and guanine in the mammal.

Studies with isotopic phosphorus, P^{32} , indicate its rapid incorporation into nucleic acid in the walls of the intestine (Hevesy and Ottesen, 1943)

with less rapid uptake in spleen, testis, and muscle, a still slower one in liver, and a very slow uptake in kidney and brain. Essentially the same results are reported by others. It thus seems clear that the intestinal mucosa is the prime organ for synthesis of nucleic acid.

Catabolism of the purine nucleotides derived from nucleic acid involves (1) hydrolyses, (2) oxidative deaminations, and (3) other oxidations. The last named produce uric acid and, in some species, further oxidation products. Processes (1) and (2) are in various sequences so that deamination may precede or follow hydrolysis or occur at an intermediate stage. The scheme of Fig. 83 shows these possibilities. Hydrolysis and deamination are indicated, respectively, by +H₂O and -NH₂. Most of the compounds shown in the scheme have been recognized in tissues. Specific enzymes have been recognized for the majority of the reactions indicated. The scheme shows only one pathway of oxidation of oxypurines and only one enzyme, **xanthine oxidase**. It establishes an equilibrium in the reaction

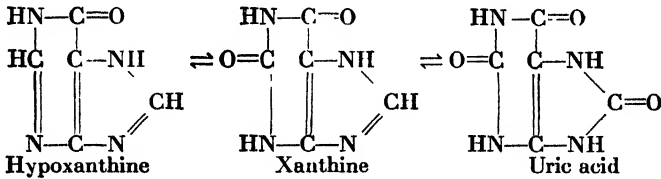

This enzyme has been prepared in concentrated form as a flavoprotein (p. 371).

The possibility of other intermediary oxidations, in addition to those shown in Fig. 83, is not excluded in view of the reported finding in erythrocytes of a uric acid riboside.

Some of these reactions occur in muscle, at least in some species. An example is the enzyme which deaminates adenylic acid to form inosinic acid. But for the most part, purine oxidation occurs in the kidney, spleen, and liver, especially in liver. The occurrence and the distribution of the enzymes show species peculiarities. For example, pig liver lacks guanase (18). Correspondingly, the pig sometimes has pathological accumulations of guanine, the so-called "guanine gout." Man, unfortunately, lacks uricase so that uric acid can accumulate, as it does in gout, forming concretions of uric acid crystals in joints, kidney, and some other locations. Apparently gout is due to defective elimination of uric acid by the kidney. Only the anthropoid apes and one breed of dogs, the Dalmatian hound, have been found to resemble man in lacking uricase. All other mammals destroy most of the uric acid

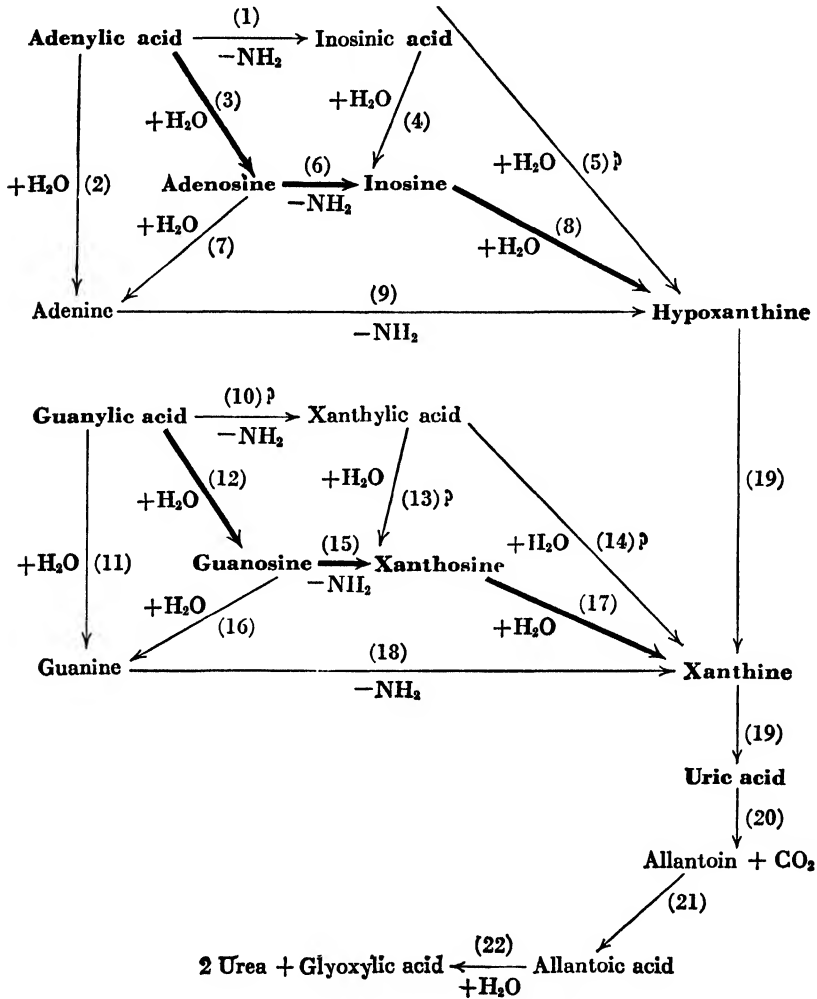
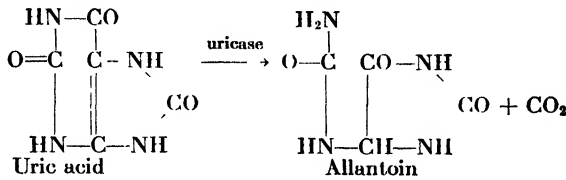

FIG. 83. Scheme to indicate catabolism of purine nucleotides. Only purine compounds are shown in the scheme. Sugar and phosphoric acid liberated by hydrolysis are omitted. The main channel of catabolism is indicated in heavy type. Enzymes known to catalyze the numbered reactions include the following:

- | | |
|---|--------------------------|
| (1) Adenylases | (9) Adenase |
| (2) Purine nucleotidase | (15) Guanosine deaminase |
| (3), (4), and (12) Phosphatases | (18) Guanase |
| (5), (10), (11), (13), and (14) Hypothetical reactions not known to occur | (19) Xanthine oxidase |
| (6) Adenosine deaminase | (20) Uricase |
| (7), (8), (16), and (17) Purine nucleosidase | (21) Allantoinase |
| | (22) Allantoicase |

produced and excrete allantoin as the chief end product of purine oxidation.



Oxidation of uric acid *in vitro* under controlled conditions can produce allantoin. The small amount of allantoin (average about 30 mg. per day) in human urine probably comes from food. Although named from its original discovery in allantoic fluid, it does not occur in the human uterus. It is formed in considerable amounts by certain maggots which clear up suppurative wounds. This has led to the successful use of allantoin in treatment of wounds and ulcers.

In amphibia and fishes, allantoin is still further hydrolyzed and oxidized by the action of the enzymes **allantoinase** and **allantoicase** to yield urea and glyoxylic acid.

In birds and the scaly reptiles, uric acid rather than urea is the chief end product of protein metabolism as a whole. This corresponds to

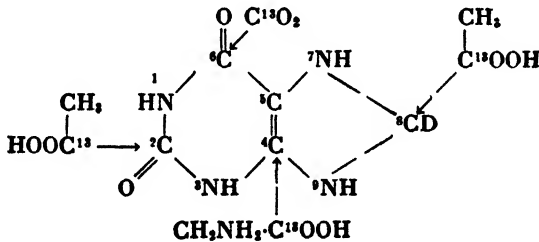

FIG. 84. Scheme to show incorporation in uric acid of C¹³ from isotope-labeled compounds administered to pigeons.

the absence of arginase from their livers. Although extensively studied, the intermediary reactions have not been clearly deciphered. Feeding of isotope-labeled compounds to pigeons showed (Sonne, Buchanan, and Delluva, 1946) the possible sources of the C atoms of uric acid of the birds' excreta. When acetates with C¹³ as the carboxyl carbon were fed, C¹³ was found as ²C and ⁸C of the uric acid; when glycine similarly tagged was fed, C¹³ appeared in ⁴C and possibly ⁵C of uric acid; labeled CO₂ when administered to the pigeons led to the presence of C¹³ in ⁶C of uric acid. These observations are indicated schematically in Fig. 84.

There is some evidence to indicate that ^{14}C of pigeons' uric acid could be derived from lactic acid. The reactions which these incorporations might suggest seem too complex for even a hypothetical formulation at present. The derivation of the N atoms of birds' uric acid has been less completely investigated, but it is reported that N^{15} given as ammonia appears in pigeons' uric acid. Purine bases can also contribute N.

The methylated purines, caffeine, theobromine, and theophylline, appear in the urine partly unchanged but in large measure partially demethylated to form mono- and dimethyl purines. To some extent caffeine appears to yield urea.

Pyrimidines. The pyrimidine nucleotides seem to be hydrolyzed and absorbed in the intestine much as are the purine nucleotides. Nucleo-protein and other sources of pyrimidine compounds in the food of growing animals are inadequate to provide for production of nucleic acids of the cells. Thus pyrimidine synthesis must occur.

Structural formulas of pyrimidines of biological interest suggest possible relationships.

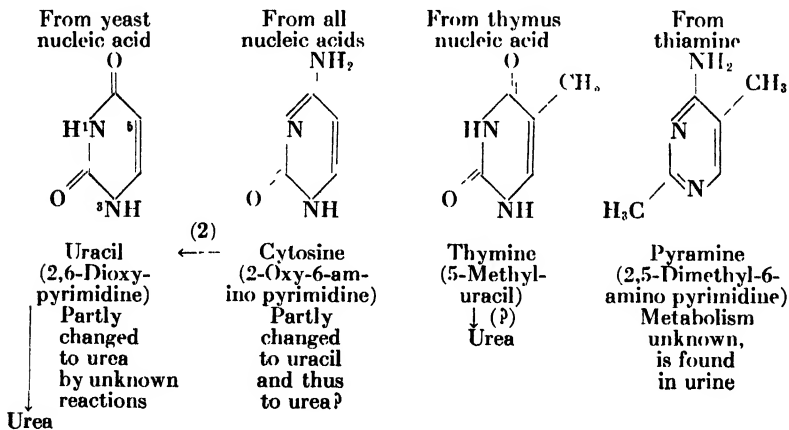

Intermediary metabolism of pyrimidine nucleotides has not been extensively investigated, but such evidence as is available suggests that combined effects of hydrolysis, deamination, and other oxidations can occur. The urinary end products of metabolism of the pyrimidine bases include urea. It increases in the urine of dogs after feeding uracil and to a lesser degree after feeding thymine. It is possible that cytosine may be deaminated to yield uracil. Cytosine fed to dogs is largely excreted unchanged but is accompanied by some uracil.

The reactions by which uracil could, theoretically, yield urea were

investigated by Cerecedo. *In vitro* oxidation by potassium permanganate takes the following course:

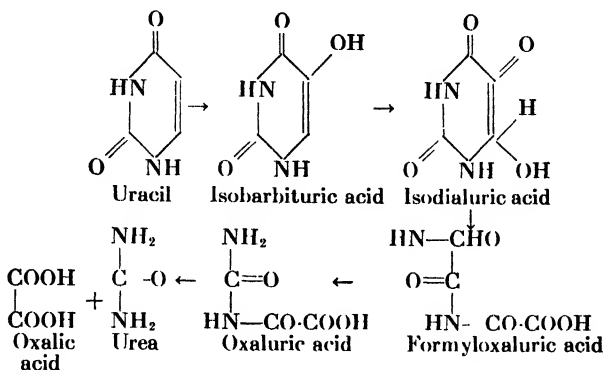

Correspondingly, isobarbituric, formyloxaluric, or oxaluric acid fed to dogs increased urea output.

When comparatively large amounts of *free* pyrimidine bases are fed, a considerable part is found in the urine unchanged. Relatively small amounts are completely metabolized. But when fed *as nucleic acid*, in amounts containing pyrimidines equivalent to that which would cause excretion of the free bases, no pyrimidine is found in the urine. Thus the oxidative metabolism appears to be completed more readily in the combined than in the free form. Complete oxidation normally occurs. This is inferred from the lack of pyrimidines in urine. Deuel could discover no trace of them in 150 liters of normal human urine.

Metabolism of the pyrimidine group of thiamine has not been investigated.

The pharmacologist is interested in compounds of the pyrimidine type because so many of the useful hypnotics are derivatives of barbituric acid, 2,4,6-trioxypyrimidine. Among the more favored ones are dial, 5,5-diallyl-; barbital, 5,5-diethyl-; luminal, 5-ethyl-5-phenyl-; and pentobarbital (nembutal), ethyl-1-methyl-butylbarbituric acid.

Autolysis. The self-digestion of tissues post mortem is called autolysis. In the broader sense it includes any chemical change, such as glycogenolysis, occurring in dead or dying cells; but unless otherwise specified, autolysis commonly refers to protein digestion. The usual method of observation is to hash the tissue and suspend it in an antiseptic aqueous medium. It is then retained at some chosen temperature and buffered pH, with or without addition of enzyme activators. Other methods employ more or less purified preparations of the cell proteases. In such experiments a protein substrate, *e.g.*, undenatured hemoglobin,

is added. In all methods, progress of the reaction may be followed by periodic measurements of the increase in free amino groups or free carboxyl groups (p. 101) or by measurement of decrease in precipitable protein.

Autolysis causes the "tenderizing" of meat held under bacteriostatic conditions. An analogous process occurs during atrophy of muscle paralyzed by severing its nerve connections or held immobile as when a limb is in a plaster cast. In such atrophy, however, as during starvation, the muscle protein establishes dynamic equilibrium with the lymph and blood, which in turn supply the protein requirements of more vital tissues. The similar use of muscle protein during spawning migration of fishes was mentioned above.

The enzymes of autolysis were at one time listed as (1) cathepsin, which is a true proteinase attacking native proteins, (2) carboxypolypeptidase (p. 264), (3) aminopolypeptidase (p. 265), and (4) dipeptidase. But this list is undergoing modification and extension. For example, Bergmann and his associates have presented evidence for the occurrence of four different cathepsins in spleen.

As implied in earlier discussions (p. 212) the cathepsins are assumed to catalyze the continuous synthesis and hydrolysis of proteins in living cells. The predominance of hydrolysis and the apparent absence of synthesis in dead cells is probably due to protoplasmic disorganization. This interferes with oxidative metabolism and disturbs the normal flow of energy. It is also notable that for hydrolysis of proteins during autolysis the optimal pH for cathepsin is about 4, although it exhibits some activity over a wide range of pH values, from about 2 to about 6. At pH 7, cathepsin is inactive in protein hydrolysis. The prevailing pH of protoplasm, so far as is known, is near 7, but localized, temporary, reversible increases in (H⁺) may well occur in the cell.

REFERENCES

- A general view of protein metabolism is presented in "The Biochemistry of the Amino Acids" by H. H. Mitchell and T S Hamilton, New York, 1929.
- Among books previously referred to, E. Baldwin's "Dynamic Aspects of Biochemistry" and E. Holmes's "The Metabolism of Living Things" are helpful.
- The reviews listed below cover most aspects of the subject.
- ALLISON, J. B., The Metabolism of Proteins and Amino Acids, *Ann. Rev. Biochem.*, 17, 275, 1948.
- BEARD, H. H., The Biochemistry of Creatine and Creatinine, *Ann. Rev. Biochem.*, 10, 245, 1941.
- BERG, C. P., The Metabolism of Proteins and Amino Acids, *Ann. Rev. Biochem.*, 13, 239, 1944
- BORBOOK, H., and DUBNOFF, J. W., The Metabolism of Proteins and Amino Acids, *Ann. Rev. Biochem.*, 12, 183, 1943.
- BRADLEY, H. C., Autolysis and Atrophy, *Physiol. Rev.*, 2, 415, 1922.
- COHEN, P. P., The Metabolism of Proteins and Amino Acids, *Ann. Rev. Biochem.*, 14, 357, 1945.
- COHN, E. J., Properties and Functions of the Plasma Proteins, *Chem. Rev.*, 28, 395, 1941.
- CUTBERTSON, D. P., The Metabolism of Proteins and Amino Acids, *Ann. Rev. Biochem.*, 16, 153, 1947.
- DU VIGNEAUD, V., Interrelationships between Choline and Other Methylated Compounds, *Biol. Symposia*, 5, 234, 1941.

- ELMAN, R., Maintenance of Nitrogen Balance by the Intravenous Administration of Plasma Proteins and Protein Hydrolysates, *Physiol. Rev.*, **24**, 372, 1944.
- HERRIOTT, R. M., Proteolytic Enzymes, *Ann. Rev. Biochem.*, **12**, 27, 1943.
- HEVEY, G., Nucleic Acid Metabolism, *Advances in Biol. Med. Phys.*, **1**, 409, 1948.
- JUKES, T. H., Choline, *Ann. Rev. Biochem.*, **16**, 193, 1947.
- LEWIS, H. B., and GARNER, R. L., The Metabolism of Proteins and Amino Acids, *Ann. Rev. Biochem.*, **9**, 277, 1940.
- MADDEN, S. C., and WHIPPLE, G. H., Plasma Proteins, Their Source, Production and Utilization. *Physiol. Rev.*, **20**, 194, 1940.
- RAPPORT, D., The Interconversion of the Major Foodstuffs, *Physiol. Rev.*, **10**, 349, 1930.
- RITTENBERG, D., and SHEMIN, D., The Metabolism of Proteins and Amino Acids, *Ann. Rev. Biochem.*, **15**, 247, 1946.
- ROSE, W. C., Amino Acid Requirements of Man, *Federation Proc.*, **8**, 546, 1949.
- ROSE, W. C., The Nutritive Significance of the Amino Acids, *Physiol. Rev.*, **18**, 109, 1938.
- SCHOENHEIMER, R., and RATNER, S., The Metabolism of Proteins and Amino Acids, *Ann. Rev. Biochem.*, **10**, 197, 1941.
- The following papers are representative of several prominent phases of research in this field:
- ABBOTT, L. D., JR., and LEWIS, H. B., Comparative Studies of the Metabolism of the Amino Acids. VIII, *J. Biol. Chem.*, **131**, 479, 1939.
- ADDIS T., LEE, D. D., LEW, W., and POO, L. J., The Protein Content of the Organs and Tissues at Different Levels of Protein Consumption, *J. Nutrition*, **19**, 199, 1940.
- CHAMBERS, W. H., CHANDLER, J. P., and BARKER, S. B., The Metabolism of Carbohydrate and Protein during Prolonged Fasting, *J. Biol. Chem.*, **131**, 95, 1939.
- CHAMBERS, W. H., and MILHORAT, A. T., Muscular Exercise and Nitrogen Metabolism of Dogs, *J. Biol. Chem.*, **77**, 603, 1928.
- CUTHBERTSON, D. P., and MUNRO, H. N., The Relationship of Carbohydrate Metabolism to Protein Metabolism. I. The Roles of Total Dietary Carbohydrate and of Surfeit Carbohydrate in Protein Metabolism, *Biochem. J.*, **33**, 128, 1939.
- DAFT, F. S., ROBSCHETT-ROBBINS, F. S., and WHIPPLE, G. H., Plasma Protein Given by Vein and Its Influence upon Body Metabolism, *J. Biol. Chem.*, **123**, 87, 1938.
- DEUEL, H. J., *et al.* A Study of the Nitrogen Minimum, *J. Biol. Chem.*, **76**, 391, 1928.
- DU VIGNEAUD, V., CHANDLER, J. P., COHN, M., and BROWN, G. B., The Transfer of the Methyl Group of Methionine to Choline and Creatine, *J. Biol. Chem.*, **134**, 787, 1940.
- DU VIGNEAUD, V., CHANDLER, J. P., MOYER, A. W., and KEPPEL, D. M., The Effect of Choline on the Ability of Homocystine to Replace Methionine in the Diet, *J. Biol. Chem.*, **131**, 57, 1939.
- GORNALL, A. G., and HUNTER, A., The Synthesis of Urea in the Liver with Special Reference to Citrulline as an Intermediary in the Ornithine Cycle, *J. Biol. Chem.*, **147**, 593, 1943.
- GREEN, D. E., NOCITO, V., and RATNER, S., *l*-Amino Acid Oxidase of Animal Tissues, *J. Biol. Chem.*, **148**, 461, 1943.
- HEGSTED, D. M., Growth in Chicks Fed Amino Acids, *J. Biol. Chem.*, **156**, 247, 1944.
- JACKSON, R. W., and BLOCK, R. J., The Metabolism of Cystine and Methionine. The Availability of Methionine in Supplementing a Diet Deficient in Cystine, *J. Biol. Chem.*, **98**, 465, 1932.
- JONES, D. B., CALDWELL, A., and HORN, M. J., Availability of DL-lanthionine for the Promotion of Growth When Added to a Cystine-deficient Diet, *Federation Proc.*, **7**, 162, 1948.
- LAN, T. H., The *d*-Amino Acid Oxidase, Uricase, and Choline Oxidase in Normal Rat Liver Cells, *J. Biol. Chem.*, **151**, 171, 1943.
- LEIFER, E., ROTH, L. J., and HEMPELMANN, L. H., Metabolism of C¹⁴-labeled Urea, *Science*, **108**, 748, 1948.
- LEWIS, H. B., The Chief Sulfur Compounds in Nutrition, *J. Nutrition*, **10**, 99, 1935.
- LU, G. D., and NEEDHAM, D. M., Adenylic Deaminase Activity in B₁-Avitaminosis and in Starvation, *Biochem. J.*, **35**, 392, 1941.
- MADDEN, S. C., FINCH, C. A., SWALBACH, W. G., and WHIPPLE, G. H., Blood Plasma Protein Production and Utilization. The Influence of Amino Acids and of Sterile Abscesses, *J. Exptl. Med.*, **71**, 283, 1940.
- McCLELLAN, W. S., and HANNON, R. R., Nitrogen-equilibrium with a Low Protein Diet, *J. Biol. Chem.*, **95**, 327, 1932.
- McNAUGHT, J. B., SCOTT, V. C., WOODS, F. M., and WHIPPLE, G. H., Blood Plasma Protein Regeneration Controlled by Diet, *J. Exptl. Med.*, **63**, 277, 1936.
- MILLER, L. L., The Metabolism of *dl*-Methionine and *l*-Cystine in Dogs on a Very Low Protein Diet, *J. Biol. Chem.*, **152**, 603, 1944.
- MOSS, A. R., and SCHOENHEIMER, R., The Conversion of Phenylalanine to Tyrosine in Normal Rats, *J. Biol. Chem.*, **135**, 415, 1940.
- NEUBERGER, A., and SANGER, F., The Metabolism of Lysine, *Biochem. J.*, **38**, 119, 1944.

- PLENTL, A. A., and SCHOENHEIMER, R., Studies in the Metabolism of Purines and Pyrimidines by Means of Isotopic Nitrogen, *J. Biol. Chem.*, 153, 203, 1944.
- RATNER, S., RITTENBERG, D., KESTON, A. S., and SCHOENHEIMER, R., The Chemical Interaction of Dietary Glycine and Body Proteins in Rats, *J. Biol. Chem.*, 134, 665, 1940.
- ROSE, W. C., HAINES, W. J., JOHNSON, J. E., and WARNER, D. T., Further Experiments on the Role of the Amino Acids in Human Nutrition, *J. Biol. Chem.*, 148, 456, 1943.
- ROSE, W. C., and RICE, E. E., The Significance of the Amino Acids in Canine Nutrition, *Science*, 90, 186, 1939.
- RITTENBERG, D., SCHOENHEIMER, R., and KESTON, A. S., Studies in Protein Metabolism. IX. The Utilization of Ammonia by Normal Rats on a Stock Diet, *J. Biol. Chem.*, 128, 603, 1939.
- SEALOCK, R. R., and GOODLAND, R. J., The Oxidation of L-Tyrosine by Guinea Pig Liver Extracts, *J. Biol. Chem.*, 178, 939, 1949.
- SCHMIDT, C. L. A., ALLEN, F. W., and TARVER, H., A Theory of Protein Metabolism: The Transformation of Proteins, *Science*, 91, 18, 1940.
- SCHOENHEIMER, R., RATNER, S., and RITTENBERG, D., The Metabolic Activity of Body Proteins Investigated with *l*(-)-leucine Containing Two Isotopes, *J. Biol. Chem.*, 130, 703, 1939.
- SHAMBAUGH, N. F., LEWIS, H. B., and TOURTELLOTTE, D., Comparative Studies of the Metabolism of the Amino Acids. IV. Phenylalanine and Tyrosine, *J. Biol. Chem.*, 92, 499, 1931.
- SHEMIN, D., The Biological Conversion of *l*-Serine to Glycine, *J. Biol. Chem.*, 162, 297, 1946.
- SHEMIN, D., and RITTENBERG, D., Some Interrelationships in General Nitrogen Metabolism, *J. Biol. Chem.*, 153, 401, 1944.
- SHOHL, A. T., BUTLER, A. M., BLACKFAN, K. D., and MACLACHLAN, E., Nitrogen Metabolism during the Oral and Parenteral Administration of the Amino Acids of Hydrolyzed Casein, *J. Pediatr.*, 15, 469, 1939.
- SONNE, J. C., BUCHANAN, J. M., and DELLUVA, A. M., Biological Precursors of Uric Acid Carbon, *J. Biol. Chem.*, 166, 395, 1946.
- TARVER, H., and SCHMIDT, C. L. A., The Conversion of Methionine to Cystine: Experiments with Radioactive Sulfur, *J. Biol. Chem.*, 130, 67, 1939.
- WAELSCH, H., and MILLER, H. K., The Relation of Keto-acid Excretion to Amino Acid Metabolism, *J. Biol. Chem.*, 145, 1, 1942.
- WAELSCH, H., SCHWERIN, P., and BENSMAN, S. P., Function of the System, Glutamic Acid-glutamine, in Brain Metabolism, *Federation Proc.*, 8, 264, 1949.
- WEINHOUSE, S., and MILLINGTON, R. H., Ketone Body Formation from Tyrosine, *J. Biol. Chem.*, 175, 995, 1948.
- WILSON, J. W., and LEDUC, E. H., Inhibition of Growth of Mice on a Low Protein, Choline Deficient Diet by Coranine, *Federation Proc.*, 8, 169, 1949.
- WOLF, P. A., and CORLEY, R. C., Significance of Amino Acids for the Maintenance of Nitrogen Balance in the Adult White Rat, *Am. J. Physiol.*, 127, 589, 1939.

CHAPTER XVII

URINE

Excretion is, in the main, elimination of the end products of metabolism, but it also involves, to a lesser degree, output of intermediary products. Consideration of these two types of excretions is helpful for an understanding of metabolism, both normal and pathological. Even food metabolites, such as amino acids and glucose, may be excreted in traces, normally, and in larger amounts under abnormal or pathological conditions.

While the main organs of excretion are the lungs which excrete gases and the kidneys which excrete water and dissolved substances, other paths of excretion are available. The sweat glands and other skin glands excrete water, small amounts of the typical urinary waste substances, sebaceous material, etc. The liver as an excretory organ (p. 270) has been considered. The intestinal mucosa is an excretory path for some substances, notably calcium. In a limited sense any externally secreting gland may be incidentally excretory. Thus saliva and tears carry NaCl. Foreign substances (drugs, inorganic salts, etc.) when in the blood above a critical concentration may appear in saliva.

Physiology of Urine Secretion. A brief summary of kidney functioning, although not a part of biochemistry, will be a useful review as a preliminary to an understanding of the variability of urine composition. Recalling the histology of the mammalian kidney, one sees that the important types of structure are the malpighian body, the tubular system (together constituting a renal unit), and the especially adapted blood supply. These are shown diagrammatically in Fig. 85.

The essential facts of urine secretion are

1. A filtrate forms from the blood in the glomerulus (a knot of capillaries) and passes through the Bowman capsule, which surrounds the glomerulus.
2. The rate of formation of the filtrate is determined by the net filtration pressure, which is the hydrostatic pressure of the blood minus its colloid osmotic pressure.
3. The glomerular filtrate contains all the noncolloidal, diffusible, plasma constituents.
4. The filtrate passing through the complex tubular system is sub-

jected to a process of resorption by which useful blood constituents (salts, glucose, amino acids, etc.) are returned to the blood in the intricate capillary network which surrounds the tubules. The resorption of salts and water is so adjusted as to aid in the regulation of the pH and the osmotic pressure of the blood.

5. In parts of the tubular system, certain waste products are apparently secreted by cells of the tubule wall.

6. The fluid finally emerging from the convoluted tubular system into the collecting tubule is urine.

7. It is carried to the pelvis of the kidney, passes via the ureter to the bladder, and is voided through the urethra.

Volume of Urine. The rate of urine secretion is so variable that it is usually more informative to measure the total 24-hr. output than that of shorter periods. The average volume for an adult is sometimes said to be 1,500 ml. per day, but experience of most American observers would indicate that 1,250 ml. is perhaps a better average.

Under normal conditions the volume is determined primarily by the amount of fluid ingestion. It is well to note that the water intake in seemingly solid foods constitutes a large proportion of the total water ingestion. The response of the kidney in secreting more urine after water drinking may be noticed within 5 to 10 min., provided the stomach is in a condition for rapid emptying. But the activity of the sweat glands

is also a determining factor. The volume of urine may be greatly reduced by profuse sweating.

Any condition affecting blood pressure in the renal arterioles can alter the rate of urine secretion. On this account reflex effects, operating through vasoconstrictor nerves, are prominent. Some diuretics (excit-

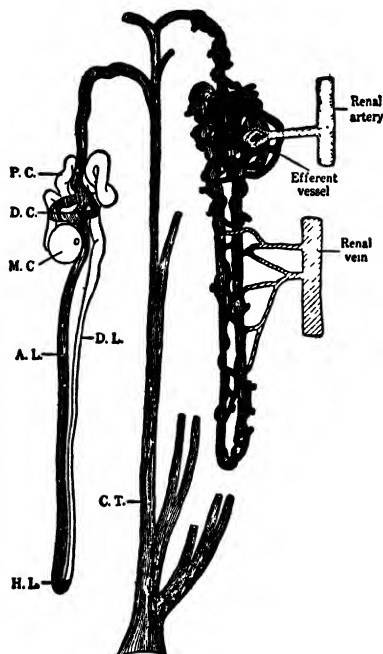

FIG. 85. Two secretory units of the kidney. The one on the right shows the rich capillary blood supply. The other is represented without blood vessels to permit labeling of its functional parts. *M.C.*, Malpighian corpuscle; *P.C.*, proximal convoluted tubule; *D.L.*, descending limb of Henle's loop; *H.L.*, Henle's loop; *A.L.*, ascending limb of Henle's loop; *D.C.*, distal convoluted tubule; *C.T.*, collecting tubule. (A. R. Cushney, "The Secretion of Urine," Longmans, Green and Company.)

ants of urine secretion) may act, in part at least, by an effect on the blood flow through the glomerulus.

An abnormally large volume of urine (polyuria) is characteristic of untreated diabetes and of the rare disease diabetes insipidus, an endocrine disturbance which will be described in Chap. XX. In both cases intense thirst is characteristic of the condition. An abnormally small volume of urine (oliguria) results from diarrhea, fevers, and other diseases, especially those affecting the kidney function.

The kidney is the most important of the organs which regulate the water balance of the body. Although a plus balance (retention of water) or a negative one (loss of water) may occur temporarily, a steady state is regularly and normally maintained.

Specific Gravity. The urine specific gravity may be as low as 1.003 or as high as 1.045; but the majority of human urines are between 1.016 and 1.024, tending to vary inversely with the volume. A high specific gravity with large volume is found in untreated diabetes because the sugar content is sufficient to raise the specific gravity. Normal urines may be high in specific gravity because of high NaCl content during liberal use of salt or because of high urea content resulting from a high-protein diet.

Corresponding to specific gravity the osmotic pressure of the urine is also variable. Measured by the cryoscopic method (freezing-point determination) the Δ value, which is the lowering of the freezing point as compared with that of pure water, usually varies between 1.3 and 2.3°C. It is subject to rapid and wide fluctuations, thus reflecting the indispensable role of the kidneys in compensatory regulation of the osmotic pressure of body fluids.

Color. Urines vary from a pale straw color to a deep brownish or reddish yellow. The color intensity tends to vary inversely with the volume. The correspondence is due to the daily excretion of a fairly constant quantity of waste pigments formed in normal metabolism so that the urinary concentration of pigment depends upon the volume of water excreted.

The chief pigment of normal urine is the yellow one called **urochrome**. It is a compound of a polypeptide with **urobilin**. The latter occurs free in the intestinal contents and in feces. It is formed from bile pigment by reduction due to intestinal bacteria. It is the chief coloring matter of feces. It was long known as **stercobilin** (*stercus*, feces) but is now generally regarded as identical with urobilin. There is very little if any free urobilin in fresh urine, but a colorless reduction product called **urobilinogen** probably absorbed from the intestine is present and yields urobilin upon oxidation due to exposure to air. Urobilin is

brown and, correspondingly, urine takes on a darker color during storage at room temperature and especially so upon heating, which may liberate urobilin from urochrome. Urochrome also occurs in urine as a colorless reduction product, urochromogen.

The relation of these pigments and chromogens to each other is shown schematically.

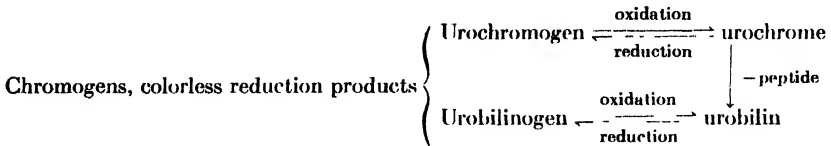

The total excretion of urobilin (free, in urochrome, and in the chromogens) in feces and urine is taken as an index of the extent of catabolism of hemoglobin. This assumes that urobilin is the chief product of the breakdown of heme.

Representative values to indicate the amount excreted by human adults are

	Mg. per Day
Urobilin (stercobilin) in feces	100-200 (includes some urobilinogen)
Urochrome in urine	75 (approximate value)
Urobilinogen in urine	2-3
Urobilin in urine	Trace, if any

The total urochrome excreted per day is reported to vary directly with the rate of basal metabolism so that there is an increase during fever.

Pigments abnormally found in urine include the bile pigments and hemoglobin or its colored derivatives. Occasionally certain drugs and food substances may cause abnormal color of the urine. Black urines due to alcaptonuria or to melanin excretion were explained in connection with tyrosine metabolism.

Relative Transparency. Freshly voided, normal urine is usually clear but tends to become cloudy on standing. A "mucous cloud" always settles out in time. It is due to mucus secreted from the urinary passages and contains some epithelial cells and leucocytes. Other normal sediments are urates, which form in a relatively acid urine, and alkaline phosphates of calcium and magnesium, which separate from alkaline urines and may be present in amount sufficient to make the urine cloudy even when voided. Loss of CO₂ to the air tends to make urine alkaline with consequent precipitation of phosphates on standing.

Abnormal and pathological urine sediments (p. 539) arise from varied causes. *

Reaction. Normal urine is usually slightly acid, pH 6 ± 0.5 . Acidity is due largely to acid phosphates but partly to organic acids. More strongly acid urines result from a protein-rich diet which increases the output of $\equiv\text{PO}_4$ and $=\text{SO}_4$ groups. These, combining with excreted bases (Na, K, Ca, Mg, etc.), tend to acidify the urine. Ketonuria causes acidity during acidosis. The high rate of oxidation during fevers has the same effect.

Alkalinity of urine may have no pathological significance, resulting from abundant intake of bases. Ingestion of 0.5 g. of NaHCO_3 per kg. of body weight produces urine alkalinity in normal individuals. Fruits, even highly acid ones such as lemons, can make urine alkaline because the acids are completely oxidized, the resulting CO_2 is eliminated by the lungs, and the bases, originally present as citrates, malates, etc., are excreted in urine. A temporary alkalinity, known as "the alkaline tide," frequently follows a full meal while the kidneys are compensating for the secretion of HCl in gastric juice. Pathologically, any alkalosis (p. 347) is accompanied by alkalinity of the urine.

Determination of the urine pH (preferably with the glass electrode) may afford information useful in confirmation of other diagnostic tests. But the potentially acid substances of urine are largely undissociated so that titration with 0.1N NaOH and phenolphthalein as indicator (measuring the total urinary acid) may also be useful. The urine reflects the functioning of the kidneys for preservation of the acid-base balance of the body.

Odor. Urine has a characteristic odor which is different for different species. Its cause is not definitely attributable to any specific substance in normal human urine. Urine of cystitis has a strongly ammoniacal odor as do normal urines after standing at room temperature without antiseptic. Ammonia is liberated from urea by many forms of bacteria. A number of drugs cause more or less specific urinary odors. The peculiar and offensive odor after the eating of asparagus is said to be due to methyl mercaptan, $\text{CH}_3\text{-SH}$.

Composition of Normal Human Urine. Data showing representative results for solutes which have been extensively studied in human urine are presented in Table 63.

The compounds tabulated would ordinarily constitute about 90 per cent of urinary solutes. Of the remainder a considerable part consists of substances represented by undetermined nitrogen. Measurement of amino groups by formol titration (p. 102) shows that amino nitrogen is more than 2 per cent of the total nitrogen of normal urine. Some of the amino nitrogen, possibly one-fourth, is in free amino acids, but the major part is in the many urinary compounds which represent more

TABLE 63. —COMPOSITION OF REPRESENTATIVE HUMAN URINE
 Volume for 24 hr. 1,250 ml.
 Specific gravity 1.018

Constituents	Weight	Relative nitrogen content
	g.	% of total N
Water	1214.0	
Total solids ¹	58.5	
Total nitrogen.	15.5	100
Nitrogen-containing constituents:		
Urea	28.5	85.8
Creatinine.	1.7	4.2
Ammonia as NH ₃	0.7	3.7
Uric acid.	0.65	1.4
Hippuric acid.	0.60	0.3
Allantoin.	0.01	
Indican, indoxyl potassium sulfate.	0.01	
Undetermined nitrogen in various forms		4.6
Other organic constituents:		
Carbohydrates ² and related compounds.	0.90	
Phenolic compounds, <i>e.g.</i> , <i>p</i> -hydroxyphenylacetate.	0.25	
Oxalates, as oxalic acid.	0.015	
Lactates, as lactic acid.	0.01	
Ketone substances, acetone, etc.	0.01	
Glucuronates.	0.04	
Inorganic constituents:		
Chlorides as NaCl.	12.0	
Phosphates as P ₂ O ₅	2.3	
Sulfates as SO ₃	1.8	
Potassium.	2.0	
Calcium as CaO.	0.2	
Magnesium as MgO.	0.2	
Iron.	0.005	

¹ Computed by Long's formula: Solids = 2,600 (sp. grav. - 1) × volume/1000.

² Computed as the equivalent of glucose in reducing power.

complex intermediary products of metabolism. Undetermined nitrogen also includes the traces of purine bases derived from nucleic acid and the slightly larger amounts of methylated purines, such as epiguanine, paraxanthine, heteroxanthine, and 1-methylxanthine, resulting from ingestion of tea, coffee, and some other vegetable substances.

Other unlisted substances are the urine pigments, minute amounts of vitamins, certain hormones and intermediary products of hormone metabolism, enzymes in traces, and other proteins, such as mucoids.

The sulfates and phosphates are not entirely in the form of inorganic salts but are partly in organic combinations such as ethereal sulfates and glycerol phosphate.

A list of all the substances which have been detected in urine would be a very long one, especially if urines of experimental animals and pathological urines were included. The incomplete list given here serves to indicate what constituents are frequently determined in urine analysis for the study of problems of metabolism.

The quantitative results in Table 63 are only representative. Actual results vary over a considerable range because of the effects of diet and state of health upon metabolism. Such variations will be considered in the discussions of specific urinary constituents.

Urea. The structural formula of urea usually shows it as the diamide of carbonic acid, but other tautomeric forms occur.

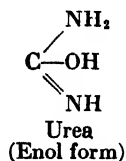
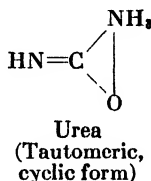
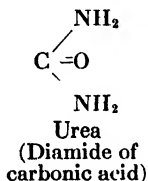
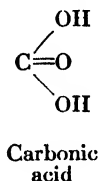

It can unite with acids to make urea salts such as the nitrate, $\text{CO}(\text{NH}_2)_2\text{HNO}_3$, which readily crystallizes in characteristic rhombic and hexagonal plates.

Urea is prepared from urine after removal of the precipitate formed by adding a mixture of $\text{Ba}(\text{OH})_2$ and $\text{Ba}(\text{NO}_3)_2$. The filtrate is evaporated to a sirup and extracted with warm 95 per cent ethanol. This extract, filtered, contains urea and pigments. The latter are adsorbed on charcoal, and after another filtration, urea is allowed to crystallize at refrigerator temperature. The crystals are long, four- or six-sided prisms.

Urea is soluble in water and ethanol but not in ether or chloroform. Heated, dry, it decomposes to form cyanuric acid, biuret, and ammonia.

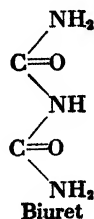
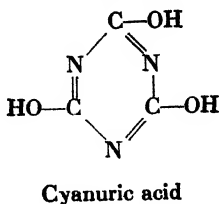

The violet color of biuret with CuSO_4 and KOH was described in connection with the protein color tests. Urea reacts with sodium hypobromite to give off free nitrogen. This reaction is the basis of an older but inaccurate method for determination of urea by measurement of the volume of N_2 liberated.

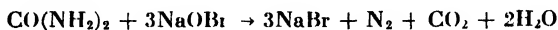

Urea is rapidly and completely decomposed to NH_3 and CO_2 by enzymatic action of urease, which occurs in many bacteria and plant structures. The most active plant extracts are made from the jack bean. Soybeans are a good source. Most of the current methods for urea determination employ urease with subsequent measurement of the NH_3 liberated. A number of color reactions for urea have been described. But in each of them the color developed varies with reaction conditions and with time so that little use has been made of these reactions for colorimetric measurements of urea.

The origin of urea (p. 490) in metabolism indicates clearly that the amount excreted tends to vary directly with the protein ingested. The amount excreted thus varies over a wide range. Not only the absolute amount (5 to 60 g. per day with occasional values outside of this range) but the relative amount is variable. Thus on a protein-poor or protein-free diet urea nitrogen may be less than 60 per cent of the total nitrogen, but on a high protein diet it often amounts to 96 per cent or more of the total nitrogen. When forced to economize on protein, the body converts relatively little of it to urea. During *luxus* protein intake much of the excess is excreted as urea.

Abnormal deficiency in the output of urea causes a heightened urea level in the blood (uremia) characteristic of several forms of kidney disease.

Ammonia. Inasmuch as ammonia, arising in the body from deamination, tends to be converted into urea, any increase in urinary ammonia is at the expense of urea. Failure of the ammonia to be converted into urea is due chiefly to combination with organic acids other than H_2CO_3 but to some extent to combination with mineral acids. Ammonia acts as an aid in maintenance of acid-base equilibrium of the body. Thus any tendency toward a lowered alkali reserve of the blood shows a corresponding rise in urinary NH_3 . In acidosis, relatively high values (up to 5 g. per day) are found. It is important to distinguish between excreted NH_3 and that produced in urine by bacterial action. Measurements should be made on freshly voided or suitably preserved urines.

Determinations are made by adding a fixed base, K_2CO_3 , in amount sufficient to liberate NH_3 from all ammonium compounds. This is

done in a closed container through which a strong current of NH_3 -free air is passed and delivered to a receiver containing a measured excess of standard acid. "Back titration" of the excess of acid permits computation of NH_3 . The same procedure is used to measure ammonia derived from urea by use of urease. Urea is computed from the NH_3 in excess of that preformed in the urine.

Creatinine and Creatine. The similarity in molecular constitution of these compounds (p. 505) and their close relation in metabolism were discussed in Chap. XVI.

Creatinine is prepared from undecomposed urine as its ZnCl_2 salt. To precipitate creatinine, 18 g. of picric acid in 45 ml. of boiling ethanol are added per liter of urine. After standing some 10 or more hours the supernatant liquid is siphoned off and the precipitate is brought nearly to dryness on a suction filter. After being washed with a cold, saturated, aqueous solution of picric acid, the nearly dry precipitate is ground with about 60 per cent of its weight of concentrated HCl . The precipitate is removed, and the filtrate is treated with solid magnesium oxide until neutralized. It is again filtered and the filtrate strongly acidified with acetic acid and diluted with four volumes of 95 per cent ethanol. After another filtration, a 30 per cent solution of ZnCl_2 is added, and crystallization is awaited at refrigeration temperature. Creatinine zinc chloride forms tufts of fine needle crystals. Decolorized in aqueous solution with charcoal and recrystallized, it may be treated with an excess of NH_3 under pressure to release pure creatinine. It crystallizes in monoclinic prisms, is soluble in water and warm ethanol, forms salts with strong mineral acids, and shows a slight reducing power that is sufficient in concentrated urines to simulate a positive glucose test by copper reduction. It does not respond to Nylander's test (bismuth reduction), which is therefore used to distinguish between reduction due to high creatinine concentration in urine and reduction due to low but significant glucose concentration.

Creatinine forms a red compound with picric acid in alkaline solution (Jaffe's test). As the intensity of the color is proportional to the creatinine concentration, this reaction is used for quantitative determination (Folin's method) of creatinine in urine, blood, and tissue extracts. It is also used for creatine determination after the latter has been converted by the action of HCl (p. 505) to creatinine.

Another color reaction (Weyl's test) is obtained when urine or creatinine solutions are treated with sodium nitroprusside and NaOH . The ruby-red color first formed soon changes to yellow. Further treatment with acetic acid and heat changes the yellow to green (Salkowski's test) and finally to blue. Prussian blue may be precipitated.

The creatinine in a 24-hr. urine shows less variation than do other urinary constituents. The relative constancy was discussed (p. 506) in connection with its specialized origin from creatine of tissues. So nearly constant is the output, except as affected by creatinine of the food, that a given individual is characterized by what is called the creatinine coefficient, milligrams of creatinine per unit of time per kilogram of body weight. On a creatinine-free diet it may remain almost constant over long periods. Much investigation has been directed to the problem of what determines this coefficient, but the matter is still problematical. The coefficient is independent of the level of protein feeding. While related roughly to the size of the muscle mass, it has not been shown unequivocally to vary with muscular strength or activity nor with athletic training. Some experiments suggest that it varies with what is called "muscle tonus."

Pathologically it rises in a number of diseases (typhoid and typhus fevers, pneumonia, and tetanus) and usually falls in anemia, paralysis, muscular atrophy, serious kidney degeneration, and leucemia.

Creatine, absent or present in mere traces in normal urine of adults, occurs in creatinuria as explained in Chap. XVI. It is well to reemphasize the relationship between creatine excretion and disturbed carbohydrate metabolism. Evidently carbohydrate oxidation must furnish energy in intensity sufficient to ensure ample phosphate donors for synthesis of phosphocreatine if creatine is to be retained normally in the cells.

Uric Acid. The origin and significance of uric acid was discussed in connection with nucleic acid metabolism.

Uric acid is easily separated by acidifying with HCl, which causes formation of crystals of uric acid colored reddish brown by urine pigments. It is purified by dissolving in concentrated H_2SO_4 which does not decompose it at room temperature. It is reprecipitated by diluting with water or ethanol. Crystals obtained from urine are in a number of more or less characteristic shapes, but pure uric acid crystals are transparent, colorless, rhombic plates.

It is insoluble in ethanol and ether, difficultly soluble in hot water, and practically insoluble in cold water. It forms soluble salts in alkaline solutions, but in strongly alkaline solution it disintegrates by autoxidation. From its mildly alkaline solution it is readily precipitated by acidification. The soluble salts are the mono- and dibasic sodium or potassium urates. With ammonia it forms difficultly soluble salts. Salt formation (no carboxyl group being present) is explained on the basis of enolization, changing the lactam (keto) to a lactim (enol) form.

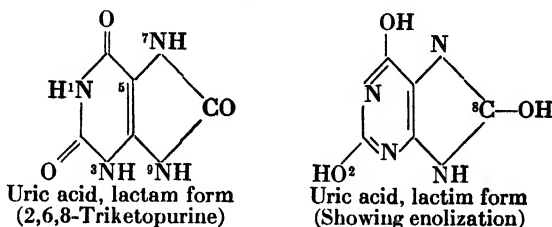

Enolization at positions 2 and 8 appears to account for the formation of mono- (acid) and di- (neutral) urates. Dissociation constants are indicated for these groups by the pK_a values (log of reciprocal of dissociation constants), which are approximately 5.7 and 9.8. In most urines (pH 6 ± 0.5) acid urates with traces of free uric acid are thus to be expected. This accounts for failure of uric acid to crystallize from normal urines. While the acid urates are not very soluble, acid sodium urate is more than 20 times as soluble in water at body temperature as uric acid (0.0065 per cent). Acid urates do separate from urines more acid than normal, and uric acid itself may crystallize from highly acid urines.

The blood pH is sufficiently high to hold uric acid (about 3 mg. per cent) in solution with little of it in the free form and most of it as acid urates. The failure of the body fluids to retain uric acid in solution under gouty conditions has not been fully explained. It is due in part, at least, to increased uric acid concentration. It has been reported as high as 15 mg. per cent in the blood. Before an attack of gout the urine contains relatively small amounts of uric acid. Later, during the acute crisis and during recovery, the uric acid output increases sometimes to twice that of normal urine and the blood uric acid subsides to the normal level. Apparently, the gouty kidney holds back uric acid up to a critical stage where it can hold no more and then releases it in large amount.

Uric acid gives several color reactions. In the murexide test, it is treated with enough concentrated HNO_3 to moisten it, dried without excessive heat, and, after cooling, is treated with dilute NH_4OH . The reddish-purple color of murexide is obtained.

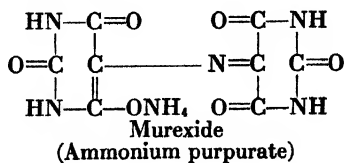

A blue color is given with sodium phosphotungstate in alkaline solution (Folin reaction) and also with sodium arsenophosphotungstate,

using NaCN as alkaline buffer (Benedict), the latter reaction being more nearly specific for uric acid. This reaction is the basis of the quantitative determination of uric acid by colorimetric measurement.

Uric acid in sufficient concentration shows reduction of copper or silver in alkaline solutions but, like creatinine, gives no reduction of bismuth in Nylander's test.

Glucuronates. Glucuronic acid, $\text{CHO}\cdot(\text{CHOH})_4\cdot\text{COOH}$, has not been found free or as salts with inorganic bases in urine. It occurs as organic combinations called the conjugate glucuronates. Their origin was explained in connection with detoxication. Among the substances with which it conjugates are phenol, benzoic acid, indole, and skatole, which are derived from intestinal putrefaction. Drugs and other foreign substances are also conjugated. Borneol, bromophenol, camphor, chloral hydrate, menthol, morphine, phenolphthalein, and turpentine increase the urinary output of glucuronates. Female sex hormones are excreted in part as glucuronates. The nature of the structure of the glucuronates is indicated by a type formula

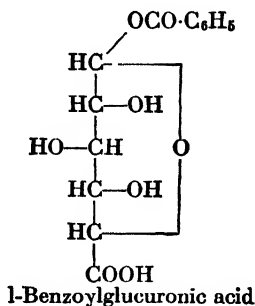

Free glucuronic acid is dextrorotatory, $(\alpha)_D = +36$; but a number of its conjugates are levorotatory. This property is utilized in detection of glucuronates in urine. Glucuronates reduce alkaline copper solution. When present in urine in concentration above normal, they may thus give a "false positive" sugar test. But they are not fermentable, so that after the urine has been fermented by yeast to remove sugar, a levorotation of the clarified urine gives evidence of the presence of glucuronates.

Borneol, $\text{C}_{10}\text{H}_{17}\text{OH}$, occurring in certain essential oils, *e.g.*, rosemary, or prepared by reduction of camphor, is used to demonstrate glucuronate excretion. After borneol is fed to an experimental animal, the urinary glucuronate may be isolated as its zinc compound from which, after removal of zinc by H_2S , pure glucuronic acid is liberated by hydrolysis

in boiling dilute H_2SO_4 . In pure form it is a sirup. It loses H_2O in glacial acetic acid to form its lactone (p. 17), which crystallizes in needles, has a sweet taste, is dextrorotatory, and reduces copper nearly as strongly as does glucose.

The intermediary reactions leading to its formation in bio-oxidation have not been explained. In normal human urine it rarely amounts to more than 50 mg. per day and is generally less.

Sulfur-containing Compounds. Three classes of sulfur compounds occur in urine: inorganic sulfates, ethereal sulfates, and "neutral sulfur" compounds. Inorganic sulfates compose the major part and arise from the neutralization of H_2SO_4 , formed chiefly by oxidation of cystine and methionine. The necessary bases, chiefly Na, K, and Ca, are provided by the alkali reserve of body fluids. The sulfates vary directly with the sulfur content of the food proteins. Thus there is a relation between sulfates and the total nitrogen of the urine, but the ratio N:S in urine is not constant because the sulfur content of the diet varies with the nature of its proteins.

The origin of the ethereal sulfates was explained (p. 286) as part of the mechanism of detoxication. The formation of indican serves as an example.

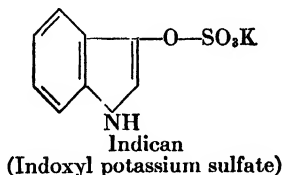

Its amount in urine is used as a rough index of the relative intensity of intestinal putrefaction. One of the convenient tests is Obermayer's. Urine is treated with an equal volume of the mild oxidizing reagent (concentrated HCl containing 0.3 per cent FeCl_3) and is then shaken with a small volume of chloroform. Oxidation converts indican to indigo blue.

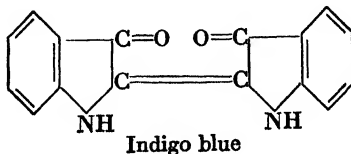

The indigo, easily soluble in chloroform, colors it blue with intensity proportional to the indican concentration. Other similar tests (Jaffe's test and Jolle's test) are used.

The total amount of ethereal sulfates, including indican, is determined, after hydrolysis with boiling dilute HCl, by precipitation with BaCl₂. The resulting BaSO₄ minus that due to inorganic sulfates (determined before hydrolysis by precipitation with BaCl₂) gives the result. Ethereal sulfates (p. 286) were listed as detoxication products.

Abnormally high excretion of ethereal sulfates (indicanuria) occurs during various digestive disturbances (intestinal obstruction, certain forms of constipation, deficient secretion of HCl in gastric juice, etc.) resulting in excessive putrefaction in the intestine.

"Neutral sulfur" is contained in various incompletely oxidized metabolic products, cystine, cysteine and the related mercapturic acid (p. 501), taurine, mercaptan, organic sulfides, etc. The amount in urine is measured in the dried solids by ashing, oxidizing (*e.g.*, with sodium peroxide) to sulfate, and determination of the latter as precipitated BaSO₄. This represents the total sulfur of the urine. From this value "neutral sulfur" is computed after subtraction of the separately determined sulfur of inorganic and ethereal sulfates. The daily excretion of "neutral sulfur" in man is relatively constant, suggesting that it represents some steady state of metabolism.

Some values given by Cole (Table 64) will serve to indicate ranges of values for urinary sulfur compounds.

TABLE 64.—SULFUR OF HUMAN URINE

Type of sulfur compounds	Average diet		Higher protein diet		Protein-poor diet	
	Amount as SO ₃	Relation to total S	Amount as SO ₃	Relation to total S	Amount as SO ₃	Relation to total S
	g.	per cent	g.	per cent	g.	per cent
Inorganic.....	2.92	88.2	3.27	90.0	0.46	60.5
Ethereal.....	0.22	6.6	0.19	5.2	0.10	13.2
"Neutral".....	0.17	5.2	0.18	4.8	0.20	26.3
Total.....	3.31	100.0	3.64	100.0	0.76	100.0

Phosphates. Urinary phosphates are almost entirely inorganic with only traces of phosphate esters. The chief sources are (1) oxidation of the phosphoproteins (casein of milk and vitellin of egg yolk) and (2) hydrolytic liberation of phosphates from nucleoproteins and nucleotides. Another source is calcium phosphate of milk and other dairy products. Thus phosphate excretion tends to reflect the intake of milk and other foods of animal origin. Some phosphate (1 to 2 g. per day) is excreted during fasting or the use of a protein-free diet. It represents, in part, the

catabolism of phospholipids and of nucleic acids and nucleotides of the cells. There is also some loss of inorganic phosphates of the fluids and tissues.

Urine phosphates may be separated into two portions, alkali-earth phosphates (Ca and Mg) and the alkaline phosphates (Na and K). Separation is effected by adding NH_4OH , which precipitates the alkali-earth phosphates. The filtrate, treated with magnesia mixture, forms a precipitate of the other phosphates.

Phosphates may form either amorphous precipitates or crystalline deposits in urine. They are due to alkalinity. Urines high in ammonia have characteristic crystals of ammonium magnesium phosphate, also called "triple phosphate." Calcium phosphate crystals form less frequently.

Quantitative determination may be made by a colorimetric method (Youngburg) in which the diluted urine is treated with a solution of sodium molybdate containing H_2SO_4 to form phosphomolybdic acid which is then reduced by addition of stannous chloride. The intensity of the resulting blue color is proportional to the total inorganic phosphate. Other methods, *e.g.*, titration with uranium acetate, are also used.

The amount of phosphate excretion is not closely related to other urinary constituents although it tends to rise and fall with uric acid since both are derived from nuclear catabolism.

The urinary phosphates have little significance in pathology although they increase in certain bone diseases (osteomalacia) and in rickets.

Chlorides. Excretion of chlorides is very nearly proportional to the NaCl ingested. Conservation of the chlorides of the body fluids is demonstrated by the rapid decrease in excretion during use of a salt-free diet. In two days the 24-hr. output of chlorides may fall from 10 g. (computed as NaCl) to a small fraction of a gram. This again emphasizes the role of the kidneys in maintaining the steady state of the osmotic pressure of the blood.

Quantitative determination is usually made by addition of a measured excess of standard AgNO_3 solution, removal of the resulting precipitate of AgCl , and "back titrating" the excess of silver with standard ammonium thiocyanate, using a ferric salt as indicator.

Chloride excretion may be decreased in certain stages of pneumonia and in some other acute infectious diseases. It may also decrease in nephritis associated with edema.

Abnormal and Pathological Constituents. It is not always easy to distinguish between normal and abnormal urinary compounds. A number of substances which are commonly found in urine in very small amounts may increase significantly under conditions which are usually

but not always pathological. Examples are sugar, amino acids, and ketone substances. Even proteins of certain types are found in normal urine although the kinds which have pathological significance are not commonly detected. Quantitative determination of urinary compounds is more valuable than qualitative tests. It happens, however, that some compounds occur in normal urines in concentrations too low to respond positively to the ordinary qualitative tests. The sugar, for example, does not give Benedict's test, and ketone substances rarely show a positive test unless concentrated by distillation.

An abnormal increase in concentration of a urinary constituent may sometimes be the result of a lowered kidney threshold. Excretory products may be roughly classified as nonthreshold and threshold. Creatinine and urea are examples of nonthreshold substances inasmuch as they are effectively excreted by the healthy kidney irrespective of their concentration in the blood. Glucose, on the other hand, is a typical threshold substance (p. 428) although the critical blood level at which the kidney excretes it is variable even in apparently healthy subjects.

Melliturias. There is apparently no type of sugar which under one circumstance or another may not appear in urine. The so-called "alimentary glycosurias," which follow the ingestion of a massive dose of some one kind of sugar, have been observed with disaccharides, hexoses, and pentoses. Mellituria (*mel*, honey) is a general term for the presence of any sugar in urine.

Glucosuria, also known as **glycosuria**, is usually defined as the presence in urine of glucose in amount which affords reducing power in excess of that given by 0.1 per cent of glucose. While, as explained above, a lower concentration of sugar is detectable in normal human urine and the evidence that some of it is glucose seems unequivocal, the extent to which glucose is a regular component of these normally excreted sugars is not determined.

Methods for qualitative detection (p. 14) and quantitative measurement (p. 425) have been outlined. Titration with the Benedict quantitative copper solution is widely used, and the Somogyi-Shaffer-Hartman method is also favored in many laboratories. In the latter method, reducing substances are given opportunity to reduce copper in boiling alkaline solution. Sulfuric acid is added. This causes iodate, present in the reagent, to react with iodide, liberating free iodine. The latter oxidizes the reduced copper, Cu_2O . The remaining free iodine is determined by the familiar and sensitive titration with sodium thiosulfate, using starch for detection of the end point. A blank is also run. The difference between the two titrations permits calculation of the glucose equivalent.

The amount of copper reduced under standard, controlled conditions varies with different sugars. It is much higher for glucose, for example, than for lactose. On this account the kind of sugar must be known and standard values (Munson-Walker) must be consulted in order to compute results. The Munson-Walker values do not apply to the Somogyi-Shaffer-Hartman method.

The amount of glucose excreted in untreated diabetes rises with the progress of the disease. In mild or early cases glucose may be less than 0.5 per cent of the urine or some 10 to 15 g. per day. At more severe stages excretion of 100 g. per day is not uncommon, and even larger amounts have been observed. This represents intense gluconeogenesis.

The so-called **renal glucosuria**, due to a lowered kidney threshold, occurs rather rarely (about one in 500 glucosurias). It is sometimes a benign inborn characteristic but is more frequently due to pregnancy or to some form of kidney disease. It is recognized by determination of the blood-sugar level; the blood is not hyperglycemic. The glucose tolerance is also normal.

Emotional glucosuria (p. 128) has little clinical significance as it rarely accompanies mental disease. Its significance in the study of nervous and hormonal (adrenine) effects upon carbohydrate metabolism has been important.

Fructosuria sometimes accompanies glucosuria in diabetes and may be sufficient to make the urine levorotatory. There is also a benign, inborn error of fructose metabolism in which the kidney threshold for fructose is so low that this sugar appears in the urine.

Lactosuria frequently occurs in late stages of pregnancy or when milk is not withdrawn from the active mammary gland, as during weaning. This condition is not pathological and is distinguished from glycosuria by use of the mucic acid test (p. 17) and by failure to give the Nylander-Almen test (p. 14).

Pentosuria of the alimentary type follows eating of large amounts of pentose-rich fruits, such as cherries, grapes, plums, or prunes. It is temporary and has no diagnostic significance. L-Arabinose has been detected in such urines.

A benign, inborn error of carbohydrate metabolism causes a different kind of pentosuria. It constitutes about one in 1,000 cases of the meliturias. It has been studied in the hope of finding its relation to normal carbohydrate metabolism. The pentose is L-xyloketose. Its excretion is increased (Enklewitz and Lasker) by feeding glucuronic acid to the pentosuric or by feeding drugs which induce the production of glucuronic acid. It has therefore been suggested that the pentose arises through a form of oxidation involving decarboxylation of glucuronic acid to produce

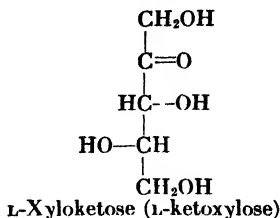

Ketonuria. The ketone substances excreted (p. 462) in ketonuria (acetonuria) were discussed in connection with metabolism of fatty acids and amino acids. All three ketone substances have essentially the same significance because of the relationship

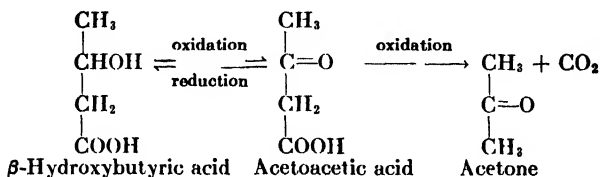

Acetoacetic acid is oxidized to acetone when the urine is boiled, thus collecting in the distillate both preformed acetone and that representing the acetoacetic acid. Several qualitative tests for acetone are in use. One of the best is the formation of iodoform (assuming ethanol to be absent) when the distillate is treated with NaOH and I—KI (Lugol) solution. The odor and the characteristic crystals of iodoform may be detected. Acetone also gives a red color (Legal's test) with sodium nitroprusside and NaOH. Unlike the similar test (Weyl's) for creatinine, the color is not changed by addition of acetic acid.

Acetoacetic acid may be detected in fresh urines by the production of a red color (Gerhardt's test) on addition of FeCl₃. As this reaction is not specific it is advisable to make a control test after boiling to convert acetoacetic acid to acetone which does not respond in this test. A negative result should now be obtained if interfering substances are absent.

β-Hydroxybutyric acid can be detected only after certain preliminary procedures which prepare the urine for extraction of this acid by means of its comparatively good solubility in ether. Evaporating ether from the extract and dissolving the precipitate in water prepares it for a color reaction (Black's test) which slowly develops a deep pink after the addition of FeCl₃ containing a little FeCl₂.

Quantitative determination is usually made by the Van Slyke method which, in principle, is the oxidative conversion of the two acids to acetone followed by precipitation of the latter as its basic mercury sulfate compound which is determined either gravimetrically or by titration. The

result is a measure of the total acetone substances. In order to determine β -hydroxybutyric acid, the urine is first boiled to remove acetone and acetoacetic acid and then, after oxidation, is treated as above.

The small amount of ketone substances (some 3 to 15 mg. per day) in normal urines can be increased under abnormal conditions so as to reflect ketonemia from any cause. Thus moderate increases accompany fasting, use of a carbohydrate-free diet, etc. Most forms of acidosis are accompanied by ketonuria. It might be defined as the excretion of more than 20 mg. of total ketone substances per day. In severe, untreated diabetes at the acidosis stage, excretion of 6 g. per day is not uncommon. Much larger amounts are on record. A high excretion of β -hydroxybutyric acid is an index of the relative severity of acidosis.

Proteinurias. The presence in urine of protein in excess of the normal "trace" constitutes proteinuria. As different kinds of protein appear, we have albuminuria, hemoglobinuria, etc. The pathological conditions causing proteinurias are numerous and varied but in most cases involve damage to the kidney. It normally prevents protein from passing into urine; the pathological kidney may excrete protein. When proteins in the blood are of such a character as to pass through the seemingly undamaged kidney, the proteinuria is said to be the *prerenal* type; if they pass because of obvious kidney damage, it is the *renal* type; but if due to protein additions in the urinary passages, it is *postrenal*. The postrenal is characterized by the presence of blood, pus, or vaginal secretions.

Albuminuria, a common form of proteinuria, is the excretion of serum proteins. Both albumins and globulins are commonly found in the urine but albumin more abundantly. Rarely, globulin predominates.

The common protein precipitation tests (p. 127) are used for detection. It is advisable to use more than one test to avoid a "false positive" result. A number of quantitative methods are in use. A simple and convenient one (Esbach) is treatment of urine in a suitably graduated test tube with a mixture of picric and citric acids. The volume of the protein picrate sedimented after 24 hr. is read from the graduations. Another method measures turbidity in the urine, previously clarified by centrifuging, after addition of sulfosalicylic acid.

In milder forms of albuminuria, the protein rarely exceeds 0.5 per cent. This is especially the case in the so-called "benign albuminurias" which are temporary and of ill-defined origin. In a number of kidney diseases large amounts are excreted, and in chronic nephrosis, the 24-hr. urine has been found to contain 100 g. or more of protein.

Proteins having the salting-out properties of proteoses appear in urines of patients with carcinoma or osteomalacia. These proteins are

of prerenal origin. One of them, *Bence-Jones protein*, appears as a symptom of a number of diseases, myeloma, osteosarcoma, certain other sarcomas, Hodgkin's disease, and leukemia. This protein has the unique property of forming a flocculent precipitate, resembling a protein coagulum, when the urine is warmed to about 60°, redissolving at higher temperature, and reappearing when cooled to 60°C.

Hemoglobin in corpuscles of bloody urine, free hemoglobin (hemoglobinuria), or certain of its derivatives may be detected by use of the benzidine or other chemical tests (p. 325) or by use of the spectroscope. Hemoglobinuria occurs when the blood plasma contains more than 135 mg. per cent of hemoglobin set free by hemolysis.

Bile Compounds. During obstructive jaundice or when for any reason the outflow of bile from the liver cannot keep pace with bile secretion, bile pigments and bile salts become sufficiently concentrated in the blood to appear in the urine in easily detectable amounts. Pigments are detected by color reactions such as Gmelin's (p. 269) and bile salts, by their effect in lowering the surface tension of urine, or by a color test (Pettenkofer's) in which the urine, treated with a small amount of furfural, is stratified above concentrated H_2SO_4 . A red zone appears above the acid.

Microscopy of Urine Sediments. Chemical tests of urine are effectively supplemented by microscopic recognition of many kinds of crystals and a number of formed elements in sediments. The microscopy of urine is a technique of the clinical laboratory. Details will be found in practical manuals. Certain sediments of biochemical significance are listed in Table 65.

Testing Kidney Efficiency. For both research and diagnostic purposes, biochemical tests are used to measure the rate at which the kidney eliminates water, waste products, metabolites, and other substances. So many diseases damage the kidney or indirectly affect its efficiency that such tests have real practical value. Many methods have been devised for testing kidney efficiency.

A widely used one measures the rate of excretion of phenolsulfonephthalein. This dye, a pH indicator commonly known as "phenol red," is injected (usually 6 mg. intramuscularly), the urine is collected at frequent intervals, and its content of the dye is determined colorimetrically in each sample after it is made alkaline. Phenol red is excreted by the kidneys only, and at a rate independent of water elimination. The normal kidney should excrete 50 ± 10 per cent of the phenol red in 1 hr. and 22.5 ± 2.5 per cent during the second hour.

Another method, the Mosenthal concentration test, involves the measurement of volume, specific gravity, total nitrogen, and chlorides

TABLE 65.—URINE SEDIMENTS

Microscopically identified objects	Description	Significance
Crystalline:		
Ammonium magnesium phosphate	Characteristic prisms, rarely feathery forms	Ammoniacal urines
Calcium phosphate	"Stellar" forms	Alkaline urine or high phosphate concentration
Calcium oxalate	"Dumbbell" forms or octahedral shapes	Oxaluria, defective bio-oxidation ¹
Uric acid	Varied pigmented forms, whetstone shape common	Acid urines
Urates, usually acid salts of NH ₄ and Na	Varied shapes, "thorn-apple" type frequent	Acid urine, sometimes ammonia-rich urine
Hippuric acid	Needles or rhombic prisms, often in starry clusters	Ingestion of benzoates, as such, or in foods
Cystine	Hexagonal plates	Cystinuria or, rarely, other disturbed metabolism
Tyrosine	Sheaves or tufts of needles	Disturbed protein metabolism, <i>e.g.</i> , tyrosinosis
Indigo	Dark blue, starry clusters of needles	High concentration of indican in alkaline urine
Organized, noncrystalline forms:		
Erythrocytes	Usually "crenated" forms unless urine is dilute	Hematuria due to lesion of kidney or urinary tract differs from hemoglobinuria which is not postrenal
Casts	Roughly cylindrical forms, cast off from within the kidney tubules. May be waxy, transparent, granular, or fatty, and may carry blood or pus cells	Kidney disease involving more or less albuminuria
Epithelial casts	Shaped like other casts but carry epithelial cells from walls of kidney tubules	Acute nephritis

Other identifiable, urinary structures, such as bacteria, other microorganisms, and pus cells, all of which indicate infections and especially those of the genital or urinary systems, also spermatozoa and excessive numbers of epithelial cells are of interest to the pathologist.

¹ The small amount of oxalic acid in normal urine is believed to arise from the breakdown of dehydroascorbic acid.

in daily urine collections of two 6-hr. samples and one (nighttime) 12-hr. sample. The patient is maintained meanwhile under standard conditions of diet and of fluid ingestion.

Several especially informative methods are designed to measure blood clearance by the kidneys. Maximum clearance is defined as the volume

of the blood which contains the amount of some specified substance removed by kidney activity during 1 min. For example, in case urea clearance is measured

$$C_m = \frac{U}{B} V$$

where C_m is maximum clearance, U is the concentration of urea in the urine, B is the concentration of urea in the blood, and V is the volume of urine produced per minute. If U is 11 mg. per ml. of urine, B is 0.31 mg. per ml. of blood, and V is 2.1 ml. of urine per minute, C_m is 74.5. This means that 74.5 ml. of blood are cleared of urea per minute. The range in normal health is 64 to 99 ml. and the average is about 75 ml. The value rapidly falls in many types of kidney disease. It is a more useful index than uremia (heightened concentration of urea, etc., in blood).

Corrections are made for children and for adults of stocky build. The urine volume is multiplied by the factor 1.73 and divided by the body-surface area in square meters.

When the volume of urine is less than 2 ml. per min. and under some other circumstances, the standard clearance, C_s , is computed.

$$C_s = \frac{U}{B} \sqrt{V}$$

The average of the normal value of C_s for urea is 54. Values used for diagnostic purposes are often reported as per cent of the normal.

Blood-clearance values for other waste products, *e.g.*, creatinine and uric acid, have been determined; but urea excretion seems to reflect most sensitively the efficiency of the kidney.

Clearance values are also recorded for many substances which are foreign to the blood and which are administered by feeding or injection. Of these, inulin has been used with conspicuous success. This carbohydrate is not attacked in animal metabolism but is efficiently excreted. It appears to be a strictly nonthreshold substance in the sense that it is not measurably resorbed by the kidney tubules. Its clearance value, normally about 120 ml. per min. but variable in certain kidney disorders, is a useful measure of the rate of glomerular filtration.

REFERENCES

A standard monograph on this subject is "The Physiology of the Kidney" by H. W. Smith, Oxford University Press, 1937.

Routine examination of urine and renal functional tests are given in Chaps. I and II of "Laboratory Methods of the U.S. Army" edited by J. S. Simmons and C. J. Gentskow, 5th ed., Philadelphia, 1944.

Methods of urine analysis for study of metabolism both normal and pathological will be found in "Practical Physiological Chemistry" by P. B. Hawk and O. Bergeim, 11th ed., Philadelphia, 1937.

Among reviews on kidney functioning and related matters are the following:
 Bock, J. C., The Benign Meliturias, *Physiol. Rev.*, 24, 169, 1944.

- BRAUN-MENENDEZ, E., *Kidney, Ann. Rev. Physiol.*, 6, 265, 1944.
- GRIFFITH, W. H., The Relation of Choline to the Kidneys, *Biol. Symposia*, 5, 193, 1941.
- LEITER, L., *Kidney, Ann. Rev. Physiol.*, 3, 509, 1941.
- PETERS, J. P., Water Exchange, *Physiol. Rev.*, 24, 491, 1944.
- SHANNON, J. A., *Kidney, Ann. Rev. Physiol.*, 4, 297, 1942.
- SMITH, H. W., *Kidney, Ann. Rev. Physiol.*, 1, 503, 1939.
- The following papers are selected to suggest some of the ways in which urine chemistry can be utilized in the study of metabolism and nutrition.
- BLATHERWICK, N. R., Foods in Relation to the Composition of the Urine, *Arch. Internal Med.*, 14, 409, 1914.
- CARDEN, G. A., PROVINCE, W. D., and FERREBEE, J. W., Clinical Experiences with the Measurement of the Urinary Excretion of Vitamin B₁, *Proc. Soc. Exptl. Biol. Med.*, 45, 1, 1940.
- CATHERWOOD, R., and STEARNS, G., Creatine and Creatinine Excretion in Infancy, *J. Biol. Chem.*, 119, 201, 1937.
- CAVETT, J. W., and FOSTER, W. C., Studies on the Formation of Ammonia by the Kidney, *Am. J. Physiol.*, 124, 66, 1938.
- CLOUSE, R. C., The Effect of Grape as Compared with Other Fruit Juices on Urinary Acidity and the Excretion of Organic Acids, *J. Nutrition*, 9, 593, 1935.
- DALY, C., and DILL, D. B., Salt Economy in Humid Heat, *Am. J. Physiol.*, 118, 285, 1937.
- DEVINE, J., An Analysis of Bence-Jones Protein, *Biochem. J.*, 35, 433, 1941.
- JOHNSON, S. W., and ZILVA, S. S., The Urinary Excretion of Ascorbic and Dehydroascorbic Acids in Man, *Biochem. J.*, 28, 1393, 1934.
- KNOTT, E. M., Determination of Vitamin B₁ Requirement of Infants by Means of Urinary Excretion of Thiamin, *Proc. Soc. Exptl. Biol. Med.*, 45, 765, 1940.
- SCHAFFER, N. K., The Determination of Uric Acid in Urine with Crude Uricase, *J. Biol. Chem.*, 153, 163, 1944.
- WORTIS, H., LIEBMAN, J., and WORTIS, E., Vitamin C in the Blood, Spinal Fluid, and Urine, *J. Am. Med. Assoc.*, 110, 1890, 1938.

CHAPTER XVIII

COMPOSITION OF FOODS: DIETETICS

The chemistry of food and the science of dietetics are described in detail in works specifically dealing with these branches of physiological chemistry. They are also dealt with in works of a more comprehensive nature describing the whole science of nutrition. This chapter will deal only with the outlines of the knowledge of food chemistry required for successful diet planning.

It is commonly recognized that foods may be divided into certain classes or types, each of which shows certain outstanding characteristics with respect to nutritive value. Thus we recognize (1) the protein-rich foods, such as lean meats, fish, and eggs; (2) the starchy foods, such as rice, some other cereals, potatoes, and some other root vegetables; (3) the sugars, including molasses, maple, and other sirups, candy, honey, etc.; (4) foods containing much cellulose (roughage) as do most fruits and vegetables; and (5) the fats and fat-rich foods such as butter, cream, fatty tissue of meat, and the vegetable oils. There is a modern tendency to set up another group, *the protective foods*. They include certain fruits, green salads, eggs, and milk and are so designated because their content of vitamins and mineral substances affords protection against dietary-deficiency diseases.

The fundamental principles underlying the choice of a diet in accordance with present-day knowledge of nutrition are concerned with the relative proportions and the actual amounts of each of these classes of foods which are to be supplied for optimal nutrition.

The Methods of Approximate Food Analysis. An exact analysis of foods is rarely made. For the most part approximate determinations are relied upon. These, when supplemented by more exact determinations of certain constituents, such as vitamins and inorganic substances, supply the nutritionist with the data required for the planning of satisfactory diets.

Protein is determined by an analysis for nitrogen. This is done by the use of some modification of the Kjeldahl method in which the material is subjected to destructive oxidation in the presence of concentrated sulfuric acid and a suitable oxidative catalyst, e.g., CuSO_4 . Nitrogen

is completely converted to $(\text{NH}_4)_2\text{SO}_4$. Ammonia, liberated by excess of NaOH, is distilled off and determined in the usual way. Nitrogen is computed from the NH_3 , and protein is calculated by multiplying the nitrogen by 6.37, assuming that food proteins contain on the average 15.7 per cent of nitrogen.

Fat is commonly regarded in approximate food analysis as the ether-soluble matter (p. 64) and is determined by extraction of a weighed quantity of the previously dried food with anhydrous ether. After evaporation of the ether the residue is weighed. Several uncertainties, due to oxidation during drying processes and also to varying solubility of lipids in their natural state, are involved in these determinations of ether-soluble matter. They can be guarded against only by the use of standard methods.

Carbohydrate determination is usually made by measurement of the total reducing substances after complete hydrolysis in acid solution. This obviously is only an approximation, which does not take into account the availability of the carbohydrate when it is digested and absorbed in the animal body.

Inorganic substances are usually determined as the weight of ash, produced under standard conditions of ignition, as obtained from a weighed amount of the food. Further analyses for the determination of individual inorganic constituents, Ca, P, Fe, etc., are done by any of the standard quantitative methods.

Fuel values (calories) may be determined (p. 388) in a calorimeter, but for the most part the fuel values are computed from the results of protein, fat, and carbohydrate determinations using the factors given in Chap. XIII.

The Approximate Composition of Representative Foods. Extensive data showing the average results of analyses of practically all the foods in modern use have been made available in tabular form by governmental and other agencies in all civilized countries. Of these tabulations the one prepared by Chatfield and Adams and printed in *U.S. Department Agriculture Circular 549* (1940) is recommended. From it, values for representatives of the types of foods commonly used in America have been selected for Table 66. The analyses do not as a rule add up to 100 per cent. The remainder consists of inorganic constituents and water. Values given for carbohydrate include, in the case of certain fruits and vegetables, organic acids, such as malic and citric acids, which are metabolized by the same oxidative chemical mechanism as are carbohydrates. The arrangement of foods in the table shows the classification of foods into categories which suggest some of their especial nutritive values. Any such grouping, however, is only suggestive. Obviously, the majority of

TABLE 66.—PROTEIN, FAT, CARBOHYDRATE, AND ENERGY VALUES OF THE EDIBLE PORTION OF REPRESENTATIVE FOODS

Food	Protein	Fat	Carbo- hydrate	Fuel value per 100 g.	100-Cal. portion
Protein-rich foods:	per cent	per cent	per cent	Cal.	g.
Almonds.....	18.6	54.1	19.6	640	16
Beans, green, Lima.....	20.7	1.3	61.6	341	29
Beef, lean, round.....	19.7	8.0	151	66
Cheese, American, Cheddar.....	23.9	32.3	1.7	393	25
Chicken, total, edible part.....	21.6	2.7	111	90
Clams.....	12.8	1.4	3.4	77	129
Codfish, fresh.....	16.5	0.4	70	144
Eggs, total edible.....	12.8	11.5	0.7	158	64
Halibut.....	18.6	5.2	121	82
Lamb, leg, medium fat.....	18.0	17.5	230	44
Liver, calf.....	19.0	4.9	4.0	136	73
Peanuts.....	26.9	44.2	23.6	600	17
Peas, fresh.....	6.7	0.4	17.7	101	99
Pork, ham, medium fat.....	15.2	31.0	340	29
Salmon, canned.....	20.6	9.6	169	59
Soybeans, fresh.....	12.5	6.5	6.0	132	75
Fats and fat-rich foods:					
Bacon, broiled.....	25.0	55.0	1.0	599	17
Butter.....	0.6	81.0	0.4	733	14
Cream, light.....	2.9	20.0	4.0	208	48
Duck, total edible.....	16.0	28.6	321	31
Egg yolk.....	16.3	31.9	0.7	355	28
Oils, salad.....	100.0	900	11
Pork, fat.....	3.9	80.0	736	14
Sausage.....	11.3	41.2	416	24
Carbohydrate-rich foods:					
Bread, graham, made with some milk.....	9.5	3.5	48	262	38
Bread, white, commercial.....	8.5	2.0	52.3	261	38
Corn, sweet, fresh.....	3.7	1.2	20.5	108	93
Corn meal.....	9.1	3.7	73.9	365	27
Crackers, soda, plain.....	9.6	9.6	72.7	416	24
Jellies, commercial.....	0.5	0.3	70.8	288	35
Macaroni.....	13.0	1.4	73.9	360	28
Wheat, shredded.....	10.4	1.4	78.7	369	27
Fruits:					
Apples.....	0.3	0.4	14.9	64	156
Bananas.....	1.2	0.2	23.0	99	101
Cantaloupe.....	0.6	0.2	5.9	28	360
Grape juice.....	0.4	18.5	76	132
Oranges.....	0.9	0.2	11.2	50	199
Pineapple juice, canned.....	0.3	0.1	13.0	54	185
Prunes, dried.....	2.3	0.6	71.0	299	33
Strawberries.....	0.8	0.6	8.1	41	244
Green vegetables:					
Asparagus.....	2.2	0.2	3.9	26	381
Cabbage.....	1.4	0.2	5.3	29	350
Celery.....	1.3	0.2	3.7	22	459
Cucumbers.....	0.7	0.1	2.7	14	690
Lettuce.....	1.2	0.2	2.9	18	549
Spinach.....	2.3	0.3	3.2	25	405
Root vegetables:					
Beets, fresh.....	1.6	0.1	9.6	46	219
Carrots.....	1.2	0.3	9.3	45	224
Onions.....	1.4	0.2	10.3	49	206
Potatoes.....	2.0	0.1	19.1	85	117
Sweet potatoes.....	1.8	0.7	27.9	125	80
Milk, etc.:					
Milk, cow, whole.....	3.5	3.9	4.9	69	146
Milk, canned, evaporated.....	7.0	7.9	9.9	139	72
Milk, dried, skim.....	35.6	1.0	52.0	359	28
Ice cream, plain.....	3.9	13.0	20.3	214	47

foods furnish nutrients which would place them in more than one of these categories. This is especially the case for milk, which is nutritively useful in many ways.

Requirements of an Adequate Diet. Any diet which supports good nutrition must furnish an animal (1) protein sufficient to yield the

necessary amino acids; (2) fats in optimal proportion and supplying the indispensable fatty acids; (3) some carbohydrate, which, though not demonstrated to be strictly indispensable, is unquestionably advantageous for most animals; (4) the inorganic requirements, of which calcium, iron, and iodine are the elements most frequently found to be deficient in diets, although copper, manganese, cobalt, and possibly others, such as zinc and fluorine, are indispensable ones occasionally reported to be deficient in the food of man or animals; and (5) the vitamin requirements which were discussed in Chap. VI.

The minimal and the optimal amounts of most of these dietetic requirements have been approximately determined by experiments on laboratory animals, studies of human diets as related to nutritive well-being, and, to some extent, dietetic experiments in human nutrition. An entirely satisfactory interpretation of the great mass of data resulting from such observations in many lands is not yet attainable. It is significant, however, that consultation and conference among students of research throughout the world has been extensive and fruitful in an effort to find the best diet for man. Incidentally, similar efforts among agronomists and animal husbandmen have been directed toward the establishment of optimal nutrition for domestic animals.

Dietary standards for human beings as set up by the Food and Nutrition Board of the National Research Council are presented in Table 67. It is to be noted that these are *recommended* dietary allowances and as such are still subject to revisions and additions. Neither the Food and Nutrition Board nor other students of nutrition in America or elsewhere would claim that these allowances are *optimal* even though they are believed to be adequate and, in the case of some allowances, are in at least slight excess of minimal requirements.

A sample dietary is presented in Table 68 together with calculations to indicate that it meets the "standard" allowances shown in Table 67.

Studies which employ newer methods of observation of nutritional states have been carried on in many lands upon sizable groups of people both in the growing and in the adult stage. The results have justified the suspicion that, in addition to the numerous poverty-stricken groups which suffer from evident dietary-deficiency diseases (malnutrition) or from partial starvation (subnutrition), there are relatively large numbers of people, even in the more prosperous countries, whose diet is mildly deficient in one way or another so as to prevent them from enjoying abounding health and vitality.

A committee of the Food and Nutrition Board of the National Research Council presented a report (1943) on "Inadequate Diets and Nutritional Deficiencies in the United States: Their Prevalence and Sig-

TABLE 67.—RECOMMENDED DIETARY ALLOWANCES¹
(Food and Nutrition Board National Research Council)

	Calories	Protein	Calcium	Iron	Vitamin A ₃	Thiamine (B ₁) ²	Riboflavin	Niacin (nicotinic acid)	Ascorbic acid ³	Vitamin D
Man (70 kg.):										
Sedentary.....	2500	70	0.8	12	5000	1.2	1.6	15	75	*
Moderately active.....	3000	70	0.8	12	5000	1.5	2.0	18		*
Very active.....	4500	70	0.8	12	5000	2.0	2.6	23		
Woman (56 kg.):										
Sedentary.....	2100	60	0.8	12	5000	1.1	1.5	11	70	*
Moderately active.....	2500	60	0.8	12	5000	1.2	1.6	12		
Very active.....	3000	60	0.8	12	5000	1.5	2.0	15		
Pregnancy (latter half).....	2500	85	1.5	15	6000	1.8	2.5	18	100	400 to 800
Lactation.....	3000	100	2.0	15	8000	2.0	3.0	20	150	400 to 800
Children up to 12 years:										
Under 1 year ⁴	100/kg.	3 to 4/kg.	1.0	6	1500	0.4	0.6	4	30	400 to 800
1-3 years ⁵	1200	40	1.0	7	2000	0.6	0.9	6	35	
4-6 years.....	1600	50	1.0	8	2500	0.8	1.2	8	50	
7-9 years.....	2000	60	1.0	10	3500	1.0	1.5	10	60	
10-12 years.....	2500	70	1.2	12	4500	1.2	1.8	12	75	
Children over 12 years:										
Girls, 13-15 years.....	2800	80	1.3	15	5000	1.3	2.0	13	80	*
Boys, 13-15 years.....	2400	75	1.0	15	5000	1.2	1.8	12	80	
Boys, 16-20 years.....	3200	85	1.4	15	5000	1.5	2.1	15	90	*
Boys, 16-20 years.....	3800	100	1.4	15	6000	1.8	2.5	18	100	

¹ Tentative goal toward which to aim in planning practical diets; can be met by a good diet of natural foods. Such a diet will also provide other minerals and vitamins, the requirements for which are less well known. Revision of 1945.

² mg. thiamine equals 353 I. U.; 1 mg. ascorbic acid equals 20 I. U.

³ Requirements may be less if provided as vitamin A; greater if provided chiefly as the provitamin carotene.

⁴ Needs of infants increase from month to month. The amounts given are for approximately 6 to 8 months. The amounts of protein and calcium needed are less if derived from human milk.

⁵ Allowances are based on needs for the middle year in each group (as 2.5, 8, etc.) and for moderate activity.

* Vitamin D is undoubtedly necessary for older children and adults. When not available from sunshine, it should be provided probably up to the minimum amounts recommended for infants.

Recommendations, adopted 1942.

The requirement for iodine is small; probably about 0.002 to 0.004 mg. per day for each kg. of body weight. This amounts to about 0.15 to 0.30 mg. daily for the adult. This need is easily met by the regular use of iodized salt; its use is especially important in adolescence and pregnancy.

The requirement for copper for adults is in the neighborhood of 1.0 to 2.0 mg. per day. Infants and children require approximately 0.05 mg. per kg. of body weight. The requirement for copper is approximately one-tenth of that for iron.

The requirement for vitamin K is usually satisfied by any good diet. Special consideration needs to be given to newborn infants. Physicians commonly give vitamin K either to the mother before delivery or to the infant immediately after birth.

TABLE 66.—FOOD VALUE OF DAILY ALLOWANCE FOR A MODERATELY ACTIVE MAN OF 60 KG.
(*Nutrition Conference for Defense, Washington, 1941*)

Foods	Amount	Approximate measure	Cal.	Protein	Calcium	Iron	Vitamin A	Thiamine (B ₁)	Riboflavin	Ascorbic acid
Milk.....	g. 480	1 pint	336	15.8	0.58	0.15	I.U. 528	γ 244	γ 1,000	mg. 6
Meat.....	100	$\frac{1}{4}$ pound	150	21.0	.01	3.00	50	120	225	
Potatoes.....	350	3 medium	300	7.2	.05	3.66	144	432	162	12
Baked beans.....	500	1 cup	200	13.2	.09	4.00	110	235	130	
Cabbage, raw.....	100	1 cup	25	1.1	.04	.43	88	70	72	35
Carrots.....	100	$\frac{1}{4}$ cup	40	1.2	.04	.64	2,100	60	58	
Tomato.....	200	$\frac{1}{8}$ cup	50	2.4	.02	.80	2,000	182	122	48
Prunes, stewed.....	200	$\frac{1}{8}$ cup	250	1.4	.03	1.88	990	120	132	
Oleomargarine.....	66	5 tablespoons	500	2,600	
Oatmeal, cooked.....	300	$\frac{1}{4}$ cups	200	8.0	.03	2.40	270	60	
Bread, whole wheat or "enriched".....	200	6 slices	500	19.0	.10	3.0	480	207	
Gingerbread.....	75	Large piece	200	3.5	.08	2.0	10	30	
Sugar, jam.....	250	
Totals.....	3001	93.8	1.07	22.0	8,602	2,253	2,234	101
Compared with recommended allowances.....	3000	70.0	.80	12.0	5,000	2,255 mg. 1.50 mg.	2,233 mg. 2.10 mg.	75

nificance." A part of the findings is summarized in *Nutrition Reviews* as follows:

The report begins by pointing out that every dietary survey in the past decade has shown that the foods eaten by the people in the United States are such that they do not supply the dietary essentials in amounts which are considered desirable by most nutritionists. The standards used by the Committee are the recommended allowances developed by the Food and Nutrition Board. These standards are admittedly liberal but it should be remembered that accumulating evidence indicates the wisdom of high standards. If people are to secure the maximum benefit from advances in nutrition they probably should set their goal high. Few persons would disagree with the view that dietary improvement is desirable when 26 per cent of a group of people are found to be ingesting less than 50 per cent of the recommended levels for riboflavin, 13 per cent less than half the recommended allowances for thiamin and calcium, 5 per cent less than half the allowances for Calories and for vitamin A, and 4 per cent less than half the recommended intakes of ascorbic acid. Yet these results have been reported in a study of 225 private patients in the upper income brackets examined in Philadelphia in 1940 by Kelly and Sheppard. In this group were nine physicians whose diets were no better than those of the patients. The results of other studies on people in lower income groups, as might be expected, show an even greater deficiency when compared with recommended dietary allowances. As a matter of fact, when records of the individual foods consumed by any group of people are examined one wonders how the human race ever has managed to get along as well as it has.

Human dietary errors are frequently deficiencies in one or more of the following: Calcium, iron, vitamin A, thiamine, riboflavin, niacin, ascorbic acid, and vitamin D. However, it is probable that the most frequent dietary error in the United States is overconsumption of carbohydrate in the form of sugar. While sugar is of prime value in nutrition, its excessive intake tends so to satisfy the appetite that sufficient intake of the "protective foods," providing indispensable minerals and vitamins, is not attained. An example of the effects of this dietary error is found by students of dentition. A review (Jay, 1940) of the relation of diet to dental caries states that, "Control of carbohydrate consumption is the only dietary procedure thus far demonstrated by which the disease can be controlled." This reviewer believes that during an excessive carbohydrate intake dental caries is not effectively controlled by the addition of minerals and vitamins to the diet.

Simple Rules of Nutrition. Recommended standards can be a useful guide to professional dietitians who plan menus for hospitals, army and navy forces, institutions, etc.; but the housekeeper and the individual who must choose his food at restaurants can hardly be expected

to make the somewhat complex calculations or even to possess the knowledge necessary for making a diet conform to standards. Fortunately, this is not at all necessary for good nutrition. A few simple rules suffice for the choice of an adequate diet.

An example of a good diet as approved by the Council on Food and Nutrition of the American Medical Association follows:

1. Milk: Two or more glasses daily for adults, 3 to 1 glasses daily for children (including milk as beverage and in foods)
2. Vegetables: Two or more servings daily besides potatoes, both green and yellow, vegetables (one of them raw) to be used
3. Fruits: Two or more servings daily, one as citrus fruit or tomato
4. Eggs: Three to five a week
5. Meat, cheese, fish, or legumes: One or more servings daily
6. Cereal or bread: Most of it whole grain or "enriched"
7. Butter: Two or more tablespoons daily or fortified oleomargarine

The Optimal Protein Intake. As explained in previous chapters proteins, as such, are not indispensable. Instead, the real requirement is an adequate supply of each of the amino acids (p. 181) which the animal cannot synthesize. The practical problem for the dietitian is the selection of foods containing protein of such quality and in such quantity that the nutritional needs for amino acids will be met.

To meet the quality requirement two principles are invoked: (1) Include in the diet foods of varied origin. Proteins from different sources tend to supplement each other in respect to their yields of amino acids. For example, proteins of meat can make good the amino acid deficiencies of cereal proteins. (2) Include some foods which supply nutritively complete proteins. Those of milk, eggs, and green vegetables are outstanding in this respect.

An experiment (Mabee and Morgan, 1949) to test the relative nutritive value of different proteins will serve as an example of many researches on this problem. Diets containing the various proteins were fed to young dogs, keeping records of food intake and of growth. The latter was evaluated in terms of weight gain per gram of protein. Regarding egg yolk as 100, the relative values were as shown in Table 69.

The optimal quantity as distinct from the minimal requirement is still debatable. Arguments in favor of the use of protein in excess of the minimal requirement are based in part on the generally stimulating effects of amino acids in metabolism and, in part, on other considerations such as the economic and cultural attainments of those population groups which tend to use a diet liberal in its protein content. Arguments in favor of a more restricted protein intake are based in part upon the idea of "physiological economy in nutrition." The limited ability of

the animal to store protein results in the oxidative destruction of amino acids irrespective of whether or not they are required. This puts unnecessary work upon the "metabolic mill" and upon the kidneys, which must excrete the resulting urea and other waste products. A further argument is an economic one. Protein-rich foods tend to be more costly than the cereals and other vegetable foods.

Historically, the recommended protein allowance has been decreased. An older standard (Voit) of 118 g. of protein per day for an adult working man was based on statistics of actual protein consumption and is now regarded as unnecessarily high. Much evidence has led to this change of opinion. The most important experiments were those of Chittenden,

TABLE 69.—PROTEINS EVALUATED BY GROWTH OF DOGS

Proteins fed ¹	Relative value	Relative absorbability
Egg yolk raw (12%).....	100	87
Whole egg powder.....	77	82
Beef muscle.....	73	89
Casein.....	71	93
Casein (heated) + lysine (0.6%).....	67	78
Casein (heated).....	65	76
Egg powder (heated).....	61	61
Peanut flour.....	41	88
Wheat gluten.....	28	96
Wheat gluten (40%).....	34	
Dried egg albumin.....	25	45

¹ Except where otherwise shown the protein was 18 per cent of the diet.

who found that soldiers, athletes, students, and others could be maintained in nitrogen equilibrium and in an obviously good state of nutrition on diets furnishing 35 to 50 g. of protein per day.

As would be expected, the minimal protein requirement varies (p. 478) with other components of the diet. All statements regarding minimal protein requirements assume that protein-sparing foods are supplied.

The recommended standards presented in Table 67 provide for the needs of pregnancy, lactation, and periods of rapid growth. In each of these allowances the recommended amount of protein is somewhat in excess of that required for maintenance of nitrogen equilibrium and thus provides what might be termed a "margin of safety." It seems evident upon study of statistics that the majority of the human race subsists on diets providing less protein than is here recommended. Even among comparatively well-fed Americans, many families in the low-income group do not attain to these standards.

The significance of proteins for growth is indicated by the relationship (Fig. 86) between the protein content of milk and the growth rate of mammals shortly after birth. It is found that for some mammals there is a straight-line relationship between the log of the concentration of protein in the milk and the log of the comparative rate of growth. Other mammals, requiring more than 1 month for doubling of the birth weight, do not show this relationship although higher protein content of the milk does accompany more rapid growth rates.

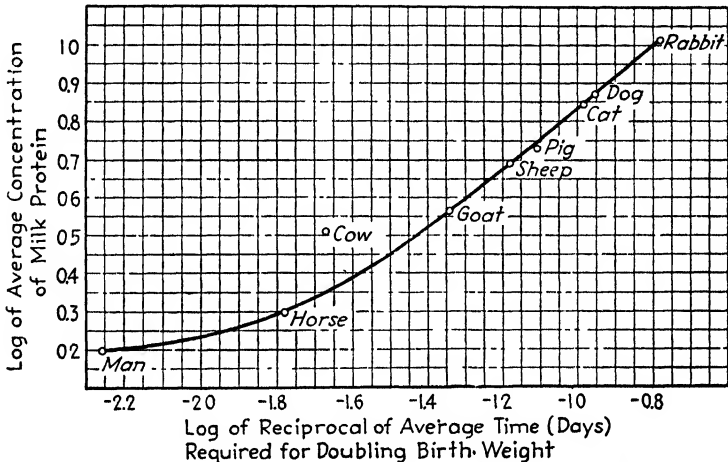

FIG. 86. The relation between the rate of growth of the young of various species and the protein content of the milk. For six of the more rapidly growing species there is a practically straight-line relationship between the log of the average protein concentration of the milk and the log of the reciprocal of the time required for doubling of the birth weight. This relationship is not a general one as is indicated by points for the human, equine, and bovine species.

The Balanced Diet. The expression "balanced diet" is often used in a restricted sense to refer to the distribution of the energy value of the food between proteins, fats, and carbohydrates. Dietitians appear to have assumed that there is an optimal distribution, but physiological experiments have failed to establish it. An inconclusive argument might be deduced from the relationships between the major constituents of milk. In human milk 49 per cent of the total calories are supplied by fat (on the average), 43 per cent by carbohydrate, and only about 8 per cent by protein. The milk of other species shows different but somewhat similar distributions. There is probably some advantage in having both carbohydrate and fat in the diet along with the indispensable proteins. This seems especially true of carbohydrate as was indicated (p. 464) in discussions of metabolism. Nevertheless, laboratory animals can main-

tain good nutrition without carbohydrate, and the Eskimos regularly subsist on a fat-rich and nearly carbohydrate-free diet. Rats kept at -2°C . and permitted self-selection of foods consume a relatively large amount of fat, about 50 per cent of the calories. Survival of rats at low temperatures is significantly greater on a fat-rich than on a fat-poor diet. Human tolerance to cold is likewise improved with little ketonuria on the fat-rich diet. Laboratory animals can be maintained in satisfactory nutritive condition on a fat-free diet provided the necessary minimum of indispensable fatty acids is furnished. Young rats were found, however, to have a more rapid growth rate and to show a higher retention of nitrogen when fat was fed than otherwise, and both of these "improvements" were in the same order as the amount of fat fed up to the point where the fat furnished about 30 per cent of the calories. In the human body, ketosis (pp. 462 to 465) affords a warning against excessive use of fat, but the individual variability of the ketosis threshold is so great that a definite statement about how much fat may be tolerated has no meaning for a population group. In a recent study, a group of men all showed definite ketosis when fats supplied 71 per cent of the calories.

It is true, nevertheless, that a very wide range in the proportions of the major foodstuffs consumed is possible for both man and animals. Such adaptability is not surprising in view of the ready interconvertibility of foodstuffs in metabolism. As concluded by a recent reviewer (van Veen) there is no standard or normal proportion constituting the balanced diet although what might be called habit norms characterize the diets of individuals or of large population groups. In short, there are high carbohydrate feeders and high fat feeders. In this connection the intake of thiamine is important because the minimal requirement for this vitamin rises (p. 168) with the increase of carbohydrate in the food.

The Cholesterol Problem. A special aspect of balance in the diet has attracted considerable attention as a clinical problem, namely: How much cholesterol may be safely included in the diet? It seems to be clearly established that a long-sustained hypercholesterolemia causes atheromatosis (fatty degeneration of the walls of arteries in arteriosclerosis), and this result has been obtained by feeding cholesterol to rabbits and guinea pigs. In rabbits less than about one year of age, no arterial lesions were produced although the hypercholesterolemia was as high as in the older animals. This corresponds to the fact that human patients suffering from this type of arterial disease are adults.

The seriousness of the problem may be inferred from the fact that typical statistics compiled by a very large insurance company show that, in 1948, causes of death for which insurance was paid included "angina pectoris, coronary disease, organic heart disease and hemorrhage of the

brain," diseases apt to involve arteriosclerosis, and these four as "causes of death" amounted to 56 per cent of all death claims for the year, *i.e.*, *more than deaths from all other causes.*

There is a question as to whether or not the disease-producing effect of cholesterol is confined to certain species. Thus experiments with *Macacus rhesus* monkeys failed to produce atheromatosis by feeding cholesterol. In adult dogs the lesion is produced only when a sufficiently high (3 to 10 times the normal) serum-cholesterol concentration is maintained long enough, more than 6 months. A tendency to progressive increase with age in the cholesterol content of the aortas of normal people is shown by autopsies, but this is *not* paralleled by a progressive increase in the serum-cholesterol level. It is evident that the story of the relation of cholesterol to arterial disease is incomplete. The rate of cholesterol synthesis in the body may be more important than the amount of it in food. But in any case, it would seem only an ordinary precaution for persons past forty to avoid a high cholesterol intake. That means decreased use of foods of animal origin (the sterols of plants are not well absorbed from the intestine) except milk which contains practically no cholesterol. Probably liver and egg yolk are the important dietary sources of cholesterol, nervous tissue has the highest concentration of it, and all animal fats except butter are significant sources.

Requirements for Calcium and Phosphorus. Calcium phosphate, as will be explained more fully in Chap. XIX, is the chief constituent of the hard part of bones and teeth. During the growth period, therefore, requirements for skeletal development and dentition are added to the amounts of calcium and phosphates needed for maintenance of the composition of all the other tissues. It will be noticed that recommended allowances for calcium (Table 67) take this into account together with the high requirements for pregnancy and lactation.

Methods for determination of the minimal calcium requirements include balance studies of calcium intake and excretion. It is assumed that the minimal requirement is met only when calcium output is not more than the intake. Both feces and urine must be analyzed because calcium and phosphates are excreted through the intestinal wall as well as by the kidneys. The amount of intestinal excretion is considerable, and the proportional amount is highly variable so that it cannot be satisfactorily estimated. This is especially true in the case of calcium. Another type of method employs animal feeding experiments over fairly long periods during which the growth rate, the general condition of nutrition, the reproductive performance, and longevity are observed. Rats have been chiefly used in these experiments.

Less work has been done in the study of phosphorus requirements

than in that of calcium allowances. Phosphorus is not apt to be deficient in the diet of man or animals. This is the case because phosphates and phosphoric acid derivatives, prominent in metabolic reactions, are widely distributed in plant and animal structures. Only a diet composed largely of purified food substances and low in content of foods in the natural state would be deficient in phosphates. The phosphoproteins, casein of milk and vitellin of eggs, are further sources of phosphorus important in human nutrition.

It might be assumed, erroneously, that the chief store of calcium phosphate in the body as it exists in bones is inert and exerts little if any demand for replacement. Such, however, is not the fact. Bone calcium phosphate, like other seemingly inert tissue constituents, is in a constant state of flux, exchanging with the blood and the other tissues. Many older observations on the effects of diet and of hormones upon bone composition had partially revealed this fact. More recent work with isotopes has definitely established it. Radioactive phosphorus, fed or injected as phosphates, is found abundantly in bone calcium phosphate.

The plasticity of the calcium phosphate deposits in bone, while revealed in many ways, becomes especially conspicuous in the study of rickets. The relationship of dietary supplies of calcium and phosphorus to rickets (p. 199) was stated in Chap. VI. A significant feature of the relationship is the fact that the amounts supplied are not the only consideration. The calcium: phosphorus ratio is also significant. The ratio must be not less than 1 nor more than 2.

The recommended allowances of calcium (Table 67) have not been shown to be optimal. Sherman, after extended studies of calcium balances as related to states of good nutrition, has suggested that the optimal calcium intake is probably somewhat in excess of the minimal requirement and proposes an allowance of 1 g. per day for adults.

The amounts of calcium, phosphorus, and some other minerals found in representative foods are shown in Table 70.

One cannot be sure that the calcium content of the foods provided actually meet a given allowance because of the poor and variable absorption of calcium in the intestines. Perhaps not all the calcium of milk is actually utilized although milk is better in this respect than are most other foods. Green vegetables which yield oxalic acid are poor sources, apparently because of the formation of insoluble calcium oxalate. Thus from spinach (0.9 per cent of oxalic acid) calcium is not well utilized while from broccoli, cabbage, cauliflower, lettuce, and kale (low in or free from oxalic acid), calcium is utilized almost as well as from milk.

It is generally conceded by students of nutrition that calcium deficiency is one of the more frequently occurring forms of human malnutri-

TABLE 70.—AMOUNTS OF CERTAIN MINERAL ELEMENTS IN THE EDIBLE PORTIONS OF REPRESENTATIVE FOODS

Food	Mineral elements as per cent of food					
	Ca	Mg	K	P	S	Fe
Almonds.....	0.254	0.252	0.759	0.475	0.150	0.0044
Beans, dried.....	0.148	0.159	1.201	0.463	0.237	0.0103
Beef, lean.....	0.013	0.024	0.338	0.204	0.230	0.0030
Cheese, hard.....	0.873	0.042	0.131	0.610	0.218	(0.001)
Chicken (fowl).....	0.016	0.027	0.372	0.218	0.252	0.0019
Clams.....	0.102	0.089	0.172	0.105	0.219	
Codfish.....	0.014	0.022	0.339	0.188	0.203	0.0015
Eggs.....	0.058	0.013	0.138	0.224	0.197	0.0031
Halibut.....	0.011	0.024	0.340	0.209	0.212	0.0007
Lamb (mutton).....	0.015	0.024	0.301	0.208	0.211	0.0030
Liver.....	0.008	0.022	0.298	0.373	0.251	0.0121
Peanuts.....	0.066	0.167	0.614	0.392	0.226	0.0019
Peas, fresh.....	0.022	0.027	0.284	0.122	0.056	0.0019
Pork, medium, lean.....	0.010	0.024	0.304	0.215	0.206	0.0022
Soybean flour.....	0.216	0.223	?	0.583	(0.3)	(0.0027)
Butter.....	0.016	0.001	0.014	0.016	0.009	0.0002
Cream.....	(0.09)	(0.01)	(0.13)	(0.07)	(0.03)	0.0002
Egg yolk.....	0.157	0.016	0.118	0.538	0.194	0.0087
Bread, white.....	(0.05)	0.030	0.109	(0.10)	0.054	0.0009
Bread, whole wheat.....	(0.06)	(0.15)	(0.45)	(0.37)	(0.15)	0.0030
Corn, sweet.....	0.009	0.038	0.113	0.120	0.046	0.0005
Corn, meal.....	0.016	0.084	0.213	0.152	0.111	0.0009
Macaroni.....	0.021	0.034	0.174	0.147	0.146	0.0013
Apples.....	0.007	0.006	0.116	0.011	0.005	0.0003
Bananas.....	0.008	0.031	0.373	0.028	0.012	0.0006
Cantaloupe.....	0.017	0.017	0.249	0.016	0.015	0.0004
Grapes.....	0.017	0.007	0.254	0.021	0.009	0.0006
Oranges (or juice).....	0.025	0.010	0.181	0.019	0.008	0.0003
Pineapple.....	0.016	0.011	0.214	0.011	0.007	0.0003
Prunes, dried.....	0.062	0.040	0.848	0.093	0.028	0.0035
Strawberries.....	0.022	0.012	0.145	0.022	0.012	0.0009
Asparagus.....	0.021	0.012	0.187	0.052	0.046	0.0012
Cabbage, headed.....	0.045	0.012	0.294	0.028	0.067	0.0004
Celery.....	0.072	0.027	0.291	0.046	0.022	0.0007
Cucumbers.....	0.010	0.009	0.140	0.021	0.012	0.0003
Lettuce.....	0.054	0.011	0.311	0.031	0.018	0.0011
Spinach.....	0.083	0.055	0.489	0.048	0.027	0.0034
Beets.....	0.026	0.023	0.336	0.039	0.017	0.0009
Carrots.....	0.042	0.017	0.311	0.040	0.021	0.0007
Onions.....	0.032	0.015	0.183	0.044	0.068	0.0005
Potatoes.....	0.013	0.027	0.496	0.053	0.029	0.0011
Sweet potatoes.....	0.033	0.024	0.373	0.052	0.026	0.0008
Milk, cow's.....	0.118	0.012	0.143	0.093	0.034	0.0002

tion although data on the actual incidence of this condition are somewhat unsatisfactory. Criteria of satisfactory calcium supply for man are not easily applied. In animal experimentation, however, the effects of mild calcium insufficiency have been amply demonstrated. For example, rats reared on a diet containing 10 mg. per cent of calcium fail to mate, and females transferred from a normal to a low calcium diet show a marked decrease in fertility. Sherman and his coworkers have reported extensive investigations on rats which demonstrate that both reproduction and longevity are increased by a liberal calcium allowance. Extensive studies under the auspices of U.S. government agencies indicated that in most of the communities studied 40 per cent, and in some places as many as 70 per cent, of families in low-income groups used diets which furnished less than 0.45 g. of calcium daily to an individual. This is only about half of the recommended allowance. Studies made by nutritionists in India lead to the conclusion that one of the most frequent defects of typical Indian diets is calcium insufficiency.

Magnesium, which resembles calcium in some of its physiological effects, is also indispensable. Requirements are small and its deficiency in diets of man or domestic animals has not been shown to be a dietetic problem. Magnesium is widely distributed in foods. Requirements for rats are met by inclusion of about 50 parts per million of magnesium in the diet. Young chicks are reported to require a larger proportion.

Requirements for Iron and Copper. The relation of nutritional anemia to iron and copper (p. 303) was stated in connection with hemopoiesis. The iron required for sustained production of hemoglobin (0.33 per cent of iron) represents the major part of the demand. It should be noted, however, that other iron-containing complexes, such as myohemoglobin of muscle and the iron-containing catalysts (catalase, peroxidase, cytochromes, etc.), are also physiologically important. But hemoglobin deficiency is the obvious, frequently observed symptom of insufficient iron supply.

The minimum requirement for iron has been estimated from studies of balance of intake and output. Many of these observations indicate that iron balance may be maintained by an adult with an intake of 5 to 7 mg. per day. The allowance of 12 mg. per day for an adult is even more liberal than was supposed when recommended (1941) by the Food and Nutrition Board. It is found, however, that maintenance of iron balance may require a higher intake when the diet is deficient in some other respect than when an entirely adequate diet is supplied. In any case, iron requirements are met by a few milligrams per day. The smallness of the need is due to iron conservation in the body. Liberated from hemoglobin in the liver, iron is carried (p. 304) to the hemopoietic

tissues to be used over again. Only the small amount excreted has to be replaced.

The prevalence of mild anemia, presumably due to dietary deficiency, is indicated by data shown in Table 71. Similar observations on a number of other large groups of people, both adults and school children, have indicated a not inconsiderable incidence of mild anemia. So far as it is of dietary origin, it is due to dependence upon foods largely composed of refined white flour, sugar, and milk. Such a diet is apt to be deficient in foods which are better sources of iron, *e.g.*, meats, poultry, fish, green leafy vegetables, oatmeal, entire wheat, and nuts.

TABLE 71.—INCIDENCE OF MILD ANEMIA

Values are based on observations of 200 families in urban and rural communities in Pennsylvania

Incidence of Anemia (Defined as Less than
13 g. Hemoglobin per 100 g. Blood)
per Cent of Group

Men:

17-20 years old	12.5
20-40 years old	34
More than 40 years old	37

Incidence of Anemia (Defined as Less than
11.5 g. Hemoglobin per 100 g. Blood)
per Cent of Group

Women:

17-20 years old	13
20-40 years old	36
More than 40 years old	27

Animal requirements for copper and its utilization in metabolism have been investigated chiefly in connection with iron requirements. These metals function together in erythrocyte production. Human requirements have been estimated as probably not more than 2 mg. of copper per day. This small amount is probably yielded by all except very peculiar diets and experimental diets composed of highly purified materials. Copper is widely distributed in natural foods. Most of them contain less than 0.5 mg. per cent of copper although liver is exceptional. Its somewhat variable copper content averages more than 4 mg. per cent.

The role of copper as a part of certain enzyme complexes (p. 226) was presented in Chap. XII. The smallness of the copper requirement and the small amount of it (100 to 150 mg.) in the entire human body further suggest that its functioning must be catalytic.

Cobalt. As previously stated (p. 303), cobalt is effective in stimulation of hemopoiesis. Dogs with nutritional anemia (milk diet) are reported to respond to iron and copper therapy by showing less hemoglobin production than when the iron and copper are supplemented with

cobalt. Similar effects have been obtained with rats. The chief observations on cobalt effects, however, have been made with the aid of nature's experiments. Domestic animals suffer from deficiency diseases which, though given various names in different countries, always involve defective hemoglobin production among other varying symptoms. The so-called "bush sickness" of sheep and cattle in Australia and New Zealand is one of these conditions. Complete success in treatment by adding iron compounds to the ration was found to be possible only when cobalt in traces "contaminated" the iron-containing material.

Observations on sheep have shown that injection of cobalt, in the place of feeding it, gave no benefit to the deficient animals. The action, therefore, may involve the formation of something in the digestive system, such as vitamin B₁₂ (p. 214).

No cases of cobalt deficiency in man have been reported.

The Iodine Requirement. The role of iodine in the synthesis of thyroxine (p. 97) by the thyroid gland will be presented in Chap. XX. Of the total amount of iodine in the human body, estimated to be about 25 mg., some 15 mg. is in the thyroid. The daily requirement may be

AVERAGE IODINE CONTENT IN PARTS PER BILLION OF DRY SOLIDS

Food	Goitrous regions	Nongoitrous regions
Wheat.....	1-6	1-9
Oats	10	23-175
Carrots....	2	170 or more
Potatoes.....	85	226

as little as 0.05 mg. This figure is based on estimates of the small amount excreted. The recommended allowance, 0.15 to 0.30 mg. per day, is perhaps generous. People living on or near the seacoast can hardly fail to consume this small amount of iodine. The earth's chief store of iodine is in sea water. Correspondingly, the seaboard soil and plants grown upon it as well as the drinking water contain iodine although in amounts so small as to be reckoned in parts per billion. Sea foods are higher in iodine content. Codfish, for example, contain 5.35 parts per million and oysters 1.8 to 3.5 parts per million.

In certain inland areas, such as the Great Lakes region of America and regions near Central Europe, iodine is deficient in the soil. Plants grown upon it and the drinking water are correspondingly low in iodine. This condition is unequivocally related to the incidence of common goiter in such regions. This is a symptom of iodine deficiency and is prevented or arrested by iodine administration. The iodine deficiency

of foods from goitrous regions is indicated by some analyses reported by McClendon, who extensively investigated this matter.

The modern practice of adding sodium iodide to table salt has practically abolished dietary deficiency of iodine. Some cities in goitrous regions add a trace of iodide to the water supply during the process of its purification.

Fluorine. Bone contains about 0.02 per cent of fluorine (increasing with age), and enamel of the teeth contains 0.01 to 0.015 per cent. Traces of fluorine have been found in other tissues. Blood is reported to contain 0.027 to 0.074 mg. per cent. Some surprising discoveries of recent years have shown significant effects of fluorine. A peculiar condition of the teeth described as mottled enamel is endemic in regions where drinking water contains about 2 parts per million or more of fluorine. This is in excess of the usual trace. Even in regions where the drinking water contains only 1 part per million, 10 per cent of persons who have used it throughout infancy and childhood are reported to show slight mottling of the enamel. In severe cases the surfaces of teeth have many chalky white patches and the enamel is often pitted and corroded. The condition is fairly prevalent in many regions. In the United States, for example, some 400 communities have been discovered where fluorine in drinking water is associated with varying degrees of incidence of mottling. The disease is technically termed *fluorosis*. A human case has been reported where it appeared to involve skeletal defects. Bone injuries were found in sheep on a ration containing 1.5 parts per million of fluorine. The defects increased in severity with increase in fluorine content of the food. Mottled nails may also be a symptom of fluorosis in man.

In spite of these undesirable effects of fluorine, its normal occurrence in teeth suggests that it contributes to physiological properties of structure such as the hardness of enamel. In agreement with this idea are results of statistical studies on populations and of experiments on rats. Unfortunately, difficulties involved in preparation of a fluorine-free diet have not yet been overcome so that the indispensability of fluorine in nutrition cannot be regarded as fully established. Nevertheless, there seems little doubt but that dental caries is more prevalent among people of all ages who live in regions affording extremely low fluorine in drinking water than among those in areas supplying slightly larger amounts. Rat experiments yield similar results although most investigators find that the level of fluorine intake affording unequivocal protection for teeth is higher than that causing fluorosis in man. But it is also found that rats reared on a diet very low in fluorine show a greatly increased susceptibility to tooth decay as compared with controls on a normal diet.

The mechanism of the protective fluorine effect has been investigated with results suggesting that it may be either or both of the following: (1) Fluorine from the blood incorporated in enamel improves its structure and resistance to decay, which might be especially important during growth and maturation of teeth; or (2) fluorine in the mouth so alters bacterial metabolism and perhaps enzyme action that attack of fermentation acids upon enamel is reduced. The relative importance of these two mechanisms and even their validity remain to be established.

Enthusiasm for the addition of small amounts of fluoride to the drinking water of communities lacking the usual amount of fluoride has been dampened by the conflicting results of research. The practice, although tried in a few cases, has not been permanently adopted. The danger of excessive fluorine intake must be considered. In addition to fluorosis many cases of fluorine poisoning are on record. For example, the accidental inclusion of a fluoride-containing insecticide (mistaken for dried milk) in a meal affected 263 people, of whom 47 died. Inasmuch as fluorine can accumulate in the body its intake even at low levels might be dangerous.

Silicon, which, like fluorine, is found in larger concentration in bones and teeth than in other tissues (except hair), does not seem to be required in amounts beyond that supplied by foods. Nearly all foods contain traces of this element.

Manganese. The nutritional indispensability of manganese has been demonstrated chiefly by the work of McCollum and his associates. Because of the widespread occurrence of traces of this element in nature and the extreme smallness of the estimated requirement, the demonstration of effects of its deficiency is extraordinarily difficult. It has been possible, however, to prepare diets practically manganese free. They have been used in experiments on rats, mice and chicks. The resulting nutritive failures include stunted growth, poor reproductive performance (sometimes sterility), and testicular degeneration in rats, and a type of bone deformity (chondrodystrophia), and slipped tendon (perosis) in chicks. Slipped tendon (p. 211), interfering with walking and perching, is believed to be the result of a deficiency of phosphatase activity. Manganese is known to be an activator of some of the phosphatases, the activity of which shows a relationship to the amount of manganese in the diet. It also activates arginase and dipeptidase of animal tissues and laccase of plants.

Although reports from different laboratories are somewhat conflicting, the balance of evidence clearly indicates that this metal is indispensable for both plants and animals. If so, it must function in a catalytic manner inasmuch as its amount in tissues is very small. Its concentra-

tion in blood is estimated to be 0.15 parts per million. Most of this is in erythrocytes. Slightly higher concentrations are found in some tissues, *e.g.*, liver and bone. There is no marked tendency toward accumulation of manganese unless it is fed at unphysiologically high levels. It is excreted more freely by the liver than by the kidneys. Excessive manganese intake in rats is reported to retard growth and to induce rickets. The latter effect is attributable to bone decalcification by hyperactivity of phosphatase.

Zinc. Like manganese, zinc is widely distributed in organisms. In mammals the blood contains about 0.6 mg. per cent with more in the corpuscles than in plasma. Bone (about 10 mg. per cent) and teeth (about 25 mg. per cent) are accumulators of this metal. Liver, kidney, and spleen (4.5 to 6 mg. per cent) are intermediate, and other organs contain smaller concentrations (0.8 to 2.5 mg. per cent). Tissues of marine animals have a relatively high content of zinc. Oysters, for example, contain 40 mg. per cent. It is also found in plant structures, and foods of plant origin (cereals, fruits, vegetables) are fair dietary sources. Milk contains less than 1 mg. per cent.

Zinc is indispensable. Symptoms of its deficiency in rats include growth stunting and "hyperirritability." Zinc is a component of insulin (p. 432), which contains 0.5 per cent, and of the enzyme, carbonic anhydrase (p. 226), which contains 0.33 per cent. Beyond these facts, little is known about its functions. Injections of radioactive zinc have been tried on dogs and mice. Traced in the body, it is found to be absorbed by the intestinal mucosa and carried in the blood plasma. Considerable amounts are removed from the plasma by the pancreas, and part of this is excreted in pancreatic juice. Other studies have shown a decreased concentration of zinc in the diabetic pancreas as compared with the normal.

Zinc is excreted chiefly in feces but, unlike copper, manganese, and some other metals, it is not put out by the liver via bile to any significant extent. Like calcium it is excreted largely by the intestinal mucosa.

While the zinc content of the animal body (about 2.2 g. in the human adult) is larger than that of the trace elements, the requirement is readily met by all ordinary diets. For children an estimate of the requirement is 0.3 mg. per day per kg. of body weight. Diets, so far as they have been analyzed for their zinc content, are found to yield more than 12 mg. per day. Supply of zinc is not a practical problem of dietetics, and human deficiencies are not known to occur.

Dispensable Trace Elements. More than 20 inorganic chemical elements, in addition to those discussed above, have been detected in animal tissues. The presence of these elements appears to be "acci-

dental" in the sense that they are without apparent function. Most of them are regular constituents of plant structures and so gain entrance directly or indirectly into animals. A number of them occur in amounts so small as to escape detection by methods of chemical analysis and are determined spectroscopically. Like the indispensable elements (copper, cobalt, etc.) these dispensable ones are referred to as "trace" elements. Inasmuch as they have no known food value and apparently are not dietetic requirements, discussion of them (Chap. XIX) is deferred.

A few of these elements are sufficiently toxic to be dangerous even in the small amounts in which they occur in foods. A conspicuous case is that of selenium. In certain localities, in South Dakota and Wyoming, the selenium of the soil is sufficient to make plants grown upon it highly toxic to man and domestic animals.

Vitamin Requirements. The occurrence of vitamins in foods and the requirements of man and of animals were discussed in Chap. VI. The recommended dietary allowances for the six vitamins which prevent the major human avitaminoses are given in Table 67.

The exact computation of the vitamin content of diets is difficult because of the variability of the amount of the vitamins in foods. This is due to the effects of soil, climate, and methods of cultivation upon vegetable foods and to the effects of aging, methods of handling, preparing, and cooking of all foods. Such uncertainties are among the reasons for the recommendation of liberal allowances of vitamins.

Milk. The high nutritive value of milk may be inferred from its adequacy as the sole food of the mammal during the critical period of early growth. Its more significant nutritive values are, specifically,

1. The quality of milk proteins is superior. A normal growth rate of the young rat can be maintained with a lower intake of milk proteins than of many other proteins or protein combinations which have been similarly tested. The concentration of protein in milk (p. 551) is also advantageous.

2. The balanced relations between protein, fat, and carbohydrate of milk appear to be advantageous.

3. Milk fats yield the indispensable fatty acids, linoleic and arachidonic.

4. Calcium and phosphorus in milk furnish an adequate, well-utilized, and correctly proportioned supply of these minerals which, although especially important for ossification and dentition during growth, are also important for adult nutrition.

5. Milk is a good source of vitamin A and a somewhat less satisfactory source of other vitamins.

While milk is justly regarded as one of the most, and possibly the most, valuable of the protective foods, its use (as of any good thing)

may be overdone. There is a growing conviction among students of nutrition that children at certain ages may develop the habit of milk drinking to a point where the appetite is diminished and the consumption of foods which can make good the nutritive deficiencies of milk is too small. Such children are apt to indulge in candy and other carbohydrate-rich foods so that the cause of their poorly nourished condition cannot often be attributed beyond question to overconsumption of milk.

It is true, however, that milk is nutritively deficient for a mammal after the normal weaning time. An especially notable deficiency is due to the low iron content (about 0.04 mg. per cent in cow's milk) which is quite inadequate when milk is the only food. This is not serious for the normal infant which, at birth, has a reserve store of iron estimated to be at least 175 mg. in addition to that in hemoglobin and muscle. As the major part of this "reserve" is accumulated during the latter part of gestation, premature infants are in need of iron-containing supplements to milk at an earlier age than are full-term babies. Even the normal infant may largely exhaust its iron reserve in about 6 months, after which gradually increasing amounts of foods containing iron (egg yolk, meat juices, certain fruits and vegetables) are required. Milk is also deficient in thiamine and is usually a poor source of ascorbic acid. It is almost entirely lacking in vitamin D unless fortified by exposure to ultraviolet light, addition of a vitamin D concentrate, or by feeding the cows a fortified ration. Milk shares the latter deficiency, however, with all ordinary foods. Only fish-liver oils (p. 202) are rich sources. This seeming anachronism of natural adaptation is only apparent inasmuch as exposure to sunshine can obviate the need of an abundant source of vitamin D for any animal obtaining calcium and phosphorus in the amounts and proportions found in milk or in mixtures of natural foods. Experiments show that milk fats are not superior in nutritive value to those of vegetable fats such as are used in commercial oleomargarine.

Milk is an important source of minerals. Aside from the NaCl added to foods, milk consumed in recommended amounts furnishes about 40 per cent of the minerals of the common foods of man. This may be contrasted with cereals, which are estimated to supply about 15 per cent of the minerals.

The varying composition of different kinds of milk is indicated in Table 72. All of the milks tabulated are used as human food. Obviously reindeer milk is used only in restricted areas, *e.g.*, in Lapland. Other milks used by man include that of the ass, mare, buffalo, and camel. Dairying and the processing and distribution of canned and dried milk have so developed in recent decades that cow's milk has become the chief substitute for human milk.

Variation in the composition of cow's milk is considerable, depending upon the breed and the state of lactation. Some breeds give milk low in fat content (Holstein milk is often as low as 2.5 per cent); other breeds, such as Jerseys and Guernseys, are characterized by fat-rich milk, often more than 6 per cent fat. Milk under modern conditions of marketing

TABLE 72.—AVERAGE COMPOSITION OF THE MILK OF DIFFERENT SPECIES¹

Kind of milk	Water	Protein	Fat	Lactose	Mineral matter (ash)	Fuel value per 100 g.
	per cent	per cent	per cent	per cent	per cent	Cal.
Human.	87.5	1.4	3.7	7.2	0.2	68
Cow.	87.0	3.5	3.9	4.9	0.7	69
Goat.	87.0	3.3	4.2	4.8	0.7	70
Sheep.	82.6	5.5	6.5	4.5	0.9	99
Reindeer.	63.7	10.3	19.7	4.8	1.5	238

¹ Compiled by Food Composition Section, Bureau of Home Economics.

is generally a mixture of the product of large herds or many herds so that, commercially, milk is relatively constant in composition. The effect of the state of lactation is indicated, in the case of human milk, in Table 73. It will be seen that, while lactose is relatively constant, protein and inorganic substances are higher during earlier periods than in later ones,

TABLE 73.—THE COMPOSITION OF HUMAN MILK AT DIFFERENT PERIODS
The values given are approximate averages

State of lactation	Protein	Fat	Sugar	Ash
	per cent	per cent	per cent	per cent
Colostrum period, first 10 days.	2.25	2.83	7.59	0.31
Transition period, 10-30 days.	1.56	4.37	7.74	0.24
Mature period, 1-9 months.	1.15	3.26	7.50	0.21
Late period, 10-20 months.	1.07	3.16	7.47	0.20

thus providing for rapid early growth rates. There is also considerable change in milk composition during a single nursing or milking with a tendency to progressive increase in fat, protein, and total solids.

Colostrum, the secretion of the mammary gland just before parturition and during the first 2 to 3 days of a lactation period, differs somewhat from ordinary milk. It is higher in protein and inorganic constituents and lower in water content and has a yellow color. The protein includes

a relatively high proportion of globulin, with much of it of the euglobulin type similar to that of blood serum. The globulin content is sufficient to make colostrum heat coagulable in contrast to milk which does not coagulate on boiling. Human and cow's colostrum are much richer (2 to 10 times) than the milk in content of vitamin A. Colostrum has a laxative effect on the young mammal.

Modification of cow's milk to improve it as a suitable substitute for human milk is made in accordance with any of a number of formulas. The underlying principles are (1) dilution to make the proteins and inorganic constituents more nearly equal to human milk, and (2) addition of sugar (lactose, dextrimaltose, or even sucrose) to increase the carbohydrate content. Addition of cream to the diluted milk is a less common practice. The use of canned condensed milk to which sugar has already been added requires only dilution. Pediatricians have stressed the conviction that no substitute is as desirable as mother's milk. Differences in digestibility are stressed more than those in nutritive value.

Milk inspection by governmental agencies involves both chemical and bacteriological analyses. The standards set for chemical composition differ in different localities but all are designed to prevent skimming and watering of the milk. Bacteriological standards are even more important because milk is a potentially effective carrier of pathogenic bacteria. Production and marketing of raw (not pasteurized) milk of high purity, such as certified milk with not more than 10,000 bacteria per ml., require extraordinary precautions in hygiene of the herd and the dairy and in protection, refrigeration, and speedy delivery of the milk. Pasteurization (mild heating) to destroy pathogenic bacteria is an almost universal practice. Significant improvements in this technique have been achieved. They include (1) the use of containers which avoid contact of the milk with any metal which catalytically hastens oxidative destruction of vitamins, and (2) the use of the optimum combination of temperature and duration of heating. Details of milk inspection and techniques of milk production and handling are to be found in manuals on the subject.

Soybeans and Other Legumes. The legumes occupy a special place among the nutritionally valuable plants. They fix atmospheric nitrogen because of the symbiotic relations between their roots and the root-nodule-forming bacteria which carry on nitrogen fixation. Leguminous plants are thus enabled to become accumulators of protein and among vegetable foods may be regarded as the most important source of protein. They afford protein of high nutritive value at low cost. It is not without reason that beans have long been called "the poor man's

meat." Both beans and peas furnish high quality of protein and are also important sources of vitamins and minerals. There may be some need of supplements as indicated by a report in the use of the Alaska field pea as the sole source of protein for the young rat. If subjected to prolonged cooking or to high heat, the peas required supplementation with a small proportion of cystine or methionine to make the protein adequate. This is explained as due to a low content of methionine which is adequate in raw peas because of the "sparing" action of cystine (p. 501) on the methionine requirement. The cystine, however, appeared to be destroyed by the heating.

Among the various legumes, soybeans (soyas or soya beans) deserve especial comment. Prolific and agriculturally profitable, they have long been an important food in parts of the Orient, especially in China. Soybeans are good sources of fat (6.5 per cent of the fresh and 18.1 per cent of the dried bean). After extraction of the oil, which is a valuable commercial product, soybean flour is prepared. The protein content (12.5 per cent of the fresh and 35 per cent of the dried beans) renders them of high nutritive value. One of the proteins, glycinin, is nutritively complete, ranking with milk and egg proteins, and the entire protein content furnishes high quality at low cost. Soybeans are also significant sources of vitamins of the B-group and of minerals, especially iron, phosphorus, and calcium. Fast becoming a favored crop on American farms, soybeans bid fair to be increasingly near to attainment of the prominent place they deserve in our diets.

Cereal Foods. Cereal grains supply so large a part of the food of man and domestic animals that they are a mainstay of nutrition. Listed in approximately decreasing order of the amounts used by mankind, they are rice, wheat, maize, oats, rye, barley, sorghum, buckwheat, millet, and spelt. Rice probably affords more than 70 per cent of the calories consumed by nearly 50 per cent of the human race. Wheat is the most important cereal in human diets in North America and in many parts of Europe. It is estimated that 25 per cent of the calories of the food of the population of the United States is supplied by wheat. Corn (maize) is also important, although it is used more as a food for domestic animals than for man. Oatmeal is not used to the extent which its nutritive value (protein, thiamine, and mineral content) warrant.

As wheat is used much more in the form of flour than in other forms, the nutritive value of flour is a significant factor in our nutrition. If the entire grain were consumed, a number of dietary problems would be solved or at least partially solved. The milling process to produce white flour removes the germ and bran. This slightly depletes the nutritive quality of the protein, reduces the content of calcium, phosphorus, iron, and

other minerals, and seriously robs the wheat of its vitamins (Table 74). One might suppose that the obvious remedy is to modify the milling of wheat, and indeed some improvement in human diets has been attained by making bread and breakfast cereals of entire wheat and by milling flour only to a degree which removes less of its nutritive value. Unfortunately, however, some people are unable to use entire wheat because of irritation of the digestive system by the bran, and an unwarranted

TABLE 74.—COMPOSITION OF WHITE FLOUR, "ENRICHED" WHITE FLOUR, AND WHOLE WHEAT FLOUR
Compiled by Lepkovsky, *Physiol. Rev.*, 24, 272, 1944

	White flour	"Enriched" white flour	Whole wheat flour
Thiamine, mg. per lb.	0.3	1.7	2.3
Riboflavin, mg. per lb.	0.15	1.2	0.6
Nicotinic acid, mg. per lb.	3.5	6.0	26.0
Pyridoxine, mg. per lb.	1.0	1.0	2.0
Pantothenic acid, mg. per 100 g.	2.5	2.5	5.0
Carotene (provitamin A), mg. per lb.	1.5
α -Tocopherol (vitamin E), mg. per lb.	1.4
Fat, per cent.	1.2	1.2	2.4
Protein, per cent.	11.0 ¹	11.0 ¹	12.7 ²
Calcium, per cent.	0.02	0.02	0.045
Phosphorus, per cent.	0.092	0.092	0.423
Iron, mg. per lb.	3.0	6.0	20.0
Manganese, g. per 750 Cal.	0.1	0.1	6.7
Potassium, per cent.	0.115	0.115	0.473
Copper, g. per 750 Cal.	0.40	0.40	1.6
Ash, per cent.	0.37	0.37	1.70

¹ Low quality.

² High quality.

preference for bread made with refined flour is widely prevalent. Furthermore, only highly milled flour has the keeping qualities which favor prolonged storage.

Fortification of bread and flour is a modern answer to the problem. A simple, time-honored, but relatively expensive method is to make bread with milk instead of water and to use a generous amount of yeast with high content of the B-group of vitamins. Added vitamin D concentrates have been occasionally used. None of these devices, however, corrects the iron deficiency of the bread. Fortification of the flour itself can restore some, at least, of the food values removed by milling. This

has been made permissible and has been defined by the proper Federal government authorities. Enriched flour contains in each pound

2.0 to 2.5 mg. thiamine
1.2 to 1.5 mg. riboflavin
16.0 to 20.0 mg. niacin
13.0 to 16.5 mg. iron (Fe)

Enrichment by these additions is relatively inexpensive and seems worthy of universal adoption. It should be noted, however, that the product is "enriched" only in comparison with refined flour and still lacks some of the nutritive values of whole-wheat flour.

Use of Vitamin and Mineral Concentrates. Preparations of vitamins, artificially synthesized or concentrated from natural sources, are widely available as are also mineral supplements to the diet. They are largely used, often without medical prescription. For persons on restricted diets, as in cases of peptic ulcer or certain other digestive disturbances and in some other cases of abnormal or pathological states, the food regimen may be such that it definitely requires these supplements. It should be apparent, however, that the majority of people could use a diet which would be adequate without them. If the diet regularly includes foods in the natural or comparatively "unsophisticated" state, raw salads, fresh fruits, whole wheat, milk, etc., every nutritional requirement will be met. One of the penalties of civilization is abundance and cheapness of refined flour and sugar. On the other hand, modern transportation and refrigeration have made fresh foods available in great variety under normal conditions.

The complete requirements of nutrition and the optimal amounts of some essentials are not fully determined. It would seem, therefore, that the day of the synthetic diet has not yet arrived and the products of the farm and orchard are still more valuable as human food than are those of the chemical factory.

Moreover, several groups of investigators have reported that if a diet is adequate in its content of nutrients from natural sources, the addition of vitamin supplements affords no measurable improvement in strength, resistance to fatigue, or other general aspects of good health.

REFERENCES

An especially good introduction to the study of this subject is "Nutrition: The Chemistry of Life" by L. B. Mendel, New Haven, 1923.

The books referred to in connection with metabolism: Lusk's "Science of Nutrition" and McCollum's "Newer Knowledge of Nutrition" are again recommended.

Other useful books are "The Chemistry of Food and Nutrition" by H. C. Sherman, 7th ed., New York, 1947; "The Fundamentals of Nutrition" by E. E. Hawley, Springfield, Ill., 1940; and "The Foundations of Nutrition" by M. S. Rose, 3d ed., New York, 1937.

In more popular vein is Mrs. Rose's "Feeding the Family," 4th ed., New York, 1940.

On the composition of food see "Proximate Composition of American Food Materials" by C. Chatfield and G. Adams, *U.S. Dept. Agr. Circ.* 549, 1940, and *Misc. Pub.* 572.

A standard and still useful work on protein requirements is "Physiological Economy in Nutrition" by R. H. Chittenden, New York, 1905.

The relationship of agriculture and economics to food problems is presented in "Changes in the Food Supply and Their Relation to Nutrition" by L. B. Mendel, New Haven, 1916.

Of many books on milk, "The Most Nearly Perfect Food: The Story of Milk" by S. J. Crumrine and J. A. Tobey, Baltimore, 1929, is recommended.

"Advances in Food Research" edited by E. M. Mrak and G. F. Stewart, New York, Vol. I, 1948, and Vol. II, 1949, should be useful as a survey.

Of the following reviews, some deal with the broader aspects of nutrition and some with specialized problems.

CLAUSEN, S. W., The Influence of Nutrition upon Resistance to Infection, *Physiol. Rev.*, 14, 309, 1934.

DAVIDSON, L. S. P., and LEITCH, I., The Nutritional Anemias of Man and Animals, *Nutr. Abs. & Revs.*, 3, 901, 1934.

ELVEHJEM, C. A., The Biological Significance of Copper and Its Relation to Iron Metabolism, *Physiol. Rev.*, 15, 471, 1935.

FENN, W. O., The Role of Potassium in Physiological Processes, *Physiol. Rev.*, 20, 377, 1940.

HART, E. B., and ELVEHJEM, C. A., Mineral Metabolism, *Ann. Rev. Biochem.*, 5, 271, 1936.

HOPKINS, F. G., Nutrition and Human Welfare, *Nutr. Abs. & Revs.*, 1, 3, 1931.

JOLLIFFE, N., and MOST, R. M., The Appraisal of Nutritional States, *Vitamins and Hormones*, 1, 60, 1943.

LANFORD, C. S., and SHERMAN, H. C., Nutrition, 1941 and 1942, *Ann. Rev. Biochem.*, 12, 397, 1943.

LEPKOVSKY, S., The Bread Problem in War and in Peace, *Physiol. Rev.*, 24, 239, 1944.

MCCLENDON, J. F., The Distribution of Iodine with Special Reference to Goiter, *Physiol. Rev.*, 7, 189, 1927.

MCCANCE, R. A., and WIDDOWSON, E. M., Mineral Metabolism, *Ann. Rev. Biochem.*, 13, 315, 1944.

McHENRY, E. W., and LEESEN, H. J., Nutrition, *Ann. Rev. Biochem.*, 16, 401, 1947.

ROSE, M. S., The Nutritional Significance of Some Mineral Elements Occurring as Traces in the Animal Body, *Yale J. Biol. Med.*, 4, 499, 1932.

STARE, F. J., HEGSTED, D. M., and MCKIBBIN, J. M., Nutrition, *Ann. Rev. Biochem.*, 14, 431, 1945.

SCHULTZE, M. O., Metallic Elements and Blood Formation, *Physiol. Rev.*, 20, 37, 1940.

SEBRELL, W. H., Nutrition, *Ann. Rev. Biochem.*, 13, 441, 1944.

STIEBELING, H. K., and LEVERTON, R. M., Nutrition, *Ann. Rev. Biochem.* 10, 423, 1941.

UNDERWOOD, E. J., The Significance of the "Trace Elements" in Nutrition, *Nutr. Abs. & Revs.*, 9, 515, 1940.

VON OETTINGEN, W. F., Manganese: Its Distribution, Pharmacology and Health Hazards, *Physiol. Rev.*, 15, 175, 1935.

VAN VEEN, A. G., Nutrition, *Ann. Rev. Biochem.*, 11, 391, 1942.

Papers representative of most of the active fronts where progress is being made in nutritional research are included in the following list. Some of the papers deal with comparatively recent advances in fields not actively explored at present.

ASCHAM, L., A Study of Iron Metabolism with Preschool Children, *J. Nutrition*, 10, 337, 1935.

AUSTONI, M. E., and GREENBERG, D. M., Studies in Iron Metabolism with the Aid of Its Artificial Radioactive Isotope: The Absorption, Excretion, and Distribution of Iron in the Rat on Normal and Iron-deficient Diets, *J. Biol. Chem.*, 134, 27, 1940.

BEDFORD, C. L., and MCGREGOR, M. A., Dehydroascorbic Acid in Frozen and Cooked Frozen Vegetables, *Science*, 107, 251, 1948.

BELSER, W. B., HAUCK, H. M., and STORVICK, C. A., A Study of the Ascorbic Acid Intake Required to Maintain Tissue Saturation in Normal Adults, *J. Nutrition*, 17, 513, 1939.

BING, F. C., SAURWEIN, E. M., and MYERS, V. C., Hemoglobin Production and Iron and Copper Metabolism with Milk of Low Copper Content, *J. Biol. Chem.*, 107, 343, 1934.

BOSWORTH, A. W., Studies of the Fat of Human Milk, *J. Biol. Chem.*, 106, 235, 1934.

BROWN, H. B., SHOHL, A. T., et al. The Effect of Various Levels and Ratios of Calcium to Phosphorus in the Diet upon the Production of Rickets, *J. Biol. Chem.*, 98, 207, 1932.

BUTLER, A. M., and CUSHMAN, M., Distribution of Ascorbic Acid in the Blood and Its Nutritional Significance, *J. Clin. Investigation*, 19, 459, 1940.

CHELDELIN, V. H., and WILLIAMS, R. R., Studies of the Average American Diet. II. Riboflavin, Nicotinic Acid and Pantothenic Acid Content, *J. Nutrition*, 26, 417, 1943.

CHON, T. P., and ADOLPH, W. H., Copper Metabolism in Man, *Biochem. J.*, 29, 476, 1935.

COULSON, E. J., The Iodine Content of Some American Fishery Products, Investigational Report No. 23, *Bur. Fisheries, U.S. Dept. Commerce*, 1935.

- COWGILL, G. R., Vitamin Deficiencies and the Nervous System: A Consideration of the Contributions of Animal Experimentation, *Yale J. Biol. Med.*, **12**, 205, 1940.
- DANIELS, A. L., and EVERSON, G. J., The Relation of Manganese to Congenital Debility, *J. Nutrition*, **9**, 191, 1935.
- DANIEL, E. P., and MUNSELL, H. E., Vitamin Content of Foods, *U.S. Dept. Agr., Misc. Publ.* 275, 1937.
- DANIELS, A. L., HUTTON, M. K., KNOTT, E. M., WRIGHT, O. E., EVERSON, G. J., and SCOUJAR, F., A Study of the Protein Needs of Pre-school Children, *J. Nutrition*, **9**, 91, 1935.
- DAY, H. G., and MCCOLLUM, E. V., Mineral Metabolism, Growth, and Symptomatology of Rats on a Diet Extremely Deficient in Phosphorus, *J. Biol. Chem.*, **130**, 269, 1939.
- DENHAM, H. G., and GORTNER, R. A., Cobalt—An Essential Element, *Science*, **85**, 382, 1937.
- DIXON, J. K., The Use of Cobaltized Salt Lick in the Control of a Lamb Ailment at Norton Mains, Southland, New Zealand, *J. Sci. Tech.*, **18**, 892; *Chem. Abs.*, **31**, 8013, 1937.
- DUCKWORTH, T., GODDEN, W., and WARNOCK, G. M., The Effect of Acute Magnesium Deficiency on Bone Formation in Rats, *Biochem. J.*, **34**, 97, 1940.
- DURKEE, M. M., Soybean Oil in the Food Industry, *Ind. Eng. Chem.*, **28**, 898, 1936
- FENTON, F., TRESSLER, D. K., CAMP, S. C., and KING, C. G., Losses of Vitamin C During the Cooking of Swiss Chard, *J. Nutrition*, **14**, 631, 1937.
- FINCKE, M. L., and SHERMAN, H. C., The Availability of Calcium from Some Typical Foods, *J. Biol. Chem.*, **110**, 421, 1935.
- GRULEE, C. G., SANFORD, H. N., and HERRON, P. H., Breast and Artificial Feeding. Influence on Morbidity and Mortality of Twenty Thousand Infants, *J. Am. Med. Assoc.*, **103**, 735, 1934.
- HAAG, J. R., and PALMER, L. S., The Effect of Variations in the Proportions of Calcium, Magnesium, and Phosphorus Contained in the Diet, *J. Biol. Chem.*, **76**, 367, 1928.
- HART, E. B., and STEENBOCK, H., At What Level Do the Proteins of Milk Become Effective Supplements to the Proteins of a Cereal Grain? *J. Biol. Chem.*, **42**, 167, 1920.
- HARTE, R. A., and TRAVERS, J. J., Human Amino Acid Requirements, *Science*, **105**, 15, 1947.
- HILDITCH, T. P., and THOMPSON, H. M., The Effect of Certain Ingested Fatty Oils upon the Composition of Cow Milk Fat, *Biochem. J.*, **30**, 677, 1935.
- HILDITCH, T. P., and MADDISON, L., The Component Acids of Phosphatides Present in Cow's Milk Fat, *Biochem. J.*, **35**, 24, 1941.
- HOLMES, A. D., TRIPP, F., WOELFFER, E. A., and SATTERFIELD, G. H., The Influence of Pasteurization on the Ascorbic Acid Content of Certified Milk, *J. Am. Dietet. Assoc.*, **15**, 363, 1939.
- HOPKIRK, C. S. M., and GRIMMETT, R. E. R., Importance of Cobalt. Relationship to the Health of Farm Animals, *New Zealand J. Agr.*, **56**, 21, 1938; *Chem. Abs.*, **32**, 4198, 1938.
- HUBBELL, R. B., MENDEL, L. B., and WAKEMAN, A. J., A New Salt Mixture for Use in Experimental Diets, *J. Nutrition*, **14**, 273, 1937.
- JARVIS, B. W., Milk Sugar in Infant Feeding, *Am. J. Diseases Children*, **40**, 993, 1930.
- JOHNS, C. O., and FINKS, A. J., The Nutritive Value of Soy Bean Flour as a Supplement to Wheat Flour, *Am. J. Physiol.*, **55**, 455, 1921.
- JOHNS, C. O., and FINKS, A. J., The Role of Cystine in Nutrition as Exemplified by Experiments with the Proteins of the Navy Bean, *Phaseolus Vulgaris*, *J. Biol. Chem.*, **41**, 379, 1920.
- JONES, D. B., FINKS, A. J., and JOHNS, C. O., Nutritive Values of Mixtures of Proteins from Corn and Various Concentrates, *J. Agr. Research*, **24**, 971, 1923.
- KAO, H. C., CONNER, R. T., and SHERMAN, H. C., The Availability of Calcium from Chinese Cabbage, *J. Biol. Chem.*, **123**, 221, 1938.
- KELLIE, A. E., and ZILVA, S. S., The Vitamin C Requirements of Man, *Biochem. J.*, **33**, 153, 1939.
- KING, C. G., and MENTEN, M. L., The Influence of Vitamin C upon the Resistance to Diphtheria Toxin, *J. Nutrition*, **10**, 129, and 141, 1935.
- KOEHLE, A. E., RAPP, I., and HILL, E., The Nutritive Value of Lactose in Man. *J. Nutrition*, **9**, 715, 1935.
- KRUSE, H. D., SCHMIDT, M. M., and MCCOLLUM, E. V., Changes in the Mineral Metabolism of Animals Following Magnesium Deprivation, *J. Biol. Chem.*, **106**, 553, 1934.
- MABEE, D., and MORGAN, A. F., Evaluation of Six Standard Proteins by Growth of Young Dogs, *Federation Proc.*, **8**, 221, 1949.
- MASON, I. D., and PALMER, L. S., Utilization of Gelatin, Casein and Zein by Adult Rats, *J. Nutrition*, **9**, 489, 1935.
- MCCLENDON, J. F., Results of Goiter Prophylaxis with Iodized Salt, *Science*, **81**, 381, 1935.
- MCINTOSH, J. A., TRESSLER, D. K., and FENTON, F., The Effect of Different Cooking Methods on the Vitamin C Content of Quick-frozen Vegetables, *J. Home Econ.*, **32**, 692, 1940.
- MELLANBY, M., and KING, J. D., Vitamins and Dental Caries, *Ergeb. d. Einz. u. Horm. Forschung*, **2**, 1, 1939.
- MENDEL, L. B., and HUBBELL, R. B., Relation of Rate of Growth to Diet. III, *J. Nutrition*, **10**, 557, 1935.

- MENDEL, L. B., Nutrition and Growth, The Harvey Lectures, Series of 1914-1915, 101, and *J. Am. Med. Assoc.*, 64, 1539, 1914.
- MITCHELL, H. H., and SMUTS, D. B., The Amino Acid Deficiencies of Beef, Wheat, Corn, Oats, and Soy Beans for Growth in the White Rat. *J. Biol. Chem.*, 95, 263, 1932.
- NEAL, W. M., and AHMANN, C. F., Cobalt as an Essential Element in Animal Nutrition, *Science*, 86, 225, 1937.
- NEWBURGH, L. H., and CURTIS, A. C., Production of Renal Injury in the White Rat by the Protein of the Diet: Dependence of the Injury on the Duration of Feeding and on the Amount and Kind of Protein. *Arch. Internal Med.*, 42, 801, 1928.
- NEWELL, J. M., and MCCOLLUM, E. V., Studies on the Role of Zinc in Nutrition, *J. Nutrition*, 6, 289, 1933.
- NEWMAN, K. R., and FELLERS, C. R., Vitamin C in Packaged Food Purchased in Retail Markets, *J. Am. Dietet. Assoc.*, 16, 695, 1940.
- ORENT, E. R., and MCCOLLUM, E. V., Effects of Deprivation of Manganese in the Rat, *J. Biol. Chem.*, 92, 651, 1931.
- PITTMAN, M. S., The Utilization by Human Subjects of the Nitrogen, Calcium, and Phosphorus of the Navy Bean with and without a Supplement of Cystine, *J. Nutrition*, 5, 277, 1932.
- SCOULAR, F. I., A Quantitative Study by Means of Spectrographic Analysis of Zinc in Nutrition, *J. Nutrition*, 17, 103, 1939.
- SEBRELL, W. H., Nutritional Diseases in the United States, *J. Am. Med. Assoc.*, 115, 851, 1940.
- SHERMAN, H. C., and CAMPBELL, H. L., Improvement in Nutrition Resulting from an Increased Proportion of Milk in the Diet, *J. Biol. Chem.*, 60, 5, 1924.
- SHERMAN, H. C., and MACLEOD, F. L., Relation of Vitamin A to Growth, Reproduction and Longevity, *J. Am. Chem. Soc.*, 47, 1658, 1925.
- SHERMAN, H. C., Calcium and Phosphorus Requirements of Human Nutrition, *U.S. Dept. Agr. Yearbook*, "Food and Life," 187, 1939.
- SHERMAN, H. C., Calcium Requirement for Maintenance in Man, *J. Biol. Chem.*, 44, 21, 1920.
- SHERMAN, H. C., CAMPBELL, H. L., and LANFORD, C. S., Experiments on the Relation of Nutrition to the Composition of the Body and the Length of Life, *Proc. National Acad. Science*, 25, 16, 1939.
- SHERMAN, H. C., Phosphorus Requirement of Maintenance in Man, *J. Biol. Chem.*, 41, 173, 1920.
- SHIELDS, J. B., FAIRBANKS, B. W., BERRYMAN, G. H., and MITCHELL, H. H., The Utilization of Calcium in Carrots, Lettuce, and String Beans in Comparison with the Calcium in Milk, *J. Nutrition*, 20, 263, 1940.
- SKINNER, J. T., VAN DONK, E., and STEENBOCK, H., Manganese as a Factor in Reproduction, *Am. J. Physiol.*, 101, 591, 1932.
- SMITH, H. V., SMITH, M. C., and FOSTER, E. O., Mottled Enamel in the Salt River Valley and the Fluorine Content of the Water Supplies, *Arizona Agr. Exptl. Sta. Tech. Bull.*, 61, 373; *Child Development Abs.*, 11, 33, 1936.
- STIEBELING, H. K., and CLARK, F., Planning for Good Nutrition, *U. S. Dept. Agr. Yearbook*, "Food and Life," 321, 1939.
- STIEBELING, H. K., and COONS, C. M., Present-day Diets in the United States, *U. S. Dept. Agr. Yearbook*, "Food and Life," 296, 1939.
- STIEBELING, H. K., Iron Contents of Fruits and Vegetables, *U. S. Dept. Agr., Circ.* 205, 1932.
- STIRN, F. E., ELVEHJEM, C. A., and HART, E. B., The Indispensability of Zinc in the Nutrition of the Rat, *J. Biol. Chem.*, 109, 347, 1935.
- TOVERUD, G., The Influence of Diet on Teeth and Bones, *J. Biol. Chem.*, 58, 583, 1923.
- VAN HORN, A. L., Chronic Endemic Dental Fluorosis in Ohio, *Ohio, Conf. Water Purif.*, 16th Ann. Rept. 1936, 21; *Chem. Abs.*, 31, 8002, 1937.
- WILGUS, H. S., JR., NORRIS, L. C., and HEUSER, G. F., The Role of Manganese and Certain Other Trace Elements in the Prevention of Perosis, *J. Nutrition*, 14, 155, 1937.
- WILLIAMS, R. D., WICKS, L., BIERMAN, H. R., and OLMSTEAD, W. H., Carbohydrate Values of Fruits and Vegetables, *J. Nutrition*, 19, 593, 1940.

CHAPTER XIX

THE CHEMISTRY OF ANIMAL TISSUES

The composition of the major tissues, muscular, nervous, connective, epithelial, etc., has been investigated during more than a century. The only methods available to the earlier workers were those of ordinary macrochemistry and, though developed so as to yield important results, their interpretation was restricted because the methods were not sensitive enough to permit analysis of small amounts of material, such as a single cell, the organelles, or other fragments of a cell. Yet knowledge of the distribution of constituents within the cell, conforming to its organization for vital activity (p. 384), is fundamental to an understanding of metabolism. Modern micromethods have been and are being developed to such an extent that there is a considerable body of knowledge constituting histological chemistry or histochemistry (microchemistry of tissues). Important subdivisions are cytochemistry (chemistry of cells) and the chemistry of embryology. A systematic treatment of histochemistry is beyond the scope of this book, but the student of biochemistry should expect that many important future advances will be made in this field.

The tissues peculiar to each organ or organ system have characteristic composition. The distinguishing feature in each case is *primarily* the nature of its proteins, which aside from water are the chief materials of typical protoplasm and its enzymes. Proteins also predominate in animal intercellular substance. Nonprotein compounds may also be characteristic of a given tissue. A considerable number of the nonprotein substances, however, are widely distributed in various tissues. Preceding chapters have included discussions of significant variations in tissue content of proteins, amino acids, glycogen, glucose, fat, and other lipids together with the intermediary and final products of the metabolism of these nutrients. In this chapter salient features of the more characteristic constituents of the major tissues will be presented.

Water Content of Tissues. The distribution of water between body fluids and tissues is subject to considerable variation due to dynamic equilibrium characterizing water movements. The chief factors affecting them are the relative permeability of membranes which control the

diffusion of osmotically active solutes and the intensity of cellular catabolism, which affects the rate at which relatively large molecules are broken down to smaller ones, thus increasing osmotic pressure in the tissues. Even in the resting state, tissues tend to show parallelism between the rate of oxidative metabolism and the average water content. Approximate values for the latter, as found in a number of tissues and organs, are given in Table 75. It will be noted that the more actively metabolizing structures contain more than 70 per cent of water with lower proportions in the less active ones. The brain as an intact organ presents an apparent exception to this generalization. Its oxidative

TABLE 75.—WATER CONTENT OF TISSUES
Values are approximate averages for adult human organs

	Per Cent		Per Cent
Brain, gray matter.....	84	Liver.....	74
Kidneys.....	81	Pancreas.....	73
Cardiac tissues.....	79	Brain (white matter).....	70
Lungs.....	78	Skin.....	70
Spleen.....	77	Skeleton (entire).....	46
Brain (entire).....	76	Bone (freed from marrow).....	22.5
Skeletal muscles.....	75 ¹	Adipose tissue ²	30
Stomach and intestines.....	75		

¹ Skeletal muscles, composing about 20 per cent of the body weight, contain about 49 per cent of the entire body water.

² Variable over a wide range.

rate, measured in terms of O₂ uptake per unit of weight and of time, is low in proportion to its high water content. This seems to be due to the large amount of white matter (with a low O₂ requirement) in the brain. The O₂ uptake of gray matter, as measured in surviving tissue slices of the cortex of the brain, is higher.

Distribution of Inorganic Constituents. The approximate concentrations of the major inorganic materials are shown for a number of tissues in Table 76. Values are chosen from the relatively small number of analyses available so as to be representative. Not being statistically validated averages, these serve merely to give a rough idea of the relative abundance of certain inorganic salts in the tissues. Differences in water content and in the degree to which the tissue was freed from blood and lymph before sampling affect the results. It must also be understood that, in general, the observed value, especially that for free inorganic phosphate, varies with the state of metabolism, of health, and of nutrition. The distribution of a number of the less abundant and the trace elements was given in Chap. XVIII. The distribution of inorganic constituents between blood plasma and corpuscles (p. 293) was shown in Chap. X.

In addition to the inorganic elements included in Table 76 and the other nutritively indispensable ones discussed in Chap. XVIII, many occur in traces so small that they are usually detectable only by spectroscopic methods. In the absence of knowledge regarding their functional activity, they are generally regarded as mere accidental constituents, which, having gained access to the body, are retained in the tissues and

TABLE 76.—APPROXIMATE CONCENTRATIONS OF CERTAIN INORGANIC CONSTITUENTS OF HUMAN TISSUES

Values are given as per cent of the whole tissue

Organ or tissue	Sodium	Potassium	Magnesium	Calcium	Inorganic phosphate as PO ₄	Chloride	Iron
Adrenals.....	0.04	0.1	0.01	0.016	0.17	0.05	
Brain.....	0.12	0.29	0.012	0.01	...	0.13	0.008
Bone (without marrow).....	0.4	0.13	0.2	18-20	22-25	0.01	
Cartilage.....	0.55	0.24	0.11	0.04	0.31	0.25	
Kidney.....	0.15	0.16	0.02	0.02	0.5	0.2	0.016
Liver.....	0.12	0.21	0.018	0.008	0.13	0.050
Lung.....	0.21	0.15	0.007	0.016	0.26	0.007
Muscle:							
Cardiac.....	0.17	0.27	0.02	0.009	0.45	0.12	0.007
Nonstriated...	0.14	0.14	0.02	0.03	0.16	0.27	
Striated.....	0.06	0.30	0.02	0.007	0.05 ¹	0.07	0.004
Pancreas.....	0.08	0.21	0.018	0.015	0.25	0.14	0.005
Skin.....	0.15	0.09	0.01	0.014	0.20	0.18	
Spleen.....	0.10	0.014	0.01	0.13	0.040
Testis.....	0.15	0.01	0.009	0.23	0.005
Thyroid.....	0.11	0.01	0.032	0.17	0.006

¹ This value is for resting frog muscle frozen *in situ* before sampling. Inorganic phosphate is much higher in fatigued or dead muscle.

excreted only very slowly. Retention of heavy metals is especially prolonged. Judgment regarding possible functioning of trace elements might well be suspended. Experience with copper, cobalt, manganese, and zinc, once regarded as adventitious, now known to be nutritionally indispensable, suggests caution. Moreover, intimations of possible functions for some of them have appeared. Boron, for example, can act in very low concentration as a plant-growth stimulant.

The following have been detected in animal organs or in the ash of the body:

Aluminum	Gold	Selenium
Antimony	Lead	Silver
Arsenic	Lithium	Strontium
Barium	Molybdenum	Thallium
Bismuth	Nickel	Tin
Boron	Platinum	Titanium
Cadmium	Radium	Tungsten
Chromium	Rubidium	Vanadium

This list, although lengthy, is not claimed to be complete.

Chemistry of Brain. The high water content, averaging about 76 to 77 per cent of the entire brain, is notable. About 40 per cent of the solid matter is protein and more than 50 per cent lipid. The predominance of lipids is due to their abundance in myelin sheaths which are not typical protoplasmic material.

Of the proteins, two have been shown to be globulins and one a nucleoprotein. Another, which has been more thoroughly characterized, is called **neurokeratin**. It is regarded as the chief constituent of the fibrils (neuroglia) which hold the intricate structures of the brain together. It has also been suggested (Block) that it is a component of neurofibrils (dendrites and axon fibers). In its behavior toward proteolytic enzymes it resembles keratin of the skin more nearly than it does the collagen of the fibrous connective tissues. This resemblance is in accord with the embryological development of the nervous system from the ectodermal layer. It differs from ordinary keratin (eukeratin), however, in that the proportion of the basic amino acids, according to Block, is different. In neurokeratin he found the ratio, histidine:lysine:arginine to be 1:3:3 while in eukeratin (wool) the proportion is 1:4:12. Neurokeratin is relatively low in arginine content. Gray matter yields about 0.3 per cent and the sciatic nerve 0.6 per cent of neurokeratin.

The total lipids of the fresh brain (human adult) are reported to be 12 to 15 per cent of its weight. Values for the three main classes of lipids are indicated in Table 77.

TABLE 77.—APPROXIMATE LIPID CONTENT OF BRAIN
Values are per cent of fresh tissue

	Phospholipids	Sterols	Galactolipids
Whole brain.....	6	4	2
Gray matter.....	4	1	1-2
White matter.....	9	4	1-2

The brain lipids are subject to only slight fatty acid exchanges as compared with those which occur in other tissues. Labeled fatty acids

present in oil partially hydrogenated with deuterium are found in only very small amounts in the brains of rats to which the oil is fed. This is in sharp contrast to the larger uptake (p. 450) by lipids of liver, intestinal, and adipose tissues. Galactolipids are much more abundant in nervous tissue than in any others.

Metabolism in the Brain. Nervous tissue, including even the gray matter with its numerous cell bodies, never has any large store of glycogen (about 100 mg. per cent) and is also low in glucose (fermentable sugar), while lactic acid has been found in concentrations varying from 11 to 36 mg. per cent.

Several lines of evidence point to glucose rather than glycogen as the prime fuel oxidized in brain. (1) The RQ, as determined by analyses of the arterial and venous blood or by the use of surviving brain slices, is 1 and is not lowered in diabetes. This indicates that carbohydrate is used. (2) Glycogen does not accumulate. Heightened blood-sugar levels, either with or without insulin, have not been found to increase the brain glycogen. This is in sharp contrast to muscle which stores and uses glycogen. What little glycogen there is in brain tissue is not known to undergo glycolysis. If it did, it should be able to sustain oxidation in brain deprived of glucose. Yet surviving tissue slices of brain (unlike similar preparations from other organs) show a rapid decline in the rate of O_2 uptake almost from the first moment they are placed in a solution which lacks glucose or some similar nutrient, such as fructose, mannose, lactate, pyruvate, glycerophosphate, etc. (3) The brain is strikingly dependent upon its glucose supply for normal functioning. Hypoglycemia as developed in insulin shock (p. 427) produces the following symptoms that are striking evidence of cerebral depression: Feelings of fatigue, hunger, apprehension, confusion, followed by delirium or even convulsions, and if not relieved by glucose administration, complete unconsciousness (coma) and death. While glucose injection affords the best relief, fructose and mannose (closely related structurally to glucose) can also be effective. But others of the metabolites, lactate, pyruvate, etc., which are able to sustain some degree of oxidation in surviving brain slices are not effective. The case of fructose is instructive. Although it slowly relieves insulin shock in an intact animal, it fails to do so in an animal deprived of its liver, the organ which converts fructose to glucose. It would seem, then, that glucose is used in brain cells for an indispensable and special process which differs in some respects from the more thoroughly investigated glycolysis in muscle where glycogen is the preferential fuel. A further contrast is suggested by experiments which indicate that adenosine triphosphate does not hasten lactic acid production in brain under circumstances which would permit this

effect in some other tissues. This probably does not mean that phosphorylation, so prominent a feature of carbohydrate metabolism in general, fails to occur in some way in nervous tissue. In this connection, the finding of phosphocreatine (Kerr, 1935) in brain tissue seems significant although the amount reported was relatively small, about 10 mg. per cent of fresh tissue. It might occur in higher concentration in living cells of the brain and, indeed, the creatine of dead brain tissue, probably representing hydrolyzed phosphocreatine, is somewhat higher in concentration, more than 100 mg. per cent.

In some respects, carbohydrate breakdown in the brain shows resemblances to that in muscle. For example, the production of pyruvic acid as an intermediary (p. 441) occurs in both cases and lactic acid can be formed in brain as it is in muscle. Some of the enzyme systems for which activity has been observed in brain tissue and its extracts appear to be the same as or similar to those catalyzing glycolytic and related reactions in muscle. There is good evidence to show that the tricarboxylic acid cycle (p. 381) functions in brain as in other organs. Some of the coenzymes of brain, coenzyme I (p. 365) and cocarboxylase (p. 377), are identical with those found in other tissues. Cocarboxylase (thiamine pyrophosphate) is of especial interest because of the failure to oxidize pyruvic acid in thiamine deficiency. This was discussed (p. 171) in Chap. VI.

In addition to thiamine, other vitamins appear to be important in brain tissue. The relatively high concentration of ascorbic acid (some 15 mg. per cent in cerebrum and about 25 mg. per cent in cerebellum as compared with 4 mg. per cent in muscle) suggests that it plays a significant role. As a redox system (p. 357)



it could conceivably function catalytically in bio-oxidation. Vitamin A is definitely known to be important for nervous tissue. As a result of its deficiency, lesions occur in both brain and nerve.

Metabolism in Nerve. Metabolism as an accompaniment to the propagation of nerve impulses could be studied only after the development of highly sensitive methods. It was easy to show that a nerve deprived of oxygen by immersion in nitrogen gas could be excited and could conduct nerve impulses. The excitability soon failed, however, and was restored by readmission of oxygen. These earlier observations suggested what was later shown more clearly, namely, oxidative metabolism is not immediately required for nerve excitation but is required for recovery of the nerve so as to restore its excitability. But the amount of metabolism is relatively small, corresponding to an uptake of 0.3

cu. mm. of O₂ per hr. per mg. of solids in a stimulated frog nerve at 15°C. In the resting nerve it is less than one-third as much. This is in contrast to brain tissue, in which the O₂ uptake is 10 to 20 cu. mm. under comparable conditions and similarly computed.

Chemistry of Muscle. The solids of muscle tissue are chiefly proteins, which amount to 20 per cent or more of the muscle substance and about 80 per cent of the solids. Protein tends to be higher in non-striated than in striated muscle.

As will be seen in Table 78, **myosin** is the chief protein. While resembling globulins in most respects, it is not typical of them. Its

TABLE 78.—PROPERTIES OF MUSCLE PROTEINS

Protein	Approximate percentage of total protein	Solubilities	Estimated molecular weight	Iso-electric point
Myosin (a complex)	67-68	Soluble in KCl solution, dilute HCl; insoluble in H ₂ O	1,000,000	5.5
Globulin X.....	20-21	Like other globulins	5.0-5.2
Myogen ¹	10	Like other albumins	150,000	6.3-6.7
Myoalbumin.....	1	Like other albumins	3.0-3.5
Myoglobin (muscle hemoglobin).	Less than 1 per cent in red muscle fibers; little or none in white ones	Same as blood hemoglobin	17,200 (see p. 579)	

Other proteins present in minute and unknown concentration are nucleoproteins, proteins of enzyme systems, insulin, and other hormones of a protein character.

¹ Myogen is separable; the component myogen A is regarded as probably identical with aldolase (p. 440), and myogen B has properties similar to those of triosephosphate dehydrogenase.

properties have been intensively studied in connection with its probable role in muscular contraction. Its solutions in dilute KCl form threads when spurted through a fine orifice into water. These have optical properties (anisotropism) related to those of the microfibrils in living muscle. What had been regarded as pure preparations were reported (Szent-Györgyi, 1946) to be complexes, containing a protein which Szent-Györgyi named **actin**. Later investigations revealed the presence of still other proteins, so that as many as six separable proteins may perhaps make up the "myosin complex." Some change in the shape of this complex, about which theories are still under debate, seems to be the cause of muscular contraction. The close association of myosin with the enzyme (p. 420) which catalyzes the rapid, almost explosively sudden breakdown of adenosine triphosphate, was shown in connection with phosphorylation.

Globulin-like proteins, other than myosin, and the albumins of muscle have not been thoroughly characterized. There is, indeed, no certainty as to which, if any, of them exist as such in the living muscle. Muscle protein is very apt to be denatured by manipulative processes as is also true of many tissue proteins. A type of denaturing occurs during *rigor mortis*, when the protein, more especially the myosin, coagulates, becomes insoluble, and causes the characteristic stiffness or rigor. The subsequent softening of the muscle is caused by autolysis. The proteins of meat are not those of living muscle. The process of myosin coagulation, as in *rigor mortis*, has been shown to differ from the coagulation of most proteins in that myosin shows no change in its sulfhydryl and disulfide groups.

Study of muscle proteins and some other constituents of the living substance is facilitated by preparation of muscle plasma. The muscle is frozen in the living animal and, without being permitted to melt, is finely ground to form muscle snow. This is subjected to high pressure to express the muscle plasma, free from sarcolemma and other insoluble material. Muscle plasma coagulates spontaneously and rapidly at room temperature. This method is older than Meyerhof's (p. 435) method.

Red muscle fibers contain an iron-porphyrin protein called **myoglobin** or muscle hemoglobin which is very similar to hemoglobin. While the heme part of these two proteins is probably identical, the globin part is different. Its function is generally regarded as that of holding a reserve of oxygen in those muscles that, required for sustained work, might be unable sufficiently to go into "oxygen debt" during anaerobic glycolysis (p. 442) and would thus need an inner source of oxygen. After wounding which involves extensive crushing of muscle, the kidney excretes a substance which seems to be myoglobin.

The glycogen of muscle, as was shown in discussions of carbohydrate metabolism, may vary from almost nothing in an exhausted muscle to the maximum store, which is said to be about 1.5 per cent in mammalian striated muscle.

A group of substances, commonly referred to as the nitrogen-containing extractives of muscle, include creatine and phosphocreatine (p. 417), the most abundant, and a number of others. Those already considered in connection with metabolism are adenylic acid, adenosine triphosphate, inosinic acid, the purine bases (especially hypoxanthine), and small amounts of waste products, such as urea and creatinine. Some others are of unknown significance as to metabolic functioning. They include **carnosine** and **anserine**, dipeptides which, like pantothenic acid, contain the β -alanine group. Carnosine is hydrolyzed by an enzyme found in liver, spleen, and kidney.

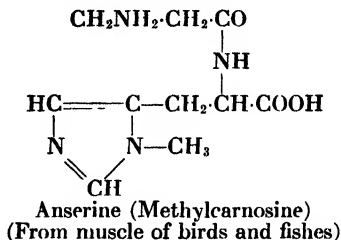
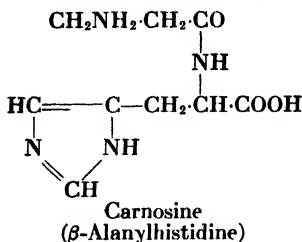

Carnitine, also of unknown significance, is α -hydroxy- γ -butyrobetaine. Its structure and those of some related compounds are

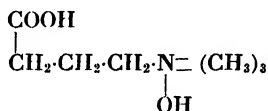
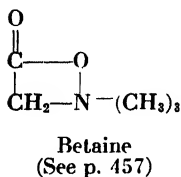

γ -Butyrobetaine
(Formed by decarboxylation and methylation of glutamic acid in putrefying meat)

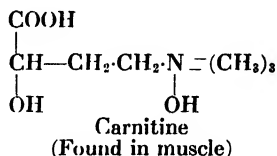

Carnitine
(Found in muscle)

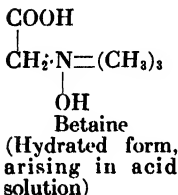

The substances which are classified as the nitrogen-free extractives of muscle include carbohydrates, both free and phosphorylated, lactic acid, and various other intermediary products of carbohydrate metabolism.

Inasmuch as meat is a good source of some and a fair source of others of the B group of vitamins, they are thus shown to be constituents of living muscle. One of them, inositol (p. 180), is comparatively abundant (about 20 mg. per cent) although it is also found in other tissues. Meat is not a significant source of any fat-soluble vitamin and is only a fair source of ascorbic acid.

Neutral fat is generally reported to be a variable constituent of muscle, but there is doubt that it is found inside the actual muscle fiber as an intracellular substance. Certainly most of it is intermuscular. Phospholipids are reported to constitute 0.7 to 1.2 per cent of different kinds of muscle, and cholesterol is found in smaller amounts, 70 to 180 mg. per cent.

Epithelial Tissue. The epidermal layers of the skin and the dermal outgrowths (nails, hair, horns, hoofs, and feathers) are largely composed

of **keratins**. They are the most nearly insoluble of the scleroproteins (albuminoids) and, indeed, are not dissolved by anything except strong acids or alkalis, which decompose them. Preparations of keratin are accordingly made by successive extractions with mildly acid and alkaline reagents, with lipid solvents, and with active pepsin and trypsin solutions to remove soluble compounds. The remainder is keratin. Its failure to be hydrolyzed by proteases does not prove that it lacks any food value. It is reported that wool is digested by the clothes moth under the influence of an intestinal enzyme, effective in the presence of the reducing action of H_2S produced by intestinal bacteria. Moreover, keratin, reduced in vitro so that its S—S bonds are converted to sulfhydryl, (—SH) groups, can be digested by pepsin and trypsin. Several investigators have reported that keratin of wool, hoofs, and feathers in finely powdered form (ball mill) can serve, with supplements to make good its amino acid deficiencies, as protein food for laboratory and domestic animals.

Two classes of keratins are recognized, *eukeratins* of hair, wool, nails, etc., and the *pseudokeratins* of the skin epidermis and nervous tissues. They are distinguished (p. 575) by their different yields of the basic amino acids and especially by the low arginine content of the pseudokeratins.

The sulfur content of keratins is relatively high but is variable. Some representative values are

	Per Cent Sulfur
Hair, American Indian.....	4.82
Japanese.....	4.96
Negro.....	4.84
Caucasian, adult.....	5.22
Caucasian, young.....	4.93
Horn.....	3.20
Nails.....	2.80

Much of the sulfur is contained in cystine groups although methionine is also obtained from keratins. Human hair yields 16 to 21 per cent of cystine, wool 8 to 11, and feathers 7 to 12 per cent.

Corresponding to its relatively high cystine content, hair is reported to show subnormal growth in rats on a diet deficient in proteins, which are the good sources of cystine.

The color of hair is due almost entirely to melanins although some diffuse yellow pigment is present. The black pigments of skin are also classed with the melanins. Skin contains some carotene and other pigments known as "melanoids."

The ether-soluble material obtainable from the surface of the skin and from hair and wool is largely composed of cholesterol esters. Wool fat,

from which lanolin is prepared, contains esters of stearic, palmitic, and oleic acids and also yields less common acids, such as cerotic and lanoceric. In addition to cholesterol, certain sterol-like compounds, known as "agnosterol" and "lanosterol" (p. 93), are found. To some extent the fatty acids are esterified with carnaubyl, $C_{24}H_{49}OH$, and ceryl, $C_{26}H_{53}OH$, alcohols. The large use of lanolin as the base of skin creams and ointments makes its composition of some interest.

The more significant characteristics of the digestive glands, including the liver, were presented in connection with digestion, metabolism, and nutrition. Certain features of the composition of ductless glands will be considered in Chap. XX. A high content of protein, including nucleoproteins, in glands is a significant feature and is in accord with the relatively high proportion of the active protoplasmic mass of secretory cells in gland tissue.

Connective Tissues. The tendons, ligaments, and the widespread areolar fibers are characterized by their content in varying proportions of two albuminoids, **collagen** and **elastin**. Analyses of a tendon and a ligament are shown in Table 79.

TABLE 79.—COMPOSITION OF REPRESENTATIVE CONNECTIVE TISSUES
(As reported by Gies and his associates)

	Tendon of Achilles (beef)	Ligamentum nuchae (beef)
	per cent	per cent
Water.....	62.9	57.6
Inorganic material.....	0.47	0.47
Ether-soluble material.....	1.04	1.12
Coagulable protein.....	0.22	0.62
Mucoid protein.....	1.28	0.53
Elastin.....	1.63	31.67 ²
Collagen.....	31.59 ¹	7.23
"Extractives".....	0.90	0.80

¹ Collagen is 86 per cent of the total solids.

² Elastin is 75 per cent of the total solids.

In each tissue, collagen and elastin together constitute about 90 per cent of the total solids.

Collagen is insoluble in all reagents which do not change it. In this respect it resembles keratin, but, unlike keratin, it responds to the action of boiling water to form gelatin and thus does not quite conform in its properties to the definition of any of the subgroups of proteins. In solubility and in precipitation reactions gelatin resembles albumins, but in its unbalanced content of amino acids (p. 106) it is albuminoid. Gelatin is readily digested and, if it is duly supplemented by other proteins, is of

nutritive value. When it constitutes more than about one-third of the total protein of the food, its amino acid deficiencies are apt to be apparent. The total amounts of the indispensable amino acids obtained from gelatin constitute only about 27 per cent of its weight, and the complete lack of valine and tryptophan and the low yield of some others make gelatin a conspicuously incomplete protein. Glycine, proline, and hydroxyproline together constitute 60 per cent of gelatin. Although largely converted to gelatin in cooked meat, collagen is itself digestible even when uncooked. It is more readily acted on by pepsin than by trypsin and best by the successive action of both enzymes. Collagen is relatively low in its content of the sulfur-containing amino acids, cystine and methionine. Collagen forms readily observable fibers and fibrous sheets in tissues. The molecular structure of collagen is thus of interest. Based largely on X-ray studies, a theory (Astbury) of the structure of the fiber suggests a series of repetitions of the unit

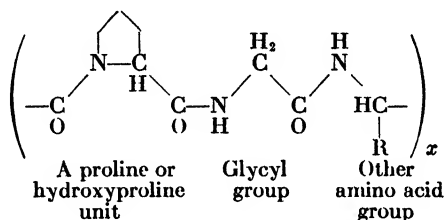

Electron photomicrographs of collagen fibers show a banded or cross-striated appearance, as though the chains of amino acid units were arranged in a systematic parallel form. The arrangement of collagen "sheets" is still a speculative matter. The nature of the reaction, collagen \rightarrow gelatin, has not been clarified.

Elastin resembles collagen in many of its properties and is digested slowly by pepsin and trypsin. It is not changed to gelatin, however, by boiling water. It resembles collagen in its high yield of glycine and proline but differs from collagen in its content of other amino acids.

The **mucoïd** of the connective tissues is a glycoprotein resembling the mucin of saliva and is called **tendomucoïd** to distinguish it from **chondromucoïd** of cartilage and **osseomucoïd** of bone.

Cartilage. Collagen is prominent among the organic materials of cartilage. Another somewhat similar constituent is **chondroalbumoid**. A third protein is called **chondromucoïd**. It is a glycoprotein. One of the products of its mild hydrolysis is **chondroitin sulfuric acid** which, completely hydrolyzed, yields glucuronic acid, galactosamine, acetic acid, and sulfuric acid. The assigned formula is

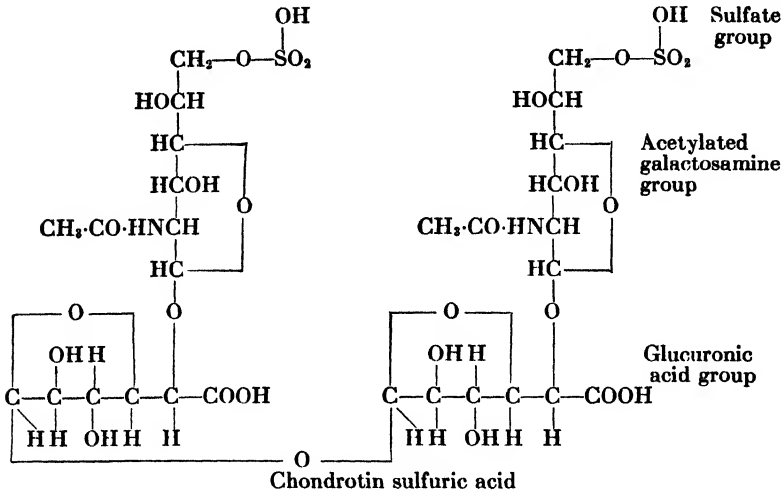

The mucoids of fibrous connective tissue, cartilage, and bone have not been clearly distinguished from each other. All three of them yield chondroitin sulfuric acid. The latter in a modified form is reported to be a component of the complex (p. 300) which gives the heparin effect, but it is not obtained from the salivary glycoprotein, mucin, which yields a mucoitin sulfuric acid. This contains glucosamine rather than galactosamine.

Bone. The hard part of bone may be thought of as a cartilaginous matrix impregnated with mineral matter by the process of calcification. The matrix contains collagen, an ossealbuminoid, and osseomuroid. Collagen is sufficient to yield considerable amounts of gelatin, which is best obtained by boiling the softened matrix prepared by prolonged soaking in dilute HCl for removal of most of its mineral content. The albuminoid and the muroid resemble those of fibrous connective tissue.

The entire bone, including marrow, is complex in composition, as could be inferred from the hemopoietic functions of the marrow. But the marrow-free bone in adult condition contains so small a proportion of cellular material that it is nearly all composed of calcified matrix. Dried and treated with a fat solvent to extract the small amount of lipids present, it yields some 60 to 70 per cent ash. The chief constituents of the ash as determined by various analysts, using normal bone of adult animals, are

	Per Cent of Total Ash
Calcium.....	35.7 -37.5
Magnesium.....	0.46- 0.85
Phosphorus.....	15.8 -18.5
Carbonate as CO ₂	4.6 - 5.7

The actual inorganic compounds represented by these results are not substances of definite and fixed composition. This was implied in stating (p. 554) that the calcium and phosphorus of bone are in a continual state of flux. Theories of the nature of the bone substance produced in the calcification process are still inconclusive. Most of them attempt to relate the substance to the minerals called "apatites" of which the common example is fluorapatite, $\text{Ca}_{10}(\text{PO}_4)_6\text{F}_2$. A theory proposed by Hendricks and Hill is based in part upon the *in vitro* preparation of a hydrated calcium triphosphate, which in electron photomicrographs is shown to be crystalline and which gives X-ray diffraction patterns indicating the same type of crystal lattice as is found in apatite minerals. The compound is regarded as probably

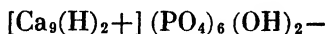

This is, in effect, an apatite with the fluorine replaced by hydroxyl groups and one calcium atom replaced by two hydrogen ions. In such a compound, carbonate can replace phosphate and the theory assumes that the calcifying material of bone is such a replacement compound, $4(\text{CO}_3)^-$, partially replacing $3(\text{PO}_4)^=$ with the resulting excess of positive charge balanced by substitution of sodium for calcium. But it is also possible for magnesium to replace calcium in such a compound. This substitution appears to occur in bone. The net result of these fluxions is regarded by Hendricks and Hill as giving an *average* composition of the chief mineral deposit in human bone represented by



Any compound having the structure of the apatite minerals is known to be able to undergo exchange reactions with any of a long list of elements and groups. This accounts in part for the fact that bone ash contains small amounts or mere traces of heavy metals, rare earth minerals, and many other trace elements. It sometimes results in considerable accumulations of metals, such as lead (chronic lead poisoning), in bones. Fluorine (p. 559) is regularly present. The phosphate group is subject to exchange as is proved by finding radioactive phosphorus in bone ash after administration in the form of phosphate. Calcium leaves or redeposits in bones with considerable facility; indeed, it appears as though blood calcium is in a dynamic equilibrium with bone calcium. This has been studied largely in connection with rickets. It will be further considered in Chap. XX as it is affected by the parathyroid hormone.

The demands for calcium and phosphate made by the developing

fetus during pregnancy may be met in part by robbing the maternal skeleton. Lactation during a calcium-deficient diet also has this effect.

Teeth. The hard part of the tooth external to the pulp is dentin, and this is covered on the exposed part of the tooth by the much harder enamel. Cementum, a covering of the root of the tooth, is also hardened. All the hard parts are calcified in a manner more or less like the calcification of bone. Corresponding to relative hardness, enamel contains approximately 98.5 per cent of inorganic material, dentin 77 per cent, and cementum about 70 per cent. The organic matter of enamel is chiefly a protein resembling keratin. Traces of unidentified lipids are reported to be present. Dentin and cementum are more like bone, having collagen as the chief organic constituent. Other proteins and some lipid material are also found.

The amounts of the chief inorganic constituents are shown in Table 80. Considerable variations are reported. They are due, in part, to

TABLE 80.—MAJOR INORGANIC CONSTITUENTS OF MATURE HUMAN TEETH
(Values reported by different analysts are shown)

Material analyzed	Calcium	Phosphorus	Magnesium	Carbonate as CO ₂
	Per cent	Per cent	Per cent	Per cent
Inorganic residue of whole teeth.....	37.5 ± 9.8	16.3 ± 0.9	0.32 ± 0.25	
Inorganic residue of whole teeth.....	35.2 ± 0.7	16.8 ± 0.3	3.45 ± 0.26
Sound dentin, dried and extracted with alcohol and ether.	26.18 ± 0.34	12.74 ± 0.48	0.83 ± 0.08	3.57 ± 0.10
Enamel of sound teeth, dried and extracted with alcohol and ether.....	35.41 ± 0.96	17.45 ± 0.51	0.30 ± 0.05	3.00 ± 0.24
Sound part of enamel of carious teeth, dried and extracted with alcohol and ether.	35.64 ± 0.59	17.21 ± 0.39	0.32 ± 0.05	3.01 ± 0.14

methods of preparing the whole tooth, the enamel, or dentin for analysis. The term "inorganic residue" as used in the table refers to the remainder after the tooth has been leached by boiling it in a solution of KOH in ethylene glycol. This removes the organic material. In other cases the material is dried and extracted with alcohol and ether. The data of Table 80 were selected from a large number of analyses collected by Armstrong from his own papers and those of other investigators and serve to show that (1) analyses of whole teeth yield highly variable

results; (2) enamel is higher in calcium and phosphorus, lower in magnesium and carbonate than dentin; (3) the sound part of enamel of teeth, already subject to decay, shows no significant difference in its content of calcifying minerals from the enamel of noncarious teeth.

It has been suggested that the deposit in enamel is more basic than that in bone and might be represented, so far as the average constitution of its chief constituent is concerned, by the formula of a hydroxylapatite

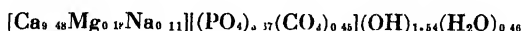

Comparing this formula with the corresponding one for bone (p. 585) one notes the presence of the hydroxyl group, the relatively high content of calcium, and the lower content of magnesium, sodium, carbonate, and water. The calcification complex of dentin appears to be intermediate between that of bone and that of enamel.

In teeth, as in bones, the hardening complex is not static but is subject to exchange. An interesting exchange is that which brings fluorine into the complex. Its significance was discussed (p. 559) in connection with dietetic requirements. How fluorine fits into the compound is not known. It need not necessarily correspond to the fluorine in fluorapatite (p. 585) although it probably does. Many other elements, most of those listed as trace elements (p. 575), have been detected in teeth. But the exchange process is relatively slow. Thus radioactive phosphorus injected as phosphate into a cat was found after 5 days to be present in the following percentages of the amount administered: Enamel 0.00055, dentin 0.0088, bone epiphysis (femur) 0.0611. While dentin made the exchange some 16 times as rapidly as enamel, bone could make it more than 100 times as rapidly. Nevertheless there was clear evidence of some exchange even in so hard a structure as enamel.

The relative hardness, *i.e.*, the degree of calcification, of teeth is determined by many factors. Several were discussed in connection with nutrition. Calcium and phosphorus supply in the food, their relative proportions, the fluorine intake, and adequacy of vitamins D and vitamins A all appear to influence the calcification process of teeth as observed in the rat. It is reported that the ratio Ca:P may vary between 0.5 and 4 in rat's food without bad effect upon the teeth provided neither element constitutes less than 0.3 per cent of the diet. If either is inadequately supplied, however, calcification of teeth is more seriously disturbed when the ratio is 0.5 than when it is 1.0 or more. This differs from bone calcification, which is interfered with more seriously by diets having a high Ca:P ratio. This and the observation that calcium, once deposited in teeth, is not withdrawn by certain conditions which can remove it from bone suggest that calcification in teeth is not identical with bone calci-

fication. It has been shown, however, by the use of radioactive calcium, Ca^{45} , that it is taken up by mature teeth as well as by bone.

The entire process of dentition, of which calcification is only one aspect, cannot result in normal, perfect teeth without healthy osseous tissue of the jaw developing during the period of dentition at a rate which affords good spacing of the teeth. This is especially true of the alveolar bone in which the roots of teeth are imbedded.

It is also important that the gingival tissues be normal. This is one reason why ascorbic acid, the lack of which causes sore jaws, is important for good dentition and maintenance of sound teeth. It is generally agreed, however, that ascorbic acid has direct effects upon dentin formation. It is even reported that dentin is formed in incisors of guinea pigs at a rate roughly proportional to the dietary supply of ascorbic acid up to 5 mg. per day. Animals receiving less than 0.75 mg. per day showed irregularities as well as deficiency in dentin formation. The effect of ascorbic acid appears to involve the production of collagen.

REFERENCES

The composition and metabolism of nervous tissues is treated by I. H. Page in "Chemistry of the Brain," Springfield, Ill., 1937.

In Biological Symposia, Vol. X, edited by N. H. Hoerr, Lancaster, Pa., 1944, some useful material under the subject "Frontiers in Cytochemistry" will be found.

The study of mucins and similar proteins and their hydrolysis products has been developed chiefly in connection with the chemistry of certain tissues. A useful book on this subject is "Hexosamines and Mucoproteins" by P.A.T. Levene, New York, 1924.

Some reviews of specific aspects of tissue chemistry and of the techniques and results of the rapidly developing field of micro- and biochemistry are listed.

ARMSTRONG, W. D., Biochemical and Nutritional Studies in Relation to the Teeth, *Ann. Rev. Biochem.*, 11, 441, 1942.

BENEDICTI-PICHLER, A. A., Microchemistry, *Ann. Rev. Biochem.*, 12, 639, 1943.

COX, G. J., A Critique of the Etiology of Dental Caries, *Vitamins and Hormones*, 2, 255, 1944.

GLICK, D., Histochemistry, *Ann. Rev. Biochem.*, 13, 705, 1944.

KIRK, P. L., The Application of Microchemistry to Biochemical Analysis, *Ann. Rev. Biochem.*, 9, 593, 1940.

LEIGESTER, H. M., The Biochemistry of Teeth, *Ann. Rev. Biochem.*, 15, 361, 1946.

LOGAN, M. A., Recent Advances in the Chemistry of Calcification, *Physiol. Rev.*, 20, 522, 1940.

MCLEAN, F. C., Physiology of Bone, *Ann. Rev. Physiol.*, 5, 79, 1943.

MELLANBY, M., The Influence of Diet on the Structure of Teeth, *Physiol. Rev.*, 8, 545, 1928.

MELLANBY, M., Diet and the Teeth. Part 3. The Effect of Diet on Dental Structure and Disease in Man, *Med. Res. Council. Spec. Rept., Series*, No. 191, London, 1934.

MILLIKAN, G. A., The Chemistry of Muscle, *Ann. Rev. Biochem.*, 11, 497, 1942.

MOXON, A. L., and RHIAN, M., Selenium Poisoning, *Physiol. Rev.*, 23, 305, 1943.

QUASTEL, J. H., Metabolism of Brain and Nerve, *Ann. Rev. Biochem.*, 8, 435, 1939.

SANDOW, A., Muscle, *Ann. Rev. Physiol.*, 11, 297, 1949.

STEWART, C. P., and PERCIAU, G. H., Calcium Metabolism, *Physiol. Rev.*, 8, 283, 1928.

SEENT-GYÓRGYI, A., Contraction and the Chemical Structure of the Muscle Fibril, *J. Colloid Sci.*, 1, 1, 1946.

SEENT-GYÓRGYI, A., "Nature of Life—A Study on Muscle," New York, 1948.

WILLIAMS, R. J., The Significance of the Vitamin Content of Tissues, *Vitamins and Hormones*, 1, 229, 1943.

Papers which report modern research on various subjects discussed in this chapter are selected.

ANTON, C., and FREEMAN, W. H., The Relation of the Diet to the Composition of Tissue Phospholipids, *J. Biol. Chem.*, 143, 405, 415, 423, 1943.

BANGA, I., and PETERS, R. A., Pyruvate Oxidation in the Brain. VII. Some Dialyzable Components of the Pyruvate Oxidation System, *Biochem. J.*, 33, 1980, 1939.

- BESSEY, O. A., KING, C. G., QUINN, E. J., and SHERMAN, H. C., The Normal Distribution of Calcium between the Skeleton and Soft Tissues, *J. Biol. Chem.*, 111, 115, 1935.
- BEVERIDGE, J. M. R., and LUCAS, C. C., The Dicarboxylic and Basic Amino Acids of Human Hair, *Biochem. J.*, 38, 88, 1944.
- BEVERIDGE, J. M. R., and LUCAS, C. C., Isolation of Proline from Human Hair, *Biochem. J.*, 38, 95, 1944.
- BLOOR, W. R., Distribution of Unsaturated Fatty Acids in Tissues, *J. Biol. Chem.*, 80, 443, 1928.
- BOYD, J. D., DRAIN, C. L., and STEARNS, G., Metabolic Studies of Children with Dental Caries, *J. Biol. Chem.*, 103, 327, 1933.
- BRAY, H. G., GREGORY, J. E., and STACEY, M., Chondroitin from Cartilage, *Biochem. J.*, 38, 142, 1944.
- BRIWA, K. E., and SHERMAN, H. C., The Calcium Content of the Normal Growing Body at a Given Age, *J. Nutrition*, 21, 155, 1941.
- BRODIE, J. B., and MACLEOD, F., Quantitative Experiments on the Occurrence of Vitamin B in Organs, *J. Nutrition*, 10, 179, 1935.
- BRÜCKMANN, G., and ZONDEK, S. G., Iron, Copper, and Manganese in Human Organs at Various Ages, *Biochem. J.*, 33, 1845, 1939.
- CLARKE, M. F., BASSIN, A. L., and SMITH, A. H., Skeletal Changes in the Rat Induced by a Ration Extremely Poor in Inorganic Salts, *Am. J. Physiol.*, 115, 556, 1936.
- DICKENS, F., The Citric Acid Content of Animal Tissue, with Reference to Its Occurrence in Bone and Tumor, *Biochem. J.*, 35, 1011, 1941.
- EICHELBERGER, L., EISELE, C. W., and WERTZLER, D., The Distribution of Water, Nitrogen, and Electrolytes in Skin, *J. Biol. Chem.*, 151, 177, 1943.
- ELVEHJEM, C. A., and PETERSON, W. H., The Iron Content of Animal Tissues, *J. Biol. Chem.*, 74, 433, 1927.
- EVANS, R. J., and PHILLIPS, P. H., Skeletal Storage of Fluorine in the Growing Rat Fed Bone Meals of Varying Fluorine Content, *Proc. Soc. Exptl. Biol. Med.*, 39, 188, 1938.
- GAUNT, W. E., and IRVING, J. T., The Influence of Dietary Calcium and Phosphorus upon Tooth Formations, *J. Physiol.*, 99, 18, 1940.
- GLOCK, G. E., LOWATER, F., and MURRAY, M. M., The Retention and Elimination of Fluorine in Bones, *Biochem. J.*, 35, 1235, 1941.
- HANSON, H. T., and SMITH, E. L., Enzymatic Hydrolysis of Carnosine and Related Peptides, *Federation Proc.*, 8, 204, 1949.
- HILDITCH, T. P., and ZAKY, Y. A. H., Sheep Body Fats. 2. Component Glycerides of Perinephric and External Tissue Fats from the Same Animal, *Biochem. J.*, 35, 940, 1941.
- HOLTZ, P., The Bound Ascorbic Acid in Animal Tissues, *Ztschr. physiol. Chem.*, 263, 187; *Nutr. Abs. & Revs.*, 10, 331, 1940.
- IRELAND, J. T., The Colorimetric Estimation of Total Cholesterol in Whole Blood, Serum, Plasma, and Other Biological Material, *Biochem. J.*, 35, 283, 1941.
- KAO, H. C., and SHERMAN, H. C., Influence of Nutritional Intake upon the Concentration of Vitamin A in Body Tissues, *Proc. Soc. Exptl. Biol. Med.*, 45, 589, 1941.
- KEHOE, R. A., CHOLAK, J., and STORY, R. V., A Spectrochemical Study of the Normal Ranges of Concentration of Certain Trace Metals in Biological Materials, *J. Nutrition*, 19, 579, 1940.
- KEHOE, R. A., CHOLAK, J., and STORY, R. V., Manganese, Lead, Tin, Aluminum, Copper, and Silver in Normal Biological Material, *J. Nutrition*, 20, 85, 1940.
- KENT, N. L., and McCANCE, R. A., The Absorption and Excretion of "Minor" Elements by Man. I. Silver, Gold, Lithium, Boron, and Vanadium, *Biochem. J.*, 35, 837, 1941.
- KENT, N. L., and McCANCE, R. A., The Absorption and Excretion of "Minor" Elements by Man. 2. Cobalt, Nickel, Tin, and Manganese, *Biochem. J.*, 35, 877, 1941.
- KING, C. G., MUSULIN, R. R., and SWANSON, W. F., Effects of Vitamin C Intake upon the Degree of Tooth Injury Produced by Diphtheria Toxin, *Am. J. Public Health*, 30, 1068, 1940.
- KLEIN, J. R., Oxidation of Fructose by Brain in vitro, *J. Biol. Chem.*, 153, 295, 1944.
- LANFORD, C. S., and SHERMAN, H. C., Further Studies on the Calcium Content of the Body as Influenced by That of the Food, *J. Biol. Chem.*, 126, 381, 1938.
- McLEAN, F. C., and HASTINGS, A. B., The State of Calcium in the Fluids of the Body, *J. Biol. Chem.*, 108, 285, 1935.
- MANERY, J. F., and HASTINGS, A. B., The Distribution of Electrolytes in Mammalian Tissues, *J. Biol. Chem.*, 127, 657, 1939.
- MANLY, R. S., HODGE, H. C., and MANLY, M. L., The Relation of the Phosphorus Turnover of the Blood to the Mineral Metabolism of the Calcified Tissues as Shown by Radioactive Phosphorus, *J. Biol. Chem.*, 134, 293, 1940.
- MARTIN, A. J. P., and SYNGE, R. L. M., The Amino Acid Composition of Wool, *Biochem. J.*, 35, 91, 1941.
- MENDEL, L. B., HUBBELL, R. B., and WAKEMAN, A. J., The Influence of Some Commonly Used Salt Mixtures upon Growth and Bone Development of the Albino Rat, *J. Nutrition*, 14, 261, 1937.

- NAGELSCHMIDT, G., and KING, E. J., The Biochemistry of Silicic Acids, 9. Isolation and Identification of Minerals in Lung Residues and Air-borne Dusts from Coal Mines, *Biochem. J.*, **35**, 152, 1941.
- SHERMAN, H. C., The Influence of Nutrition upon the Chemical Composition of the Normal Body, *Carnegie Inst. Wash., Pub. No. 501*, "Cooperation in Research," 1938.
- SHERMAN, H. C., and QUINN, E. J., The Phosphorus Content of the Body in Relation to Age, Growth and Food, *J. Biol. Chem.*, **67**, 667, 1926.
- SIMMONDS, N., Present Status of Dental Caries in Relation to Nutrition, *Am. J. Pub. Health*, **28**, 1381, 1938.
- STONE, W. E., Acid-soluble Phosphorus Compounds of Cerebral Tissue, *J. Biol. Chem.*, **149**, 29, 1943.
- LASNITZKI, A., and BREWER, A. K., A Study of the Isotopic Constitution of Potassium in Various Rat Tissues, *Biochem. J.*, **35**, 144, 1941.
- TENENBAUM, B., and BIBBY, B. G., Action of Fluorine in Limiting Dental Caries, *Medicine*, **20**, 211, 1941.
- YAVORSKY, M., ALMADEN, P., and KING, C. G., The Vitamin C Content of Human Tissues, *J. Biol. Chem.*, **106**, 525, 1934.

CHAPTER XX

CHEMISTRY OF THE HORMONES

A hormone, defined in its broadest sense and in accord with the derivation of the word (Greek, *hormao*, I excite), could include any substance produced in any kind of cell and starting or increasing activity in any cell. In actual usage, however, enzymes, vitamins, and some other substances having stimulating effects are not included among hormones. Nor is any general product of normal oxidative metabolism so designated even though it may be definitely stimulating in general or specific ways. Thus, CO₂ is definitely stimulating to the respiratory center but is not called a hormone. The term is restricted to *organic compounds which serve as chemical messengers*. Secreted in a specific tissue and carried by the blood, they cause a definite response in some other tissue. Hormones are recognized in both plants and animals. The term "chalones" to designate chemical messengers which cause inhibitory effects has been suggested but is not widely used.

Hormones are sometimes spoken of as endocrines (*endon*, within, *krino*, I separate) or endocrine secretions because they are secreted internally, that is, into circulatory fluids. But they are not exclusively the product of ductless (endocrine) glands. The liver, the kidney, the pancreas, and the mucosa of the stomach and intestines are externally as well as internally secreting organs. Nevertheless, the majority of hormones are produced in endocrine glands, of which the most important are (1) the pituitary gland, also called the "hypophysis," which has three chief parts, the anterior pituitary, the posterior pituitary, and the *pars intermedia*; (2) the thyroid; (3) the parathyroids, varying in number; (4) the islands of Langerhans, which, although located in the pancreas, have no connection with its ducts and are thus endocrine structures; (5) the adrenal glands, having two separate and functionally distinct parts, the medulla and the cortex; (6) the endocrine structures of the ovary, the follicular tissue and the corpus luteum; and (7) the interstitial tissues of both ovary and testis. Other ductless glands are the pineal and the thymus, for neither of which is an endocrine secretion definitely recognized.

The field of biological science which includes the chemistry and the physiological and pathological effects of hormones is called "endocrinology." It is a large and rapidly increasing body of knowledge.

The thousands of endocrine researches reported annually are the work of chemists, biologists, and physicians. That many workers should be attracted to this field is not surprising in view of the fundamental importance of hormonal action and the profound disturbances or even fatal effects of malfunctioning of any one or more of the endocrine mechanisms. Indeed, the normal action of the hormones so as to knit together all the varied chemical activities in different organs to produce a balanced pattern of interrelated and controlled metabolism in the *organism as a whole* is indispensable for normal growth, development, and maintenance. Hormonal correlation of metabolism thus ranks with activities of the nervous system, which correlates the more physical aspects of animal activities. Of the two systems, the endocrine mechanism is the more primitive. Probably, as several writers have suggested, its origin in the course of evolution preceded that of a nervous system.

An account of the striking physiological effects of the hormones belongs in the field of physiology and can be given only brief mention in this chapter, which will deal mostly with the chemical nature of the several hormones and their specific effects upon metabolism.

Thyroxine and Related Substances. All the effects exerted by feeding desiccated or fresh thyroid tissue and especially the chief effect (p. 406), an increase in oxidative metabolism, follow feeding or injection of the iodine-containing amino acid thyroxine. It is therefore regarded as the active thyroid hormone although it does not appear to circulate as such in the blood but is more probably in a protein complex. In the thyroid gland it exists as an amino acid group in the protein **thyroglobulin**, also called **iodothyroglobulin**, a prominent constituent of the translucent colloid material of the thyroid alveoli.

Thyroglobulin does not show the characteristics of a definite chemical substance but appears to be capable, like many proteins, of forming aggregates of varying molecular size. In any case, however, it is of high molecular weight, estimated as 650,000. It varies in its iodine content from about 0.05 per cent to about 0.58 per cent and, in extreme cases of goiter due to iodine deprivation, is even found to be almost iodine free. Thyroglobulin administration causes a rise in oxidative metabolism, as does entire thyroid substance or thyroxine. Moreover, thyroglobulin is reported to cause an increased O_2 consumption in surviving tissue slices while thyroxine itself does so only after a long lag period sufficient for its conversion to an active form. Yet thyroglobulin can hardly be regarded as the hormone inasmuch as efforts to find it in the blood stream have been unsuccessful. The balance of the evidence at hand suggests that thyroxine circulates as a constituent group of some protein, such as an albumin, of molecular weight less than that of thyroglobulin. It is

possible that thyroxine, synthesized in the thyroid as constituent groups of thyroglobulin, is then given off to other protein carriers. Studies made with the isotope I^{131} prove that thyroxine is mostly protein-bound in blood plasma.

Among hydrolysis products obtained from purified thyroglobulin are thyroxine (0.28 per cent), diiodotyrosine (0.67 per cent), cystine (4.3 per cent), methionine (1.3 per cent), tryptophan (1.9 per cent), tyrosine (3.0 per cent), and D-glucosamine (2.2 per cent). The yields of the first two of these are equivalent to 0.58 per cent of iodine.

The structure of thyroxine, established by artificial synthesis, is

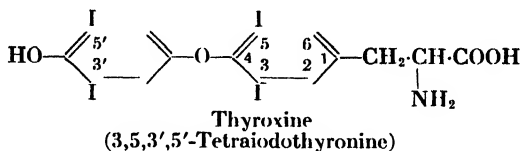

The formula clearly shows its relation to tyrosine and to diiodotyrosine

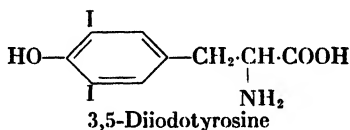

Both of these iodine compounds are obtainable from the products of hydrolysis of either the entire thyroid or thyroglobulin. The combined yields of thyroxine and 3,5-diiodotyrosine obtained from thyroglobulin do not always account for all of the iodine in the protein. Other iodine-containing groups may be present but have not been discovered. There is some evidence to indicate that diiodotyrosine is an intermediary compound in the synthesis of thyroxine. Surviving slices of thyroid were shown by Morton and Chaikoff to be able to synthesize diiodotyrosine and smaller amounts of thyroxine. Iodine was added to the surrounding Ringer solution. That synthesis occurred during the experiment was proved by use of radioactive iodine, I^{131} , as a label. Both diiodotyrosine and thyroxine were isolated, purified, and found to be radioactive. Incidentally, the importance of maintaining the thyroid cell structure (p. 385) intact was demonstrated. Crushed tissue was almost devoid of synthetic power. It is also reported that, when a solution of the sodium salt of diiodotyrosine (pH 8) is kept at 70°C . during some weeks, acidification of the solution gives a deposit of thyroxine crystals. Apparently iodine is conserved in the body and used over and over. This is indicated by the fact that, while a thyroidectomized person requires a minimum of thyroxine equivalent to about 200 γ of iodine per day, a normal person

requires not more than 50 γ of iodine per day in the diet. The thyroid normally serves as a storage place for a reserve supply of iodine. When it has acquired some 10 to 20 mg. per cent of iodine, it reaches its "saturation" point and further amounts of iodine in the blood are excreted by the kidney. Nevertheless the thyroid has a remarkable capacity to "select" iodine from the blood, taking some 80 times as much as do other tissues on the average.

The isolation of thyroxine by Kendall (1916) was a notable achievement and illustrates some of the difficulties involved in hormone chemistry. From 3 tons of thyroid glands he obtained 33 g. of thyroxine. Harington (1926) devised a method which may yield as much as 0.027 per cent of the weight of the gland. Its artificial synthesis was accomplished by Harington (1927). The naturally occurring form, as isolated from the products of proteolytic enzyme digestion, is L-thyroxine. Some, at least, of the measurements of the effects of the L-form and the racemic DL-form reveal the former to be twice as effective as the latter, suggesting that the unnatural or D-form is physiologically inert. Not all the observations are in agreement with this, and in view of the transamination reactions of tyrosine (p. 484) there is, of course, the possibility that D-thyroxine might be partly converted to the L-form in the body.

Thyroxine may crystallize in tufts of needles, is difficultly soluble, and is often used as its more soluble sodium salt. It is characterized by its high content of iodine (65 per cent). The L-form shows $(\alpha)_D = -4.2^\circ$ and melting point, 230 to 232°C. Its amount may be estimated in thyroid preparations by bioassay (increase in oxidative metabolism of small animals) or by its action in protecting mice against the toxicity of acetonitrile.

Activity as Related to Structure. The entire structure of thyroxine is necessary for its *full* physiological activity, but when changed by removal of part of the iodine to yield 3,5-diiodothyronine

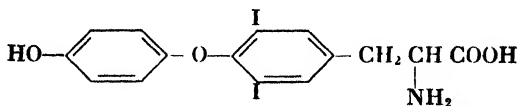

it shows some, though lessened, activity. Completely deiodinated to form thyronine

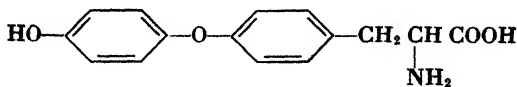

it is without activity and 3,5-diiodotyrosine has very little, if any, effect. The latter observation is surprising in view of the fact that thyroglobulin,

which may yield as much as 33 per cent of its iodine content as 3,5-diiodotyrosine, shows physiological activity nearly proportional to its *total* iodine content. This paradox is not explained. Indeed, the nature of the atomic grouping which confers physiological activity upon thyroxine and related compounds remains to be established. In this connection it is significant that artificially synthesized 3',5'-diiodothyronine

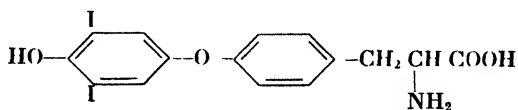

is nearly one-fourth as active as thyroxine itself. This observation and others made upon various derivatives of thyroxine led Niemann to suggest that, in order to show the thyroxine effect, a compound must be potentially able to assume a quinoid structure such as

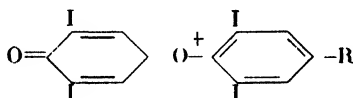

If this hypothesis could be substantiated, it would open the way to a study of the catalytic functioning of thyroxine-like compounds as hydrogen donors and acceptors in oxidative cycles.

Because of the various forms in which iodine occurs in the thyroid, a determination of iodine in desiccated thyroid (still widely used as a therapeutic agent) is not an accurate measure but only an approximate index of physiological activity. The proportion of iodine found shows considerable variation, depending on the available iodine supply (p. 558) and showing a seasonal variation in some animals, being higher in late summer and lower in the winter.

Control and Locus of Thyroxine Production. Some important effects are exerted by other endocrine glands upon the development, size, and activity of the thyroid. Thus in the female there is an increase in the size and activity of the thyroid during pubescence and pregnancy, both of which are themselves influenced by hormones. The thyroid shows some response to the menstrual periods, the endocrine control of which will be described (p. 607) in connection with sex cycles. The chief chemical control of the thyroid, however, is exerted by the thyrotrophic hormone (p. 621) from the anterior pituitary. Some inhibitory or regulative control appears to be exerted by the adrenal cortex inasmuch as injury to this tissue produces increase in thyroid activity reflected in a heightened metabolic rate.

The organ for thyroxine synthesis is primarily the thyroid. Its marked tendency to accumulate iodine and its yield of thyroglobulin led to the assumption that it was the only source of the hormone. But after it was shown that rats deprived of the thyroid (thyroidectomized) responded to iodine administration, other sources of the hormone were suspected. Chaikoff and his associates, after administering radioactive iodine to rats, isolated radioactive thyroxine from the blood, liver, and intestines although the rats appeared to have been deprived of all thyroid tissue.

A number of investigators report that proteins iodinated by exposure to elemental iodine under suitable conditions (pH, temperature, time of incubation) are found to contain thyroxine. Reineke and Turner, for example, prepared an iodinated casein which, hydrolyzed in a butanol- H_2SO_4 mixture, yielded about 0.1 per cent of crystalline L-thyroxine.

The Nature of Thyroid Action. The thyroid effect on oxidative metabolism is so exerted as to speed up the utilization of carbohydrate, fat, and protein. All of the many and varied thyroid effects, as described by physiologists, might conceivably be attributable to this general action. One rather spectacular effect illustrates this hypothesis. In certain vertebrates, metamorphosis occurs under the influence of the thyroid. The tadpole, thyroidectomized, does not metamorphose into a frog but continues to grow in the form of a large tadpole. On the other hand, very small tadpoles, when fed thyroid, metamorphose into tiny frogs, sometimes as small as flies. The same effect can be produced, though less rapidly, by feeding iodides. Moreover, the axolotl, a Mexican salamander which normally remains in larval form throughout life, can metamorphose into an adult salamander if fed thyroid. But metamorphosis is probably controlled by differential metabolic rates so that a peculiar and specialized function of the thyroid hormones need not necessarily be involved in causing these effects.

It is obvious, however, that much remains to be discovered in connection with the endocrinology of the thyroid in spite of the fact that research has been fruitful in the study of this gland over a longer period than in the case of other endocrines and is still very active.

Pathology of the Thyroid. Thyroid pathology is of three types, (1) subnormal functioning, "hypothyroidism," (2) overactivity, "hyperthyroidism," and (3) malfunctioning, "thyrotoxicosis." Types (2) and (3) are not always distinguished from each other.

An example of the first type is the so-called "common goiter" (p. 558) due to dietary deficiency of iodine. Another example is the disease

called "myxedema" of which the most striking symptom is a form of dropsy (edema) causing a puffy appearance of the hands and face. Hypothyroidism due to iodine deficiency during fetal and early life often causes the condition called "cretinism." A cretin is in a pitiable condition, stunted in growth and physically and mentally incompetent. There are abnormally large and peculiarly disposed fat accumulations. A cretin resembles in some ways an experimental animal thyroidectomized at an early age. Both respond, as do myxedematous patients, to thyroid therapy by restoration of the lowered metabolic rate to normal levels, increased general activity, and the disappearance of symptoms of abnormal metabolism. Growth of the cretin or thyroidectomized animal may be restored to normal in rate and character. The use of iodine or iodides, rather than thyroid or its hormonal preparations, is entirely adequate for the arrest or prevention of simple goiter but is less effective for myxedema and cretinism. In the thyroidectomized animal it has relatively little effect so that extrathyroid production of the hormone (p. 596) must be inadequate.

Hyperthyroidism appears in a number of milder forms but is best observed in patients suffering from Graves' disease, also called "exophthalmic goiter" in recognition of two prominent symptoms, exophthalmos, a protrusion of the eyeballs from their sockets ("popeye"), and goiter, enlargement of the thyroid. All hyperthyroid conditions are characterized by a heightened metabolic rate (p. 406) and are thus detected. The BMR may be +40 per cent. Even higher rates have been found though it is usually between +20 and +35 per cent. Symptoms include nervous agitation, hypersensitivity, insomnia, physical unrest, rapid heart rate, and loss of weight, sometimes to emaciation. The patient is, so to speak, burning himself up. The fatal termination is usually due to an overstrain of the heart. Surgical treatment, usually a partial removal of the thyroid, is still the only established, successful corrective. In many cases of the thyrotoxicosis type, symptoms are very similar to hyperthyroidism; yet beneficial effects are obtained through carefully controlled dosage with iodine or with thyroid hormones. Considerable effort has been directed toward the discovery of drugs which might counteract the hyperthyroid condition. A number have been found to show an apparent inhibition of thyroxine formation. Among them sulfonamides, (p. 645) uracil (p. 145), and thiourea, $\text{CS}(\text{NH}_2)_2$, and some of its derivatives are reported to be useful in human thyrotoxicosis. Certain agents which depress bio-oxidation (cyanides, azides, carbon monoxide, etc.) are found (Chaikoff *et al.*) to inhibit thyroxine formation by surviving slices of thyroid; but their use as therapeutic agents is

hazardous. Young rabbits injected with methyl cyanide (Marine) develop goiters and even exophthalmos.

Epinephrine (Adrenine). A pair of small glands, named from their location upon the kidney, are called (according to etymological preference) the "adrenal," "suprarenal," or "epinephral" glands. Correspondingly, a hormone which they secrete is known as adrenaline, adrenine, suprarenine, or epinephrine. It is produced only in the inner part, the medulla, of the gland. The distinctive structure and composition of the two parts of the gland (medulla and cortex) is understandable in view of their different embryological history. The medulla develops from sympathetic ganglia and shows certain staining properties (affinity for chromium) relating it to chromaffin structures of the ganglia. The cortex develops from cells which bud off from the coelomic epithelium and has a peculiar composition (p. 601). While these two structures fuse together in many animals to form what seems to be a single gland, they should be thought of chemically and physiologically as distinct and separate organs.

Epinephrine was the first hormone isolated from an endocrine gland. It was obtained by several investigators (Abel, Takamine, Aldrich) in 1901 by independent methods. Its structure, shown by its reactions and confirmed by artificial synthesis, is

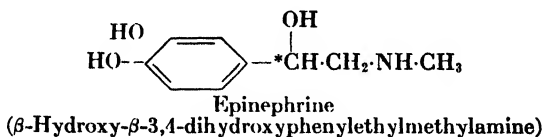

It is catechol condensed with a methylamine derivative of ethanol. It crystallizes in feathery tufts of needles and is insoluble in dilute alkalies and the fat solvents. It forms soluble salts in acids and is commonly dispensed as its HCl salt. It is easily oxidized in alkaline solutions. Its oxidation is hastened by light. Under some conditions it can yield dark colored melanins (p. 499).

Epinephrine shows a number of color reactions. It gives a green color with FeCl_3 in slightly acid solution (Vulpian test); it reduces the Folin uric acid reagent, a tungstate-phosphomolybdate solution also called the "tyrosine reagent," to give a blue color; it gives a red color with potassium persulfate. Colorimetric determination of epinephrine by use of these reactions is unsatisfactory because they are not specific. Bioassay methods are extremely sensitive and generally used. In one of them, the rise in blood pressure in a standardized experimental animal is measured after injection of an epinephrine-containing solution.

The natural form, L-epinephrine, is levorotatory. The racemic form is little more than half as active physiologically as the natural one, and the D-form is said to be about one-fifteenth as active.

Physiological Action of Epinephrine. It exerts an astounding number of physiological effects. Many of them can be summarized by the statement that epinephrine excites the nerve endings of sympathetic nerves. The adrenal medulla is itself excited to secrete epinephrine by nerve impulses entering via sympathetic nerves so that it serves as a mechanism for the projection, with a rather wide diffusion through the body, of sympathetic excitation. Thus it constricts a number of arteries and arterioles, producing a general rise in blood pressure, it steadies the heart beat, relaxes intestinal muscles, etc. Its effects on metabolism include increased glycogenolysis (p. 424), a rise in blood sugar, and sometimes a rise in blood lactic acid. Some direct effect upon carbohydrate metabolism in muscle is alleged but difficult to prove satisfactorily because the observed increase in lactic acid production and in working power, with deferment of extreme fatigue, after epinephrine injections might be due to an increased sugar supply. Epinephrine tends to increase protein catabolism.

Origin and Fate of Epinephrine. The reactions by which epinephrine is produced are not fully known. Tyrosine might be assumed to be the starting point, but this has not been satisfactorily proved. Production in the rat may start with phenylalanine. When it is labeled with C^{14} or with tritium (H^3), the isotopic atoms are in epinephrine.

Epinephrine is rapidly oxidized *in vivo*. On this account, all of its physiological effects are transient. Its blood-pressure-raising action, for example, lasts only some seconds, at the most a few minutes, after it is injected. It shows no effects when taken by mouth other than local vasoconstriction in the oral cavity. Its disappearance in the digestive system, as in the circulatory system, is due partly to oxidation and partly to conjugation. In both reactions, the products lack the physiological properties of epinephrine. One of the oxidation products formed by some *in vitro* oxidations and by certain tissue enzymes (polyphenol oxidase and amine oxidase) is the red pigment **adrenochrome**.

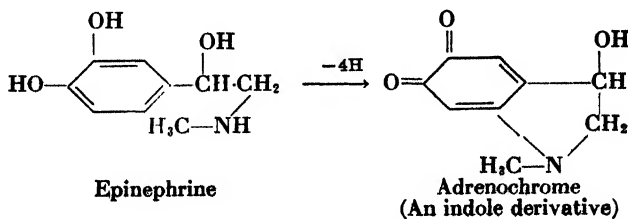

This reaction is hastened by the presence of cytochrome *c*. While epinephrine destruction appears to occur in all tissues, it is reported to be quite rapid in the liver.

A conjugation with what is believed to be a sulfate group is detected by testing human urine after the subject has taken successive doses of epinephrine by mouth. As much as 70 per cent of the ingested epinephrine in some experiments could be found in urine but in a form detectable only after the urine was hydrolyzed.

Physiological and Therapeutic Value of Epinephrine. The question of whether epinephrine is continuously secreted or only occasionally produced has been extensively debated. Cannon's emergency theory assumes that the chief and perhaps the only use of epinephrine is in response to certain stresses as in strong emotion (fear, pain, rage, etc.) or exposure to cold. Under such circumstances, heightened blood sugar and all the other physiological effects of epinephrine would aid in meeting the crisis. Other physiologists believe that in addition to the emergency outflow of larger amounts of epinephrine, there is a steadily maintained secretion of small amounts which promote normal conditions in the circulatory system. It is reported, however, that animals from which the medullas of both adrenals have been removed can recover from the operation and maintain indefinitely what seems to be good physiological condition.

The therapeutic uses of epinephrine include relief of asthmatic attacks (relaxation of bronchial muscles), prevention of excessive bleeding during minor operations (local constriction of arterioles), and relief of surgical and some other forms of shock (general rise of blood pressure).

Sympathins and the Adrenergic Effect. Although functioning as chemical transmitters (p. 81) and therefore not typically hormonal in action, the sympathins resemble epinephrine chemically and physiologically. They are thus appropriately considered at this point.

Many nerve fibers when excited give off acetylcholine (p. 469) at their synaptic terminals and are, therefore, said to be "cholinergic." Other nerve fibers similarly cause the liberation of a substance called *sympathin*. As it closely resembles epinephrine (adrenine), such nerve fibers are said to be "adrenergic." Sympathin can be detected, by the use of bioassay methods, in blood or perfusion fluids circulating through tissues while they are excited by adrenergic nerves. But it has not been obtained in amount sufficient for chemical identification. Its physiological effects so closely resemble those of epinephrine that the two were at one time supposed to be identical. Cannon, Rosenblueth, and their collaborators, however, described distinct differences and therefore

introduced the term "sympathin." The word is appropriate because this substance mediates sympathetic nerve impulses. The majority of the postganglionic sympathetic fibers are adrenergic. Two kinds of sympathins are believed to occur, sympathin E, which mediates excitatory impulses, and sympathin I, mediating inhibitory ones. Cessation of their action appears to be due to oxidation, for which a specific enzyme may be present. It will be recalled that epinephrine itself is also destroyed by oxidation. Such effects are in contrast to the cessation of acetylcholine action which is due to hydrolysis under the influence of an esterase.

Adrenal Cortex. Unlike the medulla, the cortex of the adrenal is indispensable for life. Complete, bilateral adrenalectomy has been tried on a number of species of laboratory animals with essentially the same result. The animal recovers from the operation and for a day, or at most a few days, appears essentially normal. Soon severe symptoms appear, extreme prostration, muscular weakness, a marked loss of vascular tone with consequent fall in blood pressure, loss of weight with excessive loss of water, lowered body temperature, and various severe disturbances in metabolism. If not relieved by suitable therapy, the symptoms increase in severity with fatal termination some 1 or 2 weeks after the operation. The average survival of cats is 7 to 8 days. The relief measures used include the following: (1) A high salt (NaCl) diet which relieves some of the symptoms and prolongs life but not indefinitely; (2) administration, preferably by injection, of extracts of the adrenal cortex which, if suitably prepared, can prolong life indefinitely; (3) injection of purified adrenal cortical steroids or of similar compounds artificially synthesized. Some investigators conclude that no one of these compounds or any known combination of them has been used with unequivocal success in imitating the effects of preparations made by extraction, without separation, of adrenocortical hormones. It therefore seems as though the cortex produces several indispensable hormones, not all of which appear to have been isolated as yet.

The chemical composition of the cortex is peculiar in that it has the highest content (about 5 per cent) of steroids of any animal tissue. Much of this consists of sterols, chiefly cholesterol (about 4 per cent) most of which is in the form of esters. The hormones, however, are steroids and are found only in minute amounts. Phospholipid (about 1.5 per cent) and small amounts of neutral fat are reported. The adrenal gland has the highest content of ascorbic acid (average, about 130 mg. per cent) of any animal tissue, and ascorbic acid deficiency may cause adrenal atrophy. Pantothenic acid deficiency in rats and mice is also reported to cause adrenal disturbance but only in the cortex.

Metabolism after Adrenalectomy. A striking disturbance following adrenalectomy is the increased output of sodium, chiefly as NaCl, in urine. The normal ability of the kidney to restore sodium from the glomerular filtrate to the blood is impaired. Accompanying this is an excessive loss of water with a tendency to decreased (as much as 40 per cent in one week) blood plasma volume. There is also a decrease in urinary excretion of potassium and a mobilization of it from cells to the body fluids. Some of the outwardly visible symptoms of adrenal deficiency are aggravated by potassium ingestion, and, indeed, the symptoms resemble potassium intoxication. It seems established that the normal functioning of the kidney in maintaining the physiological ratio of Na:K in the body is dependent upon the adrenal cortical hormones. Another important disturbance due to adrenal deficiency affects carbohydrate metabolism (p. 430), and while the effects are complex, they include impaired glycogen storing power and a lowering of gluconeogenesis. Basal metabolism is decreased.

All metabolic disturbances following adrenalectomy are corrected by suitable administration of cortical preparations. Correct dosage is important, and sustained treatment is necessary. Its omission during 2 to 3 days causes reappearance of disturbances.

Addison's disease results from adrenal degeneration (usually tubercular or syphilitic) and is marked by symptoms closely resembling those of adrenalectomy. They also include vomiting, loss of appetite (anorexia), progressive loss of weight, anemia, and, frequently, a striking pigmentation of the skin appearing in brown melanin patches. All symptoms except the latter are helped and the patient's life is greatly prolonged by cortical hormone therapy.

Adrenal cortical deficiency, both experimental and in Addison's disease, is relieved and the amount of hormones required is lessened by use of a fairly high carbohydrate diet (thiamine being correspondingly high) with restricted potassium intake and extra allowances of sodium salts (usually NaCl with some bicarbonate and citrate).

In addition to effects upon the regulation of the Na:K ratio in the body and upon carbohydrate metabolism, the functions of the adrenal cortex include influences upon growth and development of sex.

The Cortical Hormones. Some of the earlier preparations (1930-1931) made from extracts of the cortex by Swingle and Pfiffner and by Hartman and his coworkers were called cortin but contained more than one hormone. Subsequently, many investigators have prepared pure individual substances from cortical material, established their molecular structure, and synthesized them. The following have been obtained from the cortex:

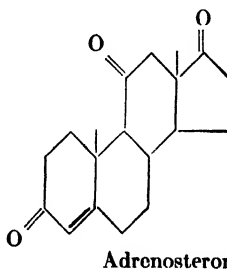
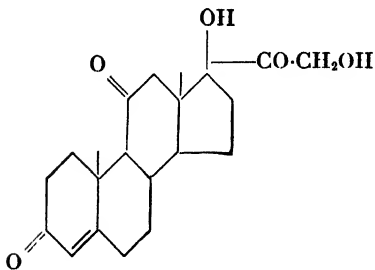
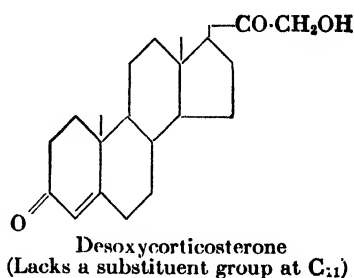
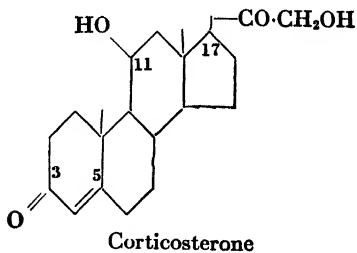

(A triketone which can be produced by oxidation of compound E)

Comparison of these formulas with the classification of sterids (p. 89) shows that three of them are pregnane derivatives. They have the *cis* configuration. Adrenosterone is a *trans* form related to androstane. It has some of the properties of male hormones.

A number of other related compounds have also been synthesized. They include 17-hydroxycorticosterone, 17-hydroxydesoxycorticosterone, 11-dehydrocorticosterone, and some others.

From their own experiments and those of other investigators, Thorn, Engels, and Lewis deduced a scheme which attempts to bring order out of the chaos of relationships between effects upon metabolism and molecular structure of cortical hormones.

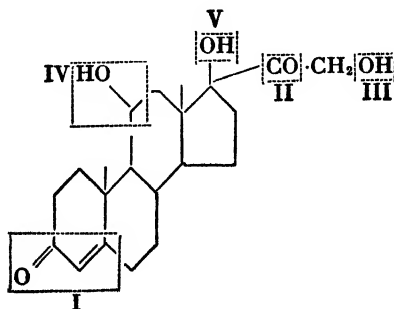

SCHEME TO RELATE MOLECULAR STRUCTURE TO CORTICO-HORMONAL EFFECTS

Groupings enclosed at I and II are essential for all known physiological activities of these hormones.

The hydroxyl group (III) enhances sodium retention by the kidney and is necessary for activity in carbohydrate metabolism.

The grouping at IV, which may be either hydroxyl or ketonic, decreases (in the presence of III) sodium retention and increases carbohydrate activity.

The hydroxyl group at C₁₇ (V) in the presence of III and IV(?) increases carbohydrate activity and induces sodium excretion.

This scheme affords an explanation of the effects of desoxycorticosterone. Used (generally in the form of its somewhat soluble acetate) for treatment of Addison's disease, it is not as advantageous as might be expected from observation of its use in the adrenalectomized animal. In the latter it seems to be the most potent of the adrenal hormones in relieving distress. Comparison between its formula and the scheme indicates that it is a sodium-retaining hormone, and since disturbance in the Na:K ratio produces serious effects, its administration affords dramatic relief. But given as the only replacement hormone in Addison's disease, it may cause a rapid onset of edema, due apparently to over-retention of sodium salts. In contrast, adequate dosage of a potent adrenal cortical extract avoids this difficulty presumably because the extract contains a mixture of sodium-retaining and sodium-excreting factors.

The cortex also affects fat metabolism, and the hormone involved appears to differ from those acting upon sodium retention or carbohydrate metabolism. The hormone has been isolated and when given to adrenalectomized animals restores the ability to deposit fat in the liver and fat depots although this ability is notably impaired in the absence of adrenals.

The different sterids produced in the cortex have been classified (Selye and Jensen, 1946) and are said to include (1) glucocorticoids, causing hyperglycemia and glycogen deposition; (2) lipocorticoids, causing fat deposition, especially in the liver; (3) mineralocorticoids, causing sodium retention and correction of the subnormal blood-sodium and blood-chloride levels in adrenalectomized animals; and (4) testoids, virilizing compounds.

The Cortex in Relation to Other Endocrine Glands. Products of the adrenal cortex exert marked influences upon sex. Many cases are recorded of sexual precocity in which overactivity of the cortex seems to be involved. Boys, for example, may show adult development of external genitals and sexual potency before they are ten years old. While this is not surely attributable to the adrenals, it is known that adrenalectomy in animals tends to cause atrophy of the genital organs and injections of

certain cortical extracts stimulate their growth, development, and activity.

Another type of disturbance, known as "adrenal virilism," occurs in women. Male secondary sex characters, hirsutism (growth of beard and mustache), lower pitch of the voice, and other evidences of maleness become prominent while some feminine characteristics are depressed. This may be associated with disturbance in the adrenal gland, such as a tumor in the cortex. Moreover, it is found that malignant growths in the cortex, such as occur in adrenal carcinoma, are apt to be accompanied by definite increases in urinary excretion of androgenic (producing maleness) substances. This occurs in female as well as male patients.

Even after castration, that is, in eunuchs and doubly ovariectomized women, some androgens are found in the urine. The adrenal cortex is their most probable source.

Female estrogenic (producing sexual receptivity) substances have been found in heightened concentration in the urine of some patients with adrenal virilism. This might be an indirect effect rather than a result of the actual production of the female hormone in the cortex.

Compounds having sexual hormone properties have been isolated from the adrenal cortex. One of them, adrenosterone (p. 603), is reported to be about one-fifth as potent in producing comb growth of the capon (castrated cock) as is testosterone, a typical androgenic substance. One notes, however, that adrenosterone can be produced *in vitro* by oxidation of compound E (p. 603) which is definitely a cortical hormone. Cortisone, synthetic compound E, is used to relieve arthritis. Another cortical preparation is estrone (p. 608), a potent estrogenic substance. It is not as potent, however, as estradiol, formed in the ovary.

The relation of the adrenals to sex is obviously an unsolved problem. While they can produce substances having the properties of sex hormones, they are not the important sources, and these substances might well be mere incidental products of metabolism. Adrenal effects upon sex development and activity might be due, in part at least, to the direct action of adrenal hormones but might well be indirect effects exerted by adrenal hormones upon other endocrine structures, such as the gonads.

A significant relation of the adrenals to another endocrine gland is the one between them and the anterior pituitary. It produces an adrenotrophic hormone (p. 616) which largely controls activity of the adrenal cortex.

The Female Hormones. Important hormones are found in the ovary and exert specific effects upon female sex functions. They are of two types, (1) the estrogenic hormones which produce estrus (receptivity for the male) and cause development or accentuation of femaleness; and

(2) progesterone (progestin) which so affects the uterus as to assist in preparing it for implantation and nutrition of the embryo.

Ovarian hormones are generally prepared from fat-solvent extracts of entire ovaries, but there is ample evidence in support of the view that special ovarian structures, the follicular tissue and the corpus luteum, are the chief if not the only sources of these hormones. As each ovum matures it is imbedded in the developing follicular tissue, which disappears after ovulation. The corpus luteum then develops at the same site. In the nonpregnant condition the luteal tissue reaches its maximum development in the human ovary in about 2 weeks and then undergoes a hyaline degeneration and is resorbed. If pregnancy occurs, the corpus luteum continues its development, maintains maximum size until the fifth or sixth month, and disappears during the seventh month. The control of these processes is due to the interrelations between the ovary and the anterior lobe of the pituitary. The latter produces the two gonadotrophic hormones, the follicle-stimulating hormone (FSH) and the luteinizing hormone (LH). The interaction of the ovarian and gonadotrophic hormones, as they control the normal menstrual cycle in women, are suggested diagrammatically in Fig. 87. The menstrual flow, it will be noted, accompanies the rapid degeneration of the endometrium of the uterus, which is associated with a sharp decrease in production of estrogens (theelin) and a more gradual decrease in progesterone (progestin) production. The relative rates of production of these hormones during pregnancy is probably indicated by the amounts of certain substances found in the urine and believed to be products of metabolism of the hormones.

Estrogenic Substances: Estrogens. Potency in causing estrus and other characteristics of femaleness is a property of a considerable number of compounds. Two of them, estrone (also called "theelin") and estradiol, have been obtained from the ovary and are apparently the primary estrogenic hormones. A "cholesterol-like compound" found in the ovary is believed to be the parent substance of estrogens.

The ovary is not the only producer of estrogens. They are found in urine after ovariectomy. They occur in the urine of men and of male animals. Indeed, the urine of stallions is one of the richest known sources of estrogens and may contain some 1,700,000 international units in a day's output. This unit is the equivalent of the estrogenic potency of 0.1 γ (microgram) of estrone tested on mice. A male is thus shown to be able to produce the equivalent of 170 mg. of estrone daily. Moreover, estrogens are found in plants, e.g., in the oil of palm kernels and in the pussy willow (*Salix discolor*).

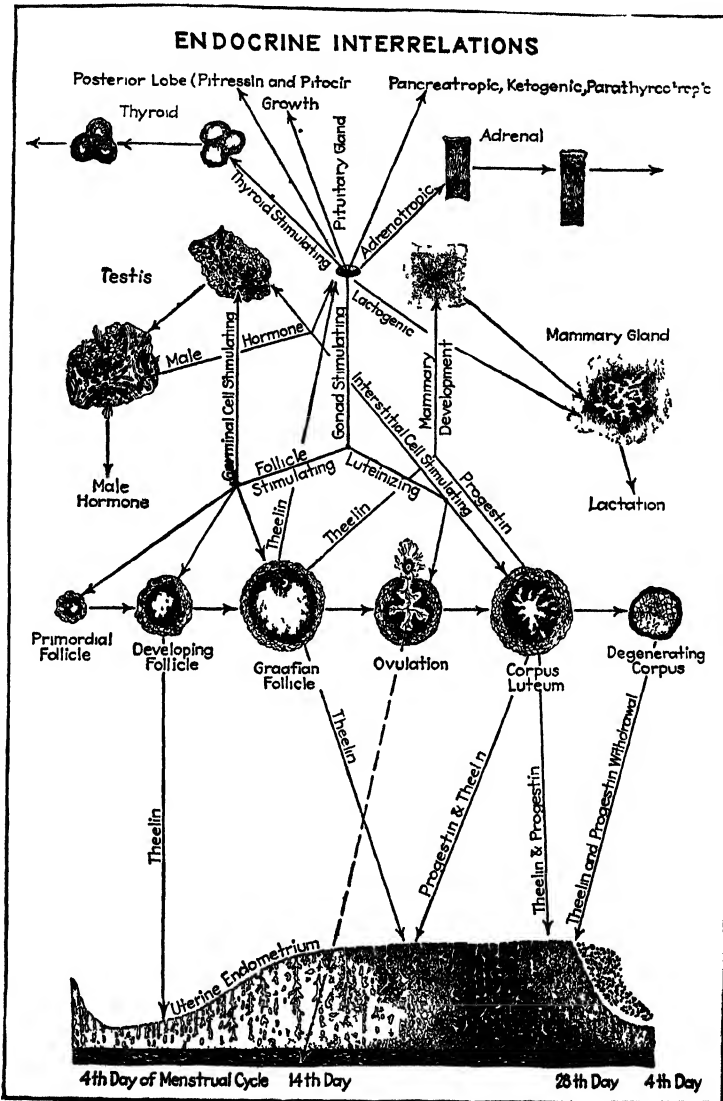

FIG. 87. Hormonal interrelations, including those which operate in the regulation of the menstrual cycle. (Schmidt and Allen, "Fundamentals of Biochemistry.")

TABLE 81.—ESTROGENIC SUBSTANCES (ESTROGENS)

Name	Structure	Natural source	Relative estrogenic potency
Estradiol, dihydrotheelin, dihydroestrone	3,17-Dihydroxy $\Delta^{1,3,5}$ -estratriene, $C_{18}H_{22}O_2$	Ovaries, mare's urine ¹	Highest of all known natural estrogens
Estrone, theelin	3,-Hydroxy-17-keto- $\Delta^{1,3,5}$ -estratriene	Ovaries, urine of both mares and stallions, urine of pregnant women, palm-nut oil	About one-sixth as potent as estradiol. The international unit of estrogenic activity is 0.1 γ of estrone
Estriol, theelol	3,16,17-Trihydroxy- $\Delta^{1,3,5}$ -estratriene	Placenta, pregnancy urine, ² pussy willow	About one-tenth as potent as estrone
Equilin	3-Hydroxy-17-keto- $\Delta^{1,3,5,7}$ -estraetraene	Urine of pregnant mares	About one-third as potent as estrone
Equilenin	3-Hydroxy-17-keto- $\Delta^{1,3,5,6,8}$ -estrapentaene ³	Urine of pregnant mares	About one-tenth as potent as estrone

¹ Estrogenic substances have been detected in urine of men, the zebra, and the bull. They may occur in urines of all mammals. The relative abundance in horse urines has made possible the isolation of identifiable compounds.

² Urines contain the glycuronide of estriol, called "emmetin."

³ Equilenin has both rings I and II of the nuclear framework unsaturated as in benzene. This contrasts with estrone, etc., which have only ring I of the benzene type.

The known natural estrogens are shown, together with certain data, in Table 81. The formula of one of them and that of the steroid hydrocarbon of which they are derivatives are given as

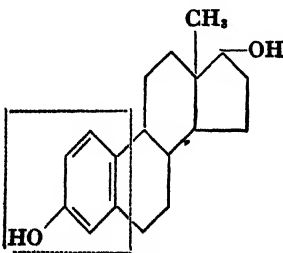

Estradiol (dihydroestrone)
(3-17-Dihydroxy- $\Delta^{1,3,5}$ -estratriene)

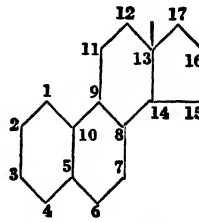

Estrane ($C_{18}H_{30}$)
(The "parent" substance; see Table 13, p. 88)

The characterizations given in the second column of Table 81 afford data for writing the other structural formulas. They will be found to have in common the atomic grouping enclosed in dotted lines in the above formula for estradiol. This group might well be the indispensable one for estrogenic activity.

An exception is found in the activity of the compound generally known as "stilbestrol," also called "diethylstilbestrol," a synthetic derivative of stilbene, $C_6H_5 \cdot CH : CH \cdot C_6H_5$. Diethylstilbestrol is nearly three times as potent, when tested in bioassay for estrogenic effect, as is estrone; and dihydrodiethylstilbestrol, also called "hexostrol," is roughly equivalent to estradiol, the most potent of the natural estrogens. But when the formulas for these synthetic substances are written as shown below, they suggest (Dodds *et al.*) a possible relationship to the estradiol formula.

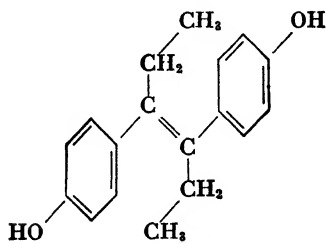

Diethylstilbestrol

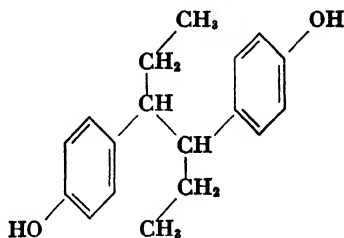

Dihydrodiethylstilbestrol

Substances of considerable diversity of molecular structure have been shown, however, to be more or less estrogenic. They include the compounds

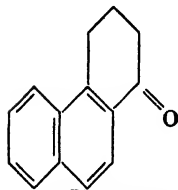

1-Keto-tetrahydrophenanthrene

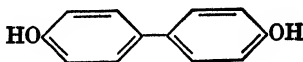

4,4-Dihydroxybiphenyl

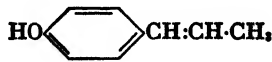

p-Hydroxypropenylbenzene

Even ergosterol (p. 91) and calciferol (p. 164) are reported to be slightly estrogenic. The extent to which such substances are excitants of secretion of natural estrogens rather than being themselves estrogenic is not sharply defined. Even when they are demonstrated to be effective in castrated animals, the possibility of extra-ovarian production of estrogens is not excluded.

Synthetic products are relatively inexpensive substitutes for natural estrogens in the therapy of amenorrhea, dysmenorrhea, and some other metabolic derangements and female disorders. Use in the form of the esters (acetate or propionate) has been recommended since these are more slowly absorbed from the intestine and thus give more sustained action. Oral dosage (natural estrogens must be injected) affords a further advantage. A disadvantage is the fact that, under some conditions, stilbestrols may be more or less toxic. Unless used in very small dosage, diethylstilbestrol is partly excreted in urine as its glucuronide. A synthetic product, benzenestrol, $C_6H_4(OH) \cdot CH(CH_3) \cdot CH(C_2H_5) \cdot CH(C_2H_5) \cdot C_6H_4OH$, gives maximal effects with minute doses and is reported to be relatively free from toxic effects. Another highly active estrogen, dehydrodoisylnolic acid, is effective when taken by mouth.

In further consideration of the relation between molecular structure and estrogenic action, attention is given to the group at C_{17} in the sterids. This group seems important because its nature alters potency. Note that in the reduced form (hydroxyl group in estradiol) it multiplies the effectiveness about six times as compared with the oxidized form (keto group in estrone). Moreover, estrone, hydrogenated, can be reduced to estradiol; but, of the two stereoisomeres thus formed, one, presumably the natural one, known as α -estradiol is some thirty times as potent as the other, β -estradiol.

Theories of the metabolism of the estrogens are still in a formative state. While estradiol could be assumed to be the primary product from which various oxidation and reduction processes gave rise to the other estrogens which occur in tissues and in the urine, it might also be possible that some at least of these other products could be precursors of estradiol. When comparatively large doses of purified estrogens are injected, the metabolic changes which they undergo can be estimated by study of estrogenic substances appearing in the urine. The methods for isolating them from urine admittedly fall short of being quantitatively accurate, and the bioassays of the separated hormones yield, as with most bioassays, only approximate results. Nevertheless, these studies are interpreted to indicate that the following reactions occur in the body:



If estrone is injected, for example, the urine contains estriol as the chief resulting product and a small amount of estradiol is also found. But when estriol is injected, the major part of it appears in urine.

Estriol treated with $KHSO_4$ is dehydrated to estrone; but this reaction is not known to occur in the body. Equilin and equilenin in horse urine appear to be formed by oxidation of estrone.

Urinary estrogens are largely in the form of a glucuronic acid combination, which is relatively water-soluble, is only mildly active biologically, and is readily broken apart by mild hydrolysis.

It is tempting to suppose that cholesterol, abundantly available in the body, might be the starting point for the vital synthesis of estrogens. It would also be available in fair quantity as the initial material for artificial synthesis, a highly desirable accomplishment. An astounding amount of research has been undertaken in the hope of converting cholesterol into estradiol. Among the important results of such work are the conversion of ring I of the cholesterol nucleus into the aromatic condition and the production of a small yield of estradiol from a similarly aromatized androstane derivative. The artificial synthesis of estrone (Miescher, 1949) is reported.

Progesterone. This hormone, first isolated from ovarian extracts and later found in the corpus luteum and the placenta, has been proved by its reactions and by synthesis to have the structure

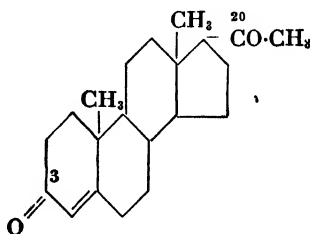

Progesterone
(3,20-Diketo- Δ^{4-5} -pregnene, *cis*)

Being a derivative of pregnane, it is related to the adrenocortical hormones. It is assayed by testing its effect upon the endometrium (uterine lining membrane) when injected into standardized animals. The international unit of activity is the effect produced by 1 mg. of crystalline progesterone. It has no estrogenic effect. When accompanied by estrogens, it assists in stimulating the development of mammary glands preparatory to lactation (p. 617). It is used clinically in oil solution (injected intramuscularly) to prevent threatened abortion and to relieve certain disturbances of menstruation.

Unlike the estrogenic effect, progesterone action is relatively specific. Some other substances, *e.g.*, the male hormone testosterone, are slightly progesterone-like in their effects; but only progesterone itself is significantly potent.

Progesterone is reduced in the body to form chiefly pregnandiol (3,20-dihydroxypregnane, *cis*) which appears in urine as the glucuronide. This

has made possible an experiment to show the probable origin of progesterone. Deuterium-labeled cholesterol was given to a woman in the eighth month of pregnancy, and from the urine, the isolated pregnandiol glucuronide had an isotope content sufficient to indicate clearly that the conversion of cholesterol to progesterone is a normal process. But urine of pregnant women has yielded traces of the trans form called allopregnanediol. Both these forms can be produced by reduction of progesterone *in vitro*. Neither of them has progesterone activity. The less completely reduced forms, 3-hydroxy-20-ketopregnane and allopregnane, have also been detected in pregnancy urine.

The reverse of these reduction processes, conversion of pregnandiol to progesterone, has been accomplished *in vitro*.

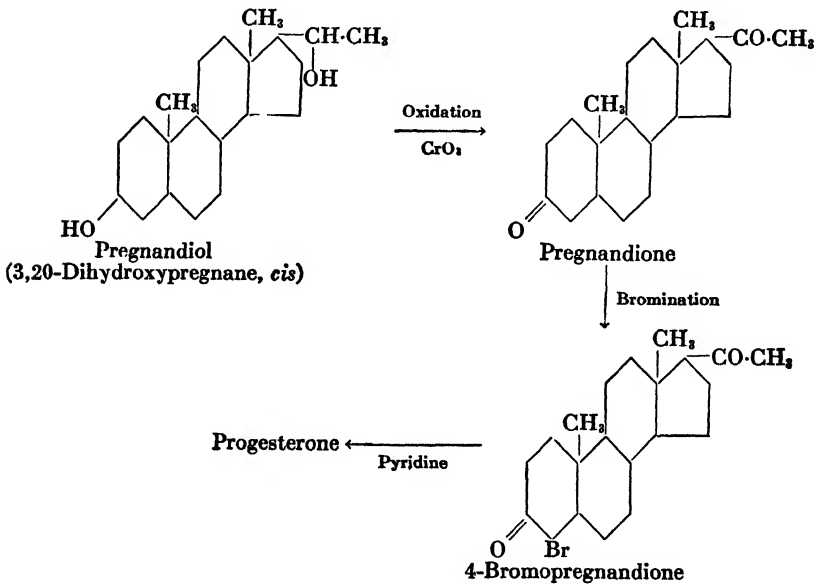

It is difficult to detect progesterone in tissues or body fluids, even during pregnancy. It is apparently reduced to pregnandiol rather rapidly. The reduction can occur in the uterus and in the liver.

Androgenic Substances: Androgens. The various hormones which cause the development of the secondary sex characteristics of maleness are called androgens (Greek, *andros*, man or male). They include testosterone, androsterone, dehydroandrosterone, and adrenoesterone. The formulas of the most potent one, testosterone, and that of the "parent" hydrocarbon, androstane (p. 88), are

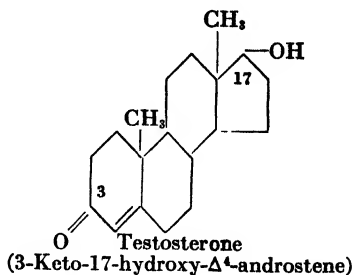
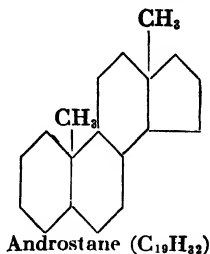

Androsterone is 3-hydroxy-17-keto androstane; dehydroandrosterone is 3-hydroxy-17-keto- Δ^5 -androstene; adrenoesterone (p. 603) is a triketone. Androsterone has been synthesized from cholesterol.

Although color reactions may be utilized for colorimetric determination of androgens, bioassays are also used. One method depends upon the androgenic effect of these hormones upon comb development in the cock. After the cock is caponized (castrated) the comb is small and shriveled, but injection of an androgenic substance causes it to increase in size by an amount proportional to the androgen. In such tests it is found that testosterone is some eight times as effective as androsterone while dehydroandrosterone has only about 40 per cent and adrenoesterone about 20 per cent of the activity of androsterone. The international unit of androgenic activity is that produced by 0.1 mg. of androsterone.

Testosterone is prepared from extracts of the testis. It appears to be the primary male hormone. Evidence clearly points to the interstitial tissue (cells of Leydig) as the source. Other testicular structures (seminiferous tubules) may degenerate from any of several causes without loss of maleness such as follows castration. The interstitial cells are developed and stimulated by an anterior pituitary gonadotrophin, the luteinizing hormone. This is not only proved by direct experimentation but by indirect evidence, namely, the fetal testis contains testosterone produced in response to maternal gonadotrophin. The young male produces practically none but begins to secrete testosterone at puberty. Animals which become sexually active only at a rutting season secrete testosterone correspondingly.

The testes are not the only sources of androgenic substances. Urines contain androgens, and this is not only true of normal males but of eunuchs, castrated animals, women, and female animals. The probable extratesticular source is the adrenal cortex. One of its androgenic substances, adrenoesterone (p. 603), has one-fifth of the potency of androsterone. Others have been prepared from adrenals.

Androgens other than testosterone and those from adrenals are not sufficiently abundant in tissues for successful preparation. They have

been isolated from urine. Apparently they arise through various oxidations and reductions of the primary male hormone. Androsterone, for example, which increases in the urine after administration of testosterone, is a product of reduction of ring I and of oxidation at C₁₇.

Comparing the structures of the androgens (p. 613) one notes that, except for testosterone, they are 17-ketosteroids. As products of testosterone catabolism they constitute the major part of the 17-ketosteroids of urine. Their rate of excretion in men has been studied with interesting results. There is a daily rhythm, rising during the day and subsiding at night. A study of airplane pilots showed that conditions of stress cause excess excretion of these compounds, and the amounts showed a direct relation in pilots to the percentage of "flying time." Yet under normal conditions men tend to excrete rather constant amounts of 17-ketosteroids, 15.7 mg. per day being the average for young men. The total per day rises very slowly in young children but increases more rapidly at puberty, especially in boys. Rapid growth is associated with increase in excretion of 17-ketosteroids.

Testosterone, usually in the form of its propionate ester, has been used with more or less success in treatment of cryptorchidism (failure of descent of testes) in boys. It causes some masculinization. It is also reported to be beneficial in treatment of benign hypertrophy of the prostate. Like estrogens, it can be absorbed from the skin when applied in a skin cream. Good results are claimed for use of pellets implanted beneath the skin. Testosterone can exert a spermatogenic effect, *i.e.*, increase sperm production.

Protein Hormones. Some hormones are proteins. At least six derived from the anterior lobe of the pituitary, the hormone of the parathyroid gland, and insulin are now known to be proteins. Others are believed to be proteins. A problem in the general physiology of the cell is thus presented. Cell membranes appear to be typically impermeable to proteins. The escape of protein hormones from the producing cells and their entrance into cells upon which they act remain to be explained. Activity at cell surfaces is one obvious possibility. Some of these hormones are found to have relatively low molecular weights but hardly low enough to ensure diffusion through cell membranes. It is possible, however, to prepare several of these hormones from urine, suggesting that kidney cells are permeable to them.

As protein hormones are destroyed by digestive enzymes they cannot be given by mouth but must be injected for experimental or clinical use.

The Pituitary (Hypophysis). This small organ at the base of the brain weighs only about 0.7 g. in the human adult (0.001 per cent of the body weight) but exerts such varied and profound effects, especially those

due to hormones secreted by the anterior lobe, that the latter is sometimes referred to as the "master gland" of the body. This term is possibly misleading in that an animal can exist for some time after complete removal of the pituitary, but is useful in calling attention to the idea of correlation of the internal secretions. The endocrine functions are carried on so as to assist in regulative control of the innumerable chemical dynamic equilibria which characterize and underlie the operation of the organism as a whole.

Adjustments of these chemical equilibria, now favoring constructive anabolism and again causing destructive oxidation to predominate, underlie growth, reproduction, lactation, aging, resistance to stressful conditions, etc., and are chiefly due to internal secretions. The coordination of their functioning is largely attained through the influence of pituitary hormones, the **trophic hormones**, upon the activities of various endocrines.

In addition, the pituitary secretes a number of hormones which operate directly rather than by an indirect effect exerted upon other endocrines.

A brief review, calling to mind the morphology of the pituitary, aids in comprehension of the manifold nature of its chemical activities. It has four main parts, (1) the anterior lobe, *pars glandularis*, (2) the *pars nervosa*, (3) the *pars intermedia*, which wraps around the *pars nervosa*, and (4) the stalk (infundibular portion), which connects the pituitary with the brain. The *pars nervosa* and its enveloping layer of tissue composing the *pars intermedia* together constitute the posterior lobe. The anterior lobe is obviously glandular and develops from an invagination of the buccal ectoderm. The *pars nervosa* is more like nervous tissue, having a large number of neuroglia cells and fibers (a few of which are nerve fibers) and develops as an outgrowth of the floor of the third ventricle of the brain. It also contains ependymal (cloaking) cells and some colloid material. The *pars intermedia* is epithelial and is derived from the buccal ectoderm.

The Trophic Hormones. Products of the anterior pituitary which affect the morphology and functioning of other glands or act directly upon growth are trophic hormones. They might be called trophins (Greek, *trophein*, to nourish). So far as known, all of them are proteins as are also trophic hormones obtained from the chorion and the uterine endometrium.

The various anterior pituitary hormones are not all produced in the same kind of cells. A number of cell types are distinguished histologically in this gland. Specialization of their chemical functions has been widely investigated. An example of the results is production of specialized

castration cells in the anterior pituitary after its stimulus, due to sex hormones, is withdrawn by gonadectomy.

Six anterior pituitary trophins have been prepared in a state of purity or near purity: Thyrotrophic, adrenocorticotrophic, lactogenic (so-called mammotrophic), somatotrophic (growth-promoting), and the two gonadotrophic hormones (follicle-stimulating and luteinizing).

Other hormones have been postulated as anterior pituitary products. But they have not been isolated so that their existence as separate entities remains to be established. They include the pancreotrophic hormone, the fat-metabolizing (ketogenic) hormone, the diabetogenic hormone, and a hormone said to increase liver fat.

The Thyrotrophic Hormone (Thyrotrophin). Injected into experimental animals, this hormone causes an increase in size of the thyroid with hypertrophied (enlarged) cells, decrease in colloid material and iodine content, and a rise in the basal metabolic rate, in short, symptoms of hyperthyroidism. Even exophthalmos can be produced in this way. On the other hand, extirpation of the pituitary (hypophysectomy) from a young animal causes a thyroid atrophy, which can be largely arrested by implantation of fresh anterior pituitary tissue into the hypophysectomized animal. Hypophysectomy also decreases the metabolic rate, but does not further lower the rate in a previously thyroidectomized animal. The action of the hormone has been demonstrated on surviving fragments of thyroid which form secretion droplets and show decrease in the colloid material when the hormone is added during microscopic observation. There seems to be a balanced relation between the thyroid and anterior pituitary glands. Excessive production or administration of thyroid hormone may depress the production of thyrotrophic hormone even to the extent of causing involution of the thyroid itself. Lowered production of the thyroid hormone is followed by increased liberation of thyrotrophic hormone.

As separated from beef pituitary, the hormone shows the characteristics of a pure protein with the solubilities of a pseudoglobulin. The most concentrated preparations contain glucosamine as do some other trophins. Its specific effects, as detected by the use of radioactive iodine, are reported to include a more rapid uptake of iodine by the thyroid and increased conversion of diiodotyrosine to thyroxine. The potency of hormone preparations can be assayed by their effect in increasing the metabolic rate. High and low rates, diagnosed in patients as thyroid trouble, may involve some disturbance in thyrotrophin production.

The Adrenocorticotrophic Hormone (ACTH). Existence of this hormone was first evidenced by the atrophy of the adrenal cortex after hypophysectomy. Improvement follows pituitary implantation or injec-

tion of suitable preparations from the anterior pituitary. The hormone has been prepared, as a pure protein of molecular weight about 20,000, isoelectric point, 4.7 to 4.8. It is exceptionally heat stable, showing no loss in potency after 2 hr. heating at 100°C. and pH 7.5.

Preparations made from sheep and swine showed the same properties, molecular weight, isoelectric point, potency, and analysis. They contain no carbohydrate, phosphorus, or cysteine but are rich in cystine (7.19 per cent). The fact that they are not species specific is in contrast to some other trophins which are. Treatment with nitrous acid to remove $-\text{NH}_2$ groups or with ketene, $\text{CH}_2:\text{CO}$, to mask $-\text{OH}$ groups destroys potency. Apparently both $-\text{NH}_2$ and $-\text{OH}$ groups must be free to permit activity. Surprisingly, it is found that nonprotein nitrogen-containing material set free from the hormone by HCl hydrolysis and dialyzed through collodion is still potent in ACTH activity. The active material appears to be a peptide containing about seven amino acid residues.

Recalling the many and varied effects of steroid hormones from the adrenal cortex, it is not surprising that the action of the corresponding trophin is also complex. It is claimed that the trophin exists in two forms, one of them causing increase in weight of the cortex and the other modifying the composition of its lipids. As previously explained, the high concentration of ascorbic acid and the cholesterol supply in the adrenal cortex diminish during secretory activity, *i.e.*, after injection of ACTH. This hormone is antagonistic, in some respects, to the growth hormone, inhibiting both the weight increase and the nitrogen-excretion decrease caused by the latter. ACTH also decreases the tissue alkaline phosphatase which is increased by growth hormone. Injection of ACTH can produce glucosuria in rats, as does 17-hydroxycorticosterone (p. 603), and also increases sugar excretion during alloxan-induced diabetes. In general ACTH aggravates diabetes and opposes insulin. As would be expected, the general effects of cortical hormones affording resistance to cold and other stressful conditions are enhanced by ACTH administration.

Use of this hormone in treatment of Addison's disease has brought about improvement in some but not all cases. Other experiments on human subjects show that ACTH can increase excretion of urinary 17-ketosteroids (p. 614), increase the urinary total nitrogen, and decrease the excretion of Na; in short, ACTH stimulates the human adrenal cortex.

As with other trophins, anterior pituitary production of ACTH is so regulated by the body needs that the corticosteroid hormones in the body fluids are inversely proportional to the rate of ACTH production.

Prolactin. The hormone which stimulates milk secretion is called prolactin or the lactogenic hormone. Mammothrophin, a term sometimes used, is somewhat misleading inasmuch as the mammary gland develop-

ments which occur at puberty and during pregnancy are controlled by other hormones while the prolactin effect is exerted upon milk production, a secretagogue effect. Nevertheless, as was shown in Riddle's work, by which prolactin was discovered, it does determine the development of the crop glands in the pigeon as well as production of the "crop milk." It also causes a marked increase in the size of mammary gland cells, a trophic effect.

Other effects attributed to prolactin include those upon maternal behavior, instincts of motherhood, such as brooding in hens, and the nesting habits in various species.

Prolactin has been isolated from beef and sheep pituitaries. It has also been obtained in microcrystalline form. Several of the preparations have properties of a pure protein. The isoelectric point is 5.70. The purified hormone preparations from different sources do not have identical physicochemical properties so that they may have species specificity. The molecular weight estimations are not in agreement but vary, among different preparations, from 22,000 to 35,000. The sulfur content is relatively high (1.8 to 2.0 per cent) and, correspondingly, the beef hormone yields cystine, 3.0 to 3.4 per cent and methionine, 4.3 per cent. Some other amino acids have been determined, tyrosine, 5.5 to 5.7; tryptophan, 1.3; and arginine, 8.3 per cent. Tyrosine of the sheep hormone (4.5 per cent) is less than that reported for beef.

If species specificity, seemingly established for this and some other trophic hormones, can be shown to characterize most of them, it will have general physiological interest as a characteristic of heredity. ACTH and insulin, also a protein hormone (p. 625) but not a trophin, appear to be nonspecific although minor species differences have not been excluded.

Among bioassay methods of estimation of potency of prolactin preparations, the one which measures the effect upon the crop gland of the pigeon is widely used. Its action on mammary glands is also observed. Injection of the hormone can cause lactation not only in the normal pregnant female but also in the hypophysectomized animal, otherwise incapable of milk production. Prolactin can even cause some lactation in the male animal if it has been suitably conditioned by previous injections of estrogen.

Chemical control of prolactin secretion in the normal pituitary is complex. Prolonged injections of prolactin cause effects which are interpreted to indicate its decreased production by the anterior lobe as though its production were self-inhibiting. The normal inhibitors of secretion, however, during the absence of lactation, appear to be sex hormones. At any rate the sharp decline in production of estrins and progesterone believed to occur at the time of parturition is followed by

onset of prolactin secretion. The nervous reflex excitation of milk flow aroused by suckling and milking is said to be accompanied by increased prolactin liberation.

Although the quantity of milk secreted by experimental animals is increased by prolactin, its use for women deficient in milk production is not reported to be uniformly successful.

The Growth Hormone. The anterior pituitary growth factor is properly named "somatrophin" because it exerts its effects upon the entire body. This is shown by experiments in which "giants" are produced by continued injections of the hormone during growth. The resulting large individuals show no distortion in the proportions characteristic of the species. "Giant" dachshunds, thus produced, are still obviously dachshunds. Nature's experiments with this hormone produce human giants and dwarfs. Dwarfism may be hereditary.

More specific aspects of its effects are observed. It increases bone growth, and a method of bioassay of the hormone is based upon increase in amount of cell proliferation or in width of epiphyseal cartilages in animals injected with it. It tends to produce a plus nitrogen balance, *i.e.*, to increase protein storage. Perhaps related to nitrogen retention is the action of the hormone in decreasing arginase activity in the liver. This has been demonstrated after injections of the hormone into both normal and hypophysectomized rats. It shows some effects on carbohydrate metabolism, increase in muscle glycogen, and increase in glucose excretion of partially depancreatized rats. It tends to lower the RQ, thus suggesting a tendency to increased fat metabolism. Its effects (p. 451) on fat metabolism are not well established, however.

The growth hormone has been prepared in highly concentrated form, approaching purity and free from certain other trophic hormones. Its behavior clearly proves it to be a protein. Highly purified, crystalline proteins obtained by Li, Evans, and their associates from ox pituitaries by salting-out methods showed evidence of chemical purity by electrophoresis measurements. The isoelectric point is 6.85. The molecular weight is about 47,000. Nearly all its amino acid content has been determined without showing any striking peculiarity in its composition. A total dosage of 0.1 mg. injected daily in 10 equal amounts caused an increase of 10 g. in the weight of young hypophysectomized rats, but 50 times this amount of the hormone (5 mg.), when similarly tested, showed no evidence of thyrotrophic, adrenocorticotrophic, lactogenic, or gonadotrophic action.

Treated with nitrous acid or with ketene the growth hormone loses its activity. This suggests that its free amino groups are essential for growth-promoting action.

Control of its production is one of the interesting aspects of the limitation of growth. It seems probable that there is some change in its liberation when growth ceases. It seems to be still present in the gland since it is not necessary to select pituitaries from young animals in order to prepare the hormone. It is reported (Evans, Simpson, and Li, 1946) that both adult normal rats or hypophysectomized rats respond to injections of the hormone by continued growth without any sign of failure to respond during a period of more than 400 days. The injected animals gained on the average more than five times as much weight as the controls, and the overgrowth appeared to be like normal growth inasmuch as internal organs all increased in proportion to the total body weight and size. Thus it would seem that there is no inhibitor of the free growth hormone acting at the time growth normally ceases, but the liberation of the growth hormone from its source in the anterior pituitary is somehow checked. In general, growth slows down during sexual maturation and ceases not long after. This suggests an effect of sex hormones and, experimentally, suitably timed injections of estrogens can check growth. On the other hand growth of the castrate, though sometimes in excess of normal, is not unchecked. Sex hormones cannot be the only controlling factor. The diminished growth of cretins and thyroidectomized animals might be regarded as the direct result of hypothyroidism, but an indirect effect (depression of growth-hormone production) is also possible. It has been shown, indeed, that thyroidectomized animals can be stimulated to better growth by use of thyroid and growth hormones together than by either of them alone.

Pathologically, deficiency in growth-hormone production may be associated with infantilism in various forms, some of which respond favorably to pituitary therapy. A conspicuous type of pituitary deficiency is marked by symptoms known as the Fröhlich syndrome, sluggish growth, obesity with abnormal disposition of fat, sexual infantilism, and other deficiencies.

The most striking disorder of the pituitary is acromegaly, which results from a hyperpituitary condition occurring in the adult. Growth is resumed but it is an abnormal type of growth affecting chiefly bones of the face and hands. The usual cause is irritation of the pituitary by tumor growth.

The Gonadotrophic Hormones. The sex hormones are produced under the influence of specific trophins from the anterior pituitary. Their action in controlling sex cycles (p. 606) was outlined in connection with female hormones. Gonadotrophins also affect growth and development of testes and ovaries.

Gonadotrophins are of different origin, function, and chemical struc-

ture. The sources from which they are obtained are indicated in the following list:

Anterior pituitary gonadotrophins:

Luteinizing hormone (LH) also called interstitial-cell-stimulating hormone (ICSH)

Follicle-stimulating hormone (FSH)

Chorionic and placental (uterine) gonadotrophins not yet differentiated

Blood gonadotrophin:

Pregnant mare's blood gonadotrophin, closely related to, if not identical with, the chorionic gonadotrophin

Urinary gonadotrophins:

Pregnancy urine gonadotrophins, closely related to, if not identical with, the chorionic gonadotrophins

Other urinary gonadotrophins

All gonadotrophins so far investigated are glycoproteins. They yield sugar when hydrolyzed. A hexosamine, which in some cases appears to be glucosamine, has been obtained from some of them. Mannose but not galactose has been found in those from the anterior pituitary, while galactose but not mannose is obtained from chorionic (pregnancy urine) gonadotrophin.

Interstitial-cell-stimulating Hormone (ICSH). A trophin, long known as the **luteinizing hormone** because of its action in developing the corpus luteum in the ovary, is now called the interstitial-cell-stimulating hormone (ICSH) in recognition of its effects on such cells in both ovary and testis. In the male, stimulation of Leydig cells is accompanied by secretion of androgens and the consequent development of all of the secondary sex characteristics of maleness. It is also found that spermatogenic tissues of the testis are stimulated to activity by doses of ICSH too small to cause changes in the accessory sex organs such as would result from stimulation of cells of Leydig or other interstitial structures of the testis. It now seems, therefore, that ICSH is a complete trophin for the testis, affecting all its functions. In birds, ICSH can cause striking increases in weight of the testis. In the female, its effect on interstitial tissues is believed to be synergistic (cooperative) with FSH. Together, and only together, they cause ovarian development in immature or hypophysectomized animals.

This hormone has been obtained in what appears to be chemical purity from pituitaries of several species. Some of the characteristics of these proteins from swine and sheep are given in Table 82. They represent results of different investigators. But even allowing for possible variations due to methods of observation, differences due to source are apparent. Immunological work has also shown that these two proteins are not identical.

Chemical control of the production of ICSH in the male is not demonstrated, but in the female the rate of its discharge changes in conformity with mammalian sex cycles and the requirements of pregnancy. The rate is determined chiefly by the relative amounts of sex hormones produced in the ovary. Probably the rate of discharge is more variable than the rate of production.

The Follicle-stimulating Hormone (FSH). This hormone is sometimes called the "gametogenic hormone" because it exerts its effects upon cells that are concerned with production of ova and sperm. In the male

TABLE 82.—CHARACTERISTICS OF PURIFIED ICSH PROTEINS

Source of pituitaries	Estimated molecular weight	Isoelectric point	Content of			
			Hexosamine	Mannose	Tryptophan	Cystine
			per cent	per cent	per cent	per cent
Swine.....	100,000 ¹	7.45	2.2	2.8	3.8	
Sheep.....	40,000 ²	4.60	5.9	4.5	1.0	5.4

¹ Ultracentrifuge method. ² Osmotic pressure measurement.

FSH causes development of the spermatogenic tissue but appears to have no effect on interstitial tissues of the testis. It is not yet clear how ICSH and FSH are related in their effects upon the testis. In the female, growth of follicles is stimulated by FSH.

FSH has been prepared (Li, Simpson, and Evans, 1949) in a state of relatively high purity free from other hormones. It has solubilities and other properties resembling those of albumins. It is soluble in water, in half-saturated $(\text{NH}_4)_2\text{SO}_4$, and in the absence of electrolytes, in 70 per cent ethanol. Its aqueous solutions at pH 7 to 8 are comparatively heat stable; the FSH potency is not lost after 30 min. at 75°C. The isoelectric point is estimated to be about 4.8. The most potent preparation, as tested by effects upon the gonads in bioassay, was obtained from sheep pituitaries. It was found to be higher in carbohydrate content (about 13 per cent) than ICSH. It yielded some 8 per cent of hexosamine. A preparation from swine pituitaries yielded 4.4 per cent of hexosamine and gave an approximately equal yield of mannose.

The extent to which FSH production may fluctuate is not well determined.

Nonpregnant Urinary Gonadotrophins. Gonadotrophins, too small in amount to afford satisfactory chemical characterization, are detectable in the urine of males and of female castrates. This suggests

that gonadotrophins of the anterior pituitary or substances derived from them are excreted by the kidney.

The material from male urine acts upon spermatogenic tissue. It can restore or maintain spermatogenesis in the hypophysectomized rat and causes definite increases in testis weight if it is a young animal.

Gonadotrophins of the Chorionic Type. Some of the early work on gonadotrophins was done with preparations made from pregnancy urines. Separated in fairly concentrated form, such preparations were found to exert effects upon certain reproductive organs as striking as those caused by anterior pituitary extracts. The urinary trophins were therefore named "anterior-pituitary-like" (APL) hormones. Later it was found that the chorion yielded a trophin with essentially the same chemical and physiological properties. It is also detectable in the blood of pregnant mares. The present hypothesis is that it is formed in the uterus, circulates in the blood, and is excreted in the urine. Preparations from these three sources are thus included, tentatively, under the term "chorionic gonadotrophins." It is by no means certain, however, that the chorion is the only or even the prime source. Preparations are made, in some cases, from the entire mass of fetal membranes. The placenta, in intimate contact with the chorion, appears to contain some of the trophin, and it is reported that *in vitro* tissue cultures of growing placenta cells yield the hormone for as long as 60 days, which suggests that they synthesize it.

The chief effect of this hormone, as in the case of pituitary ICSH, is on the luteal tissue. This is the basis of the well-known **Asheim-Zondek test** for human pregnancy. About one month after conception, when, or a few days after, menstruation first fails to occur, the urine contains enough of the hormone to permit its biological detection. In Friedman's modification of the test, 10 to 20 ml. of the urine are injected into an adult female rabbit which has been kept in isolation for three weeks. The ovaries, examined some 16 to 36 hr. later, will show, if the urine contained the hormone, definite luteinization and other evidence of stimulation, such as hemorrhage in some follicles. A convenient test (Wiltberger and Miller, 1948) employs the male frog. Injected subcutaneously with pregnancy urine, the frog gives off spermatozoa into the urine. The test is reported to be very reliable for early detection of pregnancy. The changes in rate of secretion of the gonadotrophin during pregnancy, as shown by bioassay, include a marked rise during the first 2 months, a considerable decrease during the next 2 months, and a more gradual decrease during the last half of the period of pregnancy.

The pregnancy urine hormone (mare's urine is the usual source) when injected into male animals causes stimulation of Leydig cells and growth

of interstitial tissue. The latter is also stimulated in the female. There is a considerable action of this trophin upon germinal tissues of the testis.

Evidence has been reported to indicate that the pregnancy urine gonadotrophin consists of two principles, one stimulating germinal tissues, a gametogenic hormone like ICSH, and another acting upon Leydig cells and gonadal interstitial tissue. But their separate identity is not yet established.

From the urine of pregnant mares and from human pregnancy urines preparations of very near purity and high potency (bioassay) have been made. Like pituitary gonadotrophins they are glycoproteins but contain galactose, not mannose. Hexosamine is present, however, as in the pituitary type. They appear to be relatively acid proteins, *i.e.*, low isoelectric points. Characteristics of purified preparations are shown in Table 83. Again there is evidence of species specificity.

TABLE 83. —CHARACTERISTICS OF PURIFIED URINARY GONADOTROPHINS

Source of pregnancy urine	Estimated molecular weight	Isoelectric point	Galactose content	Hexosamine content	Tyrosine content	Tryptophan content
Women.....	100,000	3.2-3.3	per cent 12	per cent 6	per cent	per cent
Mares.....	*	2.6	17.6	8.5	3.54	1.37

* Shows evidence of two components in electrophoresis.

Trophins and Chemical Structure. What feature of the molecular construction of trophins gives them their specific physiological properties? Although considerable efforts have been directed toward the solution of this problem, the only answer available is that apparently the entire molecule functions as a unit. Any hydrolytic treatment, *e.g.*, use of proteases, destroys their activity. Treatment with ketene, $\text{CH}_2\text{:CO}$, which causes acetylation of free amino groups and of the hydroxyl group of tyrosine, inactivates prolactin, the gonadotrophins, and others (p. 619). The progressive increase in ketene treatment is parallel to the loss of activity. Reduction of the —S—S— group of cystine also appears to destroy activity, at least in some cases. A structure as labile as a protein molecule can be altered in what may seem minor respects and yet show profound changes in physiological properties.

Postulated Anterior Pituitary Hormones. An astounding list of hormones from the anterior pituitary could be compiled if each of the many and varied effects observed in different laboratories following injections of pituitary extracts were attributed to a specific hormone. Trophins, in addition to those already described, have been regarded as

probably occurring. They include a parathyrotrophin, for the parathyroid gland, and a pancreatotrophin, affecting the pancreas. Evidence for their existence is not conclusive.

There are the so-called metabolizing hormones, the diabetogenic hormone (p. 433), and the fat-metabolizing or ketogenic hormone (p. 433), which have been assumed to exist in order to explain some well-established experimental facts. It might also be assumed that the effect on liver arginase (p. 619) and the liver-fat-increasing action of pituitary preparations could be due to specific pituitary hormones. Several others could be postulated. But, as was suggested in connection with the chemistry of the growth hormone, it remains to be demonstrated that these are separate substances rather than one or a few.

Insulin. The relation of insulin to carbohydrate metabolism in health and disease was given in Chap. XIV. Owing to the interrelations between carbohydrate oxidation and that of fats and proteins, insulin

TABLE 81. CHARACTERISTICS OF CRYSTALLINE INSULIN
Molecular weight, 35,100-46,000
Isoelectric point, 5.35

Composition	Per Cent
Leucine....	30.00
Glutamic acid	30.00
Tyrosine..	12.20
Cystine (computed as cysteine).....	12.20
Histidine.....	8.00
Arginine.....	3.22
Lysine.....	2.26
Serine.....	3.57
Threonine.....	2.66
Proline.....	Present
Phenylalanine.....	Present
Methionine.....	Possibly present
Ammonia (amide groups).....	1.65
Total sulfur ¹	3.30
Zinc.....	0.3-0.6

¹ This is only slightly more than that of the cystine, so that if methionine is present it must be very small in amount.

also has important effects upon all aspects of metabolism, as was shown in Chaps. XV and XVI. The chemistry of insulin remains to be discussed.

In comparison with other protein hormones, insulin has been rather precisely characterized. Its preparations in crystalline form satisfy criteria of chemical purity. Analytical data obtained with purified insulin are shown in Table 84. The amino acid determinations are selected from results of different investigators and, as in all such determinations, are subject to revision. They add up to more than 100 per cent (water introduced by hydrolysis is not subtracted), and this sug-

gests that the insulin molecule is nearly all accounted for. The high content of leucine, glutamic acid, tyrosine, and cystine is notable. It is a slightly acid protein, isoelectric point at pH 5.35. It is fairly stable in mildly acid solution but is rapidly destroyed by alkali.

The zinc content is variable and determined by the pH of the solution from which the insulin crystallizes. This suggests that some, at least, of the zinc is present in simple salt form. Some of it can be removed by mere water treatment. Insulin is commonly used as its zinc compound. The zinc content of the pancreas (about 3 mg. per cent), though higher than that of most tissues, is less than that of liver, spleen, and kidney. Zinc may have some association with the formation or storage of insulin since the zinc content of the diabetic pancreas is comparatively low.

Insulin, like other protein hormones, is destroyed by proteases and cannot be given by mouth. Partly on this account, a substitute for insulin has been widely sought but without any real success. In this connection it would be of interest to know how the activity of insulin is related to its structure. Any treatment (*e.g.*, with proteolytic enzymes) causing hydrolysis diminishes potency in direct relation to the extent of the hydrolysis. The partial hydrolysis products, separated by ultrafiltration, are inactive. Treatment with ketene, under circumstances believed to acetylate the $-\text{NH}_2$ groups but not the $-\text{OH}$ groups of tyrosine, does not destroy activity. When the latter are acetylated, potency is greatly reduced. It is notable that insulin is relatively high in tyrosine content. Cystine, also abundantly present, seems to be important. Reductions which affect the $-\text{S}-\text{S}-$ grouping of insulin abolish its activity, and subsequent oxidation by H_2O_2 is claimed to afford partial restoration.

In order to decrease the number of injections required per day in diabetic patients, a slow, steady absorption at the point of injection is advantageous. This is secured by the preparation of zinc-insulin in a complex with another protein, such as protamin (Fig. 88). This complex can maintain a blood-sugar-lowering effect during as much as 24 hr.

Insulin prepared from the pancreas of beef, pork, lamb, fish, bison, and man appears to have the same properties, and insulins from different species are found to be immunologically the same.

Experimental Production of Diabetes. Knowledge of the fundamental cause of diabetes would be valuable. Although some hereditary factor seems to be involved, conditions which precipitate diabetes are sought. Much research has been directed toward their discovery. Studies of possible nervous causes (p. 428) have not been conclusive. Experimental diabetes is produced in many ways (pp. 431 and 433) and

even by certain infections in some species, but most of these methods involve either removal of the pancreas or a serious injury to it. They are, as is sometimes said, "insults to the pancreas." Such profound injuries are not the cause of ordinary human diabetes. More subtle effects must be sought. In this situation, diabetes caused by a substance related to biological materials is of interest. It has been shown by several investigators that injection of fairly large doses (300 to 400 mg. per kg. of body weight) of alloxan in rats caused damage to the islet tissue of the

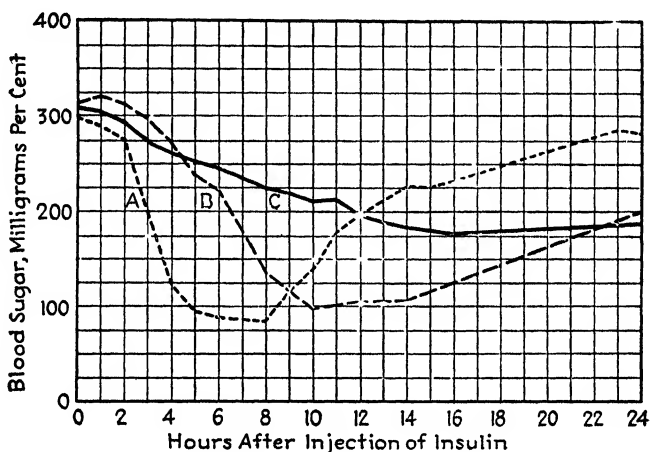

FIG. 88. Curves to indicate the effects of insulin and its complexes on the blood-sugar level. Each of the three curves is a composite of a number of observations on each of five fasting diabetic subjects. Curve A gives results with crystalline insulin; curve B, with protamin-insulin zinc; curve C, with histone-insulin zinc. Another set of observations with globin-insulin zinc gave results essentially identical with those for protamin-insulin zinc. The amounts of insulin injected (0.15 to 0.2 unit of insulin per kilogram of body weight) were comparable in all cases. Blood samples were taken hourly, except between 11 P.M. and 7 A.M. No food was given during the test. The slower and more prolonged action of insulin in complex form, as contrasted with crystalline insulin, is apparent. (After Bailey and Marble.)

pancreas and produced an experimental diabetes which responded to insulin treatment. Similar results have been obtained with dogs and with rabbits. Alloxan (2,4,5,6-tetraoxypyrimidine) is an *in vitro* product of the oxidation or of the acid hydrolysis of uric acid and is reported to be present in the liver of several species of animals. It has not been shown that alloxan or any similar substance is the cause of human diabetes. Dialuric acid (2,4,6-trioxy-5-hydroxypyrimidine) is also reported to cause diabetes when repeatedly injected in rather large doses into rats.

Insulin Production and Destruction. Experience in the use of insulin both for experimental purposes and in the treatment of diabetes has shown clearly that the amount required for maintenance of normal conditions is in direct proportion to the amount of carbohydrate metabolized. The natural inference is that insulin is normally produced as required. That the blood-sugar level directly influences the amount of insulin produced in the healthy pancreas seems clearly established. There is also some evidence that when the blood has a relatively high concentration of insulin its liberation is suppressed. Studies of the insulin content of the pancreas of experimental animals shows reduction after fasting and after high-fat feeding. There is also a reduction after the use of diets deficient in indispensable amino acids. Hormonal control has been alleged but is difficult to establish. While some injections of certain pituitary preparations lead to an increase in the insulin content of the rat pancreas, hypophysectomy does not prevent insulin production. Estrogens can increase the insulin content of the pancreas, yet castration does not change the insulin content of the pancreas. There are similar results with thyroxine and the adrenal hormones. The most profound effect is that exerted by diabetogenic pituitary preparations (p. 433), which cause definite lowering of the insulin content of the pancreas with certain specific degenerative effects in the islet tissue. Obviously control of insulin production is complex and not yet fully explained.

The rapid disappearance of insulin once it is in the circulation suggests that it is consumed as it exercises its function. While its rate of disappearance from the blood is decreased when the kidney is excluded from the circulation, it has not been possible to find insulin in the urine even when it is injected in comparatively large amounts.

The Parathyroid Hormone. Total extirpation of all the parathyroid glands and, in some animals, the extirpation of only a few is fatal. Although the animal may recover well from the operation, conditions of distress appear within a few days. Among the complex symptoms, which have been given extensive physiological study, are those such as severe tetanus (muscular spasms) and other nervous disturbances which can be explained by changes in the blood content of calcium. Blood calcium falls from its normal level (9 to 11.5 mg. per cent) to about half its usual value. There is a temporary rise in the blood inorganic phosphate level which subsides later. These changes can be counteracted by injections of parathyroid extract. Its sustained use may fail to be effective, presumably because of antihormone (p. 634) production. Injection of the extract into normal animals, imitating a hyperparathyroid condition, causes (Fig. 89) a rise in blood calcium and phosphate accompanied by their increased excretion in urine. The explanation is still incomplete. There is some evidence, unconfirmed, that the hormone has a direct effect

upon the kidney, enabling it better to retain phosphate in the blood. An increase in blood alkaline phosphatase, an enzyme functioning in bone calcification, has been demonstrated in hyperparathyroid patients. This suggests that the parathyroid hormone in some way affects the equilibrium (p. 585) between calcium phosphate of bone and that of blood. Relief of hypoparathyroid symptoms is afforded by mere feeding or injection of calcium (*e.g.*, the lactate) which may sometimes indefinitely prolong the life of parathyroidectomized animals.

The parathyroid hormone, sometimes called **parathormone** or **parathyrin**, has been separated from extracts of the glands in highly concentrated form. It is undoubtedly a protein. This is indicated by its behavior in salting out, adsorption, and other procedures employed in

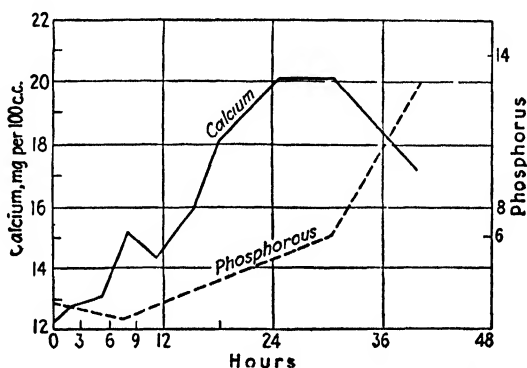

FIG. 89. The effect of parathyroid hormone upon blood Ca and phosphorus. Both the serum Ca and the whole blood inorganic phosphorus increase as a result of repeated injections of the parathyroid hormone. These results were obtained in the normal dog and represent overdose, hyperparathyroid condition. (After Collip.)

its preparation. Furthermore, it is inactivated by proteases as are other hormones known to be proteins. It is also inactivated by acetylation with ketene and has a minimum solubility at pH 6 as though it had an isoelectric point.

Control of the production of parathormone was at one time supposed to be due to an anterior pituitary effect (a specific trophin), but later work has shown that hypophysectomy is followed by no symptoms of parathyroid failure.

A therapeutic application of knowledge of this hormone is its use in treatment of infantile tetany, which seems to be due to a deficiency of the parathyroids, a hypoparathyroid condition. The distressing symptoms of this disease, commonly known as "children's fits," can be strikingly relieved by injection of the hormone. Another application is in the treatment of the spasmodic seizures which follow removal of the para-

thyroids (*tetania parathyropriva*) as may occur in operations on the thyroid gland. Some of the parathyroid structures are close to or even embedded in the thyroid and may be removed, injured, or rendered deficient in blood supply during a thyroidectomy even when only a part of the thyroid is removed.

The Renin-Hypertensin System. The kidney is the source of a protein called "renin," which can raise blood pressure by increasing the tone of arterial muscles, constricting them to cause hypertension. While renin is not known to be the cause of the all-too-frequent cases of hypertension, it has been extensively investigated partly because it might throw light upon the nature of this human affliction and partly because it involves an interesting biochemical reaction.

The phenomenon was first shown in Goldblatt's experiments, in which he found that compression of the renal arteries, so as to decrease the blood flow through the kidneys, resulted in persistent hypertension in the dog. Further experiments showed that this rise in blood pressure was due to the release of some substance from the kidney into the blood. From extracts of the kidney the active principle, renin, has been prepared in a highly concentrated although not pure state. All its behavior indicates that it is a protein of the globulin type. Its effects are shown by intravenous injection. It is not *of itself* a blood-pressure-raising substance. This is proved by dissolving it in Ringer solution and perfusing it through the blood vessels of any organ. It then causes no arterial constriction although other hormones, such as epinephrine, which cause arterial constriction would be effective under these conditions. Renin acts upon one of the serum α -globulins, known as **hypertensinogen**, to form the really active substance, **hypertensin** which is also called angiotonin (Greek, *angio-*, vessel and *tonos*, tension).¹ Hypertensinogen is produced by the liver. Hypertensin is a crystalline amine, thermostable, dialyzable, precipitated by saturation with $(\text{NH}_4)_2\text{SO}_4$ or by addition of phosphotungstate but not precipitated by trichloroacetic acid. It is insoluble in ether. These and some other properties characterize it as a complex polypeptide. It contains phenol groups (tyrosine). The enzymes tyrosinase and amino peptidase render it inactive. It is also inactivated by tyrosinase which has been heated (40 min. at 60°C.) sufficiently to destroy its typical enzymatic power. This suggests the possibility that hypertensin can lose its potency by a non-enzymatic reaction which masks its physiologically active groups. The latter would seem to be phenolic.

¹ Angiotonin is the name used by North American investigators. Hypertensin, the term used by Buenos Aires workers, is consonant with the nomenclature of other substances involved in this system.

Renin is specific for hypertensinogen, its only substrate so far discovered. It is even species specific. Human renin, for example, acts only on human hypertensinogen. On the other hand, hypertensinogen does not require a specific enzyme for its cleavage. Pepsin can cause activation although it is effective only in an acid medium (pH 2 to 6) while renin has a pH zone of optimum activity on the alkaline side (pH 7.5 to 8.5).

The hypertensin effect appears to be a property of various protein cleavage products. Thus, casein and egg albumin, when partially split by pepsin, yield products which resemble hypertensin in physical and chemical properties and can raise blood pressure.

Hypertensin is destroyed in the blood. This is due to a substance which has the properties of an enzyme and is called "hypertensinase." It probably originates in the kidney. It cannot be found in the blood of the dog after both kidneys are removed (double nephrectomy).

Ideas regarding the renin-hypertensin reaction system (as now postulated) are summarized in the following scheme:

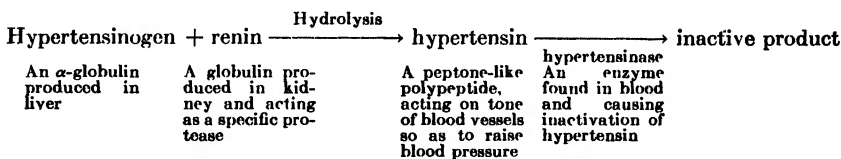

There is pretty general agreement that renin may properly be called a hormone. But it is unique among hormones in that its enzymatic quality is demonstrated. The minute amount which is sufficient for normal activity of any hormone suggests, of course, that all hormones function in some catalytic manner, but this cannot be shown in the present paucity of knowledge about the chemical mechanisms of hormone influence upon metabolism.

The amount of renin liberated into the blood under *normal* conditions is not known, but experiments indicate that there is probably some of it. Normal kidneys secrete detectable renin when the arterial blood pressure falls. Theoretically, a balance is maintained between renin production, with consequent hypertensin, and hypertensinase production—with consequent hypertensin destruction. Supposedly, some cases of chronic hypertension might be due to a disturbance in this balance. Practical applications for relief, thus suggested, are not yet realized.

Secretin and Pancreozymin. Control of secretion of pancreatic juice (p. 262) is due to the hormone secretin. Its production in the mucosa of the duodenum is the result of the action of HCl upon a mucosa

protein called "prosecretin." When the chyme lacks HCl (achlorhydria), fatty acids in the intestine appear to be able to cause secretin liberation. Secretin acts predominantly upon the acini of the pancreas to cause them to set up a flow of pancreatic juice. But secretin also shows some stimulatory effect upon the secretion of bile and may, perhaps, excite secretion of intestinal juice. The latter effect, however, may be due (p. 633) to another hormone.

Pancreozymin (p. 262), which arises along with secretin, was more recently discovered and is not as yet well characterized although its properties have been shown to resemble those of secretin. Both secretin and pancreozymin are destroyed by incubation with blood serum. There seems to be a secretinase in the blood.

Secretin has been prepared in purified form, isolated as the crystalline picrolonate, and shown to be a polypeptide, minimal molecular weight about 5,200. It probably contains only 36 amino acid groups. They are predominantly basic. Secretin is digested by the action of gastric and pancreatic juices, and since digestion destroys its physiological activity, it is not effective when taken by mouth. It is also ineffective when injected subcutaneously because, thus slowly absorbed, it is destroyed by the blood before it reaches the pancreas in effective concentration. Both secretin and pancreozymin are tested (bioassay) by intravenous injection.

Gastrin. While there is no question but that a hormone can be prepared from extracts of the mucosa of the pyloric portion of the stomach (p. 260), there is some question as to whether it is merely histamine, a powerful excitant for secretion of HCl by gastric glands, or a protein hormone resembling secretin. Recent work reported by a group of Canadian investigators has shown that preparations which are regarded as histamine-free contain two active protein-like secretagogue hormones, one stimulating the gastric glands and the other increasing the secretion of pancreatic juice.

Other Hormones Concerned with Digestive Processes. **Cholecystokin** (p. 270), which is obtained from extracts of the small intestine and stimulates the flow of bladder bile, has not been completely characterized.

Another hormone-like substance, **enterogastrone**, obtained in highly concentrated form from the mucosa of the upper intestine, acts as an inhibitor of gastric secretion. Preparations containing the so-called **anthelone** which is like enterogastrone, prevent the development of ulcers in the stomach and upper intestine of the dog under certain circumstances. Considerable evidence has been presented to show that the urine contains a substance resembling enterogastrone in its physiological activity. It is called **urogastrone**. Although it may be an excretory product of the metabolism of enterogastrone, the two are not identical.

Enterocrinin is the name given to an intestinal preparation believed to be a secretin-like hormone. It excites secretion in the intestinal glands and is reported not to be identical with secretin.

Neurohypophyseal Hormones. Extracts of the posterior lobe of the pituitary (neurohypophysis) show hormonal activities. Such extracts go under the name of pituitrin. Their physiological effects could be grouped into two types, (1) excitation of nonstriated muscle causing contractions of arterial, intestinal, gall bladder, and uterine muscle, and (2) a decrease in urine secretion, an antidiuretic effect.

Their action on the blood vessels causes a marked rise in blood pressure—more long-lasting than that of epinephrine. The action is also characterized by its occurrence in denervated arteries. This again is in contrast to the effects of epinephrine, which excites nerve endings.

The action upon uterine muscle causes powerful contractions if the uterus is properly conditioned by previous action of estrogens and the near absence of progesterone. The uterus is very sensitive to the pituitrin effect at the time of parturition. Presumably, although this is not proved, the posterior pituitary functions hormonally as a stimulus for parturition.

The hormonal action upon the kidney appears to be exerted constantly. At least, this is one interpretation of the effect of extirpation of the neurohypophysis. It causes the secretion of enormous volumes of urine (polyuria), and the same result can be obtained by severing nerve connections between the brain and the posterior lobe. This suggests that something which restrains loss of water through the kidneys is normally liberated from the posterior pituitary under the influence of nerve excitation. Curiously enough, polyuria does not follow removal of the *entire* pituitary, as though something from its other structures operated upon the kidney in the absence of the neurohypophyseal hormone. In this connection it is significant that, in the hypophysectomized rat, injections of anterior pituitary extracts can produce polyuria.

The polyuria which characterizes the disease called *diabetes insipidus* can be checked and greatly relieved by injections of posterior pituitary preparations.

The chemical nature of the neurohypophyseal hormones seems to be protein. All the various effects of pituitrin are exerted by a preparation which contains protein. Although not isolated, it has been prepared by Abel and his coworkers in a highly concentrated and partly purified form as a tartrate and has been concentrated by other methods. Its properties, observed by use of the ultracentrifuge and in electrophoresis, are those of a protein with a molecular weight exceeding 30,000 and isoelectric at pH 4.8. It has been extensively investigated, and further

fractioning, as carried on by Kamm and his associates and continued by others, has yielded at least two preparations which are more specific in their physiological effects. The fractions are called α -hypophamine (dispensed commercially as oxytocin and also as pitocin) and β -hypophamine (sold under the names pitressin or vasopressin). The name oxytocin (Greek, *tokos*, birth), referring to its outstanding property of exciting contraction of uterine muscles, is well chosen for the first of these. While it produces some rise in blood pressure (the pressor effect), it is not so powerful in this respect as is the other component, which is well named pitressin (pituitary pressor substance). The latter has practically no effect on the uterine muscles. The separation of these two principles from each other has afforded great advantage in their practical use. For example, oxytocin can be injected to hasten labor and, more particularly, to facilitate the afterbirth and to assist in involution of the uterus without producing excessive rises in blood pressure, such as follow the use of pituitrin.

Both oxytocin and pitressin have the properties of peptides of low molecular weight (about 1,000) and are isoelectric at pH 8.5 and 10.8, respectively. Their small molecular size is in agreement with the theory that they are cleavage products of the larger pituitrin molecule.

Intermedin. A hormone which has been prepared from the *pars intermedia* of the hypophysis has the property of causing expansion of the epidermal melanophores so that their pigment granules become more dispersed and the animal takes on a darker color. This phenomenon has been studied in amphibia and in fishes. Liberation of the hormone is partly under nervous control. It may occur, for example, in response to visual excitation. Correspondingly, the reflex is destroyed by severing of nerve connections between the brain and the hypophysis.

Intermedin has the properties of a protein and is destroyed by trypsin although it is resistant to the action of pepsin and is heat stable.

Another factor which seems to be specific is obtained from the *pars intermedia*. It closely resembles intermedin in its chemical properties but, physiologically, it operates to cause a rise in the basal metabolic rate when it is injected into thyroidectomized or adrenalectomized animals.

Antihormones. After certain of the protein hormones, especially the trophins, have been repeatedly injected into the same animal it becomes refractory. It no longer responds typically to administration of the hormone. Collip, who with his associates did much of the pioneering work of investigation of this phenomenon, proved that the blood of the refractory animal introduced into a normal animal made the latter refractory. Obviously, the blood contains what Collip named an "antihormone." When injected with hormones that are homologous, animals do not usually develop the antihormone. Also, insulin, which is not a

A number of the stimulators of plant growth are vitamins in animal nutrition. Thus thiamine, although synthesized in plants, can cause marked acceleration of growth of the roots of certain plants when it is added in very low concentration to a nutrient growth solution. Some plants are similarly stimulated by niacin. Pyridoxine is a stimulant for the tomato plant.

Many synthetic organic compounds can stimulate plant growth. Among them are substances which are produced by bacterial action (p. 272) on tryptophan, *e.g.*, indoleacetic acid. While such substances may not be true hormones but only artificial stimulants, the case of indoleacetic acid is interesting because it is especially effective as an auxin and is now known to be formed not only in lower plants, where first recognized, but even in higher ones. It has been isolated in crystalline form from maize. The impure auxin preparations from various plants (tomato, spinach, radish, and kelp) show evidence of containing indoleacetic acid. Auxin appears to be partly free in plant tissues and partly in "bound" form in a protein complex. There is evidence to suggest that in the case of indoleacetic acid the bound form may be the tryptophan residues in protein. Tryptophan, in some plants, seems to change to indolpyruvic acid (p. 499), this becomes indolacetaldehyde and the latter oxidizes to indoleacetic acid, although it may possibly act as auxin in its own right. Indoleacetic acid is easily inactivated *in vivo* by plant enzymes, *in vitro* by oxidizing agents such as H_2O_2 ; but in the "bound" form it is protected.

Traumatic acid, found in certain plants after they have been cut or bruised, is a dicarboxylic fatty acid, of which the formula is $HOOC \cdot CH_2 - CH \cdot (CH_2)_8 \cdot COOH$. It and homologous acids can stimulate growth by resumption of division of mature cells. Such substances are called "wound hormones."

Among other growth stimulants are derivatives of anthracene, benzene, and naphthalene. They are not known to be produced by plants and are thus not properly called hormones.

How effective a given synthetic compound may be is sometimes determined by the synthetic powers of the plant to which it is fed. Thus *Phycomyces*, a mold, responds to thiamine but almost equally well to thiazole in combination with certain pyrimidine derivatives. From these "fragments" of the thiamine molecule, it can synthesize thiamine. Other similar cases are known.

Much of the work on stimulation of plant growth has been done with the coleoptile (sprout) of the seed of oats (*Avena sativa*), which has proved to be a sensitive test object. In a well-established method, the growing tips of *Avena* coleoptiles are cut off and replaced by blocks of agar jelly

containing the auxin to be tested in known concentration. If the agar block is applied asymmetrically, the side of the coleoptile thus made to receive the downward diffusing auxin grows so rapidly as to cause bending

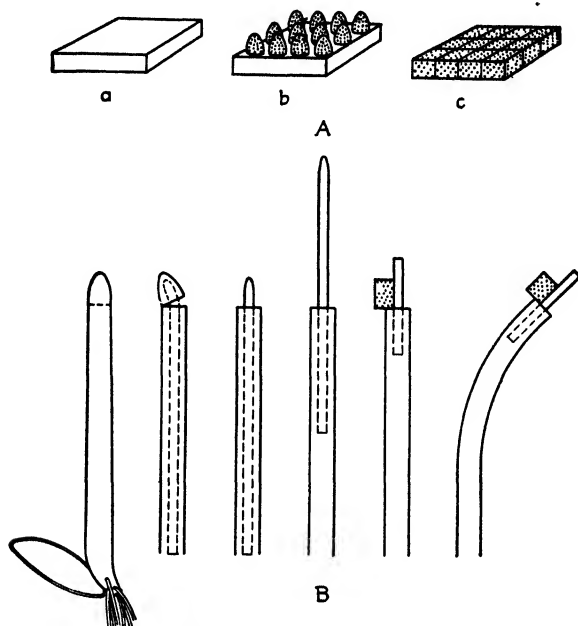

FIG. 90. *Avena* coleoptile test for plant hormones. On a block of agar jelly, A(a), tips of the coleoptile, removed as indicated by the left-hand diagrams in B, are placed as in A(b). After sufficient time for downward diffusion of the growth hormone from the tips into the agar, the latter is cut into pieces of standard size as at A(c). The small agar blocks are placed asymmetrically upon decapitated coleoptiles as shown by right-hand diagrams in B. Growth hormone, diffusing downward, causes excess of cell growth on the treated side as compared with the unstimulated side. The angle through which the consequent bending occurs under standardized conditions is measured and is used as an index of the amount of hormone supplied. Extracts of tissues, artificially synthesized compounds, and other materials to be tested for growth potency, may be used to impregnate agar blocks, which are then applied to coleoptiles under standard conditions. In practice, a number of coleoptiles are used for each determination so that the average of the observed values of the angle of bending may be used for calculation of the quantitative result. (From P. Boysen-Jensen, *Growth Hormones in Plants*.)

by an amount which affords a roughly quantitative measure of the auxin (Fig. 90).

Other methods depend on the observation of the rate of root growth of germinated seeds or cuttings. Growth of the entire plant is observed in some cases. Specific functions, leaf development, flowering, seed for-

mation, and the like are also observed in some types of measurements. Inhibitory processes, delay of leaf shedding, prevention of seeding, etc., may also be influenced by specific chemical agencies and are observed in some investigations.

The practical applications of knowledge of plant hormones in horticulture, pomology, and some other subdivisions of agriculture are of definite economic value. Among the numerous applications which could be listed are use of certain naphthalene derivatives to check abscission (premature fall) of fruit as successfully applied to apple trees; checking of abscission of leaves of the ornamental plant *Coleus* by indoleacetic acid; production of a high proportion of seedless tomatoes by the use of certain auxins; improvement in root development of cuttings through application of hormones to many plants of economic importance; and improved vigor of general growth of entire crops through application of traces of auxins to the soil or to the plants.

Progress in Hormone Chemistry. The student of endocrinology feels that, while much is known, more remains to be discovered. This is especially true of the chemistry of the hormones. The wonder is, however, that cultivation of this field of biochemistry has yielded as large and useful a crop of results as we now have. Recalling that the first separated hormone (p. 598) was discovered less than 50 years ago, one sees that hormone chemistry is a comparatively new subject. If one adds to this the problem of separating such minute amounts of material from natural sources, the intricacy of molecular structure of many hormones, and the complexity and variability of physiological responses to hormones (involving uncertainty in bioassays), one attains an appreciation of the difficulties to be overcome in the progress of hormone chemistry.

As an example of the degree of specialization required for progress, one might note that a series of research conferences was attended by a goodly number of investigators each of whom had spent some 10 years or more in intensive research on the adrenal cortex alone. Other similar examples could be given. The significance of the hormones in general physiology and the as yet only partially realized benefits of hormone therapy would seem to justify further intensive efforts. There is still a brilliant future for this type of research.

REFERENCES

- Of the many books dealing with endocrinology, "Recent Advances in Endocrinology" by A. T. Cameron, 5th ed., Philadelphia, 1945, is apt to be especially useful to the student.
- Other monographs which are also highly recommended are "Essentials of Endocrinology" by A. Grollman, Philadelphia, 1941; and "Endocrinology" by R. G. Hoskins, New York, 1941.
- Some monographs deal with special phases of the subject.
- "Insulin: Its Chemistry and Physiology" by H. F. Jensen, New York, 1938.
- Two useful works relating to the thyroid hormone are "Thyroxine" by E. C. Kendall, New York,

1929; and "The Thyroid Gland: Its Chemistry and Physiology" by C. R. Harington, Oxford University Press, 1933.

For the morphology, physiology, and pathology of the adrenal gland, see "The Adrenals" by A. Grollman, Baltimore, 1936.

"Sex and Internal Secretions," edited by Edgar Allen and written by 27 specialists (2d ed., Baltimore, 1939) is a book of outstanding value.

The same subject presented in a form suited to lay readers is "The Hormones in Human Reproduction" by G. W. Corner, Princeton, 1942.

For background reading in the complex field of study relating to the pituitary, consult "The Physiology and Pharmacology of the Pituitary Body" by H. B. Van Dyke, Chicago, 1936. This book provides a bibliography of some 3,000 titles.

Three series of review publications in this field are: (1) "Vitamins and Hormones" edited by R. S. Harris and K. V. Thimann, New York, published annually since 1943; (2) "Recent Progress in Hormone Research" edited by G. Pincus, New York, published annually since 1947; and (3) "The Hormones" edited by G. Pincus and K. V. Thimann, New York, Vol. I, 1948, and Vol. II, 1949.

From a large number of reviews the following are selected to cover many phases of progress in endocrinology.

ANDERSON, D. H., The Relationship between the Thymus and Reproduction, *Physiol. Rev.*, 12, 1, 1932.

ARDELL, S. A., The Growth and Function of the Corpus Luteum, *Physiol. Rev.*, 8, 313, 1928.

BOYSEN-JENSEN, P., Growth Regulators in the Higher Plants, *Ann. Rev. Biochem.*, 7, 513, 1938.

DRILL, V. A., Interrelations between Thyroid Function and Vitamin Metabolism, *Physiol. Rev.*, 23, 355, 1943.

EVANS, H. M., Endocrine Glands: Gonads, Pituitary, and Adrenals, *Ann. Rev. Physiol.*, 1, 577, 1939.

FRAENKEL-CONRAT, H., The Chemistry of the Hormones, *Ann. Rev. Biochem.*, 12, 273, 1943.

GALLAGHER, T. F., Biochemistry of the Hormones, *Ann. Rev. Biochem.*, 17, 349, 1948.

GOLDBLATT, H., The Renal Origin of Hypertension, *Physiol. Rev.*, 27, 120, 1947.

GROSSMAN, M. I., Gastrointestinal Hormones, *Physiol. Rev.*, 30, 33, 1950.

HAIST, R. E., Factors Affecting the Insulin Content of the Pancreas, *Physiol. Rev.*, 24, 409, 1944.

IVY, A. C., The Role of Hormones in Digestion, *Physiol. Rev.*, 10, 282, 1930.

JENSEN, H., and EVANS, E. A., JR., The Chemistry of Insulin, *Physiol. Rev.*, 14, 188, 1934.

JENSEN, H., The Chemistry of the Hormones, *Ann. Rev. Biochem.*, 13, 347, 1944.

KENDALL, E. C., Hormones, *Ann. Rev. Biochem.*, 10, 285, 1941.

KOCH, F. C., The Steroids, *Ann. Rev. Biochem.*, 13, 263, 1944.

LEBLOND, C. P., Iodine Metabolism, *Advances in Biol. Med. Phys.*, 1, 353, 1948.

LI, C. H., The Chemistry of the Hormones, *Ann. Rev. Biochem.*, 16, 291, 1947.

LUKENS, F. D. W., Alloxan Diabetes, *Physiol. Rev.*, 28, 304, 1948.

PFIFFNER, J. J., and KAMM, O., The Chemistry of the Hormones, *Ann. Rev. Biochem.*, 11, 283, 1942.

PFIFFNER, J. J., The Adrenal Cortical Hormones, *Advances in Enzymol.*, 2, 325, 1942.

REICHSTEIN, T., and SHOPPEE, C. W., The Hormones of the Adrenal Cortex, *Vitamins and Hormones*, 1, 346, 1943.

ROBBINS, W. J., and KAVANAGH, V., Plant Growth Substances, *Ann. Rev. Biochem.*, 10, 491, 1941.

SELYE, H., and JENSEN, H., The Chemistry of the Hormones, *Ann. Rev. Biochem.*, 15, 347, 1946.

SKOOG, F., Growth Substances in Higher Plants, *Ann. Rev. Biochem.*, 16, 529, 1947.

SPEERT, H., Local Action of Sex Hormones, *Physiol. Rev.*, 28, 23, 1948.

SWINGLE, W. W., and REMINGTON, J. W., The Role of the Adrenal Cortex in Physiological Processes, *Physiol. Rev.*, 24, 89, 1944.

THOMPSON, K. W., Antihormones, *Physiol. Rev.*, 21, 588, 1941.

THOMSON, D. L., and COLLIP, J. B., The Parathyroid Glands, *Physiol. Rev.*, 12, 309, 1932.

VAN OVERBEEK, J., Growth-regulating Substances in Plants, *Ann. Rev. Biochem.*, 13, 631, 1944.

WHITE, A., Preparation and Chemistry of Anterior Pituitary Hormones, *Physiol. Rev.*, 26, 574, 1946.

ZIMMERMAN, P. W., and HITCHCOCK, A. E., Plant Hormones, *Ann. Rev. Biochem.*, 17, 601, 1948.

The following list of references to research reports includes some representative results of present day work in endocrinology:

ASTWOOD, E. B., SULLIVAN, J., BISSELL, A., and TYSLOWITZ, R., Action of Certain Sulphonamides and of Thiourea upon the Functions of the Thyroid Gland of the Rat, *Endocrinology*, 32, 210, 1943.

BLANCHARD, E. W., STUART, A. H., and TALLMAN, R. C., Studies on a New Series of Synthetic Estrogenic Substances, *Endocrinology*, 32, 307, 1943.

Editorial, Influence of Thyroid Therapy on Mental Growth of Cretins, *J. Am. Med. Assoc.*, 118, 62, 1939.

ENGBLOM, W. W., and MASON, H. L., A Study of the Colorimetric Assay of Urinary 17-Ketosteroids, *Endocrinology*, 33, 229, 1943.

EVANS, H. M., SIMPSON, M. E., and LI, C. H., Continuous Growth of Normal Rats Receiving Pure Growth Hormone, *Endocrinology*, 39, 71, 1946.

- FRANKLIN, A. L., and CHAIKOFF, I. L., The Effect of Sulfanilamide on the Conversion in Vitro of Inorganic Iodine to Thyroxine and Diiodotyrosine by Thyroid Slices, *J. Biol. Chem.*, 148, 719, 1943.
- GOLDNER, M. G., and GOMORI, C., Studies on the Mechanism of Alloxan Diabetes, *Endocrinology*, 35, 241, 1944.
- HANDS, A. P., GREENGARD, H., FAULAY, G. B., and IVY, A. C., Prevention of Experimental Gastrojejunal Ulcer by Enterogastrone, *Fed. Proc.*, 2, 18, 1943.
- HARRINGTON, C. R., and BARGER, G., Constitution and Synthesis of Thyroxine, *Biochem. J.*, 21, 169, 1927.
- HECHTER, O., LEVINE, R., and SLOSKIN, S., Possible Physiological Significance of the Zinc Content of Insulin, *Proc. Soc., Exptl. Biol. Med.*, 43, 361, 1940.
- HEIDELBERGER, M., and PEDERSON, K. O., The Molecular Weight and Isoelectric Point of Thyroglobulin, *J. Gen. Physiol.*, 19, 95, 1935.
- HOUSSAY, B. A., and MARTÍNEZ, C., Experimental Diabetes and Diet, *Science*, 105, 548, 1947.
- INGLE, D. J., LI, C. H., and EVANS, H. M., The Effect of Pure Adrenocorticotrophic Hormone on the Work Performance of Hypophysectomized Rats, *Endocrinology*, 35, 91, 1944.
- JONES, M. E., The Effect of Varying Levels of Iodine Intake on the Thyroglobulin Content of the Thyroid Gland, *Am. J. Physiol.*, 107, 513, 1934.
- KATZMAN, P. A., GODFRID, M., CAIN, C. K., and DOISY, E. A., The Preparation of Chorionic Gonadotropin by Chromatographic Adsorption, *J. Biol. Chem.*, 148, 501, 1943.
- KIMBALL, O. P., Prevention of Goiter in Michigan and Ohio, *J. Am. Med. Assoc.*, 108, 860, 1937.
- LAHR, E. L., and RIDDLE, O., The Action of Steroid Hormones on the Mature Dove Testis, *Endocrinology*, 35, 261, 1944.
- LEWIS, H. A., and GOLDBLATT, H., Studies on Experimental Hypertension, *Bull. N.Y. Acad.*, 18, 459, 1942.
- LI, C. H., and EVANS, H. M., and SIMPSON, M. E., Adrenocorticotrophic Hormone, *J. Biol. Chem.*, 149, 413, 1943.
- LI, C. H., EVANS, H. M., and SIMPSON, M. E., Isolation and Properties of the Anterior Hypophyseal Growth Hormone, *J. Biol. Chem.*, 159, 353, 1945.
- LI, C. H., EVANS, H. M., and SIMPSON, M. E., Crystallization of Hypophyseal Growth Hormone, *Science*, 108, 624, 1948.
- LI, C. H., SIMPSON, M. E., and EVANS, H. M., Isolation of Pituitary Follicle-stimulating Hormone (FSH), *Science*, 109, 445, 1949.
- LUKENS, F. D. W., DOHAN, F. C., and WOLCOTT, M. W., Pituitary Diabetes in the Cat: Recovery following Phlorhizin Treatment, *Endocrinology*, 32, 475, 1943.
- MOORE, C. B., and MORGAN, C. F., First Response of Developing Opossum Gonads to Equine Gonadotropic Treatment, *Endocrinology*, 32, 17, 1943.
- MORTON, M. E., and CHAIKOFF, I. L., The Formation in Vitro of Thyroxine and Diiodotyrosine by Thyroid Tissue with Radioactive Iodine as Indicator, *J. Biol. Chem.*, 147, 1, 1943.
- MORTON, M. E., CHAIKOFF, I. L., REINHARDT, W. O., and ANDERSON, E., The Isolation of Radioactive Thyroxine from Thyroid-less Rats after Administration of Radio Iodine, *J. Biol. Chem.*, 147, 757, 1943.
- PAGE, E. W., A Blood Test for Estimating the Week of Pregnancy, *Science*, 105, 292, 1947.
- REINEKE, E. P., and TURNER, C. W., The Recovery of Crystalline Thyroxine from Iodinated Casein, *J. Biol. Chem.*, 149, 555, 563, 1943.
- RIDDLE, O., and LAHR, E. L., On Broodiness of Ring Doves Following Implants of Certain Steroid Hormones, *Endocrinology*, 35, 255, 1944.
- RIDOUT, J. H., HAM, A. W., and WRENSHALL, G. A., The Correlation of the Insulin Content and the Histological Picture of the Pancreas at Intervals after the Administration of Alloxan, *Science*, 100, 57, 1944.
- SALTER, W. T., and PEARSON, O. H., The Enzymic Synthesis from Thyroid Diiodotyrosine Peptone of an Artificial Protein which Relieves Myxedema, *J. Biol. Chem.*, 112, 579, 1936.
- SIMPSON, M. E., LI, C. H., and EVANS, H. M., Sensitivity of the Reproductive System of Hypophysectomized 40 Day Male Rats to Gonadotropic Substances, *Endocrinology*, 35, 96, 1944.
- SIMPSON, M. E., MARX, W., BROCKS, H., and EVANS, H. M., Response of Adrenalectomized-hypophysectomized Rats to the Pituitary Growth Hormone, *Endocrinology*, 35, 234, 1944.
- SPINGARN, C., MULINOS, M. G., and MACULLA, E., The Effects of Pitressin Tannate and Water Restriction on the Water Exchange and Renal Function of Normal Dogs, *Endocrinology*, 35, 249, 1944.
- STERNHEIMER, R., The Effect of a Single Injection of Thyroxine on Carbohydrates, Protein, and Growth in the Rat Liver, *Endocrinology*, 25, 899, 1939.
- STETTEN, DEW., JR., and BOXER, G. E., Studies in Carbohydrate Metabolism. III. Metabolic Defects in Alloxan Diabetes, *J. Biol. Chem.*, 156, 271, 1944.
- SWINGLE, W. W., Iodine and Amphibian Metamorphoses, *Biol. Bull.*, 45, 229, 1923.

- TIPTON, S. R., The Effects of Adrenalectomy on the Activity of Cytochrome Oxidase and the Concentration of Cytochrome *c* in Rats, *Endocrinology*, **34**, 181, 1944.
- WAKERLIN, G. E., and JOHNSON, C. A., Reductions in Blood Pressure of Renal Hypertensive Dogs by Hog Renin, *Proc. Soc. Exptl. Biol. Med.*, **46**, 104, 1941.
- WAKERLIN, G. E., JOHNSON, C. A., SMITH, E. L., MOSS, W. G., and WEIR, J. R., Prophylactic Treatment of Experimental Hypertension with Renin, *Am. J. Physiol.*, **137**, 515, 1942.
- WHITE, A., CATCHPOLE, H. R., and LONG, C. N. H., A Crystalline Protein with High Lactogenic Activity, *Science*, **86**, 82, 1937.
- WILTBERGER, P. B., and MILLER, D. F., The Male Frog, *Rana pipiens*, as a New Test Animal for Early Pregnancy, *Science*, **107**, 198, 1948.

CHAPTER XXI

CHEMOTHERAPY

The term chemotherapy suggests the curative use of chemical substances for disease. Actually, however, the word has a somewhat restricted usage and refers to the administration of chemical substances which are specifically more injurious to invading microorganisms than they are to the tissues of the animal body. The great majority of antiseptic substances used to kill microorganisms are too harmful to the animal body to be used in dosage which satisfactorily combats invading organisms.

The most effective chemotherapeutic agents are not apt to be bactericidal. In short, they are not properly regarded as antiseptics. They are bacteriostatic. This means that they inhibit bacterial metabolism or reproduction or both of these processes. They thus afford an opportunity for the natural defenses of the body to overcome the invaders. The hope of finding agents that could specifically destroy infectious organisms without serious injury to their hosts has long been held. Attainment of the goal has been beset with many difficulties and disappointments. The hope, however, has been justified for nearly three centuries because of experience in combating malaria with quinine-containing preparations or with quinine itself.

Antimalarial Substances. Quinine is the oldest of known specific remedies. It is prepared from the bark of various species of *Cinchona* (Peruvian bark). Its use in malarial fever has grown in importance ever since its discovery in the seventeenth century. It specifically combats the plasmodium causing malaria. Its formula, $C_{20}H_{24}N_2O_2 \cdot 3H_2O$, represents a complex organic structure which has been deciphered as the result of prolonged and intensive research. It is generally used in the form of its relatively soluble salts, such as the hydrochloride or the sulfate.

Quinine substitutes have been widely sought. Among those which have been given some use are atabrin, plasmochin, and atabrine. The last named, a complex derivative of acridine, attained wide use after development of a shortage of quinine in 1942. It is considered by some medical authorities to be as useful as quinine, but there is difference of opinion inasmuch as there is some danger of liver damage by atabrine. Nevertheless, its importance for the armed forces of the Allied Powers led one

reviewer (Manwell, 1949) to say, "without atabrine it is almost certain that our struggle with the Axis would have been lost or the issue greatly delayed."

The formulas for quinine and four of the artificial substitutes for it are shown below. Quinine itself has been artificially synthesized, but the processes involved appear to be too expensive for successful competition with natural quinine or its substitutes. Chloroquin has the advantage of lengthening the time between recurrency of attacks as compared with the action of quinine or atabrine. Paludrine is reported to be at least as effective as atabrine and to be less toxic.

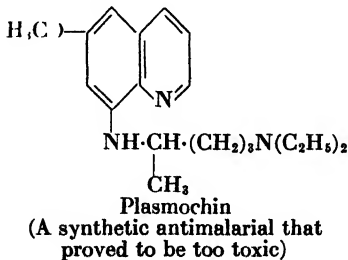
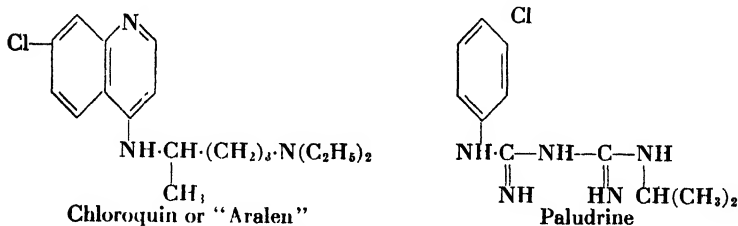
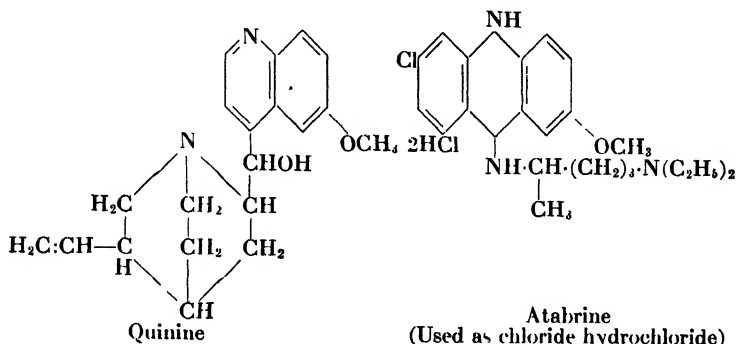

There seems to be no specific group of atoms common to all anti-malarials, although the quinoline framework is a prominent feature of four of the five formulations here shown and of other antimalarial compounds too toxic for practical use.

Although the relative merits of antimalarial drugs are still under investigation, the general consensus of opinion seems to be that certain synthetic drugs are better than quinine. All investigators agree that the ideal drug should entirely eliminate the malarial organism during one comparatively brief course of treatment, *i.e.*, should not only give relief but also prevent relapse, and should be nontoxic. Such a drug is still to be found.

The Arsenicals. Although mercury compounds and the other so-called "mercurials," such as ointments containing mercury or its oleate, were long used for syphilis, no really successful or specific curative for this disease was available until Paul Ehrlich investigated the use of organic compounds containing arsenic. Because of his brilliant work he is justly called the founder of modern chemotherapy.

The compound which he designated as "606" was described in 1910. He suggested that it be called salvarsan. Its organic name is arsphenamine.

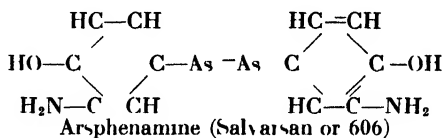

Its more soluble modification, one of Ehrlich's later synthetic products, is called neosalvarsan.

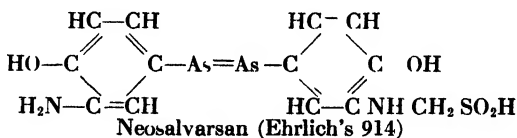

For three decades these arsenicals have been the best known agents for combating the spirochete of syphilis, for which it is nearly specific. The long course of treatment required and the necessity of intravenous injection make salvarsan far from the ideal curative. Newer bacteriostatic agents are preferred in syphilis therapy.

The Sulfa Drugs. Domagk published in 1935 the first report of the action of a compound, called "prontosil," in protecting mice against infection with streptococci. Prontosil is a vital-staining red dye, an azo derivative of the long-known sulfanilamide. (See formula, below.) It had been discovered in connection with research on dyestuffs. A group of French workers soon showed that the bacteriostatic effect of prontosil was really attributable to the sulfanilamide group. Investigations of the chemistry of sulfanilamide derivatives and of the therapeutic

uses of such compounds, including prontosil, developed very rapidly after 1935.

The chief members of this group of compounds which have been used to combat infections are

Sulfanilamide itself
Sulfapyridine
Sulfathiazole
Sulfadiazine
Sulfaguanidine

Their structural formulas are shown as follows:

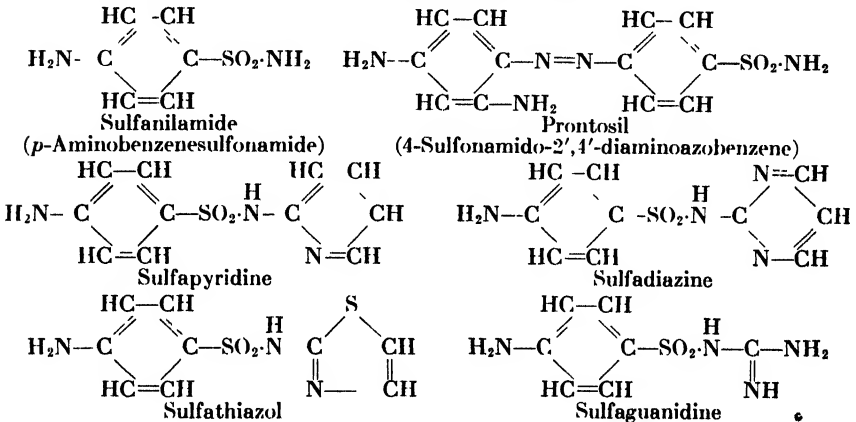

It will be noticed that the substituent groups in these useful compounds are attached to N of the sulfamino radical.

These different derivatives have specialized uses. Sulfanilamide is used in combating infections with hemolytic streptococci, meningococci, pneumococci, and gonococci. It has had extensive use for gonorrhoea. In some clinics sulfadiazine is preferred to sulfanilamide. Sulfaguanidine has been found most effective in treatment of infectious diseases of the intestine, such as acute bacillary dysentery. Its effectiveness in such cases is correlated with its slow absorption from the intestine. The other sulfa drugs are more readily absorbed and can be given by mouth for treatment of septicemias and tissue infections. They have also been given extensive use by direct application to clear up septic wounds or to prevent sepsis. Among the infections for which sulfa drugs have been effective are chancroid, gas gangrene, lymphatic infections in venereal disease, certain forms of skin diseases (such as pemphigus), peritonitis, trachoma, urinary tract infections, undulant fever, puerperal fever, erysipelas, and some forms of severe endocarditis (infection of the heart). Their use has been successful for some types of pneumonia.

The sulfa drugs are not effective in the treatment of some diseases—tuberculosis, typhoid fever, paratyphoid infections, cholera, and some others. Also, the diseases due to virus infections are not usually treated successfully by these drugs. Thus infantile paralysis, measles, and small-pox are not significantly helped by this kind of treatment. The sulfa drugs have not been found helpful in the treatment of colds and influenza.

Theory of Sulfa Drug Action. The nature of the action of the sulfa drugs is not fully understood. It is found that sulfanilamide can be antagonized so as to lose its therapeutic value for experimental animals by the administration of relatively large doses of the vitamin *p*-aminobenzoic acid. A similar antagonism is shown *in vitro*. Yeast, which is a good source of this vitamin, acts similarly. Such observations led to a theory proposed by Woods, namely, that sulfanilamide and related substances owe their bacteriostatic effects to their ability to compete with *p*-aminobenzoic acid. Combining with an enzyme of the bacterial cell, they prevent it from utilizing the vitamin in the normal way. The resulting change in the nutritive condition of the bacterial cell checks its multiplication and appears to render it susceptible, in some cases at least, to the destructive effects of certain of the natural defenses of the body. The theory receives a general biochemical significance from observations of a similar antagonism exerted by *p*-aminobenzoic acid upon the action of sulfa drugs upon wheat and other plants. Some chemotherapeutic agents are believed to be similarly bacteriostatic by interfering with the use of pantothenic acid by bacteria. There is some evidence that the indispensable amino acid tryptophan may fail to be used in the normal way because of bacteriostatic effects.

Antibiotic Substances. A remarkable development in research and in practical therapy occurred during the period from 1940 to 1945. This is the discovery, large-scale production, and therapeutic use of what are called "antibiotic substances." An authoritative definition (A. E. Oxford, 1945) refers to them as "soluble, organic substances which are produced by microorganisms (yeasts, molds, actinomycetes, and bacteria) from a harmless constituent (or constituents) of a medium and which are markedly inhibitory to the growth or activity of a second microorganism when the antibiotic substance is dissolved in a medium otherwise suitable for the normal growth or activity of the second organism." This definition is further delimited by the qualification that "the antibiotic substance must have been isolated and tested in a pure state." The possibility that substances derived from algae and from higher plants may eventually be included in the category of antibiotic substances is to be borne in mind. For example, one might classify quinine from cinchona bark as an antibiotic agent. Allicin, a bacteriostatic substance isolated

(1944) from garlic, is another example. But for the present it seems convenient to restrict the use of the term to substances produced by yeasts, molds, actinomyces, and bacteria. Oxford further restricts the definition by suggesting that a truly antibiotic substance should be able to show a measurable effect upon the inhibited organism *in vitro*, when the substance is present in the medium in a concentration of not more than about 50 parts per million. He states, "A less active substance is unlikely to be of any therapeutic value."

It is not always easy to draw sharp distinctions between the antibiotic substances which are bacteriostatic and those which are bactericidal. Some have been described as bacteriostatic when present in comparatively low concentration but bactericidal at some higher concentration. It is probable that bacteriostatic effects are due to enzyme blocking (see p. 239 and p. 646).

A considerable number of substances which are antibiotic *in vitro* are without therapeutic value. Some of them are too toxic to animal tissues. Others are inactive *in vivo* because they lose their antibiotic activity when exposed to the effects of animal metabolism or are not sufficiently soluble in body fluids.

History of Antibiotics. Although the present usage of the term antibiotic substance is new, the idea which it represents is much older. As far back as 1860, **pyocyanin**, the blue crystalline pigment formed by *Pseudomonas aeruginosa* (older name, *Bacillus pyocyaneus*), was prepared in a purified state. Although it was not definitely proved to be an antibiotic substance until 1932, it was the first antibiotic to be discovered. It is known to be able to inhibit the enzyme succino-dehydrogenase so that it may block the tricarboxylic acid cycle. Its structure, finally established (Hillemann, 1938), is

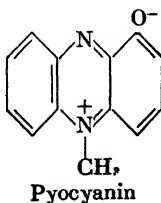

Not long after pyocyanin was discovered, another bacterial pigment, namely, the red **prodigiosin** produced by *Serratia marcescens* (older name, *Chromobacterium prodigiosus*) was said to show inhibitory effects upon the anthrax bacillus. The structure of prodigiosin was established (Wrede and Rothaas) in 1934. It has three pyrrole-like groups and is shown thus:

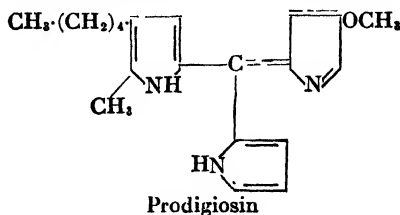

Neither pyocyanin nor prodigiosin has proved to be a useful therapeutic agent in comparison with others now known. Pyocyanin is highly toxic to animals, and prodigiosin does not have properties which make its use practical.

Pasteur was one of those who suggested (1877) that infections might be combated by making use of the antagonism between different organisms, *i.e.*, the antibiotic effect. But in spite of these and some other early observations, the idea of the practical use of products of microorganisms to combat other microorganisms received no serious attention during about three-quarters of a century after these early discoveries.

It was not until about 1939 that the attention of biochemists, microbiologists, and clinicians was sharply directed toward the possibilities of real therapeutic use of antibiotics. Even the discovery (1929) of the now famous penicillin did not arouse much attention until spectacular results with other antibiotic substances reawakened interest in it. Some of these other antibiotics obtained from soil bacteria will be described first.

Antibiotic Substances of Bacterial Origin. The well-known tendency for certain pathogenic organisms to disappear from infected soil suggested that they might be destroyed by products of the metabolism of other organisms. This idea led to extensive researches in the hope of finding producers of useful antibiotic substances. The work of Dubos and his associates at the Rockefeller Institute was outstandingly successful.

The method of attack was systematic. Water suspensions of soil, rich in organic matter and likely to contain many types of microorganisms, were streaked across suitably prepared cultures of an isolated pathogen. After incubation for growth of the pathogen, any area in the culture where it had failed to grow was examined for the presence of organisms which might be inhibitors. The latter could then be obtained in pure culture and their antibiotic properties observed.

Dubos obtained (1939) the antibiotic **tyrothricin** from cultures of a soil bacillus, the Gram-positive (capable of staining by Gram's method), motile, spore-bearing *Bacillus brevis*. Tyrothricin was separated (1941) to yield two crystalline substances, namely, **gramicidin** and **tyrocidin**. Both are polypeptides which resist the action of proteolytic enzymes.

Tyrothricin is treated with a mixture of acetone and ether. From the resulting solution, gramicidin is separated and is crystallized from its acetone solution. From the residue which is insoluble in acetone-ether, tyrocidin hydrochloride is prepared and is recrystallized from alcohol containing HCl. Gramicidin is antibiotic toward Gram-positive bacteria only; tyrocidin is antibiotic toward both Gram-positive and Gram-negative bacteria and also toward certain fungi.

Gramicidin. Of these two substances, gramicidin has been more extensively studied biochemically. Its molecular weight, approximately 2,800, is low in comparison with proteins. The amino acids obtained by hydrolysis include L-tryptophan (more than 40 per cent of the polypeptide) together with leucine, valine, glycine, and an unidentified hydroxyamino acid. All or nearly all of the leucine and about half of the valine have the so-called "unnatural" or D-configuration. It is believed that the latter forms do not arise as a result of inversion during the processes used for hydrolysis and separation. In fact, the D-forms have been obtained by different methods and by different investigators. The occurrence of these "unnatural" amino acids is a matter of considerable biochemical interest although their possible significance in relation to antibiotic activity remains to be investigated. The steric inversion of biochemical compounds or the formation of "unnatural" stereoisomers is recognized as a not infrequent result of bacterial action. The formation of coprosterol from cholesterol (p. 91) by intestinal bacteria is one instance. Certain bacteria produce D-arabinose from glycerol although L-arabinose is the common form of this sugar in nature.

Gramicidin shows no evidence of the presence of any free basic or acidic groups. Correspondingly, it is nearly insoluble in water but is soluble in acetone and alcohol and is even slightly soluble in ether. The lack of any free amino or carboxyl groups suggests that it is a cyclic polypeptide, and analytical results indicate that it probably contains 24 peptide linkages.

Gramicidin is highly toxic for Gram-positive bacteria. Unlike the sulfa drugs and many antibiotics, it is not merely bacteriostatic but is bactericidal. This explains the origin of its name. As little as 5 γ can kill 10^9 pneumococci or group A streptococci at 37°C. in 2 hr. in vitro, and 2 γ injected into a mouse protects it against a dose of streptococci 10,000 times the fatal one. As little as 1 γ is reported to protect against 10,000 times the lethal dose of pneumococci. It is most effective when injected intraperitoneally. Its therapeutic use, however, is somewhat hazardous. As little as 0.3 mg. per kg. of body weight is definitely toxic for mammals when injected. This would be 12 γ for a mouse of 25 g. weight. The margin of safety between the protective and the toxic dose

is rather small. The therapeutic use of gramicidin for local application to wounds or to mucous membranes infected with Gram-positive bacteria, such as streptococci, is regarded as more valuable than its internal use. For some bacteria, *e.g.*, group D streptococci, gramicidin is bacteriostatic and not bactericidal.

Tyrocidin. Neither the chemistry nor the therapeutic usefulness of tyrocidin has been extensively investigated. It is known to be a polypeptide. Its molecular weight is not known. Its hydrolysis products include tryptophan, phenylalanine, leucine, valine, proline, tyrosine, aspartic acid, glutamic acid, and ornithine. The phenylalanine has the *D*-configuration. Unlike gramicidin, tyrocidin has free amino groups and acidic groups and is slightly soluble in water. It is strongly levorotatory in alcoholic solution. It is highly bactericidal and is about as toxic as gramicidin. It is not employed therapeutically.

Gramicidin S. This antibiotic was discovered (1944) by a group of Russian investigators. It is also obtained from *Bacillus brevis* but not from the same strain as that used by Dubos. Like tyrocidin it is antibiotic for both Gram-positive and Gram-negative organisms. It is heat stable. Although reported to be more effective than gramicidin against Gram-negative organisms, it is not less toxic. Its clinical use for application to infected wounds and for other local therapy has been recommended. The amino acid residues and their sequence in the molecule are reported to be [α -L-valyl-L-ornithyl-L-leucyl-D-phenylalanyl-L-prolyl-] and the structure seems to be that of a cyclopeptide since no free α -amino or carboxyl groups are detected. It is thus similar to gramicidin itself.

Antibiotic Substances from Molds. It has long been known that certain molds when growing in culture media may check the growth of bacteria. Antibiotic preparations have been made from the culture medium filtrates of a number of molds. Among these preparations are **penicillin** from *Penicillium notatum* (1929), **citrinin** from *Penicillium citrinum* (1931), **gliotoxin** from *Gliocladium fimbriatum* (1936), **fumigatin** from *Aspergillus fumigatus* (1938), **aspergillic acid** from *Aspergillus flavus* (1940), and **clavacin** (1942) from a number of molds, *Aspergillus clavatus*, *Aspergillus fumigatus*, *Penicillium patulum*, *Penicillium expansum*, and some others. Preparations from these different sources were given different names by their respective discoverers, but eventually they have been shown to be identical with clavacin.

The structural formulas of some of these substances have been established and are given as shown on page 651.

One may hope that a sufficient extension of knowledge of the molecular structure of antibiotic substances may afford useful clues to the nature

of bacteriostatic action. It is highly probable that the inhibitory action in different microorganisms is exerted upon different enzyme systems and correspondingly the known structures of specific antibiotics show considerable diversity.

Other antibiotics from molds are **penatin**, also called **notatin**, obtained (1942) from *Penicillium notatum*, as is penicillin, **puberulic acid** from *Penicillium aurantiovirens* (1942), **helvolic acid** from a mutant strain of *Aspergillus fumigatus* (1943), and **chaetomin** from *Chaetomium cochliodes* (1943).

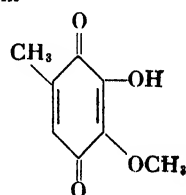
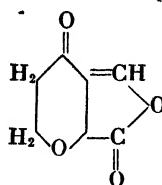
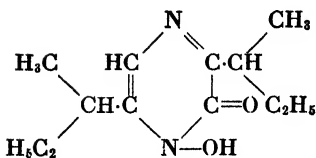
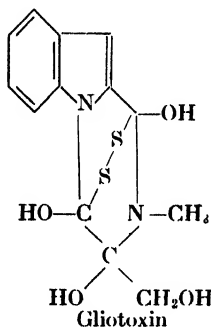
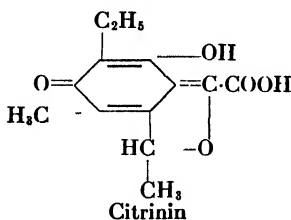

Penicillins. Of the numerous antibiotic substances derived from molds, penicillin, the first one discovered, has been found to be the most useful as a therapeutic agent. The combination of very low toxicity (it is almost nontoxic to mammals) with relatively high bacteriostatic action in vivo make it superior to all the other mold products so far tested. Its discovery (1929) by the English bacteriologist Fleming was the result of air-borne contamination of a culture of *Staphylococcus aureus*, the well-known organism sometimes found in human boils. Fleming noted that over a considerable area of the culture, in the neighborhood of the mold colony, there was no growth of the bacteria. He proved that this inhibitory effect was due to a soluble, diffusible mold product which could be obtained in concentrated form from a culture medium in which an isolated colony of the mold had been grown. The product was named penicillin because the mold was a species of *Penicillium*, later identified

as *Penicillium notatum*. It is now known that instead of one substance there are different naturally occurring compounds, called "the penicillins," which have similar antibiotic properties. They are thus isotelic (p. 192) substances.

Finding that his crude penicillin preparations were relatively nontoxic to animals, Fleming suggested that this substance should be of therapeutic value. But it was not until after the publication of Dubos's striking results with antibiotic agents, such as gramicidin from microorganisms of the soil, that the attention of the medical world was sharply directed to the great possibilities presented by such agents. In the meantime (1937-1940) a group of investigators at Oxford University had made successful progress in the study of penicillin preparations and their antibiotic properties. In 1941 a combined and organized war-effort attack upon the problem was started by a large group of English and American workers.

Rapid developments due to organized efforts included an intensive search for strains of mold which would be able to produce relatively high yields of penicillin. Many thousands of cultures, some obtained from natural sources, some derived from mutations artificially induced by irradiation of natural strains, were tested. Improvement in the composition of the culture medium for mold growth made rapid progress as did also the determination of physicochemical conditions of growth, the most favorable temperature, pH, surface tension, and method of aerating the culture. Especially important were developments in methods of isolation, purification, standardization, and large-scale production. A good index of the effectiveness of these attacks is the improved yield. Penicillin preparations are assayed in terms of what is generally called the "Oxford unit." This was at one time defined as an amount of penicillin activity which could prevent growth of *Staphylococcus aureus* over an area 24 mm. in diameter in a standard culture medium. Later, however, a standardized preparation of the pure crystalline sodium salt of penicillin was chosen for setting up an international unit. In terms of this standard, an Oxford unit appears to be approximately equivalent to 0.6 γ of penicillin. While earlier efforts produced yields of 1 to 2 Oxford units per ml. of culture medium, modern methods may give yields of 250 units per ml. or approximately 150 mg. of penicillin per liter. Inasmuch as a single therapeutic injection of penicillin contains many thousands of units (sometimes more than 100,000 units are used during a 24-hr. treatment), the necessity of large-scale production in order to realize the benefits of this drug is apparent. The requirements of the armed forces for penicillin practically precluded its use for civilian therapy until the summer of 1945. The story of its wartime significance

in combating disease and as a lifesaver is too familiar to require retelling.

Properties. Penicillin preparations are soluble in water to the extent of 0.5 per cent. They are also soluble in certain organic solvents, including acetone, ethanol, ether, amyl acetate, ethyl acetate, dioxane, and butanol, but are less soluble in benzene, chloroform, and carbon tetrachloride. They are highly unstable substances, readily destroyed by heat, by oxidizing agents, and by the presence of heavy metals. In acid solutions of pH less than 5 and in any alkaline solution, they are unstable. They are more unstable in solution in water or in alcohol than in the dry form. They are also destroyed by various microorganisms, *e.g.* *Escherichia coli* and some air-borne forms. Such organisms yield the enzyme **penicillase**. Because of the destructive action of the enzyme, asepsis is carefully maintained during processes of production and preparation of penicillins. The enzyme is useful, however, in a practical way. It is added to penicillin solutions so as to facilitate subsequent testing of them for sterility.

Many *Penicillin salts* have been prepared, but there is more information available about the Na and the Ca salts than has been published about others. Both are obtained in crystalline form. The Na salt, as usually prepared, is a light orange-colored, hygroscopic powder. The Ca salt is less hygroscopic than the Na salt and can be preserved for months in sealed ampules at room temperature without apparent loss of activity. The Ca salt and other salts with alkaline-earth metals are soluble in absolute methanol but insoluble in absolute ethanol. Penicillin is generally dispensed as its Ca salt.

Penicillin esters, such as the methyl, ethyl, *n*-butyl, benzhydryl, and benzyl, have been prepared. Some of them were prepared and studied (Cavallito *et al.*, 1945) in the hope of finding a therapeutically useful ester, more stable than penicillin. The benzyl ester appeared to be the most promising of those observed. It is reported to be heat stable even at 100°C. or higher, in contrast to penicillin salts, and is also more stable in solution in alcohol than any of the salts. It is only slightly soluble in water but is soluble in alcohol, ether, chloroform, ethyl acetate, propylene glycol, and oil. Its bacteriostatic action, when tested *in vitro*, is very slight; but *in vivo* (injected into or fed to mice), it is reported to show even better activity against streptococcal infection than does penicillin itself. This suggests that penicillin is liberated from its ester by some process of animal metabolism. This idea is substantiated by restoration of the *in vitro* antibiotic activity of the ester after it is incubated with rat or guinea-pig serum, although human, horse, rabbit, and dog serums did not produce this effect. Extracts of rat kidney, however, are highly potent in making the ester antibiotic. This may be due to

the presence of an enzyme which splits the benzyl ester so as to liberate penicillin, since boiled kidney extracts are ineffective.

The Chemistry of Penicillins. As a part of the concerted research attack, the molecular structure of penicillin was investigated in 38 English and American laboratories. They were connected with universities, governmental establishments, and other research organizations. The results are reported in a statement issued by the Committee on Medical Research, Washington, and the Medical Research Council, London. Penicillin is shown to occur in a number of forms collectively referred to as "antibiotics of the penicillin class." All of them have the empirical formula $C_9H_{11}O_4SN_2 \cdot R$. The nature of the group represented by R is established for a number of preparations as shown in Table 85.

TABLE 85.—ANTIBIOTICS OF THE PENICILLIN CLASS

Names	Earlier names	Formula of side chain (R)
Δ - $\beta\gamma$ -Pentenylpenicillin.....	I or F	--CH ₂ .CH:CH.CH ₂ .CH ₃
Benzylpenicillin.....	II or G	--CH ₂ .C ₆ H ₅
<i>p</i> -Hydroxyphenylpenicillin.....	III or X	--CH ₂ .C ₆ H ₄ —OH
<i>n</i> -Heptylpenicillin.....	k	--CH ₂ .(CH ₂) ₅ .CH ₃
Δ - $\gamma\delta$ -Pentenylpenicillin.....	--CH ₂ .CH ₂ .CH:CH.CH ₃
<i>n</i> -Amylpenicillin.....	--CH ₂ .(CH ₂) ₃ .CH ₃

For the elementary analyses leading to empirical formulas and for determination of molecular weights, the pure crystalline Na salts of the penicillins have been chiefly used. Molecular weights computed from the empirical formulas are approximately 334.4 and 356.4 for Na salts of F-penicillin and G-penicillin, respectively. These values are of the same order as the molecular weight of sucrose (342.3) and are small enough to be in agreement with the observed penetrability of penicillin through animal cells and membranes and its ready excretion by the kidney. Molecular weight determinations on G-penicillin are in satisfactory agreement with the formula assigned to it.

The penicillins are relatively strong, monobasic acids (pK_a , approximately, 2.8) and during electrometric titration show no evidence of the presence of a basic group. On treatment with hot dilute mineral acid, all penicillins yield one molecular equivalent of CO₂ and an amino acid which has been named "**penicillamine.**" It is D - β , β -dimethylcysteine, HS-C(CH₃)₂-CHNH₂-COOH. It may also be called β -thiovaline. It is believed that the acidic group in a penicillin is the carboxyl group of its penicillamine residue. It has been shown, however, that during an inac-

tivation process, a penicillin can acquire a second carboxyl group by taking on the elements of water, *i.e.*, by a mild form of hydrolysis. The resulting compound is known as a "penicilloic acid." The penicilloic acids have been intensively studied with results leading to the conclusion that they are thiazolidines.

A penicilloic acid in the form of its salt is produced by the action of alkalies on the corresponding penicillin. This would account for the loss of antibiotic activity in alkaline solutions. It is also probable that the enzyme penicillase inactivates by forming a penicilloic acid.

Inactivation of any of the penicillins also occurs under the influence of acids. The transformation of a penicillin held in dilute mineral acid solution at about 30°C. can be followed polariscopically. When the change in specific rotation is completed, a crystalline isomeride of the penicillin may be readily isolated. These products are known as "penillic acids." They are dicarboxylic and contain a basic group but no —SH group. By their properties and by artificial synthesis they are shown to have a structure with two five-membered rings, while penicilloic acids have only one.

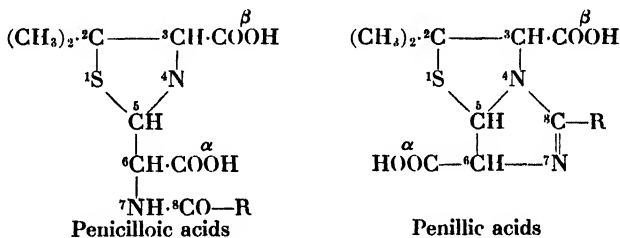

In each of these structures R may be any of the groups shown in Table 85. The atoms of the framework structure are numbered for reference. The carboxyl groups are designated as α and β .

The structures of the penicilloic and penillic acids, the reactions leading to these and other derivatives of penicillin, together with the physical properties and finally the artificial synthesis of benzylpenicillin, have led to the following formula for the penicillin structure:

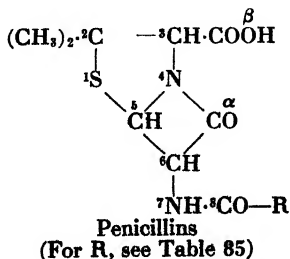

The part of this structure difficult to prove is the four-membered ring. This is rare in nature and is unstable. It thus accounts for the instability of penicillin preparations. It may be significant for its physiological behavior.

Administration. Because of its instability in acid, a penicillin is destroyed by gastric juice and is not regularly given by mouth. Attempts to overcome this limitation have been made. Suspensions of penicillin in oil, which would not be subject to gastric digestion, have been tried. In one method, the Ca salt of the penicillin is incorporated in a mixture of corn oil and lanolin and taken in gelatin capsules. The possible use of the benzyl ester for oral administration has been suggested. Adsorbed on aluminum hydroxide or magnesium hydroxide, penicillin may be successfully given by mouth. In most cases, however, injections of a physiological salt solution containing penicillin are given. A problem has arisen in view of the rather rapid excretion of penicillins in urine. On this account, intravenous injection is not suitable. In order to maintain a bacteriostatic level in the blood, penicillin is injected intramuscularly at rather frequent (usually 3-hr.) intervals. Further to slow the rate of absorption and thus to decrease the number of injections required, various devices have been tried. They include injection of penicillin in an oil-wax mixture and chilling by the use of ice packs applied to the site of injection. For treatment of localized infection and in some cases for general infections, a "continuous drip" method of injection is favored.

Uses. An account of the clinical uses of penicillin belongs in works on medicine and pharmacology rather than in biochemistry, but a few brief statements are in order. Many Gram-positive organisms and some Gram-negative forms are susceptible. They include the following: Gonococci, meningococci, spirochetes, actinomyces, clostridia, and others. The list of diseases for which penicillin treatment is successful and of those for which it is reported to be helpful is a long one. Its uses in the treatment of wound infections and in the cure of gonorrhoea have attracted much attention, but other and even more important uses are being found for it. It is perhaps premature to attempt to appraise the *ultimate* place of penicillin among therapeutic agents. Sir Alexander Fleming, who was knighted for his discovery, was acclaimed on the occasion (1945) of the award of an honorary degree as "the discoverer of penicillin, the most potent weapon yet known to man in the war of science against disease."

It was Fleming himself, however, who first called attention to the probability that many microorganisms produce bacteriostatic and bactericidal substances and suggested that agents more useful than penicillin might be found. The first part of his prophecy has been realized. As outlined above, other species of *Penicillia*, various other

molds, and a number of bacterial forms are now known to be sources of such substances, and more than one antibiotic may be obtained from the same organism. *Penicillium notatum*, for example, is known to be the source of antibacterial agents other than a penicillin.

Streptomycin. The second part of Fleming's prophecy may also be realized. Perhaps the nearest approach to its realization is the discovery (1944) of streptomycin by Waksman and his associates. The discovery was the result of a systematic search for antibacterial microorganisms of the soil. From *Actinomyces larendulae*, a substance named **streptothrycin** was obtained (1942); but although it is highly effective, in vitro, against many forms, it shows a delayed and cumulative toxicity with other fatal results when used in vivo. Some other antibiotics which have been obtained from certain species of actinomyces have also proved to be too toxic for therapeutic use. A promising organism which Waksman investigated was a strain of another species of filamentous bacteria, *Actinomyces griseus*. The antibiotic substance which these organisms produce was named streptomycin. One of its interesting characteristics is its antibiotic activity against both Gram-positive and Gram-negative microorganisms. This is in contrast to penicillin preparations, the activity of which is exerted, with some exceptions, upon Gram-positive forms. One of the actions of streptomycin is to inhibit the condensation between oxaloacetate and pyruvate in susceptible strains of *E. coli*. In mitochondrial preparations (tissue homogenates) this same effect occurs but not to a detectable degree in the intact animal.

The chemical structure is that of a glycoside in which a compound called streptidine is united with a disaccharide named streptobiosamine. The latter is made up of the peculiar sugar, streptonose and 2-N-methyl-L-glucosamine. Provisionally, the formula is given (Folkers *et al.*, 1947) as follows:

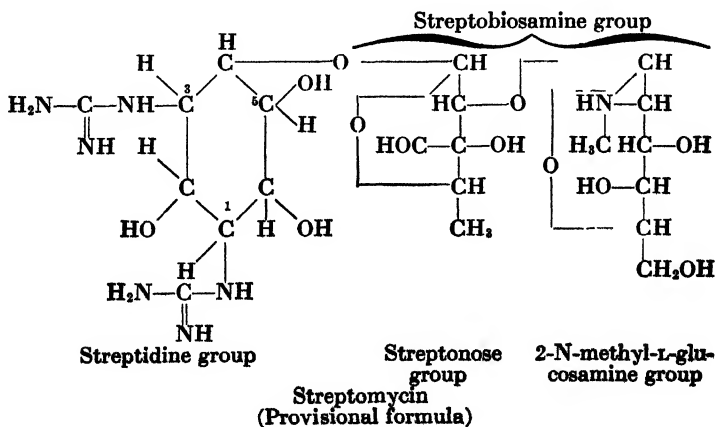

Streptidine is represented as 1,3-diguanidino-2,4,5,6-tetrahydroxycyclohexane, a derivative of inositol. It is notable that the glucosamine component is of the L-form, and the available evidence indicates that the streptonose component is also an L-sugar.

Streptomycin is soluble in water and dilute acids but insoluble in ether and chloroform. It is thermostable, but subject to hydrolysis in warm acid. It is relatively resistant to gastric digestion and can be used in treatment of gastrointestinal infections. Its toxicity is so low that for many practical purposes it may be regarded as nontoxic. It is readily excreted by the kidneys so that, like penicillin, it is injected intramuscularly at rather frequent intervals in order to maintain a certain concentration of it in the blood.

Interest in streptomycin is aroused because it appears to be able to take over where other antibiotics leave off. It is effective against organisms which are resistant to penicillin, and the list of pathogens which it inhibits *in vitro* is a long one. Among diseases resistant to penicillin treatment but reported to be arrested or cured by the use of streptomycin are certain urinary tract infections, typhoid fever, *Salmonella* infections, and undulant fever. Particular interest is attached to its strong antibacterial effect upon strains of *Mycobacterium tuberculosis* which cause human tuberculosis. This effect was first shown *in vitro*. Later, guinea pigs, which are highly susceptible to this disease, were infected with pure cultures of the organism. Some were observed as controls, others were treated with streptomycin over periods varying from 39 to 61 days. At the end of two months, 2 of 17 control animals were dead and the others had severe tuberculosis in advanced stages. Of 13 treated animals, those which had been given streptomycin over shorter periods showed slight evidence of macroscopic tuberculosis in an arrested state and 9 which had received streptomycin during 54 to 61 days showed no signs of the presence of tuberculosis. This striking result with guinea pigs was followed by demonstration of its usefulness for certain forms of human tuberculosis. This was the first time in the history of the fight against the "white plague" that an effective specific chemotherapeutic agent had been found.

Neomycin. Certain limitations on the use of streptomycin, especially over long periods as in treatment of tuberculosis, became apparent. It may produce neurotoxic symptoms, and the infective organisms can develop resistance to it. It thus seemed desirable to seek an antibiotic of still better properties. Waksman and his associates obtained (1949) from cultures of a strain related to *Streptomyces fradiae* a preparation effective against streptomycin-resistant bacteria and notably so against the *M. tuberculosis* strains that are streptomycin-resistant. It is distinctly different from streptomycin, but its properties have not yet

(1949) been reported on. Its toxicity is low enough to afford promise of being therapeutically useful.

Bacitracin. A chance infection of a bacterial culture led to the discovery of penicillin. Antagonistic action as it affects microorganisms in soil gave clues leading to the discovery of some other antibiotic substances. A similar antagonistic effect exerted by organisms infecting wounds upon other organisms in the same infection led to the discovery of an antibiotic. It was found (Johnson, Anker, and Meleney, 1945) that sometimes organisms would appear on a blood-agar plate culture obtained from injured tissue but could not be found in broth cultures made at the same time from the same wound material. This suggested that the latter cultures contained some organism inhibitory toward others. The phenomenon was noted frequently when the broth culture showed an abundant growth of aerobic, Gram-positive, sporulating rod forms. Some of these were isolated and tested for their inhibitory effects on certain forms. One of the isolated strains, a member of the *Bacillus subtilis* group, was highly active in its bacteriostatic effects. Filtrates from its broth cultures were found to be active both *in vitro* and *in vivo*. The antibiotic substance, called "bacitracin," is extracted from the medium by *n*-butanol and concentrated by steam distillation *in vacuo*. It is obtained in powder form but is not reported as having been prepared in a pure state. At first regarded as nontoxic, bacitracin was later shown to have an effect upon human kidneys leading to much proteinuria. Unless this toxicity for the kidney should prove to be due to a removable impurity, bacitracin would seem to be precluded from therapeutic use by injection.

Aureomycin. An antibiotic which is effective against certain kinds of viruses and rickettsial infections and is active against both Gram-positive and Gram-negative organisms was isolated from the growth media of *Streptomyces aureofaciens* by a group of nine workers who were pursuing researches initiated and directed by Subbarow and Williams. The substance is called aureomycin because the producing organism forms yellow colonies and the crystalline substance itself has a golden color. It is a weakly basic compound containing both nitrogen and chlorine. Its molecular weight is reported to be 508. It gives certain color reactions. It is slightly soluble in water and in methanol, ethanol, acetone, and benzene. It is insoluble in ether and petroleum ether. If clinical experience with this antibiotic shows that it is really effective against human virus diseases, an important new weapon will be provided for medicine.

A considerable number of other new antibiotics, discovered and named between 1945 and 1949, are also not yet well characterized. One of them, **chloromycetin**, obtained (1947) from cultures of *Streptomyces venezuelae*,

has attained prominence because of its value in treatment of rickettsial and viral infections. Its low toxicity and its effectiveness when given by mouth are also in its favor.

The Outlook in Chemotherapy. While the triumphs of chemotherapy have included the conquest of previously baffling diseases, the results of further research may be equally significant. At present there is considerable difficulty and expense involved in attainment of the large-scale production of any antibiotic substance so that it may be made available for general use. The synthetic production of such substances is obviously desirable. But before this can be attained, knowledge of the organic structure of antibiotics is required. Judging from experience with the older chemotherapeutic drugs, it seems reasonable to hope that when knowledge of chemical structure is understood in relation to antibiotic action, suitable agents can be prepared synthetically even though they are not exact duplicates of the natural antibiotics. The deciphering of this relationship is only in a beginning stage. It is indicated, so far as it had progressed up to the end of 1944, in a review by Oxford. Further progress in this analysis is anticipated by biochemists.

Other useful information would be knowledge of how biochemical mechanisms operate to produce a bacteriostatic effect in the case of each pathogenic microorganism which is subject to inhibition. This matter, too, has only a rudimentary development. Further progress in the study of the metabolism of pathogenic forms is required. There are already available the results of extensive studies of the biochemistry of *M. tuberculosis*, and less intensive work has also been done on many other forms. But there is still a great need for more information about the activity of the enzyme systems and about the cell architecture of pathogenic forms. Only when such knowledge is attained can a truly broad foundation be laid for building a genuine science of chemotherapy.

REFERENCES

The history of chemotherapy together with a useful account of the sulfa drugs is given in the book "Behind the Sulfa Drugs" by I. Gladston, New York, 1943.

A statement on "The Chemistry of Penicillin," *Science*, 102, 627, 1945, has been issued by the Committee on Medical Research, Washington, and the Medical Research Council, London.

The monograph, "Penicillin and Other Antibiotic Agents" by W. E. Herrell, Philadelphia, 1945, is helpful, authoritative, and timely. It contains excellent bibliographies.

From the viewpoint of the biochemist, Oxford's review (listed below) is especially illuminating for the chemistry of antibiotics.

Useful brochures, dealing mostly with penicillin, were issued in 1945 by The Lilly Research Laboratories, Indianapolis, and by Merck and Company, Rahway, N. J. The latter brochure contains an annotated bibliography of more than 500 titles.

A popularized report, "Streptomycin, New Weapon Against Death" by J. D. Ratcliff, will be found in *Hygeia*, 23, 822, 1945.

Among reviews dealing with this subject are the following:

BLANCHARD, K. C., Antimalarial Drugs, *Ann. Rev. Biochem.*, 16, 587, 1947.

CHAIN, E., The Chemistry of Penicillin, *Ann. Rev. Biochem.*, 17, 657, 1948.

- DUBOR, R. J., Utilization of Selective Microbial Agents in the Study of Biological Problems, *Harvey Lectures*, 35, 223, 1939-1940.
- DUBOR, R. J., Microbiology, *Ann. Rev. Biochem.*, 11, 659, 1942.
- LEMIEUX, R. U., and WOLFROM, M. L., The Chemistry of Streptomycin, *Advances in Carbohydrate Chem.*, 3, 337, 1948.
- MANWELL, R. D., Malaria, Birds and War, *Am. Scientist*, 37, 60, 1949.
- MARSHALL, E. K., JR., Bacterial Chemotherapy, *Ann. Rev. Physiol.*, 3, 643, 1941.
- MUELLER, J. H., The Chemistry and Metabolism of Bacteria, *Ann. Rev. Biochem.*, 14, 733, 1945.
- OXFORD, A. E., The Chemistry of Antibiotic Substances Other than Penicillin, *Ann. Rev. Biochem.*, 14, 749, 1945.
- ROBLIN, R. O., JR., Metabolite Antagonists, *Chem. Revs.*, 38, 255, 1946.
- TATUM, E. L., Biochemistry of Fungi, *Ann. Rev. Biochem.*, 13, 667, 1944.
- VOEGTLIN, C., The Pharmacology of Arsphenamine (Salvarsan) and Related Arsenicals, *Physiol. Rev.*, 5, 63, 1925.
- WINTERSTEINER, O., and DUTCHER, J. D., Chemistry of Antibiotics, *Ann. Rev. Biochem.*, 18, 559, 1949.
- WOOLLEY, D. W., Recent Advances in the Study of Biological Competition between Structurally Related Compounds, *Physiol. Rev.*, 27, 308, 1947.
- Some original reports of research in this field are listed.
- BIGGER, J. W., Synergic Action of Penicillin and Sulphonamides, *Lancet*, 247, 142, 1944.
- BRIAN, P. W., Effect of *p*-Aminobenzoic Acid on the Toxicity of *p*-Aminobenzenesulphonamide to Higher Plants and Fungi, *Nature*, 153, 83, 1944.
- BROSCHARD, *et al.*, Aureomycin, A New Antibiotic, *Science*, 109, 199, 1949.
- DU VIGNEAUD, V., *et al.*, Synthetic Penicillin, *Science*, 104, 431, 1946.
- FELDMAN, W. H., and HINSHAW, II. C., Effects of Streptomycin on Experimental Tuberculosis in Guinea Pigs; a Preliminary Report, *Proc. Staff Meetings Mayo Clinic*, 19, 593, 1944.
- FLEMING, A., On the Antibacterial Action of Cultures of a Penicillium, *Brit. J. Exptl. Path.*, 10, 226, 1929.
- FOLKERS, *et al.*, The Position of the Linkage of Streptobiosamine to Streptodine in Streptomycin, *J. Am. Chem. Soc.*, 69, 1234, 1947.
- FOSTER, J. W., and WOODRUFF, H. B., Improvements in the Cup Assay for Penicillin, *J. Biol. Chem.*, 148, 723, 1943.
- FOSTER, J. W., WOODRUFF, H. B., and McDANIEL, L. E., Production of Penicillin in Surface Cultures of *Penicillium notatum*, *J. Bact.*, 46, 421, 1943.
- GORDON, A. H., MARTIN, J. P., and SYNGE, R. L. M., The Amino Acid Composition of Gramicidin, *Biochem. J.*, 37, 88, 1943.
- GAUSE, G. F., and BRAZHNIKOVA, M. G., Gramicidin S and Its Use in the Treatment of Infected Wounds, *War Med.*, 6, 180, 1944.
- HEATLEY, N. G., A Method for the Assay of Penicillin, *Biochem. J.*, 38, 61, 1944.
- HILLEMANN, H., Über die Stellung der Methylgruppe im Pyocyanin, *Ber. deut. chem. Ges.*, 71, 46, 1938.
- HOTCHKISS, R. D., The Chemical Nature of Gramicidin and Tyrocidine, *J. Biol. Chem.*, 141, 171, 1941.
- JOHNSON, B. A., ANKER, H., and MELENY, F. L., Bacitracin: A New Antibiotic Produced by a Member of the *B. subtilis* Group, *Science*, 102, 376, 1945.
- LEE, S. W., FOLEY, E. J., EPSTEIN, J. A., and WALLACE, J. H., JR., Improvements in the Turbidimetric Assay for Penicillin, *J. Biol. Chem.*, 152, 485, 1944.
- MORRIS, C. J. O., The Determination of Sulphanilamide and its Derivatives, *Biochem. J.*, 35, 952, 1941.
- TRUMPER, M., and HUTTER, A. M., Prolonging Effective Penicillin Action, *Science*, 100, 432, 1944.
- SCHATZ, A., BUGIE, E., and WAKSMAN, S. A., Streptomycin, a Substance Exhibiting Antibiotic Activity Against Gram-positive and Gram-negative Bacteria, *Proc. Soc. Exptl. Biol. Med.*, 55, 66, 1944.
- SCHATZ, A., and WAKSMAN, S. A., Effect of Streptomycin and Other Antibiotic Substances upon *Mycobacterium tuberculosis* and Related Organisms, *Proc. Soc. Exptl. Biol. Med.*, 57, 244, 1944.
- SEAGER, L. D., Blood Levels of Penicillin after Oral Administration with Various Antacids, *Science*, 103, 353, 1946.
- VAN BRUGGEN, J. T., REITHEL, F. J., CAIN, C. K., KATZMAN, P. A., DOISY, E. A., MUIR, R. D., ROBERTS, E. C., GABY, W. L., HOMAN, D. M., and JONES, L. R., Penicillin B: Preparation, Purification, and Mode of Action, *J. Biol. Chem.*, 148, 365, 1943.
- WAKSMAN, S. A., Standardization of Streptomycin, *Science*, 102, 40, 1945.
- WAKSMAN, S. A., Nomenclature of Streptomycin Preparations, *Science*, 107, 233, 1948.
- WAKSMAN, S. A., and LECHEVALIER, H. A., Neomycin, a New Antibiotic Active against Streptomycin-resistant Bacteria, including Tuberculosis Organisms, *Science*, 109, 305, 1949.
- WELCH, H., PRICE, C. W., and CHANDLER, V. L., Prolonged Blood Concentrations after Oral Administration of Modified Penicillin, *J. Am. Med. Assoc.*, 128, 845, 1945.
- WÆDE, F., and ROTHAAAS, A., Über Prodigiosin, den roten Farbstoff des *Bacillus prodigiosus*, *Z. physiol. Chem.*, 226, 95, 1934.

AUTHOR INDEX

A

- Abbott, L. D., Jr., 517
Abderhalden, E., 100
Abel, J. J., 432, 446, 598, 633
Adams, G., 569
Adams, R., 44
Addis, T., 517
Adolph, W. H., 569
Agner, K., 385
Ahmann, C. F., 571
Akesson, A., 373
Aldrich, T. B., 598
Allen, E., 639
Allen, F. W., 152, 518, 607
Alles, G. A., 473
Allison, J. B., 516
Almaden, P., 590
Almquist, H. J., 105, 108, 216
Alt, H. L., 329
Alvarez, W. C., 275
Anchel, M., 289
Anderson, A. C., 275
Anderson, D. H., 639
Anderson, E., 640
Anderson, H. D., 217
Anderson, R. J., 93
Anderson, W. E., 473
Angier, R. B., 211
Anker, H., 659, 661
Ansbacher, S., 216
Anslow, W. P., Jr., 251
Anson, M. L., 140, 225, 385
Arcus, C. L., 70, 93
Armstrong, E. F., 42, 44
Armstrong, H. E., 245, 246
Armstrong, K. F., 44
Armstrong, W. D., 586, 588
Arnold, W., 59
Arrhenius, S., 233
Artom, C., 588
Ascham, L., 569
Asdell, S. A., 639
Asenjo, C. F., 217
Astbury, W. T., 33, 44, 136, 140, 149, 583
Astwood, E. B., 639
Atwater, W. O., 389, 391, 392, 413
Austin, J. H., 328
Austoni, M. E., 569
Avery, J., 44
Axelrod, A. E., 385
- Babkin, B. P., 275
Bacharach, A. L., 216
- Bacon, J. S. D., 44
Bahra, A. M., 213, 219
Baker, E. E., 44
Baldwin, E., 44, 242, 250, 333, 516
Balfour, D. C., 275
Ball, E. G., 361-363, 385, 386
Balls, A. K., 44, 225, 250
Baly, E. C. C., 55, 62
Banga, I., 588
Banting, F. G., 432
Barbieri, J., 97
Barcroft, J., 334
Barger, A. N., 446
Burker, (i. R.), 152
Barker, S. B., 517
Barnes, F. W., Jr., 152
Barnes, L. L., 413
Barnes, R. H., 289, 473, 474
Barron, E. S. G., 355, 385
Barsky, J., 218
Barton-Wright, E. C., 55
Bass, L. W., 151
Bassin, A. L., 589
Bauer, A. C., 218
Bauer, C. D., 481
Baumann, C. A., 217
Baumberger, J. P., 298, 329
Bawden, F. C., 152
Bawn, C. E. H., 386
Baxter, J. G., 217
Bayliss, W. M., 221, 262
Bazott, H. C., 413
Beard, H. H., 516
Beard, J. N., 152
Beaumont, W., 256, 275
Beck, L. V., 289, 446
Becks, H., 640
Bedford, C. L., 569
Bell, D. J., 44
Bell, G. H., 218
Belsler, W. B., 569
Bendich, A., 329
Benedict, F. G., 391, 392, 400, 402, 404, 409, 413
Beneditti-Pichler, A. A., 588
Benson, A. A., 60
Berg, C. P., 140, 481, 516
Bergeim, O., 169, 326, 327, 540
Bergel, F., 217
Bergmann, M., 123, 138, 140, 227, 228, 250, 251,
276, 480, 516
Berkson, J., 405, 413
Bernard, C., 338, 420, 428, 445
Bernheim, F., 474
Bernstein, A., 290

B

- Bernthal, T., 353
 Berryman, G. H., 571
 Bessey, O. A., 217, 589
 Bessman, S. P., 518
 Best, C. H., 216, 275, 457, 473
 Bethell, F. H., 329
 Beveridge, J. M. R., 589
 Bhattacharya, R., 473
 Bibby, B. G., 590
 Bicknell, F., 217
 Bierman, H. R., 571
 Bigger, J. W., 661
 Bills, C. E., 217, 473
 Bing, F. C., 569
 Binkley, S. B., 217
 Birch, T. W., 112, 163, 217
 Bischoff, F., 353
 Bishop, K. S., 205
 Bissell, A., 639
 Blackfan, K. D., 518
 Blanchard, E. W., 639
 Blanchard, K. C., 660
 Blatherwick, N. R., 353, 541
 Bloch, F., 93
 Bloch, K., 473
 Block, R. J., 114, 137, 139, 140, 491, 507, 517, 575
 Bloomfield, A. L., 276
 Bloor, W. R., 93, 94, 448, 473, 589
 Boas, M. A., 181
 Bock, J. C., 540
 Boer, J., 213, 217
 Bohr, C., 334
 Bolling, D., 139, 140
 Bollman, J. L., 289
 Bolton, C., 289
 Bondy, P. K., 473
 Booher, L. E., 172, 251, 264
 Boothby, W. M., 402, 405, 413
 Borsook, H., 244, 250, 251, 386, 516
 Bosworth, A. W., 93, 569
 Bouckaert, J. P., 422, 445
 Bourgeois, A., 99
 Bourne, M. C., 289
 Bourquin, A., 172
 Boxer, G. E., 473, 640
 Boyd, E. M., 448, 473
 Boyd, J. D., 589
 Boyd, W. C., 328
 Boysen-Jensen, P., 637, 639
 Brachett, F. S., 329
 Braconnot, H., 95, 97
 Bradley, H. C., 275, 516
 Brady, T. G., 152
 Brand, E., 140
 Braun-Menendez, E., 541
 Bray, H. G., 589
 Brazhnikova, M. G., 661
 Breusch, F. L., 464
 Brewer, A. K., 590
 Brian, P. W., 661
 Brink, N. G., 218
 Briwa, K. E., 589
 Brock, J. F., 329
 Brodie, J. B., 589
 Broschard, R. W., 661
 Brown, G. B., 517
 Brown, G. L., 473
 Brown, H. B., 569
 Brown, J. B., 93, 449
 Brown, W. R., 473
 Browne, C. A., 44
 Bruckmann, G., 589
 Bruner, H. D., 328
 Buchanan, J. M., 446, 513, 518
 Buchner, H., 220
 Buell, M. V., 152
 Bugie, E., 661
 Bull, H. B., 93
 Bunney, W. E., 140
 Burk, D., 230, 231
 Burk, N. F., 131, 132
 Burr, G. O., 70, 93, 289, 473
 Burr, M. M., 93
 Burton, A. C., 413
 Bushell, W. J., 93
 Buston, H. W., 97, 100
 Butler, A. M., 518, 569
 Butlerow, A., 55
 Butt, H. R., 216
 Butts, J. S., 473
 Butz, L. W., 99
- C
- Cahen, R. L., 473
 Cain, C. K., 640, 661
 Cajori, F. A., 240
 Caldwell, A., 501, 517
 Caldwell, M. L., 243, 251, 264
 Calvery, H. O., 251
 Calvin, M., 60
 Camp, S. C., 570
 Campbell, D. H., 329
 Campbell, H. L., 571
 Cannon, W. B., 275, 600
 Canzanelli, A., 413
 Carden, G. A., 541
 Cardini, C. E., 474
 Carlson, A. J., 256, 275
 Carpenter, D. C., 140
 Carpenter, F. H., 152
 Carpenter, T. M., 413
 Carter, H. E., 462
 Castle, W. B., 329
 Catchpole, H. R., 641
 Catherwood, R., 541
 Cavett, J. W., 541
 Cawley, J. D., 290
 Cerecedo, L. R., 515
 Chaikoff, I. L., 330, 445, 455, 457, 458, 473, 474
 593, 596, 597, 640
 Chain, E., 660
 Chambers, W. H., 517
 Chamelin, I. M., 290
 Chance, B., 251
 Chandler, J. P., 517

- Chandler, V. L., 661
 Chargaff, E., 152, 328, 329, 473
 Chase, M. W., 329
 Chatfield, C., 569
 Cheldelin, V. H., 569
 Chen, T. T., 361
 Chesler, A., 446
 Chibnall, A. C., 63
 Chittenden, R. H., 483, 550, 569
 Cholak, J., 589
 Chon, T. P., 569
 Christian, W., 367, 371
 Claff, C. L., 354
 Clark, F., 571
 Clark, W. M., 341, 360
 Clarke, M. F., 589
 Clausen, S. W., 569
 Cleckley, H. M., 219
 Cline, J. K., 169, 219
 Clouse, R. C., 541
 Coffey, R. J., 289
 Cohen, B., 359, 360
 Cohen, P. P., 489, 490, 516
 Cohen, S. S., 329
 Cohn, E. J., 140, 329, 516
 Cohn, M., 517
 Cole, S. W., 97
 Collier, H. B., 245
 Collip, J. B., 432, 634, 639
 Colowick, S. P., 423, 446
 Comroe, J. H., Jr., 353
 Conn, J. W., 473
 Conner, R. T., 570
 Conden, R., 114, 140
 Coons, C. M., 571
 Cooperstein, S. J., 386
 Corbet, R. E., 218
 Cori, C. F., 225, 420, 424, 426, 434, 440, 445, 446
 Cori, G. T., 225, 426, 445, 446
 Corley, R. C., 518
 Corner, G. W., 639
 Cornett, M. L., 473
 Coulson, E. J., 569
 Cowgill, G. R., 169, 570
 Cox, C. J., 217
 Cox, G. J., 588
 Cramer, D. L., 449
 Cramer, E., 97
 Crowfoot, D., 93
 Crozier, W. J., 235
 Crumbine, S. J., 569
 Cullen, G. E., 354
 Curry, J., 54
 Curtis, A. C., 571
 Cushman, M., 569
 Cushney, A. R., 520
 Cuthbertson, D. P., 516, 517
 Cutler, C. H., 473
- D
- Daft, F. S., 329, 517
 Dakin, H. D., 98, 113, 329, 460
- Dalldorf, G., 216
 Daly, C., 541
 Dam, H., 208, 216, 329
 Daniel, E. P., 570
 Daniels, A. L., 570
 Dann, M., 473
 Darby, W. J., 217
 Daubert, B. F., 93
 Davidson, J. N., 152
 Davidson, L. S. P., 569
 Davis, M., 158, 193
 Day, H. G., 216, 570
 Day, P. L., 219
 Deighton, T., 413
 Delbruck, M., 152
 Delluva, A. M., 513, 518
 Denham, H. G., 570
 Deuel, H. J., Jr., 289, 445, 473, 478, 479, 515, 517
 Devine, J., 541
 Dewar, M. M., 353
 Dickens, F., 589
 Dill, D. B., 353, 541
 Di Somma, A. A., 289
 Dixon, J. K., 570
 Dodds, E. C., 609
 Doebbeling, S. E., 243
 Dohan, F. C., 446, 640
 Doisy, E. A., 208, 217, 640, 661
 Domagk, G., 644
 Donath, P., 166
 Doolittle, D. B., 413
 Dore, W. H., 33
 Dorfman, A., 445
 Dounce, A. L., 152, 225, 376
 Downey, H., 328
 Dragstedt, C. A., 329
 Dragstedt, L. R., 458, 473
 Drain, C. L., 589
 Drechsel, E., 97, 98
 Drill, V. A., 639
 Dubnoff, J. W., 516
 DuBois, E. F., 402, 403, 409, 412
 DuBois, K. P., 446
 Dubos, R. J., 648, 652, 661
 Dubrunfaut, A. P., 7
 Duckles, D., 329
 Duckworth, T., 570
 Dunn, H. L., 405, 413
 Durkee, M. M., 570
 Dutcher, J. D., 661
 Dutcher, R. A., 216, 289
 Duve, C., de, 422, 434, 445
- E
- Eakin, R. E., 217
 Earle, I. P., 354
 Eccles, J. C., 473
 Eckstein, H. C., 93, 473
 Eddy, W. H., 216
 Edkins, J. S., 260, 262
 Edsall, J. T., 140
 Ehrlich, F., 97

- Ehrlich, P., 644
 Eichel, B., 386
 Eichelberger, L., 589
 Eijkman, C., 153, 166
 Eisele, C. W., 354, 589
 Ellinger, G. F., 218
 Elliott, K. A. C., 385
 Ellis, N. R., 94, 473
 Elman, R., 517
 Elvehjem, C. A., 108, 175, 211, 216-218, 329, 330,
 385, 569, 571, 589
 Embree, N. D., 216
 Emerson, G. A., 205, 217, 218
 Emerson, O. H., 205, 217
 Emerson, R., 59, 63
 Engels, L. L., 603
 Engstrom, W. W., 639
 Entenman, C., 473
 Epprecht, A., 218
 Epstein, J. A., 661
 Euler, H. von, 362
 Eusterman, G. B., 275
 Evans, E. A., Jr., 385, 445, 492, 639
 Evans, H. M., 205, 217, 218, 620, 622, 639, 640
 Evans, R. J., 589
 Evans, T. F., 45
 Everson, G. J., 570
- F**
- Fairbanks, B. W., 571
 Farber, S., 217
 Faulay, G. B., 640
 Feldberg, W., 329
 Feldman, W. H., 661
 Fellers, C. R., 571
 Fenn, W. O., 569
 Fenton, F., 570
 Ferguson, J. H., 298, 300, 328, 329
 Ferguson, J. K. W., 336
 Ferrebee, J. W., 541
 Feulgen, R., 83, 141
 Fieser, L. F., 93, 217
 Fieser, M., 93
 Finch, C. A., 517
 Fincke, M. L., 570
 Finkelstein, J., 218
 Finks, A. J., 570
 Fischer, E., 96, 98, 113, 124, 227
 Fischer, H. O. L., 445
 Fishler, M. C., 330, 473
 Fishman, W. H., 588
 Fiske, C. H., 418
 Fleming, A., 651, 661
 Florey, H. W., 275
 Floyd, N. F., 461, 474
 Flynn, J. E., 290, 328
 Folch, J., 83, 84, 93
 Foley, E. J., 661
 Folin, O., 418
 Folkers, K., 218, 657, 661
 Forbes, E. B., 409, 413
 Forbes, I. A., 45
- Forbes, W. H., 353
 Foster, E. O., 571
 Foster, J. W., 661
 Foster, W. C., 541
 Fouts, P. J., 217
 Fox, E. L., 413
 Fraenkel-Conrat, H., 639
 Franck, J., 63
 Frankel, J., 93
 Franklin, A. L., 640
 Frazer, A. C., 280
 Freundenberg, K., 40, 44
 Friedman, M. H. F., 275
 Frohlich, T., 187
 Frost, D. G., 216
 Frost, D. V., 329
 Fruton, J. S., 250, 251
 Fuller, R. C., 218
 Fulton, J. F., 473
 Funk, C., 153, 158, 166, 199
- G**
- Gaby, W. L., 661
 Gaffron, H., 63
 Gagge, A. P., 413
 Gallagher, T. F., 639
 Garner, R. L., 517
 Garner, W. E., 386
 Garry, R. C., 275
 Gast, J. H., 474
 Gaunt, W. E., 589
 Gause, G. F., 661
 Gavin, G., 473
 Geeslin, L. E., 219
 Gemmill, C. L., 353
 Gentzkow, C. J., 540
 Gesell, R., 353
 Gibbs, H. D., 360
 Gilman, H., 44, 151
 Gladston, I., 660
 Glavind, J., 329
 Glick, D., 276, 588
 Glock, G. E., 589
 Godden, W., 570
 Godfrid, M., 640
 Goebel, W. F., 45
 Goepf, R. M., 44
 Goettsch, E., 330
 Goldberger, J., 159, 176
 Goldblatt, H., 630, 639, 640
 Goldner, M. G., 640
 Goldsmith, G. A., 218
 Gomori, C., 640
 Gomori, G., 446
 Gonoe, J. E., Jr., 217
 Good, C. A., 446
 Goodhart, R., 218
 Goodland, R. L., 518
 Gordon, A. H., 140, 661
 Gornall, A. G., 517
 Gortner, R. A., 570
 Gorup-Besanez, E., 97

Gosney, H. W., 245, 246
 Granick, S., 304, 328
 Gray, E. LeB., 290
 Gray, J. S., 275
 Greaves, J. D., 290
 Green, A. A., 225, 446
 Green, D. E., 378, 385, 517
 Green, T. G., 93
 Greenberg, D. M., 105, 131, 132, 250, 569
 Greengard, H., 640
 Greenstein, J. P., 140
 Gregory, J. E., 589
 Griffith, W. H., 474, 541
 Grijns, G., 166
 Grimmett, R. E. R., 570
 Grollman, A., 639
 Grossman, M. I., 639
 Grulee, C. G., 570
 Guerrant, N. B., 216, 289
 Guerry, D., 219
 Guest, M. M., 330
 Guild, R., 413
 Gulland, J. M., 152
 Gunde, B. G., 93
 Guzman, A. R. F. de, 217
 György, P., 177, 181, 217, 218

H

Haag, J. R., 570
 Haas, E., 371, 386
 Haggard, H. W., 413
 Hahn, P. F., 328
 Haines, W. J., 518
 Haist, R. E., 639
 Haldane, J. S., 314, 325, 351, 353
 Hallman, L., 289, 473
 Ham, A. W., 640
 Ham, T. H., 329
 Haman, R. W., 218
 Hamilton, J. G., 445
 Hamilton, T. S., 139, 516
 Hammarsten, E., 262
 Hand, D. B., 251
 Handler, P., 474
 Hands, A. P., 640
 Hannon, R. R., 517
 Hansen, A. E., 473
 Hanson, H. T., 589
 Harington, C. R., 594, 639, 640
 Harper, A. A., 262
 Harris, L. J., 112, 216, 217
 Harris, P. L., 289
 Harris, R. S., 639
 Harris, S. A., 147, 218
 Harrop, G., 332
 Harrow, B., 289, 290
 Hart, E. B., 108, 211, 218, 329, 569-571
 Harte, R. A., 570
 Hartman, F. A., 602
 Hartree, E. F., 372, 376
 Hartzler, E. R., 289
 Hassid, W. Z., 44, 446
 Hastings, A. B., 354, 446, 589
 Hauck, H. M., 569
 Hauge, S. M., 213
 Hawk, P. R., 275, 326, 327, 540
 Hawkins, W. W., 218
 Hawley, E. E., 568
 Haworth, W. N., 10, 42, 44, 45, 187
 Hayano, M., 490
 Hayden, R. L., 329
 Heatley, N. G., 661
 Hecht, S., 216, 218
 Hodin, S. G., 98
 Hegsted, D. M., 517, 569
 Heidelberg, M., 41, 329, 354, 640
 Heidenhain, R., 256
 Heilbron, I. M., 62, 63, 93, 216, 218
 Heim, J. W., 326
 Helmer, O. M., 217
 Hemingway, A., 474
 Hempelmann, L. H., 491, 517
 Henderson, L. J., 350, 353
 Henderson, Y., 413
 Hendricks, S. B., 585
 Henriques, O. M., 337
 Herbert, D., 329
 Hernandez-Morales, F., 218
 Herrell, W. E., 660
 Herrin, R. C., 275
 Herrington, L. P., 413
 Herriott, R. M., 251, 275, 517
 Herron, P. H., 570
 Hershey, J. M., 457
 Hertz, R., 217
 Hess, A. F., 199, 216
 Heuser, E., 44, 217
 Heuser, G. F., 571
 Hevesy, G., 510, 517
 Hewitt, L. F., 140
 Hickman, K., 217
 Hilditch, T. P., 93, 94, 473, 474, 570, 589
 Hill, E., 570
 Hill, W. L., 585
 Hilleman, H., 647, 661
 Himwich, H. E., 446
 Hinshaw, H. C., 661
 Hirschberger, C., 211
 Hirst, E. L., 44
 Hitchcock, A. E., 639
 Hitchcock, D. I., 140
 Hoagland, C. L., 152
 Hodge, H. C., 589
 Hoerr, N. H., 588
 Hogan, A. G., 210
 Hogness, T. R., 385
 Hollander, F., 257, 276
 Holmes, A. D., 570
 Holmes, E., 445, 516
 Holmes, H. N., 218
 Holst, A., 187
 Holt, L. E., Jr., 482
 Holter, H., 265
 Holtz, P., 589
 Homan, D. M., 661

Honeywell, E. M., 217
 Hopkins, F. G., 97, 153, 198, 383, 569
 Hopkirk, C. S. M., 570
 Horecker, B. L., 329
 Horn, M. J., 501, 517
 Hotchkiss, R. D., 45, 661
 Houssay, B. A., 432, 433, 640
 Howell, S. F., 232, 251
 Howell, W. H., 297, 300, 328
 Hubbell, R. B., 570, 589
 Hudson, C. S., 44, 45, 229
 Huggins, M. L., 138, 140
 Hunter, A., 517
 Hunter, F. E., 454
 Husemann, E., 33
 Hutter, A. M., 661
 Hutton, M. K., 570
 Huxley, T. H., 326
 Hyman, A. J., 99

I

Ichaporria, M. B., 94
 Ingle, D. J., 640
 Ireland, J. T., 589
 Irving, J. T., 589
 Ivy, A. C., 262, 275, 276, 639, 640
 Izquierdo, J. J., 445

J

Jackson, R. W., 517
 Jacob, A., 217
 Jaffe, M., 100
 James, W. O., 440
 Jansen, B. C. P., 166, 217
 Jarvis, B. W., 570
 Jaspersen, H., 94
 Jay, P., 548
 Jeanloz, R. W., 44
 Jensen, D., 604
 Jensen, H., 639
 Jensen, K. A., 218
 Johns, C. O., 570
 Johnson, B. A., 659, 661
 Johnson, C. A., 641
 Johnson, H. C., 217
 Johnson, J. E., 518
 Johnson, R. E., 353, 446
 Johnson, S. W., 541
 Johnson, T. B., 151
 Johnston, W. A., 461
 Jolliffe, N., 569
 Jones, D. B., 501, 517, 570
 Jones, E., 217
 Jones, E. R. H., 93
 Jones, L. R., 661
 Jones, M. E., 640
 Jones, R. N., 218
 Jones, W., 145
 Jones, W. E., 216
 Jordan, D. O., 152
 Jorpes, E., 300

Josephson, B., 275
 Joslin, E. P., 445
 Jowett, M., 461, 464
 Jukes, T. H., 217, 517

K

Kalckar, H. M., 419, 446
 Kamen, M. D., 445
 Kanim, O., 634, 639
 Kao, H. C., 570, 589
 Karel, L., 277, 289
 Karrasch, R. J., 210
 Karrer, P., 208, 218
 Kastle, J. H., 244
 Katzman, P. A., 640, 661
 Kavanagh, V., 639
 Keewick, R. A., 140
 Kehoe, R. A., 589
 Keilin, D., 238, 371, 372, 376
 Kekwick, R. A., 386
 Kellie, A. E., 570
 Kelly, H. T., 548
 Kemmerer, K. S., 140
 Kendall, E. C., 97, 594, 639
 Kent, N. L., 589
 Kentie, A., 217
 Kenyon, F., 354
 Koppel, D. M., 517
 Kersztesy, J. C., 218
 Kerr, S. E., 577
 Keston, A. S., 518
 Kidder, G. W., 218
 Kimball, O. P., 640
 King, C. G., 217, 276, 570, 589, 590
 King, E. J., 590
 King, H., 86
 King, J. D., 570
 Kirch, E. R., 169
 Kirk, J. S., 251
 Kirk, P. L., 588
 Kitagawa, M., 99
 Kleczkowski, A., 152
 Kleiber, M., 413
 Klein, G., 55
 Klein, J. R., 386, 589
 Klein, W., 147
 Kleiner, I. S., 259, 276
 Klenk, E., 85
 Knight, C. A., 152
 Knoop, F., 459-461
 Knott, E. M., 541, 570
 Koch, F. C., 639
 Kögl, F., 635
 Koehler, A. E., 570
 Kohler, G. O., 218
 Kohn, H. J., 386
 Kollen, S., 386
 Koniuszy, F. R., 218
 Kossel, A., 98, 141
 Kramer, H., 446
 Krasnow, F., 276
 Kratzer, F. H., 290

Krebs, H. A., 367, 380, 445, 461
 Kreider, L. C., 45
 Krogh, A., 353
 Kruse, H. D., 219, 570
 Kühne, W., 220
 Kugelmass, I. N., 191
 Kuizenga, M. H., 329
 Kunitz, M., 152, 222, 223, 225, 251

L

Lahr, E. L., 640
 Lan, T. H., 517
 Landsteiner, K., 324
 Lanford, C. S., 569, 571, 589
 Lardy, H. A., 218, 385
 Laskowski, M., 376
 Lasnitzki, A., 590
 Lauffer, M. A., 152
 Lawrence, J. H., 445
 Lazarus, S., 218
 Lea, C. H., 135, 474
 Leblond, C. P., 639
 Lechevalier, H. A., 661
 Lederer, E., 329
 Leduc, F. H., 507, 518
 Lee, D. D., 517
 Lee, S. W., 661
 Leeson, H. J., 569
 Lehninger, A. L., 464, 474
 Leicester, H. M., 588
 Leifer, E., 491, 517
 Leitch, I., 569
 Leiter, L., 541
 Lemberg, R., 376
 Lemieux, R. U., 661
 Lepkovsky, S., 178, 217, 569
 Levene, P. A., 45, 145, 147, 148, 151, 152, 588
 Leverton, R. M., 569
 Levine, R., 640
 Levy, M. N., 275
 Lew, W., 517
 Lewis, H. A., 640
 Lewis, H. B., 517, 518
 Lewis, R. A., 603
 Lewkowitsch, J., 93
 Li, C. H., 620, 622, 639, 640
 Liebig, J., 97
 Liebmann, J., 541
 Lifson, N., 446
 Lillie, R. D., 176
 Linderström-Lang, K., 250, 265
 Lineweaver, H., 225, 230, 231
 Lipman, F., 180, 377, 384-386
 Lipschitz, M. A., 218
 Little, J. M., 290
 Loeb, J., 117, 129, 130
 Loevenhart, A. S., 244
 Logan, M. A., 588
 Lohman, K., 419, 440, 445
 Long, C. N. H., 641
 Long, C. W., 44
 Long, M. L., 353

Longenecker, H. E., 93, 94, 450
 Longscope, W. T., 329
 Loofbourow, J. R., 217
 Loomis, W. E., 63
 Loop, W., 35
 Lorber, V., 446
 Loring, H. S., 152
 Lowater, F., 589
 Lu, G. D., 517
 Lucas, C. C., 473, 589
 Lucke, B., 329
 Luckey, T. D., 218
 Lukens, F. D. W., 446, 639, 640
 Lundsgaard, F., 439, 445
 Lusk, G., 392, 398, 408, 409, 412, 492, 493
 Lutwak-Mann, C., 445

M

Mabee, D., 549, 570
 McCance, R. A., 569, 589
 McCay, C. M., 413
 McClellan, W. S., 517
 McClendon, J. F., 398, 559, 569, 570
 McCollum, E. V., 158, 169, 193, 216, 218, 560, 568, 570, 571
 McCready, R. M., 44, 446
 McCutcheon, M., 329
 McDaniel, I. E., 661
 MacDougall, E. J., 275, 289
 McFarlane, A. S., 140
 McGregor, M. A., 569
 Macherer, H., 33
 McHenry, E. W., 473, 569
 MacIntosh, F. C., 329
 McIntosh, J. A., 570
 MacKay, E. M., 473
 McKee, R. W., 217
 Mackenzie, C. G., 218
 McKibbin, J. M., 569
 McKinley, W. A., 217
 MacLachlan, E., 518
 McLean, F. C., 588, 589
 Maclean, H., 93
 Maclean, I. S., 93
 MacLeod, F., 589
 MacLeod, F. L., 571
 MacLeod, G., 330
 Macleod, J. J. R., 432
 McNaught, J. B., 517
 McQuarrie, I., 473
 Maculla, E., 640
 Macy, I. G., 354
 Madden, S. C., 517
 Maddison, L., 570
 Magee, H. E., 275, 289
 Majnarich, J. J., 215
 Major, R. T., 219
 Mandelbaum, J., 218
 Manery, J. F., 589
 Manly, M. L., 589
 Manly, R. S., 589
 Mann, F. C., 289

- Mann, T., 445
 Manwell, R. D., 643, 661
 Marenzi, A. D., 474
 Marine, D., 598
 Marrack, J. R., 329
 Marshall, E. K., Jr., 661
 Martin, A. J. P., 140, 589
 Martin, G. J., 183
 Martin, J. P., 661
 Martinez, C., 640
 Marton, L., 152
 Marvel, C. S., 44, 140
 Marx, W., 640
 Mason, H. L., 639
 Mason, I. D., 570
 Maynard, L. A., 218, 413
 Mazur, A., 290
 Medes, G., 461, 474
 Meiklejohn, G. T., 386
 Meldrum, N. U., 373
 Meleny, F. L., 659, 661
 Mellanby, E., 199
 Mellanby, M., 570, 588
 Melville, D. B., 217
 Mendel, L. B., 193, 218, 446, 473, 568-571, 589
 Mendenhall, D. R., 329
 Menten, M. L., 230, 242, 570
 Mering, J. von, 431
 Mertz, A. R., 63
 Meyer, K. H., 44
 Meyerhof, D., 423
 Meyerhof, O., 435, 440, 445
 Michaelis, L., 207, 230, 231, 239, 242, 370, 385
 Mielikan, G. A., 445
 Miescher, K., 141, 510, 611
 Mikeska, L. A., 152
 Milhorat, A. T., 517
 Miller, D. F., 613, 641
 Miller, E. C., 63
 Miller, E. S., 93, 289
 Miller, L. L., 517
 Millikan, G. A., 588
 Millington, R. H., 518
 Milstone, J. H., 329
 Mims, V., 219
 Minkowski, O., 431
 Minot, G. R., 316, 329
 Miraky, A. E., 152, 385
 Mitchell, H. H., 139, 516, 571
 Mitchell, H. K., 218
 Mörner, C. T., 99
 Monge, C., 353
 Monobe, S., 99
 Montgomery, M. L., 473
 Moore, C. B., 640
 Moore, P. R., 218
 Moore, T., 218
 Morawitz, P., 298
 Morgan, A. F., 549, 570
 Morgan, C. F., 640
 Morgan, W. T. J., 45
 Morgareidge, K., 290
 Mori, T., 152
 Morrell, C. A., 251
 Morris, C. J. O., 661
 Morrison, P. R., 413
 Morton, M. E., 593, 640
 Moss, A. R., 517
 Moss, W. G., 641
 Most, R. M., 569
 Moxan, A. L., 588
 Moyer, A. W., 517
 Mrak, E. M., 569
 Mudd, S., 329
 Mueller, J. H., 98, 661
 Muir, R. D., 661
 Mulder, G. J., 95
 Mulinos, M. G., 640
 Munro, H. N., 218, 517
 Muntwyler, E., 329
 Murlin, J. R., 275, 413
 Murphy, W. P., 316
 Murray, M. M., 589
 Murschhauser, H., 413
 Musulin, R., R., 589
 Myers, V. C., 329, 569
 Myrbäck, K., 250
- N
- Nachmansohn, D., 473
 Nagelschmidt, G., 590
 Neal, W. M., 571
 Needham, D. M., 517
 Needham, J., 385
 Neill, J. M., 354
 Nelson, J. M., 45
 Neabitt, F. B., 446
 Neuberger, A., 517
 Neurath, H., 134, 135
 Newburgh, L. H., 452, 473, 571
 Newell, J. M., 571
 Newman, K. R., 571
 Nicolet, B. H., 386
 Niemann, C., 139, 595
 Nier, A. D., 474
 Nocito, V., 517
 Nord, F. F., 250, 446
 Norman, A. G., 44
 Norris, E. R., 215, 218
 Norris, L. C., 217, 571
 Northrop, J. H., 45, 151, 222, 223, 225, 228, 229, 232, 235, 246, 250, 251, 259, 264, 275, 321
 Novac, A. F., 213
 Nussemer, M., 217
- O
- O'Brien, H., 335
 Ochoa, S., 386, 423
 Oettingen, W. F., von, 569
 Ogston, A. G., 446
 Olleman, E. D., 45

- Olmstead, W. H., 571
 Orent, E. R., 571
 Orent-Keiles, E., 216
 Osborne, T. B., 193
 Oser, B. L., 217
 Ottesen, J., 510
 Oxford, A. E., 646, 661
- P**
- Pacsu, E., 45
 Pader, M., 290
 Paechnatz, G., 54
 Page, E. W., 640
 Page, I. H., 588
 Palmer, L. S., 570
 Pappenheimer, A. N., 217
 Parmenter, H. S., 413
 Pasteur, L., 648
 Patterson, J. M., 473
 Pauling, L., 320, 329
 Paulson, D. L., 413
 Pavlov, I. P., 256
 Pearson, O. H., 640
 Pearson, O. P., 413
 Peat, S., 44, 45
 Pedelty, W. H., 474
 Pedersen, K. O., 140, 386, 640
 Pennington, D. E., 45
 Percival, E. G. V., 45
 Percival, G. H., 588
 Perlman, I., 474
 Peters, J. P., 541
 Peters, R. A., 170, 588
 Peterson, W. H., 589
 Pfflner, J. J., 602, 639
 Phillips, P. H., 589
 Pigman, W. W., 44
 Pincus, G., 639
 Pirie, N. W., 152
 Piskur, M. M., 473
 Pi-Suñer, A., 353
 Pittman, M. S., 571
 Pitts, R. F., 353
 Plentl, A. A., 518
 Pliason, A., 98
 Poling, C. E., 218
 Pollock, H., 251
 Ponder, E., 302
 Poo, L. J., 517
 Porter, J. R., 276
 Potter, R. L., 218
 Potter, V. R., 218, 329, 446
 Pratt, M. C., 55
 Prebluda, H. J., 169
 Pressman, D., 329
 Price, C. W., 661
 Price, T. D., 464, 474
 Priestly, J. G., 353
 Prins, D. A., 44
 Proust, M., 97
 Province, W. D., 541
 Pucher, G. W., 386
- Q**
- Quastel, J. H., 461, 464, 588
 Quick, A. J., 289, 299, 328
 Quigley, J. P., 275
 Quinn, E. J., 589, 590
- R**
- Radley, J. A., 44
 Raistrick, H., 45
 Ramsay, W. N. M., 330
 Ramsdell, P. A., 386
 Randle, S. B., 218
 Raper, H. S., 262
 Rapp, I., 570
 Rapport, D., 413, 517
 Ratcliff, J. D., 660
 Ratner, S., 517, 518
 Raymond, A. L., 44
 Reh fuss, M. E., 256, 257
 Reichert, E. T., 44
 Reichstein, T., 187, 639
 Reifman, A., 289
 Reineke, E. P., 596, 640
 Reinhardt, W. O., 330, 640
 Reiser, R., 447, 474
 Reithel, F. J., 661
 Remington, J. W., 639
 Rettger, L. F., 275, 276
 Rhian, M., 588
 Rice, E. E., 108, 482, 518
 Rich, A. R., 329
 Richardson, H. B., 413
 Richardson, L. R., 210
 Rickes, E. L., 214, 218
 Riddle, O., 618, 640
 Ridout, J. H., 216, 473, 640
 Riemenschneider, R. W., 94
 Rittenberg, D., 446, 460, 464, 473, 474, 517, 518
 Ritter, D. M., 45
 Ritthausen, H., 98
 Robbins, W. J., 639
 Roberts, E. C., 661
 Robeson, C. D., 217
 Robinson, C. S., 290
 Roblin, R. O., Jr., 661
 Robscheit-Robbins, F. S., 329, 517
 Rony, H. R., 472
 Rose, C., 217
 Rose, M. S., 330, 404, 568, 569
 Rose, W. C., 97, 105, 107, 108, 140, 212, 219, 482, 517, 518
 Rosenberg, H. R., 158, 216
 Rosenblueth, A., 600
 Rosenheim, O., 86, 264, 290
 Ross, L. E., 218
 Ross, W. F., 330
 Rossiter, R. J., 386
 Roth, L. J., 491, 517
 Rothaas, A., 647, 661
 Roughton, F. J. W., 335-337, 353, 354
 Rowntree, J. I., 290

- Rubner, M., 389, 400, 408
 Ruegger, A., 218
 Ruell, D. A., 44
 Ruigh, W. L., 93
 Rusing, B. M., 217
 Russell, J. A., 446
- S
- Sabalitschka, T., 54
 St. Julian, R. R., 140
 Salter, W. T., 473, 640
 Samant, K. M., 218
 Sandow, A., 588
 Sanford, H. N., 570
 Sanger, F., 517
 Sansum, W. D., 353
 Satterfield, G. H., 570
 Saurewein, E. M., 569
 Scarborough, H., 191, 218
 Schaffer, N. K., 541
 Schatz, A., 661
 Schiff, E., 211
 Schiff, F., 328
 Schlenk, F., 485
 Schmidt, C. F., 353
 Schmidt, C. L. A., 139, 290, 518, 607
 Schmidt, M. M., 570
 Schoenheimer, R., 152, 289, 441, 446, 460, 472, 474, 480, 483, 507, 517, 518
 Scholander, P. F., 354
 Schryver, S. B., 97, 98, 100
 Schuck, C., 446
 Schützenberger, P., 99
 Schulbach, H. H., 35
 Schultz, H. W., 473
 Schultze, M. O., 330, 386, 569
 Schulze, E., 97, 98
 Schwerin, P., 518
 Schwimmer, S., 44
 Scott, J. C., 413
 Soott, V. C., 517
 Soular, F. I., 571
 Scull, C. W., 140
 Seager, L. D., 661
 Sealock, R. R., 518
 Sebrell, W. H., 219, 569, 571
 Seegers, W. H., 298, 299, 328, 330
 Seltzer, C. C., 413
 Selye, H., 290, 604, 639
 Sendroy, J., Jr., 353
 Shaffer, P. A., 446, 463
 Shambaugh, N. F., 518
 Shannon, J. A., 541
 Shay, H., 276
 Sheldon, C. C., 93
 Shemin, D., 496, 517, 518
 Sheppard, M., 548
 Sherman, C. C., 386, 446
 Sherman, H. C., 172, 243, 251, 264, 554, 556, 568-571, 589, 590
 Shertz, F. W., 63
 Sherwin, C. P., 289
 Shields, J. B., 571
 Shimotori, N., 218
 Shine, W. M., 420
 Shohl, A. T., 518, 569
 Shoppee, C. W., 639
 Shorb, M. S., 218
 Shriner, R. L., 44
 Shute, E. V., 207, 209
 Simmonds, N., 590
 Simmons, J. S., 540
 Simpson, M. E., 620, 622, 639, 640
 Sinclair, H. M., 218
 Sinclair, R. G., 473
 Sisson, E. W., 93
 Sizer, I. W., 235, 236, 250, 251
 Skinner, J. T., 571
 Skoog, F., 639
 Sloskin, S., 640
 Slutzky, B., 275
 Smedley-Maclean, I., 70, 93
 Smith, A. H., 416, 589
 Smith, E. L., 214, 276, 589, 641
 Smith, H. M., 413
 Smith, H. P., 328
 Smith, H. V., 571
 Smith, H. W., 540, 541
 Smith, M. C., 571
 Smith, S. E., 213, 218
 Smithies, O., 446
 Smuts, D. B., 571
 Smyth, D. H., 474
 Snell, A. M., 216
 Snell, E. E., 140, 217, 218
 Snell, J. F., 413
 Snider, R. H., 94, 473
 Snow, G. A., 446
 Sober, H. A., 140, 218, 385
 Sobotka, H., 93, 275
 Somers, G. F., 250
 Somerville, J. C., 45
 Somogyi, M., 446
 Sonne, J. C., 513, 518
 Sørensen, S. P. L., 102
 Soarkin, S., 396, 434, 446
 Spaulding, L. B., 329
 Speert, H., 639
 Sperling, G., 413
 Sperry, W. M., 84, 93
 Spies, T. D., 217, 218
 Spingarn, C., 640
 Sponsler, O. L., 33
 Stacey, M., 42, 45, 152, 589
 Stadie, W. C., 332, 335, 473
 Stanley, W. M., 150, 152
 Stare, F. J., 569
 Starling, E. H., 262
 Staudinger, H., 33
 Stearns, G., 541, 589
 Steenbock, H., 194, 199, 217, 218, 570, 571
 Steiger, E., 98
 Steinhaus, A. H., 413
 Stekol, J. A., 289, 290
 Stern, K. G., 239, 385

Sternheimer, R., 610
 Stetten, DeW., Jr., 424, 473, 474, 640
 Stewart, C. P., 330, 386, 446, 588
 Stewart, G. F., 569
 Stiebeling, H. K., 569, 571
 Still, E. U., 275
 Stiller, E. T., 218
 Stirn, F. E., 571
 Stokstad, E. L. R., 217
 Stoll, A., 63
 Stone, W. E., 590
 Storvick, C. A., 569
 Story, R. V., 589
 Strain, H. H., 46
 Strain, W. H., 93
 Strandskov, H. H., 329
 Straub, F. B., 225
 Strauss, M. B., 329
 Strecker, A., 97
 Stuart, A. H., 639
 Stumpf, P. K., 385
 Sturgis, C. C., 329
 Suarez, R. M., 218
 Suarez, R. M., Jr., 218
 Subbarow, Y., 418, 659
 Sullivan, J., 639
 Sumner, J. B., 225, 232, 250, 251, 376
 Sutherland, E. W., 432, 446
 Svedberg, T., 132, 139
 Swalbnch, W. G., 517
 Swanson, W. F., 589
 Swendseid, M. E., 461, 474
 Swenson, O., 354
 Swingle, W. W., 602, 639, 640
 Sydenstricker, V. P., 219
 Synge, R. L. M., 589, 661
 Szent-Gyorgyi, A., 187, 191, 380, 578, 588

T

Tadokoro, T., 225
 Takamine, J., 598
 Takasugi, H., 225
 Tallman, R. C., 639
 Tanret, G., 8
 Tarver, H., 518
 Tatum, E. L., 661
 Tauber, H., 259, 276, 385
 Templeton, C. M., 219
 Tenenbaum, B., 590
 Thayer, S. A., 217
 Theorell, H., 225, 371, 373, 375, 385, 386
 Thimann, K. V., 639
 Thomas, J. E., 275
 Thompson, H. M., 570
 Thompson, J. C., 446
 Thompson, K. W., 639
 Thomson, D. L., 639
 Thorn, G. W., 603
 Thudichum, J. L. W., 79, 100
 Tidwell, H. C., 474
 Tipson, R. S., 152
 Tipton, S. R., 641

Tiselius, A., 115, 117
 Titus, H. W., 94
 Todd, A. R., 217
 Toennies, G., 140
 Toothill, M. C., 446
 Torda, C., 474
 Torquati, T., 99
 Torry, J. C., 276
 Totter, J. R., 219
 Tourtellotte, D., 518
 Toverud, G., 571
 Town, B. W., 140
 Travers, J. J., 570
 Treadwell, C. R., 474
 Trelease, S. F., 54
 Tressler, D. K., 570
 Tripp, F., 570
 Trumper, M., 661
 Turner, C. W., 596, 640
 Tyslowitz, R., 639
 Tytell, A. A., 236, 251

U

Umbreit, W. W., 446
 Underwood, E. J., 569

V

Vahlteich, E. McC., 330
 Van Bruggen, J. T., 661
 Van Donk, E., 571
 VanDyke, H. B., 639
 Van Heyningen, W. E., 474
 Van Horn, A. L., 571
 Van Liere, E. J., 275
 Van Overbeek, J., 639
 Van Slyke, D. D., 332, 344-347, 354
 Van Veen, A. G., 99, 552, 569
 Van Wagtenonk, W. J., 213, 218
 Vaughan, W. T., 278
 Vennesland, B., 446
 Verworn, M., 95
 Verzar, F., 275, 289
 Vickery, H. B., 386
 Vigneaud, V. du, 99, 181, 217, 457, 501, 507, 516,
 517, 661
 Vischer, E., 152
 Voegtlin, C., 661
 Vogelsang, A., 207, 219
 Voit, E., 401, 402
 Voit, F., 550
 Voris, L., 413

W

Wada, M., 99
 Waddell, W. W., Jr., 219
 Waelsch, H., 518
 Wagreich, H., 290
 Wainio, W. W., 386
 Waisman, H. A., 175
 Wakeman, A. J., 570, 589

- Wakerlin, G. E., 641
 Waksman, S. A., 657, 658, 661
 Wald, G., 195, 217, 219
 Waldschmidt-Leitz, E., 250
 Wallace, J. H., Jr., 661
 Walti, A., 225
 Wangensteen, O. H., 275
 Warburg, O., 172, 362, 367, 371
 Ware, A. G., 299, 328, 330
 Warner, D. T., 518
 Warner, E. D., 290
 Warnock, G. M., 570
 Wasteneys, H., 244, 251
 Waymouth, C., 152
 Weaver, J. W., 219
 Webster, T. A., 290
 Weech, A. A., 330
 Weidling, H., 54
 Weil-Malherbe, H., 385
 Weinhouse, S., 461, 474, 518
 Weinstein, L., 275
 Weir, J. R., 641
 Weiss, J. E., 275
 Welch, A. D., 219
 Welch, H., 661
 Werkman, C. H., 250
 Werner, O., 55
 Wertzler, D., 589
 West, H. D., 290
 West, R., 219, 329
 Wheldale, M., 42
 Whipple, G. H., 276, 295, 303, 316, 329, 517
 White, A., 639, 641
 Wicks, L., 571
 Widdowson, E. M., 569
 Wieland, H., 86, 355
 Wiener, A. S., 324, 330
 Wilgus, H. S., Jr., 571
 Wilhelmi, A. E., 473
 Wilhelmj, C. M., 413
 Williams, R. D., 571
 Williams, R. J., 178, 192, 217-219, 588
 Williams, R. R., 155, 166, 169, 219, 569
 Williams, R. T., 289
 Williams, S. A., 218
 Willstätter, R., 57, 63
 Wilson, C. A., 354
 Wilson, J. W., 507, 518
 Wiltberger, P. B., 623, 641
 Windaus, A., 86, 202
 Winnick, T., 250
 Wintersteiner, O., 661
 Wirick, A. M., 217
 Witzemann, E. J., 473
 Woelffer, E. A., 570
 Wohl, K., 62
 Wolbach, S. B., 217
 Wolcott, M. W., 640
 Wolf, P. A., 518
 Wolf, S., 275
 Wolff, H. C., 474
 Wolff, H. G., 275
 Wolfram, M. L., 35, 44, 45, 661
 Wollaston, W. H., 98
 Wollman, S. H., 207
 Womack, M., 140, 212, 219
 Wood, H. G., 446
 Wood, T. R., 218
 Woodruff, H. B., 661
 Woods, D. D., 646
 Woods, F. M., 517
 Woolley, D. W., 83, 94, 211, 217, 219, 661
 Work, T. S., 217
 Wortis, E., 541
 Wortis, H., 541
 Wrede, F., 647, 661
 Wrenshall, G. A., 640
 Wright, G. P., 289
 Wright, K. A., 45
 Wright, L. D., 219
 Wrinch, D. M., 138
 Wulzen, R., 213, 218, 219
 Wurster, O. H., 94
- Y
- Yavorsky, M., 590
 Young, E. G., 140
 Young, F. G., 433, 446
 Young, L., 289, 290
- Z
- Zaky, Y. A. H., 589
 Zbarsky, S. H., 290
 Zeller, J. H., 473
 Zerban, F. W., 44
 Zilva, S. S., 446, 541, 570
 Zilversmit, D. B., 473
 Zimmerman, P. W., 639
 Zondek, S. G., 589
 Zuntz, E., 398

SUBJECT INDEX

A

- Absorption, nature of, 283
paths of, 277
- Acacia gum, 36
- Acapnia, 336
- Accessory stomach, 256
- Acetaldehyde, 444
oxidation of, 378, 379
- Acetanilide, 285
- Acetate, use of, in cholesterol synthesis, 471
- Acetates, oxidation of, 383
- Acetic acid, production of, 378
- Acetoacetic acid, 431
acidosis from, 353
production of, 460-462
from tyrosine, 498
urinary, 536, 537
- Acetone, 431
production of, 462
urinary, 536, 537
- Acetone bodies, 431
- Acetone substances, 431
- Acetylation, 180
detoxication by, 289
- Acetylation reactions, 163
- Acetylcholine, 600
action of, 468
- Acetyl group, 180, 380
- Acetyl number, 78
- Agglubulin, 298
- Achlorhydria, 261, 316
- Achromic point, 254
- Achromotrichia, 162, 179
- Acid, dissociation of, 340
- Acid-base regulation, kidney functioning in, 352
- Acid value, 77
- Acidosis, 345-347
cause of, 463
use of ammonia in, 526
- Aconitase, 382
- Acrodynia, 162, 176
- Acrolein, 72
- Aoromegaly, 620
- ACTH, 616-617
- Actin, 578
- Actinomyces griseus*, 657
- Addison's disease, 602, 604
relief of, 617
- Adenase, 147, 512
- Adenine, 156, 512
metabolism of, 510
structure of, 143
- Adenosine, 147, 152
- Adenosine diphosphate (ADP), 149
definition of, 419
- Adenosine pyrophosphate, 419
- Adenosine triphosphate (ATP), 149, 417, 419,
438, 578, 579
definition of, 417
splitting of, 420
- Adenylases, 512
- Adenylic acid (AMP), 145, 149, 156, 418, 419,
438, 512, 579
definition of, 418
in muscle, 146
- Adermin, 156
- ADP (*see* Adenosine diphosphate)
- Adrenal, degeneration of, 164
- Adrenal cortex, 601-605
lesions of, 162
as source of androgens, 613
- Adrenal virilism, 605
- Adrenalectomy, fatal effect of, 601
metabolism after, 602
- Adrenaline, 598
- Adrenals, phospholipids of, 453
- Adrenergic effect, 600
- Adrenaline, 598-600
effect of, on blood sugar, 428
- Adrenochrome, 599
- Adrenocorticotrophic hormone (ACTH), 616-617
- Adrenosterone, 603, 605, 612, 613
- Agar-agar, 36
- Age, effect of, on metabolism, 402, 403, 405
- Agglutinins, 321
- Aglycoones, 42
- Agmatine, 272
- Agnosterol, 93, 582
- Air, gases of, 332
- Alanine, 97
- β -Alanine, 178, 579
- Albumin, 106
- Albuminoids, 120, 122
- Albumins, 119, 122
- Albuminuria, 537
- Alcaptonuria, 497, 498, 522
- Alcohol, oxidation of, 376
- Alcohols, glycogen from, 420
- Aldobionic acid, 41
- Aldolase, 440
- Alexin, 321
- Alkali deficit, 345, 349
- Alkali excess, 349
- Alkali reserve, 344, 345
significance of, 346
- Alkali tolerance, 345
- Alkaloidal reagents, 127

- Alkalosis, 345-347
 Allantoic acid, 512
 Allantoicase, 512, 513
 Allantoin, 512, 513
 Allantoinase, 512, 513
 Allergens, 322
 Allergic reactions, 322
 Allicin, 646
 Allopregnane, 612
D-Allose, 5
 Alloxan, diabetes caused by, 627
 Alopecia, 164
 Altitude, effect of, on blood, 302, 303
 Alveolar air, analysis of, 345
 Amandin, molecular weight of, 133
 Amboceptor, 321
 Amenorrhoea, therapy of, 610
 Amide nitrogen, 124
 Amine oxidase, 379
n-amino acid oxidase, 367, 371, 488
 Amino acids, 96-114
 of blood and tissues, 475
 classification of, 100
 crystalline forms of, 103
 n-forms of, 105
 discovery of, 96
 dissociation of, 108-112
 dissociation constants of, 111
 dynamic effect of, 409
 entrance of, into tricarboxylic-acid cycle, 492
 as glycogen formers, 421
 from growth hormone, 619
 indispensable, 107
 amount required of, 481
 ketogenesis from, 494
 nutritional significance of, 106-108
 optical activity of, 103-106
 from prolactin, 618
 reactions of, 101
 separation of, 112-114
 steric inversion of, 105
 sugar production from, 493
 synthesis of, 481
 yields of, from proteins, 106, 114
L-Amino acid oxidase, 488
 Aminobenzoic acid, 155
p-Aminobenzoic acid (PAB), 183
 Aminobutyric acid, 99
 β -Aminoethanol, 82
p-Aminophenol, 286
 Aminopolypeptidase, 516
 Ammonia, in acidosis, 353
 determination of, 345
 excretion of, 526
 use of, in amino acids, 483
 AMP (*see* Adenylic acid)
 Amphiprotic substances, 108
 Amphoteric electrolytes, 108
 Amygdaline, 43
 Amylase, 233
 pancreatic, 264
 salivary, 254
 α -Amylase, 244
 β -Amylase, 244
 Amylopectin, 29
 synthesis of, 424
 Amylopsin, 264
 Amylose, 29
 synthesis of, 424
 Anaphylactin, 322
 Anaphylatoxin, 322
 Anaphylaxis, 322
 Androgens, 612-614
 adrenal, 605
 bioassay of, 613
 Androstane, 613
 Androsterone, 612
 Anemia, 186
 incidence of, 557
 Anemias, 316-318
 Ancurin, 156, 159
 Angiotonin, 630
 Animal protein factor (APF), 212
 Animal tissues, phospholipids of, 453
 Anisotropism, 578
 Anoxemia, 351
 Anserine, 504, 579, 580
 Anterior lobe, pituitary, 615
 Anterior-pituitary-like hormones (APL), 623
 Anthelone, 632
 Antiaerodynia factor, 156
 Antibiotics, 646-659
 history of, 647
 Antibodies, 294, 320
 Anticytopenia factor, 157
 Antienzymes, 248
 Antigen, 320
 Antihemorrhagic factor, 157
 Antihormones, 634, 635
 Antioxidant effects, 190
 Antioxidants, 77
 Antipneumonia factor, 157
 Antiprothrombin, 297, 300
 Antirachitic vitamins, 156
 Antirickettic rays, 203
 Antiscorbutic vitamin, 156
 Antisterility vitamins, 157
 Antistiffness factor, 213
 Antithrombins, 300
 Antitoxins, 321
 Antiurease, 248
 Apatite, 585
 Apepsia, 261, 316
 APF, 212
 APL, 623
 Apnea, 336
 Apoenzyme, definition of, 247
 Apoferritin, 304
 Arabans, 21, 37
D-Arabinose, 5, 21
L-Arabinose, 6
 absorption of, 279
 urinary, 535
 Arachidic acid, 66
 Arachidonic acid, 67, 70, 455
 nutritive value of, 70

- Aralen**, 643
Arbutin, 43
Arginase, 226
 occurrence of, 491
 urea production by, 489
Arginine, 98
 color reaction of, 127
 metabolism of, 503
 need of, in testis, 483
 production of, 491
 putrefaction of, 272
 requirement for, 481
 transamination of, 484
 use of, in creative production, 506
Argon, 331
Ariboflavinosis, 155, 160, 174
Arrhenius equation, 234
Arsenicals, 644
Arsphenamine, 644
Ascheim-Zondek test, 623
Ascorbic acid, 155, 156, 161, 187-191, 588
 in brain, 577
 content of, in foods, 189
 in cortex, 601
 recommended dietary allowance of, 546
 requirements for, 188
 storage of, 190
 use of, in healing, 190
Ascorbic acid oxidase, 190
Ascorbigen, 188
Asparaginase, 505
Asparagine, ammonia from, 353
 function of, 496
Aspartic acid, 98
 dissociation of, 110
 metabolism of, 495
 transamination of, 485
Aspergillus acid, 650, 651
Asthma, relief of, 600
Asymmetric C atom, 3
Atabrine, 642
Atheromatosis, 552, 553
ATP (*see* Adenosine triphosphate)
ATPase, 419
Aureomycin, 659
Autocatalysis, 246
Autointoxication, 284
Autolysis, 249, 515-516, 579
Auxins, plant, 635
Avena coleoptiles, 636
Avidin, 182
Avitaminosis, definition of, 153
Avocado pear, 21
Axerophthol, 156
Axolotl, effect of thyroid on, 596
- B**
- Bacitracin**, 659
Bacteriophage, 151
 shape of, 135
Bacteriostatic effect, 642
Balanced diet, 551-552
Barbaloin, 21
Barbital, 515
Barfoed's test, 14
Basal metabolic rate (BMR), definition of, 399
 in goiter, 59
 measurement of, 399
Basal metabolism, 399
 factors affecting, 400-407
Batyl alcohol, 72
Bee moth, 374
Beef, riboflavin content of, 173
Beef tallow, 79
Behenic acid, 66
Bence-Jones protein, 538
 molecular weight of, 133
Benedict's reaction for uric acid, 530
Benedict's test, 14
Benzestrol, 610
Benzidine test, 325
Benzoates, 288
Benzoic acid, 272, 285
Benzyl alcohol, 123
Bergmann's hypothesis, 139
Beriberi, 155, 160
 cure of, 153
 symptoms of, 171
Betaine, 580
 use of, for fatty liver, 457
Bicarbonate, buffering by, 339
 glycogen from, 421
Bile, 266-271
 amount of, 267
 composition of, 267
 flow of, 269
 functions of, 270
Bile compounds, urinary, 538
Bile pigments, 269, 522
Bile salts, 266, 267
 effect of, on enzymes, 247
 hemolysis by, 305
Biliary calculi, 270
Bilirubin, 269
Biliverdin, 269
Bioassay methods, 169
Biocatalyst, 221
Bio-oxidation, enzymes for, 362, 364, 365
 summary of, 384-385
Biotin, 157, 164, 181-183
 absorption of, 282
 action of, 182
 determination of, 182
Biuret, 525
Biuret test, 125
Blackman reaction, 59
Black-out, 351
Black's test, 536
Black-tongue disease, 162, 175
Blood, buffers of, 338-344
 characteristics of, 291
 coagulation of, 296-302
 composition of, 327
 detection of, 325
 functions of, 291

- Blood, inorganic constituents of, 293**
 osmotic pressure of, 292
 structure of, 291
Blood analysis, diagnostic, 325, 326
 uses of, 414
Blood-clearance values, 540
Blood grouping, 323
Blood pH, 344, 345
Blood pressure, effect of, on kidneys, 520
Blood proteins, buffering by, 339
Blood-sugar level, regulation of, 426-428
 scheme of, 436
Bloor's theory, 448
BMR (see Basal metabolic rate)
Body temperature, regulation of, 407
Bomb calorimeter, 387
Bone, chemistry of, 584-586
Bone growth, 619
Bone marrow, phospholipids of, 453
Bordet test, 325
Borneol, excretion of, 530
Boron, effect of, 574
Bowlegs, 201
Bowman capsule, 519
Bradycardia, 160, 170
Brain, chemistry of, 575
 glycogen of, 420
 metabolism in, 411, 576-577
 phospholipids of, 453
Brassicasterol, 92
Broccoli, calcium of, 554
Bromelin, 481
Bromophenol, excretion of, 530
Buffers, blood, 338-344
 CO₂-carrying power of, 343
Buffy coat, 292
Bush sickness, 558
Butter, fatty acids of, 73
Butterfat, 79
 energy value of, 389
- C**
- Cabbage, calcium of, 554**
Cadaverine, 272
Calciferol, 92, 164, 202
 estrogenic effect of, 609
 structure of, 203
Calcification of teeth, 587
Calcium, blood, regulation of, 628
 in bone, 585
 recommended dietary allowance of, 546
 requirements for, 553, 554, 556
 in teeth, 586
Calcium intake, optimal, 554
Calcium phosphate, bone, 554
Calomel electrode, 358
Caloric requirements, 410-411
Calorie values of foods, 390
Calories, definition of, 387, 388
 recommended dietary allowance of, 546
Calorimeter, animal, 391
 bomb, 388
 Calorimetry, indirect, 396-399
Camphor, excretion of, 530
Canavanine, 99
Caprine, 100
Caproic acid, oxidation of, 460
Carbamino compound, 315, 335
Carbomethoxy group, 123
Carbohydrases, intestinal, 265
 reversibility of, 244
Carbohydrate, effect of, on ketosis, 463
 energy value of, 388
 fat formation from, 444-445
 fermentation of, 443
 overconsumption of, 548
Carbohydrate metabolism, hormones affecting, 430-435
Carbohydrate synthesis, 61
Carbohydrates, absorption of, 278
 definition of, 1
 hydrolysis of, 2
 interconversion of, 416
Carbon dioxide, transport of, 335-337
Carbon-tetrachloride poisoning, 456
Carbonate in teeth, 586
Carbonic anhydrase, 222, 226, 337, 364
 gastric, 258
Carbonylhemoglobin, 311, 314
Carboxylase, 171, 222, 226, 364, 444
 coenzyme of, 161
 oxalacetic, 382
Carboxylases, 377
Carboxypeptidase, 264
Carboxypolypeptidase, 516
Carcinoma, 537
Carnaubyl alcohol, 582
Carnine, 148
Carnitine, 580
Carnosine, 579, 580
L-Carnosine, 504
Carotene, 194
 structure of, 51-52
Carotenoids, 47, 62
Carr-Price reaction, 196
Carrageenin, 36
Carrots, riboflavin content of, 173
Cartilage, chemistry of, 583, 584
Casein, 106, 118, 125
 molecular weight of, 133
 osmotic pressure of, 131
 phosphorus of, 554
Castor oil, 79
Castration, effect of, on obesity, 451
Castration cells, pituitary, 616
Catalase, 226, 233, 375, 376
 turnover number of, 244
Catalases, 364
Catalysts, 220
 enzymes as, 237-238
Cataracts, 160, 500
Catechol, 364
Cathepsin, 481, 516
Cathepsins, 249, 475
Cauliflower, calcium of, 554

- Cellobiose, 22, 23
Cells of Leydig, 613, 621
Cellular enzymes, preparation of, 414
Cellulose, 31-33
 structure of, 32
 utilization of, 271
Cementum, 586
Cephalin, 301
 nonlipotropic, 457
Cephalins, 82
 definition of, 64
 distribution of, 453, 454
Cereal foods, nutritive values of, 566
Cerebron, 85
Cerebronic acid, 67, 85
Cerebrosides, 85
 definition of, 65
 metabolism of, 469
Ceryl alcohol, 582
Cevetamic acid, 156
Chaetomin, 651
Chalones, 591
Chastek paralysis, 182
Chaulmoogra oil, 79
Chaulmoogric acid, 68
Cheese, riboflavin content of, 173
Cheilosis, 160, 173
Chemotherapy, definition of, 642
 nature of, 239
Chicks, amino acid needs of, 482
 growth of, 108
Children, basal metabolism of, 404
Chimyl alcohol, 72
Chinovin, 21
Chitin, 21
Chloral hydrate, excretion of, 530
Chloride shift, 342, 348
Chlorides, urinary, 533
Chloromycetin, 659
Chlorophyll, 47
 forms of, 62
 properties of, 47-48
 spectra of, 50
 structure of, 48-49
Chloroplasts, 47
Chloroquin, 643
Cholecystokinin, 270, 632
Cholestanol, 90, 274
Cholesterol, 86, 281
 blood, 447, 448
 conversion of, to progesterone, 612
 in cortex, 601
 crystals of, 91
 dietary, 552, 553
 distribution of, 471
 metabolism of, 470-471
 structure of, 89
 synthesis of, 470
Cholesterol accumulation, 456
Cholesterol esterase, 264
Cholic acid, 268
Choline, 80, 81, 158, 162, 180, 274
 use of, for fatty liver, 456, 457
Choline acetylase, 469, 509
Choline esterase, 469, 509
Choline metabolism, 468
Choline oxidase, 468
Cholinergic, 600
Chondrodystrophia, 560
Chondroitin, 158
Chondroitin sulfuric acid, 583, 584
Chondromucoid, 583
Chromaffin structures, 598
Chromoproteins, 120
Chromosomes, nucleic acid in, 149
Chyle, 278
Chylomicrons, 293, 448
Chyme, 261
Chymosin, 259
Chymotrypsin, 264
 crystalline, 222, 223
Chymotrypsinogen, 246
Cinchol, 92
Cirrhosis of liver, 457
Citric acid, glycogen from, 421
Citric acid cycle, 380
Citrin, 191
Citrinin, 650-651
Citrogenase, 382, 464
Citrulline, in urea cycle, 489
Clavacin, 650, 651
Clotting, blood, 296-302
 theory of, 297
Clupanodonic acid, 67
Clupein, 119
CO₂ deficit, 349
CO₂ excess, 349
CO₂ tension, 57
Coagulated proteins, 121
Coagulation, blood, 296-302
 (See also Blood)
Cobalt, 317
 presence of, in B₁₂, 214
 requirements for, 557
 use of, in anemia, 303
Cobione, 214
Coccarboxylase, 171, 377
Cod-liver oil, 79
Coenzyme, 362
 definition of, 247
Coenzyme I, 364, 366, 441
Coenzyme II, 364
Coenzyme A, 180, 469
Coenzyme R., 165, 181
Coenzymes, 176, 247
Coenzymes I and II, 163
CO-hemoglobin, 315
Coleoptile, 636
Coleoptile test, 637
Collagen, 582-583
 synthesis of, 190
 in teeth, 586
Colloid osmotic pressure, 296
Color index, blood, 308
Colostrum, 564, 565
Coma of acidosis, 347

- Complement**, 321
Compound E, 603
Compound proteins, 120
Coniferin, 43
Coniferol, 43
Conjugation, detoxication by, 286, 287
Connective tissues, chemistry of, 582-583
Convolvulin, 21
Copper, recommended dietary allowance of, 546
 requirements for, 556
 use of, in anemia, 303
Coprosterol, 91, 274
Corn oil, 79
Corpus luteum, 591, 606
Corticosterone, 603
Cottonseed oil, 79
Coumarin, 299
Cozymase, 367
Creatine, 417, 418, 508, 579
 excretion of, 205
 metabolism of, 505-507
 properties of, 527-528
 synthesis of, 163
Creatinine, energy value of, 389
 metabolism of, 505-507
 properties of, 527-528
Creatinine coefficient, 528
Creatinine-zinc chloride, 527
Creatinuria, 507, 528
Crenated corpuscles, 307
Cresol, 273
Cretinism, 597
Crop gland, pigeon, 618
Crotonic acid, 67
Cryoscopic method, 132, 292
Cryptorchidism, 614
Curled toe, 160
Cyanhydrin synthesis, 4
Cyanides, effect of, on oxidation, 371
Cyanosis, 351
Cyanuric acid, 525
Cyclol arrangement, 138
Cystathionine, 508
 production of, 501
Cysteine, 383
 detoxication by, 288
 functions of, 502
 metabolism of, 500-502
Cystine, 98, 107, 124, 568, 274
 ACTH content of, 617
 amount of, in ICSH, 622
 functions of, 502
 insulin content of, 625
 metabolism of, 500-502
 specific rotation of, 104
 in thyroglobin, 593
 in trophins, 624
Cystinuria, 501, 502
Cytidylic acid, 145
Cytochemistry, 572
Cytochrome, 226
Cytochrome-c reductase, 371
Cytochrome oxidase, 437
Cytochrome oxidases, 364
Cytochromes, 364
 absorption bands of, 373
 function of, 372, 373
Cytolysins, 308, 321
Cytopenia, 185
Cytosine, metabolism of, 514
 structure of, 145
Cytosine riboside, 147
Cytotoxins, 308
Cytozyme, 301
- D**
- Dachshunds, giant**, 619
Dalmatian hound, 511
Dark reaction, 59, 62
Deaminase, 419
 adenosine, 512
Deamination, 486-488
 enzymes for, 488
 purine, 147
 reversibility of, 487, 488
Deaminations, bacterial, 272
Decarboxylase, oxalosuccinic, 382
 oxidative, 382
Decarboxylation, oxidative, 378
 use of biotin in, 182
Decarboxylations, 272
Defibrinated blood, 293
Dehydroandosterone, 612
Dehydroascorbic acid, 164
Dehydrocholesterol, 92
7-Dehydrocholesterol, 90
 as provitamin, 471
Dehydrocorticosterone, effect of, on sugar metabo-
lism, 431
Dehydrodoisynolic acid, 610
Dehydrogenase, 235
 glutamic, 382
 isocitric, 382
 lactic acid, 380
 malic, 382
 succinic, 382
Dehydrogenases, 176, 364, 368, 369
 cytochrome-reducing, 376
Dental caries, 253-254
Dentin, 586
Dentition, requirements for, 588
Derived proteins, 121
Dermatitis, 160, 162
Desaturation of fatty acids, 455
Desoxycorticosterone, 603, 604
Desoxy-D-ribofuranose, 143
Desoxyribose, 18, 141, 416
Desoxy-D-ribose, 21
Desoxyribosides, 147
Desoxysugars, 18
Desquamation, 181
Desthiobiotin, 165
Detoxication, 283-289
 oxidative, 284
 by reduction, 285

- Deuterium, in fatty acids, 450
use of, 415
- Dextran, synthesis of, 424
- Diabetes, 349, 431-433
acidosis in, 346
effect of ACTH on, 617
experimental, 626
pituitary, 433
- Diabetes insipidus, 521, 633
- Diabetogenic hormone, 430, 433
- Dial, 515
- Dialuric acid, 145
diabetes caused by, 627
- Dialysis, 117
- Diapedesis, 319
- Diaphorase, 367
- Diastase, 424
- Dibromotyrosine, 99
- Dicoumarol, 300
- Diet, adequate, 544-548
effect of, on metabolism, 404
inadequate, 545, 548
Indian, 556
sample daily allowance for, 547
- Dietary standards, 545, 546
- Diethylstilbestrol, 609
- Digitalis, 42
- Digitalose, 21
- Digitogenin, 43
- Digitonin, 43
- Digitoxin, 43
- Digitoxose, 21
- Digoxin, 43
- Dihydrocholesterol, 90
- Dihydrocortrone, 608
- Dihydroxyacetone, 1, 21
- Dihydroxyphenylalanine, 99
- Diiodotyrosine, in thyroglobulin, 593
- Diketopiperazine ring, 102, 121
- Dipeptidase, 516
- Dipeptidases, 265
- Dipeptide, 124
- Diphosphopyridine nucleotide, 441
- Direct calorimetry, 391
- Disaccharides, 20, 22-25
- Disease, effect of, on metabolism, 405
- Dissociation constant, 340
- Diuretics, 520
- Djenkolic acid, 99
- D: N ratio, 492
- Dopa, 99, 499
- Drying oils, 78
- Dysmenorrhea, therapy of, 610
- Dyspnea, 351
- Dystrophy, muscular, 205
- E
- Eclampsia, 349
- Edema, 597
serum proteins in, 296
- Edestin, 106, 125
molecular weight of, 133
preparation of, 118
- Eggs, riboflavin content of, 173
- Egg-white injury, 182
- Egg yolk, phospholipids of, 453
- E_a* scale, 358, 359
- E_c*, definition of, 359
- Elaeostearic acid, 67
- Elaidic acid, 69, 450
- Elastin, 582-583
- Electrodialysis, 117
- Electron acceptor, 356
- Electron microscope, 135
- Electron pressure, 357
- Electrophoresis, 115
- Element constant, 472
- Emmetin, 608
- Emotional glucosuria, 535
- Emphysema, 349
- Emulsions, 74
- Enamel, hardness of, 559
- Endocarditis, 645
- Endocrines, 591
- Endocrinology, definition of, 591
- Endometrium, 606
- Energy, expenditure of, during activity, 410
from photosynthesis, 46
- Enterocinin, 633
- Enterogastrone, 632
- Enterokinase, 263
- Enzyme, effect of concentration of, 229
sulfur-containing groups of, 237
- Enzyme action, 230
kinetics of, 238-244
- Enzyme blocking, 239, 647
- Enzymes, activation of, 246-247
adjuvants of, 247
cellular, 248, 249
classification of, 221
copper-protein, 364
crystalline, 225
definition of, 220
effects on, of oxidation and reduction, 236
of light, 237
flavoprotein, 364
iron-porphyrin-protein, 364
metal-containing, 226
naming of, 221
optimal pH for, 231-233
pancreatic, 263, 264
practical applications of, 250
properties of, 222
purification of, 222
pyridinoprotein, 364
reversibility of, 244-246
specificity of, 226-227
temperature characteristics of, 234-236
thiaminoprotein, 364
types of, 221
- Epicoprosterol, 87
- Epinephrine, 598-600
action of, 599
effect of, on blood sugar, 428
origin and fate of, 599
structure of, 598

- Epinephrine**, value of, 600
Epithelial tissue, chemistry of, 580-582
Equilenin, 87, 608
Equilibria, 347
Equilin, 608
Erepsin, 264
Ergosterol, 91-92, 201, 202, 281
 estrogenic effect of, 609
Ergothioneine, 504
Errors of metabolism, inborn, 497
Erucic acid, 67
Erysipelas, 645
Erythroblastosis fetalis, 324
Erythrocyte, molecular weight of, 133
Erythrocytes, 302-315
 buffering by, 342
 composition of, 305
 destruction of, 304
 production of, 302
n-Erythrose, 5
Eserine, 469
Eskimo, diet of, 465
Estradiol, 87, 608
 α -Estradiol, 610
 β -Estradiol, 610
Estrane, 608
Estriol, 608
Estrogens, 606-611
 metabolism of, 610
 urinary, 611
Estrone, 87, 608
 potency of, 606
Ethanol, 444
Ethanolamine, 82
Ethereal sulfates, excretion of, 532
 origin of, 531
 urinary, 286
Euglobulin, 294
Eukeratin, 575
Excelsin, molecular weight of, 133
Excretion, organs of, 519
Exophthalmos, 597
Extractives of muscle, 579
Extrinsic factor, 316
- F**
- Factor S**, 212
Factor T, 211
Factor U, 183
Fasting, effect of, on metabolism, 406
Fat deposits, 449
Fat metabolism, effect of hormones on, 458
 role of liver in, 454-459
 vitamin effects on, 466
Fat-metabolizing hormone, 433
Fats, absorption of, 279, 280, 447
 definition of, 64
 deposition of, 450
 energy value of, 388
 oxidation of, 471-472
 production of, 444-445
 RQ for, 395
 storage of, 449
 synthesis of, 63
Fatty acids, 65-68
 blood, 447-448
 boiling points of, 68
 of human fat, 449
 indispensable, 70, 451
 phosphorylation of, 464
 synthesis of, 445
Fatty alcohols, 65, 71
Fatty aldehydes, 71
Fatty livers, 455-456
 types of, 456
Feces, 274
Fehling's test, 14
Female hormones, 605
Fermentability of sugars, 27
Fermentation, alcoholic, 444
 intestinal, 271
Ferments, unorganized, 220
Ferritin, 304
Fibrin, 293, 297
Fibrin foam, 302
Fibrinogen, 293, 297
 synthesis of, 296
Fibroin, 106
Fish-liver oils, vitamin-A content of, 197
 vitamin-D content of, 202
Flavianic acid, 113
Flavins, 172
Flavonones, 191
Flavoprotein enzymes, 367, 371
Flavoproteins, 364
Flour, enriched, 567
 definition of, 568
 whole wheat, 567
Fluorapatite, 585
Fluorine, 585
 requirements for, 559
Fluorosis, 559
Folic acid group, 183-186
Folin and Looney test, 127
Folin method, 425
 for creatinine, 527
Folin reaction, of uric acid, 529
Follicle-stimulating hormone (FSH), 606
 (See also FSH)
Follicular tissue, 591
Food analysis, methods of, 542-543
Foods, caloric value of, 390
 composition of, 543-544
 mineral content of, 555
 protective, 542
Formaldehyde theory of Baeyer, 54-55
Formhydroxamic acid, 63
Formol titration, 102
Formyloxaluric acid, 515
Fragility test, 307
Free-radical theory, 370
Friedman's test, 623
Frohlich syndrome, 620
Fructofuranose, 11
Fructopyranose, 11

- Fructose, 21
 absorption of, 279
 use of, in brain, 576
- Fructose diphosphate, 439
- Fructose-6-phosphate, 438
- Fructosuria, 535
- Fruits, vitamin-A content of, 197
- FSH, 606, 621, 622
- Fucosan, 21
- Fucose, 21
- Fucosterol, 92
- Fumarase, 222, 382
- Fumigatin, 650, 651
- Furan, 10
- G
- Galactans, 21
- Galactogen, 35
- Galactolipids, 85, 576
 brain content of, 575
 definition of, 65
 functions of, 469
- Galactolipins, 21
- D-Galactosamine, 19
- Galactose, 21, 85
 absorption of, 279
 synthesis of, 416
- D-Galactose, 5
- Galleria mellonella*, 374
- Gallstones, 270
- Gangliosides, 85
- Gases, blood, 331-333
 intestinal, 271
- Gastric analysis, 260-261
- Gastric digestion, 255-261
- Gastric fistula, 255-256
- Gastric juice, artificial, 256
 composition of, 257
- Gastric proteolysis, 258
- Gastrin, 260, 632
- Geiger-Müller counter, 415
- Gelatin, 106, 114, 125
 formation of, 582
 molecular weight of, 133
- Gentianose, 26
- Gentiobiose, 23
- Gerhardt's test, 536
- Giants, experimental, 619
- Gingival tissues, 588
- Glands, endocrine, 591
 epinephral, 598
 gastric, 255
 intestinal, 265
 salivary, 252
- Glandular tissues, nucleoproteins of, 142
- Glialin, 106, 114, 118, 125
- Glilotoxin, 650, 651
- Globin, 309
 hydrolysis of, 312
- Globulin X, 578
- Globulins, 106, 120, 122
- Glomerulus, 519
- Glucocorticoids, 604
- Glucofuranose, 11
- Gluconeogenesis, 436
 from amino acids, 492
 definition of, 421
- Gluconic acid, 16
 formation of, 443
- D-Gluconolactone, 17
- α -D-Glucofuranose-1-phosphate, 422, 437
- Glucopyranose, 11
- Glucosamine, 19, 21
- D-Glucosamine in thyroglobulin, 593
- Glucosazone, 15
- Glucose, 21
 absorption of, 279
 determination of, 425
 energy value of, 389
 importance of, in brain, 576
 phosphorylation of, in kidney, 428
 RQ for, 395
- D-Glucose, 5
- Glucose-1-6-diphosphate, 438
- Glucose oxidase, 380
- Glucose-6-phosphate, 438
- Glucose-tolerance tests, 429
- β -Glucosidase, 233
- Glucosidases, 227
- Glucosuria, 428, 436, 534-536
- Glucuronates, urinary, 530
- Glucuronic acid, 17
 formation of, 443
- Glucuronic acid conjugation, 287
- Glutamic acid, 98, 383
 from histidine, 503
 metabolism of, 495
 transamination of, 485
- Glutaminase, 505
- Glutamine, ammonia from, 353
 function of, 496
 origin of, 495
- Glutathione, 289, 383
 production of, 501
- Glutelins, 120, 122
- Glutenin, 106
- Glyceric aldehyde, 1
- Glycerol, 72
 metabolism of, 459
- Glycerophosphoric acid, 467
- Glycerose, 2
- D-Glycerose, 5, 21
- L-Glycerose, 6
- α -Glycerolphosphorylcholine, 467
- Glycine, 97, 268, 383
 amount of, produced in body, 483
 detoxication by, 287
 dissociation of, 109
 metabolism of, 494
 titration curve of, 112
 use of, in creative production, 506
- Glycine oxidase, 488
- Glycocholic acid, 267
- Glycocoll, 97
- Glycoxyamine, 506, 508

- Glycogen**, 34-35
 in adipose tissue, 450
 brain, 576
 determination of, 425
 energy value of, 389
 function of, 420
 of muscle, 579
Glycogen formers, 420
Glycogenase, 424
Glycogenesis, 420-421, 436
 enzymes in, 422
Glycogenolysis, 436
 definition of, 424
Glycol, 468
Glycollic aldehyde, 3
Glycolysis, 435, 437-443
 definition of, 425
 energy liberation in, 442
Glycoproteins, 120
 gonadotrophins as, 621
Glycosides, 42-43
Glycosuria, 534-536
Glycyl-alanine, 123
Glyoxylic acid test, 126
Gmelin's test, 269, 538
G:N ratio, 492
Goiter, common, 596
 exophthalmic, 597
 incidence of, 558
Gonadotrophins, 620-624
 chorionic-type, 623
 urinary, 622, 624, 635
Gonorrhea, treatment of, 645
Gout, 529
 cause of, 511
Gramicidin, 648, 649
 action of, 649
Gramicidin S, 650
Gram-positive, definition of, 648
Grana, 47
Granulocytes, 318
Grass-juice factor, 211
Graves' disease, 597
Growth, relation of protein to, 551
Growth hormone, 619-620
Guaiac test, 325
Guanase, 147, 512
Guanine, 512
 metabolism of, 510
 structure of, 144
Guanosine, 147, 512
Guanylic acid, 145, 146, 512
D-Gulose, 5
Gum arabic, 36
- H**
- Hagedorn-Jensen method**, 425
Hair, cystine from, 502
 sulfur of, 581
Haptens, 323
Hard water, 73
Harden-Young ester, 439
HCl, origin of, 257-258
Heart, anaerobic process in, 443
Heart failure in vitamin-E deficiency, 207
Heat of combustion, 387
Helium, 331
Helvolic acid, 651
Hematin, 309
Heme, 49, 309
Hemicelluloses, 36
Hemin, 309
Hemin test, 325
Hemocyanin, 333
 molecular weight of, 133
Hemoglobin, 125, 308-315
 buffering by, 239, 240, 242, 243
 crystallization of, 311, 312
 derivatives of, 311
 function of, 313-315
 molecular weight of, 131
 spectra of, 312, 313
 urinary, 538
Hemoglobinuria, 308
Hemolysis, 307, 308, 321
Hemolysis, 82, 305, 308
 causes of, 305, 306
Hemophilia, 302
Hemopoiesis, 185, 213, 302, 316, 317
Hemopoietin, 317
Hemorrhagic kidney, 162
Henderson-Hasselbach equation, 340
Heparin, 300
Hepatectomy, 491
Hepatoflavin, 156, 172
Hesperidin, 191
Hexokinase, 423, 437
 inhibition of, 434
Hexosamine, amount of, in ICSH, 622
Hexoses, glycogen from, 420
Hexostrol, 609
Hexuronic acid, 156, 187
Hibernation, RQ during, 396
High-energy phosphate bond, 417
Hippuric acid, 287
 amount produced in body, 483
Hirudin, 300
Histamine, 274, 322
 as gastric stimulant, 260
Histidase, 503, 504
Histidine, 98
 disassociation of, 110
 in globin, 310
 metabolism of, 503-504
 purines from, 510
 transamination of, 484
L-Histidine, specific rotation of, 104
Histinuria, 504
Histochemistry, 572
Histone-insulin zinc, 627
Histones, 120, 122
Hock disease, 211
Homeostasis, 249, 338
Homocystine, 99, 163
 metabolism of, 500-502

- Homocysteine, 508
 Homogentisic acid, 497
 Hormonal interrelations, 607
 Hormone, 262
 (See also Hormones, Pancreozymin)
 Hormone chemistry, progress in, 638
 Hormones, adrenocorticotrophic, 616-617
 cortical, 602, 604
 definition of, 591
 estrogenic, 605
 follicle-stimulating, 622
 gametogenic, 624
 gonadotrophic, 620-624
 interstitial-cell-stimulating (ICSH), 621
 ketogenic, 625
 lactogenic, 617
 metabolizing, 625
 neurohypophyseal, 633-634
 ovarian, 606
 parathyroid, 628-630
 plant, 635-638
 protein, 614
 thyrotrophic, 616
 trophic, 615-622
 Horn, sulfur of, 581
 Horseradish, 42
 Human fat, 79
 Human milk, substitutes for, 565
 Humin nitrogen, 124
 Hydnicarpic acid, 68
 Hydrogen acceptor, 355, 356
 Hydrogenation, 76
 Hydrolysis, agents of, 2
 Hydroquinone, 43
p-Hydroxybenzoic acid, detoxication of, 288
 β -Hydroxybutyric acid, 431
 acidosis from, 353
 production of, 462
 significance of, 537
 urinary, 536, 537
 Hydroxyglutamic acid, 98
 Hydroxylysine, 98
p-Hydroxyphenylpyruvic acid, 497
 Hydroxyproline, 96, 98
 metabolism of, 495
 Hydroxystearic acid, 84
 Hydroxyvaline, 100
 Hypercholesterolemia, 552
 Hyperglycemia, definition of, 427
 Hyperglycemic index, 430
 Hyperinsulinism, effect of, on obesity, 451
 Hyperpnea, 349
 Hypertensin, 630
 Hypertensinase, 631
 Hypertensinogen, 630, 631
 Hyperthyroidism, 596
 Hypertonic, 307
 Hypervitaminosis, 215, 216
 Hypnotics, 515
 Hypoglycemia, definition of, 427
 Hypoglycemic shock, 427, 433
 α -Hypophamine, 634
 β -Hypophamine, 634
 Hypophysectomy, effect of, on sugar metabolism, 433
 Hypophysis, 591, 614-622
 (See also Pituitary)
 Hypothyroid, effect of, on obesity, 451
 Hypothyroidism, 596
 Hypotonic, 307
 Hypoxanthine, 512, 579
 structure of, 144
- I
- ICSH, definition of, 621
 (See also Hormones)
n-Idose, 5
 Immune substances, 320
 Immunological polysaccharides, 40-42
 Indican, 286
 amount of, in urine, 531
 Indicanuria, occurrence of, 532
 Indigo blue, 531
 Indirect calorimetry, 391
 Indole, 273, 286
 Indoleacetic acid, action of, in plants, 636
 Indoleethylamine, 273
 Indolepyruvic acid, 499
 Indophenol oxidase, 374
 Indoxyl, 286
 Infantile tetany, 629
 Infantilism, 620
 Inorganic constituents, distribution of, 573-574
 Inosine, 148, 512
 Inosinic acid, 148, 419, 512, 579
 Inosite, 82
 Inositol, 82, 155, 164, 180
 glucose from, 421
 muscle content of, 580
 Insulin, 106, 625-626
 action of, 430
 in muscle, 422
 crystalline, 432
 function of, 434
 molecular weight of, 133
 physiological action of, 433-435
 production of, 628
 Insulin shock, 427
 symptoms of, 576
 Intermedin, 634
 International unit, thiamine, 167
 Interstitial tissues, 591
 Intestinal fermentation, 271-274
 Intestinal mucosa, 265-266
 Intrinsic factor, 316
 Inulin, 35
 Iodine, recommended dietary allowance of, 546
 requirements for, 558, 594
 Iodine number, 77
 Iodoacetate effect, 439, 444
 Iodogorgic acid, 97
 Iodothyroglobulin, 592
 Ion exchange, 342
 Iron, in porphins, 310
 recommended dietary allowance of, 546

- Iron, requirements for, 556**
 storage and transport of, 304
 use of, in anemia, 303
Islands of Langerhans, 432
Isoalloxazine-adenine-dinucleotide, 367, 370
Isobarbituric acid, 515
Isoelectric precipitation, 117
Isohydric change, 343
Isolactose, 24
Isoleucine, 97
 metabolism of, 494
L-Isoleucine, human requirement for, 482
Isomaltose, 24
Isorhamnose, 21
Isosmotic solution, 307
Isotetic substances, 192
- J**
- Jaffe's test, 527, 531**
Jalopin, 21
Japanese acid, 67
Jaundice, 538
 hemorrhagic, 166
 obstructive, 299
Jolle's test, 531
- K**
- Kale, calcium of, 554**
Keratin, 106
 preparations of, 581
 X-ray pictures of, 136
Keratinization, 160
 β -Ketobutyric acid, 460
Ketogenesis, 462-466
 endocrine effects upon, 465
Ketogenic-antiketogenic ratios, 465
Ketogenic hormone, 430, 433
 α -Ketoglutaric acid, production of, 380
Ketoneuria, 431, 433, 462, 464, 537
Ketone substances, 431
 urinary, 534
Ketoneuria, 431, 433, 462, 464, 523, 536, 537
Ketosis, 349, 463, 464
 effect of work on, 471
Ketosis threshold, 465
17-Ketosteroids, urinary, 614
L-Ketoxylase, 536
Kidney, phospholipids of, 453
 production of arginine in, 490
Kidney-efficiency tests, 538-540
Kidney threshold, 428
Kjeldahl method, 542
Knock-knees, 201
Knopp's theory, 459-462
Koagulations factor, 157
Koagulations vitamin, 208
Krypton, 331
Kynurenic acid, 499, 500
Kynurenine, 499, 500
- L**
- Laccase, 226, 364**
Lactalbumin, molecular weight of, 133
Lactase, 233, 240, 279
 intestinal, 265
Lactation vitamins, 157
Lacteals, 277
Lactescence, 448
Lactic acid, 366
 determination of, 425
 glycogen from, 421
 production of, 440-442
Lactic acid cycle, 426
Lactic dehydrogenase, 441
***Lactobacillus casei* factor, 183**
***Lactobacillus lactis* Dorner (LLD) units, 214**
Lactoflavin, 156
Lactoglobulin, molecular weight of, 133
Lactone, 16
Lactose, 20, 22
 uses of, 416
Lactosuria, 535
Laking, 305
Lanolin, 582
Lanosterol, 93, 582
Lanthionine, 99
Lard, 79
Lauric acid, 66
Lead poisoning in bones, 585
Lecithin, 274
Lecithinase, 264
Lecithinase A, 467
Lecithinase B, 467
Lecithins, 80-82
 definition of, 64
 distribution of, 453, 454
Lecithoproteins, 120
Leech, 300
Legal's test, 536
Legumes, nutritive values of, 565
Lettuce, calcium of, 554
Leucine, 97
 metabolism of, 494
L-Leucine, human requirement for, 482
Leucocytes, 318-319
Leucotaxin, 319
Leucyl-glycine, hydrolysis of, 228
Levan, synthesis of, 424
Leydig cells, 621
LH (see Luteinizing hormone)
Liebermann-Burchard test, 90
Liebermann reaction, 126
Light intensity, 57
Lignin, 39
Lignoceric acid, 66, 84
Line test, 199
Linoleic acid, 67, 69, 455
 action of, on fatty livers, 466
 nutritive value of, 70
Linseed oil, 79
Lipase, 233, 235
 gastric, 257, 259-260

- Lipases, reversibility of, 244, 245
 Lipemia, 448
 fasting, 471
 Lipids, blood, 447, 448
 classification of, 64
 definition of, 64
 uses of, 472
 Lipocaic, use of, for fatty liver, 456, 457
 Lipocaic effect, 458-459
 Lipocorticoids, 604
 Lipoproteins, 121
 Lipositol, 83
 Lipotropic effect, 457
 Liver, phospholipids of, 453
 production of acetoacetic acid in, 464
 riboflavin content of, 173
 synthesis in, 480
 Liver threshold, 434
 LLD units, 214
 Lock-and-key theory, 227
 Long's formula, 524
 Luminal, 515
 Lumisterol, 202
 Lupeose, 26
 Lutein, 52
 Luteinizing hormone (LH), 606
 definition of, 621
 Lymph, 326, 328
 Lymphocytes, 318
 Lyoenzymes, 220
 Lysine, 98, 483
 metabolism of, 502-503
 putrefaction of, 272
 requirement for, 304
 not transaminated, 484
 L-Lysine, human requirement for, 482
 Lysolecithin, 467
 Lysolecithins, 81
 D-Lyxose, 5
- M**
- Macrophages, 320
 Magnesium, in bone, 585
 requirements for, 556
 in teeth, 586
 Male, lactation in, 618
 Maltase, 233, 279
 intestinal, 265
 salivary, 255
 Maltose, 22
 Mammary glands, development of, 611
 Mammotrophin, 617
 Mandelonitrile, 43
 Manganese, requirements for, 560
 D-Mannitol, 7
 Mannoketohexose, 21
 Mannosans, 21, 37
 Mannose, 21
 absorption of, 279
 amount of, in ICSH, 622
 Mannotetrose, 26
 Masculinisation, 614
 Master gland, 615
 Meat extractives, 417
 Meats, vitamin-A content of, 197
 Melanin, 499
 in hair, 581
 Melanosarcomas, 499
 Melezitose, 26
 Melibiose, 23
 Melissic acid, 66
 Melitose, 25
 Melliturias, 534-536
 Men, amino acids required by, 482
 Mental activity, energy for, 411
 Menthol, excretion of, 530
 Mercapturic acid, 288
 Mercurials, 644
 Mesenteric veins, 277
 Mesoinositol, 164
 Metabolism, errors of, 497
 inborn errors of, 501
 Metallic ions, effect of, on enzymes, 247
 Metals, enzymes containing, 226
 excretion of, 271
 Metamorphosis, influence of thyroid on, 596
 Metaprotein, 128
 Metaproteins, 121
 Methemoglobin, 311, 314
 Methionine, 98, 107, 508
 functions of, 502
 lipotropic action of, 457, 458
 metabolism of, 500-502
 in thyroglobulin, 593
 use of, for fatty liver, 456
 L-Methionine, human requirement for, 482
 Methyl cyanide, effect of, on goiter, 598
 Methyl glucosides, 9-10
 Methyl glyoxal, glycozen from, 421
 Methylamine, 273
 Methylated purines, excretion of, 524
 Michaelis constant, 242-244
 significance of, 242
 Michaelis equation, 242
 Microbiological assay methods, 113-114
 Milk, calcium of, 554
 composition of, 563
 food value of, 562-565
 riboflavin content of, 173
 vitamin-A content of, 197
 Milk inspection, 565
 Millon's test, 126
 Mineralocorticoids, 604
 Mineral elements in foods, 555
 Mixed glycerides, 72
 Molds, antibiotics from, 650
 Molisch reaction, 27
 Monoamino nitrogen, 125
 Mononucleotides, 145
 Monosaccharides, 2-20
 absorption of, 416
 occurrence of, 19-21
 oxidation of, 16
 reactions of, 13-16
 stereoisomerism among, 3-7
 subdivision of, 3

Mörner's test, 126, 383
 Morphine, excretion of, 530
 Morphotic protein, 476
 Motherhood, instincts of, 618
 Mottled enamel, 559
 Mucic acid, 17
 Mucic acid test, 28
 Mucin, 584
 Mucoïd, 583
 Muconic acid, 285
 Multiple-alternate-oxidation theory, 461
 Munson-Walker values, 535
 Murexide test, 529
 Muscarine, 274
 Muscle, chemistry of, 578-580
 glycogen of, 420
 glycogenesis in, 422
 phospholipids of, 453
 Muscle plasma, 579
 Muscle tonus, 528
 Muscular dystrophy, 166, 249
 Mustard, 42
 Mutarotation, 7-9
 theory of, 11
 Mutase effect, 379
 Mutton tallow, 79
 Myoalbumin, 578
 Myogen, 578
 Myogen A, 440
 Myoglobin, 578, 579
 molecular weight of, 133
 Myokinase, 419
 Myosin, 419, 420, 578
 Myristic acid, 66
 Myxedema, 597

N

Nails, sulfur of, 581
 Naphthoquinone, 193, 208
 α -Naphthol reaction, 27
 Narcoïsis, 349
 Nembutal, 515
 Neomycin, 658
 Neon, 331
 Neosalvarsan, 644
 Nephritis, 349
 Nerve, metabolism in, 577
 Nervon, 85
 Nervonic acid, 85
 Nervous tissue, phospholipids of, 454
 Neuberg ester, 438
 Neurine, 274
 Neurokeratin, 575
 Neutral sulfur, urinary, 532
 Niacin, 162, 175
 absorption of, 282
 recommended dietary allowance of, 546
 Niacinamide, 155, 175
 Nicotinamide, 149, 155, 159, 174-176
 Nicotinic acid, 155, 159, 174-176
 content of, in foods, 175
 detoxication of, 288

Night blindness, 160, 195
 Ninhydrin reaction, 126
 Nippe's test, 325
 Nitriles, 4
 Nitrobenzene, 286
 Nitrogen equilibrium, 476
 p -Nitrophenol, 286
 Nitrous-acid reaction, 101, 102
 NO-methemoglobin, 315
 Nonsaponifiable matter, 78
 Nonyl aldehyde, 69
 Nonylic acid, 69
 Norleucine, 100
 metabolism of, 494
 Norvaline, 100
 Notatin, 651
 Nucleases, intestinal, 265
 Nucleic acid, hydrolysis of, 143
 structure of, 148
 from viruses, 150
 Nucleic acids, properties of, 142
 types of, 141
 Nuclein, 141
 Nucleoproteins, 120
 metabolism of, 509-513
 properties of, 142
 Nucleosidase, 266
 purine, 512
 Nucleotidase, purine, 512
 Nucleotides, 145
 catabolism of, 511, 512
 Nutrition, simple rules of, 548
 Nylander-Almen test, 14
 Nylander's test, 527, 530

O

Oatmeal, thiamine content of, 168
 Obesity, 451-453
 Oleic acid, 67
 Oliguria, 521
 Olive oil, 79
 energy value of, 389
 Opsonic index, 320
 Opsonins, 320
 Oranges, riboflavin content of, 173
 Ornithine, 100
 detoxication by, 288
 not transaminated, 484
 in urea cycle, 489
 Oryzamin, 156
 Osazone test, 15
 Osmotic effects on corpuscles, 306
 Osmotic pressure, colloid, 519
 Osteomalacia, 533, 537
 Ovalbumin, molecular weight of, 133
 preparation of, 119
 Ovary, endocrine structures of, 591
 Overweight, disadvantage of, 412
 Ovoflavin, 156, 172
 Oxaloacetates, oxidation of, 383
 Oxaloacetic acid, 59
 Oxaluric acid, 515

Oxford unit, 652
 Oxidant, 357
 Oxidase, ascorbic acid, 226, 364, 384
 cytochrome, 374
 Oxidases, miscellaneous, 379
 monophenol, 364
 polyphenol, 364
 Oxidation, carbohydrate, 443
 types of, 356
 β -Oxidation-condensation theory, 461
 β -Oxidation theory, 460
 ω -Oxidation theory, 462
 Oxoisomerase, 438
 Oxycholesterol, 90
 Oxygen debt, 442
 Oxygen transport, 333-335
 Oxyhemoglobin, 313
 buffering by, 343
 dissociation curves of, 314, 334
 Oxynervon, 85
 Oxynervonic acid, 85
 Oxytocin, 634

P

PAB (see *p*-Aminobenzoic acid)
 Palmitic acid, 66
 Paludrine, 643
 Pancreas, phospholipides of, 453
 Pancreatic digestion, 261-264
 Pancreatic juice, composition of, 263
 Pancreatic secretin, 262
 control of, 262
 Pancreatotrophin, 625
 Pancreozymin, 262, 632
 Panniculus adiposus, 449
 Pantothenic acid, 155, 162, 178-180, 469
 absorption of, 282
 determination of, 179
 distribution of, 180
 Pantothenic-acid deficiency, 179
 Papain, 233, 245, 481
 Paper chromatography, 114
 Parathormone, 629
 Parathyrin, 629
 Parathyroid hormone, effect of, 629
 Parathyroids, 591
 Parathyrotrophin, 625
 Parietal cells, 255
Pars glandularis, 615
Pars intermedia, 591, 615
Pars nervosa, 615
 Partial pressure, 333
 Pasteur effect, 444
 Peanut oil, 79
 Pectic acids, 39
 Pectic substances, 38-39
 Pectin, 38
 Pectinic acids, 39
 Pellagra, 155, 162
 symptoms of, 175
 Pellagra-producing diet, 175, 176
 Pemphigus, 645
 Penatin, 161
 Penicillamine, 654
 Penicillase, 653
 Penicillic acids, 655
 Penicillins, 650-656
 chemistry of, 654
 properties of, 653
 structure of, 655
 uses of, 656
Penicillium notatum, 652
 Penicilloic acid, 655
 Pentobarbital, 515
 Pentosans, 37
 Pentosuria, 535
 Pepsin, 106, 227, 257
 crystalline, 224
 molecular weight of, 133
 optimal pH zones of, 231, 232
 Pepsinogen, 246
 Peptidase, 226
 Peptidases, 265
 Peptide, from ACTH, 617
 scale model of, 135
 streptogenin as, 212
 Peptide linkage, 137
 Peptides, synthesis of, 121-124
 Peptones, 121
 Peritonitis, 645
 Permeability, differential, 306
 Permeability vitamin, 157, 192
 Pernicious anemias, 213, 316
 Perosis, 162, 211, 560
 Peroxidase, 226, 374, 375
 Peroxidases, 190, 364
 Perseulose, 21
 Peters factor, 156
 Pettenkofer's test, 538
 PGA (see Pteroylglutamic acid)
 pH, effect of, on E_o' values, 361
 pH effect, on enzymes, 231
 Phagocytosis, 319-320
 Phenaceturic acid, 459
 Phenanthrene, 86
 Phenol, 273
 Phenol red, use of, in kidney test, 538
 Phenolphthalein, excretion of, 530
 Phenolsulfonephthalein, use of, in kidney test, 538
 Phenylacetic acid, 285, 459
 Phenylalanine, 97, 107
 metabolism of, 497-499
 putrefaction of, 272
 L-Phenylalanine, human requirement for, 482
 Phenyl-glucosazone, 15
 Phenylhydrazine, 15
 Phenylhydrazone, 15
 Phenylketonuria, 497, 498
 Phenylsazone, 15
 Phenylpyruvic acid, 497
 Phloritin, 43
 Phlorizin, 42, 43
 use of, 421
 Phloroglucinol-HCl test, 28
 Phosgene, 123

- Phosphagen**, 418
Phosphatase, 233
 blood alkaline, 629
 intestinal, 265
Phosphatases, 419, 467
Phosphate, regulation of, 628
Phosphate cycle, 417
Phosphates, buffering by, 338, 339
 urinary, 523, 532-533
Phosphatides, 79
Phosphoarginine, 418
Phosphocreatine, 417, 418, 505, 579
 splitting of, 439
Phosphodiesterase, 467
Phosphofructokinase, 440
Phosphoglucomutase, 423, 438
Phosphoglyceric acid, 60, 444
Phosphoglycerides, 84
Phosphoglyceromutase, 441
Phosphoinositides, 84
Phospholipid in cortex, 601
Phospholipid metabolism, 466-468
Phospholipids, 79-84
 absorption of, 281
 blood, 447, 448
 brain content of, 575
 cephalin-like, 82
 distribution of, 453
Phosphomonoesterase, 467
Phosphoproteins, 121
Phosphoric acid, significance of, 384
 titration curve of, 341
Phosphorus, requirements for, 553, 554, 556
 in teeth, 586
Phosphorus poisoning, 456
Phosphorylase, 423, 437
Phosphorylation, carbohydrate, 417
 in glycogenesis, 422
 intestinal, 416
 summary of, 440
Phosphosphingosides, 84
Phosphotriose isomerase, 441
Phosphotungstic acid, 118
Photosynthesis, energy requirements in, 55-57
Photosynthetic ratio, 57
Phrenosin, 85
Phthioic acid, 67
Physoctigmine, 469
Phyt hormones, 635
Phytol, 49
Phytosterols, 92
Picramic acid, 285
Picric acid, 285
Pilocarpine, 252
Pineal glands, 591
Piria's test, 126
Pituitary, 614-622
 effect of, on obesity, 451
 morphology of, 615
Pituitrin, effect of, 633
pK_a, definition of, 340
Planck's constant, 56
Plant hormones, practical use of, 638
Plants, estrogens of, 606
Plasmalogens, 83
 definition of, 65
Plasmapheresis, 295, 296, 480
Plasmin, 298
Plasmochin, 643
Plasteins, 245, 478
Platelets, function of, 300
 phospholipids of, 453
Pneumonia, 349
Polariscope, use of, 7
Polycythemia vera, 318
Polycythemias, 318
Polyhydric alcohols, 1
Polymorphonuclear leucocytes, 319
Polyneuritis, 160
 cure of, 170
Polynucleotidase, 266
Polypeptide, folding of, 136
Polypeptides, 124
Polyphenol oxidase, 226
Polysaccharides, classification of, 29
 synthesis of, 424
Polyuria, 521, 633
Pomelin, molecular weight of, 133
Porphin, 309
Porphyrin protein, 374
Porphyropsin, 161, 195
Portal vein, 277
Posterior lobe, pituitary, 615
Potassium intoxication, 602
Potatoes, riboflavin content of, 173
Precipitins, 321
Pregnancy test, 623
Pregnandiol, 611, 612
Pregnanedione, 612
Prodigiosin, 647
Proenzymes, 246
Progesterone, 606, 611-612
Progestin, 606
Prolactin, 617-619
Prolamines, 120, 122, 485
Proline, 96, 98
 metabolism of, 495
Proline oxidase, 495
Prontosil, 644, 645
Prosecretin, 632
Prosthetic group, 362
Protamin, 626
Protamin-insulin zinc, 627
Protamines, 119, 120, 122
Proteases, pancreatic, 263
Protective foods, 548
Protein, absorption of, 278
 energy value of, 388
 fat formation from, 450, 451
 formation of, in plants, 62
 labile, 477
 recommended dietary allowance of, 546
 storage of, 476-478
 (See also Proteins)
Protein conservation, 478
Protein intake, optimal, 549-551

- Protein metabolism, exogenous, 477
Protein purity, criteria of, 115
Protein synthesis, 478-481
 rate of, 479
Proteinases, reversibility of, 244
Proteins, building stones of, 96
 classification of, 119-121
 color reactions of, 125-127
 combining power of, 128-131
 heat coagulation of, 128
 isoelectric, 130
 lipotropic action of, 457
 molecular structure of, 134-139
 molecular weight of, 131-134
 nitrogen distribution in, 124-125
 nutritive value of, 549, 550
 osmotic pressure of, 131
 purification of, 115
 RQ for, 395
 significance of, for growth, 551
 specific rotation of, 105
Protein-sparing action, 478
Proteinurias, 537, 538
Proteoses, 121
Prothrombin, 166, 297-299
 origin of, 299
Prothrombin level, 299
Protopectin, 38
Protoporphyrin, 310
Provitamins A, 193, 201
Provitamins D, activation of, 202
Pseudoglobulin, 294
Pseudokeratins, 581
Pteric acid, 184
Pteroylglutamic acid (PGA), 157, 183-186, 214
 action of, 186
Pteroylheptaglutamic acid, 184
Pteroyltriglutamic acid, 184-185
Ptomaines, 272
Ptyalin, 254
Puberulic acid, 651
Pubescence, effect of thyroid on, 595
Puerperal fever, 645
Pulmotor, 337
Puncture diabetes, 428
Purgic acid, 21
Purine bases, 143-144
Purines, metabolism of, 510-512
 methylated, excretion of, 514
Pussy willow, estrogens of, 606
Putrefaction, 271-274
Putrescine, 272
Pyloric sphincter, 261
Pyocyanin, 647
Pyramine, 172
 metabolism of, 514
Pyran, 10
Pyridine nucleotide, 362
Pyridinoprotein enzymes, 365-369
Pyridoxal, 178
Pyridoxamine, 178
 use of, in transamination, 486
Pyridoxine, 156, 159, 162, 176-178
 absorption of, 282
 determination of, 177
 need of, in fat production, 451
Pyrimidine bases, 144
Pyrimidine mononucleotides, 146
Pyrimidines, metabolism of, 514, 515
Pyrophosphates, significance of, 417
Pyrophosphoric acid, 419
Pyruvic acid, 59, 171, 172, 180, 183, 366, 444
 decarboxylation of, 378
 glycogen from, 421
 oxidation of, 380-383
 production of, in brain, 577
Pyscosin, 85
- Q
- Quanta, 56
Quercetin, 43
Quercitrin, 43
Quinine, 642
- R
- Rachitosterols, 156
Radioactive isotopes, use of, 415
Raffinose, 21, 25
Rancidity, 76
Rat pellagra, 174, 176
Reader factor, 156
Redox potential, 237, 357
Redox systems, 357-360
Reductant, 357
Reichert-Meissl number, 77
Renal glucosuria, 428, 535
Renin, 630, 631
Renin-hypertensin system, 630-631
Rennet, 256, 259
Rennin, 257, 259
Resorcinol-HCl reaction, 28
Respiration, definition of, 331
 nervous regulation of, 350
Respiratory center, 350, 351
Respiratory quotient (RQ), 394-396
 brain, 576
 definition of, 394
 in muscle, 443
 nonprotein, 397, 398
Retinene, 195
Reversibility, enzyme, 244-246
Rh blood factor, 324
Rhamnose, 21, 26
Rhamnose, 1, 3, 18, 19, 21, 191
Rhamnoside, 192
Rhodose, 21
Rhodopsin, 161, 195
Riboflavin, 149, 155, 156, 157, 159, 160, 172-174
 absorption of, 281
 chemistry of, 174
 content of, in foods, 173
 oxidation of, 370
 recommended dietary allowance of, 546

- Ribofuranose, 143
 Ribonuclease, 266
 Ribose, 21, 141
D-Ribose, 5, 416
 Ricinoleic acid, 67
 Rickettic rosary, 201
 Rickets, 155, 533
 symptoms of, 201
 Rickettsial diseases, 183
 Rigor mortis, 579
 Ringer-Locke solution, 292
 Ringer solution, 292
 Robinose, 21, 26
 Robison-Emlden ester, 438
 RQ (*see* Respiratory quotient)
 Running, caloric requirement for, 410
 Rutin, 43, 191
 Rutinose, 21, 191
- S
- Saccharic acid, 17
 Saccharolactone, 17
 Salicin, 43
 Salicylic acid, detoxication of, 288
 Saligenin, 43
 Saliva, amount of, 252
 composition of, 252, 253
 functions of, 255
 pH of, 253
 Salivary digestion, 252-255
 Salkowaki test, 90, 527
 Salmine, 106, 114, 119
Salmonella infections, use of streptomycin in, 658
 Salting-out, 118
 Salvarsan, 644
 Saponification, 73
 Saponification number, 77
 Sarcosine, 506
 Saturation index, blood, 308
 Schiff test, 90
 Schütz rule, 230
 Scleroproteins, 120
 Sourvy, 155
 symptoms of, 187
 Sourvy-producing diet, 188
 Sea foods, iodine content of, 558
 Second wind, 443
 Secretagogues, 260
 Secretin, 631, 632
 Secretions, effect of, on metabolism, 405
 Sediments, urinary, 522
 Sedoheptose, 21
 Selachyl alcohol, 72
 Seliwanoff's test, 28
 Septicemias, treatment of, 645
 Serise, 82, 97, 501, 508
 metabolism of, 496
 Serum, definition of, 293
 Serum albumins, 295
 Serum globulin, molecular weight of, 133
 Serum globulins, 294
 Serum proteins, 294
 functions of, 296
 Sewing, caloric requirement for, 410
 Sex, influence of, on metabolism, 403
 Sex hormones, 530
 Sexual precocity due to adrenals, 604
 Shock, relief of, 600
 Silicon, requirements for, 560
 Simple proteins, review of, 122
 Sinigrin, 43
 Sitosterol, 281
 Sitosterols, 92
 Sitting, caloric requirement for, 410
 Skatole, 273, 286
 Soap, definition of, 73
 as emulsifier, 74
 Somogyi-Shaffer-Hartman method, 534
 Sorbitol, 2, 21
 D-Sorbitol, 7
 Sorbose, 21
 Soybean oil, 79
 Soybeans, nutritive value of, 565
 Specific dynamic action, 408-409
 Specific gravity, of blood, 291
 of urine, 521
 Specific rotation, 7
 of mutarotating sugars, 12
 Spectacled eye, 164, 179, 181
 Sperm oil, 79
 Spermatogenesis, arginine for, 483
 Spermatozoa, 142
 Sphingol, 83, 85
 urinary, 470
 Sphingomyelins, 83-84
 definition of, 65
 distribution of, 453, 454
 Sphingosine, 83
 Spinach, calcium of, 554
 riboflavin content of, 173
 Spinasterol, 92
 Spleen, phospholipids of, 453
 Spotted fever, 183
 Sprue, 185, 186, 317
 Stachyose, 21, 26
 Stair climbing, caloric requirement for, 410
 Stallions, estrogens from, 606
 Standing, caloric requirement for, 410
 Starch, 29-31
 energy value of, 399
 hydrolysis of, 30
 structure of, 30, 31
 Starvation, effect of, on lipids, 472
 on metabolism, 404
 Steady state, 249, 338, 443
 Steapsin, 264
 Stearic acid, 66
 Steep water, 181
 Stercobilin, 521
 Sterids, 86-93
 blood, 447, 448
 classification of, 88-89
 Sterility from lack of manganese, 560
 Sterol, definition of, 87

- Sterols, brain content of, 575
 Stigmasterol, 92
 Stilbene, 609
 Stilbestrol, 609
 Stillbirths, 166
 Stokes' solution, 315
 Stomach tube, 257
 Stonecrop, 21
 Stratographic analysis, 53
 Stratographic method, 114
 Strepogenin, 211, 212
 Streptidine, 657
 Streptobiosamine, 657
 Streptomycin, 657-658
 Streptonose, 657
 Streptothrycin, 657
 Stroma, 305, 317
 Stromatin, 305
 Sturin, 119
 Substrate, concentration of, 230
 Succinic acid cycle, 380
 Succinic dehydrogenase, 235
 action of malonate on, 239
 Sucrase, 229, 233, 235, 279
 intestinal, 265
 Sucrose, 24-25
 energy value of, 389
 inversion of, 241
 Sugar, restoring action of, 472
 ring structures of, 10-11
 Sugars, aldehydic and ketonic reactions of, 13
 dissociation constants of, 13
 esters of, 13
 ether formation by, 13
 interconversion of, 16
 Sulfa drugs, 644
 action of, 646
 Sulfadiazine, 645
 Sulfguanidine, 645
 Sulfanilamide, 645
 Sulfapyridine, 645
 Sulfathiazol, 645
 Sulfonamides, use of, for thyroid, 597
 Sulfur-containing compounds of urine, 531-532
 Sullivan's test, 127
 Suprarenine, 598
 Surface films, cholesterol in, 471
 Sweating, effect of, on kidneys, 520
 Sweeping, caloric requirement for, 410
 Sweetness of sugars, 27
 Sympathins, 600
 Syphilis, detection of, 321
- T
- Tachysterol, 202
 Tague tree, 37
 D-Talose, 5
 Tapeworm, antienzymes of, 248
 Tartar, 253
 Taurine, 268
 Taurocholic acid, 267
 Teeth, chemistry of, 586-588
 Temperature, effect of, on photosynthesis, 58-59
 Temperature characteristic, 234
 Temperature effects, on enzymes, 233
 Tenderizing of meat, 516
 Tendomucoid, 583
 Testes, phospholipids of, 453
 trophin for, 621
 Testoids, 604
 Testosterone, 87, 612
Tetania parathyropriva, 630
 Tetanus, 628
 Tetany of alkalosis, 347
 Tetranucleotide, 148, 149
 Tetrasaccharide, 26
 Theelin, 606, 608
 Theelol, 608
 Thiamine, 149, 155, 156, 159-161, 166-172
 absorption of, 281
 content of, in foods, 168
 effect of, on plants, 636
 human requirements for, 168
 recommended dietary allowance of, 546
 requirement for, 456
 Thiamine pyrophosphate, 377
 Thiaminoprotein enzymes, 376-377
 Thiocyanate in saliva, 253
 Thioneine, 504
 Thiourea, use of, for thyroid, 597
 Thoracic duct, 277
 Threonine, 97, 105
 discovery of, 108
 L-Threonine, human requirement for, 482
 D-Threose, 5
 Threshold substance, 534
 Thrombin, 293, 297-299
 Thrombocytes, 297
 function of, 300
 Thrombokinas, 301
 Thromboplastin, 297, 300, 301
 Thrombosis, 300, 301
 Thymine, 186
 metabolism of, 514
 structure of, 145
 Thymus, 591
 Thymus nucleic acid, 143
 Thyroglobulin, 592
 Thyroid, 591
 pathology of, 596-598
 Thyroid action, nature of, 596
 Thyronine, 594
 Thyrotoxicosis, 596
 Thyrotrophin, 616, 635
 Thyroxine, 97, 592-594
 effect of, on carbohydrate, 431
 production of, 595
 structure of, 593, 594
 in thyroglobulin, 593
 Tiselius method, 294
 Tissue slices, use of, 415
 Tissues, water content of, 572-573
 Tobacco mosaic virus, 150
 α -Tocopherol, 157
 Tocopherols, 205

- Tollens reaction**, 28
Toluene, 124
Trace elements, 561, 562, 574
 in teeth, 587
Trachoma, 645
Transaminase, 382
 aspartic acid, 485
 glutamic acid, 485
Transamination, 178, 483-486
Transferring enzyme, 423
Transmethylation, 507, 508
Traumatic acid, 636
Trehalose, 25
Tricarboxylic acid cycle, 183, 380-383, 443
 in brain, 577
 scheme of, 381
 use of, in deamination, 487
Trimethyl amine, 468
Triolein, 72
Triose phosphate, 60
Triosephosphate dehydrogenase, 441
Trioses, glycogen from, 420
Tripalmitin, 72
Trisaccharides, 25-26
Triticonucleic acid, 141
Tritium, 415
Trommer's test, 14
Trophic hormones, 615
Trypsin, 229, 231, 233, 263
 crystalline, 222, 223
Trypsinogen, 246
 crystalline, 224
Tryptase, 298
Tryptophan, 97, 113, 480
 aldehyde reactions of, 127
 amount of, in ICSH, 622
 dietary deficiency of, 500
 metabolism of, 178, 499-500
 putrefaction of, 273
 requirement for, 481
 in thyroglobulin, 593
L-Tryptophan, human requirements for, 482
Tryptophanase, 273, 500
Tuberculosis, use of streptomycin in, 658
Tuberculostearic acid, 67
Tubules, function of, 520
Tung oil, 79
Turanose, 24
Turnover numbers, 244
Turpentine, excretion of, 530
Typewriting, caloric requirement for, 410
Typhoid fever, use of streptomycin in, 658
Tyramine, 273
Tyrocidin, 648, 650
Tyrode solution, 292
Tyrosinase, 226, 499
Tyrosine, 97, 107
 insulin yield of, 625
 metabolism of, 190, 497-499
 putrefaction of, 273
 in thyroglobulin, 593
Tyrosinosis, 497, 498
Tyrosine, 648
- U
- Ultracentrifuge**, 115, 132
Ultraviolet irradiation, effect of, on enzymes,
Ultraviolet light and vitamin D, 204
Undulant fever, 645
 use of streptomycin in, 658
Uracil, metabolism of, 514
 structure of, 145
 use of, for thyroid, 597
Uracil riboside, 147
Urates, 529
Urea, energy value of, 389
 origin of, 526
 production of, 488-491, 514
 properties of, 525-526
 use of, 491
Urease, 233, 235
 action of, 526
 as affected by pH, 232
Uremia, 526
Uric acid, 512
 production of, in birds, 513
 properties of, 528-530
Uric acid riboside, 511
Uricaninase, 504
Uricase, 380, 511-513
Uridylic acid, 145
Urine, composition of, 523-525
 odor of, 523
 osmotic pressure of, 521
 pH of, 523
 secretion of, 519-521
 specific gravity of, 521
 volume of, 520
Urine sediments, 538, 539
Urobilin, 521
Urobilinogen, 521
Urocanic acid, 503
Urochrome, 521
Urochromogen, 522
Urogastrone, 632
Uronic acids, 17
 formation of, 443
Uterus, pituitrin effect on, 633
- V
- Vaccenic acid**, 69, 213
Valine, 97
L-Valine, human requirement for, 482
Van Slyke method, 101
van't Hoff relationship, 233
Vegetable gums, 36
Vegetable ivory, 37
Vegetables, vitamin-A content of, 197
Ventriculin, 317
Vicianose, 21
Virus, molecular weight of, 133
Virus particles, size of, 150
Viruses, 149-151
Visual purple, 195
Vitagens, 158

- Vitamin, definition of, 154
- Vitamin A, action of, 197
in brain, 577
content of, in foods, 197
determination of, 196
distribution of, 196, 197
recommended dietary allowance of, 546
- Vitamin A₁, 195
- Vitamin B₂, 157, 159
- Vitamin B₃, 156
- Vitamin B₄, 156
- Vitamin B₅, 156
- Vitamin B₆, 159, 177
use of, in transamination, 486
- Vitamin B₇, 156, 157
- Vitamin B₈, 156
- Vitamin B₁₀, 183
- Vitamin B₁₁, 183
- Vitamin B₁₂, 213-214
- Vitamin B₁₃, 213
- Vitamin B₁₄, 215
- Vitamin B, conjugase, 185
- Vitamin B_p, 211
- Vitamin concentrates, 568
- Vitamin D, 155
content of, in foods, 202
determination of, 201
recommended dietary allowance of, 546
requirement for, 204
- Vitamin D₂, 92, 164, 202
- Vitamin D₃, 92
- Vitamin E, action of cod-liver oil on, 466
deficiency of, 205
- Vitamin G, 156
- Vitamin H, 157, 181
- Vitamin I, 156
- Vitamin K, destruction of, 466
- Vitamin M, 183, 185
- Vitamin P, 157
bioassay of, 192
- Vitaminlike substances, 158
- Vitamins, absorption of, 281
B group of, 158-159
in brain, 577
fat soluble, 158
incompletely identified, 210
naming of, 155-157
summary of data on, 160-167
water-soluble, 158
- Vitamins A, 193-198
absorption of, 282
- Vitamins B, 157, 183
- Vitamins D, 156, 164, 198-205
absorption of, 282
structure of, 204
- Vitamins E, 157, 166, 205-208
absorption of, 282
determination of, 206
- Vitamins K, 157, 166, 208-210
absorption of, 282
distribution of, 209
requirement for, 209
- Vitamins L, 157
- Vitellin, 106
phosphorus of, 554
- Volume index, blood, 308
- Vulpian test, 598
- W
- Walking, caloric requirement for, 410
- Wassermann reaction, 321
- Water, absorption of, 278
use of, in amino acids, 483
- Water balance, relation of, to diet, 452
- Weyl's test, 527, 536
- Wheat germ, riboflavin content of, 173
thiamine content of, 168
- Wheat-germ oil, vitamin E in, 207
- Wheeler and Johnson test, 145
- Williams-Waterman factor, 156
- Wool, digestion of, 581
- Wool fat, 79, 581
- Work, effect of, on metabolism, 409
- Wound hormones, 636
- Wounds, treatment of, with allantoin, 513
- X
- Xanthine, 512
structure of, 144
- Xanthine oxidase, 371, 511
- Xanthophylls, 52
- Xanthoproteic test, 126
- Xanthosine, 148, 512
- Xanthylic acid, 148, 512
- Xerophthalmia, 155, 160, 193
- X-ray diffraction pattern, 82
- X-ray studies of nucleic acids, 149
of proteins, 136
- X rays, effect of, on enzymes, 237
- Xylans, 37
- L-Xyloketose, urinary, 535
- Xylose, 21
- D-Xylose, 5
- L-Xylose, absorption of, 279
- Y
- Yeast, dry, riboflavin content of, 173
norite eluate factor, 183
- Yeast nucleic acid, 141, 143
- Yellow enzyme, 161, 172, 367, 371
- Yellow oxidizing enzymes, molecular weight of, 133
- Z
- Zein, 106, 114
- Zinc, insulin content of, 625, 626
requirements for, 561
- Zinc-insulin, 626
- Zymase, 220
- Zymogens, 246
- Zytoplasmic substance, 301
- Zwitter-ion theory, 110

