

BIRLA CENTRAL LIBRARY
PILANI [RAJASTHAN]

Class No. 531.0311

Book No. M489S

Accession No. 30398

Acc. No

ISSUE LABEL

Not later than the latest date stamped below.

--	--	--

STATISTICAL MECHANICS

STATISTICAL MECHANICS

JOSEPH EDWARD MAYER

Associate Professor of Chemistry, Columbia University

AND

MARIA GOEPPERT MAYER

Lecturer in Chemistry, Columbia University

NEW YORK

JOHN WILEY & SONS, INC.

LONDON: CHAPMAN & HALL, LIMITED

COPYRIGHT, 1940

by

JOSEPH EDWARD MAYER and MARLA GOEPPERT MAYER

All Rights Reserved

*This book or any part thereof must not
be reproduced in any form without
the written permission of the publisher.*

THIRD PRINTING OCTOBER 1947

Printed in U. S. A.

Dedicated to our teachers

Gilbert N. Lewis

and

Max Born

PREFACE

The rapid increase, in the past few decades, of knowledge concerning the structure of molecules has made the science of statistical mechanics a practical tool for interpreting and correlating experimental data. It is therefore desirable to present this subject in a simple manner in order to make it easily available to scientists whose familiarity with theoretical physics is limited. This book, which grew out of lectures and seminars given to graduate students in chemistry and physics, aims to fulfill this purpose.

The development of quantum mechanics has altered both the axiomatic foundation and the details of the methods of statistical mechanics. Although the results of a large number of statistical calculations are unaffected by the introduction of quantum mechanics, the chemist's interest happens to be largely in fields where quantum effects are important. Consequently, in our presentation, the laws of statistical mechanics are founded on the concepts of both quantum and classical mechanics. The equivalence of the two methods has been stressed, but the quantum-mechanical language has been favored. We believe that this introduction of quantum statistics at the beginning simplifies rather than puts a burden upon the initial concepts. It is to be emphasized that the simpler ideas of quantum mechanics, which are all that is used, are as widely known as the more abstract theorems of classical mechanics which they replace.

Simplicity of presentation rather than brevity and elegance has been our endeavor. However, we have not consciously sacrificed rigor.

Care has been taken to make the book suitable for reference by summarizing and tabulating final equations as well as by an attempt to make individual chapters complete in themselves without too much reference to previous subjects.

All the theorems and results of mechanics and quantum mechanics which are used later have been summarized, largely without proof, in Chapter 2. The last section, 2k, on Einstein-Bose and Fermi-Dirac systems, ties up closely with Chapters 5 and 16 only.

Chapters 3 and 4 contain the derivation of the fundamental statistical laws on which the book is based. Chapter 10 is prerequisite for Chapters 11 to 14. Otherwise, individual subjects may be taken up in different order.

In Chapters 7 to 9 considerable space is devoted to the calculation of thermodynamic functions for perfect gases, which was considered justified by the value of the results for the chemist. These chapters may be omitted by readers uninterested in the subject.

Chapters 13 and 14 on the imperfect gas and condensation theory, respectively, are somewhat more complicated than the remainder, but are included because of our special interest in the subject.

The aim of the book is to give the reader a clear understanding of principles and to prepare him thoroughly for the use of the science and the study of recent papers. Many of the simpler applications are discussed in some detail, but in general language without comparison with experiment. The more complicated subjects have been omitted, as have been those for which at present only partial solutions are obtained. This choice has excluded many of the contemporary developments, especially the interesting work of J. G. Kirkwood, L. Onsager, H. Eyring, and W. F. Giaque.

In conclusion we express our gratitude to Professors Max Born, Karl F. Herzfeld, and Edward Teller, who have read and criticized several parts of the manuscript. We also thank Dr. Elliot Montroll, who aided in reading proof and who made many helpful suggestions.

JOSEPH EDWARD MAYER
MARIA GOEPPERT MAYER

NEW YORK CITY
March 31, 1940

CONTENTS

CHAPTER

1 GAS THEORY, 1

(a) Introduction, 1. (b) A Simplified Model of the Perfect Gas, 3. (c) The Number of Molecules with a Given Velocity, 5. (d) The Classical Perfect Gas, Pressure, 8. (e) The Maxwell-Boltzmann Distribution Law, 10. (f) The Average Velocity, 14. (g) The Number of Molecules Hitting a Wall, 17. (h) The Mean Free Path, 18. (i) Viscosity, 22. (j) Heat Conduction, 26. (k) Diffusion, 27. (l) The Scope of Statistical Mechanics, 31.

2 MECHANICAL AND QUANTUM-MECHANICAL PRELIMINARIES, 33

(a) Introduction, 33. (b) Coordinates, 35. (c) Momenta, 36. (d) Classical Mechanics and Phase Space, 38. (e) The Uncertainty Principle, 41. (f) Quantum States, 42. (g) Quantum States of Some Simple Systems, 45. (h) The Combination of Independent Systems, 49. (i) Equal Probability of Single States, 53. (j) Liouville Theorem and Equal Probability in Phase Space, 58. (k) Identical Particles, Einstein-Bose and Fermi-Dirac Systems, 63.

3 TERMINOLOGY AND DEFINITIONS, 68

(a) The States of a Thermodynamic System, 68. (b) Forces of a Thermodynamic System, 70. (c) The Distribution of Independent Molecules in Space, 74. (d) The Concept of a Distribution, 78. (e) The Most Probable Distribution, 80. (f) Idealized Systems and Inhibitions, 81. (g) Summary, 85.

4 THE DERIVATION OF THE LAWS OF THERMODYNAMICS, 86

(a) Introduction, 86. (b) Characteristics of the Logarithm of Ω , 87. (c) The Quantity $S = k \ln \Omega$, 92. (d) Identification of Entropy, Temperature, and Pressure, 95. (e) The Limits of Validity of the Second Law of Thermodynamics, 98. (f) The Relation between Entropy and the Uncertainty in the Energy, 100. (g) The Third Law of Thermodynamics, 103. (h) The Conditions of Equilibrium and the Chemical Potential μ , 104.

5 THE PERFECT MONATOMIC GAS, 109

(a) The Mathematical Representation of the System, 109. (b) The Distribution of Energy among the Atoms, 110. (c) The Most Probable Distribution, 112. (d) Boltzmann Statistics, 114. (e) The Equation of State, 117. (f) Maxwell-Boltzmann Distribution, 119. (g) Evaluation of e^{α} and Limit of Applicability of Boltzmann Statistics, 120.

6 THE PERFECT GAS WITH INTERNAL DEGREES OF FREEDOM, 123

(a) Introduction, 123. (b) The Partition Function, 123. (c) The Separation of the Partition Function as a Product, 127. (d) The General Equations, 129. (e) The Distribution of Molecules among Internal States, 132. (f) The Influence of the Zero of Energy, 134. (g) The Influence of Nuclear Spin, 135. (h) The Entropy of Isotope Mixing, 138. (i) The Internal Partition Function of a Monatomic Gas, 140. (j) The Classical Internal Partition Function of Molecules, 144.

CHAPTER

- 7 DIATOMIC GASES, 149
(a) The Ideal Diatomic Molecule, 149. (b) The Partition Function of a Rotator, 151. (c) The Partition Function of an Oscillator, 157. (d) The General Diatomic Molecule, 160. (e) The Classical Equations for the General Diatomic Molecule, 167. (f) Molecules Composed of Two Identical Atoms, 172.
- 8 POLYATOMIC GASES, 179
(a) Introduction, 179. (b) The Number of Degrees of Freedom, 181. (c) Vibrational Contributions, 183. (d) Rotation, 191. (e) The Symmetry Number, 195.
- 9 MIXTURES OF GASES AND CHEMICAL EQUILIBRIUM, 200
(a) Introduction, 200. (b) Gaseous Mixtures, 201. (c) Chemical Equilibrium, 203. (d) The Entropy of Isotope Mixing, 209. (e) An Interpretation of the Equilibrium Equation, 213. (f) Estimation of Equilibrium Constants, 215.
- 10 GENERAL EQUATIONS FOR SYSTEMS COMPOSED OF DEPENDENT PARTICLES, 218
(a) Introduction, 218. (b) The Equation for the Work Function A , 220. (c) Application to the Perfect Gas, 223. (d) Systems of Fixed Energy, 225. (e) Energy Fluctuations in Systems of Fixed Temperature, 227. (f) The Semi-Classical Expression for Q , 228. (g) The Configuration Integral Q_r , 229. (h) The Probability of a Configuration, 230. (i) An Alternative Derivation, 232. (j) Summary of Thermodynamic Equations, 235.
- 11 THE CRYSTALLINE SOLID, 237
(a) The Crystal, 237. (b) Harmonic Vibrations, 237. (c) Classical Calculation, 240. (d) Another Derivation of the Classical Formulas, 242. (e) Quantum-Mechanical Treatment, 243. (f) A One-Dimensional Crystal Model, 246. (g) The Frequencies of Simple Isotropic Lattices, 248. (h) The Debye Formula, 251. (i) Deviations from the Debye Formula, 255. (j) Strain and Stress Variables, 258.
- 12 THE VAN DER WAALS EQUATION, 262
(a) Introduction, 262. (b) The Approximate Statistical Treatment, 263. (c) The Interpretation of a and b , 266. (d) The Law of Corresponding States, 269. (e) Condensation and the van der Waals Equation, 272. (f) Phase Changes and a General Equation of State, 274.
- 13 THE IMPERFECT GAS, 277
(a) Introduction, 277. (b) The Cluster Integrals b_l , 278. (c) Simplification of the Configuration Integral Equation, 282. (d) The Maximum Term in Q_r/N , 283. (e) The Limiting Case of the Perfect Gas, 284. (f) The Equation for the Cluster Integrals in Terms of Irreducible Integrals β_k , 285. (g) Development in Inverse Powers of v , 288. (h) The Thermodynamic Properties of the Imperfect Gas, 291. (i) Summary of the Method, 294.
- 14 CONDENSATION AND THE CRITICAL REGION, 295
(a) Introduction, 295. (b) The Value of the Cluster Integrals b_l for Large Values of l , 297. (c) Large Clusters Present at Equilibrium, 299. (d) The

CHAPTER

- Pressure and Free Energy in the Condensation Range, 301. (e) The Determination of the Volume per Molecule, v_s , of the Saturated Vapor, 303. (f) The Dependence of the Irreducible Integrals on the Temperature, 305. (g) The Critical Point, 308. (h) The Temperature T_m , 310. (i) The Physical Interpretation of T_m , 311. (j) The Thermodynamic Functions of the Saturated Vapor, 314. (k) Phase Changes in the Condensed Phase, 317. (l) The Cell Method of Calculating Liquid Partition Functions, 319.
- 15 ELECTRIC AND MAGNETIC FIELDS, 327
 (a) Introduction, 327. (b) Rigid Dipoles in an Electric Field, 327. (c) The Dielectric Constant, 331. (d) Electronic Polarization, 331. (e) Comparison with Refractive Index and Experimental Data, 333. (f) Non-Rigid Molecules, 335. (g) The Lorentz-Lorenz Force, 338. (h) Para- and Diamagnetism, 340. (i) Paramagnetism in Quantum Mechanics, 342. (j) Ferromagnetism, 348. (k) Magnetic Cooling, 352. (l) Thermodynamic Equations in Electric Fields, 356. (m) The Calculation of F in a Field, 359.
- 16 DEGENERATE GASES, 363
 (a) Introduction, 363. (b) Definition of Black-Body Radiation, 365. (c) The Quantum States of Radiation, 368. (d) The Planck Black-Body Distribution Law, 369. (e) The Thermodynamic Functions of the Radiation Field, 372. (f) The Degenerate Fermi-Dirac Gas at Zero Temperature, 374. (g) The Integrals Occurring in the Equations for the Fermi-Dirac Gas, 378. (h) The Thermodynamic Functions of a Degenerate Fermi-Dirac Gas, 385. (i) Electrons in Metals, 387. (j) The Richardson Effect, 390. (k) Approximate Calculation of the Heat and Electrical Conductivity of Metals, 397. (l) The Maxwell-Boltzmann Collision Equation and Its Application to Electrons in Metals, 401. (m) Electrical and Heat Conductivity and the Thermoelectric Effect, 407. (n) Liquid Helium II, 414. (o) The Degenerate Bose-Einstein Gas, 416.
- APPENDIX, 427
 (I) The Notation of Calculus, 427. (II) Some Definite Integrals, 430. (III) The Euler-Maclaurin Summation Formula, 431. (IV) The Factorial and the Stirling Approximation, 432. (V) The Volume of an N -dimensional Sphere, 433. (VI) The Method of Undetermined Multipliers, 433. (VII) Combinatory Problems, 435. (VIII) General Thermodynamic Relationships, 438. (IX) Summary of Thermodynamic Functions of a Perfect Gas, 440. (X) The Coefficient of the Term $\Pi \beta_k^{a_k}$ in b_p , 455. (XI) Application of the Theory of Functions to the Functions Appearing in the Theory of the Imperfect Gas, 459. (XII) Constants of Diatomic Molecules, 468. (XIII) Physical Constants, 470. (XIV) Conversion of Energy Units, 471. (XV) Greek Alphabet, 472.
- GLOSSARY OF SYMBOLS, 473
- PROBLEMS, 483
- AUTHOR INDEX, 487
- SUBJECT INDEX, 489

STATISTICAL MECHANICS

CHAPTER 1

GAS THEORY

(a) Introduction. (b) A Simplified Model of the Perfect Gas. (c) The Number of Molecules with a Given Velocity. (d) The Classical Perfect Gas, Pressure. (e) The Maxwell-Boltzmann Distribution Law. (f) The Average Velocity. (g) The Number of Molecules Hitting a Wall. (h) The Mean Free Path. (i) Viscosity. (j) Heat Conduction. (k) Diffusion.
(l) The Scope of Statistical Mechanics.

1a. Introduction

In the theory of mechanics, which treats the motions of bodies subjected to known forces, there enter certain quantities known as integrals of the equations of motion. These integrals are the quantities which remain constant in an isolated system consisting of bodies upon which no forces are exerted from outside the system itself. The most important of these integrals is called the energy.

For most simple ideal mechanical systems the energy falls naturally into two additive terms. One of these, the kinetic energy or *vis viva*, is the sum or integral over the system of one-half the product of the mass by the linear velocity squared. The other, the potential energy, is a function of the position of the parts of the system alone, and independent of the velocities. From these characteristics of the equations of motion one becomes accustomed to thinking of energy as a quantity existing in two forms, kinetic and potential, readily convertible into each other, and actually changing from one form into the other during the motion of the system.

However, this simple idealization of the laws of mechanics is never found to apply exactly to the motions of macroscopic bodies. It is always necessary, in order to obtain exact agreement with experiment, to introduce into the theoretical description certain frictional forces, which have the property of reducing the kinetic energy of the system, without a corresponding increase in the potential. It is true that in many almost ideal systems these frictional forces are practically neg-

ligible, as in the motion of the solar system, but in others they assume extreme importance.

The investigations of Rumford, in the eighteenth century, followed by the considerations of Mayer, Joule, and others, showed that the decrease in the mechanical energy of the system through frictional forces is always accompanied by a rise in temperature of the system, or of parts of the system. A new quantity, foreign to mechanics, called heat, may be introduced, and defined in such a way that the heat produced in the system is always equal to the mechanical energy lost through friction. By this inclusion of heat as a third form of energy, the mechanical statement that the energy of an isolated system remains constant with time retains its validity, and in this form the law of conservation of energy is known as the first law of thermodynamics.

Observations made by Brown in 1827 on particles of microscopic size suspended in solution showed that these are in a state of continual random motion, which suggested that the invisible atoms and molecules making up matter in bulk are not at rest. It is immediately obvious that, if this motion is real, the system of atoms and molecules composing bulk matter has associated with it energy, in the form of kinetic and potential mechanical energy, not different in kind from that associated with a macroscopic system.

The assumption that the mysterious disappearance of mechanical energy of a macroscopic system into the heat of its component parts, due to frictional forces, is merely the conversion of macroscopic mechanical energy into the submicroscopic mechanical energy of the atoms and molecules, is known as the kinetic hypothesis. In this theory heat is no longer essentially distinct in kind from mechanical energy. The theory has been amply confirmed by the remarkable accuracy with which the properties of bulk matter can be predicted by its use.

* This is then the fundamental step of the kinetic theory: to identify heat with the mechanical energy of the molecules. The motion of these molecules and their constituent parts may be expected to be governed by the laws of mechanics. However, it has been found that the equations of classical mechanics are asymptotic approximations, valid only for large systems, to the more universal equations which make up what is called quantum mechanics. With this enlargement of the meaning of the word mechanics to the quantum-mechanical laws for systems of atomic size, the motion of the constituents of bulk matter is actually governed by the laws of mechanics. The laws which bulk matter is known to obey, the laws of thermodynamics and of physical chemistry, are then presumably consequences of the laws of mechanics. The methods by which these laws can be derived, and by which their numer-

ical constants can be calculated from the mechanical properties of the molecules, form the science of statistical mechanics.

The problem appears at first to be somewhat hopeless of solution. The strict equations of mechanics are difficult to solve for systems consisting of more than two particles. How can one expect to draw any conclusions from the application of these equations to systems composed of 10^{23} particles? The very complexity of the problem is the secret of its solution. The details of the mechanical motion of the atoms within a system are unimportant for the calculation of the overall behavior of the system, which determines its macroscopic properties. Certain averages of the system's characteristics can be calculated from the mechanical laws governing the motion of its parts, and it is these averages which are actually observed. In most actual problems an essential simplification is gained from the fact that there are but a few different kinds of constituent molecules, although the number of each kind may be enormous.

In this chapter a rather simple example, that of the perfect monatomic gas, will be used to illustrate the possibilities of statistical methods.

1b. A Simplified Model of the Perfect Gas

One of the simplest cases, for which very elementary considerations lead to rather valuable conclusions, is that of the perfect monatomic gas. A dilute gas at rather high temperature consists of individual molecules which possess kinetic energy of motion, but which, on the average, are so far away from each other that they exert negligible forces on each other. Stated somewhat more specifically, only a very small fraction of all the possible instantaneous positions of all the molecules correspond to a total potential energy which is not infinitesimally small compared with the total kinetic energy of the system.

If the gas is monatomic it is known from experience that at ordinary temperature the molecules possess no appreciable internal energy. In Chapter 6 it will be found that this behavior is to be expected, and certain possible exceptions will be noted. For the normal dilute monatomic gas the only important part of the total energy is the kinetic energy of translation of the atoms.

*We shall attempt to predict the properties of an idealized system consisting of N identical point particles, each of mass m , exerting no forces on each other, and contained in a vessel of volume V , the walls of which reflect the striking molecules perfectly. N will be assumed to be a very large number. Since no forces are operative the potential energy must be independent of the positions of the particles, and will be chosen as zero. The total energy E of the system will be the kinetic

energy, the sum of $\frac{1}{2}mv^2$ for all the particles. The properties of such a system may be expected to be very close to those of a dilute monatomic gas of an element of atomic weight N_0m , in which N_0 is Avogadro's number. †

In section 1d, the properties of this system will be calculated without the introduction of any unnatural assumptions concerning the further characteristics of the molecules, but in this section the calculation will be carried out with the use of two entirely improbable assumptions. It will be assumed, namely, that all the N molecules have exactly the same magnitude of velocity v , and that they move only in the directions of the three principal Cartesian axes, one-sixth of the molecules moving in the positive direction, and one-sixth in the negative direction, of each axis. If a molecule hits one of the walls, which are taken to be parallel to the coordinate planes, its velocity changes sign. It so happens that the equations derived under these assumptions are the correct ones, and since the method of derivation is illustrative of the more exact one to come it appears to be excusable to use these assumptions for preliminary considerations.

†The pressure exerted on a wall of the vessel is the force exerted normal to the wall per unit area. This force arises from, and is equal and opposite to, the change in momentum per second suffered by the molecules which are reflected from the wall. If one considers 1 cm.² of wall perpendicular to the x axis it is clear that this section of the wall will be struck in 1 sec. only by the molecules moving toward the wall along the x axis, and lying, at the beginning of the second, in a rectangular parallelepiped of length v along the x axis, and with a cross-sectional area 1 cm.². If the density of molecules in all parts of the system is uniformly N/V , the number hitting the wall per square centimeter per second will be $vN/6V$. Each molecule striking has a momentum mv normal to the wall, and, if the molecules are reflected after striking, the change of momentum per molecule will be $2mv$. The total change of momentum per square centimeter per second is the pressure,

$$P = 2mv \cdot \frac{vN}{6V},$$

$$(1. 1) \quad PV = \frac{2}{3}N\left(\frac{1}{2}mv^2\right) = \frac{2}{3}E,$$

since the total energy E is $\frac{1}{2}Nmv^2$. The pressure-volume product, PV , is a constant for constant energy of the system, and proportional to the total energy. †

We should prefer, however, to relate the pressure-volume product to the more easily measured variable T , the temperature of the system,

rather than to the total energy. Here a difficulty is encountered which is not connected with the particular system, but rather with the essentially complicated nature of the function T . It will later be shown that two such systems as this, if brought into thermal contact so that energy can flow from one of them to the other, will come into equilibrium in such a way that the average kinetic energy per molecule is equal in the two systems. The qualitative definition of temperature is that it be equal in two systems which are in thermal equilibrium, and that it be higher in the system from which the energy flows than in the system which gains in energy if the two systems are brought into thermal contact. It follows that the energy per molecule, $\epsilon = E/N$, is a monotonous function of the temperature alone.

Anticipating this result of later considerations, one sees from equation (1) that the pressure-volume product can be written

$$PV = Nf(T),$$

in which $f(T)$ is a monotonously increasing function of the temperature. Until some more specific definition of the temperature is available one can proceed no further.

Actually, however, the temperature T has first been defined by just this equation, namely, by setting $f(T) = kT$, where $k = R/N_0$ is the gas constant per molecule, usually called the Boltzmann constant. Its numerical value is $k = 1.3804 \times 10^{-16}$ erg · deg.⁻¹. The definition of temperature is made by means of the perfect gas equation,

$$(1. 2) \quad PV = \frac{N}{N_0} RT = NkT.$$

By combining (1) and (2), a relationship between the kinetic energy per molecule and the temperature is found

$$(1. 3) \quad \frac{1}{2}mv^2 = \frac{3}{2}kT.$$

The equations of this section will be derived in section 1d in an exact and only slightly more complicated manner. Before doing this it is necessary to define and discuss a quantity based on an extremely useful concept frequently met in statistical mechanics.

1c. The Number of Molecules with a Given Velocity

If an attempt is made to determine, in a gas, the total number, or fraction, of all the molecules which have a certain vectorial velocity \vec{v} , defined by the three components v_x, v_y, v_z , in the x, y , and z directions, respectively, the necessity of a careful definition of the term is immediately faced. Obviously, the more accurately the velocities of the

molecules are measured, the fewer will be found to have the prescribed values of the velocity components.

The difficulty is obviated by defining the quantity $N(\vec{v}) = N(v_x, v_y, v_z)$ in such a way that $N(v_x, v_y, v_z) dv_x dv_y dv_z$ is the total number of molecules having velocity components lying between v_x and $v_x + dv_x$, v_y and $v_y + dv_y$, v_z and $v_z + dv_z$. $N(v_x, v_y, v_z)$ may then be termed the number of molecules having the velocity v_x, v_y, v_z , per unit volume in the three-dimensional space of the velocities. If $dv_x dv_y dv_z$ were chosen so small that the velocities of only a few molecules lie in the corresponding range, $N(v_x, v_y, v_z)$ would vary erratically in adjoining regions. If the regions $dv_x dv_y dv_z$ are, however, chosen large enough to contain very many molecules, $N(\vec{v})$ becomes a well-defined function, namely, the density of particles in the velocity space. Owing to the extremely large number of molecules in real systems, regions which are physically very small still contain large numbers of particles, so that no difficulty is encountered in treating $N(v_x, v_y, v_z)$ as a continuous function of its arguments. If we treat $N(\vec{v})$ as a function which is independent of time, we wish it to signify the *average* density of particles in the velocity space. At a given instant deviations from this average density may be observed, but owing to the tremendous number of molecules in a real gas the *fractional* deviations will be very small.

It will be convenient to define

$$(1.4) \quad N(v_x, v_y) = \int_{-\infty}^{+\infty} N(v_x, v_y, v_z) dv_z,$$

$$N(v_x) = \int_{-\infty}^{+\infty} N(v_x, v_y) dv_y = \int_{-\infty}^{+\infty} \int_{-\infty}^{+\infty} N(v_x, v_y, v_z) dv_y dv_z,$$

so that $N(v_x) dv_x$ is the total number of molecules having x components of velocity between the values v_x and $v_x + dv_x$, irrespective of the values of the components in the y and z directions. The total number of molecules N must be given by

$$(1.5) \quad N = \int_{-\infty}^{+\infty} N(v_x) dv_x = \int_{-\infty}^{+\infty} \int_{-\infty}^{+\infty} N(v_x, v_y) dv_x dv_y$$

$$= \int_{-\infty}^{+\infty} \int_{-\infty}^{+\infty} \int_{-\infty}^{+\infty} N(v_x, v_y, v_z) dv_x dv_y dv_z.$$

One also finds use for another quantity, $N(v)$ or N_v , defined by the statement that $N(v) dv$ is the total number of molecules having scalar magnitudes of velocity between v and $v + dv$. The scalar magnitude

v must be equal to or greater than zero, in contradistinction to v_x , v_y , and v_z , which may be negative. Also

$$(1. 6) \quad \int_0^{\infty} N(v) dv = N.$$

The area of the surface of a sphere of radius v is $4\pi v^2$. The volume in the velocity space corresponding to the range of scalar magnitude from v to $v + dv$ is therefore $4\pi v^2 dv$.

If the gas is isotropic, that is, if all properties of the gas, including the distribution* of molecules in the various velocity ranges, are the same for all directions, it follows that

$$(1. 7) \quad \begin{aligned} N(\vec{v}) &= N(\vec{u}), \quad \text{if } |\vec{v}| = |\vec{u}|, \\ N(v) &= 4\pi v^2 N(\vec{v}), \quad \text{if } v = |\vec{v}|. \end{aligned}$$

The calculation of quantities of the nature of $N(\vec{v})$ and $N(v)$ under conditions of equilibrium in the system is one of the important tasks of statistical mechanics.

The value of a knowledge of the dependence of such a quantity, say $N(v)$, upon its variable, may be illustrated by showing one of its uses. Suppose that the average value of the kinetic energy of the molecules composing the gas is sought. The kinetic energy of one molecule is $\frac{1}{2}mv^2$. If this is multiplied by the number of molecules $N(v) dv$ having the velocity magnitude v , and then summed, by means of integration, over all velocity ranges, the total kinetic energy, E , is obtained as

$$(1. 8) \quad E = \int_0^{\infty} \frac{1}{2}mv^2 N(v) dv.$$

The average kinetic energy per molecule is the total kinetic energy divided by the total number of molecules, N . If the average kinetic energy is denoted by $\frac{1}{2}m\bar{v}^2$, we have

$$(1. 9) \quad \frac{1}{2}m\bar{v}^2 = \frac{m}{2N} \int_0^{\infty} v^2 N(v) dv.$$

In general, if $f(v)$ is any function of the magnitude of velocity of a single molecule (in the special case just considered $f(v) = \frac{1}{2}mv^2$), then the average value of this function, $\overline{f(v)}$, will be given by

$$(1. 10) \quad \overline{f(v)} = \frac{1}{N} \int_0^{\infty} f(v) N(v) dv.$$

* In general, unless the contrary is explicitly stated, the small effect of the gravitational gradient in making the vertical direction unique will be neglected.

If $f(v_x, v_y, v_z)$ is a function of the three components of the velocity vector its average value is given by

$$(1. 10') \quad \overline{f(v_x, v_y, v_z)} = \frac{1}{N} \int_{-\infty}^{\infty} \int_{-\infty}^{\infty} \int_{-\infty}^{\infty} f(v_x, v_y, v_z) N(v_x, v_y, v_z) dv_x dv_y dv_z.$$

In the special case that f depends only on the combination $(v_x^2 + v_y^2 + v_z^2)$, that is, only on the magnitude of velocity v , the integration over the directions of the velocity vector in (10') may be performed immediately; (10') then reduces to (10).

Equations (10) and (10') may be regarded as definitions of the average value of a function. They represent the sum of the values of the function for all molecules, divided by the total number of molecules.

1d. The Classical Perfect Gas, Pressure

The system consisting of N identical, independent, point mass particles in a volume V will again be considered in this section. The unnatural assumption of equal velocities and of only six directions of motion will not be made, but the justifiable assumption of equation (7), that the gas is completely isotropic, will be kept.

Let us again calculate the pressure due to the collisions of the particles on the walls. The pressure is equal to the change in momentum per second of the particles hitting unit area of wall. The element of wall considered will be chosen normal to the x axis, and of area 1 cm.².

In general it would be unjustifiable to assume that every particle of velocity v_x, v_y, v_z hitting the wall was perfectly reflected, and left with the velocity $-v_x, v_y, v_z$. However, since isotropy has been assumed, and therefore in the assumed stationary state $N(v_x, v_y, v_z) = N(-v_x, v_y, v_z)$, it follows that just as many molecules leave the wall with the velocity $-v_x, v_y, v_z$ as hit with the velocity v_x, v_y, v_z , and the total change of momentum per second experienced by the molecules due to collision with the wall will be the same as if the molecules were perfectly reflected. One may, therefore, without loss of generality, calculate the total change of momentum per square centimeter per second as being the product $2mv_x$ times the number of molecules of velocity component v_x hitting 1 cm.² of wall normal to the x axis, per second, summed by integration over all values of v_x from zero to infinity.

A figure including all the vectors \vec{v} with given components v_x, v_y, v_z , whose end points fall in the square centimeter of wall normal to the x axis, is a parallelepiped of base 1 cm.² and height v_x , the volume of which is v_x cm.³; see Fig. 1. 1. All the $v_x N(\vec{v})/V$ molecules of velocity \vec{v} which are in this figure at any moment will strike the square centimeter of wall within the ensuing second. Integration over all values of v_y, v_z ,

equation (4), gives $[v_x N(v_x)/V] dv_x$ as the number of molecules of x components of velocity between v_x and $v_x + dv_x$ striking 1 cm.^2 of wall normal to the x axis per second. Multiplication of this by $2mv_x$, the change of momentum per molecule, and integration, gives for the total

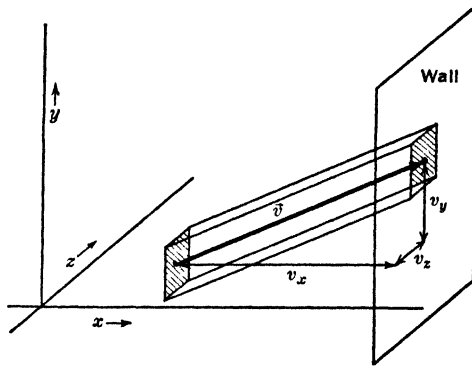

FIG. 1. 1.

change of momentum per square centimeter per second, equal to the pressure P ,

$$(1. 11) \quad P = \frac{m}{V} 2 \int_0^{\infty} v_x^2 N(v_x) dv_x.$$

Since $N(v_x) = N(-v_x)$, the integration from zero to infinity is equal to just half the integral from minus infinity to plus infinity. In view of (10'), one obtains

$$(1. 12) \quad PV = 2\left(\frac{1}{2}m\overline{v_x^2}\right)N,$$

where $\overline{v_x^2}$ is the average value of v_x^2 . Since isotropy has been assumed, $\overline{v_x^2} = \overline{v_y^2} = \overline{v_z^2}$, and their sum is $\overline{v^2}$, so that $\overline{v_x^2} = \overline{v^2}/3$, and

$$(1. 13) \quad PV = \frac{2}{3}\left(\frac{1}{2}m\overline{v^2}\right)N = \frac{2}{3}E.$$

As before, the pressure-volume product is found to be two-thirds of the total kinetic energy of the system.

Comparison of (13) with the perfect gas equation, (2), shows that

$$(1. 14) \quad \frac{1}{2}m\overline{v^2} = \frac{3}{2}kT, \quad E = \frac{3}{2}NkT,$$

which is similar to (3) except that now the *average* kinetic energy per molecule is used instead of assuming that the kinetic energy is the same for all molecules.

1e. The Maxwell-Boltzmann Distribution Law

It is interesting to study more closely the distribution of molecules over the velocity ranges, that is, the functional dependence of $N(v_x, v_y, v_z)$ on its arguments. In this section, two proofs of the Maxwell-Boltzmann distribution law will be given.

The first derivation, published originally by Maxwell in his first paper on the subject, does not consider the mechanism of collisions between the molecules. This proof, however, is not rigorous, since it is based on an assumption which should first be proved. Maxwell assumed that the distributions of the molecules among the components of velocity in the direction of the three coordinate axes are independent of each other; in other words, the probability that the x component of the velocity has the value v_x is not influenced by the components in the other two directions. The number of molecules, $N(\vec{v})$, of the velocity \vec{v} , can then be expressed as a product of three functions of v_x , v_y , and v_z , alone. Since the space is assumed to be isotropic these three functions must be the same, and, moreover, $N(\vec{v})$ can depend only on the magnitude of velocity, or if we wish to write it so, on the square of the magnitude, $v_x^2 + v_y^2 + v_z^2 = v^2$.

These two conditions lead to the relation that

$$(1. 15) \quad N(\vec{v}) = f(v_x) \cdot f(v_y) \cdot f(v_z) = F(v^2).$$

If $v_x = v_y = 0$, then $v^2 = v_z^2$, and if the symbol a is used for the value of f when its argument is zero, $a = f(0)$,

$$a^2 f(v_x) = F(v_x^2),$$

or, by insertion into (15),

$$(1. 16) \quad F(v^2) = a^{-6} F(v_x^2) \cdot F(v_y^2) \cdot F(v_z^2).$$

This functional relationship (16) is satisfied only if F is of the form $Ae^{-\alpha v^2}$. To show this, equation (16) may be transformed into a differential equation by differentiating both sides with respect to v_y^2 , and then setting $v_y = v_z = 0$. The symbol α is defined by

$$(1. 17) \quad \alpha = -a^{-3} \left(\frac{\partial F(v_y^2)}{\partial (v_y^2)} \right)_{v_y=0}.$$

Since $F(0)$ is a^3 , one obtains

$$(1. 18) \quad \frac{\partial F(v_x^2)}{\partial (v_x^2)} = -\alpha F(v_x^2),$$

or

$$(1. 19) \quad F(v_x^2) = Ae^{-\alpha v_x^2}, \quad N(\vec{v}) = Ae^{-\alpha v^2}.$$

The value of the parameters A and α can be determined from the total number of particles N and the total kinetic energy E of the system. Before doing this we shall derive (19) rigorously without making the assumption that the distribution of the molecules among the components of the velocity is independent.

In order to do this it will be necessary to consider the collisions between the molecules in the system. In order to have collisions by which kinetic energy can be transferred from one molecule to another it must be assumed that there are forces operative in the system. The magnitude of the forces, or the laws governing them, need not be known, but it is essential that they be negligibly small except at distances of approach between the molecules which are very small compared to the average distances between them. Only under this condition is the potential energy negligible for all probable positions of the molecules in the system. Stated differently, it is important that at any instant an infinitesimal fraction of the molecules are in the process of undergoing a collision.

Consider one particular type of collision process, and its reverse, namely, the process by which particles of the vectorial velocities \vec{v} and \vec{u} collide, and emerge with the velocities \vec{v}' and \vec{u}' , respectively. Since the sum of the kinetic energies of the particles must remain unchanged in the collision, the condition

$$(1. 20) \quad v^2 + u^2 = v'^2 + u'^2$$

must be fulfilled.

The total number of times that this process occurs in a second will be called the rate of the process, and must be proportional to the number of particles of velocity \vec{v} and \vec{u} present, that is, to the product $N(\vec{v}) \cdot N(\vec{u})$. The rate of the reverse process in which particles of velocities \vec{v}' and \vec{u}' emerge with velocities \vec{v} and \vec{u} has to be proportional to $N(\vec{v}') \cdot N(\vec{u}')$. At equilibrium the rates of the two processes are equal.* We shall show that the proportionality constants entering into the two rates are also identical, from which the relation

$$(1. 21) \quad N(\vec{v}) \cdot N(\vec{u}) = N(\vec{v}') \cdot N(\vec{u}')$$

between the equilibrium numbers of molecules of velocities \vec{v} , \vec{u} , \vec{v}' and \vec{u}' results. The only solution of (21) with (20) is (19).

That the proportionality constants of the two rates in question must be equal, if the two particles are unaffected during the course of the

* We are assuming complete reversibility, namely, that at equilibrium the rate of any process and that of its inverse are equal. The fact that this is generally true is discussed at the end of section 2i.

collision by the walls or by the other particles of the system, may be demonstrated in the following manner. Take the point of view of an observer moving with the velocity of the center of gravity of the two particles, namely, $\frac{1}{2}(\vec{v} + \vec{u}) = \frac{1}{2}(\vec{v}' + \vec{u}')$ (conservation of momentum; see Fig. 1. 2). To this observer the two processes, one which converts

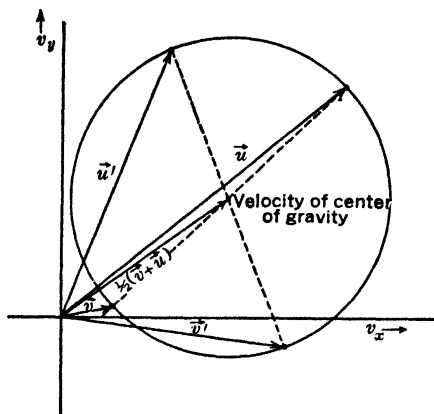

FIG. 1. 2. Representation of the velocity vectors in two-dimensional velocity space, before and after a collision between two particles of equal mass.

velocities \vec{v} and \vec{u} into \vec{v}' and \vec{u}' , and the other which converts \vec{v}' and \vec{u}' into \vec{v} and \vec{u} , are exactly similar. In both cases two molecules moving with equal and opposite velocities of magnitude $\frac{1}{2}|\vec{v} - \vec{u}| = \frac{1}{2}|\vec{v}' - \vec{u}'|$ approach, collide, and leave each other with velocities again oppositely directed, and of the original magnitude. The angles by which the particles are deflected are the same for both particles and for the two processes. There is no conceivable cause, other than the effect of the other particles or the walls of the system,* which could

make the two absolute rate constants differ. Equation (21) is thereby proved.

The functional relationship (21), together with (20), has (19) as its only solution. This can be shown by taking the special case that $\vec{v}' = 0$, for which $u'^2 = v^2 + u^2$. Since the space is isotropic, so that $N(\vec{v})$ can depend only on the magnitude, and not on the direction, of \vec{v} , one may, as before, write $N(\vec{v}) = F(v^2)$, obtaining

$$(1. 22) \quad F(0) \cdot F(v^2 + u^2) = F(v^2) \cdot F(u^2).$$

This equation has essentially the same nature as (16), and may also be transformed into the differential equation (18) by differentiation with respect to u^2 and subsequent choice of $u = 0$.

It is readily seen that collisions between more than two particles do not change this result.

The number $N(v)$ of molecules with magnitude of velocity v , from

* The influence of the distribution of the other molecules in the velocity space is the cause of the difference between the results of this consideration and that of Chapter 5 in which quantum mechanics is employed.

(7) and (19), is seen to take the form

$$(1. 23) \quad N(v) = 4\pi v^2 N(\vec{v}) = 4\pi A v^2 e^{-\alpha v^2}.$$

The two constants A and α are calculated from the total number of molecules N , and the total kinetic energy E , which is related to the temperature by (13) and (14). In performing these operations two

definite integrals, $\int_0^\infty v^2 e^{-\alpha v^2} dv$ and $\int_0^\infty v^4 e^{-\alpha v^2} dv$, are encountered. The

transformation to the new variable $z = \alpha v^2$, $dz = 2\alpha v dv$, leads to the forms

$$\int_0^\infty v^2 e^{-\alpha v^2} dv = \frac{1}{2} \alpha^{-3/2} \int_0^\infty z^{1/2} e^{-z} dz = \frac{1}{4\alpha} \left(\frac{\pi}{\alpha}\right)^{1/2}$$

$$\int_0^\infty v^4 e^{-\alpha v^2} dv = \frac{1}{2} \alpha^{-5/2} \int_0^\infty z^{3/2} e^{-z} dz = \frac{3}{8\alpha^2} \left(\frac{\pi}{\alpha}\right)^{1/2}.$$

The values of integrals of this sort are tabulated in the Appendix, A II.

The condition

$$(1. 24) \quad N = \int_0^\infty N(v) dv = 4\pi A \int_0^\infty v^2 e^{-\alpha v^2} dv = A \left(\frac{\pi}{\alpha}\right)^{3/2}$$

leads to

$$A = N \left(\frac{\alpha}{\pi}\right)^{3/2}$$

or, with (23),

$$(1. 25) \quad N(v) = 4\pi N \left(\frac{\alpha}{\pi}\right)^{3/2} v^2 e^{-\alpha v^2}.$$

The parameter α is necessarily positive, for otherwise the integration of equation (24) could not have been performed. Indeed, a formula predicting an infinite number of molecules with infinite velocities is obviously nonsensical. For the evaluation of α the total kinetic energy is calculated by the use of (8), and compared with (14) which equates the average kinetic energy per molecule to $3kT/2$. The steps are:

$$(1. 26) \quad E = \int_0^\infty \frac{1}{2} m v^2 N(v) dv = 2\pi m N \left(\frac{\alpha}{\pi}\right)^{3/2} \int_0^\infty v^4 e^{-\alpha v^2} dv = \frac{3mN}{4\alpha},$$

and combining the above with (14),

$$E = \frac{3}{2} NkT = \frac{3mN}{4\alpha},$$

$$(1. 27) \quad \alpha = \frac{m}{2kT}.$$

With this value of α the final form of the Maxwell-Boltzmann distribution law is

$$(1. 28) \quad N(\vec{v}) = N(v_x, v_y, v_z) = N\left(\frac{m}{2\pi kT}\right)^{3/2} e^{-mv^2/2kT},$$

$$(1. 29) \quad N(v) = 4\pi N\left(\frac{m}{2\pi kT}\right)^{3/2} v^2 e^{-mv^2/2kT}.$$

The quantity in the exponent, $mv^2/2kT$, is the kinetic energy of the molecule divided by kT . It will be found, in general, that, in dealing with molecules having internal energy, the exponential of the energy divided by kT always occurs in the expression for the distribution of molecules with respect to the energy.

If the gas as a whole moves with respect to the observer, that is, if the gas is streaming with the velocity \vec{u} , the velocities \vec{v} of the individual particles will be distributed randomly about this prevalent velocity. In this case equation (28) has the form

$$(1. 28') \quad N(\vec{v}) = N(v_x, v_y, v_z) = N\left(\frac{m}{2\pi kT}\right)^{3/2} e^{-m(\vec{v}-\vec{u})^2/2kT}.$$

It is readily seen that then the average value of \vec{v} is equal to \vec{u} .

1f. The Average Velocity

Average values of functions of the velocity vector, or of the velocity magnitude, may be found with the aid of the functions (28) and (29).

The function $N(\vec{v}) = N(v_x, v_y, v_z)$, (28), is plotted in Fig. 1. 3 against the magnitude of the velocity. The function has a maximum at $v_x = v_y = v_z = 0$. If v_y and v_z are kept constant and $N(\vec{v})$ is plotted as a function of v_x , the resulting curve is proportional to the curve of $N(\vec{v})$ plotted against v , is symmetrical in $+v_x$ and $-v_x$, decreasing from a maximum at $v_x = 0$ exponentially to zero on both sides. From this fact it is immediately obvious that the average value of v_x , namely,

$$(1. 30) \quad \bar{v}_x = \frac{1}{N} \int_{-\infty}^{+\infty} v_x N(v_x, v_y, v_z) dv_x dv_y dv_z = 0,$$

since the integrand is positive for positive values of v_x , and antisymmetrically negative for negative values of this variable. Indeed, the average value of any odd power of v_x vanishes. The average value of the velocity vector \vec{v} is therefore $\vec{v} = 0$. This fact is inherent in the assumption of isotropy, the assumption of equation (7) that no preferential direction exists.

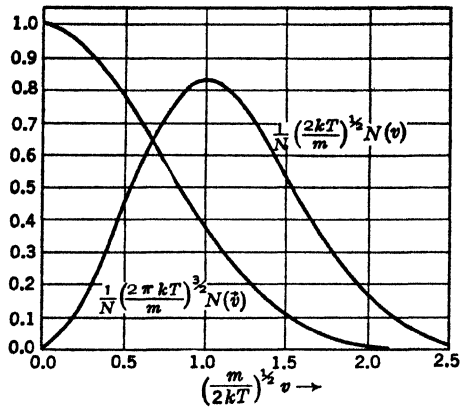

FIG. 1. 3. Maxwell-Boltzmann Distribution.

The nature of the function $N(v)$, (29), is quite different. This function is defined only for positive values of v , the magnitude of velocity. It, also, is plotted in Fig. 1. 3. It rises from 0 at $v = 0$ to a maximum at $v = v_m$, and goes asymptotically to zero as v goes to infinity. The velocity which corresponds to the maximum, v_m , is the most probable velocity magnitude, or briefly, the most probable velocity. Its value is determined by the condition that

$$\begin{aligned} & \text{Plot of} \\ & \frac{1}{N} \left(\frac{2kT}{m} \right)^{1/2} N(v) = \frac{4}{\pi^{1/2}} \frac{m}{2kT} v^2 e^{-mv^2/2kT} \\ & \text{and} \\ & \frac{1}{N} \left(\frac{2\pi kT}{m} \right)^{3/2} N(v) = e^{-mv^2/2kT} \\ & \text{against} \\ & \left(\frac{m}{2kT} \right)^{1/2} v \\ & \left[\int_0^{\infty} \frac{1}{N} \left(\frac{2kT}{m} \right)^{1/2} N(v) d \left(\frac{m}{2kT} \right)^{1/2} v = 1 \right] \end{aligned}$$

$$\left(\frac{\partial N(v)}{\partial v} \right)_{v=v_m} = 0$$

or

$$\left(1 - \frac{mv_m^2}{2kT} \right) = 0,$$

$$(1. 31) \quad v_m = \left(\frac{2kT}{m} \right)^{1/2}$$

The kinetic energy corresponding to the most probable velocity is kT .

The function $N(v)$, (29), may be used to calculate the average of any power of the magnitude of velocity. It is to be noted that the ν th root of the average of the ν th power of the velocity is *not* the same as the

average velocity, \bar{v} . For the average velocity,

$$\begin{aligned}
 \bar{v} &= \frac{1}{N} \int_0^{\infty} v N(v) dv = 4\pi \left(\frac{m}{2\pi kT} \right)^{3/2} \int_0^{\infty} v^3 e^{-mv^2/2kT} dv \\
 &= 4\pi \left(\frac{m}{2\pi kT} \right)^{3/2} \left(\frac{2kT}{m} \right)^2 \int_0^{\infty} x^3 e^{-x^2} dx \\
 &= \frac{4}{\pi^{1/2}} \left(\frac{2kT}{m} \right)^{1/2} \frac{1}{2} \int_0^{\infty} ye^{-y} dy, \\
 (1. 32) \quad \bar{v} &= \frac{2}{\pi^{1/2}} \left(\frac{2kT}{m} \right)^{1/2} = 1.1283 \left(\frac{2kT}{m} \right)^{1/2}
 \end{aligned}$$

is obtained. The average of the velocity squared is

$$\begin{aligned}
 (1. 33) \quad \overline{v^2} &= \frac{1}{N} \int_0^{\infty} v^2 N(v) dv = \frac{4}{\pi^{1/2}} \left(\frac{2kT}{m} \right) \frac{1}{2} \int_0^{\infty} y^{3/2} e^{-y} dy \\
 &= \frac{3}{2} \left(\frac{2kT}{m} \right).
 \end{aligned}$$

The root mean square velocity is the square root of this:

$$(1. 34) \quad (\overline{v^2})^{1/2} = \left(\frac{3}{2} \right)^{1/2} \left(\frac{2kT}{m} \right)^{1/2} = 1.2247 \left(\frac{2kT}{m} \right)^{1/2}.$$

These various averages of the velocity are all proportional to $(2kT/m)^{1/2}$, but differ from each other, and from the most probable velocity v_m , in numerical factors, not greatly different from unity. The $(\nu + 1)$ th root of the average of the $(\nu + 1)$ th power of the velocity is always greater than the ν th root of the average of the ν th power. In calculations into which averages of the velocity enter, care must be taken that the correct average is used. In general, the average value of any function $f(v)$ of the velocity is given by the integral $N^{-1} \int f(v) N(v) dv$, equation (10); if the average of a function involving the ν th power of the velocity is sought, the average of this ν th power, and *not* the ν th power of the average velocity, must be taken. For instance, it is the root mean square velocity, (34), which gives the correct value of the average kinetic energy. Of course, the average velocity square, (33), may just as well be calculated from $N(v_x, v_y, v_z)$ by $\overline{v^2} = \overline{v_x^2} + \overline{v_y^2} + \overline{v_z^2}$, or, since $\overline{v_x^2} = \overline{v_y^2} = \overline{v_z^2}$, simply as $\overline{v^2} = 3\overline{v_x^2}$.

The numerical values of these average velocities are surprisingly

high. One finds, for instance, that the average velocity, \bar{v} , is 1750 meters per second for H_2 at $273^\circ K.$, and 425 meters per second for O_2 at the same temperature. These high velocities were once regarded as a severe objection to the theory, since they had to be reconciled with the observed low diffusion velocities. However, these velocities are completely random in direction. A molecule makes frequent collisions with others, so that the macroscopic velocity with which it progresses through the gas is very much smaller. The theory of the mean free path, defined in section 1h, is able to predict the correct diffusion velocities (see sections 1h, i, j, and k).

1g. The Number of Molecules Hitting a Wall

For the calculation of the pressure in section 1d it was found that the number of molecules with x component of velocity between v_x and $v_x + dv_x$ striking unit surface of a wall which is normal to the x axis is $[v_x N(v_x)/V] dv_x$ per second. The total number Z of molecules striking the wall per square centimeter per second is, then,

$$(1. 35) \quad Z = \frac{1}{V} \int_0^{\infty} v_x N(v_x) dv_x,$$

or, from the expression (4) defining the function $N(v_x)$, and from (28) giving $N(v_x, v_y, v_z)$,

$$(1. 36) \quad Z = \frac{N}{V} \left(\frac{m}{2\pi kT} \right)^{3/2} \int_0^{\infty} \int_{-\infty}^{\infty} \int_{-\infty}^{\infty} v_x e^{-m(v_x^2 + v_y^2 + v_z^2)/2kT} dv_x dv_y dv_z,$$

where the integration over dv_y and dv_z is extended from minus to plus infinity, but that over dv_x from only zero to plus infinity.

The transformation to new variables, $\zeta = (m/2kT)^{1/2} v_y$, and an analogously defined variable in place of v_z changes the integral over dv_y and dv_z to the product of two integrals of the type $\int_{-\infty}^{\infty} e^{-\zeta^2} d\zeta$, each of which has the value $\pi^{1/2}$. Changing to $x = mv_x^2/2kT$, $dx = (mv_x/kT) dv_x$ transforms the integral over dv_x into an integral of the type $\int_0^{\infty} e^{-x} dx$, which has the value unity. One then obtains for Z ,

$$(1. 37) \quad Z = \frac{N}{V} \frac{1}{\pi} \left(\frac{kT}{2\pi m} \right)^{1/2} \left[\int_{-\infty}^{+\infty} e^{-\zeta^2} d\zeta \right]^2 \left[\int_0^{\infty} e^{-x} dx \right] \\ = \frac{N}{V} \left(\frac{kT}{2\pi m} \right)^{1/2}.$$

The use of the perfect gas equation (2), that $PV = NkT$, so that $N/V = P/kT$, enables one to express Z in terms of the pressure, instead of the number of molecules per unit volume, N/V ,

$$(1. 38) \quad Z = \frac{P}{(2\pi mkT)^{1/2}}.$$

This, then, is the expression for the number of molecules, Z , striking a square centimeter of wall per second.

Numerical evaluation of the constants leads to

$$(1. 39) \quad Z = 3.537 \times 10^{22} \frac{P_{\text{mm.}}}{(MT)^{1/2}} \text{sec.}^{-1} \text{cm.}^{-2},$$

in which $P_{\text{mm.}}$ is the pressure expressed in millimeters of mercury, and M is the molecular weight of the gas.

The quantity Z is also the number of molecules escaping per second per square centimeter of hole into a vacuum, provided that the pressure is sufficiently low, so that the mean free path of the molecules is larger than the diameter of the hole.

It is seen from equation (39) that in hydrogen, of molecular weight $M = 2$, at 1 atmosphere pressure, $P = 760$ mm., and at room temperature, $T = 300^\circ\text{K.}$, Z has the value $1.1 \times 10^{24} \text{sec.}^{-1} \text{cm.}^{-2}$. The number of molecules hitting a square centimeter of wall per second corresponds to approximately 1.8 moles of gas.

1h. The Mean Free Path

The average distance traveled by a molecule between collisions cannot be so clearly defined, or so unambiguously measured, as the pressure and average energy.

For a rough calculation we shall assume the molecules to act as rigid spheres. Two molecules of diameters d_1 and d_2 , respectively, collide when the distance between their centers becomes equal to the sum of their radii, $\frac{1}{2}(d_1 + d_2)$. In considering the collisions which one specified molecule of diameter d_1 undergoes we may therefore treat that molecule as a point particle, whereas the others are treated as having their diameter increased by d_1 , that is, the molecule n as having the diameter $d_1 + d_n$.

Assume the molecule in question, of diameter d_1 , moving in the x direction, to be shot into a gas consisting of molecules of diameter d_2 . Each of the gas molecules presents to the approaching one a target of diameter $d_1 + d_2$, and of area $\pi(d_1 + d_2)^2/4$. The number of such targets in a plate normal to the x direction, of unit area and thickness Δx , is $(N_2/V) \Delta x$, where N_2 denotes the number of molecules of kind 2

in the system, and V the total volume. The total area covered by these targets, neglecting possible overlapping, is $[\pi(d_1 + d_2)^2 N_2 / 4V] \Delta x$. The probability that the incoming particle makes a collision in traversing the distance Δx is, then, the ratio of the surface covered by the targets to the total surface, namely,

$$\frac{\pi}{4} (d_1 + d_2)^2 \frac{N_2}{V} \Delta x.$$

The quantity

$$(1. 40) \quad \frac{\pi}{4} (d_1 + d_2)^2 \frac{N_2}{V} = \frac{1}{l},$$

having the dimension of a reciprocal length, will be abbreviated by the symbol $1/l$.

The significance of l is that it represents the mean free path, or the average distance traversed by a particle (of kind 1) before a collision (with a particle of kind 2). This can be seen in the following manner. Assume that a number n_0 of particles with velocities of approximately equal magnitude and direction, chosen as the x direction, enter the gas at $x = 0$. Each collision removes a particle from the beam, so that the number of particles, $n(x)$, arriving at a distance x , is uniformly decreasing. The decrease of n at a place x is equal to the number of molecules reaching that place multiplied by the probability per particle of a collision, namely,

$$-\frac{dn}{dx} \Delta x = \frac{1}{l} n(x) \Delta x.$$

This has the solution

$$(1. 41) \quad n(x) = n_0 e^{-x/l}.$$

The distance x at which a particle makes a collision is called its free path. The mean free path is obtained by multiplying the path x by the number of particles colliding between x and $x + \Delta x$, summing over all ranges Δx , and dividing by the total number of molecules, namely,

$$(1. 42) \quad -\frac{1}{n_0} \int_0^\infty x \frac{dn}{dx} dx = \int_0^\infty \frac{x}{l} e^{-x/l} dx = l,$$

which identifies the quantity l with the mean free path.

At the distance $x = l$ the number of particles in the beam has been reduced to the fraction e^{-1} of the initial number, that is, more than half of the molecules have undergone a collision at some smaller value of x . The fact that l is nevertheless the mean free path comes about because,

of the molecules reaching the place $x = l$, some go very far: a fraction e^{-1} of them go further than $x = 2l$ before a collision, a fraction e^{-2} further than $x = 3l$, etc.

This formula for the mean free path has been derived by assuming that one molecule is moving, whereas the others are practically at rest. If we use this expression for the motion of one gas molecule among others of the same kind, and therefore of the same average velocity, we introduce a certain inaccuracy. However, this amounts only to a small numerical factor, which is unimportant in view of the much graver assumption of rigid molecular diameters.

We find, therefore, within the accuracy of this argument, for a gas of one constituent,

$$(1. 43) \quad l = \frac{V}{\pi d^2 N}.$$

In a mixture of two gases the total number of collisions which one particle undergoes is composed additively of the number of collisions which it suffers with each kind of particle. We find, therefore, for the mean free path l_1 and l_2 of each kind of particle

$$(1. 44) \quad \begin{aligned} l_1 &= 4V(4\pi d_1^2 N_1 + \pi(d_1 + d_2)^2 N_2)^{-1}, \\ l_2 &= 4V(\pi(d_1 + d_2)^2 N_1 + 4\pi d_2^2 N_2)^{-1}. \end{aligned}$$

To obtain an idea of the order of magnitude of the mean free path one can use the equation of state of the perfect gas to replace the density N/V in l by P/kT , obtaining

$$(1. 45) \quad l = \frac{kT}{\pi d^2 P}.$$

At room temperature, $T = 300^\circ\text{K}$., and if the diameter d is measured in Ångström units, that is, in 10^{-8} cm., one finds

$$(1. 46) \quad l = 132(Pd_\text{Å}^2)^{-1}.$$

This relation gives l in centimeters if the pressure is measured in c.g.s. units, namely, in dynes per square centimeter. If P is measured in millimeters of mercury the relation becomes

$$(1. 47) \quad l \cdot P_{\text{mm.}} = 0.1(d_\text{Å})^{-2},$$

with l in centimeters. For atoms and simple molecules the diameter d is a few Ångström units, so that the mean free path in millimeters times

the pressure in millimeters is about one-tenth. With $d = 5\text{\AA}$ one obtains the following numerical results:

P dynes per cm^2	P mm of Hg	P atmospheres	l cm
1	7.5010×10^{-4}	9.8697×10^{-7}	5.3
1.332×10^3	1	1.3158×10^{-3}	3.9×10^{-3}
1.0132×10^6	760	1	5.2×10^{-6}

The average time between collisions is obtained by dividing the mean free path by the average velocity. At room temperature the velocity is of the order of a hundred meters per second, so that the time between collisions at atmospheric pressure is about 10^{-10} sec. One molecule of a gas at standard conditions undergoes about 10^{10} collisions per second.

In this development the assumption furthest from the truth is the representation of the molecules as rigid spheres. It is due to this simplification that a mean free path independent of velocity, and therefore independent of temperature, was obtained. Actually, the molecules exert long-range attractive forces and short-range repulsive forces upon one another. It is then obviously rather difficult to define a collision and a mean free path, since each particle is at any time interacting with others, and is constantly suffering slight deflections of its path. This is borne out by experiments with sharply defined molecular beams* in almost perfect vacuum. The effective cross section of the remaining gas particles appears then to be much larger than that calculated from gas kinetic data, since a very small deflection effectively removes a molecule from the beam. However, a very small deflection corresponds to a transfer of only a small amount of momentum and energy and is therefore of no importance for the transfer of heat or the viscosity of gases.

A better approximation for the expression of the mean free path was obtained by Sutherland† by representing the molecules as hard spheres, of diameter d_0 , which, in addition, attract one another. An appreciable deflection of one molecule is obtained only if its sphere touches another one, and only in this case shall we speak of a collision. If a fast molecule travels past another one which is at rest, it will be but

* O. Stern, *Z. Physik*, **39**, 751 (1926).

† W. Sutherland, *Phil. Mag.*, (V) **36**, 503 (1893).

slightly deflected. A slow molecule, however, approaching along the same line, may be deflected so much that it touches the other one, that is, it makes a collision. The effective cross section of a molecule in a collision depends then upon the relative velocity, and the average cross section upon temperature. One obtains

$$(1. 48) \quad d^2 = d_0^2 \left(1 + \frac{C}{T} \right),$$

where the quantity C , the Sutherland constant, is determined by the nature of the attractive forces.

1i. Viscosity

The mean free path enters into the theories of all phenomena of propagation of physical properties over macroscopic distances. These are notably the transport of momentum, which is connected with the viscosity of gases; the transport of energy, or heat conduction; and the transport of mass, or diffusion. These three processes will be treated here in a rather crude manner. The averaging over different molecules will be done somewhat incorrectly, so that numerical factors are quite untrustworthy. A more exact theory, however, becomes very complicated.

The mechanical set-up in an experiment for the determination of the viscosity of gases is usually such that the gas is contained between two parallel plane plates a distance a from each other. The plates may be taken to be parallel to the xy plane and located at the height $z = 0$ and $z = a$, respectively. The lower plate is kept at rest, while the upper one is moving with a constant velocity u in the x direction.

If the distance a between the plates is large compared to the mean free path the gas "sticks" to the plates: near the upper plate, at $z = a$, the average velocity of the molecules is $\bar{v}_x = u$; near the lower one, at $z = 0$, $\bar{v}_x = 0$. The average velocity at a height z between the two plates will be denoted by $u(z)$ (compare end of section 1e). Since, owing to the random motions of the particles, equally many molecules from above and from below reach the height z , the average velocity $u(z)$ will be a linear function of the height, namely, $u(z) = uz/a$. If the mass of the gas particles is denoted by m there exists a linear drop of average momentum

$$(1. 49) \quad G(z) = \frac{muz}{a}.$$

Although equally many molecules from above and from below reach the height z during a second the ones from above will, on the average,

bring with them a greater value of G than the ones from below. There will therefore be a constant flow of momentum through any vertical plane. This flow, through a square centimeter per second, will be denoted by $\Gamma(z)$ and will be calculated presently. If the flow in the positive z direction is calculated, $\Gamma(z)$ will be negative.

The momentum *arriving* at the lower plate, $-\Gamma(0)$, represents the force per square centimeter of surface which tends to move the lower plate in the same direction as the upper one. $-\Gamma(a)$ is the momentum lost to the gas by the upper plate per square centimeter of surface per second, or the frictional force counteracting the uniform motion.

The ensuing calculation of $\Gamma(z)$, the flow of the physical quantity G per second through a square centimeter parallel to the xy plane at the height z , will be done without making use of the special form of $G(z)$. The result may then be taken over immediately for cases in which any physical property $G(z)$ varies with height.

The number of particles of velocity $\vec{v} = (v_x, v_y, v_z)$ which pass in a second through the square centimeter in question is, precisely as discussed in the calculation of the pressure in section 1d, equal to the number of particles which are

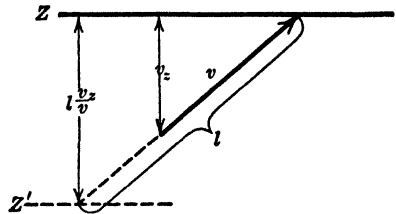

FIG. 1. 4.

located at the beginning within a parallelepiped the base of which is the square centimeter and the length of which is \vec{v} . The height of the figure is therefore $|v_z|$, its volume $|v_z|$, and the average number of particles in it $|v_z| \times N(v_x, v_y, v_z)/V$. If $v_z > 0$ the particles cross the surface from below; otherwise they come from above. The *net* flow of particles through the square centimeter, that is, the surplus of particles going from below to above, is obtained by integrating $v_z \times N(v_x, v_y, v_z)/V$, without the absolute value sign, over all velocities. In a stationary state the net flow of particles *must* be zero. If the velocity component $+v_z$ occurs just as frequently as $-v_z$, that is, if the variation of G with height does not influence the distribution of the z component of the velocity, $\int_{-\infty}^{\infty} v_z N(v_x, v_y, v_z) dv_z$ is obviously zero.

The particles arriving at the height z have traveled in a straight line since they underwent their last collision. On the average, they will, since that time, have traversed the distance l , if l signifies the mean free path. The last collision of a particle with velocity \vec{v} has therefore, on the average, occurred at a height z' which is given by $z' = z - (v_z l/v)$.

The assumption is now made that at that collision the particle has come into equilibrium with its surroundings. The average value of the quantity G which the particles of velocity \vec{v} , coming from the height z' , bring with them is then

$$(1. 50) \quad G(z') = G[z - (v_z l/v)] = G(z) - \frac{v_z l}{v} \cdot \frac{dG}{dz}.$$

The net flow of G , namely, the difference of the amount of G carried up through the plane and the amount carried downward, is obtained by multiplying (50) by the number $v_z N(\vec{v})/V$ of particles crossing the surface in the positive direction, and integrating over all velocities,

$$(1. 51) \quad \Gamma(z) = G(z) \iiint_{-\infty}^{\infty} \frac{N(\vec{v})}{V} v_z dv_x dv_y dv_z \\ - l \frac{dG}{dz} \iiint_{-\infty}^{\infty} \frac{v_z^2 N(\vec{v})}{vV} dv_x dv_y dv_z.$$

The first term, $G(z)$ times the excess of particles streaming through the element of plane in one direction, is zero in the stationary state. The second term may be simplified by considering that in an isotropic space, on the average, $v_x^2 = v_y^2 = v_z^2 = (1/3)v^2$. Actually, in the problem treated here, the velocity in the x direction is somewhat different owing to the average motion of the substance in the x direction. However, the plate velocity u is very small compared to the gas kinetic velocities. One obtains then

$$(1. 52) \quad \Gamma(z) = -\frac{1}{3} l \frac{dG}{dz} \frac{N}{V} \bar{v}.$$

The minus sign in the formula shows that the flow takes place in the direction from higher to lower G values. If dG/dz is positive the flow in the $+z$ direction must be negative.

In the special case of transport of momentum, according to (1. 49), $dG/dz = mu/a$, one finds

$$(1. 53) \quad \Gamma = -\frac{1}{3} \frac{N}{V} ml\bar{v} \frac{u}{a}.$$

The frictional force per square centimeter of surface acting on the upper plate is usually written

$$F = -\frac{\eta u}{a};$$

η , the coefficient of viscosity, has, according to (53), the value

$$(1. 54) \quad \eta = \frac{1}{3} \frac{N}{V} m \bar{v}.$$

If equation (43) for the mean free path is inserted in (54), one obtains

$$(1. 55) \quad \eta = \frac{1}{3\pi} \frac{m\bar{v}}{d^2}.$$

The average velocity \bar{v} is, according to (32), $\bar{v} = 2(2kT/\pi m)^{1/2}$. This leads to

$$(1. 56) \quad \eta = \frac{1}{3} \left(\frac{2}{\pi}\right)^{3/2} \frac{(mkT)^{1/2}}{d^2}.$$

This equation predicts that the coefficient of viscosity is independent of the density, or the pressure, a function of temperature only. This result was first deduced theoretically by Maxwell and considered at that time to be rather startling. Subsequent experimentation confirmed the theoretical conclusion over a wide range of pressures. That the viscosity is independent of the pressure has since been regarded as a strong support of the kinetic theory.

Gibson,* for instance, has measured the viscosity of hydrogen at 25°C. in the pressure range from 11 to 295 atmospheres. The viscosity η is 894×10^{-7} poise (gm. cm.⁻¹ sec.⁻¹) at 10.92, 12.66, and 15.28 atmospheres. It then increases gradually to 901×10^{-7} at 60 atmospheres, and 958×10^{-7} at 294.7 atmospheres. The gradual increase does not exceed that expected from deviations from the perfect gas law, which are considerable at the higher pressures.

The fact that the density N/V drops out of equation (56) comes about in the following manner. The number of particles arriving per second at the height z is proportional to the density. The mean free path, however, is inversely proportional to the density: at increasing density the molecules have made their last collision closer to the z plane in question and therefore bring with them values of G which are more nearly equal to $G(z)$.

At very low pressures deviations from (56) are observed; η begins to decrease. This is due to the fact that the assumption that the gas sticks to the plates becomes invalid when the mean free path is comparable to the distance a between the plates (see Problem 1. 4).

Equation (56) predicts further that the viscosity increases propor-

* R. O. Gibson, Dissertation, Amsterdam, 1933, given in Landolt-Börnstein, Eg. IIIa, p. 189.

tionally to $T^{1/2}$. Actually, a much stronger dependence on temperature has been observed. If, instead of a temperature-independent molecular diameter, the Sutherland approximation (48) is used, one obtains

$$(1. 57) \quad \eta = \frac{1}{3} \left(\frac{2}{\pi} \right)^{3/2} \frac{(mkT)^{1/2}}{d_0^2 \left(1 + \frac{C}{T} \right)},$$

where the constant C , a function of the attractive forces, is unknown. If C is properly adjusted, satisfactory agreement between observed and calculated data is obtained.

1j. Heat Conduction

If there is a gradient of temperature in the z direction, the average energy per molecule, $\bar{\epsilon}$, will vary with height. We wish to calculate the flow of energy through a plane at the height z and therefore, in the equations of the previous section, have to replace the quantity G by

$$(1. 58) \quad G(z) = \bar{\epsilon}(z), \quad \frac{dG}{dz} = \frac{d\bar{\epsilon}}{dT} \frac{dT}{dz}.$$

$d\bar{\epsilon}/dT$ is connected with the heat capacity C_V at constant volume. C_V is defined as the increase of energy with increasing temperature for a mole of substance; that is, for N_0 molecules, if N_0 is Avogadro's number,

$$(1. 59) \quad C_V = \frac{dE}{dT} = N_0 \frac{d\bar{\epsilon}}{dT}.$$

This leads to

$$(1. 60) \quad \frac{dG}{dz} = \frac{C_V}{N_0} \frac{dT}{dz}.$$

By inserting (60) into (52) the flow of heat through a square centimeter parallel to the xy plane at the height z is found to be

$$(1. 61) \quad \Gamma(z) = -\frac{1}{3} l \frac{N}{V} \frac{C_V}{N_0} v \frac{dT}{dz}.$$

This is usually written

$$\Gamma(z) = -\kappa \frac{dT}{dz}.$$

The heat conductivity, κ , is then

$$(1. 62) \quad \kappa = \frac{1}{3} l \frac{N}{V} \frac{C_V}{N_0} v.$$

Comparison with (54), considering that mN_0 is the molecular weight M gives the relation

$$(1. 63) \quad \kappa = \frac{\eta C_V}{M}.$$

$C_V/M = c_V$ is the specific heat per gram of substance, so that $\eta c_V/\kappa = 1$. A more exact theory still predicts this quotient to be constant, but somewhat different from unity. In Table 1. 1 the quotient has been calculated for a few monatomic gases* from the values of κ and η given in Landolt-Börnstein. c_V was calculated from the energy relation (14) and the molecular weight.

TABLE 1. 1

Substance	$\kappa \times 10^5$	$\eta \times 10^5$	c_V	$\eta c_V/\kappa$
Helium.....	33.63	19.41	0.745	0.402
Neon.....	10.92	31.11	0.149	0.424
Argon.....	4.06	22.17	0.74	0.404

κ in cal. cm.⁻¹ sec.⁻¹ deg.⁻¹; η in c.g.s. units; c_V in cal. degree⁻¹.

1k. Diffusion

If two vessels connected by a tube with a stopcock are filled with two different gases, and if the stopcock is then opened, molecules will flow from the vessel with higher pressure to that of lower pressure. If pressure and temperature on both sides of the stopcock are equal there will be no streaming of gas. However, owing to the random heat motion, particles of kind 1 will drift into the vessel which originally contained particles of kind 2 only, and vice versa, until finally both vessels are filled with a uniform mixture of the two gases. This phenomenon is called diffusion.

For the calculation of the rate at which this process takes place an idealized experiment is considered. Assume a tube (of infinite diameter) to be filled with a mixture of two gases of kinds 1 and 2. Let the axis of the tube be the z direction, and assume that the composition of the mixture varies along z . The density of molecules of kind 1, that is, the number of molecules of kind 1 per cubic centimeter, which shall be denoted by n_1 , and the density of molecules of kind 2, n_2 , will then be

* We have compared here data for monatomic gases only. For these gases the total energy is the kinetic energy of translational motion, equation (14). Polyatomic molecules possess, in addition, internal energy (Chapter 6). It is questionable whether this energy will be readily transferred from one molecule to another in every collision.

functions of z . If we stipulate that pressure and temperature are uniform throughout the vessel, the equation of state of the perfect gas demands that the total density of molecules, $n = n_1(z) + n_2(z)$, be constant everywhere. This leads to

$$(1. 64) \quad n = n_1(z) + n_2(z); \quad \frac{dn_1}{dz} + \frac{dn_2}{dz} = 0.$$

Since the distribution of velocities is independent of the density of the gas, the number of particles of each kind per cubic centimeter with a certain velocity \vec{v} may be written

$$(1. 65) \quad n_1(\vec{v}, z) = n_1(z)f_1(\vec{v}), \quad n_2(\vec{v}, z) = n_2(z)f_2(\vec{v}),$$

where f_1 and f_2 are independent of z . Indeed, $f_1(\vec{v})$ is essentially the Maxwell distribution function, only normalized in such a fashion that

$\iiint_{-\infty}^{\infty} f_1(\vec{v}) dv_x dv_y dv_z = 1$. The average magnitude of velocity of the particles of kind 1 is independent of z and given by

$$(1. 66) \quad \bar{v}_1 = \iiint_{-\infty}^{\infty} |v| f_1(\vec{v}) dv_x dv_y dv_z.$$

A corresponding equation holds for molecules of kind 2.

The random motion of the molecules tends to bring about a uniform mixture of the gases. If $dn_1/dz > 0$, that is, if the concentration of particles of kind 1 is greater at larger height, there will be an excess of these particles streaming through a plane at the height z in the downward direction. The net flow of particles of kind 1, through an area of 1 cm.² of the plane perpendicular to the z axis, at the height z , in the direction of positive z , $\Gamma_1(z)$, will then be negative. It is usually written

$$(1. 67) \quad \Gamma_1(z) = -D_1 \frac{dn_1}{dz},$$

where D_1 is the diffusion constant.

The flow is calculated in precisely the same manner as in section 1i. A particle of kind 1 and velocity \vec{v} arriving at the height z comes, on the average, from a height $z' = z - (v_z l_1 / v)$, where l_1 is the mean free path of the molecules of kind 1. The density of such molecules at that height is

$$(1. 68) \quad n_1(\vec{v}, z') = n_1(z')f_1(\vec{v}) = n_1(z)f_1(\vec{v}) - \frac{v_z}{v} l_1 \frac{dn_1}{dz} f_1(\vec{v}).$$

The number of such particles crossing a square centimeter of a plane at the height z in the $+z$ direction per second is then

$$(1. 69) \quad v_z n_1(\vec{v}, z') = n_1(z) v_z f_1(\vec{v}) - \frac{v_z^2}{v} l_1 \frac{dn_1}{dz} f_1(\vec{v}).$$

The expression (69) is positive for all particles coming from below, that is, with $v_z > 0$; negative for those coming from above. The excess of particles going in the positive direction, Γ_1 , is, therefore, obtained by integrating (69) over all velocities. The first term vanishes, as before, leading to

$$(1. 70) \quad \Gamma_1(z) = -l_1 \frac{dn_1}{dz} \iiint_{-\infty}^{\infty} \frac{v_z^2}{v} f_1(\vec{v}) dv_x dv_y dv_z.$$

The integral is simply the average value of v_z^2/v . Since all directions of the velocity are equally probable, $\overline{v_z^2/v} = (1/3)\bar{v}$. The diffusion constant of the molecules of kind 1 is therefore

$$(1. 71) \quad D_1 = \frac{1}{3} l_1 \bar{v}_1.$$

Similarly, one obtains for the flow of particles of kind 2

$$(1. 67') \quad \Gamma_2 = -D_2 \frac{dn_2}{dz}$$

with

$$(1. 71') \quad D_2 = \frac{1}{3} l_2 \bar{v}_2.$$

By inserting into these equations the value of the mean free path (44) one obtains

$$(1. 72) \quad D_1 = \frac{4}{3\pi} \bar{v}_1 [4n_1 d_1^2 + n_2 (d_1 + d_2)^2]^{-1},$$

$$(1. 72') \quad D_2 = \frac{4}{3\pi} v_2 [n_1 (d_1 + d_2)^2 + 4n_2 d_2^2]^{-1}.$$

The D 's are inversely proportional to the density. If n is expressed with the help of the perfect gas law, $n = N/V = P/kT$, one obtains

$$(1. 73) \quad D_1 = \frac{4}{3\pi} \frac{kT\bar{v}_1}{P} \left[4 \frac{n_1}{n} d_1^2 + \frac{n_2}{n} (d_1 + d_2)^2 \right]^{-1},$$

$$(1. 73') \quad D_2 = \frac{4}{3\pi} \frac{kT\bar{v}_2}{P} \left[\frac{n_1}{n} (d_1 + d_2)^2 + 4 \frac{n_2}{n} d_2^2 \right]^{-1}$$

It is seen that D_1 and D_2 depend on the relative concentrations, n_1/n , n_2/n , but not very strongly, since the diameters of the molecules will not be vastly different. If the difference between the diameters is neglected one gets a relation between the diffusion constant of a gas and its viscosity coefficient,

$$D \cong \frac{V\eta}{Nm}.$$

This equation can at least be used to obtain the order of magnitude of D .

In general, the two diffusion constants D_1 and D_2 for the two kinds of particles are different, $D_1 \neq D_2$. It is then easily seen that the constants calculated in this manner cannot possibly be those which are observed in a closed tube. The total flow of particles in the $+z$ direction may be calculated by using the relation (64),

$$(1.74) \quad \Gamma = \Gamma_1 + \Gamma_2 = -D_1 \frac{dn_1}{dz} - D_2 \frac{dn_2}{dz} = -(D_1 - D_2) \frac{dn_1}{dz},$$

and it is seen that this does not vanish. This means that the density of particles, n , and therefore the pressure, do not remain constant throughout the tube, but, if Γ is positive, increase in the upper part. This absurd result is usually corrected by assuming that upon the calculated diffusion there is superimposed a uniform motion which just counteracts the increase in pressure. This uniform motion corresponds to a velocity $-\Gamma/n$ per particle, and a flow $-(n_1/n)\Gamma$ and $-(n_2/n)\Gamma$ of particles of kinds 1 and 2, respectively, through a square centimeter at the height z in the $+z$ direction.

If this flow is added to the one previously calculated, one obtains the corrected diffusion

$$(1.75) \quad \begin{aligned} \Gamma_1^* &= \Gamma_1 - \frac{n_1}{n} \Gamma = \frac{n_2}{n} \Gamma_1 - \frac{n_1}{n} \Gamma_2 \\ &= -\left(\frac{n_2}{n} D_1 + \frac{n_1}{n} D_2\right) \frac{dn_1}{dz} = -D^* \frac{dn_1}{dz}, \end{aligned}$$

$$(1.75') \quad \Gamma_2^* = -\left(\frac{n_2}{n} D_1 + \frac{n_1}{n} D_2\right) \frac{dn_2}{dz} = -D^* \frac{dn_2}{dz}.$$

The new diffusion constant D^* is equal for the two kinds of particles. The particles of kind 1 diffuse downward just as rapidly as those of type 2 diffuse upward, and the pressure remains constant.

It is seen that D^* depends greatly upon the composition of the mixture. The diffusion rate will therefore be considerably different at different heights in the tube.

11. The Scope of Statistical Mechanics

The problems and methods of the preceding few sections are quite typical of the problems and methods of statistical mechanics. It is true that they were particularly chosen as illustrative because their handling required the introduction of a comparatively small number of new terms and concepts, and also required no preliminary elaborate build-up of general principles. As more complicated, and more general, problems are undertaken, it will be found advisable to shorten the total labor necessary to solve all of them by the preliminary proof of a number of general theorems, and the development of general methods which will find wide applicability. It is essentially these theorems and methods which make up the science of statistical mechanics.

One of the most characteristic features of the usual statistical mechanical problem is the enormity of the number of elementary particles which go to make up the system treated. In dealing with the perfect gas, the assumption of a large value of N was necessary to assure the very existence of a constant pressure on the walls of the vessel and to lend a useful significance to the velocity distribution function, $N(v)$. The statistical method makes possible the calculation of the probability of any arbitrary distribution, and for many sciences, notably the biological and sociological sciences, in which investigations are made with systems containing a relatively small number of units, the calculation of the probability of an abnormal distribution is of importance. In physics and chemistry it is true that experiments exist which show the presence of fluctuations from complete equilibrium, and statistical mechanics has been applied to the calculation of the probability of such fluctuations, but this part of statistical mechanics will not be of such great interest to a chemist. In most chemical and physical systems, the deviations from the equilibrium value shown by most of the observable properties which one attempts to calculate by statistical methods are either infinitesimally small or negligibly rare. It is sufficient to calculate the most probable, or the average, value of the observable property, and to treat this as though it were the only possible solution.

In section 1e it was found necessary to assume the existence of forces between the molecules, in order to assure the existence of a mechanism by which equilibrium could be established. However, it was unnecessary to specify the nature or magnitude of these forces, except to assume that they were not too large. One of the greatest advantages of the science lies in the ability to obtain general results without the necessity of too detailed a knowledge of all the characteristics of the material handled.

In this particular case, the calculation of the Maxwell-Boltzmann

distribution law, the dependence of the force acting between two molecules on the distance between them, determines the frequency of collisions in the gas, and therefore the rate at which the equilibrium distribution of the molecules in the various velocity ranges would be attained. This rate, of course, was not calculated. We have no method of ascertaining, without recourse to a more complicated calculation, whether it might take fractions of a second, or years, to attain equilibrium. We know, however, what to expect after equilibrium has been attained. This is characteristic of many of the methods and problems of statistical mechanics, problems in which the static properties of the material are calculated; the mechanism by which the stationary state is reached has no effect on the results, but, conversely, the speed with which equilibrium is attained is not determined.

Certain very important relationships between some of the experimentally measurable properties of a system may be deduced by means of thermodynamics. As will be shown later in this book, the laws of thermodynamics may be explicitly derived as consequences of the fundamental assumptions of statistical mechanics. Thermodynamics may then be regarded, to a certain extent, as a part of statistical mechanics. Many who are more familiar with the thermodynamic method will consequently hasten to formulate many statistical problems in thermodynamic terminology, and to solve them by thermodynamic methods. For that reason, one of the most useful services of statistical mechanics is to give a prescription for the calculation of the values of the thermodynamic functions of a system from the mechanical properties of its constituents.

✓ One of the more recent and, for the chemist, one of the most fruitful accomplishments of statistical mechanics has been the accurate calculation of the free energy, entropy, and specific heat of many of the simpler gases from spectroscopic information.

In the examples treated so far, no fundamental assumptions were made except the validity of the laws of mechanics. This will be found to be generally true. The fundamental axioms of statistical mechanics are the fundamental laws of mechanics. Statistical mechanics is, as the name implies, the application of the statistical method, with the laws of mechanics, to systems for which, because of their great complexity and size, the detailed methods of mechanics would be valueless.

CHAPTER 2

MECHANICAL AND QUANTUM-MECHANICAL PRELIMINARIES

- (a) Introduction. (b) Coordinates. (c) Momenta. (d) Classical Mechanics and Phase Space. (e) The Uncertainty Principle. (f) Quantum States. (g) Quantum States of Some Simple Systems. (h) The Combination of Independent Systems. (i) Equal Probability of Single States. (j) Liouville Theorem and Equal Probability in Phase Space. (k) Identical Particles, Einstein-Bose and Fermi-Dirac Systems.

2a. Introduction

Although the axioms of statistical mechanics are those of mechanics, no great familiarity with the more detailed methods of mechanics is required for the application of statistics to a system. One may go far in statistical mechanics with a rather elementary knowledge of the laws of mechanics or of quantum mechanics.

The necessary axioms and concepts will be discussed in some detail in this chapter. Before entering upon this task we wish to sum them up in a few words. The most accurate description of the instantaneous state of a system obeying the laws of classical mechanics consists in giving the values of all the coordinates of the system, and of all the momenta conjugated to the coordinates. If f , the number of degrees of freedom of the system, is the total minimum number of coordinates, then the $2f$ dimensional coordinate-momentum space is called the phase space of the system.

The point describing the state of the system moves through this phase space along a path, and with a velocity, determined by the laws of classical mechanics. The calculation of this path and velocity may be a very complicated problem, and fortunately concerns us practically not at all.

The only property of the motion of this point through the phase space which it is necessary for us to know and to use is the following: If a system, known to have an energy lying between E and $E + \Delta E$, is isolated, so that its state point moves through the phase space belonging to this energy range, it will, on the average, over a long period of time, spend equal times in equal volume elements ΔW of the phase space, whatever their location.

It is this property of the phase space, or coordinate-momentum space, which makes it uniquely useful in the description of the mechanical state, and which leads us to choose it, rather than, say, the coordinate-velocity space, for the description of the state of the system.

That the knowledge of this one theorem stating the equal probabilities of equal volumes in phase space is so powerful a tool may be illustrated as follows: Every conceivable instantaneous property of a system is determined by the $2f$ values of the f coordinates and f momenta. In short, any function, such as the pressure P on a certain area element of the wall of the container, may be expressed as a function of the position of the system in the phase space. This pressure P will actually vary with time, but its time average value represents the pressure which is experienced thermodynamically. Since the system spends, on the average, equal times in equal volume elements dW of phase space, consistent with given total energy, the average pressure \bar{P} will be $\bar{P} = \int P dW / \int dW$, the average value in the phase space, where both integrals are taken over that region of phase for which the energy lies between E and $E + \Delta E$.

All real systems obey the laws of quantum mechanics, which are somewhat different from those of classical mechanics. Our language is then slightly altered, although the fundamental concepts are not greatly different.

Quantum mechanics is characterized by the occurrence of stationary states of discrete energy. The coordinates and momenta of the system in one of these states are determined only within a certain range, so that the quantum state corresponds to a cell of volume h^f in the phase space. These cells fill up the phase space completely. The quantum-mechanical analogue to the classical theorem of equal probability of equal volumes of phase space has then the simple form: All (non-degenerate) quantum states of the allowed energy are equally probable.

This theorem of equal probability for the quantum states, with some very general characteristics of the methods of counting the states of a system from those of its parts, is all that is used in Chapters 3 and 4 of this book to derive the general laws of thermodynamics, and to show the methods by which the thermodynamical properties of a system may be calculated.

In the subsequent chapters these methods are applied to special systems. It then becomes necessary to use some of the more detailed results of quantum-mechanical calculations for the constituent molecules. For instance, the equations for the energy levels of monatomic, diatomic, and polyatomic molecules in terms of their quantum numbers are used in calculating the free energies of gases composed of these

molecules. Actually, the numerical values of the energy levels are always taken from experimental spectroscopic tabulations.

It is not necessary for the student to be able to solve the relatively involved differential equations giving the energy levels of these molecules, or even to know how the solutions are made. The results of the solutions are actually used as type forms into which the experimental data can be fitted, and serve as useful methods of extrapolating energy values for the higher quantum numbers.

In the subsequent sections of this chapter we have gathered all the mechanical information that is needed later. The fundamental concepts are discussed in detail and illustrated with some simple systems. These examples have been chosen as those for which the energy levels have to be used in later calculations.

The one fundamental theorem of equal probabilities of quantum states, or equal phase volumes, is stated and proved, both as a quantum-mechanical, and as a classical, theorem.

2b. Coordinates

In order to treat the system mathematically it is necessary to introduce coordinates, by which the position of each constituent is described. There exists a fixed minimum number of coordinates which are needed to determine fully the position of a particle. For all cases that interest us here this number coincides with the number of degrees of freedom and will be denoted by f . If the particle is a point in space it is $f = 3$; for two mass points which are restricted to stay at a fixed distance from each other (dumb-bell) we have $f = 5$, etc.

The coordinates for the description of a particle can be chosen in several different ways. For a point particle, for instance, we may use Cartesian coordinates, x, y, z , cylindrical coordinates, or spherical coordinates, but invariably three will be required. When the forces acting on the particle are known, convenience will usually dictate the choice. For example, the positions of two mass points acting upon each other with a force dependent only on their distance, r , can be described completely by the Cartesian coordinates of each point. It is more advantageous, however, to introduce six new coordinates, namely, the distance, r , between the points; the three coordinates of the center of mass, X, Y, Z , and two angles, which determine the orientation of the main axis, the line joining the two mass points. These angles are usually measured with respect to a coordinate system fixed in space, in such a way that θ denotes the angle between the main axis and the fixed z axis, ϕ the angle between the projection of the main axis on the xy plane and the x axis. If the distance between the mass points is

rigidly fixed, the last five of these coordinates alone determine the position of the system completely. The same coordinates can be used to describe the position of an infinitely thin rod. If the rod is restricted to motion in a plane only, three coordinates, two for the center of mass and one angle, are sufficient.

If the set of coordinates used is not explicitly specified they will be referred to as generalized coordinates, and designated by the letter q .

2c. Momenta

The state of motion of the system is defined by the values of the coordinates q , and the velocities, that is, the derivatives of the coordinates with respect to the time. Time derivatives will always be denoted by a dot, namely, $dq/dt = \dot{q}$. Instead of the velocities we prefer to introduce the generalized momenta, which are obtained with the help of the kinetic energy.

The kinetic energy of one mass point is given by the well-known formula (2), which follows. For a system of several mass points the total kinetic energy, \mathbf{T} , is obtained by adding the kinetic energies of the individual points. The Cartesian coordinates of the mass points, which will, in general, not be independent, can now be expressed as functions of the generalized coordinates q . By differentiating these relations with respect to the time, and putting them into the expression for \mathbf{T} , one obtains the kinetic energy as a function of the generalized coordinates and velocities, $\mathbf{T}(q, \dot{q})$. (The one symbol q is always meant to stand for all the coordinates, q_1, q_2, \dots, q_f , and correspondingly \dot{q} for all the velocities. If the system has f degrees of freedom \mathbf{T} will depend on all f velocities \dot{q} , and may depend on some or all of the coordinates, that is, it will be a function of between f and $2f$ variables.)

The momentum conjugate to the coordinate q_ν , designated by p_ν , is defined as the partial derivative of the kinetic energy with respect to the velocity \dot{q}_ν ,

$$(2. 1) \quad p_\nu = \frac{\partial \mathbf{T}}{\partial \dot{q}_\nu}.$$

For example, the kinetic energy of one point particle has the form,

$$(2. 2) \quad \mathbf{T} = \frac{1}{2}m(\dot{x}^2 + \dot{y}^2 + \dot{z}^2),$$

where m denotes the mass, and Cartesian coordinates have been used. This leads to the ordinary relation between linear velocity and linear momentum,

$$(2. 3) \quad \frac{\partial \mathbf{T}}{\partial \dot{x}} = p_x = m\dot{x}; \quad p_y = m\dot{y}; \quad p_z = m\dot{z}.$$

Relations (1) can always be used to express the velocities as functions of the coordinates and the momenta and to eliminate the q 's from \mathbf{T} , obtaining instead \mathbf{T} as a function of the coordinates and the momenta, $\mathbf{T}(q,p)$. In this special case we find

$$(2. 2') \quad \mathbf{T} = \frac{1}{2m} (p_x^2 + p_y^2 + p_z^2).$$

The kinetic energy of two mass points with masses m_1 and m_2 can be expressed either in Cartesian coordinates as the sum of two expressions of the type (2), or in the coordinates of the center of mass, X, Y, Z , the distance r , and the angles θ and ϕ , discussed in section 2b. In the latter coordinates it takes the form

$$(2. 4) \quad \mathbf{T} = \frac{m_1 + m_2}{2} (\dot{X}^2 + \dot{Y}^2 + \dot{Z}^2) + \frac{r^2}{2} \frac{m_1 m_2}{m_1 + m_2} (\dot{\theta}^2 + \sin^2 \theta \dot{\phi}^2) + \frac{1}{2} \frac{m_1 m_2}{m_1 + m_2} \dot{r}^2.$$

Introducing the abbreviations: the total mass $M = m_1 + m_2$, the reduced mass $\mu = m_1 m_2 / (m_1 + m_2)$, and the moment of inertia $I(r) = \mu r^2$, this becomes,

$$(2. 4') \quad \mathbf{T} = \frac{1}{2} M (\dot{X}^2 + \dot{Y}^2 + \dot{Z}^2) + \frac{1}{2} I (\dot{\theta}^2 + \sin^2 \theta \dot{\phi}^2) + \frac{1}{2} \mu \dot{r}^2.$$

From this, according to (1), one obtains the momenta,

$$(2. 5) \quad p_x = M \dot{X}, \quad p_y = M \dot{Y}, \quad p_z = M \dot{Z},$$

$$(2. 6) \quad p_\theta = I(r) \dot{\theta}, \quad p_\phi = I(r) \sin^2 \theta \dot{\phi},$$

$$(2. 7) \quad p_r = \mu \dot{r}.$$

The first three expressions are analogous to those obtained in (3) for p_x as a function of x . In fact, the momenta conjugate to the Cartesian coordinates of the center of mass are always given by (5). p_ϕ and p_θ are two components of the angular momentum \vec{p} . p_ϕ is the component along the z axis, ($\theta = 0$ axis), and p_θ that in the variable direction normal to both z and the main axis. Elimination of the velocities out of (4'), with the help of (5), (6), and (7), leads to

$$(2. 4'') \quad \mathbf{T}(p,q) = \frac{1}{2M} (p_x^2 + p_y^2 + p_z^2) + \frac{1}{2I(r)} \left(p_\theta^2 + \frac{1}{\sin^2 \theta} p_\phi^2 \right) + \frac{1}{2\mu} p_r^2.$$

If the distance r between the two particles is rigidly fixed, \dot{r} will be zero, the last term in (4), (4'), and (4'') will be absent, and the moment of inertia I will be a constant. In this case the coordinates and momenta obtained can also be used to describe an infinitely thin rigid rod, with M the total mass of the rod, and I the moment of inertia with respect to the center of mass; or, indeed, to describe any rigid body for which one of the three principal moments of inertia is zero and the other two are equal.

It is important to notice that it follows from (1) that the product of a coordinate and its conjugate momentum has always the dimensions of energy multiplied by time.

2d. Classical Mechanics and Phase Space

In all mechanical problems concerning us here the forces acting on the particles of the system will depend on the position only and, moreover, will be of the special type called conservative forces. This means that there exists a function \mathbf{U} of the coordinates of the system, called the potential energy, which has the property that the force acting on any point particle constituent of the system in any, say the x , direction is given by the negative derivative of \mathbf{U} with respect to the x coordinate of that point,

$$(2. 8) \quad F_x = - \frac{\partial \mathbf{U}}{\partial x}.$$

For forces of this nature the law of conservation of energy holds: the sum of kinetic and potential energy of the system is constant during the motion. This theorem will lead us immediately to the first law of thermodynamics.

If we express \mathbf{T} as a function of the coordinates and momenta, we shall designate the sum of the kinetic and potential energies by the letter H , and have, therefore, the relation

$$(2. 9) \quad H(p, q) = \mathbf{T}(p, q) + \mathbf{U}(q) = E,$$

where E denotes the constant value of the energy. $H(p, q)$ is called the Hamilton function of the system. It should be pointed out that in more general cases than those considered here $H(p, q)$ may not coincide with the energy.

Using the Hamilton function, the equations of motion can be expressed in the so-called canonical form

$$(2. 10) \quad \dot{p}_\nu = - \frac{\partial H}{\partial q_\nu} \quad \dot{q}_\nu = \frac{\partial H}{\partial p_\nu}.$$

If the forces between, and the outer forces acting on, the particles are given, the laws of classical mechanics (for instance, in the form [10]) permit the calculation of the motion of the system, that is, of the numerical values of all the coordinates and the momenta, as a function of time. There exist very many different solutions of the equations of motion. For a system of f degrees of freedom the motion is uniquely defined only if $2f$ arbitrary "initial conditions" are prescribed, for instance, the numerical values of all the coordinates and momenta (or velocities) at a certain time t_0 . Exact knowledge of the state of the system at one time enables one to determine its exact behavior in the future.

Instead of fixing the $2f$ arbitrary constants of the solution by giving the initial values of the p 's and the q 's, it is of course equivalent to stipulate the initial values of any $2f$ independent functions of the coordinates and momenta. Since the energy is fully determined by the initial conditions and, moreover, remains constant during the motion, it is very often preferable to choose these functions in such a way that the energy is one of them.

A useful concept for the illustration of the motion of the system, and one that plays an important role in classical statistics, is the "phase space," a space of $2f$ dimensions, the axes of which are all the coordinates and momenta of the system. At any time the state of the system is given by one point in this space; in time the system travels along some perfectly fixed path, which can, in principle, though not always in practice, be calculated from the laws of mechanics. Through every point in this space there passes only one possible orbit of this system.

Since, as we have already noted, the product of any coordinate and its conjugate momentum has the dimensions of energy times time, the dimensions of a volume element of the phase space of f coordinates and f momenta will be those of the f 'th power of energy multiplied by time. If different coordinates are chosen for the description of the same system, phase spaces are obtained in which the paths of the system look entirely different. The dimensions of the volume element in two different phase spaces of the same system are the same, however. Furthermore, it can be shown that all points filling the volume element ΔW in one phase space of the system fill precisely the same volume in any phase space obtained by different coordinates.

It can be seen readily that a mere change of scale of one coordinate of a system does not alter the phase volume, since, from equation (1), a change from x to $x' = ax$ brings about a change in the corresponding momentum from p_x to $p_x' = p_x/a$, if the units of energy and time are

held constant. The general proof can be found in Gibbs* that the Jacobian leading from one set of coordinates and conjugate momenta to another such set is unity.

The reasons for choosing the space of coordinates and momenta instead of that of coordinates and velocities, or of coordinates and some other functions of the velocities, are intimately connected with these considerations, and with the Liouville theorem, discussed in section 2j.

For one point particle which is restricted to motion along a straight line, the x axis only (bead on a string), the phase space has two dimensions, and the coordinates x and p_x . If the point is under the influence of no forces, the Hamilton function consists of the kinetic energy $T = (1/2m)p_x^2$, and the equations of motion lead immediately to $\dot{p}_x = 0$, or $p_x = \text{constant}$. The possible paths of the system consist therefore of straight lines of constant p_x , parallel to the x axis. If the particle can move in a plane, with coordinates x and y , the phase space has four dimensions. In the absence of outer forces, p_x and p_y are constants, and the paths of the system are again straight lines, lying in the two-dimensional planes of constant p_x and p_y , normal to the p_x and p_y axes. Elimination of the time from the equations for the path shows that the x and y coordinates are connected by the relation $p_y x - p_x y = \text{constant}$.

The points corresponding to one value of the energy E form a surface of dimension $2f - 1$ in the phase space, which divides the space into two parts, one of higher and the other of lower energy. Obviously, surfaces of different energy do not intersect. The paths or orbits of a system lie in these surfaces. In the first example quoted, the surfaces of constant energy coincide with the lines of constant p_x ; in the second one they are three-dimensional, independent of x and y , and their intersections with the p_x, p_y plane form circles around the origin, $p_x^2 + p_y^2 = 2mE$.

We will later be interested in systems made up out of N independent, identical subsystems (the molecules), which we shall, for convenience, term particles. The phase space of the individual constituents of dimensions $2f$ is called the ' μ -space' (the molecule space). The configuration of the total system is given by N points in this μ -space. The phase space of the total system, in which one point describes the locations and momenta of all particles, has the dimension $2fN$, and is called the ' γ -space' (the gas space). These concepts will be used continuously in subsequent chapters.

* J. Willard Gibbs, *Collected Works*, Longmans, Green, New York, 1928, Vol. II, Part 1, p. 14.

2e. The Uncertainty Principle

Quantum mechanics introduces a change in these concepts of the motion of a system in phase space. Classical theory always takes for granted that all coordinates and momenta can be measured with any desired accuracy; that the reaction upon the system of the act of measuring a quantity can be made arbitrarily small, since the sample body with which we measure can be made as small, and the light by which we see as weak, as we want. Now we know that this is not so, and that there is not only an experimental but even a theoretical limit below which the influence of the measurement on the measured system cannot be suppressed. The measurement of a coordinate of a particle necessarily changes the momentum conjugate to that coordinate, by larger amounts the more accurately the measurement of the coordinate is made, and changes it in an unpredictable way.

The type of argument by which this is shown may be indicated by an example. If, for instance, we want to measure the position of an electron (or even the position of a larger body) with the help of an ideal microscope, we cannot possibly hope to determine it within a smaller range, Δq , than the wavelength, λ , of the light by which we are observing; light of short wavelength will therefore be more advantageous. For the measurement we have to use at least one quantum of energy, and for light of frequency ν this has the energy $h\nu$ and the momentum $h\nu/c$, in which h is Planck's constant of dimensions energy multiplied by time, and numerical value 6.626×10^{-27} erg second, and c the velocity of light. In the process of measurement the quantum transfers all, or part, of its momentum to the measured particle, so that after the observation the momentum p of the particle will be altered by some amount which can be as much as $h\nu/c$. Since $\nu \cdot \lambda = c$, the product of the range Δq , within which q was determined, and the range Δp , within which p was changed by the measurement, is at least

$$(2. 11) \quad \Delta p \cdot \Delta q \geq h.$$

Similarly, an observation of the momentum brings about a change in the coordinate. On account of this reaction of the measured system to the measurement it is impossible, even with an idealized experiment, to determine both the coordinate q and its conjugate momentum p for any system exactly, and all quantitative investigations show that they can be determined simultaneously only within accuracies Δq and Δp , respectively, such that (11) holds.

Now it is one of the characteristic features of quantum mechanics that it answers questions of experimental significance only; statements

about quantities that cannot be experimentally verified are sacrificed in order to obtain correct results for measurable magnitudes. We have just discussed the fact that the exact value of the coordinate and its conjugate momentum can never be determined simultaneously by experiment. It is therefore not surprising that the inequality (11) follows from the fundamental principles of quantum mechanics and is known as the *Heisenberg uncertainty principle*.

The uncertainty principle means that p or q can be determined with absolute accuracy, but that if so the conjugate quantity is absolutely unknown. Many ingenious ways have been tried to construct in thought an experiment that would permit determination of p and q more exactly than the Heisenberg principle allows, but none has ever been, or should ever be, found. The example we gave above is incomplete in that we showed only that a change in p as large as $\Delta p = h\nu/c$ occurred, but did not prove that it is impossible to say with greater accuracy which change did occur.

As is made likely by the discussion of the reasons for it, the uncertainty principle does not affect the results of classical mechanics for large and heavy bodies. For these, given absolute uncertainties of Δp and Δq , in agreement with (11), mean a percentage error so small as to be quite negligible; also a given deviation in the momentum, mass times velocity, means a small uncertainty of the velocity alone. That an inaccuracy of the initial conditions does not grow in time follows from the Liouville theorem treated in section 2j.

The most accurate statement about the system that can be made in agreement with the uncertainty principle is that the system is in a "cell" in phase space of volume h^f .

2f. Quantum States

The *state* of a system in quantum mechanics must then necessarily be defined in some different, less precise, way than by the stipulation of the values of all the momenta and coordinates.

Let us for a moment restrict ourselves to systems of one degree of freedom. We found before that instead of coordinate and momentum we could as well use the values of *energy* and coordinate for the description of the classical state. The law of conservation of energy is known to hold for quantum-mechanical processes as well as for classical ones. Therefore, the energy of a state is a quantity of physical significance and can be used as a partial description of it. If we know the energy, however, we can no longer hope to determine the coordinate exactly, for that would amount to a complete fixing of the classical "state," and be in disagreement with the uncertainty principle. Instead, we

can calculate only a certain function of the coordinate, called the "wave function" or "eigenfunction" of the system, designated by $\psi(q)$. This function, sometimes complex, has the physical significance that its absolute value squared,* $|\psi(q)|^2$, a real quantity, multiplied by Δq is the probability of the coordinate having a numerical value between q and $q + \Delta q$, for the given energy of the system. If the system is an electron, and q designates its position, $e|\psi(q)|^2$ is the average electric density at the place q due to the motion of the electron; it describes the cloud of electricity into which the electron seems to dissolve.

The ψ function is calculated with the help of the Hamiltonian. In this function the momentum p is replaced by the differential operator $(h/2\pi i)(d/dq)$, and the differential equation for the determination of ψ becomes

$$(2. 12) \quad H\left(\frac{h}{2\pi i} \frac{d}{dq}, q\right) \cdot \psi = E \cdot \psi,$$

which, in Cartesian coordinates, amounts to

$$-\frac{h^2}{8\pi^2 m} \frac{d^2\psi(x)}{dx^2} + U(x) \cdot \psi(x) = E \cdot \psi(x),$$

where E is the value of the energy. We have to demand that the solution ψ , and its derivative, be continuous and finite everywhere, and that it have the property of a probability function,

$$(2. 13) \quad \int |\psi(q)|^2 dq = 1,$$

namely, that the probability of finding the system somewhere is unity. If the range of the coordinate q is finite, this condition can always be fulfilled, since multiplication of ψ by any constant does not alter the fact that it is a solution of (12). If the range of q is infinite, however, (13) imposes the condition that ψ go to zero as q goes to infinity sufficiently strongly so that the integration can be performed.

It is a mathematical fact that for a system confined to a finite volume

* An imaginary number, bi , is the product of a real number b times the imaginary unit, $i = (-1)^{1/2}$. A complex number ψ is the sum of a real number a , and an imaginary number bi , $\psi = a + bi$. The quantity $a^2 + b^2$ is referred to as the absolute value squared of ψ , $|\psi|^2 = a^2 + b^2$. In case the imaginary part of ψ is zero, $b = 0$; that is, if ψ is real, then the absolute value squared is just the square of the real number, $|\psi|^2 = \psi^2$.

Except in the presence of magnetic fields the quantum-mechanical eigenfunction can always be chosen real. The reader unfamiliar with complex numbers may therefore forget about the absolute value sign, and think of $|\psi|^2$ as ψ^2 .

range* a ψ function satisfying these conditions can be found only for certain discrete values of the energy E , called the energy levels of the system. These levels can be numbered consecutively by integers \mathbf{n} , the "quantum numbers," in such a way that $\mathbf{n} = 0$ usually designates the lowest energy level of the system, higher \mathbf{n} 's corresponding to higher energies. We denote energy and ψ function belonging to the \mathbf{n} th level by $E_{\mathbf{n}}$ and $\psi_{\mathbf{n}}$. For these systems of one degree of freedom the phase space is two-dimensional and the points of constant energy form non-intersecting lines in it. The lines corresponding to the energies $E_{\mathbf{n}}$ of the permissible levels subdivide the phase space into cells. The volume of these cells, really an area of physical dimensions energy multiplied by time, is exactly h . The statement that the system has the quantum number \mathbf{n} is then the most accurate possible description of its state that can be made without violation of the uncertainty principle. A quantum-mechanical state is therefore defined by the quantum number.

The occurrence of discrete energy levels is an experimental characteristic of the behavior of atoms and molecules. Classical mechanics was unable to explain this phenomenon, since by its laws the energy can always have a continuous range of values. In systems of large and heavy bodies the levels lie so close together that the energy is for all purposes continuous, and classical mechanics is the limiting case of quantum mechanics, applicable to large and heavy bodies.

For systems of more than one degree of freedom the wave function will depend on all f coordinates. $|\psi(q_1, \dots, q_f)|^2 \Delta q_1 \dots \Delta q_f$ is the probability of the coordinates having simultaneously numerical values between q_1, \dots, q_f , and $q_1 + \Delta q_1, \dots, q_f + \Delta q_f$, respectively. Every discrete energy level can be designated by f quantum numbers $\mathbf{n}_1, \dots, \mathbf{n}_f$, each capable of taking integral values only. The quantum-mechanical state of the system is defined if all f quantum numbers are known.

The states of the system are packed into the phase space in such a way that each corresponds to a volume h^f . That means that the number of quantum states having energies lying between E_1 and E_2 will become equal to the volume of phase space between these energies, divided by h^f , if the interval between E_1 and E_2 is not too small. The quantum-mechanical state gives a description with the greatest accuracy allowed by the Heisenberg principle.

It will sometimes happen that several sets of quantum numbers correspond to the same value of the energy, in other words, that for

* If the volume available to the system is infinite the energy levels may not be discrete (compare section 2g, example 1). The complications arising from this are overcome here by always considering finite, although possibly very large, volumes.

one energy value we obtain several, say g , different, linearly independent eigenfunctions. In that case we say that the level is g -fold degenerate, or that it consists of g states. A state, according to our definition, is always non-degenerate.

In general the prescription for the calculation of the wave function is the same as for one degree of freedom; p_v , the momentum conjugate to the coordinate q_v , is replaced by the differential operator $(\hbar/2\pi i)(\partial/\partial q_v)$ in the Hamilton function. The wave functions are the solutions of the partial differential equation:

$$(2. 12') \quad H\left(\frac{\hbar}{2\pi i} \frac{\partial}{\partial q_1}, \dots, \frac{\hbar}{2\pi i} \frac{\partial}{\partial q_f}, q_1, \dots, q_f\right) \cdot \psi(q_1, \dots, q_f) \\ = E \cdot \psi(q_1, \dots, q_f).$$

ψ and its derivatives must be continuous and finite, and the "normalization" condition is

$$(2. 13') \quad \int \dots \int |\psi(q_1, \dots, q_f)|^2 dq_1 \dots dq_f = 1.$$

If the range of the q 's is finite this condition can always be fulfilled by multiplication of ψ with a suitable constant, for $c\psi$ is also a solution for the same energy value as ψ and will, of course, not be called a different solution.

It follows from the nature of the differential equation (12'), namely, from the fact that it is linear and homogeneous in ψ , that, if two ψ functions are eigenfunctions belonging to the same energy value E , their sum and difference are also solutions of the equation. Therefore, out of the g wave functions of the same degenerate level one can construct in many ways g linearly independent combinations which describe the degenerate level just as well as the original functions. This means that a degenerate level is made up of single states, the total number of which, g , is fixed, but the single states themselves are not unambiguously defined.

2g. Quantum States of Some Simple Systems

A few examples are given of systems the energy states of which are to be used later.

Example 1. A point particle moving in field-free space. From a classical point of view this system has already been discussed in sections 2c and 2d. Since the potential energy is constant the total energy is kinetic and the Hamiltonian is given by equation (2'),

$$H = \mathbf{T} = (1/2m)(p_x^2 + p_y^2 + p_z^2).$$

The wave equation in this case is

$$-\frac{\hbar^2}{8\pi^2m} \left(\frac{\partial^2 \psi}{\partial x^2} + \frac{\partial^2 \psi}{\partial y^2} + \frac{\partial^2 \psi}{\partial z^2} \right) = E \cdot \psi(x, y, z),$$

and the most general solution is given most conveniently in the complex* form:

$$\psi = \text{const. } e^{(2\pi i/h)(p_x x + p_y y + p_z z)},$$

with

$$\frac{1}{2m} (p_x^2 + p_y^2 + p_z^2) = E.$$

Since solutions with positive and negative components of p belong to the same energy value all levels are degenerate, and we can also use linear combinations of the exponential, for instance, the sine and cosine functions, as solutions.

Let us first assume that the particle is restricted to motion in one dimension, along the x axis, only. If the space is truly infinite, that is, x can run from $-\infty$ to $+\infty$, then there are no discrete energy levels, and the system can have any amount of energy. The eigenfunctions are complex exponential functions, so that $|\psi|^2$ is a constant, that is, the particle can with equal probability be found at any point in space. The momentum p_x is then sharply defined, in agreement with the uncertainty principle, since the value of the coordinate is absolutely undetermined. In this case the ψ function cannot be normalized, corresponding to the fact that the probability of finding the particle in any finite range, Δx , of the coordinate x , is zero. If, however, the particle is restricted to a space of length l , that means $0 \leq x \leq l$, and if the walls at zero and l are assumed to be perfectly reflecting, so that the energy of the particle remains unchanged, then in classical theory the particle will be reflected back and forth between the walls. In quantum mechanics this imposes a boundary condition on the ψ function. Obviously, if the walls are perfectly reflecting, the probability of finding the particle outside should be zero, which is to be expressed by $\psi = 0$. Since the ψ function is to be continuous in space, ψ has to be zero at the boundary, namely, at $x = 0$ and at $x = l$. This condition can be fulfilled only for certain discrete values of the energy, and therefore of the magnitude of the momentum, namely, for

$$(2.14) \quad |p_x| = \frac{h}{2l} k_x, \quad E = \frac{1}{2m} p_x^2 = \frac{h^2}{8ml^2} k_x^2,$$

where k_x is any positive integral number. All energy levels are non-degenerate. The eigenfunctions are sine functions

$$(2.15) \quad \psi = \sqrt{\frac{2}{l}} \sin \frac{2\pi}{h} p_x x = \sqrt{\frac{2}{l}} \sin \pi \frac{k_x x}{l}.$$

* The complex number e^{ia} may be resolved into its real and imaginary parts by means of the equation $e^{ia} = \cos a + i \sin a$. It follows that the absolute value squared is always unity, $|e^{ia}|^2 = \cos^2 a + \sin^2 a = 1$. It is seen that, for $a = 0, \pi/2, \pi, 3\pi/2, \text{ and } 2\pi$, the value of e^{ia} is 1, i , -1 , $-i$, and 1, respectively. The function e^{ia} is periodic with the periodicity 2π in a , $e^{ia} = e^{i(a+2\pi)}$.

If the particle can move in three dimensions, but is confined to the inside of a cube of side length l , volume $V = l^3$, with perfectly reflecting walls, each state is characterized by three integral, positive numbers, k_x, k_y, k_z , which we may regard as components of a vector \vec{k} of magnitude k . The three components of the momentum are

$$(2. 16) \quad |p_x| = \frac{\hbar}{2l} k_x, \quad |p_y| = \frac{\hbar}{2l} k_y, \quad |p_z| = \frac{\hbar}{2l} k_z,$$

so that the magnitude p of the momentum is proportional to the magnitude k . The energy levels are given by

$$(2. 17) \quad E = \frac{1}{2m} p^2 = \frac{\hbar^2}{8mV^{2/3}} k^2 = \frac{\hbar^2}{8mV^{2/3}} (k_x^2 + k_y^2 + k_z^2),$$

and the eigenfunctions are products of sine functions

$$(2. 18) \quad \psi = \left(\frac{2}{l}\right)^{3/2} \sin \pi \frac{k_x x}{l} \cdot \sin \pi \frac{k_y y}{l} \cdot \sin \pi \frac{k_z z}{l}.$$

Here we find that most of the levels are degenerate. The energy is determined by the magnitude p of the vector \vec{p} , but in general there will exist several vectors \vec{p} of different orientations with the same total magnitude. This corresponds to states of motion with the same velocity but differing directions of propagation. For instance, the state given by $k_x = 1, k_y = 2, k_z = 3$ has the same energy as the one for which $k_x = 2, k_y = 1, k_z = 3$, and several others.

Example 2. The harmonic oscillator. A system with one degree of freedom in which the force is proportional to the displacement, q , from an equilibrium position, $q = 0$,

$$(2. 19) \quad m\ddot{q} = F_q = -aq,$$

is called a simple harmonic oscillator. m designates the mass. The Hamiltonian of this system is

$$(2. 20) \quad H(p, q) = \frac{1}{2m} p^2 + \frac{a}{2} q^2,$$

and the solution of the classical equation of motion is

$$(2. 21) \quad q = b \cos 2\pi\nu(t + \alpha), \quad 2\pi\nu = \sqrt{a/m}.$$

The motion is periodic with the frequency ν ; b and α are the two arbitrary constants which can be adjusted to fit any initial conditions for q and $p (= m\dot{q})$.

In quantum theory the energy levels of this system are all non-degenerate and equally spaced,

$$(2. 22) \quad E_{\mathbf{v}} = h\nu(\mathbf{v} + \frac{1}{2}),$$

where h is Planck's constant, ν the classical frequency of vibration, and \mathbf{v} can be any integral number from zero to infinity. It turns out that even in the lowest state, $\mathbf{v} = 0$, the oscillator has the energy $\frac{1}{2}h\nu$, the "zero point energy," whereas classically the state of lowest energy is the state of rest with zero amplitude and zero energy.

We shall meet the oscillator equation when we consider the vibrations of molecules. The coordinates q will then be the normal coordinates of the modes of vibration, which sometimes depend in a rather complicated manner on the coordinates of the individual atoms. The corresponding masses will be combinations of the masses of the atoms. In the special case of diatomic molecules q is simply the difference between the actual and the equilibrium distances of the two atoms, and the mass is the reduced mass. (See example 4 of section 2h.)

Example 3. The rotator. A rotator is a body the position of which at any moment is fully characterized by the two angles which give the direction of a straight line, its main axis, in space. We want to consider the case where no outer forces are acting on the body. This system is realized by a mass point tied with a string to some point in three-dimensional space. The motion around the center of mass of an infinitely thin rod, or a dumb-bell which can rotate about any axis in space, obeys the same laws.

The coordinates of this system are the θ and ϕ described in sections 2b and 2c, where also the corresponding momenta are calculated. The Hamiltonian of the system is given by part of (2. 4'') and is

$$(2. 23) \quad H = \frac{1}{2I} \left(p_{\theta}^2 + \frac{1}{\sin^2\theta} p_{\phi}^2 \right).$$

The classical calculation shows that the motion always consists of rotation with uniform angular velocity in a plane, so that the total angular momentum \vec{P} is a constant, and the energy $E = (1/2I) \vec{P}^2$.

The quantum-mechanical states are characterized by two integral numbers, \mathbf{j} and \mathbf{m} , where \mathbf{j} can take any positive value from zero to infinity, whereas \mathbf{m} has any value between $-\mathbf{j}$ and \mathbf{j} , so that $|\mathbf{m}| \leq \mathbf{j}$. \mathbf{j} determines the total angular momentum by the equation

$$(2. 24) \quad \vec{P}^2 = \mathbf{j}(\mathbf{j} + 1) \left(\frac{h}{2\pi} \right)^2.$$

$(h/2\pi)\mathbf{m}$ is equal to the projection of the angular momentum vector on

the z axis, and its magnitude must therefore be equal to or smaller than j . \mathbf{m} corresponds to the orientation of the classical plane of motion. The energy depends only on j and is given by

$$(2. 25) \quad E_{jm} = \frac{1}{2I} \left(\vec{P} \right)^2 = j(j+1) \frac{h^2}{8\pi^2 I}.$$

Therefore all energy levels except the lowest one for which $j = 0$ are degenerate, the degree of degeneracy being given by the number of values of \mathbf{m} consistent with a fixed value of j , which is $2j + 1$.

The preference of the z axis is arbitrary and due to our choice of coordinates. A different choice of axes would bring about different ψ functions which are, however, only linear combinations of the original $2j + 1$ eigenfunctions belonging to the same energy value, in agreement with the fact that the single states that make up a degenerate level can be chosen in different ways, as discussed in section 2f.

Example 4. The symmetrical top. One more system the energy levels of which will be needed for the discussion of polyatomic molecules is the so-called symmetrical top, moving with fixed center of gravity under the influence of no forces. The symmetrical top is a body for which two principal moments of inertia are equal, denoted in the following by A , the third one being denoted by C . The system has three degrees of freedom, its position can be characterized by three angles, and therefore each energy state by three quantum numbers, j , \mathbf{m} , and \mathbf{k} . j can have positive values only, whereas \mathbf{m} and \mathbf{k} can also take negative values, but are both restricted to lie between $-j$ and j : $|\mathbf{m}| \leq j$, $|\mathbf{k}| \leq j$. The energy levels are

$$(2. 26) \quad E_{j, \mathbf{m}, \mathbf{k}} = \frac{h^2}{8\pi^2} \left\{ j(j+1) \frac{1}{A} + \left(\frac{1}{C} - \frac{1}{A} \right) \mathbf{k}^2 \right\}.$$

Since \mathbf{m} does not occur in E and \mathbf{k} and $-\mathbf{k}$ lead to the same value, it is seen that a level with $\mathbf{k} = 0$ is $(2j + 1)$ -fold, one with $\mathbf{k} \neq 0$, $2(2j + 1)$ -fold, degenerate.

The simple rotator is the limiting case of the symmetrical top for $C = 0$. Finite energy levels are then obtained only if $\mathbf{k} = 0$, and these coincide with those given by equation (2. 25).

2h. The Combination of Independent Systems

In the future we shall very often be interested in systems which consist of two or more, and indeed usually of very many, subsystems, which are independent of one another. It is therefore important to know how the eigenfunctions and energy values of the total system depend on those of its parts.

By the statement that two systems, a and b , are independent we mean that the motion of one system is not in any way influenced by the state of the other one, that is, that no forces are acting between the two systems. This finds its mathematical expression in the statement that the Hamilton function, H , which for all purposes of this book is the energy as a function of the coordinates and momenta, is a sum of two parts, H_a and H_b , H_a depending on the coordinates and momenta of a , H_b on those of b only:

$$(2. 27) \quad H = H_a(p_a, q_a) + H_b(p_b, q_b).$$

In that case the eigenfunction ψ of the total system, the combination of the two independent parts, a and b , is the product of the eigenfunctions ψ_a and ψ_b ,

$$(2. 28) \quad \psi = \psi_a \cdot \psi_b,$$

and the energy E is, as one would expect, the sum of the energies E_a and E_b of the subsystems.

$$(2. 29) \quad E = E_a + E_b.$$

A state of the total system is defined by the quantum numbers of the two independent parts. For this treatment it is completely immaterial whether the subsystems are near or far, equal or very different. The only condition is independence. For truly identical subsystems some of the quantum states of the total system are not realized in nature, as will be discussed in section 2k.

A special case of this occurs if in a system the motion of one coordinate is not influenced by the motion of the others, so that the portion of the Hamiltonian containing this coordinate and its momentum behaves, mathematically, like that of an independent system. Classically this means that the variables are separable.

Example 1. We have already encountered one example of this in section 2g, example 1. The three Cartesian coordinates of a particle moving in a field-free space occur not at all, the momenta only in three additive terms in the Hamiltonian. The boundaries, and therefore the boundary conditions, each involve only one coordinate. The motion in the x direction is completely independent of that in the z or y direction. The eigenfunction of the particle, therefore, can be written as a product of three functions, each depending on one coordinate only. The energy is the sum of the kinetic energies of each component. Since, furthermore, the motion in all three directions is subject to the same conditions, the possible states and energies are the same for each component. In this way equations (17) and (18) can be derived from (14) and (15).

Example 2 is that of the dumb-bell discussed in section 2c, which is subject to no outer forces, so that the total energy is kinetic and given by (4'') with the last term containing p_r omitted,

$$(2. 30) \quad H = \frac{1}{2M} (p_x^2 + p_y^2 + p_z^2) + \frac{1}{2I} \left(p_\theta^2 + \frac{1}{\sin^2 \theta} p_\phi^2 \right).$$

Here the motion of the center of mass does not influence the rotation, since the part of H depending on X, Y, Z , does not involve θ or ϕ , and vice versa. If we again assume the particle to be confined to a cubic space of volume $V = l^3$, with perfectly reflecting walls, the eigenfunctions and states of the translation of the center of mass are the same as those of a point particle in this space, (17) and (18). A state of the total system is determined by the state of translation and of rotation (see section 2g, example 3) namely, by five quantum numbers, $\mathbf{k}_x, \mathbf{k}_y, \mathbf{k}_z$, and \mathbf{j} and \mathbf{m} . The energy of the state is

$$(2. 31) \quad E = \frac{\hbar^2}{8MV^{2/3}} (\mathbf{k}_x^2 + \mathbf{k}_y^2 + \mathbf{k}_z^2) + \frac{\hbar^2}{8\pi^2 I} \mathbf{j}(\mathbf{j} + 1).$$

Let us now assume that in this dumb-bell model the distance r between the two mass points is not rigidly fixed, but that the points are tied together by a weightless spring. We will then have an additional term in the kinetic energy, (4''), and also a potential energy depending on r , which, at least for small deviations from the equilibrium distance r_0 , is proportional to the square of this deviation, $\xi^2 = (r - r_0)^2$, so that the total Hamilton function becomes

$$(2. 32) \quad H = \frac{1}{2M} (p_x^2 + p_y^2 + p_z^2) + \frac{1}{2I} \left(p_\theta^2 + \frac{1}{\sin^2 \theta} p_\phi^2 \right) + \frac{1}{2\mu} p_\xi^2 + \frac{a}{2} \xi^2.$$

The additional last two terms are the Hamiltonian of an oscillator, (20), with frequency $2\pi\nu = \sqrt{a/\mu}$, the energy levels of which are given by (22). These terms are also independent of the coordinates of the center of mass. However, oscillation and rotation interact, since the part of the Hamilton function which contains p_θ and p_ϕ also contains $I(r) = \mu r^2$. The moment of inertia changes during the vibration, and the centrifugal force displaces the equilibrium position. However, if neither rotation nor oscillation is very large, these effects are of second order, so that one can treat the motions roughly as independent, by replacing $I(r)$ by the moment of inertia at equilibrium, $I_0 = \mu r_0^2$. With

that simplification the energy states of the oscillator-rotator are defined by the six quantum numbers k_x , k_y , k_z , j , m , and v , and given by

$$(2.33) \quad E = E_{\text{trans.}} + E_{\text{rot.}} + E_{\text{vib.}}$$

$$= \frac{\hbar^2}{8MV^{2/3}} (k_x^2 + k_y^2 + k_z^2) + \frac{\hbar^2}{8\pi^2 I} j(j+1) + h\nu \left(v + \frac{1}{2} \right).$$

This approximation to the energy of the levels is not always good enough for exact calculation. In Chapter 7 we will take into account the deviations from this equation.

Example 3. A system consisting of one atom is described by the three coordinates of the nucleus and the three coordinates of position of each electron. In addition, each electron has a spin of $\frac{1}{2}$, that is, an angular momentum of $\frac{1}{2}$ measured in units of $(\hbar/2\pi)$, which can have either of two possible orientations. The spin of the nucleus will be designated by s_n , an integer or half integral number, which can have $(2s_n + 1)$ different orientations. The magnetic moment associated with the nuclear spin is extremely small, so that the interaction between it and the electrons can be neglected, and all orientations of nuclear spin have the same energy.

If no outer force is acting on the atom, the motion of the center of mass, which practically coincides with that of the nucleus, can be separated from that of the other coordinates. The energy consists then of the sum of translational and electronic energies, the former being given by (17). We will fix the zero of energy in such a way that the energy of the lowest electronic level is zero. The energy of the next level is usually very much (several electron volts) higher than that of the ground level, so that, as will be seen in Chapter 6, it will not affect our statistical calculations. For these cases, the energy levels of the total system, the atom, can simply be represented by (17). It has to be borne in mind, however, that a *state* of the total system is defined by all quantum numbers, translational, electronic, and spin. If, therefore, the electronic ground level is g_e -fold degenerate, owing to electron spin or for other reasons, and if the nuclear spin has the magnitude s_n , each level determined by k_x , k_y , k_z in (17) is $g = g_e(2s_n + 1)$ -fold degenerate, that is, it consists of g single states of the total system.

Example 4. A diatomic molecule, moving under the influence of no outer forces, is also a system for which the motion of the center of mass can be separated. Again the higher electronic levels can usually be neglected, since they have so high an energy that they are not excited at ordinary temperatures. The motion of the electrons,

owing to their smaller mass, is very much faster than that of the nuclei, with the result that they act on the nuclei like a stationary cloud of negative electricity. In this cloud there exists an equilibrium distance between the two nuclei, that is, a distance of least energy. This position will, of course, be different for different electronic levels.

For deviations from this equilibrium position the electronic cloud exerts a force on the nuclei which is, in the first approximation, proportional to the displacement. In addition, the axis of the nuclei in space is not fixed so that the whole system can rotate. Consequently, for any given electronic state, the system can be approximately represented by an oscillator-rotator whose Hamiltonian is given by (32). Since the electrons are very light, the moment of inertia is determined by the distance between, and the masses of, the nuclei, only. The energy levels of the molecule are therefore given approximately by (33).

However, there will be deviations from this equation, due, first, to the fact that the force acting on the nuclei is not exactly proportional to the displacement, but also contains higher powers of ξ , so that the vibrations are not purely harmonic; and, second, to the interaction of rotation and vibration discussed under example 2.

If the electronic level is g_e -fold degenerate, and if the nuclei have spins s_{n1} and s_{n2} , respectively, the levels of (33) have a further degeneracy in addition to that due to the $2j + 1$ different values of the quantum number m , for every value of j , namely, each level defined by \mathbf{k}_x , \mathbf{k}_y , \mathbf{k}_z , j , m , and \mathbf{v} , corresponds to $g = g_e(2s_{n1} + 1)(2s_{n2} + 1)$ states of the total system. If the nuclei are identical, some of these states are not realized in nature, as will be discussed in section 2k and Chapters 6 and 7.

2i. Equal Probability of Single States

We will later be interested mainly in systems which consist of very many (10^{23}) individual particles, and which, therefore, have a very great number of degrees of freedom. In that case the possible energy levels, which are determined by f quantum numbers, are usually considerably degenerate and lie close together, so that for practical purposes they are continuous. We will be interested in knowing the density of this continuum, that is, the number of quantum states of the system the energies of which lie in a range ΔE , between E and $E + \Delta E$. If we chose the range ΔE too small, the number in question would be small and would vary erratically with E . If, however, the value of ΔE taken is large compared to the difference between the energies of neighboring levels, the number will be large, approaching a smooth function of E , and be proportional to the energy range ΔE .

We shall denote this function by $\Omega(E) \Delta E$ for large systems composed of many particles, and by $C(E) \Delta E$ for simple (constituent) systems.

Actually this crowding together of states occurs even for the higher quantum numbers of some simple systems. For instance, the energy levels of a point particle in a cubic space of volume V are, according to (17),

$$(2. 17) \quad E = \frac{h^2}{8mV^{2/3}} (k_x^2 + k_y^2 + k_z^2) = \frac{h^2}{8mV^{2/3}} k^2,$$

where k_x, k_y, k_z have to be integral, positive numbers. We can imagine these three numbers to be the components of a vector \vec{k} of magnitude k . For a large vector, large compared to 1, the condition that its three components be integers is less stringent than for a small vector, so that

the levels become more degenerate and closer together as the energy increases.

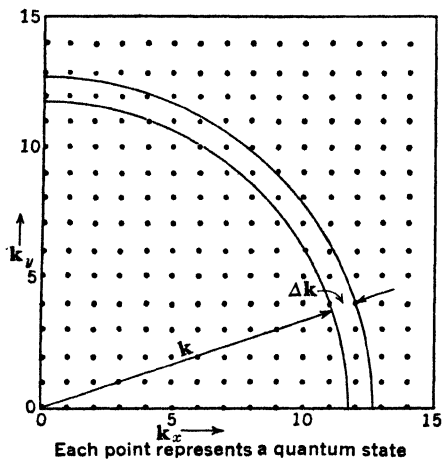

FIG. 2. 1. Diagram of a two-dimensional k space.

To calculate the number $C(E)$ for this system it is easiest to imagine the end points of the vector \vec{k} plotted in a three-dimensional k space. A cross section through this space, that is, a two-dimensional k space, is shown in Fig. 2. 1. All the points corresponding to quantum states lie in the eighth part of the space for which all three components are positive, and there form a simple cubic

lattice point, the number of lattice points in a certain region will be given by the volume of that region, provided that the region is chosen large enough so that small discrepancies at the borders have no noticeable effect. The number of lattice points whose distance from the origin lies between k and $k + \Delta k$ is equal to one-eighth of the volume of the spherical shell of radius k and thickness Δk , namely,

$$\frac{4\pi}{8} k^2 \Delta k.$$

By expressing \mathbf{k} in terms of the energy with the help of (17) one obtains the desired number as

$$(2. 34) \quad C(E) \Delta E = 4\pi \frac{mV}{h^3} (2mE)^{1/2} \Delta E.$$

With many degrees of freedom obviously the effect will be much more pronounced, that is, the number of states in an energy region ΔE will be much larger and can always be represented very accurately by a smooth function, $\Omega(E)\Delta E$. Under such circumstances we will lose interest in knowing the exact quantum state of the system. In fact, this statement becomes meaningless; namely, if a very small perturbation acts on the system, this perturbation will induce the system to make discontinuous transitions from one state to another with practically the same energy. These perturbations are always present. They may come from the outside or, more often, from effects inside the system that have been neglected in the mathematical idealization. In this latter case the law of conservation of energy must hold. For example, an atom in a certain excited quantum state can radiate spontaneously, but the energy it loses will be found in space as light. Or, if we consider a large system, made up of independent small systems, for instance point particles, there will certainly, in reality, exist interactions among the particles, at least in the form of elastic collisions, in which classically, as well as quantum mechanically, energy and momentum are conserved, although the state of the total system is changed.

Actually, the energy of a state is sharply defined only if the state is a true stationary state, that is, if the system remains in it for an infinite time. If, however, perturbations are acting, such that the system makes a transition in a time Δt , the energy can be determined only within a range ΔE such that

$$(2. 35) \quad \Delta E \cdot \Delta t \geq h.$$

This uncertainty relation between time and energy is quite analogous to that existing between coordinate and conjugate momentum (11). An example of this is the natural width of a spectral line, $\Delta\nu$. The width of energy, $\Delta h\nu$, is connected with the lifetime of the (upper) state by equation (35).

Therefore, in a large system, on account of the fact that the energy levels are not sharp, owing to inner perturbations, transitions will be possible not only between states of exactly the same energy, but also between states of approximately the same energy. This is no violation of the law of conservation of energy, since it means only that the energy values calculated are not the true ones, and the quantum states not the true stationary states, which would be found if all perturbations were taken into account.

Obviously, if Δt were very short, ΔE , therefore, very large, the assumed energy states would become very bad approximations to the true ones, and the calculations would no longer represent the true state of affairs.

It would, in principle, be conceivable to take all these inner perturbations into account in a perfect calculation of the true stationary states. If then the system were to remain completely isolated for infinite time it would stay in one state of sharp energy. Every observation or experiment performed on the system, however, induces transitions, and the energy of the complete system cannot be determined more accurately than relation (35) allows if Δt is the time elapsing between observations.

The energy of any system has a natural uncertainty δE , determined by the extent to which the system is influenced by its surroundings. This means that a definite number $\Omega = \Omega(E) \delta E$ of quantum states are available to a system, even if its energy is determined as accurately as possible.

The rate at which the transitions between these Ω states take place depends on the strength of the perturbation; it will not interest us in the calculation of equilibrium phenomena. However, transitions are governed by some general laws which are very important for the foundation of statistical mechanics. If the system is originally in the state r let us denote the probability of finding it after a time dt in the state s by $w_{rs} dt$; similarly, the probability of finding the system in the state r after it was known to be in the state s will be denoted by $w_{sr} dt$. It follows from the general laws of quantum mechanics that

$$(2. 36) \qquad w_{rs} = w_{sr},$$

that is, the probability of a process and that of the inverse one are equal. This theorem, known as the principle of detailed balancing, is a direct and strict mathematical consequence of the theory of perturbations.

It is conceivable that a system, starting in a state r , can never go, directly or indirectly, that is even by detours over other states, into a certain group of quantum states of the same energy. In that case the system will be called non-ergodic. In the future we shall always make the assumption that all our systems are ergodic, that is, that every quantum state of the system can be reached, directly or indirectly, from every other state.

For ergodic systems the following fundamental law can be proved: if the system starts in a state r , it will in time pass over into every one of the states of approximately the same energy, and will on the average spend equally long times in each. This means that if the energy of the system is determined, within a range ΔE , the probability of finding the system in a certain state, compatible with that energy, is the same for each state. This "law of equal probability of single states" is the basis of statistical mechanics.

This theorem implies that every time average over the behavior of the system can be replaced by the average over the different states. If, for instance, the energy of the system is fixed within a range ΔE , and if we want to know the average value of any quantity which is a function of the momenta and coordinates $A(p, q)$, we can obtain it by summing the average value of A for each quantum state over all states compatible with the energy, and dividing by the number of states.

A level which is g -fold degenerate, that is, which consists of g states, is g times as probable as a single one; one says that the level has the statistical weight g .

A proof of the theorem of equal probability of single states can be obtained in the following manner. Assume that we have very many identical, independent, large systems. We shall have to consider this case frequently later, and we shall call it an "ensemble" of systems. In the ensemble the large systems play the same role as the subsystems (molecules) play in the gas.

Let r, s , etc., denote quantum states of the large system compatible with a definite energy, E , which shall be the same for all the systems of the ensemble. At a given time, a certain number, N_r , of all the systems will be in the state r , N_s in the state s , etc. We wish to prove that in equilibrium $N_r = N_s$, that is, that the number of systems in all states is equal. Since the average over the numerous systems of the ensemble must be the same as the time average over one system, we will have obtained the desired proof.

The number of systems in the state r decreases on account of transitions from this to other states, and increases because systems in other states go over into the state r . The total change of N_r is given by

$$\dot{N}_r = -N_r \sum_{\mathbf{s}} w_{r\mathbf{s}} + \sum_{\mathbf{s}} N_{\mathbf{s}} w_{\mathbf{s}r},$$

or, using the principles of detailed balancing, $w_{r\mathbf{s}} = w_{\mathbf{s}r}$, (36),

$$(2. 37) \quad \dot{N}_r = \sum_{\mathbf{s}} w_{r\mathbf{s}} (N_{\mathbf{s}} - N_r).$$

In equilibrium the change with time of all the N 's, and therefore the left-hand side of these equations, must be zero. The relation $N_{\mathbf{s}} - N_r$ equals zero, for all values of \mathbf{s} and r , is obviously a sufficient condition for this. We have as many homogeneous linear equations in the unknowns N_r as there are states, and therefore unknowns. These equations, however, are not independent since the total number of systems, $\sum_{\mathbf{r}} N_{\mathbf{r}}$, is fixed: The determinant of the coefficients of the N 's is equal to zero. However, if the determinant of the coefficients of $(N_{\mathbf{s}} - N_r)$, that is, of the $w_{r\mathbf{s}}$, differs from zero, the only possible solution of (37) is that all the N 's are equal.

This can also be shown in the manner of Jordan.* We will assume that not all

* P. Jordan, *Statistische Mechanik auf quantentheoretischer Grundlage*, Braunschweig, 1933.

the N 's are equal and show that this leads to a contradiction. The N 's can be ordered according to their size, so that $N_1 \geq N_2 \geq N_3 \geq \dots$. The first l of the N 's may be equal. At least one of these l states, \mathbf{r} , must have a transition probability different from zero to a state \mathbf{s} for which $N_{\mathbf{s}} < N_{\mathbf{r}}$, since otherwise the system would not be ergodic. The equation for the change of the number of systems in this state is

$$\dot{N}_{\mathbf{r}} = \sum_{\mathbf{s} \geq l+1} w_{\mathbf{rs}}(N_{\mathbf{s}} - N_{\mathbf{r}}).$$

Every term in this sum is negative, and one at least is not zero; therefore, certainly, $\dot{N}_{\mathbf{r}}$ is less than zero, in contradiction to the assumption of a stationary distribution.

The ergodic hypothesis is essential for this proof. If we had two groups of quantum states denoted by \mathbf{r} , \mathbf{s} and ρ , σ , respectively, such that no state of one group can ever be attained from any state of the other one, $w_{\mathbf{r}\rho} = 0$ for all \mathbf{r} and ρ , the determinant of the w 's is zero. We have the additional relation that the number of systems in each group remains constant, and we can conclude only that in a stationary state the number of systems in every one of the quantum states of the first group are the same, $N_{\mathbf{s}} = N_{\mathbf{r}}$, and also those in the second one, $N_{\sigma} = N_{\rho}$, but $N_{\mathbf{r}} - N_{\rho}$, the difference of number of systems in a state of the first and a state of the second group, can have any desired value.

2j. Liouville Theorem and Equal Probability in Phase Space

In classical mechanics the state of a system is defined by the values of all the coordinates and momenta, that is, by a point in phase space. The quantity analogous to the number of states whose energy lies in a region ΔE is here the volume of phase space for which the energy lies between E and $E + \Delta E$, that is, the volume of the space between the two energy surfaces E and $E + \Delta E$. As mentioned before, this volume has the physical dimensions of energy multiplied by time to the power f . Since it is more desirable to use a dimensionless quantity, one divides the volume by a constant of the same dimensions. A number which has correct dimensions is h^f . For small values of ΔE , the volume, measured in units of h^f , becomes proportional to ΔE , and we shall denote it by $W(E) \Delta E$:

$$(2.38) \quad W(E) \Delta E = (1/h^f) \text{ times volume of phase space for which the energy lies between } E \text{ and } E + \Delta E.$$

This definition of $W(E)$ corresponds to the quantum mechanical definition of $\Omega(E)$, given in section 2i, since the quantum states are packed into the phase space in such a way that to each state there corresponds the volume h^f .

It must be borne in mind, however, that the classical function $W(E)$

is truly continuous, whereas the number of quantum states of an energy region can only be approximated by a smooth function $\Omega(E)$. Therefore, if the states of the system are not close together (as, for instance, in an oscillator), quantum-mechanical and classical calculations will differ. An additional essential discrepancy between classical and quantum-mechanical $W(E)$ and $\Omega(E)$ occurs, however, in the case of identical particles, treated in section 2k.

The fundamental property which distinguishes the phase space, the space of the momenta and coordinates, from all other conceivable spaces in which the motion of the system could also be represented, is the conservation of volume of phase space during the motion, expressed in the Liouville theorem. Each point in phase space defines a state of the system which determines its future unambiguously; in time the system, and therefore the point representing it, move along a completely determined orbit. All points originally in a region a of volume W_a , in phase space, will have moved in the time t into a region b of volume W_b .* The Liouville theorem states that $W_a = W_b$.

As an example we may consider a point of mass m with one degree of freedom only, moving under the influence of a constant force F . The solutions of the equations of motion are

$$m\dot{x} = p = Ft + \overset{\circ}{p},$$

$$x = \left(\frac{F}{2m}\right)t^2 + \left(\frac{\overset{\circ}{p}}{m}\right)t + \overset{\circ}{x},$$

where $\overset{\circ}{p}$ and $\overset{\circ}{x}$ are two integration constants, the initial values of p and x . Elimination of t out of these equations gives p as a function of x , that is, the path in phase space going through the point $\overset{\circ}{p}, \overset{\circ}{x}$. These paths are parabolas having the x axis as major axis. This result would have been obtained more quickly by the consideration that the possible paths of a one-dimensional system coincide with the lines of constant energy, in this case $(p^2/2m) - Fx = E$.

Let us now consider all points $\overset{\circ}{p}, \overset{\circ}{x}$, within a region of phase space, for instance, within the rectangle $\alpha \leq \overset{\circ}{p} \leq \alpha + \Delta\alpha, \beta \leq \overset{\circ}{x} \leq \beta + \Delta\beta$, with volume $W_a = \Delta\alpha \cdot \Delta\beta$. After the time t , these points have gone over into the region determined by

$$Ft + \alpha \leq p \leq Ft + \alpha + \Delta\alpha,$$

$$\frac{Ft^2}{2m} + \frac{\overset{\circ}{p}t}{m} + \beta \leq x \leq \frac{Ft^2}{2m} + \frac{\overset{\circ}{p}t}{m} + \beta + \Delta\beta,$$

* Provided that the orbit is a continuous function of the initial conditions.

or, changing the latter inequality by introducing p instead of \dot{p} ,

$$\frac{pt}{m} - \frac{Ft^2}{2m} + \beta \leq x \leq \frac{pt}{m} - \frac{Ft^2}{2m} + \beta + \Delta\beta.$$

This means that the points p, x all lie in a parallelogram the edges of which are given by the four lines

$$\begin{aligned} p &= Ft + \alpha, & p &= Ft + \alpha + \Delta\alpha, \\ x &= -\frac{Ft^2}{2m} + \frac{t}{m} p + \beta, & x &= -\frac{Ft^2}{2m} + \frac{t}{m} p + \beta + \Delta\beta. \end{aligned}$$

This parallelogram, see Fig. 2. 2, has the base $\Delta\beta$, height $\Delta\alpha$; the sides are inclined against the base at an angle δ with $\tan \delta = m/t$. The area

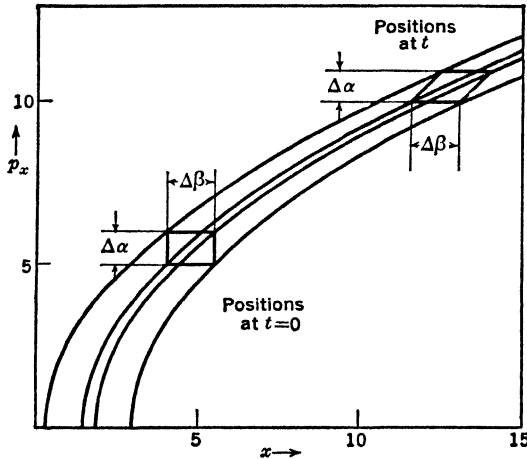

FIG. 2. 2. Motion of point particles under the action of a constant force. Parabolas represent paths in phase space.

of the region is independent of δ , namely, $\Delta\alpha \cdot \Delta\beta$, identical with that of the original region.

The theorem of conservation of volume in phase space may be mathematically expressed in the following way. The volume of a certain region is given by

$$W_0 = \int \cdots \int d\dot{p}_1 \cdots d\dot{p}_f d\dot{q}_1 \cdots d\dot{q}_f,$$

a $2f$ -fold integral. After a time t , systems whose states correspond to the points on the boundary of the region have gone over into other points, also

enclosing a region. The integral over the region of space with these new boundaries may be denoted by

$$W(t) = \int \cdots \int dp_1 \cdots dp_f dq_1 \cdots dq_f.$$

We wish to prove that $dW/dt = 0$. This can be done by the method of Gibbs. The region may be assumed to be small and bounded by planes of constant values of the coordinates and momenta. Let us consider first the change of volume due to the motion of two of the boundaries, say those bounding p_1 by $p_{1l} \leq p_1 \leq p_{1u}$. In the small time interval dt a point of the upper boundary will have moved by the amount $\dot{p}_{1u} dt$, increasing the volume if \dot{p}_{1u} is positive, a point of the lower one by the amount $\dot{p}_{1l} dt$, decreasing the volume for positive \dot{p}_{1l} . The total change due to the motion of both boundaries is the difference between these two effects and therefore depends essentially on the difference between \dot{p}_{1u} and \dot{p}_{1l} . We can replace this difference by $\int_{p_{1l}}^{p_{1u}} \partial \dot{p}_1 / \partial p_1 dp_1$, and we find that the change of volume due to the motion of these two boundaries is

$$\int \cdots \int \frac{\partial \dot{p}_1}{\partial p_1} dp_1 \cdots dp_f dq_1 \cdots dq_f dt.$$

Obviously, the change due to the motion of the other arguments, whether p 's or q 's, can be obtained in exactly the same manner, so that the total change of W in the time interval dt is

$$(2. 39) \quad \int \cdots \int \sum_{\nu=1}^f \left(\frac{\partial \dot{p}_\nu}{\partial p_\nu} + \frac{\partial \dot{q}_\nu}{\partial q_\nu} \right) dp_1 \cdots dp_f dq_1 \cdots dq_f dt.$$

Changes of volume due to the effects at the edges of the rectangular region contain a higher power of the small quantity dt . From the equations of motion in the Hamilton form, (10), it follows immediately that each term under the integral is zero, since we have that

$$\frac{\partial \dot{p}_\nu}{\partial p_\nu} + \frac{\partial \dot{q}_\nu}{\partial q_\nu} = - \frac{\partial^2 H}{\partial p_\nu \partial q_\nu} + \frac{\partial^2 H}{\partial q_\nu \partial p_\nu} = 0.$$

The integral is therefore zero, and we find that

$$\frac{dW}{dt} = 0.$$

The Liouville theorem is essential for the complete understanding of the uncertainty principle discussed in section 2e. If at one time the coordinate of a particle is known within an accuracy Δq , the momentum within a range Δp , in agreement with the uncertainty principle, the

predictions that can be made for the future are neither more nor less accurate than the initial uncertainty, namely,

$$\Delta p \cdot \Delta q = \Delta \dot{p} \cdot \Delta \dot{q} \geq \frac{h}{2\pi}.$$

We may also state the Liouville theorem in the following equivalent manner: if we have several, say N , identical systems, and if at a time t their states fill a part of the phase space with a certain density, they will, after a time t , have moved to a different part of phase space corresponding to the same energy, which they fill with the *same* density.

To proceed, we have to make here, as in the quantum-mechanical case, the ergodic hypothesis that, starting from any given volume element of phase space, every other region of phase space of the same energy is eventually reached by the system. Under this assumption the stationary distribution of N systems in phase space will be that of equal density. If this distribution is once obtained, it will not change in time, and it is also the only distribution which has this property if the systems are ergodic.

Returning to one system, this implies that the state of the system remains equally long in equal volumes of phase space, since otherwise there would occur an accumulation of systems in regions where the systems dwell longer. The probability of finding the system in a region is proportional to the volume of that region, or *equal volume elements of phase space are equally probable*. The time average over the motion of the system can therefore be replaced by the average over the volume of phase space.

This is the classical equivalent to the quantum-mechanical theorem of equal probability of single states. The great analogy between these two theorems is obvious: since the quantum states lie with constant density throughout the phase space, the quantum-mechanical theorem also gives equal volumes of phase space the same statistical weight. The regions in phase space which will concern us most are those between two neighboring energy surfaces, namely, the $W(E) \Delta E$ of equation (38) or its quantum-mechanical equivalent, the number of states with energy between the same values, $\Omega(E) \Delta E$. These two quantities are essentially equal (except in the case of identical particles) if the energy range ΔE is sufficiently large so that $\Delta E/h$, the range per degree of freedom, is large compared to two neighboring quantum states differing only by unity in the value of any one quantum number.

Whereas the assumption that the system is ergodic is, to say the least, somewhat artificial in classical mechanics, it is more natural and more real for a quantum-mechanical system. It can actually be demon-

strated that a classical system cannot be truly ergodic. In view of this it is necessary to define quasi-ergodic behavior in a somewhat more complicated manner than here, and to assume that all classical systems follow this behavior, in order to deduce the laws of classical statistics. A quantum-mechanical system, however, can be truly ergodic, since only a finite number, Ω , of cells is available to it at one energy.

Of course, the classical theorem was known long before quantum mechanics. In fact, the agreement between the two methods is not at all accidental, since quantum mechanics was created with the importance of phase space and the statistical considerations as guiding principles. Quantum mechanics has the essentially statistical characteristic of predicting probabilities rather than certainties. For this reason it seems particularly adapted to be the foundation of statistical mechanics, and the law of equal probability of single states is a more direct consequence of quantum mechanics than the equal probability of phase space is of classical mechanics.

2k. Identical Particles, Einstein-Bose and Fermi-Dirac Systems

Let us assume the system to consist of two or more identical independent constituent systems, which we shall for convenience call particles, and let the states of the individual particles, which will be called cells, since they may be regarded as forming cells in the μ -space, be denoted by the quantum numbers \mathbf{k} . An example for this is provided by several point particles moving in the same field-free space. It appears at first sight that now a new degeneracy occurs since the state in which particle 1 has quantum numbers \mathbf{k}_1 , particle 2 quantum numbers \mathbf{k}_2 , has exactly the same energy as the one where the particles are exchanged, that is, where 1 has quantum numbers \mathbf{k}_2 , 2 has \mathbf{k}_1 . For truly identical particles, however, these two possibilities have to be counted as one only, and for more identical particles correspondingly: *all* states of the total system which can be made up out of each other by permuting the particles within the cells have to be counted as one only. This means that a state of the total system is fully determined by giving the number of particles in each single-particle quantum cell, \mathbf{k} , instead of the cell in which each particle is. For this it is necessary that the particles be not only alike, but absolutely identical, so that there is no conceivable experimental way of distinguishing among them, and, therefore, among the different states that are counted as one.

The reasons for this are intimately connected with the fact that linear combinations of eigenfunctions belonging to the same degenerate energy level describe the state just as well as the original functions. Instead of the eigenfunctions which definitely denote which particle is in which cell, namely, the

products of eigenfunctions of the independent particles, we can form linear combinations of products of this type, namely, of all those that originate from one product by permutation of the particles. For two particles, the two products are $\psi_{\mathbf{k}_1}(1) \cdot \psi_{\mathbf{k}_2}(2)$, and $\psi_{\mathbf{k}_2}(1) \cdot \psi_{\mathbf{k}_1}(2)$. The linear combinations, which no longer have as simple a meaning as the products, are also possible ψ functions of the same energy value. Outstanding among these are the "symmetric" and the "antisymmetric," namely, one that remains unchanged, and one that changes sign upon the exchange of any two particles. For two particles, these are $\psi_s = 2^{-1/2}[\psi_{\mathbf{k}_1}(1) \cdot \psi_{\mathbf{k}_2}(2) + \psi_{\mathbf{k}_2}(1) \cdot \psi_{\mathbf{k}_1}(2)]$, and $\psi_a = 2^{-1/2}[\psi_{\mathbf{k}_1}(1) \cdot \psi_{\mathbf{k}_2}(2) - \psi_{\mathbf{k}_2}(1) \cdot \psi_{\mathbf{k}_1}(2)]$. Since all outer influences and all inner interactions act absolutely symmetrically on all identical particles, a linear combination will keep its symmetry character under all perturbations. A symmetric function remains symmetric, an antisymmetric one antisymmetric, forever. In other words, the probability of transition of the system from a symmetrical state s , that is, a state with a symmetrical eigenfunction,* to any other state, r , is zero, unless the end state, r , is also a symmetrical state. The corresponding statement holds true for antisymmetric states. Therefore the symmetric states alone form one ergodic system, as do also the antisymmetric ones. All identical particles of one kind, for instance all electrons, will at one time have been in either a symmetric or an antisymmetric state, and therefore will always remain in states of the same symmetry character. We then have to exclude all other mathematically possible eigenfunctions in counting the number of states available to the system.

Obviously, the law of the occurrence of symmetric and antisymmetric states is valid not only if the particles are independent, but also if there is any kind of interaction between them. In that case, the quantum mechanically calculated eigenfunctions of non-degenerate levels automatically have some symmetry character, and only those which are either symmetric or antisymmetric in all particles are realized in nature. The transition probability from the naturally occurring to those of the wrong symmetry character are always zero, so that the

* In general, the symmetric function is constructed by adding all $n!$ eigenfunctions obtained from the original product by a permutation of the n particles and dividing by the proper normalization factor, $(n!)^{1/2}$. The antisymmetric one is formed by multiplying each eigenfunction by $(-1)^\alpha$ before adding, where α is odd or even according to whether the permutation of particles in question consists of an odd or an even number of transpositions. This is the same as expressing the antisymmetric eigenfunction as a determinant

$$\Psi_a = (n!)^{-1/2} \begin{vmatrix} \psi_{\mathbf{k}_1}(1) & \psi_{\mathbf{k}_1}(2) & \cdots & \psi_{\mathbf{k}_1}(n) \\ \psi_{\mathbf{k}_2}(1) & \psi_{\mathbf{k}_2}(2) & \cdots & \psi_{\mathbf{k}_2}(n) \\ \vdots & \vdots & \ddots & \vdots \\ \psi_{\mathbf{k}_n}(1) & \psi_{\mathbf{k}_n}(2) & \cdots & \psi_{\mathbf{k}_n}(n) \end{vmatrix}$$

Since a determinant is zero if two of its rows or columns are alike it is seen that Ψ_a vanishes identically if two of the functions $\psi_{\mathbf{k}_k}$ are the same.

fact that we have to rule out a certain number of states influences the others in no way. We will encounter this phenomenon, for instance, in the rotation-vibration levels of diatomic molecules composed of identical atoms, where alternate rotational levels have different symmetry character, so that only half of the states occur in nature.

The question whether for a given kind of particle the symmetric or antisymmetric states are realized cannot, of course, be answered by theoretical considerations; for this it is necessary to investigate the symmetry character of the observed states. Now, the difference of possibilities, 1, symmetrical, and 2, antisymmetrical, is essentially this: it is always possible to construct exactly one linear combination of the product eigenfunctions discussed above, which is symmetrical in all particles. An antisymmetrical eigenfunction, however, can be constructed only if no two of the single-system eigenfunctions are alike, that is, if no two particles are in the same cell. Particles with antisymmetric states, therefore, satisfy the Pauli exclusion principle, which postulates that there is never more than one particle in a given single cell.

Investigations of atoms and nuclei have shown that all elementary material particles, namely, electrons, protons, neutrons, and neutrinos, fulfill the exclusion principle. The radiation of the black body (Chapter 16) shows that light quanta have symmetrical eigenfunctions only. The behavior of composite systems, that is, nuclei, atoms, and molecules, can be deduced from the laws for the elementary ones. If the subsystems are composed of n elementary particles, permutation of two subsystems amounts to n transpositions of elementary particles and, therefore, since the permutation of each pair of elementary particles multiplies the eigenfunction by -1 , must multiply it by $(-1)^n$. If n is even, this means that the eigenfunction is unchanged upon the exchange of two subsystems, or it is symmetrical. If n is odd, the eigenfunction is antisymmetric in the subsystems.

Systems composed of several independent truly identical subsystems fall into two groups, depending on the nature of the subsystems:

1. *Einstein-Bose systems (symmetrical eigenfunctions)*. The particles or subsystems are indistinguishable. Eigenfunctions of the total system which differ only in a permutation of the subsystems have to be counted as giving rise to only one quantum state of the total system. All configurations of the total system which differ only in being permutations of the subsystems among the cells or quantum states of the subsystems have to be counted as one only. Therefore, a state of the total system is determined if the number of subsystems in every cell or quantum state of the subsystems is known.

✓ Light quanta and all atoms and molecules composed of an even number of elementary material particles form Einstein-Bose systems.

2. *Fermi-Dirac systems (antisymmetric eigenfunctions)*. A state of the total system is defined if the number of subsystems in every cell or quantum state is known, as under 1. In addition these systems obey

the Pauli exclusion principle, which states that there is never more than one subsystem in each cell.

Fermi-Dirac systems are formed by all elementary material particles,* that is, by positive and negative electrons, protons, neutrons, and neutrinos, and furthermore by all subsystems composed of an odd number of elementary particles.

With these two types of systems which are realized by atoms and molecules we want to contrast a third which is not, namely the composite system we would have obtained had we disregarded the principal identity of the subsystems:

3. *Boltzmann systems.* A state of the total system is defined by the quantum states of each constituent subsystem.

This latter method of counting the states of the system corresponds to the classical one, since the volume in phase space, measured in units of h^f , between two energy surfaces E and $E + \Delta E$ is equal to the number of states in the Boltzmann system. It is applicable only if all subsystems are different and distinguishable in principle, as for instance billiard balls are, which could be painted in different colors. No identical subsystems of molecular size form Boltzmann systems.

It is interesting to compare the number of states for the three types of systems. If all N identical particles happen to be in different states this gives rise to one state in the Fermi-Dirac or Einstein-Bose systems, but to $N!$ states in the Boltzmann system, since the $N!$ permutations of particles in the cells are counted as different states.

If some cells contain several particles this still corresponds to exactly one state of the Einstein-Bose system, is never attained at all in the Fermi system, and corresponds to somewhat less than $N!$ states in the Boltzmann system, since a permutation of particles which are in the same cell does not lead to a different state of the total system. If all particles are in the same cell this means one state for the total Einstein-Bose as well as the Boltzmann system.

Particles which form Einstein-Bose, Fermi-Dirac, or Boltzmann systems would have differing numbers of states consistent with a given energy, even if the cells or quantum states of the individual particle had the same energy in all three cases. There would be more states in the Einstein than in the Fermi system. The Boltzmann system would have somewhat less than $N!$ times as many states as the Einstein system, and somewhat more than $N!$ times as many states as the Fermi system.

The number of states of the Boltzmann system is always arbitrarily

* The heavy electron may possibly be an elementary particle obeying Einstein-Bose statistics.

divided by $N!$, and in the future it will be understood that this division is made when Boltzmann systems are referred to. This division of the phase space by the factorial of the number of identical particles occurring had been undertaken in classical statistics long before the underlying reasons had been explained by quantum mechanics. Gibbs, for instance, found it consistent with the spirit of the statistical method to count configurations that differed only in the exchange of the positions of identical particles as being the same.

The number of states for this corrected Boltzmann counting lies between the number for Einstein and that for Fermi counting. If there are many individual quantum states which correspond to the given energy region, and relatively few particles, very few of the total number of states will have two or more particles in the same cell. The numbers of quantum states with energy E , the numbers $\Omega(E)$ of section 2i, then become asymptotically equal for the three kinds of systems. In general, however, the results of statistical calculations for the three kinds of systems will be different. One obtains what is called Einstein-Bose, Fermi-Dirac, or Boltzmann statistics, respectively. We should like to point out that there is no difference in the statistical methods employed. The difference lies exclusively in the mechanical model treated, as discussed above.

The number of quantum states of a system calculated with the Boltzmann counting that omits the division by $N!$ corresponds to the volume of the classical phase space. For real systems, which obey either Einstein-Bose or Fermi-Dirac counting rules, if N_i identical particles of type i are present, the number of states available to the system corresponds to, and under certain conditions becomes asymptotically equal to, the phase volume W measured in units of h^f divided by the product of the N_i factorials, $\prod_i N_i!$. If calculations are made using the classical phase volume, instead of the number of quantum-mechanical states, we shall always correct the Boltzmann counting by division with the product of the factorials.

Systems of Einstein or Fermi type cannot be said to consist of strictly independent particles. The quantum states of one particle are influenced by the presence and behavior of the other particles. One should say that the particles are mechanically, but not statistically, independent. However, for the sake of simplicity, we shall continue to speak of independent subsystems.

CHAPTER 3

TERMINOLOGY AND DEFINITIONS

(a) The States of a Thermodynamic System. (b) Forces of a Thermodynamic System. (c) The Distribution of Independent Molecules in Space. (d) The Concept of a Distribution. (e) The Most Probable Distribution. (f) Idealized Systems and Inhibitions. (g) Summary.

3a. The States of a Thermodynamic System

It has already been mentioned in section 1a that the method of statistical mechanics is applied almost exclusively to systems which are composed of a very large number of particles, and in which, moreover, usually all the particles are alike or of a few different types. If there are N_i particles, usually molecules, of type i , each having f_i degrees of freedom, then $f_\gamma = \sum_i N_i f_i$ is the number of degrees of freedom of the total system. f_γ coordinates are necessary to specify the instantaneous position of every part of the system, and f_γ momenta to specify the state of motion. The phase space formed by the f_γ coordinates and their f_γ conjugate momenta is referred to as the γ -space of the system.

As discussed in detail in Chapter 2, in classical mechanics one point in this $2f_\gamma$ -dimensional phase space completely determines the state of the system, and therefore also its energy. There exists a continuous range of points, in this γ -space, consistent with a single total energy, and we sometimes refer to such a range as an energy surface.

According to the laws of classical mechanics the specification of the exact state of even a complicated isolated system exactly predetermines the state of the system at any definite later time. For the systems dealt with in statistical mechanics such information would be not only impractically difficult to calculate, but valueless if obtained. Even were a kindly disposed mathematical archangel to undertake the calculation of the exact position and velocity of every helium atom in a one-liter flask at standard conditions, for some definite future time, we would be far too uninterested and lazy to even read the tediously long information handed to us about every one of the 10^{22} atoms.

The fact that all real systems obey the laws of quantum mechanics, according to which the coordinates and momenta cannot be specified exactly at the same time, does not alter this at all. The most exact

location of the system in the γ -space which retains physical significance is the statement that the system is in one of a network of adjoining cells, each of volume $h^{f\gamma}$. Each cell corresponds to a state of the system, and is defined by f_γ quantum numbers. If the system is known to be in a certain state at a definite time, the laws of quantum mechanics make possible, in principle, the calculation of the probabilities of finding it in any of the other states at any later time. But for a large system this information is also much too detailed ever to interest us.

The total number of quantum numbers necessary to specify the state of a system, f_γ , is completely determined by the specifications of the system, and the volume in phase space occupied by a state, $h^{f\gamma}$, is also fixed.* However, the exact choice of the meaning of the quantum numbers is more or less arbitrary, in much the same way as the exact choice of the f_γ coordinates in classical mechanics is not completely predetermined by the description of the system. That is, the shape of the cell in phase space of volume $h^{f\gamma}$ determined by the f_γ quantum numbers is more or less arbitrary, and may be thought of as altered to suit the needs of the investigator in attacking different problems. However, just as the forces in the system frequently make the choice of one particular set of coordinates almost imperative, so also the most convenient set of quantum numbers for a particular problem is usually pretty definitely determined.

If in future discussions we speak of the state of a system this may be interpreted as meaning either the quantum-mechanical state, or the classical point in phase space. In the second case the expression "number of states" has to be read as "volume in phase space." This volume is always assumed to be measured in units of $h^{f\gamma}$ and to be divided by the product of the factorials of the numbers of identical particles occurring. The general statistical laws can be built up equally well on either concept. In fact, as the discussions in sections 2j and 2k suggest, for many systems the numerical results will be the same with quantum or with classical calculation.

Unfortunately, in thermodynamics the same word state is used in a different sense. For this concept we shall always explicitly write "thermodynamic state." The thermodynamic state of a system is described by a very few observable quantities. The specification of only two variables determines the thermodynamic state of a one-

* This does not mean that the possible values of p and q for each quantum state lie within a sharply bounded region of size $h^{f\gamma}$ in the γ -space; there exists a finite, although small, probability that the system will be observed outside. For many, n , adjoining quantum states, however, the volume of the range of reasonable probability for the p 's and q 's approaches asymptotically $nh^{f\gamma}$.

component system, a system consisting of only one kind of particles. The two which have the most obvious mechanical significance are the volume and the energy. All other observables, the pressure and temperature, for instance, may be expressed as functions of these two. Extremely many mechanical states of the system correspond, then, to fixed values of these two quantities, and we know from section 2i that an ergodic system reaches each one of these states with equal probability.

It is our aim to obtain relationships between the experimental observables of a system, to be able to predict that a system of given composition, given volume, and total energy exerts a certain pressure on its surroundings, and will have a certain temperature, entropy, and free energy. The accomplishment of this falls naturally into two steps. The first one is the identification of the thermodynamic properties with mechanically defined quantities, and the derivation of the general laws of thermodynamics. The second step, which reaches further than the scope of pure thermodynamics, consists in the numerical evaluation of the thermodynamic properties of a given system from a knowledge of its mechanical nature. Such calculations shed light on the atomistic interpretation of microscopic phenomena. For instance, in section 1d, we have seen that the pressure exerted by a gas on the walls of its container is due to the impacts of the molecules.

3b. Forces of a Thermodynamic System

If a completely defined system is in a fixed quantum state r the most probable or expectation value of any property that is a function of the coordinates and momenta $A(p, q)$, can be calculated from mechanical consideration. Let us designate this value by A_r . However, it is hopeless to undertake the determination of the exact quantum state for a large system. If the total energy E and therefore the macroscopic or thermodynamic state are determined, a large number of quantum states, designated in section 2i by Ω , are available to the system. We know further from section 2i that all these states are reached with equal probability by an ergodic system. It follows that the time average of a property A of a macroscopic system is the same as the average taken over all quantum states consistent with the energy, namely, the sum of A_r over all Ω quantum states r , divided by Ω ,

$$(3. 1) \quad \bar{A} = \Omega^{-1} \sum_{r=1}^{r=\Omega} A_r.$$

If x denotes an outer variable of the system, for instance, the volume or one of the strain components defining the shape of a rigid solid, the quantity $-\partial E_r / \partial x$ is the generalized force with which the system in

the quantum state r resists an infinitesimal decrease in x , or the force which must be balanced from outside to prevent x from increasing. The average value of the force is then

$$(3. 2) \quad F_x = -\Omega^{-1} \sum_{r=1}^{r=\Omega} \frac{\partial E_r}{\partial x}.$$

In particular, if the outer variable x is chosen to be the volume V , the force resisting a decrease of V is called the pressure, P , and we find

$$(3. 3) \quad P = -\frac{1}{\Omega} \sum_{r=1}^{r=\Omega} \frac{\partial E_r}{\partial V}.$$

Assume that a very small but finite change, Δx , in the outer variable x is undertaken so slowly that the change does not induce transitions. (A process of that type is called adiabatic in quantum mechanics.) If the system is in the state r the corresponding change of energy is given by

$$(3. 4) \quad \Delta E_r = \frac{\partial E_r}{\partial x} \Delta x.$$

Now if the change is made even slower, so that the system makes many quantum transitions during the process, as in any natural process, the total energy change is again the average of the above quantity taken over all quantum states available to the system.

$$(3. 4') \quad \Delta E = \frac{1}{\Omega} \sum_{r=1}^{r=\Omega} \Delta E_r = \frac{1}{\Omega} \sum_{r=1}^{r=\Omega} \frac{\partial E_r}{\partial x} \Delta x.$$

Obviously, to have any physical significance, the energy change ΔE must be larger than the uncertainty δE in the energy of the system.

We wish now to prove that in a process like this the number of quantum states with energies below that of the system remains constant. In other words, the number of states of the system, with outer variable x , below the energy E , is equal to the number of states below $E + \Delta E$ if the outer variable has the value $x + \Delta x$ and ΔE is related to Δx by (4'). Expressed mathematically:

$$(3. 5) \quad \int_0^E \Omega(x, E) dE = \int_0^{E+\Delta E} \Omega(x + \Delta x, E) dE.$$

The proof of this statement is almost self-evident. The change of energy of the system, ΔE , is defined by (4') as the average of the changes of energy of the states near the topmost energy. This means that, owing to the change in x , equally many states, previously located below E , have passed to energies above $E + \Delta E$ as states from above

E to energies below $E + \Delta E$. This statement, in turn, is equivalent to saying that after the process the number of states with energies below $E + \Delta E$ is the same as the number of states which previously had energies below E . Q.E.D.

For a mathematical proof the total change in $\int \Omega(E) dE$ can be split up into two additive parts. The first one is due to the change of energy at constant value of x , and the second one to the change of x at constant energy. The first constituent is obviously

$$\Omega(E) \frac{dE}{dx} \Delta x = \Omega(E) \frac{1}{\Omega_r=1} \sum_{r=1}^{r=\Omega} \frac{\partial E_r}{\partial x} \Delta x.$$

The second contribution is due to the fact that states at the boundary E cross this boundary on account of the change in x . Since an increase in energy of such a state takes it out of the energy region in question and therefore decreases $\int \Omega(E) dE$ by unity this leads to a change in $\int \Omega(E) dE$ by

$$- \sum \frac{\partial E_r}{\partial x} \Delta x,$$

summed over the states with energy $E_r = E$. The number of these is $\Omega(E)$. Their average change of energy is the same as the average energy change of the states available to the system at the energy E (since the uncertainty of energy δE is assumed to be small compared to ΔE). The second part of the change of $\int \Omega(E) dE$ is then

$$-\Omega(E) \frac{1}{\Omega_r=1} \sum_{r=1}^{r=\Omega} \frac{\partial E_r}{\partial x} \Delta x,$$

which precisely cancels the first. Equation (5) is thereby proved.

It follows from (5) that, if two energy values E_1 and E_2 of the total system are altered to E'_1 and E'_2 , respectively, by the small and slow variation of an outer variable, the number of states between E_1 and E_2 is the same as that between E'_1 and E'_2 .

Conversely, if a variation of an outer variable x leaves the number of quantum states below the energy of the system unchanged, the changes of E and x must be connected by (4). We can, therefore, using (2), write (4) in the form

$$(3.6) \quad \left(\frac{\partial E}{\partial x} \right) \int_0^E \Omega(E) dE = \frac{1}{\Omega_r=1} \sum_{r=1}^{r=\Omega} \frac{\partial E_r}{\partial x} = -F_x;$$

the generalized force with which a system resists a decrease in x is the

negative of the derivative of the energy with respect to x at constant $\int_0^E \Omega(E) dE$. In particular, the pressure P is

$$(3. 7) \quad P = -\left(\frac{\partial E}{\partial V}\right)_{\int_0^E \Omega(E) dE}.$$

From (1) it is seen that it is possible to predict only average values of the properties of the system. Owing to the tremendously large number of states these average values are the ones usually found by experiment. Correspondingly, there is a significant difference between the thermodynamic laws, which we wish to develop, and the laws of other fields of physics, say those of mechanics. In these other fields the predictions are made with complete certainty; all cases must be expected to behave experimentally in exact agreement with the predictions of the calculations if no error has been made in the assumptions of the nature of the system. The thermodynamic laws, on the other hand, are predictions only of the most probable happenings. Fluctuations may and will occur, the magnitude and probability of which may be calculated. That appreciable deviations from these laws occur very seldom is due only to the very large number of particles, which makes such deviations very improbable.

This difference between statistical mechanics and what is usually called mechanics has been largely eliminated by the discovery that the classical mechanics is only an asymptotic approximation to the more exact quantum mechanics, the laws of which give merely the *probabilities* of certain happenings. In view of this the predictions of classical mechanics must also be regarded as giving only a result of enormous probability.

That the laws of thermodynamics merely predict occurrences of enormously high probability can be seen clearly by considering the example of the perfect gas treated in Chapter 1. The mechanical system consists of N independent mass points moving in a given volume V . If volume and energy of this one-component system are given, the thermodynamic "state" is fixed. Thermodynamics, then, predicts that the system will exert a uniform pressure on its surroundings, determined completely by the energy and the volume.

If we examine the mechanical behavior of this system, it is immediately obvious that, among the extremely many states consistent with the given outer variables, volume and energy, there are many that give rise to completely uneven pressure on the walls; for instance, it is mechanically possible that the velocities of all molecules lie in the same, say the x direction, giving rise to zero pressure on all but one wall!

Moreover, we are assured by the Liouville theorem that there exists a definite, non-zero, probability of the system's reaching this region of the phase space. However, it is quite evident that an occurrence of this extreme nature will be extraordinarily rare; the region of phase space corresponding to it is very small compared to the total region consistent with the given energy.

In section 1d the well-known thermodynamic relation between the pressure, volume, and energy was derived on the basis of two assumptions: that the velocities of the molecules were distributed evenly in all directions, and that the molecules were distributed in space with constant density. We are going to show that these "distributions" are the most probable ones. Indeed, on account of the very great number of molecules they are overwhelmingly probable, that is, the probability of an appreciable deviation from these "distributions," and therefore from uniform pressure and the relation (1. 13), is extremely small. To demonstrate this we wish to investigate the second of these conditions more closely.

3c. The Distribution of Independent Molecules in Space

We may consider the volume V of the perfect gas of section 1d as being divided into M regions of equal volume. If the regions are numbered $1, \dots, i, \dots, M$, and N_i is the number of particles in the region i , then the total number of particles is $N = \sum_i N_i$. Obviously, if the regions are too small, that is, if we have about as many volume elements as particles, the numbers N_i will vary erratically with time; regularity can exist only if we postulate that $M \ll N$. A distribution of the molecules with respect to the volume regions is then defined by giving the values of the numbers N_i , the numbers of particles in each of the regions. We have assumed intuitively in section 1d that the most probable distribution is given by $N_i = N_j = N/M$, which means that, if N is large, the number of particles n in any volume $v > V/M$ is $n = vN/V$.

The extent to which we can be certain that the condition of equal density in all parts of the system will actually be fulfilled in practice may be estimated in the following manner. Let us, for simplicity, take $M = 2$; that is, we divide the container of the N independent particles, in thought at least, into two equal volumes, a and b . We shall calculate the probability that at any randomly chosen time there would be $(N/2) + n$ particles in the part a and $(N/2) - n$ particles in the b part of the container. We have assumed that the particles are independent, in other words, that no forces exist between them. We shall proceed classically and assume that the molecules are statistically inde-

pendent. The chance that any single specified particle would be found in the a half of the container will be one-half, independent of the positions of the others. The chance that it would be in the b part will also be one-half. The chance of finding any single completely specified configuration in which, for each previously numbered particle, the half of the container in which it is to be found is specified, will be the product of N one-halves or 2^{-N} , and independently of whether all the particles are to be found in one half of the container or whether the division is to be half and half. That is, the chance of finding $N/2 + n$ specified particles in a is independent of n . This is in analogy to the fact that the chance of picking up any one completely determined bridge hand is just as small as the chance of finding a hand of thirteen spades.

However, our interest was not in the chance of finding $(N/2) + n$ specified particles in a , but in the chance of finding any $(N/2) + n$ particles in a . We must therefore multiply 2^{-N} by the number of configurations compatible with our distribution, that is, with the number of ways in which N numbered particles can be separated into two groups of $(N/2) + n$ and $(N/2) - n$ particles, respectively. This number is* $N! / ((N/2) + n)! ((N/2) - n)!$.

The result for w_n , the chance of finding $(N/2) + n$ particles in part a of the vessel, is

$$(3. 8) \quad w_n = \frac{2^{-N} N!}{\left[\frac{N}{2} + n \right]! \left[\frac{N}{2} - n \right]!}.$$

Inspection of this expression shows immediately that it has its maximum value, w_0 , for $n = 0$, as we expected. Since expressions involving factorials are somewhat awkward to handle one may bring equation (8) into a different, approximate, form, which expresses its functional dependence on n more conveniently. Use of the Stirling approximation† for the factorial, namely, that $M! = M^M e^{-M} (2\pi M)^{1/2}$, immediately gives the maximum, w_0 , in the simple form

$$(3. 9) \quad w_0 = \frac{2^{-N} N!}{([N/2]!)^2} = \left(\frac{2}{\pi} \right)^{1/2} \frac{1}{(N)^{1/2}}.$$

The ratio of w_n to w_0 is seen to be, from (8),

$$(3. 10) \quad \frac{w_n}{w_0} = \frac{([N/2]!)^2}{([N/2] + n)! ([N/2] - n)!} \\ = \frac{N}{N + |2n|} \cdot \frac{N - 2}{N + |2n| - 2} \cdots \frac{N - |2n| + 2}{N + 2},$$

* See Appendix A VII.

† See Appendix A IV.

which lies between the value of two simple expressions

$$(3.11) \quad \left(\frac{N}{N + |2n|} \right)^{|n|} > \frac{w_n}{w_0} > \left(\frac{N - |2n|}{N} \right)^{|n|}$$

If we define $x = |2n|/N$, then

$$(3.12) \quad \left(\frac{1}{1+x} \right)^{x(N/2)} > \frac{w_n}{w_0} > (1-x)^{x(N/2)}.$$

For $x \ll 1$, when $\ln(1+x) \cong x$, and therefore $(1+x)^{(N/2)x} = e^{(N/2)x \ln(1+x)} \cong e^{-(N/2)x^2}$, both upper and lower limits become asymptotically equal to

$$(3.13) \quad \frac{w_n}{w_0} = e^{-(N/2)x^2}.$$

Using (13) and (9), an alternative approximate expression for w_n , when N is very large and x is very small, is obtained as

$$(3.14) \quad w_n = \frac{1}{(\pi)^{1/2}} \left(\frac{2}{N} \right)^{1/2} e^{-(N/2)x^2}.$$

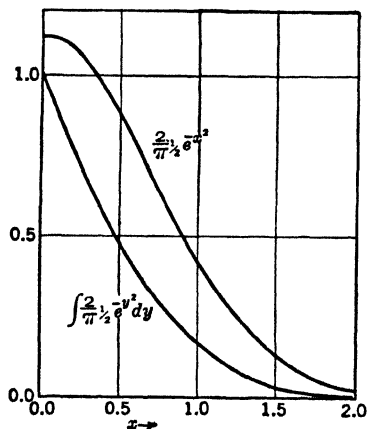

FIG. 3.1.

Plot of

$$\frac{2}{\pi^{1/2}} e^{-x^2} \quad \text{and} \quad \int_x^{\infty} \frac{2}{\pi^{1/2}} e^{-y^2} dy$$

against x

Since the integral of $e^{-x^2} dx$ from minus to plus infinity is $\pi^{1/2}$, we see that the sum, or integral, of all the values of w_n is unity.*

Equation (14) is known as the Gauss error function, which is plotted in Fig. 3. 1. If any act which may, with equal probability, have a result a or a result b is carried out independently N times, w_n gives the probability that the result a will be obtained $(N/2) + n$ times. This applies as well to the throws of an unweighted coin as to the problem with which we started, the distribution of independent particles between two equal volumes.

* The approximation of (14) is valid only if $x \ll 1$. However, for large values of N the value of w_n becomes negligibly small even for very small values of x . The integration, then, yields the same value if the limits are taken as $x = -\infty$ and $+\infty$ or as $x = \delta$ and $-\delta$ as long as $N \delta^2/2 \gg 1$, which may well be true for large enough values of N even if $\delta \ll 1$.

The quantity $x = |2n|/N$ is the fractional deviation of the number of particles $(N/2) + n$ in the part a from the most probable number $N/2$. The number Δn of values of n included in an interval $dx = 2\Delta n/N$ is $\Delta n = \frac{1}{2}N dx$ so that the chance of finding a distribution lying between x and $x + dx$ will be

$$(3. 15) \quad w_x dx = \frac{1}{(\pi)^{1/2}} \left(\frac{N}{2}\right)^{1/2} e^{-(N/2)x^2} dx,$$

and the chance of finding a distribution of fractional deviation from the equilibrium greater than z in either direction will be

$$(3. 16) \quad w(>z) = 2 \int_z^\infty w_x dx = \frac{2}{(\pi)^{1/2}} \left(\frac{N}{2}\right)^{1/2} \int_z^\infty e^{-(N/2)x^2} dx.$$

Values of $w(>z)$ for different values of N and z are tabulated in Table 3. 1. It is seen that, for a liter of gas at standard conditions ($P = 1$ atm., $T = 273.1^\circ\text{K.} = 0.0^\circ\text{C.}$), for which $N \cong 10^{22}$, the chance of finding a deviation of more than one part in a million from the normal in one-half of the flask is only one chance in 10^{-10^0} .

TABLE 3. 1

Values of $w(>z)$ for different values of z and N .

$w(>z)$ is the probability of obtaining a greater than z fractional deviation from equality in the number of results from N independent performances of an act capable of having two results of equal probability.

$$w(>z) = f\left(\sqrt{\frac{N}{2}} z\right) = \frac{2}{\pi^{1/2}} \int_{\sqrt{N/2} z}^\infty e^{-t^2} dt.$$

N	$z = 10^{-1}$	10^{-2}	10^{-3}	10^{-4}	10^{-5}	10^{-6}
2×10^2	0.157	0.887	0.989			
2×10^4	10^{-44}	0.157	0.887			
2×10^6	10^{-4340}	10^{-44}	0.157	0.887		
2×10^8	10^{-10^6}	10^{-4340}	10^{-44}	0.157	0.887	
2×10^{10}	10^{-10^8}	10^{-10^6}	10^{-4340}	10^{-44}	0.157	0.887
2×10^{20}					$10^{-10^{10}}$	10^{-10^8}

The quantum-mechanical attack of the problem may be undertaken in two ways. A division in the volume of the system may be introduced and therefore the quantization done in such a way that each quantum state of the system corresponds to a definite distribution. Or one may use the quantum states of section 2g, example 1, corresponding to the total volume, in which case each state can give rise to any distribution. For each state the probability of finding certain molecules in certain regions of space can be calculated

immediately owing to the physical significance of the eigenfunction ψ , namely, by integration of $|\psi|^2$ over the regions in question.

If the molecules of the perfect gas were statistically as well as mechanically independent, so that we could use the product eigenfunctions of section 2h, the probability of finding a specified molecule in a part v of the total volume V is v/V , just as in the above consideration. If, on the other hand, we have Einstein-Bose statistics, and have to use symmetrical eigenfunctions, a certain statistical attraction is present; for Fermi-Dirac statistics, a statistical repulsion. The considerations which lead to the proof of the prevalence of equal density remain essentially unaltered since the factor $N!/([N/2] + n)!([N/2] - n)!$ arising from the number of ways in which, out of N particles, $(N/2) + n$ can be put into one box and $(N/2) - n$ into another box enters here too, and its dependence on n is strong enough to overshadow completely any other effect that might be present.

3d. The Concept of a Distribution

As we have seen already in the last two sections, it is very often found useful to introduce a description of the instantaneous configuration of the system which is intermediate between the very detailed one of the mechanical and the very broad one of the thermodynamic state. Such descriptions shall be designated by the somewhat general term of *distribution*. Extremely many states correspond to one distribution, but many distributions are consistent with the same energy. Or, every point in phase space belongs to a certain distribution. The region of phase space consistent with any distribution is large compared to that of one state, but may be small compared to the total region of given energy.

In Chapter 1, and in the two previous sections of this chapter, we have used the term distribution and encountered two different types of distributions of molecules for the same system, the perfect gas: namely, the distribution of molecular velocities over the different directions, and the distribution of molecules in space. In the second, which was discussed more carefully, we saw that the concept was a useful one only if the subdivision of space considered was large compared to the volume per molecule. If this is so, one distribution corresponds to a much less detailed description of the configuration than the location of each molecule in space. This criterion of a distribution, that it be not too detailed, is just what we wish to postulate generally.

Other distributions which we are going to consider are those of molecules in different ranges of kinetic energy; or of energy between two specified parts of the system; or, if we have atoms capable of forming various types of molecules, the distribution of atoms between the different molecular species.

On account of the varied types of distributions which are important, a general definition of the word can hardly be given. All distributions will, however, have this characteristic: a subdivision of the system, or the phase space of the system, into different parts is undertaken in thought, with the restriction that it be not too fine, so that the parts are not of molecular dimensions. The subdivision may be of a type that can easily be obtained experimentally, as the division of volume into several parts, or a separation of the different molecular species. It may just as well be such as to be realizable in thought only, that is, impracticably difficult to obtain experimentally, as for instance a division of the μ -space, the phase space of the individual molecules, into regions of different energy (section 5b). A distribution of a physical quantity with respect to this subdivision is then characterized by a set of numbers, D , one number of the set for each of the regions, giving the value of the physical quantity for that region. If the subdivision is one of volume, and the physical quantity is the number of molecules, one distribution D is given by the numbers of molecules in each volume region. A distribution of energy may be defined for the same subdivision into volume parts by giving the energy contained in each region.

The subdivision may be in the μ -space, the individual regions consisting of all those molecules with kinetic energies lying in certain ranges, and the distribution defined by the numbers of molecules in each kinetic energy range. This type of distribution is investigated in the treatment of the monatomic perfect gas, sections 5b and 5c.

At any instant the system will be in some distribution D ; in time its configuration passes over into other distributions with respect to the same subdivision.

Instead of the division of the system into many parts, one may always consider the distribution between any one of the parts and the rest of the system. Since the division is then into two parts only, a distribution is given by one number D . We may, therefore, without loss of generality, treat D like a single number.

The number of quantum states which give rise to a distribution D shall be designated by Ω_D . The sum of Ω_D over all distributions is equal to the value of Ω for the system,

$$(3. 17) \quad \sum_D \Omega_D = \Omega.$$

It is then immediately possible to calculate the probability of finding the system in a certain distribution D with respect to a fixed subdivision. Namely, since the probabilities of all single states are equal, the

probability of a distribution D is the ratio of the number of quantum states consistent with D to the total number of quantum states, Ω_D/Ω . In classical language, the probability of a distribution is equal to the ratio of the volume W_D of all points of phase space for which the system is in the considered distribution, divided by the phase volume W consistent with the total energy, namely, W_D/W . If the values of these two expressions should not coincide the quantum-mechanical one has to be used.

Obviously, every point in phase space corresponds to one distribution. We have tacitly assumed that every quantum-mechanical state of the whole system also belongs to one distribution only. If the distribution is according to a subdivision into energy regions, this is usually the case. For others it is always possible to quantize in such a way that each state corresponds to exactly one distribution (see, for instance, the end of section 3c).

3e. The Most Probable Distribution

Among all the different distributions with respect to a fixed subdivision of the system we shall denote the most probable one by D_0 . This means that the number of quantum states consistent with D_0 is larger than that of any other distribution, $\Omega_{D_0} \geq \Omega_D$. Obviously, a distribution which differs extremely little from D_0 has practically the same Ω_D . If, for instance, the numbers D defining the distribution are large integers, a difference of a few units in some of them will not change Ω_D considerably. On the other hand, such a neighboring distribution is experimentally indistinguishable from the most probable one.

It may, and indeed it does usually, occur that one distribution is overwhelmingly probable in the following sense: namely, that all distributions differing from the most probable one by a noticeable *percentage* in the number D have a very small probability of occurrence compared to D_0 and its neighboring distributions, which are, for all physical purposes, alike.

We found this to be so in the example of section 3d. If we consider the distribution of $N = 10^{20}$ particles between two equal volumes, each distribution can be characterized by just one number, D , the number of molecules in one half of the system. The most probable distribution is given by $D_0 = N/2$. Distributions differing from D_0 by a few units have an Ω_D whose fractional deviation from Ω_{D_0} is only a few parts in N . If we choose $\Delta D = 10^{12}$, the most extreme distributions in this range differ only by about one part in 10^8 in density, the quantity which would be measured experimentally. The probability of finding deviations from equal numbers in each part by more than 10^{12} is,

according to equation (3. 16), only 10^{-10} . We find, therefore, that

$$\sum_{D=D_0-\Delta D}^{D=D_0+\Delta D} \Omega_D \gg \sum_{D=0}^{D=D_0-\Delta D} \Omega_D + \sum_{D=D_0+\Delta D}^{D=N} \Omega_D,$$

or, remembering that the sum of Ω_D over all distributions is Ω , the number of states consistent with the energy,

$$(3. 18) \quad \sum_{D=D_0-\Delta D}^{D=D_0+\Delta D} \Omega_D \gg \Omega - \sum_{D=D_0-\Delta D}^{D=D_0+\Delta D} \Omega_D.$$

In the general case we shall define by ΔD a range of distributions which are, experimentally, indistinguishable from the most probable one. If the inequality (18) holds, it expresses mathematically the fact that the sum of probabilities of all distributions which are undetectably different from the most probable one D_0 is very much greater than the sums of probabilities of all other distributions. In this case, only, will the most probable distribution be referred to as the *equilibrium distribution*. We may then with confidence assume that all properties of the system are expressed by those of the most probable distribution, and calculate the thermodynamic relations assuming equilibrium.

In actual practice the amount of material with which a chemist deals usually contains such an enormous number of molecules that it is rather difficult to find a useful type of distribution problem for which condition (18) does not hold, and in general we shall assume (18) in all practical problems without proof.

3f. Idealized Systems and Inhibitions

Mathematical abstractions must always be made when the calculation of the properties of any physical object is undertaken, and the more complicated the object, the more necessary this becomes. The naturally occurring system is never treated in statistical mechanics, but instead an idealized system with properties so chosen as to resemble, as much as possible, those of the true one. The idealized system has certain exact and sharply defined characteristics, which are nearly, but frequently not exactly, realized in the natural counterpart. For instance, in sections 1d and 1e, it was the aim to calculate the properties of a dilute real gas, and, instead, the properties of an idealization of a gas, a system composed of independent mass points, was investigated. The condition of independence is certainly not strictly fulfilled in the real gas, but actually the first approximation of the interaction between molecules was taken into account by considering that transitions between different quantum states occurred. The transitions between

states are due to the collisions between molecules, which, in turn, can be present only if interactions in some form or other are permitted. It is these transitions which permit us to treat the system as ergodic, and to assume the equal probability of states, or of equal phase volumes, and which assure the attainment of equilibrium distributions.

For calculations of equilibrium phenomena, the rate at which transitions take place is usually of no interest. In some natural systems, however, it sometimes happens that transitions between some groups of quantum states are very rare. All real systems are presumably ergodic in the strict sense of the word, that is, they have a finite probability of attaining every quantum state from every other one, but they may need a very long time to go over from one group of states to another. This time may be so long that such transitions simply do not occur during the course of a physical experiment. The experimental behavior will then not correspond to complete equilibrium, but to equilibrium between the states within the group only. In other words, the system behaves as if it were non-ergodic.

Such groups of states, between which transitions are rare, always correspond to very different physical pictures of the system, for instance, to different distributions of atoms between different molecular species.

A drastic example is furnished by the nuclear reactions. Since all nuclei are built of the same elementary particles, the material contained in a flask of hydrogen could also appear in the form of other atoms and molecules, and hydrogen is certainly not in equilibrium with respect to these nuclear transmutations. Probably, in infinite time, the system is truly ergodic, and transitions to all states consistent with the energy and constitution would occur, but except at stellar temperatures the transmutation of the so-called stable elements occurs rarely even if time is measured in units of geologic periods. In investigating the properties of any system composed of stable elements, it is more than obvious to assume these transitions to be strictly inhibited, that is, to treat the atomic composition of the physical object as given and unchanging.

In other cases, however, the difference in rate between the establishment of equilibrium within a group of states, and between groups corresponding to certain different distributions, is not so extreme but still is sufficiently obvious to require special treatment. At room temperature it takes years, in the absence of a catalyst, to establish equilibrium with respect to the reaction between hydrogen and oxygen gases to form water. Many experimental measurements, such as that of the specific heat or the pressure, could easily be made on a system composed of oxygen, hydrogen, and water, under conditions where the mixture was certainly not in equilibrium with respect to the possible chemical

reaction. The introduction of a catalyst into the system, or a comparatively small change in the total energy, and therefore temperature, would entirely alter the rate with respect to the chemical reaction.

The results of an experimental measurement of some property, say the specific heat or the change of pressure with volume, on a chemical system in which a fairly slow chemical reaction takes place, may depend on the speed with which the measurement is made. If the system is heated, or the volume changed, more rapidly than the chemical reaction can establish equilibrium under the new conditions, the measured inflow of heat, or change of pressure, will be different from what it will be if the changes are made so slowly that complete equilibrium is established during the change.

Corresponding to these two different experimental results, it will sometimes be found desirable to make two different calculations of the statistical behavior of one system, one calculation in which complete equilibrium is assumed to be established with reference to some distribution, and one in which the system is assumed to be inhibited to remain in one particular distribution.

Among the idealizations which will be assumed in the systems whose properties are to be investigated, then, one of the most convenient will be the idealization that the system is *inhibited* to remain in a certain distribution with respect to some subdivision. That is, we shall treat an idealized system which is completely ergodic, and can reach all the quantum states available to it, but which differs from the natural system in that certain whole groups of quantum states which are reached but slowly by the natural object are regarded as entirely non-existent in the idealization.

These inhibitions may be used either to eliminate the necessity of considering transitions never observed in the time at man's disposal, such as conceivable nuclear transmutations, or to enable us to calculate the properties of a system not in equilibrium with respect to some relatively slow chemical or physical change, or even to calculate the properties of a system in some distribution, not that of equilibrium, with respect to some subdivision in which equilibrium is established very rapidly in the natural system.

By this subterfuge of the introduction of an inhibition upon the idealized system we avoid the difficulty of explicitly considering non-ergodic systems. Perhaps it is more correct to say that the necessity of calculating the properties of pseudo non-ergodic systems, for which we can say only that those quantum states which can be reached within reasonable time are equally probable, forces us to treat idealized systems subject to certain inhibitions.

There exists a tendency on the part of some workers to say that thermodynamics can be applied only to systems in complete equilibrium. Strict adherence to this condition would limit the applicability of thermodynamics rather severely. Few organic compounds can ever be said to be stable in the sense that they could exist pure if every conceivable reaction went at an appreciable rate. In view of the existence of nuclear reactions we could even say that this would exclude the application of thermodynamics to any ordinary chemical system. The use of the concept of the completely inhibited idealized system is a convenient artifice to overcome this difficulty. We calculate the properties of an imaginary system which is in complete equilibrium with respect to all its possible reactions. This idealized system is then said to correspond to the real system having other conceivable reactions, with respect to which the rate of attainment of equilibrium is almost infinitely slow compared to the time interval during which its properties are investigated.

It is a hypothesis, however, which seems very natural and probable, that all transitions between states that do not differ from each other in some marked physical or chemical property, such as the percentage of different molecular species, occur with sufficient probability so that the system may be regarded as truly ergodic with respect to all of them. However, it is to be noted that there have been in the past, and may possibly occur in the future, some surprises with respect to this hypothesis. For instance, there exists in nature an inhibition making transitions of hydrogen molecules between odd and even rotation states very slow. Although this effect is actually very readily explained, it would have appeared most amazing before a fairly complete understanding of quantum mechanics existed.

The possibility of imposing and lifting inhibitions in an idealized system offers us another convenience. All occurrences take place at constant energy of the whole universe. We are, therefore, imposing no limitation on the general type of processes that we consider if we limit ourselves to processes at constant energy. All acts on a system, starting or stopping a process, may then be idealized by regarding them as the lifting or imposing of certain inhibitions at constant energy, since the source or sink of energy can always be taken as part of the system. The attainment of equilibrium with respect to any variable of a real system from a definite condition of non-equilibrium can always be described as due to the lifting of an inhibition.

For instance, the act of opening or shutting a stopcock between two flasks containing gas may be considered as the lifting or imposing of an inhibition against the flow of matter between two part volumes. Similarly, two isolated systems may be treated as one system of two parts with inhibitions against the flow of matter and energy between

them. The physical act of bringing the two systems into thermal contact would be described as the lifting of the latter inhibition. The process of allowing the hydrogen, oxygen, and water molecules of the earlier example to come into contact with a catalyst may also be described as the lifting of the inhibition prohibiting the chemical reaction.

3g. Summary

The state of a system, the most complete description of its instantaneous condition which it is possible to make, is defined, if the system is assumed to obey classical mechanics, by giving the values of f_γ coordinates and f_γ momenta, and if the system obeys quantum mechanics, by giving the f_γ quantum numbers necessary to define a cell of volume h^{f_γ} in the γ -space.

A system in a certain distribution with respect to the value or values of some physical variable may be in any of a large number of states consistent with that distribution D . The number of states corresponding to D is called Ω_D , and since all states have the same *a priori* probability, the probability of a distribution is proportional to Ω_D . For macroscopic chemical systems and distributions with respect to the type of subdivisions in which one is interested, the sum of the probabilities of all those distributions which do not differ significantly from the most probable one add up to a value of practically unity. In this case the most probable distribution is referred to as the equilibrium distribution.

Idealized systems of sharply defined characteristics are more convenient as objects of calculation than the real systems which they are intended to simulate. Such idealized systems may frequently be assumed to be subjected to certain inhibitions preventing the change of the distribution of the system with respect to some physical quantity, if this change in the real system takes place more slowly than the time necessary to measure the experimental quantities calculated. The lifting of such an inhibition corresponds to the starting of a spontaneous reaction in the real system.

CHAPTER 4

THE DERIVATION OF THE LAWS OF THERMODYNAMICS

(a) Introduction. (b) Characteristics of the Logarithm of Ω . (c) The Quantity $S = k \ln \Omega$. (d) Identification of Entropy, Temperature, and Pressure. (e) The Limits of Validity of the Second Law of Thermodynamics. (f) The Relation between Entropy and the Uncertainty in the Energy. (g) The Third Law of Thermodynamics. (h) The Conditions of Equilibrium and the Chemical Potential μ .

4a. Introduction

In this chapter a quantity S will be defined as $k \ln \Omega$, in which k is the Boltzmann constant, and Ω , defined in sections 2i and 3b, is the total number of quantum states available to the system. It will be shown that S , for a sum of two independent systems, is the sum of their two S values, and that S is an extensive property. It will also be shown that S increases for all spontaneous changes occurring in a system at constant energy. These are also the fundamental characteristics of the thermodynamic entropy.

Two quantities, τ and π , of the dimensions of temperature and pressure, respectively, will be defined as $1/\tau = (\partial S/\partial E)_V$ and $\pi/\tau = (\partial S/\partial V)_E$. It will be shown that τ is a monotonous function of the temperature alone, the same function for all systems, and π a monotonous function of pressure, the same for all systems of the same τ value. In section 4d it will be demonstrated that π is the pressure in all systems. It will similarly be shown that τ is proportional to the thermodynamic temperature, and that τdS is equal to the heat absorbed.

The first law of thermodynamics is an immediate consequence of the laws of mechanics as soon as heat is identified with the kinetic and potential energy of the molecules and atoms composing matter. The characteristics of S , discussed in the first paragraph, combined with its identification as entropy, then prove the second law of thermodynamics as a consequence of the laws of mechanics.

The number of quantum states available to a system, Ω , has a definite value, so that $S = k \ln \Omega$ has no undetermined integration constant, except the proportionality factor k , which is connected with the arbitrarily chosen scale of temperature. This is equivalent to the third law of thermodynamics, which, in its most general, and possibly only

correct, form, states that the entropy of a system has a definite natural value in which the integration constant present in the classical definition is naturally determined in such a way that S is not large at the absolute zero of temperature.

4b. Characteristics of the Logarithm of Ω

The number Ω is an extremely large number for a macroscopic system, so large that even its logarithm, $\ln \Omega$, is of the order of magnitude of N , the number of molecules of the system. In section 2i we have defined $\Omega = \Omega(E) \delta E$ as the number of quantum states available to the system, in which the natural uncertainty of energy is δE . Since this uncertainty δE of energy is somewhat vaguely defined, the value of Ω , which is proportional to δE , is also but vaguely determined. However, because of the enormous magnitude of Ω an uncertainty of many fold in the value of Ω itself still permits the value of $\ln \Omega$ to be determined within a completely negligible error. Indeed, $\ln \Omega$ is so large that it makes no numerical difference in its value whether Ω is calculated as the total number of quantum states below the energy E , $\Omega = \int_0^E \Omega(E) dE$,

or as the number of quantum states belonging to some narrow energy range at the energy E , $\Omega = \Omega(E) \delta E$. This will be discussed in greater detail in section 4f. For the present we shall retain the definition of Ω given in section 2i, that it is the number of quantum states available to a system, the energy of which is E , within some definite range of uncertainty δE .

The logarithm of Ω is a perfectly defined number of considerable importance in determining the properties of the system.

The first characteristic of $\ln \Omega$ which we wish to emphasize is that of being additive for independent systems. If there is a system a with number of quantum states Ω_a , and an independent distinguishable system b with Ω_b , the value of the number of quantum states, Ω_{a+b} , for a system consisting of the sum of the two independent parts a and b will be

$$(4. 1) \quad \Omega_{a+b} = \Omega_a \cdot \Omega_b.$$

This is self-evident from a consideration of the way in which quantum states for the system consisting of the two parts a and b are counted. The quantum state of the combined system is defined by giving the quantum numbers of the part a and the part b (section 2h), provided that the two subsystems a and b are distinguishable from each other. Each state of a can be combined with any of the states of b to form a state of the total system. It follows that the number of possible states

of the combined system is the product of the numbers of states of the two parts.

From (1) we find that the value of $\ln \Omega$ is additive for two independent systems,

$$(4. 2) \quad \ln \Omega_{a+b} = \ln \Omega_a + \ln \Omega_b.$$

For n equal independent systems, $\ln \Omega$ of the whole system is n times the $\ln \Omega$ of one of the parts. We shall later show that if the n systems are united to form one, $\ln \Omega$ is unchanged, and is therefore an extensive property, namely, proportional to the size of the system.

In section 3d we defined the quantity Ω_D as the number of quantum states available to the system if it were restricted to a particular distribution D with respect to some subdivision. The probability of the distribution was seen to be proportional to the value of Ω_D , and the equilibrium distribution D_0 was defined as that for which Ω_D had a maximum value, the most probable distribution. Furthermore, we agreed not to use the word equilibrium unless the sum of the values of Ω_D for all the distributions differing by a negligible experimental amount from D_0 was very much larger than the sum of the Ω_D 's for all other distributions. This is equivalent to demanding that we define our distributions in such a way that their total number, M , is small compared with the total number of quantum states, Ω , of the system. Since the value of Ω_{D_0} , the number of quantum states of the most probable distribution, must be greater than Ω/M , the total number of quantum states of the system divided by the total number of distributions, and Ω_{D_0} must also, obviously, be less than Ω , it follows that we can write

$$(4. 3) \quad \ln \Omega > \ln \Omega_{D_0} > \ln \Omega - \ln M.$$

Now we have assumed that

$$(4. 4) \quad \ln M \ll \ln \Omega,$$

and so we can write as a sufficient approximation that

$$(4. 5) \quad \ln \Omega_{D_0} = \ln \Omega.$$

The logarithm of the number of quantum states of the most probable distribution is numerically the same as the logarithm of the total number of quantum states of the system.

We may illustrate this by the calculation for a system which is not, in the narrow sense, physical. The system consists of a pack of $2N$ cards, N of which are red and N black. A single state of this system may be defined by giving the color of the card in every position in the pack.

One state will be that arrangement for which the first card is red, the second black, the third black, the fourth red, etc. This definition of a state is analogous to the physical one, since if the cards are not distinguishable other than by their color it gives the most complete description that can possibly be made of the condition of the pack. Each state so defined corresponds to $(N!)^2$ arrangements of distinguishable cards. Honest shuffling of the cards will show each state to be equally probable. The total number of states, Ω , is,

$$(4. 6) \quad \Omega = \frac{(2N)!}{(N!)^2},$$

since it is equal to the number of arrangements of distinguishable cards divided by the number of arrangements per state (Appendix A VII). By using the Stirling approximation (Appendix A IV) for the factorial, we find

$$(4. 7) \quad \ln \Omega = 2N \ln 2 - \frac{1}{2} \ln (\pi N).$$

Now, if a distribution is defined as the number of red cards, D , among the first N cards of the deck, it is fairly obvious that the most probable distribution will be given by the value $D_0 = \frac{1}{2}N$, in which case there will be equal numbers of red and black cards in both halves of the deck. The value of Ω_{D_0} will be the product of the Ω 's for the two half-packs, namely,

$$(4. 8) \quad \Omega_{D_0} = \frac{(N!)^2}{[(N/2)!]^4},$$

$$\ln \Omega_{D_0} = 2N \ln 2 - \ln \left(\frac{1}{2}\pi N\right).$$

The difference,

$$(4. 9) \quad \ln \Omega - \ln \Omega_{D_0} = \frac{1}{2} \ln (\pi N/4),$$

increases with N as the logarithm of N . The value of $\ln \Omega$ increases much more rapidly, indeed, linearly with N . In Table 4. 1 the values of $\ln \Omega$, $(\ln \Omega - \ln \Omega_{D_0})$, and the fractional error, $(\ln \Omega - \ln \Omega_{D_0})/\ln \Omega$, are tabulated for various values of N . It is seen that, if the number of cards approaches that of the molecules in a chemical system, about 10^{19} or greater, the percentage error introduced by substituting $\ln \Omega_{D_0}$ for $\ln \Omega$, or *vice versa*, would be entirely negligible. This does not mean, of course, that Ω_{D_0} equals Ω ; the ratio of these two quantities is given in the last column of the table and is seen from (9) to be $\frac{1}{2}(\pi N)^{1/2}$. We have previously stated that this ratio Ω/Ω_{D_0} must be smaller than M , the total number of possible distributions, which in this case is equal to N , the total number of places in the half-deck.

Equation (5) which states that the logarithm of the number of quantum states of the most probable distribution may be substituted for the logarithm of the total number of quantum states of the system has a great practical applicability. It is frequently far easier to evaluate $\ln \Omega_{D_0}$ numerically than $\ln \Omega$. In Chapter 5, in which $\ln \Omega$ for a perfect monatomic gas is sought, the method actually used is to evaluate $\ln \Omega_{D_0}$ for the equilibrium distribution of energy among the molecules.

TABLE 4. 1

The value of $\ln \Omega$ and $\ln \Omega_{D_0}$ for a deck of $2N$ cards, N each of two colors, if a distribution is defined by giving the number of red cards among the first N cards. The most probable distribution is $D_0 = \frac{1}{2}N$.

N	$\ln \Omega$	$\ln \Omega - \ln \Omega_{D_0}$	$\frac{\ln \Omega - \ln \Omega_{D_0}}{\ln \Omega}$	$\frac{\Omega}{\Omega_{D_0}}$
10^2	135.76	2.18	0.016	8.9
10^3	1382.2	3.34	0.0024	28
10^4	1.3858×10^4	4.48	3.2×10^{-4}	89
10^8	1.3863×10^8	9.09	6.5×10^{-8}	8.9×10^3
10^{16}	1.3863×10^{16}	18.30	1.3×10^{-15}	8.9×10^7
10^{24}	1.3863×10^{24}	27.51	2×10^{-23}	8.9×10^{11}

Equation (5) has been derived at this place for another purpose, however. If an inhibition that prohibits transitions between quantum states belonging to different distributions is imposed upon a system, the system will be "frozen" into the distribution in which it happens to be found. As we have seen, the probability is overwhelming that this would be one which is experimentally indistinguishable from equilibrium. Indeed we can neglect entirely the infinitesimal chance that the system will be found in a distribution experimentally different from equilibrium. After the inhibition has been imposed, the value of $\ln \Omega$ will be that of $\ln \Omega_{D_0}$ for the distribution into which the system has been frozen. Since this distribution must be one of the probable ones whose value of $\ln \Omega_{D_0}$ is large and approximately that of $\ln \Omega_{D_0}$, it follows that the value of $\ln \Omega$ for the system will be only negligibly decreased by the imposition of the inhibition. *The imposition of an inhibition upon a large system does not decrease the value of $\ln \Omega$ by an appreciable fractional amount.*

The closing of a stopcock between two flasks of equal volume will, with overwhelming probability, result in fixing practically equal numbers of molecules in each flask. If the molecules were different and distinguishable, this physical act would do much more than limit the system to this most probable

distribution, for it would trap about $\frac{1}{2}N$ specified molecules in each of the two part volumes. This would decrease Ω by the factor $(\frac{1}{2}N)!^2/N! = 2^{-N}$, the logarithm of which, $-N \ln 2$, is by no means negligible. The same holds for every physical inhibition which affects the distribution of molecules.

Molecules of one species are, in truth, identical and indistinguishable. The quantum states of systems of many identical particles are of Einstein-Bose or Fermi-Dirac type (section 2k), and do not specify the location or state of any particular particle as distinguished from the others. With this method of counting the states the difficulty mentioned above does not occur.

The problem was solved in classical (Boltzmann) statistics by division of the phase space by $N!$. This is necessary in order to show, as we shall do immediately, that $S = k \ln \Omega$ is an extensive property of the system.

As said in sections 2k and 3a we always use the phase space divided by $\Pi_i N_i!$ as the classical analogy to the number of states.

If, however, we consider a system under the influence of an imposed inhibition restricting it to a certain distribution D , and then lift the inhibition, we see that one of two cases may prevail. Either the distribution D was one of those indistinguishable from the equilibrium distribution, in which case no change will occur and the value of $\ln \Omega$ will not be appreciably altered; or, if D were a distribution far from equilibrium, one can expect the system to be in a more probable one after a finite time interval, and $\ln \Omega$ would be increased. Eventually, the equilibrium distribution will be attained. *The lifting of an inhibition will either cause no change in the system, or, if a change takes place, the value of $\ln \Omega$ will be increased.*

These properties are sufficient to prove that S is an extensive quantity. The insertion of a material wall, preventing flow of matter and energy between two parts of the system, is the type of inhibition discussed above. This process divides the system into two independent parts. The value of S for the total system, after the insertion, is the sum of the S values of the independent parts. Since this physical inhibition does not change S , it follows that, also without any wall: S is the sum of the values of S for any volume parts, and S is proportional to the size of a homogeneous system, provided that the intensive properties, such as density and energy per molecule, are kept constant.

We shall frequently refer to the value of $\ln \Omega$ of a system in a certain distribution D , which will be $\ln \Omega_D$. Experimentally, it would be impossible to measure the properties of a system in a certain distribution unless we had some method of assuring ourselves that the distribution would be maintained during the course of the experiment by some hindrance or inhibition against the transition into other distributions. For this reason, when we refer to the value of any property of the system in a certain distribution D , such as the value of $\ln \Omega_D$, we

shall always assume implicitly the existence of an inhibition against the transition of the system into quantum states corresponding to other distributions.

All changes which can be brought about at constant energy in a system without causing a change in the properties of some other system in the universe may be described by the lifting or imposing of an inhibition upon the system in question. This has been discussed in detail in section 3f.

We have shown that an operation on an isolated system, which does not cause a change in some other system, cannot produce a measurable decrease in the quantity $\ln \Omega$, and that if this operation causes a change in the original system $\ln \Omega$ must increase.

4c. The Quantity $S = k \ln \Omega$

The dimensionless quantity $\ln \Omega$ has the most important characteristics of the thermodynamic entropy. It is an extensive property of all systems and increases for any spontaneous change which the isolated system undergoes at constant energy. The thermodynamic entropy is so defined as to have the dimensions of energy divided by temperature.

We shall define a quantity S by the equation

$$(4. 10) \quad S = k \ln \Omega,$$

in which the constant k has the dimensions of energy per degree of temperature so that the dimensions of S are those of entropy. We shall now proceed to prove that the quantity S is proportional to the thermodynamic entropy. The numerical value of k is at our disposal, and in Chapter 5 we shall see that, if it is chosen to be the Boltzmann constant of value $k = 1.3804 \times 10^{-16}$ erg per degree Kelvin, S becomes identical with the entropy.

$\ln \Omega$ is the logarithm of the total number of quantum states available to the system and will be a function of the total energy and of the volume, as well as being dependent on any inhibitions that may be presumed to exist.

The quantities τ and π are defined by

$$(4. 11)* \quad \left(\frac{\partial S}{\partial E} \right)_V = \frac{1}{\tau},$$

$$(4. 12) \quad \left(\frac{\partial S}{\partial V} \right)_E = \frac{\pi}{\tau},$$

* We are employing here the usual nomenclature of thermodynamics $(\partial/\partial x)_{v,s}$, in which the subscripts indicate the variables kept constant during the partial differentiation. This device is necessary since the thermodynamic quantities can be expressed as functions of several different sets of variables, for instance, the entropy as function of volume and energy, or of volume and temperature, etc. (see Appendix A I).

so that τ has the dimensions of a temperature, and π those of energy per volume, or pressure, force per area.

Consider any system of fixed total energy, E , consisting of two parts, a and b , of energies E_a and E_b , between which energy can flow, but which are otherwise entirely independent. We wish to examine the equilibrium condition for the distribution of energy between the two parts. If the symbol δE_a is used to indicate an infinitesimal variation in the energy E_a of part a , the condition of constancy of the total energy requires that

$$(4. 13) \quad E = E_a + E_b; \quad \delta E = 0 = \delta E_a + \delta E_b; \quad \delta E_a = -\delta E_b.$$

The value of S_D , for the complete system in a given distribution D , determined by the value of E_a , is the sum of the values of the part systems,

$$(4. 14) \quad S_D = S_a + S_b,$$

S_a being a function of E_a and S_b of E_b . Indicating, by $\delta S_D = (dS_D/dE_a) \delta E_a$, the infinitesimal change in S_D brought about by a change δE_a in the energy of a , one obtains the equation

$$(4. 15) \quad \delta S_D = \left(\frac{dS_D}{dE_a} \right) \delta E_a = \left(\frac{\partial S_a}{\partial E} \right)_V \delta E_a + \left(\frac{\partial S_b}{\partial E} \right)_V \delta E_b,$$

and, from (13) and (11),

$$(4. 16) \quad \frac{dS_D}{dE_a} = \left(\frac{\partial S_a}{\partial E} \right)_V - \left(\frac{\partial S_b}{\partial E} \right)_V = \frac{1}{\tau_a} - \frac{1}{\tau_b}.$$

Equilibrium corresponds to a maximum of S_D , and therefore to $dS_D/dE_a = 0$, which is satisfied by $\tau_a = \tau_b$. Spontaneous change in E_a will take place only in such a way that S_D increases, that is, that δS_D is positive. From (16) it follows that if $1/\tau_a > 1/\tau_b$, or $\tau_a < \tau_b$, δE_a must be positive, that is, the energy of part a of the system will grow at the expense of the energy of part b .

We arrive at the conclusion that between any two systems energy flows spontaneously from the system of higher τ value to that of lower τ value, and the two systems will be in equilibrium if they have identical values of τ . The qualitative definition of temperature is just this, that energy will flow from a system of high temperature to one of low temperature, and will cease to flow if their temperatures become identical. The condition of equilibrium which we have just found, equal τ values, is also the condition of equal temperatures. Since any two systems whatsoever that have the same T have also the same value of τ , it fol-

lows that τ is the same function of T , and only T , for all systems. Furthermore, since high T 's correspond to high τ 's, we know that τ is a monotonously increasing function of T . In Chapter 5 we shall find that the energy of a monatomic gas is $3R\tau/2$ per mole, which identifies τ with the temperature in a perfect gas and therefore in all systems.

We shall now investigate equilibrium with respect to the distribution of volume between two systems. Consider a system of fixed total energy E , and volume V , consisting of two parts, a and b , with energies and volumes E_a , E_b , V_a , and V_b . Energy will be assumed to flow between a and b , and the volume of one system may grow at the expense of the volume of the other, but otherwise the two part systems a and b are independent, so that no matter may be transferred from a to b . We shall study the value of S_D of the system as a function of V_a , that is, as a function of the distribution of volume between the two systems.

As before, we have condition (13) of constant total energy, that $\delta E_a = -\delta E_b$, and the additional condition of constant total volume,

$$(4. 17) \quad V = V_a + V_b, \quad \delta V = 0, \quad \delta V_a = -\delta V_b.$$

The two parts of the system will remain in equilibrium with respect to the flow of energy between them, which, as we have just seen, assures us that $\tau_a = \tau_b$. The change in S_D , $\delta S_D = (dS_D/dV_a)\delta V_a$, brought about by an increase δV_a in the volume V_a of part a , will be composed of two parts, one due directly to the change in volume of the parts, and the other due to the changes in energy $(dE_a/dV_a)\delta V_a$ necessary to maintain equilibrium with respect to the distribution of energy,

$$(4. 18) \quad \delta S_D = \frac{dS_D}{dV_a} \delta V_a = \left[\left(\frac{\partial S_a}{\partial V_a} \right)_E - \left(\frac{\partial S_b}{\partial V_b} \right)_E \right] \delta V_a \\ + \left[\left(\frac{\partial S_a}{\partial E_a} \right)_V - \left(\frac{\partial S_b}{\partial E_b} \right)_V \right] \frac{dE_a}{dV_a} \delta V_a.$$

Using (11), and the condition that $\tau_a = \tau_b$, the coefficient of the latter term is seen to be zero, and with (12) one obtains

$$(4. 19) \quad \delta S_D = \frac{dS_D}{dV_a} \delta V_a = \frac{1}{\tau} (\pi_a - \pi_b) \delta V_a.$$

If $\pi_a = \pi_b$, the system is in equilibrium. The spontaneous change, for which δS_D is positive, will take place with an increase in V_a if π_a is greater than π_b , and in the opposite direction if $\pi_a < \pi_b$.

Two such systems are in equilibrium only if their pressures are equal, and so we see that any two systems of equal τ , and therefore of equal temperatures, have equal values of π if their pressures are equal. For

all systems at the same temperature, π is the same monotonously increasing function of pressure alone.

Therefore, if the identification of τ with temperature and π with pressure is undertaken for *one* system only, it can immediately be generalized for all systems.

The simplest system for this purpose is the perfect gas, treated in Chapter 5. We might therefore refer the reader at this stage to that chapter and anticipate the results found there. This procedure would be complete and logical. It seems somewhat unsatisfactory, however, partly in view of the fact that the pressure is a purely mechanical quantity which can be, and has been in section 3b, directly defined.

In the next section we will show that the definition (3. 7) of P is identical with the one of π made here, (12), and that τ can be made to coincide with the thermodynamic temperature by adjustment of the scale factor k in S .

4d. Identification of Entropy, Temperature, and Pressure

The quantity S which is to be identified with the entropy is defined as a function of the volume and the energy of the system. All other outer variables on which the system, and therefore S , may depend will at first be assumed to remain constant. The functional dependence of S on V and E may be used to express the energy E as a function of V and S . The quantities τ and π defined by $1/\tau = (\partial S/\partial E)_V$ and $\pi/\tau = (\partial S/\partial V)_E$ appear then as derivatives of the energy with respect to S and V . Namely, if first V is kept constant, it follows that

$$(4. 20) \quad \left(\frac{\partial E}{\partial S}\right)_V = \left(\frac{\partial S}{\partial E}\right)_V^{-1} = \tau.$$

If S is to remain constant the change of E with V must be such that

$$\left(\frac{\partial S}{\partial V}\right)_E + \left(\frac{\partial S}{\partial E}\right)_V \left(\frac{\partial E}{\partial V}\right)_S = 0,$$

or

$$(4. 21) \quad \left(\frac{\partial E}{\partial V}\right)_S = - \left(\frac{\partial S}{\partial V}\right)_E \left(\frac{\partial S}{\partial E}\right)_V^{-1} = -\pi.$$

Now the pressure P was defined in section 3b as a purely mechanical quantity. It was shown there that P is the negative derivative of the energy with respect to volume under certain conditions, namely, if the energy changes with volume in such a way that the number of quantum states of the system below the energy remains constant. We have stated in section 4b, and will discuss at greater length in section 4f,

that the Ω determining S by the relation $S = k \ln \Omega$ could be calculated as just this quantity: the number of quantum states below the energy of the system. It follows that P as defined in equation (3. 7) is the negative derivative of energy with respect to volume at constant value of S , $P = -(\partial E/\partial V)_S$. Equation (21) therefore proves π to be equal to the pressure.

In general the thermodynamic state of the system, and therefore S , may depend on several outer variables $x_1 \cdots x_n$ (for instance, for a crystal, on those determining the exact shape). Precisely the same considerations may be applied to these as to V . If we define the quantities F_{x_ν} by

$$(4. 22) \quad \frac{F_{x_\nu}}{\tau} = \left(\frac{\partial S}{\partial x_\nu} \right)_{E, x_1, \dots, x_{\nu-1}, x_{\nu+1}, \dots, x_n},$$

it follows that

$$(4. 23) \quad F_{x_\nu} = - \left(\frac{\partial E}{\partial x_\nu} \right)_{S, x_1, \dots, x_{\nu-1}, x_{\nu+1}, \dots, x_n},$$

which is, according to the previous discussion, equivalent to the definition (3. 6) of the generalized force with which the variable x_ν tends to increase.

We may write then

$$(4. 24) \quad dE = - \sum_{\nu=1}^{\nu=n} F_{x_\nu} dx_\nu + \tau dS,$$

or, if the volume only is changed,

$$(4. 24') \quad dE = -P dV + \tau dS.$$

The first n terms in (24) represent the work done by the outer forces, or the negative of the work w done by the system. By definition, then, the last term τdS is equal to the heat absorbed, q ,

$$(4. 25) \quad dE = -w + q = -w + \tau dS.$$

It is known in thermodynamics that the total amount of heat absorbed by a system in a finite process is not a function of the initial and final thermodynamic state alone but depends on the path between these states. The mathematical expression of this fact is that the infinitesimal heat absorbed, $q = dE + w$, is not the complete differential of any function of outer variables and energy. The definition of the thermodynamic temperature, and simultaneously of the entropy, is that the expression

$$(4. 26) \quad \frac{q}{T} = \frac{1}{T} (dE + \sum_{\nu} F_{x_\nu} dx_\nu) = dS$$

is a complete differential, that is, that there exists a function S which depends only on the state of the system, namely, the thermodynamic entropy, for which $dS = q/T$. This is stated usually in the short form that $1/T$ is the integrating factor of the heat.

The relation obtained above, $q = \tau dS$, shows that the quantity τ has just this property which is used to define T . Moreover, it can be shown easily that, except for a multiplicative constant, $1/\tau$ is the *only* integrating factor which has at the same time the property of being the equilibrium parameter for heat flow, that is, of being equal for two systems in thermal contact.

Any other function ϕ satisfying the relation $d\phi = q/f(x_1, \dots, x_n, E)$ must be a function of S alone, $\phi = \phi(S)$, and therefore $f(x_1, \dots, x_n, E) = \tau(d\phi/dS)^{-1}$. If this latter quantity is to be the same for any two systems in thermal contact, $d\phi/dS$ must be a constant, and ϕ proportional to S .

Now the definition of S contains the factor k which has as yet not been determined. τ is proportional to k^{-1} , and the heat $q = \tau dS$ independent of k . It is consequently possible to adjust the constant k in such a way that the scale of τ is identical with the scale of the thermodynamic temperature T . T is defined with the help of the perfect gas, and in the next chapter we shall show that τ and T become identical if k is chosen as the Boltzmann constant.

We have proved, then, that τ is equal to the thermodynamic temperature and that S is equal to the thermodynamic entropy.

We may now write the equations for the change of energy in the form

$$(4. 27) \quad \begin{aligned} dE &= -\sum F_x dx_x + T dS \\ &= -w + T dS, \end{aligned}$$

or, if the only outer variable of importance is the volume,

$$(4. 27') \quad dE = -P dV + T dS.$$

The physical significance of equation (27) is the following. Any infinitesimal change of energy has been split into two additive terms. The first one arises from the action of outer forces, or changes of outer variables. Owing to these changes the mechanical conditions of the system are altered and therefore the energies of all quantum states are changed. The total energy of the system varies in this process as the average of the energies of all states available to it. This energy change is equal to the work done on the system. During the change the number Ω of quantum states available to the system, and therefore the entropy $S = k \ln \Omega$, remain constant.

The second part of the change of energy takes place at constancy of all outer variables. The mechanical description and the location of all quantum states remain unaltered. The system merely absorbs or gives up internal energy by going to a range of quantum states of higher or lower energy. A measure of this is obtained through the function S which depends monotonously on E . This part of the energy change, $T dS$, is called the heat absorbed by the system.

4e. The Limits of Validity of the Second Law of Thermodynamics

“What, never?” “No, never!”
 “What, never?” “Well, hardly ever!”

H. M. S. Pinafore.

The second law of thermodynamics can be stated in the form: the entropy of an isolated system never decreases. We have now claimed that this fundamental law is a consequence of the theorems of mechanics. It is appropriate at this time to investigate the extent to which exceptions to this law might conceivably be observed.

The entropy of a system has been identified with the quantity $S = k \ln \Omega$, in which Ω is the number of states available to the system. The statement that S never decreases in an isolated system of constant energy was based on three propositions: all processes carried out upon a system without changing its energy or involving a change in some other system correspond to the lifting or imposing of an inhibition; the lifting of an inhibition always increases the available states; and the imposition of an inhibition decreases the value of S by only a negligible amount.

The first of these statements is obvious enough if we consider that any system, no matter how complicated, can be described by means of states in phase space; and that all the processes obeying the criterion of not resulting from a change in other systems merely allow changes in the distribution of the system, or prevent such changes from occurring. The second assertion, that the lifting of an inhibition can only increase S , is sufficiently evident.

We may now examine more closely the last statement, that imposing an inhibition results in a negligible decrease in S . The application of an inhibition limits the system to some particular distribution D with respect to some subdivision. The decrease in S caused by this process may be arbitrarily divided into two parts. The first of these is that which accompanies the inhibition to the most probable distribution D_0 , $k \ln \Omega - k \ln \Omega_{D_0}$. The second part is the difference between the entropy of the most probable distribution D_0 and that of the real distribution D into which the system happens to be frozen, $k \ln \Omega_{D_0} - k \ln \Omega_D$.

The first of these decreases is of no physical significance and has nothing to do with the actual validity of the second law, but concerns only the validity of the method of calculating entropy. This is clearly seen if we consider the

nature of the physical act to which the imposition of the inhibition is made to correspond. Closing a stopcock between two flasks of gas in case they are in equilibrium can cause no change in the system which could violate a law of thermodynamics. Similarly, the prevention of a chemical reaction from fluctuating away from equilibrium by removing a catalyst, or the prevention of variations in the temperature of two bodies by severing thermal contact, cannot have results that are contradictory to the second law.

The numerical equivalence of $k \ln \Omega_{D_0}$ and $k \ln \Omega$ is due to the nature of the acts which can be undertaken experimentally to limit a real system to one distribution. Such operations always correspond to subdivisions of the system which are so coarse that the logarithm of the number of distributions is truly negligible compared to the logarithm of Ω (see equation 3).

This does not prevent an individual from making a stupid mistake of calculation by attempting to identify $\ln \Omega_{D_0}$ and $\ln \Omega$ for a distribution subdivision so fine that the two quantities are not equivalent. Such an error has nothing to do with the laws of thermodynamics, and indeed the values of $\ln \Omega$ are so great in practice that such a blunder is rather difficult to make.

On the other hand, there exists a definite finite probability that a given decrease in entropy may be observed by trapping a system in a condition of non-equilibrium. This probability can be calculated.*

We wish to determine the chance that the distribution found, after imposing an inhibition upon a system, will have a lower entropy than that of the most probable one by an amount $-\Delta S$ or greater. If we consider subdivisions of the system into two parts only, the distributions can be numbered, arbitrarily, from negative to positive values, in such a way that the most probable distribution has the number zero, $D_0 = 0$. This was done, for instance, in the example in section 3c. The quantity $\ln \Omega_0 - \ln \Omega_D$ is then developed as a power series in D . The constant term in the series must be zero, and since by definition $D = 0$ has the maximum value of $\ln \Omega_D$, also the linear term is absent. The series begins with a quadratic term. Higher powers can certainly be neglected for small values of D , and actually in large systems up to very large values of the quadratic term, so that

$$(4. 28) \quad \ln \Omega_0 - \ln \Omega_D = aD^2, \quad S_0 - S_D = s = kaD^2.$$

The quantity a will depend on the type of system, its size, and the sort of subdivision to which the distribution corresponds.

The ratio of the probability of the distribution D to the distribution 0 is $\Omega_D/\Omega_0 = e^{-aD^2} = e^{-s/k}$, from (28). The probability of any distribution D is then

$$P_D dD = C e^{-aD^2} dD$$

and the undetermined constant C can be evaluated by integrating† this equa-

* The method followed is essentially that of Einstein, *Ann. Physik*, **33**, 1275 (1910).

† P_D becomes negligibly small for large D , so that we can use the above approximation up to $D = \infty$ without appreciable error.

tion from $-\infty$ to $+\infty$, obtaining $C(\pi/a)^{1/2}$, which must be unity, since the sum of all probabilities is one. Then,

$$(4. 29) \quad P_D dD = \left(\frac{a}{\pi}\right)^{1/2} e^{-aD^2} dD.$$

Now from (28) the number of distributions dD in an interval ds of entropy is $dD = ds/2kaD$, which, however, must be multiplied by 2, since both positive and negative distributions contribute to the same range ds . The probability, P_s , of a distribution with entropy less than that of the most probable one by an amount s , per unit range ds , is

$$(4. 30) \quad P_s ds = (\pi ks)^{-1/2} e^{-s/k} ds.$$

For moderately large values of $\Delta S/k$, the integral of this function from ΔS to infinity

$$(4. 31) \quad \int_{\Delta S}^{\infty} P_s ds \cong \frac{e^{-\Delta S/k}}{(\pi \Delta S/k)^{1/2}}$$

is the probability that a decrease in entropy of ΔS or greater will be observed.

The result is simple and perfectly general. Independently of the size of the system, of its nature, or the kind of distribution inhibited, the probability that a distribution differing from that of equilibrium by an entropy difference of ΔS or greater can be found is, neglecting the relatively unimportant denominator, $e^{-\Delta S/k}$.

The order of magnitude of this figure can be appreciated only by ascertaining the value of the entropy of some real system. S/k for one mole of helium at 273°K., 1 atm., is 4×10^{26} . It is seen that the chance of observing an entropy decrease in any system of one-millionth of this amount is about $10^{-10^{11}}$, a sufficiently small number.

The probability calculated above refers to a given absolute decrease in entropy. An appreciable *relative* decrease $\Delta S/S$ may be observed in a sufficiently small system. However, owing to the multiplicative law of independent probabilities, it is clear that the same chance exists for observing a given absolute entropy decrease by simultaneous independent application of inhibitions to many small systems as to one experiment on a large one.

4f. The Relation between Entropy and the Uncertainty in the Energy

The entropy of any system was found to be $S = k \ln \Omega$, where Ω is the total number of quantum states available to the system at a given energy. The exact definition of Ω (section 2i) equates it to the number of quantum states within a certain range of uncertainty δE , so that we can write $\Omega = \Omega(E) \delta E$. If δE is large compared to two neighboring energy levels, $\Omega(E)$ is a smooth function of the energy which is unam-

biguously defined and calculable. However, Ω is proportional to the somewhat undetermined quantity δE .

Numerical calculations of S , on the other hand, are independent of the size of δE over a wide range. Indeed, to within the limits of accuracy with which one determines S in practice, it makes no difference whether it is equated to the logarithm of the number of states whose energy deviates from E by less than δE , or even to the logarithm of the number of states whose energies lie below E , $\int_0^E \Omega(E) dE$. This can be seen readily. Since $d\Omega/dE$ is always positive, $\Omega(E)$ increases monotonously with E , and the two numbers in question differ at most by a factor $E/\delta E$,

$$(4. 32) \quad \ln \int_0^E \Omega(E) dE - \ln \frac{E}{\delta E} \leq \ln [\Omega(E) \delta E] \leq \ln \int_0^E \Omega(E) dE.$$

Unless δE is chosen extremely small, $\ln (E/\delta E)$ is completely negligible compared to the tremendous numbers of states. For example, the system consisting of one mole of helium at 273°K. and 1 atm. pressure has $\ln \Omega = 4 \times 10^{25}$. An excellent experiment might determine the energy to within one part in a million. This corresponds to a value of $\ln (E/\delta E)$ about equal to 14. Even if $\delta E/E$ is chosen as small as $10^{-10^{20}}$, $\ln (E/\delta E) \cong 10^{20}$, the difference of the right- and left-hand sides of the above inequality is only one part in 10^5 , and the definitions of S as proportional to the logarithm of the number of states in the region δE , or of the number of states below E , would differ only by 10^{-3} per cent. It is seen, therefore, that for macroscopic systems the uncertainty in any ordinary experimental measurement of the energy is far greater than any δE which would affect the numerical value of the entropy.

However, from the purely theoretical point of view, one would feel quite uncomfortable if there existed no natural limit to the smallness of δE . If someone were to insist that in the example above $\delta E/E = 10^{-10^{20}}$ be chosen, the entropy of helium would be very appreciably affected. Actually, such a natural lower bound to the value of δE does exist as was discussed in section 2i.

It is obvious that, if a system a is in thermal contact with another one b , so that a and b constantly influence each other and exchange energy, it is nonsense to speak of the energy of a as exactly determined. In fact, there exists a relationship (2. 35) between the utmost accuracy, δE , with which the energy can conceivably be determined, and the time Δt for which the system must remain undisturbed.

$$(4. 33) \quad \delta E \cdot \Delta t \geq h.$$

This means that in order to determine the energy within an accuracy δE the system must be kept so that no energy enters or leaves it for at least a time interval Δt connected to δE by (33). The energy of a system, then, has an infinitely sharp value only if the system is completely isolated for an infinite length of time.

To get an idea of the order of magnitude, one may calculate that, if Δt is one second, $\delta E \geq h/1 = 6 \times 10^{-27}$; and if Δt is a year or 3×10^7 seconds, $\delta E \geq 2 \times 10^{-34}$ erg. Now the energy of a mole of helium at standard conditions is about 3×10^{10} ergs, so that, using one year, which would be a pretty long time to completely and successfully isolate a mole of helium, and certainly an impractically long time to leave between observations, we find that $\delta E/E \geq 10^{-44}$. Since we have seen that this quantity could be as small as $10^{-10^{20}}$, without disturbing us much, we find that we are pretty safe.

The fact that δE decreases as the inverse time of isolation appears to lead to the result that a really isolated system, isolated for infinite time, has zero entropy. Indeed, the true stationary states of sharp energy, which on principle could be calculated, but cannot in practice, owing to our limited capabilities, have just the property that the system persists in them unless perturbed by outer influences. The *exact* degeneracy of the corresponding levels will presumably be small and independent of the size of the system. Classically, these states correspond to closed orbits in phase space, but because of the uncertainty principle of coordinate and momentum (2. 11) phase relations cannot be determined. A completely isolated system is absolutely non-ergodic with respect to these states.

An observation of any kind made upon the system immediately introduces an uncertainty into its energy and causes unpredictable transitions to any one of Ω states of approximately the same energy. An exact determination of the energy of a system precludes the knowledge of its entropy. This fact was stated clearly from a classical basis by Gibbs.

The necessary uncertainty in the energy of a system upon which observations are being made is sufficient to lead to an asymptotic value of the entropy, practically independent of the conditions of observation, provided that the system is of macroscopic size.

Since the entropy is linearly proportional to the size of the system, it is small enough for systems of molecular size to be appreciably affected by uncertainties in the energy, which are essentially independent of size. In that case, only the method of Gibbs (Chapter 10) can be applied. It consists in treating, not the one system, but instead a large number, N , of identical systems in thermal contact. Energy NE , and entropy NS as function of NE , for this combination system can be calculated without trouble. The entropy S of the small system is thereby found as a function of its average energy E .

4g. The Third Law of Thermodynamics

The number $\ln \Omega$ for any system is naturally and completely determined and contains no additive integration constant. Moreover, it is necessarily positive. The entropy S , of dimensions energy per degree, has, therefore, a fixed positive numerical value dependent only on the units of energy and temperature. This is, perhaps, the most general statement of the third law of thermodynamics.

It is clear that although W , the phase volume measured in units of h^f , and Ω , the number of quantum states, are asymptotically equal for many systems under certain conditions, nevertheless, the existence of an absolute entropy is a consequence only of the laws of quantum mechanics. For the definition of entropy and the derivation of the second law, it is quite immaterial in what units the classical phase volume is measured; a change of units results only in the occurrence of an additive constant in S . The use of W as a dimensionless quantity, phase volume divided by h^f , fixes this integration constant in such a way that the classical expression for the entropy corresponds to the quantum-mechanical one. However, h is essentially a quantum magnitude, and classical mechanics itself has no natural way of defining a quantity of correct dimensions in whose units the phase volume could be measured. Moreover, as the energy of the system is lowered, the phase volume approaches zero, the classical entropy minus infinity. Quantum mechanically the system can never exist in less than one state, of phase volume h^f , so that S can at worst become zero. The third law of thermodynamics is the quantum-mechanical law of thermodynamics, although it was independently discovered.

The general statement of the third law given above has no great value to the experimental thermodynamicist. It is scarcely consoling to know that the integration constant present in the thermodynamic definition of entropy is naturally defined, if no experimental method is given for its determination.

Actually it appears to be impossible to give general directions for its determination in purely experimental terms. It is probable that all completely uninhibited real systems have one state of lowest energy, or possibly a small number of states, independent of the size of the system. S will then be zero, or practically so, at the lowest possible energy of the system. However, this state may not be reached in reasonable time by the system at low temperatures. All reaction rates go down with temperature, so that real systems have an even greater tendency to behave in a quasi non-ergodic manner at low temperatures than at high ones. If brought into thermal contact with a heat reservoir at almost absolute zero for considerable periods of time, they may

not even nearly reach this lowest state. In that case the entropy at absolute zero may not reach zero but a residual value, the zero point entropy, which, however, is never large.

Such systems may not differ in any single, simply detectable, experimental way from others which have zero entropy at the absolute zero of temperature. Carbon monoxide and hydrogen exhibit this behavior. The zero point entropy of carbon monoxide is due to the fact that for the relatively high temperature at which the crystal freezes the most probable arrangement is one with (almost) random orientation of the molecules with respect to the oxygen and carbon ends. At low temperatures, reorientation is extremely slow, although presumably one preferred orientation would be most stable. In hydrogen the zero point entropy is connected with the slowness of transitions between even and odd rotational states, which will be discussed later in greater detail. In neither of these cases is the behavior surprising when once understood. An idealized system with corresponding inhibitions can be imagined, and the calculated entropies agree with measurements. There is no reason to believe that the entropy of the real systems would drop appreciably at lower temperatures than have been investigated.

Several objections may be raised to the common attempt to state the third law of thermodynamics as: the entropies of perfect crystalline substances at absolute zero are zero. The criterion of whether the crystal is perfect or not is hard to apply except just by a determination of its entropy. It also appears that certain non-crystalline substances have zero entropy at 0°K . Theoretically this is predicted for the perfect gas and observed for the electron gas in metals, and it also appears that the entropy of liquid helium approaches zero at absolute zero.

Nevertheless, whatever difficulties may be present in making an exactly valid and also experimentally useful statement of the third law of thermodynamics, the value of this law must not be underestimated. Even were it not for the relatively recent calculations of entropies by means of statistical mechanics, in which, of course, the absolute values are determined, the fact that many systems have zero S at 0°K . has been extremely useful to the experimental thermodynamicist and has greatly aided in the calculation and tabulation of entropies and free energies.

4h. The Conditions of Equilibrium and the Chemical Potential μ

After the identification of π , τ , and S with pressure, temperature, and entropy has been performed, thermodynamics is shown to be a consequence of statistics. For the definition and characteristics of thermodynamic potentials we might simply refer to any textbook on

thermodynamics. However, partly on account of the confusion of nomenclature, we prefer to give a short outline here. The discussion of this section is purely thermodynamic.

The entropy S , which may be defined by equations analogous to (11) and (12),

$$(4. 34) \quad \left(\frac{\partial S}{\partial E}\right)_V = \frac{1}{T},$$

$$(4. 35) \quad \left(\frac{\partial S}{\partial V}\right)_E = \frac{P}{T},$$

is stated by the second law to increase in all spontaneous changes taking place at constant energy. The condition of equilibrium in an isolated system of constant energy and volume is that S be a maximum. If any variable x which defines a distribution of some sort in the system is allowed to change, the change in S accompanying the variation δx in the variable x is $\delta S = (\partial S/\partial x)_{V,E} \delta x$. This change must be zero at equilibrium; $(\partial S/\partial x)_{V,E} = 0$ will determine the equilibrium value of x .

However, we seldom investigate experimentally the properties of systems kept at constant volume and energy, but rather of systems at constant volume and temperature, or even more frequently at constant pressure and temperature. It will be found convenient to define new extensive properties of the system, $A(V,T)$, a natural function of volume and temperature, and $F(P,T)$, a natural function of pressure and temperature, as

$$(4. 36) \quad A(V,T) = E - TS,$$

$$(4. 37) \quad F(P,T) = A + PV = E + PV - TS.$$

A is called by various authors either the Helmholtz free energy, the free energy at constant volume, or the work function by Lewis and Randall. F is called the Gibbs free energy, the free energy at constant pressure, the thermodynamic potential at constant pressure, or simply free energy by Lewis and Randall. The equilibrium conditions at constant temperature and volume are that A have its minimum value or that $(\partial A/\partial x)_{V,T} = 0$. For a system maintained at constant pressure and temperature, equilibrium will be attained if $(\partial F/\partial x)_{P,T} = 0$.

These conditions are easily proved. We regard the system a which we wish to maintain at constant volume and temperature as a subsystem in thermal contact with an infinite heat reservoir b , of the same temperature, the whole comprising a combined system which is kept at constant energy and volume. A change δx in the distribution variable x within the subsystem a will cause in a a change in entropy $\delta S_a =$

$(\partial S_a/\partial x)_{V,T} \delta x$, and also a change in energy, $\delta E_a = (\partial E_a/\partial x)_{V,T} \delta x$, which will be accompanied by an equal decrease in the energy of b , $\delta E_b = -\delta E_a$. This decrease causes a change $(\partial S_b/\partial E_b)_V \delta E_b = \delta S_b$ in the entropy of the reservoir b . Since $(\partial S_b/\partial E_b)_V = 1/T$, and $\delta E_b = -\delta E_a$, this entropy change is $\delta S_b = (-1/T) \delta E_a$. The total variation of entropy δS of the combined system is

$$(4. 38) \quad \delta S = \left(\frac{\partial S}{\partial x}\right)_{V,E} \delta x = \left[\left(\frac{\partial S_a}{\partial x}\right)_{V,T} - \frac{1}{T} \left(\frac{\partial E_a}{\partial x}\right)_{V,T} \right] \delta x \\ = -\frac{1}{T} \left(\frac{\partial A_a}{\partial x}\right)_{V,T} \delta x,$$

from (36). δS must be positive for every spontaneous change, from which it can be seen that the spontaneous reaction takes place in such a direction that A_a decreases. Equilibrium will be attained when $(\partial S/\partial x)_{V,E} = 0$, or when $(\partial A_a/\partial x)_{V,T} = 0$.

The condition for equilibrium in subsystem a , kept at constant volume and temperature, is that the property A remains unchanged for an infinitesimal variation in the variable x ; the spontaneous process takes place in such a direction as to decrease the value of A .

Similarly, if the part a is kept at constant temperature and pressure, so that the infinite reservoir b is allowed, not only to lose energy to a , but also to change in volume by an amount $-\delta V_a$ for an increase $\delta V_a = (\partial V_a/\partial x)_{P,T} \delta x$, brought about in a by a change in the variable x , one obtains for a change δx in x ,

$$(4. 39) \quad \delta S = \left(\frac{\partial S}{\partial x}\right)_{V,E} \delta x = \left(\frac{\partial S_a}{\partial x} - \frac{1}{T} \frac{\partial E_a}{\partial x} - \frac{P}{T} \frac{\partial V_a}{\partial x}\right)_{P,T} \delta x = \\ -\frac{1}{T} \left(\frac{\partial F_a}{\partial x}\right)_{P,T} \delta x.$$

Equilibrium is established when $(\partial F_a/\partial x)_{P,T}$ is zero, and the spontaneous process goes in such a direction as to decrease F .

One of the most frequent problems of distribution to which the interest of the chemist will be drawn is that of the number of molecules of a certain kind between two parts a and b of a system. If N_i , the number of molecules of kind i in the whole system, kept at constant volume and energy, is fixed, and N_{ai} and N_{bi} are the numbers in the two subsystems, respectively, $N_{ai} + N_{bi} = N_i$, we may ask for the condition that will determine the equilibrium values of N_{ai} and N_{bi} . We shall first consider that the interchange of energy and volume between a and

b is inhibited, so that, during the transfer of $\delta N_{ai} (= -\delta N_{bi})$ molecules from b to a , the energy and volume of a and b remain unaltered.* We may write immediately

$$(4. 40) \quad \delta S = \left(\frac{\partial S}{\partial N_{ai}} \right)_{V,E} \delta N_{ai} = \left[\left(\frac{\partial S_a}{\partial N_{ai}} \right)_{V,E} - \left(\frac{\partial S_b}{\partial N_{bi}} \right)_{V,E} \right] \delta N_{ai}.$$

The equilibrium condition is that of equal values of $(\partial S/\partial N_i)_{V,E}$ in the two parts of the system.

If the chemical potential, μ_i , of molecules of type i , is defined as

$$(4. 41) \quad \left(\frac{\partial S}{\partial N_i} \right)_{V,E} = -\frac{\mu_i}{T},$$

then (40) leads to the result that, if the whole system is at one temperature, molecules i will move spontaneously from that part of the system in which their chemical potential is high, to that part in which it is low, and equilibrium will be attained when their chemical potentials are the same in both parts of the system.

If, in the original system, energy were not inhibited from flowing between parts a and b , the equilibrium condition would be that $T_a = T_b$, and the total entropy of the system would be unchanged by an (infinitesimal) transfer of energy from b to a . In consequence of this, even if the transfer δN_{ai} of molecules from a to b were accompanied by an energy transportation, equation (40) would still give the total entropy change in the combined system, and the condition of equilibrium would be, as before, that $\mu_{ai} = \mu_{bi}$. It is obvious that the same consideration holds if changes in the volumes V_a and V_b are uninhibited.

Using (36) for $A(V, T)$, we see that any change $(dA)_{V,T}$ in A at constant volume and temperature can be written as

$$(4. 42) \quad (dA)_{V,T} = -T(dS)_{V,T} + (dE)_{V,T},$$

and the change $(dS)_{V,T}$ can be written as the sum of the changes $(dS)_{V,E}$ at constant energy plus $(\partial S/\partial E)_V (dE)_{V,T} = (1/T) (dE)_{V,T}$. Putting this in (42), the terms due to the change in energy cancel, and we obtain

$$(dA)_{V,T} = -T(dS)_{V,E},$$

or using (41)

$$(4. 43) \quad \left(\frac{\partial A}{\partial N_i} \right)_{V,T} = -T \left(\frac{\partial S}{\partial N_i} \right)_{V,E} = \mu_i.$$

* This process, obviously, does not correspond to any simple physical or chemical experiment, but can be undertaken in thought.

Similarly, for $(dF)_{P,T}$ we may substitute

$$(4. 44) \quad (dF)_{P,T} = P(dV)_{P,T} + (dA)_{P,T} \\ = P(dV)_{P,T} + (dA)_{V,T} + \left(\frac{\partial A}{\partial V}\right)_T (dV)_{P,T}.$$

It is a well-known thermodynamic formula that $(\partial A/\partial V)_T = -P$, so that

$$(dF)_{P,T} = (dA)_{V,T},$$

and we obtain from (43) that

$$(4. 45) \quad \left(\frac{\partial F}{\partial N_i}\right)_{P,T} = \mu_i.$$

Now if we inquire into the condition of equilibrium numbers N_{ai} and N_{bi} of molecules in two parts a and b of a combined system, kept at constant volume and temperature, or constant pressure and temperature, we must demand that A , or F , respectively, be unchanged by the transfer δN_{ai} of molecules from b to a . From (43) and (44) we see that in these cases as well as when the total system is kept at constant energy and volume we arrive at the general relationship that at equilibrium

$$(4. 46) \quad \mu_{ai} = \mu_{bi}.$$

The chemical potential μ_i is the partial molal free energy, F_i , of Lewis and Randall, divided by Avogadro's number. It might be called the partial molecular free energy of the molecules of type i , and must at equilibrium have the same value in all parts of the system. In a system of one component, consisting of one kind of molecules only, the derivative of the *extensive* quantity F with respect to the number of molecules, $(\partial F/\partial N)_{P,T}$, in which the *intensive* pressure and temperature are held constant, is independent of the number of molecules, and it follows that F is just the number of molecules, N , times μ ,

$$(4. 47) \quad F = N\mu \quad (\text{one-component system}).$$

If one deals in thermodynamics with different parts of a system, one usually refers to parts which are not only experimentally distinguishable, but even obviously distinguished, such as different phases, liquid and gas, solid and liquid, etc. There is, however, no logical limitation to the application of the laws derived above to finer subdivisions of the system. In statistical mechanics it will be found extremely useful to do this.

CHAPTER 5

THE PERFECT MONATOMIC GAS

(a) The Mathematical Representation of the System. (b) The Distribution of Energy among the Atoms. (c) The Most Probable Distribution. (d) Boltzmann Statistics. (e) The Equation of State. (f) Maxwell-Boltzmann Distribution. (g) Evaluation of e^α and Limit of Applicability of Boltzmann Statistics.

5a. The Mathematical Representation of the System

In this chapter we wish to calculate the properties of the simplest thermodynamic system, namely, the perfect, monatomic gas. These calculations are used not only as an example; they belong in the scope of the general discussions, in so far as the results obtained here will enable us to identify the quantity τ , defined in equation (4. 11) and shown to be proportional to the temperature in section 4d, with the temperature itself, provided that the proportionality factor k is chosen as the Boltzmann constant.

We will represent the perfect monatomic gas by an idealized ergodic system of independent mass points.

The treatment of the atoms as independent is certainly justified at sufficient dilution. Since the forces between the atoms are of short range, an atom will, most of the time, travel in field-free space, and will but seldom be within the range of the forces of other atoms. The interaction, therefore, takes the form of collisions, that is, spontaneous transitions to other quantum states which make the system ergodic (compare section 3f). Since all gases become perfect at low enough densities, independence of the atoms must be the criterion of a perfect gas.

The states of electronic excitation of the atoms are neglected completely. This is justified for normal temperature ranges if, and only if, the energy of these excited levels is very high. A proof of this statement, and a detailed discussion of the cases of deviation from this assumption, are presented in section 6e. In one way, however, we wish to take the internal degrees of freedom of the atoms into account: the ground level of the atom may be g -fold degenerate. (Compare section 2h, example 3.) Actually, in stable atoms this happens only on account of the possible orientations of the nuclear spin, s_n , so that $g = 2s_n + 1$.

The mechanical behavior of the atom is then the same as that of a mass point, except that every state of the point corresponds to g states of the atom.

The quantum states, or cells, of one point of mass m in a volume V have been calculated in section 2g, example 1. To distinguish it from the energy E of the total system, the energy of the individual molecules will from now on always be designated by ϵ . The energy of an atom in any of the cells described by the three integral quantum numbers, $\mathbf{k}_x, \mathbf{k}_y, \mathbf{k}_z$, is given by

$$(5. 1) \quad \epsilon = \frac{h^2}{8mV^{2/3}} (\mathbf{k}_x^2 + \mathbf{k}_y^2 + \mathbf{k}_z^2).$$

The asymptotic number of states of one mass point, whose energies lie between ϵ and $\epsilon + \Delta\epsilon$, was calculated in equation (2. 34) and has to be multiplied by g to give the corresponding number of states of the atom,

$$(5. 2) \quad C(\epsilon) \Delta\epsilon = 4\pi g \frac{mV}{h^3} (2m\epsilon)^{1/2} \Delta\epsilon.$$

The energy, E , of the *total* system is the sum of the energies, (1), of the individual constituents. The possible states of the total system, and therefore the number $\Omega(E)$ of states consistent with E , and the quantity $S(E)$ of Chapter 4, depend on the kind of system the individual particles form: Einstein-Bose or Fermi-Dirac (compare section 2k). The calculations will be made for both cases, and for the third, classical one, which treats the atoms as distinguishable in principle and leads to Boltzmann statistics.

5b. The Distribution of Energy among the Atoms

First, the most probable distribution of atoms over the ranges of energy will be determined. Assume the scale of energy, ϵ , of the single particles to be divided into regions, the j th one extending from ϵ_{j-1} to ϵ_j . The ϵ_j values may be chosen equidistant or otherwise, but the difference between consecutive energy values, $\Delta_j\epsilon = \epsilon_j - \epsilon_{j-1}$, must be large compared to two neighboring levels of an atom; it will later be demanded that $\Delta_j\epsilon$ also be small enough to allow summations over the different regions to be replaced by integration over ϵ . The surfaces of constant energy ϵ_j divide the six-dimensional phase space (μ space) of the individual mass points into ranges, each of which contains very many cells, or quantum states of the particles. The phase volume of the j th region, that is, the number of quantum states whose energies lie

between ϵ_{j-1} and ϵ_j , will be designated by C_j , and is equal to the quantity $C(\epsilon_j) \Delta_j \epsilon$ of equation (2).

A distribution D of the atoms over these energy regions is defined by giving the numbers N_j of molecules whose energies lie in the j th region. It is now our task to calculate the number of states, Ω_D , which are consistent with one distribution. The result is different for the different kinds of systems.

1. *Einstein-Bose systems.* If a state of the total system is determined by the number of atoms in each cell it is necessary to calculate the number of ways in which N_j identical (unnumbered) balls can be distributed among C_j boxes. This is the same as the number of ways in which N_j can be expressed by a sum of C_j integers, some of which may be zero, different order of the summands being counted as different. In Appendix A VII. 10 this number is calculated to be

$$\frac{(C_j + N_j - 1)!}{(C_j - 1)! N_j!}$$

The total number of states is the product of this expression for all ranges,

$$(5. 3) \quad \Omega_D = \prod_j \frac{(C_j + N_j - 1)!}{(C_j - 1)! N_j!}$$

2. *Fermi-Dirac systems.* If there may never be more than one atom in a cell, N_j must be equal to or less than C_j . The number of ways in which N_j indistinguishable balls can be distributed into C_j boxes, no more than one to a box, must be calculated. This amounts to a calculation of the number of ways in which the C_j boxes can be divided into two groups, of N_j full ones and $(C_j - N_j)$ empty ones. This number is given (see Appendix A VII. 9) by

$$\frac{C_j!}{N_j! (C_j - N_j)!}$$

The total number of states is the product of this expression over all regions,

$$(5. 4) \quad \Omega_D = \prod_j \frac{C_j!}{N_j! (C_j - N_j)!}$$

3. *Boltzmann systems.* If the particles were actually different and distinguishable, a different state is obtained dependent on which of the total N particles belong to each region. We have, therefore, first of all

to calculate the number of ways in which N particles can be divided into groups of N_j each, such that $\sum_j N_j = N$. This number is

$$\frac{N!}{N_1! \cdots N_j! \cdots} = \frac{N!}{\prod_j N_j!}.$$

Since the particles are completely independent, the number of ways in which N_j particles can be put into C_j cells is simply $C_j^{N_j}$, and the number of states consistent with the distribution is

$$(5.5) \quad \Omega_D = N! \prod_j \frac{C_j^{N_j}}{N_j!}.$$

For corrected Boltzmann counting (5) has to be divided by $N!$, the factorial of the number of identical particles (see section 2k).

In all three cases the numbers N_j have to obey two additional conditions, namely, that the total number of particles and the total energy are fixed:

$$(5.6) \quad N = \sum_j N_j,$$

$$(5.7) \quad E = \sum_j N_j \epsilon_j.$$

Formula (7) is an approximately correct expression for the energy only if the width $\Delta_j \epsilon$ of the regions is small compared to the average energy of one atom.

5c. The Most Probable Distribution

First of all, it is desirable to transform these expressions for Ω_D into continuous functions of the variables N_j . If all N_j 's and C_j 's are large, this can be done by using the Stirling approximation for the factorial. Now it is obviously impossible that the N_j 's of every region are large, since we have chosen an infinite number of energy ranges. On the other hand, ranges with a small number, N_j , of atoms, contribute little to the value of $\ln \Omega_D$, so that the ensuing error is negligible.

The results for the different cases are:

1. Einstein-Bose systems, if we also neglect unity compared to C_j ,

$$(5.8) \quad \ln \Omega_D = \sum_j [(C_j + N_j) \ln (C_j + N_j) - N_j \ln N_j - C_j \ln C_j] \\ = \sum_j \left[C_j \ln \left(1 + \frac{N_j}{C_j} \right) + N_j \ln \left(\frac{C_j}{N_j} + 1 \right) \right].$$

2. Fermi-Dirac systems

$$(5. 9) \quad \ln \Omega_D = \sum_j [C_j \ln C_j - N_j \ln N_j - (C_j - N_j) \ln (C_j - N_j)] \\ = \sum_j \left[-C_j \ln \left(1 - \frac{N_j}{C_j} \right) + N_j \ln \left(\frac{C_j}{N_j} - 1 \right) \right].$$

3. Boltzmann systems

$$(5. 10) \quad \ln \Omega_D = \ln N! + \sum_j [N_j \ln C_j - N_j \ln N_j + N_j].$$

It is easily seen that, if $N_j \ll C_j$, the numerical values of (8) and (9) approach each other, that is, they differ only in terms of the order of N_j^2/C_j . Their common value is (10), if the term $\ln N!$ is omitted. This had already been stated in general in section 2k. Since the factor $N!$ is the same for all distributions, it does not affect their relative probabilities. We shall, therefore, omit the term $\ln N!$ from now on, and use what we called in section 2k "corrected" Boltzmann counting for Boltzmann systems. That this division of Ω_D by $N!$ for Boltzmann systems is actually necessary also in pure classical calculations, if one wishes to identify $k \ln \Omega_{D_0}$ with the entropy will be discussed in detail at the end of section 5d. We find, then, that the number of states belonging to a distribution in a corrected Boltzmann system (which is not realized in nature) is the limiting value of the statistical weights of the same distribution for an Einstein and a Fermi system in case of great dilution of the gas in the μ space, that is, if $N_j \ll C_j$.

The next step is the calculation of those values of N_j for which Ω_D is a maximum, subject to the conditions (6) and (7) that the total number of particles and total energy remain constant. The method is the usual one for finding the maximum of a function of several variables which are subject to restrictions (see Appendix A VI). The restricting equations (6) and (7) are multiplied by constants α and β and subtracted from $\ln \Omega_D$, the function whose maximum is to be found. The values of the variables N_j at the maximum must fulfill the conditions

$$(5. 11) \quad \frac{\partial}{\partial N_j} [\ln \Omega_D - \alpha \sum_j N_j - \beta \sum_j \epsilon_j N_j] = 0.$$

The undetermined multipliers α and β have then to be determined by putting the values of N_j obtained into the equations (6) and (7).

One finds for the different cases:

$$1. \text{ Einstein-Bose, } \ln (C_j + N_j) - \ln N_j - \alpha - \beta \epsilon_j = 0;$$

$$(5. 12) \quad \frac{N_j}{C_j} = \frac{1}{e^{\alpha + \beta \epsilon_j} - 1}.$$

$$2. \text{ Fermi-Dirac, } \ln(C_j - N_j) - \ln N_j - \alpha - \beta \epsilon_j = 0;$$

$$(5. 13) \quad \frac{N_j}{C_j} = \frac{1}{e^{\alpha + \beta \epsilon_j} + 1}.$$

$$3. \text{ Boltzmann, } \ln C_j - \ln N_j - \alpha - \beta \epsilon_j = 0;$$

$$(5. 14) \quad \frac{N_j}{C_j} = e^{-\alpha - \beta \epsilon_j}.$$

5d. Boltzmann Statistics

The elimination of α and β through (6) and (7), calculation of the entropy, and identification of β with $1/kT$, are mathematically easy only for case 3, Boltzmann statistics. It is seen that both (12) and (13) become identical with (14) if e^α is much greater than unity, when the 1 in the denominator can be safely left out. This is, of course, precisely the condition that $N_j \ll C_j$. We shall, therefore, limit ourselves from now on explicitly to those ranges of values of E and N for which $e^\alpha \gg 1$. In the last section of this chapter we shall calculate e^α and see what the restriction actually amounts to. It will turn out that for all gases composed of atoms and molecules (but not for light quanta and electrons) deviations from Boltzmann statistics occur only at very low temperatures and high concentrations, that is, under conditions where the real system is not even gaseous.

To calculate α and β in terms of N and E the numbers N_j of the most probable distribution, (14), must be inserted into (6) and (7). The summation over the energy ranges can be replaced by an integration, the number of states in an infinitesimal region being given by (2). The numerical values of two definite integrals occurring in the calculation are

$$\int_0^\infty x^{1/2} e^{-x} dx = \frac{1}{2} \pi^{1/2}, \quad \int_0^\infty x^{3/2} e^{-x} dx = \frac{3}{4} \pi^{1/2}.$$

The results are then

$$\begin{aligned} N &= \sum_j N_j = \sum_j C_j e^{-\alpha - \beta \epsilon_j} = e^{-\alpha} \int_0^\infty C(\epsilon) e^{-\beta \epsilon} d\epsilon \\ &= 2\pi g \left(\frac{2m}{h^2} \right)^{3/2} V e^{-\alpha} \int_0^\infty \epsilon^{1/2} e^{-\beta \epsilon} d\epsilon \\ &= 2\pi g \left(\frac{2m}{\beta h^2} \right)^{3/2} V e^{-\alpha} \int_0^\infty x^{1/2} e^{-x} dx, \end{aligned}$$

$$\begin{aligned}
 (5. 15) \quad N &= g \left(\frac{2\pi m}{\beta h^2} \right)^{3/2} V e^{-\alpha}; \\
 E &= \sum_j N_j \epsilon_j = \sum_j C_j \epsilon_j e^{-\alpha - \beta \epsilon_j} = e^{-\alpha} \int_0^\infty C(\epsilon) \epsilon e^{-\beta \epsilon} d\epsilon \\
 &= 2\pi g \left(\frac{2m}{h^2} \right)^{3/2} V e^{-\alpha} \int_0^\infty \epsilon^{3/2} e^{-\beta \epsilon} d\epsilon \\
 &= \frac{2\pi g}{\beta} \left(\frac{2m}{\beta h^2} \right)^{3/2} V e^{-\alpha} \int_0^\infty x^{3/2} e^{-x} dx, \\
 (5. 16) \quad E &= \frac{3}{2} g \frac{1}{\beta} \left(\frac{2\pi m}{\beta h^2} \right)^{3/2} V e^{-\alpha}.
 \end{aligned}$$

Division of (16) by (15) eliminates α and leads to

$$(5. 17) \quad E = \frac{3}{2} \beta^{-1} N, \quad \beta = \frac{3N}{2E},$$

and from (15) with (17) one obtains

$$(5. 18) \quad e^\alpha = g \left(\frac{2\pi m}{\beta h^2} \right)^{3/2} \frac{V}{N} = g \left(\frac{4\pi}{3} \frac{mE}{h^2 N} \right)^{3/2} \frac{V}{N}.$$

The logarithm of the number of quantum states in the most probable distribution, D_0 , or the quantity $S = k \ln \Omega_{D_0}$ of Chapter 4, as a function of energy and volume of the system can now be obtained by inserting the values of N_j , (14), into (10) and using (17) and (18) to eliminate α and β . This leads to

$$\begin{aligned}
 S &= k \ln \Omega_{D_0} = k \sum_j N_j \left(\ln \frac{C_j}{N_j} + 1 \right) \\
 &= k \sum_j N_j (\alpha + \beta \epsilon_j + 1) = k\beta E + k(\alpha + 1)N \\
 &= \frac{5}{2} kN + kN \ln \left[g \left(\frac{2\pi m}{\beta h^2} \right)^{3/2} \frac{V}{N} \right], \\
 (5. 19) \quad S &= \frac{5}{2} kN + kN \ln \left[g \left(\frac{4\pi mE}{3h^2 N} \right)^{3/2} \frac{V}{N} \right].
 \end{aligned}$$

In Chapter 4 it was proved in general that the quantity $S = k \ln \Omega_{D_0}$ is the entropy for every system, provided that k is chosen correctly. Equation (19) shows that S for the perfect gas is an extensive property. It is proportional to the number of particles and depends otherwise only on the density, N/V , the energy per particle, E/N , the mass m , and finally on the small number g , the statistical weight of the

ground level of the atom. Equation (19) is known as the Sackur-Tetrode equation for the entropy of a monatomic gas.

It was stated in Chapter 4 that the same numerical value for S is obtained whether it is defined as the logarithm of the number of states of the most probable distribution, of the number of all states consistent with the energy, or even of all states whose energy lies below the given total energy E . Let us assume the ground level of the atom to be non-degenerate, that is, $g = 1$. The number of states with energy below E is, then, for the corrected Boltzmann system, proportional to the volume of all points in the $6N$ -dimensional phase space (γ -space) whose energies lie below E . Since the energy is independent of the $3N$ positional coordinates, x , this phase volume is obtained by integration over all values of the x 's, leading to a factor V^N , and by integration over all $3N$ momenta, p , subject to the condition that $(p_1^2 + \cdots + p_{3N}^2) \leq 2mE$. This latter integral is the volume of a sphere of radius $(2mE)^{1/2}$ in $3N$ dimensions, its asymptotic value for large N is given by $(4\pi mE/3N)^{3N/2}$ (see Appendix A V).

This phase volume has still to be divided by h^{3N} , to make it a dimensionless quantity, and by $N! = N^N e^{-N}$. The result

$$\int_0^E \Omega(E) dE = \left(\frac{V}{N}\right)^N e^{5N/2} \left(\frac{4\pi mE}{3h^2N}\right)^{3N/2}$$

or

$$S = k \ln \int_0^E \Omega(E) dE = \frac{5}{2}kN + kN \ln \left[\left(\frac{4\pi mE}{3h^2N}\right)^{3/2} \frac{V}{N} \right],$$

is in complete agreement with (19).

$\Omega(E)$ itself differs from $\int_0^E \Omega(E) dE$ only by a factor $3N/2E$; therefore, S

defined as $k \ln \Omega(E)$ differs from the value obtained above only by the additive terms $k \ln (3N/2) - k \ln E$, which are absolutely negligible compared to $kN \ln N$ and $kN \ln E$.

The division of the phase volume by $N!$ was introduced because all real systems are of the Einstein-Bose or Fermi-Dirac type, and only the "corrected" Boltzmann counting is the limiting case for both types. It is, however, easy to show that, even from purely classical considerations, apart from any knowledge of quantum phenomena, this division of the phase volume by $N!$ is necessary if we desire to identify S with the entropy. If it had not been done, S would contain the additive term $kN \ln N - kN$. Since this term is constant for a fixed number of particles, it would not influence the identification of temperature and pressure, undertaken later, or the relations between these quantities. But S itself would no longer be proportional to the size of the

system. If we have two identical, but separated, systems, that is, systems of the same density, N/V , same β or E/N , and size, N , the S of the combined system is simply twice the value of S of each part. But, if we remove a wall between the two gases, so that we obtain one system, of the same density and β as before, but of $2N$ particles, the S value would not be the sum of the S values of both parts but would be larger, on account of the term $kN \ln N$, by the amount $2kN \ln 2$, which is by no means negligible. On the other hand, the removal or insertion of a wall between two parts of the system is a process which leaves the thermodynamic entropy unchanged. For this reason the division of the phase volume by $N!$ was introduced somewhat arbitrarily into classical statistics long before quantum mechanics gave the true explanation for it.

It is seen, then, that purely classical considerations lead to the same value for S , (19), that we obtained from quantum-mechanical arguments, except, of course, for the term $3N \ln h$, which, however, only fixes the additive constant in the entropy in agreement with the third law.

5e. The Equation of State

The temperature T was defined in equation (4. 11) as the inverse of the derivative of entropy with respect to energy. Using (19) one obtains

$$\frac{1}{T} = \left(\frac{\partial S}{\partial E} \right)_V = \frac{3}{2} kN \frac{1}{E},$$

so that

$$(5. 20) \quad E = \frac{3}{2} kNT.$$

Comparison with (17) shows that

$$(5. 21) \quad \beta = \frac{1}{kT}.$$

That β must be a function of the temperature alone could have been shown directly, without resorting to calculation of the entropy. If we have, namely, two completely independent gases of, respectively, $N^{(1)}$ and $N^{(2)}$ molecules each, with energies $E^{(1)}$ and $E^{(2)}$, and if we divide the μ space into energy regions and calculate the equilibrium distribution for both systems simultaneously, we find that

$$\ln \Omega_D = \ln \Omega_D^{(1)} + \ln \Omega_D^{(2)}$$

The maximum of this quantity must be determined subject to the four conditions

$$(5. 22) \quad \begin{aligned} N^{(1)} &= \sum_j N_j^{(1)}, & N^{(2)} &= \sum_j N_j^{(2)}, \\ E^{(1)} &= \sum_j N_j^{(1)} \epsilon_j, & E^{(2)} &= \sum_j N_j^{(2)} \epsilon_j. \end{aligned}$$

This means that the four quantities have to be multiplied by the undetermined constants $\alpha^{(1)}$, $\alpha^{(2)}$, $\beta^{(1)}$, $\beta^{(2)}$ and subtracted from $\ln \Omega_D$ before differentiation with respect to the N_j 's. As is to be expected, the most probable distribution of each system is in no way affected by the existence of the other one. For each system, the ratio N_j/C_j will be given by one of the equations (12), (13), or (14), depending on the nature of that system.

If, now, energy is allowed to flow between the two systems, so that only the *total* energy $E = E^{(1)} + E^{(2)}$ is fixed, we have only three conditions instead of the four of (22), and have, therefore, to multiply $E^{(1)}$ and $E^{(2)}$ by the *same* constant β before subtracting from $\ln \Omega_D$. The most probable distribution will have the same form as before, except that the relation must hold that

$$(5. 23) \quad \beta^{(1)} = \beta^{(2)} = \beta.$$

This means that two gases in energy contact, which are therefore at the same temperature, have the same value of β . In other words, β is a function of temperature only.

This fact was derived quite independently of the nature of the gases; it is valid for Fermi and for Einstein gases as well as for Boltzmann systems, and even for a combination of two gases of different nature. Since we have identified $1/k\beta$ with the temperature for the Boltzmann gas, the relation $\beta = 1/kT$ holds also for the Einstein and Fermi gases.

The relation (20) expresses the fact that the energy at fixed temperature is independent of the volume; experimentally this means that the Joule-Thomson coefficient for a perfect gas is zero.

The pressure of any system, according to equation (4. 12), is defined by the relation

$$\frac{P}{T} = \left(\frac{\partial S}{\partial V} \right)_E,$$

or, from (19),

$$(5. 24) \quad PV = kNT.$$

This is the well-known equation of state for a perfect gas.

We had shown in general only that T was a linear function of the

temperature. Now we find that if the proportionality factor k is chosen as the Boltzmann constant $k = 1.3804 \times 10^{-16}$ erg per degree, so that k multiplied by Avogadro's number, N_0 , is R , the gas constant per mole, the statistical and perfect gas temperatures are identical.

The pressure of the perfect gas can, of course, also be calculated directly, without resorting to the general considerations of Chapter 4 and the identification of S with entropy. According to (1) the energy of every state of a single particle depends on the volume in the same way, namely, it is proportional to $V^{-2/3}$. Since the energy of any state \mathbf{n} of the total system is the sum of the energies of the independent particles, it follows that

$$\frac{\partial E_{\mathbf{n}}}{\partial V} = -\frac{2}{3} \frac{1}{V} E_{\mathbf{n}}.$$

The pressure is defined as the force per area resisting a change in volume, averaged over all quantum states available to the system; we find the relation

$$(5. 25) \quad P = -\frac{\overline{\partial E_{\mathbf{n}}}}{\partial V} = \frac{2}{3V} E,$$

which, in combination with (20), also leads to the equation of state (24).

It is seen that the considerations of this chapter could have been carried out quite independently of the general discussions of Chapter 4. Indeed, had we not already identified the quantities π with pressure and τ with temperature in section 4d, we could have done so with the help of this example: the identity of equation (25) with (24) after insertion of (20) proves the pressure to be $\tau(\partial S/\partial V)_E$, and relation (24) then shows $\tau = 1/(\partial S/\partial E)_V$ to be the perfect gas temperature. Since $(\partial S/\partial E)_V$ had been demonstrated in section 4c to be the same monotonous function of T , and $\tau(\partial S/\partial V)_E$ at constant T the same function of pressure for all systems, the identification would have been complete and S proved to be the entropy for all systems.

It was essential to the discussions in Chapter 4 that the constant k in the definition of entropy as $S = k \ln \Omega$ be the same for all systems. The choice of k as the gas constant R divided by Avogadro's number assures us that, for all systems, equations (4. 10) and (4. 11) define entropy and temperature in agreement with the conventional scale.

5f. Maxwell-Boltzmann Distribution

Going back to the formula for the most probable distribution, (14), and using relation (21) between β and temperature, we find

$$(5. 26) \quad N_j = C_j e^{-\alpha} e^{-\epsilon_j/kT}.$$

This implies that the ratio of the number of atoms in a quantum state \mathbf{k} with energy $\epsilon_{\mathbf{k}}$ to those in a state \mathbf{k}' of energy $\epsilon_{\mathbf{k}'}$ is

$$(5. 27) \quad \frac{N_{\mathbf{k}}}{N_{\mathbf{k}'}} = e^{(\epsilon_{\mathbf{k}'} - \epsilon_{\mathbf{k}})/kT}.$$

As previously, the number of molecules N ; whose energy lies in the region between ϵ and $\epsilon + \Delta\epsilon$ will be written $N(\epsilon) \Delta\epsilon$, the number of single particle cells in that region as $C(\epsilon) \Delta\epsilon$, given in (2). The most probable number of molecules in the region $\Delta\epsilon$ is then

$$N(\epsilon) \Delta\epsilon = e^{-\alpha} 4\pi g \frac{mV}{h^3} (2m\epsilon)^{1/2} e^{-\epsilon/kT} \Delta\epsilon.$$

Elimination of $e^{-\alpha}$ with relation (18), using $\beta = 1/kT = 3N/2E$, gives

$$(5. 28) \quad N(\epsilon) \Delta\epsilon = \frac{2}{\pi^{1/2}} N \left(\frac{1}{kT} \right)^{3/2} \epsilon^{1/2} e^{-\epsilon/kT} \Delta\epsilon.$$

This formula can be transformed further by noting that the energy ϵ of a single particle is related to the magnitude of the velocity, v , by the equation $\frac{1}{2}mv^2 = \epsilon$. A range $\Delta\epsilon$ of energy corresponds to the range $mv \cdot \Delta v$ of magnitude of velocity. If we designate by $N(v) \Delta v$ ($= N(\epsilon) \cdot mv \cdot \Delta v$) the number of particles with velocities between v and $v + \Delta v$, we find

$$(5. 29) \quad N(v) \Delta v = \left(\frac{2}{\pi} \right)^{1/2} N \left(\frac{m}{kT} \right)^{3/2} v^2 e^{-mv^2/2kT} \Delta v.$$

This is the familiar Maxwell-Boltzmann law of distribution of velocities. This equation was derived in Chapter 1 (equation 1. 29) in a less strict manner, and some of its applications and consequences were discussed there. In Chapter 6 it will be shown that this law also holds for gases with internal degrees of freedom.

5g. Evaluation of e^α and Limit of Applicability of Boltzmann Statistics

At the beginning of section 5d it was mentioned that, although all true gases are either Einstein-Bose or Fermi-Dirac systems, the results of sections 5d and 5e, which are derived for Boltzmann systems, hold as long as the quantity e^α in (14) is very large compared to unity. We now wish to investigate in which way this condition limits the applicability of the formulas of the last three sections. e^α was calculated in (18). Substitution of $1/kT$ for β brings this into the form

$$(5. 30) \quad e^\alpha = g \left(\frac{2\pi mkT}{h^2} \right)^{3/2} \frac{V}{N} = g \left(\frac{4\pi mE}{3h^2 N} \right)^{3/2} \frac{V}{N},$$

or, introducing the pressure instead of the density,

$$(5. 30') \quad e^\alpha = g \left(\frac{2\pi mkT}{h^2} \right)^{3/2} \frac{kT}{P}.$$

The quantity α has a direct physical significance. It was shown in equation (4. 41) that $(\partial S/\partial N)_{V,T} = -\mu/T$, in which μ is the chemical potential or, for a one-component system, such as the one we are treating here, the free energy per molecule. Differentiation of (19) with respect to N at constant volume and energy gives

$$(5. 31) \quad \left(\frac{\partial S}{\partial N} \right)_{V,E} = -\frac{\mu}{T} = k \ln \left[g \left(\frac{4\pi mE}{3h^2 N} \right)^{3/2} \frac{V}{N} \right].$$

Comparison of (30) and (31) shows that

$$(5. 32) \quad \alpha = -\frac{\mu}{kT}.$$

The condition $e^\alpha \gg 1$ demands a certain dilution of the molecules in μ space: the greater the volume per molecule and the energy per molecule the less often it will occur that two or more particles occupy the same cell.

e^α increases with decreasing P , and rapidly with increasing T . Of the individual characteristics of the molecule only the mass and the g factor enter into the equation for e^α . From (30) and (30') one sees that at given density and temperature, or at given pressure and temperature, a substance with small m will have low e^α and show deviations from Boltzmann statistics most easily. Helium, therefore, which remains perfect to very low temperatures, should be the most favorable gas for the demonstration of this effect. Numerical evaluation shows that

$$(5. 33) \quad e^\alpha = 0.026g \frac{M^{3/2} T^{5/2}}{P_{\text{atm.}}},$$

where M is to be given in atomic-weight units, P in atmospheres, T in degrees absolute. Helium, $M = 4$, has no nuclear spin and a non-degenerate lowest electronic level; therefore, $g = 1$. Since it is made up out of an even number of elementary particles (two protons, two neutrons, and two orbital electrons) it obeys Bose statistics. For the boiling point of helium, $T = 4.2^\circ\text{K.}$, and $P = 1 \text{ atm.}$, we find $e^\alpha = 7.5$. It is therefore not inconceivable that deviations from Boltzmann statistics for helium could be found experimentally. However, at these high densities, the attractions between the atoms mask the statistical

effect sufficiently so that this has not been demonstrated clearly so far.*

All other material gases have much higher boiling points, therefore show imperfections at much higher temperatures, so that the condition $e^\alpha \gg 1$ is amply fulfilled. The values of e^α at the respective boiling points for the following substances are:

$$\begin{array}{lll} \text{H}_2, & T = 20.3^\circ\text{K.}, & e^\alpha = 1.4 \times 10^2, \\ \text{Ne}, & T = 27.2^\circ\text{K.}, & e^\alpha = 9.3 \times 10^3, \\ \text{A}, & T = 87.4^\circ\text{K.}, & e^\alpha = 4.7 \times 10^5. \end{array}$$

Matters become very different if we consider an electron gas at high density, such as we find inside of metals. In that case Boltzmann statistics would become applicable only at temperatures far above the melting point of the metals, and the formulas derived in sections 5d, 5e, and 5f cannot even be used as approximations, but Fermi statistics (13) has to be employed throughout (Chapter 16). For photons, which obey Einstein-Bose statistics, (12) must be used (Chapter 16).

* See, for instance, Erich Beth and George E. Uhlenbeck, *Physica*, IV, pp. 915-924 (1937).

CHAPTER 6

THE PERFECT GAS WITH INTERNAL DEGREES OF FREEDOM

(a) Introduction. (b) The Partition Function. (c) The Separation of the Partition Function as a Product. (d) The General Equations. (e) The Distribution of Molecules among Internal States. (f) The Influence of the Zero of Energy. (g) The Influence of Nuclear Spin. (h) The Entropy of Isotope Mixing. (i) The Internal Partition Function of a Monatomic Gas. (j) The Classical Internal Partition Function of Molecules.

6a. Introduction

In Chapter 5 the ratio N_j/C_j of the number of molecules, N_j , to the number of cells, C_j , in an ideal monatomic gas was calculated. The region j was defined in such a way that N_j consisted of all the molecules, and C_j of all the cells, the energy of which lay between ϵ_j and $\epsilon_j + \Delta_j\epsilon$. The calculation was made for the two different kinds of quantum-mechanical systems: one, the eigenfunctions of which were all symmetric (Einstein-Bose); and the other, the eigenfunctions of which were all antisymmetric (Fermi-Dirac). For this one-component system the chemical potential μ is the free energy per molecule. In terms of μ and ϵ_j , the expression was found to be

$$(6. 1) \quad \frac{N_j}{C_j} = \frac{1}{e^{(-\mu + \epsilon_j)/kT} \mp 1}$$

the negative sign referring to the Einstein-Bose, and the positive sign to the Fermi-Dirac, systems.

It can be seen that, although the equation was derived for a perfect monatomic gas, the method used would be just as applicable to a system composed of any N mechanically independent identical molecules with C_j any number of arbitrarily chosen cells, the energy of none of which was lower than ϵ_j , or higher than $\epsilon_j + \Delta_j\epsilon$. We shall repeat the argument in an independent and somewhat briefer form in order to demonstrate this.

6b. The Partition Function

A system composed of N identical independent particles in a volume V will be considered. The number of degrees of freedom, f , per particle, the number of coordinates necessary to specify completely the position of the particle will not be limited to three. In general, then, not only

the three Cartesian coordinates X, Y, Z , of the center of mass, but in addition $f - 3$ other coordinates will be needed to describe the position of one molecule completely. If the particles are idealizations of diatomic molecules f will be six, and the three internal coordinates chosen would be θ, ϕ , and r or ξ , as stated in Chapter 2. Corresponding to the f coordinates there will be f quantum numbers, and the quantum-mechanical specification of the state of a single molecule will be made complete by giving the values of these f quantum numbers which specify a single cell of volume h^f in the μ space. The energy of the particle will be the sum of two terms, one depending on the translational quantum numbers alone, $\mathbf{k}_x, \mathbf{k}_y$, and \mathbf{k}_z , and the other, the internal energy, depending on the $f - 3$ internal quantum numbers. Since the different quantum states of translational energy, at least, lie very close together in the energy scale, there will be a great number of cells in any small energy range.

The eigenfunctions of the system may be either all symmetric (Einstein-Bose), or all antisymmetric (Fermi-Dirac). We shall assume, as always, that N is a very large number. Of all the possible quantum states of the individual molecules one group is singled out, consisting of C_j arbitrarily, but definitely, chosen states, the energies of all of which lie between ϵ_j and $\epsilon_j + \Delta_j\epsilon$. We shall investigate the distribution of molecules between these and the remaining quantum states. The N_j molecules occupying any of the chosen C_j states will be said to form the part j of the system. This part j occupies the whole volume of the system. The other part consists of the remainder, coexistent in the same volume. Both N_j and C_j will be assumed to be large.

The value of S_j , the entropy of the part j , is $k \ln \Omega_j$, and will depend only on the number of cells C_j and on the number of particles N_j in the part j of the whole system. S_j has been found by equations (5. 8) and (5. 9) to be

$$(6. 2) \quad S_j = k \ln \Omega_j = k \left[\pm C_j \ln \left(1 \pm \frac{N_j}{C_j} \right) + N_j \ln \left(\frac{C_j}{N_j} \pm 1 \right) \right],$$

in which the upper signs refer to the Einstein-Bose, and the lower signs to the Fermi-Dirac, systems. The total derivative of S_j with respect to N_j is

$$(6. 3) \quad \frac{dS_j}{dN_j} = k \ln \left[\frac{C_j}{N_j} \pm 1 \right].$$

If the total system is to be in equilibrium with respect to the transfer of particles between these two parts of the system at constant total

energy, the entropy must have a maximum value with respect to such a process. This requires that the increase in entropy of the remainder of the system upon adding to it a particle from the part j must equal the expression of equation (3). This transfer of a particle from the region j to the remainder of the system involves not only the addition of a particle to the remainder of the system but also the addition of an amount of energy dE_j/dN_j , so that the change, $-dS_r/dN_j$, in the entropy of the remainder of the system upon the addition to it of a particle from the region j may be written

$$(6. 4) \quad -\frac{dS_r}{dN_j} = \left(\frac{\partial S}{\partial N}\right)_{E,V} + \left(\frac{\partial S}{\partial E}\right)_{N,V} \frac{dE_j}{dN_j}.$$

For these partial derivatives of the entropy the thermodynamic expressions may be used: $(\partial S/\partial N)_{E,V}$ is the negative of the thermodynamic potential μ divided by the temperature, equation (4. 41), and $(\partial S/\partial E)_{N,V}$ is the reciprocal of the temperature, (4. 34). The quantity dE_j/dN_j , the energy removed from the region j to the remainder of the system with one particle, is just ϵ_j , the energy of one particle in the region j . One obtains

$$(6. 5) \quad -\frac{dS_r}{dN_j} = \frac{-\mu + \epsilon_j}{T}.$$

Equating the two relations (3) and (5) leads to equation (1).

For all real gases at moderate temperatures, $-\mu/kT$, which is always positive, has a large value compared to 1, and unity can be neglected compared to the very large exponential, so that the approximate form

$$(6. 6) \quad \frac{N_j}{C_j} = e^{(\mu - \epsilon_j)/kT},$$

which is the classical equation, is obtained. We shall assume the validity of this equation (6), which is equivalent to assuming that $N_j/C_j \ll 1$, in the remainder of this, and in the next several chapters.

Equation (6) holds for any arbitrarily chosen region j of energy ϵ_j . The sum of N_j over all possible regions, covering exactly all the cells, must be N , the total number of particles of the system. We may write

$$(6. 7) \quad N = \sum_j N_j = e^{\mu/kT} \sum_j C_j e^{-\epsilon_j/kT}.$$

The sum $\sum C_j e^{-\epsilon_j/kT}$ is the sum over all quantum states of one molecule of the expression $e^{-\epsilon/kT}$. This sum will be called the total partition function of the molecules, and will be designated by the letter Q . It is also variously known as the sum of states, or in German as the

“Zustandsumme,” although these terms are more frequently reserved for the analogous sum over the internal quantum states of the molecules, which we shall introduce later and designate by Q_i . The sum can be written omitting the C_j if it is understood that the summation is to go over all the cells, or quantum states of the molecules, for which we shall use the summation index n .

Defining Q as

$$(6. 8) \quad Q = \sum_n e^{-\epsilon_n/kT},$$

and solving equation (7) for the chemical potential, μ , we obtain a very useful equation for this important thermodynamic property of the system,

$$(6. 9) \quad \mu = kT[\ln N - \ln Q].$$

The partition function Q is the sum over all quantum states or cells of the molecules of the exponential of minus the energy over kT . The energy, in classical mechanics, expressed as a function of the coordinates and the momenta is the Hamilton function, $H(p,q)$. The number of quantum states in a region of phase space between q_1 and $q_1 + \Delta q_1$, p_1 and $p_1 + \Delta p_1$, q_2 and $q_2 + \Delta q_2$, \dots , p_f and $p_f + \Delta p_f$, will be, if all the products $\Delta q_i \Delta p_i$ are large compared to h , just the volume of this region of the phase space in units of h^f ,

$$(6. 10) \quad C = h^{-f} \Delta q_1 \Delta p_1 \Delta q_2 \cdots \Delta q_f \Delta p_f.$$

The product, number of quantum states times the exponential, is then

$$(6. 11) \quad C e^{-\epsilon/kT} = h^{-f} e^{-H(p,q)/kT} \Delta q_1 \cdots \Delta p_f,$$

and the sum can be approximated by an integral*

$$(6. 12) \quad Q = \iiint \cdots \int h^{-f} e^{-H(p,q)/kT} dq_1 \cdots dp_f.$$

This expression will be valid as an accurate approximation for the partition function if the expression $H(p,q)/kT$ does not change appreciably, compared to unity, if for any coordinate both q_i and p_i are changed by an amount Δq_i and Δp_i such that $\Delta q_i \Delta p_i = h$. This condition means that all the quantum states are separated from their neighbors by an energy interval which is small compared to kT .

* The effect of the symmetry of the equilibrium configuration of the molecule which necessitates multiplication of this integral by the reciprocal of the symmetry number is discussed in sections 7f and 8e.

6c. The Separation of the Partition Function as a Product

For all molecules, within the approximation that the mass is independent of the internal energy, the Hamiltonian or energy function, $H(p, q)$, is separable into (at least) two additive parts, the one depending only on the coordinates and momenta of the center of mass, and the other only on the internal coordinates and momenta, q_i, p_i . To a somewhat less accurate approximation the internal part may itself usually be separated into a sum of terms, each depending on one only, or a few only, of the various $2(f - 3)$ internal coordinates and momenta. In these cases, as discussed in section 2h, the quantum mechanically allowed energies can be expressed as a sum of terms, each a function of one, or a few only, of the total f quantum numbers. If \mathbf{k} is used for the set $\mathbf{k}_x, \mathbf{k}_y$, and \mathbf{k}_z , the quantum numbers of translation of the center of mass, and \mathbf{i} is used for a set of $f - 3$ internal quantum numbers, the total energy of the molecule, a function of \mathbf{k} and \mathbf{i} , can be written as

$$(6. 13) \quad \epsilon(\mathbf{k}, \mathbf{i}) = \epsilon(\mathbf{k}) + \epsilon(\mathbf{i}).$$

The energy of translation $\epsilon(\mathbf{k})$ is itself a sum of three terms, each depending on one only of the three quantum numbers, $\mathbf{k}_x, \mathbf{k}_y$, or \mathbf{k}_z . If m is the total mass of the molecule, and the quantization is assumed for convenience to be made in a cubic box of side $V^{1/3}$ along each of the three principal axes of space, then equation (2. 17) gives the energy of translational motion as

$$(6. 14) \quad \epsilon(\mathbf{k}) = \frac{\hbar^2}{8V^{2/3}m}(\mathbf{k}_x^2 + \mathbf{k}_y^2 + \mathbf{k}_z^2).$$

The sum Q of equation (8) is to be taken over all quantum numbers, all values of \mathbf{k} and of \mathbf{i} . The values which \mathbf{k} can take are independent of those of \mathbf{i} , so that the summation may be represented as an independent summation over \mathbf{k} and over \mathbf{i} . Using (10) for the energy, and remembering that $e^{x+y} = e^x \cdot e^y$, we obtain

$$(6. 15) \quad \begin{aligned} Q &= \sum_{\mathbf{k}} \sum_{\mathbf{i}} e^{-[\epsilon(\mathbf{k}) + \epsilon(\mathbf{i})]/kT} \\ &= \sum_{\mathbf{k}} e^{-\epsilon(\mathbf{k})/kT} \sum_{\mathbf{i}} e^{-\epsilon(\mathbf{i})/kT} = Q_{\mathbf{k}} \cdot Q_{\mathbf{i}}. \end{aligned}$$

If now equation (14) is used for $\epsilon(\mathbf{k})$, it is seen that $Q_{\mathbf{k}}$ is itself a product of three independent and identical sums, and we may write

$$(6. 16) \quad Q_{\mathbf{k}} = \left[\sum_{\mathbf{k}=1}^{\infty} e^{-\hbar^2/(8V^{2/3}mkT)|\mathbf{k}^2} \right]^3.$$

For ordinary values of V and T , and masses corresponding to that of the hydrogen atom or greater, the argument of the sum changes very

slowly with \mathbf{k} . Writing $[h/2V^{1/3}(2mkT)^{1/2}]\mathbf{k} = z$, and replacing the summation by an integration, one obtains

$$(6. 17) \quad Q_{\mathbf{k}} = 8V \left(\frac{2mkT}{h^2} \right)^{3/2} \left[\int_0^\infty e^{-z^2} dz \right]^3 = V \left(\frac{2\pi mkT}{h^2} \right)^{3/2},$$

$$\text{since } \int_0^\infty e^{-z^2} dz = \sqrt{\pi}/2.$$

We may now use (17) with (15) in (9) to obtain the equation for the free energy of one mole of the gas, $\mathbf{F} = N_0\mu$, with N , the number of particles, replaced by Avogadro's number N_0 , and \mathbf{V} , the volume per mole,

$$(6. 18) \quad \mathbf{F} = RT \left[\ln \left(\frac{h^2}{2\pi mkT} \right)^{3/2} \frac{N_0}{\mathbf{V}} - \ln Q_i \right],$$

$$(6. 19) \quad Q_i = \sum_i e^{-\epsilon(i)/kT}.$$

all internal quantum states, i

The sum Q_i is the sum of $e^{-\epsilon(i)/kT}$ for all the internal quantum states of the molecules. This is the internal partition function of the molecules. It is often referred to as the sum of states, or, in German, as the "Zustandsumme," and is sometimes designated in the literature as Q . Equation (15) is perfectly general and applies to a perfect gas consisting of molecules of any degree of complexity whatsoever. The only assumptions used in its derivation are that the molecules are mechanically independent of each other, and that \mathbf{F}/RT has a moderately large negative value so that (6) is justified.

The condition that the Hamiltonian can be written as a sum of terms, each depending on one pair only (or a few pairs only), of the coordinates and their conjugate momenta, is the same as the condition that the quantum-mechanical expression for the energy of the molecule can be separated into a sum of terms depending each on only one (or on a few only) of the f quantum numbers. Under these conditions the classical expression for Q , just as the quantum-mechanical, can be separated into a product of terms. In the classical expression each of these terms is an integral, corresponding to the sum of the quantum-mechanical expression.

It frequently happens that the Hamiltonian can be expressed as a sum of terms, each depending on only one or a few pairs of the coordinates and conjugate momenta, and that for several of these terms, at a given temperature, the condition that the energy difference between adjacent quantum states be small compared to kT is amply fulfilled,

whereas for others the condition is definitely not obeyed. The classical integral can then be substituted for the quantum-mechanical sum in the factor of Q containing those degrees of freedom for which the quantum energy differences are small, and the sum expression may be used for the degrees of freedom for which this is not true.

Essentially this simplification has just been used in calculating $Q_{\mathbf{k}}$. The additive part of the Hamiltonian due to the motion of the center of mass of the molecule is $(1/2m)(p_x^2 + p_y^2 + p_z^2)$, and does not contain the coordinates. Substituted in (12), the integration over the coordinates can be performed at sight, giving, by definition, just the volume V of the system. The integration over the momenta remains to be performed in order to calculate the classical expression for $Q_{\mathbf{k}}$. The expression is, then,

$$(6. 20) \quad Q_{\mathbf{k}} = Vh^{-3} \iiint_{-\infty}^{+\infty} e^{-(p_x^2 + p_y^2 + p_z^2)/2mkT} dp_x dp_y dp_z.$$

Separation of this into a product of three identical integrals, and the introduction of the integration variable $z = p/(2mkT)^{1/2}$, give us

$$(6. 21) \quad Q_{\mathbf{k}} = V \left(\frac{2mkT}{h^2} \right)^{3/2} \left(\int_{-\infty}^{+\infty} e^{-z^2} dz \right)^3 = V \left(\frac{2\pi mkT}{h^2} \right)^{3/2}.$$

The expression of (21) is identical with that of (17).

6d. The General Equations

We shall now proceed to derive the equations for the other thermodynamic functions. To do this we calculate the entropy, S , as a sum of the values of the entropy, S_j , for the various regions j , using the equilibrium values of N_j/C_j in equation (2). With equations (3) and (5) it is found that

$$N_j k \ln \left(\frac{C_j}{N_j} \pm 1 \right) = N_j \frac{dS_j}{dN_j} = N_j \frac{\epsilon_j - \mu}{T}.$$

This is the second term of S_j in (2). If summed over all j values, since $\sum N_j = N$ and $\sum N_j \epsilon_j = E$, one obtains $(E - F)/T$, remembering that $N\mu$ is the free energy F . Using this, and the thermodynamic equation

$$S = \frac{PV + E - F}{T}$$

for the entropy, one finds

$$(6. 22) \quad S = \sum_j S_j = \frac{E - F}{T} \pm \sum_j k C_j \ln \left(1 \pm \frac{N_j}{C_j} \right) = \frac{E - F}{T} + \frac{PV}{T}.$$

From this, the perfectly general equation

$$(6. 23) \quad \frac{PV}{kT} = \pm \sum_j C_j \ln \left(1 \pm \frac{N_j}{C_j} \right)$$

is obtained independently of any special assumption that N_j/C_j is small. Equation (23) is valid for Einstein-Bose systems (with the positive sign) and for Fermi-Dirac systems (with the negative sign).

When N_j/C_j is small one can develop

$$\pm \ln \left(1 \pm \frac{N_j}{C_j} \right) = \frac{N_j}{C_j},$$

so that the sum in (23) is $\sum N_j = N$, and

$$(6. 24) \quad \frac{PV}{kT} = N, \quad PV = RT \quad (\text{for one mole})$$

is obtained for Boltzmann systems.

Substitution of $N_0/V = P/kT$ in equation (18) gives the free energy, \mathbf{F} , of the system in terms of its natural variables, P and T , per mole of material, as

$$(6. 25) \quad \mathbf{F} = RT \left[\ln \left(\frac{h^2}{2\pi mkT} \right)^{3/2} \frac{P}{kT} - \ln Q_i \right] \quad (\text{per mole}).$$

The work function \mathbf{A} differs from \mathbf{F} by $PV = RT$ (which is the same as for a monatomic gas with a non-degenerate ground energy level), so that the contributions of the internal degrees of freedom to these two properties of the system are the same,

$$(6. 25') \quad \mathbf{F}_i = \mathbf{A}_i = - RT \ln Q_i = - RT \ln \sum_i e^{-\epsilon_i/kT}.$$

The derivative of \mathbf{F} with respect to \mathbf{T} at constant pressure is the negative of the entropy,

$$(6. 26) \quad - \left(\frac{\partial \mathbf{F}}{\partial T} \right)_P = \mathbf{S} = R \left[\ln \left\{ \left(\frac{2\pi mkT}{h^2} \right)^{3/2} \frac{kT}{P} e^{5/2} \right\} + \frac{d}{dT} T \ln Q_i \right] \quad (\text{per mole}),$$

where the negative sign has been eliminated by inverting the fraction under the logarithm, and the $5R/2$ obtained in the differentiation has been added by multiplying the expression under the logarithm by $e^{5/2}$.

The contribution of the internal degrees of freedom to the entropy is

$$(6. 26') \quad S_i = R \frac{d}{dT} T \ln Q_i = R \left[\ln Q_i + \frac{1}{Q_i} \sum_i \frac{\epsilon(i)}{kT} e^{-\epsilon(i)/kT} \right].$$

For the heat content, \mathbf{H} , we may use the thermodynamic equation

$$(6. 27) \quad \mathbf{H} = \mathbf{F} + TS = \mathbf{F} - T \left(\frac{\partial \mathbf{F}}{\partial T} \right)_P = -T^2 \left(\frac{\partial}{\partial T} \right)_P \left(\frac{\mathbf{F}}{T} \right),$$

obtaining

$$(6. 28) \quad \mathbf{H} = RT \left[\frac{5}{2} + T \frac{d}{dT} \ln Q_i \right] \quad (\text{per mole}).$$

The energy per mole, \mathbf{E} , differs from the heat content by $PV = RT$, so that the contributions of the internal degrees of freedom to these two properties are the same:

$$(6. 28') \quad \mathbf{H}_i = \mathbf{E}_i = RT^2 \frac{d}{dT} \ln Q_i = RT \frac{1}{Q_i} \sum_i \frac{\epsilon(i)}{kT} e^{-\epsilon(i)/kT}.$$

We shall presently derive equation (32), that the total number, $N_{i'}$, of molecules with the internal quantum number i' , and therefore with the internal energy $\epsilon(i')$, is $(N_0/Q_i) e^{-\epsilon(i')/kT}$ per mole of gas. Equation (28') for the internal energy, then, has the very simple interpretation that it is the sum over all internal quantum states i of the product of the internal energy per molecule, $\epsilon(i)$, by the number of molecules, N_i , having this energy.

The expression for the heat capacity per mole at constant pressure, \mathbf{C}_P , is

$$(6. 29) \quad \mathbf{C}_P = \left(\frac{\partial \mathbf{H}}{\partial T} \right)_P = R \left[\frac{5}{2} + \frac{d}{dT} \left(T^2 \frac{d}{dT} \ln Q_i \right) \right] \quad (\text{per mole}).$$

The contributions of the internal degrees of freedom to both \mathbf{C}_P and to \mathbf{C}_V are the same:

$$(6. 29') \quad \mathbf{C}_{P_i} = \mathbf{C}_{V_i} = R \frac{d}{dT} \left(T^2 \frac{d}{dT} \ln Q_i \right) = N_0 \frac{d}{dT} \left[\frac{\sum_i \epsilon(i) e^{-\epsilon(i)/kT}}{Q_i} \right].$$

Carrying out the indicated operation of differentiation leads to

$$(6. 29'') \quad \mathbf{C}_{P_i} = \mathbf{C}_{V_i} = R \left[\frac{1}{Q_i} \sum_i \left(\frac{\epsilon(i)}{kT} \right)^2 e^{-\epsilon(i)/kT} - \left\{ \frac{1}{Q_i} \sum_i \frac{\epsilon(i)}{kT} e^{-\epsilon(i)/kT} \right\}^2 \right],$$

which may be brought into the form of a double sum:

$$(6. 29''') \quad C_{P_i} = C_{V_i} = \frac{1}{2} R \frac{1}{Q_i^2} \sum_{i>j} \sum_{j \geq 0} \left(\frac{\epsilon(i)}{kT} - \frac{\epsilon(j)}{kT} \right)^2 e^{-[\epsilon(i) + \epsilon(j)]/kT}.$$

All the extensive thermodynamic properties, F , A , S , H , E , C_P , and C_V , of a perfect gas with internal degrees of freedom can be arbitrarily divided into two additive parts, one of which is due to the translational motion of the center of mass of the molecules and is the same as for a perfect ideal monatomic gas with a non-degenerate ground level. The other part, the contribution of the internal degrees of freedom, is a simple function of the logarithm of the internal partition function of the molecules.

6e. The Distribution of Molecules among Internal States

Equation (6) may be used to calculate the average number $N_{\mathbf{k}'i'}$ of molecules in one particular quantum state, the quantum numbers of which are \mathbf{k}' and i' . If one uses equation (13), that the energy, $\epsilon(\mathbf{k}', i')$, of the molecules in this quantum state can be expressed as a sum, $\epsilon(\mathbf{k}', i') = \epsilon(\mathbf{k}') + \epsilon(i')$, one obtains

$$(6. 30) \quad N_{\mathbf{k}'i'} = e^{\mu/kT} \cdot e^{-\epsilon(\mathbf{k}')/kT} \cdot e^{-\epsilon(i')/kT}.$$

If now the number of molecules, $N_{i'}$, in the one single internal quantum state i' , but having any quantum state, \mathbf{k}' , of translation, is obtained by summing (30) over all values of \mathbf{k}' , one finds

$$(6. 31) \quad \begin{aligned} N_{i'} &= e^{\mu/kT} \cdot \left(\sum_{\mathbf{k}} e^{-\epsilon(\mathbf{k})/kT} \right) \cdot e^{-\epsilon(i')/kT} \\ &= e^{\mu/kT} \cdot Q_{\mathbf{k}} \cdot e^{-\epsilon(i')/kT} \\ &= e^{\mu/kT} \cdot V \left(\frac{2\pi mkT}{h^2} \right)^{3/2} \cdot e^{-\epsilon(i')/kT}. \end{aligned}$$

In this expression (7) or (9) may be used, $e^{\mu/kT} = N/Q = N/Q_{\mathbf{k}}Q_i$, so that

$$(6. 32) \quad N_{i'} = \frac{N}{Q_i} e^{-\epsilon(i')/kT}.$$

The internal Hamiltonian, $H(p_i, q_i)$, may often be separable into two additive parts, so that the energy $\epsilon(i)$ can be expressed as the sum of two terms, $\epsilon(\mathbf{m}) + \epsilon(\mathbf{n})$, in which \mathbf{m} and \mathbf{n} represent two independent sets of internal quantum numbers (see section 2h, example 2). If this is so we may write

$$(6. 33) \quad \begin{aligned} Q_i &= Q_{\mathbf{m}}Q_{\mathbf{n}} \quad \text{if} \quad \epsilon(i) = \epsilon(\mathbf{m}) + \epsilon(\mathbf{n}), \\ Q_{\mathbf{m}} &= \sum_{\mathbf{m}} e^{-\epsilon(\mathbf{m})/kT}, \quad Q_{\mathbf{n}} = \sum_{\mathbf{n}} e^{-\epsilon(\mathbf{n})/kT}. \end{aligned}$$

It is clear that the same argument used to derive equation (32) may be employed to arrive at the expression

$$(6. 34) \quad N_{\mathbf{m}'} = \frac{N}{Q_{\mathbf{m}}} e^{-\epsilon(\mathbf{m}')/kT}$$

for the number $N_{\mathbf{m}'}$ of molecules in the quantum state of value \mathbf{m}' , independent of the value of the quantum numbers of the set \mathbf{n} .

To the range $\Delta q_1 \Delta p_1 \cdots \Delta q_i \Delta p_i \cdots \Delta q_m \Delta p_m$ of the m coordinates and momenta contributing an independent additive term, $H_m(p, q)$, to the Hamiltonian of the system, there correspond $\Delta q_1 \Delta p_1 \cdots \Delta q_m \Delta p_m / h^m$ quantum states, provided that the range is so chosen that *all* the m products $\Delta q_i \Delta p_i$ are large compared to h . If the temperature is such that $H_m(p, q)$ changes negligibly compared to kT over the whole range, the exponential $e^{-H_m(p, q)/kT}$ is essentially constant over the whole range, and the number, $N_m(p, q) \Delta q_1 \Delta p_1 \cdots \Delta q_m \Delta p_m$, of molecules in the portion of the μ space corresponding to this range of the m coordinates and m momenta will be given by

$$(6. 35) \quad N_m(p, q) \Delta q_1 \Delta p_1 \cdots \Delta q_m \Delta p_m \\ = \frac{N}{h^m Q_m} e^{-H_m(p, q)/kT} \Delta q_1 \Delta p_1 \cdots \Delta q_m \Delta p_m.$$

If this condition of negligible change in $H_m(p, q)$ compared to kT for every range $\Delta q_i \Delta p_i \geq h$ is satisfied, the factor Q_m of the partition function due to these m degrees of freedom may be calculated by means of the classical integral as has just been discussed.

Equation (35) is the complete classical Maxwell-Boltzmann distribution law for a system of independent particles, the Hamiltonian of which includes a potential energy. The m degrees of freedom considered in (30) may be all the degrees of freedom of the molecules, including the translational, or a small fraction of them, provided that these m degrees of freedom are separable from the others of the system, that is, provided that the Hamiltonian is composed of two additive parts, one containing only the coordinates and momenta of the m degrees of freedom considered, and the other containing only the remaining degrees of freedom.

From equation (31) it is seen that the ratio, $N_i/N_{i'}$, of the numbers, N_i , and $N_{i'}$, of molecules in the two internal quantum states i and i' , respectively, is given by

$$(6. 36) \quad \frac{N_i}{N_{i'}} = e^{-[\epsilon(i) - \epsilon(i')]/kT}.$$

It is to be noted that in equations (31) and (36) as well as elsewhere the symbols i and i' are used to designate single (non-degenerate) states of the molecules, and not energy levels, which might be degenerate and consist of several states. If the ratio, $N_l/N_{l'}$, of the numbers of molecules in two levels, l and l' , respectively, is sought, the expression on the right of (36) must be multiplied by the ratio of the degeneracies of the levels, that is, by the ratio of g_l , the number of states in the level l , to $g_{l'}$, the number of states in the level l' . The expression then becomes

$$(6. 36') \quad \frac{N_l}{N_{l'}} = \frac{g_l}{g_{l'}} e^{-[\epsilon(l) - \epsilon(l')]/kT}$$

The expressions (36) and (36') may be thought of as the simplest cases of the general thermodynamic relationship, $\Delta F^0 = RT \ln K$, in which ΔF^0 is the free energy difference, at standard pressure, of one mole of products and one mole of reactants in a chemical reaction for which the mass action constant is K . The reaction $A_{l'} \rightarrow A_l$ is a simple reaction of one reactant to give one product for which K , the ratio of the partial pressures, is just $N_l/N_{l'}$, if the materials are perfect gases. Since both reactants and products are, by definition, inhibited to single internal quantum states, they satisfy the definition of having no internal degrees of freedom, and behave therefore like monatomic gases. Since the product and reactant have the same molecular weights, their entropy difference is zero. One mole of reactants gives one mole of products, so the change of PV in the reaction is also zero. It follows that $\Delta F^0 = \Delta E = N_0[\epsilon(i) - \epsilon(i')]$ per mole. The use of this expression for ΔF^0 , and the substitution of $N_l/N_{l'}$ for K in the thermodynamic equation, lead to (36).

If the reaction $A_{l'} \rightarrow A_l$ is considered, the change in PV is still zero, but the change in entropy is not. Reactant and product have entropies $R \ln g_{l'}$ and $R \ln g_l$ respectively greater, per mole, than the ideal monatomic gas, due to the $g_{l'}$ and g_l internal quantum states of the same energy which they may occupy. Using $\Delta S = R \ln (g_l/g_{l'})$ and $\Delta F^0 = \Delta E + \Delta PV - T \Delta S$ leads to (36').

6f. The Influence of the Zero of Energy

The internal partition function Q_i is defined as the sum, over all internal quantum states of the molecules, of $e^{-\epsilon/kT}$ to the power minus the energy over kT .

Since the energy of the lowest quantum level of the molecules or atoms may be arbitrarily assigned any value, such as zero, or ϵ_0 , it is interesting to investigate the influence of this choice on the thermodynamic functions. The entropy, which is determined by the number of quantum states available to the system, would, at any given temperature, be expected to be independent of an arbitrary translation of the energy scale. The energy, heat content, and free energy should be

raised in value by an amount $N_0\epsilon_0$ per mole, if ϵ_0 instead of zero is chosen for the energy of the lowest level of the molecules. The specific heats should be unaffected by the choice. This is actually so.

The value of Q_i calculated under the convention that the lowest energy is zero will be designated by the symbol Q_{i0} , and that calculated with the lowest energy assigned the value ϵ_0 will be designated by $Q_{i\epsilon}$. Every term in $Q_{i\epsilon}$ will differ from the corresponding term in Q_{i0} by having an additive $-\epsilon_0/kT$ in the exponent, the terms in $Q_{i\epsilon}$ will each be smaller than the corresponding ones in Q_{i0} by a multiplicative factor $e^{-\epsilon_0/kT}$. The complete sum $Q_{i\epsilon}$ must then be smaller than Q_{i0} by this factor, and the logarithm of the sum less by the additive term $-\epsilon_0/kT$,

$$(6. 37) \quad \ln Q_{i\epsilon} = \ln Q_{i0} - \frac{\epsilon_0}{kT},$$

$$(6. 38) \quad T \left(\frac{d}{dT} \right) \ln Q_{i\epsilon} = T \left(\frac{d}{dT} \right) \ln Q_{i0} + \left(\frac{\epsilon_0}{kT} \right),$$

$$(6. 39) \quad \frac{d}{dT} (T \ln Q_{i\epsilon}) = \frac{d}{dT} (T \ln Q_{i0}).$$

Comparison of these equations with equations (25') to (29') shows that, whereas **S** and **C** are independent of the assignment of the energy of the lowest level, **F**, **H**, and **E** are raised by $\epsilon_0 R/k = N_0\epsilon_0$ if this value is chosen as ϵ_0 instead of zero.

In general, unless the contrary is specifically stated, the convention will be adopted that the energy scale will be measured from the lowest level of the atoms or molecules, so that this energy will be assigned the value zero. In this case the energy, heat content, and also, with certain exceptions which will be discussed later, the free energy and entropy, will be zero at the absolute zero of temperature, 0°K .

6g. The Influence of Nuclear Spin

In calculating the value of Q_i for an atom it is customary to sum over the different electronic quantum states of the atoms only. For a diatomic molecular gas, or a polyatomic one, the summation is made over rotational and vibrational states, as well as over the electronic, but for most gases, atomic or molecular, the different nuclear spin states are neglected.

The nucleus of an atom may, and often does, have a nuclear spin magnitude of s_n other than zero (measured in units of $h/2\pi$). This nuclear spin magnitude is fixed, and cannot change (without great change in energy), for a given isotope of a given element. The nuclear spin of magnitude s_n can take $2s_n + 1$ different orientations along any unique

axis in space. These different orientations are distinguished from each other in that the projection of the spin along the chosen axis may take any of the $2s_n + 1$ values which differ by integers from $-s_n$ to $+s_n$ inclusive. (s_n is always an integer or a half odd integer; it is integral if the atomic weight of the isotope is even, and a half odd integer if the atomic weight is odd.)

The magnitude of the magnetic moment associated with the nuclear spin is so small that there is no appreciable energy difference between the states of differing nuclear spin orientation, even if the atom or molecule has itself an appreciable magnetic moment due to other causes. (The very slight energy difference is responsible for the hyperfine structure observed in the atomic spectra with very good instruments.)

From a statistical standpoint, then, the effect of the nuclear spin is only to increase the number of quantum states in every energy level of the molecule by a factor $2s_n + 1$ for every atom present in the molecule. This means that every term of Q_i is greater by a factor equal to the product of all the $(2s_n + 1)$'s for all the atoms in the molecule. The result is an additive term in the logarithm of Q_i , the sum of the logarithms of the $(2s_n + 1)$'s. This term is, of course, temperature independent, and will not enter into any of the temperature derivatives except $(d/dT)T \ln Q_i$, to which it will also add the sum of the logarithms of the $(2s_n + 1)$'s. The result for the thermodynamic properties is that the nuclear spin contributes nothing to the energy, heat content, or specific heat, but adds $R \ln (2s_n + 1)$ and $-RT \ln (2s_n + 1)$ to the entropy and free energy, respectively, for every gram atom of the element (or isotope) of nuclear spin s_n . Since the number of atoms remains constant in every chemical or physical change, except those of transmutation, this term cancels in every entropy or free energy *difference*, and in no way influences the thermodynamic behavior of the system.

This, however, is not the whole story. In symmetrical diatomic or polyatomic molecules, that is, in molecules which contain several identical atoms, only those states are realized in nature for which the eigenfunctions are symmetric, or antisymmetric, respectively, depending on whether the mass number of the atoms is even or odd. For given mutual orientation of the spins not all rotation-vibration states are possible. It can be shown that for any given spin orientation only a fraction $1/\gamma$ of adjacent rotational levels have the correct symmetry. The number γ is called the symmetry number. It is the number of ways in which a molecule may be rotated into positions which would be different from the original one if the identical atoms were numbered and distinguishable, but which look identical to the original orientation in view of the identity of the atoms of the same element. For diatomic elements $\gamma = 2$.

In a comparatively large range of rotational levels there will be only $1/\gamma$ th as many states existing in a symmetric as in a non-symmetric molecule, independent of the nuclear spin. As long as the energy difference between adjacent rotation levels is small compared to kT the result is only to add the term $-\ln \gamma$ to the internal partition function, Q_i . The fact remains, however, that there are precisely $(2s_n + 1)^m$ times as many states in a symmetrical molecule of m identical atoms of nuclear spin s_n , as there would be if the spins were zero.

As long as the energy difference between adjacent rotational quantum levels is small compared to the temperature so that the value of the exponential $e^{-\epsilon/kT}$ is the same for adjacent levels the effect of the nuclear spin will always be to add $\ln(2s_n + 1)$ to $\ln Q_i$, for every atom of the isotope of spin s_n present, for symmetrical as well as for non-symmetrical molecules.

If, however, the energy difference between adjacent rotational levels is large compared to the temperature so that the value of the exponential $e^{-\epsilon/kT}$ is appreciably different for two neighboring j values, then the value of $\ln Q_i$ will depend on whether the odd or the even values of j are available to the molecules. This in turn will depend on the electronic and vibrational quantum numbers, and on whether the atoms require symmetric or antisymmetric eigenfunctions, and also, if there is a nuclear spin other than zero, on the mutual orientation of the nuclear spin vectors in the two atoms.

This will be discussed in detail in sections 7f and 8d.

In symmetrical diatomic or polyatomic molecules containing identical atoms, although the effect of the nuclear spin is always only to increase the number of quantum states in any range of energy which includes many rotational levels of the molecule, by a factor equal to the product of the $(2s_n + 1)$'s for all the atoms of the molecule, the actual rotational states which are available to the molecule are different for different mutual orientations of the nuclear spins. If the energy difference between adjacent rotational levels is large compared to kT this results in a complicated effect on $\ln Q_i$. At high temperatures, however, the effect is always to add $\ln(2s_n + 1)$ to $\ln Q_i$ per atom in the molecule. It is really only in molecular hydrogen and a few hydrogen derivatives, for which the moment of inertia of the molecule is small and, consequently (see equation 2. 25), the spacing between the rotational levels large, that the more complicated effect of the nuclear spin is observable at a temperature sufficiently high for the material to exist in the gaseous state.

The addition of $R \ln(2s_n + 1)$ per gram atom of isotope to the entropy, and consequently $-RT \ln(2s_n + 1)$ to the free energy, is an effect that alters none of the properties of the system, and none of the equilibria in which the number of atoms of the various isotopes is unchanged. Therefore, except in respect to hydrogen, just mentioned, and then only at low temperatures, the fact that nuclear spins exist

can be entirely forgotten in attempting to predict the behavior of matter in bulk. This is rather fortunate, since with a few exceptions the magnitude of the nuclear spin s_n is only imperfectly known. It is customary to omit nuclear spin entropy in calculating or tabulating entropy and free energy values. *Unless the contrary is specifically stated nuclear spin entropies will always be omitted.*

6h. The Entropy of Isotope Mixing

One other complication present in a real system, which is usually neglected and negligible in effect, is the fact of the existence of different isotopes of the same element. Different isotopes of the same element are different atoms of the same atomic number (nuclear charge), but of differing integral atomic weights. For most substances, although not, of course, for hydrogen, the weights of the different isotopes are sufficiently close, percentually, to the average atomic weight so that the use of this for the mass of any of the isotopes introduces a negligible error in any of the equations. The internal quantum states of the different isotopes have also almost the same energies. Substances in which the masses cannot be regarded as identical, and in which the internal quantum states of the molecules have appreciably different energies if they contain different isotopes, will not be considered here. The isotopes of these substances can be separated chemically. We wish to discuss at present only the effect of the fundamental non-identity of the different isotopes on the value of the thermodynamic properties of the system.

We see that here we must expect no effect on the observable properties of the system, since, although we are assuming that the isotopes are really distinguishable in some way in principle, we intend from the start to neglect all physical differences. This will actually be the result of our considerations, but only if the temperature is moderately high, that is, where the effect of the nuclear spin can be neglected.

The calculations of this chapter have been made under the specific assumption that all the N particles were absolutely identical. Suppose that the system which we treat consists of N_1 molecules of one kind and N_2 of another kind, with $N_1 + N_2 = N$. Since the molecules of kind 1 and those of kind 2 are entirely independent, they may be treated as composing two different systems, coexistent in the volume V , and in equilibrium with respect to exchanges of energy. This equilibrium assures their having the same temperature.

The molecules of the two different types, although in some way physically distinguishable, are so similar in all properties that the quantum states of the molecules have the same energies for a given set

of the f quantum numbers. The Q 's and Q_i 's of the two kinds of molecules are then numerically identical.

The mole fraction of the molecules of kind 1 is $n_1 = N_1/N$, and that of the second kind is $n_2 = N_2/N$, so that $n_1 + n_2 = 1$. The free energy, per mole of material, and hence per n_1 moles of the molecules of type 1, will be, for the first kind of molecules, just n_1 times the expression of equation (18), with, however, N_1 replacing N_0 under the logarithm. Since $N_1 = n_1 N_0$, this can be written as n_1 times the expression of equation (18) plus a term $n_1 RT \ln n_1$. The free energy of the whole system, the sum of the free energies of both kinds of molecules, will be, since $n_1 + n_2 = 1$, less than the free energy of a system composed of only one kind of particle by just the additive (negative) term $RT(n_1 \ln n_1 + n_2 \ln n_2)$. In taking the derivative with respect to T , equation (26), to obtain S , an additive $-R(n_1 \ln n_1 + n_2 \ln n_2)$ will be introduced into this property. E and H will be unaffected.

In section 2k it was pointed out that if one attempted to describe a quantum state of a system composed of N identical particles by describing the cell of each (numbered) particle, out of the $N!$ states which differed only in permutations of the particles in the cells, there could be formed only one eigenfunction which was completely symmetric in the permutation of the particles, or only one which was completely antisymmetric. The equations of this chapter were derived by using this method of counting, that is, by counting only the number of particles in each cell instead of the cell of each numbered particle. If, however, the eigenfunctions were only to be symmetric (or antisymmetric) in permutations of the N_1 particles of the first kind with themselves, and in permutations of the N_2 particles of the second kind with themselves, but did not need to have any particular symmetry character with respect to permutations of one kind of particle with one of the other kind, then every state of the old system with all particles identical would correspond to $N!/N_1!N_2!$ states of the system with the two kinds of particles.

The value of Ω for the system of two kinds of particles will then be greater than that of one kind of particle by the factor $N!/N_1!N_2!$. The logarithm of this factor, multiplied by k , which gives the difference in entropy, is $k(N \ln N - N_1 \ln N_1 - N_2 \ln N_2)$ or $-R(n_1 \ln n_1 + n_2 \ln n_2)$ per mole.

In a gas composed of molecules which contain one atom each of an element having the mole fraction n_j of isotope of type j present, the entropy of mixing due to the isotopes is $-R \sum_j n_j \ln n_j$, which is of course a positive quantity, since the mole fractions n_j must be smaller than unity.

In a later chapter we shall show that at moderate temperatures, and indeed under the same conditions that the nuclear spin entropy is given by $R \ln (2s_n + 1)$ per gram atom, even if molecules are present con-

taining several atoms of the element having the different isotopes, the entropy of mixing due to the presence of the isotopes is the same per gram atom of the element. This means that the entropy and free energy differences between systems for which the number of atoms of the different elements is the same are unaffected by the existence of the isotopes. As with nuclear spin entropy, *unless otherwise stated, the entropy of isotope mixing will be omitted from the calculations and tabulations of entropy and free energy.*

6i. The Internal Partition Function of a Monatomic Gas

The various internal quantum levels of an atom, which are due to different electronic configurations, are usually separated from each other by an energy difference of the order of magnitude of an electron volt, or some tens of kilocalories per mole. The value of kT at 1000°K . is 0.08616 in electron volts, or 1.9864 k cal./mole. The exponential $e^{-\epsilon/kT}$ for a state of energy 1 e.v. = 23.055 k cal./mole is then $e^{-11.5}$ or about 10^{-5} at 1000°K . For a gas composed of atoms, Q_i consists of a sum of terms only a very few of which differ appreciably from zero at all ordinary temperatures.

Since we have agreed to designate the energy of the lowest level as zero, the exponential for a state of the lowest energy level is e^0 or unity. The contribution to Q_i of the states of zero energy will then always be an integer, the number of states in the lowest level.

The spectroscopic notation which is in common use for most atoms* is to designate a level of the atom, or spectroscopic term, by a capital letter carrying a left-hand superscript and a right-hand subscript. This is known as the Russell-Saunders notation, which is applicable to atoms having Russell-Saunders coupling. The superscript gives the "system" to which the term belongs, which may be singlet, doublet, triplet, etc., designated by 1, 2, 3, etc.

This superscript, the system number, is $2s + 1$, in which s is the value of the resultant electron spin of all the electrons measured in units of $h/2\pi$. (The square of the vector sum of all the electron spins is $s(s + 1)(h/2\pi)^2$.) s may take integral or half integer values, and is integral if the atom or ion contains an even number of electrons, otherwise being a half odd integer. The vector of magnitude s can take different orientations with respect to another vector of magnitude l .

The vector of magnitude l is the vector sum of the orbital angular momenta of the electrons, and l is always an integer. The value of l for the term is indicated by the capital letters S, P, D, F corresponding to $l = 0, 1, 2, 3$, respectively.

The magnitude of the vector sum of the spin, \vec{s} , and the orbital angular momentum, \vec{l} , both vectors, is called j , and is the total angular momentum.

* See, for instance, L. Pauling and S. Goudsmit, *The Structure of Line Spectra*, McGraw-Hill, New York, 1930.

j may take values differing by integers between the two values $|s - l|$ and $s + l$, inclusive. The number of different values which j may take for a given s and given l is the smaller of the two numbers, $2s + 1$ or $2l + 1$. The value of j is written as a right-hand subscript in the term symbol.

The term 1S_0 is then to be read as: singlet system (superscript 1), the value of the resultant electron spin s is therefore zero, the resultant orbital angular momentum l is zero (given by S), and the total angular momentum j is zero (given by the subscript 0).

The term ${}^2S_{1/2}$ is doublet system, $s = 1/2$, $l = 0$, $j = 1/2$.

In these two examples, as in all terms belonging to the singlet system for which $s = 0$, and also for all S terms for which $l = 0$, the value of j is uniquely determined by the values of s and l . However, the term ${}^2P_{1/2}$, doublet system, $s = 1/2$, $l = 1$, with $j = 1/2$, has a companion term ${}^2P_{3/2}$ in which the only difference is that j is $3/2$. These two terms have energies lying moderately close to each other, which is the origin of the designation that these terms belong to the doublet system. However, since for any P term $l = 1$ and $2l + 1 = 3$, there can never be more than three terms even if the system is quadruplet or quintuplet, just as there never can be more than a single S term even in a doublet or triplet system (except at entirely different energies for which an independent S term may exist).

It is, then, to be expected that if the lowest term of an atom is an S term, or any term belonging to a singlet system, there will probably not be another term of the atom which is very close to the first in the energy scale, although this may happen accidentally. If, however, the lowest term of an atom is not an S term, and does not belong to the singlet system, it follows that there must be one or more companion terms not differing very greatly in energy from the first.

Just to make it harder for the reader, and perhaps easier for the typesetter, one finds in some books and journals that instead of half odd integer values of j , the next larger integer is given. Since s is a half integer for doublet, quadruplet, and sextet systems, j is always a half odd integer in these cases and never for singlet, triplet, and quintuplet systems. The nomenclature is therefore unique. One must then take care to notice that for systems of even multiplicities, if the right-hand subscript of the term is written as an integer, the real value of j is that of the subscript minus one-half.

The right-hand subscript j in the spectroscopic notation of the term level is the total angular momentum due to the electrons of the atom, measured in the quantum units of $h/2\pi$. This angular momentum may be regarded as a vector of magnitude j which can take $2j + 1$ different orientations in space, with the component of the vector along any arbitrarily chosen axis taking values differing by integers from $-j$ to $+j$, inclusive. These $2j + 1$ different orientations of the angular momentum correspond to different states of the atom, each with the same energy (in the absence of a magnetic field). They therefore belong to the same level or term.

The number of states belonging to the lowest level, the degeneracy of the term, is then $2j + 1$. If the lowest term is an S term, or if it belongs to the singlet system, it usually happens that there exists no other level than the lowest with energies less than several electron volts. In these cases up to several thousand degrees, and always in the neighborhood of 0°K ., one can write $Q_i = 2j + 1$, where j is the subscript in the spectroscopic notation of the lowest term. The derivative of $\ln Q_i$ with respect to temperature is then zero. In such cases, one sees from equations (25') to (29') that the contribution of the internal quantum states to the entropy is $R \ln(2j + 1)$ per mole, to F it is $-RT \ln(2j + 1)$ per mole, and the contribution to E , H , and C is zero.

The lowest spectroscopic term of all the noble gases is a 1S_0 term. The level consists of a single quantum state. The next level has an energy* of $159,843 \text{ cm.}^{-1} = 19.72 \text{ e.v.}$ or $454.6 \text{ k cal./mole}$ in helium, and less in the other gases until it is 8.273 e.v. for xenon. Even at 5000°K . this level contributes only 10^{-8} to the sum Q_i in xenon, and less in the other noble gases. We see that we may well write $Q_i = 1$, $\ln Q_i = 0$, for the noble gases up to considerable temperatures, and these gases are ideal monatomic gases in the sense used in the preceding chapter of having only one effective internal quantum state, that is, $g = 1$.

For the alkali metals the lowest term is $^2S_{1/2}$, so that $j = 1/2$, and the degeneracy is 2. At 0°K . $\ln Q_i = \ln 2$, and the entropy per mole would be greater than that of an ideal monatomic gas by $R \ln 2$ per mole. The second term, a $^2P_{1/2}$, with a companion $^2P_{3/2}$ of only slightly higher energy, has the energy $14,903.8 \text{ cm.}^{-1}$ in lithium and $11,178.3 \text{ cm.}^{-1}$ in cesium. For the other alkali metals the value of the term lies between these two limits. The $11,178.3 \text{ cm.}^{-1}$ term of cesium has an exponential $e^{-\epsilon/kT}$ of 1.1×10^{-7} at 1000°K . and 3.35×10^{-4} at 2000°K .

One particular example which occurs in calculating the thermodynamic properties of some monatomic gases is instructive and extremely easy to handle. In the halogen atoms the lowest term is a $^2P_{3/2}$, which is accompanied by a $^2P_{1/2}$ term of slightly higher energy, and then comes a rather large energy gap before the next excited level. The $^2P_{1/2}$ term has an energy of 407.0 cm.^{-1} in fluorine, $\epsilon/k = 582.7^\circ$; and 3685 cm.^{-1} , $\epsilon/k = 5275^\circ$, in bromine. The next term has an energy of

* Energy differences in atoms and molecules are observed by spectral lines the wave numbers, $1/\lambda$, of which are directly measured. The wave numbers are connected with the energy differences by the relation $\Delta\epsilon = h\nu = hc/\lambda$, and in this sense cm.^{-1} may be used as an energy unit; see conversion table A XIV.

102,412 cm.^{-1} in fluorine and 63,429 cm.^{-1} in bromine. Even at 10,000°K. this latter term contributes less than 10^{-4} to Q_i in bromine, whereas the ${}^2P_{1/2}$ term has an exponential $e^{-\epsilon/kT}$ of 0.512 at this temperature. These atoms may be treated as if only two terms existed, and all the higher terms may be neglected. In this particular example the degeneracy, or number of quantum states, in the lowest term, g_0 , is $2(3/2) + 1 = 4$; the degeneracy of the second term is 2.

We shall consider a particle which has g_0 quantum states of zero energy, and g_1 states of energy ϵ , and no other states whatsoever. Q_i is then $g_0 + g_1 e^{-\epsilon/kT}$, and $\ln Q_i$ may be written as

$$(6. 40) \quad \ln Q_i = \ln (g_0 + g_1 e^{-\epsilon/kT}). \quad \text{Let } \epsilon/kT = u$$

Differentiating,

$$(6. 41) \quad T \frac{d}{dT} \ln Q_i = \frac{\epsilon}{kT} \frac{g_1}{(g_0 e^{\epsilon/kT} + g_1)},$$

$$(6. 42) \quad \frac{d}{dT} (T \ln Q_i) = \frac{\epsilon}{kT} \frac{g_1}{(g_0 e^{\epsilon/kT} + g_1)} + \ln (g_0 + g_1 e^{-\epsilon/kT}),$$

$$(6. 43) \quad \frac{d}{dT} \left(T^2 \frac{d}{dT} \ln Q_i \right) = \left(\frac{\epsilon}{kT} \right)^2 \frac{g_1 g_0 e^{\epsilon/kT}}{(g_0 e^{\epsilon/kT} + g_1)^2}.$$

Using the symbol u for ϵ/kT , and inserting the above equations in (25') to (29'), one obtains for the contribution of the internal quantum states to the thermodynamic properties, per mole,

$$(6. 44) \quad F_i = -RT \ln (g_0 + g_1 e^{-u}),$$

$$(6. 45) \quad H_i = E_i = RTu \frac{g_1}{g_0 e^u + g_1},$$

$$(6. 46) \quad S_i = R \left[u \frac{g_1}{g_0 e^u + g_1} + \ln (g_0 + g_1 e^{-u}) \right],$$

$$(6. 47) \quad C_{Pi} = C_{Vi} = Ru^2 \frac{g_1 g_0 e^u}{(g_0 e^u + g_1)^2}.$$

At high temperatures for which u approaches zero, $-F/RT$ and S/R approach the same asymptotic value of $\ln (g_0 + g_1)$. E/RT and C/R approach zero at high temperatures. With $u = 0$ the fraction of the molecules in the upper level approaches $g_1/(g_0 + g_1)$ and the internal energy per mole becomes $N_0 \epsilon$ times this value, which can be seen to be the asymptotic value of (45) as $T \rightarrow \infty$, $u \rightarrow 0$.

The functions E_i/RT , $-F_i/RT$, S_i/R , and C_i/R are plotted against

a logarithmic scale of $1/u = kT/\epsilon$, in Fig. 6. 1, with g_0 and g_1 both taken equal to unity. The specific-heat curve is seen to have a sharp maximum

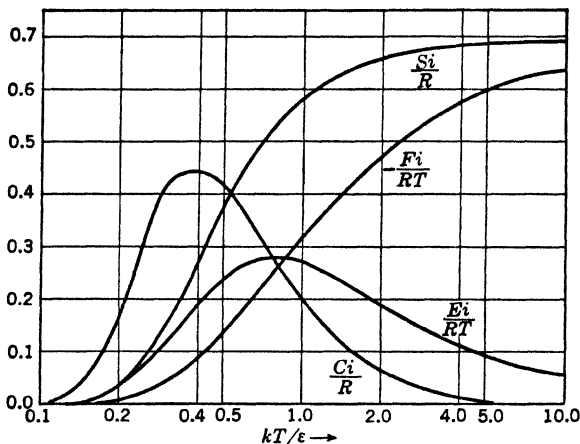

FIG. 6. 1. The contribution to the thermodynamic properties of a mole of gas due to the internal quantum states of the molecules, if there are only two non-degenerate states with an energy difference ϵ , plotted against kT/ϵ on a logarithmic scale.

at a temperature of about $0.4\epsilon/k$. The maximum of E_i/RT is at about twice this temperature. S_i/R rises rather rapidly to its high temperature value of $\ln 2$, being within 10 per cent of this value below $1/u = 2$.

6j. The Classical Internal Partition Function of Molecules

The classical expression for the internal partition function, Q_i , may be written as

$$(6. 48) \quad Q_i = \frac{1}{h^{f_i}} \int e^{-H_i(p,q)/kT} dp_1 \cdots dp_{f_i} dq_1 \cdots dq_{f_i},$$

in which f_i is the number of internal degrees of freedom, and $H_i(p,q)$ is the Hamiltonian for the internal degrees of freedom, the total Hamiltonian for the molecule minus the kinetic energy due to the translation of the center of mass.

In general, the classical expression will never be valid, at reasonable temperatures, for the electronic degrees of freedom. If the contribution of the electronic degrees of freedom to the partition function cannot be expressed as a simple temperature-independent integral factor (see section 6i), then it will be impossible to use the simple purely classical form of (48) for Q_i . We shall consequently assume that, at the temperature in which we are interested, no electronic levels are excited.

The number of degrees of freedom of the molecule is not influenced

by the presence or absence of forces, and since three coordinates are necessary to specify the position of an atom in space, the total number of degrees of freedom of n atoms will be $3n$, whether they are independent of each other, or whether they are the constituent atoms of a molecule. The number of internal degrees of freedom will be less by the three coordinates of the center of gravity of the molecule, so that

$$(6. 49) \quad f_i = 3n - 3,$$

in which n is the number of atoms in the molecule.

There will be one geometric arrangement of the n atoms in the molecule which will have the lowest potential energy, and the usual convention is to choose this energy as zero. In this equilibrium position all the atoms may be in one line, in which event the molecule would be called a linear molecule, or they may not be, and the molecule would be termed non-linear. A diatomic molecule must obviously always be linear, as are also a few polyatomic molecules such as carbon dioxide, CO_2 , and acetylene, C_2H_2 . If the molecule is linear, two of the $3n - 3$ coordinates, namely, the two angles θ and ϕ discussed in section 2b, will determine only the orientation of the molecule in space with fixed center of gravity, and will not influence the distance between atoms, and therefore also not the potential energy. If the molecule is non-linear there will be three such angles.

The additive contribution to the Hamiltonian due to these angles will be only to the kinetic energy, and will be of the form

$$(6. 50) \quad H_r(p, q) = \sum_{r=1}^{r=2 \text{ or } 3} \frac{1}{2I_r f(q_r)} p_r^2,$$

where q_r is the angle, $f(q_r)$ is some function of the angle, which may be just unity, p_r is the conjugate momentum to the angle, and I_r is the moment of inertia in the equilibrium configuration of the molecule corresponding to the angle q_r .

The potential energy will depend only on the remaining $3n - 5$ or $3n - 6$ coordinates. For a diatomic molecule for which n is two, and which is necessarily linear, this one coordinate, upon which the potential energy depends, is simply the distance between the two atoms or, preferably, the difference between this distance and the equilibrium distance, the ξ of equation (2. 32).

It will always be possible to choose these $3n - 5$ or $3n - 6$ coordinates for linear or non-linear molecules, respectively, so that they are all zero at the equilibrium position of zero potential energy. If the potential energy is expressed as a power series in these coordinates, the constant term gives the lowest value of the potential, which is taken

as zero, and since the forces must be zero at equilibrium, the linear terms must also all be zero. The first terms in the expansion will be the quadratic terms. For sufficiently small displacements one can neglect the higher-power terms. Now it is a mathematical theorem that one can always find a transformation to new coordinates, q_s , called normal coordinates, such that there will be only perfect squares occurring both in the expression for the kinetic energy and in the quadratic terms of the potential energy, so that

$$(6. 51) \quad H_s(p, q) = \sum_{s=1}^{\substack{s=3n-5 \\ \text{or } 3n-6}} \frac{1}{2\mu_s} p_s^2 + \frac{a_s}{2} q_s^2,$$

in which μ_s is the reduced mass corresponding to the coordinate q_s , p_s the conjugated momentum, and a_s the force constant. The choice of the normal coordinates has eliminated cross products of the sort $a_{st}q_sq_t$ from the potential energy.

The total internal Hamiltonian will be the sum of (50) and (51). In integrating equation (48), the limits of integration for all $3n - 3$ momenta will be minus and plus infinity, and the integrals for each of the momenta will be of the type $\int_{-\infty}^{+\infty} e^{-bz^2} dz = (\pi/b)^{1/2}$, so that $3n - 3$ products of this sort will be introduced into Q_i . For the angular momenta b will be of the form $(2I_r k T f(q_r))^{-1}$, in which, as mentioned before, $f(q_r)$ may be absent, that is, be identically unity. Since q_r occurs nowhere else in the Hamiltonian, the integration over the angle q_r , which will be between definite limits such as zero and π , or zero and 2π , will yield an expression of the type $\int f^{1/2}(q_r) dq_r$, and the result will be some small definite quantity independent of the temperature.

The total contribution of each of the angular coordinates plus its conjugated momentum to the partition function will then be a product of the general type $(c_r I_r k T)^{1/2}$, in which c_r is some small dimensionless number, usually containing π .

The contribution from one of the vibrational momenta p_s will be $(2\pi\mu_s k T)^{1/2}$. Since equation (51) is valid for only relatively small displacements, that is, for small values of the q_s 's, the whole partition function will be correctly calculated only if kT is small enough so that the exponential $e^{-H/kT}$ becomes almost zero for even rather small displacements. The limits minus and plus infinity may then be used for integration of the coordinates q_s . They, then, also contribute integrals of the type $\int_{-\infty}^{+\infty} e^{-bz^2} dz = (\pi/b)^{1/2}$, and since b is $(a_s/2kT)$, their contribution is each $(2\pi k T/a_s)^{1/2}$.

The product of the contribution of one of the vibrational coordinates q_s with that of its conjugated momentum is $(4\pi^2\mu_s/a_s)^{1/2}kT$. The natural frequency ν_s of vibration of the molecule along the normal coordinate q_s is $(a_s/\mu_s)^{1/2}(2\pi)^{-1}$, so that the contribution of this coordinate and momentum to the partition function is just the factor kT/ν_s .

Finally, multiplying all these factors together, dividing by h^{f_i} , and assigning one h^{-1} to each degree of freedom, and then taking the logarithm, one obtains

$$(6. 52) \quad \ln Q_i = \sum_{s=1}^{\substack{s=3n-5 \\ \text{or } 3n-6}} \ln \left(\frac{kT}{h\nu_s} \right) + \sum_{r=1}^{\substack{r=2 \\ \text{or } 3}} \frac{1}{2} \ln \left(\frac{c_r I_r kT}{h^2} \right).$$

The contribution to the free energy F , due to these internal degrees of freedom, is $F_i = -RT \ln Q_i$. The contribution to the energy E , of the internal freedom, is $E_i = RT^2(d/dT) \ln Q_i$, which has the extremely simple form

$$(6. 53) \quad E_i = (3n - 4)RT \quad \text{or} \quad (3n - \frac{5}{2})RT,$$

depending on whether the molecule is linear or non-linear, respectively. The internal specific heat is $(3n - 4)R$ or $(3n - \frac{5}{2})R$, respectively, for the two conditions.

It is well to examine how far these extremely simple results depend on the special assumptions made concerning the nature of the molecules.

In the first place it was absolutely essential to assume that the classical form (48) could be used for the coordinates considered. The assumption that the molecule has an equilibrium position of zero potential, with the interatomic distances fixed, leads to the conclusion that, for sufficiently small displacements, at least, the potential energy must be expressible in a quadratic form, and equations (52) and (53) should be valid at sufficiently low temperatures.

At higher temperatures, for which configurations of higher potential energy are attained, deviations from these equations might be expected. However, the Hamiltonian for the molecule could always be expressed in the Cartesian coordinates of the atomic centers, although the potential would have a rather complicated form in these coordinates. In this form, the kinetic energy does not include the coordinates, and, if magnetic forces are neglected, the potential energy is independent of the momenta. The momenta occur as squares in the Hamiltonian, and also in the exponent of the unintegrated partition function, so that integration over each of the momenta introduces $T^{1/2}$ as a factor in Q_i , and an additive $\frac{1}{2}RT$ per mole in E_i . The negative potential energy occurs

in the exponent divided by kT . The integrand of the partition function, and consequently also the definite integral, must always increase, or at least *not decrease*, as T increases. Q_i , then, receives a factor from the integration over the coordinates which either remains constant or increases with increasing T , and E_i always contains a *positive* (or zero) additive contribution from the potential energy.

The heat capacity would have to receive an additive contribution of at least $\frac{1}{2}R$ per internal degree of freedom per mole, at any temperature, if the classical equation were valid.

Most diatomic molecules have an observed heat capacity C_v at constant volume, of about $\frac{5}{2}R$, which, subtracting $\frac{3}{2}R$ for the translational motion of the center of gravity, leaves only R for the three internal degrees of freedom. This specific heat is due only to the two rotational angles. The vibrational degree of freedom, which should, classically, contribute R to C_v , is actually almost completely frozen out by the quantum conditions. The first excited vibrational level of energy $h\nu$ above the lowest level (equation 2. 22) has an energy considerably in excess of kT at ordinary temperatures. Classically the average energy of the molecule in this degree of freedom should be kT , $\frac{1}{2}kT$ of kinetic energy and an equal average potential energy. In the neighborhood of this energy, however, there is no quantum level, and most of the molecules are actually constrained to remain in the unexcited vibrational level of lowest energy. Only a very small fraction, $e^{-h\nu/kT}$, of the molecules attain the first excited level, contributing $RT(h\nu/kT)e^{-h\nu/kT} \ll RT$ to the energy of the mole of gas.

We have assumed that the number of quadratic terms in the classical potential energy was $3n - 5$ in linear, and $3n - 6$ in non-linear molecules. Such molecules as ethane, H_3CCH_3 , might conceivably have free rotation about the C-C bond, so that here one would introduce four angles which do not influence the potential energy, and therefore expect only $3n - 7$ quadratic terms in the potential. Actually it appears that the hindrance to free rotation is great enough so that at room temperature only a few molecules have sufficient energy to rotate.

CHAPTER 7

DIATOMIC GASES

- (a) The Ideal Diatomic Molecule. (b) The Partition Function of a Rotator.
(c) The Partition Function of an Oscillator. (d) The General Diatomic Molecule. (e) The Classical Equations for the General Diatomic Molecule.
(f) Molecules Composed of Two Identical Atoms.

7a. The Ideal Diatomic Molecule

A large proportion of all the chemically stable diatomic molecules have a singlet (Σ_0) lowest electronic level without angular momentum, and no other electronic level with energy low enough to become appreciably excited below several thousand degrees. The low internal energy states of such a molecule will depend on three quantum numbers, ν , j , and m , associated with the coordinates giving the displacement from the equilibrium distance between atoms, and the two angles of the axis, respectively (compare section 2h, example 4). The lower of these states will be approximated fairly accurately by a formula giving the energy as the sum of two terms, one depending on ν alone, and one on j (equation 2. 33). The energy does not depend on the value of m . A molecule for which this was strictly true might be termed an ideal diatomic molecule.

The ideal diatomic molecule will be defined as one whose internal energy is given by the equation

$$(7. 1) \quad \epsilon_i = \left(\nu + \frac{1}{2}\right)h\nu + j(j+1) \left(\frac{h^2}{8\pi^2 I}\right),$$

with

$$(7. 2) \quad I = \mu r_0^2, \quad \mu = \frac{m_1 m_2}{m_1 + m_2}. \quad 4$$

I is the moment of inertia, μ is the reduced mass, r_0 is the equilibrium distance between the two atoms of masses m_1 and m_2 , and ν is the natural frequency of vibration of the molecule along the line of centers of the two atoms. The quantum number m , which does not occur in the equation for the energy, gives the projection on an arbitrary axis of the total angular momentum vector of magnitude j . The values which m can take depend on j , namely, $2j + 1$ values differing by integers from

$-j$ to $+j$. In order to simplify the writing of subsequent equations it will be convenient to define two new quantities, u and σ , so that

$$(7.3) \quad u = \frac{h\nu}{kT} = \frac{h\omega c}{kT},$$

$$(7.4) \quad \sigma = \frac{h^2}{8\pi^2IkT} = \frac{hBc}{kT},$$

where $\omega = \nu/c$ and $B = h/8\pi^2Ic$, of dimensions cm^{-1} , are most frequently found tabulated in the literature. Values of these constants for some diatomic molecules are given in the Appendix table, A XII.

Since equation (1) assigns the energy $h\nu/2$ to the lowest state of the molecule with $\mathbf{v} = 0$ and $j = 0$, which is obtained by measuring the energy from the lowest part of the potential-energy diagram of the molecule, we will change the equation in such a way as to measure the energy from the lowest quantum state. Using (3) and (4), we then obtain

$$(7.5) \quad \frac{\epsilon_i}{kT} = \mathbf{v}u + j(j+1)\sigma.$$

It is obvious that since the energy is written as the sum of a term depending on \mathbf{v} alone, and one depending on j alone, we can separate Q_i into a product of two terms, in the same way that Q was separated into $Q_{\mathbf{v}} \cdot Q_j$,

$$(7.6) \quad Q_i = Q_{\mathbf{v}} \cdot Q_{jm}.$$

The equations for $Q_{\mathbf{v}}$, the partition function for one degree of freedom in oscillation, and Q_{jm} , the partition function of a two-dimensional rotator, are

$$(7.7) \quad Q_{\mathbf{v}} = \sum_{\mathbf{v} \geq 0} e^{-\mathbf{v}u},$$

$$(7.8) \quad Q_{jm} = \sum_{j \geq 0} (2j+1)e^{-j(j+1)\sigma},$$

in the second of which the summation over \mathbf{m} has been performed, resulting in the multiplication of every term by $(2j+1)$.

The terms of $Q_{\mathbf{v}}$ are to be summed over all integral values of \mathbf{v} equal to and greater than zero. In the sum Q_{jm} , however, there are three different possibilities. If the molecule considered is one of a compound, that is, if the two atoms composing it are not identical, but are of different elements, or even if they are atoms of the same element but of two different isotopes of the element, then j takes all integral values equal to, and greater than, zero. If, however, the two atoms composing the molecule are identical, then for any given mutual orientation

of the nuclear spins of the atoms either only the odd values of j , or only the even values of j , correspond to possible states of the molecule. The reason for this difference between molecules composed of identical atoms and those composed of two different kinds of atoms has already been discussed to some extent in the paragraphs in fine print of section 6g, in which its influence on the entropy of nuclear spin was discussed. We shall treat the subject later (section 7f) at greater length. At the present time it will be sufficient to notice that the three different cases may occur: that for which all integral values of j are allowed, and which will be designated by Q_{jmt} ; that for which j may take only odd values, Q_{jmo} ; or that for which it may take only even values, Q_{jme} . The two last conditions can occur only in elements.

7b. The Partition Function of a Rotator

The partition function for a rotator, a body with finite (and equal) moments of inertia, I , about only two axes, is given by equation (8), in which j may take all integral values, Q_{jmt} , or only even values, Q_{jme} , or only odd values, Q_{jmo} . Obviously

$$(7. 9) \quad Q_{jme} + Q_{jmo} = Q_{jmt}.$$

If (8) is used for only odd j values, the lowest level, for which j is equal to unity, is assigned the energy $2kT\sigma$. This would be in contradiction to our agreement always to assign the energy zero to the lowest level of the molecule. We shall designate by Q_{jmo}^* the partition function for a rotator having only odd levels with the energy scale so chosen that the lowest level with $j = 1$ has zero energy. It follows from the argument given in section 6f that

$$(7. 10) \quad Q_{jmo}^* = Q_{jmo}e^{2\sigma}.$$

Both the free energy and the energy calculated from Q_{jmo}^* will be smaller, per mole, by an amount $2RT\sigma$ than the values calculated from Q_{jmo} . The specific heat and entropy will be the same from both partition functions.

The molecule H_2 has the smallest moment of inertia of any molecule, and consequently, from (4), the largest value of $T\sigma$, namely, 84.971° . Iodine has about the largest I encountered in a diatomic molecule which can be obtained gaseous at moderately low temperatures. The value of $T\sigma$ for I_2 is 0.05340° . Between these two extremes, $T\sigma$ for HCl is 14.946° , for N_2 it is 2.847° , and for O_2 it is 2.059° . It is seen that, except for H_2 , the value of σ at or above the boiling point is fairly low for all gases. The values at the boiling points are 4.18 at $T = 20.3^\circ K$. for H_2 , 0.079 at $T = 189.4^\circ K$. for HCl , 0.037 at $T = 77.3^\circ K$. for N_2 , and 0.023 at $T = 90.1^\circ K$. for O_2 .

It is for H_2 alone that one is interested in the partition function for values of σ of about unity or greater. For this molecule it is essential, and not very difficult, to sum equation (8) by actual numerical summation, term by term. If σ is small, however, the terms of (8) converge very slowly and numerical summation becomes tedious. It is possible, then, to use an easy approximation method known as the Euler-Maclaurin summation formula. This method approximates the sum of a function of j , extended over integral values of j , in terms of the integral of the function and successive derivatives of it at the value of j corresponding to the first term. The method is applicable, of course, only if the successive terms of the approximation converge, and, as might be expected, when applied to (8) it is found that the convergence is good for only small values of σ .

Actually it is found that the method works fairly successfully for σ as large as unity for Q_{jmt} , although the approximations for E_{jmt} and C_{jmt} , the contribution to the energy and the specific heat, respectively, are accurate only for somewhat lower values of σ . For Q_{jme} and Q_{jmo} , for which j takes values differing by 2, it is easy to substitute $2k$ and $2k + 1$, respectively, for j , so that the summation goes over all integral values of k . The convergence is considerably poorer in these cases than in the summation over all j values, and the approximation formulas derived are valid only if σ is less than or equal to about 0.2.

The range of values of σ for which the approximation formulas, or direct summation, are to be used is largely a question of convenience, and dependent on the desired accuracy of the results. We shall show the application of the summation formula to (8).

If $\sum_{n=a}^{n=\infty} f(n)$ is the sum, extended over values of n differing by integers, from a to infinity, of a function, $f(n)$, then the sum can have a finite value (be convergent) only if the function and all its derivatives are zero at infinity. We may denote by $f(x)$ the same function of a continuous variable x . The first term of the sum will be $f(a)$. The symbols $f^I(a)$, $f^{III}(a)$, and $f^V(a)$ may be used to designate the first, third, and fifth derivatives of the function with respect to x , at $x = a$. The Euler-Maclaurin summation formula gives

$$(7. 11) \quad \sum_{n=a}^{n=\infty} f(n) = \int_a^{\infty} f(x) dx + \frac{1}{2}f(a) - \frac{1}{12}f^I(a) + \frac{1}{720}f^{III}(a) - \frac{1}{30240}f^V(a) + \dots$$

This formula is also discussed in Appendix A III. The approximation is valid, of course, only if the sum on the right converges.

Applying this* to (8) for Q_{jmt} , for which j takes all integral values, and the first value, a , is zero, the function $f(x)$ is seen to be $(2x + 1)e^{-x(x+1)\sigma}$. The first term of the sum on the left-hand side, obtained by substituting zero for x in $f(x)$, is unity. Differentiation and subsequent substitution of zero for x give $(2 - \sigma)$ for $f'(0)$, $(-12\sigma + 12\sigma^2 - \sigma^3)$ for $f''(0)$, and $(120\sigma^2 - 180\sigma^3 + 30\sigma^4 - \sigma^5)$ for $f'''(0)$. The next odd derivative would begin with a cubic term in σ . The integral can easily be found by substituting the new variable $z = x(x + 1)$, $dz = (2x + 1) dx$, obtaining

$$(7.12) \quad \int_0^\infty f(x) dx = \int_0^\infty (2x + 1)e^{-x(x+1)\sigma} dx = \int_0^\infty e^{-z\sigma} dz = \frac{1}{\sigma}.$$

If these values are substituted in (11), and terms of higher than the second power in σ are omitted, one obtains

$$(7.13) \quad Q_{jmt} = \sigma^{-1} \left(1 + \frac{\sigma}{3} + \frac{\sigma^2}{15} + \frac{4\sigma^3}{315} + \dots \right), \quad \sigma \leq 1.0.$$

The limit of validity given, that σ must be smaller than or equal to unity, is the limit for calculations within 1 per cent. For larger values of σ one must use

$$(7.13') \quad Q_{jmt} = 1 + 3e^{-2\sigma} + 5e^{-6\sigma} + 7e^{-12\sigma},$$

which are sufficient terms to give the sum within 0.1 per cent at $\sigma = 0.7$. Fewer terms need be used as σ increases.

If now the Euler-Maclaurin summation formula is applied to Q_{jme} in (8), for which j takes only even values, the substitution of $2k = j$ gives a sum over all integral values of k , and the function $f(x)$ becomes $(4x + 1)e^{-2x(2x+1)\sigma}$. The integral of the function from zero to infinity is just half the previous value, or $1/2\sigma$. The first term of the sum is the same as before, and the n th derivative is 2^n -fold greater than with Q_{jmt} . Substitution of the corresponding values in (11) leads to $Q_{jme} = Q_{jmt}/2$, an equation which is valid for small values of σ . However, the sum of (11) does not converge nearly as rapidly, for the same value of σ , when used for Q_{jme} as when used for Q_{jmt} , and indeed one can see that with $\sigma = \frac{1}{4}$ the convergence of (11) for Q_{jme} is about the same as it is with $\sigma = 1$ for Q_{jmt} . The special order of collecting terms of the same power of σ gives the illusion in the equation for Q_{jme} corresponding to (13) that the sum is convergent up to relatively large σ values, whereas this was actually not so at all in (11). Consequently,

* This leads to the same result as that first obtained by H. P. Mulholland, *Proc. Cambridge Phil. Soc.*, **24**, 280 (1928).

it is illusory to include the last correction term of (13) in the equation for Q_{jme} .

Since, within the range of validity of the approximation method, Q_{jme} is just half of Q_{jmt} , it follows from (9) that $Q_{jmo} = Q_{jme}$. The corrected partition function for odd states, Q_{jmo}^* , calculated by assigning the energy zero to the level $j = 1$, is $e^{2\sigma}Q_{jmo}$ from (10). The equations are, then,

$$(7. 14) \quad Q_{jme} = Q_{jmo} = \frac{1}{2\sigma} \left(1 + \frac{\sigma}{3} + \frac{\sigma^2}{15} \right), \quad \sigma \leq 0.3,$$

the limit of validity, as before, being assigned for calculation within 1 per cent. At higher values of σ one must use

$$(7. 14') \quad \begin{aligned} Q_{jme} &= 1 + 5e^{-6\sigma} + 9e^{-20\sigma} + 13e^{-42\sigma}, \\ Q_{jmo} &= 3e^{-2\sigma} + 7e^{-12\sigma} + 11e^{-30\sigma} + 15e^{-56\sigma}, \\ Q_{jmo}^* &= 3 + 7e^{-10\sigma} + 11e^{-28\sigma} + 15e^{-54\sigma}. \end{aligned}$$

The contribution to the various thermodynamic properties of the gas due to these internal rotational levels can then be immediately calculated by means of equations (6. 25') to (6. 29'). In taking the logarithm of the sum $1 + \sigma/3 + \dots$ it is convenient to use the approximation that $\ln(1+x) = x - \frac{1}{2}x^2 + \dots$. The quantity σ is inversely proportional to the temperature, (4), so that $T(d/dT)\sigma = -\sigma$. The equations for the high-temperature approximations follow. The low-temperature range occurs so seldom that it seems to be unnecessary to make the special developments which are most convenient for numerical calculations. Tables of the functions for high values of σ are to be found in Appendix A IX.

The limits of validity given after the expressions are those for which the approximations give the functions within 1 per cent or better. The equations are:

$$(7. 15) \quad \begin{aligned} F_i &= -RT \ln Q_i, \\ F_{jmt} &= RT \left(\ln \sigma - \frac{\sigma}{3} - \frac{\sigma^2}{90} - \frac{8\sigma^3}{2835} \right), \quad \sigma \leq 0.95. \\ F_{jme} = F_{jmo} &= RT \left(\ln \sigma + \ln 2 - \frac{\sigma}{3} - \frac{\sigma^2}{90} \right), \quad \sigma \leq 0.35. \\ F_{jmo}^* &= RT \left(\ln \sigma + \ln 2 - \frac{7\sigma}{3} - \frac{\sigma^2}{90} \right), \quad \sigma \leq 0.35. \end{aligned}$$

$$(7. 16) \quad E_i = RT^2 \frac{d}{dT} \ln Q_i,$$

$$E_{jmt} = RT \left(1 - \frac{\sigma}{3} - \frac{\sigma^2}{45} - \frac{8\sigma^3}{945} \right), \quad \sigma \leq 0.9.$$

$$E_{jme} = E_{jmo} = E_{jmt}, \quad \sigma \leq 0.3.$$

$$E_{jmo}^* = RT \left(1 - \frac{7\sigma}{3} - \frac{\sigma^2}{45} \right), \quad \sigma \leq 0.3.$$

$$(7. 17) \quad S_i = R \frac{d}{dT} (T \ln Q_i) = RT \frac{d}{dT} \ln Q_i + R \ln Q_i,$$

$$S_{jmt} = R \left(1 - \ln \sigma - \frac{\sigma^2}{90} - \frac{16\sigma^3}{2835} \right), \quad \sigma \leq 0.9.$$

$$S_{jme} = S_{jmo} = S_{jmo}^* = R \left(1 - \ln \sigma - \ln 2 - \frac{\sigma^2}{90} \right), \quad \sigma \leq 0.3.$$

$$(7. 18) \quad C_i = R \frac{d}{dT} T^2 \frac{d}{dT} \ln Q_i.$$

$$C_{jmt} = R \left(1 + \frac{\sigma^2}{45} + \frac{16\sigma^3}{945} \right), \quad \sigma \leq 0.8.$$

$$C_{jme} = C_{jmo} = C_{jmo}^* = C_{jmt}, \quad \sigma \leq 0.2.$$

In Figs. 7. 1, 7. 2, and 7. 3 the functions F/RT , E/RT , and C/R are plotted against σ .

F/RT for all j values and for even j values goes exponentially to zero as T decreases, σ increases, the molecules all settling into the single lowest state for which $j = 0$. For odd j values the molecule all seeks the lowest level of three states for which $j = 1$ as the temperature decreases. This level has an entropy $R \ln 3$ per mole. If the level is assigned zero energy, F_{jmo}/RT becomes asymptotic to $-\ln 3$, but when assigned the energy $2kT\sigma$, the corresponding function F_{jmo}/RT becomes asymptotic to $2\sigma - \ln 3$.

E/RT is seen always to approach unity at infinite temperature and to go exponentially to zero at low temperatures, except for E_{jmo}/RT , which approaches 2σ , the energy assigned to the lowest level divided by kT .

C/R has the classical value of unity at high temperatures, increases at first as T is lowered, then decreases exponentially to zero at zero temperature.

The difference in energy between the lowest and the first excited level is different in all three cases. For all j values it is 2 measured in units of $kT\sigma$. For only even j 's the difference is 6 in these units, and for only

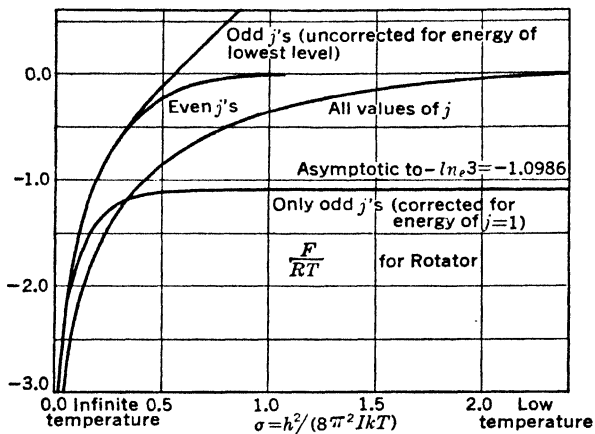

FIG. 7. 1. Free Energy per mole due to rotation, divided by RT .

odd j 's it is 10. Correspondingly, all the functions approach their asymptotic low temperature values at lower σ values, that is, at higher

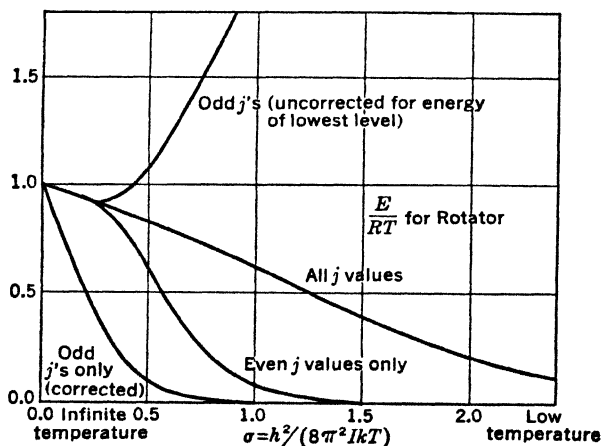

FIG. 7. 2. Energy per mole due to rotation, divided by RT .

temperatures, for odd j values than for even j 's, and lower σ values for even j 's than for all j 's.

C/R and E/RT both approach unity at high temperatures for all three cases, that is, whether all j values, or only the odd, or only the

even, levels are available to the molecules does not affect the average energy at sufficiently high temperatures. If, however, the two atoms of the molecule are identical, so that only half of the rotational levels are available to it, whether they are the odd or the even half, the effect

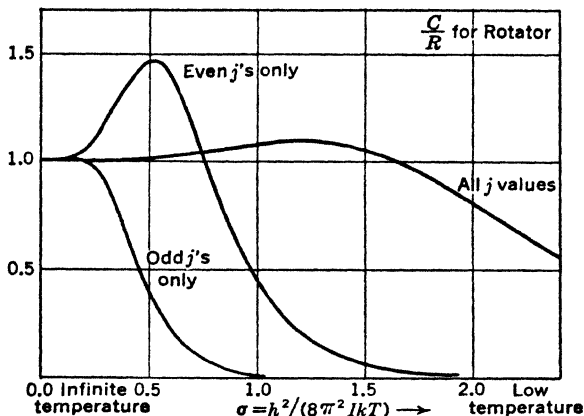

Fig. 7. 3. Heat capacity per mole due to rotation, divided by R .

is to make the value of the entropy lower by just $R \ln 2$ per mole at high temperatures. Correspondingly, the value of the free energy is increased by $RT \ln 2$ if only half of the levels are occupied. We shall see in section 7f that this also follows from classical considerations.

7c. The Partition Function of an Oscillator

The value of $h\nu$ for any given molecule is always greater than the value of $\frac{h^2}{8\pi^2 I}$, so that the quantity u , equation (3), at a definite temperature, is greater than the value of σ , equation (4). For most molecules, and for ordinary temperatures, u is considerably greater than unity. The quantity $h\nu/k$, which is frequently assigned the symbol θ , has the value 5958° for hydrogen, the highest value of any diatomic gas, and is 305.1° for iodine, which is about the lowest value encountered in a chemically stable diatomic molecule which can be obtained gaseous at ordinary temperatures. At 300°K . it is seen that u is 19.86 for H_2 , and 1.017 for I_2 .

The sum Q_v of equation (7) is the partition function of an oscillator. The sum is of the general type $1 + e^{-u} + (e^{-u})^2 + (e^{-u})^3 + \dots$, and since e^{-u} is necessarily smaller than unity, this sum can be expressed in closed form by

$$(7. 19) \quad Q_v = (1 - e^{-u})^{-1}.$$

At ordinary temperatures u is appreciably larger than unity for most

molecules, e^{-u} is small, and Q_v is scarcely greater than unity. In Q_v is then very small and the vibrational contribution to the thermodynamic functions is almost negligible.

For rather high temperatures, u about equal to unity or less, a useful approximation can be made by expanding the exponential as a power series in u , $e^{-u} = 1 - u + \frac{1}{2}u^2 - \dots$. The algebra is straightforward. The result,

$$(7. 19') \quad Q_v = u^{-1} \left(1 + \frac{u}{2} + \frac{u^2}{12} - \frac{u^4}{720} + \dots \right),$$

is exactly what would be obtained by application of the Euler-Maclaurin summation formula (11) to the sum of (7). This can be readily verified, since the continuous function is just e^{-ux} , the integral of which from zero to infinity is u^{-1} , the value of the function at $x = 0$ is unity, and the n th derivative at $x = 0$ is just $(-u)^n$.

In taking the logarithm of the form (19') for Q_v the usual development is made of $\ln(1+x) = x - \frac{1}{2}x^2 + \dots$. Since u is inversely proportional to T , (3), one has $T du/dT = -u$. Substitution in equations (6. 25') to (6. 29') for the contribution to the various thermodynamic functions offers no difficulties. The equations are:

$$(7. 20) \quad \begin{aligned} F_v &= -RT \ln Q_v = RT \ln(1 - e^{-u}) \\ &= RT \left(\ln u - \frac{u}{2} + \frac{u^2}{24} - \frac{u^4}{2880} \right) \\ &= RT \left(\ln u + \frac{u^2}{24} - \frac{u^4}{2880} \right) - \frac{1}{2}N_0 h\nu. \end{aligned}$$

$$(7. 21) \quad \begin{aligned} E_v &= RT^2 \frac{d}{dT} \ln Q_v = RT \frac{u}{e^u - 1} \\ &= RT \left(1 - \frac{u}{2} + \frac{u^2}{12} - \frac{u^4}{720} \right) \\ &= RT \left(1 + \frac{u^2}{12} - \frac{u^4}{720} \right) - \frac{1}{2}N_0 h\nu. \end{aligned}$$

$$(7. 22) \quad \begin{aligned} S_v &= R \frac{d}{dT} T \ln Q_v = R \left[\frac{u}{e^u - 1} - \ln(1 - e^{-u}) \right] \\ &= R \left(1 - \ln u + \frac{u^2}{24} - \frac{u^4}{960} \right). \end{aligned}$$

$$\begin{aligned}
 (7. 23) \quad C_v &= R \frac{d}{dT} T^2 \frac{d}{dT} \ln Q_v \\
 &= R \frac{u^2 e^u}{(e^u - 1)^2} \\
 &= R \left(1 - \frac{u^2}{12} + \frac{u^4}{240} \right).
 \end{aligned}$$

The second term in the equations for F_v and E_v is $-\frac{1}{2}RTu$. This term is temperature independent, since u is inversely proportional to the temperature, and, by replacing u with $h\nu/kT$ and noting that R/k is N_0 , Avogadro's number, the term can be written as $-\frac{1}{2}N_0h\nu$. In section 6f, equations (6. 37) and (6. 38), it was found that an alteration in the zero from which the energy of the molecules was measured resulted in a corresponding change in the value of E and F .

By using (5) for the energy of the diatomic molecule the zero of energy has been so chosen that that of the lowest quantum level is zero. As a consequence (21) gives zero energy to the system at absolute zero temperature. This choice of zero from which to measure the energy of the molecules is not the usual quantum-mechanical one of equation (1), which was so chosen that the lowest point of the potential-energy diagram of the molecule should be zero. The two differ by $\frac{1}{2}h\nu$ per molecule or $\frac{1}{2}N_0h\nu$ per mole, just the value of the second term in the development of the free energy and the energy of the system.

The free energy and energy, according to our equations, are, then, less, by exactly $\frac{1}{2}N_0h\nu$, than they would have been found to be if the zero of energy had been chosen as the lowest potential energy of the molecules, and if this latter choice had been made, the equations obtained would have been those of the last lines of (20) and (21), omitting the constant term $\frac{1}{2}N_0h\nu$. The equations for entropy and heat capacity would have been unaltered.

We shall later see, section 7e, that, with the omission of these constant terms, the terms in the expansions of equations (20) to (23) which do not approach zero at high temperatures are the same as the expressions obtained with the classical partition function, in which case, of course, the zero of energy is chosen as the lowest potential energy of the molecule.

The functions F_v/RT , E_v/RT , S_v/RT , and C_v/R are plotted against u in Fig. 7. 4. It is seen that all of them approach zero at the absolute zero of temperature, and indeed they are all small at $u = 5$ to 10, which is about the value of u for most gases at room temperature. Since the

vibrational contribution to the heat capacity is often negligible, and the rotational contribution has the classical value R , the total heat capacity, at constant volume, of most diatomic gases is $5R/2$ or about 5 cal. per deg.

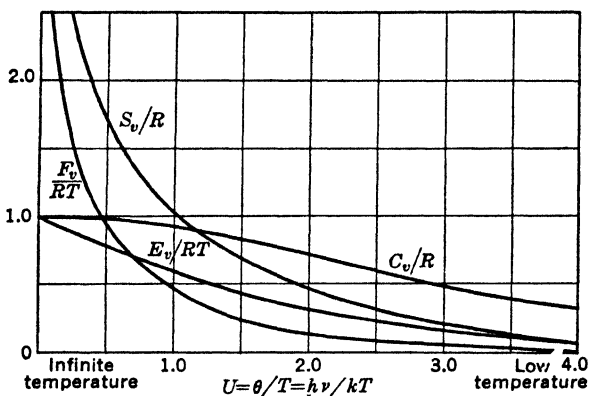

FIG. 7. 4. Thermodynamic functions of one mole of monochromatic oscillators.

7d. The General Diatomic Molecule

Although very many real diatomic molecules have only a single electronic state which is important, up to temperatures of several thousand degrees, the approximation of equation (1) for the energy due to rotation and vibration is never exact, and deviations from it are often appreciable for levels whose energies are comparable with kT at as low as 500°K . The next and fairly satisfactory approximation for the energy in terms of ν and j is

$$\epsilon_i = (\nu + \frac{1}{2})h\nu_e - x_e(\nu + \frac{1}{2})^2h\nu_e + j(j+1)\frac{h^2}{8\pi^2I_e} - D_ehcj^2(j+1)^2 - \alpha hc(\nu + \frac{1}{2})j(j+1),$$

or, in terms of wave numbers,

$$(7. 24) \quad \frac{1}{hc} \epsilon_i = (\nu + \frac{1}{2})\omega_e - (\nu + \frac{1}{2})^2x_e\omega_e + j(j+1)B_e - j^2(j+1)^2D_e - (\nu + \frac{1}{2})j(j+1)\alpha.$$

An alternative form is frequently found in the literature, in which the energy of the lowest level, $\nu = 0, j = 0$, is taken to be zero,

$$(7. 24') \quad \frac{1}{hc} \epsilon_i = \nu\omega_0 - \nu^2x_0\omega_0 + j(j+1)B_0 - j^2(j+1)^2D_e - \nu j(j+1)\alpha.$$

For the alternative forms (24) and (24'), the relations

$$(7. 25) \quad \omega_0 = \omega_e(1 - x_e),$$

$$(7. 26) \quad x_0 = x_e(1 + x_e) \cong x_e,$$

$$(7. 27) \quad B_0 = B_e \left(1 - \frac{1}{2} \frac{\alpha}{B_e} \right)$$

must hold for any molecule. The quantities α and D_e have the same value in the two forms.

Equations (24) or (24') are essentially empirical developments in powers of the quantum numbers, the terms proportional to $(v + \frac{1}{2})^2$ or v^2 , $j^2(j + 1)^2$, and $(v + \frac{1}{2})j(j + 1)$ or $vj(j + 1)$ being introduced as first-order corrections to the simpler equation (1) involving only two terms. The development may also be made using the perturbation theory and quantum mechanics. It is then seen that the dimensionless quantity x_e is due to the deviation of the true potential energy of the molecule from the Hooke's law equation, $U(\xi) = \frac{1}{2}a\xi^2$. If the potential is assumed to be given by the expansion $U(\xi) = \frac{1}{2}a\xi^2(1 - b\xi + [7b\xi^2/12])$, which is the expansion of the Morse function, then x_e is related to b by the equation

$$(7. 28) \quad x_e = \frac{h}{2\pi} b^2 \frac{1}{(a\mu)^{1/2}},$$

with μ the reduced mass. However, theoretically the quantities D_e and α are determined by I_e , ω_e , and x_e . The relationships

$$(7. 29) \quad \frac{D_e}{B_e} = 4 \left(\frac{B_e}{\omega_e} \right)^2 = 4\gamma^2,$$

$$(7. 30) \quad \frac{\alpha}{B_e} = 6 \frac{B_e}{\omega_e} \left[\left(\frac{\omega_e x_e}{B_e} \right)^{1/2} - 1 \right] = \delta,$$

which also may be taken as definitions of the new dimensionless quantities γ and δ , are not always found to be strictly obeyed by the values of D_e and α found empirically and tabulated in the literature. This is not very surprising, since the empirical values always contain a certain averaged correction due to still higher-order corrections to equations (24) or (24'). Nevertheless, (29) and (30) are frequently useful where D_e and α have not been determined spectroscopically. In general, if the experimental values from which they have been taken are reliable, the empirical values of D_e and α are preferable for our purposes to the theoretical values of (29) and (30), just because they give a better

approximation to the actual levels by empirically taking into account the averaged higher-order corrections.

Both (24) and (24') have the disadvantage that the frequency ω_e or ω_0 does not give the difference in energy between the lowest and first excited vibration level. By writing the equation in such a way that the difference in energy of the two lowest vibration levels enters directly, the equations of the past section will give the contribution of vibration to the thermodynamic properties most accurately, and the correction terms which will be developed in this section will be smaller at any given temperature.

We shall, consequently, use

$$(7.31) \quad \frac{\epsilon_i}{kT} = \nu u - x\nu(\nu - 1)u + j(j + 1)[1 - 4\gamma^2j(j + 1) - \delta\nu]\sigma,$$

where,

$$(7.32) \quad u = \frac{\theta}{T} = \frac{h\nu}{kT} = \frac{h\omega c}{kT} = \frac{h\omega_e c}{kT}(1 - 2x_e) = \frac{h\omega_0 c}{kT}(1 - x_0),$$

$$(7.33) \quad \sigma = \frac{B_0 hc}{kT} = \frac{B_e hc}{kT}(1 - \frac{1}{2}\delta).$$

The internal partition function Q_i is the sum of the exponential of minus the energy over kT , extended over the quantum numbers ν , j , and m , and will be designated by $Q_{\nu jm}$. It is given by the equation

$$(7.34) \quad Q_{\nu jm} = \sum_{\nu=0}^{\nu=\infty} \sum_{j=0}^{j=\infty} (2j + 1) e^{-u[\nu - 2\nu(\nu - 1)] - \sigma j(j + 1)[1 - 4\gamma^2j(j + 1) - \delta\nu]}.$$

This sum must now be evaluated.

To do so, we first sum over j , using the approximation method of (11), by integrating and adding one-half the value of the first term and subtracting one-twelfth of the initial derivative. In the integration, as in (12), the variable z is substituted for $j(j + 1)$, with $dz = (2j + 1)dj$. In the initial derivative the term proportional to σ is neglected, so that the approximation is carried to two powers of σ less than in deriving (13). One obtains

$$(7.35) \quad \sum_{j=0}^{j=\infty} (2j + 1) e^{-\sigma j(j + 1)(1 - 4\gamma^2j(j + 1) - \delta\nu)}$$

$$= \int_0^{\infty} e^{-\sigma(1 - \delta\nu)z + 4\gamma^2\nu\sigma^2 z} dz + \frac{1}{2} - \frac{1}{6}.$$

The integral, as also the original sum, would be infinity, if integrated

(or summed) correctly. This is because the positive part of the exponential, proportional to the square of the variable, becomes predominant at large values of the variable. The error, of course, is introduced by the use of the approximate equation (31) which is not valid to infinite j 's. One nevertheless can obtain a correct approximation by expanding the factor $e^{4\gamma^2\sigma z^2}$ before integration into $1 + 4\gamma^2\sigma z^2$, and then integrating, obtaining

$$\begin{aligned} \int_0^\infty e^{-\sigma(1-\delta\mathbf{v})z+4\gamma^2\sigma z^2} dz &\cong \int_0^\infty (1 + 4\gamma^2\sigma z^2)e^{-\sigma(1-\delta\mathbf{v})z} dz \\ &\cong \frac{1}{\sigma(1-\delta\mathbf{v})} \int_0^\infty \left(1 + 4\gamma^2\frac{1}{\sigma}y^2\right) e^{-y} dy \\ &\cong \sigma^{-1}(1-\delta\mathbf{v})^{-1}(1 + 8\gamma^2\sigma^{-1}) \\ &\cong \sigma^{-1}(1 + 8\gamma^2\sigma^{-1} + \delta\mathbf{v}). \end{aligned}$$

Inserting this in (35), one obtains

$$(7. 36) \quad \sum_{j=0}^{j=\infty} (2j+1)e^{-\sigma j(j+1)(1-4\gamma^2j(j+1)-\delta\mathbf{v})} = \sigma^{-1}\left(1 + \frac{\sigma}{3} + 8\gamma^2\sigma^{-1} + \delta\mathbf{v}\right).$$

The use of (36) in (34) yields

$$(7. 37) \quad Q_{\mathbf{vjm}} = \sum_{\mathbf{v}=0}^{\mathbf{v}=\infty} \sigma^{-1}\left(1 + \frac{\sigma}{3} + \frac{8\gamma^2}{\sigma} + \delta\mathbf{v}\right) e^{-u[\mathbf{v}-x\mathbf{v}(\mathbf{v}-1)]}.$$

Again developing $e^{ux\mathbf{v}(\mathbf{v}-1)}$ as $1 + ux\mathbf{v}(\mathbf{v}-1) + \dots$, and using this in (37), one arrives at

$$(7. 38) \quad Q_{\mathbf{vjm}} = \sum_{\mathbf{v}=0}^{\mathbf{v}=\infty} \sigma^{-1}\left(1 + \frac{\sigma}{3} + \frac{8\gamma^2}{\sigma} + (\delta - xu)\mathbf{v} + xuv^2\right) e^{-u\mathbf{v}}.$$

The sum, $\sum e^{-u\mathbf{v}}$, has already been found to be $(1 - e^{-u})^{-1}$, (19); and the sum $\sum \mathbf{v}e^{-u\mathbf{v}}$ is $(-d/du)\sum e^{-u\mathbf{v}}$, which is $e^{-u}(1 - e^{-u})^{-2}$. Similarly, the sum $\sum \mathbf{v}^2 e^{-u\mathbf{v}}$ is found to be $e^{-u}(1 - e^{-u})^{-2} + 2e^{-2u}(1 - e^{-u})^{-3}$. Using this in (38) finally yields

$$(7. 39) \quad Q_{\mathbf{vjm}} = \frac{1}{\sigma(1 - e^{-u})} \left[1 + \frac{\sigma}{3} + \frac{8\gamma^2}{\sigma} + \frac{\delta}{e^u - 1} + \frac{2xu}{(e^u - 1)^2} \right].$$

Upon developing $\ln(1+x) = x - \dots$, the equation for $\ln Q_{vjm}$ is seen to be

$$(7.40) \quad \ln Q_{vjm} = -\ln \sigma + \frac{\sigma}{3} - \ln(1 - e^{-u}) \\ + \frac{8\gamma^2}{\sigma} + \frac{\delta}{e^u - 1} + \frac{2xu}{(e^u - 1)^2}.$$

The first two terms of the above expression are the first terms in the old development, (15), for $\ln Q_{jmt}$, and the third term is the expression (20) for $\ln Q_v$. The last three of the terms are new correction terms which vanish at low temperatures.

We may define the correction term $\ln Q_c$ as the difference between $\ln Q_{vjm}$ and the sum of the two approximations obtained by the use of (1) in which the contributions of the rotation and vibration to the energy are separated, $\ln Q_{jm}$ and $\ln Q_v$, so that,

$$(7.41) \quad \ln Q_c = \ln Q_{vjm} - \ln Q_{jm} - \ln Q_v.$$

From (29) it is seen that $\gamma = B_e/\omega_e$. Neglecting the small difference between B_e and B_0 , between ω_e and ω , using (32), $u = \hbar c/kT$, and (33), $\sigma = B_0 \hbar c/kT$, one may write $\gamma = \sigma/u$, $8\gamma^2/\sigma = 8\gamma/u$. One then finds

$$(7.42) \quad \ln Q_c = u^{-1} \left[8\gamma + \delta \frac{u}{e^u - 1} + 2x \frac{u^2}{(e^u - 1)^2} \right].$$

Since the term $\ln Q_c$ is important only at high temperatures where u is moderately small, the expansion of the first two expressions of (21), $u/(e^u - 1) = 1 - u/2 + u^2/12 - u^4/720$, and consequently $u^2/(e^u - 1)^2 = 1 - u + 5u^2/12 - u^3/12 + u^4/240$, may be used. The equation then takes the form

$$(7.43) \quad \ln Q_c = u^{-1}(8\gamma + \delta + 2x) - \left(\frac{\delta}{2} + 2x \right) \\ + u \left(\frac{\delta}{12} + \frac{5x}{6} \right) - u^2 \frac{x}{6} - u^3 \left(\frac{\delta}{720} - \frac{x}{120} \right) + \dots$$

In these expressions, γ , δ , and x are dimensionless and independent of the temperature. The quantity u is inversely proportional to the temperature, (32). Although the development (43) has temperature-independent terms and terms which grow with decreasing temperatures it is evident from the unexpanded form (42) that $\ln Q_c$ approaches zero with decreasing temperature, as u becomes large.

Of the quantities γ , δ , and x , only two are independent according to equations (29) and (30). We may use the two, $\gamma = \sigma/u$, and x , as independent, writing (30) in the form

$$(7. 44) \quad \delta = 6\gamma^{1/2}x^{1/2} - 6\gamma,$$

and so further simplify (43) to

$$(7. 45) \quad \ln Q_c = u^{-1}(2\gamma + 6\gamma^{1/2}x^{1/2} + 2x) + (3\gamma - 3\gamma^{1/2}x^{1/2} - 2x) \\ + \frac{u}{6}(-3\gamma + 3\gamma^{1/2}x^{1/2} + 5x) - \frac{u^2}{6}x + \frac{u^3}{120}(\gamma - \gamma^{1/2}x^{1/2} + x) - \dots$$

Since $T(du/dT) = -u$, it is no great chore to perform the necessary differentiations in order to calculate the additive contributions of these correction terms to the various thermodynamic functions of the gas. Using (45) one obtains

$$(7. 46) \quad F_c = -RT \ln Q_c = RT \left[-u^{-1}(2\gamma + 6\gamma^{1/2}x^{1/2} + 2x) \right. \\ \left. - (3\gamma - 3\gamma^{1/2}x^{1/2} - 2x) - \frac{u}{6}(-3\gamma + 3\gamma^{1/2}x^{1/2} + 5x) + \frac{u^2}{6}x \right. \\ \left. - \frac{u^3}{120}(\gamma - \gamma^{1/2}x^{1/2} + x) - \dots \right].$$

$$(7. 47) \quad E_c = RT^2 \frac{d}{dT} \ln Q_c = RT \left[u^{-1}(2\gamma + 6\gamma^{1/2}x^{1/2} + 2x) \right. \\ \left. - \frac{u}{6}(-3\gamma + 3\gamma^{1/2}x^{1/2} + 5x) + \frac{u^2}{3}x - \frac{u^3}{40}(\gamma - \gamma^{1/2}x^{1/2} + x) + \dots \right].$$

$$(7. 48) \quad S_c = R \left(T \frac{d}{dT} \ln Q_c - \ln Q_c \right) \\ = R \left[u^{-1}(4\gamma + 12\gamma^{1/2}x^{1/2} + 4x) \right. \\ \left. + (3\gamma - 3\gamma^{1/2}x^{1/2} - 2x) + \frac{u^2}{6}x \right. \\ \left. - \frac{u^3}{60}(\gamma - \gamma^{1/2}x^{1/2} + x) + \dots \right].$$

$$\begin{aligned}
 (7.49) \quad C_c &= R \frac{d}{dT} T^2 \frac{d}{dT} \ln Q_c \\
 &= R \left[u^{-1} (4\gamma + 12\gamma^{1/2} x^{1/2} + 4x) \right. \\
 &\quad \left. - \frac{u^2}{3} x + \frac{u^3}{20} (\gamma - \gamma^{1/2} x^{1/2} + x) + \dots \right].
 \end{aligned}$$

The actual numerical values of the quantities γ and x vary from $1.43 \cdot 10^{-2}$ and $2.736 \cdot 10^{-2}$, respectively, for H_2 , to $0.0175 \cdot 10^{-2}$ and $0.278 \cdot 10^{-2}$, respectively, for I_2 . The coefficient of the term RT/u in F_c and E_c is, then, 0.2018 for H_2 and 0.0101 for I_2 . However, $uT = \theta$ is 5958° for H_2 and only 305.1° for I_2 , so that at $T = 500^\circ K$, $u = 11.92$ for H_2 and 0.6102 for I_2 . The first term in the development (46) for I_2 is $-0.0165RT = -16.5$ cal. at $500^\circ K$. The whole correction, F_c , is -11 cal. at this temperature for this gas. For hydrogen at this temperature, with $u = 11.9$, the development of (46) is invalid and we must use the undeveloped equation (42). The only term which is appreciable at this temperature is the first, $-RT8\gamma/u$, in F_c , and its numerical value turns out to be -9.6 cal. at $500^\circ K$. This term is due only to the rotational stretching.

Since the whole free energy of these gases is about a thousand times as large at these temperatures, the corrections amount to about 0.1 per cent, but they increase rather rapidly in importance as the temperature rises. It is seen from the values given that the corrections are of the same order of magnitude for the two gases H_2 and I_2 at the same temperature, although the values of γ and x are very different. This is not so surprising, since the correction terms depend mostly on the shape of the potential energy function at the energy corresponding approximately to kT , which is roughly the same for all molecules having about the same binding energy. Actually N_2 , which has an abnormally high binding energy because of the triple bond, and consequently, in spite of the high reduced mass, almost as high a value of $uT = \theta(3336.6^\circ)$ as H_2 , shows only about a third as large correction terms as H_2 .

For H_2^* and some other molecules, especially those containing a hydrogen atom, the corrections become appreciable at temperatures where u is much greater than unity and the expanded equations (46) to (49) are not applicable. For these cases the unexpanded form (42), and the equations derived from this form by differentiation, must be used.

* W. F. Giaque, *J. Am. Chem. Soc.*, **52**, 4816 (1930), and also Clyde O. Davis and Herrick L. Johnston, *ibid.*, **56**, 1045 (1934), found it desirable to calculate Q_1 for H_2 by summation of observed numerical energy levels, instead of attempting to use correction equations.

7e. The Classical Equations for the General Diatomic Molecule

In sections 6b and 6j it was shown that the classical analogue of the quantum-mechanical partition function is obtained by integrating over all coordinates and momenta the exponential of the negative of the Hamiltonian divided by kT . The internal coordinates of the diatomic molecule are the two angles ϕ and θ and the distance ξ of stretching from the equilibrium distance r_0 of the two atoms. These coordinates have already been discussed in section 2h, example 2.

Since the classical approximation is valid only at high temperatures, for which the deviations from truly harmonic vibration are appreciable, it will be found advisable to take deviations from the ideal form of the potential energy into account; that is, we shall not assume, as in section 2h, that $U(\xi) = \frac{1}{2}a\xi^2$. It will also be necessary to consider, at least in first approximation, the influence of the motion on the moment of inertia I ; that is, departing from our practice in the example in section 2h, we shall write I explicitly as a function of ξ , $I(\xi)$.

The most satisfactory simple general equation which has been found to give the potential energy of a diatomic molecule as a function of the coordinate ξ fairly well is the Morse function,

$$(7. 50) \quad U(\xi) = K(1 - e^{-A\xi})^2.$$

This function is so chosen that its minimum value at $\xi = 0$ is zero. Expanding the exponential, one obtains.

$$(7. 51) \quad U(\xi) = KA^2\xi^2 - KA^3\xi^3 + \frac{7}{12}KA^4\xi^4 - \dots$$

for low values of ξ .

If this is written in the form

$$(7. 51') \quad U(\xi) = \frac{1}{2}a\xi^2 \left(1 - b\xi + \frac{7}{12}b^2\xi^2 + \dots \right),$$

one sees by comparison of the two forms (51) and (51') that

$$(7. 52) \quad a = 2KA^2, \quad b = A.$$

The experimentally observable quantity x_e , which occurs in the equation for the energy of the various vibrational levels of the molecule, $\epsilon_v = (v + \frac{1}{2})h\nu_e - (v + \frac{1}{2})^2x_e h\nu_e$, is found by quantum-mechanical calculation to be related to b by the equation*

$$(7. 53) \quad x_e = \frac{h\nu_e}{4K} = \frac{h\nu_e b^2}{2a}.$$

* See, for instance, Pauling and Wilson, *Introduction to Quantum Mechanics*, McGraw-Hill, New York, 1935, page 271.

Remembering that $(a/\mu)(1/4\pi^2) = \nu_e^2 = (\omega_e c)^2$ (equation 2. 21), where μ is the reduced mass, and using $B_e = h/(8\pi^2 I_e c)$ (equation 4), with $I_e = \mu r_0^2$, one can express br_0 as

$$(7. 54) \quad br_0 = \left(\frac{x_e \omega_e}{B_e} \right)^{1/2} = x^{1/2} \gamma^{-1/2},$$

where the γ of equation (29), $\gamma = B_e/\omega_e$, has been used. This equation will be used later.

The Hamiltonian for the diatomic molecule may be written (compare equation 2. 32) as

$$(7. 55) \quad H = \frac{1}{2I(\xi)} \left(p_\theta^2 + \frac{p_\phi^2}{\sin^2 \theta} \right) + \frac{1}{2\mu} p_\xi^2 + \frac{a}{2} \xi^2 \left(1 - b\xi + \frac{7}{12} b^2 \xi^2 \right),$$

where

$$(7. 56) \quad I(\xi) = I_e \left(1 + \frac{\xi}{r_0} \right)^2, \quad I_e = \mu r_0^2.$$

The integration of the exponential of minus the Hamiltonian divided by kT must be made over the three coordinates ϕ , θ , and ξ , and over the three momenta conjugate to these coordinates, p_ϕ , p_θ , and p_ξ . The limits of integration are plus infinity and minus infinity for the three momenta, and these limits may also be used for ξ . The limits are 0 to π for θ , and 0 to 2π for ϕ . The expression for Q_i , corrected by division with h^3 , to obtain the dimensionless quantity consistent with the quantum-mechanical equations, is then

$$(7. 57) \quad Q_i = \frac{1}{h^3} \int_{-\infty}^{+\infty} \int_0^\pi \int_0^{2\pi} \int_{-\infty}^{+\infty} \int_{-\infty}^{+\infty} \int_{-\infty}^{+\infty} e^{-H(p,q)/kT} d\xi d\theta d\phi dp_\xi dp_\theta dp_\phi,$$

in which equation (55) must be substituted for $H(p,q)$.

Integration over each of the three momenta is of the type $\int_{-\infty}^{+\infty} e^{-ax^2} dx = (\pi/a)^{1/2}$, so that three products of this type are introduced into Q . The angular coordinate ϕ does not occur in the Hamiltonian, so that integration from 0 to 2π just gives 2π as a product. From the integration over p_ϕ one obtains $(2\pi I(\xi)kT)^{1/2} \sin \theta$, and since $\int_0^\pi \sin \theta d\theta = 2$, subsequent integration over the coordinate θ yields 2. The integration over ξ remains to be performed, so that one obtains

$$(7. 58) \quad Q_i = \frac{1}{h^3} \int_{-\infty}^{+\infty} (2\pi I(\xi)kT)^{1/2} \cdot (2\pi I(\xi)kT)^{1/2} \cdot (2\pi\mu kT)^{1/2} \\ \cdot 2\pi \cdot 2 \cdot e^{-(\alpha/2kT)\xi^2[1-b\xi+(7/12)b^2\xi^2]} d\xi.$$

This may be shortened by using (56) for $I(\xi)$ and $8\pi^2 I_e kT/h^2 = \sigma_e^{-1}$, equation (4). Further, since $u_e = h\nu_e/kT = h(a/\mu)^{1/2}/2\pi kT$, one may multiply and divide by $(2\pi kT/a)^{1/2}$, obtaining

$$(7. 58') \quad Q_i = \frac{1}{\sigma_e} \frac{1}{u_e} \frac{1}{\pi^{1/2}} \int_{-\infty}^{+\infty} \left(1 + \frac{\xi}{r_0}\right)^2 e^{-(\alpha/2kT)\xi^2[1-b\xi+(7/12)b^2\xi^2]} d\left(\frac{a}{2kT}\right)^{1/2} \xi.$$

If, in this expression, b is taken to be zero, and the term ξ/r_0 is neglected, one may use

$$(7. 59) \quad z = \left(\frac{a}{2kT}\right)^{1/2} \xi,$$

and the integral becomes $\int_{-\infty}^{+\infty} e^{-z^2} dz = \pi^{1/2}$. The first approximation, which neglects the change of I with rotation or vibration and also neglects the deviations from Hooke's law, is obtained, that

$$(7. 60) \quad Q_i = (\sigma_e u_e)^{-1}.$$

It will be found convenient to substitute the variable z , (59), for ξ , and to note that

$$(7. 61) \quad \frac{2kT}{ar_0^2} = 4 \cdot \frac{h^2}{8\pi^2 \mu r_0^2 kT} \cdot \frac{4\pi^2 k^2 T^2 \mu}{h^2 a} = 4 \frac{\sigma}{u^2} = 4 \frac{\gamma}{u}.$$

Combining (59) and (61) with (54), $br_0 = x_e^{1/2} \gamma^{-1/2}$, one finds that

$$(7. 62) \quad b\xi = br_0 \left(\frac{2kT}{ar_0^2}\right)^{1/2} z = 2u_e^{-1/2} x_e^{1/2} z,$$

and from (59) and (61) alone,

$$(7. 63) \quad \frac{\xi}{r_0} = \left(\frac{2kT}{ar_0^2}\right)^{1/2} z = 2u_e^{-1/2} \gamma^{1/2} z.$$

The use of (62) and (63) in (58') leads to

$$(7. 64) \quad Q_i = \frac{1}{\sigma_e u_e \pi^{1/2}} \int_{-\infty}^{+\infty} (1 + 2u_e^{-1/2} \gamma^{1/2} z)^2 \\ \cdot e^{-z^2[1-2x_e^{1/2} u_e^{-1/2} z + (7/3)x_e u_e^{-1} z^2]} dz.$$

The small terms of the exponential may now be expanded in powers of z , the expansion multiplied by the square of the term in the brackets, and

the whole expression carried out to terms of the first power in γ/u_e or x_e/u_e . One obtains

$$(7. 65) \quad Q_i = \frac{1}{\sigma_e u_e \pi^{1/2}} \int_{-\infty}^{+\infty} \left[1 + 4\gamma^{1/2} u_e^{-1/2} z + 4\gamma u_e^{-1} z^2 + 2x_e^{1/2} u_e^{-1/2} z^3 + \left(8x_e^{1/2} \gamma^{1/2} u_e^{-1} - \frac{7}{3} x_e u_e^{-1} \right) z^4 + 2x_e u_e^{-1} z^6 \right] e^{-z^2} dz.$$

The integral $\int_{-\infty}^{+\infty} z^n e^{-z^2} dz$ is zero if n is odd. For $n = 0, 2, 4,$ and $6,$ it is respectively $\pi^{1/2}, \frac{1}{2}\pi^{1/2}, 3\pi^{1/2}/4,$ and $15\pi^{1/2}/8.$ One obtains for Q_i

$$(7. 66) \quad Q_i = \frac{1}{\sigma_e u_e} \left[1 + \frac{1}{u_e} (2\gamma + 6x_e^{1/2} \gamma^{1/2} + 2x_e) \right].$$

The logarithm is, as usual, developed, $\ln(1+x) = x - \dots,$ when x is small, so that

$$(7. 67) \quad \ln Q_i = -\ln \sigma_e - \ln u_e + u_e^{-1} (2\gamma + 6x_e^{1/2} \gamma^{1/2} + 2x_e).$$

The equivalent quantum-mechanical expression is the $\ln Q_{\text{vjm}}$ of equation (40), which has to be developed in a power series of u for comparison. The same result may be obtained directly by taking the negative of the equations for the free energy $\mathbf{F},$ and dividing by $RT,$ using the sum of the expanded forms given in (15), (20), and (46) for the rotational, vibrational, and interaction contributions, respectively. Neglecting terms of higher than the first negative power of $T,$ one obtains

$$(7. 68) \quad \ln Q_i \text{ (quantum mechanical)} = -\ln \sigma + \frac{\sigma}{3} - \ln u + \frac{u}{2} + u^{-1} (2\gamma + 6x^{1/2} \gamma^{1/2} + 2x) + (3\gamma - 3x^{1/2} \gamma^{1/2} - 2x) + \frac{u}{6} (-3\gamma + 3x^{1/2} \gamma^{1/2} + 5x).$$

In this expression, however, σ and u are obtained from the moment of inertia in the lowest vibrational level, and from the difference in energy of the lowest and first excited vibrational level, respectively, so that

$$(7. 69) \quad \sigma = \sigma_e (1 - \frac{1}{2}\delta) = \sigma_e (1 - 3x^{1/2} \gamma^{1/2} + 3\gamma),$$

from (33) and (30), and

$$(7. 70) \quad u = u_e (1 - 2x)$$

from (32).

The quantum-mechanical expression (68) also differs from the classical expression (67) in that the zero of energy is differently chosen. The energy ϵ_{00} of the lowest quantum-mechanical state is $kT (\frac{1}{2}u_e - \frac{1}{4}x_e u_e)$ higher than the lowest potential energy of the molecule, so that the quantum-mechanical $\ln Q_i$ is expected to be greater than the classical expression of (67) by $\frac{1}{2}u_e - \frac{1}{4}x_e u_e$, as has been discussed in section 7c.

Using (69) and (70) in (68), expanding $\ln (1 - \frac{1}{2}\delta)$ and $\ln (1 - 2x)$, and using $\sigma = u\gamma$, one obtains

$$(7. 71) \quad \ln Q_i \text{ (quantum mechanical)} = -\ln \sigma_e - \ln u_e \\ + u_e^{-1}(2\gamma + 6x^{1/2}\gamma^{1/2} + 2x) + \frac{\epsilon_{00}}{kT} + \frac{u_e}{12}(-2\gamma + 6x^{1/2}\gamma^{1/2} + x) - \dots,$$

in which the small difference between x and x_e has been neglected.

Except for the expected term ϵ_{00}/kT , the only difference between (67) and (71) is in the small terms proportional to u and therefore to the reciprocal of the temperature. Terms proportional to higher inverse powers of T have been neglected in the quantum-mechanical expression; the largest of these was $-u^2/24$, (20).

It is quite usual to find that the difference between the quantum-mechanical and classical expressions for $\ln Q$ is only in terms proportional to the second or higher inverse power of T . In the above example it can be seen that the small terms proportional to T^{-1} arise from a combination of quantum corrections proportional to T^{-2} and interaction terms proportional to T .

Returning to an examination of the classical expression (67), since σ_e and u_e are both proportional to T^{-1} , one obtains for the contribution E_i to the energy, and C_i to the heat capacity,

$$(7. 72) \quad E_i = RT^2 \frac{d}{dT} \ln Q_i \\ = RT[2 + u^{-1}(2\gamma + 6x_e^{1/2}\gamma^{1/2} + 2x_e)], \\ C_i = R \frac{d}{dT} T^2 \frac{d}{dT} \ln Q_i = \frac{dE_i}{dT} \\ = R[2 + 2u^{-1}(2\gamma + 6x_e^{1/2}\gamma^{1/2} + 2x_e)].$$

Both internal energy and internal heat capacity have the classical values $2RT$ and $2R$, respectively, calculated in section 6f for a diatomic molecule, plus an additional correction term proportional to T^2 and T , respectively, which arises from the interaction between rotation and vibration, and from the deviation from the Hooke's law equation for the potential energy assumed in section 6j.

7f. Molecules Composed of Two Identical Atoms

It was remarked at the end of section 7a that, if the two atoms of a diatomic molecule are identical and have no nuclear spin, only half of the rotational levels are allowed quantum levels of the molecule. For non-zero nuclear spin every second rotational level is allowed for a given mutual orientation of the spin. In section 7b the partition function of rotation for the occurrence of only odd and only even j 's was calculated, along with the case that all rotational levels were allowed.

It was found that, at high temperatures, the partition function for only odd j 's is equal to that for only even j 's, and to half the partition function for all j 's. The effect is that, at high temperatures, the energy, (16), and heat capacity, (18), is the same for all three cases, but the molecule with only half of the levels allowed has a lower entropy, (17), by $-R \ln 2$, and consequently a higher free energy, (15), by $RT \ln 2$, than the molecule with all levels allowed.

The reason for the prohibition of the even or odd j levels is that the wave functions of rotation are alternately symmetrical and antisymmetrical with respect to exchange of the nuclei, for even and odd j 's. If the two atoms are identical, only wave functions which have a definite symmetry character with respect to this exchange occur in nature, so that only odd, or only even, rotational levels can actually exist. The complete consideration of the details of the selection is somewhat complicated by the role of the nuclear spin and will be discussed at greater length in fine print at the end of this section.

One analogy may be found enlightening. The necessity of using only symmetric (Einstein-Bose) or only antisymmetric (Fermi-Dirac) wave functions resulted in reducing the total number of quantum states of a system of independent particles, from the number mathematically possible with distinguishable particles, by an amount that was practically equivalent to division by $N!$ if the particles were identical and the number of particles per cell was small. The effect of having two identical atoms in a diatomic molecule is to reduce the number of quantum states in a large range of j levels, by $2!$, or to one-half the number of states in a molecule with distinguishable atoms.

This had already been proved classically by Ehrenfest and Trkal.* As we have frequently mentioned, the classical phase volume is to be measured in such a way that points which differ only in a permutation of the identical atoms are counted once only. It is seen, then, that a rotation of a molecule consisting of two identical atoms by an angle around the center of mass corresponds exactly to such a permutation. The two points of phase space differing only in such a rotation should

* Ehrenfest and Trkal, *Proc. Sect. Sci. Amsterdam*, **23**, 169 (1920).

then be counted as only one point. In this way, of the possible range of values of the orientation angles, only one-half lead to intrinsically different configurations of the molecule; the phase volume is therefore cut in half, and the entropy, $S = k \ln W$, contains the additive term $-k \ln 2$ per molecule, due to the fundamental identity of the atoms.

To express the same statement differently, the phase volume W to be used in the equation $S = k \ln W$ must be calculated by using numbered particles, and then subsequently dividing by the factorials of the numbers of identical particles, if the entropy S is to be an extensive property of the system.

A diatomic gas, A_2 , containing N identical molecules, each composed of two identical atoms, actually consists of $2N$ identical atoms of the element. The phase space of such a system must be divided by $2N! \cong 2^{2N} N^{2N} e^{-2N}$.

This gas must be compared with a gas AB containing N identical molecules each consisting of two distinguishable atoms of types A and B, respectively. The molecules, however, will be assumed to have the same mechanical properties, mass, frequency, and moment of inertia, as in the first gas. The actual phase space calculated with numbered atoms will be different from that of the former gas, and indeed smaller by the factor 2^{-N} . This is seen from the fact that in gas A_2 with all atoms identical any atom can combine with any other atom, leading to $2N! / 2^{2N} N! = 2^N N^N e^{-N}$ different possible molecules if the atoms were numbered. In the gas AB only molecules in which atoms of type A are combined with atoms of type B are presumed to be present so that $N! = N^N e^{-N}$ different molecules of numbered atoms are present. However, this phase space calculated with numbered atoms is to be divided now, not by $2N!$ as formerly, but by $N_a! N_b! = N!^2 = N^{2N} e^{-2N}$. The total phase volume W , corrected by division with the factorials, will be less in the gas A_2 by the factor 2^{-N} than in the gas AB of the distinguishable atoms. The entropy $S = k \ln W$ will be less by the additive $-R \ln 2$ per mole for an elementary diatomic gas than for a mechanically similar compound.

That this difference between identical and distinguishable atoms in one molecule is a necessary consequence of the division of the phase space of a monatomic gas by $N!$, and not merely an unnecessary, although logical, extension of the idea, is shown by the following consideration. Suppose that we calculate S at different energies classically, for the element consisting of $2N$ identical atoms. At very high energies this system will actually be completely dissociated into a monatomic gas of $2N$ mechanically (almost) independent atoms, and our convention demands division by $2N!$. At lower energies there is obviously no dis-

continuous change in the properties of the system which would allow us to change this convention. At low energies, however, if the mechanical properties of the atoms are such as to form diatomic molecules, this will actually take place, and the system will exist as a diatomic gas of N molecules.

It is necessary classically to make the division by the factorials of the numbers of identical particles in the system consistently, whether all the particles are independent or not, in order to calculate correctly the equilibria between dissociated and undissociated molecules.

Quantum-mechanical rules for the selection of only symmetrical or only antisymmetrical wave functions lead to the result that, if nuclear spin is absent, only odd or only even j 's can occur in a diatomic element, with resulting decrease in S by the term $-R \ln 2$.

In diatomic elements with nuclear spin the same result is obtained at high temperatures, but in a more complicated manner. If the nucleus has spin s_n there exist $(2s_n + 1)^2$ possible orientations of the two nuclei in the molecule. Then both odd and even j 's occur, but with any *given* mutual spin orientation of the two atoms, only odd or only even j values are allowed. The total number of states, in a large range of j 's, is then exactly half of $(2s_n + 1)^2$ times the number which would be present if the atoms were not identical, and no spin were present. At high temperatures, where a range of j values can be regarded as having constant ϵ/kT , the entropy of a diatomic element has an additive contribution $2R \ln (2s_n + 1)$ per mole, due to nuclear spin, and $-R \ln 2$ per molecule to the symmetry. It was stated in section 6g that the entropy of nuclear spin cancels in all reactions and will always be neglected.

Let us consider a molecule made up of two identical atoms, that is, atoms which are both the same isotope of one element. The formula for the construction of the allowed wave functions for this molecule is first to label the nuclei of the atoms as if they were distinguishable, and then to pick only those functions which have the correct symmetry character with respect to exchange of the two nuclei. If the number of elementary particles in the nucleus is even, the mass number, or integral atomic weight, will be even, since the particles composing the nucleus are protons and neutrons of unit mass, and in this case the correct symmetry character is that the wave function be symmetric, that is, be not altered by an exchange of the two nuclei. If the mass number is odd, the number of elementary constituents of the nucleus is odd, and the correct wave functions are antisymmetric, that is, they are altered by only a change of sign if the two nuclei are exchanged.

In first approximation the wave function can be considered to be a product of the functions of the coordinate of the center of mass, the vibrational function, the electronic function, the rotational function, and the nuclear spin function. The exact wave function may have a somewhat different form and slightly

different energy from this simple product, but no perturbation which may have been neglected could change its symmetry character, so that one is justified in using this product to pick the symmetrical or antisymmetrical functions.

The coordinates of the center of mass of the molecule are unchanged by a permutation of the two identical nuclei of identical masses, so the wave function of these coordinates must also be unchanged, or completely symmetric, in such an exchange. The vibrational coordinate ξ is defined as the difference between the distance apart of the nuclei and their equilibrium distance. This coordinate is also unaffected by exchange of the nuclei. The vibrational wave function is consequently symmetrical. The electronic wave function of the lowest level is already antisymmetric in all permutations of electrons, but may be either symmetric or antisymmetric in exchange of the nuclei. The type of electronic function that makes up the most stable level of almost all diatomic molecules is symmetric with respect to nuclear exchanges. In order to fix the conditions let us assume this to be so for the molecule we are considering.

Each of the three functions, translational, vibrational, and electronic, is unaffected by the exchange of nuclei, so their product must also be unaffected by, or symmetrical with respect to, this permutation. The symmetry character of the complete wave function will be that of the product of the rotational and the nuclear spin functions. The product of two symmetrical functions is obviously symmetric, and that of an antisymmetric function with a symmetric one is antisymmetric, whereas the product of two antisymmetric functions is multiplied by $(-1)^2$ and is unchanged, symmetric, by the permutation of the nuclei.

The rotational function is a function of two angles, θ and ϕ , defined in section 2b as the angles which the axis from one of the atoms to the other makes with the z axis, and the angle which the projection of this axis on the xy plane makes with the x axis. An exchange of the two atoms reverses the direction of the axis and of the projection, changing the value of θ to $\pi - \theta$, and changing ϕ to $\phi + \pi$.

It is now necessary to examine the solution of rotational wave equation to ascertain what happens to the function if in every place that θ appears one substitutes $\pi - \theta$, and in every place that ϕ appears one substitutes $\phi + \pi$. The wave function is a product of a function of θ multiplied by one of ϕ . The θ function is a product of a power of $\sin \theta$ and a polynomial of $\cos \theta$ of order $j - m$ containing only odd, or only even, powers of $\cos \theta$, depending on whether $j - m$ is odd or even, respectively. The quantum number m is the number which gives the orientation of the total angular momentum j along the z axis. The function of ϕ is $e^{im\phi}$. The function $\sin \theta$ is unchanged by replacing θ with $\pi - \theta$; $\cos \theta$ changes sign in this operation.

The polynomial in $\cos \theta$ is multiplied by $(-1)^{j-m}$ by the replacement of θ with $\pi - \theta$, and $e^{im\phi}$ is multiplied by $e^{im(\phi + \pi)} = (-1)^m e^{im\phi}$ upon replacing ϕ with $\phi + \pi$. The total wave function is multiplied by $(-1)^{j-m}(-1)^m = (-1)^j$ if the nuclei are permuted; that is, functions of even j are symmetric, and those of odd j are antisymmetric, with respect to the exchange of the nuclei.

The next task is to examine the symmetry characters of the nuclear spin

functions. If the magnitude of the spin (in units $h/2\pi$) is s_n , then each atom may have any of $2s_n + 1$ spin functions. Let us designate these functions by α_i or by α_j , where i and j run from 1 to $2s_n + 1$. If atom a has spin function α_{ia} , and b has the function α_{jb} , then the spin function of the molecule will be $\alpha_{ia}\alpha_{jb}$, or some linear combination of this with the permuted function $\alpha_{ja}\alpha_{ib}$ (section 2k). The symmetric linear combination is $\alpha_{ia}\alpha_{jb} + \alpha_{ja}\alpha_{ib}$, and such a combination will always be possible. The antisymmetric function is $\alpha_{ia}\alpha_{jb} - \alpha_{ja}\alpha_{ib}$, but this function is zero if $i = j$.

There are $s_n(2s_n + 1)$ choices of i and j such that $i \neq j$, and for each of these one symmetric and one antisymmetric function can be constructed. There are $(2s_n + 1)$ values of $i = j$ which can be chosen, and for these only a symmetric function can be constructed. Out of the total of $(2s_n + 1)^2$ functions, then, there can be constructed $(s_n + 1)(2s_n + 1)$ symmetric functions and $s_n(2s_n + 1)$ antisymmetric ones, with respect to the permutation of the nuclei.

If one considers first the simple case that $s_n = 0$, so that only one spin function exists for each atom, and consequently only one for the molecule, this single function is symmetric. If the mass number of the nucleus is even the total wave function must be symmetric, and with a symmetric electronic function only symmetric rotational functions will be allowed, that is, only even values of j will be present. If the mass number is odd,* with symmetric electronic function, only odd j values will lead to the allowed antisymmetric total wave function of the molecule. With antisymmetrical electronic function, the situation would be reversed, and odd j 's would appear with even-mass-number, and even j 's with odd-mass-number elements.

In either case only half of the rotational levels would be permitted, and we have seen in section 7b that this results, at high temperatures, in an entropy lower by $-R \ln 2$ per mole than if all j 's were allowed.

If the spin magnitude s_n is not zero, both even and odd j levels will occur, but with different degeneracies, that is, with different statistical weights. With given electronic symmetry character, and given mass number, the odd j values can occur only with a certain specified nuclear spin symmetry character, and even j 's with the other. The degeneracy of one of the sets of j levels will be increased by the factor $(s_n + 1)(2s_n + 1)$, and the degeneracy of the levels of the other set by $s_n(2s_n + 1)$.

On the average, then, out of range of many j levels the number of states is $\frac{1}{2}(2s_n + 1)^2$ fold greater than for a molecule with all j levels filled and without nuclear spin. This will result in an entropy term, at high temperatures, of $2R \ln(2s_n + 1) - R \ln 2$ per mole. The first of these terms is the $R \ln(2s_n + 1)$ per gram atom of element due to nuclear spin which is present in all compounds and in the monatomic gas of the element. The second of the terms, $-R \ln 2$, is the usual term due to the symmetry of the diatomic molecule with the two identical atoms.

With nuclear spin, or without it, one always finds that the entropy of a diatomic gas at high temperatures is $-R \ln 2$ smaller if the two

* Odd-mass-number nuclei never have zero spin.

atoms composing a molecule are identical than if they are distinguishable.

At low temperatures transitions from symmetrical to antisymmetrical spin states are extremely slow. This is not so much due to any resistance which the nucleus offers to a force tending to reorient it, but rather to the fact that it is too slippery to be attacked by a force. The only force which tends to orient the spins is a magnetic one, and that acts but weakly. Normal collisions with other molecules, except strongly paramagnetic ones, have no effect.

At high temperatures the equilibrium is such that the ratio of the number of molecules with symmetrical spin functions to the number with antisymmetrical functions is the ratio of the numbers of the functions, namely, $(s_n + 1)/s_n$. As the temperature is lowered this ratio remains constant if no catalyst for the transitions is present.

The gas then behaves like a mixture of two kinds of molecules with fixed ratios of numbers, one kind of which exists only in odd, and the other kind only in even, rotational levels.

In hydrogen this phenomenon is marked. The moment of inertia is small, and the energy separation of the rotational levels is consequently great. The boiling point of hydrogen is extremely low, so that the gas can be obtained experimentally at very low temperatures. At the boiling point the temperature is sufficiently low compared to the energy of separation of the rotational levels that the rotation is almost completely "frozen" and that the specific heat is almost exactly that of a monatomic gas.

The hydrogen nucleus has a spin of one-half. There exist three symmetric spin functions, $(s_n + 1)(2s_n + 1)$, corresponding to the three orientations of a total vector of unity made up of the two half-vectors pointing in the same direction. Only one antisymmetric function exists, $s_n(2s_n + 1)$, for which the two nuclear spins are oppositely oriented with a resultant of zero. The total number of functions is four, which is just $(2s_n + 1)^2$. The symmetric functions form what is called ortho-hydrogen (probably because the spins are parallel), and the antisymmetric spins form what is called para-hydrogen.

At high temperatures one-fourth of the molecules exist as para-, and three-fourths as ortho-hydrogen. If hydrogen is cooled in the absence of a catalyst for the conversion, the relative numbers of the two kinds of molecules remain constant.

The total wave function of hydrogen must be antisymmetric (change sign) with respect to the exchange of nuclei, which consist of one elementary proton. The para-hydrogen, with antisymmetrical spin function, can exist only in the rotational levels of even j values which have

symmetrical wave functions, in order that the product of the functions shall be antisymmetric. The ortho-hydrogen is similarly limited to the odd j 's.

The behavior of hydrogen will be that of a mixture of the two kinds of molecules in the number ratio three to one, the more abundant ortho-hydrogen having only odd j 's with the lowest level of $j = 1$, the less abundant para molecules having only even j 's. The lowest energy which this inhibited system could attain is $\frac{3}{4}N_0$ times the energy of the rotational level $j = 1$.

The degeneracy of the lowest level of ortho-hydrogen, $j = 1$, is three, due to the nuclear spin states, multiplied by three for the $2j + 1$ different orientations of the j vector, or nine in all. The entropy of a mole of ortho-hydrogen in the lowest internal level is $R \ln 9$ plus the entropy of a monatomic gas. The total entropy of a mole of "inhibited" hydrogen at a temperature where the specific heat is that of a monatomic gas will be greater than that of a monatomic gas of the same molecular weight by the entropy of three-fourths of a mole of ortho-hydrogen, $\frac{3}{4}R \ln 9$, plus the entropy $\frac{3}{4}R \ln \frac{4}{3} + \frac{1}{4}R \ln 4$ of mixing of $\frac{3}{4}N_0$ molecules of ortho gas with $\frac{1}{4}N_0$ molecules of para gas (section 6h). This adds up to $R \ln 4 + \frac{3}{4}R \ln 3$.

If a catalyst which is capable either of dissociating the molecules on its surface, and consequently permitting their recombination in the lower energy form, or by its magnetic properties of reorienting the nuclear spins, is introduced into the low-temperature gas, the inhibition against transitions between ortho and para gas is removed. The molecules will all tend to attain the single low-energy state in which the spins are anti-parallel, and the rotational quantum number j is zero. This para-hydrogen has zero energy and zero entropy at the absolute zero.

CHAPTER 8

POLYATOMIC GASES

- (a) Introduction. (b) The Number of Degrees of Freedom. (c) Vibrational Contributions. (d) Rotation. (e) The Symmetry Number.

8a. Introduction

The purely statistical part of the problem of calculating the thermodynamic functions of a gas composed of polyatomic molecules is not difficult to solve. The mechanical problem of interpreting the spectral data, Raman, infra-red, or ultra-violet, in such a way as to learn the mechanical constitution of the molecule, however, is usually rather difficult. Until this is solved for a particular molecule, the methods of statistics cannot be applied to the gas.

It is usual to assume that the potential energy, which depends only on the distances between the atoms, has a single minimum at one particular geometrical relative configuration of the individual atoms, and that any displacement from this configuration results in an increase in potential energy.

If two essentially different minima occur, as often happens with complicated organic molecules, these two minima usually correspond to different molecular species which are structural isomers. An illustration is encountered in butane, C_4H_{10} , which may exist as normal butane, $CH_3CH_2CH_2CH_3$, or as isobutane, $(CH_3)_3CH$. These two configurations of the atoms correspond to distinctly different chemical compounds, and will be treated as such, so that configurations in the neighborhood of one of the minima only would be considered in making calculations for one of these compounds. If various minima exist, they may have almost the same energy, as in normal and isobutane of the above example, or they may have entirely different energies. If the two minima correspond to two optical antipodes, which differ only in the sense that the right and left hand differ, the energies of the two minima are identical.

In any event, the chemical problem of finding the properties of a system composed of one structural isomer alone finds its statistical analogy in determining the properties of a system which is inhibited to

that part of the phase space, or to those quantum states, corresponding to the neighborhood of one of the potential minima alone.

However, the total energy of the system may be so high that such transitions do actually occur at an appreciable rate. One may then use the method of Chapter 9 for an equilibrium mixture of gases capable of undergoing a chemical reaction.

A third condition is sometimes met, namely, one in which the height of the potential hill separating the minima is low compared with the average energy of the molecules. Then the quantum states of the molecules, and indeed those which are populated by the majority of the molecules under the conditions considered, cannot be said to belong to either one of the minima alone. The method of treating the equilibrium mixture of two isomers as a reaction equilibrium, in which the free energies of the isomers can be individually calculated, implies that all those quantum states of the molecules which are thickly populated can be said to belong to one and one only of the various isomers. Whether this is true or not will usually depend on the total energy, or temperature, of the system. However, it may well happen that even the lowest energy level of the molecule, which has the half-quantum of vibrational energy, may have a higher energy than that necessary to surmount the potential hill between two neighboring minima.

In such a case it is at once obvious that the two structural isomers could never be separated chemically. Many examples are known in which the separation of conceivable isomers has never succeeded, although obviously the experiments have never been conducted at the absolute zero of temperature. For instance, the organic chemist says that there is free rotation around the carbon-carbon bond in the substituted ethanes, $XYZC-CXYZ$. There are, presumably, three minima in such a compound, differing by a 120-degree mutual rotation of the two $-CXYZ$ groups about the axis of the $C-C$ bond. The evidence of organic chemistry indicates that even below room temperature there are rapid transitions between these minima. It is then doubtful that the quantum states of the molecule which are populated at room temperature can all be said to belong definitely to one or the other of these three minima. One must expect that the determination of the energies of the quantum levels of such a molecule will be a problem of considerable complexity.

Another distinction between different isomers and isomers which are to be treated as identical must be clearly understood. If the four tetrahedral hydrogens of the methane molecule, CH_4 , were different and distinguishable, two *different* minima would be found, as evidenced by the existence of two optical antipodes of $CClBrIH$, in which three

of the hydrogens have been replaced by different atoms. These two minima in CH_4 , however, are indistinguishable because of the identity of the hydrogen atoms.

In evaluating the *classical* phase space available to a molecule of methane below a certain energy one must double the phase space available in the neighborhood of one of these minima. This must, however, be divided by $4! = 24$, the factorial of the number of identical atoms. The total phase space available to the molecule with a certain energy must then be calculated by dividing that in the neighborhood of one of the minima by 12. This 12 is the symmetry number, γ , of the methane molecule, defined as the number of ways in which the molecule can be oriented without changing its potential energy in the orientation process, that is, by pure rotation, so as to obtain identical appearing configurations.

Stated differently, the classical phase space available to a molecule must be divided by the product of the factorials of all the numbers of identical atoms. Each one of these $\prod_i n_i!$ exchanges of atoms would lead to a different configuration of the molecule if all the atoms were numbered. We must, therefore, count the phase space available to one of these configurations only. If γ of these configurations can be converted into each other by rotation alone, then integration over all orientation angles calculates the phase space of γ configurations and must be divided by γ before use in the thermodynamic equations.

We shall, then, discuss first the methods of calculating the thermodynamic properties of a molecule in which it is assumed that all complications are absent, and later discuss in more detail the corrections due to symmetry in the molecule, and the cases in which the simplifying assumptions which have been made are unjustified.

8b. The Number of Degrees of Freedom

The number of degrees of freedom of a polyatomic molecule has already been discussed in section 6j. Most polyatomic molecules are stable only at relatively low temperatures (below 1000°K .), and fortunately the greater number of those which are chemically important have a single lowest electronic state with no excited level of energy so low that it is appreciably excited at these temperatures.

The configuration and motion of the molecule can then be described by the $3n$ Cartesian coordinates, and $3n$ conjugated momenta of the n atoms composing the molecule. The molecule has $3n$ degrees of freedom. One may transform to new coordinates, which must, however, be $3n$ in number.

Three of the new coordinates will naturally be chosen as the Cartesian

coordinates of the center of mass of the molecule, defined by

$$(8. 1) \quad X = \frac{\sum_i m_i x_i}{\sum_i m_i}, \quad \text{etc.},$$

where x_i is the x coordinate, and m_i the mass, of the i th atom. The wave function of the coordinates of the center of mass will be that of a free particle with mass equal to the sum of the masses of the atoms. These coordinates will then contribute additive terms to the thermodynamic functions of the gas equal to those of a monatomic gas of this mass.

Of the $3n - 3$ internal coordinates either two or three angles can be chosen which determine the orientation of the rigid frame of the atoms with their mutual distances fixed in the position of minimum potential energy. The potential energy does not depend on these angles. Two angles will be sufficient if this minimum corresponds to a linear molecule with all the atoms in a straight line. Three angles will be needed if the potential minimum corresponds to a non-linear figure.

If the molecule is linear, as the diatomic molecule, one can assume as a first approximation that the single moment of inertia is constant, and the variables in the Hamiltonian will be separable. One obtains an additive contribution from the rotational quantum number j to the energy of each quantum state, and corresponding additive contributions to the thermodynamic functions. These will be the same as the rotational contributions to a gas of diatomic molecules with the same value of the moment of inertia I . The moment of inertia of the polyatomic linear molecule is given by

$$(8. 2) \quad I = \sum_{i=1}^{i=n} m_i x_i^2,$$

where x_i is the distance of the i th atom of mass m_i from the center of mass, so that $\sum_i m_i x_i = 0$.

If the molecule is non-linear, one can assume, as a first approximation at least, that the moments of inertia will be fixed as those corresponding to the position of the minimum of potential energy. The Hamiltonian will again be separable, and the three angles will make additive contributions to the energies of the quantum levels of the molecule and to the thermodynamic properties of the gas. These calculations will be carried out in section 8d.

The potential energy of the molecule depends only on the remaining coordinates of the molecule which are called the vibrational coordinates.

8c. Vibrational Contributions

There remain $f_u = 3n - 6$ or $3n - 5$ degrees of freedom in non-linear and linear molecules, respectively. That is, there are f_u coordinates, q_i , and the potential energy can be expected to depend, at least to some extent, on all of them. These coordinates can be so chosen that zero value of all of them corresponds to the position of minimum potential, which will be assigned the energy zero. These coordinates then represent displacements of the figure from the position of equilibrium.

If the total potential energy U of the molecule is developed as a power series in the coordinates q_i , the condition that $U = 0$ when all the q_i 's are zero requires that the constant term in the development be absent. The condition that this energy be a minimum, i.e., $\partial U / \partial q_i = 0$ for all q_i 's when all q_i 's are zero, requires that the power series begin with the quadratic terms, that is, that all linear terms are zero. The cubic and higher-order terms will be smaller than the quadratic at sufficiently small displacements from the equilibrium position, at small values of the q_i 's. As a first approximation they may be neglected, so that the potential can be written as a sum of terms, each of which is quadratic in the q_i 's, but among which there will, in general, occur cross-product terms of the type $q_i q_j$.

It is a mathematical theorem that, whatever the values of the force constants (the coefficients of the various terms) and whatever the values of the reduced masses (one-half the inverse of the coefficients of the terms p_i^2 in the kinetic energy), one can always transform to new "normal coordinates" q_λ such that, with their conjugated momenta p_λ , the Hamiltonian has the form

$$(8.3) \quad H_u(q_\lambda, p_\lambda) = \sum_{\lambda=1}^{\lambda=f_u} \frac{a_\lambda}{2} q_\lambda^2 + \sum_{\lambda=1}^{\lambda=f_u} \frac{1}{2\mu_\lambda} p_\lambda^2.$$

In this equation the essential simplification which has been reached is the elimination of the second-order cross-product terms of the type $q_i q_j$ in the potential energy (without the introduction of cross products $p_i p_j$ in the kinetic energy). The a_λ 's are the generalized force constants, and the μ_λ 's the generalized reduced masses. (By a linear change of scale the coordinates are often so determined that the reduced masses are all unity.)

The third-order terms in the potential, if included in the above equation, would, unfortunately, contain cross products. Their neglect is justified only if they are negligible compared with the quadratic terms for such displacements q_λ that the quadratic terms $(a_\lambda/2)q_\lambda^2$ are of the order of magnitude of kT .

If the third-order terms are neglected, the Hamiltonian is separable,

that is, it consists of a sum of terms each depending on one only of the f_u coordinates with its conjugated momentum. The wave function is a product, and the energies of the quantum states a sum of terms, each depending on the one quantum number v_λ associated with the normal coordinate q_λ . The additive part of the Hamiltonian for each coordinate with its conjugated momentum is exactly the Hamiltonian of the harmonic oscillator with the force constant a_λ and the mass μ_λ . The solution in classical, or in quantum mechanics consists then of independent harmonic vibrations of the system along all of the normal coordinates, each with its own frequency $\nu_\lambda = (1/2\pi)(a_\lambda/\mu_\lambda)^{1/2}$. The contribution of each coordinate to the energy of a quantum state of the molecule will be, as for the vibration of a diatomic molecule, $\epsilon_\lambda = (v_\lambda + \frac{1}{2})h\nu_\lambda$.

The partition function Q is then a product, and $\ln Q$ a sum, of f_u terms, each of the same type as the Q_v and $\ln Q_v$ calculated for the diatomic molecule in section 7c, in which the frequency ν_λ must be used in the term Q_λ or $\ln Q_\lambda$.

The analysis of the motion of the molecule as harmonic oscillation along the normal coordinates is essentially a formal one. It has no more, but also no less, physical significance than the arbitrary analysis of a wave as a Fourier sum or integral of sine and cosine waves. In the case of white light the spectrograph makes a physical analysis of the wave which is exactly that of the formal mathematical analysis into a Fourier integral. So also certain experiments analyze the motion of a large-scale model of a molecule, which obeys the classical laws, into harmonic vibration along the normal coordinates.

If such a model is distorted from its equilibrium shape, and then released, the rather complicated motion which ensues may be analyzed in the formal manner described as harmonic vibration along the normal coordinates. If the original displacement were such that only one, q_λ , of the normal coordinates q_λ were different from zero, and if the cubic interaction terms were really zero, the subsequent motion would actually be true harmonic vibration along this coordinate, q_λ , with the frequency ν_λ , all the other coordinates remaining zero during the motion.

If such a model is shaken with a variable frequency, say by an electric motor, the amplitude of the motion of the molecule will be small at most frequencies. If, however, the frequency of the shaking becomes that of one of the normal coordinates, the amplitude will increase markedly and the molecule will vibrate along that coordinate.*

In Fig. 8.1, the directions of the motion given by displacements along

* C. F. Kettering, L. W. Shutts, and D. H. Andrews, *Phys. Rev.*, **36**, 531 (1930); D. E. Teets and D. H. Andrews, *J. Chem. Phys.*, **3**, 175 (1935).

the normal coordinates are shown for some of the simpler types of molecules. The exact angles of the displacements will depend on the numerical values of the forces and of the masses, but certain of the characteristics of the motion can be deduced from considerations of the symmetry of the molecule alone. These considerations are of prime

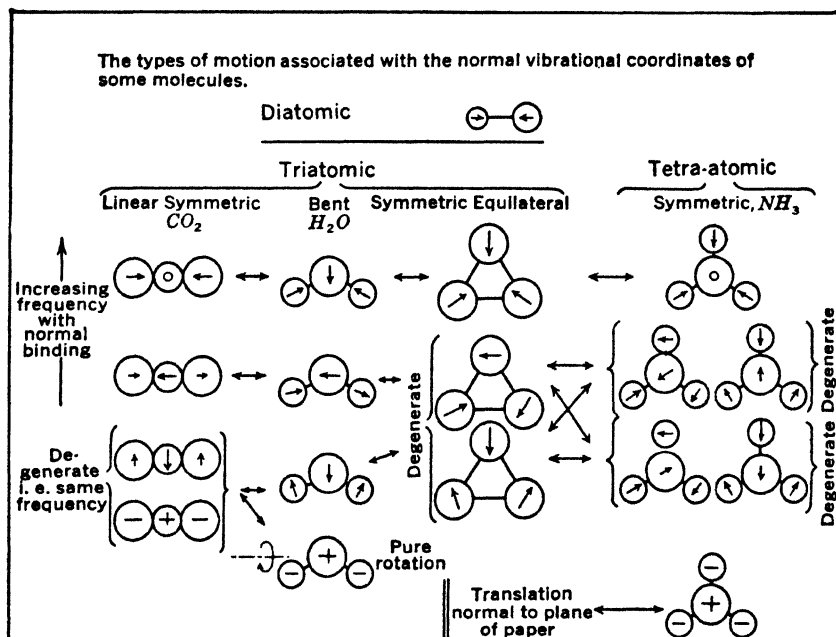

FIG. 8. 1.*

importance in the case of such a relatively complicated, but extremely symmetrical, molecule as benzene, C_6H_6 .† The most useful tool for these considerations is the mathematical theory of groups.

In general if the molecule has some degree of symmetry, not all the f_u frequencies, ν_λ , will have different numerical values, but there may be several of the normal coordinates for which the frequencies will be necessarily identical. In this case it is also true that the choice of the normal coordinates will not be unique, since any linear combination of two coordinates with the same frequency will also be a normal coordinate of the system. However, the number of normal coordinates, and therefore the number of terms in Q_λ which enter into the thermodynamic functions, is uniquely fixed.

* The order of frequencies depends on the masses and binding. That of the upper two is, for instance, reversed in CO_2 .

† E. B. Wilson, Jr., *Phys. Rev.*, **45**, 706 (1934).

In such a case the coordinates of identical frequencies are said to be degenerate, and two or more $\ln Q_\lambda$ terms enter into the thermodynamic expressions with the same frequencies.

The numerical values of the frequencies are always obtained from an analysis of the spectrum of the molecule. They may be observed in the infra-red, the Raman, or the visible or ultra-violet spectrum of the gas.

If the molecule is completely unsymmetrical all f_u frequencies will be essentially different, although, of course, one cannot completely rule out the possibility that by pure chance two of them may be very close to each other in value. In this case of a completely unsymmetrical molecule all f_u frequencies will be, in principle at least, observable in any one of the above spectra.

If all f_u different frequencies are actually observed, no mechanical analysis of the motion of the molecule is necessary. The contribution of the f_u degrees of freedom to the thermodynamic properties of the gas will be given by f_u terms of the same type as the contribution due to vibration in a diatomic molecule, each depending on one frequency alone.

In a symmetrical molecule, however, certain difficulties are encountered. The frequencies due to certain of the normal coordinates will be absent in one, or even conceivably in all three, of the above types of spectra. For instance, the first type of motion for the symmetrical linear triatomic molecule CO_2 shown in Fig. 8. 1 is one in which the oxygens always move in opposite directions, and the carbon remains fixed. For this motion there is no dipole displacement of the electric charge, and the frequency associated with this normal coordinate will be absent, or at least very weak, in the infra-red spectrum of the gas.

Even if all the different frequencies are actually observed their total number will often be less than f_u owing to the essential degeneracies present in a molecule of the given symmetry. One must then ascertain which of the observed frequencies are to be used twice or more often in the thermodynamic terms. In order to do this an analysis of the mechanical motions of the molecule is necessary. For some of the simpler molecules this may be done almost intuitively; for others it is extremely complicated.

For CO_2 a few qualitative considerations are sufficient to enable one to place the observed frequencies uniquely. The four modes of motion of the four normal coordinates can be seen intuitively to be those sketched in Fig. 8. 1. The first motion shown will not occur in the infra-red but will be present in the Raman spectrum of the molecule. This type of motion, in which the oxygen atoms move oppositely, will have a frequency between the other two (about 7.5μ). The second type of motion in which the oxygens move together should be observed in the

infra-red, since in this type of motion the center of gravity of the negative charge, associated with the oxygen atoms, moves with respect to the center of gravity of the positive charge. This frequency will be missing in the Raman spectrum. This type of motion has the highest frequency (about 4.7μ). The third type of motion is degenerate, and it is this frequency which must be used twice in the thermodynamic terms. This type of motion is a bending of the molecule, and will be infra-red active, but Raman inactive. However, the forces resisting bending in a molecule are much weaker than those resisting changes of distance between the atoms, so that this frequency would be expected to be decidedly lower in value than either of the others (about 15μ).

One expects, then, for CO₂, to find two strong infra-red frequencies reported, one of which should be very considerably lower than the other. In the Raman spectrum one expects only one strong line, the frequency of which should lie between those of the two infra-red-active vibrations. The lower of the two infra-red-active frequencies is the degenerate one.

The actual situation in CO₂ is complicated by the occurrence of what is called an accidental degeneracy. The frequency of the bending motion is almost exactly half of that of the frequency of the Raman active vibration, so that the two quantum levels, one in which there are two quanta in the bending degrees of freedom and the one in which there is one quantum in the stretching degree of freedom, have the same energy. These two levels combine, that is, they form two new levels, one of lower, and one of higher energy, each of which has some of the mechanical properties of both of the original levels.* Consequently, two Raman lines are observed, instead of the single line which we had been led to expect. The regular equal spacing of the vibrational levels in the energy scale is also distorted, and so for CO₂ one cannot expect that the thermodynamic properties would be correctly calculated by the simple equations which have been derived here.

For the CO₂ molecules, as for most molecules consisting of only three or four atoms, simple qualitative considerations are sufficient to enable one to predict the type of spectral frequencies which will be found and to interpret any anomalies which occur. For more complicated molecules, such as benzene, a careful mathematical analysis of the mechanical problem is necessary before the observed frequencies can be utilized for statistical calculations.

The usual method of attack involves first a group theoretical analysis of the normal coordinates, making use of the symmetry properties of the molecule. The number of *different* frequencies is determined in this

* Enrico Fermi, *Z. Physik*, **71**, 250 (1931).

manner, the degeneracy of each type of motion is found, and for each frequency it is determined if it will be infra-red or Raman active. By qualitative considerations, an attempt is made to order the different modes of motion in order of the numerical values of their frequencies, and thus to associate the observed infra-red and Raman lines with the different normal coordinates.

If, as in benzene, some of the frequencies are completely absent in both the Raman and the infra-red spectra, and are also not known from the electronic transition spectrum, a further numerical analysis is necessary. The force constants for the different normal coordinates may be expressed as functions of the forces between the individual atoms. By neglecting the forces between distant atoms, and making ample use of the symmetry of the molecule, the number of different force functions between the atoms may be reduced to equal or less than the number of observed frequencies. One has then, in principle, enough observed data to determine all the unknown forces, and so to calculate numerical values for the unobserved frequencies. Needless to say, the operations are rather difficult.*

In order to deduce that the contribution of the f_u oscillatory coordinates to the thermodynamic function, X , of the gas was to add f_u terms of the type X_v , calculated in section 7c, it was necessary to assume that the cubic terms properly present in equation (3) were negligible. It is obvious that for sufficiently small displacements q_λ this is legitimate. However, the actual displacements at any temperature are approximately given by the relation that the quadratic term has the value kT , so that the temperature range of validity can be estimated by these conditions. It is not always true that the approximation is justified even at room temperature.

Two rather different types of deviations may occur.

One of these is that the cubic and higher-order terms for one of the normal coordinates alone must be considered, but the cross-product terms in which the coordinate is multiplied by others may be neglected. In this type of deviation the Hamiltonian is still separable, but the energy of a quantum level due to the coordinate q_r is not now given by the simple equation $(\nu_r + \frac{1}{2})h\nu_r$, even for energies of about kT or less, but by some more complicated expression. The additive contribution of this coordinate to $\ln Q$ may still be calculated as one term, independently of the others, but will not be given by the form of $\ln Q_v$ due to simple harmonic vibration.

The problem is again essentially mechanical, and not statistical. If the actual quantum levels due to this coordinate can be found in the

* R. C. Lord, Jr., *J. Phys. Chem.*, **41**, 149 (1937).

spectra then numerical summation of $e^{-\epsilon_r/kT}$ will yield the desired value of Q_r . If, instead, the actual form of the potential were known, or could be guessed with reasonable certainty, it would always be possible to solve for the quantum levels, if necessary, by numerical integration of the one-dimensional wave equation, and to find Q_r by direct summation.

A problem of this sort which has not been completely solved arises in ethane, $\text{H}_3\text{C}-\text{CH}_3$. One of the normal coordinates of this molecule corresponds to equal and opposite rotation of the two CH_3 groups about the axis of the $\text{C}-\text{C}$ bond. Now two extreme cases are conceivable, and it is probable that the true state of affairs lies between them. One might assume that the three symmetrical positions of minimum potential energy for this coordinate are separated by such low potential hills that it would be possible to treat the potential energy as though it were independent of the value of this coordinate. The quantum-mechanical solution is then easy,* and leads to the energy levels

$$(8. 4) \quad \epsilon_r = \frac{\mathbf{r}^2 h^2}{16\pi^2 C},$$

where \mathbf{r} is an integral quantum number, and C is the moment of inertia of *one* of the CH_3 groups about the $\text{C}-\text{C}$ axis of the molecule.

The other extreme would be to assume that the minima along this coordinate are so steep that one can use the quadratic term in the potential expression alone, and assume that the rotational vibrational amplitude is never great enough to leave the region near one of the minima where this is allowable. This is, of course, justifiable only if the potential hills separating the minima are much higher than the value of kT . If this is assumed $\epsilon_r = (\mathbf{r} + \frac{1}{2})h\nu_r$.

One might assume that a decent approximation of the potential for all values of the coordinate q_r would be obtained by the equation

$$(8. 5) \quad u(q_r) = \frac{1}{2}A(1 + \cos 3q_r).$$

At q_r equal to zero, $2\pi/3$, and $4\pi/3$, the cosine has the value unity and the potential has the maximum value of A , the top of the hill between the minima. At $q_r = \pi/3$, π , and $5\pi/3$, the potential is zero; these are the positions of the three minima.

The quantum levels can be calculated for this type of potential, and their values are obtained as a function of the unknown A .† Motion

* J. E. Mayer, S. Brunauer, and M. Goeppert Mayer, *J. Am. Chem. Soc.*, **55**, 37 (1933).

† E. Teller and K. Weigert, *Nachr. Ges. Wiss. Göttingen*, 218 (1933).

along this coordinate is neither infra-red nor Raman active, so the calculated levels cannot be compared with spectroscopic frequencies in order to determine A . The only available method to determine this parameter is to compare the thermodynamic properties of the gas with the calculated values, assuming that all the other frequencies are correctly determined. This method of comparison is open to several uncertainties.

The second type of deviation from the assumption of f_u simple harmonic oscillational degrees of freedom is one in which the cross-product cubic terms in the potential are appreciable at energies corresponding to the temperature for which the calculations are made. Under these conditions the situation becomes so complicated mechanically that it is doubtful that such a problem will be successfully solved in the near future.

We have already encountered, in the discussion of the CO_2 molecule, an example of the accidental degeneracy of two levels causing difficulty in the interpretation of the spectra. The magnitude of the energy splitting which arises when two levels of the molecule approach each other in energy, due to such an accidental numerical relationship in the values of the different frequencies, is dependent on the magnitude of the cubic and higher-order terms containing cross products between the q_λ 's. If the coefficients of these terms are identically zero the splitting will be zero.

Another difficulty which sometimes reduces the accuracy of the values of $\ln Q$ obtained by the method outlined here is the stretching of the molecule in the higher vibrational and rotational levels. This results in a dependence of the moment of inertia on the angular momentum and on the quantum numbers of vibration. This effect was specifically calculated for diatomic gases in section 7d. It is impossible to make as general a calculation for all types of polyatomic molecules, and since the rotational spectrum is not usually analyzed, the constants for such an empirical formula as (7. 24) are unknown. For any particular molecule it is always possible to ascertain the extent of the stretching if all the frequencies are known,* but this is usually a moderately involved mechanical calculation.

It is to be expected that for such rigid molecules as CH_4 , or C_6H_6 , this effect of lack of constancy of the moments of inertia would not be very important. For propane, $\text{CH}_3\text{CH}_2\text{CH}_3$, in which the carbons are not in a straight line, the effect may be very appreciable at room temperature.

It is seen that one is usually restricted to making much less accurate

* E. B. Wilson, Jr., *J. Chem. Phys.*, **4**, 526 (1936).

calculations for polyatomic than for diatomic molecules. Nevertheless, the methods outlined in this chapter are capable of giving rather good results for many molecules.

8d. Rotation

The rotational contribution to the partition function of a linear polyatomic molecule is the same as that for a diatomic molecule with the same moment of inertia. The moment of inertia of the polyatomic molecule must be calculated by equation (2).

The rotational spectra even of most linear polyatomic molecules have not been analyzed. The moment of inertia is consequently not known from the spectral data, and must be calculated from equation (2) using distances obtained from electron diffraction, X-ray, or semi-empirical information. The distance between definite atomic pairs with a given type of chemical binding appears to be remarkably constant and independent of the particular molecule in which the pair occurs.

For non-linear polyatomic molecules we must calculate the partition function due to the three degrees of freedom of rotation. The general quantum-mechanical solution for the rotational coordinates of a rigid body cannot be made, but, since the moments of inertia are almost invariably large, the quantum levels are closely spaced compared with the value of kT at the boiling point of the gas, and the classical approximation may be safely used.

The moment of inertia, A , of a body composed of n mass points of masses $m_1, \dots, m_i, \dots, m_n$, about any axis in space is given by the equation

$$(8. 6) \quad \sum_{i=1}^{i=n} m_i r_i^2 = A,$$

where r_i is the perpendicular distance of the mass point from the axis. If the axis passes through the center of mass of the molecule it follows that

$$(8. 7) \quad \sum_{i=1}^{i=n} m_i \vec{r}_i = 0$$

if \vec{r}_i is considered a vector.

If the magnitudes of the moments of inertia of any rigid body about the various axes passing through one point in space are plotted along the directions of the axes, they fall on the surface of an ellipsoid with its center at the origin of the plot. This means that three perpendicular axes can be found such that the moment of inertia about one of them is a maximum (is larger or equal to the moment about any other axis),

the moment about the second is a minimum, whereas the moment about the third axis is in a saddle point, so that it is smaller than the moment of any other axis in the plane common to it and the first axis, and greater than that of any other axis in the plane common to it and the second axis.

These three moments of inertia, about the center of mass of a molecule, are called its three principal moments of inertia, A , B , C , and the three axes are referred to as the principal axes of the molecule.

If the three principal moments are all equal, as in methane, the molecule is called a spherical top, and, of course, the moments about all axes through the center of mass then have the same value. If two moments are equal, but the third has a different value, the molecule is said to be a symmetrical top, and then all axes in the plane of the two axes with equal moments have the same moments of inertia. Benzene, ethane, and chloroform molecules are symmetrical tops.

If the position of the i th atom in Cartesian coordinates is x_i , y_i , z_i , then

$$\sum_{i=1}^{i=n} m_i x_i = \sum_{i=1}^{i=n} m_i y_i = \sum_{i=1}^{i=n} m_i z_i = 0,$$

if the center of mass is taken as the origin. The moments of inertia about the x , y , and z axes are, respectively,

$$I_{xx} = \sum_{i=1}^{i=n} m_i (z_i^2 + y_i^2), \quad I_{yy} = \sum_{i=1}^{i=n} m_i (z_i^2 + x_i^2), \quad I_{zz} = \sum_{i=1}^{i=n} m_i (x_i^2 + y_i^2),$$

and products of inertia I_{yz} , I_{xz} , I_{xy} , may be defined as

$$I_{yz} = \sum_{i=1}^{i=n} m_i y_i z_i, \text{ etc.}$$

The three equations

$$\begin{aligned} \alpha(I_{xx} - \eta) - \beta I_{xy} - \gamma I_{xz} &= 0 \\ -\alpha I_{xy} + \beta(I_{yy} - \eta) - \gamma I_{yz} &= 0 \\ -\alpha I_{xz} - \beta I_{yz} + \gamma(I_{zz} - \eta) &= 0 \end{aligned}$$

with

$$\alpha^2 + \beta^2 + \gamma^2 = 1$$

can be solved for three different values of η which are the three principal moments of inertia. The corresponding values of α , β , γ are the direction cosines of the three principal axes. It is seen that if all the products of inertia are zero the x , y , and z axes are the principal axes and their moments are the principal moments of inertia of the molecule.

The three Eulerian angles, θ , ϕ , and ψ are used to describe the orientation of a rigid body in space.

If x , y , and z are taken as the three Cartesian coordinates fixed in space, and ξ , η , ζ as the three principal (perpendicular) axes of the body, then θ is the angle between the body axis ζ and the space axis z . The line in the xy plane perpendicular to the plane common to ζ and z is called the nodal line. The angle between this nodal line and the x axis is ϕ . Thus θ and ϕ completely determine the direction of the ζ axis in space. The angle between the nodal line and the ζ axis in the body is ψ . This, then, completely defines the orientation of the whole body with fixed center of gravity.

The angle θ may vary between 0 and π ; the two angles ϕ and ψ take all values from 0 to 2π .

The Hamiltonian of the rigid body with fixed center of gravity is just the kinetic energy, written as a function of these angles and their conjugated momenta, namely,

$$(8. 8) \quad H = \frac{\sin^2 \psi}{2A} \left\{ p_\theta - \frac{\cos \psi}{\sin \theta \sin \psi} (p_\phi - \cos \theta p_\psi) \right\}^2 + \frac{\cos^2 \psi}{2B} \left\{ p_\theta + \frac{\sin \psi}{\sin \theta \cos \psi} (p_\phi - \cos \theta p_\psi) \right\}^2 + \frac{1}{2C} p_\psi^2.$$

This can be transformed into an expression which will be found more convenient for future operations,

$$(8. 9) \quad \frac{H}{kT} = \frac{1}{2kT} \left(\frac{\sin^2 \psi}{A} + \frac{\cos^2 \psi}{B} \right) \left\{ p_\theta + \left(\frac{1}{B} - \frac{1}{A} \right) \frac{\sin \psi \cos \psi}{\sin \theta \left(\frac{\sin^2 \psi}{A} + \frac{\cos^2 \psi}{B} \right)} (p_\phi - \cos \theta p_\psi) \right\}^2 + \frac{1}{2kT AB \sin^2 \theta} \frac{1}{\left(\frac{\sin^2 \psi}{A} + \frac{\cos^2 \psi}{B} \right)} (p_\phi - \cos \theta p_\psi)^2 + \frac{1}{2kTC} p_\psi^2.$$

The partition function due to the rotation of this body is

$$(8. 10) \quad Q_{\text{Rot.}} = \int_{-\infty}^{+\infty} \int_{-\infty}^{+\infty} \int_{-\infty}^{+\infty} \int_0^\pi \int_0^{2\pi} \int_0^{2\pi} \frac{1}{h^3} e^{-H(p,q)/kT} dp_\theta dp_\phi dp_\psi d\theta d\phi d\psi.$$

The substitution of (9) in (10) appears to lead to a rather formidable integral, but direct integration in the order p_θ , p_ϕ , p_ψ actually offers no difficulties. It is necessary to remember that

$$\int_{-\infty}^{+\infty} e^{-a(x+b)^2} dx = \int_{-\infty}^{+\infty} e^{-ax^2} dx = \left(\frac{\pi}{a} \right)^{1/2}.$$

Integration over p_θ leads to the factor

$$(2\pi kT)^{1/2} \left\{ \frac{\sin^2 \psi}{A} + \frac{\cos^2 \psi}{B} \right\}^{-1/2}.$$

Subsequent integration over p_ψ yields

$$(2\pi kTAB)^{1/2} \sin \theta \left\{ \frac{\sin^2 \psi}{A} + \frac{\cos^2 \psi}{B} \right\}^{1/2},$$

as a factor, which cancels part of that obtained in the first integration. Integration over p_ψ yields the factor

$$(2\pi kTC)^{1/2}.$$

Integration of $\sin \theta d\theta$ from 0 to π gives 2, and the other angles give each a factor 2π , so that

$$(8.11) \quad Q_{\text{Rot.}} = \pi^{1/2} \left(\frac{8\pi^2 AkT}{h^2} \right)^{1/2} \left(\frac{8\pi^2 BkT}{h^2} \right)^{1/2} \left(\frac{8\pi^2 CkT}{h^2} \right)^{1/2}.$$

If, in conformity with the notation adopted in section 7b for the diatomic molecule, we define

$$(8.12) \quad \sigma_A = \frac{h^2}{8\pi^2 AkT}, \quad \sigma_B = \frac{h^2}{8\pi^2 BkT}, \text{ etc.,}$$

then

$$(8.13) \quad \ln Q_R = \frac{1}{2} \ln \frac{\pi}{\sigma_A \sigma_B \sigma_C}.$$

Using equations (6. 25') to (6. 29') for the contribution of these three degrees of rotational freedom to the thermodynamic properties of the gas, one obtains

$$(8.14) \quad \mathbf{F}_R = -RT \ln Q_R = RT \frac{1}{2} \ln \frac{\sigma_A \sigma_B \sigma_C}{\pi},$$

$$(8.15) \quad \mathbf{S}_R = R \frac{d}{dT} (T \ln Q_R) = R \left(\frac{3}{2} + \frac{1}{2} \ln \frac{\pi}{\sigma_A \sigma_B \sigma_C} \right),$$

$$(8.16) \quad \mathbf{E}_R = \frac{3}{2} RT,$$

$$(8.17) \quad \mathbf{C}_R = \frac{3}{2} R.$$

8e. The Symmetry Number

Just as in symmetrical diatomic molecules consisting of two identical atoms, for which only half of the rotational levels occur, symmetrical polyatomic molecules do not have as many allowed rotational levels as unsymmetrical ones.

The symmetry number γ of a molecule is defined as the number of different values of the rotational coordinates which all correspond to one orientation of the molecule, remembering that the identical atoms are indistinguishable. Thus the symmetry number of a diatomic molecule of two identical atoms is two. The molecule CO_2 , which is linear, $\text{O}=\text{C}=\text{O}$, has also a symmetry number two. The symmetry number of tetrahedral methane is twelve, since any of the four corners of a tetrahedron may be placed upright without altering its apparent orientation, and with each of the four corners up the three positions differing by a rotation of $2\pi/3$ about the vertical axis look identical. The symmetry number of benzene, C_6H_6 , is also twelve, if, as is presumed, the molecule is a regular hexagon with all the atoms lying in one plane. With either side of the plane facing upwards there are six positions differing by rotation of integrals of $\pi/3$ about the vertical axis, all of which are identical if the atoms are unnumbered.

If the molecule contains n_1 identical atoms of kind 1, \dots , n_i of kind i , then $\prod_i n_i!$ permutations of these atoms are possible. If the atoms were all distinguishable in principle these $\prod_i n_i!$ permutations would all lead to different configurations of the molecule, but only $(\prod_i n_i!)/\gamma$ of these would be different molecules, since each of the configurations could be transformed into γ other ones by a rotation of the molecule alone. The number of distinct minima, Λ , in the potential energy diagram of such a molecule, all having identical energies, will be

$$\Lambda = \frac{1}{\gamma} \prod_i n_i !,$$

in which γ is the symmetry number.

For example, in methane there are four identical hydrogen atoms, or twenty-four different permutations, of which twelve can be obtained by rotation. The two essentially different configurations show up as the two optical isomers if three of the hydrogens are replaced by different groups.

The classical phase space of such a molecule must be divided by $\prod_i n_i!$ (and by h^f) in order to obtain agreement with the number of quantum states in a certain energy interval. However, if, as is usually done, the phase space in the neighborhood of *one* of the Λ minima alone

is calculated, then this must be multiplied by Λ before division by $\prod_i n_i!$, which, from the equation for Λ , can be seen to result in a division by the symmetry number γ . As in the case of symmetrical diatomic molecules the classical phase space of the molecule (in the neighborhood of one potential minimum) must be divided by the symmetry number, γ , in order to calculate the correct thermodynamic properties.

The quantum-mechanical problem has the corresponding solution. Out of a range containing a large number of rotational levels found in the mathematical solution, only the fraction $1/\gamma$ will have the symmetry character with respect to permutations of the identical atoms which is necessary in order to satisfy the conditions imposed by nature on the complete wave function of the molecule. The actual form of the symmetry which will be necessary in the rotational eigenfunctions, whether symmetrical, antisymmetrical, or even some more complicated character, and the actual rotational states which are allowed, will depend on many factors such as the mutual orientation of the nuclear spins, the mass number of the nuclei, and the vibrational and electronic level. However, at high temperatures (and for a polyatomic molecule all reasonable temperatures may be regarded as high) the values of the thermodynamic properties depend only on the average number of states allowed. The effect of symmetry in the molecule is always to add $-R \ln \gamma$ per mole to the entropy, and $RT \ln \gamma$ per mole to the free energy. The nuclear spin entropy is, as always at high temperatures, just $R \ln (2s_n + 1)$ per gram atom of element with spin s_n .

With certain molecules one appears to get into some difficulties with the symmetry number, since two differing viewpoints are possible. Closer inspection shows the difficulties to be easily resolvable, since both viewpoints, if developed systematically, lead to the same result. It may, however, be instructive to analyze one such molecule.

It has already been stated in section 8a that it is questionable whether, for the molecule ethane, $\text{H}_3\text{C}-\text{CH}_3$, one should regard the opposite mutual rotation of the CH_3 groups about the axis of the $\text{C}-\text{C}$ bond as completely inhibited or as partially free. If rotation about this bond is completely prevented, so that one calculates the distribution of the molecules in the phase space, or quantum states, in the neighborhood of one of the three symmetrical potential minima only, the symmetry number arrived at is six. This is seen by considering that rotation of the molecule as a whole about the $\text{C}-\text{C}$ axis leads to three corresponding positions, and rotation by π about an axis normal to the $\text{C}-\text{C}$ bond leads to another set of three equivalent positions.

If independent rotation of the methyl groups around the $\text{C}-\text{C}$ axis is assumed the symmetry number is threefold greater, or $\gamma = 18$.

There are six identical hydrogen atoms and two carbon atoms in the molecule, so that $\prod_i n_i! = 6!2! = 1440$. The number of different isomers, Λ (that is, different if the atoms were distinguishable), assumed in hindered oscillation is $1440/6 = 240$, and in free rotation, one-third of this number, or 80. For free rotation one can count the 80 isomers as due to the $(6!/3!3!) = 20$ different ways that one can associate three out of six numbered hydrogen atoms with each of the two numbered carbon atoms, multiplied by 4 because around each carbon the order of the hydrogens in a cycle may take two different values. With hindered mutual oscillation about the C—C bond there are three times as many isomers.

That is, for ethane, one may either choose $\gamma = 18$, $\Lambda = 80$, or $\gamma = 6$, $\Lambda = 240$, depending on whether one counts, respectively, the total phase

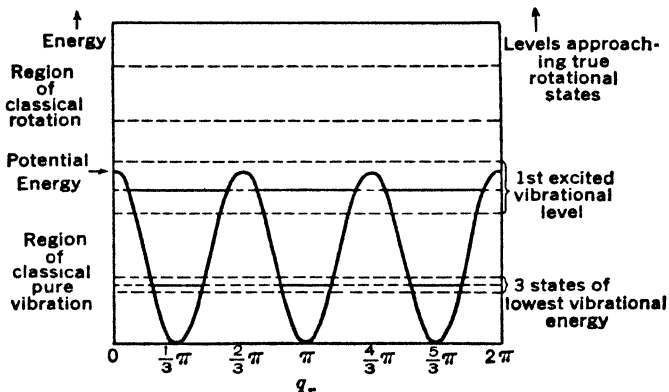

FIG. 8. 2. Potential energy and quantum state diagram for the internal rotational degree of freedom in ethane.

space with a given energy in all three of the minima positions, or one-third of this space in the neighborhood of only one of these positions. The corrected phase space, after division by the symmetry number, is the same in either case.

In Fig. 8. 2 the potential energy is plotted as a function of q_r , the angle between the projections of two specifically chosen hydrogen atoms, one on each carbon atom, on a plane normal to the C—C axis. The equation used for the potential is that already given in equation (5). With energy ranges below the hills separating the three minima it is clear that in counting the classical phase volume due to the coordinate it is immaterial whether one takes the coordinate range at one of the minima and divides by the symmetry number 6, or whether one adds all

three equal coordinate ranges and divides by 18. At energies higher than that of the hills it is obviously more natural to include the whole coordinate range and divide by the symmetry number 18 corresponding to free rotation.

The quantum-mechanical solution is somewhat less trivial. The levels which are far below the energy of the tops of the hills show each three different states, and in the zeroth approximation each of these states corresponds to the molecule existing in one of the three different minima. However, a more exact solution of the wave equation is obtained by using certain linear combinations of the three states that correspond to the different minima. The three linear combinations will have slightly differing energies, the amount of the splitting depending on the height of the hills between the minima and the moment of inertia of the CH_3 groups. Even if the energy splitting were negligible, it is statistically important that there are three states to each level; the levels are triply degenerate.

The complete wave equation for the molecule, which must be antisymmetric with respect to permutations of the identical hydrogen nuclei and symmetric with respect to exchange of the two carbon nuclei, will be a product of a function of this coordinate q_r , with the functions of the other coordinates, the electronic functions, and the nuclear spin function. In order to make the total function antisymmetric it will be necessary to use particular linear combinations of the functions of the coordinate q_r , which correspond to the minima, namely, those which have what is called a definite symmetry character with respect to permutations. Each one of the three linear combinations of one level, if multiplied by a definite vibrational, spin, and electronic function, can only be multiplied by $1/18$ of the various rotational functions to give a completely antisymmetric total wave function.

If the moment of inertia is large, and the hills between the minima high, so that the lower levels of this coordinate are negligibly split in energy, it is then immaterial whether one regards each level as being threefold degenerate, and each state of the level combining with one-eighteenth of all the rotational states, or whether one forgets the degeneracy and says that each level combines with one-sixth of all the rotational states. The higher levels of this coordinate will certainly be considerably split in energy, and those whose energies lie close to the top of the hills will be so strongly split that the classification into levels corresponding to the vibrational states in the localized minima is no longer useful. For energies very much higher than the tops of the hills the equation for the energy of the different states will go over asymptotically into those given by equation (4) for free rotation.

A similar situation is encountered in ammonia, NH_3 . If the molecule were planar with the hydrogen atoms symmetrically placed, the symmetry number would be six, and only one structural isomer would exist. If the molecule is pyramidal, $\gamma = 3$, two structural isomers could be formed with distinguishable hydrogen atoms. Keeping the positions of the hydrogen atoms fixed, these isomers differ in one having the nitrogen atom above the other having it below, the plane of the hydrogens. These configurations cannot be transformed into each other by rotation alone. For both structures one of the normal coordinates corresponds to displacement of the nitrogen normal to the plane of the hydrogen atoms, and uniform displacement of the three hydrogen atoms in the opposite direction.

For the planar structure the single minimum along this coordinate is at the point where the nitrogen is in the plane of the three hydrogen atoms. If the molecule has a pyramidal structure it means that there are two minima, which will be symmetrically placed with respect to this position in which the atoms are all in one plane. The maximum in the plot of the potential along this coordinate will then be at the place where the atoms are in one plane. If this maximum is sufficiently high the vibrational levels of this coordinate may either be treated as doubly degenerate, each of the two *states* of the level being allowed with one-sixth of the rotational states, or one could forget about the degeneracy and say that each of the *levels* combines with one-third of the rotational states.

If, as is actually the case, the maximum separating the two minima is very low, the levels will be split in energy due to the interaction of the two isomeric positions, and one will observe, in the spectra, the different single states with different energies, each combining with one-sixth of the rotational states. The energy spacing of the vibrational states of this coordinate is not given by the simple $\nu h\nu$, the lower states occurring in pairs, noticeably closer in energy than the average spacing. The contribution of this coordinate to $\ln Q$ cannot be calculated by using the simple $\ln Q_v$ formula, but must be calculated by direct summation of the observed energies.

CHAPTER 9

MIXTURES OF GASES AND CHEMICAL EQUILIBRIUM

- (a) Introduction. (b) Gaseous Mixtures. (c) Chemical Equilibrium.
(d) The Entropy of Isotope Mixing. (e) An Interpretation of the Equilibrium Equation. (f) Estimation of Equilibrium Constants.

9a. Introduction

The laws of thermodynamics have been shown in the preceding chapters to be a consequence of the laws of mechanics. In considering a gas composed of a mixture of two or more kinds of molecules the usual methods of thermodynamics may be employed as a logical part of the theoretical approach which has been developed here. In such a use of the thermodynamic method it would be necessary only to use the fact that, by definition, the thermodynamic properties of one perfect gas are uninfluenced by the inclusion of another perfect gas in the same vessel.

Similarly, the thermodynamic condition that the free energy be a maximum at equilibrium leads to the well-known relationship between the equilibrium constant and the difference in free energy of the products and reactants of a chemical reaction.

Any statistical derivations of the equivalent statistical relationships are, of course, essentially only repetitions of the thermodynamic proofs in other language. Nevertheless we shall, in this chapter, show how the methods of Chapters 5 and 6, if applied to a system containing more than one kind of molecule, lead to the equations for a mixture of gases. We shall also derive the equations for the conditions of chemical equilibrium by a variation of the same methods.

The equations for chemical equilibrium will be applied to a mixture of isotopes to show that the equilibrium in all chemical reactions, at high temperatures, with the neglect of the effect of the differences in masses,* is not altered by the presence of the isotopic differences between some of the atoms of an element. The absolute entropy of mixing of the isotopes is the same, per gram atom of element, whatever the state of molecular aggregation.

A very simple interpretation of the conditions for chemical equilibrium will be demonstrated, and some short methods of estimating the equilibrium constant will be discussed.

* See Problem 9. 1.

9b. Gaseous Mixtures

A system consisting of N_1 independent molecules of type 1, N_2 independent molecules of type 2, \dots , N_ζ of type ζ , with the total volume V and total energy E , will be considered.

The different types of molecules will have distinctly different quantum states. A quantum state of the whole system is determined by the number of molecules of the type ζ in each of the quantum cells of this type of molecule, for all values of the running index ζ . Analogously to the method employed in Chapters 5 and 6, the phase space is divided into regions indicated by two indices j and ζ . The region $j\zeta$ includes a large number, $C_{j\zeta}$, of cells available to the molecules of type ζ , each having an energy lying between $\epsilon_{j\zeta}$ and $\epsilon_{j\zeta} + \Delta_{j\zeta}\epsilon$. The part $j\zeta$ of the system consists of the $N_{j\zeta}$ molecules which are in the region $j\zeta$. The combinatory part of the problem is the same as that of Chapter 5, and the entropy, $S_{j\zeta}$, of the part system $j\zeta$ will be given by equation (6. 2). The value of $dS_{j\zeta}/dN_{j\zeta}$ will be given by equation (6. 3), which is

$$(9. 1) \quad \frac{dS_{j\zeta}}{dN_{j\zeta}} = k \ln \left[\frac{C_{j\zeta}}{N_{j\zeta}} \pm 1 \right] \cong k \ln \frac{C_{j\zeta}}{N_{j\zeta}},$$

in which the unity will be omitted under the assumption that we always deal with conditions for which $C_{j\zeta}/N_{j\zeta}$ is very large.

The total entropy of the system will be the sum of the entropies of all conceivable regions, the sum of $S_{j\zeta}$ over all values of j and of ζ . The value of $N_{j\zeta}/C_{j\zeta}$ may be found by either the method of Chapter 5 or that of Chapter 6. That of Chapter 5 was to make the total entropy a maximum, subject to the conditions that the total energy and the total number of particles remain constant. The only difference between the one-component system treated previously and the present system is that for this system the total number of particles of each kind must be kept constant independently.

The limiting conditions are

$$(9. 2) \quad \sum_j N_{j\zeta} = N_\zeta \quad (\text{for all } \zeta\text{'s}),$$

$$(9. 3) \quad \sum_j \sum_\zeta \epsilon_{j\zeta} N_{j\zeta} = E.$$

After multiplication of each of the equations (2) by a different constant $k\alpha_\zeta$ and the one equation (3) by $k\beta$, these are subtracted from the equation for the entropy and differentiated with respect to $N_{j\zeta}$,

$$(9. 4) \quad \frac{\partial}{\partial N_{j\zeta}} \left[\sum_j \sum_\zeta S_{j\zeta} - k \sum_\zeta \alpha_\zeta \sum_j N_{j\zeta} - k\beta \sum_j \sum_\zeta \epsilon_{j\zeta} N_{j\zeta} \right] = 0.$$

The condition that the differential coefficient be zero for each value of $j\zeta$ is the condition for the maximum of S .

The equations obtained are

$$(9. 5) \quad N_{j\zeta} = C_{j\zeta} e^{-\alpha_{\zeta} - \beta \epsilon_{j\zeta}}$$

for each value of ζ . The α_{ζ} 's will be different for each kind of molecule ζ . Each α is to be determined by the use of equation (5) in equation (2); α_{ζ} is seen to depend on N_{ζ} only, and in the same way as in a pure gas of the same volume. The presence of the other molecules does not affect the value of α . The parameter β is a constant of the system. The subsequent manipulation is exactly the same as that of Chapter 5. That the value of β is the same for each of the molecular species insures a single temperature for the system. The entropy and energy of the mixture are sums of the values for each species of molecule, and for each species they have the same values as functions of volume and temperature that they would have if the other molecular types were absent from the vessel.

Since $P = T(\partial S/\partial V)_E$, from equation (4. 35), we may define the partial pressure P_{ζ} as the pressure which would be exerted by the molecules ζ in the same concentration N_{ζ}/V at the same temperature in a pure gas, and the total pressure P is the sum of the partial pressures of the different molecular species,

$$(9. 6) \quad P = \sum_{\zeta} P_{\zeta} = \frac{kT}{V} \sum_{\zeta} N_{\zeta}.$$

The total pressure is just RT/V times the total number of moles of gas present.

The quantities A , H , and F are also additive sums of the values of these quantities for the pure gases at the same concentrations or the same partial pressures.

That these relationships must be obtained is obvious from the original description of the system. The molecules were all presumed to be independent of each other, except in so far as it was tacitly assumed that they were in equilibrium with respect to the exchange of energy. This interdependence assured uniformity of temperature throughout the system. Their independence required that the properties of that part of the system composed of one molecular species alone would be the same as if it occupied the whole volume of the system by itself.

The method of Chapter 6 could as well have been used as that of Chapter 5. The uniformity of temperature in the system would first be deduced from the condition that all energy exchanges were assumed to be allowed. For each species of molecule the value of μ_{ζ} must be

constant in all parts of the system, but the values of the μ_ζ 's for the different kinds of molecules are entirely independent.

The equations for one particularly simple mixture of gases are worth recording. If the different kinds of molecules are mechanically similar in all their properties, and equal, or at least very nearly equal, in mass, then the values of the partition functions Q_ζ will be identical for all values of ζ . In this case, for one mole of gas, ($\sum_\zeta N_\zeta = N_0$), the equation for the total free energy of the system will be

$$(9. 7) \quad F = \sum_\zeta N_\zeta \mu_\zeta = \sum_\zeta N_\zeta kT (\ln N_\zeta - \ln Q)$$

from equation (6. 9) for the chemical potential μ .

If the mole fraction $x_\zeta = N_\zeta/N_0$ is introduced, the equation, per mole, becomes

$$(9. 8) \quad F = RT(\ln N_0 - \ln Q + \sum_\zeta x_\zeta \ln x_\zeta).$$

This differs from the free energy of the gas composed of one component only by the additive $RT\sum_\zeta x_\zeta \ln x_\zeta$ which is always negative since the mole fractions, x_ζ , must, by definition, always be smaller than unity.

The entropy of the mixture of gases is greater by the additive $-R\sum_\zeta x_\zeta \ln x_\zeta$, which is positive.

The energy, E , and also H , C_V , and C_P , will be the same as for the gas composed of only one component.

9c. Chemical Equilibrium

Methods similar to those of the last section may be employed to calculate the conditions for chemical equilibrium in a system consisting of a mixture of perfect gases. A gas composed of molecules of various kinds will be investigated, but it will not be supposed that the number of each kind of molecule is fixed. A chemical reaction will be considered to take place in the mixture, so that the numbers of molecules of some kinds may grow at the expense of those of other species. The reaction will be written

$$(9. 9) \quad -m_a A - m_b B - \dots = m_g G + m_h H + \dots$$

The m 's are small integers, so that the value of m_ζ for one of the molecules ζ , which is a *reactant* of the reaction as written, is the negative of the number of molecules *entering* into the chemical reaction. m_ζ is then the number of molecules of kind ζ which are *produced* in the reaction as written. For instance, for the simple reaction $2\text{H}_2 + \text{O}_2 = 2\text{H}_2\text{O}$ the value of m_{H_2} is -2 , that of m_{O_2} is -1 , and that of $m_{\text{H}_2\text{O}}$ is 2 .

If the molecule of type ζ contains $n_{x\zeta}$ atoms of kind X , then the stoichiometry of equation (9) demands that

$$(9.10) \quad \sum_{\zeta} m_{\zeta} n_{x\zeta} = 0, \quad \text{for all } x\text{'s.}$$

The choice of the m 's of the left-hand side of the reaction as negative quantities enables us to express this condition in the form of one sum. Equation (10) is merely the mathematical statement that the total number of atoms of each element remains constant during the course of the reaction. The total number of atoms of the element X is

$$(9.11) \quad N_x = \sum_{\zeta} N_{\zeta} n_{x\zeta}.$$

One considers divisions of the system into parts consisting of the $N_{j\zeta}$ molecules of type ζ in $C_{j\zeta}$ cells of the same energy, $\epsilon_{j\zeta}$. For the total number of atoms of the element X one has

$$(9.12) \quad N_x = \sum_{\zeta} \sum_j n_{x\zeta} N_{j\zeta}.$$

The total energy of the system may be written as

$$(9.13) \quad E = \sum_{\zeta} \sum_j \epsilon_{j\zeta} N_{j\zeta}.$$

Hitherto the convention had been adopted that for each molecule the energy is measured from that of the lowest quantum state. The chemical reaction (9) is accompanied by a definite energy change. In order to account correctly for this energy difference between the products and reactants it is necessary to adopt some common zero point for the energy of the molecules. For the purposes of this particular reaction it is sufficient that the energies of the lowest states, $\epsilon_{0\zeta}$, be so chosen that

$$\sum_{\zeta} m_{\zeta} \epsilon_{0\zeta} = \Delta\epsilon,$$

where $\Delta\epsilon$ is the energy absorbed in the reaction as written at 0°K .

In general the most logical convention appears to be to choose all energies so that the energy of every element is zero at the absolute zero of temperature, that is, to make the lowest quantum state of the elements zero. In calculating the free energies and other thermodynamic properties of individual molecules, however, it is often convenient to do as we have indicated in the past, namely, to choose the energy of the lowest state of each molecule as zero, since the calculated values are then not subject to change if redeterminations of the heats of reactions are made. In the absence of complete thermodynamic and spectral data it is not practical as yet to adopt a uniform convention.

In all discussions involving the equilibrium in chemical reactions it

will be assumed that the energies of the lowest quantum states of the molecules are so chosen that the energy of the reaction is correctly accounted for. From section 6f we know that an alteration in the energy scale involves a multiplication of the partition function by a factor $e^{\epsilon/kT}$, and a linear additive change in the functions **E**, **F**, **A**, and **H**, but no alteration in the values of **S**, **C_V**, and **C_P**, at a given temperature.

Returning now to the system under discussion, the entropy $S_{j\zeta}$ for the part $j\zeta$ of the system is calculated as before. The sum of $S_{j\zeta}$ over all values of j and of ζ gives the total entropy, which will be a maximum at equilibrium, subject to the conditions that the total number of atoms of each element is constant, and that the total energy of the system is constant. Equations (12), each multiplied by a constant $k\alpha_x$, and equation (13), multiplied by $k\beta$, are subtracted from the total entropy. The differential coefficient of this with respect to every $N_{j\zeta}$ is zero when the entropy is a maximum,

$$(9. 14) \quad \frac{\partial}{\partial N_{j\zeta}} \sum_{\zeta} \sum_j (S_{j\zeta} - k \sum_x \alpha_x n_{x\zeta} N_{j\zeta} - k\beta \epsilon_{j\zeta} N_{j\zeta}) = 0.$$

With (1) for $\partial S_{j\zeta}/\partial N_{j\zeta}$, this becomes

$$(9. 15) \quad k \ln \frac{C_{j\zeta}}{N_{j\zeta}} = k \sum_x \alpha_x n_{x\zeta} + k\beta \epsilon_{j\zeta},$$

$$(9. 16) \quad \frac{N_{j\zeta}}{C_{j\zeta}} = e^{-\sum_x \alpha_x n_{x\zeta} - \beta \epsilon_{j\zeta}}.$$

This equation is of the familiar form of equation (5) with $\sum_x \alpha_x n_{x\zeta}$ replacing α_ζ . The thermodynamic properties of the system are the sums of the properties of the individual gases as with all mixtures of perfect gases, but a definite relation is prescribed between the α_ζ 's of the different molecule kinds. Previously the known number of molecules N_ζ has been used to evaluate the α_ζ 's. The relationship that $\alpha_\zeta = \sum_x \alpha_x n_{x\zeta}$ imposes a relationship on the values of the N_ζ 's and this restriction we shall show to be the mass-action law.

One may identify $\sum_x \alpha_x n_{x\zeta}$ with $-\mu_\zeta/kT$, in which μ_ζ is the chemical potential of the molecules of kind ζ in various ways. For instance, one knows that, for the part $j\zeta$ of the system, μ_ζ must be the same as for all parts of the system, so that

$$(9. 17) \quad \left(\frac{\partial A_{j\zeta}}{\partial N_{j\zeta}} \right)_{V,T} = \mu_\zeta = \epsilon_{j\zeta} - T \left(\frac{\partial S_{j\zeta}}{\partial N_{j\zeta}} \right) = \epsilon_{j\zeta} - kT \ln \frac{C_{j\zeta}}{N_{j\zeta}},$$

which by comparison with (15) shows that

$$(9. 18) \quad \mu_{\zeta} = -kT \sum_x \alpha_x n_{x\zeta}.$$

The quantity α_x is some characteristic of the X atoms which is constant throughout the system. $n_{x\zeta}$ is the number of X atoms in the molecule ζ . If the monatomic gaseous element X were in equilibrium concentration in the system, for that molecular species ζ , only for one X would $n_{x\zeta}$ differ from zero, and its value would be unity. For such a case the interpretation of the quantity α_x is clear, namely, $\alpha_x = -\mu_x/kT$. This interpretation is really general, $-kT\alpha_x$ is the chemical potential of the atoms of the element X in the system, and from this value the equilibrium concentration of the monatomic element in the system can be calculated. We may write (18) as

$$(9. 19) \quad \mu_{\zeta} = \sum_x n_{x\zeta} \mu_x,$$

the chemical potential of the molecules is the sum of the chemical potential of the atoms composing them, and the chemical potential of the atoms of any one element is a constant for all parts of the system.

In Chapter 6 the equation equivalent to (16) combined with (18) was used to calculate μ by a relationship

$$(9. 20) \quad \sum_j N_{j\zeta} = N_{\zeta} = e^{\mu_{\zeta}/kT} Q_{\zeta}, \quad Q_{\zeta} = \sum_j C_{j\zeta} e^{-\epsilon_{j\zeta}/kT},$$

in which Q_{ζ} was called the partition function of the molecule. For the reacting mixture, relationship (19) between the values of μ_{ζ} for the different kinds of molecules puts a restriction on the values of the N_{ζ} 's, which are no longer independent. We shall now proceed to show the nature of this restriction.

If the equilibrium product for the chemical reaction (9), in terms of the numbers of molecules, is formed, and calculated by the use of equations (20) and (19), the μ_{ζ} 's cancel in the expression, and the equilibrium product is obtained as a function of the Q_{ζ} 's alone. The steps are:

$$K_N = \prod_{\zeta} N_{\zeta}^{m_{\zeta}} = e^{\sum_{\zeta} m_{\zeta} \mu_{\zeta}/kT} \prod_{\zeta} Q_{\zeta}^{m_{\zeta}},$$

from (20). Using (19), one sees that

$$\sum_{\zeta} m_{\zeta} \mu_{\zeta} = \sum_x \mu_x \sum_{\zeta} m_{\zeta} n_{x\zeta},$$

but from (10), that $\sum_{\zeta} m_{\zeta} n_{x\zeta} = 0$, one obtains $\sum_{\zeta} m_{\zeta} \mu_{\zeta} = 0$, and

$$(9. 21) \quad K_N = \prod_{\zeta} N_{\zeta}^{m_{\zeta}} = \prod_{\zeta} Q_{\zeta}^{m_{\zeta}}.$$

Whereas the left-hand side of this relation depends on the numbers of molecules only, the right-hand side is independent of the concentration.

Equation (21) gives a relationship between the values of N_{ζ} which must be fulfilled for every chemical reaction with respect to which the system is in equilibrium. The fact that K_N is independent of the densities is known as the mass-action law.

This equation may readily be transformed into the usual thermodynamic relation between the equilibrium constant in terms of the pressures, and the difference in standard free energy of products and reactants. Let N be the number of molecules of a gas which, in the volume of the system, would exert unit pressure at the temperature of the system. The partial pressure P_{ζ} of the molecules ζ will be N_{ζ}/N . The value μ_{ζ}^0 of the chemical potential of the ζ type molecules at unit pressure is related to Q_{ζ} and N by

$$(9. 22) \quad \frac{Q_{\zeta}}{N} = e^{-\mu_{\zeta}^0/kT}.$$

from equation (20).

The sum of the chemical potentials of the products at unit pressure, minus the sum of the chemical potentials at unit pressure of the reactants of the chemical reaction (9), is

$$(9. 23) \quad \Delta\mu^0 = \sum_{\zeta} m_{\zeta}\mu_{\zeta}^0,$$

and may be called the change in the chemical potential at unit pressure for the reaction, or the standard chemical potential change.

Using (22) and (23) with (21), one obtains for the equilibrium constant, in terms of the pressures,

$$(9. 24) \quad K_P = \prod_{\zeta} P_{\zeta}^{m_{\zeta}} = \prod_{\zeta} \left(\frac{N_{\zeta}}{N}\right)^{m_{\zeta}} = \prod_{\zeta} \left(\frac{Q_{\zeta}}{N}\right)^{m_{\zeta}} = e^{-\Delta\mu^0/kT}.$$

The free energy per mole is just Avogadro's number times the chemical potential, $F_{\zeta}^0 = N_0\mu_{\zeta}^0$, and the change of free energy per mole at unit pressure in the reaction is $\Delta F^0 = N_0\Delta\mu^0$, so that (24) can be written as

$$(9. 25) \quad \Delta F^0 = -RT \ln K_P.$$

This is the usual thermodynamic form for the relationship between the free energy change in a chemical reaction and the equilibrium constant.

The whole derivation given here is unnecessarily long. One might at once use the condition that the total free energy of the system

$$(9. 26) \quad F = \sum_{\zeta} N_{\zeta}\mu_{\zeta}$$

must be a minimum at equilibrium. Since for the chemical equation (9) the ratio of the number of molecules of the different species produced in the reaction is fixed as the ratio of the m_r 's, one can set $dN_r = m_r dn$. At equilibrium

$$(9. 27) \quad \frac{\partial F}{\partial n} = 0 = \sum_r m_r \frac{\partial F}{\partial N_r} = \sum_r m_r \mu_r.$$

From equation (6. 9) for the chemical potential,

$$(9. 28) \quad \sum_r m_r \mu_r = kT \sum_r m_r (\ln N_r - \ln Q_r) = 0,$$

which is equivalent to equation (21).

In the original derivation the statement that the total number of atoms of each element was to remain constant was the only condition imposed on the possible changes in the numbers of molecules of each species. The result of the considerations is that for any conceivable stoichiometrical equation the condition for the corresponding equilibrium constant must be fulfilled. The condition for a chemical equation to be stoichiometrically possible is just the condition of equation (10). If, however, the chemical system is actually in equilibrium with respect to one of the conceivable chemical reactions, but not in equilibrium with respect to others, then the conditions for only the particular equilibrium constant with respect to which the system is actually in equilibrium must be fulfilled. The other conceivable reactions are to be regarded as inhibited. This offers no formal difficulties.

One condition implied in the derivations of the equations was that all the quantum states of the molecules which are actually reached with appreciable probability can be said to belong to one or other of the molecular species considered. If the temperature were so high than an appreciable fraction of the material existed, at any instant, in quantum states which could not be definitely assigned to any of the molecular species considered, then the equations derived here begin to lose their meaning. This has already been discussed to some extent in the last chapter.

The total free energy is given by equation (26), in which the values of the N_r 's must be calculated from the original quantities of material introduced, using the stoichiometrical relations of the chemical equation, and the condition of equation (21) imposed on the equilibrium constant.

A particularly simple example may be instructive to consider. Sup-

pose that the chemical reaction is of the type

$$(9. 29) \quad A = B,$$

that is, a simple isomeric change in a single molecule.

The equations are then particularly simple. Since $N_a + N_b = N$, the total number of molecules, one obtains, from (21), $N_a/N_b = Q_a/Q_b$, that

$$(9. 30) \quad N_a = \frac{Q_a}{Q_a + Q_b} N, \quad N_b = \frac{Q_b}{Q_a + Q_b} N,$$

and

$$(9. 31) \quad \mu_a = kT(\ln N_a - \ln Q_a) = kT[\ln N - \ln(Q_a + Q_b)],$$

which is equal to μ_b , as it must be at equilibrium. For the total free energy,

$$(9. 32) \quad F = N_a\mu_a + N_b\mu_b = N\mu_a = N\mu_b, \\ \mathbf{F} = RT[\ln N_0 - \ln(Q_a + Q_b)]$$

per mole of gas.

The chemical reaction has been artificially introduced by considering some of the quantum states of the molecule as belonging to one molecular species, and others as belonging to a different species. The free energy of the systems is correctly calculated either by using the equations for a chemical reaction at equilibrium, or by counting all the quantum states of both species together as being states of one molecule.

9d. The Entropy of Isotope Mixing

The equations of the last section will now be applied to a particular reaction, namely, the dissociation of a molecule into its elementary monatomic constituents. The reaction will be written as



The subscript m will be used to refer to the molecule AX_n . The equilibrium constant K_N for this reaction is, from (21)

$$(9. 34) \quad K_N = \frac{N_a N_x^n}{N_m} = \frac{Q_a Q_x^n}{Q_m}.$$

A complicated extension of this case will now be considered in detail, namely, that the X atoms in the system are not all identical, but consist of many isotopes, for which the running index y will be used. The number of isotopes of type y existing in the form of the monatomic gas

will be denoted by N_y , with $\sum_y N_y = N_x$, the total number of atoms of element X which are free.

There will be a large number of different molecules corresponding to the chemical formula AX_n , if the n X atoms of the molecules consist of various isotopes X^y . The index ζ will be used as a subscript to indicate the different kinds of molecules. In every molecule of kind ζ there will be a definite number, $n_{y\zeta}$, of isotopes of type y , so that

$$(9. 35) \quad \sum_y n_{y\zeta} = n.$$

The molecule ζ will also have a definite symmetry number γ_ζ which will, in general, be different from and never greater than the symmetry number γ_m of the molecule composed of only one isotope. In general, however, the molecule type is not completely determined by the values of the $n_{y\zeta}$'s and γ_ζ , but there will be several isomers of different ζ 's with any given values of the $n_{y\zeta}$'s.

The reaction

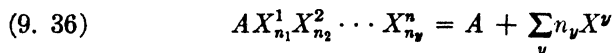

will be considered. For this reaction

$$(9. 37) \quad K_N = \frac{N_a \prod_y N_y^{n_{y\zeta}}}{N_\zeta} = \frac{Q_a \prod_y Q_y^{n_{y\zeta}}}{Q_\zeta}.$$

It will be explicitly assumed that the partition function Q_y for every isotope y is the same, so that we may write that $Q_y = Q_x$ for every y . This will be so if the masses of the isotopes differ by negligible fractional amounts and the nuclear spin is neglected. It will also be assumed that the partition functions of the various molecule types ζ differ only in so far as they have different symmetry numbers, so that

$$(9. 38) \quad Q_\zeta = Q_m \frac{\gamma_m}{\gamma_\zeta}.$$

This will also be the case if the isotope mass differences are negligible and if the temperature is high compared with the energy separation of the rotational levels of the molecules. At low temperatures the symmetry number loses its significance entirely as a determining factor in the magnitude of the partition function, and the subsequent considerations are entirely invalid. The differing masses of the isotopes cause differences in the values of the Q_y 's and the Q_ζ 's, which become quite

appreciable for the light elements but approach zero asymptotically for the heavier elements. This difference is neglected here.

If these items are left out of consideration, (37) may be written

$$(9. 39) \quad K_N = \frac{N_a \prod_y N_y^{n_y \zeta}}{N_\zeta} = \frac{Q_a Q_x^n}{Q_m} \frac{\gamma_\zeta}{\gamma_m},$$

$$N_\zeta = \frac{N_a Q_m}{Q_a Q_x^n} \prod_y N_y^{n_y \zeta} \frac{\gamma_m}{\gamma_\zeta}.$$

Use must now be made of the fact that the sum of γ_m/γ_ζ for all the different isomers with fixed values of the n_y 's is always $n!/\prod_y n_y!$, the multinomial coefficient,

$$(9. 40) \quad \sum_{\substack{\zeta \\ n_y \text{ constant} = n_y}} \frac{\gamma_m}{\gamma_\zeta} = \frac{n!}{\prod_y n_y!}.$$

This can be seen as follows. The total number of permutations of the n atoms of element X among the n positions in the molecule is $n!$. For the isomers of fixed number of each isotope n_y , only the fraction $1/\prod_y n_y!$ of all the permutations do not correspond to the exchanges of identical isotopes. Therefore, $n!/\prod_y n_y!$ exchanges of non-identical particles are possible. Any one of these exchanges leads to a configuration which is either a new isomer, or which could be obtained from the original configuration by a rotation. This rotation has to be such that the resultant configuration is not identical to the original one, but would be if the difference between the isotopes were neglected. Furthermore, all possible isomers of this value of n_y , and all such rotations of these isomers, are produced from one configuration by these permutations. The sum of the numbers of these rotations for all possible isomers of given n_y is therefore $n!/\prod_y n_y!$.

The number of these rotations for the isomer will be shown to be γ_m/γ_ζ . If all the atoms X were distinguishable there would exist γ_m configurations, obtainable from each other by rotation alone, which would be equivalent with indistinguishable atoms. If some of the isotopes are identical certain of these configurations become equivalent. Since the symmetry number, γ_ζ , signifies the number of ways in which the isomer ζ may be rotated into equivalent positions, it is seen that only the number γ_m/γ_ζ of configurations are not equivalent for the molecule ζ . Equation (40) is thereby proved.

If the total number of molecules N_m is found by summing the equa-

tion (39) for N_{ζ} over all values of ζ , with the use of (40) one finds

$$(9.41) \quad N_m = \sum_{\zeta} N_{\zeta} = \frac{N_a Q_m}{Q_a Q_x^n} \sum_{\substack{n_y \\ \sum n_y = n}} \frac{n!}{\prod_y n_y!} N_y^{n_y} = \frac{N_a Q_m}{Q_a Q_x^n} (\sum_y N_y)^n,$$

or, using $\sum_y N_y = N_x$,

$$(9.42) \quad \frac{N_a N_x^n}{N_m} = \frac{Q_a Q_x^n}{Q_m}.$$

The last equation is identical with (34). *The equilibrium between the molecules and the atoms is the same whether or not the element consists of a mixture of isotopes.*

The total number of atoms of the isotope y' combined in the molecules is the sum $\sum_{\zeta} n_{y'\zeta} N_{\zeta}$, and will be designated $N_{my'}$. With equation (39) summation can be performed analogously to (41). One obtains

$$(9.43) \quad N_{my'} = \sum_{\zeta} n_{y'\zeta} N_{\zeta} = \frac{N_a Q_m}{Q_a Q_x^n} \sum_{\substack{n_y \\ \sum n_y = n}} \frac{n!}{\prod_y n_y!} n_{y'} N_y^{n_y} \\ = n \frac{N_a Q_m}{Q_a Q_x^n} N_x^n \frac{N_{y'}}{N_x},$$

which, by comparison with (41), shows that

$$(9.44) \quad \frac{N_{my'}}{n N_m} = \frac{N_{y'}}{N_x}.$$

The total number of atoms of the element X combined in the molecules is $n N_m$, so that the ratios of the numbers of isotopes is the same in the molecules and in the monatomic gas.

Since the equilibrium constant is the same whether or not there are different isotopes, the difference between the entropies of the monatomic gas of the element and of the molecules is the same in the two cases. The absolute entropy of the monatomic gas has a term due to the mixing of the isotopes, equation (8), which is

$$(9.45) \quad S_{\text{mix.}} = - \sum_y x_y R \ln x_y,$$

per gram atom of element, in which $x_y = N_y/N_x$ is the mole fraction of the isotope y . The same additive contribution to the absolute entropy is present per gram atom of element in any gas containing this element.

The special assumption of the chemical equation (33) that the

molecule contains only one other atom, A , in addition to the atoms of the element X is obviously unnecessary. The conclusions are equally valid for a molecule consisting only of X atoms, or one containing many other atoms of various kinds. It is further clear that there would be no difficulty in extending the argument to a molecule for which two or more of the elementary constituents consisted of mixtures of isotopes.

The assumption that the nuclear spins of the isotopes are zero, or all equal, is likewise unnecessary. If the nuclear spins of the isotopes differ, the partition functions Q_v would contain the factor to $2s_{n_v} + 1$ and the partition functions of the molecules ζ would be proportional to $\prod_v (2s_{n_v} + 1)^{n_v}$ so that the ratio $\prod_v Q_v^{n_v} / Q_\zeta$ in equation (37) would be unchanged by the presence of the nuclear spin. It is only this ratio which is used in the subsequent equations.

At temperatures for which rotation is classical the existence of isotopes has no effect on the equilibrium of any chemical reaction, or on the difference of entropy involved in the reaction, except in so far as the differing masses of the isotopes affect the mechanical properties of the constituents of the system and therefore the partition functions of these constituents. The percentage difference in mass of different isotopes of the lighter elements causes sufficient mechanical differences to permit their separation.

9e. An Interpretation of the Equilibrium Equation

The physical significance of the equation for the equilibrium constant is seen most clearly if the classical equation for the partition function Q_ζ is used.

If the potential energy, U , of the molecule ζ as a function of its f coordinates is defined in such a way that the lowest value of the potential at the equilibrium position of the atoms is zero, then the classical equation for the partition function may be written

$$(9. 46) \quad Q_\zeta = e^{-\epsilon_\zeta^0/kT} \frac{1}{\gamma_\zeta h^f} \int \dots \int e^{-H_\zeta(p,q)/kT} dp_1 \dots dp_f dq_1 \dots dq_f.$$

In this equation the total number of degrees of freedom f is three times the number of atoms comprising the molecule, γ_ζ is the symmetry number of the molecule, and $H_\zeta(p,q)$ is the Hamiltonian or energy of the molecule expressed as a function of the f coordinates and the f momenta. The exponential of $-\epsilon_\zeta^0/kT$ as a factor arises from the choice of zero as the lowest value of the potential for each molecule whereas the energies of all molecules have to be measured from a common zero point.

The energy of the molecule in its lowest state, the energy of the gas per molecule at 0°K. , is ϵ_ζ^0 , and must be chosen in such a way that the

energy of a chemical reaction at 0°K . is given by the sum of the ϵ_f^0 's of the products minus that of the reactants. This choice assures one that the energies of reactions at other temperatures will be correctly given by the thermodynamic energies of the gases calculated from the partition functions.

The most natural choice of the value of ϵ_f^0 would be that it is the energy necessary to form one gaseous molecule ζ from its elements at 0°K . Other choices differing from the above by a constant amount, ϵ_x , per atom of element X for all molecules would, however, be equally satisfactory.

The choice of the f coordinates used in the Hamiltonian in (46) is not prescribed, except by reasons of convenience. If the Cartesian coordinates of the atoms are used, the kinetic energy is of the form $(p_x^2 + p_y^2 + p_z^2)/2m_x$ for each atom, X . Integration over the momenta of equation (46) leads to the factor $(2\pi m_x kT/h^2)^{3/2}$ for the three degrees of freedom due to the atom X , if the h^3 is included with the momentum term. There remains the integral of the exponential of the negative potential energy divided by kT , integrated over the whole configuration space of the molecule and divided by the symmetry number. This term has the dimensions of a volume raised to the power of the number of atoms in the molecule, and may be called the product of the volumes v_x available to the atoms of the molecule,

$$(9.47) \quad \prod_x v_x = \frac{1}{\gamma} \iint e^{-U/kT} \prod_x d\tau_x.$$

The equilibrium constant K_N of a reaction is equal to, equation (21), the product of the partition functions, Q_r , of the products of the reaction, divided by that of the reactants, each partition function raised to the power of the number of molecules entering the chemical equation. If $\Delta\epsilon^0$ is the energy of the reaction at absolute zero,

$$(9.48) \quad \Delta\epsilon^0 = \sum_f m_f \epsilon_f^0,$$

in which the m_f 's are the number of molecules ζ produced in the reaction as used in equation (9). The energy exponentials of (46) used in the expression (21) for K_N then lead to a factor $e^{-\Delta\epsilon^0/kT}$. The factors $(2\pi m_x kT/h^2)^{3/2}$ due to the momenta cancel in the numerator and denominator since the number of atoms remains constant in the reaction.

Using the classical expression (46) for Q_f , with (47) and (48) in the equation (21) for the equilibrium constant K_N , one obtains

$$(9.49) \quad K_N = \prod_f N_f^{m_f} = e^{-\Delta\epsilon^0/kT} \frac{\prod_x v_x \text{ (products)}}{\prod_x v_x \text{ (reactants)}}.$$

The equilibrium constant K_N is equal to the factor $e^{-\Delta e^0/kT}$, multiplied by the ratio of the products of the volumes available to the atoms in the products of the reaction, divided by the volumes in the reactants. The tendency of the reaction to go, as measured by the equilibrium constant, is directly proportional to the product over all the atoms of the ratio of the volumes available to them in the products and in the reactants.

9f. Estimation of Equilibrium Constants

Equation (49) serves as a very useful method of making rapid rough estimations of the magnitude of equilibrium constants for reactions. It is somewhat more convenient to eliminate the large numbers involved in K_N , the equilibrium constant expressed in numbers of molecules, by using, instead, K_P , the equilibrium constant expressed in partial pressures. As in deriving (24) the conversion of K_N to K_P can be accomplished by multiplication of K_N with $N^{-\Sigma m_i}$, where N is the number of gaseous molecules which would give unit pressure in the volume of the system.

In equation (49) the calculation of the volume available to every atom always gives the total volume of the system as one term in the product for every molecule. That is, one may treat one atom in every molecule as free to wander about the whole system, dragging the molecule with it; the other atoms of that molecule are constrained to lesser volumes in the neighborhood of the one atom considered as free. The multiplication of this by $N^{-\Sigma m_i}$ results in replacing each of these terms V by $V/N = v^0$, the volume per molecule at unit pressure. The other volumes of the constrained atoms on the molecule are to be calculated as before.

The equation for the equilibrium constant K_P is, then,

$$(9. 50) \quad K_P = \prod_i P^{m_i} = e^{-\Delta e^0/kT} \frac{\prod_x v_x \text{ (products)}}{\prod_x v_x \text{ (reactants)}} N^{-\Sigma m_i},$$

in which Δe^0 , equation (46), is the energy absorbed in the conversion of the reactants into the products at 0°K .

A simple numerical calculation shows that, if the unit of pressure is taken to be one atmosphere, the volume per molecule is

$$(9. 51) \quad v^0 = \frac{V}{N} = 4 \times 10^5 \frac{T}{300} \text{ cubic \AA ngstr\u00f6ms.}$$

The one-dimensional length available to an atom along the coordinate giving its distance from another atom to which it is bound is twice the

average amplitude $\frac{1}{2}\xi$ of vibration. The value of ξ as a function of temperature is given rather accurately by the empirical equation, in which D is the energy necessary to break the bond,

$$(9. 52) \quad \xi = \left(\frac{RT}{D}\right)^{1/2} \text{ \AA ngstr\AA om units,}$$

if the vibration is classical. This equation follows from the empirical fact that the product $M_1M_2\omega^2/(M_1 + M_2)$ is about 10^5 times the energy of dissociation D in kilogram calories for almost all diatomic molecules.

The two-dimensional surface available to an atom rotating about another is

$$(9. 53) \quad A = 4\pi r_0^2,$$

in which r_0 is the distance between the two atoms.

In order to illustrate the use of such considerations, we shall estimate the equilibrium constant for the reaction

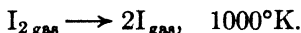

The energy D necessary to break the I-I bond is 35.40 k cal. per mole, so that $D/RT = \Delta\epsilon^0/kT = 17.81$, and $e^{-\Delta\epsilon^0/kT}$ is 1.8×10^{-8} .

The volume available to the free I atoms, divided by the number of atoms N necessary to give a pressure of one atmosphere, is, from (51), $v^0 = 13 \times 10^5 (\text{\AA.U.})^3$, which occurs squared in the numerator of the expression for K_P . For the molecule, the same term v^0 occurs once in the denominator, canceling one of the v^0 's in the numerator. The constrained atom of the molecule moves in a shell of radius r_0 and thickness ξ about the atom which was regarded as free. For I_2 the value of r_0 is 2.66 \AA.U., and from (52) $\xi = 0.24$ \AA.U. at 1000°K . The volume $4\pi r_0^2\xi$ must be divided by the symmetry number two. One obtains $2\pi r_0^2\xi = 10 (\text{\AA.U.})^3$, as the volume available to the dependent atom. The ratio $v^0/2\pi r_0^2\xi = 1.3 \times 10^4$. One finds

$$(9. 54) \quad K_P = \frac{P_{\text{I}}^2}{P_{\text{I}_2}} = e^{-\Delta\epsilon^0/kT} \frac{(v^0)^2}{v^0 2\pi r_0^2\xi} = 2.3 \times 10^{-4}.$$

Iodine should be approximately one per cent dissociated at one atmosphere pressure and 1000°K .

Equation (50) is an exact equation if the volumes per atom are correctly calculated. The classical equation (47) for these volumes is, of course, valid only at rather high temperatures. There exists a quantum-mechanical equation analogous to (47), making use of the wave func-

tions, by which the available volumes of the atoms, to be used in (50), can be calculated at any temperature.

The effect of the quantum-mechanical equation is always to give v_x values which are larger than the classical values by an amount which decreases with increasing temperature. This is a consequence of the uncertainty principle. The integral over a momentum in the partition function gives the average value of the momentum at the temperature of the integration. If, however, this average value of the momentum is so small that its product with the average range of position along the conjugated coordinate, as calculated by (47), is less than h , the uncertainty principle would be violated, and one must expect the quantum-mechanical calculation to lead to a greater position uncertainty. Stated differently, the contribution of the product of any coordinate with its conjugated momentum to the partition function Q can never be less than unity.

The contribution of one of the three momenta associated with an atom to Q is $(2\pi mkT/h^2)^{1/2}$, which is $10^8 M^{1/2} (T/300)^{1/2} \text{ cm}^{-1}$, in which M is the atomic weight. If for any coordinate the classical expression leads to a range of less than $(300/TM)^{1/2} \text{ \AA.U.}$, then one can be sure that the classical expression is false, and a better approximation will be obtained by inserting this value for the available length to the atom in this coordinate. If the classically calculated available length is larger, for every coordinate, than $(300/TM)^{1/2}$, then the classical equations may be deemed to be sufficiently valid.

The use of (50) for making estimations of the equilibrium constants of chemical reactions is by no means limited to such simple cases as the dissociation of diatomic molecules. Especially if the molecules on the two sides of the chemical reactions have certain groups in common, such as, say, CH_3 radicals or phenyl radicals, C_6H_5 , the volume available to the atoms of such a radical will be approximately the same for the reactants and products and will cancel out of the expression for K_P .

CHAPTER 10

GENERAL EQUATIONS FOR SYSTEMS COMPOSED OF DEPENDENT PARTICLES

(a) Introduction. (b) The Equation for the Work Function A . (c) Application to the Perfect Gas. (d) Systems of Fixed Energy. (e) Energy Fluctuations in Systems of Fixed Temperature. (f) The Semi-Classical Expression for Q . (g) The Configuration Integral Q_r . (h) The Probability of a Configuration. (i) An Alternative Derivation. (j) Summary of Thermodynamic Equations.

10a. Introduction

If no forces are acting between the particles of a system, the system is said to be composed of completely independent particles and is a perfect gas. In the preceding five chapters the methods for calculating the thermodynamic properties of such systems have been developed, and the equations derived have been discussed in some detail. If the forces acting between the particles of the system are so large that they may not be neglected, the system is not a perfect gas, although, if the forces are weak, it may exist entirely in the gaseous phase, obeying an equation of state differing but little from that of the perfect gas. At lower temperatures, or smaller total volumes, part or all of the system will be in a condensed phase, liquid or solid. The methods of calculation for such systems will be developed in subsequent chapters.

The thermodynamic entropy S of a system was defined in Chapter 4 as $k \ln \Omega$, in which Ω is the total number of quantum states available to the system at a given total energy E and volume V . If the quantity Ω is known as a function of the energy, it is possible, in principle, to calculate all the thermodynamic properties of the system by means of equations (4. 34) and (4. 35), defining the temperature T and the pressure P in terms of S and E .

This method, however, is not practical for most systems. In the mechanical description of the system, which is necessary before the methods of statistics may be applied, the energy, as a function of the coordinates q and momenta p which make up the phase space, is explicitly given. The equation for the volume in phase space, measured in units of h^f , between two surfaces of constant energy E and $E + \Delta E$, which is the classical equivalent of $\Omega(E) \Delta E$, is not given explicitly and is often extremely difficult to calculate directly.

In treating the perfect gas the quantity $\Omega(E)$ was directly determined in section 5d only for monatomic molecules. The method which was employed to derive the equations for general gases did not calculate this quantity. Instead the value of $S = k \ln \Omega$ was found for that distribution of molecules in various energy ranges which made this quantity S , the entropy, a maximum. The entropy for this equilibrium distribution was used as the value for the uninhibited system. The equation for the entropy was not obtained directly in terms of the energy, but in terms of a parameter β which was shown to be very simply related to the temperature.

Since the temperature, rather than the energy, of a system is most easily measured experimentally, the equations for the thermodynamic functions in terms of temperature and volume or temperature and pressure are entirely satisfactory, and indeed rather preferable to those in terms of the energy and volume.

If the molecules of a system are not independent it means that they have mutual potential energies due to the forces acting between them. The energy of one particular molecule is then an ambiguous quantity, and the distribution of molecules with respect to their individual energies has no meaning.

One may, however, by means of an artifice first introduced by Gibbs, make a calculation which is strikingly similar to that of the distribution of molecules in a gas with respect to their energies, even for systems composed of dependent particles. This method treats what is called an ensemble, or large number of independent identical systems. The individual systems, which are of macroscopic size and may consist of a mole of material, play the same role in the ensemble that is played by the independent molecules of the perfect gas. The energy of the systems composing the ensemble is not fixed, but the sum of their energies, that of the ensemble, may be.*

The temperature of the ensemble may be defined by the condition (4. 34) that $(\partial S/\partial E)_V = 1/T$. The distribution of the systems with respect to their energies may be calculated and is found to be given by an equation which is analogous to (6. 6) for the molecules of a perfect gas. The essential difference between the systems of the ensemble and the molecules of the gas is that the energy-distribution curve of the former has an enormously sharper peak which is due to the greater complexity of the unit. The energies of the systems fluctuate about a mean value, as do those of the molecules in the gas, but the fractional fluctuation is smaller, the greater the size of the system. For systems con-

* In the canonical ensemble of Gibbs the total energy of the ensemble was not explicitly fixed.

taining a mole of material the percentage fluctuation is entirely negligible.

The ensemble is conceived of as a large number of identical systems, each with the same numerical volume, in thermal contact, and coexistent in time. For a given total energy of the ensemble equations will be derived for the equilibrium fraction of members of the ensemble in any portion of the phase space of these members.

Now the chance that any randomly selected system of the ensemble is in a given portion of phase space is just the fraction of systems of the ensemble which are in this part of the phase space. With the assumption that the systems are ergodic, and the knowledge of the Liouville theorem of section 2j, it also follows that this is the fraction of time that one system spends in this portion of the phase space.

The properties of a given system depend only on the values of its external variables, such as temperature and volume, and not on the particular type of the other systems with which it is in contact. It therefore follows that a randomly selected member of the ensemble has the properties of *any* system of this type at the given temperature and volume which it is assumed to occupy in the ensemble.

Actually, in section 10i we shall derive the same equations that are discussed in the succeeding few sections by considering one system in contact with an infinite heat reservoir, without the assumption that this heat reservoir consists of an ensemble of systems which are identical to the one considered. That is, in section 10i a proof is given of the equations of this chapter without the use of the concept of an ensemble. It is also to be remarked here that in section 10d the fact that these equations are numerically equivalent to those obtained by the method of Chapter 4 is discussed.

10b. The Equation for the Work Function A

A large number, N , of independent identical systems will be treated. The total sum of these systems will be referred to as the ensemble. The equation for the work function A , per system, will be calculated and found to be related to a quantity Q . The analytical expression for the partition function Q in terms of the energy states of the system is exactly the same as that of the partition function per molecule Q in terms of the energy states of the molecule.

The N independent systems of the ensemble are constrained to different regions of space, but the volume allotted to each has the same numerical value, V . Unlike the perfect gas, in which all the molecules occupy the same volume V , the systems of the ensemble, although mechanically identical, are distinguishable and numbered by the portion of space which they occupy. This is the only fundamental differ-

ence between the ensemble of independent systems and the perfect gas composed of independent molecules. The quantum state of the ensemble is given by the state or quantum cell of each individual numbered system. Because of the identity of the systems, to every quantum cell \mathbf{k} of system a there exists a corresponding cell \mathbf{k} of every other system, but the ensemble is in a different quantum state when a is in cell \mathbf{k} and b in cell \mathbf{m} than when a is in \mathbf{m} and b in \mathbf{k} , owing to the different spatial positions in the ensemble of the systems a and b .

The systems of the ensemble are in thermal contact and may exchange energy. The energy of the whole ensemble will be designated by NE , so that E is the average energy per system.

The cells, or quantum states of the systems, will be divided into regions for which the subscript index j will be used. The Ω_j cells of the j th region* will all be contiguous in the phase space, and in particular the energy of all of them will lie between E_j and $E_j + \Delta_j E$. The total number of systems whose quantum states are in the region j will be designated by N_j . The entropy NS for a given distribution, defined by the values of the N_j 's, will be calculated, and the equilibrium value of the numbers N_j determined by making this a maximum, subject to fixed total energy NE and fixed total number of systems N . This entropy of the equilibrium distribution is then also the entropy of the uninhibited ensemble.

The number of quantum states allowed to N_j specified systems in the region j is $\Omega_j^{N_j}$, since each of the systems may be in any of Ω_j cells, and the systems are numbered. For the whole ensemble the number of quantum states consistent with an arrangement in which the region for every one of the numbered systems is specified is $\prod_j \Omega_j^{N_j}$. To obtain the number of states of the ensemble consistent with a given set of the numbers N_j , this must be multiplied by the number of ways in which N numbered systems can be assigned to the regions, N_j to the region j , namely $N! / \prod_j N_j!$. The entropy NS of the ensemble is k times the logarithm of this product,

$$(10. 1) \quad NS = k \ln \left[N! \prod_j \frac{\Omega_j^{N_j}}{N_j!} \right] = k \left[N \ln N + \sum_j N_j \ln \frac{\Omega_j}{N_j} \right],$$

if the ensemble is inhibited to the distribution defined by the value of the N_j 's.

The equilibrium values of the numbers N_j will be those for which

* The symbols Ω_j and E_j instead of C_j and ϵ_j in the corresponding calculation for the perfect gas are used here in recognition of the fact that the systems are of macroscopic and not molecular size.

NS is a maximum with given fixed value of the total energy NE and number of systems N ,

$$(10. 2) \quad NE = \sum_j N_j E_j,$$

$$(10. 3) \quad N = \sum_j N_j.$$

The maximum entropy may be found by subtracting $k\beta$ times (2) and $k\alpha$ times (3) from (1), and setting the derivative with respect to N_j equal to zero, namely,

$$\frac{\partial}{\partial N_j} (NS - k\alpha N - k\beta NE) = k \left[\ln \frac{\Omega_j}{N_j} + \ln N - \alpha - \beta E_j \right] = 0.$$

This leads to the equation for the ratio of N_j to Ω_j ,

$$(10. 4) \quad \ln \frac{\Omega_j}{N_j} = \alpha - \ln N + \beta E_j, \quad N_j = N e^{-\alpha} \Omega_j e^{-\beta E_j}.$$

For the determination of α this equation is used in (3); one obtains

$$N = \sum_j N_j = N e^{-\alpha} Q,$$

where Q is defined as

$$(10. 5) \quad Q = \sum_j \Omega_j e^{-\beta E_j},$$

so that

$$(10. 6) \quad e^{-\alpha} = \frac{1}{Q}, \quad \alpha = \ln Q.$$

With this value of $e^{-\alpha}$ in (4) the equation for N_j becomes

$$(10. 7) \quad N_j = \frac{N}{Q} \Omega_j e^{-\beta E_j}.$$

The total energy NE of the ensemble may be obtained by the use of (7) in (2), which leads to

$$(10. 8) \quad NE = \sum_j N_j E_j = \frac{N}{Q} \sum_j \Omega_j E_j e^{-\beta E_j} = -N \frac{\partial \ln Q}{\partial \beta}.$$

If equation (4) for $\ln (\Omega_j/N_j)$ is used in (1) for the total entropy NS the result,

$$\begin{aligned} NS &= k[N \ln N + \sum_j N_j (\alpha - \ln N + \beta E_j)] \\ &= k[N\alpha + \beta NE] \end{aligned}$$

may be transformed, by the use of (6) for α into

$$(10. 9) \quad S = k(\ln Q + \beta E).$$

This is the average entropy per system of the ensemble in the equilibrium distribution of the systems with respect to the regions, and it is therefore the entropy per system of the uninhibited ensemble.

The quantity β may now readily be determined by the use of the fundamental equation (4. 34) for the reciprocal of the temperature,

$$\left(\frac{\partial(NS)}{\partial(NE)}\right)_{V,N} = \frac{1}{T} = \left(\frac{\partial S}{\partial E}\right)_{V,N} = k \left[\frac{\partial \ln Q}{\partial \beta} \frac{\partial \beta}{\partial E} + E \frac{\partial \beta}{\partial E} + \beta \right].$$

In view of equation (8) the first two terms in the brackets are seen to cancel, leaving

$$(10. 10) \quad \frac{1}{T} = k\beta, \quad \beta = \frac{1}{kT}.$$

Inserting (10) for β in equation (5) for the partition function of the system Q , one obtains

$$(10. 11) \quad Q = \sum_j \Omega_j e^{-E_j/kT}.$$

If β is replaced by $1/kT$ in equation (9) for S , the equation

$$(10. 12) \quad S = k \ln Q + \frac{E}{T}$$

is obtained.

The work function A , or Helmholtz free energy of the system, is defined thermodynamically as $A = E - TS$, so that

$$(10. 13) \quad A = -kT \ln Q.$$

The quantity Q may be called the partition function of the system. It is the quantum-mechanical analogue of the Gibbs phase integral. Just as in the identically defined partition function of the molecules, Q , the symbol Ω_j may be omitted from under the summation sign if the summation is explicitly extended over all non-degenerate quantum states n of the system. The alternate equation,

$$(10. 14) \quad Q = \sum_{\substack{n \\ \text{all quantum} \\ \text{states } n}} e^{-E_n/kT},$$

may then be used.

10c. Application to the Perfect Gas

Equation (13) with (14) is applicable to any system whatsoever. If the system itself is composed of N independent identical molecules it is a perfect gas, and the application of these equations must lead to the results previously obtained for this type of system. We shall proceed to show this.

The energy of a perfect gas is the sum of the energies of the individual independent molecules composing it. If the index ν is used to designate the ν th molecule of the gas, $1 \leq \nu \leq N$, and \mathbf{m}_ν the quantum cell of the ν th molecule, so that $\epsilon_{\mathbf{m}_\nu}$ is its energy, one may write for $E_{\mathbf{n}}$, the energy of the system in the quantum state \mathbf{n} ,

$$(10. 15) \quad E_{\mathbf{n}} = \sum_{\nu} \epsilon_{\mathbf{m}_\nu}.$$

The quantum state \mathbf{n} of the whole gas is given by the number $N_{\mathbf{m}}$ of molecules in the cell \mathbf{m} , rather than by the values \mathbf{m}_ν for the individual molecules, since the molecules are unnumbered and indistinguishable. A quantum state of the system for which no more than one molecule is in any cell \mathbf{m} will correspond to $N!$ different sets of the N numbers \mathbf{m}_ν , differing only by permutation of the indices ν . A Fermi-Dirac system, for which no two molecules may have the same quantum cell \mathbf{m} , will have no states \mathbf{n} for which any of the numbers $N_{\mathbf{m}}$ exceed unity. For an Einstein-Bose system the states \mathbf{n} corresponding to some of the $N_{\mathbf{m}}$'s exceeding unity will correspond to fewer than $N!$ different sets of \mathbf{m}_ν 's, since permutations of the molecules in the same cell \mathbf{m} do not lead to new sets.

In either case, if the volume per molecule, V/N , and the temperature T are moderately high, the number of cells \mathbf{m} in any energy range $\Delta\epsilon$ will exceed the number of molecules of this range so greatly that the quantum states of the system for which two or more of the molecules have the same value of \mathbf{m} will be a negligible fraction of the states. Only in this case can the calculation be performed easily. One may then use equation (15) for $E_{\mathbf{n}}$ in (14), and sum over all values of \mathbf{m}_ν for each ν , dividing the sum by $N!$ to correct for the fact that approximately $N!$ different values of the \mathbf{m}_ν 's, all with the same total energy, correspond to one state \mathbf{n} of the system. This means that the molecules are treated as statistically independent, and must lead to the equations of a Boltzmann system.

One obtains, as an equation for the partition function Q of the system,

$$Q = \frac{1}{N!} \sum_{\mathbf{m}_\nu} e^{-\epsilon_{\mathbf{m}_\nu}/kT} = \frac{1}{N!} \left[\sum_{\mathbf{m}} e^{-\epsilon_{\mathbf{m}}/kT} \right]^N.$$

Since $\sum_{\mathbf{m}} e^{-\epsilon_{\mathbf{m}}/kT}$ is just the partition function Q of the molecules, (6. 8),

this leads to

$$(10. 16) \quad Q = \frac{1}{N!} Q^N.$$

Using (16) for Q in (13) for the work function A , with the Stirling approximation for the logarithm of the factorial, one obtains

$$(10. 17) \quad A = kTN(\ln N - 1 - \ln Q).$$

Since $kTN = PV$ for the perfect gas, and $F = A + PV$, the equation for the free energy F is

$$F = kTN(\ln N - \ln Q),$$

and for the chemical potential $\mu = F/N$, for this one-component system,

$$(10. 18) \quad \mu = kT(\ln N - \ln Q).$$

This is identical with equation (6. 9) for μ in terms of the partition function Q per molecule, which was the starting point for the derivation of all the equations of the perfect gas.

10d. Systems of Fixed Energy

The equation for the work function A as derived from the method of Chapter 4 for a system with given fixed energy E appears, at first sight, to differ from (13). In this section it will be shown that the equations are numerically equivalent for large systems, and the seeming discrepancy will be discussed.

The entropy S of a system of fixed energy is $S = k \ln \Omega(E)$, in which $\Omega(E)$, the number of quantum states of the system, is a function of the energy E . For the work function, $A = E - TS$, one may write

$$(10. 19) \quad \begin{aligned} A &= -kT \ln \Omega(E) + E, \\ A &= -kT \ln [\Omega(E)e^{-E/kT}], \end{aligned}$$

where the temperature $T = (\partial S / \partial E)^{-1}_V$ is determined by

$$(10. 20) \quad \frac{1}{T} = k \frac{\partial \ln \Omega(E)}{\partial E}.$$

In equation (13), that $A = -kT \ln Q$, with (11) for Q , it is seen that, since for the large systems considered here Ω is a continuous function of the energy, the sum (11) may be replaced by an integral, and A may be written as

$$(10. 21) \quad A = -kT \ln \left[\int_0^\infty \Omega(E) e^{-E/kT} dE \right].$$

The integrand of this integral has a maximum value when

$$\frac{\partial}{\partial E} [\Omega(E)e^{-E/kT}] = 0$$

or

$$(10. 22) \quad \frac{1}{T} = k \frac{\partial \ln \Omega(E)}{\partial E}.$$

Equations (22) and (20) are identical. Equations (21) and (19) for A differ in that (21) gives A as $-kT$ times the logarithm of an integral, and (19) as $-kT$ times the logarithm of the largest value of the integrand. Equation (19) gives the value of A for a system of fixed energy, whereas (21) gives A for a system in contact with a heat reservoir the temperature of which is such that the average value of the energy of the system is the same as that used in (19).

For systems of macroscopic size the value of the logarithm of the integral \mathbf{Q} , and that of the greatest value of its integrand, are numerically equivalent. This may best be illustrated by considering a simple example.

A system with a constant heat capacity, $C_V = Gk$, has the energy

$$(10. 23) \quad E = GkT.$$

The entropy S is $\int_0^T C_V d \ln T$ or $Gk \ln T - C$. The number of quantum states $\Omega = e^{S/k}$ is therefore proportional to T^G , or from (23) to E^G . We may write

$$(10. 24) \quad \Omega(E) = aE^G.$$

With this equation for $\Omega(E)$ the integral \mathbf{Q} , in the expression (21) for A , is

$$(10. 25) \quad \mathbf{Q} = \int_0^\infty aE^G e^{-E/kT} dE = a(kT)^{G+1} G!$$

and A , using the Stirling approximation for $\ln G!$ in (21), becomes

$$(10. 26) \quad A = -kT[G \ln GkT - G + \ln a + \ln kT].$$

The alternative expression (19) for A leads to

$$(10. 27) \quad A = -kT[G \ln GkT - G + \ln a].$$

The difference between (26) and (27) is only in the one term $\ln kT$, whereas a term $G \ln kT$ occurs in both. Now if the system contains

approximately a mole of material the number G is of the order of magnitude of the number of molecules, or about 10^{23} . In this case it is clear that equations (26) and (27) do not differ numerically by an appreciable fractional amount.

The reason for the numerical equivalence of the two forms (19) and (21) for A lies in the enormous steepness of the function $\Omega(E)e^{-E/kT}$ around its maximum value. This will be further discussed in the next section.

10e. Energy Fluctuations in Systems of Fixed Temperature

From equation (7), with $\beta = 1/kT$, it is evident that the number of systems of the ensemble with energies between E and $E + dE$, and therefore the probability that a system of the temperature T has an energy of this range is proportional to

$$\Omega(E)e^{-E/kT} dE.$$

For the system considered in the last section the function $\Omega(E)e^{-E/kT}$ has its maximum at $E_m = GkT$, and Ω obeys the equation $\Omega = aE^G$. The ratio P_Δ of the value of the function for the energy $E_m(1 + \Delta)$ to the value at E_m is

$$P_\Delta = (1 + \Delta)^G e^{-G\Delta}$$

$$\ln P_\Delta = G \ln (1 + \Delta) - G\Delta.$$

Expanding $\ln (1 + \Delta) = \Delta - \Delta^2/2 + \dots$, for small values of Δ , one finds

$$(10. 28) \quad \ln P = -G \frac{\Delta^2}{2}.$$

Numerically, if $G = 10^{23}$, for $\Delta = 10^{-8}$, one finds that $\ln P_\Delta = -10^7$, and $P_\Delta = e^{-10^7}$.

We see that, for a system containing approximately a mole of material, the chance P_Δ , per unit energy range, of observing it to have an energy differing from its most probable energy by one part in a hundred million is e^{-10^7} . For all practical purposes the energy of a macroscopic system of fixed temperature is constant. The integrand of the function Q is seen to have an enormously steep maximum at the most probable energy.

However, equation (13) for the work function A of a system with fixed temperature is not limited to large systems. It therefore relieves a logical difficulty inherent in the treatment of Chapter 4. As has already been discussed in section 4f the value of the entropy defined by $S = k \ln \Omega$ is incompletely determined owing to an uncertainty in the energy of the system. The corresponding uncertainty in S is frac-

tionally negligible for macroscopic systems, but precludes the use of this equation for the entropy of a single molecule if its energy is known.

The whole procedure of Chapter 4 is essentially limited to large systems. This is entirely in agreement with thermodynamics, which assumes strict functional relationships between energy, temperature, volume, and entropy, and is consequently also applicable only to macroscopic systems.

The method of this chapter, which is adapted from that of Gibbs, allows us to calculate the thermodynamic properties of a system in equilibrium with a heat reservoir of macroscopic dimensions, quite independently of the size of the system concerned.

The thermodynamic properties are all then functions of the temperature. The value of the energy so calculated, for instance, is the average energy, and not an energy which the system will certainly be observed to have if removed from thermal contact with its surroundings. The temperature is defined only in terms of the sum of the system and the heat reservoir as $T = (\partial S/\partial E)^{-1}$, which is legitimate as long as the heat reservoir, at least, is large.

10f. The Semi-Classical Expression for Q

The classical equation for the partition function of the system Q , as for the partition function Q of the molecules, equation (6. 48), is an integral over phase space.

If the number of degrees of freedom of the system is f , there are f coordinates, q_1, \dots, q_f , and f momenta, p_1, \dots, p_f , conjugated to the coordinates, which together form the phase space of the system. In this space, the volume W measured in units of h^f includes W quantum states, provided that the volume W is large enough in all dimensions and that there are no identical particles in the system. If there are N_i identical atoms of kind i , the number of quantum states Ω is

$$(10. 29) \quad \Omega = \frac{W}{\prod_i N_i!} = \frac{1}{h^f \prod_i N_i!} \Delta q_1 \cdots \Delta q_f \cdot \Delta p_1 \cdots \Delta p_f,$$

if each of the products $\Delta q_k \Delta p_k$ is large compared to h . The division by $\prod_i N_i!$ is necessary because permutations of the numbering on the atoms lead to this many corresponding regions of the classical phase space which are physically identical and indistinguishable and correspond to but one quantum state.*

* The division by $\prod_i N_i!$ is not correct in regions where all the coordinates and momenta of one particle have the same value as the corresponding ones of another particle which is identical with the first. This is a region for which there are no

Provided that the energy, or Hamiltonian, $H(p,q)$, varies negligibly compared to kT for all changes $\Delta q_k \Delta p_k = h$, the sum (14) for Q may be replaced by the integral

$$(10. 30) \quad Q = \frac{1}{h^f \prod_i N_i!} \int \cdots \int e^{-H(p,q)/kT} dq_1 \cdots dp_f.$$

Except for the factor in front, this integral is the classical Gibbs phase integral. We shall refer to expression (30) as the normalized phase integral, or simply the phase integral.

If the Hamiltonian is separable as a sum of terms, each of which includes one or a few only of the various pairs of conjugated coordinates and momenta, and these variables occur in no other terms, the integral becomes a product of simpler integrals. Of course, in this case, the quantum-mechanical sum also becomes the product of simpler sums, and, as in the case of the partition function of the molecules, the function Q can be written as a product of terms.

For some of the coordinates the change $\Delta q_k \Delta p_k = h$ may result in a change of $H(p,q)$ which is appreciable compared to kT . For these coordinates and momenta the summation over the quantum states must be used instead of the integral form (30). If the other coordinates and momenta occur separately in the Hamiltonian the integral form may be kept for them alone.

10g. The Configuration Integral Q_T

If the Cartesian coordinate system is used for the N point particles making up a system, and if as is usual when magnetic forces are neglected the potential energy depends on the coordinates only, the Hamiltonian contains the momenta only as the sum of $3N$ terms of the type $p^2/2m_i$, in which m_i is the mass of particle i . Equation (30) may then be integrated readily over the momenta, leading to the product of $3N$ integrals, each of the type

$$(10. 31) \quad \int_{-\infty}^{+\infty} e^{-p^2/2m_i kT} dp = (2\pi m_i kT)^{1/2}.$$

quantum states at all if the wave function is antisymmetrical in permutations of these particles, Fermi-Dirac systems. If the wave function is symmetrical, Einstein-Bose systems, the number of states will be greater than given by (29), since the permutation of the two identical particles, which never leads to a new quantum state of the system, also does not lead to a different region of the classical phase space in this case.

The equation for the normalized phase integral may then be written as

$$(10. 32) \quad \mathbf{Q} = \prod_i \left(\frac{2\pi m_i kT}{h^2} \right)^{3N_i/2} \frac{\mathbf{Q}_r}{\prod_i N_i!}.$$

The configuration integral, \mathbf{Q}_r , is defined as

$$(10. 33) \quad \mathbf{Q}_r = \iiint \dots \int e^{-U(q)/kT} d\tau_1 \dots d\tau_N,$$

$$(10. 34) \quad d\tau_i = dx_i dy_i dz_i,$$

and $U(q)$ is the potential energy of the system as a function of the coordinates.

This integral, the integrand of which is the exponential of the negative potential energy divided by kT , and which is extended over the configuration space of the system, is the only volume-dependent portion of the normalized phase integral \mathbf{Q} .

The product $p_k \cdot q_k$ of any coordinate q_k with its conjugated momentum p_k has the dimensions of energy multiplied by time. This follows from the definition of p_k as $\partial T(q, \dot{q}) / \partial \dot{q}_k$, in which $T(q, \dot{q})$ is the kinetic energy expressed as a function of the coordinates q and their time derivatives \dot{q} . As long as the units of energy and time are kept fixed the element of volume in the phase space, $dq_1 \cdot dp_1 \dots dq_f \cdot dp_f$ remains unchanged by a transformation to new coordinates with their conjugated momenta. The element of volume in the phase space divided by h^f is dimensionless.

The volume element of the configuration space, $dx_1 dy_1 dz_1 \dots dx_N dy_N dz_N$, of dimensions length to the power $3N$, is not, however, generally given by the expression $dq_1 \dots dq_f$, for generalized coordinates q , but can be expressed as some function of the q 's, the Jacobian, times this product, $f(q) dq_1 \dots dq_f$.

Equation (32) giving the relationship between \mathbf{Q} and \mathbf{Q}_r was derived using the Cartesian coordinate system, for which the integration over the momentum space could be easily performed. However, the function $U(q)$, the potential energy of the system, may become much more simple in some coordinate system other than the Cartesian. In this case the configuration integral \mathbf{Q}_r may be integrated in the generalized coordinate system, but care must be taken that the correct expression for the volume element of the configuration space is used.

10h. The Probability of a Configuration

The quantity N_j/N , the ratio of the number of systems in the region j to the total number of the ensemble, is the probability P_j that any

randomly chosen system will be found to occupy one of the quantum states of the region j . From (7) this is

$$(10. 35) \quad P_j = \frac{N_j}{N} = \frac{1}{Q} \Omega_j e^{-E_j/kT}.$$

The probability P_n of finding a system in the single quantum state n is

$$(10. 36) \quad P_n = \frac{N_n}{N} = \frac{1}{Q} e^{-E_n/kT}.$$

The probability that a system, known to be in the quantum state n , is at a certain place q in the configuration space formed by the f coordinates q , is, per unit volume of the configuration space, given by the square of the wave function, $|\psi_n(q)|^2$. The wave function is, of course, normalized, so that the integral of $|\psi_n(q)|^2$ over the configuration space is unity.

The multiplication of P_n in (36) by $|\psi_n(q)|^2$, and summation over all quantum states of the system, gives the probability, $P(q)$, of finding the system in any quantum state whatsoever, but in the spatial part q of the configuration space,

$$(10. 37) \quad P(q) d\tau_1 \cdots d\tau_N = \frac{1}{Q} \sum_n e^{-E_n/kT} |\psi_n(q)|^2 d\tau_1 \cdots d\tau_N,$$

where the symbol $d\tau_i = dx_i dy_i dz_i$ is used for the element of the configuration volume due to the i th particle.

This expression may, of course, be integrated over any portion of the configuration space to give the integrated probability of that portion. Since the integral of $|\psi_n(q)|^2$ over the whole configuration space is unity, and $\sum_n e^{-E_n/kT} = Q$, it is seen that the integral of (37) over the whole configuration volume of the system is unity.

The classical equation for the probability $P(p, q)$ of finding the system in any part p, q of the phase space is obtained from expression (30),

$$(10. 38) \quad P(p, q) dp dq = \frac{1}{h^f \prod N_i! Q} e^{-H(p, q)/kT} dp dq.$$

The classical expression for $P(q)$ analogous to (37) may be obtained from (38) by integration over the momenta, and can be seen to be

$$(10. 39) \quad P(q) d\tau_1 \cdots d\tau_N = \frac{1}{Q_r} e^{-U(q)/kT} d\tau_1 \cdots d\tau_N.$$

10i. An Alternative Derivation

We shall now undertake an alternative derivation of equation (38) for the probability of finding a general system of known temperature in a given portion of the phase space. This derivation avoids the use of the ensemble, although the method is somewhat similar to that employed previously.

We use, as before, our knowledge, derived in Chapter 4, of the properties of a system of constant energy, and also, this time, our knowledge of the thermodynamic equations of a perfect monatomic gas. The transition from the system of constant energy to one of known temperature is made, as before, by considering a system a in equilibrium with a very large reservoir b , the combination of system plus reservoir having constant energy. If the system and the heat reservoir were independent, the Hamiltonian and energy of their sum would be the sum of the Hamiltonians and energies, respectively, of the two parts. A weak interaction between the two systems is assumed, however, which offers a mechanism permitting energy to flow from one to the other, but which is not great enough to influence the assumption of additive energies. The probability that the system a is in a certain portion of phase space is therefore influenced by its contact with the reservoir b . It is necessary, consequently, to know something about the properties of b .

In the method followed in section 10b the properties of the reservoir were determined by the assumption that it consisted of an ensemble of systems identical in character to a . In this derivation the properties of the reservoir are fixed by the assumption that it consists of a perfect monatomic gas, the equations for which have already been derived.

Since the behavior of a depends only on its external variables the limitation on the character of the reservoir is inessential. The nature of the reservoir is fixed only in order to determine explicitly the analytical expression for certain quantities entering into the equations derived for a . The results are perfectly general for the system a in contact with any heat reservoir determining its temperature.

The calculations will be carried out assuming the system a to obey the classical equations. It is clear that the derivation for a quantum-mechanical system would be very similar.

The symbols p and q will designate values of the complete set of momenta and coordinates for the combined system a and reservoir b , p_a and q_a those of a , and p_b and q_b those of the reservoir b . The Hamiltonian and energy of the combined system are the sums of those of the parts:

$$(10. 40) \quad \begin{aligned} H(p,q) &= H_a(p_a,q_a) + H_b(p_b,q_b), \\ E &= E_a + E_b. \end{aligned}$$

The classical phase volume $W_E \Delta E$ of the system for a given range, ΔE , of energy, between E and $E + \Delta E$, for the combination of the two parts a and b , is

$$(10. 41)^* \quad W_E \Delta E = \int_E^{E+\Delta E} dp dq.$$

where the integration is to be taken over all values of p and q between the energies E and $E + \Delta E$.

The probability $P \Delta p \Delta q$ that the combined system of constant energy is in the region $\Delta p \Delta q$ of phase space is

$$(10. 42) \quad P \Delta p \Delta q = \frac{1}{W_E \Delta E} \Delta p \Delta q. \cdot$$

We now wish to find the probability, $P_a(p_a, q_a) \Delta p_a \Delta q_a$, that the part a of the combined system is in the region of phase space between p_a and $p_a + \Delta p_a$, q_a and $q_a + \Delta q_a$. This function $P_a(p_a, q_a)$ is found by integrating P of equation (42) over all values of p_b and q_b which are consistent with the values of p_a and q_a of the part a , and also with the condition that the total energy of the combined system lies between E and $E + \Delta E$. The only way in which the values of the momenta and coordinates of a limit the values of those of the part b is through the condition that the total energy lies between E and $E + \Delta E$, that is, by limiting the energy of b to lie in the range between E_b and $E_b + \Delta E$, where

$$(10. 43) \quad E_b = E - H_a(p_a, q_a).$$

By introducing the symbol $W_b(E_b)$, defined as

$$(10. 44) \quad W_b(E_b) \Delta E = \int_{E_b}^{E_b+\Delta E} dp_b dq_b,$$

the integration to be made over the whole phase space within the indicated energy range, one finds

$$(10. 45) \quad P_a(p_a, q_a) \Delta p_a \Delta q_a = \frac{W_b[E - H_a(p_a, q_a)]}{W_E} \Delta p_a \Delta q_a.$$

The quantity W_E in the denominator of (45) may be evaluated by first integrating (41) over the momenta and coordinates of the part b ,

* The symbol W is used here for completely classical phase volume, uncorrected by division with h^f or h^{3N} . The inclusion of these normalizing factors would only add to the complexity of the equations and would completely cancel in the end.

which, with the use of (44), leads to the equation:

$$(10. 46) \quad W_E = \int W_b[E - H_a(p_a, q_a)] dp_a dq_a,$$

in which the integration can be extended over all energies of the system a , as long as it is understood that the function W_b becomes zero for negative values of its argument.

At this place the properties of the reservoir b will be used. If b is assumed to be a perfect monatomic gas consisting of N_b molecules, the quantity W_b is proportional to the surface of a $3N_b$ dimensional sphere of radius $(2mE_b)^{1/2}$ (section 5d). Thus W_b is proportional to the $3N_b/2$ power of its argument E_b ,

$$(10. 47) \quad W_b[E - H_a(p_a, q_a)] = K \times [E - H_a(p_a, q_a)]^{3N_b/2}.$$

Equation (47) being taken with (46) in (45), the proportionality constant K is seen to cancel in numerator and denominator. Dividing both numerator and denominator by $E^{3N_b/2}$ one obtains

$$(10. 48) \quad P_a(p_a, q_a) \Delta p_a \Delta q_a = \frac{\left[1 - \frac{H_a(p_a, q_a)}{E}\right]^{3N_b/2}}{\int \left[1 - \frac{H_a(p_a, q_a)}{E}\right]^{3N_b/2} dp_a dq_a} \Delta p_a \Delta q_a.$$

We now go over to the limiting case where the size of the reservoir b approaches infinity, for only in this event will the temperature of the system a be completely determined. The energy of the combined system E and that of the reservoir E_b then approach the same value, and the temperature is determined by the equation

$$(10. 49) \quad \frac{3}{2} N_b k T = E_b \cong E.$$

As N_b approaches infinity the equation

$$(10. 48') \quad \left[1 - \frac{2}{3N_b} \frac{H_a(p_a, q_a)}{kT}\right]^{3N_b/2} = e^{-H_a(p_a, q_a)/kT}$$

becomes asymptotically valid. Use of these two equations in (48) leads to

$$P_a(p_a, q_a) \Delta p_a \Delta q_a = \frac{e^{-H_a(p_a, q_a)/kT}}{\int e^{-H_a(p_a, q_a)/kT} dp_a dq_a} \Delta p_a \Delta q_a.$$

Introduction of Q , equation (30), shows this to be identical to (38).

10j. Summary of Thermodynamic Equations

The partition function, or sum of states of a system, is

$$(10. 50) \quad Q = \sum_{\substack{\mathbf{n} \\ \text{all quantum} \\ \text{states } \mathbf{n}}} e^{-E_{\mathbf{n}}/kT} = \sum_j \Omega_j e^{-E_j/kT} = \int_0^{\infty} \Omega(E) e^{-E/kT} dE.$$

The classical expression for Q is that of the normalized phase integral,

$$(10. 50') \quad Q = \frac{1}{h^f \prod_i N_i!} \iint \dots \int e^{-H(\mathbf{p}, \mathbf{q})/kT} dq_1 \dots dp_f \\ = Q_r \prod_i \left(\frac{2\pi m_i kT}{h^2} \right)^{3N_i/2} \frac{1}{N_i!},$$

where Q_r is the configuration integral, and N_i is the number of identical particles of type i in the system. The configuration integral Q_r is

$$(10. 51) \quad Q_r = \iint \dots \int e^{-U(\mathbf{q})/kT} d\tau_1 \dots d\tau_N,$$

where $d\tau_i = dx_i dy_i dz_i$, and $U(\mathbf{q})$ is the potential energy of the system.

The work function, also called the Helmholtz free energy, is

$$(10. 52) \quad A = -kT \ln Q.$$

The derivative of A with respect to the volume is the negative of the pressure,

$$(10. 53) \quad P = -\left(\frac{\partial A}{\partial V}\right)_T = kT \left(\frac{\partial \ln Q}{\partial V}\right)_T,$$

or, since Q_r is the only volume-dependent factor of Q , this may also be written

$$(10. 53') \quad P = kT \left(\frac{\partial \ln Q_r}{\partial V}\right)_T.$$

The pressure-volume product, PV , is

$$(10. 54) \quad PV = kT \left(\frac{\partial \ln Q}{\partial \ln V}\right)_T = kT \left(\frac{\partial \ln Q_r}{\partial \ln V}\right)_T.$$

The free energy F , which is the Gibbs free energy or the free energy at constant pressure, is $A + PV$, so that

$$(10. 55) \quad F = kT \left[-\ln Q + \left(\frac{\partial \ln Q}{\partial \ln V}\right)_T \right].$$

The derivative of the work function with respect to the temperature at constant volume is the negative of the entropy,

$$(10. 56) \quad S = -\left(\frac{\partial A}{\partial T}\right)_V = k \left[\ln Q + \left(\frac{\partial \ln Q}{\partial \ln T}\right)_V \right].$$

The energy E is $A + TS$,

$$(10. 57) \quad E = kT^2 \left(\frac{\partial \ln Q}{\partial T}\right)_V = kT \left(\frac{\partial \ln Q}{\partial \ln T}\right)_V,$$

which is the same as equation (8) with $1/kT$ replacing β . The heat content H is $E + PV$, and so

$$(10. 58) \quad H = kT \left[\left(\frac{\partial \ln Q}{\partial \ln T}\right)_V + \left(\frac{\partial \ln Q}{\partial \ln V}\right)_T \right].$$

The heat capacity of the system at constant volume, C_V , may be obtained from (57) by further differentiation with respect to the temperature, as

$$(10. 59) \quad C_V = k \left(\frac{\partial}{\partial T}\right)_V T^2 \left(\frac{\partial \ln Q}{\partial T}\right)_V = k \left[2 \left(\frac{\partial \ln Q}{\partial \ln T}\right)_V + T^2 \left(\frac{\partial^2 \ln Q}{\partial T^2}\right)_V \right].$$

CHAPTER 11

THE CRYSTALLINE SOLID

- (a) The Crystal. (b) Harmonic Vibrations. (c) Classical Calculation. (d) Another Derivation of the Classical Formulas. (e) Quantum-Mechanical Treatment. (f) A One-Dimensional Crystal Model. (g) The Frequencies of Simple Isotropic Lattices. (h) The Debye Formula. (i) Deviations from the Debye Formula. (j) Strain and Stress Variables.

11a. The Crystal

In the solid state the distance between neighboring atoms or molecules is so small that the forces which they exert upon each other are considerable.

The investigation of the solid crystalline state is simplified by its great regularity. X-rays show that a crystal is in a state of complete order. A certain fundamental arrangement of a few atoms or molecules is repeated periodically in space. In an ideal crystal, therefore, the centers of the atoms form the points of a regular space lattice which is triply periodic, that is, periodic in three directions which are not in the same plane.

If the lattice arrangement is stable, the lattice points must be equilibrium positions for the atoms, which implies that there must be no force acting on any atom, or, in other words, that the forces upon any one atom from all others must exactly cancel, if all atoms are at the lattice points. Moreover, all tensions must be zero, and the equilibrium position must be an energetic minimum.

If the forces are known it can be decided by calculation which lattice is stable for a given substance. In practice the opposite procedure is usually employed, and from the observed crystal structure conclusions are drawn about the forces. This, however, is a purely mechanical problem and does not interest us here. In all calculations of this chapter the lattice structure is assumed to be given.

11b. Harmonic Vibrations

Actually, the atoms are never at rest at the lattice points, but perform small vibrations around these equilibrium positions. Let us denote the Cartesian coordinates of the deviation from the equilibrium position for each atom by ξ_i , the index i running from 1 to $3N$, if the crystal contains N atoms; let m_i be the masses of the particles and $p_{\xi_i} = m_i \dot{\xi}_i$ the momenta. For small deviations ξ_i from equilibrium the

potential energy of the system may be developed with respect to the ξ_i 's. If we choose the potential at the equilibrium, $\xi_i = 0$, as the zero of energy, the development has no constant term. The linear terms in ξ_i must vanish, since it was supposed that no forces are acting upon the atoms in their equilibrium positions. The first terms arising are therefore quadratic in the ξ_i 's, and the energy may be written as

$$(11. 1) \quad H(p, \xi) = \sum_{i=1}^{3N} \frac{1}{2m_i} p_i^2 + \frac{1}{2} \sum_{i,j=1}^{3N} a_{ij} \xi_i \xi_j.$$

For small enough displacements cubic and higher-order terms may be neglected. The mechanical task of calculating the force constants a_{ij} from the forces between the atoms is beyond the scope of this book.

If, instead of the deviations ξ_i of individual atoms, linear combinations of ξ_i 's are used as coordinates, the potential energy in (1) expressed in these new coordinates remains a quadratic expression, and the kinetic energy a quadratic expression in the corresponding momenta. It is a theorem of mechanics, or rather of mathematics, that there exist $3N$ special independent linear combinations of the $3N$ ξ_i 's, which are called the normal coordinates and shall be designated by q_i . They have the property that, if (1) is expressed in the q_i 's and the corresponding momenta p_i , the potential energy contains no cross terms between two different q_i 's, while the kinetic energy is a sum of squares,

$$(11. 2) \quad H(p, q) = \frac{1}{2} \sum_{i=1}^{3N} (p_i^2 + 4\pi^2 \nu_i^2 q_i^2).$$

These normal coordinates are analogous to those used in Chapter 8 for polyatomic molecules. They differ only in that the mass factor before the momenta has been eliminated by a change of scale.

The Hamiltonian is thereby expressed as a sum of $3N$ functions, each containing one of the coordinates and the corresponding momentum only. Moreover, these functions are the well-known Hamilton functions of a harmonic oscillator of frequency ν_i . The ν_i^2 are complicated functions of the force constants a_{ij} . If the crystal is stable, that is, if the energy for $q_i = 0$ is a minimum, all ν_i^2 must be positive.

The equations of motion are

$$\dot{q}_i = \frac{\partial H}{\partial p_i} = p_i, \quad \ddot{q}_i = \dot{p}_i = -\frac{\partial H}{\partial q_i} = -4\pi^2 \nu_i^2 q_i,$$

and the classical solution

$$q_i = A_i \cos(2\pi \nu_i t + \delta_i).$$

If only one normal coordinate q_i is excited, the others constantly zero, all particles in the crystal vibrate with the same frequency ν_i , but with different ampli-

tudes, determined by the coefficients with which the displacement ξ_i enters into q_i . In a general state of vibration the motion of each particle is a complicated superposition of motions of different frequencies.

Equation (2) shows that a crystal consisting of N strongly coupled atoms is mechanically equivalent to a system of $3N$ independent oscillators. The terms of third and higher orders in q_i in the development of the potential energy, which were neglected in (1) and (2), introduce a coupling between the oscillators and make an exchange of energy between them possible. These deviations from harmonicity in the vibrations establish the equilibrium distribution of energy between the oscillators. They play, therefore, much the same role here that the collisions do for the perfect gas. With increasing temperature, as the amplitudes of vibration become larger, it may be no more correct to neglect these terms. Their influence on the specific heat, etc., of the crystal can then be calculated in essentially the same way that was used for molecular vibrations in Chapter 7. This is analogous to the fact that at high concentration in a gas the forces between atoms give rise to deviations from the perfect gas law.

Among the normal coordinates there will be three which describe the simple translations of the crystal as a whole along the three axes, $\sum \xi_i$, etc., and three which correspond to rotations around the center of mass. The forces counteracting these six motions are zero. It follows that six of the ν_i 's in (2) vanish, so that the second sum should be extended only over $3N - 6$ terms. However, since six is a very small number compared to $3N$, this difference may be neglected.

A state \mathbf{n} of the total crystal is determined by the numbers n_i of quanta of vibration for each normal coordinate. Its energy, according to equation (2. 22), is

$$(11. 3) \quad E_{\mathbf{n}} = \sum_{i=1}^{3N} (n_i + \frac{1}{2}) h\nu_i.$$

The lowest energy of the crystal, when all n_i 's are zero, is $\sum \frac{1}{2} h\nu_i$. In treating the diatomic and polyatomic molecules the zero of energy was altered to give the lowest quantum state zero energy. We shall *not* follow that practice here.

The partition function of the system becomes a product of the partition functions for each individual oscillator,

$$(11. 4) \quad Q = \sum_{\mathbf{n}} e^{-E_{\mathbf{n}}/kT} = \prod_{i=1}^{3N} \left[\sum_{n_i \geq 0} e^{-h\nu_i(n_i + 1/2)/kT} \right],$$

$$Q = \prod_{i=1}^{3N} \frac{e^{-h\nu_i/2kT}}{(1 - e^{-h\nu_i/kT})},$$

These factors differ from the Q_v used for molecular vibrations in the gas, equation (7. 19), by the multiple $e^{-h\nu_i/2kT}$ originating from the zero point energy. One obtains

$$(11. 5) \quad \ln Q = - \sum_{i=1}^{3N} \left[\frac{h\nu_i}{2kT} + \ln (1 - e^{-h\nu_i/kT}) \right].$$

In this formula equal atoms have been treated as unnumbered, and the complete identity of the atoms has been taken care of. For, if there are N equal atoms in the crystal, and if the position of each of these atoms is specified, all atoms are in different quantum states, owing to their different location, and the partition function of each crystal with a specified arrangement of atoms must be divided by $N!$. On the other hand, there exist $N!$ crystals which are outwardly indistinguishable and differ only in the distribution of the N identical atoms over the lattice points. These two factors cancel.

11c. Classical Calculation

In classical mechanics the partition function Q is given by an integral over all coordinates and momenta. Since $H(p, q)$, (2), is a sum of functions of one coordinate and momentum only the classical Q becomes a product of integrals each referring to one oscillator only, namely,

$$(11. 6) \quad Q = \prod_{i=1}^{3N} \frac{1}{h} \int_{-\infty}^{+\infty} \int_{-\infty}^{+\infty} e^{-(p_i^2 + 4\pi^2\nu_i^2 q_i^2)/2kT} dp_i dq_i.$$

Since all the oscillators are different the division by $N!$ is omitted (compare end of last section). The integration can be performed immediately. Since $\int_{-\infty}^{+\infty} e^{-bx^2} dx = (\pi/b)^{1/2}$, one obtains

$$(11. 7) \quad Q = \prod_{i=1}^{3N} \frac{kT}{h\nu_i} = (kT)^{3N} \left(\prod_{i=1}^{3N} h\nu_i \right)^{-1}.$$

From this one derives the average energy of the crystal at the temperature T , according to equation (10. 57), to be

$$(11. 8) \quad E = kT^2 \left(\frac{\partial \ln Q}{\partial T} \right)_v = 3NkT.$$

Here we encounter again the law of equipartition of energy: the system has $3N$ degrees of freedom; the energy depends quadratically on each of the $3N$ coordinates and momenta; the average energy for each coordinate and for each momentum at the temperature T is $\frac{1}{2}kT$. The heat capacity at constant volume is therefore a constant for all crystals, namely,

$$(11. 9) \quad C_v = \left(\frac{\partial E}{\partial T} \right)_v = 3Nk.$$

If the substance in question is monatomic, the value of C_V for a mole of substance is $3R = 5.959 \text{ cal. deg.}^{-1}$. This theorem is called the law of Dulong-Petit. Experimentally, direct determination of C_V is difficult. C_V is, however, connected with the easily measurable quantity C_P , the heat capacity at constant pressure, through the relation

$$(11. 10) \quad C_P - C_V = \frac{9 \alpha^2 VT}{\kappa},$$

in which α signifies the linear expansion coefficient,

$$(11. 11) \quad \alpha = \frac{1}{3V} \left(\frac{\partial V}{\partial T} \right)_P,$$

and κ the compressibility,

$$(11. 12) \quad \kappa = - \frac{1}{V} \left(\frac{\partial V}{\partial P} \right)_T.$$

This relation is based on purely thermodynamic considerations and may, for instance, be derived in the following manner. C_P is defined as the increase of the heat content, $H = E + PV$, with temperature,

$$(11. 13) \quad C_P = \left(\frac{\partial H}{\partial T} \right)_P = \left(\frac{\partial E}{\partial T} \right)_P + P \left(\frac{\partial V}{\partial T} \right)_P.$$

Since the natural variables of the energy are V and S , the first term on the right-hand side may be transformed

$$\begin{aligned} \left(\frac{\partial E}{\partial T} \right)_P &= \left(\frac{\partial E}{\partial T} \right)_V + \left(\frac{\partial E}{\partial V} \right)_T \left(\frac{\partial V}{\partial T} \right)_P \\ &= \left(\frac{\partial E}{\partial T} \right)_V + \left(\frac{\partial E}{\partial V} \right)_S \left(\frac{\partial V}{\partial T} \right)_P + \left(\frac{\partial E}{\partial S} \right)_V \left(\frac{\partial S}{\partial V} \right)_T \left(\frac{\partial V}{\partial T} \right)_P. \end{aligned}$$

By putting this in (13), using the definitions (9) and (11), and remembering that $(\partial E/\partial V)_S = -P$, $(\partial E/\partial S)_V = T$, one obtains

$$(11. 14) \quad C_P = C_V + 3\alpha VT \left(\frac{\partial S}{\partial V} \right)_T.$$

The term $(\partial S/\partial V)_T$ may then be transformed by using

$$\left(\frac{\partial S}{\partial V} \right)_T^{-1} = \left(\frac{\partial V}{\partial S} \right)_T = \left(\frac{\partial V}{\partial P} \right)_T \left(\frac{\partial P}{\partial S} \right)_T.$$

With definition (12) we obtain

$$C_P - C_V = - \frac{3\alpha T}{\kappa} \left(\frac{\partial S}{\partial P} \right)_T.$$

Finally, it follows from the form of the free energy, $dF = V dP - S dT$, that

$$\frac{\partial^2 F}{\partial P \partial T} = \left(\frac{\partial V}{\partial T} \right)_P = - \left(\frac{\partial S}{\partial P} \right)_T,$$

and, applying definition (11) again,

$$C_P - C_V = \frac{9\alpha^2 VT}{\kappa}.$$

The value of C_V calculated from these experimental quantities is in excellent agreement with the theoretical one (9) for most monatomic and simple ionic crystals at room temperature. However, for all substances the heat capacity falls below this classical theoretical value at low temperatures and, indeed, approaches zero at the absolute zero. Classical mechanics was unable to account for this. The explanation is given by the quantum-mechanical treatment of the vibrations (see section 11e). A few monatomic crystalline elements show deviations from the law of Dulong-Petit even at room temperature. These are diamond, beryllium, and silicon, which have some unusually large vibrational frequencies. In crystals containing di- or polyatomic molecules, for instance CO_3^- groups, the vibration frequencies of the *molecule* are so high that their average energy at room temperature is less than the classical value kT (compare section 11i).

The entropy of the crystal at room temperature is, according to equations (10.56) and (7),

$$(11.15) \quad S = k \ln \mathbf{Q} + \frac{E}{T} = 3Nk \left[\ln kT + 1 - \frac{1}{3N} \sum_{i=1}^{3N} \ln h\nu_i \right].$$

It is seen that for the calculation of the classical heat capacity of crystals the knowledge of the values of the frequencies is unnecessary. The frequencies, however, contain the volume dependence of the entropy and therefore play an important part if the equation of state of the crystal is to be determined. The product of the frequencies, which enters into the entropy, also has to be known if calculations of equilibrium between the crystal and other phases are made.

11d. Another Derivation of the Classical Formulas

The equations of the last section can also be derived by the methods developed in Chapter 4, in much the same way that those of the perfect gas were derived in section 5d.

The classical number of states of the system below the energy E is first determined. For $3N$ oscillators this is h^{-3N} times the integral over all p_i 's and q_i 's subject to the condition that $\sum (p_i^2 + 4\pi^2\nu_i^2 q_i^2)$ is less or

equal to twice the energy. If new variables $\eta_i = 2\pi\nu_i q_i$ are introduced, we find

$$(11. 16) \quad \int_0^E \Omega(E) dE = \frac{1}{h^{3N}} \left(\prod_{i=1}^{3N} \frac{1}{2\pi\nu_i} \right) \iiint \dots \int dp_i d\eta_i. \\ \sum_i p_i^2 + \eta_i^2 \leq 2E$$

The integral on the right-hand side is the volume of a sphere of $6N$ dimensions and of radius $(2E)^{1/2}$. Its value is $(2\pi eE/3N)^{3N}$ (see Appendix AV). This leads to

$$(11. 17) \quad \int_0^E \Omega(E) dE = \left(\frac{eE}{3N} \right)^{3N} \prod_{i=1}^{3N} (h\nu_i)^{-1}.$$

It is again seen that the logarithm of the number of states below the energy E , $\ln \int \Omega(E) dE$, and the logarithm of the number of states at the energy E , differ by the negligible term $\ln(3N/E)$. The entropy as a function of energy and volume becomes

$$(11. 18) \quad S = k \ln \Omega = 3Nk (1 + \ln E - \ln 3N) - k \sum_{i=1}^{3N} \ln h\nu_i.$$

The temperature is obtained by differentiating S with respect to E ,

$$\frac{1}{T} = \left(\frac{\partial S}{\partial E} \right)_V = \frac{3Nk}{E},$$

$$(11. 8) \quad E = 3NkT,$$

which is equation (8) obtained before. Inserting (8) into (18) we obtain equation (15) for the entropy as a function of temperature and volume,

$$S = 3Nk(\ln kT + 1) - k \sum_{i=1}^{3N} \ln h\nu_i.$$

11e. Quantum-Mechanical Treatment

For the quantum-mechanical treatment $\ln Q$ is given by equation (5). It is seen that all thermodynamic quantities are sums of functions, each referring to one oscillator only. The average energy of the crystal at the temperature T becomes, according to equation (10. 57),

$$(11. 19) \quad E = kT^2 \left(\frac{\partial \ln Q}{\partial T} \right)_V = \sum_{i=1}^{3N} \left[\frac{1}{2} h\nu_i + \frac{h\nu_i}{e^{h\nu_i/kT} - 1} \right] \\ = kT \sum_{i=1}^{3N} \left[\frac{1}{2} u_i + \frac{u_i}{e^{u_i} - 1} \right],$$

upon introduction of the abbreviation $u_i = h\nu_i/kT$. The constant term in (19) is the zero point energy of the oscillators, which remains at

the absolute zero of temperature. The heat capacity at constant volume is

$$(11. 20) \quad C_V = \left(\frac{\partial E}{\partial T} \right)_V = k \sum_{i=1}^{3N} \frac{u_i^2 e^{u_i}}{(e^{u_i} - 1)^2},$$

and the entropy, according to equation (10. 56),

$$(11. 21) \quad S = k \ln \mathbf{Q} + \frac{E}{T} = k \sum_{i=1}^{3N} \left[-\ln(1 - e^{-u_i}) + \frac{u_i}{e^{u_i} - 1} \right].$$

For high enough temperatures these three expressions, (19), (20), (21), go over into the corresponding classical ones (8), (9), and (15). For, if kT is large compared to the difference between energy levels for every oscillator, $kT \gg h\nu_i$, $u_i \ll 1$, a development with respect to u_i may be made and higher powers neglected. One then obtains

$$(11. 19') \quad \begin{aligned} E &= kT \sum_{i=1}^{3N} \left[1 + \frac{u_i^2}{12} + \dots \right] \\ &= 3NkT \left[1 + \frac{1}{36N} \sum_i u_i^2 + \dots \right]. \end{aligned}$$

The zero point energy is precisely canceled by the term in the development which is linear in u_i , and the first correction term goes to zero as T^{-1} at high temperatures. The heat capacity is

$$(11. 20') \quad C_V = 3Nk \left[1 - \frac{1}{36N} \sum_i u_i^2 + \dots \right].$$

The expansion for the entropy becomes

$$(11. 21') \quad \begin{aligned} S &= k \sum_{i=1}^{3N} \left[1 - \ln u_i + \frac{1}{24} u_i^2 - \dots \right] \\ &= 3Nk(1 + \ln kT) - k \sum_{i=1}^{3N} \left[\ln h\nu_i - \frac{1}{24} u_i^2 + \dots \right]. \end{aligned}$$

It is seen that the quantum-mechanical equations have the classical ones as the limiting case for high temperatures. Since it is known experimentally that the heat capacity has reached the classical value even at room temperature for most substances one must expect the lattice frequencies to be very low compared to molecular frequencies. The decrease of the heat capacity at lower temperatures is correctly predicted by the quantum-mechanical formula. As the temperature tends to zero, the average energy content of the crystal approaches the zero point energy, and the heat capacity approaches zero. From (20)

it is seen that the contribution of any one frequency to C_V decreases exponentially as kT becomes much smaller than $h\nu_i$, that is, as u_i becomes very large. In that case the unity in the denominator may be neglected compared to e^{u_i} , and the additive part becomes $ku_i^2 e^{-u_i}$, in which the exponential term is overwhelmingly important. However, the experimental heat capacity of the crystal does not decrease as rapidly with decreasing T at low temperature, but only with about the third power of the temperature. This shows that it is impossible to approximate the behavior of the crystal by oscillators of one or of a few frequencies only. Some of the crystal frequencies are extremely low and are classical even at very low temperature, so that the dependence of the sum of terms in (20) on the temperature is different from that of any single term. The detailed calculation of the frequencies in section 11g bears this out.

The partition functions for the individual oscillators have, of course, the same form as those obtained for the vibrations of di- and polyatomic molecules, Chapters 7 and 8, except for the zero point energy. A physical difference is brought in through the order of magnitude of the frequencies. In this section the zero point energy of vibration has been taken into the energy content, (19) and (19'), since it cancels out for fully excited vibration.

It is interesting to note that if all $3N$ frequencies of the crystal were assumed to be identical, the thermodynamic functions of the crystal would be the same as those for the vibrational contribution to $3N$ identical diatomic molecules. One then finds the simple equations:

$$(11. 19'') \quad E = 3NkT \left[\frac{1}{2} u + \frac{u}{e^u - 1} \right],$$

$$(11. 20'') \quad C_V = 3Nk \frac{u^2 e^u}{(e^u - 1)^2},$$

$$(11. 21'') \quad S = 3Nk \left[-\ln (1 - e^{-u}) + \frac{u}{e^u - 1} \right].$$

These are referred to as the Einstein equations for a crystal, and (20'') is the Einstein equation for the heat capacity, the same as that for the vibrational contribution of one frequency to the independent molecules of a gas. Under this simple assumption of equal numerical value to all $3N$ frequencies of the crystal Einstein* had first explained the observed decrease of the heat capacity below the Dulong-Petit value of $3NkT$ at low temperature.

* Albert Einstein, *Ann. Physik* [4], **22**, 180 (1907).

In the following sections the problem of determining the actual frequencies, or, more properly speaking, the number of frequencies in a given frequency range, will be attacked.

11f. A One-Dimensional Crystal Model

The frequencies of a general three-dimensional lattice can be determined only with the use of various approximations. Before discussing these we wish to treat a simple crystal model which is not realized in nature, but which shows the essential characteristics of a general lattice without cumbersome mathematics.* This model is the so-called one-dimensional crystal.

Consider N point particles arranged on a line, the x axis, and restricted to move along that line only. The particles will be numbered according to their position, from left to right, by indices i running from 1 to N . It will be assumed that neighboring particles only act upon each other with a potential energy depending on the distance between them, $\phi(x_{i+1} - x_i)$. The total potential energy of the N points is then given by

$$(11. 22) \quad U = \sum_{i=1}^{N-1} \phi(x_{i+1} - x_i).$$

If the points are placed equidistant the forces acting on any of the middle particles from both neighbors cancel. A stable equilibrium is reached only if there are also no forces acting on the two end points, a condition which determines the distance a between the points by the relation

$$(11. 23) \quad \left(\frac{d\phi(r)}{dr} \right)_{r=a} = 0.$$

It follows that the minimum of potential energy is obtained if the particles form a regular one-dimensional lattice. With suitable choice of the arbitrary zero point of the x axis, the equilibrium position of the first particle is $x_1 = 0$; of the i th particle, $x_i = (i - 1)a$.

A small displacement of the i th particle from its equilibrium point shall be denoted by ξ_i . The potential energy (22) may be developed with respect to these quantities. The linear terms vanish on account of (23). If all terms higher than quadratic in the ξ 's are neglected, the potential energy becomes

$$(11. 24) \quad U = (N - 1)\phi(a) + \frac{1}{2} \phi''(a) \sum_{i=1}^{N-1} (\xi_{i+1} - \xi_i)^2,$$

where the symbol $\phi''(a)$ is used to denote the second derivative of ϕ with respect to r at $r = a$. We shall now make the further assumption that the masses of all particles are equal. The equation of motion for the i th particle in this potential is then given by

$$(11. 25) \quad m\ddot{\xi}_i = - \frac{\partial U}{\partial \xi_i} = \phi''(a) (\xi_{i+1} + \xi_{i-1} - 2\xi_i).$$

* M. Born and Th. von Karman, *Physik Z.*, **13**, 297 (1912).

For the two particles at the ends, $i = 1$ and $i = N$, the equations are somewhat different.

The equations (25) for different values of i are satisfied by a motion corresponding to a standing wave, namely,

$$(11. 26) \quad \begin{aligned} \xi_i &= \sin \left[\frac{2\pi x_i}{\lambda} + \alpha \right] A \sin 2\pi\nu t \\ &= \sin \left[\frac{2\pi a}{\lambda} (i - 1) + \alpha \right] A \sin 2\pi\nu t. \end{aligned}$$

Inserting (26) in (25) leads to

$$-4\pi^2\nu^2 m \xi_i = \phi''(a) \left[2 \cos \frac{2\pi a}{\lambda} - 2 \right] \xi_i = -\phi''(a) 4 \sin^2 \left(\frac{\pi a}{\lambda} \right) \xi_i,$$

or

$$(11. 27) \quad \nu = \frac{1}{\pi} \left(\frac{\phi''(a)}{m} \right)^{1/2} \sin \frac{\pi a}{\lambda}.$$

Not the whole course of the wave function (26), but only its values at isolated points $x_i = a(i - 1)$, are of physical significance. It is seen that waves of wavelength λ' with $a/\lambda' = (a/\lambda) + 1$ or with $a/\lambda' = 1 - (a/\lambda)$ give rise to exactly the same displacements ξ_i at every lattice point as those of wavelength λ (in the latter case with opposite sign, different phase). From (27) it follows that they also have the same value of ν^2 . It is therefore sufficient to restrict ourselves to wavelengths with $(a/\lambda) \leq \frac{1}{2}$, or $\lambda \geq 2a$. The frequencies take on all possible values which the function (27) can have as λ goes from infinity to $2a$. To the shortest wavelength $\lambda = 2a$ corresponds the highest frequency, $\nu = (1/\pi)[\phi''(a)/m]^{1/2}$. The mode of this vibration is such that neighboring particles have opposite amplitudes; the distance between nodes is $\frac{1}{2}\lambda = a$, equal to the distance between particles. The occurrence of this smallest wavelength is characteristic for the lattice structure in contradistinction to a continuum for which no lowest wavelength exists.

To avoid the complications arising from the ends we shall assume that the two end points are fixed in their equilibrium positions, that is, $\xi_1 = \xi_N = 0$. As in the case of the vibrating rod, to which this problem has great similarity, this border condition of clamped ends influences the types of vibrations, but not the distribution of the frequencies. Besides, it reduces the number of degrees of freedom by two, which is of little importance since N is assumed to be a very large number. One of the types of motion excluded this way is the simple translation along the x axis.

The border condition that the waves have nodes at the ends is taken care of at $i = 1$, $x_i = 0$ by choice of the phase factor $\alpha = 0$ in (26). At $i = N$ it imposes

$$\sin \frac{2\pi a}{\lambda} (N - 1) = 0, \quad \frac{2(N - 1)a}{\lambda} = n,$$

where n is a whole number. The distance between nodes, that is, half the wavelength λ , must be equal to the length of the lattice, $(N - 1)a$, divided by an integral number.

For a one-dimensional continuum of length L all possible displacements, subject to the conditions that the ends remain fixed, can be represented by linear combinations of functions $\sin(\pi n x/L)$, where n goes from 1 to infinity. The amplitude factors of these functions represent the components of the Fourier development of the displacement. They may therefore be used as coordinates for the description of the system. If the mass is discretely distributed, according to the previous discussion, the functions $\sin[\pi n(i - 1)/a(N - 1)]$ with $1 \leq n \leq N - 1$ suffice; every conceivable displacement of the $N - 2$ inner mass points may be expressed as a linear combination of these $N - 2$ functions. The amplitudes of the wave functions may therefore be used as coordinates, and the equations of motion show that they vary periodically in time. The normal coordinates are

$$q_n = \left(\frac{2m}{N - 1} \right)^{1/2} \sum_{i=1}^N \sin \left[\frac{\pi n(i - 1)}{(N - 1)} \right] \xi_i \\ = \left[\frac{(N - 1)m}{2} \right]^{1/2} A_n \sin 2\pi\nu_n t,$$

where A_n are the amplitudes in (26). The normalization factor in front has been chosen such as to make the kinetic energy a sum of squares in the momenta $p_n = \dot{q}_n$ without mass factors, in agreement with (2).

The $N - 2$ frequencies are

$$(11. 28) \quad \nu_n = \frac{1}{\pi} \left[\frac{\phi''(a)}{m} \right]^{1/2} \sin \frac{\pi n}{2(N - 1)}, \quad 1 \leq n \leq N - 2.$$

For the very low frequencies one may replace the sine by the argument in (27) or (28) and obtain

$$(11. 29) \quad \nu\lambda = a \left[\frac{\phi''(a)}{m} \right]^{1/2}.$$

It is seen that in a large lattice there exist vibrations of extremely low frequency. Physically, these motions represent elastic or acoustic waves. The quantity on the right-hand side is then the velocity of sound. For decreasing wavelength, when (29) ceases to be valid, the velocity of sound is dependent on the wavelength. However, if one uses (29) up to the shortest wavelength, an approximation which has to be made for the general crystal, the error made is not very large. The highest frequency would then become $\frac{1}{2}[\phi''(a)/m]^{1/2}$ instead of $(1/\pi)[\phi''(a)/m]^{1/2}$, as obtained from the correct formula (28).

11g. The Frequencies of Simple Isotropic Lattices

An approximative formula for the distribution of the frequencies of a simple three-dimensional lattice may be obtained following a method of

Debye.* Let us at first neglect the lattice structure entirely and treat the crystal as an isotropic elastic continuum. If, for simplicity, the crystal is assumed to have the shape of a cube with major axes parallel to the x , y , z axes, the proper vibrations of this block of elastic matter are standing waves, the displacements at any point x , y , z being proportional to

$$(11. 30) \quad u(x,y,z) = \sin 2\pi\tau_x x \sin 2\pi\tau_y y \sin 2\pi\tau_z z.$$

The waves are characterized by vectors $\vec{\tau}$ with positive components τ_x , τ_y , τ_z , whose magnitude is inversely proportional to the wavelength, $|\vec{\tau}| = \lambda^{-1}$. The standing wave is a superposition of the eight progressive waves of the same wavelength but different directions of propagation given by the eight vectors $(\pm\tau_x, \pm\tau_y, \pm\tau_z)$, which have the same magnitude, but different sign, of components as the vector $\vec{\tau}$. The nodal planes of the waves are parallel to the surface planes. The distance between the nodal planes normal to the x axis is $(2\tau_x)^{-1}$.

The border conditions at the surface determine the possible vectors $\vec{\tau}$. We may either stipulate that there is no motion at all at the surface, that is, the surface particles are rigidly fixed, so that the wave function (30) must have a node there, or that the ends are free to vibrate and are therefore a place of maximum amplitude. In either case these conditions demand that the length L of the side of the cube, divided by the distance between the nodal planes normal to it, be an integer number, n namely,

$$(11. 31) \quad \tau_x = \frac{n_x}{2L}, \quad \tau_y = \frac{n_y}{2L}, \quad \tau_z = \frac{n_z}{2L}.$$

To every wave vector $\vec{\tau}$, (31), and function u , (30), there belong three different types of vibration, since the displacements may be in any direction in space. The three waves originate from the two transversal and one longitudinal progressive waves. In an isotropic medium the frequencies of the vibrations depend on the wavelength through the relation

$$(11. 32) \quad \nu_1\lambda = \nu_2\lambda = c_t, \quad \nu_3\lambda = c_l,$$

where c_t , c_l are the velocities of the transversal and longitudinal elastic waves. The (compressional) longitudinal wave is the sound wave.

The number of longitudinal vibrations whose frequencies lie between ν and $\nu + \Delta\nu$ is then the same as the number of vectors $\vec{\tau}$ with $\nu/c_l \leq |\vec{\tau}| \leq (\nu + \Delta\nu)/c_l$, or the same as the number of vectors \vec{n} with

* P. P. Debye, *Ann. Physik*, **39**, 789 (1912).

positive, integer components n_x, n_y, n_z , whose end points lie in a spherical shell determined by

$$\frac{2L\nu}{c_l} \leq (n_x^2 + n_y^2 + n_z^2)^{1/2} \leq \frac{2L(\nu + \Delta\nu)}{c_l}.$$

This latter number is asymptotically equal to one-eighth of the volume of the spherical shell, namely, $4\pi(L/c_l)^3\nu^2\Delta\nu$. The number of transversal waves in the same frequency range is twice the same expression, but with c_t in place of c_l . The total number of vibrations with frequencies between ν and $\nu + \Delta\nu$ is then, considering that $L^3 = V$, the volume,

$$(11. 33) \quad N(\nu) \Delta\nu = 4\pi V \left(\frac{2}{c_l^3} + \frac{1}{c_t^3} \right) \nu^2 \Delta\nu.$$

In a lattice the form of the vibrations is essentially the same as in the continuum. The displacements from equilibrium of a lattice particle in a simple harmonic vibration are proportional to the value of a standing wave, u , (30), at the equilibrium position. An essential difference enters, however, owing to the fact that now not the whole course of the function u , but only its value at discrete points, is of physical importance. This introduces an upper limit for the components of the vector $\vec{\tau}$, that is, a lower limit for the wavelength. Motions with nodes closer together than the distance between neighboring particles may just as well be described as motions with smaller τ , greater distance between nodes, just as in the one-dimensional lattice. If the lattice contains N particles, there exist precisely N different wave vectors $\vec{\tau}$ which give rise to functions u which are different from each other at the N lattice points. This means that there exist $3N$ different modes of harmonic vibration, as many as the number of degrees of freedom.

For motions with long wavelength the lattice structure plays no important part, so that (32) is still fulfilled. Only, now the velocity of the elastic waves will, in general, be somewhat different for different directions. For wavelengths comparable with the distance between particles, (32) breaks down completely.

An approximate distribution of the frequencies may be obtained by assuming (32) to hold for all permissible wavelengths and directions of propagation. The velocity of the elastic waves must then be replaced by some average over the different directions. The distribution of frequencies is still given by (33). The lattice structure will now be taken into account by cutting (33) at a highest frequency ν_m , determined in

such a way that the total number of vibrations has the correct value, $3N$, namely,

$$(11. 34) \quad \begin{aligned} 3N &= 4\pi V \left(\frac{2}{c_l^3} + \frac{1}{c_t^3} \right) \int_0^{\nu_m} \nu^2 d\nu \\ &= \frac{4\pi V}{3} \left(\frac{2}{c_l^3} + \frac{1}{c_t^3} \right) \nu_m^3. \end{aligned}$$

(34) may be used to eliminate the sound velocities out of (33), leading to

$$(11. 35) \quad N(\nu) \Delta\nu = 9N \frac{\nu^2}{\nu_m^3} \Delta\nu,$$

for $\nu \leq \nu_m$.

11h. The Debye Formula

With this distribution (35) of the frequencies of the oscillators, the average energy of the lattice at any temperature T may immediately be calculated from (19). The average energy of one oscillator is multiplied with the number $N(\nu) \Delta\nu$ of oscillators with frequencies in the range $\Delta\nu$, and the product integrated over ν from zero to ν_m

$$E = \frac{9N}{\nu_m^3} \int_0^{\nu_m} \left[\frac{1}{2} h\nu + \frac{h\nu}{e^{h\nu/kT} - 1} \right] \nu^2 d\nu.$$

This integral is abbreviated by the use of the symbol $D(u)$ for the Debye function,

$$(11. 36) \quad D(u) = \frac{3}{u^3} \int_0^u \frac{x^3 dx}{e^x - 1},$$

in which

$$(11. 37) \quad u = \frac{h\nu_m}{kT} = \frac{\theta}{T}, \quad \theta = \frac{h\nu_m}{k}.$$

The quantity θ is called the Debye temperature, or characteristic temperature of the lattice. Using (37) in the equation for the energy, one obtains

$$(11. 38) \quad E = \frac{9}{8} N h \nu_m + 3NkT \cdot D\left(\frac{h\nu_m}{kT}\right).$$

The first term is the zero point energy of the oscillators.

The Debye function (36) is plotted in Fig. 11. 1. For purposes of numerical calculation one can find two series approximations to (36), one of which is valid at high and the other at low temperatures. The range of temperatures for which the two series converge overlaps.

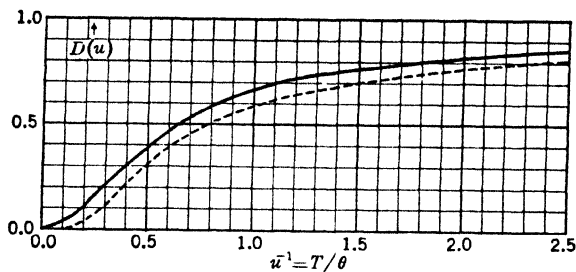

FIG. 11. 1. Plot of the Debye function, $D(u) = \frac{3}{u^3} \int_0^u \frac{x^3 dx}{e^x - 1}$ against u^{-1} . [For comparison the function $\frac{u}{e^u - 1}$ for one oscillator is shown dotted.]

At high temperatures u is small, and since the integral extends from zero to u , x is small throughout the range of integration. One can develop

$$\begin{aligned} \frac{3}{u^3} \frac{x^3}{e^x - 1} &= \frac{3x^3 (1 - \frac{x}{2} + \frac{x^2}{24} - \dots)}{u^3 (x + x^2/2 + x^3/6 + x^4/24 + x^5/120 + \dots)} \\ &= \frac{1}{u^3} \left(3x^2 - \frac{3}{2}x^3 + \frac{x^4}{4} - \frac{x^6}{240} \dots \right), \end{aligned}$$

and then integrate, obtaining

$$(11. 36') \quad D(u) = 1 - \frac{3}{8}u + \frac{1}{20}u^2 - \frac{1}{1680}u^4 \quad (u \leq 1).$$

For low temperatures, u is large, and it is more convenient to transform to

$$D(u) = \frac{3}{u^3} \left[\int_0^\infty \frac{x^3 dx}{e^x - 1} - \int_u^\infty \frac{x^3 dx}{e^x - 1} \right].$$

The first integral is a definite integral having the value $\pi^4/15$. In the second term x is large throughout the range of integration, and one can develop

$$\frac{x^3}{e^x - 1} = \frac{x^3 e^{-x}}{1 - e^{-x}} = x^3 e^{-x} + x^3 e^{-2x} + \dots$$

Integration of this leads to

$$(11. 36'') \quad D(u) = \frac{\pi^4}{5} \frac{1}{u^3} - \left(3 + \frac{9}{u} + \frac{18}{u^2} + \frac{18}{u^3}\right) e^{-u} \\ - \left(\frac{3}{2} + \frac{9}{4u} + \frac{9}{4u^2} + \frac{9}{8u^3}\right) e^{-2u}.$$

The energy of the crystal may then be written as

$$(11. 39) \quad E = \frac{9}{8} Nh\nu_m + 3NkT \cdot D\left(\frac{\theta}{T}\right) \\ = 3NkT \left\{1 + \frac{1}{20} \left(\frac{\theta}{T}\right)^2 - \frac{1}{1680} \left(\frac{\theta}{T}\right)^4 + \dots\right\} \\ = \frac{9}{8} Nh\nu_m + 3NkT \left\{\frac{\pi^4}{5} \left(\frac{T}{\theta}\right)^3 - \dots\right\}$$

for high and low temperatures.

The heat capacity at constant volume is the derivative of the energy with respect to temperature.

$$C_V = 3Nk \cdot D\left(\frac{\theta}{T}\right) + 3NkT \cdot \frac{d}{dT} D\left(\frac{\theta}{T}\right).$$

The derivative of the Debye function is

$$\frac{d}{dT} D\left(\frac{\theta}{T}\right) = -\frac{1}{T} u \cdot \frac{d}{du} D(u)$$

and, from (36),

$$\frac{d}{du} D(u) = -\frac{3}{u} \cdot D(u) + \frac{3}{e^u - 1},$$

so that

$$(11. 40) \quad C_V = 3Nk \left\{4D\left(\frac{\theta}{T}\right) - \frac{3(\theta/T)}{e^{\theta/T} - 1}\right\}.$$

At high temperatures the approximative formula is

$$(11. 40') \quad C_V = 3Nk \left\{1 - \frac{1}{20} \left(\frac{\theta}{T}\right)^2 + \frac{1}{560} \left(\frac{\theta}{T}\right)^4 \dots\right\},$$

which goes over into the classical $3Nk$ at sufficiently high temperatures. At low temperatures,

$$(11. 40'') \quad C_V = 3Nk \left\{ \frac{4\pi^4}{5} \left(\frac{T}{\theta} \right)^3 + \dots \right\}$$

Experimental measurements at very low temperatures bear out this proportionality of the specific heat to the cube of the temperature.

It is seen that the heat capacity (40), as well as E/NkT , depend only on θ/T . By shifting the temperature scale the curves for various substances should be brought into coincidence.

For isotropic monatomic crystals the course of the experimentally observed specific heats is moderately well represented by a formula of the type (40). The values of θ , and therefore ν_m , determined from thermal data, are in fair agreement with those obtained from elastic constants. The Debye temperature for most substances lies below room temperature. This is in agreement with the observed and calculated fact that the lattice frequencies, due to small force constants and large vibrating masses, are very small.

However, careful comparison of the experimental heat capacity curves with those predicted by equation (40) shows consistent, although small, discrepancies. Actually the proportionality of the heat capacity to T^3 is observed for higher temperatures than would be predicted from the Debye equation. Blackman* has made a detailed calculation of the number of frequencies $N(\nu) \Delta\nu$ in a given frequency range for a three-dimensional cubic lattice. His method is an extension of that used in section 11f for the linear lattice. Blackman finds that the curve of the function $N(\nu)$ is fairly complicated, deviating very considerably from the ν^2 law of equation (35), and even showing a maximum at a frequency considerably lower than ν_m as well as the higher maximum at about ν_m predicted in (35). It appears that the agreement with experiment obtained with the Debye function is partly fortuitous.

For crystals which are not monatomic and isotropic, other, more complicated types of behavior occur. Qualitatively, some of these are predictable. They give rise to heat capacity functions considerably different from Debye's. The behavior of such lattices will be discussed briefly in the next section.

The entropy, according to (21) and (35), is determined by

$$S = 9Nk \left(\frac{\theta}{T} \right)^3 \int_0^{\theta/T} \left[-\ln(1 - e^{-x}) + \frac{x}{e^x - 1} \right] x^2 dx.$$

* M. Blackman, *Proc. Roy. Soc., London*, **A159**, 416 (1937).

Partial integration of the first term brings this into the form

$$(11. 41) \quad S = 3Nk \cdot \left\{ \frac{4}{3} \cdot D \left(\frac{\theta}{T} \right) - \ln (1 - e^{-\theta/T}) \right\}.$$

At high temperatures this becomes

$$(11. 41') \quad S = 3Nk \left\{ \frac{4}{3} - \ln \left(\frac{\theta}{T} \right) + \frac{1}{40} \left(\frac{\theta}{T} \right)^2 - \frac{1}{2240} \left(\frac{\theta}{T} \right)^4 + \dots \right\}.$$

At low temperatures the approximation is

$$(11. 41'') \quad S = 3Nk \left\{ \frac{4\pi^4}{15} \left(\frac{T}{\theta} \right)^3 + \dots \right\}.$$

The work function $A = E - TS$ takes the form

$$(11. 42) \quad \begin{aligned} A &= \frac{9}{8} N h \nu_m + 3NkT \left\{ \ln (1 - e^{-\theta/T}) - \frac{1}{3} \cdot D \left(\frac{\theta}{T} \right) \right\} \\ &= 3NkT \left\{ \ln \left(\frac{\theta}{T} \right) - \frac{1}{3} + \frac{1}{40} \left(\frac{\theta}{T} \right)^2 - \frac{1}{6720} \left(\frac{\theta}{T} \right)^4 + \dots \right\} \\ &= \frac{9}{8} N h \nu_m - 3NkT \left\{ \frac{\pi^4}{15} \left(\frac{T}{\theta} \right)^3 + \dots \right\}, \end{aligned}$$

which may also be derived from the relation $A = -kT \ln Q$.

The Debye temperature θ depends on the interaction of the atoms and therefore on the volume V of the crystal. The pressure,

$$P = - \left(\frac{\partial E}{\partial V} \right)_S = - \left(\frac{\partial A}{\partial V} \right)_T,$$

contains, therefore, $d\theta/dV$, a quantity which is not easily evaluated. The heat content H , and the free energy F , differ from E and A , respectively, by the term PV . However, the volume per molecule, V/N , in a crystal is very much smaller, indeed about one-thousandth, of that in a gas at room temperature and one atmosphere pressure. Except at high pressure the term PV is therefore about one-thousandth of RT per mole, and of little importance.

11i. Deviations from the Debye Formula

In the last two sections the transition from continuum to lattice was made without specifying anything about the type of crystal.

The assumption was made, however, that the crystal be isotropic. If it is not, that is, if the velocity of sound is very different for propaga-

tion in different directions, the distribution of frequencies is necessarily more complicated than (35), and the Debye formula must be expected to fail. This indeed happens.

Simple, isotropic, monatomic lattices, although Blackman's detailed calculation shows that the distribution of frequencies is not given very well by a formula of the type (35), still obey the Debye equation rather remarkably.

The formulas of the last section may be used with some success for many crystals of simple ions, like the alkali halides. These substances form lattices in which each ion is surrounded by a rather large number (six or eight) of equivalent neighbors of the opposite charge. The forces acting upon the positive and negative ions are essentially the same, so that the modes of vibration are of the same type as in the monatomic crystal.

The vibration with smallest wavelength and largest frequency in the lattice is that where neighboring particles vibrate with opposite phase. In ionic crystals like the alkali halides, neighboring particles are oppositely charged. This fastest oscillation corresponds then to a large vibrating electric dipole moment and should therefore be capable of emitting and absorbing light. This is indeed the fact. These optically active frequencies of salt crystals are usually called Reststrahlen, or residual ray frequencies, after the method by which they were first observed. They are so far in the infra-red (optical wavelength between 20 and 150μ) that optical absorption methods failed until rather recently* to disclose them. Rubens† discovered them originally by studying the selective reflection of salt crystals.‡

Vibrations of slightly longer wavelength have slightly lower frequency. If the masses of the different ions in the crystal are equal, or nearly equal, as for instance in KCl, the optical frequencies of increasing wavelength go continuously over into the elastic frequencies. The optical frequency, ν_0 , is then simply the highest frequency, ν_m , and may be used in the Debye formula (40) to calculate the heat capacity. The total number of degrees of freedom is, of course, three times the total number of ions, or six times the total number of KCl molecules.

If the masses of the constituent particles are different, however, the situation is more complicated. One finds then gaps in the frequencies, that is, ranges of frequency between the optical and the elastic frequen-

* O. Reinkober, *Z. Physik*, **39**, 437 (1926); M. Czerny, *Z. Physik*, **65**, 600 (1930); R. B. Barnes, *Z. Physik*, **75**, 723 (1932).

† H. Rubens and E. F. Nichols, *Wied. Ann.*, **60**, 45 (1897), and numerous later papers.

‡ The laws of optics show that the frequency of the light which is selectively reflected is somewhat different from that which is most strongly absorbed; the latter is the true frequency of the vibrational motion in the crystal.

cies, which correspond to no lattice vibration. In the alkali halides, for instance, where one Reststrahlen frequency is observed, the lattice frequencies form two branches, each containing half as many vibrations as there are degrees of freedom in the lattice. The distribution of frequencies in the lower or elastic branch is given rather well by (35), replacing the number of ions, N , by $\frac{1}{2}N$. The frequencies of the upper or optical branch are all higher than the largest one of the elastic branch, and the highest of them is the Reststrahlen frequency. If the masses of the ions are very different all $3N/2$ optical vibrations have closely the same frequency.

The reason for this effect lies not in a difference of force constants but in a difference in the vibrating masses. For the motion corresponding to the Reststrahlen frequency the vibrating mass is the reduced mass of the two kinds of particles, $m_1m_2/(m_1 + m_2)$, which is smaller than the mass of either particle, and nearly equal to the mass of the lighter particle if m_1 and m_2 are very different. The vibrations of the optical branch consist primarily of vibration of the different kinds of particles against each other, down to the vibration of the lighter particles alone. The elastic branch consists of vibrations in which neighbors move in phase, up to the motions of the heavier particles alone.

This can be seen very clearly in the simple one-dimensional lattice. Assume the particles to have alternately different masses, m_1 and m_2 , with $m_1 > m_2$. The break in the frequencies occurs at the wavelength $\lambda = 4a$, where every second particle is standing still. To this wavelength correspond two motions of exactly the same force constant but different frequency: for the lower one the heavier, for the higher one the lighter, particles vibrate alone. The frequencies are given by $\nu_1 = (1/\pi)[\phi''(a)/2m_1]^{1/2}$ and $\nu_2 = (1/\pi)[\phi''(a)/2m_2]^{1/2}$ respectively, since $\sin(\pi/4) = 2^{-1/2}$. There are $\frac{1}{2}N$ vibrations with longer wavelength, which have lower frequencies than ν_1 , and $\frac{1}{2}N$ with shorter wavelength and higher frequency than ν_2 , up to the highest with $\nu_0 = (1/\pi)[\phi''(a)(m_1 + m_2)/2m_1m_2]^{1/2}$.

In this case, a fair approximation for the specific heat may be obtained by representing the heat capacity of the oscillators of the elastic branch by a Debye formula containing $3N/2$ vibrations. The frequencies of the optical branch may be considered to be identical to the Reststrahlen frequency ν_0 , so that their heat capacity is given by $3N/2$ times the average heat capacity of one oscillator. The energy of the crystal is similarly calculated as the sum of two parts, each contributed to by $3N/2$ degrees of freedom,

$$(11. 43) \quad E = \frac{9}{16} N h \nu_m + \frac{3}{2} N k T \cdot D\left(\frac{\theta}{T}\right) \\ + \frac{3}{4} N h \nu_0 + \frac{3}{2} N k T \frac{(h \nu_0 / k T)}{e^{h \nu_0 / k T} - 1}$$

The Reststrahlen frequency is of the same order of magnitude as ν_m , so that the heat capacity of these substances at room temperature has the classical value, kT times the number of ions.

Still different are molecular crystals, or crystals which contain molecular ions, for instance, CO_2^- groups. The forces within the molecules are usually much stronger than those between the molecules. The shape of the molecule or ion complex remains, therefore, essentially the same as in the gas or in solution, and the molecular frequencies, at least the higher ones corresponding to the stretching of bonds and not to bending, are but little influenced by the fact that the molecule is cemented into the lattice. The molecular frequencies are so much higher than the lattice frequencies that their contribution to the heat capacity at room temperature is very small. The contribution of the true lattice frequencies may again be represented by a Debye curve.

11j. Strain and Stress Variables

The Debye equation gives the thermodynamic properties of the crystal as a function of temperature in terms of one parameter, ν_m or θ , the maximum frequency of the crystal in question. It is tacitly assumed that θ is *not* a function of temperature, and the volume dependence of θ , and therefore of the thermodynamic functions, has not been discussed.

Previously we have dealt only with gases, which are fluids, having the characteristic that their thermodynamic properties depend only on temperature and volume, and not on the shape of the containing vessel. A crystal, on the other hand, resists efforts to distort its shape, as well as changes of the volume alone. The thermodynamic properties of the crystal, then, depend on other extensive variables than volume, variables that have to do with the distortion of the shape of the crystal, the various strains. These strains are usually defined in such a way that they are intensive rather than extensive variables, just as the specific volume, or volume per mole, is an artificial manner of introducing an intensive property in place of the extensive total volume.

There are, apparently, nine coefficients of homogeneous displacement in a rigid body. Consider a rigid body, with no outer forces acting on it, and a Cartesian coordinate system drawn from some point in the body as origin. If the body is subject to some stress, that is to some force tending to distort it, a point in the body formerly at the position x, y, z will be displaced to a new position $x + \Delta x, y + \Delta y, z + \Delta z$. Keeping the origin fixed, the displacement is said to be homogeneous if the displacements $\Delta x, \Delta y, \Delta z$ are linearly proportional to the distances x, y, z from

the origin:

$$(11. 44) \quad \begin{aligned} \Delta x &= x_x x + y_x y + z_x z, \\ \Delta y &= x_y x + y_y y + z_y z, \\ \Delta z &= x_z x + y_z y + z_z z. \end{aligned}$$

The nine coefficients x_x, \dots, z_z , determine the type of displacement.

Now a displacement for which $y_z = -z_y$ corresponds to a pure rotation about the x axis, and is not resisted by a restoring force. Similarly, displacements with $x_z = -z_x$ or $x_y = -y_x$ correspond to rotations about the y and z axes. Instead of describing the displacement by the nine coefficients x_x, x_y , etc., one might use x_x, y_y, z_z , and $\frac{1}{2}(y_z + z_y), \frac{1}{2}(y_z - z_y), \frac{1}{2}(z_x + x_z), \frac{1}{2}(z_x - x_z), \frac{1}{2}(x_y + y_x), \frac{1}{2}(x_y - y_x)$. The three coefficients $\frac{1}{2}(y_z - z_y), \frac{1}{2}(z_x - x_z), \frac{1}{2}(x_y - y_x)$ determine the amount of rotation about the three axes, x, y , and z , and the energy does not depend on these coefficients.

The strain in the body, then, depends only on six coefficients, $x_x, y_y, z_z, \frac{1}{2}(y_z + z_y), \frac{1}{2}(z_x + x_z), \frac{1}{2}(x_y + y_x)$. Instead of writing $\frac{1}{2}(y_z + z_y)$ it is sufficient to treat only displacements for which $y_z = z_y, \frac{1}{2}(y_z - z_y) = 0$, etc., that is displacements for which the rotation is zero.

A homogeneous strain in the body may then be described by the six coefficients: $x_x, y_y, z_z, y_z, z_x, x_y$, it being understood that always $y_z = z_y, z_x = x_z, x_y = y_x$.

The total thermodynamic work function A , of a crystal, is the sum of the potential energy U , at absolute zero, and of the expression $-NkT \ln Q$, given by (5), or by equation (42) if the Debye approximation is used.

The potential energy U at $T = 0$ depends on the six strain coefficients, x_x, \dots, x_y , and may be calculated from the sum of the mutual potentials between the molecules when they are at the lattice positions of the strained lattice. The frequencies ν_i entering (5), or the maximum Debye frequency ν_m (or $\theta = h\nu_m/k$) in (42) are also to be calculated from the forces acting on the molecules in the strained lattice. Thus both U and the frequencies are functions of these strains, which determine the shape and volume of the crystal. The frequencies ν_i do not depend explicitly on temperature, but do depend on the strains.

One may, then, in principle at least, arrive at an equation for the work function A as a function of $T, x_x, y_y, z_z, y_z, z_x$, and x_y . The stress tensor components, X_x, Y_y, \dots, X_y , are the forces

$$(11. 45) \quad \begin{aligned} X_x &= - \left(\frac{\partial A}{\partial x_x} \right)_{T, y_y, \dots, x_y}, \\ &\vdots \\ X_y &= - \left(\frac{\partial A}{\partial x_y} \right)_{T, x_x, y_y, \dots, z_z}, \end{aligned}$$

resisting the strain displacements. A must be taken, in (45), as the work function *per unit volume*. At $T = 0$, $A = U$, and equation (45) is most commonly met with the total potential energy per unit volume U , replacing A .

The Hooke's law assumption is that these stresses are proportional to the strains

$$\begin{aligned} -X_x &= c_{11}x_x + c_{12}y_y + c_{13}z_z + c_{14}y_z + c_{15}z_x + c_{16}x_y, \\ -Y_y &= c_{21}x_x + c_{22}y_y + \cdots \\ &\vdots \\ -X_y &= c_{61}x_x + \cdots + c_{66}x_y. \end{aligned}$$

One can show that necessarily

$$c_{kk'} = c_{k'k}$$

so that there are only 21 elastic constants instead of the 36 seemingly appearing in the above equation.

For a regular (cubic) crystal, with all three axes equivalent, only three independent elastic constants,

$$c_{11}, c_{12}, c_{44},$$

remain.

For a more complete discussion of this classical theory of elasticity the reader is referred to various books in which the subject is treated more exhaustively.*

It is, of course, necessary to use some approximations in order to arrive at the equation for the work function A in terms of the strain tensor. Herzfeld and Goeppert Mayer† have used the Debye approximation, as has Brillouin.‡ Born§ has carried out this method rather completely, calculating directly the expression for the product of all frequencies, which, at high temperatures, is sufficient to determine $\ln Q$, equation (7).

If the work function A is accurately given as a function of temperature and the six strain components, it is possible to set certain outer limits on the range of stability of the crystal.

For instance, no stable thermodynamic system could have an equation of state such that the pressure increased with volume. The coefficient $-(\partial P/\partial V)_T$ must always be positive. In general, at low temperatures

* For instance, see M. Born, *Atomtheorie des festen Zustandes*, Leipzig, 1923.

† K. Herzfeld and M. Goeppert Mayer, *Phys. Rev.*, **46**, 995 (1934).

‡ L. Brillouin, *Phys. Rev.*, **54**, 916 (1938).

§ M. Born, *J. Chem. Phys.*, **7**, 591 (1939).

and high pressures, this is the case. If, however, this quantity is calculated as a function of P and T , one will find a line in the $P-T$ diagram for which $\partial P/\partial V$ becomes zero and is negative for higher temperatures and lower pressures. Herzfeld and Goepfert Mayer have assumed that this line gives the melting curve, and the numerical agreement is as good as could be wished. It is found, for instance, in agreement with experiment, that crystal helium should not be stable at zero pressure, even at $T = 0$.

This line, at which $(\partial P/\partial V)_T = 0$, certainly determines the upper limit of the melting temperature, in so far as the numerical calculation is correct. One is, of course, not certain that the liquid phase does not have a lower free energy than the crystal at lower temperatures than those given by the line $(\partial P/\partial V)_T = 0$. In this case one would say that the crystal is metastable between the line for which the free energies F of the crystal and liquid are equal and the line for which $(\partial P/\partial V)_T = 0$.

Herzfeld and Goepfert Mayer base their assertion that the line $(\partial P/\partial V)_T = 0$ represents the melting line upon the observed fact that ordinary crystals cannot be superheated, from which they deduce that no metastable region exists.

Born* has emphasized that not only $-(\partial P/\partial V) > 0$ must be satisfied if the crystal is to be even metastable, but also that the crystal must retain rigidity with respect to all distortions. For a regular (cubic) crystal this requires three conditions for the three elastic constants, c_{11} , c_{12} , c_{44} , to be satisfied, instead of only the one, $-(\partial P/\partial V) > 0$. Born also tries to deduce the character of the phase which is formed upon the breakdown of any one of these conditions. He believes that only the transition when $c_{44} = 0$ corresponds to melting into a liquid.

Numerically Herzfeld and Goepfert Mayer found c_{44} to be still positive when $(\partial P/\partial V)_T$ became zero.

It is not desirable to go into detail here concerning the differences in point of view of the different workers. It is at least apparent that, within certain limits upon the accuracies with which numerical calculations can be made, the limits of metastability of the crystal can be set.

In discussing the theories concerning the limits of stability of the crystalline phase the interesting theory of Lennard-Jones and Devonshire,† who attempt to determine the $P-T$ line for which the crystal changes into a more random type of lattice structure, should be mentioned.

* M. Born, *J. Chem. Phys.*, **7**, 591 (1939).

† J. E. Lennard-Jones and A. F. Devonshire, *Proc. Roy. Soc.*, **A169**, 317 (1939).

CHAPTER 12

THE VAN DER WAALS EQUATION

(a) Introduction. (b) The Approximate Statistical Treatment. (c) The Interpretation of a and b . (d) The Law of Corresponding States. (e) Condensation and the van der Waals Equation. (f) Phase Changes and a General Equation of State.

12a. Introduction

The perfect gas is a system in which the mutual potential energies of the molecules may be neglected owing to the large average distances between them. If a real gas is compressed, deviations from the perfect gas equation of state, $PV = RT$, are observed, and these deviations are due to the increasing importance of the forces between the molecules as the distances between them are decreased.

A very simple semi-empirical equation of state, which gives a surprisingly good approximation to the observed $P-V$ relationship, even down to the volume of the condensed phase, is the van der Waals equation,

$$(12. 1) \quad \left[P + \frac{N^2 a}{V^2} \right] \left[V - Nb \right] = NkT.$$

For relatively low pressures and large volumes this equation may be developed as

$$PV = NkT - \frac{N^2 a}{V} + NbP + \dots,$$

which, with the substitution of $P = NkT/V$ as a zeroth-order approximation for the pressure, gives the beginning of the expansion of PV as a power series in $1/V$ to be

$$(12. 2) \quad PV = NkT \left[1 + \frac{N}{V} \left(b - \frac{a}{kT} \right) + \dots \right].$$

Equation (2) may be derived theoretically by the use of certain reasonable approximations, giving a means of evaluating the two constants a and b in terms of parameters occurring in the equation for the mutual potential of two molecules. The derivation which follows is used frequently and gives the correct result, although it does so by the

accident of two compensating errors. The correct derivation was first given by Ursell,* and an exact method, similar to his, will be discussed fully in the next chapter. The incorrect method will be used here because of its simplicity and because it is sufficiently similar to the exact method to form a usefully instructive introduction to it.

12b. The Approximate Statistical Treatment

A gas composed of N identical molecules in a volume V will be considered. Since the essential features of an imperfect gas are observed in the noble monatomic gases as well as in the more complicated polyatomic gases, it will be simpler to choose a monatomic one as an example, and to assume that the molecules treated have no excited internal degrees of freedom. Since, further, the behavior of the imperfect gas is not due to quantized energy levels, but occurs at temperatures and volumes, in the heavier gases at least, for which the classical equations are valid, we shall use the classical integration methods throughout.

The $3N$ Cartesian coordinates of the molecules, and their conjugated momenta, will be used. The indices i and j as subscripts will indicate the molecules i and j . The Hamiltonian contains the sum of $3N$ kinetic energy terms $p^2/2m$. The additional potential-energy terms, functions of the coordinates alone, will be responsible for the difference between the equations derived and those of the perfect gas. The phase integral Q may be integrated at once over the $3N$ momenta from minus to plus infinity, leading to

$$(12. 3) \quad Q = \left(\frac{2\pi mkT}{h^2} \right)^{3N/2} \frac{Q_\tau}{N!},$$

which is the simplified form of equation (10. 32) for systems of one kind of molecule only. The configuration integral Q_τ is

$$(12. 4) \quad Q_\tau = \iiint \dots \int e^{-U(q)/kT} d\tau_1 \dots d\tau_i \dots d\tau_N,$$

with

$$(12. 5) \quad d\tau_i = dx_i dy_i dz_i,$$

and $U(q)$ is the potential energy of the system.

The potential energy, $U(q)$, will be assumed to have certain simplified characteristics, which are probably almost exactly obeyed in almost all real gases composed of chemically saturated molecules. It will first be assumed that $U(q)$ can be written as a sum of terms, each depending only on the distance apart r_{ij} of two molecules i and j . This assumes

* Ursell, *Proc. Cambridge Phil. Soc.*, **23**, 685 (1927).

that the potential of three molecules, all close together, is the same as that of three independent pairs of molecules having the same distances apart as the three pairs which can be formed of the group of three. In the system of N molecules there are $\frac{1}{2}N(N - 1)$ different pairs which can be formed, so that this assumption is that $U(q)$ is the sum of $\frac{1}{2}N(N - 1)$ terms, namely,

$$(12. 6) \quad U(q) = \sum_{i>j}^{i=N} \sum_{j=1}^{j=N-1} u(r_{ij}),$$

where $u(r_{ij})$ is the potential energy of the pair of molecules i and j as a function of their distance apart r_{ij} .

The function $u(r)$ has the same general characteristic form for all neutral, chemically saturated molecules. It is zero for large values of the argument r , decreasing to a minimum negative value at a distance r of a few Ångström units, and then increasing rapidly, as r decreases, to very high positive values for smaller distances of approach. Later it will be necessary to make more special assumptions about this potential in order to arrive at equation (2). For the present it will be desirable to assume only that $u(r)$ approaches zero for large values of r more rapidly than the inverse third power of the distance.

With (6) for $U(q)$ the exponent of the integrand in (4) for Q_r is a sum of terms. The integrand itself is then a product. However, the coordinates of two molecules occur in each term of the product, and the coordinates of each molecule occur in $N - 1$ different terms of the product. The complete integral is not to be written as a product of integrals as were the momenta integrals. One may write

$$(12. 7) \quad e^{-U(q)/kT} = \prod_{N \geq i > j \geq 1} e^{-u(r_{ij})/kT}$$

Each term $e^{-u(r_{ij})/kT}$ becomes unity for large values of the argument r_{ij} , for which $u(r_{ij})$ is zero, so that it is convenient to define a function,

$$(12. 8) \quad f(r_{ij}) = f_{ij} = e^{-u(r_{ij})/kT} - 1,$$

which becomes zero for large values of r_{ij} . Since

$$e^{-u(r_{ij})/kT} = 1 + f_{ij},$$

equation (7) may be written as,

$$(12. 9) \quad e^{-U(q)/kT} = \prod_{N \geq i > j \geq 1} (1 + f_{ij}).$$

This product may be expanded into a sum of terms,

$$(12. 10) \quad e^{-U(q)/kT} = 1 + \sum_{N \geq i > j \geq 1} f_{ij} + \sum \sum f_{ij} f_{i'j'} + \dots,$$

in which each term becomes zero if the argument r_{ij} is large for any pair ij occurring as a function f_{ij} in the term.

The complete development of this equation will be considered in the next two chapters. For the present the unjustifiable assumption will be made that the contribution to the integral of the unity, and the $\frac{1}{2}N(N-1)$ terms containing only one f_{ij} , need be considered, and that all the other terms may be neglected. Using (10) in (4), with this assumption, one obtains

$$(12. 11) \quad Q_T = \iiint \dots \int \left[1 + \sum_{N \geq i > j \geq 1} f_{ij} + \dots \right] d\tau_1 \dots d\tau_j \dots d\tau_i \dots d\tau_N.$$

The integration over the unity leads to a factor V for each molecule, since the configuration space allowed to each molecule is the volume of the system. The product of these factors for all N molecules is V^N . If $u(r)$ were identically zero for all r 's, then all the f_{ij} 's would be zero and this term alone would be present. This value, V^N , for Q_T gives the perfect gas equation for the pressure (see equation 10. 54).

The integration over each of the $\frac{1}{2}N(N-1)$ different f_{ij} 's gives the same value. For each such term, containing one f_{ij} , integration over the configuration space of a molecule other than i or j leads to V as a factor. There are $N-2$ such molecules, so that the term is

$$V^{N-2} \iint f_{ij} d\tau_i d\tau_j.$$

Now f_{ij} drops rapidly to zero as r_{ij} becomes large, so that, if the position of i does not happen to be within molecular distance of the walls of the vessel,

$$(12. 12) \quad \int f_{ij} d\tau_j = \int_0^\infty f(r) 4\pi r^2 dr = \beta,$$

since $d\tau_j$ can be expressed in spherical coordinates with molecule i as a center, and the integration over the angles performed. The integral β has the dimensions of volume. β is independent of the position of molecule i , at least to within a few Ångströms of the wall, so that

$$\int \beta d\tau_i = \beta V.$$

There are $\frac{1}{2}N(N-1)$ such terms, and since N is very large this is practically $\frac{1}{2}N^2$. One may write

$$Q_r = V^N \left(1 + \frac{1}{2} N^2 \frac{\beta}{V} \right),$$

or

$$(12. 13) \quad Q_r = N^N v^N \left(1 + \frac{1}{2} N \frac{\beta}{v} \right),$$

with the introduction of the volume per molecule, v ,

$$(12. 14) \quad v = \frac{V}{N}.$$

In taking the logarithm of Q_r , the unjustifiable assumption is made that $\frac{1}{2}N\beta/v$ is small compared to unity,* so that $\ln(1 + \frac{1}{2}N\beta/v) = \frac{1}{2}N\beta/v$,

$$(12. 15) \quad \ln Q_r = N \left[\ln N + \ln v + \frac{\beta}{2v} \right].$$

The pressure P is $-(\partial A/\partial V)_T$, and since A is $-kT \ln Q$, the product PV is $kT(\partial \ln Q/\partial \ln V)_T$. The only volume-dependent factor of the phase integral Q is the configuration integral Q_r , so that

$$(12. 16) \quad PV = kT \left(\frac{\partial \ln Q_r}{\partial \ln V} \right)_T = kT \left(\frac{\partial \ln Q_r}{\partial \ln v} \right)_T,$$

which is the same as equation (10. 54). Applying this to (15), one obtains

$$(12. 17) \quad P = \frac{kT}{v} \left[1 - \frac{\beta}{2v} \right].$$

12c. The Interpretation of a and b

Equation (17) shows merely that the pressure P can be developed in terms of a power series in v^{-1} . However, the constant β is defined by (12) and (8) as

$$(12. 18) \quad \beta = 4\pi \int_0^\infty r^2 (e^{-u(r)/kT} - 1) dr$$

* The correction term appearing in the final equation is $\frac{1}{2}\beta/v$, so that if this term is appreciable compared to unity the term $\frac{1}{2}N\beta/v$ is certainly not small. Actually if the higher products of the sum (10) are taken into account Q_r may be shown to approach $V^N(1 + \frac{1}{2}\beta/v)^N$, and (13) is only made up of the first two terms in the expansion of this power. This equation leads directly to (15), which is the correct approximation to $\ln Q_r$ to within terms of the order of v^{-1} .

in terms of the potential $u(r)$ between two molecules. The development (2) of the van der Waals equation gives β as a function of the temperature, namely, by comparison of (2) with (17), that

$$(12. 19) \quad \frac{1}{2}\beta = \frac{a}{kT} - b.$$

This functional relationship of β on temperature depends on a particular form for the potential $u(r)$, and it will now be shown what form leads to this equation, (19).

The necessary and sufficient condition for (19) is that $u(r)$ should be positive and extremely large compared to kT for some range of the variable r , and that for all other values of r its absolute magnitude should be much smaller than kT . When $u(r)$ is plus infinity the integrand of (18) is independent of T , since $e^{-u(r)/kT}$ is zero. The integral over this range of r gives rise to the negative and temperature independent part, $-b$, in (19). When $|u(r)| \ll kT$ the exponential $e^{-u(r)/kT}$ may be developed as $1 - u(r)/kT$, and for this range of r values the integrand is $-u(r)/kT$, which is inversely proportional to T .

The simplest equation which satisfies these conditions is also a rather close approximation to the potential curve for real molecules, and is

$$(12. 20) \quad u(r) = \infty, \quad 0 \leq r \leq r_0,$$

$$u(r) = -u_0 \left(\frac{r_0}{r} \right)^m, \quad r_0 < r \leq \infty.$$

This potential, with the corresponding $f(r)$ for $u_0/kT = \frac{1}{2}$, which corresponds to a temperature approximately twice the critical temperature, is plotted in Fig. 12. 1, for $m = 6$.

The molecules obeying this potential law behave like hard spheres of

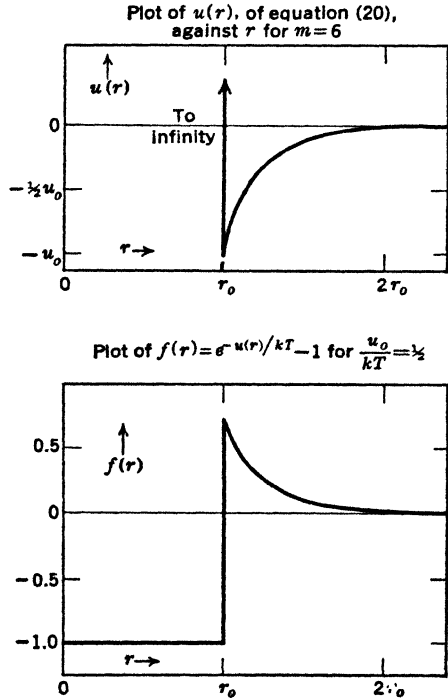

FIG. 12. 1.

radius $\frac{1}{2}r_0$ and volume

$$(12. 21) \quad v_0 = \frac{4\pi}{3} \left(\frac{r_0}{2} \right)^3 = \frac{\pi}{6} r_0^3,$$

repelling each other infinitely when their centers are a distance r_0 apart. For distances greater than r_0 they attract each other, having a minimum negative mutual potential of $-u_0$ at $r = r_0$. It is assumed that $u_0 \ll kT$, although the subsequent method of evaluating β is not greatly in error for values of u_0 as great as $\frac{1}{2}kT$. The value of m which would most closely approximate the true potential curve for most molecules is about six.

For values of r between zero and r_0 the exponential is zero and b may be defined as,

$$(12. 22) \quad b = \frac{1}{2} \int_0^{r_0} 4\pi r^2 dr = \frac{2\pi}{3} r_0^3 = 4v_0.$$

For r values between r_0 and infinity

$$e^{-u(r)/kT} - 1 \cong -\frac{u(r)}{kT} = \frac{1}{kT} u_0 r_0^m r^{-m}$$

and a may be defined as,

$$(12. 23) \quad a = \frac{1}{2} 4\pi u_0 r_0^m \int_{r_0}^{\infty} r^{-(m-2)} dr = \frac{2\pi}{m-3} u_0 r_0^3 \\ = \frac{12}{m-3} u_0 v_0.$$

By insertion of these values into (18), equation (19) is seen to be indeed fulfilled.

The van der Waals constant b is four times the volume v_0 of the molecules. The constant a is proportional to the volume of the molecules and to the minimum potential u_0 , with a proportionality constant dependent on the shape of the attractive potential determined by m . As is to be expected, for real gases both b and a are found actually to be somewhat temperature dependent.

It is to be emphasized that, even with the assumptions made, only the approximate equation (2), and not the van der Waals equation (1), has been derived. Equation (1) is certainly not exactly obeyed by any experimental system. Its original derivation by van der Waals, although based on extremely ingenious reasoning, was not deduced from statistical methods. Indeed, an equation of the van der Waals type showing an unstable region will not be obtained by direct statistical calculations. This will be discussed further in section 12f.

The quantity $kT\beta/2$, equation (17), which is the coefficient v^{-2} in the development of the pressure as an inverse power series in the volume, is known as the second virial coefficient. (The first virial coefficient is just kT .) The second virial coefficient for different gases at various temperatures has been the subject of many experimental investigations. From a knowledge of its values, then, the potential, $u(r)$, between molecule pairs which reproduces the experimental values of β when used in equation (18) can be determined. Lennard-Jones, particularly, has undertaken such determinations, and finds that, if the potential is written in the form

$$u(r) = \frac{A}{r^n} - \frac{B}{r^m}, \quad m < n,$$

n is about 11 to 13, and m about 6. This is the best source of our experimental knowledge of the forces between chemically saturated molecules.

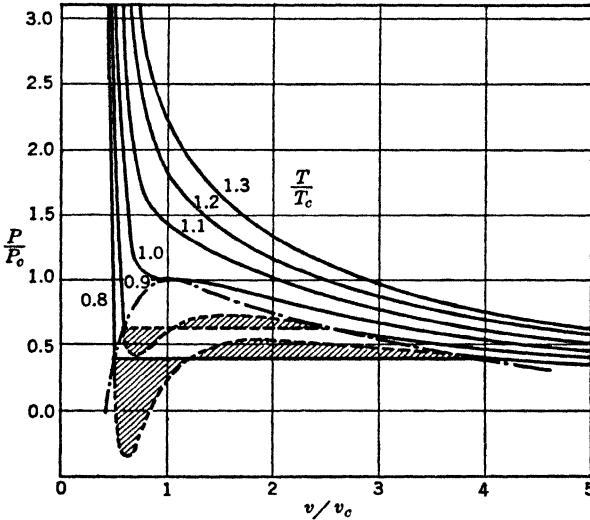

FIG. 12. 2. van der Waal's equation. Plot of P/P_c against v/v_c for various values of

$$T/T_c. \quad \frac{P}{P_c} = \frac{8(T/T_c)}{3(v/v_c) - 1} - \frac{3}{(v/v_c)^2}.$$

12d. The Law of Corresponding States

The van der Waals equation is cubic in the volume, and by the multiplication of (1) with V^2/PN^3 it may be brought into the form

$$(12. 24) \quad v^3 - \left(\frac{kT}{P} + b\right)v^2 + \frac{a}{P}v - \frac{ab}{P} = 0.$$

If P is plotted against v at constant T , see Fig. 12. 2, the curve rises

with decreasing volume from $P = 0$ at infinite volume, to $P = \infty$ at $v = b$. At high temperatures the rise is monotonous, that is, $(\partial P/\partial v)_T < 0$ for all volumes. At lower temperatures the curve has a loop, and for a range of the pressure P there are three real positive volumes which are solutions of (24). There exists one temperature, T_c , the critical temperature, such that all curves of higher temperatures are monotonous, and all curves of lower temperatures have a loop. As one point, P_c and v_c , the curve at the critical temperature is horizontal, $(\partial P/\partial v)_T = 0$, and at this one point, which is the critical point, the three roots for v of (24) are identical and real. (For $T > T_c$ at all P 's there are only one real and two imaginary roots of equation (24) for v .)

It follows that for $T = T_c$ and $P = P_c$ equation (24) must be a perfect cube, of the form

$$(12. 25) \quad (v - v_c)^3 = v^3 - 3v_c v^2 + 3v_c^2 v - v_c^3 = 0.$$

By equating the coefficients of (24) and (25),

$$v_c^3 = \frac{ab}{P_c}, \quad 3v_c^2 = \frac{a}{P_c}, \quad 3v_c = \frac{kT_c}{P_c} + b,$$

the constants a and b can be obtained in terms of the critical volume per molecule v_c , and the critical pressure P_c . One obtains

$$(12. 26) \quad b = \frac{v_c}{3}, \quad a = 3P_c v_c^2.$$

The equation

$$(12. 27) \quad T_c = \frac{8}{3} \frac{P_c v_c}{k}, \quad \frac{P_c v_c}{k T_c} = \frac{3}{8},$$

is also obtained; the pressure volume product at the critical point is $\frac{3}{8}$ the value of that of a perfect gas at the same temperature. This is not very far from the observed value of about 0.3.

Use of the values (26) for a and b in equation (1), with the introduction of (27) for T_c , enables us to express the van der Waals equation in the reduced form

$$(12. 28) \quad \left[\frac{v}{v_c} - \frac{1}{3} \right] \left[\frac{P}{P_c} + \frac{3}{(v/v_c)^2} \right] = \frac{8}{3} \frac{T}{T_c},$$

in which the ratios of volume, pressure, and temperature to the values at the critical point appear, and all constants of the equation are universal and independent of the particular gas.

Equation (28) is a special case of the law of corresponding states, which predicts that the equations of state of all "normal" substances

are the same, if the volumes, pressures, and temperatures are always expressed in terms of the volumes, pressures, and temperatures, respectively, of some unique point in the equation, such as the critical point.

The law of corresponding states follows rigorously from certain assumptions concerning the mutual potential of pairs of molecules. The true form of the potential $u(r)$ between two molecules may be approximated rather accurately by the equation

$$u(r) = \frac{A}{r^n} - \frac{B}{r^m}, \quad m < n,$$

which can be transformed into

$$(12. 29) \quad u(r) = u_0 \left[\frac{m}{n-m} \left(\frac{r_0}{r} \right)^n - \frac{n}{n-m} \left(\frac{r_0}{r} \right)^m \right].$$

This equation has a minimum value $-u_0$ at $r = r_0$. In the preceding section, equation (20) was essentially of this form with $n = \infty$, and m left undetermined.

If, in the configuration integral (4), a transformation of coordinates to new dimensionless variables $q_{x_i} = x_i/r_0$ is made, then

$$d\tau_i = r_0^3 dq_{x_i} dq_{y_i} dq_{z_i}.$$

The new limits of integration will depend only on the ratio of the volume V of the system to r_0^3 , or, if we prefer, to $v_0 = \pi r_0^3/6$. The integrand is a function of u_0/kT , and does not contain either u_0 or T in any other form.

If now it is assumed that for all molecules the numerical values of the constants n and m are identical, the law of corresponding states follows. With two systems of different kinds of molecules, but having the same number of them, N , and with the same value of V/v_0 and u_0/kT , the configuration integrals of the two systems will differ only by a factor of v_0^N for the two kinds of molecules. This factor is independent of the temperature or volume. That is, one may write, for all systems with the same values of n and m ,

$$(12. 30) \quad \mathbf{Q}_\tau = v_0^N F \left(\frac{V}{v_0}, \frac{kT}{u_0} \right),$$

where F is a universal function dependent only on n and m for its form. The quantities v_0 and u_0 , with the dimensions of volume and energy, respectively, vary from molecule to molecule.

The pressure P is (equation 10. 53'),

$$(12. 31) \quad P = kT \left(\frac{\partial \ln \mathbf{Q}_\tau}{\partial V} \right)_T = \frac{u_0}{v_0} \frac{kT}{u_0} \left(\frac{\partial \ln F}{\partial (V/v_0)} \right).$$

If the scale of volume is measured in units of v_0 , the scale of temperature in terms of u_0/k , and that of pressure in u_0/v_0 , the equation of state of all systems composed of molecules for which the mutual potential is given by (29) with the same values of n and m will be identical.

This conclusion is based on the use of the integral form (equation 10. 50') for the translational part of the complete partition function of the system. If the temperature is low, and the masses of the molecules small, so that the quantum-mechanical sum (equation 10. 50) must be used, corrections will enter which depend on the absolute values of T and V . The law of corresponding states will not apply.

We have explicitly limited the calculations of this chapter to monatomic gases for which the number of degrees of freedom per molecule is three. For diatomic and polyatomic gases there will be additional internal degrees of freedom for every molecule. If, however, the mutual potential energy of a pair of molecules is given by equation (29) independently of the internal quantum state of the molecules, which means that the Hamiltonian is separable in the translational and internal coordinates, the conclusions of the preceding sections will be equally valid. The internal degrees of freedom, then, will only contribute an additional factor to the partition function Q , which will not be volume dependent, so that the equation for the pressure will remain unchanged.

It appears that for non-polar molecules one may assume with moderate accuracy that the attractive potential is inversely proportional to the sixth power of the distance, that is, that $m = 6$. The equation of state at high volumes depends less on n . Probably $n = 12$ is a fair average value for the repulsive power. For non-polar molecules the law of corresponding states holds fairly satisfactorily, even in comparing monatomic gases with polyatomic gases such as methane.

Strongly polar molecules, such as water, obey decidedly different equations of state from those obeyed by non-polar molecules.

12e. Condensation and the van der Waals Equation

The isothermals, or plots of pressure against volume, for various constant temperatures, from the van der Waals equation, are shown in Fig. 12. 2. The units chosen are the critical values, so that the critical point is 1, 1 on the diagram.

For temperatures lower than the critical, $T/T_c < 1$, the isothermals show a loop, that is, for a region of volume the quantity $(\partial P/\partial V)_T$ is positive. It is obvious that the curve in this range, where the pressure *increases* with increasing volume, does not correspond to any phase which can exist in nature.

On the diagram, horizontal lines, of constant pressure, are drawn to

connect the volumes at the same pressure which are on the two branches of the curve for which $(\partial P/\partial V)_T$ is negative. The lines are so drawn that the area between the horizontal and the van der Waals curve above it is equal to the area between the horizontal and the portion of the curve below it. The two end points on the van der Waals curve connected by the horizontal then correspond to two phases of the system having the same free energy F and therefore being in equilibrium with each other.

This statement is seen from the equation

$$(12. 32) \quad \left(\frac{\partial F}{\partial P}\right)_T = V, \quad F_{v_1} - F_{v_2} = \int_{v_2}^{v_1} V dP.$$

The integral is exactly the difference of the two shaded areas, that above the horizontal minus that below it.

The two phases are the liquid and the gaseous. Since their free energies are equal at the pressure of the horizontal line the two phases are in equilibrium at this pressure P_s , the vapor pressure of the liquid. At a lower pressure P than P_s , the condensed phase has a higher free energy than the gaseous at the same pressure P , since from (32), owing to its smaller volume, its free energy decreases with pressure decrease less rapidly than that of the gas. Conversely, at higher pressures than P_s , the liquid has the lower free energy and is the single stable phase.

The van der Waals isothermals in the region for which $(\partial P/\partial V)_T$ is still *negative*, but in the volume range of condensation, for which the phases they represent are unstable, have a physical significance. The liquid may be maintained under a pressure less than its vapor pressure, or even by tension under a negative pressure, at least temporarily. The gas may also be obtained temporarily in the supersaturated state with the pressure higher than the vapor pressure.

Whether the region of the curve for which $(\partial P/\partial V)_T$ is positive can have any physical significance whatsoever is doubtful. It is supposed to represent the pressure of the material inhibited to the uniform density corresponding to the inverse volume of the system. In this region, as in any portion of the curve between the volume of the saturated vapor and that of the liquid, the lowest free energy, and therefore the stable configuration, is obtained if the material separates into two phases of different densities. Where $(\partial P/\partial V)_T$ is negative, this separation requires first the transition of microscopic portions of the system through still less stable regions, and the separation into two phases may require appreciable time. The unstable regions for which $(\partial P/\partial V)_T$ is less than zero may be called metastable. Where this quantity is positive, however, immediate separation into two phases is required, since no

less stable microscopic configuration separates the thermodynamic equilibrium from the region of uniform density.

Any continuous single equation of state, such as that of van der Waals, which pretends to express the $P-V$ relationship of two or more phases, has necessarily these characteristics of predicting the existence of unstable transition regions, both those which may be metastable as well as those which are entirely unstable. The stable phases may always be determined by calculation of the points of equal free energy at the same pressure, on the diagram.

The significance of this in terms of the general statistical method will be discussed in the next section.

12f. Phase Changes and a General Equation of State

A knowledge of the functional dependence on V and T of the configuration integral Q_r , (4), the volume-dependent factor of the phase integral Q , is sufficient to determine the equation of state of any system obeying the classical mechanical equations.

If the integration indicated in (4) is extended over the complete configuration space of the whole system the resulting equation for the pressure P will give the *equilibrium* pressure of the system as a function of V and T . If at some volume and temperature the equilibrium configuration of the system is one for which it exists in two phases, say liquid and gaseous, the integral will lead to the equilibrium pressure between these phases. The integral itself will then have its greatest contribution from that part of the configuration space which corresponds to the existence of the two phases.

For instance, the volume and temperature may be such that in equilibrium half of the molecules of the system are in the gaseous phase and half in the liquid. Then the main contribution to the configuration integral will come from that portion of the space for which half of the molecules are far apart from others and half of them are close together. If the condensed phase in equilibrium with the gaseous were the crystalline, the contribution of those molecules which were close together would come from the regions of configuration space corresponding to the regular arrangement of the crystal lattice. The contribution of all other portions of the configuration space will be negligible; their fraction of the whole integral gives the probability of finding the system in a configuration other than that of thermodynamic equilibrium.

It is only by the imposition of some arbitrary limitation on the portion of the configuration space over which the integration is extended that the equation for an unstable or metastable phase may be obtained. For instance, the neglect of that portion of the configuration space where

many molecules are close together will lead to equations for the super-saturated vapor. For this reason a complete statistical calculation can never lead to an equation of the van der Waals type, having a loop in the $P-V$ curve.

In general it appears to be impossible, as yet, to perform the integration of the configuration integral over the whole configuration space in such a way as to obtain the functional dependence of Q_r on volume and temperature in a closed form. Two general differing methods of approach have been made.

The first of these methods is illustrated by the calculations made in Chapter 11 for crystals. The experimental fact that the system is known to exist only in the neighborhood of certain portions of the configuration space is used. The integration is then arbitrarily limited to the neighborhood of this particular part of the space. If this is not done explicitly it is implied by the development of the integrand of the configuration integral in such a way that it gives the correct values only in the neighborhood of these preferred positions.

For the crystal the method is pragmatically satisfactory, although open to some rather academic objections. It is proved that the configuration assumed is mechanically stable compared to all neighboring configurations, that is, all small displacements lead to an increase of energy. From this it is known that the assumed crystal lattice is at least metastable with respect to other configurations. Since the material is observed to exist in a certain lattice type, the calculation gives the correct thermodynamic functions for the experimental phase. It will not automatically predict any phase transitions. These must be found by explicit calculations of the thermodynamic properties of other configurations, and they should, if the calculation is to be completely logical, include all other crystalline lattice types as well as all configurations of complete disorder corresponding to the glasses and fluid phase.

The same objections apply even more cogently to most theories of the liquid. Certain characteristics of the equilibrium configuration are assumed, and the integration is limited to the portions of the configuration space to which these characteristics apply. Unless the integration is extended over the complete space one can never be quite certain that the phase calculated ever corresponds to the experimental material.

The second available method of statistical calculation has certain advantages in logic but also decided limitations. It has already been illustrated crudely in section 12b, and an example of it will be developed in greater detail in the two subsequent chapters.

In this method the integrand of the configuration integral is developed

as a sum of terms, most of which differ from zero only in certain portions of the configuration space. The terms which are negligible after integration do not affect the value of Q_r , but the integration is explicitly extended over the complete configuration space. The important terms of the sum making up Q_r give the contribution from the regions of the configuration space in which the system actually exists.

For instance, in (10) the term unity has the same value in all portions of the space, but the remaining terms containing functions f_{ij} differ from zero only in that portion of the space for which their arguments, r_{ij} , are small. The correction terms considered were those containing a single f_{ij} and are non-zero only where the two molecules i and j are close together. In section 12b the other terms were incorrectly neglected. The correct application of the method, which will follow, demands the explicit consideration of all the terms in the sum (10).

This method, when correctly applied, automatically includes phase changes, since the contributions of all regions of the configuration space are evaluated. The fundamental difficulty is that the terms corresponding to the existence of the liquid cannot, as yet, be integrated in closed form.

CHAPTER 13

THE IMPERFECT GAS

- (a) Introduction. (b) The Cluster Integrals b_l . (c) Simplification of the Configuration Integral Equation. (d) The Maximum Term in $Q_\tau/N!$. (e) The Limiting Case of the Perfect Gas. (f) The Equation for the Cluster Integrals in Terms of Irreducible Integrals β_l . (g) Development in Inverse Powers of v . (h) The Thermodynamic Properties of the Imperfect Gas. (i) Summary of the Method.

13a. Introduction.

In this chapter the most general treatment of the imperfect gas will be given, although some of the proofs, which in their most rigorous form are shown in the Appendix (A X, XI) and are somewhat complicated, will be shortened and rather simplified in a manner which limits the range for which their application is rigorous. The coefficients in the virial development of the pressure as an inverse power series of the volume will be derived as specific integrals in the configuration space.

The first steps of the method are the same as in section 12b. A system consisting of N identical molecules in a volume V will be considered. The classical method will be followed throughout. It will be assumed that the molecules have only three translational degrees of freedom, with no internal coordinates, and that the potential energy $U(q)$ of the whole system can be expressed as a sum of $\frac{1}{2}N(N-1)$ terms, $u(r_{ij})$, each depending only on the distance r_{ij} between two molecules i and j (equation 12. 6).

It will be explicitly assumed that $u(r_{ij})$, the potential between a pair of molecules, falls to zero with increasing value of r_{ij} more rapidly than r_{ij}^{-3} .

The exponential $e^{-U(q)/kT}$, which occurs in the configuration integral,

$$(13. 1) \quad Q_\tau = \iint \dots \int e^{-U(q)/kT} d\tau_1 \dots d\tau_N,$$

can be developed, by means of the function

$$(13. 2) \quad f_{ij} = f(r_{ij}) = e^{-u(r_{ij})/kT} - 1,$$

into the sum

$$(13. 3) \quad e^{-U(q)/kT} = 1 + \sum_{N \geq i > j \geq 1} f_{ij} + \sum \sum f_{ij} f_{i'j'} + \dots$$

All these steps have been discussed in section 12b.

13b. The Cluster Integrals b_i .

The general term of the sum (3) will now be considered. It is convenient to make a one-to-one correspondence between the terms of this sum, which are composed of a definite product of particular functions, f_{ij} , and certain diagrams which may be drawn in a plane. If all the N molecules are represented by numbered circles in a figure such as Fig. 13. 1, and a line is drawn between the two circles i and j for every

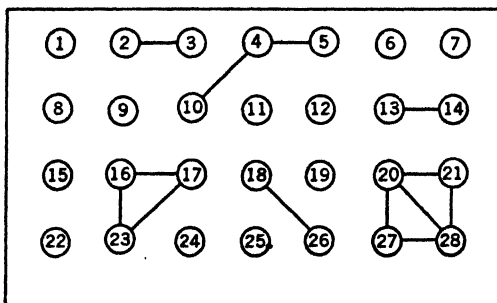

FIG. 13. 1. Diagram corresponding to the term in (3), $f_{3,2} f_{10,4} f_{6,4} f_{14,13} f_{23,16} f_{17,16} f_{23,17} f_{26,18} f_{28,27} f_{28,21} f_{28,20} f_{27,20} f_{21,20}$. Molecules 1, 6, 7, 8, 9, 11, 12, 15, 19, 22, 24 and 25 are in single clusters of one molecule each. Molecules 2, 3; 13, 14; 18 and 26 are in clusters of two molecules each. Molecules 4, 5, 10; 16, 17 and 23 are in clusters of three molecules each. Molecules 20, 21, 27 and 28 are in a cluster of four molecules. For this term, $m_1 = 12$; $m_2 = 3$; $m_3 = 2$; and $m_4 = 1$.

function f_{ij} occurring in the term, then every term of the sum (3) may be represented by one such figure, and every figure corresponds to exactly one term of the sum.

The first term, unity, in the sum, corresponds to the figure which has no line. The $\frac{1}{2}N(N-1)$ figures which can be drawn with only one line connecting any two of the numbered circles correspond each to one of the $\frac{1}{2}N(N-1)$ different terms containing only one f_{ij} .

The functions f approach zero for large values of their arguments r_{ij} (large compared to molecular distances of 10^{-8} cm.). The contribution to the configuration integral Q , of one term arises, therefore, only from that part of the space for which all the distances represented by a line of the figure are small. We may speak of the molecules which are connected by lines in the figure, or functions f_{ij} in the term, as being bound to each other in that term.

In any specified figure, that is, any specified product of f_{ij} 's, such as that sketched in Fig. 13. 1, there will be groups or clusters of molecules which are all bound to each other directly or indirectly by lines, and not bound to any molecules which are not members of the cluster.

Such molecules will be said to be part of a cluster, and by this criterion every molecule of any figure may be said to be one of a cluster of a certain number of molecules.

The simplest cluster is that consisting of a single molecule, not bound to any other, that is, its index does not occur as a subscript to any f in the term. The number of these single clusters of one molecule each, in any term, will be designated by m_1 .

The cluster of two consists of a bound pair of molecules, neither of which is bound to any other molecule. In the term the two indices i and j of the molecules in one cluster of two occur as subscripts to the same f , but to no other f . The number of such clusters of two will be called m_2 .

A cluster of three specified molecules, i , j , and k , may be formed in any of four ways:

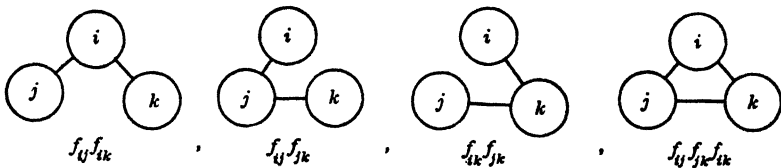

The terms in which the same molecules are bound to each other in clusters have in common the property that they differ from zero only in that part of the configuration space for which the molecules in the same cluster are close to each other. Since the larger clusters may be formed from the same molecules in several ways, there will be a considerable number of such terms. We now propose to collect these terms together.

In any term the number of clusters of l molecules each will be designated by m_l . The total number N of molecules is the sum of the number per cluster l , times the number of clusters of this size m_l , or

$$(13. 4) \quad N = \sum_{l=1}^{l=N} l m_l.$$

The integrals over the molecules which are in different clusters of one term will be independent of each other, since the clusters are so defined that the integrand contains no functions that depend on the coordinates of two molecules in different clusters. The integral of the term will be a product of the integrals over the molecules in the same cluster. We shall sum the integrals of all the products that occur when the same l molecules are in one cluster and designate this the cluster

integral b_l after multiplication by a normalization factor $1/l! V$. That is, the cluster integral b_l is defined as

$$(13. 5) \quad b_l = \frac{1}{l! V} \iint \cdots \int \sum_{\substack{i \geq i' > j \geq j' \\ \text{sum over all products con-} \\ \text{sistent with single cluster.}}} f_{ij} d\tau_1 \cdots d\tau_l.$$

The dimension of b_l is volume to the power $l - 1$. There are at least $l - 1$ f 's in the product, and at most $\frac{1}{2}l(l - 1)$ f 's in any term of the integrand of the cluster integral.

The first three cluster integrals are

$$(13. 6) \quad b_1 = \frac{1}{V} \int d\tau_1 = 1,$$

$$(13. 7) \quad b_2 = \frac{1}{2V} \iint f(r_{12}) d\tau_2 d\tau_1 = \frac{1}{2} \int_0^\infty 4\pi r^2 f(r) dr,$$

$$(13. 8) \quad b_3 = \frac{1}{6V} \iiint (f_{31}f_{21} + f_{32}f_{31} + f_{32}f_{21} + f_{32}f_{31}f_{21}) d\tau_1 d\tau_2 d\tau_3.$$

The first integral, b_1 , is identically unity. The second integral, b_2 , is just half the value of the β used in section 12b. The first three terms of the integral b_3 will have the same numerical value since the products differ only in the numbering on the molecules. The value of each is actually $V\beta^2$, a fact that will be discussed in greater detail in section 13f.

The value of the integral over $l - 1$ of the molecules is independent of the position of the l th, since the integrand drops rapidly to zero for large distances between the molecules. This is true, however, only if l has reasonable values and if the total volume of the system is of macroscopic size, that is, if the ratio V/l is considerably larger than the volume of a single molecule. The integral over the l th particle, then, leads to a factor V , which cancels the volume in the denominator of the normalization factor. The cluster integral is consequently independent of the volume of the system, at least as long as l is not too large or V too small.

With this definition of the cluster integrals, the summed contribution to the configuration integral of all the terms for which the same numbered molecules occur together in clusters is

$$\prod_l (l!)^{m_l} (V b_l)^{m_l}.$$

This contribution of these terms to Q_r comes only from that part of the configuration space for which the specified molecules which are in the same cluster are close to each other. We shall now collect all the

identical contributions of this sort with the same numbers m_l of clusters of l molecules each. These terms have in common that they contribute from the part of configuration space where there are m_l clusters of l molecules each close together, but independently of which particular numbered molecules are neighbors.

The total number of these terms which are consistent with a given set of the numbers m_l is the number of ways in which N objects can be distributed into m_l unnumbered piles of l objects each, or

$$\frac{N!}{\prod_l m_l! (l!)^{m_l}}$$

The product of the two factors above gives the contribution to Q_r of all the terms in the sum (3) for which the numbers of clusters of size l is m_l ,

$$N! \prod_l \frac{(V b_l)^{m_l}}{m_l!} = N! \prod_l \frac{(N v b_l)^{m_l}}{m_l!},$$

in which the volume per molecule

$$(13. 9) \quad v = \frac{V}{N}$$

has been introduced.

The configuration integral Q_r is the sum of all these terms, the sum over all values of m_l which obey the necessary relationship (4) that $\sum l m_l = N$, namely,

$$(13. 10) \quad \frac{Q_r}{N!} = \sum_{\sum l m_l = N} \prod_l \frac{(N v b_l)^{m_l}}{m_l!}.$$

Kahn and Uhlenbeck* have shown that this equation can also be derived by the use of the quantum-mechanical sum for the partition function Q of the system, and is also not limited to systems for which the potential is a sum of terms due to the pairs of molecules. The equation for the cluster integrals b_l is then not so direct as equation (5).

It is obvious that if the interaction between molecules is independent of their internal quantum state the assumption of no internal energy to the molecules would be superfluous, since the Hamiltonian would be separable, and the internal degrees of freedom would contribute a volume-independent factor to Q of the type which we have calculated in the chapters on the perfect gas. There is also no need to assume that

* B. Kahn and G. E. Uhlenbeck, *Physica*, V, 399 (1938).

the potential between pairs of molecules depends only on their distances apart; it could depend explicitly on their mutual orientation angles without fundamentally affecting the applicability of the method.

13c. Simplification of the Configuration Integral Equation

Equation (10) is scarcely in a convenient form for the purposes of calculation. It is expressed as a sum of a large number of terms, each of which is a fairly complicated product. The total number of terms in this sum, however, is very much smaller than the total number of terms in the sum (3). The number of terms in (10) is the number of ways in which N can be expressed as a sum of numbers l , if changing the order in which the l 's appear is not regarded as leading to a new sum. This number is called the "partitio numerorum" of N , and is designated by P_N . The logarithm of P_N has been calculated* to approach the value $\pi(2N/3)^{1/2}$ for large values of N . It will be seen later that the logarithms of the individual terms in the sum are proportional to N , which means that for large values of N the values of the individual terms are very much larger than the total number of terms.

The thermodynamic properties of the system are all functions of only the logarithm of $Q_r/N!$ and the various derivatives of the logarithm. If all the terms of the sum (10) are positive, the value of the sum $Q_r/N!$ must be greater than the value of the largest term T_m of the sum, and smaller than the product of the total number of terms P_N with the largest term,

$$T_m < \frac{Q_r}{N!} < P_N T_m,$$

or

$$(13. 11) \quad \ln T_m < \ln \frac{Q_r}{N!} < \ln T_m + \pi \left(\frac{2N}{3} \right)^{1/2},$$

using $\ln P_N = \pi(2N/3)^{1/2}$. Since $\ln T_m$ will be found to be proportional to N , the term $\ln P_N$, which is proportional to $N^{1/2}$, is negligible for large values of N , and one may write

$$(13. 12) \quad \ln \frac{Q_r}{N!} = \ln T_m,$$

where T_m is the largest term of the sum (10).

This method is rigorous only if all the terms of the sum are positive, which they will be only if all the b_l 's are positive. At low temperatures this is true, but above the critical temperature some of the b_l 's appear to be negative. The equations which will be derived from (12) are identical with those which can be derived by several methods not subject to

* Hardy and Ramanujan, *Proc. London Math. Soc.*, **16**, 130 (1917).

the limitation of positive b_l 's. One of these methods, originally proposed by Kahn and Uhlenbeck, and modified by Born and Fuchs,* is given in Appendix AXI. We shall continue with the method of using (12) but shall not limit ourselves to positive b_l 's.

The trick of substituting the logarithm of the largest term of a sum for the logarithm of the sum has been used before in Chapter 4 to show that the entropy of the equilibrium distribution is equal to the entropy of the uninhibited system. In this case $\ln(Q_r/N!)$ is an additive part of the work function A divided by kT . Every term of the sum (10) is actually the additive contribution to $Q_r/N!$ due to a certain distribution of the molecules in space, and the largest term is the contribution of the equilibrium distribution. The largest term will be characterized by a certain set of the numbers m_l , the number of clusters of l molecules each. The equilibrium distribution of the molecules which corresponds to this term is one in which m_1 molecules are randomly distributed throughout the volume of the system, m_2 pairs of molecules are close to each other in excess over the number which would be expected from the random distribution of the m_1 unbound molecules, and m_3 clusters of three molecules each exist in excess of the random expectation from the given values of m_1 and m_2 , etc.

We shall now determine these values of m_l for the maximum term T_m of the sum (10), and the value of $\ln T_m$.

13d. The Maximum Term in $Q_r/N!$

From equation (10) by use of the Stirling approximation for $\ln m_l!$ the equation for the logarithm of one of the terms may be written as

$$(13. 13) \quad \ln T = \sum_{l=1}^{l=N} m_l (\ln N v b_l - \ln m_l + 1).$$

The values of m_l for which $\ln T$ is a maximum, subject to condition (4) that $\sum l m_l = N$, are obtained by subtracting a constant which will be designated $-\ln Z$ times the condition (4) from (13), and differentiating with respect to m_l . The derivative with respect to each m_l must be zero for $\ln T_m$. This condition leads to

$$\begin{aligned} \frac{\partial}{\partial m_l} \sum m_l (\ln N v b_l - \ln m_l + 1 + l \ln Z) &= 0 \\ &= \ln N v b_l - \ln m_l + l \ln Z \end{aligned}$$

or

$$(13. 14) \quad m_l = N v b_l Z^l$$

for the maximum or equilibrium value of m_l .

* Max Born and K. Fuchs, *Proc. Roy. Soc., London*, **A166**, 391 (1938).

The parameter Z , of dimensions v^{-1} , is determined by

$$\sum_{l=1}^{l=N} l m_l = \sum_{l=1}^{l=N} N v l b_l Z^l = N, \quad (13. 15)$$

$$\sum l v b_l Z^l = 1.$$

It is seen from (14) that the l th term, $l v b_l Z^l$, of this sum is the fraction of the material in clusters of size l at equilibrium.

Substitution of (14) in (13), with (12), yields the equation for $\ln(\mathbf{Q}_r/N!)$,

$$(13. 16) \quad \ln \frac{\mathbf{Q}_r}{N!} = \ln T_m = \sum N v b_l Z^l (1 - l \ln Z) = N(\sum v b_l Z^l - \ln Z),$$

in which Z is to be determined by equation (15).

The consequences of the thermodynamic equations derivable from the forms (15) and (16) for $\ln(\mathbf{Q}_r/N!)$ will be discussed in the next chapter. In the following sections these two equations will be converted into a more convenient form for use when the system is in the gaseous phase.

13e. The Limiting Case of the Perfect Gas

Equation (15) may be readily solved for Z as the volume becomes very large. The first term of the sum (15), since $b_1 = 1$, is vZ . This term alone would lead to the solution

$$(13. 17) \quad Z = \frac{1}{v}.$$

With this solution it is seen that the remaining terms of the sum are each inversely proportional to the $(l-1)$ th power of v , so that, for large values of v for which b_l/v^{l-1} approaches zero, all the higher terms are negligible. The solution (17) is the limiting value of Z as v approaches infinity. The first term of the sum (15) which is unity under these conditions is the fraction of the molecules which are in clusters of one molecule each, that is, those which are completely independent. The largest term of the sum (10) is that for which $m_1 = N$, the term unity.

The first term of the sum, $\sum v b_l Z^l$, is also unity in this case, and the higher terms may be neglected. The equation for large values of v is then

$$(13. 18) \quad \ln \frac{\mathbf{Q}_r}{N!} = N(1 + \ln v) \quad (v \rightarrow \infty).$$

From equation (10. 53') the pressure is

$$(13. 19) \quad P = kT \left(\frac{\partial \ln \mathbf{Q}_r}{\partial V} \right)_T = kT \left(\frac{\partial \ln \mathbf{Q}_r}{N \partial v} \right)_T = \frac{kT}{v},$$

which is the equation of state of the perfect gas.

13f. The Equation for the Cluster Integrals in Terms of Irreducible Integrals β_k

Before proceeding further it is advisable to return to a consideration of the cluster integrals b_l , and to determine how their evaluation may be simplified.

Equations (6) and (7) for b_1 and b_2 , respectively, show that no difficulty is encountered in evaluating the first two members of the series. The third cluster integral b_3 , (8), however, is appreciably more complicated. It has already been mentioned that all the first three of the four terms making up b_3 had the same numerical value of $V\beta^2$. This can be readily seen.

Consider the integral of the first term which is

$$(13. 20) \quad \iint f_{31}f_{21} d\tau_1 d\tau_2 d\tau_3.$$

The coordinates of particle 3 occur in the integrand only in f_{31} , and only as the distance r_{31} from the position of particle 1. The function f_{31} drops rapidly to zero as this distance becomes large, so that integration over the space $d\tau_3$ leads to a definite integral as a factor. This integral, which is the same as the β of section 12b, will be designated as β_1 , and it is the first of a series of irreducible integrals β_k which will be introduced. It is

$$(13. 21) \quad \beta_1 = \int f_{31} d\tau_3 = \int_0^\infty 4\pi r^2 f(r) dr,$$

since the volume element $d\tau_3$ may be replaced by $4\pi r_{13}^2 dr_{13}$.

Similarly, in this term (20), integration over $d\tau_2$ leads to the factor β_1 , and integration over the coordinates of the last particle, $d\tau_1$, gives the factor V . The term (20) is then

$$(13. 22) \quad \iiint f_{31}f_{21} d\tau_1 d\tau_2 d\tau_3 = V\beta_1^2.$$

From (7) and (21) it is seen that $b_2 = \frac{1}{2}\beta_1$, so that the term (20) is just $V(2b_2)^2$.

All three of the first three terms of b_3 , equation (8), may be handled in exactly the same manner, and lead to the same numerical values after integration. The last term, however, has an entirely different value, and will be used to define β_2 , the second irreducible integral, as

$$(13. 23) \quad \iiint f_{32}f_{31}f_{21} d\tau_1 d\tau_2 d\tau_3 = 2V\beta_2.$$

With this nomenclature one obtains

$$(13. 24) \quad b_3 = \frac{1}{2}\beta_1^2 + \frac{1}{3}\beta_2.$$

In general, any single one of the terms making up the integrand of the cluster integral b_l can be represented by a figure of l numbered circles, with a line connecting the circles for every function f_{ij} in the term. In order to be a member of the cluster integral the figure must have every circle connected by at least one line to other circles, and all circles must be directly or indirectly connected by lines. Such a figure is drawn in Fig. 13. 2, for $l = 8$.

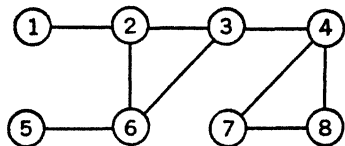

FIG. 13. 2. One term in the integrand of b_8

term gives factors β_1 for each to the total integral of the term. If two particles, such as 7 and 8 of the figure, are joined by a line, and both joined to a common particle, as 4, by lines, but to no other circles, then integration over the coordinates of these two (7 and 8) contributes the factor β_2 to the integral of the term. Subsequent integration over the other particles allows similar factoring of the integral into a product of simpler integrals. For instance, in the figure shown, the contributions of integration in the order indicated are as follows: integration over $d\tau_1$ gives β_1 , over $d\tau_5$ gives β_1 , over $d\tau_7$ and $d\tau_8$ gives β_2 , over $d\tau_4$ gives β_1 , over $d\tau_2$ $d\tau_3$ gives β_2 , and final integration over $d\tau_6$ leads to the factor V . The value of the integral over all eight particles, of the term represented by the figure, is

$$\beta_1^3 \beta_2^2 V.$$

The normalization factor in front of the integral is, from (5), $1/8! V$, so that the contribution to b_8 of this term is

$$\frac{1}{8!} \beta_1^3 \beta_2^2.$$

In general, it will frequently happen that two groups of molecules in a figure are singly connected, that is, they have one molecule in common, but there are otherwise no lines between molecules of different groups. If the coordinates of the common particle are thought of as fixed, and the integration performed over the other particles, the integration of the

two groups is quite independent and the integral corresponding to the picture reduces to a product of two integrals. In this manner the integral over any figure consistent with the cluster may be analyzed into a product of integrals over groups of particles to which this process can no longer be applied, and which shall therefore be termed irreducible integrals. In the figure corresponding to an irreducible integral, which we shall term a frame, every circle is connected with at least two others, except of course in β_1 . The frame is said to be at least doubly connected, that is, one can go from any one circle of the frame to every other by two or more entirely independent paths of lines which do not cross at any circle.

The irreducible integral $\beta_{\mathbf{k}}$ is defined as an integral over the configuration space of $\mathbf{k} + 1$ particles, multiplied by a normalization factor. The normalization factor is $1/\mathbf{k}! V$. The integrand is the sum of all products of f_{ij} 's of $\mathbf{k} + 1$ particles which cannot be further reduced into a product of integrals. This means that in the corresponding figure all the circles are more than singly connected.

The definition may be written as

$$(13. 25) \quad \beta_{\mathbf{k}} = \frac{1}{\mathbf{k}! V} \iint \cdots \int \sum_{\substack{\mathbf{k}+1 \geq i > j \geq 1 \\ \text{All products which are more} \\ \text{than singly connected.}}} \Pi f_{ij} d\tau_1 \cdots d\tau_{\mathbf{k}+1}.$$

The dimensions of $\beta_{\mathbf{k}}$ are volume to the power \mathbf{k} .

The first three irreducible integrals are

$$(13. 26) \quad \beta_1 = \frac{1}{V} \iint f_{12} d\tau_1 d\tau_2 = \int_0^\infty 4\pi r^2 f(r) dr,$$

$$(13. 27) \quad \beta_2 = \frac{1}{2V} \iiint f_{32} f_{31} f_{21} d\tau_1 d\tau_2 d\tau_3,$$

$$(13. 28) \quad \beta_3 = \frac{1}{6V} \iiiii (3f_{43} f_{32} f_{21} f_{41} + 6f_{43} f_{32} f_{21} f_{41} f_{31} + f_{43} f_{32} f_{21} f_{41} f_{31} f_{42}) d\tau_1 d\tau_2 d\tau_3 d\tau_4.$$

The origin of the coefficients 3 and 6 in β_3 is due to the fact that there are respectively 3 and 6 products, differing only in the numbering of the particles, containing the same number of functions f as these terms, and leading to the same numerical values after integration. This can be seen in Fig. 13. 3, which shows the ten diagrams corresponding to the ten irreducible products which make up β_3 .

Every cluster integral, b_l , may be expressed as a sum of terms, each of which is a numerical coefficient multiplied by a product of powers of the reduced integrals β_k , for instance,

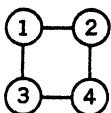
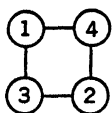
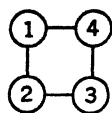

(13. 29) $b_1 = 1$

(13. 30) $b_2 = \frac{1}{2}\beta_1$

(13. 31) $b_3 = \frac{1}{2}\beta_1^2 + \frac{1}{3}\beta_2$

(13. 32) $b_4 = \frac{2}{3}\beta_1^3 + \beta_1\beta_2 + \frac{1}{4}\beta_3.$

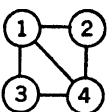
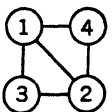
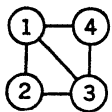

If the power with which β_k occurs in a term of b_l is designated by n_k , then the relationship for all terms that

(13. 33)
$$\sum_{k=1}^{k=l-1} kn_k = l - 1$$

must hold.

FIG. 13. 3. The ten terms composing β_3 .

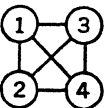
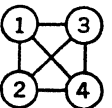

The numerical coefficients of the term $\prod_k \beta_k^{n_k}$ in b_l can be found by inspection of the possible figures which correspond to the terms in the integrand of the cluster integrals for small values of l . It must be remembered that $1/k!$ occurs as a factor in the definition (25) of β_k , and $1/l!$ in the definition (5) of b_l . The coefficients are found to be

$$\frac{1}{l^2} \prod_k \frac{l^{n_k}}{n_k!}.$$

The proof that this coefficient is general for all values of l , is given in Appendix A X.

The equation for b_l is then

(13. 34)
$$b_l = \frac{1}{l^2} \sum_{n_k} \prod_k \frac{(l\beta_k)^{n_k}}{n_k!},$$

$\sum_k n_k = l - 1$

which bears a striking resemblance to equation (10) for $Q_r/N!$ in terms of the cluster integrals b_l .

13g. Development in Inverse Powers of v

Equation (15) which determines the quantity Z cannot be solved explicitly for this parameter in a closed form. The fact that, as v approaches infinity, the limiting value $1/v$ is obtained for Z , shows that

if Z is expanded as a power series in the volume only inverse powers occur, that is, one may write

$$(13. 35) \quad Z = \frac{a_1}{v} + \frac{a_2}{v^2} + \frac{a_3}{v^3} + \frac{a_4}{v^4} + \dots,$$

in which we already know that a_1 is unity.

If the expansion (35) is used, and the coefficients a_ν are determined in terms of the irreducible integrals $\beta_{\mathbf{k}}$, it turns out that Z can be expressed as a relatively simple function of these integrals $\beta_{\mathbf{k}}$ and the volume v . If this function is used, in turn, in the expression for the configuration integral, and the various thermodynamic properties of the system which can be derived from it, simple expansions of these functions are obtained as inverse power series of the volume. The method of demonstration which will be used here is straightforward algebra, and consequently, although simple, is rather tedious.

The expression (35) for Z may be used to obtain any power of Z ,

$$Z^2 = \frac{a_1^2}{v^2} + \frac{2a_1a_2}{v^3} + \frac{2a_1a_3 + a_2^2}{v^4} + \dots,$$

$$Z^3 = \frac{a_1^3}{v^3} + \frac{3a_1^2a_2}{v^4} + \dots.$$

$$Z^4 = \frac{a_1^4}{v^4} + \dots,$$

up to, say, the term in v^{-4} . This may be used in the sum (15), $\sum l\nu b_l Z^l = 1$, which determines Z , obtaining an inverse power series in v which must be equated to unity. The first term, in which v does not occur, is then 1, and the coefficients of each inverse power of v must be zero if the equation holds for all values of v .

One then obtains

$$\begin{aligned} 1 &= \sum_{l \geq 1} l\nu b_l Z^l = b_1\nu Z + 2b_2\nu Z^2 + 3b_3\nu Z^3 + 4b_4\nu Z^4 - \dots \\ &= b_1a_1 + \frac{1}{v} (b_1a_2 + 2b_2a_1^2) + \frac{1}{v^2} (b_1a_3 + 4b_2a_1a_2 + 3b_3a_1^3) \\ &\quad + \frac{1}{v^3} (b_1a_4 + 4b_2a_1a_3 + 2b_2a_2^2 + 9b_3a_1^2a_2 + 4b_4a_1^4) + \dots \end{aligned}$$

Upon equating the coefficients of the first term to unity, and of the

others to zero,

$$\begin{aligned} b_1 a_1 &= 1, & a_1 &= \frac{1}{b_1} = 1, \\ b_1 a_2 + 2b_2 a_1^2 &= 0, & a_2 &= -2b_2, \\ b_1 a_3 + 4b_2 a_1 a_2 + 3b_3 a_1^3 &= 0, & a_3 &= 8b_2^2 - 3b_3, \\ b_1 a_4 + 4b_2 a_1 a_3 + 2b_2 a_2^2 + 9b_3 a_1^2 a_2 + 4b_4 a_1^4 &= 0, \\ & & a_4 &= -40b_2^3 + 30b_2 b_3 - 4b_4. \end{aligned}$$

These equations give the coefficients a_r in terms of the cluster integrals b_l . Much simpler equations are obtained if (29) to (32) for the b_l 's in terms of the $\beta_{\mathbf{k}}$'s are introduced. One finds, then, that

$$(13. 36) \quad a_1 = 1,$$

$$(13. 37) \quad a_2 = -\beta_1,$$

$$(13. 38) \quad a_3 = -(\beta_2 - \frac{1}{2}\beta_1^2),$$

$$(13. 39) \quad a_4 = -(\beta_3 - \beta_1\beta_2 + \frac{1}{8}\beta_1^3).$$

If the function

$$(13. 40) \quad Z = \frac{1}{v} e^{-\sum \beta_{\mathbf{k}} v^{-\mathbf{k}}}$$

is expanded as a power series in descending powers of v , the coefficients of the first four terms are given by (36) to (39), respectively.

For comparatively large values of the volume v , then, for which the terms of order higher than v^{-4} in the expansion of Z as an inverse power series in v may be neglected, equation (40) has been proved to give the correct functional dependence of Z upon the volume.

That (40) is general, even for lower volumes, may be proved by inserting it in (15) and expanding the exponential, using (34) for b_l . The complicated quadruple sum which is obtained can be shown to equal unity identically.

Equation (40) is also a consequence of the general method which is used in Appendix A XI, as is shown there.

If the expanded form (35) for Z , with the values (36) to (39) for the coefficients, and equations (29) to (32) for b_1 to b_4 are used in the sum $\sum v b_l Z^l$, which occurs in the expression (16) for $\ln(Q_r/N!)$, one obtains

$$(13. 41) \quad \sum_{l \geq 1} v b_l Z^l = 1 - \sum_{\mathbf{k} \geq 1} \frac{\mathbf{k}}{\mathbf{k} + 1} \beta_{\mathbf{k}} v^{-\mathbf{k}}.$$

This is also shown to be general in the Appendix.

From (40) it is seen that

$$(13. 42) \quad \ln Z = -\ln v - \sum_{\mathbf{k} \geq 1} \beta_{\mathbf{k}} v^{-\mathbf{k}}.$$

The use of (41) and (42) in (16) gives the final expanded expression for the logarithm of the configuration integral divided by $N!$,

$$(13. 43) \quad \ln \frac{Q_r}{N!} = N \left[1 - \sum_{\mathbf{k}} \frac{\mathbf{k}}{\mathbf{k} + 1} \beta_{\mathbf{k}} v^{-\mathbf{k}} + \sum_{\mathbf{k}} \beta_{\mathbf{k}} v^{-\mathbf{k}} + \ln v \right] \\ = N \left[1 + \sum_{\mathbf{k} \geq 1} \frac{1}{\mathbf{k} + 1} \beta_{\mathbf{k}} v^{-\mathbf{k}} + \ln v \right].$$

13h. The Thermodynamic Properties of the Imperfect Gas

The logarithm of the partition function Q , or normalized phase integral of the whole system, is

$$(13. 44) \quad \ln Q = \ln \left(\frac{2\pi m k T}{h^2} \right)^{3N/2} \frac{Q_r}{N!} \\ = N \left[\ln \left(\frac{2\pi m k T}{h^2} \right)^{3/2} e v + \sum_{\mathbf{k} \geq 1} \frac{1}{\mathbf{k} + 1} \beta_{\mathbf{k}} v^{-\mathbf{k}} \right],$$

from equations (10. 50') and (43), with v the volume per molecule, $v = V/N$.

The work function A , or Helmholtz free energy of the system, is, per mole,

$$(13. 45) \quad A = -kT \ln Q = RT \left[\ln \left(\frac{h^2}{2\pi m k T} \right)^{3/2} \frac{1}{e v} - \sum_{\mathbf{k} \geq 1} \frac{1}{\mathbf{k} + 1} \beta_{\mathbf{k}} v^{-\mathbf{k}} \right].$$

From this equation, by means of the usual thermodynamic relations, all the other thermodynamic properties of the system may be derived. The first term, $RT \ln \left(h^2/2\pi m k T \right)^{3/2} (e v)^{-1}$, is the usual term present in the expression for a perfect monatomic gas; the additional sum, $-RT \sum (\mathbf{k} + 1)^{-1} \beta_{\mathbf{k}} v^{-\mathbf{k}}$, which becomes zero for large values of the volume per molecule v , gives the corrections due to the forces between the molecules.

The expression for the pressure P is

$$(13. 46) \quad P = - \left(\frac{\partial A}{\partial V} \right)_T = - \frac{1}{N} \left(\frac{\partial A}{\partial v} \right)_T \\ = \frac{kT}{v} \left[1 - \sum_{\mathbf{k} \geq 1} \frac{\mathbf{k}}{\mathbf{k} + 1} \beta_{\mathbf{k}} v^{-\mathbf{k}} \right].$$

The $(\mathbf{k} + 1)$ th virial coefficient, which is the coefficient of $v^{-(\mathbf{k}+1)}$ in this expression for the pressure, is $-kT\mathbf{k}\beta_{\mathbf{k}}/(\mathbf{k} + 1)$, if the unit of volume used is the volume per molecule, $v = V/N$.

The pressure-volume product divided by kT , PV/kT , is, for the perfect gas, just the number of molecules in the system. The value obtained from (46) is

$$(13. 47) \quad \frac{PV}{kT} = N \left[1 - \sum_{\mathbf{k} \geq 1} \frac{\mathbf{k}}{\mathbf{k} + 1} \beta_{\mathbf{k}} v^{-\mathbf{k}} \right].$$

By comparison with (41) and (14) this is seen to be

$$(13. 48) \quad \frac{PV}{kT} = N \sum_{l \geq 1} v b_l Z^l = \sum_{l \geq 1} m_l,$$

in which m_l is the number of clusters of l molecules each in the equilibrium distribution of the gas. It is seen that each cluster plays the same role, in determining the pressure, that is played by one molecule of a perfect gas, and the pressure which the system exerts on the walls of the vessel is just the same as that of a perfect gas which has the same number of molecules as the imperfect gas has clusters in its equilibrium distribution.

The free energy \mathbf{F} , per mole, is

$$(13. 49) \quad \mathbf{F} = \mathbf{A} + PV = RT \left[\ln \left(\frac{h^2}{2\pi m k T} \right)^{3/2} \frac{1}{v} - \sum_{\mathbf{k} \geq 1} \beta_{\mathbf{k}} v^{-\mathbf{k}} \right].$$

Since, from (40), $\ln Z = -\ln v - \sum \beta_{\mathbf{k}} v^{-\mathbf{k}}$, this can also be written

$$(13. 50) \quad \mathbf{F} = RT \ln \left(\frac{h^2}{2\pi m k T} \right)^{3/2} Z.$$

The perfect gas equation is the logarithmic term of (49), which differs from (50) only in that Z replaces $1/v$ in the perfect gas equation. The physical significance of Z is seen from this equation. Z is the reciprocal of the volume per molecule, or the density in molecules per unit volume, which the system would have at the same free energy, were it a perfect gas.

This quantity Z is known as the fugacity; except in that the scale of fugacity is usually so chosen that the fugacity becomes equal to the pressure at infinite dilution, the quantity Z becomes equal to the density in molecules per unit volume at infinite volumes.

The product Zv is then the concentration activity coefficient γ_c of the system. The concentration activity coefficient is defined as the dimensionless quantity by which the concentration of the system must

be multiplied in order to obtain the concentration Z of a perfect gas with the same free energy as the system, the perfect gas, of course, being chosen with the same molecular weight and other mechanical properties as the system so that their free energies are equal at great dilution. From this,

$$\gamma_c \frac{1}{v} = Z,$$

and from (40),

$$(13. 51) \quad \gamma_c = Zv = e^{-\sum \beta_{\mathbf{k}} v^{-\mathbf{k}}}.$$

The entropy of the system per mole, \mathbf{S} , is

$$(13. 52) \quad \mathbf{S} = - \left(\frac{\partial \mathbf{A}}{\partial T} \right)_v = R \left[\ln \left(\frac{2\pi m k T}{h^2} \right)^{3/2} e v + \frac{3}{2} + \sum_{\mathbf{k} \geq 1} \frac{1}{\mathbf{k} + 1} \frac{\partial}{\partial T} (T \beta_{\mathbf{k}}) v^{-\mathbf{k}} \right],$$

and the energy is found to be

$$(13. 53) \quad \mathbf{E} = \mathbf{A} + T\mathbf{S} = RT \left[\frac{3}{2} + T \sum_{\mathbf{k} \geq 1} \frac{1}{\mathbf{k} + 1} \frac{\partial \beta_{\mathbf{k}}}{\partial T} v^{-\mathbf{k}} \right].$$

The heat content is the energy plus the pressure-volume product,

$$(13. 54) \quad \mathbf{H} = \mathbf{E} + PV = RT \left[\frac{5}{2} - \sum_{\mathbf{k} \geq 1} \frac{1}{\mathbf{k} + 1} \left(\mathbf{k} \beta_{\mathbf{k}} - T \frac{\partial \beta_{\mathbf{k}}}{\partial T} \right) v^{-\mathbf{k}} \right].$$

The heat capacity at constant volume is obtained by differentiating (53) with respect to temperature,

$$(13. 55) \quad \mathbf{C}_v = \left(\frac{\partial \mathbf{E}}{\partial T} \right)_v = R \left[\frac{3}{2} + \sum_{\mathbf{k} \geq 1} \frac{1}{\mathbf{k} + 1} \left(\frac{\partial}{\partial T} T^2 \frac{\partial \beta_{\mathbf{k}}}{\partial T} \right) v^{-\mathbf{k}} \right].$$

The derivative of the pressure with respect to the logarithm of the volume is found, by differentiation of (46), to be

$$(13. 56) \quad \left(\frac{\partial P}{\partial \ln V} \right)_T = V \left(\frac{\partial P}{\partial V} \right)_T = - \frac{kT}{v} \left[1 - \sum_{\mathbf{k} \geq 1} \mathbf{k} \beta_{\mathbf{k}} v^{-\mathbf{k}} \right].$$

The derivative of the pressure with respect to temperature is the same as the derivative of the entropy with respect to volume, and is given by

$$(13. 57) \quad - \frac{\partial^2 \mathbf{A}}{\partial T \partial V} = \left(\frac{\partial P}{\partial T} \right)_v = \left(\frac{\partial \mathbf{S}}{\partial V} \right)_T = \frac{k}{v} \left[1 - \sum_{\mathbf{k} \geq 1} \frac{\mathbf{k}}{\mathbf{k} + 1} \frac{\partial}{\partial T} (T \beta_{\mathbf{k}}) v^{-\mathbf{k}} \right].$$

131. Summary of the Method

The method of treating the imperfect gas consists of the following succession of steps.

The integrand, $e^{-U(q)/kT}$, of the configuration integral is expanded into a sum of terms, each of which, except the first which is everywhere unity, differs from zero only in a limited portion of the configuration space where some of the molecules are close to each other in clusters. Those terms characterized by belonging to the same distribution of molecules in m_l clusters of l molecules each, for all l values, are collected and integrated. Each such collection of integrated terms consists of a numerical coefficient multiplied by a product of powers of cluster integrals. The cluster integrals b_l are integrals over the configuration space of l particles.

The new integrated sum contains comparatively few terms, and the logarithm of the largest may be substituted for the logarithm of the sum. The logarithm of this largest term is the logarithm of the contribution due to the equilibrium distribution of the molecules in clusters.

The use of the logarithm of the largest term for the logarithm of the configuration integral leads to an equation for that quantity involving a new parameter Z of the dimensions of inverse volume. The physical significance of Z is that it represents the density of a perfect gas with the same free energy as the system, the fugacity of the gas expressed in density units of molecules per unit volume. The equation determining Z , however, is not explicit.

This quantity Z may be expanded as an inverse power series of the volume. The coefficients in this expansion are not simple in terms of the cluster integrals b_l . However, the cluster integrals are themselves sums of a number of terms, each of which is a numerical coefficient times a product of powers of certain irreducible integrals β_k of dimensions v^{-k} . The expansion of Z is simple in terms of these irreducible integrals β_k .

Finally, with the equation for Z in terms of an infinite series in powers of v^{-1} , explicit equations for all the thermodynamic properties of the gas may be obtained in terms of inverse power series in the volume per molecule v .

CHAPTER 14

CONDENSATION AND THE CRITICAL REGION

(a) Introduction. (b) The Value of the Cluster Integrals b_l for Large Values of l . (c) Large Clusters Present at Equilibrium. (d) The Pressure and Free Energy in the Condensation Range. (e) The Determination of the Volume per Molecule, v_s , of the Saturated Vapor. (f) The Dependence of the Irreducible Integrals on the Temperature. (g) The Critical Point. (h) The Temperature T_m . (i) The Physical Interpretation of T_m . (j) The Thermodynamic Functions of the Saturated Vapor. (k) Phase Changes in the Condensed Phase. (l) The Cell Method of Calculating Liquid Partition Functions.

14a. Introduction

The method of the preceding chapter, by which the thermodynamic functions of the imperfect gas were found as expansions with respect to inverse powers of the volume, was subject to two limitations which were not fully discussed in that chapter.

The first of these limitations concerns the volume independence of the cluster integrals b_l . The argument that the integral b_l does not depend on v is based on the fact that all terms of its integrand become zero if any one of the molecules is far from one to which it is bound. Since all molecules of the cluster are directly or indirectly bound in every term, it follows that the integrand is zero if any two molecules are widely separated. The integral over the space of all but one of the particles is consequently independent of the position of this last one, provided only that it is not too close to the walls of the vessel. This argument obviously fails if the ratio of the total volume V to the number of molecules in the cluster is of the order of magnitude of the volume of a single molecule.

For reasonably small values of l , and ordinary volumes, V/l will obviously be far greater than the volume over which the forces from one molecule operate effectively. But for clusters in which l is about the value of N , the total number of molecules of the system, and small values of the volume per molecule $v = V/N$, there will be some limit which will be designated by v_f , below which the b_l 's are no longer volume independent. It will later become apparent that v_f is the volume per molecule of the condensed phase. The assumption of volume independence of all the

b_l 's will be valid for all systems of volume large enough to permit the existence of some vapor.

The second limitation on the use of the equations of Chapter 13 concerns the expansion of Z as a power series in v^{-k} , and the analysis of the case when this is not permissible will be the main concern of this chapter.

The expansion of Z in terms of v^{-k} is valid only if the sum $\sum l v b_l Z^l$ converges, that is, if all the terms with very large values of l in this sum are practically zero. This is the sum, equation (13. 15), which was set equal to unity for the determination of the parameter Z . The l th term of the sum, $l v b_l Z^l$, has the physical interpretation of being the fraction of the molecules at equilibrium in clusters of l molecules each. If the material of the system is entirely gaseous it is obvious that no very large clusters exist, that is, none so large that a single cluster contains an appreciable fraction of all the molecules. The higher members of the sum (equation 13. 15) must then be zero, and the sum converges. If terms for which l has an extremely high order of magnitude are appreciable in the sum $\sum l v b_l Z^l$, a non-negligible fraction of the system is in the form of a condensed phase.

One explanatory remark may be advisable. The influence of the force of gravity on the particles of the system has been entirely neglected. Consequently, it is not to be expected that the equations will in any way predict that the larger clusters will be located in one part of the system, such as the bottom. Each cluster, whatever its size, will be free to move as a whole about the complete volume of the system.

In this chapter the value of b_l for large values of l will be determined in the form of a simple equation which is derived from equation (13. 34) giving b_l as a function of the irreducible integrals, the β_k 's. From this it will be shown that the higher members of the sum $\sum l v b_l Z^l$ become suddenly important at volumes below a definite value, v_s .

This volume v_s , the volume per molecule of the saturated vapor, is also the volume for which $(\partial P/\partial V)_T$ of the gas, equation (13. 56), becomes zero. For volumes lower than v_s and greater than v_f , below which the b_l 's are volume dependent, the two quantities pressure and free energy are independent of the volume. Between v_s and v_f the system undergoes a change of phase, the phenomenon of condensation. The fact that v_f is the lower volume limit of this region of constant pressure and free energy identifies it with the volume of the condensed phase.

Above a certain temperature T_c , the critical temperature, there is no condensation range, no volume for which $(\partial P/\partial V)_T$ is zero.

The system is found to have a second characteristic temperature T_m , which is lower than T_c . Between these two temperatures the

region for which the pressure is independent of the volume, $(\partial P/\partial V)_T$ is zero, the properties of the system are not those usually associated with condensation. This critical region, which is not included in the description of the system derived from the van der Waals equation, has not been generally recognized experimentally. Many of the experimental facts, however, can best be interpreted by assuming its reality.

14b. The Value of the Cluster Integrals b_l for Large Values of l

Equation (13. 34) which gives the cluster integral b_l in terms of the irreducible integrals β_k ,

$$(14. 1) \quad b_l = \frac{1}{l^2} \sum_{\substack{n_k \\ \sum k n_k = l-1}} \prod_k \frac{(l\beta_k)^{n_k}}{n_k!},$$

is scarcely practical for the evaluation of b_l if l is very large. One may, however, employ the same method that was used in section 13d to handle the very similar equation (13. 10) for $Q_r/N!$.

Equation (1) expresses b_l as a sum of terms. The total number of these terms is the partition number of $l-1$, the logarithm of which is proportional to $l^{1/2}$ for large l values. The logarithm of the largest term will be found to be proportional to l . If all the terms are positive, that is, if all the irreducible integrals β_k are positive, the logarithm of the sum of terms may be replaced by the logarithm of the largest term, at least for great values of l . For the logarithm of one term T , using the Stirling approximation, one obtains

$$(14. 2) \quad \ln T = \sum_{k=1}^{k=l-1} n_k (\ln l\beta_k + 1 - \ln n_k) - 2 \ln l,$$

which is to be made a maximum by variation of the values of the n_k 's, subject to the condition that

$$(14. 3) \quad \sum_{k \geq 1}^{k=l-1} k n_k = l - 1.$$

Multiplication of (3) by the unknown constant $\ln \rho$ and addition to (2) gives an expression which must be zero for the largest term if differentiated with respect to any n_k ,

$$(14. 4) \quad \frac{\partial}{\partial n_k} n_k (\ln l\beta_k + 1 - \ln n_k + k \ln \rho) = \ln l\beta_k - \ln n_k + k \ln \rho = 0, \\ n_k = l\beta_k \rho^k.$$

Equation (4) gives the value of n_k for the maximum term, analogously to equation (13. 14) for m_l . The parameter ρ is seen to have the dimen-

sions of inverse volume, as has Z , since $\beta_{\mathbf{k}}$ has the dimensions of volume to the power \mathbf{k} . If (4) is used in (3) the equation determining ρ is found in the same manner that that for Z was found in section 13d. Neglecting the difference between $l - 1$ and l ,

$$(14. 5) \quad \sum_{\mathbf{k}=1}^{\mathbf{k}=l-1} \mathbf{k} \beta_{\mathbf{k}} \rho^{\mathbf{k}} = 1$$

is obtained. There will be only one real positive root of ρ to this equation as long as all $\beta_{\mathbf{k}}$'s are positive.

Inserting (4) in (2), and using this value of the logarithm of the largest term as the value of the logarithm of b_l for large values of l , one finds, with omission of the negligible term $\ln l$,

$$(14. 6) \quad \ln b_l = \ln T_{\max.} = l \left(\sum_{\mathbf{k}=1}^{\mathbf{k}=l-1} \beta_{\mathbf{k}} \rho^{\mathbf{k}} - \ln \rho \right),$$

which is analogous to equation (13. 16) for $\ln(Q_r/N!)$.

Equation (6) gives the limiting value of $\ln b_l$ as l approaches infinity. This value is proportional to l , and if $\ln b_0$ is defined as $1/l$ times this limit, that is, as

$$(14. 7) \quad \ln b_0 = \sum_{\mathbf{k}=1}^{\mathbf{k}=l-1} \beta_{\mathbf{k}} \rho^{\mathbf{k}} - \ln \rho, \quad b_0 = \frac{1}{\rho} e^{\sum \beta_{\mathbf{k}} \rho^{\mathbf{k}}},$$

then

$$\lim_{l \rightarrow \infty} \ln b_l = l \ln b_0.$$

For $Q_r/N!$ the limiting value of the logarithm for large values of N was entirely sufficient, and for the cluster integrals the limiting value of $\ln b_l$ will also be found to be sufficient for our purposes, although the equations which we have use the quantity b_l itself and not its logarithm.

The logarithm of b_l may differ from $l \ln b_0$ by an additive function $\ln f(l, \beta)$ which depends on both the value of l and the values of the irreducible integrals, $\beta_{\mathbf{k}}$. We have shown that the quantity $\ln f(l, \beta)$ is small compared to l , that is, that

$$(14. 8) \quad \lim_{l \rightarrow \infty} \frac{1}{l} \ln f(l, \beta) = 0,$$

but, of course, the condition (8) still allows $f(l, \beta)$ to be a factor of b_l which differs considerably from unity. By the introduction of this function, $f(l, \beta)$, which need not be a continuous analytical function of l , and presumably is not for small values of l at least, one may write as an exact equation for b_l , for all l values,

$$(14. 9) \quad b_l = f(l, \beta) b_0^l.$$

Equation (9) really defines the function $f(l, \beta)$, but the one condition of this function, namely, that of equation (8), will be all that we shall need.

Actually by the method of steepest descents,* or by a method of quadratures,† the function $f(l, \beta)$ can be shown to be

$$f(l, \beta) = \frac{1}{l^{5/2}} \frac{\rho}{(2\pi \sum \mathbf{k}^2 \beta_{\mathbf{k}} \rho^{\mathbf{k}})^{1/2}}$$

for large values of l , as long as the sum $\sum \mathbf{k}^2 \beta_{\mathbf{k}} \rho^{\mathbf{k}}$ converges. This information is entirely unnecessary for the purposes of this chapter.

The method of using the logarithm of the largest term for the logarithm of the sum is rigorous only if all the irreducible integrals $\beta_{\mathbf{k}}$ are positive. In Appendix A XI it is shown that equations (7) and (9) are actually valid wherever (5) has a positive real solution for ρ . The smallest positive real root of (5) is always the correct one.

14c. Large Clusters Present at Equilibrium

With equation (8) for b_l , equation (13. 5), determining Z , may be written

$$(14. 10) \quad \sum_{l=1}^{l=N} l b_l Z^l = \sum_{l=1}^{l=N} l f(l, \beta) (b_0 Z)^l = 1,$$

or

$$(14. 11) \quad \sum_{l=1}^{l=N} l f(l, \beta) (b_0 Z)^l = v^{-1}.$$

These sums contain a finite although very large number of terms, the value of l running from unity to N , the total number of molecules. The l th term of (10), $l b_l Z^l$, is the fraction of the molecules in clusters of size l .

The value of v^{-1} calculated from (11) for different values of the parameter Z is plotted against this quantity in Fig. 14. 1, for some arbitrary temperature below the critical temperature, for which all the b_l 's are positive. For $Z = 0$ the value of v^{-1} is zero, $v = \infty$. The first term of the sum (11) is just Z , since b_1 is unity, equation (13. 29), and for sufficiently small values of Z all other terms may be neglected, so that the curve starts out at small Z values with a 45° slope, $Z = v^{-1}$, a fact which has already been discussed in section 13e. With increasing Z the higher terms, which are all positive, begin to become important, and v^{-1} increases more rapidly than Z .

Until the point $Z = b_0^{-1}$, $b_0 Z = 1$, the highest terms of the sum (11)

* Max Born and K. Fuchs, *Proc. Roy. Soc., London*, **A166**, 391 (1938).

† J. E. Mayer and S. F. Harrison, *J. Chem. Phys.*, **6**, 87 (1938).

do not contribute to the value of the sum, but above this value of Z they become enormous, and the curve increases practically vertically. This is a consequence of the limitation (8) on $\ln f(l, \beta)$, namely, that this quantity divided by l approaches zero for sufficiently large values of l .

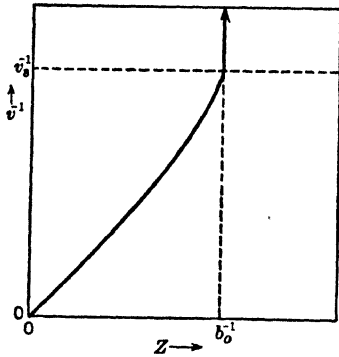

FIG. 14. 1. Plot of

$$v_s^{-1} = \sum_{l=1}^N l f(l, \beta) (b_0 Z)^l \text{ against } Z.$$

Now $\ln N$ is a comparatively small quantity; it is only about 54 for $N = 10^{23}$; the condition (8) for $\ln f(l, \beta)$ requires that $\ln(N, \beta)$ be much smaller than N , so that the term $N\epsilon$ is the most important part of $\ln T_N$. If ϵ , then, is negative, $\ln T_N$ is negative and the last term of the sum (11) is very small; but if ϵ is positive the logarithm of the term is positive and the term is large. With $N = 10^{23}$, for an increase in ϵ by an amount 10^{-10} , $N\epsilon$ and $\ln T_N$ increase by 10^{13} , which means that the contribution of the last term to the sum (11) increases by almost $10^{10^{13}}$ fold. As soon as the last term of this sum becomes appreciable, which it does at $Z = b_0$, $\epsilon = 0$, the increase in the value of the sum for very small increase in Z is enormous.

The volume per molecule when $b_0 Z = 1$ will be designated by v_s and will be shown to be the volume per molecule of the saturated vapor. It is determined by the equation

$$(14. 12) \quad \sum_{l=1}^{l=N} l f(l, \beta) = v_s^{-1}.$$

This sum (12) actually converges, so that v_s is not zero, as will become evident from an alternate equation, (23), for v_s which will be developed in the next section.

If the series (11) were an infinite series, that is, had an infinite number of terms instead of terminating at the term $l = N$, the point $Z = b_0^{-1}$ would be a point of irregularity of the series. It is a finite sum, however, but the value of the sum increases so rapidly with Z when $Z b_0$ is

To show this let us consider the last term of the sum (11) for which $l = N$. If $b_0 Z$ has the value

$$b_0 Z = e^\epsilon,$$

then when ϵ is zero $b_0 Z = 1$, when ϵ is negative it is smaller than unity, and when ϵ is positive it is larger than unity. The logarithm of the last term, T_N , of (11) is

$$\ln T_N = \ln N + \ln f(N, \beta) + N\epsilon.$$

just greater than unity that one may say conversely that, for all given values of the sum, v^{-1} , greater than v_s^{-1} , the solution for Z is b_0^{-1} . This, however, is true only as long as b_l is volume independent for all l 's, that is, true only down to v_f . We may write

$$(14. 13) \quad b_0 Z = 1 \quad (v_f \leq v \leq v_s),$$

or from (7) for b_0 ,

$$(14. 14) \quad \ln Z = \ln \rho - \sum_{k \geq 1} \beta_k \rho^k \quad (v_f \leq v \leq v_s).$$

However, although Z and all small powers of Z may be regarded as constant in the volume range between v_s and v_f , the power Z^l , when l is approximately N , is not constant. It is just the increase in these values which accounts for the increase in the sum (11) as v^{-1} increases from v_s^{-1} to v_f^{-1} . The higher terms of the sum (10), which give the fraction of material in large clusters, increase in value as the volume decreases from v_s to v_f . The terms of the smaller clusters decrease linearly with v in this range. The fraction of molecules in small clusters is proportional to the volume for volumes between v_s and v_f ; the density, or number per unit volume, of these small clusters remains constant. The fraction of material in large clusters is proportional to $(v_s - v)/v_s$ in this volume range.

At the volume v_f , the volume of the condensed phase, the density of the small clusters has the same value that it has at v_s , where the system consists only of the saturated vapor. We may interpret this as meaning that the solubility of the saturated vapor, measured in volume units, in the condensed phase, is unity. The vapor pressure of the condensed phase is due to the kinetic collisions of these small clusters with the walls of the vessel. The increased pressure, as the volume is reduced below v_f , is due to the volume dependence of the cluster integrals b_l .

14d. The Pressure and Free Energy in the Condensation Range

We shall now prove that between the two volumes v_s and v_f , where Z is constant, the pressure P and free energy $F = A + PV$ are both independent of the volume. This is the thermodynamic criterion for a volume region in which the material is changing from one phase into another.

Equation (13. 16) for the logarithm of the configuration integral in terms of the cluster integrals b_l ,

$$(14. 15) \quad \ln \frac{Q_r}{N!} = N(\sum v b_l Z^l - \ln Z),$$

is applicable at all volumes per molecule v .

We shall limit ourselves to volumes greater than v_f , for which the cluster integrals b_l do not depend on the volume, and calculate the pressure P from equation (10. 53') as

$$P = kT \left(\frac{\partial \ln (\mathbf{Q}_r / N !)}{\partial V} \right)_T = \frac{kT}{N} \left(\frac{\partial \ln (\mathbf{Q}_r / N !)}{\partial v} \right)_T,$$

$$P = \frac{kT}{v} \left[\sum v b_l Z^l - (\sum l v b_l Z^l - 1) \left(\frac{\partial \ln Z}{\partial \ln v} \right)_T \right].$$

Since Z is so determined that $\sum l v b_l Z^l = 1$, the equation becomes

$$(14. 16) \quad P = \frac{kT}{v} \sum v b_l Z^l = \frac{kT}{V} \sum N v b_l Z^l.$$

This equation has already been proved to hold in the region where the system is completely gaseous, equation (13. 48), by differentiation of the expanded form of $\ln (\mathbf{Q}_r / N !)$.

The pressure is kT/V times the total number of clusters, since each term, $N v b_l Z^l$, in the sum of (16) is the number of clusters of size l in the equilibrium distribution, equation (13. 14). Although the fraction of material in the large clusters may be appreciable, their total number must be negligible, and since each contributes only as much to the pressure as a single free molecule, the contribution to the pressure of the very large clusters may be neglected. The number of small clusters, of which there are very many, is just proportional to the volume, in the condensation range between v_s and v_f , so that the pressure, number of clusters divided by the volume, remains constant in this range.

Expressed mathematically, (16) may be differentiated

$$V \left(\frac{\partial P}{\partial V} \right)_T = v \left(\frac{\partial P}{\partial v} \right)_T = kT v \left(\frac{\partial}{\partial v} \right)_T \sum b_l Z^l,$$

$$(14. 17) \quad V \left(\frac{\partial P}{\partial V} \right)_T = \frac{kT}{v} \sum l v b_l Z^l \left(\frac{\partial \ln Z}{\partial \ln v} \right)_T = \frac{kT}{v} \left(\frac{\partial \ln Z}{\partial \ln v} \right)_T.$$

$(\partial \ln Z / \partial \ln v)_T$ may be determined by the condition that the sum $\sum l v b_l Z^l$ is constant,

$$\left(\frac{\partial}{\partial \ln v} \right)_T \sum l v b_l Z^l = 0 = \sum l v b_l Z^l + \sum l^2 v b_l Z^l \left(\frac{\partial \ln Z}{\partial \ln v} \right)_T,$$

$$(14. 18) \quad \left(\frac{\partial \ln Z}{\partial \ln v} \right)_T = - \frac{1}{\sum l^2 v b_l Z^l}.$$

Using (18) in (17) gives

$$(14. 19) \quad V \left(\frac{\partial P}{\partial V} \right)_T = - \frac{kT}{v} \frac{1}{\sum l^2 v b_l Z^l}$$

In the volume range between v_s and v_f the sum $\sum l v b_l Z^l$ contains terms of extremely large l values with magnitudes which are not negligible compared to unity. In the sum $l^2 v b_l Z^l$ these terms are l -fold greater than in $l v b_l Z^l$.

Even one cluster of very small, but macroscopic magnitude, in the system, say one containing as little as a milligram of material, has about 10^{-5} mole or 10^{18} molecules in it. The fraction of material, $l v b_l Z^l$, in such a cluster, if the system contains a mole, is only 10^{-5} , but since $l = 10^{18}$, the corresponding term $l^2 v b_l Z^l$ is 10^{13} .

In the condensation range, between v_s and v_f , the sum $\sum l^2 v b_l Z^l$ in the denominator of (19) is enormous, and the quantity $V(\partial P/\partial V)_T$ is essentially zero.

The free energy F is calculated from $A + PV$, using $A = -kT \ln Q$. The complete normalized phase integral Q is

$$Q = \left(\frac{2\pi m k T}{h^2} \right)^{3N/2} \frac{Q_r}{N!}$$

from equation (10. 50'), so that, with (15), the work function A per mole is

$$(14. 20) \quad A = RT \left[\ln \left(\frac{h^2}{2\pi m k T} \right)^{3/2} - \sum v b_l Z^l + \ln Z \right].$$

Adding to this PV from (16),

$$(14. 21) \quad F = A + PV = RT \ln \left(\frac{h^2}{2\pi m k T} \right)^{3/2} Z.$$

The complete volume dependence of F is in the term Z , which has been shown to have the value b_0^{-1} throughout the condensation range from v_s to v_f . F is independent of the volume in the region of condensation.

14e. The Determination of the Volume per Molecule, v_s , of the Saturated Vapor

In the previous section we have seen that there is a condensation range between the two volumes v_s and v_f where the sum $\sum l v b_l Z^l$ does not converge. The equations of the last chapter, namely, developments of the thermodynamic functions in inverse powers of the volume, are valid only for volumes above v_s , for which the system is entirely

gaseous. We shall now show how the equations of the last chapter and those of the previous section join at $v = v_s$. In addition, equation (12) for v_s is inconvenient for numerical calculation because of its use of the undetermined function $f(l, \beta)$. We shall arrive at an alternate equation for the volume per molecule of the saturated vapor v_s .

If we return to equation (13. 56) for $V(\partial P/\partial V)_T$, which is valid only in the gaseous phase, that

$$(14. 22) \quad V \left(\frac{\partial P}{\partial V} \right)_T = - \frac{kT}{v} \left[1 - \sum_{k \geq 1} k \beta_k v^{-k} \right],$$

it is seen that, when v takes the value v_p defined as the largest positive root of the equation

$$(14. 23) \quad \sum_{k \geq 1} k \beta_k v_p^{-k} = 1,$$

the quantity $(\partial P/\partial V)_T$ becomes zero, the pressure no longer increases with decreasing volume.

The question arises, however, whether the volume v_p is smaller than the volume v_s , in which case the equation (22) would be invalid, since then v_p would be a volume in the region of condensation. We shall show that v_p and v_s are identical, and shall do this by showing that Z_p is equal to b_0^{-1} at v_p , the value it has in the condensation region, but is smaller than this at all volumes higher than v_p .

Comparison of equation (23) with (5) shows that

$$(14. 24) \quad v_p = \rho^{-1}.$$

If now equation (13. 42), that

$$(14. 25) \quad \ln Z = -\ln v - \sum_{k \geq 1} \beta_k v^{-k},$$

is used for Z_p at the volume $v_p = \rho^{-1}$,

$$(14. 26) \quad \ln Z_p = \ln \rho - \sum_{k \geq 1} \beta_k \rho^k$$

is found. This equation is identical with (14) for the value of $\ln Z$ in the region of condensation for which $Z = b_0^{-1}$.

Now equation (25) is valid as long as the sum $\sum l v b_l Z^l$ converges, that is, as long as Z is smaller than Z_p and $b_0 Z$ is smaller than unity. In particular it is certain that the equation is valid for very large values of the volume v . If (25) is differentiated with respect to $\ln v$ one obtains

$$(14. 27) \quad \left(\frac{\partial \ln Z}{\partial \ln v} \right)_T = - \left(1 - \sum_{k \geq 1} k \beta_k v^{-k} \right),$$

which shows that $(\partial \ln Z/\partial \ln v)$ is negative and Z is smaller than Z_p ,

for all volumes larger than v_p , which, by the definition of equation (23), is the largest volume for which (27) is zero.

It follows that for all volumes greater than v_p the parameter Z is smaller than b_0^{-1} and the sum $\sum lb_l Z^l$ converges. For these volumes the system is entirely gaseous, no large clusters are present, and all the equations of the previous chapter are valid. The volume v_p defined by (23) is the largest volume for which $Z = b_0^{-1}$, and is therefore the same as v_s defined by equation (12).

At low temperatures, as will be shown in greater detail in the following section, all the β_k 's are positive. It follows, therefore, that equation (23) has a positive non-infinite root, and v_s is not zero. At sufficiently low temperatures, then, condensation takes place.

The thermodynamic equations for the saturated vapor are the equations of Chapter 13 for the imperfect gas with the volume $v_s = v_p = \rho^{-1}$, defined by equation (23). The vapor pressure of the liquid is given by the equation for the pressure of the imperfect gas at this volume, and the free energy F of the liquid at its own vapor pressure is the free energy of the vapor.

14f. The Dependence of the Irreducible Integrals on the Temperature

The general predictions which we have been able to make so far about the behavior of the system have been almost independent of any assumptions concerning the values of the irreducible integrals β_k . In order to proceed further it will be necessary to examine these integrals and to attempt to predict certain characteristics of their dependence on the temperature. Unfortunately, accurate numerical evaluation of the integrals themselves, even with rather simple assumed forms for the potential $u(r)$ between two molecules, is possible only for the first two or three members of the series.

The first integral β_1 can be evaluated readily as

$$(14. 28) \quad \beta_1 = \int_0^\infty 4\pi r^2 (e^{-u(r)/kT} - 1) dr$$

for any assumed potential $u(r)$, if necessary by graphical integration. In section 12c, equation (12. 19), it was found that β_1 , which was there simply designated as β , was approximately given by

$$(14. 29) \quad \frac{1}{2} \beta_1 = \frac{a}{kT} - b.$$

This equation holds moderately well for high temperatures, β_1 actually increasing more rapidly with decreasing temperature than is indicated by this equation as T becomes very small and a/kT becomes large compared to b .

The second integral β_2 , equation (13. 27), may be evaluated analytically using a fairly accurate approximation to the true potential, $u(r)$, without too much difficulty. It is found that, whereas at very low temperatures it is positive and considerably larger than β_1^2 , it decreases with rising temperature much more rapidly than β_1^2 and becomes negative at a temperature about three and a half times lower than the temperature at which β_1 becomes negative.

The third integral, β_3 , equation (13. 28), is considerably more difficult, but rough values* may be obtained by making approximations for the potential $u(r)$. It appears, unfortunately, to be rather strongly dependent on the exact form of the potential used, so that it is doubtful that the values so obtained are of great accuracy. β_3 has the dimensions v^3 , which are the same as β_1^3 and $\beta_2^{3/2}$. At low temperatures β_3 is larger than either β_1^3 or $\beta_2^{3/2}$, and it decreases with temperature more rapidly than either of these quantities, crossing zero to become negative at a temperature slightly lower than the temperature at which β_2 becomes negative.

The higher members of the series of integrals would be impracticably difficult to calculate, but some estimations of their behavior may be made. It is certain that they must all be positive at sufficiently low temperatures, and that, at low temperatures at least, they must decrease in value as the temperature increases. It appears to be probable that they all become negative, or at least decrease to values which are negligible compared to β_1^k at about the same temperature that β_2 and β_3 become negative.

β_1 is the second virial coefficient of the gas, and the temperature at which it is zero is known as the Boyle temperature. The three-and-a-half-fold lower temperature at which β_2 and β_3 , and also presumably all the higher β_k 's, become zero, is then slightly lower than the observed value of the critical temperature in most gases.

The integrand of each of the terms making up a certain irreducible integral β_k is a product of functions f_{ij} . Each of these functions has a maximum positive value when the distance r_{ij} between the molecules takes the value for which the potential $u(r_{ij})$ is a minimum. This maximum value of the function f_{ij} is very high at low temperatures. The terms in β_k with a large number of functions f_{ij} in the product will therefore contribute most to the integral at low temperatures. There is, however, an upper limit of approximately twelve functions per molecule which may all have simultaneously nearly their maximum values in any part of the configuration space. At low temperatures, then, the most important contribution to β_k will be expected to arise from

* Sally F. Harrison, Dissertation, the Johns Hopkins University, 1938.

those terms for which there are approximately twelve f_{ij} 's per molecule. At higher temperatures the maximum value of the functions is lower, whereas the negative value of approximately minus one in the region of low r_{ij} values, where the potential is positive, is almost independent of the temperature. The terms with a smaller number of product functions become relatively more important contributors to the complete integral $\beta_{\mathbf{k}}$ as the temperature increases.

For very large \mathbf{k} values, and at low temperatures for which all the integrals are positive, the logarithm of $\beta_{\mathbf{k}}$ will be proportional to \mathbf{k} , so that one may define β_0 , with the dimensions of volume, analogously to the definition of b_0 , as

$$(14. 30) \quad \lim_{\mathbf{k} \rightarrow \infty} \frac{1}{\mathbf{k}} \ln \beta_{\mathbf{k}} = \ln \beta_0.$$

Just as with b_l in equation (9), one may write

$$(14. 31) \quad \beta_{\mathbf{k}} = f(\mathbf{k}, T) \beta_0^{\mathbf{k}},$$

in which this equation (31) defines the function $f(\mathbf{k}, T)$, about which we only know that

$$(14. 32) \quad \lim_{\mathbf{k} \rightarrow \infty} \frac{1}{\mathbf{k}} \ln f(\mathbf{k}, T) = 0.$$

However, certain characteristics of this function $f(\mathbf{k}, T)$ may be stated with reasonable certainty. For \mathbf{k} values lower than 15 or 20 there is no term in the integrand of $\beta_{\mathbf{k}}$ containing as many as twelve f_{ij} 's per molecule for which all the functions can take their maximum values simultaneously in any part of the configuration space. Consequently at very low temperatures the \mathbf{k} th root of $\beta_{\mathbf{k}}$ for these low \mathbf{k} values must be considerably smaller than β_0 , which is the \mathbf{k} th root of $\beta_{\mathbf{k}}$ as \mathbf{k} approaches infinity. This means that for low temperatures and relatively small values of \mathbf{k} the function $f(\mathbf{k}, T)$ must be extremely small compared to unity.

Furthermore, we may estimate the behavior of this function $f(\mathbf{k}, T)$ for very large values of \mathbf{k} . The most important terms in the integrand of $\beta_{\mathbf{k}}$ will be those for which there is a function f_{ij} for every one of the distances r_{ij} which can simultaneously take the optimum value at which $u(r_{ij})$ is a minimum. In a term of large \mathbf{k} value there will be a number of molecules proportional to $\mathbf{k}^{2/3}$, which will be on the surface of the corresponding diagram, and which cannot be the optimum distance from as many neighboring molecules as those in the interior of the frame. These molecules will contribute, on the average, less to the total integral than

β_0 , so that the most important factor of $f(\mathbf{k}, T)$ will be a constant, less than unity, raised to the power $\mathbf{k}^{2/3}$.

The fact that $f(\mathbf{k}, T)$ is small for low \mathbf{k} values, and for high \mathbf{k} 's approaches zero as $e^{-\gamma \mathbf{k}^{2/3}}$, with γ positive, assures us that the sum of $f(\mathbf{k}, T)$ over all \mathbf{k} values will be small, at least at low temperatures. As the temperature becomes higher the terms in $\beta_{\mathbf{k}}$ with fewer products f_{ij} become relatively more important, and the difference of the contribution to the integral $\beta_{\mathbf{k}}$ due to the molecules on the surface and those in the interior decreases. Therefore γ decreases and $f(\mathbf{k}, T)$ increases with temperature, whereas β_0 decreases with increasing temperature.

To summarize, then, this can be said about the irreducible integrals $\beta_{\mathbf{k}}$. For temperatures lower than about the neighborhood of the critical point of the system, all $\beta_{\mathbf{k}}$'s will be positive and will be represented by equation (31). The function $f(\mathbf{k}, T)$ in this equation converges to zero with increasing \mathbf{k} as $e^{-\gamma \mathbf{k}^{2/3}}$, and will be very small for all \mathbf{k} 's at low temperatures. The function $f(\mathbf{k}, T)$ increases with increasing temperature. The quantity β_0 decreases with increasing temperature. At a temperature approximately that of the critical point the $\beta_{\mathbf{k}}$'s of higher \mathbf{k} values become negative, β_1 remaining positive until a temperature about three and a half times higher than this, the Boyle temperature of the gas.

Using these properties of the integrals $\beta_{\mathbf{k}}$ we shall show that the system must have a critical point at the temperature T_c , above which no condensation phenomenon exists, that is, above which $(\partial P / \partial V)_T$ is nowhere zero. There must also be a second characteristic temperature T_m for the system which is lower than T_c , and the usual phenomena associated with condensation, namely, that the system separates into two phases of different density and that the pressure of the supersaturated vapor is higher than the equilibrium vapor pressure, occur only below the temperature T_m . The temperature T_c must be slightly higher than the temperature at which the $\beta_{\mathbf{k}}$'s of high \mathbf{k} values become negative, and the temperature T_m is presumably lower than this temperature.

14g. The Critical Point

Since v_p of equation (23) has been identified with the volume v_s of the saturated vapor, this equation may be used for the determination of v_s , rather than the unwieldy definition (12) which contains the undetermined function $f(l, \beta)$.

As long as all $\beta_{\mathbf{k}}$'s are positive, which is true at low temperatures, equation (23) will have only one real positive root. The derivation of

equation (7) for b_0 in section 14b was rigorous only if all the β_k 's are positive, and the identification of the root v_p of (23) as the volume v_s at which b_0Z becomes unity was dependent on (7). The more involved method of Appendix A XI shows that the complete argument is valid as long as there exists a real positive root to (23).

As the temperature increases, some, at least, of the integrals β_k with high k values become negative, whereas the first, β_1 , remains positive to much higher temperatures. There exists a temperature T_c , above which there is no positive root to (23), that is, no volume v_s for which $(\partial P/\partial V)_T$ becomes zero and for which b_0Z is unity. This temperature, the highest

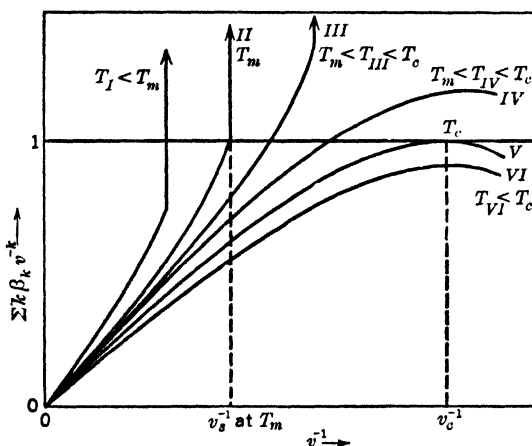

FIG. 14. 2. Plot of $\sum_{k=1}^{N-1} k\beta_k v^{-k}$ against v^{-1} at different temperatures.

for which $(\partial P/\partial V)_T$ has anywhere a zero value, is called the critical temperature.

This can best be illustrated by a plot of the sum $\sum k\beta_k v^{-k}$ against the reciprocal volume v^{-1} at temperatures in the neighborhood of the critical value, Fig. 14. 2, Curves IV, V, and VI. With the first coefficient, β_1 , positive, the sum rises, at first linearly with v^{-1} , from zero at $v^{-1} = 0$, with the slope β_1 . If the higher β_k 's are negative the slope of the curve rapidly diminishes through zero to a negative value.

At temperatures below T_c , Curve IV, the maximum value of the sum is greater than unity, and the largest root v_s of (23) is given by the value of v where the curve first crosses unity. At a temperature above T_c , Curve VI, with β_1 still positive but smaller than at the lower temperature, and the higher β_k 's more negative, the curve does not attain the value unity. At exactly T_c , Curve V, the maximum of the sum just

reaches unity, and the maximum of the curve is at v_c . This value of v_c at T_c will be designated by v_c , the critical volume per molecule.

It is clear from the figure that at the maximum of the sum

$$\frac{\partial}{\partial(v^{-1})} \sum \mathbf{k} \beta_{\mathbf{k}} v^{-\mathbf{k}} = 0 = v \sum \mathbf{k}^2 \beta_{\mathbf{k}} v^{-\mathbf{k}}.$$

This condition must be fulfilled at the critical point. The critical point, then, is determined by the two conditions, namely, that simultaneously (23), $\sum \mathbf{k} \beta_{\mathbf{k}} v_c^{-\mathbf{k}} = 1$, and

$$(14. 33) \quad \sum_{\mathbf{k} \geq 1} \mathbf{k}^2 \beta_{\mathbf{k}} v_c^{-\mathbf{k}} = 0$$

are fulfilled, which will be true only at the single temperature T_c and volume v_c .

Since (22) states that

$$\frac{V^2}{RT} \left(\frac{\partial P}{\partial V} \right)_T = \sum_{\mathbf{k} \geq 1} \mathbf{k} \beta_{\mathbf{k}} v^{-\mathbf{k}} - 1,$$

it is evident from the plot that, at T_c , $(\partial P / \partial V)_T$ is negative at all volumes above and below the critical volume v_c , having the value zero only at this volume. The point v_c is an inflection point of zero slope on the isothermal plot of P against v . At higher temperatures, Curve VI, the inflection point occurs at the volume for which $\sum \mathbf{k} \beta_{\mathbf{k}} v^{-\mathbf{k}}$ is a maximum, $\sum \mathbf{k}^2 \beta_{\mathbf{k}} v^{-\mathbf{k}} = 0$, but where the first sum is smaller than unity, so that $(\partial P / \partial V)_T$ is negative at all volumes.

14h. The Temperature T_m

A further analysis of the plot of $\sum \mathbf{k} \beta_{\mathbf{k}} v^{-\mathbf{k}}$ against the reciprocal volume v^{-1} indicates that the system must have a second characteristic temperature T_m , below T_c . A careful examination of the properties of the system shows that the usual phenomena associated with condensation appear only below T_m . If, in the range of low temperatures for which both β_0 and $f(\mathbf{k}, T)$ of (31) are positive, the sum $\sum_{\mathbf{k}=1}^{\mathbf{k}=N} \mathbf{k} \beta_{\mathbf{k}} v^{-\mathbf{k}}$, which, it must be remembered, contains only a finite number of terms, is plotted against v^{-1} , one obtains curves like I, II, and III of Fig. 14. 2, resembling that of Fig. 14. 1, for $\sum l b_l Z^l$ against Z .

For low values of v^{-1} the curve increases linearly with v^{-1} , the slope being the value of β_1 . This slope increases as the positive terms of higher \mathbf{k} values become important. At the volume for which $\beta_0 v^{-1} = 1$ the curve rises abruptly with increasing value of v^{-1} with a slope which is practically infinite.

If, as in Curve III, the value of the sum is greater than unity when

$v = \beta_0$, the volume v_s is larger than β_0 , and the volume $v = \beta_0$ is in the condensation region where the equations for the gas are invalid and would lead to the physically ridiculous case that $(\partial P/\partial V)_T$ be positive. If, however, the sum $\sum \mathbf{k}\beta_{\mathbf{k}}v^{-\mathbf{k}}$ is less than unity as $v^{-1} = \beta_0^{-1}$ is approached, Curve I, the curve crosses unity abruptly at a value of v^{-1} infinitesimally greater than β_0^{-1} , that is, at a volume infinitesimally smaller than β_0 .

Using equation (31) for $\beta_{\mathbf{k}}$ it is seen that the value of the sum when $\beta_0v^{-1} = 1$ is given by

$$(14. 34) \quad \sum_{\mathbf{k}=1}^{\mathbf{k}=N} \mathbf{k}\beta_{\mathbf{k}}v^{-\mathbf{k}} = \sum_{\mathbf{k}=1}^{\mathbf{k}=N} \mathbf{k}f(\mathbf{k}, T) \quad (\beta_0v^{-1} = 1).$$

Since we have seen that it is to be expected that the function $f(\mathbf{k}, T)$ becomes extremely small at low temperatures, and increases with increasing temperature, one may expect that at sufficiently low temperatures the sum (34) will be less than unity. It must increase with temperature, and since $f(1, T) = \beta_1/\beta_0$, this member alone must be greater than unity at some temperature lower than T_c where the higher $\beta_{\mathbf{k}}$'s are approaching zero while β_1 remains positive and moderately large. There must, therefore, be some temperature T_m for which

$$(14. 35) \quad \sum_{\mathbf{k}=1}^{\mathbf{k}=N} \mathbf{k}f(\mathbf{k}, T) = 1, \quad T = T_m,$$

and this temperature T_m must be lower than the critical temperature T_c .

For temperatures equal to and lower than T_m , v_s is determined by the equation

$$(14. 36) \quad v_s = \beta_0, \quad T \leq T_m,$$

since the curve of $\sum \mathbf{k}\beta_{\mathbf{k}}v^{-\mathbf{k}}$ crosses unity at this value of the volume in this temperature range, Curves I and II of the figure. Between T_m and T_c , equation (23) that $\sum \mathbf{k}\beta_{\mathbf{k}}v_s^{-\mathbf{k}} = 1$ must be used for the determination of v_s .

14i. The Physical Interpretation of T_m

The equation $\sum v b_l Z^l = 1$, the solution of which determines Z as a function of the volume and temperature, has two distinct ranges, depending primarily on the volume v : that for which v is greater than v_s , and the sum converges; and that for volumes less than v_s , for which the solution $b_0 Z$ is determined by the higher terms of the sum. Below v_s , the solution is still determined by the higher members of the sum, but the b_l 's are volume dependent, and their l th root is no longer given by the simple volume-independent quantity b_0 .

Similarly, the equation $\sum \mathbf{k}\beta_{\mathbf{k}}v_s^{-\mathbf{k}} = 1$, the solution of which determines v_s , the volume per molecule of the saturated vapor, as a function of the

temperature, has three ranges which depend on the temperature only. For the upper temperature range, $T > T_c$, there is no real positive root to the equation. Between T_m and T_c the sum converges at the volume v_s which is the root of the equation. For $T < T_m$ the solution $v_s = \beta_0$ is determined by the higher members of the sum.

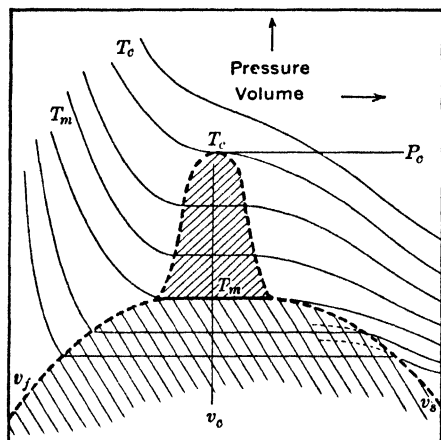

FIG. 14. 3. Plot of pressure against volume at different temperatures near the critical temperature.

The significant feature of these curves is the change in character above and below the temperature T_m . Above this temperature the sum $\sum \mathbf{k} \beta_{\mathbf{k}} v^{-\mathbf{k}}$ approaches unity continuously as the volume decreases to v_s , and consequently the slope of the isothermals, $(\partial P / \partial V)_T$, equation (22), is continuous through v_s . Below T_m the sum $\sum \mathbf{k} \beta_{\mathbf{k}} v^{-\mathbf{k}}$ approaches a value less than unity for volumes infinitesimally greater than v_s , and the slope, $(\partial P / \partial V)_T$, of the isothermals is discontinuous at v_s . The behavior below T_m is the one usually associated with condensation.

For temperatures lower than T_m one may draw a continuation of the curve for the gas into the region of condensation, a continuation which represents the higher pressure of the supersaturated vapor. The meaning of this continuation in the equations is not hard to discover. If the configuration space, over which the original integration of the configuration integral is extended, were limited *not* to include regions for which many molecules are all close to each other, the cluster integrals b_l of large l values would be absent from the integral. In this case the sum $\sum \mathbf{k} \beta_{\mathbf{k}} v^{-\mathbf{k}}$ would be limited to contain only a few members with low values of \mathbf{k} , and would not show the sharp rise at $v = \beta_0$ given in the curves of Fig. 14. 2.

In the next section the equation for $d \ln v_s / d \ln T$ will be derived, and, as may be expected, it will be evident that this quantity is discontinuous at T_m .

In Fig. 14. 3, the isothermals of pressure plotted against volume in the neighborhood of the temperatures T_c and T_m , and for volumes near v_s and v_f , are shown. The curves for volumes of v_f and below are pure improvisations based on experimental knowledge. For volumes higher than v_f , however, the general character of the curves follows unambiguously from the equations. The sig-

The system so inhibited corresponds to the supersaturated vapor when the volume is lower than v_s . Large clusters are inhibited from forming in this system, and the equations for it would lead to pressures and free energies higher than that of the mixture of saturated vapor-condensed phase, for volumes between v_s and v_f . This system, without large clusters, is thermodynamically unstable in the volume range of condensation, and the real system will separate into two phases of densities v_f^{-1} and v_s^{-1} if held at a total volume between Nv_s and Nv_f .

At temperatures above T_m no such extrapolation of the gaseous curve to higher pressures in the condensation region is possible. The continuation of the curve for the gas leads directly to a range for which the pressure does not increase with decreasing volume. A system inhibited to contain only comparatively small clusters, but an unlimited number of them, has practically the same free energy as one in which one very large cluster is present and fewer medium-sized ones. If the sum $\sum \mathbf{k} \beta_{\mathbf{k}} v^{-\mathbf{k}}$ converges at v_s , the l th root of the cluster integral b_l is independent of l and has reached the value b_0 even at comparatively small values of l .

There is no reason to believe that a system, the volume of which is decreased, at a constant temperature between T_m and T_c , through the range between v_s and v_f , will show the characteristic separation into two phases which occurs below T_m . The replacement of many medium-sized clusters in the system with one very large cluster does not result in an appreciable reduction in pressure or free energy. There is no thermodynamic driving force tending to separate the system into two different phases.

It can be shown* that the assumption which we have already pointed out to be reasonable in section 14f, that $(1/\mathbf{k}) \ln f(\mathbf{k}, T)$ goes to zero as $-\gamma \mathbf{k}^{-1/3}$, leads to a term which may be interpreted as the surface tension of the condensed phase at temperatures lower than T_m , but the equations definitely show that there can be no surface tension at temperatures higher than T_m . The absence of the surface free energy above T_m is intimately connected with the equal stability of many small or medium-sized clusters, or one very large cluster, in the condensation range of volume.

The temperature T_m is the temperature at which the sharp meniscus separating the liquid from the gaseous phase will disappear in a system heated at constant volume v between the two values v_{sm} and v_{fm} at T_m . It is well known that the disappearance of the meniscus can be observed for a range of volumes, and is a phenomenon not limited to the single

* J. E. Mayer and S. F. Harrison, *J. Chem. Phys.*, **6**, 87 (1938).

volume v_c , as would be demanded by a $P-V$ diagram such as the van der Waals equation predicts, Fig. 12. 2.

There is considerable other evidence for the existence of this critical region, but it is difficult to ascertain experimentally to what extent the magnitude of the observed region in temperature and volume interval depends, wholly or in part, on the presence of impurities in the system. The equations discussed in this chapter indicate that it must be a phenomenon observable in a pure one-component system. Until numerical calculations of the β_k 's can be performed, no indication of the theoretical temperature interval between T_m and T_c is available. Experimental evidence* indicates that this difference is 10° to 15° , and the volume difference between v_s and v_f 10 to 20 per cent, for some materials.

14j. The Thermodynamic Functions of the Saturated Vapor

The equation for the determination of the volume per molecule, v_s , of the saturated vapor, is

$$(14. 37) \quad \sum_{k \geq 1} k \beta_k v_s^{-k} = 1,$$

the solution of which, below the temperature T_m where the true liquid phase exists, is determined by the higher terms only,

$$(14. 38) \quad v_s = \beta_0,$$

$$(14. 39) \quad \ln \beta_0 = \lim_{k \rightarrow \infty} \frac{1}{k} \ln \beta_k.$$

Since the sum (37) is constant one may set its derivative with respect to the logarithm of the temperature equal to zero, obtaining

$$(14. 40) \quad \begin{aligned} \frac{d}{d \ln T} (\sum k \beta_k v_s^{-k}) = 0 &= \sum k \beta_k \frac{d \ln \beta_k}{d \ln T} v_s^{-k} \\ &\quad - \sum k^2 \beta_k v_s^{-k} \left(\frac{d \ln v_s}{d \ln T} \right), \\ \frac{d \ln v_s}{d \ln T} &= \frac{\sum k \beta_k (d \ln \beta_k / d \ln T) v_s^{-k}}{\sum k^2 \beta_k v_s^{-k}}. \end{aligned}$$

Between T_m and T_c equation (40) is convenient to use, since both sums converge, so that the inclusion of only a few terms leads to a satisfactory approximate evaluation. The terms $d \ln \beta_k / d \ln T$ are negative, so that v_s decreases with increasing temperature. At T_c , in

* See, for instance, Tapp, Steacie and Maass, *Can. J. Research*, 9, 217 (1933).

view of (33) that the sum $\sum k^2 \beta_k v_c^{-k}$ is zero, the slope of v_s against T becomes minus infinity.

Below T_m it is more convenient to use (31) for β_k , so that

$$(14. 41) \quad \frac{d \ln \beta_k}{d \ln T} = \frac{d \ln f(k, T)}{d \ln T} + k \frac{d \ln \beta_0}{d \ln T}.$$

If this is substituted in (40), one obtains

$$\frac{d \ln v_s}{d \ln T} = \frac{\sum k \beta_k (d \ln f(k, T) / d \ln T) v_s^{-k}}{\sum k^2 \beta_k v_s^{-k}} + \frac{d \ln \beta_0}{d \ln T}.$$

The terms of very large k values in the sum $\sum k \beta_k v_s^{-k}$ are appreciable in magnitude for $T < T_m$, so that the corresponding terms $k^2 \beta_k v_s^{-k}$ are enormous and the sum in the denominator of the first expression above can be said to be infinite. In view of (32) the terms of the sum in the numerator must at least be appreciably smaller than those in the sum of the denominator. The first term of the above equation may then be set equal to zero below T_m . One obtains

$$(14. 42) \quad \frac{d \ln v_s}{d \ln T} = \frac{d \ln \beta_0}{d \ln T}, \quad T < T_m,$$

which would be obtained by direct differentiation of (38).

The sum $\sum k \beta_k v^{-k}$ approaches a definite value as v decreases to the value v_s , and this limit of the sum is not unity, but smaller than unity, for values of the temperature lower than T_m . This limit is given by the equation

$$(14. 43) \quad \lim_{v \rightarrow v_s} \sum_{k \geq 1} k \beta_k v^{-k} = \sum_{k \geq 1} k f(k, T),$$

or, what is the same thing, by calculation of the first few terms only of the sum $\sum k \beta_k v^{-k}$, which converge quite rapidly. It is this limit (43) for this and similar sums which is to be used in the equations of the previous chapter to obtain the properties of the vapor at the saturation point. For instance, from (22)

$$(14. 44) \quad V \left(\frac{\partial P}{\partial V} \right)_{T, v = v_s} = - \frac{kT}{v_s} \left(1 - \sum_{k \geq 1} k \beta_k v_s^{-k} \right)$$

with equation (43) will give the value of $(\partial P / \partial V)_{T, v = v_s}$ for the saturated vapor which would be measured by velocity of sound experiments, or by any other method in which the condensation of the vapor was inhibited. If the pressure of the system were *gradually* increased so that the formation of large clusters was not inhibited, the sum should be extended to

include its members of high \mathbf{k} value, so that the sum is unity, and $(\partial P/\partial V)_T = 0$.

For the pressure P_s of the saturated vapor one may use equation (13. 46) with $v = v_s$,

$$(14. 45) \quad P_s = \frac{kT}{v_s} \left[1 - \sum_{\mathbf{k} \geq 1} \frac{\mathbf{k}}{\mathbf{k} + 1} \beta_{\mathbf{k}} v_s^{-\mathbf{k}} \right].$$

To obtain the total derivative of the vapor pressure with respect to the temperature one may use

$$(14. 46) \quad \frac{dP_s}{dT} = \left(\frac{\partial P_s}{\partial T} \right)_{v=v_s} + \left(\frac{\partial P_s}{\partial v_s} \right)_T \frac{dv_s}{dT}.$$

The term $(\partial P/\partial v_s)_T$ is zero so that

$$(14. 47) \quad \frac{dP_s}{dT} = \left(\frac{\partial P_s}{\partial T} \right)_v = \frac{k}{v_s} \left[1 - \sum_{\mathbf{k} \geq 1} \frac{\mathbf{k}}{\mathbf{k} + 1} \left\{ \frac{d}{dT} (T\beta_{\mathbf{k}}) \right\} v_s^{-\mathbf{k}} \right].$$

For temperatures below T_m this expression is better altered by the use of (41) for $d \ln \beta_{\mathbf{k}}/d \ln T$, which leads to

$$\frac{dP_s}{dT} = \frac{k}{v_s} \left[1 - \sum_{\mathbf{k} \geq 1} \frac{\mathbf{k}}{\mathbf{k} + 1} \left(1 + \frac{d \ln f(\mathbf{k}, T)}{d \ln T} \right) \beta_{\mathbf{k}} v_s^{-\mathbf{k}} - \frac{d \ln \beta_0}{d \ln T} \sum_{\mathbf{k} \geq 1} \frac{\mathbf{k}^2}{\mathbf{k} + 1} \beta_{\mathbf{k}} v_s^{-\mathbf{k}} \right].$$

Using the fact that $\mathbf{k}^2/(\mathbf{k} + 1) = \mathbf{k} - \mathbf{k}/(\mathbf{k} + 1)$ and that $\sum \mathbf{k} \beta_{\mathbf{k}} v_s^{-\mathbf{k}}$ is unity, one obtains

$$(14. 48) \quad \frac{dP_s}{dT} = \frac{k}{v_s} \left[\left(1 - \frac{d \ln \beta_0}{d \ln T} \right) \left(1 - \sum_{\mathbf{k} \geq 1} \frac{\mathbf{k}}{\mathbf{k} + 1} \beta_{\mathbf{k}} v_s^{-\mathbf{k}} \right) - \sum_{\mathbf{k} \geq 1} \frac{\mathbf{k}}{\mathbf{k} + 1} \frac{d \ln f(\mathbf{k}, T)}{d \ln T} \beta_{\mathbf{k}} v_s^{-\mathbf{k}} \right].$$

In deriving this, use was made of the fact that the sum $\sum \mathbf{k} \beta_{\mathbf{k}} v_s^{-\mathbf{k}}$ is unity, which is not true at volumes infinitesimally greater than v_s . Equation (47) gives the value of $(\partial P/\partial T)_V$ for the saturated vapor if the limit (43) is inserted for the sum. It is to be noted that

$$(14. 48') \quad \frac{dP_s}{dT} = \frac{\Delta S}{\Delta V} = \frac{S_{\text{vapor}} - S_{\text{condensed}}}{N(v_s - v_f)},$$

from equation (13. 57), which is the well-known thermodynamic Clausius-Clapeyron equation. From (48) it is seen that there is no discontinuity in dP_s/dT or $\Delta S/\Delta V$ at T_m , and consequently there is no

true change of phase in the condensed part of the system at this temperature.

The equations for the work function A , the entropy S , E , H , and C_V , for the saturated vapor may all be simply obtained by using the volume v_s in the corresponding equation of Chapter 13 for the imperfect gas.

14k. Phase Changes in the Condensed Phase

It is possible to see, qualitatively at least, the relationship between the methods used here and the treatment of the crystal in Chapter 11. It is also possible to ascertain the conditions under which a phase change would take place in the condensed phase.

As has been stated in section 14f, the most important contributors to the irreducible integrals of large \mathbf{k} will come from the terms in the integrand for which there are a considerable number of functions f_{ij} per molecule. As was also pointed out in Chapter 13 these integrands may be represented by diagrams of numbered circles, representing molecules, connected by lines for each function f_{ij} occurring in the product. For large \mathbf{k} values three-dimensional diagrams are more enlightening than figures in a plane.

The functions f_{ij} are zero if the argument r_{ij} is very large, and minus unity if this distance is extremely small, but they have a positive maximum at the distance r_{ij} for which the potential $u(r_{ij})$ between two molecules is a minimum. The term in the integrand, then, will have its maximum value if all the distances represented by lines in the figure (for which there are all functions f_{ij} in the term) are as nearly as possible equal to this optimum distance.

If a figure is drawn with $\mathbf{k} + 1$ circles arranged in a three-dimensional close-packed lattice with twelve nearest neighbors to each circle (except those of the surface of the figure), and twelve lines are drawn from each circle to each of its twelve equidistant neighbors, this figure corresponds to one of the terms in the integrand of the irreducible integral $\beta_{\mathbf{k}}$. This term receives its maximum contribution to the integral $\beta_{\mathbf{k}}$ from that part of the configuration space where the molecules actually are arranged in the manner of the figure, that is, in the close-packed lattice structure.

There will be approximately $\mathbf{k}!$ such terms, or figures, corresponding to one lattice, since $\mathbf{k}!$ different permutations can be performed between the molecules in the lattice. This cancels the $\mathbf{k}!$ in the denominator of the definition, equation (13. 25), of $\beta_{\mathbf{k}}$.

There will also, of course, be many other terms in the integrand of $\beta_{\mathbf{k}}$, and among them others which correspond to perfectly regular arrangements of the molecules in other lattice types with differing numbers of neighbors per molecule.

However, not only the terms in which there is one f_{ij} , and a line in the figure, for every pair of neighboring molecules in the crystal should be said to belong to one crystal type, but others as well. For instance, there will be $\frac{1}{2}nk$ -fold as many terms with just one line missing as there are with all the neighbors connected by lines, if n is the number of neighbors to every molecule in the crystal. There will also be approximately $\frac{1}{2}(\frac{1}{2}nk)$ ($\frac{1}{2}nk - 1$)-fold as many terms with two lines missing, and roughly $(\frac{1}{2}nk) ! / (\frac{1}{2}nk - m) ! m !$ -fold as many terms with m lines missing, at least for comparatively small values of m compared to $\frac{1}{2}nk$. These terms also will contribute to the integral $\beta_{\mathbf{k}}$ chiefly from that part of the configuration space corresponding to the regular arrangement of the molecules in the particular lattice type to which the term with no lines missing corresponds.

As well as the terms which differ from the prototype for the lattice type by the absence of certain lines or functions f_{ij} , there will be terms which differ by having an excess of functions connecting molecules which are next to neighbors. In spite of the confusion as to exactly how many missing lines there may be, or how many lines too many, before the term is no longer said to belong to a certain lattice type, it will be possible to assign the terms which are the most important at low temperatures in the integrand of $\beta_{\mathbf{k}}$ to different lattice types.

The integral over all the terms corresponding to the lattice type ν will contribute the additive quantity

$$f_{\nu}(\mathbf{k}, T) \beta_{0\nu}^{\mathbf{k}}$$

to the irreducible integral $\beta_{\mathbf{k}}$, so that one may write

$$\beta_{\mathbf{k}} = \sum_{\nu} f_{\nu}(\mathbf{k}, T) \beta_{0\nu}^{\mathbf{k}},$$

where the summation is to be carried out over all lattice types ν .

As before, the total number of terms is comparatively small, and for the logarithm of $\beta_{\mathbf{k}}$ one may use the logarithm of the largest term in the sum, that which may be designated by the subscript ν max.

The limit of the \mathbf{k} th root of $\beta_{\mathbf{k}}$ is β_0 , whose logarithm is the limit of \mathbf{k}^{-1} times the logarithm of $\beta_{\mathbf{k}}$ as \mathbf{k} approaches infinity. One then finds that

$$\beta_0 = \beta_{0\nu \text{ max}}.$$

In general, one may expect transition temperatures such that below a certain temperature one crystal type contributes most to the integral, whereas above this temperature another type gives the maximum term. The derivative of the logarithm of β_0 with respect to temperature will be

discontinuous at this temperature, and from (48) it is seen that dP_s/dT will also be discontinuous at the transition temperature.

Among the various terms β_0 , there must be some which do not correspond to any crystal type, but which have fewer functions f_{ij} per molecule, and which correspond to the liquid. One of these terms appears always to be the maximum term at sufficiently high temperatures; the transition temperature at which it exceeds in value that of the optimum crystalline type is the fusion temperature.

The various terms for the different crystalline lattices would offer no insurmountable difficulties to numerical evaluation. The integrand of the sum of all terms corresponding to one lattice type, or better, the logarithm of the sum, could be expanded as a power series in normal coordinates giving deviations from the position for which the integrand is a maximum, the stable configuration of that crystal type. The method is then closely analogous to that of Chapter 11. Unfortunately it is not clear as yet how this procedure could be applied to the terms corresponding to the liquid phase.

141. The Cell Method of Calculating Liquid Partition Functions

The method which, at the present time, appears to come closest to giving reasonable numerical values for the thermodynamic functions of liquids is entirely different from that discussed so far in this chapter and is not one which could be described as altogether satisfactory. It may be called the cell method. Briefly, it consists of estimating the contribution of an average molecule to the complete configuration integral of the system, (10. 51). The configuration integral divided by $N!$ will be approximately the N th power of the contribution from one molecule.

In a liquid, the average molecule is presumably pretty well hemmed in by its neighbors and constrained to move in a space, or a cell, the volume of which is one- N th the volume of the complete system. This cell in which the molecule can move is surrounded by other molecules, so that the potential energy of the one molecule considered will be a function of its position in the cell. Instead of writing this potential energy explicitly as a function of the positions of the neighbors, we may attempt to average by assuming some equilibrium or average position of the molecules surrounding the cell.

For instance, the simplest assumption which could be made is that the surrounding molecules were located at the centers of the lattice points of a close-packed cubic lattice, one lattice point of which is the center of the cell in question. With some such assumption regarding the positions of the neighbors it is then possible to calculate the potential energy,

$u(x,y,z)$, of the one molecule in its cell as a function of the displacements, x, y, z , of the molecule from the center of the cell.

Before going into further detail concerning the exact nature of the potential function $u(x,y,z)$ the possibilities of its use may be investigated. The configuration integral \mathbf{Q}_r of the system is given by (10. 51) as

$$(14. 49) \quad \mathbf{Q}_r = \iiint \cdots \int e^{-U/kT} d\tau_1 \cdots d\tau_i \cdots d\tau_N,$$

in which U is the potential energy of the whole system, and the integration is to be extended over the volume elements of the N molecules. As before, the discussion will be limited to monatomic molecules, for which $d\tau_i = dx_i dy_i dz_i$.

By defining the cell integral,

$$(14. 50) \quad \mathbf{q}_r = \iiint e^{-u(x,y,z)/kT} dx dy dz,$$

over the volume $v = V/N$ of one cell, one may attempt to write

$$(14. 51) \quad \frac{\mathbf{Q}_r}{N!} = \mathbf{q}_r^N,$$

since $N!$ permutations of the N molecules among the N cells lead to configurations with one molecule per cell.

The validity of this method will be estimated by investigating the results obtained in two cases for which a control is possible, namely the perfect gas and the regular monatomic crystal.

The comparison is readily made for a perfect gas. The potential $u(x,y,z)$ is zero, and the integral \mathbf{q}_r is just v , the volume of the cell, which is the volume per molecule in the gas. The cell method, equation (51), yields, then

$$(14. 51') \quad \ln \frac{\mathbf{Q}_r}{N!} = N \ln v, \quad (u \equiv 0).$$

In contrast, direct integration of the general equation (49) with $U = 0$ leads to

$$(14. 49') \quad \ln \frac{\mathbf{Q}_r}{N!} = N \ln V - \ln N! = N(\ln v + 1), \quad (U \equiv 0).$$

The difference of N between equations (49') and (51') is due to the neglect, in calculating (51'), of the possibility that more than one molecule could occupy a cell, leaving other cells empty. This difference in

the two equations leads to a difference of R per mole in the calculated absolute entropy, a term which Eyring calls the communal entropy.

One may be inclined to believe that for the perfect gas a model assuming the molecules to be limited to a distribution of one per cell would be particularly bad; however, the cell method leads to an error of only R per mole in the absolute entropy.

The application of this cell method to a crystal leads to equations equivalent to the Einstein equations for the thermodynamic functions. One assumes that the potential energy $u(x, y, z)$ of the molecule in the cell, as a function of the displacements x, y, z from the center of the cell, can be developed as a power series in these displacements. The constant term may be set equal to zero, corresponding to the choice of zero for the minimum potential of the system. If the cell is symmetrically surrounded by neighbors the linear terms must have zero coefficients. For a regular (cubic) crystal the coefficients of the quadratic cross-product terms, xy , are zero, and the three remaining quadratic coefficients are equal. One may write

$$(14. 52) \quad u(x, y, z) = \frac{a}{2} (x^2 + y^2 + z^2)$$

plus terms of higher order. If this is used in (50) for q_r , one finds

$$(14. 53) \quad q_r = \iiint_{-\infty}^{+\infty} e^{-(a/2kT)(x^2+y^2+z^2)} dx dy dz \\ = \left(\frac{2\pi kT}{a} \right)^{3/2},$$

since, for large enough values of a , the integration may be extended without error from minus to plus infinity, instead of only to the boundaries of the cell.

Using (53) in (51), and the resulting equation in (10. 50') for the complete phase integral Q of the system, one obtains

$$(14. 54) \quad Q = \left[\left(\frac{2\pi mkT}{h^2} \right) \left(\frac{2\pi kT}{a} \right) \right]^{3N/2} \\ = \left[2\pi \sqrt{\frac{m}{a}} \left(\frac{kT}{h} \right) \right]^{3N}$$

The frequency ν for the three isotropic vibrations of the molecule in

the cell of potential given by (52) is

$$(14. 55) \quad \nu = \frac{1}{2\pi} \sqrt{\frac{a}{m}},$$

so that (54) may be written

$$(14. 54') \quad Q = \left(\frac{kT}{h\nu}\right)^{3N}$$

By comparison with (11. 7) it is seen that this is the classical partition function for a crystal having $3N$ identical frequencies.

It is worthy of remark that if the communal entropy, R per mole, is added to this, which means the addition of N to the value of $\ln Q$, one finds

$$(14. 54'') \quad \ln Q = 3N \ln \frac{kT}{h\nu} + N,$$

and for $A = -kT \ln Q$,

$$(14. 56) \quad A = 3NkT \left[\ln \frac{h\nu}{kT} - \frac{1}{3} \right].$$

By comparison with (11. 42) this is seen to be the classical expression for the Debye crystal! In short, adding the communal entropy to the value obtained by the use of the cell method with equation (51) leads to an equation in agreement with that obtained from the Debye method.

The agreement, however, is somewhat illusory, since the frequency of equation (56) with which one molecule would vibrate in its cell if the surrounding molecules were fixed in position is *not* that of the maximum Debye frequency with which the molecules vibrate against each other. The error introduced by using (54') for the partition function of a crystal depends considerably on the type of forces between the molecules of the lattice, since these determine the ratio of the frequency (55) to the maximum Debye frequency of the crystal. One may, however, be in considerable doubt whether, in using this cell method, one would do better to add the communal entropy by adding N to the value of $\ln Q$, given by equation (51) even for a crystal, or to omit it, and use (51) directly.*

The equation equivalent to (51) which one would use for $Q_r/N!$ if the system is such that the communal entropy is to be added is, then,

$$(14. 57) \quad \frac{Q_r}{N!} = (eq_r)^N.$$

* O. K. Rice, *J. Chem. Phys.*, **7**, 883 (1939).

This equation, (57), and not (51), gives the correct value of the configuration integral Q_r for a perfect gas.

Eyring* has assumed that the communal entropy should be omitted and equation (51) used in calculations for a crystal, but that this entropy term should be added by the use of (57) in making calculations for a liquid. The communal entropy of R per mole enters, then, at fusion, and, according to Eyring, accounts for a considerable part of the entropy of melting. This viewpoint has been attacked,† and apparently with considerable justification.

In addition to the doubt concerning the so-called communal entropy there remains a considerable awkwardness in the interpretation of the potential $u(x,y,z)$ to be used in equation (50) for q_r . The total potential energy U of the system is the sum of the mutual potentials u_{ij} of the $\frac{1}{2}N(N-1)$ pairs, i and j , of molecules. If the sum of all the potential pairs between the molecule in the cell and its neighbors is used for calculating $u(x,y,z)$, then the sum of these cell potentials over all cells gives *twice* the total potential energy U of the system, since the potential of each pair is counted twice. In determining the potential u_0 of the center of the cell it is therefore necessary to halve the sum of the potential pairs of the molecule at this position with all its surrounding neighbors.

If, on the other hand, one desires to calculate $u(x,y,z)$ in such a way that the correct total potential is given by $(N-1)u_0 + u(x,y,z)$ when all but one molecule occupies its cell center, and the one is displaced to x, y, z , then the *total* increase in all mutual potential pairs connected to the displaced molecule must be counted into $u(x,y,z)$. Thus the force constant a of equation (52) should be calculated from the sum of all potential pairs between all other molecules and the one of the cell, if the frequency ν of equation (55) is to be the actual frequency with which one molecule would vibrate in its cell if the neighbors were held at fixed positions.

The cell potential is then calculated in the somewhat arbitrary way of counting only *one-half* of the sum of all mutual potential pairs to the cell molecule in order to calculate the value of u_0 at the center of the cell, but adding the *total* change in these potential pairs when $u(x,y,z) - u_0$ is determined. Even with this convention there remain various possible assumptions which may be made concerning the positions of the molecules surrounding the cell. Surroundings like those of one molecule in any of various types of crystals may be used. Probably the simplest assumption is that the molecules surrounding the cell are

* H. Eyring and J. Hirschfelder, *J. Phys. Chem.*, **41**, 249 (1937).

† O. K. Rice, *J. Chem. Phys.*, **5**, 492 (1937), **7**, 883 (1939), J. G. Kirkwood, *J. Chem. Phys.*, **7**, 908 (1939).

at the lattice points of a close-packed lattice, of which one point is the center of the cell in question.

One may, then, proceed to a higher approximation. The probability, $P(x,y,z) dx dy dz$, that the molecule of any cell occupy a volume element between x and $x + dx$, y and $y + dy$, z and $z + dz$, away from the center of the cell, is proportional to $e^{-u(x,y,z)/kT} dx dy dz$. This is used to calculate the probabilities that the surrounding molecules of a cell should be displaced from their "lattice points." A new potential, $u_2(x,y,z)$, may then be calculated by multiplying the potential obtained from each position of the neighbors by the probability of their occupying that position, and integrating over all positions. This method would become very tedious if no approximations were introduced, but appears to be practical if not carried out too conscientiously.

In applying this cell method of calculation, no real distinction is made between a crystal and a liquid, except by the arbitrary and dubious difference of the use of (51) for a crystal and (57) for a liquid, the difference of adding the communal entropy if the system is known to be liquid. It can scarcely be said that it offers a "theory" of the liquid. It does, however, enable very approximate calculations to be made of the thermodynamic functions of a condensed phase at the temperature and pressure for which the liquid is stable.

It is possible, of course, to assume some reasonable analytical form for q_r , equation (50), involving arbitrary parameters, and to choose these parameters* in such a way as to fit the experimental properties of the liquid with a considerable degree of accuracy. The accuracy of the fit will depend on the happiness of the choice of the analytical form of q_r and on the number of arbitrary parameters adjusted. Since many normal liquids can be made to coincide in properties by adjusting the volume and temperature scale (section 12d), one could presumably obtain a moderately good equation involving only two adjustable parameters, a volume and an energy constant.

The form of the cell potential $u(x,y,z)$ is a function of the volume of the system, since the volume of the system determines the distance of the cell neighbors from the center of the cell. Lennard-Jones† has shown that this form is such as to lead to an equation for the pressure resembling the van der Waals curve. The critical temperature is found to be given moderately satisfactorily by this method, but the critical volume somewhat less well.

Guggenheim,‡ who apparently first introduced the cell method of

* J. F. Kincaid and Henry Eyring, *J. Phys. Chem.*, **43**, 37 (1939).

† J. E. Lennard-Jones and A. F. Devonshire, *Proc. Roy. Soc., London*, **A163**, 53 (1937).

‡ E. A. Guggenheim, *Proc. Roy. Soc., London*, **A135**, 181 (1932).

calculation, has applied it to the comparison between solutions and a pure one-component system, as has also Kirkwood.* This application of the method is certainly more justifiable than an attempt to compare the liquid with other phases of the same composition.

One may make this general statement about the status of theories concerning the liquid at the present time. In section 11j it was pointed out that certain conditions on the elastic constants had to be fulfilled if a crystal were to remain rigid, that is if it were to be stable as a crystal. This enables us to bound the $P-T$ region for which any particular lattice structure is stable. In the equations of this chapter it is shown that the gas is stable only for volumes great enough that a certain sum converges, that is, for volumes greater than $v_s = \beta_0$, equation (36).

There exists, in general, a region of temperature and pressure for which neither gas nor crystal is stable. For this region one may assume a crystal-like distribution of some type and calculate by the cell method approximate values of the thermodynamic functions. One should find, in general, that the free energy of the assumed distribution is lower than that of a gas for these temperatures and pressures. A detailed investigation should also show that the elastic constants of this assumed distribution would not have the positive values necessary to give the phase the rigidity of a solid.

In so far as the calculations for the assumed distribution are accurate, the free energy so calculated is an upper limit, since the true distribution must always have a lower free energy than any other. However, in the usual calculations the free energy of the assumed distribution is artificially forced to be lower than that of the crystal by the addition of the communal entropy.

The calculations made in this way do not offer any evidence that the assumed distribution mimics, in any important respect, the actual distribution of the liquid. Until some general consistent method is developed by which a systematic investigation of the partition function Q for all distributions can be undertaken, and that distribution for which the integral is a maximum determined, it cannot be said that a truly adequate theory of the liquid exists.

The method of calculation used in the preceding sections of this and the previous chapter makes exactly such a systematic development of distributions for the gas. The distribution, in this case, is defined by the numbers m_l of clusters of l molecules each which are close together, in excess of the random distribution. By taking all possible values of m_l all conceivable distributions are counted, and the sum of the integrals over all distributions is the integral of the whole configuration space.

* J. G. Kirkwood, *Chem. Rev.*, **19**, 275 (1936).

The distribution for which the integral is a maximum, the equilibrium distribution, is then determined.

The distribution for which the system exists in the condensed phase is included; it is that distribution for which a very large fraction of all the molecules are in one cluster. The integral for this distribution, however, is too complicated to be evaluated directly. A further subdivision of the terms making up this integral into more finely defined distributions must be made. As yet no clear-cut definition of parameters, the values of which could be used to describe the distribution in a liquid, has been formulated. This represents at least one of the obstacles which must be surmounted in order to obtain a true theory of the liquid phase.

CHAPTER 15

ELECTRIC AND MAGNETIC FIELDS

- (a) Introduction. (b) Rigid Dipoles in an Electric Field. (c) The Dielectric Constant. (d) Electronic Polarization. (e) Comparison with Refractive Index and Experimental Data. (f) Non-Rigid Molecules. (g) The Lorentz-Lorenz Force. (h) Para- and Diamagnetism. (i) Paramagnetism in Quantum Mechanics. (j) Ferromagnetism. (k) Magnetic Cooling. (l) Thermodynamic Equations in Electric Fields. (m) The Calculation of F in a Field.

15a. Introduction

In all problems considered up to now the only variables of the system, besides the numbers of molecules or of atoms, were two in number, and could be chosen as E and V . Instead of the extensive properties E and V it was sometimes found convenient to express the thermodynamic functions of the system in terms of certain intensive variables with properties analogous to those of forces, the temperature and pressure.

In general, a system may be influenced by various other forces corresponding to extensive properties other than energy and volume. For instance, a rigid crystalline solid may be subjected to various tensions which result in an alteration of its shape, without necessarily involving a change in volume (section 11j). The amount of force applied is related to the displacement in these cases by one of the several elastic constants of the body.

In this chapter we shall be concerned with the effect of electric and magnetic forces applied to the systems by means of external electric or magnetic fields. The calculations will at first be made in the simplest possible manner. In later sections the more general method of development by which more complicated problems might be treated will be indicated.

15b. Rigid Dipoles in an Electric Field

A system composed of independent molecules possessing rigid permanent dipoles, and subjected to an electric field \mathcal{E} , will be treated.

The electric field, of dimensions force divided by charge, which is the same as charge divided by length squared, gives the magnitude and direction of the electric force exerted on unit charge. \mathcal{E} is therefore a vector quantity, but since only relatively simple problems will be dealt with, in which the field direction is kept constant, and in isotropic

media for which the effects are independent of the direction of the field, the equations used will involve only the magnitude of the field, which will be written \mathcal{E} .

The force acting, per unit charge, on the charged part of a molecule in a dense medium is not, in general, the same as the external applied field \mathcal{E} . In this section we limit ourselves to a dilute gas, where the difference of the local field \mathcal{E}_{loc} and the external field \mathcal{E} is negligible. The correction for this effect will be discussed under section 15g.

The dipole moment of a molecule is defined as a vector pointing from the center of negative charge to that of positive charge. The magnitude, p_0 , of the dipole moment has the dimensions charge times length. In atoms, which consist of a positive nucleus and a spherically symmetrical distribution of electrons, the centers of the positive and negative charges are located at the same place. The dipole moment is zero. This is not true of non-symmetrical molecules. The total amount of negative and positive charge in a neutral molecule must, of course, be equal, namely, ze , where z signifies the number of electrons, and e the magnitude of electronic charge. If the distance between the centers of positive and negative charge is called l , the magnitude of the dipole moment, p_0 , is defined as the product lze .

The electric field tends to orient the dipoles in space. The potential energy of the molecule in the field does not depend on the position of the center of mass, but only on the angle of orientation. If θ is the angle between the axis of the molecule and the direction of the field, so chosen that when $\theta = 0$ the positive end of the molecule is directed toward the negative plate producing the field, then the potential energy of the molecule in the field \mathcal{E} will be

$$(15. 1) \quad u(\theta) = -lze\mathcal{E} \cos \theta = -p_0\mathcal{E} \cos \theta.$$

The magnitude of the dipole moment p_0 in a real molecule will depend somewhat, but in most diatomic molecules, at least, not greatly, on the amplitude of vibration or on the quantum state of vibration. This effect will be neglected at present.

In the absence of a field the probability that any axis of the molecule lies in a certain solid angle range $d\Omega$ with respect to fixed coordinates in space is just proportional to the solid angle range $d\Omega$. The solid angle range $d\Omega$ corresponding to values of θ between θ and $\theta + d\theta$ is proportional to $\sin \theta d\theta$. The angle θ may vary between 0 and π . The integral of $\sin \theta d\theta$ from 0 to π is 2,

$$\int_0^\pi \sin \theta d\theta = 2,$$

so that, if $w(\theta) d\theta$ is used for the probability that the angle θ lies between θ and $\theta + d\theta$, one may write

$$(15. 2) \quad w(\theta) d\theta = \frac{1}{2} \sin \theta d\theta \quad (\text{zero field}).$$

The probability $w(\theta) d\theta$ of the orientation will be altered in the presence of the field by the dependence of the energy of the molecule on the angle θ , equation (1). In section 6e, it was found that the average density of molecules in the element dq of the configuration space is proportional to $e^{-u(q)/kT} dq$, where $u(q)$ is the potential energy as a function of the position q in the coordinate space. The probability $w(\theta)$ that a molecule will have the orientation θ is then proportional to the configuration volume corresponding to that angle, equation (2), times the exponential, $e^{-u(\theta)/kT}$. In this, $u(\theta)$, the part of the potential energy which depends on θ and θ alone, is given by (1). Since $w(\theta) d\theta$ must be unity when integrated over all angles θ from 0 to π , the equation has to be normalized by division with this integral.

One may, therefore, write, in the field \mathcal{E} ,

$$(15. 3) \quad w(\theta) d\theta = \frac{\frac{1}{2} \sin \theta e^{-u(\theta)/kT} d\theta}{\int_0^\pi \frac{1}{2} \sin \theta e^{-u(\theta)/kT} d\theta},$$

Expression (3) gives the classical probability that the angle θ between the dipole moment \mathbf{p}_0 and the field \mathcal{E} lies between θ and $\theta + d\theta$, if $u(\theta)$ is given by (1), independently of the complications of the molecular structure, provided only that the dipole is rigid, i.e., not stretched or altered in magnitude by the field.

The integral in the denominator of (3) may be evaluated exactly, using (1) and $\cos \theta = \zeta$, $\sin \theta d\theta = -d\zeta$

$$\begin{aligned} \int_0^\pi e^{\mathbf{p}_0 \mathcal{E} \cos \theta / kT} \frac{1}{2} \sin \theta d\theta &= \frac{1}{2} \int_{-1}^1 e^{\mathbf{p}_0 \mathcal{E} \zeta / kT} d\zeta = \frac{1}{2} \frac{kT}{\mathbf{p}_0 \mathcal{E}} \left[e^{\mathbf{p}_0 \mathcal{E} / kT} - e^{-\mathbf{p}_0 \mathcal{E} / kT} \right] \\ &= \frac{kT}{\mathbf{p}_0 \mathcal{E}} \sinh \left(\frac{\mathbf{p}_0 \mathcal{E}}{kT} \right). \end{aligned}$$

Expanding $e^x = 1 + x + \frac{1}{2}x^2 + \dots$, the result may be written

$$(15. 4) \quad \int_0^\pi e^{-u(\theta)/kT} \frac{1}{2} \sin \theta d\theta = \frac{kT}{\mathbf{p}_0 \mathcal{E}} \sinh \left(\frac{\mathbf{p}_0 \mathcal{E}}{kT} \right) \\ = 1 + \frac{1}{6} \left(\frac{\mathbf{p}_0 \mathcal{E}}{kT} \right)^2 + \dots$$

The average projection of the dipole moment along the field (posi-

tive end of the dipole toward the negative of the plates producing the field) will be

$$(15. 5) \quad \bar{p} = \int_0^{\pi} p_0 \cos \theta w(\theta) d\theta.$$

One must integrate, using again $\cos \theta = \zeta$,

$$\begin{aligned} \frac{p_0}{2} \int_{-1}^1 \zeta e^{p_0 \zeta / kT} d\zeta &= \frac{p_0}{2} \frac{kT}{p_0 \varepsilon} \left[e^{p_0 \varepsilon / kT} + e^{-p_0 \varepsilon / kT} \right] \\ &\quad - \frac{p_0}{2} \left(\frac{kT}{p_0 \varepsilon} \right)^2 \left[e^{p_0 \varepsilon / kT} - e^{-p_0 \varepsilon / kT} \right] \\ &\cong \frac{p_0}{3} \left(\frac{p_0 \varepsilon}{kT} \right) \left[1 + \frac{1}{10} \left(\frac{p_0 \varepsilon}{kT} \right)^2 + \dots \right]. \end{aligned}$$

Dividing this by (4), one finds

$$(15. 6) \quad \bar{p} = p_0 \frac{e^{p_0 \varepsilon / kT} + e^{-p_0 \varepsilon / kT}}{e^{p_0 \varepsilon / kT} - e^{-p_0 \varepsilon / kT}} - p_0 \frac{kT}{p_0 \varepsilon} = p_0 \left[\coth \left(\frac{p_0 \varepsilon}{kT} \right) - \frac{kT}{p_0 \varepsilon} \right] \\ \cong \frac{1}{3} \frac{p_0^2}{kT} \varepsilon \left[1 - \frac{1}{15} \left(\frac{p_0 \varepsilon}{kT} \right)^2 + \dots \right].$$

The function of equation (6), $\coth x - x^{-1}$, called the Langevin function, $L(x)$, is plotted in Fig 15. 3, page 347, curve for $j = \infty$. It increases monotonously with x from zero at $x = 0$, to unity as x approaches infinity. From the expansion it is seen that $L(x) = x/3$, if $x \ll 1$. For increasing argument the slope of $L(x)$ decreases, approaching zero as $x = \infty$, $L(x) = 1$. It is seen that \bar{p} behaves qualitatively as one would expect. For small fields \bar{p} is proportional to the field ε ; as $x = p_0 \varepsilon / kT$ increases, the ratio of \bar{p} / ε decreases, until, for large values of x , that is, high fields or very low temperatures, \bar{p} becomes independent of ε , $\bar{p} = p_0$. The system has then reached saturation; \bar{p} has reached its maximum value, and all the dipoles are oriented in the direction of the field.

For all practical cases with electrical fields the approximate result

$$(15. 6') \quad \bar{p} = \frac{1}{3} \frac{p_0^2}{kT} \varepsilon$$

is of sufficient accuracy, since the quantity $p_0 \varepsilon / kT$ is very small compared to unity. The exact equation (6) will be referred to later in dealing with magnetic effects.

15c. The Dielectric Constant

In the previous section it has been found that the application of an electric field of magnitude \mathcal{E} to a dilute gas composed of molecules having a permanent rigid dipole moment \mathbf{p}_0 results in a net average orientation of the dipoles in the direction of the field. The average projection \bar{p} of the dipole moment on the field is given by equation (6').

The product of the average oriented dipole moment \bar{p} per molecule, by the total number of molecules, is a quantity of the dimensions of charge times distance. The "polarization" \mathbf{P} of the gas is the value of this quantity divided by the volume, the total (oriented) net dipole moment, in the direction of the field, per unit volume,

$$(15. 7) \quad \mathbf{P} = \frac{N}{V} \bar{p}.$$

The dielectric constant ϵ of the gas may be defined in various ways. One of the definitions is

$$(15. 8) \quad \frac{\epsilon - 1}{4\pi} = \frac{\mathbf{P}}{\mathcal{E}}.$$

Using (6') in (7) and (7) in (8) one finds

$$(15. 9) \quad \epsilon - 1 = 4\pi \frac{\mathbf{P}}{\mathcal{E}} = \frac{4\pi}{3} \frac{N}{V} \frac{\mathbf{p}_0^2}{kT}.$$

Qualitatively the result of equation (9) is easily interpreted. A medium of high dielectric placed between the plates of a condenser increases the capacity. The increase in capacity is caused by an induced polarization in the material, bringing the negatively charged ends of the molecules toward the positive plate, which partially neutralizes the field, requiring a greater applied charge to produce the same voltage difference between the plates. The amount of net orientation of the molecules is proportional to their dipole moments, \mathbf{p}_0 , and to the field \mathcal{E} , and inversely proportional to the temperature which tends to keep their orientation random. The amount of polarization produced is proportional to the density and to the product of the dipole moment by the degree of orientation, therefore to the square of the moment \mathbf{p}_0 .

15d. Electronic Polarization

Monatomic molecules and symmetric di- or polyatomic molecules, like He, Ne, H₂, N₂, CH₄, and CCl₄, possess no permanent dipole moment \mathbf{p}_0 . Their gases do, however, have dielectric constants ϵ differing from unity, although usually smaller than those of gases composed of non-symmetrical molecules like HCl, CH₃Cl, and CO.

The value of $\epsilon - 1$ in gases of symmetrical molecules is due to the fact that the electric field induces a dipole moment in the molecule. This may be regarded as being caused by the equal and opposite forces of the field acting on the negatively and positively charged parts of the molecule, tending to separate their centers which are coincident in the absence of the field.

This effect is primarily electronic, namely, due to the displacement of the electron clouds around the nuclei in the electric field.

The displacement, and therefore the polarization, are proportional to the field. The proportionality constant α is called the polarizability of the molecule

$$(15. 10) \quad \mathbf{p}_i = \alpha \mathcal{E},$$

where \mathbf{p}_i is the induced dipole moment along the field. In molecules with permanent dipoles, this effect is superimposed upon that of orientation discussed in section 15b.

Actually α is not a simple number. If the molecule is not spherically symmetrical the value of α will depend on the direction of the field with respect to the various axes of the molecule. In addition, if the field is not acting parallel to a symmetry axis of the molecule, it may produce perpendicular components of polarization. These components at right angles to the field always average to zero in a gas, although they are of importance in a non-isotropic crystal.

The observed average induced dipole moment in the gas will always be in the direction of the electric field, and will be given by equation (10), where α is the value of the polarization, averaged over all orientations of the molecule with respect to the field.

If the molecule possesses a permanent dipole moment certain orientations are preferred if a field is applied. This has some, but little, influence on the interpretation of α as the average over all orientations.

The general equation for the total average projection of the dipole moment along the direction of the field will then be, instead of (6'),

$$(15. 11) \quad \bar{p} = \left(\alpha + \frac{1}{3} \frac{p_0^2}{kT} \right) \mathcal{E},$$

where α is always positive and non zero, but p_0 is zero for symmetrical molecules.

Using (11) in (7) and (8), one obtains, instead of (9),

$$(15. 12) \quad \epsilon - 1 = 4\pi \frac{P}{\mathcal{E}} = 4\pi \frac{N}{V} \left[\alpha + \frac{1}{3} \frac{p_0^2}{kT} \right].$$

This equation is known as the Debye equation for the dielectric

constant. It is found to give the temperature dependence of ϵ excellently for most simple gases. Experimentally, $\epsilon - 1$ is proportional to the density at low densities. In section 15g this equation will be further improved as regards its density dependence.

15e. Comparison with Refractive Index and Experimental Data

The dielectric constant ϵ depends on the frequency ν of the field used, if alternating fields are applied. Equation (12) was derived only for static or low-frequency fields. Connected with ϵ is the index of refraction $n(\nu)$ of light of frequency ν .

The index of refraction $n(\nu)$ is determined by the refraction of a beam of light crossing from vacuum through a sharp boundary into the medium in question. It is defined as the ratio of the sines of the angles of the incident and refracted beams.

Neglecting the truly insignificant difference between the magnetic permeability and unity, one may identify the dielectric constant ϵ with the square of the index of refraction for the same frequency

$$(15. 13) \quad \epsilon(\nu) = [n(\nu)]^2.$$

At the frequency of visible light the term in (12) due to the orientation of the permanent dipole moment, \mathbf{p}_0^2/kT , contributes nothing to the index of refraction. This may be made plausible by the observation that the frequency (10^{14}) of visible light is far higher than the frequency (10^{10}) of rotation of most molecules. The molecules have not time to orient themselves before the direction of the electric field due to the light has changed sign. They cannot follow a field of high frequency.

The polarizability α in (12) may then be obtained by either of two methods. It is the intercept on the ordinate $1/T = 0$, $T = \infty$, of a plot of $V(\epsilon - 1)/4\pi N$ against the reciprocal temperature. It may also be determined by an extrapolation to $\nu = 0$ of the index of refraction from the values for various frequencies in the visible region.

One of the standard examples for the interpretation of the experimental data, and of the information which is to be obtained from them, is the series of compounds, CH_4 , CH_3Cl , CH_2Cl_2 , CHCl_3 , and CCl_4 . Fig. 15. 1 shows Sanger's* observations of the dielectric constants of these gases as functions of temperature at constant density.

It is seen that the curves for CH_4 and CCl_4 are both horizontal, showing zero permanent dipole moments. The molecules must, consequently, be symmetrical, and either a tetrahedral or plane square arrangement of the Cl and H atoms about the carbon is demanded. The polarizability of CCl_4 is seen to be about three times that of CH_4 ,

* R. Sanger, *Physik. Z.*, **27**, 556 (1926).

owing to the far greater polarizability of the chlorine atoms than those of the carbon and hydrogen. The value of $\epsilon - 1 = 0.00096$ for CH_4 found here is fairly close to the value 0.00086 found for $n^2 - 1$ by

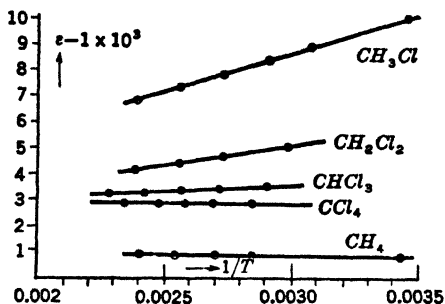

FIG. 15. 1.

Dielectric Constants* at one Atmosphere of
 CH_4 , CH_2Cl , CH_2Cl_2 , CHCl_3 , CCl_4 .

* From the data of R. Sanger, *Physik Z.*, **27**, 556 (1926); the figure is from Van Vleck, "The Theory of Electric and Magnetic Susceptibilities," Oxford University Press.

the atomic nuclei by the field, and is discussed in the next section.

The appreciable slope of the lines for the other chlorides in Fig. 15. 1 indicates that they have permanent dipole moments. The values of p_0 calculated from the slopes are

$$1.86 \times 10^{-18} \text{ e.s.u. for } \text{CH}_3\text{Cl},$$

$$1.59 \times 10^{-18} \text{ e.s.u. for } \text{CH}_2\text{Cl}_2,$$

and

$$0.95 \times 10^{-18} \text{ e.s.u. for } \text{CHCl}_3.$$

The dipole moment of a molecule containing several rigidly connected dipoles is the vector sum of their several moments. By making the unwarranted assumption that the dipoles along the C-H bonds are zero, the value of p_0 for CH_3Cl gives directly the moment of the C-Cl bond. By assuming this dipole moment for the bond to be constant, one may use the laws of vector addition to obtain the angle between the C-Cl bonds in CH_2Cl_2 and CHCl_3 .

For CH_2Cl_2 the angle ϕ between the two C-Cl bonds is found by setting $\frac{1}{2} \times 1.59/1.86 = \cos \frac{1}{2}\phi$, which leads to $\phi = 128^\circ$. For CHCl_3 the angle ψ between the CH bond and any one of the C-Cl bonds (assuming a distorted tetrahedral model so that all three angles are equal) is obtained by $\frac{1}{3} \times 0.95/1.86 = \sin(\psi - 90^\circ)$, $\psi = 96^\circ$. Considerable refinements are required before such calculations of angles

extrapolation from the measured index of refraction in the visible region. The discrepancy is presumably due to the contributions of the infra-red vibration bands to the index of refraction $n(0)$ which is not obtained by extrapolating measurements made with visible light.

This addition to n^2 at $\nu = 0$ from the infra-red vibrational bands is usually much smaller in diatomic molecules than in those of methane. It is the part of the polarizability α due to the displacement of

are to be taken too seriously. However, the measurement of dipole moments readily permits one to ascertain whether a molecule is symmetrical, and almost always distinguishes clearly between cis and trans isomers.

The numerical values of the dipole moments themselves are not without interest. Using the value of the elementary charge $e = 4.8 \times 10^{-10}$ e.s.u., one sees that the dipole moment, 1.86×10^{-18} e.s.u. of CH_3Cl , corresponds to a positive and negative elementary charge separated by $1.86/4.8 = 0.4\text{\AA}$. This is a comparatively large dipole moment. That of HCl is only 1.03×10^{-18} e.s.u., and that of HI only 0.38×10^{-18} e.s.u.

For HI , for example, band spectral data show the separation of the hydrogen and iodine nuclei to be 1.41\AA . The separation of two elementary charges corresponding to the dipole moment is only 0.08\AA .

15f. Non-Rigid Molecules

In section 15d it was stated that the polarizability α was primarily an electronic effect. This statement is not always strictly true. The qualitative distinction between electronic and atomic polarization may be described as follows.

An increase in the distance between the two atoms of a symmetrical diatomic molecule, such as H_2 or N_2 , will not in general produce a dipole moment. The induced polarization caused by the electric field may be described as being due to the displacement of the negative electrons with respect to the nuclei. However, a change in the distance of separation of the two nuclei in a molecule like HBr will, in general, result in a change of dipole moment.*

Inversely, the force of the field will tend to change the distance between the atomic centers, and the induced polarization in the field will be partly due to a change in the internal vibrational coordinates of the molecule.

A related, but at first thought apparently different, effect will arise from the change of the dipole moment with temperature due to increased vibration.

These two effects will be investigated here. Strictly, in dealing with displacements of the vibrational coordinates, a quantum-mechanical treatment should be used. The qualitative aspects, however, are given sufficiently well by classical considerations, which will be employed.

Let the symbol q stand for a value of the set of the $3n - 5$ or $3n - 6$ (linear or non-linear molecules) vibrational coordinates (Chapter 8)

* It is to be observed that an increase in the distance between nuclear centers by no means necessarily increases the dipole moment. The reverse may conceivably take place.

and dq for a volume element in the configurational space of these coordinates.

The potential energy of the molecule may be written $u(q)$. For normal coordinates and sufficiently small displacements, $q = q_1, q_2 \cdots q_i$, $u(q) = \sum_{\lambda} \frac{1}{2} a_{\lambda} q_{\lambda}^2$ and $dq = A dq_1 dq_2 \cdots dq_i$.

The dipole of the molecule will be a vector whose direction and length depend on q . Let the length be given by $\mathbf{p}(q)$. The angle between the dipole for any q and the direction of the field will be written θ . The average dipole moment projection along the field may be written at once as

$$(15. 14) \quad \bar{p} = \frac{\int_q \int_0^{\pi} \mathbf{p}(q) \cos \theta \sin \theta e^{-[u(q) - \mathbf{p}(q)\varepsilon \cos \theta]/kT} dq d\theta}{\int_q \int_0^{\pi} \frac{1}{2} \sin \theta e^{-[u(q) - \mathbf{p}(q)\varepsilon \cos \theta]/kT} dq d\theta}.$$

No numerical integration can be made until the form for the potential $u(q)$ and the dipole moment $\mathbf{p}(q)$ is known. However, in the absence of a field the average square of the dipole moment $\mathbf{p}^2(T)$ which is a function of temperature is

$$(15. 15) \quad \mathbf{p}^2(T) = \frac{\int [\mathbf{p}(q)]^2 e^{-u(q)/kT} dq}{\int e^{-u(q)/kT} dq}.$$

The integral in the denominator of (14) is the same as that in the denominator of (15) to within terms of order T^{-2} . This may be seen by developing $e^{[\mathbf{p}(q)\varepsilon \cos \theta]/kT}$ as $1 + [\mathbf{p}(q)\varepsilon \cos \theta]/kT + \cdots$. The integral $\int_0^{\pi} \frac{1}{2} \sin \theta d\theta = 1$, so the integral of the unity in the development

is the same as the denominator of (15). Since $\int_0^{\pi} \frac{1}{2} \cos \theta \sin \theta d\theta = 0$, the second term of the development contributes nothing.

The integral in the numerator of (14) is $\varepsilon/3kT$ times that in the numerator of (15). This is found by again developing

$$e^{p(q)\varepsilon \cos \theta/kT} = 1 + p(q)\varepsilon \cos \theta/kT.$$

The integral of the first term vanishes because $\int_0^{\pi} \cos \theta \sin \theta d\theta = 0$.

The integral of the second term, over θ , is $\int_0^{\pi} \frac{1}{2} \cos^2 \theta \sin \theta d\theta = \frac{1}{3}$. The

integral over q is then that of the numerator of (15) times $\varepsilon/3kT$.

One finds, therefore, that the average projection \bar{p} of the dipole moment along the field is

$$(15. 16) \quad \bar{p} = \frac{1}{3} \frac{\overline{p^2(T)}}{kT} \varepsilon,$$

where $\overline{p^2(T)}$ is the average square of the dipole moment, averaged over all internal configurations.

The two effects mentioned at the beginning of the section — the change of dipole moment with temperature, and the increase in dipole moment due to the force of the field — are seen to be both taken into account by using the average square (not the square of the average) dipole moment in equation (12). In this case the remaining term, the polarizability α , is to be interpreted as the purely electronic polarizability.

However, for normal molecules it will be shown that the average square dipole moment as a function of temperature is given by

$$(15. 17) \quad \overline{p^2(T)} = p_0^2 + 3kT\alpha_m,$$

where p_0^2 , the temperature-independent term, is the dipole moment squared at the position of minimum potential energy.

As in section 8c it will be assumed that $u(q)$, the potential energy as a function of q , may be developed, with sufficient accuracy, as a sum of squares of the normal coordinates,

$$(15. 18) \quad u(q) = \sum_{\lambda} \frac{1}{2} a_{\lambda} q_{\lambda}^2.$$

The magnitude of the dipole moment, $p(q)$, will vary linearly with q_{λ} (at least for small displacements), so that

$$(15. 19) \quad \begin{aligned} p^2(q) &= (p_0 + \sum_{\lambda} b_{\lambda} q_{\lambda})^2 \\ &= p_0^2 + 2p_0 \sum_{\lambda} b_{\lambda} q_{\lambda} + \sum_{\lambda} \sum_{\kappa} b_{\lambda} b_{\kappa} q_{\lambda} q_{\kappa}. \end{aligned}$$

Using (19) and (18) in (15), the first term in (19) leads to exactly p_0^2 after integration. The second term in (19), linear in q_{λ} , leads to a zero integral in (15), as do also the cross products with $\lambda \neq \kappa$ in the third term. The remaining parts of (19) lead to a term in (15) proportional to temperature. This is seen by using the variables $\zeta_{\lambda} = (a_{\lambda}/2kT)^{1/2} q_{\lambda}$. The integral of the denominator of (15) is $\prod_{\lambda} (2\pi kT/a_{\lambda})^{1/2}$, and that of the numerator of this part

$\prod_{\lambda} (2\pi kT/a_{\lambda})^{1/2} \times \sum_{\lambda} (3kTc_{\lambda})$ where

$$(15. 20) \quad c_{\lambda} = \frac{b_{\lambda}^2}{3a_{\lambda}}.$$

By writing

$$(15. 21) \quad \alpha_m = \sum_{\lambda} c_{\lambda}$$

equation (17) is obtained.

It is seen that as long as the temperature is low enough to use the approximate quadratic terms in the normal coordinates for the potential energy one finds, using the classical equations, that the average square of the dipole moment is that of the square of the dipole moment at the lowest potential configuration plus a term linear in T . Using (17) in (16) one obtains again the form (11) for \bar{p} or (12) for the dielectric constant.

In a molecule such as $\text{CH}_2\text{Cl}-\text{CH}_2\text{Cl}$ there exists a normal coordinate which measures the angle of the equal and opposite rotation of the two CH_2Cl groups around the C-C bond. The potential energy up to about kT at room temperature will *not* be given well by a purely quadratic term in this displacement. The vibration of this coordinate will deviate considerably from harmonic behavior. Only in cases such as this will one expect a more complicated dependence of ϵ on T in gases than that given by (12).

However, the term α_m in (21) is in one respect experimentally distinguishable from the atomic polarization term. The term α_m is due to the displacements of the heavy nuclei by the electric field, and these will not "follow" an alternating field of much higher frequency than the natural vibrational frequencies of the molecule. The extrapolation to zero frequency of index of refraction measurements made with visible light, which are unaffected by the term α_m , will consequently lead to values for the electronic polarization and will not include the part α_m in the temperature-independent part of (12).* This has already been mentioned, in the last section in the discussion of methane.

15g. The Lorentz-Lorenz Force

The electric field \mathcal{E} within a gas or any other material having a dielectric constant ϵ not unity is different from the value of the field outside of the material. In a vacuum between two condenser plates the elec-

* The term α_m is connected with the intensity of the infra-red vibrational bands of the molecule. The reader interested in the relations between the various properties of the molecules and the theory of molecular structure is referred to the book of J. H. Van Vleck, *The Theory of Electric and Magnetic Susceptibilities*, Oxford, at the Clarendon Press, 1932.

tric displacement \mathfrak{D} and the electric field \mathcal{E} are identical. If the charge on the condenser plates is kept constant the displacement \mathfrak{D} is unchanged by the introduction of the material between the plates, provided that the plates are large compared to the distance between them. The field \mathcal{E} , however, is reduced within the (isotropic) material to the value $\mathcal{E} = \mathfrak{D}/\epsilon$.

This reduction in the field \mathcal{E} is due to the polarization of the material, the induced charge brought to the surface of the material tending to cancel the effect of the charges on the condenser plates. The average electric force on an infinitesimal charge δe , averaged over all positions in the material, would be given by $\delta e\mathcal{E}$.

However, the electric force acting on the charged parts of a single molecule is different from \mathcal{E} . This is due to the fact that the average field of the molecule itself must be subtracted in making such a calculation.

The local field $\mathcal{E}_{\text{loc.}}$ acting on one molecule is therefore not \mathcal{E} but differs from it by a term which may be calculated* from the average polarization density \mathbf{P} in the material. This additional force is known as the Lorentz-Lorenz force. Its magnitude depends on the distribution in space of the molecules.

If the molecules are randomly distributed, the local field acting on a molecule, $\mathcal{E}_{\text{loc.}}$, is given by the Clausius-Mossotti formula,

$$(15. 22) \quad \mathcal{E}_{\text{loc.}} = \mathcal{E} + \frac{4\pi}{3} \mathbf{P},$$

which will not be derived here.†

By using (22) for $\mathcal{E}_{\text{loc.}}$ instead of \mathcal{E} in equation (11), and this in (7) and (8), one finds

$$(15. 23) \quad \begin{aligned} \mathbf{P} &= \frac{N}{V} \left[\alpha + \frac{1}{3} \frac{\mathbf{p}_0^2}{kT} \right] \left[\mathcal{E} + \frac{4\pi}{3} \mathbf{P} \right], \\ \frac{4\pi}{\mathcal{E}} \frac{\mathbf{P}}{\mathcal{E}} &= \frac{4\pi \frac{N}{V} \left[\alpha + \frac{1}{3} \frac{\mathbf{p}_0^2}{kT} \right]}{1 - \frac{4\pi}{3} \frac{N}{V} \left[\alpha + \frac{1}{3} \frac{\mathbf{p}_0^2}{kT} \right]} = \epsilon - 1, \\ \frac{\epsilon - 1}{\epsilon + 2} &= \frac{4\pi}{3} \frac{N}{V} \left[\alpha + \frac{1}{3} \frac{\mathbf{p}_0^2}{kT} \right]. \end{aligned}$$

* See, for instance, the discussion in the first chapter of *The Theory of Electric and Magnetic Susceptibilities*, J. H. Van Vleck, Oxford, at the Clarendon Press, 1932.

† The derivation is given in H. A. Lorentz, *The Theory of Electrons*, section 117 and note 54.

The quantity $(V/N)(\epsilon - 1)/(\epsilon + 2)$ is found to be independent of density up to very high pressures in gases. For instance, Magri* finds, in measurements on air, that it remains constant within the experimental error of about 0.4 per cent up to 180 times normal density, whereas $(V/N)(\epsilon - 1)$ increases by 4 per cent in this range.

In fact, for non-polar molecules, $p_0 = 0$, the quantity $(V/N)(\epsilon - 1)/(\epsilon + 2)$ is constant to within about 10 per cent in going from the vapor to the liquid phase. This is an extremely severe test, since the method of derivation is scarcely applicable to liquids.

15h. Para- and Diamagnetism

The equations for para- and diamagnetic materials in magnetic fields are analogous to those for molecules with and without permanent dipole in electric fields.

Assume every molecule in the gas to have the same permanent magnetic moment μ_r . In the magnetic field \mathcal{H} the potential energy is

$$(15. 24) \quad u(\theta) = -\mu_0 \mathcal{H} \cos \theta,$$

analogously to (1), where θ is the angle between the magnetic moment and the direction of the field. The subsequent calculations of section 15b are exactly valid, and one finds, for the average component of the magnetic moment $\bar{\mu}$ in the direction of the field,

$$(15. 25) \quad \bar{\mu} = \mu_0 \left[\coth \left(\frac{\mu_0 \mathcal{H}}{kT} \right) - \frac{kT}{\mu_0 \mathcal{H}} \right] \approx \frac{1}{3} \frac{\mu_0^2}{kT} \mathcal{H}.$$

The magnetic polarization (per unit volume) \mathbf{M} is

$$(15. 26) \quad \mathbf{M} = \frac{N}{V} \bar{\mu},$$

and magnetic susceptibility χ may be defined as

$$(15. 27) \quad \chi = \frac{\mathbf{M}}{\mathcal{H}} \approx \frac{1}{3} \frac{N}{V} \frac{\mu_0^2}{kT},$$

in analogy with (9). This equation holds for paramagnetic substances. The fact that the paramagnetic susceptibility is inversely proportional to temperature is called Curie's law.

Just as in section 15d we discussed the fact that the electric field induces a dipole in molecules, so molecules possessing no permanent magnetic moment acquire an induced moment in the presence of a magnetic field. However, this induced magnetic moment is always in the opposite direction to the field, that is, it opposes the field.

* L. Magri, *Physik. Z.*, **6**, 629 (1905).

The equation obtained is then analogous to (12) except that the temperature-independent term occurs with the negative sign in the magnetic case.

That the impressed magnetic moment opposes the field is a consequence of electrodynamics. The current induced in a closed electric circuit by the imposition of a magnetic field is such as to create a moment opposite to the field.

There is one other distinct difference between the influence of electric and magnetic fields. In equation (12) the two terms, α and $\mu_0^2/3kT$, are both of the same order of magnitude. The paramagnetic susceptibility (orientation effect) given by (27), if it is present at all, that is, if μ_0 is not zero, is some hundred- to several thousandfold larger than the effect of the induced magnetic moment, called the diamagnetic susceptibility. As a result one usually neglects the diamagnetic effect in dealing with paramagnetic substances, and uses equation (27) without the negligible diamagnetic term.

It is not the province of this book to treat the relation between the diamagnetic constant and the structure of the molecule. However, it may be mentioned that for free atoms the diamagnetic susceptibility is related to the average square of the distance of the electrons from the nucleus, which we shall write $\overline{r^2}$.

The equation

$$(15. 28) \quad \chi = - \frac{N}{V} \frac{e^2}{6mc^2} \sum_i \overline{r_i^2}$$

gives the diamagnetic susceptibility, χ , in which e and m are respectively the charge and mass of the electron and c the velocity of light. The sum $\sum_i \overline{r_i^2}$ is that over all electrons i of their average squared distances, r_i^2 , from the nucleus.

The method employed in this section is a hybrid of classical and quantum mechanics. The assumption has been made that every molecule (of the same kind) in the gas has the same magnetic moment μ_0 . Actually, if an attempt were made to explain the magnetic moment by the motion of electrons under the influence of the electric field of the nuclei, the application of classical statistics leads to a variety of magnetic moments each weighted with a certain probability dependent on T . Van Leeuwin* has shown that a purely classical system of electric point charges should exhibit zero magnetic susceptibility. The reason, however, is intimately connected with the complete inability of classical

* J. H. van Leeuwin, Dissertation, Leiden, 1919, or *J. de physique* (6), 2, 361, 1921.

mechanics to account for the properties of atoms if they are each composed of one point mass nucleus and of electrons.

Whereas in the electric example only the approximation to equation (25) is experimentally significant, magnetic susceptibilities in cases to which these equations apply can be measured at extremely low temperatures, and the complete equation (25) can be checked experimentally (section 15i). Although the approximation for low values of $\mathcal{H}\mu_0/kT$ is the same for classical and quantum-mechanical systems, the complete equation differs slightly for the two methods of calculation.

We shall consequently, in the next section, make a somewhat more logical development, taking cognizance of the quantum-mechanical nature of the phenomenon.

15i. Paramagnetism in Quantum Mechanics

A complete discussion of magnetic phenomena involves comparatively complicated considerations of the applications of quantum mechanics to atomic and molecular structure, which are not treated in this book. Even after making the limitation to independent atoms and ions, there remain a considerable number of different cases which must be considered separately.

For instance, the behavior of the atoms will depend on whether only one electronic level is excited at the temperature considered, or whether the "multiplet separation" of the energy levels is small compared to kT . The effect of weak and of strong fields must also be distinguished. For a complete description of the phenomena encountered the reader is again referred to Van Vleck's *Theory of Electric and Magnetic Susceptibilities*.

The discussion in this section will be limited to the example that the energy of separation of the lowest and first excited electronic levels in the atom or ion is large compared to both the energy of interaction with the magnetic field and to kT . Furthermore, diamagnetic effects will be neglected. In addition it will be assumed that all the ions or atoms considered are monatomic, and that the directions of their magnetic moments are independent of one another.

This last condition does not, however, limit the applicability of the equations derived to gases. The reason for this is that the electrostatic and exchange repulsion forces which operate between most ions and their environment in water solution or in ionic crystals do not, as a rule, concern primarily the electronic spin responsible for paramagnetism. The orientation of the magnetic moment in the ion does not affect its interaction with neighboring particles. The effect of the magnetic field on the ions may therefore be treated as if the ions were completely

independent of their surroundings, that is, as if they composed a monatomic perfect gas.

The equations derived by this method are found to apply excellently to relatively concentrated water solutions of paramagnetic ions. They also fit well the observations made on many crystals, provided only that the distance between the magnetically active ions is not too small. This is realized in practice by using crystals containing considerable water of hydration.

Ions having the completed octet electronic structure, a lowest 1S_0 state, are diamagnetic. Paramagnetism is observed only in ions of the transition elements and the rare earths. These ions have lowest electronic levels possessing an angular momentum ($j \neq 0$).

Since exactly these ions have also several low electronic levels, the limitation to cases in which the lowest excited level has a high energy compared to kT is not an unimportant restriction.

The magnetic moments of isolated atoms or ions are dependent on their angular momenta. The connection between these two quantities is not utterly simple but may be calculated correctly with the help of the so-called vector model treated below.

The angular momentum of the ion in a given electronic level is due to the rotation of the electrons. This rotation has two different components. One of these is called the orbital angular momentum and is due to the motion of the center of mass of the electrons about the nucleus. The second one is due to the spin of the electrons about their own axes.

The amount of orbital angular momentum of the atom is determined by a quantum number l in such a way that the square of the orbital angular momentum is $(h/2\pi)^2 l(l+1)$. The angular momentum squared due to spin is $(h/2\pi)^2 s(s+1)$, where s is the total spin quantum number (Russel Saunders coupling, see section 6i). The total angular momentum squared is

$$\left(\frac{h}{2\pi}\right)^2 j(j+1),$$

where j is the quantum number of total angular momentum. The projection of the total angular momentum on a fixed axis in space may take values $m h/2\pi$, where $j \geq m \geq -j$, so that m takes $2j+1$ values.

The magnetic moment μ_j is likewise determined by the rotation of the electrons.

The symbol β will be introduced for the Bohr magneton, $\beta = hc/4\pi mc$, where e and m are the charge and mass of the electron and c the velocity of light. The contribution to the magnetic moment due to orbital angular momentum is just $\sqrt{l(l+1)}\beta$, but the moment is directed along the axis of the orbital angular momentum.

The contribution to the magnetic moment due to spin is $2\sqrt{s(s+1)}\beta$, along the spin axis. The difference in the case of orbit and spin may be crudely and

very naively described as being due to the fact that in the orbits the mass and charge of the electron move together; in spin the charge, located on the surface of the electron, rotates with a greater average radius than the mass, which is distributed throughout the particle.

The square of the magnetic moment of the atom or ion may be calculated as follows:

We consider the two orbital and spin vectors of magnitude $\sqrt{l(l+1)}$ and $\sqrt{s(s+1)}$ adding vectorially to make the total angular momentum $\sqrt{j(j+1)}$, Fig. 15. 2. The orbital magnetic moment, $\sqrt{l(l+1)}\beta$, and the spin moment, $2\sqrt{s(s+1)}\beta$, are vectors of the same direction as the respective angular momenta but different relative lengths. The two vectors, orbital and spin, precess rapidly about the total angular momentum vector. The magnetic moment square is found by squaring the projection μ_0 of the vector sum of $\sqrt{l(l+1)}\beta$ and $2\sqrt{s(s+1)}\beta$ on the total angular momentum vector.

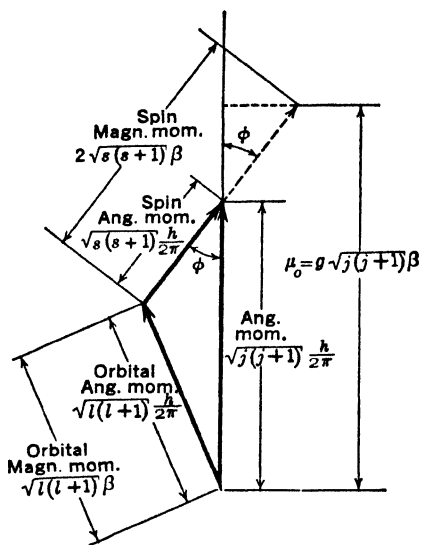

FIG. 15. 2.

Vector derivation of Landé g -factor.

The problem is one of simple trigonometry. The cosine of the angle ϕ in the figure is given by

$$\cos \phi = \frac{s(s+1) + j(j+1) - l(l+1)}{2\sqrt{j(j+1)}\sqrt{s(s+1)}}$$

From the figure it is seen that if $\mu_0 = \sqrt{j(j+1)}g\beta$ the factor g is

$$(15. 29) \quad g = 1 + \frac{\sqrt{s(s+1)}}{\sqrt{j(j+1)}} \cos \phi,$$

$$g = 1 + \frac{s(s+1) + j(j+1) - l(l+1)}{2j(j+1)}.$$

The square of the magnetic moment, μ_0^2 , of an atom or ion in an electronic level with given quantum number j of angular momentum, is

$$(15. 30) \quad \mu_0^2 = j(j+1)g^2\beta^2,$$

where β signifies the Bohr magneton,

$$(15. 31) \quad \beta = \frac{eh}{4\pi mc} = 0.9273 \times 10^{-20} \text{ e.m.u.}$$

The Landé g -factor in (30) is given by (29) in terms of the quantum numbers j , l , and s for Russel Saunders coupling.

The level, of given j , is degenerate and consists of $2j + 1$ states, differing in the value of m , the quantum number determining the projection of the angular momentum on the direction of the field. The projection μ_m of the magnetic moment along the axis of the field is

$$(15. 32) \quad \mu_m = mg\beta, \quad (j \geq m \geq -j)$$

for the state m , and the energy due to the magnetic field has the form

$$(15. 33) \quad \epsilon_m = -\mu_m \mathcal{H} = -mg\beta \mathcal{H}.$$

The probability that an ion is in the state m is proportional to $e^{-\epsilon_m/kT}$, so that the average projection $\bar{\mu}$ of the magnetic moment along the field, for all ions, is

$$(15. 34) \quad \bar{\mu} = \frac{\sum_{m=-j}^{m=+j} mg\beta e^{+mg\beta \mathcal{H}/kT}}{\sum_{m=-j}^{m=+j} e^{+mg\beta \mathcal{H}/kT}}.$$

The first approximation of (34) for low values of $g\beta \mathcal{H}/kT$ is exactly the classical result (25), with (30) for μ_0^2 . This may be seen as follows.

The exponential functions in numerator and denominator of (34) are expanded in the usual manner as $e^y = 1 + y + \dots$, and all but the first non-zero term after summation is neglected in both numerator and denominator. The first term in the denominator is obtained by using unity for the exponential and is just the number of terms, $2j + 1$. The term arising from the unity of the expansion in the numerator is zero, since $\sum m$ extended over both positive and negative m values from $-j$ to $+j$, is zero. The next term does not vanish and is linear in T^{-1} . Since

$$\mathcal{H} \frac{g^2 \beta^2}{kT} \sum_{m=-j}^{m=+j} m^2 = \mathcal{H} \frac{g^2 \beta^2}{kT} \frac{(j+1)j(2j+1)}{3},$$

one obtains

$$(15. 35) \quad \bar{\mu} = \frac{1}{3} \frac{g^2 \beta^2 j(j+1)}{kT} \mathcal{H} = \frac{1}{3} \frac{\mu_0^2}{kT} \mathcal{H}$$

with (30).

Equation (34) may be brought into an explicit form without recourse

to the series development of the exponential. By writing $e^{\beta\mathcal{H}/kT} = x$ it is seen that

$$(15. 34') \quad \bar{\mu} = g\beta \frac{\sum_{m=-j}^{m=+j} mx^m}{\sum_{m=-j}^{m=+j} x^m} \\ = g\beta x \frac{d}{dx} \left(\ln \sum_{m=-j}^{m=+j} x^m \right).$$

One uses the relations

$$\sum_{m=-j}^{m=+j} x^m = x^{-j} \sum_{n=0}^{n=2j} x^n = \frac{x^{-j} - x^{j+1}}{1 - x} = \frac{x^{(j+1/2)} - x^{-(j+1/2)}}{x^{1/2} - x^{-1/2}}$$

and

$$x \frac{d}{dx} \left[\ln \frac{x^{j+1/2} - x^{-(j+1/2)}}{x^{1/2} - x^{-1/2}} \right] \\ = (j + \frac{1}{2}) \frac{x^{(j+1/2)} + x^{-(j+1/2)}}{x^{(j+1/2)} - x^{-(j+1/2)}} - \frac{1}{2} \frac{x^{1/2} + x^{-1/2}}{x^{1/2} - x^{-1/2}}$$

If now the Brillouin function $B_j(y)$ is defined as

$$(15. 36) \quad B_j(y) = \frac{j + \frac{1}{2}}{j} \coth \left[\frac{j + \frac{1}{2}}{j} y \right] - \frac{1}{2j} \coth \frac{1}{2j} y \\ = \frac{j + \frac{1}{2}}{j} \frac{e^{(j+1/2)y/j} + e^{-(j+1/2)y/j}}{e^{(j+1/2)y/j} - e^{-(j+1/2)y/j}} - \frac{1}{2j} \frac{e^{-y/2j} + e^{y/2j}}{e^{y/2j} - e^{-y/2j}},$$

it is seen that (34) becomes

$$(15. 37) \quad \bar{\mu} = jg\beta B_j \left(\frac{jg\beta\mathcal{H}}{kT} \right).$$

The imposing function (36) is plotted in Fig. 15. 3 for several j values. It has properties similar to those of the classical $L(x) = \coth x - x^{-1}$ equation (6). For $y \ll 1$ the function may be developed, and one finds

$$B_j(y) \cong \frac{1}{3} j(j+1) \frac{y}{j^2}, \quad y \ll 1,$$

which, upon substitution of $y = jg\beta\mathcal{H}/kT$ in (37), leads to equation (35).

For $y \gg 1$, $e^y \gg e^{-y}$, both hyperbolic cotangents become unity and

$$B_j(y) \cong 1, \quad y \gg 1,$$

so that, upon substitution in (37), one finds

$$(15. 38) \quad \bar{\mu} = jg\beta, \quad \frac{jg\beta 3C}{kT} \gg 1.$$

The saturation effect is reached when all the ions are pressed, by the field, into the state $m = j$, where the projections of the magnetic

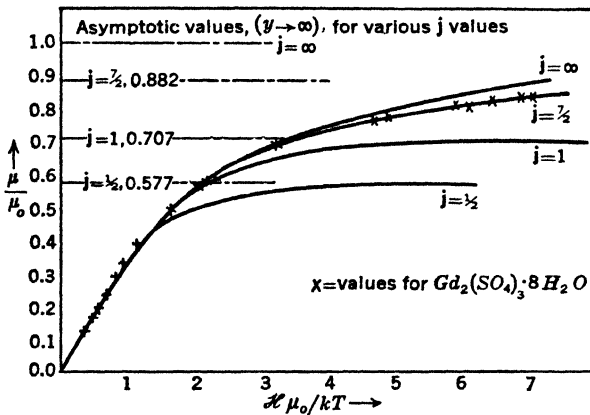

FIG. 15. 3*.

Plot of $\mu/\mu_0 = \sqrt{j/j + 1} B_j(y)$ against $H\mu_0/kT = \sqrt{(j + 1)/j} y$ for various values of j .

* This figure is from Van Vleck, "The Theory of Electric and Magnetic Susceptibilities," Oxford University Press.

moments on the direction of the field have their maximum values, $\mu_m = jg\beta$. This saturation moment, however, is *not* the square root of (30). The value of the square of the magnetic moment obtained by measurements with weak fields, using (35), leads to the $j(j + 1)$ equation (30), whereas the saturated magnetic moment obtained with a strong field is only $jg\beta$.

For large j values the difference between $j(j + 1)$ and j^2 is negligible. The Brillouin function has the property that

$$\lim_{j \rightarrow \infty} \left[B_j(y) \right] = \coth y - \frac{1}{y} = \frac{e^y + e^{-y}}{e^y - e^{-y}} - \frac{1}{y}.$$

The classical equation (25) is obtained if j becomes large, in which event the magnetic moment μ_0 is given by $jg\beta$.

Actually, at high temperatures, that is at about room temperature, saturation or even very appreciable deviations from the approximate equation (35) are not observable in the laboratory, except with ferro-

magnetic substances, discussed in the next section. The same is true of electrical polarization produced by electric fields.

However, whereas the equations derived in this chapter for the electrical polarization are strictly applicable to gases only, and, less rigorously, to dilute liquid solutions, those for magnetic fields are applicable to certain crystals. The equations derived in this section may therefore be used in comparison with experiments performed at extremely low temperatures. Since the behavior of the material depends on \mathcal{H}/kT , a lowering of the temperature corresponds to an increase in the magnetic field.

Approximate saturation has been obtained on hydrated gadolinium sulphate, $\text{Gd}_2(\text{SO}_4)_3 \cdot 8\text{H}_2\text{O}$, at 1.3°K ., in Leiden.* The gadolinium ion, Gd^{+++} , the lowest level of which is $^8S_{7/2}$, is the magnetically active ion. Since the angular momentum of this ion is entirely due to spin (S state, $l = 0$), the g factor is 2. The results agree perfectly with the prediction using $j = 7/2$, $g = 2$, $y = 7\beta\mathcal{H}/kT$ in (37). In Fig. 15. 3 the crosses indicate the experimental values on this salt.

15j. Ferromagnetism

In section 15g it was found that the electric force acting on a molecule in the material treated was not given simply by the electric field, but by the macroscopic field \mathcal{E} plus a term proportional to the polarization density \mathbf{P} . The proportionality constant was $4\pi/3$ in the Clausius-Mossotti equation (22).

If it is assumed that the forces acting on one ion contain a term due to the magnetic polarization \mathbf{M} , so that (24) or (33) has the form

$$(15. 39) \quad u(\theta) = -\mu_0(\mathcal{H} + a\mathbf{M}) \cos \theta, \quad \text{or} \quad \epsilon_{\mathbf{m}} = -\mu_{\mathbf{m}}(\mathcal{H} + a\mathbf{M}),$$

one obtains equations predicting properties similar to those of ferromagnetic substances by using a sufficiently large value of a . Without discussing the possible origin of the strong interaction term $a\mathbf{M}$ between the magnetic moments in (39) one may investigate the effect which it has upon the macroscopic behavior of the substance.

Since the classical equation (25) and the quantum-mechanical one (37) have the same qualitative features, it will be somewhat simpler, and not essentially different, to treat the classical case. The substitution of $\mathcal{H} + a\mathbf{M}$ for \mathcal{H} in (25), and multiplication of $\bar{\mu}$ by N/V to obtain \mathbf{M} , (26), leads to

$$(15. 40) \quad \mathbf{M} = \mu_0 \frac{N}{V} \left\{ \coth \left[\frac{\mu_0}{kT} (\mathcal{H} + a\mathbf{M}) \right] - \frac{kT}{\mu_0} \frac{1}{\mathcal{H} + a\mathbf{M}} \right\}.$$

* H. R. Woltjer, *Leiden Communications* 167 b.

Equation (40) determines the magnetic polarization \mathbf{M} (per unit volume) in terms of the applied magnetic field, \mathcal{H} , at any temperature. The task of analytically solving (40) for \mathbf{M} is not an easy one. The solution may, however, be undertaken readily by a graphical method.

The term in brackets on the right-hand side of (40) plotted as a function of

$$x = \frac{\mu_0}{kT} (\mathcal{H} + a\mathbf{M})$$

is the Langevin function $L(x)$ of section 15b, a monotonously increasing function, starting from zero x at $= 0$ with a slope of $\frac{1}{3}$, and approaching unity asymptotically as x goes to infinity. The quantity $\mathbf{M}V/\mu_0N$, which, according to (40), should be equal to the bracket, plotted as a function of the *same* argument x , is a straight line, namely,

$$(15. 41) \quad \frac{\mathbf{M}}{\mu_0} \frac{V}{N} = \frac{kT}{a\mu_0^2} \frac{V}{N} x - \frac{\mathcal{H}}{a\mu_0} \frac{V}{N}.$$

The slope of this line is independent of the magnetic field. With increasing field \mathcal{H} the line moves parallel to itself downward.

For given values of \mathcal{H} and T the magnetic polarization \mathbf{M} is determined by the equality of the right- and left-hand sides of (40), or, in the plot, by the intersection of the straight line (41) with the curve $\coth x - 1/x$ (see Fig. 15. 3, curve for $j = \infty$). The ordinate of the intersection point determines $\mathbf{M}V/\mu_0N$. It is seen that, with increasing field but constant temperature, both the abscissa and ordinate of the intersection point increase monotonously.

The temperature T determines the slope of (41) but not the intersection with the axis $x = 0$. For constant \mathcal{H} an increase in T increases the slope and thereby decreases the ordinate of the intersection point.

For zero magnetic field the straight line (41) goes through the origin $x = 0$, $\mathbf{M} = 0$, and intersects there the curve $L(x)$. It is then apparent that for $\mathcal{H} = 0$ two different cases may occur, dependent on the inclination of (41). If the line (41) is steeper than the slope of the curve at the origin, that is,

$$\frac{kT}{a\mu_0^2} \frac{V}{N} > \frac{1}{3}, \quad T > \frac{1}{3} \frac{a\mu_0^2}{k} \frac{N}{V}$$

this is the *only* intersection point. If this holds, as \mathcal{H} goes to zero, the magnetic polarization \mathbf{M} vanishes and for small enough values of the field \mathbf{M} is proportional to \mathcal{H} . Qualitatively the substance behaves like a paramagnetic one.

In the other case, if the slope of the line is smaller than $\frac{1}{3}$,

$$T < \frac{1}{3} \frac{a\mu_0^2 N}{k V},$$

there exists a second intersection point for $\mathcal{H} = 0$ with a non-vanishing value of \mathbf{M} . If the magnetic field is gradually reduced to zero, \mathbf{M} approaches this finite value. The substance has then a remanent magnetic moment.

The temperature T_c above which this remanent polarization disappears,

$$(15. 42) \quad T_c = \frac{1}{3} \frac{a\mu_0^2 N}{k V},$$

is called the Curie temperature.

For $T \gg T_c$, equation (40) may be developed as a power series in its argument

(15. 40')

$$\mathbf{M} = \frac{1}{3} \frac{N}{V} \frac{\mu_0^2}{kT} (\mathcal{H} + a\mathbf{M}) \left\{ 1 - \frac{1}{15} \left(\frac{\mu_0}{kT} \right)^2 (\mathcal{H} + a\mathbf{M}) + \dots \right\}.$$

Neglecting all terms but the first, the solution for \mathbf{M} leads to

$$(15. 43) \quad \mathbf{M} = \frac{\frac{1}{3} \frac{N}{V} \frac{\mu_0^2}{kT}}{\left(1 - \frac{1}{3} \frac{N}{V} \frac{a\mu_0^2}{kT} \right)} \mathcal{H} = \frac{1}{3} \frac{N}{V} \frac{\mu_0^2}{k(T - T_c)}.$$

This development breaks down as T approaches T_c .

Qualitatively, the Curie temperature corresponds to a sort of condensation temperature. The term with the constant a in equation (39) is an interaction between the atoms which reduces the energy of one of them if it orients itself in the same direction as the preponderant one of the others, which is measured by \mathbf{M} . The orientation of all the atomic magnets of the system in the same direction, even at zero magnetic field, results then in a considerable decrease in energy, but also in a decrease in the available phase space, a decrease in entropy. Above the Curie temperature T_c the temperature motion is sufficient to maintain a random orientation. If a field is applied, however, the interaction tends to aid the magnetic field, so that $T - T_c$ appears in the denominator of (43) instead of T in paramagnetic substances. As the temperature is lowered, and T_c approached from above, the interaction force becomes more and more predominant. Even a weak field, instead of

orienting only a few atoms, supplies merely the initiative. The force $a \cdot \mathbf{M}$ brings about *almost* a landslide, although, as long as T is greater than T_c , the number oriented is still proportional to the magnetic field for very weak fields.

Below T_c there exists a real landslide. The temperature motion of the atoms is not sufficient to counteract the energy decrease produced by a common preferential orientation.

The description supplied by equation (40) is essentially in agreement with the experimental observations on ferromagnetic materials. From the measured Curie temperatures of the remanent magnetic substances one may then calculate backwards the magnitude of a , the strength of the interaction. For iron, the Curie temperature is about 1000°K . The volume per atom, V/N , is $11.8 \times 10^{-24} \text{ cm}^3$. If, for μ_0 , one Bohr magneton, $\mu_0 = \beta \cong 10^{-20}$, is substituted, one obtains for the dimensionless quantity a the value 10^4 , an entirely different order of magnitude compared to the $4\pi/3$ occurring in the interaction of electric dipoles.

It might perhaps be mentioned here that not all samples of iron, which at room temperature are all below the Curie point, show permanent magnetism. This is due to the fact that the macroscopic material is composed of domains of microscopic size. Presumably, below T_c , there exist individual domains which have permanent magnetic moments, but the orientation of the moments of the individual domains is random until a slight field is applied to bring them into alignment.

In substances which are paramagnetic at room temperature, the peculiarly strong interaction of magnetic moments is missing. However, the equivalent of the Clausius-Mossotti formula, equation (22), still predicts an interaction of the type considered here with $a = 4\pi/3$. Paramagnetic substances would then have a Curie point, according to equation (42), which depends on N/V but lies, for most salts, well below 1°K . Below this temperature the substances are ferromagnetic. The experimental evidence on this point is not conclusive.

The discussion of ferromagnetism given in this section is practically the classical theory of Weiss,* which so far as it goes may be regarded as essentially correct. The chief contribution of the quantum mechanics has not been to alter the equations, except unimportantly by the substitution of the Brillouin function for (40), but to explain the occurrence of a in (39).

The nature of the strong interaction potential in ferromagnetic substances has long been a mystery. Of course, the force need not be of magnetic origin. It is entirely unessential that the energy change is written as though it depended on the magnetic moment μ_0 . Both μ_0

* P. Weiss, *J. de physique*, 6, 667 (1907).

and a are characteristics of the material, and the force tending to orient the magnetic moments of the atoms (or, rather, the spins of the electrons in the metal) may have nothing to do with magnetism. The only reason that it is connected at all with the magnetic field \mathcal{H} is that both \mathcal{H} and this force tend to accomplish the same result, a net orientation of the atoms in such a way as to tend to point all their magnetic moments in the same direction.

It remained for Heisenberg* to explain the orienting force introduced by a in (39) as due to the exchange forces between electrons. The resultant energy of one atom includes terms proportional to higher powers of \mathbf{M} than the first, which alone is considered in (39), and the complete quantum-mechanical development is not as simple as that given here.

The origin of the orienting force is intimately connected with the necessity of using antisymmetric eigenfunctions for electrons. If two electrons have parallel spins, their spin function is necessarily symmetrical. The orbital function of their positions must then be antisymmetrical.

The antisymmetrical and symmetrical orbital functions differ primarily in the fact that the probability of the electrons being spatially close together is less for the antisymmetrical function. Since the electrons repel each other, these functions, other things being equal, will have lower energy. The result is a certain force tending to line up the electron spins in the same direction so as to create the low-energy antisymmetric orbital functions.

15k. Magnetic Cooling

Low temperatures are ordinarily produced by use of the Joule-Thomson effect in gases. If the lowest-boiling gas, helium, is so liquefied, and then evaporated under reduced pressure, temperatures somewhat under 1°K . may be produced. There exists, however, a practical lower limit to the temperature which may be obtained in this manner, since the rate of evaporation, which decreases with decreasing temperature, finally becomes as low as the heat leak into the apparatus. Recourse has been taken to adiabatic demagnetization to cool even further.

The principle of the method is simple. In the absence of a magnetic field the random orientation of the angular momentum vectors of the (magnetically active) ions introduces an entropy $R \ln (2j + 1)$, per gram atom, in excess of that due to lattice vibrations. The application of a strong magnetic field, while the material is kept at constant temperature, tends to orient all the ions into the energetically lower directions, reducing the entropy. This reduction of entropy, at constant temperature, in the strong field, demands a flow of heat $q = \Delta S/T$ out of the material (calculated as if the field were applied reversibly). If the

* W. Heisenberg, *Z. Physik*, **49**, 619 (1928).

material, while under the influence of the field, is insulated, so that no heat can flow in or out, and the field removed slowly enough so that the whole process goes reversibly, no change in the total entropy of the material takes place. The material is therefore cooled, since entropy, and consequently heat, flow from the lattice vibrations to raise the orientation entropy of the magnetic moments to their original value of $R \ln (2j + 1)$.

The process is usually carried out by applying the field while the salt containing the magnetically active ions is kept in contact with liquid helium boiling at reduced pressure. The initial temperature, T_i , in the process, is then about 1°K . The entropy due to the lattice vibrations at this initial temperature is extremely low so that the method is very efficient. Temperatures as low as about 0.004°K . have been attained in this manner. Indeed, it is quite practicable at 1°K . to reduce the entropy of some salts in a magnetic field by a greater amount than the total lattice vibrational entropy at this initial temperature. The simple consideration given above would lead one to expect cooling to 0°K . in such a case, and, of course, there is obviously a flaw in the argument that leads to such a prediction.

The error made lies in the assumption that a random orientation of the magnetic moments would prevail at all temperatures in the absence of a field. If any interaction at all exists between the moments, either through a true magnetic force or owing to an interaction with the electric crystalline field, some particular specified orientation of zero entropy will be stable at 0°K . The entropy of orientation of the magnets will be greater than zero above 0°K . but will approach the high temperature value of $R \ln (2j + 1)$ only at temperatures for which kT exceeds the energy of interaction.

It is seen that the effectiveness of the magnetic cooling depends peculiarly on the substance used. If the material has a high density of ions with great magnetic moment, that is, if it has a high magnetic susceptibility, the change of entropy, ΔS , at the initial temperature T_i , with a given magnetic field, is high. In this event a relatively high initial temperature, or a relatively low magnetic field, may be used to attain a given final temperature. However, high magnetic susceptibility in the salt favors a large interaction between the magnetic moments, and if low initial temperatures and high fields are available, the final temperature reached may be appreciably lower if a salt of low magnetic susceptibility is used. For this reason salts with relatively small susceptibilities, that is, with ions not having extraordinarily high moments, and very much diluted with water of crystallization or other inert ions, are used to attain the lowest temperatures.

The interactions which cause deviations from the ideal behavior calculated here for ions with magnetic moments completely unaffected by their surroundings are of two kinds. That which has usually the higher interaction energy, and therefore becomes important at the higher temperature, is the interaction between the magnetic moment and the field of the crystal due to the surrounding (magnetically inactive) molecules or ions. This tends to favor one of the possible axes of orientation of the magnetic moment, giving it a lower energy than the others. However, the crystalline field never distinguishes between the two possible directions along this axis, that is, it always leaves 2 of the $2j + 1$ states with the same energy. As a result, if this perturbation alone were present the entropy at 0°K. would be $R \ln 2$. There remains the true magnetic interaction which tends to line up all the spins in the same direction along the axis favored by the crystal field, and which reduces the entropy at 0°K. to zero.

This magnetic interaction should presumably be calculable by using the equations of section 15j for ferromagnetism with the interaction constant a set equal to $4\pi/3$. The substance would then have a Curie temperature, T_c , given by equation (42) with $a = 4\pi/3$. There are some theoretical reasons for being skeptical of this value of a , but experimental evidence does exist indicating that some paramagnetic substances become ferromagnetic at the lowest temperatures reached.

The actual temperatures obtained are somewhat difficult to determine. One might, for instance, measure the magnetic susceptibility in a very weak magnetic field, equation (27), and attempt to use Curie's law to determine the temperature. However, marked deviations from (27) are to be expected at these low temperatures. This method, however, is used to determine a qualitative temperature scale, the T^* scale. By experiment, then, one observes that adiabatic demagnetization from the same initial temperature T_i , but from different applied fields \mathcal{H} , results in different end temperatures T^* , on this scale. In short, one can correlate the magnetic field \mathcal{H} used in the cooling with the final qualitative temperature T^* , always starting from the same initial temperature.

In order to determine the thermodynamic temperature T as a function of T^* one proceeds as follows. The entropy decrease at T_i in going from zero magnetic field to the field \mathcal{H} may be measured by the heat evolved or calculated exactly by equations given later in this section, since at this relatively high temperature, 1°K. , the perturbing influences already discussed play no role. After the adiabatic removal of the field, the amount by which the entropy is below that at T_i is then known in terms of the qualitative scale T^* . One knows, then, S as a function

of T^* , and in particular one knows $(\partial S/\partial T^*)_{V,\mathcal{H}}$ as a function of T^* , at zero field.

The next measurement is that of heat capacity, as a function of this qualitative temperature scale T^* . This is best accomplished by determining the rate of heating (on a T^* scale) as the material absorbs γ rays of known intensity. One then knows $(\partial E/\partial T^*)_{V,\mathcal{H}}$ at zero field, as a function of T^* . From the thermodynamic relationship

$$(dS)_{V,\mathcal{H}} = \frac{1}{T} (dE)_{V,\mathcal{H}},$$

one now finds the true temperature T as function of T^* by

$$T = \frac{(\partial E/\partial T^*)_{V,\mathcal{H}}}{(\partial S/\partial T^*)_{V,\mathcal{H}}}.$$

The entropy $S_{\mathcal{H}}$, at a given field, due to the orientations of the ions, may be readily calculated. It is, from equation (6. 26'),

$$(15. 44) \quad S_{\mathcal{H}} = R \frac{d}{dT} (T \ln Q_{\mathcal{H}}),$$

per gram atom of magnetically active ions, and $Q_{\mathcal{H}}$ is the sum

$$(15. 45) \quad Q_{\mathcal{H}} = \sum_{m=-j}^{m=+j} e^{m g \beta \mathcal{H} / k T}.$$

Carrying out the differentiation one finds

$$S_{\mathcal{H}} = R \left[\ln Q_{\mathcal{H}} - \frac{\sum_{m=-j}^{m=+j} \frac{m g \beta \mathcal{H}}{k T} e^{m g \beta \mathcal{H} / k T}}{\sum_{m=-j}^{m=+j} e^{m g \beta \mathcal{H} / k T}} \right].$$

The fraction is just $\mathcal{H} \bar{\mu} / k T$, as is seen by comparison with (34), which is (equation 37): $(j g \beta \mathcal{H} / k T) B_j(j g \beta \mathcal{H} / k T)$. By the same method employed to obtain (37) it is seen that

$$(15. 46) \quad \begin{aligned} \ln Q_{\mathcal{H}} &= \ln [e^{(j+1/2) g \beta \mathcal{H} / k T} - e^{-(j+1/2) g \beta \mathcal{H} / k T}] \\ &\quad - \ln [e^{g \beta \mathcal{H} / 2 k T} - e^{-g \beta \mathcal{H} / 2 k T}] \\ &= \ln \sinh \left[\frac{j + \frac{1}{2}}{j} y \right] - \ln \sinh \left[\frac{1}{2j} y \right], \end{aligned}$$

with

$$(15. 47) \quad y = \frac{j g \beta \mathcal{H}}{k T}.$$

Using this in (45), one obtains

$$(15. 48) \quad S_{\mathcal{C}} = R \left[\ln \sinh \left(\frac{j + \frac{1}{2}}{j} y \right) - \ln \sinh \left(\frac{1}{2j} y \right) - y B_j(y) \right].$$

$S_{\mathcal{C}}$ varies from $R \ln (2j + 1)$ at $y = 0$ to zero as y approaches infinity. This function then represents the dependence of the entropy on the magnetic field \mathcal{C} at constant temperature.

151. Thermodynamic Equations in Electric Fields

Throughout this chapter, up to the last section, statistical mechanics has been employed solely by the use of the Boltzmann factor $e^{-u/kT}$ to weight the various orientations of the molecules, atoms, and ions in order to ascertain the total electric and magnetic polarization. Only in the last section was a common thermodynamic function, S , calculated. This was chiefly occasioned by the fact that the thermodynamics of materials in magnetic and electric fields is not a familiar subject.

In previous chapters, the experimental properties of the systems treated might have been calculated without explicit use of the word thermodynamics, or explicit naming of the various functions which occur and are also common to the general thermodynamic treatment.

The material of this chapter might have been presented by first developing the equations for the thermodynamic properties of macroscopic systems in electric and magnetic fields and subsequently calculating the thermodynamic functions by statistical mechanics. This method will be indicated here.

In order to illustrate, rather than to prove, the thermodynamic equations for a system under the influence of an electric field, a simple plate condenser will be considered, in which all linear dimensions of the plates are large compared to their distance apart.

Two conducting parallel plates of area A each, at a distance l apart in vacuum, form a condenser of capacity

$$(15. 49) \quad C = \frac{q}{\mathcal{V}} = \frac{A}{4\pi l},$$

the ratio of the charge q on the plates, to the voltage \mathcal{V} between them, is C .

The electrical work of charging the plates gives the free energy increase as a function of q as

$$(15. 50) \quad w = \int_0^q \mathcal{V} dq' = \int_0^q \frac{4\pi l}{A} q' dq' = \frac{4\pi l}{A} \frac{q^2}{2}.$$

The electrical displacement \mathfrak{D} between the plates is

$$(15. 51) \quad \mathfrak{D} = 4\pi \frac{q}{A} = 4\pi \frac{ql}{V},$$

where in the right-hand expression the volume, $V = Al$, of the field between the plates is introduced.

The field \mathcal{E} is

$$(15. 52) \quad \mathcal{E} = \frac{\mathfrak{U}}{l},$$

which is equal to \mathfrak{D} when no material is placed between the condenser plates, that is, $\mathfrak{D} = \mathcal{E}$ in vacuum.

The work (50) may be rewritten as

$$(15. 53) \quad w = \frac{V}{4\pi} \int_0^{\mathfrak{D}} \mathcal{E} d\mathfrak{D}' = \frac{V}{8\pi} \mathfrak{D}^2.$$

Of course the final form of (53) and (50) agree if relation (51) is used.

Equation (51) for \mathfrak{D} and (52) for \mathcal{E} are both valid if a material of dielectric constant ϵ is introduced between the plates of the condenser. However, the capacity is now

$$(15. 49') \quad C = \frac{q}{\mathfrak{U}} = \frac{A\epsilon}{4\pi l},$$

so that

$$(15. 54) \quad \mathcal{E} = \frac{1}{\epsilon} \mathfrak{D}.$$

The field \mathcal{E} and displacement \mathfrak{D} are not equal in a material of dielectric constant ϵ differing from unity.

The work of charging the condenser is still $\int_0^q \mathfrak{U} dq'$, which may be written

$$(15. 53') \quad w = \frac{V}{4\pi} \int_0^{\mathfrak{D}} \mathcal{E} d\mathfrak{D}' = \frac{V}{8\pi} \frac{\mathfrak{D}^2}{\epsilon} = \frac{V}{8\pi} \mathcal{E} \mathfrak{D}.$$

If the process is carried out at constant temperature and pressure the work done on the system determines its increase in free energy, F .

One now makes the distinction that the free energy of the *field* (and its energy, since the entropy of an electric field in vacuum is zero) is still given by (53), and the difference between (53) and (53') lies in the free

energy change of the material (at constant temperature) as the field is applied. For ΔF , the change in free energy of the material, as a function of the electrical displacement \mathfrak{D} , one has

$$(15. 55) \quad \Delta F(\mathfrak{D}) = \frac{V}{8\pi} \mathfrak{D}^2 \left(\frac{1}{\epsilon} - 1 \right) = - \frac{V}{8\pi} \mathfrak{D}^2 \left(\frac{\epsilon - 1}{\epsilon} \right).$$

It was assumed, in integrating (53'), that ϵ was actually a constant. This method was employed since the equations for a condenser in terms of ϵ are more familiar than those in terms of the polarization.

One may proceed somewhat more generally. The application of the charge q to the plates induces a polarization \mathbf{P} in the material between them. The dimensions of polarization are dipole moment per unit volume, that is, charge times (vector) length in the direction normal to the plates divided by volume. \mathbf{P} has therefore the same dimensions as \mathfrak{E} or \mathfrak{D} . This polarization in the material brings an induced charge of opposite sign up to the plates, partially neutralizing the applied charge q , and the field \mathfrak{E} is reduced to

$$(15. 56) \quad \mathfrak{E} = 4\pi \left(\frac{q}{V} - \mathbf{P} \right) = \mathfrak{D} - 4\pi\mathbf{P}.$$

The use of the definition (8) of ϵ by $\epsilon - 1 = 4\pi\mathbf{P}/\mathfrak{E}$ is seen to result in (54) that $\mathfrak{E} = \mathfrak{D}/\epsilon$.

The voltage \mathfrak{U} produced on the plates is $\mathfrak{U} = \mathfrak{E}l$, so that the work of charging $\int \mathfrak{U} dq$ is, as always, given by (53) as $(V/4\pi) \int \mathfrak{E} d\mathfrak{D}$. Using (56) for \mathfrak{E} one has

$$(15. 53'') \quad w = \frac{V}{4\pi} \int_0^{\mathfrak{D}} \mathfrak{D}' d\mathfrak{D}' - V \int_0^{\mathfrak{D}} \mathbf{P} d\mathfrak{D}'.$$

The first term is the work necessary to produce the field in vacuum. The second term is the electrical work done on the material by the field. Equation (53'') assumes constant polarization \mathbf{P} and displacement \mathfrak{D} at any time in the total volume V . A more general equation would involve a double integration, that is, one over the volume in which \mathfrak{D} and \mathbf{P} are functions of position.

The equation for the change of free energy, F , of the material at constant temperature and pressure is

$$(15. 57) \quad (dF)_{T,P} = -VP(d\mathfrak{D})_{T,P}, \quad \left(\frac{\partial F}{\partial \mathfrak{D}} \right)_{T,P} = -VP.$$

It is to be noted that if a dielectric constant exists, that is, if \mathbf{P} is always proportional to ϵ , as is normally the case, $\mathbf{P} d\mathfrak{D}$ and $\mathfrak{D} d\mathbf{P}$ are equal and may be used interchangeably.

15m. The Calculation of F in a Field

If one now wishes to calculate the free energy F for a gas, the Hamiltonian or energy of each molecule must be expressed as a function of the electrical displacement \mathfrak{D} (which gives the effect of the true charges on the plates of the condenser) plus terms due to the interaction of the molecules. The interaction energy of the molecules will be different in the presence of the field than in its absence, since the field tends to orient the permanent dipoles in one direction.

If one wishes to obtain an equation equivalent to (23) in which the Lorentz-Lorenz force has been taken into account, the statistical treatment must include the interaction between the molecules, which are therefore not independent, and the method of calculation for the perfect gas may not be rigorously employed.

One may, however, use a rather illogical method which leads to almost the correct results. In this it is simply assumed that the averaging over the interaction between the molecules leads to equation (22) for the local electrical force acting on one molecule. The method is, then, logically no whit superior to that used in section 15g, indeed somewhat inferior, but will be followed here to demonstrate the use of equation (57).

It is first necessary to investigate the effect of the electric force \mathfrak{F} on the energy of the molecule due to the polarization term α . It can be shown that the energy change u_α in the molecule due to this term is

$$(15. 58) \quad u_\alpha = -\frac{1}{2}\alpha\mathfrak{F}^2.$$

This energy is made up of two terms of opposite sign: one, the electrical energy in the field, is $-\alpha\mathfrak{F}^2$; the second is the internal potential energy of the molecule, which is $+\frac{1}{2}\alpha\mathfrak{F}^2$. The electrical energy is just $-\mathbf{p}_i\mathfrak{F}$, since the induced dipole is directed along the field, and from (10) $\mathbf{p}_i = \alpha\mathfrak{F}$, so that one finds this energy to be $-\alpha\mathfrak{F}^2$. The increased internal potential energy of the molecule is due to a restoring force f tending to keep the positive and negative charges ze and $-ze$ from being displaced. The displacement l of their centers is $l = \mathbf{p}_i/ze = \alpha\mathfrak{F}/ze$ when the electrical force tending to pull them apart, which must be balanced by f , is $ze\mathfrak{F}$. Using $f = -ze\mathfrak{F}$, $dl = (\alpha/ze) d\mathfrak{F}$, and integrating

$$-\int f dl = \int_0^{\mathfrak{F}} \alpha\mathfrak{F}' d\mathfrak{F}' = \frac{1}{2}\alpha\mathfrak{F}^2,$$

one obtains the internal potential as half the negative of the electrical energy.

One may therefore write for the potential energy of the single molecule in the field \mathfrak{F} the equation

$$(15. 59) \quad u = -\mathfrak{F}p_0 \cos \theta - \frac{1}{2}\alpha\mathfrak{F}^2.$$

Equation (59) is satisfactory enough. The difficulty which arises is only what to substitute for the electrical force \mathfrak{F} .

If the electrical displacement \mathfrak{D} is substituted for \mathfrak{F} one neglects entirely the interaction between the molecules, not only that due to the Lorentz-Lorenz force making $\epsilon_{\text{loc.}}$ different from ϵ , (22), but also the surface polarization which accounts for the difference between the electrical field ϵ and the displacement \mathfrak{D} . Logically one should use \mathfrak{D} for \mathfrak{F} in (59) and add interaction terms between the dipoles of the molecules.

We shall adopt an easy way out which leads to approximately correct results.

Since from (56) $\epsilon = \mathfrak{D} - 4\pi\mathbf{P}$, and from (22) $\epsilon_{\text{loc.}} = \epsilon + 4\pi\mathbf{P}/3$, we find $\epsilon_{\text{loc.}} = \mathfrak{D} - 8\pi\mathbf{P}/3$. The correction term $-8\pi\mathbf{P}/3$ represents the averaged contribution to the electrical force acting on one molecule due to the others. This must be halved, since it is a mutual force acting between two molecules, and we may approximately account for it by assigning half the term to each molecule, writing

$$(15. 60) \quad \mathfrak{F} = \mathfrak{D} - \frac{4\pi}{3}\mathbf{P}.$$

It is now a question of straight substitution into familiar equations to arrive at the equivalent of equation (23). The potential u in (59) is a function of the angle θ alone. In calculating the classical factor of the partition function Q due to the angle for the molecule, one has, without an electric field, only the integral over the volume element $\int_0^\pi \frac{1}{2} \sin \theta \, d\theta = 1$.

One must now replace this by

$$(15. 61) \quad \int_0^\pi \frac{1}{2} \sin \theta e^{-u/kT} d\theta = Q_{\mathfrak{F}}.$$

In this $Q_{\mathfrak{F}}$ gives the factor of the partition function Q affected by the field \mathfrak{F} , and normalized in such a way that $Q_{\mathfrak{F}} = 1$ when $\mathfrak{F} = 0$.

The additional term in the free energy F due to the electric field is $-NkT \ln Q_{\mathfrak{F}}$, so that

$$(15. 62) \quad F = F_0 - NkT \ln Q_{\mathfrak{F}},$$

where F_0 is the free energy in zero field.

Substituting (59) for u into (61) for $Q_{\mathfrak{F}}$, it is seen that, except for the factor $e^{\alpha\mathfrak{F}^2/2kT}$ which does not contain θ , the integral is that already evaluated in equation (4) and

$$(15. 63) \quad Q_{\mathfrak{F}} = e^{\alpha\mathfrak{F}^2/2kT} \frac{kT}{p_0\mathfrak{F}} \sinh\left(\frac{p_0\mathfrak{F}}{kT}\right) \\ \cong e^{\alpha\mathfrak{F}^2/2kT} \left[1 + \frac{1}{6}\left(\frac{p_0\mathfrak{F}}{kT}\right)^2 + \dots\right].$$

Using this in (62),

$$(15. 64) \quad F = F_0 - N \left[\frac{\alpha}{2} + \frac{1}{6} \frac{p_0^2}{kT} \right] \mathfrak{F}^2.$$

There remains still a considerable amount of juggling to arrive at an equation for the dielectric constant. One uses (57) to find the polarization $\mathbf{P} = -(\partial F/\partial \mathfrak{D})_{T,P}/V$, with (60) for \mathfrak{F} in (64). The dielectric constant ϵ is defined by (8) as $\epsilon - 1 = 4\pi\mathbf{P}/\mathcal{E}$, which with (54) that $\mathcal{E} = \mathfrak{D}/\epsilon$ gives $\mathbf{P}/\mathfrak{D} = (\epsilon - 1)/4\pi\epsilon$. Using this in (60)

$$(15. 65) \quad \mathfrak{F} = \mathfrak{D} \left[1 - \frac{\epsilon - 1}{3\epsilon} \right] = \mathfrak{D} \frac{2\epsilon + 1}{3\epsilon}, \quad \frac{\partial \mathfrak{F}}{\partial \mathfrak{D}} = \frac{2\epsilon + 1}{3\epsilon}.$$

With (57) and (64)

$$(15. 66) \quad \mathbf{P} = -\frac{1}{V} \left(\frac{\partial F}{\partial \mathfrak{D}} \right)_{T,P} = -\frac{1}{V} \left(\frac{\partial F}{\partial \mathfrak{F}} \right)_{T,P} \frac{d\mathfrak{F}}{d\mathfrak{D}} \\ = \frac{N}{V} \left[\alpha + \frac{1}{3} \frac{p_0^2}{kT} \right] \mathfrak{D} \left(\frac{2\epsilon + 1}{3\epsilon} \right)^2$$

is obtained. Finally, noting that $(2\epsilon + 1)^2 = 3\epsilon(\epsilon + 2) + (\epsilon - 1)^2$, so that $(2\epsilon + 1)^2/9\epsilon^2 = (\epsilon + 2)/3\epsilon + (\epsilon - 1)^2/9\epsilon^2$, and neglecting $(\epsilon - 1)^2$ as a second-order correction, one arrives at (23) by using

$$(15. 23) \quad \frac{\mathbf{P}}{\mathfrak{D}} = \frac{\epsilon - 1}{4\pi\epsilon} = \frac{N}{V} \left[\alpha + \frac{1}{3} \frac{p_0^2}{kT} \right] \frac{\epsilon + 2}{3\epsilon}, \\ \frac{\epsilon - 1}{\epsilon + 2} = \frac{4\pi}{3} \frac{N}{V} \left[\alpha + \frac{1}{3} \frac{p_0^2}{kT} \right].$$

The method used in this section is rather awkward. Actually the calculation of the behavior in electric fields is one of the few examples in which the statistical method is applied most easily without following an essentially thermodynamic method. Of course the development in

section 15g is also by no means rigorous, and as far as the authors are aware there exists no strict statistical method by which equation (23) has been derived.

A careful and completely satisfactory method would use the electrical displacement \mathfrak{D} for \mathfrak{F} in (59), and, with the equations for a system of dependent particles, insert the interaction between the electric dipoles as an additional term in the Hamiltonian.

CHAPTER 16

DEGENERATE GASES

(a) Introduction. (b) Definition of Black-Body Radiation. (c) The Quantum States of Radiation. (d) The Planck Black-Body Distribution Law. (e) The Thermodynamic Functions of the Radiation Field. (f) The Degenerate Fermi-Dirac Gas at Zero Temperature. (g) The Integrals Occurring in the Equations for the Fermi-Dirac Gas. (h) The Thermodynamic Functions of a Degenerate Fermi-Dirac Gas. (i) Electrons in Metals. (j) The Richardson Effect. (k) Approximate Calculation of the Heat and Electrical Conductivity of Metals. (l) The Maxwell-Boltzmann Collision Equation and Its Application to Electrons in Metals. (m) Electrical and Heat Conductivity and the Thermoelectric Effect. (n) Liquid Helium II. (o) The Degenerate Bose-Einstein Gas.

16a. Introduction

In Chapters 5 and 6 the quantum-mechanical distribution function, equations (5. 12) and (5. 13), for the number of molecules per quantum cell

$$(16. 1) \quad \frac{N_j}{C_j} = \frac{1}{e^{\alpha + \epsilon_j/kT} \mp 1},$$

was derived. In this relation N_j denotes the number of particles which, at equilibrium, are found in a region j consisting of C_j cells, or quantum states of *one* particle, the energies of which lie between ϵ_j and $\epsilon_j + \Delta_j\epsilon$. The parameter α is determined by the condition that the total number N of particles in the system is fixed, that is, that $\sum_j N_j$, summed over all regions j , must be equal to N .

Equation (1) is applicable to all systems composed of mechanically independent particles. The minus sign in (1) is to be used if the particles have symmetric eigenfunctions, in which case they are said to obey Bose-Einstein statistics. The plus sign must be used if the particles have antisymmetric eigenfunctions, in which case they are said to obey Fermi-Dirac statistics. Which case prevails for a given kind of particle was discussed in section 2k.

In the treatment of perfect gases, Chapters 5 to 9, the distribution function (1) was always modified by omission of the unity in the denominator. The difference for the two kinds of systems then disappears,

and classical or Boltzmann statistics is obtained. This approximation can certainly be made if e^α is large, or $N_j/C_j \ll 1$, for all regions j . The parameter α was determined for monatomic gases by setting $\sum_j N_j = N$, with neglect of the unity in the denominator. The result,

$$(16. 2) \quad e^\alpha = g \left(\frac{2\pi mkT}{h^2} \right)^{3/2} \frac{V}{N} = 0.026g \frac{M^{3/2} T^{5/2}}{P_{\text{Atm.}}},$$

was found to justify, *a posteriori*, the neglect introduced. In (2), m is the mass per atom, M the atomic weight, and g the multiplicity of the ground level in one atom. Even for helium at one atmosphere and at its boiling point, $T = 4.2^\circ\text{K}$., $e^\alpha = 7.5$. Great molecular weight, low density, and high temperature all favor large values of α . For all ordinary chemical gases the assumption of large values of e^α is well justified.

There exist, however, three familiar systems which may, with varying degrees of accuracy, be treated as perfect gases, but for which e^α is not large. These are the cases of radiation, of electrons in metals, and of liquid helium at very low temperature. For these three systems the unity in the denominator of (1) may not be neglected and the full quantum-mechanical formula must be used. Systems for which this is the case are called degenerate (entartet).

The radiation contained in an enclosed space surrounded by walls of a fixed temperature T is referred to as black-body radiation. The photons which compose this radiation are strictly independent of one another in the mechanical sense. They therefore make up a truly perfect gas. However, the equivalent of mass, $m = h\nu/c^2$, is small, and the density, or number of particles per unit volume, at ordinary temperatures, is large. The number of photons per cell is considerable, and the deviations from classical behavior are very appreciable.

The treatment of this system differs from that of an ordinary perfect gas in two respects. The total number of photons in a given volume at equilibrium is not constant, but a function of temperature alone. The number of cells C_j depends on the energy differently in a photon gas than it does for molecules of finite rest mass.

The calculations will be made in sections 16b, c, d, and e. Photons obey the Bose-Einstein statistics, and the minus sign must be used in equation (1). Since this gas is the only truly perfect gas at all densities in which interactions between the particles are actually zero, the equations derived are exact. The treatment leads to the Planck black-body distribution law for the energy density as a function of frequency.

Drude, in 1900, suggested that the electrical conduction and the very

high heat conductivity of metals might be explained by assuming them to contain a "gas" of free electrons. The theory was partially successful but failed chiefly in that the observed heat capacity of metals did not include the classically expected $3k/2$ per electron.

In 1928 Sommerfeld* and his coworkers of the theoretical seminar published a series of papers in which it was shown that, if account was taken of the fact that the electrons of the gas must obey the Fermi-Dirac statistics, the observed phenomena could be accounted for satisfactorily. Owing to their small masses, and the comparatively high densities of particles in the crystalline metal, the deviations from classical behavior are marked.

The attempt to treat the electrons as independent, and moving within the metal as if in a field-free box, is, of course, highly approximate. Unlike the application to radiation, the equations derived by this method have only approximate validity for electrons in metals.

Liquid helium at low pressures does not freeze as the absolute zero of temperature is approached. Instead, there occurs a transition to a second liquid phase, called liquid helium II, which displays very curious properties. London† has shown that this strange behavior is at least partly due to deviation from classical statistics. Helium atoms form a Bose-Einstein system, and at the temperature in question, below 2°K ., and at the high density of the liquid, the neglect of the minus one in equation (1) would certainly be unjustified.

London attempts to approximate the properties of the liquid by treating part of the atoms like electrons in a metal; these atoms are assumed to behave like the independent atoms of a gas constrained to remain in the volume of the liquid.

In this chapter the equations for radiation and for Fermi-Dirac and Bose-Einstein gases at low temperatures will be developed. The relation between the properties of the two types of gases and those of electrons in metals and liquid helium, respectively, will be discussed.

16b. Definition of Black-Body Radiation

It is an everyday experience that a solid body, if heated, emits light, the intensity and color of which change with temperature. At any one temperature, the intensity and spectral distribution of the emitted radiation is a characteristic of the body, which could be determined theoretically only by a detailed investigation of the process of light emission. Statistical calculations, however, permit one to deduce the

* A. Sommerfeld, *Z. Physik*, **47**, 1 (1928), and in the same volume, W. V. Houston, page 33; Carl Eckart, page 38; A. Sommerfeld, page 43.

† F. London, *J. Phys. Chem.*, **43**, 49 (1939).

energy density at different frequencies of the radiation which is in equilibrium with the body.

The application of the second law of thermodynamics to radiation processes enables one to derive the fact that a body capable of emitting light of a certain frequency must also be capable of absorbing it, and furthermore that the radiation with which the body is in equilibrium, which is described by the intensity of radiation of different frequencies, is a function of the temperature only, and independent of the body in question. This will be demonstrated here.

We wish to introduce the device of a box with perfectly reflecting walls, that is, with walls which neither emit nor absorb radiation. Light contained in this box is then effectively insulated from the outside; if the box is otherwise empty neither intensity nor frequency distribution changes with time. In this box two different objects, a and b , are placed, and the temperature of both is maintained at the same value T . Between the objects, dividing the box into two unconnected parts, a screen is introduced, which has the property of perfectly reflecting light of all frequencies except one, ν , for which it is transparent. Although this is certainly an idealizing assumption, in practice screens could be found which approximate the qualities stipulated here to a certain degree.

If either one of the objects a or b were *alone* in the box it would emit and absorb radiation until it comes to equilibrium, that is, until the intensity of light surrounding it becomes so high that it absorbs as much light of each frequency as it emits. Let us assume that the density of light of frequency ν in equilibrium with the bodies was higher for object a than for b . If now the two objects are separated by the screen, transparent for this frequency ν only, each body tends to create the intensity of light in its surroundings with which it is in equilibrium. There would be a flow of light through the screen from side a to side b . Since this would decrease the density of light on the side a , the body a would emit more energy than it absorbs, whereas the converse would be true for b . The effect would be a net flow of energy between two objects at the same temperature, without the intervention of work, a result in disagreement with the second law of thermodynamics.

It follows that the density of light of each frequency must be the same for the radiation in equilibrium with any two bodies a and b at the same temperature, independently of the nature of the objects. The energy per unit volume of light of frequencies between ν and $\nu + \Delta\nu$ in equilibrium with a body of temperature T shall be termed $U(\nu, T) \Delta\nu$. We have reached the conclusion that $U(\nu, T)$ is a universal function of frequency and temperature alone.

A body which absorbs all the light falling on it is called black. The

energy of radiation absorbed per second by such a body is easily calculated from the radiation in equilibrium with it. Of the light of frequency ν , a fraction $d\Omega/4\pi$ has a direction located in one solid angle $d\Omega$. An element of surface is struck, in the time interval dt , by that fraction of the light contained within the hemisphere of radius $c dt$, which is directed towards it. c , the velocity of light, is independent of the frequency. The energy arriving per unit time, for each frequency, is therefore simply proportional to $U(\nu, T)$. The proportionality constant, calculated in the same way as for molecules hitting a wall, is $c/4$ for unit area and unit time. For a black surface all this energy is absorbed, and the energy emitted per second, unit area, and frequency range $\Delta\nu$, must be the same, namely, $(c/4)U(\nu, T) \Delta\nu$. For this reason the function $U(\nu, T)$ is called the black-body distribution function.

No real bodies are truly black for all frequencies. One can conclude, however, that, if r_ν signifies the reflection coefficient for the frequency ν at the temperature T , i.e. $(1 - r_\nu)$ the fraction absorbed, of the light of frequency ν striking the surface, the emission from the surface is $(1 - r_\nu)$ times the emission from a black body at the same temperature. This is known as Kirchhoff's law. The intensity of radiation emitted by a black body represents the upper limit attainable from any surface of a given temperature.

The function $U(\nu, T)$ might be determined by calculating the rate of emission from a black body. Since, however, $U(\nu, T)$ signifies the density of light in equilibrium with *any* body at the temperature T , it must be an inherent property of the radiation field itself and subject to a simpler statistical derivation.

This is undertaken in the following manner. One considers an amount of radiational energy E contained in a box of volume V with perfectly reflecting walls. One calculates the most probable distribution of the energy over the various frequencies, namely, that distribution for which the entropy of the radiation has the maximum value. The resultant spectral distribution will be the black-body radiation function. In following this procedure we must take account of the quantized nature of the light, the fact that radiational energy of the frequency ν can occur only in integer quanta of energy $h\nu$. The task is then the calculation of the most probable distribution of the light quanta over the frequency ranges, subject to the condition that the total energy is fixed. The problem becomes rather similar to that of calculating the distribution of molecules of a perfect gas over the ranges of energy. An important difference arises from the fact that the total number of photons is not prescribed.

In the calculations for the perfect gas one always assumes tacitly that

collisions take place between the otherwise independent atoms to bring about the equilibrium distribution. The light quanta, on the other hand, are strictly independent, and do not collide. To attain equilibrium one must assume the introduction, into the box, of a minute black dust particle, of negligible heat capacity, which by emission and absorption serves as a catalyst in converting photons of one frequency into others, with conservation of energy but without conservation of their number.

16c. The Quantum States of Radiation

In a closed box, with perfectly reflecting walls, the boundary conditions, deducible from Maxwell's equations, demand that only certain definite standing waves of particular wavelengths and directions of propagation can be contained in the space. If, for simplicity, the box is assumed to be cubic, of side length l , volume $V = l^3$, the vector $\vec{\lambda}$, whose direction is that of propagation, and whose magnitude is the wavelength, must have the components

$$(16. 3) \quad \lambda_x = \frac{2l}{k_x} \quad \lambda_y = \frac{2l}{k_y} \quad \lambda_z = \frac{2l}{k_z},$$

where k_x, k_y, k_z may be any positive integers. The wave number, ω , for such a wave is given by

$$(16. 4) \quad \omega^2 = \frac{1}{\lambda^2} = \frac{1}{4l^2} (k_x^2 + k_y^2 + k_z^2),$$

and the energy of one photon in it, $\epsilon = h\nu = hc\omega$, by

$$(16. 5) \quad \epsilon = \frac{hc}{2l} (k_x^2 + k_y^2 + k_z^2)^{1/2}.$$

Comparison with the quantization of the waves of material particles in a box, section 2g, shows that the quantum condition on the wavelength is the same in both cases. The dependence of energy on λ , and therefore on the quantum numbers k_x, k_y, k_z , is quite different, however.

The next task is that of determining the number of standing waves, or quantum states of photons, $C(\nu) \Delta\nu$, whose frequency lies between ν and $\nu + \Delta\nu$. By introducing the volume, $V = l^3$, the magnitude k of the vector (k_x, k_y, k_z) is related to the frequency by

$$(16. 6) \quad k = (k_x^2 + k_y^2 + k_z^2)^{1/2} = \frac{2V^{1/3}}{c} \nu.$$

The number of permissible wavelengths, that is, of positive integer

values of k_x , k_y and k_z between \mathbf{k} and $\mathbf{k} + \Delta\mathbf{k}$, is, just as stated in section 2i, one-eighth the volume of a spherical shell of radius k and thickness Δk , namely,

$$\frac{4\pi}{8} k^2 \Delta k.$$

The number of \mathbf{k} values in the frequency range Δk is obtained from this by expressing k in terms of ν with the help of (6). To find $C(\nu) \Delta\nu$ the result has to be multiplied by 2, since each wave described by the vector λ may still have two independent directions of polarization. One obtains

$$(16. 7) \quad C(\nu) \Delta\nu = 8\pi V \frac{\nu^2}{c^3} \Delta\nu.$$

This equation is analogous to equation (2. 34) or (5. 2) for a monatomic gas.

A quantum state of the complete radiation field is determined by giving the number of photons in each monochromatic standing wave or "cell."

16d. The Planck Black-Body Distribution Law

The frequency scale, running from zero to infinity, will be divided into regions in such a way that the j th interval runs from ν_j to $\nu_j + \Delta\nu_j$. The number of standing waves whose frequency lies within the j th range will be denoted by C_j .

The numbers, N_j , of photons in the quantum states of each region determine a spectral distribution of the radiation. The total energy of the system, in this distribution, is given by

$$(16. 8) \quad E = \sum_j h\nu_j N_j$$

and will be kept constant.

The entropy S of the radiation field in the distribution is equal to k times the logarithm of the number of quantum states of the radiation field which conform with the distribution. The number of quantum states is given by the number of ways in which, for each region j , numbers of photons in each of the C_j cells can be chosen such that their sum is N_j , or, in other words, the number of ways in which N_j identical objects may be placed in C_j different cells. S is the sum over all regions of the entropy of each region, $S = \sum_j S_j$, and S_j , according to equation (5. 8), is given by

$$(16. 9) \quad S_j = k \left\{ C_j \ln \left(1 + \frac{N_j}{C_j} \right) + N_j \ln \left(1 + \frac{C_j}{N_j} \right) \right\}.$$

The most probable distribution is that for which S is a maximum, subject to condition (8) that the total energy be kept constant. It is calculated with the method of undetermined multipliers, Appendix A VI, by the condition

$$(16. 10) \quad \frac{\partial S}{\partial N_j} - k\beta \frac{\partial E}{\partial N_j} = 0 = k \ln \left(1 + \frac{C_j}{N_j} \right) - k\beta h\nu_j.$$

In (10) the parameter $k\beta$ is equal to $(\partial S/\partial E)_V = 1/T$.

From (10) one obtains the equation determining the equilibrium number of photons for each region as

$$(16. 11) \quad \frac{N_j}{C_j} = \frac{1}{e^{h\nu_j/kT} - 1}.$$

In contrast to the calculation for the perfect gas, owing to the lack of conservation of numbers of photons, only *one* condition, that of constant energy, restricts the maximum of S . Correspondingly, only one undetermined multiplier $\beta = 1/kT$ occurs. For molecules the condition $\sum_j N_j = N$ introduces a second parameter α . Equation (11) differs from the distribution function (1) for material gases only in the fact that $\alpha = 0$.

The dependence of C_j on the frequency, or energy, of the region brings in a further difference between photon and material gas. Substitution of (7) for C_j and of $N(\nu) \Delta\nu$ for N_j leads to

$$(16. 12) \quad N(\nu) \Delta\nu = 8\pi V \frac{\nu^2}{c^3} \frac{1}{e^{h\nu/kT} - 1} \Delta\nu$$

for the equilibrium number of photons of frequencies between ν and $\nu + \Delta\nu$.

The density of energy $U(\nu) \Delta\nu$, or energy per unit volume, of radiation of frequencies between ν and $\nu + \Delta\nu$, is found by multiplying the number of photons per unit volume, $N(\nu) \Delta\nu/V$, in the frequency range $\Delta\nu$, by the energy of each photon, $h\nu$. The result,

$$(16. 13) \quad U(\nu) = \frac{h\nu}{V} N(\nu) = \frac{8\pi h\nu^3}{c^3} \frac{1}{e^{h\nu/kT} - 1},$$

is known as the Planck black-body distribution law.

If $h\nu/kT$ is small, which it is for very low frequencies at any given temperature, and for any given frequency range at sufficiently high temperature, one may develop $e^{h\nu/kT} - 1 \cong h\nu/kT$, and one obtains

$$(16. 13') \quad U(\nu) \cong \frac{8\pi\nu^2}{c^3} kT \quad (h\nu/kT \ll 1).$$

Equation (13') was first derived by Lord Rayleigh on the basis of purely classical statistical arguments. Rayleigh used the amplitudes of the standing waves as the normal coordinates of the "ether" composing the radiation field. Equation (7) then gives the number of vibrational degrees of freedom whose frequency lies between ν and $\nu + \Delta\nu$. Since the average energy for each vibrational degree of freedom in classical statistics is kT , equation (13') is obtained immediately. If, instead of kT , the average energy of a quantized oscillator is used (equation 7. 21 divided by N_0), $h\nu/(e^{h\nu/kT} - 1)$, one arrives at the correct equation (13) instead of (13').

Rayleigh also noticed the obvious shortcoming of the classical formula (13'): the radiation density at increasing frequency tends to infinity at any temperature — a prediction which is obviously absurd.

Another approximation to (13) is obtained by applying to the photon gas the statistical methods for a classical Boltzmann gas, instead of for an Einstein-Bose gas. The calculation yields $N_j/C_j = e^{-h\nu/kT}$, and one arrives at

$$(16. 13'') \quad U(\nu) = \frac{8\pi h\nu^3}{c^3} e^{-h\nu/kT}.$$

It is seen that the correct equation (13) becomes asymptotically equal to (13'') for $h\nu/kT \gg 1$, $N(\nu)/C(\nu) \ll 1$, low density of photons in the phase space. Equation (13'') was proposed by Wien, not on any theoretical basis, but simply as giving agreement with the observed spectral distribution for high frequencies.

Historically, equation (13) was first given by Planck as an interpolation between the Rayleigh distribution law (13'), which had been experimentally verified for low frequencies, and the Wien equation, valid for the opposite extreme. The universal constant h entered into physics for the first time through this empirical equation. Planck then showed that the average energy of any *material* oscillator, in equilibrium with the radiation field, and therefore in any temperature equilibrium, must be the same as that of one of the ether vibrations, namely given by $h\nu/(e^{h\nu/kT} - 1)$. Finally, he saw that this could be explained by the famous quantum hypothesis that an oscillator of frequency ν can possess energy values of $n h\nu$ only where n is any integer, and where each value has the same *a priori* probability. This postulate was the birth of the quantum concept.

For a fixed temperature, function (13), plotted against ν , starts at zero at $\nu = 0$ like a quadratic parabola. It rises to a maximum and approaches zero exponentially as ν goes to infinity. The area under the curve, which is equal to the total energy density, U , of the radiation

field, is finite. The distribution function has one property, which it shares with (13') and (13''), and which was derived by thermodynamical considerations before the exact form of the black-body radiation formula was known. It can, namely, be written as ν^3 times a function of ν/T , or, which is equivalent, in the form $U(\nu) = T^3 f(\nu/T)$. From this alone it follows that the maximum of the spectral distribution, obtained by equating to zero the first differential of $U(\nu, T)$ with respect to ν , is proportional to T . As the temperature increases, the maximum shifts to higher frequencies. The height at the maximum is proportional to T^3 ; and the area under the curve, the total energy, is proportional to T^4 .

16e. The Thermodynamic Functions of the Radiation Field

The total energy per unit volume, or energy density, of a radiation field is obtained by integrating (13) over all frequencies from zero to infinity,

$$U = \frac{8\pi h}{c^3} \int_0^\infty \frac{\nu^3}{e^{h\nu/kT} - 1} d\nu = \frac{8\pi h}{c^3} \left(\frac{kT}{h}\right)^4 \int_0^\infty \frac{(h\nu/kT)^3}{e^{h\nu/kT} - 1} d\left(\frac{h\nu}{kT}\right).$$

In the expression on the right-hand side the definite integral is simply a dimensionless numerical coefficient. It is evaluated easiest by expanding the denominator,

$$\frac{1}{e^{h\nu/kT} - 1} = \sum_{n=1}^{\infty} e^{-n h\nu/kT}.$$

If the new integration variable $u = h\nu/kT$ is introduced, with the fact that $\int_0^\infty u^3 e^{-nu} du = 6/n^4$, the definite integral is found to have the value

$$\int_0^\infty u^3 \sum_{n=1}^{\infty} e^{-nu} du = 6 \sum_{n=1}^{\infty} \frac{1}{n^4}.$$

The sum of the inverse fourth power over all integers is equal to $\pi^4/90$. Using this result, one finds

$$(16. 14) \quad U = \frac{8\pi^5}{15} \frac{(kT)^4}{(hc)^3}$$

for the energy density of black-body radiation at the temperature T .

The entropy is determined by inserting the result (11):

$$C_j/N_j = e^{h\nu/kT} - 1, \quad \ln\left(1 + \frac{C_j}{N_j}\right) = \frac{h\nu}{kT},$$

$$\text{and } 1 + \frac{N_j}{C_j} = (1 - e^{-h\nu/kT})^{-1},$$

into the equation (9) for S_j . With (7) for $C_j = C(\nu) \Delta\nu$ one obtains

$$S = \int_0^\infty \left\{ -8\pi V \frac{k}{c^3} \nu^2 \ln(1 - e^{-h\nu/kT}) + \frac{h\nu}{T} N(\nu) \right\} d\nu.$$

The second term is UV/T . By introducing, as before, the dimensionless integration variable $u = h\nu/kT$, the first term is seen to be

$$-8\pi V k \left(\frac{kT}{hc} \right)^3 \int_0^\infty u^2 \ln(1 - e^{-u}) du.$$

The definite integral is evaluated by expanding

$$\ln(1 - e^{-u}) = - \sum_{n=1}^{\infty} \frac{1}{n} e^{-nu},$$

and integrating, considering that $\int_0^\infty u^2 e^{-nu} du = 2/n^3$,

$$\int_0^\infty u^2 \ln(1 - e^{-u}) du = - \int_0^\infty u^2 \sum_{n=1}^{\infty} \frac{1}{n} e^{-nu} du = -2 \sum_{n=1}^{\infty} \frac{1}{n^4} = -\frac{\pi^4}{45}.$$

As a result the equation for the entropy density

$$s = \frac{S}{V} = \frac{8\pi^5}{45} \left(\frac{kT}{hc} \right)^3 k + \frac{U}{T},$$

or, with (14),

$$(16. 15) \quad s = \frac{S}{V} = \frac{4}{3} \frac{U}{T} = \frac{32\pi^5}{45} \frac{(kT)^4}{(hc)^3} \frac{1}{T},$$

is obtained.

The Helmholtz free energy, or work function $A = E - TS$, for radiation is

$$(16. 16) \quad A = UV - TS = -\frac{U}{3} V = -\frac{8\pi^5}{45} V \frac{(kT)^4}{(hc)^3}.$$

The radiation pressure may be obtained by the usual thermodynamic relationship,

$$(16. 17) \quad P = - \left(\frac{\partial A}{\partial V} \right)_T = \frac{U}{3} = \frac{8\pi^5}{45} \frac{(kT)^4}{(hc)^3}.$$

The free energy F is

$$(16. 18) \quad F = A + PV = 0.$$

This result is not surprising. In Chapter 6 it was found that the constant α introduced into the expression for N_j/C_j as calculated by the method of undetermined multipliers was always given by $\alpha = -\mu/kT$, where $\mu = F/N$ is the chemical potential. In this chapter we find that α is zero, and correspondingly in (18) the free energy F for radiation in temperature equilibrium is always zero.

16f. The Degenerate Fermi-Dirac Gas at Zero Temperature

The properties of metals, especially their electrical conductivity, may be rather satisfactorily explained by assuming that metals contain a perfect gas of electrons. The physical reasons which justify this assumption, and the extent to which the deductions drawn from such a picture may be relied upon, will be discussed in some detail in section 16i. At present we wish to focus attention on the results derived arising from that assumption.

If each metal atom contributes one, or as many electrons as its valency, to the electron gas, the density of particles in the gas is very high. The molal volume V of the electron gas is the atomic volume of the metal divided by a small integer. Atomic volumes of metals are of the order of 10 cc.

Electrons obey Fermi-Dirac statistics. The distribution function is therefore given by

$$(16. 19) \quad \frac{N_j}{C_j} = \frac{1}{e^{(\epsilon_j - \mu)/kT} + 1}.$$

The classical distribution function is that in which the unity in the denominator of this equation is omitted. The temperature above which this neglect is justified is determined by the condition that $-\mu/kT$ be considerably larger than unity. Evaluation of this quantity with omission of the unity leads to $-\mu/kT = \ln [0.000634M^{3/2} \sqrt{VT^{3/2}}]$, from equation (2). If the electron atomic weight $M = 1/1840$, and $V = 10 \text{ cm}^3$ is inserted, $-\mu/kT = \ln [8 \times 10^{-8}T^{3/2}]$. This shows that the classical equation could be applied successfully only above 10^6 degrees, a temperature for which no metal is solid. At room temperature the classical distribution function is not even suitable as a starting point for an approximate calculation.

In view of this it is interesting to study, at first, the opposite extreme, namely, the properties of the gas at $T = 0$, which gives a much better approximation for room temperature than the classical distribution. This calculation can be done without recourse to the distribution function.

The lowest energy of a classical or a Bose-Einstein gas at $T = 0$ is

$E_0 = 0$. At zero temperature all particles crowd into the lowest state and lose all kinetic energy. For a Fermi-Dirac gas this is not possible. The particles in it are subject to the Pauli exclusion principle: no more than one may be in one quantum state, or cell. The lowest energy of the gas of N particles is therefore obtained if the N cells of lowest energy are filled with one particle in each. The energy E_0 of the gas at $T = 0$ is therefore different from zero.

This quantity E_0 can be calculated easily. We shall designate by μ_0 the energy of an electron in the highest quantum state which is still filled at $T = 0$. All cells of energy below μ_0 are occupied, all cells with energy above μ_0 are empty, at zero temperature. There must, then, exist precisely N states with energy lower than or equal to μ_0 , and this condition is sufficient to determine μ_0 .

The number of quantum states, $C(\epsilon) \Delta\epsilon$, of one particle, the energy of which lies between ϵ and $\epsilon + \Delta\epsilon$, is given by equation (5.2) as

$$C(\epsilon) \Delta\epsilon = 2\pi g V \left(\frac{2m}{h^2} \right)^{3/2} \epsilon^{1/2} \Delta\epsilon.$$

In this equation m denotes the mass of the particle, V the total volume, and g the degeneracy of the internal ground level of the particles. For electrons $g = 2$, owing to the two possible orientations of the spin, so that

$$(16.20) \quad C(\epsilon) = 4\pi V \left(\frac{2m}{h^2} \right)^{3/2} \epsilon^{1/2}.$$

The number of cells with energy less or equal to μ_0 is given by

$$\int_0^{\mu_0} C(\epsilon) d\epsilon = 4\pi V \left(\frac{2m}{h^2} \right)^{3/2} \int_0^{\mu_0} \epsilon^{1/2} d\epsilon = \frac{8\pi}{3} V \left(\frac{2m\mu_0}{h^2} \right)^{3/2}.$$

Since this number must be equal to N , the total number of electrons in the system, one obtains

$$N = \frac{8\pi}{3} V \left(\frac{2m\mu_0}{h^2} \right)^{3/2},$$

or, for μ_0 , the equation

$$(16.21) \quad \mu_0 = \frac{h^2}{8m} \left(\frac{3N}{\pi V} \right)^{2/3}.$$

This quantity μ_0 , the uppermost energy of the filled cells, is frequently called the Fermi energy.

The use of (21) in (20) permits one to write an alternate form for

$C(\epsilon)$ which will sometimes be found convenient, namely,

$$(16. 20') \quad C(\epsilon) = \frac{3}{2} N \frac{\epsilon^{1/2}}{\mu_0^{3/2}}.$$

It is to be noted that we define a cell by both the translational quantum numbers, k_x, k_y, k_z and the internal quantum numbers of the particle, which in this case consist of the two spin directions. One sometimes defines a cell by the translational quantum numbers only and says that *two* electrons, of opposite spin, may occupy this cell. The difference, obviously, is one of nomenclature only.

The total energy of the N particles in this distribution, namely, the energy E_0 of the Fermi gas at $T = 0$, is given by

$$E_0 = \int_0^{\mu_0} \epsilon C(\epsilon) d\epsilon.$$

Using equations (20') and (21), and integrating, leads to

$$(16. 22) \quad E_0 = \frac{3}{5} N \mu_0 = \frac{3h^2}{40m} N \left(\frac{3}{\pi} \frac{N}{V} \right)^{2/3}$$

The average energy per electron in the Fermi gas at $T = 0$ is $\frac{3}{5}$ of that of the energetically highest particle, or $\frac{3}{5}$ of the Fermi energy μ_0 .

The energy μ_0 depends inversely on the mass of the particles. By inserting for m the mass of the electron, for N_0 Avogadro's number, and for V the molal volume V in cubic centimeters of the electron gas, which last quantity is equal to the atomic volume of the metal divided by the number of valence electrons, one obtains

$$(16. 21') \quad \begin{aligned} \mu_0 &= 4.166V^{-2/3} \times 10^{11} \text{ erg/molecule} \\ &= 26.00V^{-2/3} \text{ electron volt,} \\ N_0\mu_0 &= 599.5V^{-2/3} \text{ kcal.;} \end{aligned}$$

μ_0/k , a temperature, has the value

$$\frac{\mu_0}{k} = 301,810V^{-2/3} \text{ }^\circ\text{K.}$$

Since V is about 10 for most metals it is seen that the Fermi energy of an electron gas is extremely high. In the next section it will be shown that the thermodynamic properties of the gas above $T = 0$ can be obtained as a power series in kT/μ_0 . A series of that type must be expected to converge very rapidly, so that the behavior of the electron gas at room temperature is not greatly different from that at $T = 0$.

Equation (21) shows that both the small mass and the high density of

the electron gas favor this high value of μ_0 . Atoms or molecules have masses more than two thousand times that of an electron, so that the value of μ_0 for a chemical Fermi-Dirac gas, even at the same density, is very much smaller. A development with respect to kT/μ_0 for a chemical gas obeying the Pauli principle would lead to a series which converges at very low temperatures only, and at room temperature the thermodynamic functions are radically different from those at $T = 0$, in accordance with the discussions of Chapters 5-8.

The same results for the electron gas at zero temperature could have been obtained, of course, from the distribution function, (19). In (19) the quantity $\mu(T)$, a function of the temperature, is determined by the condition that the total number of particles is fixed. At $T = 0$ function (19) is zero if $\epsilon_j > \mu(0)$; it is equal to 1 if $\epsilon_j < \mu(0)$. The distribution function represents, then, the state that all cells with energy lower than $\mu(0)$ are filled, all cells with higher energy empty. At $\epsilon = \mu(0)$ the function has a discontinuity, as it drops suddenly from unity to zero. It is seen then that the Fermi energy μ_0 of the filled level of highest energy is equal to the value μ occurring in the function (19) at $T = 0$. In Chapter 6 it was shown in general that the quantity μ in the distribution function is the chemical potential which is $1/N$ times the free energy F . The free energy of the electron gas at $T = 0$ is therefore $F_0 = N\mu_0$. We shall verify this result by direct calculation of the various thermodynamic functions at $T = 0$.

A quantum state of the total gas is described by giving the number of electrons in each cell. It is clear then that the distribution at $T = 0$, when all cells of energy $\epsilon < \mu_0$ are full, all cells with $\epsilon > \mu_0$ are empty, can be realized by one state (or, owing to the possible small degeneracy of the very highest level with $\epsilon = \mu_0$, by a very few states) of the total system only. The entropy $S = k \ln \Omega$ of the gas at $T = 0$ is therefore practically zero since Ω is equal to a small integer.

The work function $A = E - TS$ is $A_0 = E_0$ for the gas in the lowest energy state. The pressure of the gas, $P = -(\partial A/\partial V)_T$, is obtained by using (22) for $E_0 = A_0$

$$(16. 23) \quad P_0 = -\frac{\partial E_0}{\partial V} = -\frac{3}{5} N \frac{\partial \mu_0}{\partial V} = \frac{2}{5} \frac{N}{V} \mu_0 = \frac{2}{3} \frac{E_0}{V}.$$

It is seen that the relation $P_0 V = \frac{2}{3} E_0$ is precisely the same as that for the classical gas. A difference arises here from the fact that at $T = 0$ neither P_0 nor E_0 is zero. The numerical value of μ_0 (21') shows that

$$(16. 23') \quad \begin{aligned} P_0 &= 10.04 \times 10^{12} \mathbf{V}^{-5/3} \text{ dyne/cm}^2 \\ &= 9.9 \times 10^6 \mathbf{V}^{-5/3} \text{ atm.} \end{aligned}$$

Remembering that V is of the order of 10 cc. for metals one finds that the zero-point pressure in metals is very high. A gas at such high pressures can be contained only in a very strong box. For the electron gas, the metal itself provides this "box." On account of the strong attraction between the electrons and the remaining positive metal ions the potential energy of the electrons inside the metal is much lower than outside, so that the electrons remain confined to the metal. The electron pressure, tending to increase the volume, is balanced by the attraction between the ions and the electrons which tend to decrease it.

The potential energy of the metal may be regarded as being made up, almost entirely, of the electrostatic Coulomb interaction energy between the positive ions of the lattice and the electron gas. This potential energy is negative and varies inversely as the cube root of the molal volume V . The total energy of the metal, compared to that of positive ions and electrons as a dilute gas at 0°K ., is composed additively of this negative potential energy and the positive kinetic energy E_0 of equation (22). The equilibrium volume of the metal at 0°K . will be determined by the condition that $(\partial E/\partial V)_{T=0} = P = 0$. It is seen that this total pressure of the metal will be composed of two additive terms: the negative attractive pressure due to the potential energy which varies as $V^{-4/3}$, and the positive repulsive Fermi pressure (23) varying as $V^{-5/3}$. At equilibrium the two pressures will be equal. The molal volumes and binding energies of metals calculated this way are in fair agreement with the experimental values.*

The free energy, $F = A + PV$, is, at $T = 0$, $F_0 = E_0 + P_0V$. Using (22) for E_0 and (23) for P_0 , one obtains

$$(16. 24) \quad F_0 = E_0 + P_0V = N\mu_0,$$

in agreement with the general identification of μ with F/N .

At temperatures above $T = 0$ the distribution function (19) must be used for the evaluation of the thermodynamic functions. Since the integrals cannot be evaluated in closed form, an approximation method will be developed in the next section.

16g. The Integrals Occurring in the Equations for the Fermi-Dirac Gas

The number of electrons $N(\epsilon) \Delta\epsilon$ in the energy range between ϵ and $\epsilon + \Delta\epsilon$ is obtained, as a function of the temperature and volume, by multiplying equation (20) for the number of cells, $C(\epsilon) \Delta\epsilon$, by equation (19), the number of electrons per cell,

$$(16. 25) \quad N(\epsilon) = 4\pi V \left(\frac{2m}{h^2} \right)^{3/2} \frac{\epsilon^{1/2}}{e^{(\epsilon-\mu)/kT} + 1}$$

* O. K. Rice, *J. Chem. Phys.*, **1**, 639 (1933).

Using (20') for $C(\epsilon)$ this may also be written as

$$(16. 25') \quad N(\epsilon) = \frac{3N}{2\mu_0^{3/2}} \frac{\epsilon^{1/2}}{e^{(\epsilon-\mu)/kT} + 1},$$

in which μ_0 , defined by equation (21), is the chemical potential at $T = 0$, and μ the chemical potential at the temperature in question.

The integration of (25) over all values of ϵ serves to determine μ as a function of temperature by equating the result $\int_0^\infty N(\epsilon) d\epsilon$ to the total number of particles N . It is to be observed from the form (25') for $N(\epsilon)$ that μ will necessarily result as a function of μ_0 and kT alone.

The energy may be determined from the equation

$$E = \int_0^\infty \epsilon N(\epsilon) d\epsilon.$$

It is seen that in general one is confronted with the problem of making integrations of the type

$$(16. 26) \quad I = \int_0^\infty f(\epsilon)g(\epsilon) d\epsilon,$$

where the function $f(\epsilon)$ is some simple continuous function of ϵ such as $\epsilon^{1/2}$ or $\epsilon^{3/2}$ and

$$(16. 27) \quad g(\epsilon) = \frac{1}{e^{(\epsilon-\mu)/kT} + 1}.$$

We have seen already that at $T = 0$ this function $g(\epsilon)$ is a step function, unity for $\epsilon < \mu_0$ and zero for $\epsilon > \mu_0$. Also at $T = 0$ the value of μ , $\mu = \mu_0$ is extremely high, μ_0/k is of the order of magnitude of 5×10^4 to 10^5 °K. for most metals.

It is not to be expected that μ will decrease enormously with temperature, so that at room temperature μ/kT will be of the order of magnitude of 10^2 , $e^{-\mu/kT} \approx 10^{-40}$. The approximation method used for the classical gases is valid only if μ is negative, $e^{-\mu/kT}$ greater than unity. In this section integrals of the type (26) will be evaluated under the assumption that $\mu/kT \gg 1$, and their values will be obtained in terms of a power series in the small quantity kT/μ_0 . The result will show, *a posteriori*, that for electrons in metals this assumption, $\mu/kT \gg 1$, is justified up to temperatures above those at which the metals melt.

In order to integrate equations of the type (26) it will be necessary to resort to a trick. Since, as we have found, $e^{-\mu/kT} \approx 10^{-40}$, $g(\epsilon)$, equation (27) is practically unity at $\epsilon = 0$, and decreases monotonously to

zero at $\epsilon = \infty$. Its derivative $g'(\epsilon) = dg/d\epsilon$ is always negative, but has one single sharp minimum at $\epsilon = \mu$, as long as μ is positive. For $\mu/kT \gg 1$ this maximum of $-g'(\epsilon)$ is very sharp, and the function $-g'(\epsilon)$ is negligibly small for all values of ϵ differing greatly from $\epsilon = \mu$. By a partial integration (26) may be transformed into an integral over $-F(\epsilon)g'(\epsilon)$, and because of the form of $-g'(\epsilon)$ only the values in the neighborhood of $\epsilon = \mu$ contribute to the integral. The limits of integration are actually from $\epsilon = 0$ to $\epsilon = \infty$, but since $-g'(\epsilon)$ is practically zero for $\epsilon \leq 0$ no great error is introduced by changing the limits of integration to minus infinity and plus infinity. With these limits the integration can be performed by developing the function $F(\epsilon)$ as a Taylor's series in powers of $(\epsilon - \mu)$ about the place of maximum $-g'(\epsilon)$.

The first and second derivatives of the function $g(\epsilon)$ in equation (27) are

$$(16. 28) \quad g'(\epsilon) = \frac{dg(\epsilon)}{d\epsilon} = - \frac{e^{(\epsilon-\mu)/kT}}{kT[e^{(\epsilon-\mu)/kT} + 1]^2}$$

and

$$(16. 29) \quad g''(\epsilon) = \frac{d^2g(\epsilon)}{d\epsilon^2} = - \frac{e^{(\epsilon-\mu)/kT}}{(kT)^2[e^{(\epsilon-\mu)/kT} + 1]^2} + \frac{2e^{2(\epsilon-\mu)/kT}}{(kT)^2[e^{(\epsilon-\mu)/kT} + 1]^3} = \frac{e^{(\epsilon-\mu)/kT}[e^{(\epsilon-\mu)/kT} - 1]}{(kT)^2[e^{(\epsilon-\mu)/kT} + 1]^3}.$$

The first derivative is always negative. The second derivative is zero when

$$(16. 30) \quad e^{(\epsilon-\mu)/kT} - 1 = 0, \quad \epsilon = \mu.$$

At $\epsilon = \mu$ the function $-g'(\epsilon)$ has a maximum, which is sharper the lower the temperature. The negative of the slope of the original function at this point is greatest.

Using $\epsilon = \mu$ in (27) and (28), one finds that the value of the function $g(\epsilon)$ at this point is

$$g(\mu) = \frac{1}{2},$$

and that of its derivative

$$g'(\mu) = - \frac{1}{4} \frac{1}{kT}.$$

The logarithmic decrease in $g(\epsilon)$ with $\ln \epsilon$ is

$$-\left(\frac{d \ln g(\epsilon)}{d \ln \epsilon}\right)_{\epsilon=\mu} = \frac{1}{2} \frac{\mu}{kT}.$$

From this it is seen that the relative abruptness of the descent of $g(\epsilon)$ from almost unity to almost zero increases with the value of μ/kT .

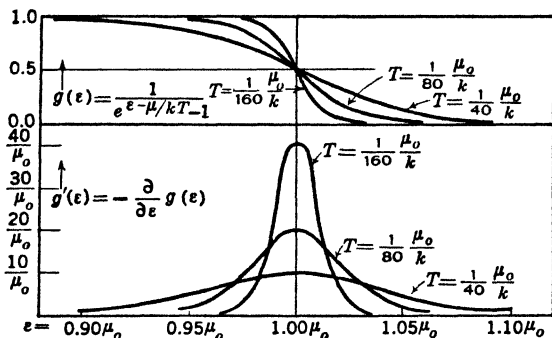

FIG. 16. 1. Plot of the Fermi distribution function and its derivative for various temperatures.*

The functions $g(\epsilon)$ and $g'(\epsilon)$ are plotted in Fig. 16. 1 for various values of kT .

By partial integration of the integral I of equation (26) one finds

$$I = \int_0^\infty f(\epsilon)g(\epsilon) d\epsilon = F(\infty)g(\infty) - F(0)g(0) - \int_0^\infty F(\epsilon)g'(\epsilon) d\epsilon,$$

where

$$(16. 31) \quad F(\epsilon) = \int_0^\epsilon f(\epsilon') d\epsilon'.$$

If $f(\epsilon)$ is not infinity at $\epsilon = 0$, then $F(0)$ and the product $F(0) g(0)$ are zero. If $f(\epsilon)$ does not go exponentially to infinity with ϵ the product $F(\infty) g(\infty)$ will be zero since $g(\epsilon)$ approaches zero as $e^{-\epsilon/kT}$ with increasing ϵ . One may consequently write

$$(16. 32) \quad I = \int_0^\infty f(\epsilon)g(\epsilon) d\epsilon = - \int_0^\infty F(\epsilon)g'(\epsilon) d\epsilon.$$

We now transform to the new variable

$$(16. 33) \quad x = \frac{\epsilon - \mu}{kT}$$

* μ should be read in place of μ_0 everywhere in this figure.

and develop the function $F(x)$ as a power series of x ,

$$F(x) = \sum_{n=0}^{\infty} \frac{x^n}{n!} F^{(n)}(x=0),$$

where, in the old variable

$$(16. 34) \quad F(x=0) = \int_0^{\mu} f(\epsilon) d\epsilon,$$

$$\begin{aligned} F^{(n)}(x=0) &= (kT)^n \left[\frac{d^n F(\epsilon)}{d\epsilon^n} \right]_{\epsilon=\mu} = (kT)^n \left[\frac{d^{n-1} f(\epsilon)}{d\epsilon^{n-1}} \right]_{\epsilon=\mu} \\ &= (kT)^n f^{(n-1)}(\mu). \end{aligned}$$

By introducing this development into (32) one may write

$$(16. 35) \quad I = -F(0) \int_0^{\infty} g'(\epsilon) d\epsilon - \sum_{n=1}^{\infty} \frac{(kT)^n}{n!} f^{(n-1)}(\mu) \int_{x=-\mu/kT}^{\infty} x^n g'(x) dx.$$

The integral of the first term is

$$(16. 36) \quad - \int_0^{\infty} g'(\epsilon) d\epsilon = g(0) - g(\infty) = (1 + e^{-\mu/kT})^{-1} \cong 1.$$

The function $g'(x)$ is obtained by using the expression (33) for x in (28),

$$(16. 37) \quad g'(x) = - \frac{1}{kT} \frac{e^x}{(e^x + 1)^2} = - \frac{1}{kT} \frac{1}{(e^x + 1)(e^{-x} + 1)}.$$

This function is completely symmetrical in x , that is, $g'(x) = g'(-x)$. The function approaches zero exponentially as x approaches minus infinity. If μ/kT is large the value of the function is already negligible at the lower limit, $x = -\mu/kT$, of the integral in equation (35). No error is introduced, consequently, by changing the limits of integration of the terms in the sum of (35) to $x = -\infty$ and $x = +\infty$.

We must now evaluate the integrals

$$\int_{-\infty}^{+\infty} \frac{x^n}{(e^x + 1)(e^{-x} + 1)} dx.$$

From the symmetry of the denominator it is seen that the integrand is antisymmetrical in x if n is odd, that is, it changes sign if x is replaced by $-x$, and the integral is therefore zero for odd n . For even values of n

we may integrate from zero to infinity, and multiply by 2, since then the integrand is symmetrical in x .

By developing

$$\begin{aligned} \frac{1}{(e^x + 1)(e^{-x} + 1)} &= \frac{e^{-x}}{(1 + e^{-x})^2} = e^{-x} - 2e^{-2x} + 3e^{-3x} - \dots \\ &= - \sum_{m=1}^{\infty} (-1)^m m e^{-mx}, \end{aligned}$$

the integration may be performed as

(16. 38)

$$\begin{aligned} \int_{-\infty}^{+\infty} \frac{x^n}{(e^x + 1)(e^{-x} + 1)} dx &= -2 \sum_{m=1}^{\infty} (-1)^m m \int_0^{\infty} x^n e^{-mx} dx \\ &= -2n! \sum_{m=1}^{\infty} \frac{(-1)^m}{m^n} \quad (n \text{ even}). \end{aligned}$$

Using (37) and (36) in (35), with (34) and (38) one finally arrives at

$$\begin{aligned} (16. 39) \quad I &= \int_0^{\infty} f(\epsilon)g(\epsilon) d\epsilon = - \int_0^{\infty} F(\epsilon)g'(\epsilon) d\epsilon \\ &= \int_0^{\mu} f(\epsilon) d\epsilon - 2 \sum_{n=1}^{\infty} (kT)^{2n} f^{(2n-1)}(\mu) \sum_{m=1}^{\infty} \frac{(-1)^m}{m^{2n}}, \\ f^{(2n-1)}(\mu) &= \left[\frac{d^{2n-1} f(\epsilon)}{d\epsilon^{2n-1}} \right]_{\epsilon=\mu}. \end{aligned}$$

The sums occurring have the numerical values

$$(16. 40) \quad - \sum_{m=1}^{\infty} \frac{(-1)^m}{m^2} = \frac{\pi^2}{12}, \quad - \sum_{m=1}^{\infty} \frac{(-1)^m}{m^4} = \frac{7\pi^4}{720},$$

so that

$$\begin{aligned} (16. 39') \quad I &= \int_0^{\infty} \frac{f(\epsilon)}{e^{(\epsilon-\mu)/kT} + 1} d\epsilon \\ &= \int_0^{\mu} f(\epsilon) d\epsilon + \frac{\pi^2}{6} (kT)^2 \left(\frac{df}{d\epsilon} \right)_{\epsilon=\mu} + \frac{7\pi^4}{360} (kT)^4 \left(\frac{d^3 f}{d\epsilon^3} \right)_{\epsilon=\mu} \\ &\quad + \dots \end{aligned}$$

Equation (39') will now be applied to calculate μ . Using (25') and

$$(16. 41) \quad N = \int_0^{\infty} N(\epsilon) d\epsilon = \frac{3N}{2\mu_0^{3/2}} \int_0^{\infty} \frac{\epsilon^{1/2} d\epsilon}{e^{(\epsilon-\mu)/kT} + 1},$$

one finds that $f(\epsilon) = \epsilon^{1/2}$ in this problem. The integral $F(\mu)$ is

$$\int_0^\mu f(\epsilon) d\epsilon = \int_0^\mu \epsilon^{1/2} d\epsilon = \frac{2}{3} \mu^{3/2}.$$

The derivatives are

$$\left(\frac{df}{d\epsilon}\right)_{\epsilon=\mu} = \frac{1}{2} \mu^{-1/2} \quad \text{and} \quad \left(\frac{d^3f}{d\epsilon^3}\right)_{\epsilon=\mu} = \frac{3}{8} \mu^{-5/2}.$$

Using these with (39') in (41) one finds

$$(16. 42) \quad \left(\frac{\mu}{\mu_0}\right)^{3/2} \left[1 + \frac{\pi^2}{8} \left(\frac{kT}{\mu}\right)^2 + \frac{7\pi^4}{640} \left(\frac{kT}{\mu}\right)^4 + \dots \right] = 1,$$

which determines μ as a function of μ_0 and T .

In order to make the equation explicit in μ the development

$$\frac{1}{(1+x)^{2/3}} = 1 - \frac{2x}{3} + \frac{5x^2}{9} - \dots$$

is used to obtain the form

$$\mu = \mu_0 \left[1 - \frac{\pi^2}{12} \left(\frac{kT}{\mu}\right)^2 + \frac{\pi^4}{720} \left(\frac{kT}{\mu}\right)^4 + \dots \right],$$

and in this $\mu^{-2} = \mu_0^{-2} [1 + (\pi^2/6) (kT/\mu_0)^2]$ is substituted in the quadratic term. In the quartic term, which is the last correction, μ_0 is simply substituted for μ . One obtains

$$(16. 43) \quad \mu = \mu_0 \left[1 - \frac{\pi^2}{12} \left(\frac{kT}{\mu_0}\right)^2 - \frac{\pi^4}{80} \left(\frac{kT}{\mu_0}\right)^4 + \dots \right],$$

as an equation for μ , the chemical potential, in terms of kT and μ_0 . μ_0 , the chemical potential at $T = 0$, is given in turn as a function of the volume V by (21).

The energy E may be calculated by using the relationship that

$$(16. 44) \quad E = \int_0^\infty \epsilon N(\epsilon) d\epsilon = \frac{3N}{2\mu_0^{3/2}} \int_0^\infty \frac{\epsilon^{3/2} d\epsilon}{e^{(\epsilon-\mu)/kT} + 1},$$

from (25').

In this integral $f(\epsilon) = \epsilon^{3/2}$ and

$$\int_0^\mu f(\epsilon) d\epsilon = \frac{2}{5} \mu^{5/2},$$

$$\frac{df}{d\epsilon} = \frac{3}{2} \mu^{1/2}, \quad \frac{d^3f}{d\epsilon^3} = -\frac{3}{8} \frac{1}{\mu^{3/2}},$$

so that

$$E = \frac{3}{5} N \left(\frac{\mu}{\mu_0} \right)^{3/2} \mu \left[1 + \frac{5\pi^2}{8} \left(\frac{kT}{\mu} \right)^2 - \frac{7\pi^4}{384} \left(\frac{kT}{\mu} \right)^4 + \dots \right]$$

is obtained.

By using (43) to replace μ with μ_0 , one finds for the energy

$$(16. 45) \quad E = \frac{3}{5} N \mu_0 \left[1 + \frac{5\pi^2}{12} \left(\frac{kT}{\mu_0} \right)^2 - \frac{\pi^4}{16} \left(\frac{kT}{\mu_0} \right)^4 + \dots \right].$$

16h. The Thermodynamic Functions of a Degenerate Fermi-Dirac Gas

The chemical potential μ , equation (43), and the energy E , equation (45), of the degenerate Fermi-Dirac gas have been obtained as power series of the temperature, in terms of μ_0 , equation (21), which is a function of the volume.

The most direct statistical method of calculating the entropy would be to use the equation for Ω_j , the number of quantum states of the region j as a function of N_j and C_j , the numbers of particles and cells, respectively. Ω_j was calculated in Chapter 5 and is given in equation (5. 4) and its logarithm in equation (5. 9). $S_j = k \ln \Omega_j$ is the entropy of the region, and $S = \sum S_j$ gives the entropy of the whole system in the equilibrium distribution if (19) is used for N_j/C_j . This procedure would involve another comparatively complicated integration and will therefore be avoided.

Equation (45), giving E as a function of temperature and volume,

$$(16. 46) \quad E = N \mu_0 \left[\frac{3}{5} + \frac{\pi^2}{4} \left(\frac{kT}{\mu_0} \right)^2 - \frac{3\pi^4}{80} \left(\frac{kT}{\mu_0} \right)^4 + \dots \right],$$

with (21),

$$(16. 47) \quad \mu_0 = \frac{\hbar^2}{8m} \left(\frac{3N}{\pi V} \right)^{2/3}, \quad \frac{d\mu_0}{dV} = -\frac{2\mu_0}{3V},$$

is sufficient to permit the calculation of all other thermodynamic functions since it has already been shown that the entropy S is zero at $T = 0$.

The heat capacity at constant volume, C_V , is found by direct differentiation of (46) to be

$$(16. 48) \quad C_V = Nk \frac{\pi^2}{2} \frac{kT}{\mu_0} \left[1 - \frac{3\pi^2}{10} \left(\frac{kT}{\mu_0} \right)^2 + \dots \right].$$

Since numerical evaluation of (47) has shown that $\mu_0/k = 301,810^\circ\text{K.} \times V^{-2/3}$, in which V , the molal volume of the electrons, is about ten in a metal, one sees from (48) that C_V at room temperature is about 10^{-2} times the classical value, $C_V = \frac{3}{2}Nk$.

The entropy may be obtained by integration of C_V/T , with respect to the temperature, from zero to T ,

$$(16. 49) \quad S = \int_0^T \frac{C_V}{T} dT = Nk \frac{\pi^2}{2} \frac{kT}{\mu_0} \left[1 - \frac{\pi^2}{10} \left(\frac{kT}{\mu_0} \right)^2 + \dots \right] \\ = \frac{N\mu_0}{T} \left[\frac{\pi^2}{2} \left(\frac{kT}{\mu_0} \right)^2 - \frac{\pi^4}{20} \left(\frac{kT}{\mu_0} \right)^4 + \dots \right].$$

The work function, $A = E - TS$, is, from (46) and (49),

$$(16. 50) \quad A = N\mu_0 \left[\frac{3}{5} - \frac{\pi^2}{4} \left(\frac{kT}{\mu_0} \right)^2 + \frac{\pi^4}{80} \left(\frac{kT}{\mu_0} \right)^4 - \dots \right] \\ = \frac{3}{5} N\mu_0 \left[1 - \frac{5\pi^2}{12} \left(\frac{kT}{\mu_0} \right)^2 + \frac{\pi^4}{48} \left(\frac{kT}{\mu_0} \right)^4 - \dots \right].$$

The pressure P is given by $-(\partial A/\partial V)_T$, and with (47) in (50) one finds

$$(16. 51) \quad P = \frac{N\mu_0}{V} \left[\frac{2}{5} + \frac{\pi^2}{6} \left(\frac{kT}{\mu_0} \right)^2 - \frac{\pi^4}{40} \left(\frac{kT}{\mu_0} \right)^4 + \dots \right] \\ = \frac{2}{5} \frac{N\mu_0}{V} \left[1 + \frac{5\pi^2}{12} \left(\frac{kT}{\mu_0} \right)^2 - \frac{\pi^4}{16} \left(\frac{kT}{\mu_0} \right)^4 + \dots \right] \\ = \frac{2}{3} \frac{E}{V}.$$

The equation $PV = 2E/3V$, found at $T = 0^\circ\text{K.}$, equation (23), is seen to be independent of temperature.

The heat content, $H = E + PV$, is accordingly

$$(16. 52) \quad H = \frac{5}{3} E = N\mu_0 \left[1 + \frac{5\pi^2}{12} \left(\frac{kT}{\mu_0} \right)^2 - \frac{\pi^4}{16} \left(\frac{kT}{\mu_0} \right)^4 + \dots \right].$$

Finally, forming $F = H - TS$, one finds

$$(16. 53) \quad F = N\mu_0 \left[1 - \frac{\pi^2}{12} \left(\frac{kT}{\mu_0} \right)^2 - \frac{\pi^4}{80} \left(\frac{kT}{\mu_0} \right)^4 + \dots \right],$$

which is, of course, seen to be $N\mu$, by comparison with (43).

It is to be noted that in all the equations for the thermodynamic properties of the gas the temperature-dependent part occurs as kT/μ_0 . Since μ_0/k is about 10^5 °K. for the molal volumes of electrons in metals, kT/μ_0 is about 10^{-3} to 10^{-2} for ordinary temperatures. The thermodynamic functions of the degenerate gas, at the concentrations considered, do not depend greatly on T . In particular the heat capacity is almost negligible compared to that due to the vibrations of the ions up to considerable temperatures.

16i. Electrons in Metals

Perhaps the best justification for treating metals as if they contained a perfect gas of electrons is that obtained *a posteriori* by the agreement between predictions and the observed experimental facts. This comparison will not be carried far in this book.

That electrons can move freely in a metal is a direct consequence of the experimental fact that the electric current is not accompanied by transport of the atoms composing the crystal lattice. Since the conductivity of true metals decreases with increasing temperature, it is clear that no "activation energy" is necessary to dislodge the electrons from an equilibrium position of rest.

The ratio of the conductivity of heat, which is much higher in metals than in insulators, to the conductivity of electricity, is a universal function of temperature, independent of the nature of the metal. This fact is known as the law of Wiedemann and Franz. Obviously, this can be explained only by attributing both phenomena to the same mechanism. The heat conductivity of metals must therefore be due essentially to the electrons, showing that they are able to move, even without an electric field, and to carry kinetic energy. The treatment of these phenomena in sections 16k-16m leads to the correct ratio between thermal and electrical conductivity.

This freedom of motion of the electrons can be well understood on the basis of quantum-mechanical calculations. Actually, an electron in a metal is not "free," but subject to strong and rapidly varying forces. These forces are of two origins: namely, the interaction of the other "valence" or "conduction" electrons on the one considered, and the attraction of the positive metal ions. The first part, the Coulomb repulsion between electrons, e^2/r , is a long-range force, varying only

slowly with distance. The potential on one electron will therefore not depend strongly on the instantaneous position of the others, and one may replace it simply by its average value. This is equivalent to treating the electrons as independent, non-interacting particles, and is, in general, not a bad assumption. However, just this simplification has to be dropped to explain ferromagnetism, and probably this assumption is also responsible for the failure of the present theory to predict satisfactorily the phenomenon of superconductivity.

There remains to be discussed the attraction of the lattice of the positive metal ions on an electron. This potential is triply periodic, with valleys at the lattice points and hills between them.

If the ions are close together, the potential energy of an electron at a hill between lattice points, even if corrected for the average repulsion of the other conduction electrons, will still be much lower than that outside of the metal. An electron with kinetic energy higher than that of the hills remains inside the metal, but it will certainly not be localized at one ion. Instead it will move freely throughout the whole lattice. From a semi-classical consideration, then, one would expect conduction to occur if neighboring metal atoms are so close together that the height of the hill of potential energy between them becomes less than the energy of the valence electrons.

Quantum-mechanical calculations show, however, that electrons with energies less than that of the lowest potential ridges are able to go "through" the hills. Even these electrons are not, as in classical mechanics, limited to stay at one ion, but can travel, and belong to the crystal as a whole. The rate at which a particle leaks through a potential hill is higher the smaller its mass, and the more nearly its energy approaches that of the top of the hill. The eigenfunctions of all the electrons in this periodic potential field extend throughout the whole lattice and do not vanish at the potential hills between the lattice points.

It is seen, then, that this picture of electrons shared equally by all metal atoms differs from that of a perfect gas of electrons only in that the number of quantum states $C(\epsilon) \Delta\epsilon$, for an electron in an energy range $\Delta\epsilon$, may be different from (20). In calculations for special cases this can be taken into account. It is apparent, however, that an alteration of the function $C(\epsilon)$ will not alter the results qualitatively, as long as $C(\epsilon)$ remains of such a form that the energy μ_0 of the highest filled level is of the order of magnitude of (21), and as long as $C(\mu_0)$ is different from zero, that is, as long as there are, at zero temperature, unoccupied electron levels above the filled ones. This latter condition distinguishes a metal from an insulator. Only if there are unfilled levels available

directly above the filled ones, can an electric field accelerate the electrons, namely, raise them to higher quantum states.

In the neighborhood of each ion the wave functions of the metal electrons will resemble those of the electron in the free atom. As long as the distance between the lattice points is rather large, each metal wave function, extending throughout the lattice, can be approximated as a sum of the atomic eigenfunctions around the different lattice points, the function at each lattice point being multiplied by a phase factor depending on the position of that point. The different metal eigenfunctions, arising from the same atomic state, differ then only in the numerical values of these phase factors. The phase factors for the possible electron waves are characterized by three quantum numbers $\mathbf{k}_x, \mathbf{k}_y, \mathbf{k}_z$; indeed, they have precisely the form of a standing wave, and may be obtained from equation (2. 18) by inserting for x, y, z the position of the lattice point in question. The numbers $\mathbf{k}_x, \mathbf{k}_y, \mathbf{k}_z$ are again connected with the linear momentum of the electron.

The energy of these eigenfunctions, in this approximation, is given, except for an additive constant involving the atomic energy, by

$$-\beta \left[\cos \frac{\pi \mathbf{k}_x}{N^{1/3}} + \cos \frac{\pi \mathbf{k}_y}{N^{1/3}} + \cos \frac{\pi \mathbf{k}_z}{N^{1/3}} \right],$$

where β is some integral over the atomic eigenfunctions. For small values of $\mathbf{k}_x, \mathbf{k}_y, \mathbf{k}_z$ this may be developed, leading to an expression analogous to that for the energy of free electrons and therefore to an analogous $C(\epsilon)$, except that the mass m is here replaced by an expression containing β .

Since there are only N atoms in the metal, and therefore only N lattice points, it follows that only N different values of $\mathbf{k}_x, \mathbf{k}_y, \mathbf{k}_z$ lead to different phase factors at the lattice points, just as the number of different lattice vibrations is limited to $3N$ in the Debye theory. Owing to spin there are then $2N$ cells in the metal corresponding to each undegenerate orbital electronic function of the free atom. The total number of states is the same in the metal as in the N free atoms of the gas.

This separation of the single electron cells into bands of $2N$ cells each (including spin states) is characteristic of the approach in terms of the non-perturbed atomic functions. It may, however, also be derived by considering the perturbing effect of the periodic lattice points on the wave functions in field-free space. In this case the band structure arises because those eigenfunctions whose nodes occur with the same periodicity as the lattice points will be particularly perturbed.

The characteristic behavior of the metal, high electrical and heat conductivity, is due to the existence of a continuous band of unfilled cells for the electrons, immediately above the filled levels. These unfilled levels will be present, either if the atoms contain only one valence electron (the alkalis), so that there are N electrons for $2N$ cells, or if the bands due to the electronic states above those of the valence electrons overlap those below. This, for instance, is true in the

alkaline earths, where the p electron bands overlap the s bands, which are filled with a pair of electrons from each atom.

In a crystal composed of rare-gas atoms, the energy of the lowest excited level is so high that the bands originating from these levels do not overlap the filled bands of the valence electrons. Similarly in molecular lattices, such as those of Cl_2 , Br_2 , O_2 , and N_2 , the first excited levels have too high an energy to lead to bands overlapping the valence electron levels. In crystals of all these materials, then, there exist no unfilled electron states immediately above the highest filled state in the crystals. These crystals are not conductors and are non-metallic.

For sodium, Slater* has undertaken a careful calculation of the eigenfunctions of the conduction electrons, showing that they are standing waves modulated at the places of the ions. The value of the density of states, $C(\epsilon)$, obtained by him is surprisingly close to that of (20). In general, it is to be expected that the electrons of energy higher than that of the potential maxima between the ions will not be greatly disturbed by the periodic potential field. Consequently, the value of $C(\epsilon)$ at the top of the Fermi distribution, $C(\mu_0)$, which enters most calculations, is somewhat more trustworthy than $C(\epsilon)$ near $\epsilon = 0$.

After this partial justification and criticism of the theory we shall return to the simple picture that the valence electrons in a metal form a perfect gas of independent particles. The potential energy for these electrons inside the metal is much lower than on the outside. If the average value of this potential in the metal is $-u$, measured from zero potential outside of the metal, it is clear that u must be considerably greater than μ_0 , equation (21), or the electrons at the top of the band, of kinetic energy μ_0 , would penetrate the surface and leave the metal, even at zero temperature.

16j. The Richardson Effect

The electrons in the metal may be regarded as a gas composed of independent particles moving in a potential energy trough with steep walls at the surface of the metal. The value of the potential outside of the metal may be taken as zero; the potential inside the metal is really periodic in space, but we approximate it as being constant, and having the value $-u$, per electron throughout the metal. The thermodynamic energies, E , F , and A , etc., of section 16h are all measured from the bottom of this potential trough, so that the choice of the potential of the space outside of the metal as zero alters their values by the additive term $-U = -Nu$.

Since, in any metal, the electrons do not leave the metal surface at $T = 0$, it follows that u must be greater than μ_0 , the kinetic energy of

* J. C. Slater, *Phys. Rev.*, **45**, 794 (1934).

the electrons of highest energy at $T = 0$. As the temperature rises, however, some of the electrons have greater kinetic energy, and at any fixed temperature a finite fraction of all the electrons will have kinetic energies greater than u , sufficient to penetrate the potential barrier at the surface and to leave the metal. This evaporation of the electrons from the metal surface is known as the Richardson effect or as thermionic emission.

A direct evaluation of the rate of emission of electrons per square centimeter of surface may be made by calculation of the numbers of electrons striking unit surface in unit time, with sufficient component of momentum, normal to the surface, to overcome the potential barrier. The calculation is not difficult but will be deferred in favor of an alternative consideration which brings out more clearly how little this electron emission depends upon the character of the metal.

At any given temperature the metal will be in equilibrium with a definite concentration of electron gas in the space surrounding it. This concentration, however, will depend not only on the temperature, but also on the electrical potential of the space surrounding the metal. It is necessary, then, that, in order to avoid complications which do not interest us at present, we assume the presence of a positive ion gas of the same electrical density as the electron gas, so that the electrical potential of the space surrounding the metal is everywhere zero, and the potential difference between the interior of the metal and all points in this space is still u .

In this case the concentration of the electron gas outside the metal, which is in equilibrium with the electrons in the metal, is simply determined by the condition that the chemical potential of this gas be $-w = \mu - u$, the same chemical potential as that of the electrons in the metal, when both are measured from the same zero of energy, namely, the potential of the space surrounding the metal. Now if the electrical potential of the space outside the metal is constant we can readily determine the number of electrons striking unit surface of metal in unit time from the outside, and can do this by using equation (1. 38) already calculated in Chapter 1.

At equilibrium the number of electrons leaving the surface of the metal, and the number entering, are necessarily equal. It follows that we may use the number hitting from the gas outside the metal at equilibrium for a calculation of the thermionic emission. However, an additional assumption is necessary before either the number of electrons striking the surface from outside, or the number of sufficient momentum from the inside, may be interpreted as giving the number of electrons leaving 1 cm.² of metallic surface per second under the conditions of

thermionic emission. This assumption is that the reflection coefficient at the surface is zero. It may be that a fraction r of the electrons having sufficient energy to cross the surface are reflected on hitting it, and only the fraction $1 - r$ of them penetrate into the space outside. The laws of mechanics demand that exactly this same fraction, $1 - r$, of the electrons striking the metal from the equilibrium gas in the vacuum penetrate into the metal. At any rate, the numbers entering and leaving the metal at complete equilibrium are equal, and since the number leaving is not affected by the presence of the gas outside, this number will give the thermionic current under the experimental conditions.

The negative of the chemical potential, w , or free energy per mole, $W = N_0 w$, of the electrons in the metal, measured from the electrical potential of the space outside the metal as zero, is called the work function for electrons of the metal in question,

$$(16. 54) \quad w = u - \mu, \quad W = U - F = N_0 w.$$

The chemical potential μ measured from the potential $-u$ in the metal is given by (43). Since μ varies but little with temperature, w is often regarded as temperature independent, which, of course, is not strictly true.

The work function w is fairly large; it is of the order of magnitude of several volts or several tens of kilocalories. $-w$ is the chemical potential of the equilibrium electron gas outside the metal, and since $w/kT \gg 1$, the unity in the expression $e^{(\epsilon+w)/kT} + 1$ may be neglected in the distribution function, and the equations for this gas may be obtained by using the classical formulas. In short, the density of the electron gas outside the metal is so low that in spite of the small mass $N(\epsilon)/C(\epsilon)$ is small for all kinetic energies, and the gas is completely non-degenerate.

Equation (6. 25) for the chemical potential $-w$ of the gas in terms of its pressure P ,

$$(16. 55) \quad -w = \frac{F}{N_0} = kT \ln \left\{ \left(\frac{\hbar^2}{2\pi m k T} \right)^{3/2} \frac{1}{Q_i} \frac{P}{kT} \right\},$$

may be used. The electron has a spin $s = \frac{1}{2}$, the degeneracy $2s + 1$ of the lowest, and only, internal quantum level of the electron is two, so that $Q_i = 2$. Equation (55) may be solved explicitly for P , as

$$(16. 56) \quad P = 2kT \left(\frac{2\pi m k T}{\hbar^2} \right)^{3/2} e^{-w/kT}.$$

This gives the vapor pressure of electrons outside the metal in terms of

the work function w , assuming that the space charge in the volume which contains the electron gas is neutralized.

Using equation (1. 38) for the number Z of gas molecules striking unit surface in unit time,

$$(16. 57) \quad Z = \frac{P}{\sqrt{2\pi mkT}},$$

the current, $I = eZ$, carried by the electrons may be calculated by inserting P from (56) in (57), as

$$(16. 58) \quad I = \frac{4\pi em(kT)^2}{h^3} e^{-w/kT}.$$

This is the Richardson* emission equation for the thermionic emission of electrons from a metallic surface. The possible reflection coefficient, r , being neglected, the numerical factor in front of (58) is independent of the metal; w alone varies from metal to metal. Numerical evaluation leads to

$$(16. 58') \quad I = 120.1T^2 e^{-w/kT} \text{ amp. cm.}^{-2}$$

Experimentally (58') is usually used in the form

$$(16. 58'') \quad \log_{10} I \text{ (amp. cm.}^{-2}\text{)} = 2.07968 + 2 \log_{10} T - \frac{w}{2.303kT},$$

so that, with the assumption that the work function is independent of temperature, a plot of $\log_{10} (I/T^2)$ against $1/T$ gives a straight line with $w/2.303k$ as the negative of the slope. If the surface area of the emitting metal is known, the absolute current may be found, and the numerical factor, 120.1 amp. cm.⁻² in (58''), checked.

For several metals this method has given the numerical factor 60 amp. cm.⁻², just half of the value in (58'). This half value, at the time of the experiments, was the theoretically predicted value, since at that time the spin of the electron was unsuspected. It has already been mentioned that (58) should actually be multiplied by $1 - r$, with r the (averaged) reflection coefficient. Quantum-mechanical calculations indicate that r should be negligible for clean metal surfaces. It is questionable whether the experimental factor of $\frac{1}{2} \times 120$ should be interpreted as showing a reflection coefficient $r = \frac{1}{2}$. More probably it is an accidental relationship, and the true explanation lies in the expected, although small, temperature dependence of w , due to expansion of the

* Derived by Laue and Dushman, M. von Laue, *Jahrb. Radioakt. Elektronik*, **15**, 205 (1918); S. Dushman, *Phys. Rev.*, **21**, 63 (1923).

metal lattice. Then, of course, the slope of (58'') no longer gives w directly.

Before leaving the subject of thermionic emission, it will be shown how, in detail, the numbers of electrons leaving the metal surface equal the numbers entering from the equilibrium gas outside of the metal. In the momentum range $dp_x dp_y dp_z$, and unit volume, there are $(2/h^3) dp_x dp_y dp_z$ cells, and $[e^{(\epsilon-\mu)/kT} + 1]^{-1}$ electrons per cell. The number from this momentum range crossing unit surface, normal to the x axis, per second, is ($v_x = p_x/m$),

$$(16. 59) \quad z = \frac{p_x}{m} \frac{2}{h^3} \frac{1}{e^{(p_x^2+p_y^2+p_z^2)/2mkT - \mu/kT} + 1} dp_x dp_y dp_z \\ = \frac{1}{mh^3} \frac{1}{e^{(p_x^2+p_y^2+p_z^2)/2mkT - \mu/kT} + 1} d(p_x^2) dp_y dp_z.$$

Only electrons whose x component of momentum is greater than p_{ox} , $p_{ox}^2/2m = u$, can overcome the potential hill at the surface and escape. The x component squared, p_{xv}^2 , after escape into the vacuum will be $p_{xv}^2 = p_x^2 - 2mu$, so that, remembering that $w = u - \mu$, (59) may be written

$$(16. 59') \quad z = \frac{1}{mh^3} \frac{1}{e^{(p_{xv}^2+p_y^2+p_z^2)/2mkT + w/kT} + 1} d(p_{xv}^2) dp_y dp_z$$

in terms of the momenta, $p_y p_z$ and p_{xv} which the electron will have in the vapor outside of the metal. Equation (59'), however, is just the equation for the number of electrons in the momentum range $dp_{xv} dp_y dp_z$ of the equilibrium gas hitting unit surface normal to the x axis in unit time, since $-w$ is the chemical potential in the gas. The total number, Z , hitting the surface is obtained by integrating (59') over all values of p_y and p_z from $-\infty$ to $+\infty$, and p_{xv}^2 from zero to infinity.

The form (58) for the Richardson effect is valuable only in so far as it can be assumed that w is essentially temperature independent. This temperature independence of the work function is due to the degeneracy of the electron gas in the metal and the consequent low specific heat of the electrons. If the gas inside of the metal were assumed to be classical, w would contain an additive term $+kT \ln T^{3/2}$, so that (58) would become

$$I \sim T^{1/2} e^{-w_0/kT}.$$

The dependence on T^2 predicted by (58) appears to be experimentally verified.

The relation between w and the potential, u , is entirely different if

the electrons in the metal are treated as a classical or, as here, a Fermi-Dirac gas. For a classical gas, μ , the chemical potential inside the metal, measured from the bottom of the trough, would be negative; $w = u - \mu$ would, consequently, be larger than the potential u . Here it is predicted that w is several electron volts smaller than u . This can be checked by comparison with other experiments.

If an electron, possessing kinetic energy ϵ outside, is shot into the metal, its energy above the bottom of the potential trough, or its kinetic energy inside, is $\epsilon + u$. Now, according to equation (2. 15), the wavelength h/p associated with the electron motion in a constant potential field is inversely proportional to the root of the kinetic energy. The ratio of the wavelength of the electron outside and inside the metal, λ_o/λ_i , the index of refraction of the electron wave, is correspondingly given by $\lambda_o/\lambda_i = [(\epsilon + u)/\epsilon]^{1/2}$.

The electron waves, precisely as light waves, are diffracted by the grating formed of the regular arrangement of the ions in the metal crystal. For the diffraction at the surface the wavelength outside, λ_o , is responsible. But the diffraction effects in the interior depend on the wavelength λ_i of the electrons inside the metal. For known lattice distances the measurements of diffraction maxima and minima due to the *space* lattice enables one to calculate λ_i . Since ϵ , and therefore λ_o , are directly determined from the known accelerating potential for the electron, one is able, in this manner, to measure u . The difference of the experimental values* of u and w is, according to the results of this section, equal to the Fermi energy μ . The agreement of the order of magnitude of $u - w$ with that of μ_o , determined from (21), is very good, indeed so good that attempts have been made to calculate from this comparison the one factor in μ_o which is not determined with certainty, namely, the number of electrons which each metal atom contributes to the electron gas. For instance, in nickel $u - w$ is 11.6 electron volts. One obtains agreement with μ_o , calculated from (21) only by assuming that there exist two conduction electrons per metal atom. However, the whole picture of completely free electrons is too rough to put much faith in these detailed considerations.

The work function w can also be determined by the photo effect. In these experiments, light of one frequency range is shone into the metal. The electrons are able to absorb a light quantum $h\nu$, transforming it into kinetic energy. If an electron is raised, by this process, to a state of energy higher than u it may be able to leave the metal. This liberation of electrons under the influence of light is called the photoelectric effect.

* H. Bethe, *Ann. Physik*, **87**, 55 (1928); E. Rupsch, *Leipziger Vortrage*, 1930.

Obviously, light of frequency ν is capable of ejecting from the metal only those electrons whose kinetic energy was originally larger than $u - h\nu$. As long as the frequency of the incident light is less than w/h , therefore, there are only very few electrons in the metal possessing energies higher than $+u - h\nu > u - w = \mu$, and the photocurrent will be effectively zero. If the frequency is increased, until $h\nu > w$, this situation is completely changed. There exist now many electrons which, by gaining the energy of one photon, arrive at a state of energy above u , from which they can escape as photoelectrons. The photocurrent will therefore start at $h\nu = w$, the sharpness of the increase depending on the temperature. This prediction is well corroborated by experiment.

The details of the calculation of the photocurrent depend on the transition probability, the derivation of which is beyond the scope of this book. The agreement with experiment is very satisfactory.*

The fact that the chemical potential μ measured from the potential energy $-u$ of the metal is different for different metals is responsible for the Volta potential. If two metals are brought in contact electrons will flow between them until the absolute chemical potentials of electrons in the two metals are equal. This flow of electrons is not sufficient to change the absolute density of the electrons in the metal appreciably and therefore does not affect the values of μ , but it does alter the electrical potential ϕ of the metals. The potential energy of the electrons in the metal, measured from the same arbitrary zero as the electrical potential ϕ , is $-e\phi$. The chemical potential measured from this arbitrary zero is then $\mu_a - e\phi_a$ in the metal a . One has, then, for two metals

$$\begin{aligned}\mu_a - e\phi_a &= \mu_b - e\phi_b \\ \phi_a - \phi_b &= \frac{1}{e} (\mu_a - \mu_b).\end{aligned}$$

The potential energy difference between an electron in the metal a and in the vacuum immediately outside of the metal surface is always $-u_a$, and the electrical potential difference between the interior of the metal and the vacuum (immediately outside of the metallic surface) is $\phi_a - \phi_{av} = u_a/e$. It follows that the electrical potential in the vacuum at the surface of two different metals is different,

$$\phi_{av} - \phi_{bv} = \phi_a - \phi_b + \frac{1}{e} (u_b - u_a)$$

* R. H. Fowler, *Phys. Rev.*, **38**, 45 (1931).

or

$$\begin{aligned}\phi_{av} - \phi_{bv} &= \frac{1}{e} [(u_b - \mu_b) - (u_a - \mu_a)] \\ &= \frac{1}{e} (w_b - w_a)\end{aligned}$$

from (54), where w_a and w_b are the work functions of the two metals.

If two parallel metallic plates of different materials are connected by a wire (at a uniform temperature), there exists an electric field in the space between these plates. This field is determined by the difference in work function of the two metals, and the distance between the plates.

16k. Approximate Calculation of the Heat and Electrical Conductivity of Metals

If the electrons suffered no collisions in the metal an electric field would accelerate them beyond all limit, and the electrical conductivity would be infinite. In Chapter 1 the transport phenomena in a classical gas were considered, and it was found that the equations obeyed in the various processes considered there all involved the mean free path of the molecules in the gas. The electrical and heat conductivity of the electrons in a metal, similarly, depends on the mean free path of the electrons in the metal.

However, the collisions which limit the free path of the electrons are not primarily those between electrons, which are negligible, but those between the electrons and the fixed ions composing the crystal lattice.

For classical particles, then, one would be inclined to assume that this mean free path l was of the order of magnitude of the distance between lattice points, and practically independent of temperature. This conclusion is false. In order to estimate the value of l it is necessary to take full account of the quantum-mechanical nature of the electronic states.

The result of such a detailed calculation of the collisions made by the electrons shows that a perfectly periodic lattice of ions would cause no collisions. The collisions are due only to the displacement of the ions from their equilibrium positions by impurities and temperature motion. As a result one finds that l is inversely proportional to temperature. It turns out that l is approximately one hundred lattice distances at room temperature. For the present, equations will be derived in which the mean free path l enters as an entirely unknown parameter.

The more exact calculations are complicated by the fact that the exclusion principle, which forbids more than one electron per cell, limits the possible results of the collisions between electrons and ions. The equations derived in this section, neglecting this effect, and making

some other simplifying assumptions, differ from those derived with the more rigorous method of section 16m in the numerical coefficients.

The heat conductivity of a metal is enormously greater than that of a non-metallic crystal. For instance, the heat conductivity of silver in calories per square centimeter cross section with a temperature gradient of one degree per centimeter is about unity, whereas that of glass is about 2×10^{-3} .

The heat conductivity of an insulator is due to the lattice vibrations, which of course also conduct some of the heat in metals. However, at least in the heavy metals, the contribution of the electrons to the heat conductivity is so much greater than that of the lattice that the latter may be entirely neglected.

The equation for the heat conductivity κ of a gas has already been derived in section 1j and is given in equation (1. 62) as

$$(16. 60) \quad \kappa = \frac{1}{3} l \frac{N}{V} \frac{C_V}{N} \bar{v},$$

where C_V is the heat capacity and \bar{v} the average velocity of the particles composing the gas. This average velocity, in the case of the electron gas, is high, even at zero degrees absolute, and changes relatively little with temperature. The value of \bar{v} at $T = 0$ will be calculated and used in (60).

Since the kinetic energy of the electrons is $\frac{1}{2}mv^2 = \epsilon$, it follows that $v = (2\epsilon/m)^{1/2}$, and the equation for the average velocity \bar{v} is

$$\bar{v} = \frac{1}{N} \int_0^{\mu_0} \left(\frac{2\epsilon}{m}\right)^{1/2} C(\epsilon) d\epsilon.$$

Using (20') that

$$C(\epsilon) = \frac{3}{2} N \frac{\epsilon^{1/2}}{\mu_0^{3/2}},$$

one obtains

$$v = \frac{3}{2\mu_0^{3/2}} \left(\frac{2}{m}\right)^{1/2} \int_0^{\mu_0} \epsilon d\epsilon = \frac{3}{4} \left(\frac{2\mu_0}{m}\right)^{1/2}.$$

Since the velocity v_μ of the particles at the top of the filled cells, whose energy is μ_0 , is given by

$$v_\mu = \left(\frac{2\mu_0}{m}\right)^{1/2},$$

one may write

$$(16. 61) \quad \bar{v} = \frac{3}{4} \left(\frac{2\mu_0}{m}\right)^{1/2} = \frac{3}{4} v_\mu.$$

Using this, and equation (48) that $C_V/N = (\pi^2/2)(k^2T'/\mu_0)$, one may write (60) for the heat conductivity κ as

$$(16. 62) \quad \kappa = \frac{\pi^2}{4} \frac{N}{V} \frac{lk^2T}{mv_\mu}.$$

In section 16m it will be seen that the more rigorous derivation leads to the numerical factor $\pi^2/3$ instead of the $\pi^2/4$ given here.

The electrical conductivity may be calculated under the simple assumptions that the electrons come to equilibrium in every collision and that they are statistically as well as mechanically independent. After a collision, then, the electron is assumed to start out with a kinetic energy, the probability of which is proportional to $N(\epsilon)$, equation (25), but with its direction of motion completely random. We shall fix our attention on a large number of specified electrons all of which are assumed to make a collision at the time $t = 0$. Owing to their random directions of motion, their average x velocity, dx/dt , is zero, and the average value of their x coordinate remains constant with time.

If these electrons are subjected to the force of an electric field \mathcal{E} , in the x direction, they experience an acceleration $-e\mathcal{E}/m$ along the x axis, which results in a change in the average value of the x coordinate with time. At the time t after the collision the value of dx/dt will be $-(\mathcal{E}e/m)t$, and the average value, $\overline{dx/dt}$, of the x component of velocity, between $t = 0$ and $t = t_0$, is $-(\mathcal{E}e/2m)t_0$. If t_0 is the time between collisions, then this expression will give the average velocity of the electrons in the field. Since $t_0 = l/\bar{v}$, one finds, for the current density $I = -(N/V)e(\overline{dx/dt})$, the expression

$$I = \frac{N}{V} \frac{e^2l}{2m\bar{v}} \mathcal{E} = \frac{2}{3} \frac{N}{V} \frac{e^2l}{mv_\mu} \mathcal{E}$$

with (61). The electrical conductivity, $\sigma = I/\mathcal{E}$, is then

$$(16. 63) \quad \sigma = \frac{2}{3} \frac{N}{V} \frac{e^2l}{mv_\mu}.$$

The more exact derivation in section 16m results in this expression without the numerical factor $2/3$.

By division of (62) with (63),

$$(16. 64) \quad \frac{\kappa}{\sigma} = \frac{3\pi^2}{8} \left(\frac{k}{e}\right)^2 T$$

is obtained for the ratio of the heat to the electrical conductivity. The fact that this ratio is proportional to the temperature and independent

of the metal is known as the law of Wiedemann and Franz. Experimentally, the ratio is constant, for different metals at the same temperature, within about 15 per cent, and the average ratio agrees well with the numerical factor $\pi^2/3$ derived in section 16m.

The only temperature-dependent quantity entering equation (63) for the electrical conductivity σ is the mean free path l . For a strictly periodic potential, such as that caused by the ions of a perfect crystal at absolute zero, with all the ions in their exact equilibrium positions, the mean free path of the electrons would be infinite. Collisions of the electrons with the ions are due only to imperfections in the lattice. These imperfections arise from two causes: impurities in the crystal, and temperature motion.

For the lattice without impurities, the interaction potential between ions and electrons is proportional to the amplitude of vibration of the ions, which, in turn, is proportional to $T^{1/2}$. The number of collisions per unit time is proportional to the square of the interaction potential and therefore to T . The effect of impurities is to cause a constant, temperature-independent contribution to the number of collisions per unit time. The mean free path is inversely proportional to the number of collisions, so that

$$(16. 65) \quad l = \frac{\lambda_0}{a + T}.$$

The temperature-independent constant a is highly dependent on the amount of impurity in the metal and, presumably, would be zero for a completely pure metal.

As a result, using (65) for l in (63) for σ , it is seen that the temperature dependence of the electrical conductivity is given as

$$(16. 66) \quad \sigma = \frac{A}{B + T},$$

the resistivity, σ^{-1} , is linear in the temperature. This is experimentally observed.

At low temperatures, for which the lattice vibrations are quantized, the conclusion that the amplitudes of vibration vary with $T^{1/2}$ is unjustified and the temperature dependence of σ is more complicated than that of (66).

Although equation (66) leads to an infinite electrical conductivity for an absolutely pure metal at $T = 0$, this prediction is not in agreement with the observed superconductivity at extremely low temperatures. In the observed phenomenon, the conductivity increases discontinuously to infinity at a sharply defined temperature. Some metals do not

become superconducting at the lowest attainable temperatures. The observed superconductivity is presumably associated with an interaction between the electrons, an effect which is neglected in the present theory.

161. The Maxwell-Boltzmann Collision Equation and Its Application to Electrons in Metals

In order to make a somewhat more realistic and more rigorous calculation of the electrical and heat conductivity of metals, a method first employed for gases by Maxwell and Boltzmann will be used.

If a temperature gradient or an electric field is applied to the metal, the electron gas is not in complete equilibrium. The distribution function $g(p_x, p_y, p_z, x, y, z)$, which will be written simply g , giving the number of electrons per cell of momentum p_x, p_y, p_z at the position x, y, z , can no longer be assumed to have the form $g_0 = [e^{(\epsilon - \mu)/kT} + 1]^{-1}$ which was derived for complete equilibrium. However, one may determine the function g under the perturbing influence of the temperature gradient and the field by two conditions which it must fulfill. The first of these is that the function approach g_0 as the field and temperature gradient become zero. The second condition is that the function g be independent of time or, as it is usually stated, that the system is in a stationary state. If the distribution function g is known, the equations for the rate of transport of heat as kinetic energy, or of charge, through the metal, are determined in principle.

The electrons in the metal are treated as a gas of mechanically independent particles; their statistical dependence due to the exclusion principle, that no two may occupy the same cell, will be taken explicitly into account. The mean free path l enters into the equations derived as a certain definite integral. The actual evaluation of this integral, which determines the numerical value of l , is a rather complicated quantum-mechanical problem which will not be attempted. It is in the evaluation of this mean free path that the essentially quantum nature of the interactions between the electrons and the ions of the lattice enters. In all other respects the description in terms of point particles of a classical nature is entirely adequate.

It will be assumed that the electric field and the temperature gradient are both in the same direction, which may be chosen as parallel to the x axis. All properties of the metal, and also of the distribution function, are constant for different y, z values at the same x . g is then a function of x ; but not of y and z . The distribution with respect to the momenta must be symmetrical in the y and z components, p_y and p_z , but not necessarily in p_x . If the symbol p is used for the magnitude of

momentum, $p = (p_x^2 + p_y^2 + p_z^2)^{1/2}$, then g may be written as a function of x , p , and p_x , $g = g(x, p, p_x)$.

For sufficiently small fields g must approach g_0 , the distribution function in complete equilibrium. It will therefore be assumed that one may expand g as a power series in p_x . At sufficiently small fields and temperature gradients it will be justifiable to retain only the linear term. We shall therefore attempt to express g in the form

$$(16. 67) \quad g(x, p, p_x) = g_0(x, p) + p_x g_1(x, p),$$

where

$$(16. 68) \quad g_0(x, p) = \frac{1}{e^{|\epsilon - \mu(x)/kT(x)|} + 1}$$

is the distribution function at equilibrium in which the dependence on x is taken into account by considering μ and T as functions of the coordinate.

Equation (67) is essentially an assumption, but it will be shown that g_1 can be so determined that (67) fulfills the condition of giving a stationary state, and that it becomes $g = g_0$ when electric field and temperature gradient are zero. It will not be proved that it is the only solution.

The condition for the stationary state is set up by considering all possible processes by which the distribution function is changed in time. The sum of all these changes due to different processes must be zero, but unlike the condition at true equilibrium, the change in g due to any one process and its inverse is not zero.

The individual effects which tend to create a change in the density of particles per cell, g , may be classified as three in number.

The first effect is due to the motion of the electrons in the momentum range considered, with a velocity $v_x = p_x/m$ along the x axis. In the time dt , particles from the coordinate position $x - (p_x/m) dt$ arrive at the position x , and those formerly at x have moved to a new coordinate. Since g is a function of x this tends to change the value of g at x . The change due to this effect is, per unit time,

$$- \frac{p_x}{m} \frac{\partial g}{\partial x}.$$

The second effect is due to the acceleration by the electrical field \mathcal{E} which decreases the x component of momentum (negative charge). In the time dt , electrons from the p_x value of $p_x + e\mathcal{E} dt$ reach the range p_x ,

so that this process contributes

$$+ e\mathcal{E} \frac{\partial g}{\partial p_x}$$

to the change in g per unit time.

It may be worth mentioning that these two changes of g will never bring about a conflict with the Fermi statistics or the Pauli principle. If the density of the electrons in the six-dimensional phase space (μ -space) is, at some instance, such that there are not more than two electrons in one cell of volume h^3 , the Liouville theorem guarantees that this density remains constant.

The third process is that of collisions of the electrons with the lattice points, which causes discontinuous transitions of momenta out of, and into, the range considered. The change in g per unit time due to collisions which take particles out of the momentum region will be called $-a$, and that due to electrons entering the region will be indicated by b .

One may write

$$(16. 69) \quad \frac{dg}{dt} = -\frac{p_x}{m} \frac{\partial g}{\partial x} + e\mathcal{E} \frac{\partial g}{\partial p_x} - a + b = 0$$

as the condition for the existence of a stationary state. The main task is the determination of the collision effects, $a - b$.

A simplification which is always made consists in neglecting completely the collisions between electrons, which would be extremely hard to handle. Only collisions between the electrons and the ions of the crystal are considered.

A further simplification which will be used here in determining $a - b$ consists in assuming that in a collision no energy is transferred from the electron to the ion. The collisions are then elastic and change only the direction, but not the magnitude, of the momentum of the electron. Actually, the amount of energy transferred to an ion in an elastic collision, determined by the condition of conservation of kinetic energy and linear momentum, is very small because of the enormous masses of the ions compared to that of the electrons. Only transitions between regions of equal magnitude of momentum p need be considered.

The decrease in $g(\vec{p})$ due to collisions which result in changing the momentum vector to \vec{p}' is proportional to the density $g(\vec{p})$ of electrons with momentum \vec{p} , and to the number of unoccupied cells, $1 - g(\vec{p}')$, at \vec{p}' . The proportionality factor will be called $r_{\vec{p}\vec{p}'}$, so that the number of collisions of this specified type is given by

$$a(\vec{p}') = r_{\vec{p}\vec{p}'} g(\vec{p}) [1 - g(\vec{p}')].$$

The increase in $g(\vec{p})$ due to those collisions which throw electrons of the momentum region \vec{p}' into the range \vec{p} is proportional to $g(\vec{p}')$, to $1 - g(p)$, and to $r_{\vec{p}'\vec{p}}$,

$$b(\vec{p}') = r_{\vec{p}'\vec{p}} g(\vec{p}') [1 - g(\vec{p})].$$

The two constants $r_{\vec{p}'\vec{p}}$ and $r_{\vec{p}\vec{p}'}$ must be equal. This can be deduced by considering the condition of complete equilibrium. Detailed reversibility will then prevail, that is, the rate of each process and its inverse will be equal. At complete equilibrium, therefore, $a(\vec{p}) = b(\vec{p})$. $g(\vec{p})$, under those circumstances, reduces to $g_0(p)$, a function of the magnitude of momentum p only. Since it was assumed that both $r_{\vec{p}\vec{p}}$ and $r_{\vec{p}'\vec{p}'}$ are zero unless the magnitudes of momenta p and p' are equal, it follows that $g_0(p) = g_0(p')$, and therefore the condition $a(\vec{p}) = b(\vec{p})$ can be satisfied only if

$$r_{\vec{p}'\vec{p}} = r_{\vec{p}\vec{p}'}$$

We write, then, since

$$g(\vec{p}) [1 - g(\vec{p}')] - g(\vec{p}') [1 - g(\vec{p})] = g(\vec{p}) - g(\vec{p}'),$$

that

$$(16. 70) \quad a(\vec{p}') - b(\vec{p}') = r_{\vec{p}'\vec{p}} [g(\vec{p}) - g(\vec{p}')].$$

The total change $a - b$ of $g(\vec{p})$, due to the collisions, is obtained by integrating (70) over all directions of the vector \vec{p}' . If the metal is isotropic, the transition probability $r_{\vec{p}'\vec{p}}$ will not depend on the orientation of the vector \vec{p} in space, but only on the angle of deflection θ between the momentum vectors \vec{p} and \vec{p}' . The orientation of \vec{p}' , relative to \vec{p} , is then determined by this angle θ and by the angle ϕ between the plane common to \vec{p} and \vec{p}' , and the plane common to \vec{p} and the x direction. ϕ is so chosen that when $\phi = 0$ the direction of \vec{p}' is closer to the x direction than when $\phi = \pi$.

The total change in g , per unit time, due to collisions, $a - b$, is the integral of $a(\vec{p}') - b(\vec{p}')$, (70), multiplied by the volume element $\sin \theta d\theta d\phi$ over these angles.

Using equations (67) and (68), and remembering always that the magnitudes p and p' are equal, one finds that

$$g(\vec{p}) - g(\vec{p}') = g_1(xp) (p_x - p'_x).$$

If ψ is the angle between \vec{p} and p_x , then

$$p_x = p \cos \psi$$

and

$$p'_x = p \cos \theta \cos \psi + p \sin \theta \sin \psi \cos \phi.$$

The interaction $r_{\vec{p}\vec{p}'}$ will depend on p and on θ , but not on ϕ , so that one may finally write

$$a - b = pg_1(x,p) \int_0^\pi \int_0^{2\pi} r(p,\theta) [\cos \psi - \cos \theta \cos \psi - \sin \theta \sin \psi \cos \phi] \sin \theta \, d\theta \, d\phi.$$

Since $\int_0^{2\pi} \cos \phi \, d\phi = 0$, $\int_0^{2\pi} d\phi = 2\pi$, the integration over ϕ yields

$$(16. 71) \quad a - b = p_x g_1(x,p) \int_0^\pi r(p,\theta) [1 - \cos \theta] 2\pi \sin \theta \, d\theta.$$

Now the main result of all this is simply that for a given magnitude of momentum p and coordinate x the value of $a - b$ is proportional to $p_x g_1(x,p)$. The proportionality constant, the definite integral in (71), depends only on the magnitude of momentum p . Since its dimensions are those of an inverse time, it may arbitrarily be written as v/l , where v is the magnitude of velocity, $v = p/m$, so that

$$(16. 72) \quad a - b = \frac{p}{ml} p_x g_1(x,p).$$

The quantity l in this equation plays the part of the mean free path. Its dependence on the momentum p could be found only by a detailed investigation of the collision process. However, it will turn out that only the value of l for the electrons of the highest filled levels, namely, those of energy $\epsilon = \mu$, enters into the final results.

The fact that the quantity l , defined by the equation

$$(16. 73) \quad \frac{1}{l} = \frac{m}{p} \int_0^\pi 2\pi r(p,\theta) [1 - \cos \theta] \sin \theta \, d\theta,$$

may be interpreted as a mean free path is unessential for our purposes but will, nevertheless, be demonstrated here.

The value of a for the equilibrium distribution $g_0(p)$,

$$a = g_0(p) [1 - g_0(p)] \int_0^\pi 2\pi r(p,\theta) \sin \theta \, d\theta,$$

represents the decrease, per unit time, of the number $g_0(p)$ of electrons per cell, due to collisions throwing electrons out of the momentum region p , and has the dimension time^{-1} . Since $g_0(p)$ is a dimensionless quantity the integral has the dimensions time^{-1} , and since m/p has dimensions time^{-1} , the quantity l in (73) is seen to be a length.

The logarithmic decrease in $g_0(p)$, $a/g_0(p)$ is the probability per unit time that one electron of momentum p makes a collision. The dimensionless factor $1 - g_0(p)$ in this arises from the fact that some of the cells into which collisions should throw the electrons are already filled. If this factor is omitted, one obtains the probability, per unit time, of a collision in a beam of electrons, of momentum p , if all cells of the same magnitude of momentum p but different directions are empty.

If now, in addition, the collisions were weighted by multiplication with $(1 - \cos \theta)$, so that those for which the angle of deflection θ is small are not counted as full collisions, and those for which the deflection θ exceeds 90° are counted as more than full collisions, the integral obtained would be that occurring in (73). This integral,

$$\tau^{-1} = \int_0^\pi 2\pi r(p, \theta) [1 - \cos \theta] \sin \theta d\theta,$$

may be termed the probability per unit time of a collision, it being understood that all cells into which the particle may be deflected are empty, and that the collisions are weighted with $1 - \cos \theta$ for the angle of deflection θ . τ , then, represents the mean time between collisions, and $v\tau = \tau p/m = l$, the mean distance traveled between collisions. In this sense l is a mean free path.

If equation (72) for $a - b$, the net effect of the collisions, is used in (69), which equates the total change of the function g with time to zero, one obtains

$$\frac{p}{ml} p_x g_1(x, p) = -\frac{p_x}{m} \frac{\partial g(x, p, p_x)}{\partial x} + e\mathcal{E} \frac{\partial g(x, p, p_x)}{\partial p_x}.$$

In the right-hand side of this equation, in contrast to the left, the contribution from g_0 does not vanish. Consequently, since $p_x g_1$ may be treated as a small additive term in g , this may be neglected and g_0 alone used. Using the fact that

$$\frac{\partial g_0}{\partial p_x} = \frac{\partial g_0}{\partial \epsilon} \cdot \frac{\partial \epsilon}{\partial p} \cdot \frac{\partial p}{\partial p_x} = \frac{p_x}{m} \frac{\partial g_0}{\partial \epsilon},$$

one obtains

$$p_x \frac{p}{ml} g_1(x, p) = -\frac{p_x}{m} \left(\frac{\partial g_0}{\partial x} - e\mathcal{E} \frac{\partial g_0}{\partial \epsilon} \right),$$

and it is seen that the right-hand side has the same form as the left one, namely p_x times a function of p and x alone. This shows that the function g of the desired form (67) is actually a solution of equation (69).

g_1 is determined by

$$(16. 74) \quad g_1(x, p) = -\frac{l}{p} \left\{ \frac{\partial g_0}{\partial x} - e\mathcal{E} \frac{\partial g_0}{\partial \epsilon} \right\}.$$

With (67) and (68) the distribution function becomes

$$(16. 75) \quad g(x, p, p_x) = g_0 - l \frac{p_x}{p} \left\{ \frac{\partial g_0}{\partial x} - e\mathcal{E} \frac{\partial g_0}{\partial \epsilon} \right\},$$

$$g_0 = \frac{1}{e^{(\epsilon-\mu)/kT} + 1}.$$

The chemical potential μ and the temperature T in (68) are functions of the coordinate x . In general, the experimental conditions are such that we wish to take $T(x)$ as the known function which determines $g(x, p, p_x)$. $\mu(x)$ may be calculated in the usual way as $\mu(T)$, where T is given as a function of x .

Carrying out the differentiation of g_0 with respect to x , one finds,

$$\frac{\partial g_0}{\partial x} = \frac{\partial g_0}{\partial \epsilon} \left[\frac{\mu}{T} - \frac{\epsilon}{T} - \frac{\partial \mu}{\partial T} \right] \frac{dT}{dx},$$

which, if inserted in (75), leads to the equation

$$(16. 75') \quad g(x, p, p_x) = g_0 - l \frac{p_x}{p} \frac{\partial g_0}{\partial \epsilon} \left[-e\mathcal{E} + \frac{dT}{dx} \left(\frac{\mu}{T} - \frac{\epsilon}{T} - \frac{\partial \mu}{\partial T} \right) \right].$$

In the next section this equation will be used to calculate the transport of electricity through the metal under the influence of an electric field, which gives the electrical conductivity, and the transport of heat under the influence of a temperature gradient, which determines the heat conductivity.

16m. Electrical and Heat Conductivity and the Thermoelectric Effect

The density of the electric current, in the x direction, or the current per second through unit cross section, I , is obtained by summing the product of the charge $-e$ by the component of velocity in the x direction, $v_x = p_x/m$, over all electrons within 1 cc. of the material. Since a volume range 1 and a momentum range $dp_x dp_y dp_z$ contains $2/h^3$ cells, there are $\frac{2}{h^3} g(x, p, p_x) dp_x dp_y dp_z$ electrons in this volume and momentum range. The current density is given by this number, multiplied by

$-ep_x/m$, and integrated over all momenta.

$$(16. 76) \quad I = -\frac{2}{h^3} \cdot \frac{e}{m} \iiint_{-\infty}^{+\infty} p_x g(x, p, p_x) dp_x dp_y dp_z.$$

Equation (75') is to be used for g , the number of electrons per cell. In order to calculate the pure electrical conductivity, the temperature is assumed constant, $dT/dx = 0$, so that the only perturbing influence is that of the electric field. Since g_0 is a symmetrical function in p_x , the integral $\int_{-\infty}^{+\infty} p_x g_0 dp_x = 0$, and the first member of (75') contributes nothing to the integral (76). The first term in the second brackets alone

$$I = -\frac{2}{h^3} \frac{e^2 \mathcal{E}}{m} \iiint_{-\infty}^{+\infty} l \frac{p_x^2}{p} \frac{\partial g_0}{\partial \epsilon} dp_x dp_y dp_z$$

determines the current.

The integration is first made over all directions of momentum with constant magnitude of p . The steps may be written by introducing the angle θ between the direction of the momentum p and the x axis, and by converting to

$$\begin{aligned} p &= \sqrt{2m\epsilon} \\ p_x &= p \cos \theta = \sqrt{2m\epsilon} \cos \theta \\ \frac{p_x^2}{p} dp_x dp_y dp_z &= 2\pi p^3 \cos^2 \theta \sin \theta d\theta dp \\ &= 4\pi m^2 \epsilon \cos^2 \theta \sin \theta d\theta d\epsilon. \end{aligned}$$

This leads to

$$I = -\frac{8\pi m}{h^3} e^2 \mathcal{E} \int_0^\infty l \epsilon \frac{\partial g_0}{\partial \epsilon} d\epsilon \int_0^\pi \cos^2 \theta \sin \theta d\theta.$$

The integral over the angle θ is $\frac{2}{3}$, so that one obtains

$$(16. 77) \quad I = -\frac{16\pi m}{3h^3} e^2 \mathcal{E} \int_0^\infty l \epsilon \frac{\partial g_0}{\partial \epsilon} d\epsilon.$$

Since $\partial g_0/\partial \epsilon$ is negative everywhere, I is seen to be positive and proportional to \mathcal{E} .

The integration over the energy ϵ is performed by using the same trick employed in section 16g and limiting ourselves to the zeroth approxima-

tion. Since $-\partial g_0/\partial \epsilon$ has a sharp maximum at $\epsilon = \mu$, which is approximately $\epsilon = \mu_0$, and $\int_0^\infty (\partial g_0/\partial \epsilon) d\epsilon = g_0(\infty) - g_0(0) = -1$, one may write

$$-\int_0^\infty l_\epsilon \frac{\partial g_0}{\partial \epsilon} d\epsilon \cong l_0 \mu_0,$$

where l_0 is the mean free path of the electrons having the energy $\epsilon = \mu_0$.

Using this simplification for the integral in (77) one finds

$$(16. 78) \quad I = \frac{16\pi m}{3h^3} e^2 \mathcal{E} l_0 \mu_0,$$

or, by expressing $1/h^3$ in terms of μ_0 , (21),

$$(16. 78') \quad I = \frac{e^2 \mathcal{E} l_0}{m} \frac{N}{V} \left(\frac{m}{2\mu_0} \right)^{1/2}.$$

The quantity $(2\mu_0/m)^{1/2}$ is v_μ , the velocity of the electrons at the upper edge of the filled bands. Since the electrical conductivity $\sigma = I/\mathcal{E}$, one obtains

$$(16. 79) \quad \sigma = \frac{I}{\mathcal{E}} = \frac{16\pi m}{3h^3} e^2 l_0 \mu_0 = \frac{N}{V} \frac{e^2 l_0}{m v_\mu}.$$

The heat flow Γ , due to the electrons, is the kinetic energy ϵ carried by them along the x axis. This is the product $v_x \epsilon = p_x \epsilon/m$, integrated, for the electrons in unit volume, over all momenta,

$$(16. 80) \quad \Gamma = \frac{2}{h^3} \frac{1}{m} \iiint_{-\infty}^{+\infty} p_x \epsilon g(x, p, p_x) dp_x dp_y dp_z.$$

At first thought one is inclined to set $\mathcal{E} = 0$ in (75') to calculate the distribution function g for a temperature gradient dT/dx and use this in (80) to determine the heat flow. However, under these conditions, $\mathcal{E} = 0$, $dT/dx = 0$, a flow of electricity would take place, that is, the integral (76) for I would not be zero. Since the experimental conditions under which heat conductivity is determined are such that no electrical current can flow, it follows that the temperature gradient in the metal establishes an electric field.

In order to calculate the heat transported under conditions of no electrical current, the field \mathcal{E} is determined in such a way that I calculated by (76) is zero for a given temperature gradient dT/dx . The

heat flow, Γ , of (80), is then calculated with the given dT/dx and the field \mathcal{E} .

It is clear that under all conditions the contributions of the first term g_0 in (75') to both Γ and I are zero, since g_0 is symmetrical in p_x . The general equations

(16. 81)

$$I = -\frac{2e}{h^3 m} \iiint_{-\infty}^{+\infty} l \frac{p_x^2}{p} \frac{\partial g_0}{\partial \epsilon} \left\{ e\mathcal{E} - \frac{dT}{dx} \left(\frac{\mu}{T} - \frac{\epsilon}{T} - \frac{\partial \mu}{\partial T} \right) \right\} dp_x dp_y dp_z$$

and

(16. 82)

$$\Gamma = -\frac{2}{h^3 m} \iiint_{-\infty}^{+\infty} l \frac{p_x^2}{p} \epsilon \frac{\partial g_0}{\partial \epsilon} \left\{ -e\mathcal{E} + \frac{dT}{dx} \left(\frac{\mu}{T} - \frac{\epsilon}{T} - \frac{\partial \mu}{\partial T} \right) \right\} dp_x dp_y dp_z$$

are obtained for the current I and heat flow Γ under arbitrary field and temperature gradient dT/dx .

The abbreviation

$$(16. 83) \quad -\frac{16\pi m}{3h^3} \int_0^\infty l \epsilon^2 \frac{\partial g_0}{\partial \epsilon} d\epsilon = J,$$

will be used. With precisely the same considerations which were applied in the calculation of the electrical conductivity, leading from (76) to (77), equations (81) and (82) may be written as

$$(16. 81') \quad I = \left[e^2 \mathcal{E} - e \frac{dT}{dx} \left(\frac{\mu}{T} - \frac{\partial \mu}{\partial T} \right) \right] J_1 + \frac{e}{T} \frac{dT}{dx} J_2,$$

$$(16. 82') \quad \Gamma = \left[-e\mathcal{E} + \frac{dT}{dx} \left(\frac{\mu}{T} - \frac{\partial \mu}{\partial T} \right) \right] J_2 - \frac{1}{T} \frac{dT}{dx} J_3.$$

Setting the current I in (81') equal to zero requires that the field \mathcal{E} must be

$$(16. 84) \quad e\mathcal{E} = -\frac{1}{T} \frac{dT}{dx} \frac{J_2}{J_1} + \frac{dT}{dx} \left(\frac{\mu}{T} - \frac{\partial \mu}{\partial T} \right).$$

If the field is now eliminated in (82') by using (84) one obtains

$$(16. 85) \quad \Gamma = -\frac{1}{T} \frac{dT}{dx} \frac{J_3 J_1 - J_2^2}{J_1}.$$

The integrals J_i must now be calculated.

To evaluate these integrals, the method developed in section 16g and summarized in equations (39) and (39') is used. The application of this equation with $F(\epsilon) = l\epsilon^\nu$, $d^{2n-1}f(\epsilon)/d\epsilon^{2n-1} = d^{2n}F(\epsilon)/d\epsilon^{2n}$ leads to

(16. 86)

$$J_\nu = \frac{16\pi m}{3h^3} \left[l\mu^\nu + \frac{\pi^2}{6} (kT)^2 \left(\frac{d^2(l\epsilon^\nu)}{d\epsilon^2} \right)_{\epsilon=\mu} \right]$$

$$= \frac{16\pi m}{3h^3} \left\{ l\mu^\nu + \frac{\pi^2}{6} (kT)^2 [\nu(\nu-1)l\mu^{\nu-2} + 2\nu l' \mu^{\nu-1} + l'' \mu^\nu] \right\},$$

where l , l' , l'' signify the zeroth, first, and second derivative of l with respect to ϵ at $\epsilon = \mu$.

Insertion of (86) in (85) shows that in the expression $(J_1 J_3 - J_2^2)/J_1$ the contribution from the terms independent of T cancels. The part which is linear in the correction terms of (86) will therefore give the major contribution. One obtains

$$\frac{J_1 J_3 - J_2^2}{J_1} = \frac{16\pi^3 m}{9h^3} (kT)^2 l\mu.$$

The derivatives of l with respect to ϵ also cancel in this expression. l and μ may now be replaced by their values l_0 and μ_0 at absolute zero. Inserting this into (85), one obtains

$$(16. 85') \quad \Gamma = - \frac{16\pi^3 m}{9h^3} l_0 \mu_0 k^2 T \frac{dT}{dx}.$$

By again eliminating h^3 with the introduction of μ_0 (21) this may also be written

$$(16. 85'') \quad \Gamma = - \frac{\pi^2}{3} \frac{N}{V} \frac{l_0}{m} \left(\frac{m}{2\mu_0} \right)^{1/2} k^2 T \frac{dT}{dx}.$$

The heat conductivity κ is defined as

$$(16. 87) \quad \kappa = - \frac{\Gamma}{dT/dx},$$

so that, using $(2\mu_0/m)^{1/2} = v_\mu$ as in the equation for the electrical conductivity,

$$(16. 88) \quad \kappa = \frac{16\pi^3 m}{9h^3} l_0 \mu_0 k^2 T = \frac{\pi^2}{3} \frac{N}{V} \frac{l_0 k^2 T}{m v_\mu}$$

is obtained for the heat conductivity.

The ratio of heat to electrical conductivity, κ/σ , is found by dividing (88) with (79) to be

$$(16. 89) \quad \frac{\kappa}{\sigma} = \frac{\pi^2}{3} \left(\frac{k}{e} \right)^2 T.$$

Equations (81') and (82') contain, besides the electrical and heat conductivity, all the thermoelectric effects arising from electrical fields or currents and temperature gradients. These are notably the Thomson effect, namely, the reversible generation of heat by electric currents in a metal in which temperature differences are sustained; the Peltier effect, namely, the generation or absorption of heat by a current at the junction between two metals; and finally the potential in a thermocouple, a chain of two metals in which the two junctions are kept at different temperatures. We wish to discuss here only the last effect.

Equation (84) gives the field, at any place in the metal, established by a temperature gradient if no current is allowed to flow. Between two places in the metal, say x_1 and x_2 , at which the temperature is T_1 and T_2 , respectively, there will be a difference of electrical potential $\phi(x_2) - \phi(x_1) \neq 0$. The electrical potential ϕ in the metal, if measured from zero in vacuum, is related to the potential energy $-u$ of the electrons in the metal compared to vacuum, $e\phi = u$. This difference, $\phi(x_2) - \phi(x_1)$, is obtained by integrating the field $-\mathcal{E}$ from x_1 to x_2 , or, since \mathcal{E} depends only on T and dT/dx , by integration over T from T_1 to T_2 . One obtains

$$\begin{aligned} e[\phi(T_2) - \phi(T_1)] &= \int_{x_1}^{x_2} \left(\frac{\partial \mu}{\partial T} - \frac{\mu}{T} + \frac{J_2}{TJ_1} \right) \frac{dT}{dx} dx \\ &= \int_{T_1}^{T_2} \left(\frac{\partial \mu}{\partial T} - \frac{\mu}{T} + \frac{J_2}{TJ_1} \right) dT \\ &= \mu(T_2) - \mu(T_1) + \int_{T_1}^{T_2} \left[-\frac{\mu}{T} + \frac{J_2}{TJ_1} \right] dT. \end{aligned}$$

If, in the term under the integral sign, $-J_1$ and $-J_2$ are replaced by their values (86), it is seen that the contribution from their temperature-independent terms cancels against $-\mu/T$. One has, then, to use the second terms in the approximation (86), and obtains

$$(16. 90) \quad e[\phi(T_2) - \phi(T_1)] \\ = \mu(T_2) - \mu(T_1) + \frac{\pi^2}{3} \int_{T_1}^{T_2} \frac{k^2 T}{\mu} \left(1 + \frac{\mu'}{l} \right) dT.$$

From equation (43) for $\mu(T)$ one sees that

$$\mu(T_2) - \mu(T_1) = -\frac{\pi^2}{12} \frac{k^2}{\mu_0} (T_2^2 - T_1^2).$$

In the integral, since $l' = dl/d\epsilon$ is not expected to be very important, the main term consists of

$$\frac{\pi^2}{3} \int_{T_1}^{T_2} \frac{k^2 T}{\mu} dT = \frac{\pi^2}{3} \int_{T_1}^{T_2} \frac{k^2}{\mu_0} T dT = \frac{\pi^2}{6} \frac{k^2}{\mu_0} (T_2^2 - T_1^2).$$

One obtains then, roughly,

$$(16.90') \quad e[\phi(T_2) - \phi(T_1)] \cong \frac{\pi^2}{12} \frac{k^2}{\mu_0} (T_2^2 - T_1^2).$$

The electrical potential $\phi(T)$ is higher at the higher temperature. Since the potential energy of the electrons is $-e\phi$, the potential energy, compared to vacuum, is lower at the higher temperature. The value of μ , the chemical potential measured from the potential energy in the metal, is also lower at higher temperatures, and by about the same amount as the difference in potential energy. The absolute chemical potential, measured from vacuum, $\mu(T) - e\phi(T)$, decreases with temperature about twice as much as either μ or $-e\phi$ alone.

The electric potential difference between two ends of a wire of one kind of metal depends on the temperature difference between the ends, but not explicitly on the form of the potential gradient, dT/dx , in the wire. If the two ends have the same temperature, there exists no potential difference, even if the temperature varies along the wire. Matters are different, however, if the wire consists of two different metals.

Let us assume that we have a wire consisting of two kinds of metal, a and b . The two ends of the wire are of the metal b and both ends are at the same temperature T_2 . The middle portion of the wire consists of the metal a , one of the junctions between the two metals being kept at T_2 , the other at the temperature T_1 . This is a typical thermocouple arrangement. The one junction between two different metals is in an oven at T_1 ; the other junction is kept at room temperature, T_2 ; and the two lead wires, both consisting of the same metal b , are attached to a potentiometer at room temperature T_2 . We wish to calculate the potential difference measured on the potentiometer, that is, the electrical potential difference between the two ends of the wire. The two free ends will be referred to as ends A and B , see Fig. 16.2.

In this calculation, not only equation (90) must be considered, but also the behavior at the junction itself. According to the discussions in deriving the Volta potential (section 16j) at these junctions the potentials of the two metals adjust themselves in such a way that the free energies in both metals are equal; since the $\mu_a(T)$, $\mu_b(T)$ signify the

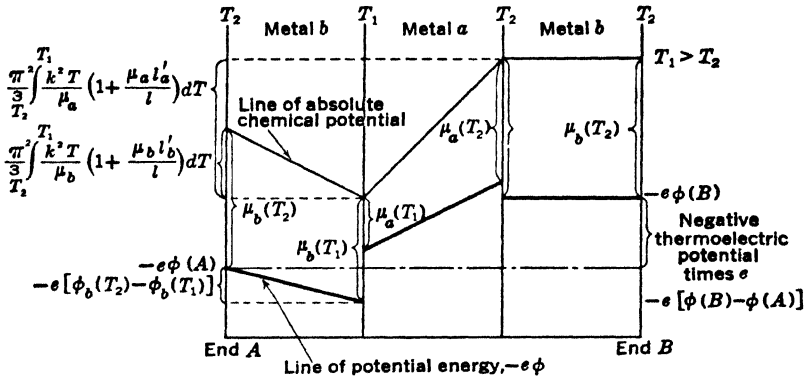

FIG. 16. 2. Illustration of the thermoelectric potential. [It is to be noted that the potential energy of on electron is *minus* e times the electric potential.]

chemical potential, or $1/N$ times the free energy, measured above the average potential energy for one electron in each metal, this means that $\mu_a(T_1)$, $\mu_b(T_1)$ at the junction are at the same *absolute* height. The same thing holds for $\mu_a(T_2)$, $\mu_b(T_2)$ at the other junction. This adjustment of the potential energy of the metals cancels precisely the contribution from the first term, $\mu(T_2) - \mu(T_1)$, in (90). One is left with

$$(16. 91) \quad \phi(A) - \phi(B) = \frac{\pi^2}{3} \frac{k^2}{e} \int_{T_1}^{T_2} T \left\{ \frac{1}{\mu_a} \left(1 + \frac{\mu_a l'_a}{l_a} \right) - \frac{1}{\mu_b} \left(1 + \frac{\mu_b l'_b}{l_b} \right) \right\} dT.$$

If μ and l are treated as temperature independent one obtains

$$(16. 91') \quad \phi(A) - \phi(B) = \frac{\pi^2}{6} \frac{k^2}{e} \left\{ \frac{1}{\mu_{0a}} \left(1 + \frac{\mu_{0a} l'_{0a}}{l_{0a}} \right) - \frac{1}{\mu_{0b}} \left(1 + \frac{\mu_{0b} l'_{0b}}{l_{0b}} \right) \right\} (T_2^2 - T_1^2).$$

16n. Liquid Helium II

In the early sections of this chapter the photon gas was treated as an example of a degenerate gas obeying the Bose-Einstein equations. This gas is in one respect not typical of a true gas of material particles:

the total number of photons is not constant. The density of the photon gas is therefore completely determined by the temperature, and is not an additional variable, as in a material gas. For this reason the typical behavior of a degenerate chemical Bose-Einstein gas is rather different.

As has been pointed out previously, the condition for a high degeneracy is, in a given gas, that the density be high and the temperature low; and for different gases at the same molal volumes and temperatures, that the masses of the particles be small.

The two molecules H_2 and He both consist of an even number of elementary particles, neutrons, protons, and electrons, and consequently form systems obeying the Bose-Einstein equations. The molecular weight of both is low, and they are in the gaseous state at low temperatures and moderate densities. The forces between hydrogen molecules are stronger than those between helium atoms. In consequence, H_2 boils at a higher temperature, $T = 20.3^\circ K.$, and helium, with a boiling point of $4.2^\circ K.$, in spite of the higher molecular weight, is more favorable for the observation of deviations from the classical behavior in the gaseous state. The predicted deviations, however, are of the same order of magnitude as those due to the molecular attractions, so that a clear example of an ideal degenerate Bose-Einstein gas is not obtained.*

A perfect gas of particles with the weight of helium atoms, at the density of liquid helium, should be completely degenerate below about $3^\circ K.$ Actually, liquid helium undergoes a transition at $2.2^\circ K.$ The low-temperature modification, called liquid helium II, seems to persist down to $0^\circ K.$ The solid state is obtained only by applying pressures above 25 atmospheres, owing to the large zero point energy of the vibrations in the crystal. London† has shown that at least some of the anomalous properties of liquid helium II are those which would be expected in a completely degenerate Bose-Einstein gas.

The type of degeneracy encountered in a Bose-Einstein gas is opposite to that of the Fermi-Dirac gas. Instead of the zero point energy of the latter, originating from the statistical repulsion of the molecules in phase space, the former is characterized by a statistical attraction in phase space, a tendency of the molecules to cluster into the same quantum state. The perfect Bose-Einstein gas therefore displays a phenomenon analogous to condensation:‡ there exists a condensation temperature T_0 below which a finite fraction of all the molecules exists in the lowest one of the translational states. The heat capacity of the

* George E. Uhlenbeck and Erich Beth, *Physica*, III, 729 (1936); IV, 915 (1937).

† F. London, *J. Phys. Chem.*, 43, 49 (1939).

‡ A. Einstein, *Ber. Berl. Akad.*, 261 (1924), 3 (1925).

gas rises from zero at $T = 0$ proportional to $T^{3/2}$ and undergoes a discontinuous change of slope at the condensation temperature. Below this temperature the existence of many molecules of exactly zero velocity leads to strange behavior of the gas with respect to transport phenomena, viscosity, and the transport of heat.

In the next section the behavior of the ideal Bose-Einstein gas at low temperatures will be calculated. It is clear, however, that in view of the non-existence of an adequate molecular theory of liquids the difficulties of correlating the behavior of an ideal gas with that of liquid helium are considerable. Nevertheless, it seems very sure that the predicted type of behavior of the ideal gas is related closely to the observed anomalies in the experimental behavior of liquid helium.

16o. The Degenerate Bose-Einstein Gas

The distribution function, N/C , giving the number of molecules per cell of energy ϵ , in a Bose-Einstein system, is

$$(16. 92) \quad \frac{N}{C} = \frac{1}{e^{(\epsilon-\mu)/kT} - 1}.$$

For a gas in a volume V , composed of molecules of mass m , with only one non-degenerate internal energy level, such as helium, the number of cells, $C(\epsilon) \Delta\epsilon$, in the energy range between ϵ and $\epsilon + \Delta\epsilon$, is given by equation (5. 2) as

$$(16. 93) \quad C(\epsilon) \Delta\epsilon = 2\pi V \left(\frac{2m}{h^2}\right)^{3/2} \epsilon^{1/2} \Delta\epsilon.$$

The chemical potential μ to be used in (92) is determined by integration of $(N/C)C(\epsilon) d\epsilon$ over all energies, and equating the result to the known total number, N , of particles. By this method, at high temperatures and low densities, for which $-\mu/kT \gg 1$, equation (6. 18), namely,

$$(16. 94) \quad -\frac{\mu}{kT} = \ln \left(\frac{2\pi mkT}{h^2}\right)^{3/2} \frac{V}{N},$$

is obtained as the limiting classical approximation. From (94) it is seen that $-\mu/kT$ decreases with decreasing temperature or volume. Since the equation is invalid as $-\mu/kT$ becomes small, it is impossible to ascertain from (94) whether μ tends to zero, or even to positive values, as T approaches zero.

Equation (92), however, serves to answer this question partially. As μ decreases toward zero, the number, N/C , of molecules per cell in the cell of zero energy, $\epsilon = 0$, approaches infinity. If, however, μ were to become positive, the ridiculous prediction of a negative number of

particles per cell would be obtained from (92) for $\epsilon = 0$. It is clear that μ may become (practically) zero with decreasing V/N and T , in which event an appreciable fraction of all the particles will be in the cell of zero energy, but that μ can never become negative.

In order to calculate μ without making use of the classical approximation, the distribution function (92) is expanded as

$$(16. 92') \quad \frac{N}{C} = \frac{1}{e^{(\epsilon-\mu)/kT} - 1} = \sum_{l=1}^{\infty} e^{l(\mu-\epsilon)/kT}.$$

The first term of this expansion is just the classical approximation, $N/C = e^{(\mu-\epsilon)/kT}$. The product of the expansion (92') with $C(\epsilon) d\epsilon$, (93), is integrated from $\epsilon = 0$ to $\epsilon = \infty$, and equated to N . Remembering that $\int_0^{\infty} x^{1/2} e^{-x} dx = \pi^{1/2}/2$, one finds

$$\begin{aligned} 2\pi V \left(\frac{2m}{h^2}\right)^{3/2} \int_0^{\infty} \sum_{l=1}^{\infty} e^{l\mu/kT} \epsilon^{1/2} e^{-l\epsilon/kT} d\epsilon \\ = V \left(\frac{2\pi mkT}{h^2}\right)^{3/2} \sum_{l=1}^{\infty} l^{-3/2} e^{l\mu/kT} = N. \end{aligned}$$

Using

$$(16. 95) \quad v = \frac{V}{N}$$

for the volume per molecule, the equation determining μ becomes

$$(16. 96) \quad \sum_{l=1}^{\infty} l^{-3/2} e^{l\mu/kT} = \frac{1}{v} \left(\frac{h^2}{2\pi mkT}\right)^{3/2}.$$

For very small values of the right-hand side of (96) only the first term, $e^{\mu/kT}$, of the sum in the left side need be used, and the classical approximation, equation (94), is obtained.

The sum on the left-hand side of (96) converges for all negative values of μ , and for $\mu = 0$. The latter solution, that $\mu = 0$, is obtained if

$$(16. 97) \quad \sum_{l=1}^{\infty} l^{-3/2} = 2.612 = \frac{1}{v} \left(\frac{h^2}{2\pi mkT}\right)^{3/2}.$$

This equation determines associated values, T_0 of temperature, and v_0 of volume per molecule, for which the chemical potential μ is zero. At lower temperatures and volumes than these we shall show that the gas condenses. This equation determines the condensation temperature $T_0(v)$ at any given volume v , or the condensation volume $v_0(T)$ at any

given temperature T ,

$$(16. 97') \quad T_0(v) = \left(\frac{1}{2.612v} \right)^{2/3} \frac{h^2}{2\pi mk} = \frac{114.7}{V^{2/3} M},$$

$$v_0(T) = \frac{1}{2.612} \left(\frac{h^2}{2\pi mkT} \right)^{3/2} = \frac{1}{N_0} \frac{1227}{(MT)^{3/2}}.$$

In the expressions on the right M is molecular weight and V the volume per mole in cubic centimeters.

At any volume, v , and temperature, T , the ratio of v to the condensation volume for that temperature, v/v_0 , and the ratio of $T^{3/2}$ to the condensation temperature raised to the $3/2$ power for the volume v , $(T/T_0)^{3/2}$, are identical,

$$(16. 97'') \quad \left[\frac{T}{T_0(v)} \right]^{3/2} = \frac{v}{v_0(T)} = 2.612v \left(\frac{2\pi mkT}{h^2} \right)^{3/2}.$$

For a gas of the molecular weight of helium, $M = 4$, and at the density of liquid helium, $V = 27.6 \text{ cm.}^3$, equation (97') leads to $T_0 = 3.14^\circ\text{K}$. At the density of the gas, $V = 345 \text{ cm.}^3$ corresponding to the boiling point at 4.2°K ., the value of T_0 for helium is 0.79°K . $(T/T_0)^{3/2}$ at the boiling point is then 12.3.

Equation (96) appears to have no solution for μ if $v < v_0$. It is obvious from a consideration of the original distribution function (92) that some error has been made in arriving at such a conclusion, since, as we have already found, as μ approaches zero the number of molecules per cell at zero energy approaches infinity. There can, consequently, be no fundamental difficulty in finding a solution with $-\mu/kT$ sufficiently close to zero for any density greater than $1/v_0$. It is to be expected, then, that the correct solution is that μ remains essentially zero for all temperatures or volumes below T_0 or v_0 .

The error which led to the mathematical difficulty lies in the use of (93) for $C(\epsilon) d\epsilon$ at $\epsilon = 0$. $C(\epsilon) \Delta\epsilon$ signifies the number of quantum states for one molecule the energy of which lies between ϵ and $\epsilon + \Delta\epsilon$. If ϵ is large, this number is well represented by the continuous function (93). But as ϵ approaches zero the discreteness of the translational levels makes itself felt. The continuous function (93) gives no cells for $\epsilon = 0$. This error is completely negligible for $v > v_0$, but for volumes less than v_0 the system has an appreciable fraction of all particles in the cell of lowest energy. London* has given a satisfactory mathematical treatment which will be omitted here. His result is that

* F. London, *Phys. Rev.*, **54**, 948 (1938).

below v_0 the value of $-\mu/kT$ is of the order of magnitude $1/N$, which, for all practical purposes, may be taken as zero.

For volumes less than v_0 , then, the chemical potential μ is zero and independent of density. This is just the thermodynamic criterion for condensation, that the free energy, $F = N\mu$, shall be independent of density. Equation (97') gives the relation between the saturated vapor volume, v_0 , per molecule, and the temperature.

Equation (96) bears a striking resemblance to equation (14. 10) from which the conditions for condensation in a classical gas were deduced. This analogy between the classical condensation and the condensation of the perfect Bose-Einstein gas was first remarked by Kahn and Uhlenbeck.* Equation (14. 10) is that

$$(16. 96') \quad \sum_{l=1}^{\infty} l b_l Z^l = \frac{1}{v},$$

in which the b_l 's are certain integrals having the dimensions of volume to the power $l - 1$, and Z is the density fugacity of the gas, or density of a perfect gas having the same chemical potential. Z is related to the chemical potential μ by equation (13. 50):

$$(16. 98) \quad e^{\mu/kT} = \left(\frac{h^2}{2\pi m k T} \right)^{3/2} \times Z = 2.612 v_0 Z.$$

Equation (96) may be brought precisely into the form (96') by using for b_l an expression which has the form of equation (14. 9),

$$(16. 99) \quad b_l = f(l, T) b_0^l = \tau^{-5/2} \left(\frac{h^2}{2\pi m k T} \right)^{3(l-1)/2} = \tau^{-5/2} (2.612 v_0)^{l-1},$$

$$f(l, T) = \tau^{-5/2} (2.612 v_0)^{-1}, \quad b_0 = 2.612 v_0.$$

Using this with (98) in (96'), equation (96) is obtained. The resemblance is carried even to the power of l upon which $f(l, T)$ here and in equation (14.9) depends. From equation (99) it is seen that $f(l, T) \sim \tau^{-5/2}$. In the imperfect classical gas, the asymptotic dependence of $f(l, T)$ on l is as $\tau^{-5/2}$ if the sums $\sum \beta_{\mathbf{r}} \rho^{\mathbf{k}}$ converge, which they do above the temperature T_m of disappearance of the meniscus.

The condensation in the classical and Bose-Einstein gases are both given by $b_0 Z = 1$. From (99) this occurs for the perfect Bose-Einstein gas when $Z = 1/2.612 v_0$, and, from (98), when $\mu = 0$. For values of v lower than v_0 , equation (96') diverges. However, whereas for the classical imperfect gas the interactions leading to the coefficients b_l

* B. Kahn and G. E. Uhlenbeck, *Physica*, V, 399 (1938).

in (96') are mechanical attractions between the particles, the perfect Bose-Einstein gas owes its condensation to the statistical attraction of the particles in phase space.

For temperatures higher than T_0 an approximate expansion for μ may be obtained from equation (96) or (96'). It is more convenient to use the form (96') since the problem of obtaining an expansion for Z in powers of $1/v$ for this equation has already been solved in Chapter 13. We found there that, setting

$$Z = \frac{a_1}{v} + \frac{a_2}{v^2} + \frac{a_3}{v^3} + \frac{a_4}{v^4} + \dots,$$

the solutions (see equations preceding 13. 36)

$$a_1 = 1,$$

$$a_2 = -2b_2 = -2^{-3/2}b_0,$$

$$a_3 = 8b_2^2 - 3b_3 = (4^{-1} - 3^{-3/2})b_0^2,$$

$$a_4 = -40b_2^3 + 30b_2b_3 - 4b_4 = (-5 \times 2^{-9/2} + 5 \times 2^{-3/2} \times 3^{-3/2} - 2^{-3})b_0^3$$

are obtained for the coefficients. Using (99) for b_0 and (98) for z , one finds

$$\begin{aligned} (16. 100) \quad Z &= \left(\frac{2\pi mkT}{h^2}\right)^{3/2} e^{\mu/kT} = \frac{1}{2.612v_0} e^{\mu/kT} \\ &= \frac{1}{v} \left\{ 1 - 0.35355 \left(\frac{h^2}{2\pi mkT}\right)^{3/2} \frac{1}{v} + 0.05755 \left(\frac{h^2}{2\pi mkT}\right)^3 \frac{1}{v^2} \right. \\ &\quad \left. - 0.005763 \left(\frac{h^2}{2\pi mkT}\right)^{9/2} \frac{1}{v^3} + \dots \right\} \\ &= \frac{1}{v} \left\{ 1 - 0.92347 \left(\frac{v_0}{v}\right) + 0.3926 \left(\frac{v_0}{v}\right)^2 \right. \\ &\quad \left. - 0.1027 \left(\frac{v_0}{v}\right)^3 + \dots \right\} \end{aligned}$$

for $v > v_0$, and

$$(16. 100') \quad Z = \left(\frac{2\pi mkT}{h^2}\right)^{3/2} = \frac{1}{2.612v_0}$$

for $v < v_0$.

At one atmosphere pressure and 4.2°K., the boiling point of helium, the ratio v/v_0 is 12.3, so that the first correction term in (100) amounts to about 7.5 per cent under these conditions.

The development for μ is obtained in the usual way by use of $\ln(1+x) = x - x^2/2 + x^3/3 \dots$, which, with (100), leads to

$$\begin{aligned}
 (16. 101) \quad \mu &= kT \left\{ \ln \left(\frac{h^2}{2\pi mkT} \right)^{3/2} \frac{1}{v} - 0.35355 \left(\frac{h^2}{2\pi mkT} \right)^{3/2} \frac{1}{v} \right. \\
 &\quad \left. - 0.00492 \left(\frac{h^2}{2\pi mkT} \right)^3 \frac{1}{v^2} - 0.00014 \left(\frac{h^2}{2\pi mkT} \right)^{9/2} \frac{1}{v^3} \dots \right\} \\
 &= kT \left\{ \ln \left(\frac{2.612v_0}{v} \right) - 0.9235 \left(\frac{v_0}{v} \right) - 0.0336 \left(\frac{v_0}{v} \right)^2 \right. \\
 &\quad \left. - 0.0024 \left(\frac{v_0}{v} \right)^3 - \dots \right\}
 \end{aligned}$$

for $v > v_0$, and

$$(16. 101') \quad \mu = 0$$

for $v < v_0$.

The energy may be evaluated in the usual manner, using the development (92') as

$$\begin{aligned}
 (16. 102) \quad E &= \int_0^\infty \epsilon \frac{N}{C} C(\epsilon) d\epsilon = 2\pi V \left(\frac{2m}{h^2} \right)^{3/2} \int_0^\infty \frac{\epsilon^{3/2} d\epsilon}{e^{(\epsilon-\mu)/kT} - 1} \\
 &= 2\pi V \left(\frac{2m}{h^2} \right)^{3/2} \sum_{l=1}^\infty e^{l\mu/kT} \int_0^\infty \epsilon^{3/2} e^{-l\epsilon/kT} d\epsilon \\
 &= \frac{3}{2} V kT \left(\frac{2\pi mkT}{h^2} \right)^{3/2} \sum_{l=1}^\infty l^{-5/2} e^{l\mu/kT} \\
 &= \frac{3}{2} N kT \frac{v}{2.612v_0} \sum_{l=1}^\infty l^{-5/2} e^{l\mu/kT},
 \end{aligned}$$

since $\int_0^\infty x^{3/2} e^{-x} dx = 3\pi^{1/2}/4$. The sum which occurs in this equation may be evaluated for $v > v_0$ by using the development (100) for $e^{\mu/kT}$ and going through the direct but tedious algebraic steps. One finds

$$\begin{aligned}
 (16. 103) \quad \sum_{l=1}^\infty l^{-5/2} e^{l\mu/kT} &= \left(\frac{h^2}{2\pi mkT} \right)^{3/2} \frac{1}{v} \left\{ 1 - 0.17678 \left(\frac{h^2}{2\pi mkT} \right)^{3/2} \frac{1}{v} \right. \\
 &\quad \left. - 0.00330 \left(\frac{h^2}{2\pi mkT} \right)^3 \frac{1}{v^2} - 0.000110 \left(\frac{h^2}{2\pi mkT} \right)^{9/2} \frac{1}{v^3} \dots \right\} \\
 &= 2.612 \frac{v_0}{v} \left\{ 1 - 0.4618 \left(\frac{v_0}{v} \right) - 0.0225 \left(\frac{v_0}{v} \right)^2 - 0.00196 \left(\frac{v_0}{v} \right)^3 - \dots \right\}
 \end{aligned}$$

for $v > v_0$, and

$$(16. 103') \quad \sum_{l=1}^{\infty} l^{-5/2} e^{l\mu/kT} = \sum_{l=1}^{\infty} l^{-5/2} = 1.341$$

for $v < v_0$.

The sum of the coefficients of the expression (103) must be such that, when $v = v_0$, (103) becomes equal to 1.341. Actually the coefficients given lead to 1.342 at $v = v_0$, which indicates the degree of convergence obtained.

Using (103) and (103') in the expression for the energy per mole, one obtains

$$(16. 104) \quad \begin{aligned} \mathbf{E} = \frac{3}{2} RT \left\{ 1 - 0.17678 \left(\frac{h^2}{2\pi mkT} \right)^{3/2} \frac{1}{v} \right. \\ \left. - 0.00330 \left(\frac{h^2}{2\pi mkT} \right)^3 \frac{1}{v^2} - 0.000110 \left(\frac{h^2}{2\pi mkT} \right)^{9/2} \frac{1}{v^3} - \dots \right\} \\ = \frac{3}{2} RT \left\{ 1 - 0.4618 \left(\frac{v_0}{v} \right) - 0.0225 \left(\frac{v_0}{v} \right)^2 \right. \\ \left. - 0.00196 \left(\frac{v_0}{v} \right)^3 - \dots \right\} \end{aligned}$$

for $v > v_0$, and

$$(16. 104') \quad \begin{aligned} \mathbf{E} = \frac{3}{2} 1.341 RT \left(\frac{2\pi mkT}{h^2} \right)^{3/2} v = \frac{3}{2} \cdot \frac{1.341}{2.612} RT \left(\frac{T}{T_0} \right)^{3/2} \\ = \frac{3}{2} 0.5134 RT \left(\frac{T}{T_0} \right)^{3/2} \end{aligned}$$

for $T < T_0$.

The heat capacity at constant volume, \mathbf{C}_V , is obtained by differentiating (104) with respect to T ,

$$(16. 105) \quad \begin{aligned} \mathbf{C}_V = \frac{3}{2} R \left\{ 1 + 0.08839 \left(\frac{h^2}{2\pi mkT} \right)^{3/2} \frac{1}{v} \right. \\ \left. + 0.0066 \left(\frac{h^2}{2\pi mkT} \right)^3 \frac{1}{v^2} + 0.000385 \left(\frac{h^2}{2\pi mkT} \right)^{9/2} \frac{1}{v^3} + \dots \right\} \\ = \frac{3}{2} R \left\{ 1 + 0.2309 \left(\frac{v_0}{v} \right) + 0.04504 \left(\frac{v_0}{v} \right)^2 + 0.00686 \left(\frac{v_0}{v} \right)^3 + \dots \right\} \end{aligned}$$

for $v > v_0$, and

$$(16. 105') \quad C_v = \frac{15}{4} 1.341R \left(\frac{2\pi mkT}{h^2} \right)^{3/2} v = \frac{15}{4} 0.5134R \left(\frac{T}{T_0} \right)^{3/2} \\ = 1.925R \left(\frac{v}{v_0} \right),$$

for $v < v_0$. The two expressions (105) and (105') lead to the same value of C_v at $T = T_0$. The heat capacity at constant volume, C_v , then, approaches the same value, $1.925R$, which is 1.283 times the classical value of $3R/2$, as the condensation temperature T_0 is approached from higher or lower temperatures. The slopes, dC_v/dT , however, are entirely different above and below T_0 . One finds, by differentiation,

$$(16. 106) \quad \frac{dC_v}{dT} = -\frac{3}{2} \frac{R}{T} \left\{ 0.34635 \frac{v_0}{v} + 0.135 \left(\frac{v_0}{v} \right)^2 + \dots \right\}$$

for $T > T_0$, $v > v_0$, and

$$(16. 106') \quad \frac{dC_v}{dT} = \frac{45}{8} 0.5134 \frac{R}{T} \frac{v}{v_0}$$

for $T < T_0$.

The entropy at 0°K . is zero, since all the molecules are in the lowest energy cell, and this configuration corresponds to only one quantum state of the system, $\Omega = 1$, $S = k \ln \Omega = 0$. S at higher temperature may be calculated by integration of $\int_0^T (C_v/T') dT'$. The integral below T_0 is obtained from (105') and is $S(T) = (5/2)0.5134R(T/T_0)^{3/2}$, $T < T_0$, so that $S(T_0) = (5/2)0.5134R$. The integral above T_0 is obtained by using (105); one finds

$$S(T) - S(T_0) = \int_{T_0}^T \frac{C_v}{T'} dT' \\ = \frac{3}{2} R \left\{ \ln \frac{T}{T_0} - \frac{2}{3} 0.2309 T_0^{3/2} \left(\frac{1}{T^{3/2}} - \frac{1}{T_0^{3/2}} \right) \right. \\ \left. - \frac{1}{3} 0.04504 T_0^3 \left(\frac{1}{T^3} - \frac{1}{T_0^3} \right) - \frac{2}{9} 0.00686 T_0^{9/2} \left(\frac{1}{T^{9/2}} - \frac{1}{T_0^{9/2}} \right) - \dots \right\} \\ = R \left\{ 0.2557 + \ln \left(\frac{T}{T_0} \right)^{3/2} - 0.2309 \left(\frac{v_0}{v} \right) \right. \\ \left. - 0.0225 \left(\frac{v_0}{v} \right)^2 - 0.0023 \left(\frac{v_0}{v} \right)^3 - \dots \right\}.$$

By using

$$\begin{aligned} R \ln \left(\frac{T}{T_0} \right)^{3/2} &= R \ln \left(\frac{2\pi mkT}{h^2} \right)^{3/2} v + R \ln 2.612 \\ &= R \ln \left(\frac{2\pi mkT}{h^2} \right)^{3/2} v + 0.9601R, \end{aligned}$$

the numerical constants, $0.9601 + 0.2557 + (5/2) 0.5134$, add up to 2.4995 or practically $2.5 = \ln e^{5/2}$. The equations for the entropy may then be written as

(16. 107)

$$\begin{aligned} S &= R \left\{ \ln \left(\frac{2\pi mkT}{h^2} \right)^{3/2} v e^{5/2} - 0.0884 \left(\frac{h^2}{2\pi mkT} \right)^{3/2} \frac{1}{v} \right. \\ &\quad \left. - 0.00333 \left(\frac{h^2}{2\pi mkT} \right)^3 \frac{1}{v^2} - 0.00013 \left(\frac{h^2}{2\pi mkT} \right)^{9/2} \frac{1}{v^3} - \dots \right\} \\ &= R \left\{ \ln \left(\frac{v e^{5/2}}{2.612 v_0} \right) - 0.2309 \left(\frac{v_0}{v} \right) - 0.0225 \left(\frac{v_0}{v} \right)^2 \right. \\ &\quad \left. - 0.0023 \left(\frac{v_0}{v} \right)^3 - \dots \right\} \end{aligned}$$

for $v > v_0$, and

$$\begin{aligned} (16. 107') \quad S &= \frac{5}{2} 1.341R \left(\frac{2\pi mkT}{h^2} \right)^{3/2} v \\ &= \frac{5}{2} 0.5134R \left(\frac{T}{T_0} \right)^{3/2} = \frac{5}{2} 0.5134R \frac{v}{v_0} \end{aligned}$$

for $v < v_0$.

The rather unsatisfactory method by which the $e^{5/2}$, which is the classical high-temperature approximation (see equation 6. 26), appears in the entropy as an apparently accidental relation between a sum of numbers is inherent in the approximative developments.

An alternative calculation of the entropy may be made, in which the constant $2.5R$ appears in a less accidental way in the equation. We use equation (5. 8)

$$(16. 108) \quad S = k \ln \Omega_D = \sum_j \left[C_j \ln \left(1 + \frac{N_j}{C_j} \right) + N_j \ln \left(\frac{C_j}{N_j} + 1 \right) \right],$$

for the entropy of the Bose-Einstein system as a sum of the entropies of the different regions at equilibrium. In this expression, (93) for $C(\epsilon) d\epsilon$ is used and (92) for N_j/C_j , which results in $\ln [(C_j/N_j) + 1] = (\epsilon - \mu)/kT$, and $\ln [1 + (N_j/C_j)] = -\ln [1 - e^{(\mu-\epsilon)/kT}]$. The sums,

$\sum N_j \epsilon_j = E$ and $\sum N_j \mu = F$, are used to obtain

$$(16. 108') \quad S = - \int_0^\infty kC(\epsilon) \ln [1 - e^{(\mu-\epsilon)/kT}] d\epsilon + \frac{E}{T} - \frac{F}{T}.$$

From the thermodynamic relationship

$$F = E + PV - TS, \quad S = \frac{E - F + PV}{T},$$

it is seen that

$$(16. 109) \quad \frac{PV}{T} = - \int_0^\infty kC(\epsilon) \ln [1 - e^{(\mu-\epsilon)/kT}] d\epsilon.$$

With (93) for $C(\epsilon)$ and the development

$$-\ln [1 - e^{(\mu-\epsilon)/kT}] = \sum_{l=1}^{\infty} l^{-1} e^{l(\mu-\epsilon)/kT}$$

one finds

$$(16. 110) \quad \begin{aligned} PV &= 2\pi V k T \left(\frac{2m}{h^2}\right)^{3/2} \sum_{l=1}^{\infty} l^{-1} e^{l\mu/kT} \int_0^\infty \epsilon^{1/2} e^{-l\epsilon/kT} d\epsilon \\ &= V k T \left(\frac{2\pi m k T}{h^2}\right)^{3/2} \sum_{l=1}^{\infty} l^{-5/2} e^{-l\mu/kT}. \end{aligned}$$

By comparison with (102) one sees that

$$(16. 110') \quad PV = \frac{2}{3} E$$

for all temperatures. This relationship was also found for the Fermi-Dirac perfect gas. Using (110') and (109) in (108'), one finds

$$(16. 111) \quad S = \frac{5}{3} \frac{E}{T} - \frac{F}{T}.$$

If the expressions (101) for $\mu = F/N_0$ and (104) for E are used in (111), (107) and (107') are obtained for S . In this derivation the constant numerical term is seen to be exactly $2.5R = R \ln e^{5/2}$.

The Helmholtz free energy $A = E - TS$ is seen from (104) and (107) to be

$$(16. 112) \quad \begin{aligned} A &= RT \left\{ \ln \left(\frac{h^2}{2\pi m k T} \right)^{3/2} \frac{1}{v e^{3/2}} \right. \\ &\quad - 0.17678 \left(\frac{h^2}{2\pi m k T} \right)^{3/2} \frac{1}{v} - 0.00162 \left(\frac{h^2}{2\pi m k T} \right)^3 \frac{1}{v^2} \\ &\quad \left. - 0.00003 \left(\frac{h^2}{2\pi m k T} \right)^{9/2} \frac{1}{v^2} - \dots \right\} \end{aligned}$$

$$A = RT \left\{ \ln \frac{2.612v_0}{ve^{3/2}} - 0.4617 \left(\frac{v_0}{v} \right) - 0.0111 \left(\frac{v_0}{v} \right)^2 - 0.00044 \left(\frac{v_0}{v} \right)^3 - \dots \right\}$$

for $v > v_0$, and

$$(16. 112') \quad A = -1.341RT \left(\frac{2\pi mkT}{h^2} \right)^{3/2} v \\ = 0.5134RT \left(\frac{T}{T_0} \right)^{3/2} = 0.5134RT \frac{v}{v_0}$$

for $v < v_0$.

Equation (110') for the pressure, $PV = 2E/3$, which, with (104) and (104'), leads to

(16. 113)

$$P = \frac{RT}{V} \left\{ 1 - 0.17678 \left(\frac{h^2}{2\pi mkT} \right)^{3/2} \frac{1}{v} - 0.00330 \left(\frac{h^2}{2\pi mkT} \right)^3 \frac{1}{v^2} - 0.000110 \left(\frac{h^2}{2\pi mkT} \right)^{9/2} \frac{1}{v^3} - \dots \right\} \\ = \frac{RT}{V} \left\{ 1 - 0.4618 \left(\frac{v_0}{v} \right) - 0.0225 \left(\frac{v_0}{v} \right)^2 - 0.00196 \left(\frac{v_0}{v} \right)^3 - \dots \right\}$$

for $v > v_0$, and

$$(16. 113') \quad P = 1.341kT \left(\frac{2\pi mkT}{h^2} \right)^{3/2} = 0.5134 \frac{kT}{v_0}$$

for $v < v_0$, shows that the pressure drops to 0.5134 times the classical value before condensation begins.

APPENDIX

(I) The Notation of Calculus. (II) Some Definite Integrals. (III) The Euler-Maclaurin Summation Formula. (IV) The Factorial and the Stirling Approximation. (V) The Volume of an N -dimensional Sphere. (VI) The Method of Undetermined Multipliers. (VII) Combinatory Problems. (VIII) General Thermodynamic Relationships. (IX) Summary of Thermodynamic Functions of a Perfect Gas. (X) The Coefficient of the Term $\Pi \beta_k^{a_k}$ in b_l . (XI) Application of the Theory of Functions to the Functions Appearing in the Theory of the Imperfect Gas. (XII) Table of Constants of Diatomic Molecules. (XIII) Physical Constants. (XIV) Conversion of Energy Units. (XV) Greek Alphabet.

AI. The Notation of Calculus

If a quantity F depends on the value of a variable x , F is said to be a function of x , and this is symbolized by writing

$$(AI. 1) \quad F = F(x).$$

The total derivative of F with respect to x is the limit of the ratio of the increase of F to the increase in x , as the latter becomes vanishingly small,

$$(AI. 2) \quad \frac{dF}{dx} = \lim_{\Delta x \rightarrow 0} \left\{ \frac{F(x + \Delta x) - F(x)}{\Delta x} \right\}.$$

n variables, x_1, x_2, \dots, x_n , are said to be independent if each of them may take any value, within a certain range, completely independently of the values of the others. If the quantity F depends on the values of the n independent variables it is said to be a function of these variables,

$$(AI. 3) \quad F = F(x_1, x_2, \dots, x_n).$$

The partial derivative of F with respect to one of the variables x_i is the limit of the ratio of the increment in F to that in x_i if all the other variables remain constant,

$$(AI. 4) \quad \frac{\partial F(x_1, \dots, x_i, \dots, x_n)}{\partial x_i} \\ = \lim_{\Delta x_i \rightarrow 0} \left\{ \frac{F(x_1, \dots, x_i + \Delta x_i, \dots, x_n) - F(x_1, \dots, x_i, \dots, x_n)}{\Delta x_i} \right\}.$$

If z is a function of two independent variables x and y , $z = z(x, y)$, then any functional quantity F which is a function of x and y may also be written as a function of x and z or of y and z . Since the functional dependence of the quantity F on x and y is different from its dependence on x and z , that is, the value of F is different when $x = a$, $y = b$ than when $x = a$, $z = b$, the usual mathe-

mathematical nomenclature is to indicate this by choosing different symbols for the function of x, y and that of x, z . The notation for the quantity F

$$(AI. 5) \quad F = G(x, y) = H(x, z)$$

may be used.

In general,

$$(AI. 6) \quad \frac{\partial G(x, y)}{\partial x} \neq \frac{\partial H(x, z)}{\partial x}$$

but

$$(AI. 7) \quad \frac{\partial G(x, y)}{\partial x} = \frac{\partial H(x, z)}{\partial x} + \frac{\partial H(x, z)}{\partial z} \frac{\partial z(x, y)}{\partial x}.$$

In physics, and particularly in thermodynamics, it is convenient and customary to keep the same symbol for the same *quantity*, that is, in the case above the symbol F would be retained for the quantity F independently of whether it were thought of as a function of x and y or of x and z . The partial derivatives are then indicated by

$$(AI. 8) \quad \frac{\partial G(x, y)}{\partial x} = \left(\frac{\partial F}{\partial x} \right)_y, \quad \frac{\partial H(x, z)}{\partial x} = \left(\frac{\partial F}{\partial x} \right)_z,$$

so that the symbol $(\partial F / \partial x)_y$ means the ratio of the increment in the *quantity* F to that of x if the variable y is kept constant, whereas $(\partial F / \partial x)_z$ is the ratio of the increments when the variable z is held constant. Equation (AI. 7) would then be written

$$(AI. 7') \quad \left(\frac{\partial F}{\partial x} \right)_y = \left(\frac{\partial F}{\partial x} \right)_z + \left(\frac{\partial F}{\partial z} \right)_x \left(\frac{\partial z}{\partial x} \right)_y.$$

If the quantity F depends on n variables the partial derivative of F with respect to any one of them should, in this notation, be written with the other $n - 1$ variables outside of the brackets to indicate that they are held constant during the differentiation. Sometimes there are some of the n variables which are practically never replaced by others, as y was replaced by z above; these variables may be omitted from outside of the brackets. For instance, the thermodynamic quantity S , the entropy, depends on the energy E , the volume V , the number of molecules N_1 of kind 1, the number N_2 of kind 2, etc. Whereas E is often eliminated by introduction of T , so that it is necessary to distinguish $(\partial S / \partial V)_E$ and $(\partial S / \partial V)_T$, and similarly V is often replaced by P , the numbers of particles are practically always assumed to be held constant in such differentiation, and are usually omitted from the symbols outside of the brackets.

If F depends on two independent variables x and y one may write for any change dx in x and dy in y ,

$$dF = \left(\frac{\partial F}{\partial x} \right)_y dx + \left(\frac{\partial F}{\partial y} \right)_x dy.$$

If the change is such that dF is zero it is a change in x and a change in y at constant F , so that one obtains

$$(AI. 9) \quad \left(\frac{\partial x}{\partial y}\right)_F = -\frac{\left(\frac{\partial F}{\partial y}\right)_x}{\left(\frac{\partial F}{\partial x}\right)_y}.$$

It may sometimes be convenient to write a quantity F explicitly as a function of x and of y even if the quantity y is not independent of x but is itself a function of x , $y = y(x)$. In this case the definition (AI. 4) may still be retained for the partial derivative of F with respect to x , in which y is thought of as a constant. Since, however, y is determined by the value of x , the quantity F depends only on the value of x , and has a total derivative with respect to x

$$(AI. 10) \quad \frac{dF}{dx} = \left(\frac{\partial F}{\partial x}\right)_y + \left(\frac{\partial F}{\partial y}\right)_x \frac{dy}{dx}.$$

Essentially the same is the case that F is explicitly a function of n variables x_1, \dots, x_n , but each of the n variables is a function of only one independent variable t . Then

$$(AI. 11) \quad \frac{dF}{dt} = \sum_{i=1}^{i=n} \frac{\partial F}{\partial x_i} \frac{dx_i}{dt}.$$

If, in a sum of numbers, $a + b + c + d \dots$, the individual terms are numbered by use of the notation $a = a_1, b = a_2, c = a_3$, the i th term being indicated by a_i , the sum is usually indicated by the notation

$$(AI. 12) \quad \sum_{i=1}^{i=n} a_i = a_1 + a_2 + \dots + a_i + \dots + a_n$$

if n is the total number of terms. The running index i , which numbers the terms, may be essentially artificial, as suggested above, or may have a natural significance in the term. For instance, the individual terms of the sum may be simple functions of a variable x for integral values i of the variable, $a_i = f(x)$ at $x = i$. In this case the value of i for a given term is naturally defined, and possibly in such a way that the first term is not that with $i = 1$, but say with $i = m$. This is then indicated by the notation $i = m$, instead of $i = 1$, for the lower limit of the sum, below the summation symbol Σ .

If the sum contains an infinite number of terms this is indicated by the upper limit $i = \infty$ above the summation symbol. The value of the sum is then determined and finite only if the individual terms approach zero in value sufficiently rapidly as the running index i increases (see the sections dealing with infinite series in any book on advanced calculus).

The terms of a sum may be numbered, naturally, not by a single integer, but by a set of two or more integers. For instance, the terms may be a simple

function $f(x,y,z)$ of three variables, x , y , and z , for integral values of these variables between zero and infinity. The terms may then be numbered by three subscript indices

$$a_{ijk} = f(x,y,z) \text{ (at } x = i, y = j, z = k \text{)}$$

and the sum written as

$$(AI. 13) \quad \sum_{i=0}^{i=\infty} \sum_{j=0}^{j=\infty} \sum_{k=0}^{k=\infty} a_{ijk}.$$

The notation of equation (13) is obviously rather cumbersome and would become especially so if the set of numbers representing the running indices included more than three simple numbers. We may use the symbol n for the set of numbers i, j, k and simply write (13) as

$$(AI. 13') \quad \sum_{n=0}^{n=\infty} a_n.$$

If the limits of summation are unambiguous from the description of the sum they are frequently omitted in the writing of the equation.

The symbol \prod is used for a product in the same way that \sum is used for a sum:

$$(AI. 14) \quad a_1 \cdot a_2 \cdots a_i \cdots a_n = \prod_{i=1}^{i=n} a_i.$$

It is clear that

$$(AI. 15) \quad \ln \left\{ \prod_{i=1}^{i=n} a_i \right\} = \sum_{i=1}^{i=n} \ln a_i.$$

AII. Some Definite Integrals

$$\int_0^{\infty} x^n e^{-ax} dx = \frac{1}{a^{n+1}} \int_0^{\infty} z^n e^{-z} dz = \frac{n!}{a^{n+1}}.$$

$$\int_0^{\infty} x^{2k+1} e^{-ax^2} dx = \frac{1}{2a^{k+1}} \int_0^{\infty} y^k e^{-y} dy = \frac{k!}{2a^{k+1}}.$$

$$\int_{-\infty}^{+\infty} e^{-ax^2} dx = \left(\frac{\pi}{a}\right)^{1/2} = \frac{1}{a^{1/2}} 1.772\ 453.$$

$$\int_{-\infty}^{+\infty} x^2 e^{-ax^2} dx = \frac{1}{2a} \left(\frac{\pi}{a}\right)^{1/2}.$$

$$\int_{-\infty}^{+\infty} x^4 e^{-ax^2} dx = \frac{3}{4a^2} \left(\frac{\pi}{a}\right)^{1/2}.$$

$$\int_{-\infty}^{+\infty} x^6 e^{-ax^2} dx = \frac{15}{8a^3} \left(\frac{\pi}{a}\right)^{1/2}.$$

AIII. The Euler-Maclaurin Summation Formula

The sum of a function of some variable j , for integral values of the variable, between two limits m and n , is symbolized by

$$(AIII. 1) \quad \sum_{j=m}^{j=n} f(j) = f(m) + f(m + 1) + \cdots + f(n - 1) + f(n).$$

If the function f is definable for non-integral values of the variable, $f(x)$, the sum may be approximated in terms of the integral of $f(x)$ between the limits m and n and the values of the function and its derivatives at the two limits. The approximation formula is known as the Euler-Maclaurin summation formula. The symbol

$$(AIII. 2) \quad f(a)^r = \left(\frac{d^r f(x)}{dx^r} \right)_{x=a}$$

is used for the r th derivative of the function at the value $x = a$. Then

$$(AIII. 3) \quad \sum_{j=m}^{j=n} f(j) = \int_m^n f(x) dx + \frac{1}{2} [f(m) + f(n)] + \sum_{k \geq 1} (-1)^k \frac{B_k}{(2k)!} [f(m)^{(2k-1)} - f(n)^{(2k-1)}]$$

where the numbers B_k are the Bernoulli numbers, $B_1 = \frac{1}{6}$, $B_2 = \frac{1}{30}$, $B_3 = \frac{1}{42}$, $B_4 = \frac{1}{30}$, $B_5 = \frac{5}{66}$.

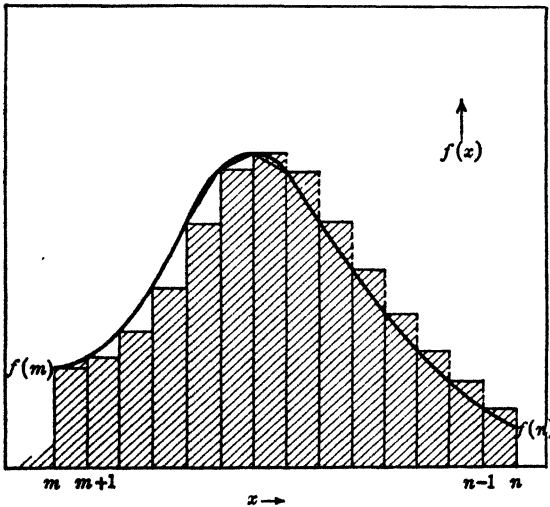

FIG. AIII. 1.

The first few terms of this development may be readily checked geometrically. In Fig. AIII. 1 a function, $f(x)$, is plotted against x between the limits m and n . The integral is the area under the smooth curve. The values of the

function at integral values of the variable x are shown as perpendicular lines, so that the sum is the sum of the heights of these lines. Since the lines are unit distance apart the sum of the heights of all but the last, $f(n)$, is given by the shaded area under the stepwise figure. If the points $f(j)$ and $f(j+1)$ are connected by straight lines, the areas under the triangles so formed above the steps form the first correction to the difference between the area of the stepwise figure and that under the smooth curve. The area of each triangle is $\frac{1}{2} [f(j) - f(j+1)]$, and the sum of their areas is $\frac{1}{2} [f(m) - f(n)]$, if account is taken of the fact that the triangles above the steps must be subtracted from the integral and those below must be added to the integral in order to approximate the sum. Adding the integrals, the areas of the triangles, and the last term of the sum, $f(n)$, one obtains the approximation (AIII. 3) up to the terms containing the derivatives.

The correction of the first derivative can also be seen geometrically rather simply, but we shall omit the argument.

If, however, it is assumed that a general equation like (AIII. 3) can be obtained, that is, one which expresses the sum between two limits in terms of the integral between these limits, and the values of the function and its derivatives at the limits, then the coefficients of the first terms may be obtained readily by the consideration of a special case.

The integral of the function e^{-ax} between zero and infinity is a^{-1} . The value of the function and of all its derivatives at $x = \infty$ is zero. The value of the function at $x = 0$ is unity, and of its r th derivative is $(-a)^r$ at this value of x . The sum e^{-aj} from $j = 0$ to $j = \infty$ can be summed in closed form and the expression expanded as a power series in a containing powers minus one, zero, and all positive powers. The coefficients of this series give the coefficients in (AIII. 3).

The steps are simple enough algebraically. The quantity $1/(1 - e^{-a})$ can be seen to be the desired sum if the indicated division is carried out. The exponential e^{-a} may be expanded in a power series in a , and the analytical expression obtained may be divided into unity, obtaining

$$(AIII. 4) \quad \sum_{j=0}^{j=\infty} e^{-aj} = \frac{1}{1 - e^{-a}} = \frac{1}{a} + \frac{1}{2} + \frac{1}{12}a - \frac{1}{720}a^3 \\ + \frac{1}{30,240}a^5 - \dots$$

The coefficients in (AIII. 4) agree with those in (AIII. 3).

AIV. The Factorial and the Stirling Approximation

The product of N factors, $N \cdot (N - 1) \cdot (N - 2) \cdot (N - 3) \cdot \dots \cdot 3 \cdot 2 \cdot 1$ is called N factorial, and written $N!$. The convention is adopted that zero factorial is unity. The logarithm of $N!$

$$(AIV. 1) \quad \ln N! = \sum_{j=1}^{j=N} \ln j$$

may be approximated by the Euler-Maclaurin summation formula (AIII). The integral of $\ln x$ is $x \ln x - x$, and between the limits 1 and N gives $N \ln N - N + 1$. The value of the function at $x = N$ is $\ln N$, and at $x = 1$ is zero. The derivatives of $\ln x$ are inverse powers of x , so that at the limit $x = N$ the derivatives may all be neglected for large values of N . At $x = 1$ the derivatives are independent of N . One obtains,

$$(AIV. 2) \quad \ln N! \cong N \ln N - N + \frac{1}{2} \ln N + c,$$

where c is a term containing a constant and inverse powers of N . The constant term in c is actually $\frac{1}{2} \ln 2\pi$, so that

$$(AIV. 3) \quad N! \cong N^N e^{-N} (2\pi N)^{1/2}$$

for large values of N .

AV. The Volume of an N -dimensional Sphere

In an N -dimensional space of coordinates x_1, x_2, \dots, x_N , the part of the space for which

$$x_1^2 + x_2^2 + x_3^2 + \dots + x_N^2 \leq r^2$$

constitutes the inside of an N -dimensional sphere of radius r . The volume of this sphere is

$$V_N = \frac{\pi^{N/2}}{(\frac{1}{2}N)!} r^N \text{ for } N \text{ even,}$$

and

$$V_N = \frac{2^N \pi^{(N-1)/2} (\frac{1}{2}N - \frac{1}{2})!}{N!} r^N \text{ for } N \text{ odd.}$$

Using the Stirling approximation for the factorial, the asymptotic expression for $\ln V_N$ is the same for both cases,

$$\ln V_N \cong \frac{N}{2} \ln \left(\frac{2\pi e r^2}{N} \right).$$

AVI. The Method of Undetermined Multipliers

Suppose that one seeks the maximum (or minimum) value of a function F of N variables, x_1, x_2, \dots, x_N . This value will be determined by the condition that the variation

$$(AVI. 1) \quad \delta F = \sum_{v=1}^N \frac{\partial F}{\partial x_v} \delta x_v = 0$$

in F for any conceivable small variation $\delta x_1, \dots, \delta x_N$ of the variables shall be zero. This condition can be satisfied for all possible variations of the variables only if every partial derivative is zero,

$$(AVI. 2) \quad \frac{\partial F}{\partial x_v} = 0.$$

Whether the extremum so found is a maximum or not must be determined by the values of the second derivatives.

However, it may be that not all the variables x are independent, but that some condition

$$(AVI. 3) \quad G(x) = 0,$$

where G is a function of all the x 's, must be obeyed.

One may then seek the maximum value of F , subject to the condition (3).

In this case equation (1), that $\delta F = 0$, must still hold at the maximum, though not for all arbitrary variations of the variables, but only for those which are such that the variation in G is zero,

$$(AVI. 4) \quad \delta G = \sum_{\nu=1}^N \frac{\partial G}{\partial x_{\nu}} \delta x_{\nu} = 0,$$

so that equation (3) is maintained. One can, then, not conclude that equation (2) must hold.

Since, for the allowed variations of the variables, the quantity δG , equation (4), is zero, and of course also $z\delta G = 0$ for any value of z , one may subtract $z\delta G$ from (1), without altering its value, and obtain

$$(AVI. 5) \quad \delta F = \sum_{\nu=1}^N \left(\frac{\partial F}{\partial x_{\nu}} - z \frac{\partial G}{\partial x_{\nu}} \right) \delta x_{\nu} = 0.$$

Equation (4) gives us one condition by means of which the variation δx_{μ} of one of the variables x_{μ} is determined if all the other variations

$$\delta x_1, \dots, \delta x_{\mu-1}, \delta x_{\mu+1}, \dots, \delta x_N$$

are arbitrarily assigned, that is, the condition (3) may be maintained with any arbitrary variation in the values of $N - 1$ of the N variables. The numerical value of z may be so chosen that, if $\partial G / \partial x_{\mu}$ is not zero,

$$(AVI. 6) \quad \frac{\partial F}{\partial x_{\mu}} - z \frac{\partial G}{\partial x_{\mu}} = 0,$$

and in the sum of (5) the μ th term is zero whatever the variation in x_{μ} is. However, the sum over the other $N - 1$ terms must be zero if F is to be a maximum, and since all conceivable variations of the $N - 1$ terms are consistent with (4), one finds that, for all values of ν ,

$$(AVI. 7) \quad \frac{\partial F}{\partial x_{\nu}} - z \frac{\partial G}{\partial x_{\nu}} = 0.$$

This is a necessary condition for the position of the maximum of F subject to condition (4) that G be held constant. The numerical value of z must be determined in such a way that the function G has the particular value zero if condition (3) is to be obeyed.

From (7) it is seen that

$$(AVI. 8) \quad z = \frac{dF}{dG}.$$

The extension to two conditions is fairly obvious and will not be discussed in detail.

AVII. Combinatory Problems

Problems frequently arise in statistical mechanics which may be shown to be identical to some problem concerning the number of ways in which objects can be arranged in order or placed in piles or boxes. The answers to some of these problems follow.

(1) The number of ways in which N distinguishable objects can be arranged in order is

$$N!$$

The object to occupy the first place may be selected out of the N different objects in N different ways. Independently of the choice for first place the selection for second place may be made from the remaining $N - 1$ objects in $N - 1$ ways, so that the first two places may be filled in $N(N - 1)$ ways. Similarly the object for the k th place may be chosen in $N - k + 1$ ways after the first $k - 1$ places have been filled. The product

$$N(N - 1)(N - 2) \cdots 3 \cdot 2 \cdot 1 \text{ is } N!$$

This number $N!$ is also the number of permutations of N objects.

(2) The number of different ways in which M objects may be selected from N distinguishable objects, irrespective of the order of choice, is

$$\frac{N!}{(N - M)! M!}.$$

The objects may be arranged in order in $N!$ different ways, and the objects in the first M places always chosen. However, many orderings lead to a choice of the same M objects, namely, all those which differ from each other only by permutations of the objects in the first M places among each other, and permutations of the remaining $N - M$ objects among each other. The number of these permutations is $M!(N - M)!$, so that every choice of the first M objects corresponds to this many different arrangements of all the particles in order. The number of choices that one can make is then $N!$ divided by the product $M!(N - M)!$.

(3) The number of ways in which N objects may be arranged in two piles of respectively M and $N - M$ objects each is

$$\frac{N!}{(N - M)! M!}.$$

The problem is the same as the preceding one since, after the selection of M objects, the remaining $N - M$ are uniquely determined.

(4) The number of ways in which N objects may be placed in P piles, m_1 in the first pile, m_2 in the second pile, . . . , m_i in the i th, with

$$\sum_{i=1}^P m_i = N,$$

is

$$\frac{N!}{\prod_{i=1}^P m_i!}.$$

The N objects are ordered, and those in the first m_1 places assigned to the first pile, those in the places $m_1 + 1$ to $m_1 + m_2$, inclusive, assigned to the second pile, etc. There are $N!$ different ways of arranging the N objects in order, but any one assignment of m_1 definite objects to the first pile, m_2 definite objects to the second, etc., corresponds to $\prod m_i!$ different arrangements of the objects in order, since all permutations of the m_i objects with each other, within the one pile i , lead to a new arrangement of the N objects but not to a new assignment to piles. The total number of ways the objects can be assigned to the piles, with given values of the m_i 's, is the total number of arrangements in order, $N!$, divided by the number of arrangements per assignment to piles, $\prod m_i!$, or $N!/\prod m_i!$.

(5) The multinomial coefficient, the coefficient of $\prod x_i^{m_i}$ in the sum $\sum x_i$ raised to the power N is

$$\frac{N!}{\prod_i m_i!}$$

with $\sum_{i=1}^P m_i = N$, if there are P members x_i in the sum. This problem can be shown to be identical to the preceding problem, (4). One writes the N th power of the sum $\sum x_i$ as N consecutive distinguishable factors. Each term in the product contains one and only one x from each factor. If from one factor the x chosen is x_i , that factor will be assigned to the pile i . The number of ways that we can make selections from the numbered factors so as to have m_i objects in the pile i for all values of i is the above expression, and this is just the number of terms in the expansion having the given powers m_i of x_i .

A special case of (5) is that there are just two values of i , so that

$$\frac{N!}{(N - M)! M!}$$

is the binomial coefficient, the coefficient of $x^M y^{N-M}$ in the expansion of $(x + y)^N$.

From (5) the values of certain sums may be ascertained. For instance

$$\sum_{M=0}^N \frac{N!}{(N-M)!M!} = (1+1)^N = 2^N,$$

$$\sum_{\substack{m_i=N \\ m_i=0 \\ i=P \\ \sum_{i=1}^{\infty} m_i=N}} \frac{N!}{i^P \prod_{i=1}^{\infty} m_i!} = P^N,$$

$$\sum_{M=0}^N \frac{N!}{(N-M)!M!} (-1)^M = (1-1)^N = 0.$$

An example of a more complicated trick which may be employed to evaluate a sum is

$$\sum_{M=0}^N \frac{N!}{(N-M)!M!} (A + BM)^k (-1)^M = \left(\frac{\partial^k}{\partial x^k} \right)_{x=0} e^{Ax} (1 - e^{Bx})^N$$

= 0 if $k < N$

(6) **The number of ways in which N distinguishable objects may be assorted into piles with m_1 piles of one object each, m_2 piles of two objects each, . . . , m_k piles of k objects each, so that**

$$\sum_{k \geq 1} km_k = N,$$

is

$$\frac{N!}{\prod_k m_k! (k!)^{m_k}}.$$

This problem differs from (4) in that the piles are unnumbered. In (4), if the first pile contained three objects and the second pile the same number of objects, the arrangement would be different if the objects in the two piles were all exchanged, whereas in this problem only the number of piles of three objects each is specified. With numbered piles the number of arrangements would be $N! / \prod_i k_i!$ which must be divided by $\prod_k m_k!$ for the numbers of permutations of piles with identical numbers of objects.

(7) **The number of ways N distinguishable objects may be placed in C numbered boxes with no restrictions on the number of objects per box is**

$$C^N,$$

since each object has C different possible choices among the C boxes, independently of the positions of the other objects.

(8) **The number of ways that N distinguishable objects can be placed in C numbered boxes with no more than one object to a box, $N \leq C$, is**

$$\frac{C!}{(C-N)!}.$$

The first object has C choices, the second $C - 1$, etc., until the last has $C - N + 1$ possible positions available. The product

$$C(C - 1) \cdots (C - N + 1) \text{ is } C!/(C - N)!$$

(9) The number of ways that N indistinguishable objects can be placed in C numbered boxes, no more than one to a box, $N \leq C$, is

$$\frac{C!}{(C - N)! N!}$$

The problem is the same as in (8) above, except that the $N!$ different permutations of the N objects in the boxes all count as the same arrangement. The answer to (8) must be divided by $N!$.

(10) The number of ways that N indistinguishable objects can be placed in C numbered boxes with no restrictions on the number per box is

$$\frac{(C + N - 1)!}{(C - 1)! N!}$$

The proof of this is less direct than that of the other problems. An arrangement is characterized by the number of objects in each of the numbered boxes, since the objects are indistinguishable. Consider the arrangement in a line of the symbols $z_1, z_2, \cdots, z_C, a_1, a_2, \cdots, a_N$, for instance

$$z_1 a_2 a_4 z_8 a_8 a_9 z_5 z_4 z_9 a_6 \cdots$$

Such an arrangement could be used to define an assignment of N numbered objects, the a 's, to C numbered boxes, the z 's, by adopting the convention that the objects to the right of each numbered z belong to the box of that number. For instance, the above corresponds to objects 2 and 4 in box 1, objects 8 and 9 in box 8, no objects in boxes 5 and 4, and object 6 in box 9. One must observe the convention that the row starts with a z , and we shall consider only arrangements of the symbols which start with z_1 . However, $(C - 1)!$ such arrangements of the symbols correspond to one arrangement of numbered objects in the same boxes, since permutations of the $C - 1$ groups of each z_i with its following a 's corresponds to the same arrangement of numbered objects in the boxes. In addition all $N!$ permutations of the a 's correspond to the same arrangement of unnumbered and indistinguishable objects to the boxes. In all, each assignment of the indistinguishable objects to the numbered boxes corresponds to $N!(C - 1)!$ arrangements of the symbols, and the $N + C - 1$ symbols (after the first) may be arranged in $(N + C - 1)!$ ways.

AVIII. General Thermodynamic Relationships

The entropy S is a "natural" function of the energy E , volume V , and number N_i of molecules of kind i . By natural function is meant that the derivatives

$$(AVIII. 1) \quad \left(\frac{\partial S}{\partial E}\right)_{V, N_i} = \frac{1}{T}, \quad \left(\frac{\partial S}{\partial V}\right)_{E, N_i} = \frac{P}{T}, \quad \left(\frac{\partial S}{\partial N_i}\right)_{E, V} = -\frac{\mu_i}{T}$$

are simple expressions. From (1),

$$(AVIII. 2) \quad dS = \frac{1}{T} dE + \frac{P}{T} dV - \frac{\mu_i}{T} dN_i,$$

or

$$(AVIII. 3) \quad dE = T dS - P dV + \mu_i dN_i,$$

$$(AVIII. 4) \quad \left(\frac{\partial E}{\partial S}\right)_{V, N_i} = T, \quad \left(\frac{\partial E}{\partial V}\right)_{S, N_i} = -P, \quad \left(\frac{\partial E}{\partial N_i}\right)_{V, S} = \mu_i.$$

The heat content H , which is sometimes called enthalpy, especially if measured in B.t.u. units, is defined as

$$(AVIII. 5) \quad H = E + PV, \quad dH = dE + P dV + V dP,$$

$$(AVIII. 6) \quad \left(\frac{\partial H}{\partial S}\right)_{P, N_i} = T, \quad \left(\frac{\partial H}{\partial P}\right)_{S, N_i} = V, \quad \left(\frac{\partial H}{\partial N_i}\right)_{S, P} = \mu_i.$$

The work function A is also called the Helmholtz free energy, or the free energy at constant volume; it is defined as

$$(AVIII. 7) \quad A = E - TS, \quad dA = dE - T dS - S dT.$$

$$(AVIII. 8) \quad \left(\frac{\partial A}{\partial T}\right)_{V, N_i} = -S, \quad \left(\frac{\partial A}{\partial V}\right)_{T, N_i} = -P, \quad \left(\frac{\partial A}{\partial N_i}\right)_{T, V} = \mu_i.$$

The free energy F , also known as the Gibbs free energy, or free energy at constant pressure, is

$$(AVIII. 9) \quad F = A + PV = H - TS, \\ dF = -S dT - V dP + \mu_i dN_i,$$

$$(AVIII. 10) \quad \left(\frac{\partial F}{\partial T}\right)_{P, N_i} = -S, \quad \left(\frac{\partial F}{\partial P}\right)_{T, N_i} = V, \quad \left(\frac{\partial F}{\partial N_i}\right)_{P, T} = \mu_i.$$

The heat capacities, C_V at constant volume, and C_P at constant pressure, are defined as

$$(AVIII. 11) \quad C_V = \left(\frac{\partial E}{\partial T}\right)_V, \quad C_P = \left(\frac{\partial H}{\partial T}\right)_P.$$

Certain relationships,

$$(AVIII. 12) \quad \frac{\partial^2 E}{\partial S \partial V} = \left(\frac{\partial T}{\partial V}\right)_S = - \left(\frac{\partial P}{\partial S}\right)_V \quad \text{from (4),}$$

$$(AVIII. 13) \quad \frac{\partial^2 H}{\partial S \partial P} = \left(\frac{\partial T}{\partial P}\right)_S = \left(\frac{\partial V}{\partial S}\right)_P \quad \text{from (6),}$$

$$(AVIII. 14) \quad \frac{\partial^2 A}{\partial V \partial T} = - \left(\frac{\partial S}{\partial V} \right)_T = - \left(\frac{\partial P}{\partial T} \right)_V \quad \text{from (8),}$$

and

$$(AVIII. 15) \quad \frac{\partial^2 F}{\partial P \partial T} = - \left(\frac{\partial S}{\partial P} \right)_T = \left(\frac{\partial V}{\partial T} \right)_P \quad \text{from (10),}$$

are sometimes useful.

The relationship

$$(AVIII. 16) \quad C_P - C_V = -T \left(\frac{\partial V}{\partial T} \right)_P^2 \left(\frac{\partial P}{\partial V} \right)_T^{-1}$$

is proved in section 11c.

Bold-face type, **S, V, E, H, F, A, C_P, C_V**, is used in this book for the extensive thermodynamic properties per mole of material.

AIX. Summary of Thermodynamic Functions of a Perfect Gas

For a perfect gas, any extensive thermodynamic property X may be written as a sum of terms,

$$(AIX. 1) \quad X = X_{\mathbf{k}} + X_{\mathbf{i}},$$

where $X_{\mathbf{k}}$ gives the contribution to X of the translational motion of the center of mass of the molecules, and $X_{\mathbf{i}}$ the contribution of the internal degrees of freedom. $X_{\mathbf{i}}$ is zero for an ideal monatomic gas, defined as one for which only one internal quantum state exists. To within varying degrees of accuracy, $X_{\mathbf{i}}$ may be written as a sum of terms due to the different internal degrees of freedom in the molecule.

(a) The Translational Contribution, $X_{\mathbf{k}}$, per mole

The symbols used are: P, V, T , pressure, volume per mole, and temperature; k , the Boltzmann constant, 1.3804×10^{-16} erg/deg.; $R = N_0 k$, with N_0 Avogadro's number; m is the mass per molecule, and M the molecular weight. The thermodynamic functions are defined in AVIII.

$$(AIX. 2) \quad \begin{aligned} \mathbf{F}_{\mathbf{k}} &= RT \ln \left(\frac{h^2}{2\pi m k T} \right)^{3/2} \frac{N_0}{V} \\ &= RT \ln \left(\frac{h^2}{2\pi m k T} \right)^{3/2} \frac{P}{kT} \\ &= RT \left(-\frac{3}{2} \ln M - \frac{3}{2} \ln T - \ln V + K_{FV} \right) \\ &= RT \left(-\frac{3}{2} \ln M - \frac{5}{2} \ln T + \ln P + K_{FP} \right). \end{aligned}$$

$$(AIX. 3) \quad \begin{aligned} \mathbf{A}_{\mathbf{k}} &= RT \ln \left(\frac{h^2}{2\pi m k T} \right)^{3/2} \frac{N_0}{V} \frac{1}{e} \\ &= RT \ln \left(\frac{h^2}{2\pi m k T} \right)^{3/2} \frac{P}{kT} \frac{1}{e} \\ &= RT \left(-\frac{3}{2} \ln M - \frac{3}{2} \ln T - \ln V + K_{AV} \right) \\ &= RT \left(-\frac{3}{2} \ln M - \frac{5}{2} \ln T + \ln P + K_{AP} \right), \end{aligned}$$

$$\begin{aligned}
 \text{(AIX. 4)} \quad S_k &= R \ln \left(\frac{2\pi mkT}{h^2} \right)^{3/2} \frac{V}{N_0} e^{5/2} \\
 &= R \ln \left(\frac{2\pi mkT}{h^2} \right)^{3/2} \frac{kT}{P} e^{5/2} \\
 &= R \left(\frac{3}{2} \ln M + \frac{3}{2} \ln T + \ln V + K_{SV} \right) \\
 &= R \left(\frac{3}{2} \ln M + \frac{5}{2} \ln T - \ln P + K_{SP} \right),
 \end{aligned}$$

$$\text{(AIX. 5)} \quad H_k = \frac{5}{2}RT,$$

$$\text{(AIX. 6)} \quad E_k = \frac{3}{2}RT,$$

$$\text{(AIX. 7)} \quad C_{Pk} = \frac{5}{2}R,$$

$$\text{(AIX. 8)} \quad C_{Vk} = \frac{3}{2}R.$$

TABLE AIX. 1
 $\ln x = 2.30259 \log_{10} x$

Quantity	Joules/Mole Deg.	Cal./Mole Deg.
R	8.3136	1.9864
$\frac{1}{2}R \ln x$	$9.5714 \log_{10} x$	$2.2869 \log_{10} x$
$R \ln x$	$19.1428 \log_{10} x$	$4.5738 \log_{10} x$
$\frac{3}{2}R \ln x$	$28.7142 \log_{10} x$	$6.8607 \log_{10} x$
$2R \ln x$	$38.2856 \log_{10} x$	$9.1476 \log_{10} x$
$\frac{5}{2}R \ln x$	$47.8570 \log_{10} x$	$11.4345 \log_{10} x$

TABLE AIX. 2
 1 atmosphere = 760 mm. = 1.013 249 baryes.

Constant	Units	Value of Constant	$R \times$ Constant joules/mole deg.	$R \times$ Constant cal./mole deg.
K_{FV}	V cc.	8.064	67.042	16.019
K_{FV}	V liters	1.156	9.611	2.296
K_{FP}	P atm.	3.657	30.403	7.264
K_{FP}	P mm.	-2.976	-24.741	-5.912
K_{FP}	P baryes	3.644	30.295	7.238
K_{AV}	V cc.	7.064	58.727	14.032
K_{AV}	V liters	0.156	1.297	0.310
K_{AP}	P atm.	2.657	22.089	5.278
K_{AP}	P mm.	-3.976	-33.055	-7.898
K_{AP}	P baryes	2.644	21.981	5.252
K_{SV}	V cc.	-5.564	-46.257	-11.052
K_{SV}	V liters	1.343	11.165	2.668
K_{SP}	P atm.	-1.157	-9.619	-2.298
K_{SP}	P mm.	5.476	45.525	10.878
K_{SP}	P baryes	-1.144	-9.511	-2.272

(b) *The Internal Contribution, \bar{X}_1 , per mole*

The internal partition function per molecule, Q_1 , is defined by

$$(AIX. 9) \quad Q_1 = \sum_i e^{-\epsilon_i/kT},$$

all internal quantum states i

where ϵ_i is the energy of the state. The energy of the lowest state is usually taken to be zero, in which case the energy \bar{E} is zero at 0°K. The sum goes over all non-degenerate states, so that the exponential of a level of degeneracy g , consisting of g states, must be multiplied by g . Then

$$(AIX. 10) \quad F_1 = A_1 = -RT \ln Q_1,$$

$$(AIX. 11) \quad S_1 = R \frac{d}{dT} (T \ln Q_1) = RT \frac{d}{dT} \ln Q_1 + R \ln Q_1,$$

$$(AIX. 12) \quad H_1 = E_1 = RT^2 \frac{d}{dT} \ln Q_1$$

$$= RT \frac{1}{Q_1} \sum_i \frac{\epsilon_i}{kT} e^{-\epsilon_i/kT},$$

$$(AIX. 13) \quad C_{P1} = C_{V1} = R \frac{d}{dT} T^2 \frac{d}{dT} \ln Q_1$$

$$= R \left(2T \frac{d}{dT} \ln Q_1 + T^2 \frac{d^2}{dT^2} \ln Q_1 \right)$$

$$= R \left[\frac{1}{Q_1} \sum_i \left(\frac{\epsilon_i}{kT} \right)^2 e^{-\epsilon_i/kT} - \left(\frac{1}{Q_1} \sum_i \frac{\epsilon_i}{kT} e^{-\epsilon_i/kT} \right)^2 \right]$$

$$= R \frac{1}{Q_1^2} \sum_{i>j} \sum_j \left(\frac{\epsilon_i}{kT} - \frac{\epsilon_j}{kT} \right)^2 e^{-(\epsilon_i+\epsilon_j)/kT}.$$

These equations are perfectly general for all perfect gases. For many molecules the progression of the energies ϵ_i of the quantum states approximately obeys one of several simple equations, and for these types of molecules the summations may be performed analytically.

(c) *General Contributions to \bar{X}_1*

The contribution due to nuclear spin of magnitude s_n , per gram atom of element, is

$$(AIX. 14) \quad F_{\text{spin}} = A_{\text{spin}} = -RT \ln (2s_n + 1),$$

$$(AIX. 15) \quad S_{\text{spin}} = R \ln (2s_n + 1),$$

$$(AIX. 16) \quad H_{\text{spin}} = E_{\text{spin}} = C_{P \text{ spin}} = C_{V \text{ spin}} = 0.$$

These equations hold for all monatomic gases, and for all di- and polyatomic gases for which the rotational contributions are given by the classical approximations, that is, at high temperatures. In practice only hydrogen and some

hydrogen derivatives at low temperatures form exceptions. These contributions, since they cancel out in all differences of free energy or entropy, for which the gram atoms of element are naturally constant, are usually neglected. The same statements apply for the contributions due to isotope mixing which follow.

If n_j is the fraction of isotopes j , and if the difference in masses of the isotopes is neglected, so that the only effect of their presence is the non-identity of atoms of different isotopes, then, **per gram atom of element**,

$$(AIX. 17) \quad F_{\text{mixing}} = A_{\text{mixing}} = RT \sum_j n_j \ln n_j,$$

$$(AIX. 18) \quad S_{\text{mixing}} = -R \sum_j n_j \ln n_j,$$

$$(AIX. 19) \quad H_{\text{mixing}} = E_{\text{mixing}} = C_P_{\text{mixing}} = C_V_{\text{mixing}} = 0.$$

(d) \mathbf{X}_1 for Monatomic Gases

The general equations (9) to (13) may be used with ϵ_1 the energy of the various spectroscopic terms. If the term value ω is given in cm^{-1} , multiplication by 1.4390 gives ϵ_1/k , and by 0.6249 gives $\epsilon_1/2.3026 k$, so that $e^{-\epsilon_1/kT}$ is $\text{antilog}_{10}(-0.6249\omega/T)$. Usually very few, and often only the lowest term for which $\epsilon_1 = 0$, contribute appreciably. The degeneracy of a term is $2j + 1$, so that the exponential of a given term must be multiplied by $2j + 1$, the number of quantum states of that energy. The quantum number j is the quantum number of total angular momentum and is the lower right-hand subscript in the usual term notation.

If only the lowest term contributes, the equations for \mathbf{X}_1 become those of (14) to (16) with j for the lowest term replacing the spin s_n .

(e) \mathbf{X}_1 for Diatomic Gases

Diatomic gases with a single lowest electronic state having no electronic angular momentum, and for which the energy of the first excited electronic level is high compared to kT , have energy levels due to molecular vibration and rotation which are often represented fairly well by the equation

$$(AIX. 20) \quad \epsilon(\nu, j) = \nu h\nu + j(j+1) \frac{\hbar^2}{8\pi^2 I}.$$

Equation (20) gives the energy above that of the lowest quantum state. The degeneracy of each level is $2j + 1$. The quantum numbers ν and j take only integral values. ν is the natural frequency in sec^{-1} , I the moment of inertia, $I = \mu r_0^2$, with μ the reduced mass, $\mu = m_1 m_2 / (m_1 + m_2)$, and r_0 the equilibrium separation of the atoms in the molecule.

Usually ω and B , both of dimensions cm^{-1} , are tabulated instead of ν and I ,

$$(AIX. 21) \quad \omega = \frac{\nu}{c},$$

$$(AIX. 22) \quad B = \frac{h}{8\pi^2 I c}.$$

If equation (20) is valid, Q_i is a product of factors, Q_v and Q_{jm} , and \mathbf{X}_i a sum of terms, $\mathbf{X}_v + \mathbf{X}_{jm}$.

Vibration. One defines

$$(AIX. 23) \quad u = \frac{\theta}{T} = \frac{h\nu}{kT} = \frac{hc\omega}{kT}.$$

The numerical conversion factors are given in the following table.

TABLE AIX. 3

Given	θ	$\theta/2.30259$	$R \ln \theta$
$h\nu$ erg/molec.	$7.245 \times 10^{15} h\nu$	$3.146 \times 10^{15} h\nu$	$72.542 + 4.5738 \log_{10} h\nu$
$h\nu$ e.volts	$1.1606 \times 10^4 h\nu$	$5.040 \times 10^3 h\nu$	$18.591 + 4.5738 \log_{10} h\nu$
ν sec. ⁻¹	$4.8000 \times 10^{-11} \nu$	$2.085 \times 10^{-11} \nu$	$-47.196 + 4.5738 \log_{10} \nu$
ω cm. ⁻¹	1.4390ω	0.6249ω	$0.723 + 4.5738 \log_{10} \omega$

The general equations for the vibrational contribution are

$$(AIX. 24) \quad Q_v = (1 - e^{-u})^{-1},$$

$$(AIX. 25) \quad F_v = A_v = RT \ln (1 - e^{-u}),$$

$$(AIX. 26) \quad S_v = R[u(e^u - 1)^{-1} - \ln (1 - e^{-u})],$$

$$(AIX. 27) \quad H_v = E_v = RTu(e^u - 1)^{-1},$$

$$(AIX. 28) \quad C_{Pv} = C_{Vv} = Ru^2 e^u (e^u - 1)^{-2}.$$

If u is small, one may develop $e^u = 1 + u + \frac{1}{2}u^2 + \dots$ and obtain

$$(AIX. 25') \quad F_v = A_v = RT \left(\ln u - \frac{u}{2} + \frac{u^2}{24} - \frac{u^4}{2880} + \dots \right),$$

$$(AIX. 26') \quad S_v = R \left(1 - \ln u + \frac{u^2}{24} - \frac{u^4}{960} + \dots \right),$$

$$(AIX. 27') \quad H_v = E_v = RT \left(1 - \frac{u}{2} + \frac{u^2}{12} - \frac{u^4}{720} + \dots \right),$$

$$(AIX. 28') \quad C_{Pv} = C_{Vv} = R \left(1 - \frac{u^2}{12} + \frac{u^4}{240} - \dots \right).$$

For values of u as great as $u = 5$ the following are valid to one per cent, and better at higher values of u ,

$$(AIX. 25'') \quad F_v = A_v = -RTe^{-u},$$

$$(AIX. 26'') \quad S_v = R(u + 1)e^{-u},$$

$$(AIX. 27'') \quad H_v = E_v = N_0 h\nu e^{-u} = RTu e^{-u},$$

$$(AIX. 28'') \quad C_{Pv} = C_{Vv} = Ru^2 e^{-u}.$$

In Table AIX. 4 the values of the functions for various values of $u = \theta/T$ are given.

TABLE AIX. 4

THERMODYNAMIC FUNCTIONS OF A MONOCHROMATIC OSCILLATOR

(For values of $u = \theta/T = h\nu/kT$ for which extrapolations of certain functions are inaccurate more easily extrapolated functions are given, i.e., $(F/RT) + \ln u$ and $(S/R) + \ln u$.)

$\frac{u}{T}$ $= \frac{h\nu}{kT}$	$\frac{E}{RT}$ $= \frac{u}{e^u - 1}$	$-\frac{\Delta f}{\Delta u}$	$\frac{C}{R}$ $= \frac{u^2 e^u}{(e^u - 1)^2}$	$-\frac{\Delta f}{\Delta u}$	$-\frac{F}{RT}$ $= [-\ln(1 - e^{-u})]$	$-\frac{F}{RT} + \ln u$	$\frac{S}{R}$	$\frac{S}{R} + \ln u$
1	2	2a	3	3a	4	4a	5	5a
0.001	0.9995		1.0000		6.9083	0.0005	7.9078	1.0000
0.005	0.9975	0.50	1.0000		5.3008	0.0025	6.2983	1.0000
0.010	0.9950	0.50	1.0000		4.6102	0.0050	5.6052	1.0000
0.050	0.9752	0.49	0.9998	0.00	3.0206	0.0249	3.9957	1.0001
0.10	0.9508	0.49	0.9992	0.01	2.3522	0.0496	3.3030	1.0004
0.15	0.9269	0.48	0.9981	0.02	1.9711	0.0740	2.8981	1.0010
0.20	0.9033	0.47	0.9967	0.03	1.7077	0.0983	2.6111	1.0017
0.25	0.8802	0.46	0.9948	0.04	1.5087	0.1224	2.3889	1.0026
0.30	0.8575	0.45	0.9925	0.04	1.3502	0.1462	2.2078	1.0038
0.35	0.8352	0.44	0.9898	0.05	1.2197	0.1699	2.0549	1.0051
0.40	0.8133	0.44	0.9868	0.06	1.1096	0.1933	1.9230	1.0067
0.45	0.7919	0.43	0.9832	0.07	1.0150	0.2165	1.8070	1.0085
0.50	0.7707	0.42	0.9794	0.07	0.9327	0.2396	1.7035	1.0104
0.55	0.7501	0.41	0.9752	0.08	0.8602	$-\frac{\Delta f}{\Delta u}$	1.6104	1.0126
0.60	0.7295	0.40	0.9705	0.09	0.7958	1.29	1.5257	1.0149
0.65	0.7100	0.39	0.9655	0.10	0.7383	1.15	1.4482	1.0174
0.70	0.6905	0.39	0.9602	0.10	0.6864	1.04	1.3769	1.0202
0.75	0.6715	0.38	0.9544	0.11	0.6393	0.94	1.3109	1.0232
0.80	0.6528	0.37	0.9484	0.12	0.5965	0.85	1.2494	$-\frac{\Delta f}{\Delta u}$
0.85	0.6345	0.36	0.9420	0.13	0.5576	0.78	1.1920	1.15
0.90	0.6166	0.35	0.9353	0.13	0.5218	0.71	1.1385	1.07
0.95	0.5991	0.35	0.9282	0.14	0.4890	0.655	1.0881	1.01
1.00	0.5820	0.34	0.9207	0.15	0.4587	0.60	1.0406	0.95
		0.34		0.15		0.56		0.89

TABLE AIX. 4 — *Continued*

$\frac{u}{T}$ $= \frac{h\nu}{kT}$	$\frac{E}{RT}$ $= \frac{u}{e^u - 1}$	$-\frac{\Delta f}{\Delta u}$	$\frac{C}{R}$ $= \frac{u^2 e^u}{(e^u - 1)^2}$	$-\frac{\Delta f}{\Delta u}$	$-\frac{F}{RT}$ $= [-\ln(1 - e^{-u})]$	$-\frac{\Delta f}{\Delta u}$	$\frac{S}{R}$	$-\frac{\Delta f}{\Delta u}$
1	2	2a	3	3a	4	4a	5	5a
1.05	0.5652		0.9130		0.4307		0.9959	
		0.33		0.16		0.52		0.84
1.10	0.5489	0.32	0.9050	0.16	0.4047	0.48	0.9536	0.80
1.15	0.5329	0.31	0.8967	0.17	0.3807	0.45	0.9136	0.76
1.20	0.5172	0.30	0.8882	0.17	0.3584	0.415	0.8756	0.72
1.25	0.5019	0.30	0.8795	0.18	0.3376	0.39	0.8395	0.68
1.30	0.4870	0.29	0.8706	0.18	0.3182	0.36	0.8052	0.65
1.35	0.4725	0.28	0.8613	0.19	0.3001	0.34	0.7726	0.62
1.40	0.4582	0.28	0.8516	0.20	0.2831	0.31	0.7413	0.59
1.45	0.4444	0.27	0.8417	0.20	0.2673	0.29	0.7117	0.57
1.50	0.4308	0.26	0.8318	0.20	0.2525	0.28	0.6833	0.54
1.55	0.4176	0.26	0.8218	0.20	0.2386	0.26	0.6562	0.52
1.60	0.4048	0.25	0.8115	0.21	0.2255	0.24	0.6303	0.49
1.65	0.3922	0.24	0.8010	0.21	0.2133	0.23	0.6055	0.47
1.70	0.3800	0.24	0.7903	0.21	0.2017	0.22	0.5817	0.46
1.75	0.3681	0.23	0.7796	0.21	0.1909	0.20	0.5587	0.44
1.80	0.3564	0.23	0.7688	0.22	0.1807	0.19	0.5368	0.42
1.85	0.3451	0.22	0.7578	0.22	0.1711	0.18	0.5159	0.40
1.90	0.3342	0.21	0.7467	0.22	0.1620	0.17	0.4960	0.38
1.95	0.3235	0.21	0.7354	0.22	0.1535	0.16	0.4770	0.37
2.00	0.3130	0.20	0.7241	0.23	0.1454	0.15	0.4584	0.35
2.10	0.2931	0.19	0.7013	0.23	0.1303	0.13	0.4234	0.32
2.20	0.2743	0.18	0.6783	0.23	0.1172	0.12	0.3915	0.30
2.30	0.2565	0.17	0.6553	0.23	0.1054	0.11	0.3619	0.27
2.40	0.2397	0.16	0.6320	0.23	0.0948	0.10	0.3346	0.25
2.50	0.2236	0.15	0.6089	0.23	0.0854	0.09	0.3092	0.24
2.60	0.2085	0.14	0.5859	0.23	0.0769	0.08	0.2855	0.22
2.70	0.1944		0.5630		0.0692		0.2637	

$\frac{u}{T}$ $= \frac{h\nu}{LT}$	$\frac{E}{RT}$ $= \frac{u}{e^u - 1}$	$-\frac{\Delta f}{\Delta u}$	$\frac{C}{R}$ $= \frac{u^2 e^u}{(e^u - 1)^2}$	$-\frac{\Delta f}{\Delta u}$	$-\frac{F}{RT}$ $= [-\ln(1 - e^{-u})]$	$-\frac{\Delta f}{\Delta u}$	$\frac{S}{R}$	$-\frac{\Delta f}{\Delta u}$
1	2	2a	3	3a	4	4a	5	5a
2.80	0.1813	0.13	0.5404	0.23	0.0624	0.07	0.2439	0.20
2.90	0.1889	0.12	0.5182	0.22	0.0562	0.06	0.2253	0.19
3.00	0.1572	0.11	0.4963	0.22	0.0507	0.06	0.2179	0.17
3.10	0.1462	0.11	0.4747	0.22	0.0458	0.05	0.1920	0.16
3.20	0.1360	0.10	0.4536	0.21	0.0413	0.04	0.1773	0.15
3.30	0.1264	0.09	0.4329	0.21	0.0373	0.04	0.1637	0.14
3.40	0.1173	0.09	0.4128	0.20	0.0336	0.04	0.1509	0.13
3.50	0.1090	0.08	0.3933	0.19	0.0304	0.03	0.1393	0.12
3.60	0.1011	0.08	0.3743	0.19	0.0275	0.03	0.1286	0.11
3.70	0.0938	0.07	0.3559	0.18	0.0248	0.03	0.1187	0.10
3.80	0.0870	0.07	0.3381	0.18	0.0223	0.02	0.1093	0.10
3.90	0.0806	0.06	0.3208	0.17	0.0200	0.02	0.1006	0.09
4.00	0.0746	0.06	0.3041	0.17	0.0180	0.02	0.0925	0.08
4.20	0.0640	0.05	0.2726	0.16	0.0148	0.02	0.0787	0.07
4.40	0.0547	0.05	0.2437	0.14	0.0119	0.01	0.0666	0.06
4.60	0.0467	0.04	0.2169	0.13	0.0097	0.01	0.0564	0.05
4.80	0.0398	0.04	0.1927	0.12	0.0079	0.01	0.0477	0.04
5.00	0.0339	0.03	0.1707	0.11	0.0063	0.01	0.0403	0.04
5.20	0.0289	0.02	0.1507	0.10	0.0052		0.0341	
5.40	0.0245	0.02	0.1328	0.09	0.0042		0.0287	
5.60	0.0208	0.02	0.1168		0.0034		0.0242	
5.80	0.0178	0.01	0.1024		0.0027		0.0205	
6.00	0.0149	0.01	0.0898		0.0022		0.0171	
6.50	0.0098	0.01	0.0636		0.0010		0.0107	
7.00	0.0064		0.0446		0.0003		0.0067	
7.50	0.0042		0.0310					

Rotation. One defines

$$(AIX. 29) \quad \sigma = \frac{Bhc}{kT} = \frac{h^2}{8\pi^2IkT}$$

so that numerically if I is measured in c.g.s. units.

$$\sigma = 1.4390 \frac{B}{T} = 39.598 \times 10^{-40} \frac{1}{IT}$$

and

$$\begin{aligned} R \ln \sigma &= 0.723 + 4.5738 \log_{10} \frac{B}{T} \\ &= 7.308 - 4.5738 \log_{10} (I \times 10^{40} T), \end{aligned}$$

in calories.

Then, the contribution of the rotational levels j , as a factor to the internal partition function per molecule, is

$$(AIX. 30) \quad Q_{jmt} = \sum_{j \geq 1} (2j + 1) e^{-j(j+1)\sigma}$$

For molecules composed of two different atoms of different elements, j takes all integral values, and for this case,

$$\begin{aligned} (AIX. 31) \quad Q_{jmt} &= 1 + 3e^{-2\sigma} + 5e^{-6\sigma} + 7e^{-12\sigma} \quad (0.1\% \text{ accuracy for } \sigma \geq 0.7) \\ &= \frac{1}{\sigma} \left(1 + \frac{\sigma}{3} + \frac{\sigma^2}{15} + \frac{4\sigma^3}{315} \right) \quad (0.1\%, \sigma \leq 0.7). \end{aligned}$$

$$\begin{aligned} (AIX. 32) \quad F_{jmt} &= A_{jmt} = -RT \ln Q_{jmt} \\ &= RT \left(\ln \sigma - \frac{\sigma}{3} - \frac{\sigma^2}{90} - \frac{8\sigma^3}{2835} \right) \quad (0.2\%, \sigma \leq 0.7). \end{aligned}$$

$$\begin{aligned} (AIX. 33) \quad S_{jmt} &= R \left[\ln Q_{jmt} + \frac{E_{jmt}}{T} \right] \\ &= R \left(1 - \ln \sigma - \frac{\sigma^2}{90} - \frac{16\sigma^3}{2835} \right) \quad (0.2\%, \sigma \leq 0.7). \end{aligned}$$

$$\begin{aligned} (AIX. 34) \quad H_{jmt} &= E_{jmt} = RT \frac{\sigma}{Q_{jmt}} (6e^{-2\sigma} + 30e^{-6\sigma} + 84e^{-12\sigma}) \quad (0.1\%, \sigma \geq 0.7) \\ &= RT \left(1 - \frac{\sigma}{3} - \frac{\sigma^2}{45} - \frac{8\sigma^3}{945} \right) \quad (0.2\%, \sigma \leq 0.7). \end{aligned}$$

$$\begin{aligned} (AIX. 35) \quad C_{Pjmt} &= C_{Vjmt} = R \left(\frac{\sigma}{Q_{jmt}} \right)^2 12e^{-2\sigma} (1 + 15e^{-4\sigma} + 20e^{-6\sigma} \\ &\quad + 84e^{-10\sigma} + 175e^{-12\sigma} + 105e^{-16\sigma}) \quad (0.2\%, \sigma \geq 0.65) \\ &= R \left(1 + \frac{\sigma^2}{45} + \frac{16\sigma^3}{945} \right) \quad (0.3\%, \sigma \leq 0.65). \end{aligned}$$

At high temperatures, small values of σ , the equations approach the classical values,

$$(AIX. 32') \quad F_{jmt} = A_{jmt} = RT \ln \sigma,$$

$$(AIX. 33') \quad S_{jmt} = R(1 - \ln \sigma),$$

$$(AIX. 34') \quad H_{jmt} = E_{jmt} = RT,$$

$$(AIX. 35') \quad C_{Pjmt} = C_{Vjmt} = R.$$

For elements in which the two atoms of the molecule are identical, j in (30) takes only even or only odd values. Which of the two it takes depends on the atomic weight and mutual nuclear spin of the atoms, as well as upon some other factors. At high temperatures, for which (32') to (35') are valid, this has only the effect of adding a term due to the symmetry of the molecule, X_{sym} , to the thermodynamic function X . These additive contributions for diatomic elements are

$$(AIX. 36) \quad F_{sym.} = A_{sym.} = RT \ln 2,$$

$$(AIX. 37) \quad S_{sym.} = -R \ln 2,$$

$$(AIX. 38) \quad H_{sym.} = E_{sym.} = C_{Psym.} = C_{Vsym.} = 0.$$

Since σ is small above the boiling point for all diatomic elements except H_2 , the classical equations (32') to (35') plus the symmetry terms (36) to (38) usually suffice. It is also only for these cases of small σ values that the nuclear spin and isotope mixing terms are given for an element by equations (14) to (19).

It is practically only for H_2 that the detailed summations of (30) with only odd and only even j values are of interest. Equations for this case are given in section 7b. Values of the functions for various values of σ are given in Table AIX. 5 for the case that the sum goes over all values of j , and in Tables AIX. 5a and AIX. 5b, respectively, for the cases that only even and only odd j 's occur.

TABLE AIX. 5
 ROTATOR FUNCTIONS FOR DIATOMIC MOLECULES
 WITH TWO DIFFERENT ATOMS
 (All j values allowed)

$$\sigma = \frac{Bhc}{kT} = \frac{h^2}{8\pi^2IkT}$$

σ	Q_{jmt}	$\ln Q_{jmt}$ $= -F_{jmt}/RT$	$T \frac{d}{dT} \ln Q_{jmt}$ $= E_{jmt}/RT$	$\frac{C_{jmt}}{R}$
0.02	50.0067	3.9187	0.9933	1.0000
0.04	25.0134	3.2322	0.9866	1.0000
0.06	16.6869	2.8334	0.9799	1.0001
0.08	12.5271	2.5525	0.9732	1.0002
0.10	10.0508	2.3360	0.9664	1.0002
0.15	6.7432	1.9475	0.9495	1.0006
0.20	5.3476	1.6766	0.9324	1.0010
0.25	4.3508	1.4704	0.9151	1.0016
0.30	3.6883	1.3052	0.8976	1.0025
0.35	3.2155	1.1680	0.8802	1.0034
0.40	2.8623	1.0516	0.8624	1.0047
0.45	2.5885	0.9511	0.8445	1.0061
0.50	2.3703	0.8630	0.8263	1.0084
0.60	2.0455	0.7156	0.7892	1.014
0.70	1.8164	0.5968	0.7702	1.024
0.80	1.6473	0.4992	0.7110	1.038
0.90	1.5186	0.4178	0.6691	1.055
1.00	1.4184	0.3496	0.6252	1.0733
1.1	1.3392	0.2921	0.5797	1.0879
1.2	1.2759	0.2436	0.5330	1.0968
1.3	1.2249	0.2028	0.4860	1.0955
1.4	1.1855	0.1702	0.4388	1.0787
1.5	1.1500	0.1397	0.3945	1.0568
1.6	1.1226	0.1134	0.3515	1.0197
1.7	1.1003	0.0956	0.3111	0.9727
1.8	1.0821	0.0789	0.2737	0.9178
1.9	1.0672	0.0650	0.2396	0.8575
2.0	1.0549	0.0535	0.2087	0.7940
2.2	1.0368	0.0301	0.1564	0.6651
2.4	1.0247	0.0244	0.1157	0.5424
2.6	1.0165	0.0165	0.0847	0.4332
2.8	1.0111	0.0111	0.0614	0.3404
3.0	1.0074	0.0074	0.0443	0.2638

TABLE AIX. 5a
 ROTATOR FUNCTIONS FOR DIATOMIC MOLECULES WHICH HAVE
 TWO IDENTICAL ATOMS AND FOR WHICH ONLY
 ROTATIONAL LEVELS
 WITH *Even j* ARE ALLOWED

σ	Q_{jmc}	$\ln Q_{jmc}$ = $-F_{jmc}/RT$	$T \frac{d}{dT} \ln Q_{jmc}$ = E_{jmc}/RT	$\frac{C_{jmc}}{R}$
0.08	6.2636	1.8593	0.9732
0.10	5.0254	1.6429	0.9664
0.15	3.3716	1.2543	0.9495
0.20	2.6739	0.9835	0.9318
0.25	2.1766	0.7778	0.9098	1.040
0.30	1.8492	0.6148	0.8772	1.117
0.35	1.6205	0.4827	0.8290	1.287
0.40	1.4566	0.3761	0.7639	1.3428
0.45	1.3371	0.2904	0.6859	1.4287
0.50	1.2493	0.2218	0.6010	1.4648
0.60	1.1367	0.1281	0.4332	1.3770
0.70	1.0750	0.0723	0.3254	1.1458
0.80	1.0411	0.0403	0.1897	0.8748
0.90	1.0226	0.0223	0.1193	0.6298
1.00	1.0124	0.0123	0.0734	0.4353
1.10	1.0068	0.0068	0.0446	0.2923
1.20	1.0037	0.0037	0.0268	0.1921
1.30	1.0020	0.0020	0.0159	0.1241
1.40	1.0011	0.0011	0.0094	0.0791
1.50	1.0006	0.0006	0.0055	0.0499

TABLE AIX. 5b

ROTATOR FUNCTIONS FOR DIATOMIC MOLECULES WHICH HAVE
TWO IDENTICAL ATOMS AND FOR WHICH ONLY
ROTATIONAL LEVELS
WITH *Odd j* ARE ALLOWED

State $j = 0$ is assumed to have zero energy, so that lowest energy per molecule for $j = 1$, is $\epsilon = 2\sigma T$.

$$E_{jmo}(0^\circ\text{K.}) = 2N_o\sigma T, S_{jmo}(0^\circ\text{K.}) = R \ln 3.$$

σ	Q_{jmo}	$\ln Q_{jmo}$ $= -F_{jmo}/RT$	$T \frac{d}{dT} \ln Q_{jmo}$ $= E_{jmo}/RT$	$\frac{C_{jmo}}{R}$
0.08	6.2636	1.8593	0.9732
0.10	5.0254	1.6429	0.9664
0.15	3.3716	1.2543	0.9494
0.20	2.6737	0.9835	0.9332	0.998
0.25	2.1742	0.7766	0.9204	0.963
0.30	1.8390	0.6092	0.9182	0.8869
0.35	1.5950	0.4469	0.9322	0.7705
0.40	1.4057	0.3405	0.9645	0.6347
0.45	1.2513	0.2242	1.0138	0.5247
0.50	1.1210	0.1142	1.0774	0.3816
0.60	0.9088	-0.0956	1.2345	0.2059
0.70	0.7414	-0.2993	1.4149	0.1038
0.80	0.6062	-0.5006	1.6063	0.0500
0.90	0.4960	-0.7011	1.8026	0.0233
1.00	0.4061	-0.9012	2.0010	0.0106

High-Temperature Corrections. At higher temperatures, when $h\nu/kT = u$ becomes unity or smaller, correction terms must be added owing to the anharmonicity of the vibration and the increase of the moment of inertia with increasing j and ν values. Especially for molecules containing hydrogen atoms these corrections are important even at relatively low temperatures, that is, for moderately large values of u .

The energy of the molecule as a function of the quantum numbers ν and j is usually given in one of the alternate forms:

$$(AIX. 39) \quad \frac{\epsilon}{hc} = (\nu + \frac{1}{2})\omega_e - (\nu + \frac{1}{2})^2 x_e \omega_e + j(j+1)B_e \\ - j^2(j+1)^2 D_e - (\nu + \frac{1}{2})j(j+1)\alpha,$$

$$(AIX. 39') \quad \frac{\epsilon - \epsilon_0}{hc} = \nu\omega_0 - \nu^2 x_0 \omega_0 + j(j+1)B_0 \\ - j^2(j+1)^2 D_e - \nu j(j+1)\alpha,$$

$$(AIX. 39'') \quad \frac{\epsilon - \epsilon_0}{hc} = \mathbf{v}\omega^* - \mathbf{v}(\mathbf{v} - 1)x^*\omega^* + \mathbf{j}(\mathbf{j} + 1)B_0 \\ - \mathbf{j}^2(\mathbf{j} + 1)^2 D_e - \mathbf{v}\mathbf{j}(\mathbf{j} + 1)\alpha.$$

The relationships between ω_e , ω_0 , and ω^* , x_e , x_0 , x^* , and B_e and B_0 are

$$(AIX. 40) \quad \omega^* = \omega_0 - x_0\omega_0 = \omega_e - 2x_e\omega_e,$$

$$(AIX. 41) \quad \omega^* x^* = \omega_0 x_0 = \omega_e x_e,$$

$$(AIX. 42) \quad B_0 = B_e - \frac{1}{2}\alpha.$$

The quantity x must be known from experimental data, but α and D_e depend on the values of ω , B , and x , as follows:

$$(AIX. 43) \quad \frac{\alpha}{B_e} = \left(\frac{6B_e}{\omega_e} \right) \left[\left(\frac{x_e\omega_e}{B_e} \right)^{1/2} - 1 \right],$$

$$(AIX. 44) \quad \gamma = \frac{1}{2} \left(\frac{D_e}{B_e} \right)^{1/2} = \frac{B_e}{\omega_e} \approx \frac{\sigma}{u}.$$

Actually, the experimental value of α is often given and does not agree perfectly with (43), which is probably because the experimental value is averaged over high approximations to the true energy formula than (39).

For diatomic gases at high temperatures the following procedure may be employed. \mathbf{X}_v and \mathbf{X}_{jm} are calculated with the aid of the equations in the preceding paragraphs, using ω^* and B_0 to calculate u and σ . The following correction terms are then added.

The negligible difference between x_e , x_0 , and x may be neglected, and any of them used for x . γ is, from (44), just σ/u . Then,

$$(AIX. 45) \quad \mathbf{F}_c = RT \left[-\frac{1}{u} (2\gamma + 6\gamma^{1/2}x^{1/2} + 2x) - (3\gamma - 3\gamma^{1/2}x^{1/2} - 2x) \right. \\ \left. - \frac{u}{6} (-3\gamma + 3\gamma^{1/2}x^{1/2} + 5x) + \frac{u^2}{6} x - \frac{u^3}{120} (\gamma - \gamma^{1/2}x^{1/2} + x) \right. \\ \left. + \dots \right].$$

$$(AIX. 46) \quad \mathbf{S}_c = R \left[\frac{1}{u} (4\gamma + 12\gamma^{1/2}x^{1/2} + 4x) + (3\gamma - 3\gamma^{1/2}x^{1/2} - 2x) \right. \\ \left. + \frac{u^2}{6} x - \frac{u^3}{60} (\gamma - \gamma^{1/2}x^{1/2} + x) + \dots \right].$$

$$(AIX. 47) \quad \mathbf{H}_c = \mathbf{E}_c = RT \left[\frac{1}{u} (2\gamma + 6\gamma^{1/2}x^{1/2} + 2x) - \frac{u}{6} (-3\gamma + 3\gamma^{1/2}x^{1/2} \right. \\ \left. + 5x) + \frac{u^2}{3} x - \frac{u^3}{40} (\gamma - \gamma^{1/2}x^{1/2} + x) + \dots \right].$$

$$(AIX. 48) \quad \mathbf{C}_{Pc} = \mathbf{C}_{Vc} = R \left[\frac{1}{u} (4\gamma + 12\gamma^{1/2}x^{1/2} + 4x) - \frac{u^2}{3} x \right. \\ \left. + \frac{u^3}{20} (\gamma - \gamma^{1/2}x^{1/2} + x) + \dots \right].$$

(f) \mathbf{X}_i for Polyatomic Gases

The total number of degrees of freedom per molecule is $3n$ if n is the number of atoms in the molecule. Of these, three are accounted for by the translation of the center of gravity, and either two or three, depending on whether the molecule is respectively linear or non-linear, will be degrees of freedom of rotation. Linear molecules will have $3n - 5$, non-linear molecules $3n - 6$, degrees of freedom due to vibration. If the $3n - 5$, respectively, $3n - 6$, frequencies are known, several of which may be numerically identical, each contributes a term \mathbf{X}_v to \mathbf{X}_i , with the appropriate value of u substituted in equations (25) to (28).

If the molecule is linear, \mathbf{X}_{im} will be the same as for a diatomic molecule with the same moment of inertia. The moment of inertia I is given by

$$(AIX. 49) \quad I = \sum_{k=1}^{k=n} m_k x_k^2,$$

where m_k is the mass of the k th atom and x_k its distance from the center of mass. The center of mass is so determined that

$$\sum_{k=1}^{k=n} x_k m_k = 0$$

if the sign of x_k is taken into account.

If the molecule is non-linear it will have three moments of inertia, A , B , C , two of which, or even three of which, may be identical. The moments of inertia may often be calculated with considerable accuracy from a knowledge of the geometry of the molecule, using accepted interatomic distances. With the exception of a few hydrogen derivatives at very low temperatures the moments of inertia are large enough so that a purely classical approximation is sufficiently accurate for the rotational contribution.

The equations for the contribution of the three rotational degrees of freedom are, if the moments of inertia are measured in c.g.s. units:

$$(AIX. 50) \quad Q_{\text{rot.}} = \left(\frac{8\pi^2 kT}{h^2} \right)^{3/2} (\pi ABC)^{1/2}.$$

$$(AIX. 51) \quad \begin{aligned} \mathbf{F}_{\text{rot.}} &= \mathbf{A}_{\text{rot.}} = RT \ln \left(\frac{h^2}{8\pi^2 kT} \right)^{3/2} \frac{1}{(\pi ABC)^{1/2}} \\ &= RT \left[-\frac{3}{2} \ln T - \frac{1}{2} \ln (ABC \times 10^{120}) + 4.946 \right]. \end{aligned}$$

$$(AIX. 52) \quad \begin{aligned} \mathbf{S}_{\text{rot.}} &= R \ln \left(\frac{8\pi^2 kT e}{h^2} \right)^{3/2} (\pi ABC)^{1/2} \\ &= R \left[\frac{3}{2} \ln T + \frac{1}{2} \ln (ABC \times 10^{120}) - 3.446 \right]. \end{aligned}$$

$$(AIX. 53) \quad \mathbf{H}_{\text{rot.}} = \mathbf{E}_{\text{rot.}} = \frac{3}{2} RT.$$

$$(AIX. 54) \quad \mathbf{C}_P \text{ rot.} = \mathbf{C}_V \text{ rot.} = \frac{3}{2} R.$$

AX. The Coefficient of the Term $\prod \beta_{\mathbf{k}}^{n_{\mathbf{k}}}$ in b_l

The cluster integral, b_l (equation 13. 5), is the integral over the configuration space of l particles of a sum of products of functions f_{ij} between the particles i and j . The sum goes over all products for which all the particles are at least singly connected by f 's. The integral is normalized by division with $l! V$.

A product in which two groups of molecules are only singly connected, that is, have one molecule in common, but no f 's connecting other molecules which are in different groups, splits into a product of two integrals. A sum of certain terms in the integrand of b_l may thus be represented as a product of irreducible integrals $\beta_{\mathbf{k}}$, each raised to the power $n_{\mathbf{k}}$, with $\sum \mathbf{k} n_{\mathbf{k}} = l - 1$. The $\beta_{\mathbf{k}}$'s are defined by equation (13. 25); they are $1/\mathbf{k}! V$ times the integral over the space of $\mathbf{k} + 1$ particles of the sum of all products of f_{ij} 's in which all the particles are more than singly connected by f 's.

If the symbol s is used to designate a certain set of the numbers $n_{\mathbf{k}}$, one has, then,

$$(AX. 1) \quad b_l = \frac{1}{l!} \sum_s K_s \prod_{\mathbf{k}} (\mathbf{k}! \beta_{\mathbf{k}})^{n_{\mathbf{k}}},$$

in which the numerical coefficient K_s gives the number of terms in the integrand of b_l which after integration yield $\prod \beta_{\mathbf{k}}^{n_{\mathbf{k}}}$. The $l!$ and $\mathbf{k}!$ in this equation arise from the inclusion of these factors as normalization factors in the integrals b_l and $\beta_{\mathbf{k}}$, respectively. The determination of this numerical coefficient K_s is the problem of this section.*

Consider a cluster of l molecules. Corresponding to any product of f_{ij} 's consistent with a single cluster, that is, any term in the integrand of equation (13. 5), it has already been shown that a diagram may be drawn with a line between the circles i and j symbolizing the function f_{ij} . So the problem of finding how many times a given product of $\beta_{\mathbf{k}}$'s occurs in the integrand of b_l reduces to a problem of finding how many lines may be drawn between numbered circles in a certain pattern. According to the formal development, there is no restriction on the number of bonds originating at any one molecule except that only one line may be used to connect each pair.

First a remark is to be made concerning the bond patterns corresponding to $\beta_{\mathbf{k}}$'s for which $\mathbf{k} > 2$. Each such $\beta_{\mathbf{k}}$ is a sum of $\frac{1}{2}\mathbf{k}(\mathbf{k} - 1)$ terms $\beta_{\mathbf{k}m}$, since $\mathbf{k} + 1$ points may be connected by $\mathbf{k} + 1, \dots, \frac{1}{2}\mathbf{k}(\mathbf{k} + 1)$ lines and still have all points more than singly connected. For example, β_4 contains integrals corresponding to the six patterns of Fig. AX. 1. Each of these integrals will occur in $\beta_{\mathbf{k}}$ with a coefficient representing the number of different permutations of the numbered molecules giving the same diagram when the numbers on the circles are neglected. The coefficient of the last pattern, that for which all the circles are connected directly to every one of the \mathbf{k} other circles, in the integrand of $\beta_{\mathbf{k}}$ is always unity, since this diagram can be drawn in one way only. The coefficient of the total $\prod \beta_{\mathbf{k}}^{n_{\mathbf{k}}}$ in b_l , however, will be the same as that for the

* The method of calculation which follows is copied with minor alterations from the dissertation of S. F. Harrison, Johns Hopkins University, 1938.

patterns with every molecule in the $\beta_{\mathbf{k}}$'s connected to every other one. So the coefficient of $\Pi\beta_{\mathbf{k}}^{n_{\mathbf{k}}}$ in b_l can be obtained by considering only the completely connected patterns for $\beta_{\mathbf{k}}$, that is, by treating the $\mathbf{k} + 1$ molecules in $\beta_{\mathbf{k}}$ as identically situated with respect to each other.

In order to make the problem easier to visualize, the bond patterns corresponding to the various integrals $\beta_{\mathbf{k}}$ may be imagined to be rigid mechanical frames, with a frame of index \mathbf{k} containing $\mathbf{k} + 1$ symmetrically situated holes.

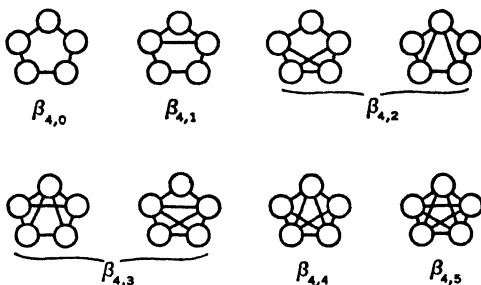

FIG. AX. 1. The different terms occurring in β_4 . It is to be noted that some of the $\beta_{\mathbf{k}m}$'s are themselves a sum of terms, since the nature of the integral is not completely defined by the number of particles and the number of bonds.

(This is, of course, a physical impossibility in three dimensions for most large \mathbf{k} values, but that is an unessential fact.) The l molecules will be replaced by l numbered bolts, which will serve to fill the holes in the frames and to bolt the frames together into a single cluster. It is fairly easy to see that such a structure will correspond to a term in the cluster, and that the problem of the number of ways in which the bolts can be inserted in the frames so as to obtain one cluster is equivalent to the problem of the determination of K_4 .

It is now necessary to find out how many ways the bolts can be put into the frames and the frames bolted together.

There are given l numbered bolts, and a total of $n = \sum n_{\mathbf{k}}$ frames, with, for every \mathbf{k} , ($1 \leq \mathbf{k} \leq l - 1$), $n_{\mathbf{k}}$ frames containing $\mathbf{k} + 1$ identical holes which are situated in such a way that every pair of holes in one frame is exactly like every other conceivable pair in the same frame. The restrictions under which the bolting process must be carried out are:

a. $1 + \sum_{\mathbf{k}} \mathbf{k} n_{\mathbf{k}} = l$.

b. Every hole must have a bolt through it.

c. No bolt can go through more than one hole in any given frame.

d. The frames must all be singly connected with each other.

Summarizing, there are:

$$\begin{aligned} & \sum_{\mathbf{k}} (\mathbf{k} + 1) n_{\mathbf{k}} \text{ holes,} \\ & \sum_{\mathbf{k}} \mathbf{k} n_{\mathbf{k}} + 1 = l \text{ bolts,} \\ & \sum_{\mathbf{k}} n_{\mathbf{k}} = n \text{ frames.} \end{aligned}$$

The excess of holes over bolts is therefore

$$\sum_{\mathbf{k}} (\mathbf{k} + 1) n_{\mathbf{k}} - \sum_{\mathbf{k}} \mathbf{k} n_{\mathbf{k}} - 1 = n - 1,$$

so that, if a washer is placed between every pair of frames which are bolted together by a common bolt, exactly $n - 1$ washers are necessary. At most, then, $n - 1$ bolts are used to connect frames together, and at least one bolt. If only one bolt is used this one bolt must pass through a hole in every frame, and will pass through all $n - 1$ washers.

Now consider an arrangement which is completely bolted together, corresponding to a term in the cluster integral b_l . This is to be dissociated, or taken apart, into n frames, each frame of index \mathbf{k} containing \mathbf{k} bolts and one empty hole, with one "free" bolt left over. By choosing the free bolt and removing it first, the method of dissociation is uniquely determined, and since any of the l bolts may be chosen as the free one there are l **different** dissociated arrangements of the bolts in the frames corresponding to every arrangement which is completely bolted together.

That is, if L_s is the number of different dissociated arrangements which can be formed, and M_s the number of ways in which each dissociated arrangement can be bolted together, the coefficient sought is

$$(AX. 2) \quad K_s = \frac{1}{l} L_s M_s,$$

since there are always l different dissociated arrangements which can be bolted together so as to form the same completely bolted arrangement.

The number L_s is the number of ways in which the l numbered bolts can be assorted into $n_{\mathbf{k}}$ piles of \mathbf{k} objects each, with $\sum \mathbf{k} n_{\mathbf{k}} = l - 1$, with one free bolt left over. This number is, see AVII (6),

$$(AX. 3) \quad L_s = \frac{l!}{\prod_{\mathbf{k}} (\mathbf{k}!)^{n_{\mathbf{k}}} n_{\mathbf{k}}!},$$

so that, from (2),

$$(AX. 4) \quad K_s = \frac{1}{l} \frac{l!}{\prod_{\mathbf{k}} (\mathbf{k}!)^{n_{\mathbf{k}}} n_{\mathbf{k}}!} M_s.$$

It will now be shown that the number of ways M_s that the dissociated arrangements can be bolted together is

$$(AX. 5) \quad M_s = l^{n-1}.$$

As has already been stated, in a cluster there are certain bolts common to two or more holes in different frames. To these bolts a particular significance attaches. Defining the "significance" λ of a bolt as one less than the number of frames to which it is common, then this "significance" of a bolt is numerically equal to the number of washers through which it passes, if, as has been suggested, we use a washer to separate every pair of frames which are bolted

together. The washers are the physical objects by which we may visualize the significance of the bolts.

The number of bolts with a significance λ will be designated by ν_λ , and since the total number of washers is $n - 1$,

$$(AX. 6) \quad \sum_{\lambda} \lambda \nu_{\lambda} = n - 1.$$

Now, if the washers are numbered and distributed among the bolts (a bolt receiving no washers is used in one frame only, and one receiving one washer is used to bolt two frames together, and so forth), then each such distribution of the numbered washers among the numbered bolts corresponds to exactly one way of making a dissociated arrangement into a cluster. When this statement is proved the problem is solved, for the number of ways that the $n - 1$ washers can be distributed among the l bolts, with no restrictions as to the number of washers per bolt, is just l^{n-1} .

Obviously two distributions of washers which differ in the numbers of washers per bolt can never lead to the same way of bolting the frames together. However $(n - 1)! / \prod_{\lambda} (\lambda!)^{\nu_{\lambda}}$ arrangements of the $n - 1$ numbered washers correspond to the same set of values of the *numbers* of washers on every bolt. We shall prove that, if the numbers λ of washers per bolt are given, the number of different ways in which the frames can be bolted together is just the same as this, namely, $(n - 1)! / \prod_{\lambda} (\lambda!)^{\nu_{\lambda}}$. It follows that the total number of ways in which the frames can be bolted together is the same as the number of ways that the numbered washers can be distributed among the numbered bolts, namely, l^{n-1} .

Consider a dissociated arrangement in which the number of washers on each bolt is determined. We select one of the bolts (other than the free bolt) containing one or more washers, say λ_1 washers. This bolt must pass through the empty hole in λ_1 frames other than its own. These frames can be chosen in $(n - 1)(n - 2) \cdots (n - \lambda_1) / \lambda_1!$ ways, the factor $1 / \lambda_1!$ arising from the fact that the order of choice is immaterial. This complex of $\lambda_1 + 1$ frames will then be an incomplete cluster still containing precisely one unoccupied hole, and for the bolting process is exactly equivalent to a single frame.

The next bolt chosen, with λ_2 washers, can now join λ_2 frames in $(n - \lambda_1 - 1)(n - \lambda_1 - 2) \cdots (n - \lambda_1 - \lambda_2) / \lambda_2!$ ways, since the formation of the first complex has reduced the number of separate units to $n - \lambda_1$. This process is repeated until a single unit corresponding to a term of the cluster has been formed. The free bolt causes no difficulty.

If the free bolt, which is put in as the last step, has no washers, the proof is complete, since at the end there will remain only one hole into which this bolt must go. If the free bolt has been assigned $\lambda_F \neq 0$ washers there is also no choice since at the end there will remain $\lambda_F + 1$ incomplete clusters with as many unoccupied holes through all of which the free bolt must pass. This unit choice is numerically $\lambda_F! / \lambda_F!$, which completes the series of factors.

We have proved, then, that the number of ways that the frames can be bolted

together after the numbers of washers on each bolt have been assigned is $(n-1)! / \prod_{\lambda} (\lambda!)^{n_{\lambda}}$, which is the same as the number of ways that the numbered washers can be assigned to the bolts with a predetermined number to each bolt. It follows that the total number of ways that the frames can be bolted together, which is M_n , is the total number of ways that the numbered washers can be assigned to the bolts, or l^{n-1} .

Equation (5) is thus proved. Inserting this in (4), and the result in (1), one obtains

$$(AX. 7) \quad b_l = \frac{1}{l^2} \sum_{n_k} \prod_k \frac{(l\beta_k)^{n_k}}{n_k!},$$

$$\sum_k n_k = l-1$$

which is equation (13. 34).

AXI. Application of the Theory of Functions to the Functions Appearing in the Theory of the Imperfect Gas

We shall apply the theory of functions of a complex variable to the series occurring in the development of the partition function of an imperfect gas.

A function of a complex variable, $f(z)$, is said to be regular at a point $z = \zeta$ if it is finite, continuous, and differentiable. This latter condition implies certain relations between the differential coefficients of the real and imaginary parts of $f(z)$ with respect to the real and imaginary parts of z . If a function is regular in a region, and if ζ is any point inside the region, $f(z)$ can always be developed as a power series of $(z - \zeta)$, containing positive and zero powers only. The coefficient a_n of $(z - \zeta)^n$ is

$$(AXI. 1) \quad a_n = \frac{1}{n!} \left[\frac{d^n}{dz^n} f(z) \right]_{z=\zeta}.$$

There exists a real quantity \mathbf{R} , called the radius of convergence (which may be infinity), such that the series converges for all points z inside the circle $|z - \zeta| = \mathbf{R}$ around ζ , and diverges for all points outside. $f(z)$ is regular within the circle of convergence, but is not regular, that is, it has a singularity, at one point, at least, on the circumference of the circle.

If the region of regularity is singly connected (comprises the whole region enclosed by one closed curve) and C is any closed curve within the region, the integral $\oint_C f(z) dz$ taken over C is zero (theorem of Cauchy).

Suppose that a function is regular and single valued in a region except in one inner point of the region, which we may take as the point $z = 0$. In that case $f(z)$ may be developed into a power series of direct and inverse powers of z ,

$$(AXI. 2) \quad f(z) = \sum_{n=-\infty}^{\infty} a_n z^n$$

(Laurent series). If there are no inverse powers, $a_n = 0$ for $n < 0$, $f(z)$ is regular at $z = 0$. If there are a finite number of inverse powers, $a_n = 0$ for $n < m < 0$, but $a_m \neq 0$, the function is said to have a pole of order m at

$z = 0$. If there are an infinite number of terms with inverse powers, $f(z)$ is said to have an essential singularity at $z = 0$. The series converges outside of $z = 0$ and inside the circle about $z = 0$ which contains on its circumference the nearest point of irregularity of $f(z)$.

The integral of the function taken over any circle around $z = 0$ within the circle of convergence has the value $2\pi i a_{-1}$, where a_{-1} is the coefficient of z^{-1} in the Laurent series. a_{-1} is called the residue of the function.

The general coefficient a_n of the Laurent series is then equal to the integral, taken over any circle about $z = 0$ within the region of convergence,

$$(AXI. 3) \quad a_n = \frac{1}{2\pi i} \oint \frac{f(z)}{z^{n+1}} dz,$$

for positive or negative values of n .

If the circle or closed curve over which the integration is performed encloses two or more isolated points of singularity the value of the integral is $2\pi i$ times the sum of the residues of the singularities.

If the coefficients a_n of the power series development of the function are all positive, the radius of convergence R can be obtained according to the theorem of Cauchy-Hadamard as

$$(AXI. 4) \quad R = \lim_{n \rightarrow \infty} (a_n)^{-1/n}.$$

These theorems will be used to investigate the functional dependence of $Q_r/N!$ on b_l , equation (13. 10), and of b_l on β_k , equation (13. 34). The method which will be used follows closely that of Born and Fuchs.*

The function $F(N, x_1, \dots, x_k, \dots)$, defined as

$$(AXI. 5) \quad F(N, x) = \sum_{n_k} \prod_k \frac{(N x_k)^{n_k}}{n_k!},$$

$$\sum_k n_k = N$$

is of the same form as equation (13. 10) for $Q_r/N!$, with vb_l replaced by x_k .

By inspection one sees that this function is the coefficient of ζ^N in the development of

$$e^{N \sum x_k \zeta^k}$$

into a power series of ζ , and therefore, from (3),

$$(AXI. 6) \quad F(N, x) = \frac{1}{2\pi i} \oint \frac{e^{N \sum x_k \zeta^k}}{\zeta^{N+1}} d\zeta,$$

where the path of integration must enclose the point $\zeta = 0$.

We shall define a function $H_0^0(z, x_1, \dots, x_k, \dots)$ as

$$(AXI. 7) \quad H_0^0(z, x) = \sum_{N=1}^{\infty} F(N, x) z^N,$$

* Max Born and K. Fuchs, *Proc. Roy. Soc., London*, A166, 391 (1938).

and prove that

$$(AXI. 8) \quad H_0^0(z, x) = \frac{\sum k x_k \zeta_0^k}{1 - \sum k x_k \zeta_0^k},$$

where ζ_0 is defined by

$$(AXI. 9) \quad z = \zeta_0 e^{-\sum x_k \zeta_0^k}.$$

The theorem is proved by using equation (6) in (7). For small enough values of z it will be shown that the path of integration of ζ can be chosen so that always

$$(AXI. 10) \quad \left| \frac{z}{\zeta} e^{\sum x_k \zeta^k} \right| < 1,$$

in which case the summation in (7) can be performed before integration. After introducing (6), the right-hand side of (7) before integration is just $1/2\pi i \zeta$ times the sum of all powers greater than zero of the quantity in (10). If relation (10) is obeyed the sum converges and may be expressed analytically by

$$\sum_{N=1}^{\infty} y^N = \frac{y}{1 - y},$$

so that

$$(AXI. 11) \quad H_0^0(z, x) = \frac{1}{2\pi i} \oint \frac{z e^{\sum x_k \zeta^k}}{\zeta - z e^{\sum x_k \zeta^k}} \frac{d\zeta}{\zeta}.$$

Just as the residue of the original exponential which is $F(N, x)$ was expressed as the integral in (6), so now we shall reverse the process and calculate the integral of (11) by determining the residues of the singularities enclosed by the path of integration. The function which is the integrand of (11) has two singularities enclosed by the path of integration, namely, where $\zeta = 0$, with the residue -1 , and a singularity at ζ_0 where equation (9) is satisfied. The residue of the singularity at ζ_0 is obtained by inserting the derivative of the denominator in (11), and with (9) this gives

$$\frac{1}{1 - \sum k x_k \zeta_0^k}$$

for the residue. Adding -1 for the residue at $\zeta = 0$ to this proves (8), provided there is one and only one point ζ_0 inside the path of integration for which (9) is satisfied.

The function

$$\frac{1}{\zeta} e^{\sum x_k \zeta^k}$$

has a pole of the first order at $\zeta = 0$. This pole is surrounded by curves along which the absolute value of the function is constant. Provided this absolute value is sufficiently high these curves are closed around $\zeta = 0$. Therefore if

z is sufficiently small we can choose the path of integration according to condition (10) just outside the curve along which

$$\left| \frac{1}{z} e^{\sum x_k r^k} \right| = \frac{1}{|z|}$$

in such a way that there is only one such curve inside the path of integration. On this curve there is one and only one point for which (9) is satisfied. Since (8) is proved for small values of z it will be true in general.

If in equation (5) the quantities x_k are replaced by vb_i the functions $F(N, vb)$ are just the quantities $Q_{r,N}/N!$, equation (13. 10), for systems of N molecules, but with the same volume per molecule v .

Consider the sum

$$(AXI. 12) \quad \sum_{N=1}^{\infty} \frac{Q_{r,N}}{N!} r^N = H_0^0(r, vb) = \frac{\sum l v b_i z^i}{1 - \sum l v b_i z^i},$$

where, corresponding to (9),

$$(AXI. 13) \quad r = z e^{-\sum v b_i z^i}.$$

The configuration integrals $Q_{r,N}$ are all integrals of a positive integrand, and so are all positive. The first irregularity of the sum (12) must occur on the real positive axis of r , say at $r = R$, and R is then the radius of the circle of convergence of (12). From (4)

$$(AXI. 14) \quad \lim_{N \rightarrow \infty} \left\{ \frac{1}{N} \ln \frac{Q_{r,N}}{N!} \right\} = -\ln R.$$

The radius R of the circle of convergence of the sum (12) determines the quantity we seek, namely the limit, as N approaches infinity, of

$$-(1/N) \ln (Q_{r,N}/N!),$$

which is the contribution of the configuration integral to the work function per mole divided by RT , A_r/RT .

If Z is the value of z when $r = R$, according to (13) one has

$$(AXI. 15) \quad \frac{A_r}{RT} = \ln R = \ln Z - \sum_{i \geq 1} l v b_i Z^i,$$

which is the same as equation (14. 20). However, in this equation Z is defined as the value in (13) corresponding to the radius of convergence R of (12).

From (13) it is seen that, when $r = 0$, then $z = 0$, and that, for small values of z and r , the real positive axis of r corresponds to the real positive axis of z , as well as the converse, since all b_i 's are real. As long as the function $\sum l v b_i z^i$ is both regular and smaller than unity, (12) converges, and if $\sum l v b_i z^i$ reaches unity it is seen that (12) is singular, and it will be proved later that if $\sum v b_i z^i$ is singular the sum $H_0^0(r, vb)$ is singular. With this proof we have what is needed.

We consider a region enclosing the real positive axis of z and r . The singularity in $H_0^0(r, vb)$ determining the radius of convergence R of (12) lies on this axis. It occurs at the smallest real positive value of z , which we have called Z , for which either condition a , that

$$(AXI. 16a) \quad \sum l v b_1 Z^l = 1$$

or condition b , that

$$(AXI. 16b) \quad \sum l v b_1 Z^l \text{ is singular,}$$

is fulfilled. Since b_1 is unity, condition a will obviously be fulfilled at lower z values than b if the volume per molecule v is sufficiently large. The value of Z for which condition a is fulfilled will depend on the volume v . At sufficiently low values of v condition b may be fulfilled before a , and the value of Z determined by this condition will be independent of the value of the volume per molecule v , since this quantity is only a factor in the sum.

The result is essentially the same as that found in Chapter 14. There we explicitly considered a system with a large but finite number, N , of molecules. As a consequence the series $\sum l v b_1 Z^l$ had a finite number of terms, N , instead of an infinite number, as here. The finite series has no singularity, but two types of solution to the equation (16), which was used to determine Z , were found. The first type of solution, which led to the equations for the imperfect gas, corresponded to the case here that condition a is fulfilled before the series becomes irregular, and was characterized by the fact that only the lower members of the series were important at the solution. In the second type of solution, at low volumes, and corresponding to the condensation range, the series value increased so rapidly with z in the neighborhood of the solution, because of the importance of the terms of high l values, that the solution was practically independent of the volume. This solution corresponds to the condition b on the infinite series.

The proof that (12) is singular if the sum $\sum l v b_1 Z^l$ has an irregularity will follow later. We shall now undertake some mathematical juggling to arrive at the virial development.

There are several functions similar to $H_0^0(z, x)$, defined by (7), which we shall have occasion to use. The functions defined as

$$(AXI. 17) \quad H_\lambda^0(z, x) = \sum_{N=1}^{\infty} \frac{1}{N^\lambda} F(N, x) z^N$$

are seen to be obtained by

$$(AXI. 18) \quad H_1^0(z, x) = \int_0^z H_0^0(z', x) \frac{dz'}{z'}.$$

By further integration the members of higher λ value may be calculated.

From (9)

$$(AXI. 19) \quad \frac{dz}{z} = (1 - \sum k x_k z^k) \frac{d\xi}{\xi}.$$

Using this in (18) with (8) for $H_0^0(z, x)$, one obtains

$$(AXI. 20) \quad H_1^0(z, x) = \int_0^{\zeta_0} \sum \mathbf{k} x_{\mathbf{k}} \zeta_0^{\mathbf{k}} \frac{d\zeta}{\zeta} = \sum x_{\mathbf{k}} \zeta_0^{\mathbf{k}}.$$

We further define

$$(AXI. 21) \quad H_{\lambda}^1(z, x) = \sum_{N=1}^{\infty} \frac{1}{N^{\lambda}} \left[\frac{1}{N} \frac{\partial}{\partial x_1} F(N, x) \right] z^N = \left(\frac{\partial}{\partial x_1} \right)_s H_{\lambda+1}^0(z, x).$$

The differentiation is to be carried out at constant z , but the functions H_{λ}^0 are expressed in terms of ζ_0 . We use (9) to obtain

$$\frac{dz}{z} = (1 - \sum \mathbf{k} x_{\mathbf{k}} \zeta_0^{\mathbf{k}}) \frac{d\zeta_0}{\zeta_0} - \zeta_0 dx_1,$$

so that, at constant z , $dz = 0$, and

$$(AXI. 22) \quad \frac{1}{\zeta_0} \left(\frac{\partial \zeta_0}{\partial x_1} \right)_s = \frac{\zeta_0}{1 - \sum \mathbf{k} x_{\mathbf{k}} \zeta_0^{\mathbf{k}}}.$$

Writing, then,

$$\left(\frac{\partial}{\partial x_1} \right)_s H_{\lambda+1}^0 = \left(\frac{\partial}{\partial x_1} \right)_{\zeta_0} H_{\lambda+1}^0 + \frac{1}{\zeta_0} \left(\frac{\partial \zeta_0}{\partial x_1} \right)_s \zeta_0 \frac{\partial H_{\lambda+1}^0}{\partial \zeta_0},$$

and with (22) one obtains from (21),

$$(AXI. 23) \quad H_{\lambda}^1(z, x) = \left(\frac{\partial}{\partial x_1} \right)_{\zeta_0} H_{\lambda+1}^0 + \frac{\zeta_0}{1 - \sum \mathbf{k} x_{\mathbf{k}} \zeta_0^{\mathbf{k}}} \zeta_0 \frac{\partial}{\partial \zeta_0} H_{\lambda+1}^0.$$

Applying this to (20) for $H_1^0(z, x)$,

$$(AXI. 24) \quad H_0^1(z, x) = \zeta_0 + \sum \mathbf{k} x_{\mathbf{k}} \zeta_0^{\mathbf{k}} \frac{\zeta_0}{1 - \sum \mathbf{k} x_{\mathbf{k}} \zeta_0^{\mathbf{k}}} = \frac{\zeta_0}{1 - \sum \mathbf{k} x_{\mathbf{k}} \zeta_0^{\mathbf{k}}}.$$

Repeating the process indicated by (18), which also applies to the calculation of $H_1^1(z, x)$, and using (19) and (24), one finds,

$$(AXI. 25) \quad H_1^1(z, x) = \int_0^z H_0^1(z', x) \frac{dz'}{z'} = \int_0^{\zeta_0} d\zeta = \zeta_0.$$

Repeating again

$$(AXI. 26) \quad H_2^1(z, x) = \int_0^z H_1^1(z', x) \frac{dz'}{z'} = \int_0^{\zeta_0} (1 - \sum \mathbf{k} x_{\mathbf{k}} \zeta^{\mathbf{k}}) d\zeta \\ = \zeta_0 \left(1 - \sum \frac{\mathbf{k}}{\mathbf{k} + 1} x_{\mathbf{k}} \zeta_0^{\mathbf{k}} \right).$$

The reason for this interest in the functions $H^1(z, x)$ is as follows. Direct differentiation of equation (5) for $F(N, x)$ shows that

$$(AXI. 27) \quad \frac{1}{N} \frac{\partial}{\partial x_1} F(N, x) = \sum_{n_k} \prod_k \frac{(NX_k)^{n_k}}{n_k!}$$

$$\Sigma kn_k = N - 1$$

and this expression is seen to be exactly that of equation (13. 34) for l^2b_l if N is replaced by l , and x_k by β_k . The sums which occur repeatedly in the discussion of the imperfect gas are then

$$(AXI. 28) \quad \Sigma l^\lambda v b_l z^l = v H_{2-\lambda}^1(y, \beta),$$

where y is defined by

$$(AXI. 29) \quad z = y e^{-\Sigma \beta_k y^k}.$$

From (26), (25), and (24),

$$(AXI. 30) \quad \Sigma_l v b_l z^l = v y \left(1 - \sum_k \frac{k}{k+1} \beta_k y^k \right),$$

$$(AXI. 31) \quad \Sigma_l l v b_l z^l = v y,$$

$$(AXI. 32) \quad \Sigma_l l^2 v b_l z^l = \frac{v y}{1 - \sum_k k \beta_k y^k}.$$

The variables y and z are related by equation (29), which is identical in form to equation (13) relating z and r . Just as with z and r , the point $y = 0$ corresponds to $z = 0$, and the real positive axis of the one variable corresponds to the real positive axis of the other.

Since the sums $\Sigma l^\lambda v b_l z^l$ are related to each other by

$$(AXI. 33) \quad \Sigma l^\lambda v b_l z^l = z \frac{\partial}{\partial z} \Sigma l^{\lambda-1} v b_l z^l,$$

it follows that if one of these sums is singular so are all the others. The same statement holds for the sums $\Sigma k^r \beta_k y^k$.

If the functions $\Sigma k^r \beta_k y^k$ are regular, and if $\Sigma k \beta_k y^k$ is smaller than unity, it is seen from equations (30) to (32) that the functions $\Sigma l^\lambda v b_l z^l$ are regular. If $\Sigma k \beta_k y^k$ becomes unity, $\Sigma l^2 v b_l z^l$ is singular from (32). The fact that if $\Sigma k^r \beta_k y^k$ becomes irregular the sums $\Sigma l^\lambda v b_l z^l$ are singular will be proved later.

We consider a region of the y space enclosing the positive real axis of y for smaller values than that for which any of the three conditions are fulfilled on the real positive axis:

$$(\alpha) \quad y = v^{-1},$$

$$(\beta) \quad \Sigma k \beta_k y^k = 1,$$

$$(\gamma) \quad \Sigma k^r \beta_k y^k = \text{singular}.$$

The corresponding region of z includes the real axis of z with smaller values of z than those which fulfill either condition a that $\sum l v b_l z^l$ be unity, or condition b that this function be singular. The corresponding region of r therefore includes the real axis for lower values than the radius R of the circle of convergence.

We now move out along the real axis of y until one of the three conditions (α) , (β) , or (γ) is satisfied. The corresponding value Y of y in (29) gives the value Z of z for which either condition a or b is fulfilled, and the variable r has reached the value R on the circumference of the circle of convergence of (12).

At sufficiently large values of the volume per molecule v , for all temperatures, condition (α) for Y must be satisfied at lower values of the variable than either (β) or (γ) . From (31) and (16) it is seen that then condition a for Z is satisfied. These large volumes, for which $1/v$ is smaller than the value of y that satisfies either (β) or (γ) , are the volumes for which the system is completely gaseous. Equations (30) to (32), with $Y = v$, are then seen to lead to the equations of Chapter 13, and the virial development for the imperfect gas is proved.

If, at $Y = \rho$, either condition (β) or (γ) is satisfied, then for $v \leq v_* = \rho^{-1}$, the value

$$(AXI. 34) \quad Z = \rho e^{-\sum \beta_k \rho^k},$$

from (29), determines the value of Z for which the sums $\sum l^k v b_l z^l$ become irregular on the real positive axis, and the quantity r has attained the value R , the radius of the circle of convergence of (12). These volumes correspond to the region of condensation.

The temperature T_m , above which condition (β) is fulfilled before (γ) , and below which (γ) is satisfied before $\sum k \beta_k y^k$ attains the value unity, has been discussed in Chapter 14. With equation (34) determining Z , and ρ determined by condition (β) or (γ) , the equations for the system are essentially those of Chapter 14.

The fundamental difference between the language of this section and that in the main text is caused by the fact that here we have gone over to the limiting case of an infinite number of molecules, so that all the series involved contain an infinite number of terms instead of a finite number. The proof presented here does not assume positive values for the integrals b_l or β_k , and so is more general than that of Chapter 13. Also, whereas the equations for the virial development of the gas were proved out to only a limited number of terms in Chapter 13, they are here shown to be general.

One real difference between the results here and in the text is present, however. If the integrals b_l or β_k are not all positive the series $\sum l v b_l z^l$ and $\sum k \beta_k y^k$ might diverge owing to a singularity off the real axis, before the singularity on the real axis corresponding to the radius R of the circle of convergence of (12) is reached. Since the coefficients of (12) are necessarily positive, the singularity of this function which determines the circle of convergence is certainly on the real positive axis of r , but the same statement does not necessarily hold for the functions $\sum l v b_l z^l$ and $\sum k \beta_k y^k$. In this case the analytical continuations of these

functions on the real axis must be used to determine the first singularity occurring with real positive z or y , respectively. This possibility appears rather unlikely. It would mean, working with the series of finite number of terms, that the coefficients b_l and β_k alternate in sign, but the term values increase in magnitude with increasing l or k in such a way that the value of the sum would depend entirely on the l or k value at which it was terminated.

It remains to be proved that if the functions $\sum k^r \beta_k Y^k$ are singular on the real positive axis the functions $\sum l^\lambda v b_l Z^l$ are singular; and also that $H_0^0(r, vb)$ is singular if $\sum l v b_l Z^l$ is singular on the real positive axis.

This may be proved as follows. It is to be remembered that $H_0^0(r, vb)$ is $r(d/dr)H_1^0(r, vb)$, so that, if one function is singular, so is the other. Similarly, from (33), if one of the functions $\sum l^\lambda v b_l z^l$ is singular it follows that the others are singular. The same relationship holds for the functions $\sum k^r \beta_k y^k$.

From (20) it is seen that the function $H_1^0(r, vb)$ is singular if $\sum v b_l Z^l$ is singular, unless $dz/dr = 0$. From (30) it follows that $\sum l^\lambda v b_l z^l$ are singular if the functions $\sum k^r \beta_k y^k$ are singular, unless $dy/dz = 0$.

We must now show that neither $dz/dr = 0$, nor $dy/dz = 0$ can occur on the real positive axis of r , knowing that the radius R of the circle of convergence of (12) is determined by a singularity for real positive values of r .

From (13) and (20),

$$(AXI. 35) \quad z = r e^{H_1^0(r, vb)},$$

$$(AXI. 36) \quad \frac{r}{z} \frac{dz}{dr} = 1 + H_0^0(r, vb).$$

From (36) one sees that dz/dr can be zero only if $H_0^0(r, vb)$ is minus unity, and since the coefficients of this function of r are all positive this cannot be the case if r is real and positive. This proves that $dz/dr \neq 0$ on the real positive axis of r .

To prove that $dy/dz \neq 0$ for real positive values of r we use (31), from which

$$(AXI. 37) \quad \frac{dy}{dz} = \frac{1}{v} \frac{d}{dz} \sum l v b_l z^l = \frac{1}{vz} \sum l^2 v b_l z^l.$$

Now from (12)

$$(AXI. 38) \quad r \frac{d}{dr} H_0^0(r, vb) = \frac{\sum l^2 v b_l z^l}{(1 - \sum l v b_l z^l)^2} \frac{r}{z} \frac{dz}{dr} = \frac{\sum l^2 v b_l z^l}{(1 - \sum l v b_l z^l)^3}.$$

Again the fact that the coefficients of $H_0^0(r, vb)$ are positive is used to deduce that the derivative with respect to r cannot be zero, and consequently that the sum $\sum l^2 v b_l z^l$ cannot be zero, on the real positive axis of r . This proves, with (37), that $dy/dz \neq 0$ for real positive values of r .

AXII. Constants of Diatomic Molecules

CHARACTERISTICS OF THE LOWEST ELECTRONIC LEVELS FOR SOME MOLECULES

Calculated from the values compiled by H. Sponer.*

$$\epsilon(\nu, j)/hc = (\nu + \frac{1}{2})\omega_e - (\nu + \frac{1}{2})^2 x_{e\omega_e} + j(j+1)B_e - j^2(j+1)^2 D_e - (\nu + \frac{1}{2})j(j+1)\alpha,$$

$$[\epsilon(\nu, j) - \epsilon(0, 0)]/hc = \nu\omega_0 - \nu^2 x_{0\omega_0} + j(j+1)B_0 - j^2(j+1)^2 D_0 - \nu j(j+1)\alpha$$

$$= \nu\omega^* - \nu(\nu-1)x^*\omega^* + j(j+1)B_0 - j^2(j+1)^2 D_0 - \nu j(j+1)\alpha.$$

$$\omega^* = \omega_0(1 - x_0) = \omega_e(1 - 2x_e); \quad x^*\omega^* = x_0\omega_0 = x_e\omega_e; \quad B_0 = B_e - \frac{1}{2}\alpha;$$

$$\gamma = \frac{1}{2}(D_e/B_e)^{1/2} = B_e/\omega_e; \quad \delta = \alpha/B_e = (\delta B_e/\omega_e)(x_e\omega_e/B_e)^{1/2} - 1].$$

Mole- cule	Lowest Electronic Term cm. ⁻¹	Energy of Next Known Electronic Term cm. ⁻¹	ω^* cm. ⁻¹	B_0 cm. ⁻¹	r_e Equilibrium Distance Atoms 10 ⁻⁸ cm.	$\theta = \frac{hc\omega^*}{k}$ deg.	$\sigma T = \frac{B_0 hc}{k}$ deg.	$x^* \times 10^2$	$\gamma \times 10^2$	$\delta \times 10^2$
H ₂	$\overset{+}{\sum} \overset{+}{\sigma_g}$	90 206	4162.	59.354	0.749	5958.	84.971	2.736	1.43	5.17
Li ₂	$\overset{+}{\sum} \overset{+}{\sigma_g}$		341.0	0.668 6	2.670	488.2	0.957 2	1.519	0.196	1.06
Na ₂	$\overset{+}{\sum} \overset{+}{\sigma_g}$		158.8	0.153 3	3.07	227.4	0.219 5	0.457	0.096 5	0.52
K ₂	$\overset{+}{\sum} \overset{+}{\sigma_g}$		91.93	0.056 11	3.91	131.6	0.080 33	0.385	0.061 0	0.39
N ₂	$\overset{+}{\sum} \overset{+}{\sigma_g}$	49 774	2330.7	1.989	1.094	3336.6	2.847	0.620	0.085 3	0.90
P ₂	X, $\overset{+}{\sum} \overset{+}{\sigma_g}$	46 790	774.8	0.296	1.88	1109.2	0.424	0.361	0.039 0	0.54
O ₂	X, $\overset{+}{\sum} \overset{+}{\sigma_g}$	7 881	1556.3	1.438	1.204	2228.0	2.059	0.771	0.092 4	1.13
S ₂	X, $\overset{+}{\sum} \overset{+}{\sigma_g}$	31 672	721.9	0.408 3	1.603	1033.5	0.584 5	0.378	0.056 2	0.17
Se ₂	X, $\overset{+}{\sum} \overset{+}{\sigma_g}$	18 317	386.6	(0.091)	(2.1)	553.5	0.130	0.162	0.023 5	0.33

*H. Sponer, *Molekülspektren*, Julius Springer, Berlin, 1935.

Te ₂	$1^1\Sigma^+$	22 671	249.9	0.032	2.86	357.7	0.046	0.21	0.012 8	0.70
Cl ₂	$1^1\Sigma_g^+$	17 710	556.9	0.242 9	1.983	797.3	0.347 7	0.72	0.043 6	0.70
Br ₂	$1^1\Sigma_g^+$	14 734	321.6	0.080 77	2.28	460.4	0.115 6	0.357	0.025 1	0.35
I ₂	$1^1\Sigma_g^+$	11 803	213.1	0.037 30	2.660	305.1	0.053 40	0.278	0.017 5	0.32
LiH	$1^1\Sigma^+$	25 932	1360.7	7.30	1.6	1948.0	10.45	1.62	0.525	(2.4)
NaH	$1^1\Sigma^+$	23 283	1133.0	4.831	1.88	1622.0	6.916	1.61	0.417	2.65
KH	$1^1\Sigma^+$	19 175	954.5	3.373	2.24	1366.5	4.829	1.46	0.347	1.97
CuH	$1^1\Sigma^+$	23 308	1965.8	7.808	1.460	2814.2	11.178	1.91	0.408	3.19
AgH	$1^1\Sigma^+$	29 898	1691.9	6.351	1.614	2422.1	9.092	1.94	0.367	3.14
HF	$1^1\Sigma^+$	3939.	3939.	20.543	0.864	5639	29.409	2.305	0.522	3.71
HCl	$1^1\Sigma^+$	2885.7	2885.7	10.440	1.272	4131.2	14.946	1.709	0.362	2.89
HBr	$1^1\Sigma^+$	2561.7	2561.7	8.361	1.410	3667.3	11.970	1.72	0.326	2.75
HI	$1^1\Sigma^+$	38 820	2142.3	6.420	1.617	9.191	9.191	0.620	0.089 4	0.91
CO	$1^1\Sigma^+$	120.9*	1877.5	1.916	1.13	3066.9	2.743	0.770	0.091 8	1.06
NO	$2^1\Pi$	1877.7	1877.7	1.724	1.146	2687.8	2.468	0.768	0.089 2	1.08
BeO	$1^1\Sigma^+$	10 364	1463.5	1.641	1.130	2688.1	2.398	0.789	0.111	1.14
SO	$3^1\Sigma^-$	39 109	1111.5	0.706 1	1.327	2095.1	2.349	0.789	0.111	1.14
CN	$2^1\Sigma^+$	10 877	2042.4	1.890	1.489	1591.2	1.011	0.543	0.063	0.80
ICI	$1^1\Sigma^+$	13 260	381.25	0.113 9	1.169	2923.9	2.706	0.645	0.092 5	0.92
					2.315	545.8	0.163 1	0.384	0.029 9	0.44

* Energy of this level above lowest.

AXIII. Physical Constants

These values were calculated by J. O. Hirschfelder from those compiled by R. T. Birge, Physical Review Supplement, July, 1929, and the revised values of e , h , and e/m given by R. T. Birge, Physical Review, **52**, 241 (1937). The last figure given is usually not significant.

Velocity of light	$c = 2.997\ 96 \times 10^{10}$ cm. sec. ⁻¹
Charge on electron	$e = 4.802\ 9 \times 10^{-10}$ abs. e.s.u.
Planck's constant	$h = 6.626 \times 10^{-27}$ erg sec.
	$\hbar = \frac{h}{2\pi} = 1.054\ 6 \times 10^{-27}$ erg sec.
Mass of electron	$m_e = 9.110 \times 10^{-28}$ gram
Mass of hydrogen atom	$M_H = 1.673\ 3 \times 10^{-24}$ gram
Ratio	$\frac{M_H}{m_e} = 1836.8$
Ratio, charge to mass of electron	$\frac{e}{m_e} = 1.758\ 5 \times 10^7$ abs. e.m.u. gm. ⁻¹
Boltzmann constant	$k = 1.380\ 4 \times 10^{-16}$ erg deg. ⁻¹ molecule ⁻¹
Avogadro's number	$N_0 = 6.023 \times 10^{23}$ molecules mole ⁻¹
Number of molecules per cubic centimeter in a perfect gas at 0°C. and 1 atm.	$= 2.687 \times 10^{19}$ cc. ⁻¹
Volume of perfect gas at 0°C. and 1 atm.	$= 22.414\ 1$ liters mole ⁻¹
Gas constant per mole	$R = 1.986\ 4$ cal. deg. ⁻¹ mole ⁻¹ $= 82.07$ atm. cm. ³ deg. ⁻¹ mole ⁻¹
Faraday constant	$F = 96\ 489$ abs. coulombs gm.-equiv. ⁻¹ $= 96\ 494$ int. coulombs gm.-equiv. ⁻¹
Normal acceleration of gravity	$g = 980.665$ cm. sec. ⁻²
Normal atmosphere	$= 1.013\ 249 \times 10^6$ dyne cm. ⁻²
Temperature of melting ice, 0°C.	$= 273.18^\circ\text{K.}$
Density of mercury (0°C. and 1 atm.)	$= 13.595\ 09$ gm. cm. ⁻³
Radius of first Bohr orbit	$a_0 = 0.5291 \times 10^{-8}$ cm.
Reciprocal of fine structure constant	$= 137.044$
Bohr magneton $\beta = \frac{eh}{4\pi m_e c}$	$= 0.927\ 26 \times 10^{-20}$ erg gauss ⁻¹

AXIV. Conversion of Energy Units

The following are all used as energy units: erg, the fundamental unit of the c.g.s. system; joule, 10^7 ergs; calorie, the heat required to raise 1 gm. of water 1°C . at 15°C .; kilocalorie, 10^3 calories; frequency in sec^{-1} , the energy of a photon of that frequency; wave number, in cm^{-1} , the energy of a photon of that wave number; volt, the energy of an electron accelerated through that number of volts; degree, the energy divided by k ; atomic units, the energy in units e^2/a_0 , twice the ionization energy of a hypothetical hydrogen isotope of infinite mass.

	$\frac{\text{erg}}{\text{molecule}}$	sec^{-1}	cm^{-1}	e.v.	$\frac{\text{joules}}{\text{mole}}$	$\frac{\text{k cal.}}{\text{mole}}$	atomic units	degrees
1 erg per molecule equals	1	1.5092×10^{26}	5.034×10^{15}	6.242×10^{11}	6.023×10^{16}	1.4391×10^{13}	2.2936×10^{10}	7.245×10^{15}
unit frequency in sec^{-1} equals	6.6258×10^{-27}	1	3.3356×10^{-11}	4.136×10^{-15}	3.9907×10^{-10}	9.536×10^{-14}	1.5197×10^{-16}	4.800×10^{-11}
unit wave number in cm^{-1} equals	1.9864×10^{-16}	2.99796×10^{10}	1	1.240×10^{-4}	11.964	2.859×10^{-3}	4.5564×10^{-6}	1.4390
1 abs. electron volt equals	1.6021×10^{-12}	2.418×10^{14}	8.065×10^3	1	9.6494×10^4	23.055	3.6747×10^{-2}	1.1606×10^4
1 abs. joule per mole equals	1.6603×10^{-17}	2.506×10^9	8.358×10^{-2}	1.0369×10^{-5}	1	2.3894×10^{-4}	3.8081×10^{-7}	0.12028
1 kilocalorie per mole equals	6.949×10^{-14}	1.049×10^{13}	3.498×10^2	4.3375×10^{-2}	4.1852×10^3	1	1.5939×10^{-3}	5.034×10^2
1 atomic unit equals	4.3600×10^{-11}	6.580×10^{15}	2.1947×10^5	27.213	2.6260×10^6	6.274×10^2	1	3.1587×10^5
1 degree equals	1.3804×10^{-16}	2.083×10^{10}	0.6949	8.616×10^{-5}	8.3136	1.9864×10^{-3}	3.1658×10^{-6}	1

AXV. Greek Alphabet

A α	Alpha	N ν	Nu
B β	Beta	Ξ ξ	Xi
Γ γ	Gamma	O \omicron	Omicron
Δ δ	Delta	Π π	Pi
E ϵ	Epsilon	P ρ	Rho
Z ζ	Zeta	Σ σ	Sigma
H η	Eta	T τ	Tau
Θ θ θ	Theta	Υ υ	Upsilon
I ι	Iota	Φ φ ϕ	Phi
K κ	Kappa	X χ	Chi
Λ λ	Lambda	Ψ ψ	Psi
M μ	Mu	Ω ω	Omega

GLOSSARY OF SYMBOLS

The Lewis and Randall notation, E , H , S , A , and F , is used for the thermodynamic functions, with bold-face \mathbf{E} , \mathbf{H} , \mathbf{S} , \mathbf{A} , \mathbf{F} , and \mathbf{V} for the values per mole. However, μ for the chemical potential or partial free energy per molecule is used instead of the partial molal free energy \mathbf{F} of Lewis and Randall. The relations between these quantities are explained in Appendix AVIII.

The Hamiltonian is distinguished from the heat content by always using $H(p, q)$.

Quantum numbers, and subscript integral indices, are printed in bold-face, \mathbf{n} , \mathbf{k} , \mathbf{l} , \mathbf{j} , etc.

The electric and magnetic fields are symbolized by script letters, \mathcal{E} , \mathcal{H} , \mathcal{D} , etc.

A , work function, Helmholtz free energy, or free energy at constant volume, $A = E - TS$.

\mathbf{A} , work function per mole.

A , one of the three principal moments of inertia of a polyatomic molecule, Chapter 8.

A , area of plates in a condenser, Chapter 15.

A_i , amplitude of the normal coordinate q_i , Chapter 11.

a , variously used as a constant parameter of a function or a special value of a coordinate or a function, also as a subscript to indicate a special object, a subsystem, or a kind of molecule.

a , the force constant of the equation for a quadratic potential, $u = \frac{1}{2}at^2$.

a , equilibrium distance between atoms, Chapter 11.

a , distance between plates in the viscosity apparatus of Chapter 1.

a , van der Waals' constant of dimensions energy times volume, equations (12. 1) and (12. 23).

B , one of the three principal moments of inertia of a polyatomic molecule, Chapter 8.

B , band spectral constant of dimensions cm.^{-1} , $B = h/8\pi^2Ic$, equation (7. 4), B_s and B_0 are defined by equations (7. 24) and (7. 24') and related in (7. 27).

$B_j(\gamma)$, the Brillouin function, equation (15. 36).

b , used as a constant or subscript index analogously to a .

b , used to give the deviation from the quadratic form of a potential, equation (7. 51').

b , van der Waals' constant, $b = 4v_0$, equations (12. 1) and (12. 22).

b_l , cluster integral of l molecules, defined by equation (13. 5).

C , Sutherland constant, Chapter 1, equation (1. 48).

C , one of the three principal moments of inertia of a polyatomic molecule, Chapter 8.

C , the number of quantum states of cells of a single molecule. C_j is the number of cells for a molecule in a region j of μ space with defined energy ϵ_j and energy interval $\Delta_j\epsilon$. $C(\epsilon) \Delta\epsilon$ is the number of cells of energy between ϵ and $\epsilon + \Delta\epsilon$. C differs from Ω in that the former refers to the quantum states (in μ -space) of the molecules, whereas Ω refers to the number of states (in the γ -space) of the complete system, or to a subdivision containing many molecules.

C , the capacity of a condenser, Chapter 15.

- C_V , heat capacity at constant volume, $(\partial E/\partial T)_V$.
- C_V , heat capacity per mole at constant volume.
- C_P , heat capacity at constant pressure $(\partial H/\partial T)_P$.
- C_P , heat capacity per mole at constant pressure.
- c , the velocity of light.
- c , subscript indicating the critical point, Chapters 12 to 14, or the Curie point in Chapter 15.
- c_V , specific heat at constant volume, per gram.
- c_t , velocity of propagation of transverse elastic waves, Chapter 11.
- c_l , velocity of longitudinal elastic (sound) waves, Chapter 11.
- D , a distribution of the system, generally used as a subscript to some property of the system to indicate the value of the property when the system is in the fixed distribution D .
- $D(u)$, the Debye function, defined by equation (11. 36).
- \mathfrak{D} , the electric displacement vector, equations (15. 51) and (15. 54).
- D_1, D_2 , diffusion constants for molecules of kinds 1 and 2, equations (1. 72) and (1. 72').
- D^* , corrected diffusion constant, equation (1. 75').
- d , the total differential operator, Appendix AI.
- d , used in the spectroscopic notation to indicate a one-electron level of orbital angular momentum $l = 2$.
- d , diameter of molecule, d_1 of molecule 1, etc., Chapter 1.
- $d\text{\AA}$, diameter of molecule in Ångström units.
- d_0 , Sutherland diameter for $T = \infty$, equation (1. 48).
- E , energy of a system. Except in Chapter 2, E is reserved for the energy of a macroscopic system and ϵ is used for that of a single molecule.
- E , energy per mole.
- E_0 , energy at $T = 0$, Chapter 16.
- \mathcal{E} , the electric field vector, equation (15. 52).
- $\mathcal{E}_{\text{loc.}}$, the local electric field on one molecule.
- e , charge of an electron.
- e , the base of the natural logarithms.
- F , free energy (Lewis and Randall notation), the Gibbs free energy, or the free energy at constant pressure.
- F , free energy per mole.
- F_x , the x component of the force. For a mechanical system $F_x = -(\partial U/\partial x)_{y,z}$, where U is the potential energy, equation (2. 8). For a thermodynamic system $F_x = -(\partial E/\partial x)_{S,y,z}$, equation (3. 6).
- f , the number of degrees of freedom, the minimum number of coordinates necessary to specify the position of all parts of the system, section 2b. The symbol f_μ is used for the number of degrees of freedom of a molecule (half the number of dimensions of the μ -space). f_γ is the number of degrees of freedom (in γ -space) of the complete system, $f_\gamma = Nf_\mu$. f_u is used in Chapter 8 for the number of vibrational degrees of freedom.
- f , spectroscopic notation for an electron level of orbital angular momentum $l = 3$.
- $f, f(x)$, most commonly used to indicate any general function of some argument x . Some special cases are $f_1(v)$, $f_2(v)$, the distribution function normalized to unity, Chapter 1; $f_{ij} = f(r_{ij})$ defined by equation (12. 8); $f(\epsilon)$, some simple function of ϵ used for $\epsilon^{1/2}$ and $\epsilon^{3/2}$ in Chapter 16. In general, $f'(x) = df/dx$.

- $G(z)$, a magnitude, such as temperature or average linear momentum, which varies with the coordinate z in a gas, Chapter 1.
- g , the degeneracy, or number of quantum states in a level. g is used instead of C if the energy difference between levels is appreciable, so that the level is naturally defined.
- g , the Landé g factor, defined by equations (15. 29) and (15. 30).
- $g, g(x)$, used as f for any general function, in particular $g(\epsilon)$ of Chapter 16 is defined by equation (16. 27); $g'(\epsilon) = dg/d\epsilon, g''(\epsilon) = dg'/d\epsilon$.
- H , heat content, enthalpy.
- H , heat content per mole.
- \mathcal{H} , magnetic field, Chapter 15.
- $H(p, q)$, the Hamiltonian, or energy as a function of the momenta p and coordinates q .
- h , Planck's constant of dimensions energy time.
- I , electric current, Chapter 16.
- I , moment of inertia, $I = \mu r_0^2$ for a diatomic molecule, equation (7. 2). $I(\xi)$ is defined by equation (7. 56).
- I_{xx}, I_{yy} , moment of inertia of a body about the x axis and product of inertia, respectively, section 8d.
- $i = \sqrt{-1}$, the imaginary base.
- i , the internal quantum number; i is a symbol for a set of these numbers, if, as is usual, there are several degrees of freedom. Used as a subscript in Q_i or F_i , it indicates the contributions to these functions due to the internal degrees of freedom.
- i , as a subscript to indicate a special molecule in Chapters 12 to 14.
- i , used as a subscript to indicate a special coordinate in Chapter 11.
- J_ν , integrals defined by equation (16. 83) and evaluated in equation (16. 86).
- j , quantum number of rotation in a diatomic molecule, equation (7. 1).
- j , quantum number of the total angular momentum in an atom, section 6e.
- j , used as a subscript to C, N and ϵ to indicate a region in the μ -space, section 5b.
- j , used as a subscript to indicate a particular molecule, Chapters 12 to 14.
- K , the equilibrium constant. K_N is the equilibrium constant expressed in terms of the numbers of molecules, K_n in terms of the numbers of moles, K_P in terms of the partial pressures.
- k , the Boltzmann constant, $k = R/N_0$.
- \mathbf{k} , the magnitude of the vector $\vec{\mathbf{k}}$.
- $\vec{\mathbf{k}}$, the vector of components k_x, k_y, k_z .
- k_x, k_y, k_z , the three quantum numbers of translation, equation (2. 16).
- \mathbf{k} , the number of particles contained in an irreducible integral $\beta_{\mathbf{k}}$, Chapters 13 and 14.
- L , length of the side of a cubic crystal, Chapter 11.
- $L(x)$, Langevin function, $L(x) = \coth x - x^{-1}$, Fig. 15. 3.
- l , variously used for a length.
- l , mean free path, Chapters 1 and 16.
- l , running index to indicate a level.
- l , quantum number of the orbital angular momentum in an atom, section 6i.
- l , the number of particles in a cluster, Chapters 13 and 14.
- M , molecular weight, the mass of an atom or molecule in atomic weight units, $O = 16$.
- \bar{M} , the total mass of a system.

- M , the mass of the whole molecule, Chapter 1, as distinguished from that of the atoms.
- \mathbf{M} , the magnetic polarization, equation (15. 26).
- m , the mass of an atom or molecule in grams, $mN_0 = M$.
- \mathbf{m} , quantum number determining the projection of the total angular momentum on a unique axis, section 7a and Chapter 15.
- m_l , used in Chapters 13 and 14 to indicate the number of clusters of l molecules each.
- m_ζ , the number of molecules of kind ζ produced in a chemical reaction, equation (9. 9).
- mole, unit of mass or quantity. One mole contains N_0 molecules, and the weight in grams of a mole is equal to the molecular or formula weight of the molecules.
- N , the number of atoms or molecules in the system. N_1, N_a , are used to indicate the number of molecules of kind 1 or a in the system, or the number of molecules in the part 1 or a of the system.
- N_0 , Avogadro's number, $N_0 = 6.023 \times 10^{23}$, the number of oxygen atoms in 16 grams of oxygen.
- N_j , the number of atoms or molecules in the region j of the μ -space, section 5b.
- $N(\epsilon), N(\epsilon) \Delta\epsilon$ is the number of molecules the energy of which lies between ϵ and $\epsilon + \Delta\epsilon$.
- $N(\vec{v}^*), N(v), N(v_x, v_y, v_z)$, the numbers of molecules of given velocities, defined in section 1c.
- $N(\nu)$, number of photons of frequency ν , defined analogously to $N(\epsilon)$.
- n , the number of moles, N/N_0 , in the system. x is also used for this quantity. n_ζ indicates the number of moles of compound ζ , n_x , the number of gram atoms of element X , in the system, Chapter 9.
- n , the number of atoms in a molecule, Chapter 8, n_x , the number of atoms of the element X in the molecule, Chapter 9.
- n_1, n_2 , in Chapter 1, the number of molecules per unit volume, of kinds 1 and 2.
- \mathbf{n} , a general quantum number.
- n_x, n_y, n_z , quantum numbers of the elastic waves in a crystal, Chapter 11.
- n_k , power of the configuration integral β_k in a term of b_l , Chapters 13 and 14.
- P , pressure. Unless otherwise indicated the unit is one barye. Subscripts mm. and atm. respectively indicate that the units of measurement are millimeters mercury or atmospheres.
- P_ζ , partial pressure in the system due to molecules of the type ζ , Chapter 9.
- P_c , critical pressure, Chapter 14.
- P_s , pressure of saturated vapor, Chapter 14.
- P_i , probability.
- \vec{P} , total angular momentum, Chapter 2.
- \mathbf{P} , polarization, equation (15. 7).
- P , designation for a spectroscopic term with total orbital angular momentum unity.
- p , momentum, subscripts indicate coordinate to which the momentum is conjugated, $p_x = mx$, definition, equation (2. 1).
- p , spectroscopic notation for a one-electron level with orbital angular momentum $l = 1$.
- p_0 , dipole moment, Chapter 15.
- \bar{p} , average projection of the dipole moment along a field, equation (15. 6).
- $p(q), p(T)$, the dipole moment regarded as a function of the internal coordinates q of the molecule, and of the temperature, respectively.

- Q , the partition function of a molecule, equation (6. 8).
 Q_k , the factor in Q due to translation, equation (6. 15).
 Q_i , the factor in Q due to internal degrees of freedom, equation (6. 15).
 $Q_{\mathcal{F}}$, $Q_{\mathcal{H}}$, contributions (as factors) to Q due to the electric force \mathcal{F} , or magnetic field \mathcal{H} , Chapter 15.
 Q_x , Q_f , the partition function of an atom of element X , or of a molecule of species ζ , respectively, Chapter 9.
 Q , the partition function of a system, equation (10. 14).
 Q_r , the configuration integral, equation (10. 33).
 q , a general coordinate.
 q_i , q_λ , normal coordinates.
 $\dot{q} = dq/dt$, a general velocity.
 q , quantity of electricity, Chapter 15.
 R , the gas constant, $R = N_0k$.
 \vec{r} , the vectorial distance from a point or an axis.
 r , the magnitude of \vec{r} , the polar coordinate.
 r_0 , the equilibrium distance between atoms of a diatomic molecule, Chapter 7. In Chapter 12, r_0 has the corresponding interpretation as the equilibrium distance between two molecules bound by van der Waals' forces, equations (12. 20) and (12. 29).
 r_{ij} , distance between two molecules i and j , Chapters 12 to 14.
 r , a general quantum number, Chapter 2.
 S , entropy.
 S , entropy per mole.
 S , designation for spectroscopic term with total orbital angular momentum zero.
 s , spectroscopic notation for a one-electron orbit with angular momentum $l = 0$.
 s , Chapter 16, entropy density, S/V .
 s , Chapter 14, used as a subscript to indicate the saturated vapor.
 s , spin, section 6i.
 s_n , nuclear spin magnitude, section 7f.
 s , general quantum number, Chapter 2.
 T , temperature, T_c , critical temperature in Chapter 14 and Curie temperature in Chapter 15. T_m is discussed in sections 14h and 14i.
 T_m , a term of a sum, section 13c.
 T , kinetic energy.
 $T(q, \dot{q})$, kinetic energy as a function of the coordinates and velocities, Chapter 2.
 $T(p, q)$, kinetic energy as a function of the momenta and coordinates.
 t , time.
 t , as a subscript, indicates total.
 U , $U(q)$, Chapter 2, potential energy.
 U , $U(q)$, Chapters 10 to 14, potential energy of the macroscopic system.
 $U = E/V$, energy density of radiation, Chapter 16.
 $U(\nu, T)$, energy density of radiation, equation (16. 13).
 u , $u(q)$, potential energy of one molecule.
 u , potential energy difference of one electron inside and outside of a metal, Chapter 16.
 $u_{ij} = u(r_{ij})$, potential energy of the pair of molecules i and j , Chapters 12 to 14.
 u_0 , absolute value of the minimum in the potential between a pair of molecules.

- $u = h\nu/kT$ for a diatomic molecule, Chapter 7;
 $= h\nu_m/kT = \theta/T$, for the maximum Debye frequency ν_m , Chapter 11;
 $= h\nu/kT$ for radiation, Chapter 16.
- $u_i = h\nu_i/kT$ for the frequency ν_i of the crystal, Chapter 11.
- u , velocity of plates in the viscosity consideration, section 1i.
- \vec{u} , vectorial velocity, Chapter 1.
- u , magnitude of \vec{u} .
- u_x, u_y, u_z , components of \vec{u} .
- V , volume.
- V , volume per mole.
- V_c , critical volume per mole.
- \mathcal{U} , voltage, Chapter 15.
- v , volume per molecule, V/N , Chapters 12 to 14.
- v_s, v_c , volume per molecule of saturated vapor, and at critical point, respectively.
- v_x , volume available to an atom of kind x in the system, section 9e.
- v_0 , volume of one molecule, defined by equation (12. 21).
- \vec{v} , vectorial velocity, Chapter 1.
- v , magnitude of \vec{v} .
- v_x, v_y, v_z , components of \vec{v} .
- ν , quantum number of vibration.
- $\bar{v}, \overline{v^2}$, average value of v and v^2 , respectively.
- W , phase volume measured in units of h^f , the classical equivalent of Ω , definition equation (2. 38).
- $W(E) \Delta E$, phase volume between E and $E + \Delta E$.
- w , work function of a metal, equation (16. 54).
- w , a probability.
- w_{sr} , transition probability between two quantum states s and r .
- X , a thermodynamic function.
- X , the Cartesian coordinate of the center of mass.
- X , a symbol for an atom of a particular element.
- x , the Cartesian coordinate.
- x , as a subscript it refers either to the Cartesian coordinate or to an atom of element X .
- Y , Cartesian coordinate of the center of mass.
- y , Cartesian coordinate.
- $y = jg\beta\mathcal{H}C/kT$, in section 15i.
- Z , Cartesian coordinate of the center of mass.
- Z , introduced as an undetermined multiplier, equation (13. 14), is later shown to be the fugacity, measured in units of molecules per unit volume, equation (13. 50).
- Z , number of molecules striking a square centimeter of wall per second, Chapter 1.
- α , an arbitrary constant in Chapter 1, later shown to be $m/2kT$, equation (1. 27).
- α , introduced as an undetermined parameter in equation (5. 11) and later identified with $-\mu/kT$.
- α , a spin function.
- α , a direction cosine, section 8d.
- α , a coefficient in the equation for the value of a spectroscopic term of a diatomic molecule, giving the rotation-vibration interaction, definition, equation (7. 24).

- α , coefficient of linear expansion, equation (11. 11).
 α , polarizability, defined by equation (15. 10).
 β , a spin function.
 β , an undetermined parameter introduced in Chapter 5 and later identified with $1/kT$.
 β , a direction cosine, section 8d.
 β , the Bohr magneton, equation (15. 31).
 β , an interaction integral between two molecules, defined by equation (12. 12) and identical to β_1 in Chapters 13 and 14.
 β_0 , limit of the k th root of β_k .
 β_k , irreducible integrals of the interaction between $k + 1$ particles, defined by equation (13. 25).
 $\Gamma(z)$, flow of G , Chapter 1.
 Γ , total flow, $\Gamma_1 + \Gamma_2$.
 Γ_1^* , corrected diffusion.
 Γ , heat current in Chapter 16.
 γ , the symmetry number, γ_f is the symmetry number of a molecule of kind f , defined in section 9d.
 γ , a direction cosine, section 8d.
 γ , the ratio of the rotational constant to the vibrational wave number of a diatomic molecule $\gamma_e = B_e/\omega_e$, equation (7. 29).
 γ_c , the activity coefficient, equation (13. 51).
 γ -space, defined in section 2d, the phase space of the whole system.
- Δ indicates the difference between two values of a variable. ΔX for a chemical reaction, with X some thermodynamic property of the system, is the increase of the value of X if the chemical reaction proceeds as written in the accompanying chemical equation. The coefficients preceding the formulas indicate the number of moles consumed or produced in the reaction. ΔX^0 is the change in the value of X if the number of moles of reactants indicated by the equation are converted from standard conditions of unit pressure or concentration to the products at unit pressure or concentration.
- ∂ , the partial differential coefficient, Appendix AI.
 δ , an infinitesimal increment.
 δ , $= \alpha/B_e$, Chapter 7, equation (7. 30).
 δ_i , phase factor in Chapter 11.
- ϵ , the energy per molecule, in distinction to E the energy per mole, and E the energy of the system. The subscripts k, i, v, j , or jm refer respectively to the additive contribution to the energy due to, and as a function of, the translational quantum number k , the internal quantum number i , the vibrational number v , or rotational numbers j or jm .
- $\bar{\epsilon}$, average energy per molecule.
 ϵ , dielectric constant, defined by equation (15. 8).
 ζ , $\cos \theta$.
 ζ , a running index to indicate a type of molecule, Chapters 8 and 9.
- η , an unknown in a set of equations, the three solutions of which are the principal moments of inertia, A, B , and C , Chapter 8.
 η , coefficient of viscosity, Chapter 1.
 θ , an angular coordinate.
 $\theta = h\nu_m/k$, Debye temperature.

κ , heat conductivity, Chapters 1 and 16.

κ , compressibility, equation (11. 12).

Λ , the number of isomers possible if the identical atoms of a polyatomic molecule were numbered and permuted, section 8e.

λ , wavelength.

λ , a running index for the normal coordinates of a polyatomic molecule.

μ , the reduced mass of a diatomic molecule, defined by equation (7. 2).

μ , the chemical potential, definition in section 4h.

$\mu_0 = \mu(0)$, the chemical potential at $T = 0$, equation (16. 21).

μ_0 , permanent magnetic moment per atom, equation (15. 30).

$\bar{\mu}$, the average component of the magnetic moment per atom parallel to the direction of the magnetic field.

μ_m , the component of μ parallel to the magnetic field for an atom in the quantum state m .

μ -space, phase space of one molecule, section 2d.

ν , frequency, sec^{-1} .

ν_0 , Einstein frequency of a crystal, Chapter 11.

ν_m , maximum Debye frequency, section 11g.

ν_i , frequency associated with the normal coordinate i , Chapter 11.

ξ , vibrational coordinate of a diatomic molecule.

ξ_i, ξ_j , displacements from the equilibrium position in a crystal, Chapter 11.

\prod , product symbol, $\prod_{i=1}^{i=N}$ reads: the product over all (integral) values of i running from one to N inclusive, of the following expression. (Appendix AI.)

π , 3.1416.

π , defined by equation (4. 12) and later identified with pressure.

ρ , a parameter of the dimensions of reciprocal volume, determined by equation (14. 5) and later identified with $1/\nu_s$.

\sum , summation symbol, $\sum_{i=1}^{i=N}$ reads: the sum over all (integral) values of i from one to N of the following expression. (Appendix AI.)

\sum , singlet state for diatomic molecules.

$\sigma = h^2/8\pi^2IkT$, defined in equation (7. 4).

σ , electrical conductivity, defined in equation (16. 63).

τ , defined by equation (4. 11) and later identified with the temperature.

$\vec{\tau}$, a vector determining the direction of propagation, and the magnitude of the wave number, of an elastic wave in a crystal, Chapter 11.

τ_x, τ_y, τ_z , components of $\vec{\tau}$.

τ , the magnitude of $\vec{\tau}$.

$d\tau_i = dx_i dy_i dz_i$, the element of configuration volume for molecule i .

ϕ , an angular coordinate.

ϕ , an arbitrary function.

$\phi(r)$, the potential energy between a pair of molecules at the distance r , Chapter 11.

ϕ , electrical potential, Chapter 16.

χ , the magnetic susceptibility, defined by equation (15. 27).

Ψ , the Schrödinger wave function, definition in section 2f.

ψ , the Schrödinger wave function.

ψ , an angular coordinate, section 8d.

Ω , the total number of quantum states available to a system, definition in section 2i.

Ω , a solid angle.

ω , wave number, ν/c , particularly for the characteristic frequency ν of a diatomic molecule. The distinction between ω_0 and ω_s is discussed in the beginning of section 7d.

ω , a probability.

PROBLEMS

1. 1. Using the method of section 1e, derive the velocity distribution functions $N_1(v_x, v_y, v_z)$ and $N_2(v_x, v_y, v_z)$ of two kinds, 1, and 2, of molecules of masses m_1 and m_2 , respectively, in the same volume V . *Note:* There are three kinds of collisions, those between two molecules of mass m_1 , two molecules of mass m_2 , and those between a molecule of mass m_1 and one of mass m_2 . The distribution functions must be such that equilibrium exists with respect to all three kinds of collisions.

Show how the results of this calculation lead to a proof of the statement that the average kinetic energy of the molecules of a perfect gas is a function of the temperature alone.

Show how this also leads to Avogadro's law: equal volumes of different gases at the same temperature and pressure contain the same number of molecules.

1. 2. In an infinite space the density of molecules of a perfect gas at some point is assumed to be known, and it is known that the velocity distribution at this point is Maxwellian. There is also known to be a gravitational force of g dynes per gram acting uniformly in the negative z direction on each molecule. Assuming all the molecules to have the same mass, and assuming that there are no collisions, calculate both density and velocity distribution as a function of position in the space such that there is a steady state, that is, such that as many molecules enter as leave each element of positional *and* velocity space.

Express the result in one function, $N(x, y, z, v_x, v_y, v_z)$ such that $N(x, y, z, v_x, v_y, v_z) dx dy \cdots dv_z$ gives the numbers of molecules having coordinates lying between x and $x + dx$, etc., and velocities between v_x and $v_x + dv_x$, etc.

Note what the potential energy of a molecule is at the height z .

1. 3. Consider a column of gas in the atmosphere subject to the constant gravitational force g per gram. Using the effect of the weight of the gas in changing the pressure with height, and using the perfect gas law, derive an equation giving the density of molecules, at constant temperature, as a function of the height. Compare this result with that of the previous problem.

1. 4. Calculate the viscosity coefficient of a gas if the pressure is so low that the mean free path l is much larger than the distance between the plates considered in section 1i. Assume that there is no slipping at the plates.

1. 5. Calculate the heat conductivity of a gas at so low a pressure that the mean free path is much greater than the distance between the plates (section 1j). Assume that the molecules leave each plate in temperature equilibrium with that plate.

2. 1. Draw, in the two-dimensional phase space of an oscillator, the classical paths corresponding to the quantum-mechanically allowed energies. Show that these lines separate the phase space into cells of volume h . Show in detail for the classical oscillator that the Liouville theorem holds.

2. 2. Draw, in the two-dimensional phase space of a rotator in a plane, the lines of constant energy which separate the phase space into cells of volume h , starting with the line of zero energy. Calculate the energy of these states. Compare the results with equation (2.25) for a rotator in three-dimensional space.

Show in detail that the Liouville theorem holds for the classical rotator in a plane.

6. 1. Assume the Boltzmann distribution law for the relative numbers of molecules in two non-degenerate quantum states, and using this alone derive the expression for the number of molecules in one internal quantum state in terms of the total number of molecules.

From this result derive the expression for the total internal energy, E_i , of the gas. By thermodynamic transformations derive from this the expressions for the other thermodynamic functions, C_i , S_i , A_i , assuming that the internal entropy at 0°K is $Nk \ln g_0$, with g_0 the number of internal states of zero energy.

6. 2. Calculate the internal contribution to the heat capacity, per gram atom, of fluorine atoms between 0°K and 3000°K (at 100° intervals to 1000°K and 250° intervals from 1000°K to 3000°K). Plot the results against T . See page 142 for data.

6. 3. For the monatomic gas considered on page 143 derive an equation relating g_0 , g_1 , and u at the temperature for which the heat capacity, C_i , is a maximum. Solve this equation for T if g_1 is extremely large. Plot C_i and E_i in the neighborhood of this temperature for $g_1 = 10^6$, $g_0 = 10^3$; for $g_1 = 10^{12}$, $g_0 = 10^3$; and for $g_1 = 10^{18}$, $g_0 = 10^3$. Change the value of ϵ in each case so that the maxima in the C_i curves occur at about the same temperature in each case.

Do these plots suggest any explanation of the behavior of a crystal in melting sharply at one temperature to a liquid?

7. 1. Calculate the thermodynamic functions F , S , H , and C_P for HCl at 100°K , 200°K , 273.1°K .

7. 2. Calculate the thermodynamic functions F , S , H , and C_P for $\text{I}_2(\text{gas})$ at 300°K , 600°K , and 900°K .

8. 1. In the linear molecule CO_2 , assume that there are no forces between the two oxygen atoms, and calculate the ratio of the two higher frequencies. Compare with the values at the bottom of page 186.

8. 2. What are the symmetry numbers of the following molecules: CH_4 , CH_3Cl , CH_2Cl_2 , CHCl_3 , CCl_4 , H_2CO , $(\text{CH}_2)_3$ (cyclopropane), CO_2 , $(\text{CH}_2)_6$ (cyclohexane, a , assuming the carbon atoms to lie in one plane; and assuming the tetrahedral angle to be preserved in which case there are two forms, b , the "bathtub" form with four carbon atoms in one plane, c , the "armchair" form with alternate carbon atoms in differing parallel planes).

9. 1. Prove generally, by the use of the classical partition function, that for a classical system, if the potential energy of the molecule is independent of its isotope composition, then no separation of isotopes can be obtained in a gaseous chemical reaction, even if the effect of the differing masses of the isotopes is considered.

9. 2. (a) For a reaction such as



show by the use of the quantum-mechanical partition function that at sufficiently high temperatures the equilibrium constant is unity (by expanding the partition functions in power series of the inverse temperature).

(b) Calculate the power series development in inverse powers of the temperature for the equilibrium constant of such a reaction.

(c) Calculate the numerical value for the equilibrium constant of the above reaction at 300°K . (The power series expansion will not be applicable at this temperature.)

10. 1. (a) If $P(p_1, p_2, \dots, p_f, q_1, \dots, q_f) dp_1 \dots dq_f$ is the (classical) probability that the system is in the element of phase space between p_1 and $p_1 + dp_1$, etc., show that

$$S = -k \int \int \dots \int P \ln P dp_1 \dots dq_f.$$

(b) If P_n is the (quantum-mechanical) probability that the system is in the quantum state n , show that

$$S = -k \sum_n P_n \ln P_n.$$

10. 2. (a) If the free volume per atom V of a classical system is defined by the equation

$$\bar{V}^N = \int \int \dots \int e^{(\bar{U}-U)/kT} d\tau_1 \dots d\tau_N,$$

in which \bar{U} is the average potential energy of the system and U is the potential energy as a function of the coordinates, prove that

$$S = k \left\{ \sum_i \ln \left(\frac{2\pi m_i kT}{h^2} \right)^{3N_i/2} \frac{e^{3N_i/2}}{N_i!} + \ln V^N \right\}.$$

(b) In what sense does it seem to be justified to refer to the quantity \bar{V} defined above as a "free volume" per atom of the system?

11. 1. Plot heat capacity per gram atom against temperature for a monatomic (Debye) regular crystal, the atoms of which have two internal non-degenerate quantum states of energies zero and ϵ , with both $\epsilon = h\nu_m/20$ and with $\epsilon = 2h\nu_m$. Assume that the internal quantum states do not interact with the lattice vibrations.

14. 1. Assuming that at the critical temperature and density only the terms for k equal to 1 and 2 are appreciable in the virial development, calculate the relation between β_1 and β_2 which would determine the critical temperature. Calculate the value of Pv/kT at the critical point on this assumption.

14. 2. For a system containing N identical monatomic molecules in a volume V , distribution functions $F_n(x_1, y_1, z_1, x_2, \dots, z_n)$ of the coordinates of n specified molecules may be defined by the statement that

$$\frac{1}{V^n} F_n(x_1, \dots, z_n) dx_1 \dots dz_n$$

is the probability that simultaneously molecule 1 will be in a volume element of volume $dx_1 dy_1 dz_1$ at the place $x_1 y_1 z_1$ and \dots molecule n in the element of volume $dx_n dy_n dz_n$ at $x_n y_n z_n$.

Derive the formal expression for F_n which involves integration in the configuration space, and the potential energy of the whole system.

Derive the equation

$$\left(\frac{h^2}{2\pi m kT} \right)^{3/2} e^{-\mu/kT} = \frac{Q_r(N+1, V, T)}{(N+1)!} \frac{N!}{Q_r(N, V, T)} = v \left[1 + \sum_{n \geq 1} \frac{v^{-n}}{n!} \int \int \dots \int F_n(x_1, \dots, z_n) \prod_{i=1}^{i=n} f_{0i} d\tau_1 \dots d\tau_i \dots d\tau_n \right]$$

in which $f_{0i} = e^{-u_{0i}/kT} - 1$, and u_{0i} is the mutual potential of the molecule i and the molecule 0 which is located, for convenience, at the origin of the coordinate

space. It is necessary to assume that the total potential energy of the system is the sum of that between pairs of molecules as was done throughout Chapters 13 and 14.

If strong repulsive forces are assumed between molecules at short distances of approach can one predict *a priori* whether the above series will converge even in a liquid or crystal?

16.1. Calculate the ratio of the heat leak in a Dewar flask due to radiation to that due to gas conduction. Assume the gas to be monatomic argon, for convenience, and that it is at a pressure of 10^{-3} mm. mercury. (Mean free path is greater than the distance between walls; see problem 1.5.) Calculate the ratio when the outer walls of the Dewar are at 300°K and the inner vessel at 80°K (liquid air), when the inner vessel is at 200°K, and when the inner vessel is at 373°K. Assume first that the accommodation coefficient for the atoms on the walls is unity, and that the walls are black-body radiators. How is the heat loss due to radiation altered if the inner wall of the Dewar is silvered so that it becomes a 90 per cent reflector? if only the outer wall is silvered? if both walls are silvered?

16.2. How many watts energy are required to keep a black cube with a 1-cm. edge, in vacuum, at 500°K, at 800°K, at 1000°K, at 2000°K? Assume that the surrounding walls are also black and are at 300°K.

16.3. The heat generated at any place in the metal is equal to the work done on the electrons minus the excess of heat carried away, or

$$q = w - \frac{\partial \Gamma}{\partial x}.$$

Calculate the heat generated at a region in the metal, and identify the various terms with the Joule heat, the heat brought into the region by heat conduction, and the heat due to the Thomson effect.

16.4. (a) Derive general equations for the thermodynamic functions of an Einstein-Bose gas with internal degrees of freedom.

(b) If only two non-degenerate quantum states of energies zero and ϵ , respectively, are appreciably excited, derive the equations for the condensation temperature as a function of ϵ . What is the ratio of the condensation temperature for such a gas as ϵ approaches zero to that of a gas with only one non-degenerate state of zero energy?

16.5. Show that a two-dimensional perfect Einstein-Bose gas does not condense.

AUTHOR INDEX

ANDREWS, D. H., 184

BARNES, R. B., 256

BETH, ERICH, 122, 415

BETHE, H., 395

BIRGE, R. T., 470

BLACKMAN, M., 254

BOLTZMANN, L., 10ff, 66, 114ff, 119, 401ff

BORN, MAX, 246, 260, 261, 283, 299, 460

BOSE, S. N., 63ff, 111ff, 229, 416ff

BRILLOUIN, L., 260, 346

BROWN, R., 2

BRUNAUER, STEPHEN, 189

CAUCHY, A. L., 459, 460

CLAUSIUS, R., 339, 348, 351

CURIE, P., 340, 350

CZERNY, M., 256

DAVIS, CLYDE, O., 166

DEBYE, P. P., 249, 255ff

DEVONSHIRE, A. F., 261, 324

DIRAC, P. A. M., 63ff, 111ff, 229, 374

DRUDE, P., 364

DULONG, P. L., 241, 245

DUSHMAN, SAUL, 393

ECKART, CARL, 365

EINSTEIN, ALBERT, 63ff, 99, 111ff, 229,
245, 415, 416ff

EHRENFEST, P., 172

EULER, L., 431

EYRING, HENRY, viii, 323, 324

FERMI, ENRICO, 63ff, 111ff, 187, 229,
374ff

FOWLER, R. H., 396

FRANZ, 400, 412

FUCHS, K., 283, 299, 460

GAUSS, C. F., 76

GIAUQUE, W. F., viii, 166

GIBBS, WILLARD J., 40, 102, 219ff, 228

GIBSON, R. O., 25

GILBERT, W. S., 98

GOUDSMIDT, S., 140

GUGGENHEIM, E. A., 324

HARDY, G. H., 282

HARRISON, SALLY F., 299, 306, 313, 455

HEISENBERG, W., 42, 352

HERZFELD, K., viii, 260

HIRSHFELDER, J. O., 323, 470

HOUSTON, W. V., 365

JOHNSTON, HERRICK L., 166

JORDAN, P., 57

JOULE, J. P., 2

KAHN, B., 281, 283, 419

KARMAN, TH. VON, 246

KETTERING, C. F., 184

KINCAID, J. F., 324

KIRCHHOFF, G., 367

KIRKWOOD, J. G., viii, 325

LANDÉ, A., 343ff

LAUE, MAX VON, 393

LEEUWIN, J. H. VAN, 341

LENNARD-JONES, J. E., 261, 269, 324

LEWIS, GILBERT, N., 108

LILOUVILLE, J., 40, 58ff

LONDON, F., 365, 415, 418

LORD, RICHARD C., JR., 188

LORENTZ, H. A., 339

LORENZ, L., 339

MAASS, O., 314

MACLAURIN, C., 431

MAGRI, L., 340

MAXWELL, CLERK, 10ff, 119ff

MAYER, ROBERT, 2

MONTROLL, ELLIOT, viii

MOSSOTTI, O. F., 339, 348, 351

MULHOLLAND, H. P., 153

NICHOLS, E. F., 256

- ONSAGER, LARS, viii
- PAULING, LINUS, 140, 167
PETIT, A. T., 241, 245
PLANCK, MAX, 364, 369ff
- RAMAN, C. V., 186
RAMANUJAN, S., 282
RANDALL, MERLE, 108
RAYLEIGH, J. W. S., 371
REINKOBER, O., 256
RICE, O. K., 322, 323, 378
RICHARDSON, O. W., 390ff
RUBENS, H., 256
RUMFORD, B. T., 2
RUPSCH, E., 395
RUSSEL, H. N., 140
- SANGER, R., 333, 334
SAUNDERS, F. A., 140
SHUTTS, L. W., 184
SLATER, J. C., 390
SOMMERFELD, A., 365
SPONER, H., 468
STEACIE, E. W. R., 314
- STERN, OTTO, 21
STIRLING, J., 75
SULLIVAN, A., 98
SUTHERLAND, W., 21
- TAPP, J. S., 314
TEETS, D. E., 184
TELLER, EDUARD, viii, 189
TRKAL, V., 172
- UHLENBECK, GEORGE E., 122, 281, 283,
415, 419
URSELL, H. D., 263
- VAN VLECK, J. H., 334, 338, 339
VOLTA, A., 396
- WAALS, J. D., VAN DER, 262ff
WEIGERT, K., 189
WEISS, P., 351
WIEDEMANN, 400, 412
WIEN, W., 371
WILSON, E. BRIGHT, JR., 167, 185, 190
WOLTJER, H. R., 348

SUBJECT INDEX

References are to pages; **bold face** type indicates definitions or more important references.

- Alkali atom, 142
Ammonia molecule, 199
Angular momentum, *see* Momenta
Antisymmetric eigenfunctions, **64**, 65,
123, **175-176**, 196, 363, 374
Argon, boiling point, 122
heat conductivity, 27
viscosity, 27
Atom, 52
Atomic spectral terms, **140-141**
- Benzene molecule, 185
Binomial coefficient, 436
Black-body radiation, 365-374
definition, 365
distribution function, 366, **370**
pressure, 373
quantum states, 368
thermodynamic functions, 372-374
Bohr magneton, 344
Boltzmann system, definition, 66-67
perfect gas, limit of treatment as a,
120-122
perfect monatomic gas treated as a,
114-122
Bose-Einstein system, 63-67
Brillouin function, 346-348
- Calculus, notation of, 427-430
Canonical ensemble, 219
Carbon dioxide molecule, 186
Cell method for liquid partition func-
tions, 319-326
Cells, as synonym for quantum states,
42, 53, **63**, 110, 123, 201, 221,
363, 401
number of, 54-55
number of translational, **54-55**, 110,
375, 416
Chemical equilibrium constant, 207
Chemical equilibrium in gases, 203-217
- Chemical estimation, 215
Chemical interpretation, 213
Chemical reactions involving isotopes,
210
Chemical potential (*see also* Thermo-
dynamic functions), **104-108**,
438-440
in a gas, 126
in a gaseous mixture, 203
in a reaction at equilibrium, 205-207
Clausius-Mossotti formula, 339
Cluster integrals, **278-288**, 297-299,
455-459
Coefficients, binomial, 436
multinomial, 436
of terms in the cluster integrals, 455-456
Collisions, in a perfect gas, 18-22
of electrons in metals, 397-407
Combination of independent systems,
49-53, 63-67
Combinatory problems, 435-438
Complex numbers, 43, 46
Condensation, from an imperfect gas,
295-317
in an Einstein-Bose system, 418-426
van der Waals', 272-274
Configuration integral, 229-230
evaluation, 277-284
Configuration space, 133, 215-217, **231**,
277
Conversion table for energy units, 471
Coordinates, 35-36
and configuration space, 229-230
and phase space, 39
Eulerian angles, 192
normal, of crystals, 238, 248
of polyatomic molecules, 183
polar, 35, 37
Corrections for high temperatures in
diatomic gas functions, **163-
166**, 452-453

- Critical point, 308-314
 in a van der Waals' gas, 270
- Crystals, 237-261
 classical treatment, 240-242
 Debye function, 251
 Debye treatment, 249-255
 general thermodynamic functions, 243-245
 normal coordinates, 238, 248
 one-dimensional model, 246-248
 stress and strain, 258-261
- Debye formula, 251
- Definite integrals, 430
- Degeneracy, 44
- Degenerate gas, *see* Einstein-Bose gas; Fermi-Dirac gas
- Degrees of freedom, **35**
 number of, in crystals, 237, 251
 in polyatomic molecules, 181
- Diatomic molecules, **51-52**
 constants (table), 468-469
 gas composed of, 149-177
 classical thermodynamic functions, 171
 classical treatment, 167-171
 elements, 172-178
 high-temperature corrections, 162-166
 nuclear spin, 174-178
 oscillator contributions, 157-160, 444
 tables, 445-447
 rotator contributions, 151-157, 448-449
 tables, 450-452
 symmetrical molecule, 172-178
 thermodynamic functions, 443-453
 with general molecules, 160-171
 quantum levels, **51-52**, 149
 quantum levels of general molecule, 160, 452
- Dielectric constant, 331-340, 361
- Diffusion in gases, 27-30
- Dipoles, 327-330
 non-rigid, 335-338
- Distribution, black-body radiation, 367, 371
 concept, 78-80
 example, 74-77, 89-90
- Distribution, Gaussian, 76-77
 Maxwell Boltzmann, 10-17, 119-120
 number of quantum states, 88
 of energy among atoms, 110-114
 of molecules, with respect to clusters in space, 283-284
 with respect to internal states, 132-134
 with respect to kinetic energy, **10-17**, 119-120
 with respect to space, 74-77, 325-326
 with respect to velocity, 10-17, 119-120
 probability of a, 79
 the most probable, 80-81, 88
- Eigenfunctions (*see also* Symmetric eigenfunctions; Antisymmetric eigenfunctions), **43-45**
 and configuration integral, 231
 of a mass point in field free space, 46
 of electrons in metals, 389-390
- Eigenvalues, *see* Quantum states
- Einstein heat capacity equation for a crystal, 245
- Einstein-Bose gas, 63-67, 111-113, **416-426**
 condensation, 418
 integrals, 419
 thermodynamic functions, 421
- Einstein-Bose systems, 63-67
- Elastic constants, 259-261
- Electric displacement vector, 357ff
- Electric field, 327ff
 thermodynamic functions for systems in an, 356-362
- Electrical conductivity of metals, 399, **407-409**
- Electron gas in metals (*see also* Fermi-Dirac gas), 364, **387-390**
- Energy (*see also* Thermodynamic functions), 1
 arbitrary zero, 134-135
 conversion of units (table), 471
 fluctuations in a system of fixed temperature, 227
 kinetic, 1, 5, 9, **36**, 147
 levels, *see* Quantum states
 potential, 1, **88**, 145, 230-231

- Energy, potential, of a crystal, 238
 of a diatomic molecule, 167
 zero point, of a crystal, 240ff
 of a Fermi-Dirac gas, 374-377
 of an oscillator, 48, 150
- Entartung (*see also* Einstein-Bose gas; Fermi-Dirac gas), 44, 364
- Enthalpy, *see* Heat content
- Entropy (*see also* Thermodynamic functions), 86, 92-98, 104-107, 438-440
 and uncertainty of energy, 100-102
 of isotope mixing, 138-140, 209-213, 443
- Equilibrium (*see also* Distribution), 81
 chemical, *see* Chemical equilibrium constant, 207
 distribution, 80-81
 position of atoms, in crystals, 237
 diatomic molecules, 149
 table of, 468-469
 polyatomic molecules, 179-181, 195-199
 thermodynamic criteria, 104-108
- Ergodic systems, 56, 62, 83
- Error function (Gaussian), 76
- Ethane molecule, 148, 189, 197
- Eulerian angles, 192
- Euler-Maclaurin summation formula, 152, 431-432
- Factorial, 432-433
- Fermi energy, 375
- Fermi-Dirac gas, 63-67, 111-114, 374-414
 distribution function, 378, 381
 integrals, 378-385
 zero point energy, 375-377
 zero point pressure, 377-378
- Fermi-Dirac systems, 63-67
- Ferromagnetism, 348-352
- First law of thermodynamics, 86
- Forces, 38
 thermodynamic, 70-74, 96-97
- Free energy (*see also* Thermodynamic functions), 105-108, 438-440
- Gamma space, 40, 68
- Gases (*see also* Perfect gas; Imperfect gases; Diatomic molecules; Polyatomic molecules, etc.), imperfect, 262-294
- Gases, mixtures, 201-203
 perfect, 1-30, 109-217
- Gaussian distribution, 76
- Gibbs' phase integral (*see also* Partition function), 223, 229, 234
- Gibbs' statistics, 218ff
- Halogen atom, 142
- Hamilton function, 38
- Harmonic oscillator, *see* Oscillator
- Harmonic vibrations in crystals, 237-240
- Heat capacity (*see also* Thermodynamic functions), 438-440
- Heat conductivity, in gases, 26-27
 in metals, 397-399, 409-411
- Heat content (*see also* Thermodynamic functions), 438-440
- Heisenberg uncertainty principle, 41-42, 62, 101
- Helium, 121
 heat conductivity, 27
 liquid, 414-426
 viscosity, 27
- Helmholtz free energy (*see also* Thermodynamic functions), 105-108
- Hindered rotation, 148, 189, 197-198
- Hydrochloric acid molecule, 151, 469
- Hydrogen molecule, 122, 151, 157, 166, 177-178, 468
- Identical particles, 63-67
- Imaginary numbers, 43
- Imperfect gases, 262-294
 condensation, 295-317
 critical point, 308-314
 general theory, 277-294
 potential energy, 277
 thermodynamic functions, 291-293
 van der Waals' equation, 262-276
- Inhibitions, 81-85
- Iodine molecule, 151, 157, 166, 469
- Irreducible integrals, 285ff
 temperature dependence, 305-308
- Isotope mixing, 138-140, 209-213
- Kinetic energy, 1, 36-38
- Kirchhoff's law, 367
- Landé g -factor, 343-345
- Langevin function, 330
 figure, 347

- Lattice, *see* Crystals
- Law of corresponding states, 269–272
- Liouville theorem, 58–63
in quantum mechanics, 56–58
- Liquid, cell method of treatment, 319–326
condensation to a, 295–317
- Liquid helium II, 414–426
- Lorentz-Lorenz force, 338
- Magnetic cooling, 352–356
- Magnetic fields, 327ff
- Magnetic susceptibility, 340–348
- Magneton, 344
- Maximum frequency of crystal oscillators, 251
- Maximum term in configuration integral development, 283–284
- Maxwell-Boltzmann collision equation, 401–407
- Maxwell-Boltzmann distribution law, 10–17, 119–120
- Mean free path, of electrons in metals, 397, 400, 405
of molecules in a perfect gas, 18–22
table, 21
- Meniscus, temperature of disappearance of, 310–314
- Method of undetermined multipliers, 113, 201, 222, 283, 297, 370, **433–435**
- Mixture of gases, 201–203
- Molecules, ammonia, 199
benzene, 185
carbon dioxide, 186
diatomic (*see also* Diatomic molecules), **52**
ethane, 148, 189, 197–198
hydrochloric acid, 151, 469
hydrogen, 122, 151, 157, 166, 177–178, 468
nitrogen, 151, 468
oxygen, 151, 468
polyatomic (*see also* Polyatomic molecules), 179–199
- Momenta (*see also* Phase space), **36ff**, 58
and uncertainty principle, 41–42
angular, 37, 48, 145, 149, 193
conjugate, 36
linear, 4, 9, 36, 46
- Moments of inertia, 37, 49
of diatomic molecules, 149, 167
table, 468–469
of polyatomic molecules, 189, 192, 454
- Mu space, **40**, 110, 124
- N*-dimensional sphere, volume, 116, 243, **433**
- Neon, boiling point, 122
heat conductivity, 27
viscosity, 27
- Nitrogen molecule, 151, 468
- Normal coordinates, of crystals, 238, 248
of polyatomic molecules, 183, 185
- Nuclear spin, 52, **135–138**
in diatomic molecules, 52, 174–178
in isotope equilibrium, 213
in polyatomic molecules, 196
- Number, of cells of translation, **54–55**, 110, 375, 416
of degrees of freedom, **35**, 181, 237, 251
of molecules hitting a wall, 17–18
with given velocity, 5–8
of quantum states of a system, 54ff, 58, 86ff
of terms in cluster integrals, 455–459
of ways of putting balls in boxes, 435–438
- Optically active isomers, 180
- Ortho-hydrogen, 177–178
- Oscillator, **47–48**
and electric moment, 335–338
deviations from harmonic behavior, 160–161, 452–453, 467
in crystals, 237ff, 258
in diatomic molecules, 149, 157–160, 444
mechanics, 47–48
thermodynamic functions, 157–159, 444
table, 445–447
- Oxygen molecule, 151, 468
- Para-hydrogen, 177–178
- Paramagnetism, 340–342
in quantum mechanics, 342–348
- Partition function (*see also* Thermodynamic functions), internal, of a molecule, 128

- Partition function, of a molecule, **123-129**
 of a system, **220-223**, 230
 separation as a product, 127-128
 Perfect gas, 109-199
 degenerate (*see also* Einstein-Bose gas; Fermi-Dirac gas), 363-426
 diatomic (*see also* Diatomic molecule), 149-178
 diffusion, 27-30
 equation of state, 5, 9, 117-119, **130**
 general thermodynamic equations, 129-132
 heat conduction, 26-27
 mean free path, 18-22
 monatomic, 109-122
 number of molecules hitting a wall, 17-18
 polyatomic (*see also* Polyatomic molecules), 179-199
 pressure, 5, 8, 117-119, **130**
 simplified model, 3-5
 symmetry number, 172-178, **195-199**
 thermodynamic functions, 129-131, **440-453**
 viscosity, 22-26
 Phase changes, 274-276, 317-319
 condensation, **295-317**
 Phase space, **38-40**, 69, 228, 232, 242
 and symmetry number, 196-199
 examples, 40, 59
 integral, *see* Gibbs' phase integral
 Liouville theorem, 58-63
 probability in, 62
 quantum states in, 42, 44, 69
 uncertainty principle, 41-42
 Physical constants, table, 470
 Planck distribution law, 370
 Polarization, electrical, 331-335
 Polyatomic molecules, 179-199
 hindered rotation, 148, 189, 197-199
 isomers, 180
 number of degrees of freedom, 181
 oscillators in, 183-191
 potential minima, 180
 rotation, 191-194
 symmetry number, 195-199
 thermodynamic functions, 194, 454
 Pressure, 72-73, 92, **95-97**, 235
 Einstein-Bose gas, 426
 Pressure, Fermi-Dirac gas, 386
 imperfect gas, 262, 291, 301
 mechanical origin, 4, **73**
 perfect gas, 4, 8, 117-119, 130
 radiation pressure, 373
 van der Waals' equation, 262
 virial equation, 291
 zero point pressure, 377-378
 Probability, *see also* Distribution
 equal, of equal volumes in phase space, 58-63
 equal, of quantum states, 53-58
 of a configuration, 133, 230-231
 of a molecule being in an internal state, 132-134
 of cards after shuffling, 88-90
 of a dipole orientation, 328-329
 of distribution of independent particles in space, 74-77
 of energy of a molecule, 123
 of kinetic energy of a molecule, 5ff, **14**, 112-114, **120**
 of orientation of magnetic moments, 340, **345**
 Quantum states, **42-45**
 density of, in phase space, 42, 44, 62, 69
 equal probability, 53-58
 in magnetic fields, 345
 number of, available to a system, 54, 68, **86ff**
 for a distribution, 79
 translational, **54-55**, 110, 375, 416
 of a crystal, 329
 of a diatomic molecule, 52, 149, **160**, 443, 452
 of a particle in field free space, 47
 of a rotator, 48-49
 of a symmetrical top, 49
 of an oscillator, 48
 of atoms, 52-53, 140-141
 of Einstein-Bose systems, 65, 66, 111
 of Fermi-Dirac systems, 65, 66, 111
 of some simple systems, 45-49
 Radiation field (*see also* Black-body radiation), 365-374
 thermodynamic functions, 372-374
 Rayleigh's law, 370

- Refractive index, 333-335
 Reversibility, principle of complete, 11, 56
 Richardson effect, 390-395/
 Root mean square velocity, 16
 Rotation, of diatomic molecules (*see also* Rotator), 52, 151-157
 interaction with vibration, 160-161
 of polyatomic molecules, 191-194
 contributions to thermodynamic functions, 194, 454
 Hamiltonian, 193
 hindered, 148, 189, 197-198
 moments of inertia, 192, 454
 Rotator, 48
 even and odd states, 150, 154-157
 in diatomic molecules, 51, 151-157
 partition function, 153
 thermodynamic functions, 154-155, 448-449
 table, 450-452
 Russell-Saunders notation, 140-141
 Saturated vapor, 295-317
 thermodynamic functions, 314-317
 volume per molecule, 303-305
 Schrödinger equation, 43
 Second law of thermodynamics, 86ff, 105-108, 438-440
 validity, 98-100
 Specific heat, *see* Heat capacity
 Spectroscopic notation, 140-141
 Spherical coordinates, 35
 Stationary state, 24, 30, 301
 Stirling approximation, 432-433
 Strain and stress in crystals, 258-261
 Summation formula, 152, 431-432
 Superconductivity, 388, 400
 Susceptibility, magnetic, 340-348
 Symmetric eigenfunctions, 64, 65, 123, 175-176, 196, 363, 368, 416
 Symmetrical top, 49, 192
 Symmetry number, in diatomic molecules, 172-178
 in polyatomic molecules, 195-199
 Systems, 1, 31, 33, 45, 49
 at constant energy, 86-100
 at constant temperature, 218-236
 combination of independent, 49-53, 63-67
 Systems, composed of dependent particles, 218-236
 composed of independent particles, 123ff
 eigenfunctions, 64
 Einstein-Bose (*see also* Einstein-Bose gas), 65
 Fermi-Dirac (*see also* Fermi-Dirac gas), 65
 partition function, 222-223
 simple examples, 45-49
 thermodynamic functions, 95-97, 235-236
 Temperature, 5, 92, 95
 Theory of functions of a complex variable, 459-467
 Thermionic emission, 390-395
 Thermodynamic forces, 70-74, 96-97
 Thermodynamic functions, 105-108, 438-440
 of an oscillator, 158-159, 444
 table, 445-447
 of a rotator, 154-155, 448-449
 table, 450-452
 of crystals, 240-245, 251-255
 of diatomic molecules, 154-155, 158-159, 165-166, 443-453
 table, 445-452
 of general gases, 130-132
 of imperfect gases, 291-293
 of monatomic gases, 143
 of polyatomic gases, 194, 454
 of saturated vapor, 314-317
 of systems in electric fields, 356-361
 of systems of dependent molecules, 235-236
 Thermodynamic state, 69
 Thermoelectric potential, 412-414
 figure, 414
 Third law of thermodynamics, 103-104
 Transition probabilities, 56-58
 Translational quantum states, 47, 54-55
 number of, in an energy range, 85, 110, 375, 416
 Uncertainty in energy, 100-102
 Uncertainty principle, 41-42, 62, 101

- Undetermined multipliers, method of,
113, 201, 222, 283, 297, 370,
433-435
- Van der Waals' gas, 262-276
- Velocity, averages in a gas, 14
- Vibration, *see* Oscillation
- Virial equation, 288ff
- Viscosity of a gas, 22-26
- Volume, of an N -dimensional sphere, 433
per molecule of saturated vapor, 303-
305
- Wave functions, *see also* Antisymmetric
eigenfunctions; Symmetric
eigenfunctions
and configuration integral, 231
of a point in field free space, 46
of electrons in metals, 389-390
- Wien's distribution law, 371
- Work function, *see also* Thermodynamic
functions
of a metal, 392, 395ff
thermodynamic, 105-108, 438-440

