

Birla Central Library

PILANI (Jaipur State)

(Engg College Branch)

Class No :- 629.133

Book No :- 9 854A

Accession No :- 30538

Acc. No. 30538

ISSUE LABEL

Not later than the latest date stamped below.

--	--	--

Military and Commercial
**AIRCRAFT
HYDRAULICS**

by

RAYMOND N. GREIF

*C.A.A. Licensed Aircraft Mechanic.
C.A.A. Licensed Ground Instructor.
Formerly, Army Air Forces Institute
Hydraulics Instructor. C. M. Johnson
Co., associated with Grumman Air-
craft Corporation.*

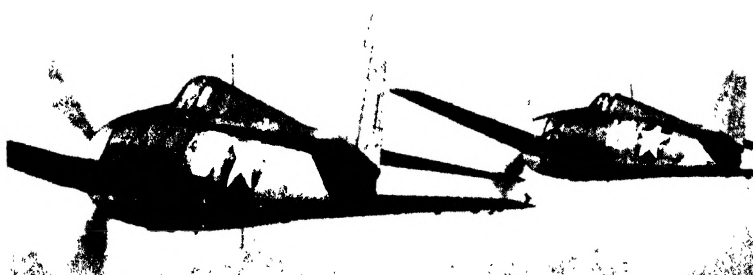

PITMAN PUBLISHING CORPORATION
NEW YORK CHICAGO

COPYRIGHT, 1944

BY

PITMAN PUBLISHING CORPORATION

*All rights reserved. No part of this book
may be reproduced in any form without
the written permission of the publisher.*

ASSOCIATED COMPANIES

SIR ISAAC PITMAN & SONS, LTD.

Bath · London · Melbourne · Johannesburg · Singapore

SIR ISAAC PITMAN & SONS (CANADA), LTD.

381-383 Church Street, Toronto

Advisory Editor

PROFESSOR ALEXANDER KLEMIN

DANIEL GUGGENHEIM SCHOOL OF AERONAUTICS
COLLEGE OF ENGINEERING, NEW YORK UNIVERSITY

To
Mother and Father

PREFACE

The current World War and the consequent necessity for the utilization of air power as an important instrument for the execution of military strategy, and the expected post-war progress in commercial and private aviation have served to emphasize one significant factor: the adequate functioning of an airplane is entirely dependent upon proper maintenance. Moreover, due to the many complexities of the modern airplane, the general all-round mechanic is being replaced by specialists of many types covering the different parts and systems of the airplane. Mechanics in charge of maintenance, to work effectively, must have theoretical as well as practical knowledge. This book supplies some measure of that theory and practice as relates to one of the most important functioning systems of the airplane; namely, the hydraulic system.

The work has been prepared to serve the following five purposes:

1. As a general text on aircraft hydraulics for use by aviation schools and air lines sponsoring training courses for their employees.
2. As a source of reference on hydraulics and hydraulic equipment for commercial and military mechanical personnel to aid them in solving everyday problems arising in their work.
3. As a home-study course for the apprentice mechanic who is seeking a knowledge of the fundamentals of aircraft hydraulics.
4. As a medium for acquainting the many post-war private aircraft owners with the various elements that make up a hydraulic system.
5. As a trade manual for those already employed as hydraulic mechanics to serve as a guide for the proper maintenance, inspection, trouble-shooting, and repair of the latest hydraulic equipment.

The author is aware that at times many complex principles and

technical problems present themselves. At all times, the author has striven to present the material in a straightforward manner giving careful analysis in a simple, logical, and interesting way. Always, terms familiar to the trade have been used; however, lucidity of explanation has never been sacrificed for complete accuracy of presentation.

Throughout the first part of this work, the organization of material is: First, working systems with their component units are presented; then, one by one, each individual unit in the system is withdrawn from the system, described in detail, and then returned to the system to show how it works in conjunction with the other units. In this way, the student is given an over-all picture of the functioning of a whole system. The second part of the book is devoted to a description of latest hydraulic equipment followed by maintenance instructions and trouble-shooting procedures for this equipment. Also, a careful explanation of hydraulic plumbing details has been included.

Questions at the end of each chapter serve to emphasize the most important points stressed in the chapter. It is suggested that where possible, the questions be answered without reference to the text; however, the text should be referred to for verification of the answers.

The author wishes to take this opportunity to acknowledge his indebtedness to the aircraft and accessory manufacturers, and others in the aviation industry who so generously co-operated in the preparation of this book. Particular thanks are due the following companies who furnished information and photographs:

Grumman Aircraft Engineering Corporation, Bethpage, New York; Bendix Aviation, Ltd., North Hollywood, California; Pesco Products Co., Cleveland, Ohio; Vickers Incorporated, Detroit, Michigan; Aircraft Accessories Corporation, Burbank, California; Electrol, Inc., Kingston, New York; Ray Pressure Snubber Co., Charlotte, North Carolina; Goodyear Tire and Rubber Company, Inc., Akron, Ohio; Adel Precision Products Corp., Burbank, California; Kenyon Instrument Co., Inc., Huntington, New York; Cuno Engineering Corporation, Meriden, Connecticut; Purolator Products, Inc., Newark, New Jersey; Parker Appliance Co., Cleveland, Ohio; Sperry Products, Inc., Hoboken, New Jersey; Tubing Seal-Cap, Inc., Los Angeles, California.

RAYMOND N. GREIF

CONTENTS

	PAGE
PREFACE	V
CHAPTER	
I ELEMENTARY HYDRAULIC SYSTEMS—BASIC UNITS . .	1
II COMPLETE HYDRAULIC SYSTEMS—BASIC UNITS (CONT'D)	18
III MISCELLANEOUS AND SPECIFIC UNITS	35
IV DESCRIPTION OF TYPICAL HYDRAULIC SYSTEMS . .	57
V MAINTENANCE OF TYPICAL HYDRAULIC UNITS . .	65
VI TROUBLE SHOOTING; HYDRAULIC FLUIDS	87
VII HYDRAULIC PLUMBING	97
INDEX	111

Chapter 1

ELEMENTARY HYDRAULIC SYSTEMS—BASIC UNITS

1. General

A hydraulic system is one wherein fluid is used to transmit a force to operate a mechanism. As applied to modern aircraft, hydraulics is of comparatively recent development. At first, hydraulic systems were used to operate wing flaps and retractable landing gears. Now, automatic pilots, engine cowl flaps, retractable air scoops for radiators, bomb-compartment doors, gun turrets, brakes, and folding wings are also hydraulically operated. Figure 1-1 shows a view of the Grumman Avenger with its wings in their hydraulically-folded position.

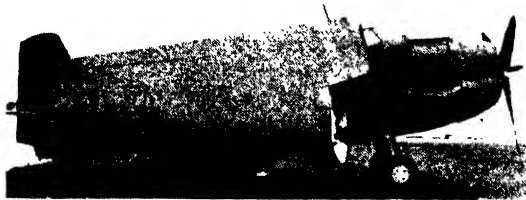

*Courtesy Grumman Aircraft
Engineering Corp.*

FIG. 1-1. SIDE VIEW OF HYDRAULICALLY FOLDED WINGS ON GRUMMAN AVENGER.

There are many advantages in the use of hydraulics for a source of power. Hydraulic systems are (1) light in weight, (2) simple to install, (3) very reliable, (4) instantaneous in operation, because of the incompressibility of the fluid, (5) capable of providing almost unlimited force, and (6) simple to maintain. For military purposes, however, a hydraulic system offers one important disadvantage: any leakage in hydraulic lines, as a result of vibration or machine-gun fire, results in total failure of the system. Moreover, hydraulic systems cannot be adequately armored because this would result in excessive weight and bulk.

2. Basic Principles

In a study of hydraulics, the basic principles of liquids must be considered. Liquids, for all practical purposes, are incompressible. Also, if pressure or force is applied to any part of a closed system containing a liquid, that pressure or force is instantaneously transmitted to all parts of the system. This second

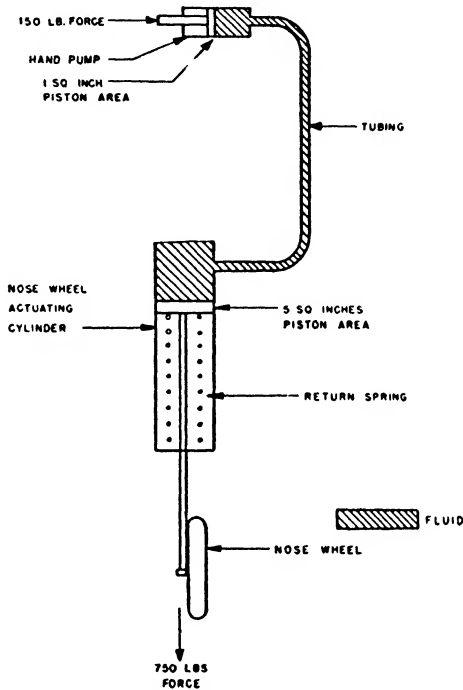

FIG. 1-2. BASIC OPERATION.

property of fluids may be summed up in the following law discovered by Pascal: *Pressure exerted anywhere on a mass of liquid is transmitted undiminished in all directions, and acts with the same intensity on all surfaces in a direction at right angles to those surfaces.*

3. Elementary Hand-pump Hydraulic System

An elementary hydraulic system is illustrated in Fig. 1-2. This system is not intended to represent a hydraulic system suitable for installation in an airplane. It merely shows the basic operation

of a hydraulic system in its simplest form. The system shown operates a nose wheel by means of a hand pump and an actuating cylinder.

A force of 150 lb is manually exerted by a hand pump having an area of 1 sq in. This means that a force of 150 lb per sq in. is transmitted to the piston of the actuating cylinder. However, since this larger piston has an area of 5 sq in., the force of 150 lb per sq in. now becomes 150×5 or 750 lb which will be exerted on the rod connecting to this piston.

The force applied at the hand pump will be transmitted to the actuating cylinder regardless of the length of the tubing or the number of bends. The amount of fluid forced out at the hand pump in Fig. 1-2 is exactly equal to the amount of fluid forced into the actuating cylinder. A definite volume of fluid has been transferred from one cylinder to another; therefore, the small piston must travel a greater distance than the large one in the same length of time. From this it is obvious that the actuating-cylinder piston must move slower than the hand-pump piston in exact proportion to the difference in volume of the two. In other words, one inch of pump piston movement will move the actuating cylinder $\frac{1}{5}$ inch. Therefore, what is gained in force is lost in speed.

4. *Hydraulic Actuating Cylinder*

The actuating cylinder is the unit in the hydraulic system which actually accomplishes the purpose for which the system is set up to perform. It may be thought of as being the hand of the hydraulic system because it is in this unit that the fluid pressure sent by the pump is received and is transposed into mechanical action. Essentially, all actuating cylinders are similar in construction, containing a piston, a piston rod, and piston-rod seals.

The actuating cylinder shown in Fig. 1-2 is a single-acting type because it is capable of exerting force only on its forward stroke. As such, it is impractical for aircraft work, but is occasionally used when positive operation in one direction only is required. A double-acting actuating cylinder, Fig. 1-3, is capable of providing power on both its forward and backward strokes; therefore, all mechanisms which require a positive, speedy operation in both directions are always controlled by this type of cylinder.

The housing of the actuating cylinder, Fig. 1-4, contains two ports, *A* and *B*. When fluid enters port *A*, the piston is forced toward the right. The piston rod transmits the motion of the piston to the mechanism to which the piston rod is fastened. This

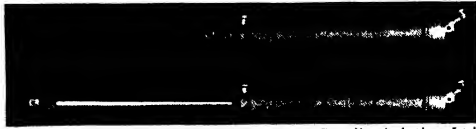

Courtesy Bendix Aviation Ltd.

FIG. 1-3. TYPICAL ACTUATING CYLINDER.

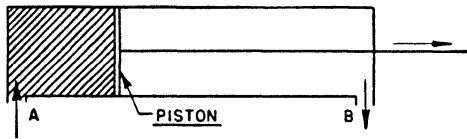

FIG. 1-4. ACTUATING CYLINDER—FLOW DIAGRAM.

causes the mechanism to move. The fluid ahead of the piston is pushed out of the cylinder through the port *B* and returns to the reservoir. By changing the setting of the selector valve, fluid may be forced to enter through port *B*, thereby reversing the direction of travel of the piston.

5. Simple Hand-pump Hydraulic System

Figure 1-5 shows a schematic diagram of a simple nose-wheel hydraulic system. This system differs from the system shown in Fig. 1-2 in that certain units have been added to make the system more operable. A double-acting hydraulic cylinder *E* similar to the one shown in Fig. 1-4 has been added to this system. Also, a four-way selector valve *D*, a reservoir *A*, a check valve *C* for the hand pump *B*, and several fluid lines have been added to the basic diagram in Fig. 1-2. These units are needed to allow fluid pressure to be delivered when needed at either end of the actuating-cylinder's piston.

In Fig. 1-5, the system is being operated to raise the nose wheel *F*. Fluid is drawn from the reservoir by the hand pump and delivered under pressure to the actuating cylinder through the four-way valve. Meanwhile, as the piston advances, it expels the fluid from the opposite end of the actuating cylinder through the four-way valve, into the return line to the reservoir. Also, as

the piston advances, the connecting rod, by a system of levers, raises the wheel.

The piston continues to move until it reaches the end of its stroke, or until force is no longer supplied from the hand pump. When the selector valve is turned to its opposite operating position, fluid under pressure forces the piston down, which in turn expels the fluid from the bottom of the cylinder, through the selector valve and back to the reservoir.

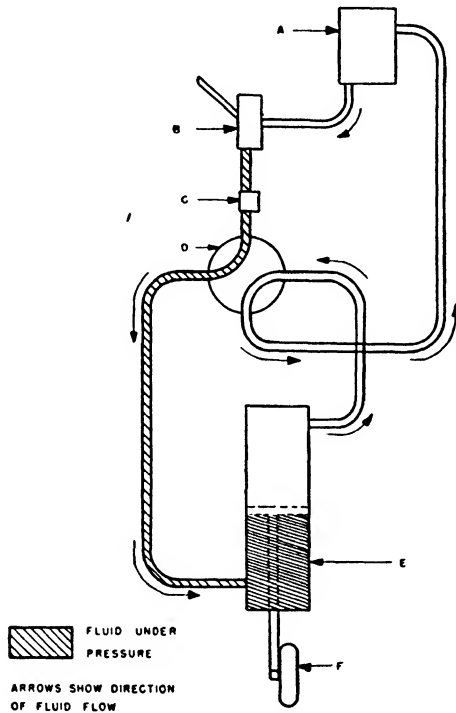

FIG. 1-5. SIMPLE NOSE-WHEEL HYDRAULIC SYSTEM.

Before continuing with more complicated systems, the units in Fig. 1-5 will be described in more detail. The double-acting actuating cylinder as used in this system has already been discussed.

6. Hand Pump

A hand pump is an extremely important unit in a hydraulic system. In very simple systems where it would be impractical to install a power pump, the hand pump provides the only source of

energy. In most systems, the hand pump is used in conjunction with the engine-driven pump to serve as a substitute for the engine-driven pump during emergencies in flight. Also, depending upon the installation, the hand pump may be used as a source of power for checking the hydraulic system when the airplane is at rest on the ground.

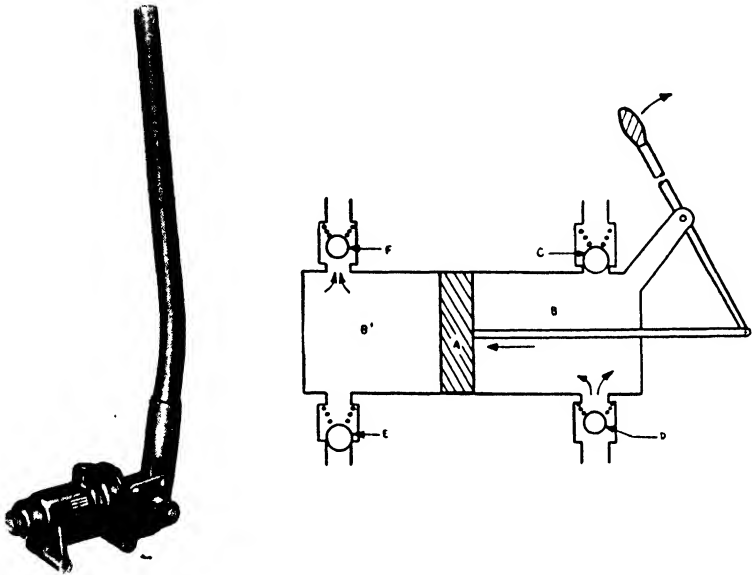

Courtesy Pesco Products Co.

FIG. 1-6 (LEFT). TYPICAL DOUBLE-ACTING HAND PUMP.
 FIG. 1-7 (RIGHT). DOUBLE-ACTING HAND PUMP—FLOW DIAGRAM.

The hand pump is a manually-operated, reciprocating, piston-type pump and may be of the single-action or double-action type. A single-action hand pump develops pressure on the forward stroke only, whereas a double-action pump develops pressure on the forward and also on the return stroke of the pump handle. A typical double-acting hand pump, capable of developing pressures up to 1800 psi (lb per sq in.), is shown in Fig. 1-6.

Referring to a flow diagram for a double-acting hand pump, Fig. 1-7, on the forward stroke by the piston *A* of this pump a suction is created in the cylinder *B*. This suction draws fluid from the reservoir through a check valve *D* located in the inlet port. The cylinder *B* is, therefore, filled with fluid. On the return

stroke, the piston forces the fluid from cylinder *B* through the outlet port past the check valve *C* into the pressure manifold. At the same time, the suction created in cylinder *B*¹ causes fluid to be drawn into the other end of the cylinder past the check valve *E* thereby filling this cylinder *B*¹. The next forward stroke of the piston forces the fluid from cylinder *B*¹ past check valve *F* while again filling the cylinder *B*. The purpose of the check valves *D* and *E* in the inlet ports is to prevent the fluid in the pump from being forced back into the reservoir. The check valves *C* and *F* in the outlet ports prevent the fluid in the system from being drawn back into the pump.

The handle of the hand pump is always located in the cockpit so that it is readily accessible to the pilot or to the members of the crew. Also, the handle is always of such length and the piston is of such area that working pressures may be developed without undue exertion on the part of the operator.

7. Reservoir

The supply of fluid for the hydraulic system is housed in the reservoir. Fluid, which is drawn from the reservoir by the hydraulic pumps and is forced by them throughout the system, is also eventually returned to the reservoir. The purpose of the reservoir is to supply the operating needs of the system, to replenish fluid lost through leakage and seepage, to serve as an overflow basin for excess fluid forced out of the system by temperature expansion and by piston-rod displacement, and to afford an opportunity for the fluid to purge itself of air bubbles introduced into the system by certain operating units. Also, foreign particles and solids picked up in the system are deposited in the reservoir.

The reservoir, Fig. 1-8, has a vent line *A* which is led overboard to the outside in order to equalize the inside and outside pres-

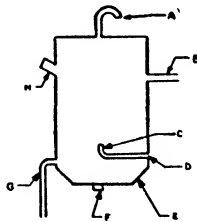

FIG. 1-8. RESERVOIR.

tures. This allows free flow of the fluid both from and back to the tank. The reservoir is filled through the filler neck *H* which is provided with a filter screen. The outlet *D* to the power pump is connected to a standpipe *C* which insures that the hand pump will be fed even though the fluid supply has been depleted to the point of starving the power pump. The outlet to the hand pump is at *G* and it will be noted that this is located at a lower level than the outlet to the power pump. The sump *E* at the bottom of the reservoir into which foreign particles may settle is provided with a drain plug *F* through which the tank may be drained and cleaned. Sometimes, a fluid-quantity gauge is installed as an accessory and may be used as a guide in filling the reservoir. Generally, the reservoir is filled to the top and the excess fluid overflows.

8. Check Valve

The purpose of a check valve is to confine fluid under pressure within some section of the hydraulic system. By preventing the fluid from reversing its normal direction of flow, the valve thereby prevents pressure from escaping into an adjacent section of the system. Check valves may be used in both the pressure

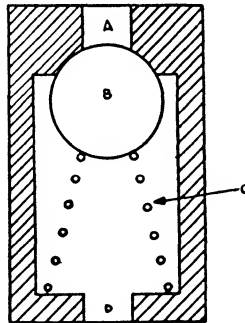

FIG. 1-9. BALL-TYPE CHECK VALVE.

side of the system and in the return side. Referring back to Fig. 1-5, the check valve is located between the hand pump and selector valve and prevents the fluid from reversing its direction after it leaves the hand pump thereby preventing possible damage to the hand pump.

A check valve may be of the ball-type, poppet-type, or swing-

check type. The underlying principle in each is the same and its operation may be understood by referring to Fig. 1-9 which illustrates a typical ball-type check valve. When pressure at the inlet port *A* overcomes the pressure of the spring *C* which is holding the ball-check *B* against its seat, the spring is forced to contract and the ball is forced off its seat. This allows unrestricted flow of fluid through the valve and the outlet *D*. When the system pressure becomes greater than the incoming pressure, the spring forces the ball to its seat. This closes the valve and prevents a reversal of fluid flow. Figure 1-9 shows the check valve in the closed position.

9. Selector Valve, Rotor-type

To complete the description of the units in the simple system of Fig. 1-5, we find a four-way selector valve. Among the various types of selector valves in use are the rotor-type, the poppet-type, and the piston-type. The selector valve is the control unit of the hydraulic system. The mechanism moved, the direction it is moved, and the distance it is moved are determined and controlled by manipulation of the selector valve or valves.

Our system in Fig. 1-5 shows the use of a rotor-type valve. This type is least used in aircraft hydraulics but it should be discussed briefly. The rotor-type valve, Fig. 1-10, is a four-port valve consisting of an inner rotor, an outer case, and a control handle. The four ports in the case are spaced 90° apart. The rotor carries two fluid channels so arranged as to connect adjacent ports. In view (A), Fig. 1-10, with the rotor *A* turned to connect the ports as shown, fluid from the pressure manifold flows past the inport *C*, through the rotor passage, and out through the port *D* leading to one end of the actuating cylinder. A third port *E* in the rotor case *B* is connected to the other end of the actuating cylinder, the return fluid flowing through the rotor passage, past the outport *F* to the return line to the reservoir.

When it is desired to change the flow from one end of the actuating cylinder to the other end, the rotor is merely turned through 90° as shown in view (B). When this is done the fluid is directed from the pressure manifold through the rotor passage and through the port *E* leading to the other end of the cylinder, while the fluid being forced out of the cylinder is returned through the rotor passage to the reservoir by way of outport *F*.

To stop the actuating cylinder before it has reached the full length of its stroke, the ports may be closed, or put in their neutral position as shown in view (C), Fig. 1-10. This use of the valve is applicable to wing-flap control when it is desired to set them in some midway position.

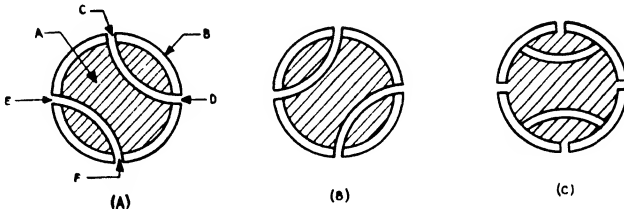

FIG. 1-10. ROTOR-TYPE SELECTOR VALVE.

At this point, it may be well for the student to refer back to Fig. 1-5 to get a clear understanding of exactly how the system operates. The other types of selector valves will be discussed later.

10. Elementary Power-pump Hydraulic System

We shall now proceed to study a system which is a bit more complicated than the one discussed in Fig. 1-5. Our new system is shown in Fig. 1-11. This system differs from the previous one in that the hand pump has been removed and a power pump *B* put in its place. Moreover, a relief valve *E* and a pressure gauge *D* have been added. Also, it will be noted, a different type selector valve *F* is being used.

The power pump *B*, in Fig. 1-11, draws fluid from the reservoir

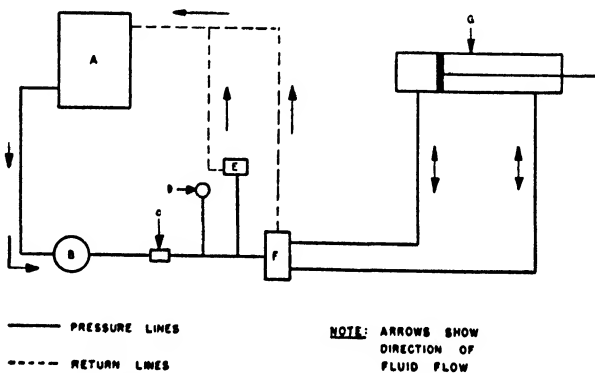

FIG. 1-11. ELEMENTARY POWER-PUMP HYDRAULIC SYSTEM.

A and forces it under pressure past the check valve *C* and into the pressure manifold. Here, the pressure gauge *D* measures the amount of pressure and the relief valve *E* bypasses the excess pressure back to the reservoir. The selector valve *F*, as in Fig. 1-5, is manually operated to determine which end of the actuating cylinder *G* should receive the fluid.

Before continuing with more complicated systems, let us examine in detail the new units which have been added.

11. *Power Pump—General*

The power pump is the energizing unit of the hydraulic system. Circulation is induced and working pressures are developed by the power pump which draws fluid from the reservoir and forces it throughout the system.

There are three main types of power pumps which find great use in present-day hydraulics. For systems which require low pressures of from 200 to 800 psi, a vane-type pump is usually used. Gear-type pumps are used in systems that require working pressures up to 1500 psi. A piston-type pump is used for high pressure systems requiring pressures of from 1500 to 3000 psi.

Power pumps may be engine-driven or they may be driven by an electric motor. In the former case they are mounted on the accessory section of the engine crankcase whereas in the latter case they are mounted in any convenient location, usually near the reservoir.

12. *Vane-type Hydraulic Pump*

The engine-driven hydraulic pump, Fig. 1-12, is a rotary, four-vane, positive-displacement type of pump designed for one direction of rotation as indicated by an arrow stamped on the mounting flange. The pump consists essentially of an aluminum alloy housing containing a hardened steel sleeve *A* with an eccentric bore in which a hollow steel rotor *B*, supported by a pair of bronze bearings, is driven by means of a coupling mated with the engine drive gear.

The pump, Fig. 1-12, is coupled directly to the engine accessory drive and operates automatically as long as the engine is running. Torque is transmitted from the engine accessory drive gear through the coupling and universal block to the rotor *B*. The bore of the sleeve *A* is divided into four sections by the rotor and the vanes *C*. Since the axis of the rotor is eccentric

with that of the bore, the sections are of unequal volume, the smaller sections being next to that point where the rotor is closest to the bore. As the rotor turns clockwise, the four sections pass successively the point where the volume of each is at a minimum. From this point, the volume of each section increases during one half revolution, thus creating a suction and drawing in fluid from the inport *D*. During the second half revolution, the section volume decreases, and since the fluid contained in the section cannot be compressed, it is forced out through the outport *E*. The rapid succession of discharges from the four sections produces a steady stream at high pressure.

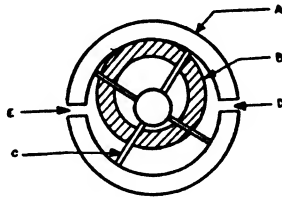

FIG. 1-12. VANE-TYPE HYDRAULIC PUMP.

13. *Pesco Gear-type Hydraulic Pump*

Among the different types of pumps now being used, the gear-type pump is most commonly used. Essentially, all gear pumps are alike, consisting of two gears mounted in a suitable casing and so arranged that one of the gears is driven from an external source of power and meshes with and drives a second gear.

The casing of the pump generally consists of a body and a close-fitting cover. One of the most important characteristics of such pumps is the fact that the efficiency of the pump is determined almost entirely by the clearances between the gears and the casing of the pump. In order that the pump can handle high pressures efficiently, these clearances must be kept to a minimum.

The *Pesco* gear-type pump, Fig. 1-13, can be used as a typical example to show the operation of this type of pump. The pump is mounted directly on the proper engine drive and operates as long as the engine is running. Torque is transmitted from the engine shaft through a coupling or pump drive shaft to the pump drive gear. The pump is designed for one direction of rotation as indicated by an arrow on the adapter. The drive gear and its driven gear are contained in a housing that provides only enough clearance for the gears to turn freely (see Fig. 1-14). In that

section of the pump where the gear teeth disengage as the gear rotates, the space between the gear increases so that a suction is created. The suction causes fluid to be drawn in from the adjacent intake port whence it is carried around between the gear teeth to where the teeth engage. There the fluid is displaced and

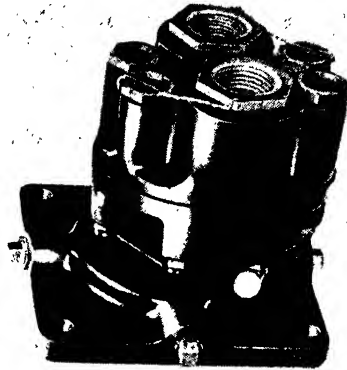

Courtesy Pesco Products Co.

FIG. 1-13. TYPICAL GEAR-TYPE POWER PUMP.

forced out through the discharge port. The rate of flow of the fluid depends on the speed at which the rotating gears revolve. This type of pump gives pressures up to 1000 psi.

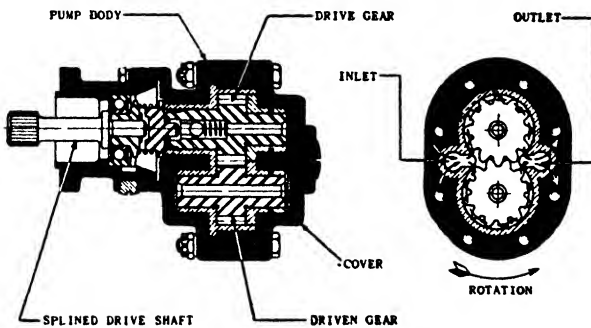

Courtesy Pesco Products Co.

FIG. 1-14. GEAR-TYPE POWER PUMP—CUTAWAY VIEW.

14. Relief Valve

A relief valve is installed in a system to relieve pressure when such pressure has reached a predetermined value. A relief valve is usually set to open at a pressure well above the normal system

pressure but below a pressure estimated to be a safe operating pressure. Relief valves which are intended only to relieve pressures caused by increase of temperature are known as temperature expansion valves.

Although relief valves may be of the poppet-type or the ball-check type, the underlying principle is the same in both. Figure 1-15 illustrates a typical ball-check relief valve. The ball *C* is held by the spring *D* against the valve seat *B*. This closes the inlet port *A*. When the pressure in the system becomes sufficient to overcome the tension of the spring, the ball is forced off its seat and

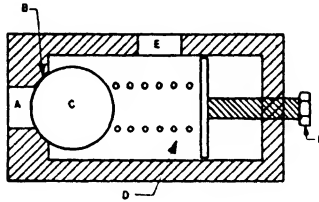
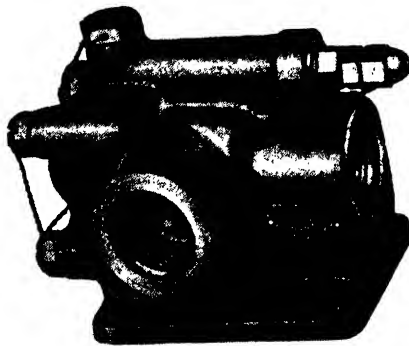

FIG. 1-15. RELIEF VALVE—FLOW DIAGRAM.

fluid flows through the port *A* and into the return line to the reservoir through the outlet *E*. When the excess pressure has been released, the tension of the spring again closes the valve. The tension of the spring is controlled by an external adjusting screw *F* so that the valve will be forced to open at any desired pressure.

Figure 1-16 shows a photograph of a Vickers relief valve.



Courtesy Vickers, Inc.

FIG. 1-16. TYPICAL RELIEF VALVE.

15. Pressure Gauge

At least one pressure gauge is found in every system. It may be mounted near the power pump in which case it will show the actual pump pressure, or it may be located near some mechanism to record the actual system pressure.

It is beyond the scope of the average hydraulic mechanic to maintain pressure gauges; therefore, a detailed description of their operation will not be dealt with here. It should suffice to say that pressure gauges are usually of a design in which pressure tends to straighten a tube inside the gauge, resulting in the movement of a pointer which indicates the amount of pressure.

16. Poppet-type Selector Valve

As mentioned before, there are three different types of selector valves. The rotor-type, as found in the system in Fig. 1-5, has been replaced in our new system (Fig. 1-11) by a poppet-type selector valve. This latter type is used more often than the other types.

A poppet-type valve is shown in Fig. 1-17. It consists of a series of spring-loaded poppets. The poppets are actuated by cams so arranged on a camshaft that rotation of the shaft opens the proper combination of poppets to effect the desired control of flow through the valve assembly. A control lever fastened to

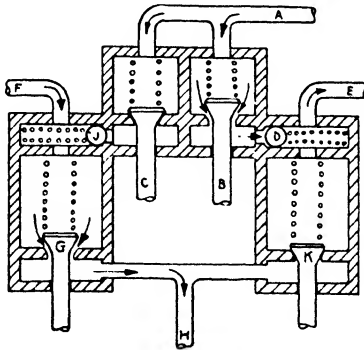

FIG. 1-17. POPPET-TYPE SELECTOR VALVE.

the camshaft provides a means of rotating the shaft. Fluid under pressure comes from the line *A*, Fig. 1-17, and flows to the inlet valves *B* and *C*. When the selector valve is turned to one position, a cam opens the poppet *B*. This allows the fluid to flow past the check valve *D* and into the line *E* leading to the desired end of

the actuating cylinder. The fluid forced out from the other end of the cylinder returns through the line *F* and passes through the poppet *G*, which is also being held open by a cam, and flows through the return line *H* to the reservoir.

When the selector valve is moved to its opposite setting, the arrangement is such that the poppet *C* opens and the poppet *B* is closed. Fluid flows past the check valve *J* and is led to the other end of the actuating cylinder. Meanwhile, the fluid being forced out of the first end of the actuating cylinder returns to the reservoir past poppet *K*, being held open by a cam, and flows out through the return line *H*. When the selector valve is set in its neutral position, all four poppets are closed and the fluid is locked in the lines.

17. Piston-type Selector Valve

The third type of selector valve in use is the piston-type valve, Fig. 1-18. This type selector valve consists of a grooved piston *B* within a cylinder *A*. The piston is hollow part of its length; the

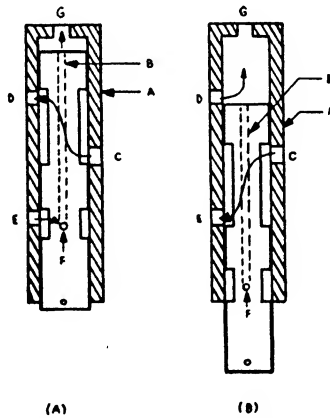

FIG. 1-18. PISTON-TYPE SELECTOR VALVE.

hole in the piston provides a fluid passage to the outlet of the valve. When the selector valve is moved so that the piston is in the position shown in Fig. 1-18 (A), fluid enters the port *C*, flows around the grooved piston and then through the port *D* to one end of the actuating cylinder. Fluid forced from the other end of the actuating cylinder enters through the port *E* and flows

through a hole *F* into the hollow passage of the piston leading to the outlet port *G*. In Fig. 1-18 (B), the selector valve has been set so that the movement of the piston has reversed the fluid pressure to the other end of the actuating cylinder, the flow of fluid being indicated by the arrows. When the piston is moved so that all the ports are closed, the valve is said to be in its neutral position and the mechanism is locked in the desired position.

QUESTIONS

1. What are the advantages and disadvantages in the use of hydraulic systems?
2. What purpose does a relief valve serve in a hydraulic system?
3. Distinguish between a double-acting and single-acting actuating cylinder.
4. Describe the operation of a double-acting actuating cylinder.
5. What is the relation between force and speed in gaining a mechanical advantage in hydraulic systems?
6. What is the purpose of a hand pump in a power-operated system?
7. What two facts about liquids are important as applied to hydraulics?
8. What function does a vent line in a reservoir serve?
9. List four construction features of a typical reservoir.
10. A hydraulic pump supplies fluid at a pressure of 900 psi to an actuating cylinder. If the area of the piston within the cylinder is 3 sq in., how great a force can be transmitted to the attached mechanism?
11. What is the purpose of a selector valve in a hydraulic system?
12. Name the three types of selector valves.
13. What is the energizing unit of the hydraulic system?
14. Name three types of power pumps and tell when each is generally used.
15. What causes the movement of the pointer in a pressure gauge?
16. What is the underlying principle in the operation of a relief valve?
17. On what important fact is the efficiency of a gear-type power pump determined?
18. How may an actuating cylinder be stopped before it reaches the end of its stroke?
19. Distinguish between a single-acting and a double-acting hand pump.
20. Name several mechanisms which may be hydraulically operated.

Chapter II

COMPLETE HYDRAULIC SYSTEMS— BASIC UNITS (CONT'D)

1. Complete Hydraulic System

Figure 2-1 shows a complete hydraulic system which incorporates all of the units studied in Chap. 1 but with the further addition of an accumulator and a pressure regulator. The single actuating cylinder may be thought of as controlling a wing flap, or possibly a bomb door. Before tracing the flow in this system, the two new units will be discussed.

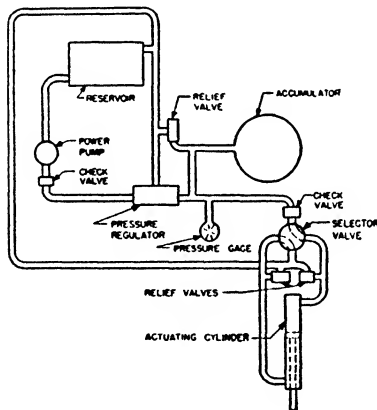

FIG. 2-1. COMPLETE HYDRAULIC SYSTEM.

2. Accumulator

An accumulator serves as an energy storage device and also damps out any pressure surges in the hydraulic system. When the system does not require the total output of the power pump, the excess fluid is forced into the accumulator. The air in the accumulator is compressed by the incoming fluid and absorbs and stores the energy to compress it. The compressed air, in turn, forces the fluid back into the pressure manifold when the output of the

power pump falls below the requirements of the hydraulic system. Under this circumstance, the fluid under pressure from the accumulator is capable of operating the mechanism for a limited time. The accumulator ordinarily supplements the power pump at periods of peak load but may also serve as the motivating force during emergencies in flight and during landing when the power pump is inactive or operating at a decreased rpm.

Accumulators are built to withstand high pressures and to contain considerable quantities of fluid. The Vickers accumulator, (Figs. 2-2 and 2-3) is divided into two compartments. The air compartment *A*, Fig. 2-3, and the fluid compartment *B* are separated by a synthetic-rubber diaphragm *C*. The tank is charged

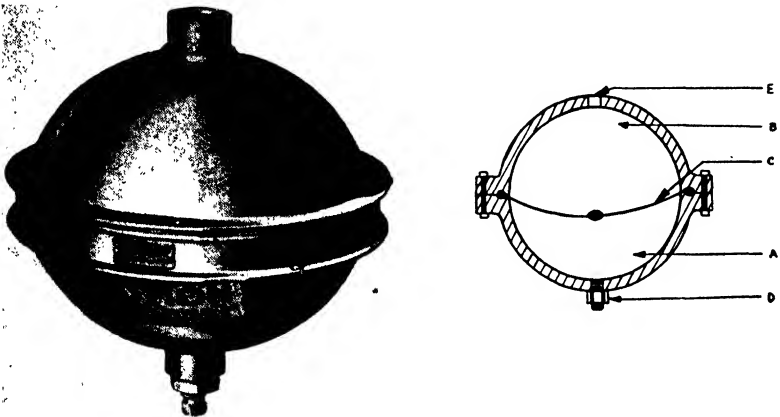

FIG. 2-2 (LEFT). VICKERS ACCUMULATOR.
FIG. 2-3 (RIGHT). ACCUMULATOR—CROSS SECTION.

with compressed air through the air valve *D*. Fluid, which enters the chamber *B* through the port *E* raises the pressure in the air chamber by forcing the diaphragm down. As soon as the pressure in the hydraulic system becomes lower than the pressure in the air chamber, fluid is forced out of the accumulator into the pressure line. Depending upon the system installation, with some types of pressure tanks the air pressure may reach 5000 psi.

3. Pressure Regulator

A pressure regulator is used in a hydraulic system to maintain constant operating pressure on the system from the power pump,

and also automatically relieves the pump of load when the system is at rest. There are two types of pressure regulators, or unloading valves as they are often called. A balanced-type regulator operates in conjunction with an accumulator, whereas a mechanical-type regulator, although not requiring an accumulator, will also operate perfectly in conjunction with one.

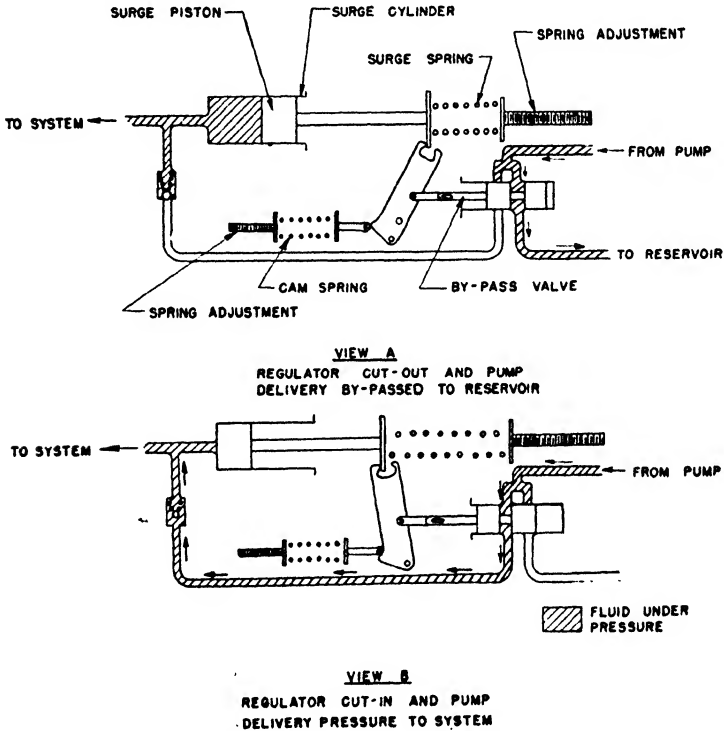

FIG. 2-4. MECHANICAL-TYPE AUTOMATIC PRESSURE REGULATOR.

Figure 2-4 shows the elements of a typical mechanical-type, automatic, pressure regulator. The type shown is the Aircraft Accessories Corporation model. The regulator is adjusted at the factory to "cut out" at approximately 100 psi above the normal operating pressure of the system. When the hydraulic pressure increases to this value, the surge-piston spring pressure is overcome, and the surge-piston linkage moves the bypass valve to open position (View A). The fluid from the pump then flows unrestrictedly back to the reservoir and the fluid in the surge

chamber is trapped by a double ball-check valve in the external line connecting the bypass valve and surge chamber, eliminating continuous loading of the engine-driven pump.

When the selector valve is left in an "open" position, the surge chamber acts as a small pressure accumulator to compensate for loss of fluid due to leaks within the actuating cylinder, piston-rod packing glands, or valves. When this surge-chamber fluid supply is exhausted, due to leaks or a change in position of the selector valve, the return movement of the surge piston automatically closes the bypass valve to engage the engine-driven pump (View

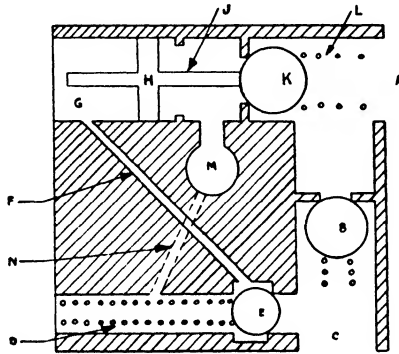

FIG. 2-5. BALANCED-TYPE PRESSURE REGULATOR.

B), and the valve remains in this position until the system pressure builds up to the normal value and the regulator again "cuts out." The range between the "cut in" and the "cut out" values is approximately 250 psi. This means that if the valve is set to "cut out" at 1500 psi, it will automatically "cut in" at 1250 psi.

The principle of operation of a balanced-type pressure regulator, used in conjunction with an accumulator, is shown in Fig. 2-5. The type shown is the Electrol unloader valve. The valve comprises a housing which contains a ball-check valve, a pressure-relief valve, and a system-pressure, control valve.

Fluid, under pressure from the engine-driven pump enters the unit through the inlet port A. The force of the liquid unseats ball-check B and the fluid flows out to the system through outlet port C. When the pressure in the system, and, therefore, in the accumulator, reaches the predetermined maximum for which the valve is adjusted, the tension of the spring D is overcome and the

ball-check *E* moves over to its left-hand seat. This permits fluid to flow through the internal passageway *F* to chamber *G*. The pressure in chamber *G* forces the plunger *H* to the right, and the check valve *K*, which has been held on its seat by spring *L*, is unseated by plunger rod *J*. When this occurs, the fluid from the pump flows past the ball *K* and returns to the reservoir by way of return port *M*. Ball *B* now returns to its seat because the pressure in the area above it is lower than the pressure in the area below it, and the entire pump output returns to the reservoir.

As soon as the system pressure drops to the predetermined minimum for which the unloader valve is set, the spring *D* forces ball *E* to return to its right-hand seat thereby blocking off the pressure in passageway *F*. This also relieves the pressure in chamber *G* and the plunger *H* moves to the left. Ball *K* is seated thereby cutting off the return line to the reservoir, and the pump output is again directed past check valve *B* into the system. The fluid trapped in chamber *G* is returned to the reservoir by flowing through internal passageways *F* and *N*, the latter being connected to the return port. When the system pressure again builds up to its maximum, the cycle repeats.

It can be seen readily that a pressure regulator operates very much as a relief valve; the difference between the two is that a pressure regulator controls pressure over a much wider range; also its valve is held open by system pressure rather than pump pressure. This condition permits the power pump to operate without load after working pressure has been attained, and throughout those periods when the output of the power pump is not required to operate any mechanism. The pressure regulator is always located at the extreme upstream end of the pressure manifold.

4. Typical Operation of Complete Hydraulic System

Now that we have completed a discussion of the new units added to the hydraulic system Fig. 2-1, we can return to that system to get a better understanding of exactly what occurs.

Referring to Fig. 2-1, the reservoir is so located that the fluid can flow freely by gravity to the power pump which is located on the accessory section of the engine. Inasmuch as the pump is driven continuously by the engine, fluid is being circulated con-

stantly whether it is required or not. Because of this fact, some means must be incorporated to bypass fluid in excess of that required to operate the actuating cylinder. To accomplish this, a pressure regulator is included in the system to bypass the fluid back to the reservoir after a predetermined pressure (for which the regulator is set) has been reached. This process decreases the working pressure on the pump, as otherwise the pump would continue to operate at maximum pressure at all times when the engine is running, whether or not power is being used. The pressure regulator is automatically closed when the working pressure in the system is reduced, thereby causing the fluid to flow through the pressure line of the system, with the power pump again operating at working capacity.

An accumulator is installed in the pressure line of this system to absorb any sudden increase in pressure and also to serve for the storage of energy. When the system does not require the total output of the pump, excess fluid is forced into the accumulator and remains under pressure. This fluid pressure may be used at any time when the output of the pump falls below the system needs, as when the engine is operating at low speed or is stopped entirely. When this happens, the accumulator returns fluid under pressure to the system, and the system will operate for a limited time.

A relief valve is installed between the accumulator and the reservoir. It serves as a safety vent in case the pressure regulator fails to function properly and stop the flow to the accumulator and pressure manifold as it should. This relief valve is set to open at a pressure somewhat higher than the normal operating pressure required to operate the system.

The control lever of the selector valve is readily accessible to the pilot. The proper direction of movement of the actuating cylinder is controlled by the position of the selector valve. The two relief valves located in the pressure line between the selector valve and the actuating cylinder prevent operation of the attached mechanism at excess speeds, and allow it to retract when an overloaded condition exists, by causing the fluid to flow through the relief valve to the return line to the reservoir.

The pressure gauge provides the pilot with a means of knowing whether the system is functioning properly. The gauge indicates the pressure in the system at all times.

5. Complete Hydraulic System with Multiple Actuating Cylinders

Figure 2-6 shows a complete hydraulic system which operates the landing gear retracting mechanism and the landing flaps. This system contains a power pump as well as a hand pump, the latter being used for emergency operation and also to test the system on the ground. New units in this system are a power-control valve *PCV*, a surge chamber *SC*, a pressure-gauge snubber *PGS*, two line disconnect valves *LDV*, and an orifice check

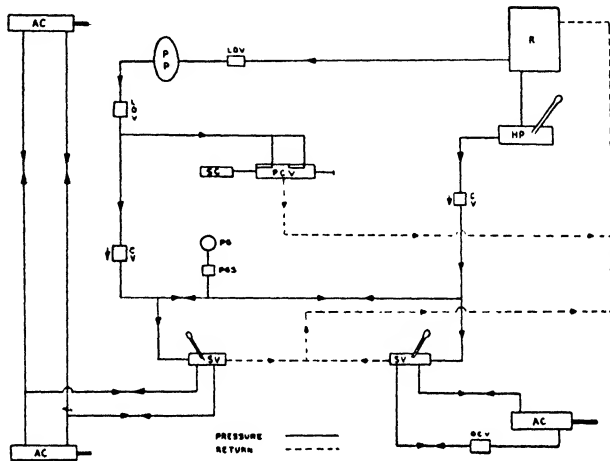

FIG. 2-6. COMPLETE HYDRAULIC SYSTEM WITH MULTIPLE ACTUATING CYLINDERS.

valve *OCV*. Also, note that there are two selector valves present; one controls the retractable landing gear, and the other controls the wing flaps. We will now proceed to a discussion of the new units.

6. Power-control Valve

A power-control valve permits the circulating of fluid from the power pump to the reservoir without imposing on the pump the burden of continuously developing the high pressures required to keep a valve open. In this respect, it performs the same function in a system without an accumulator that a pressure regulator does in a system that includes an accumulator. Essentially, a power-control valve is a hand shut-off valve with an automatic

turn-on feature. Fig. 2-7 shows a typical power-control valve.

Fluid from the pump enters the port *A*, and normally flows to the reservoir through the port *B*. When the system requires pressure, the control knob *C* is pressed inward. This causes a plunger *D* to enter the output of the valve and thus close the fluid passage through the unit. The output of the power pump is now directed into the system where pressure builds up to actuate the mechanism. When the mechanism has been moved to the limit of its stroke, excess pressure develops in the system and in the power-control valve. Fluid passing through the bleed *H* forces the

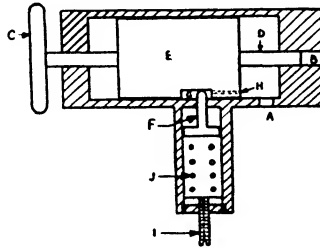

FIG. 2-7. POWER-CONTROL VALVE.

spring-loaded pin *F* out of the slot *G* and also forces the piston back. This opens the passage *B* in the valve and again permits the fluid to circulate freely to the reservoir. An external adjustment *I* is provided for the purpose of regulating the tension of the spring so that the pressure required to release the piston may be regulated.

In case more than one power-control unit is installed in a system, they are connected in series so that the manipulation of any one of them is equivalent to manipulating all of them in unison, that is, if the knob of any one of the power-control units is pushed inward, the circulation of fluid to the reservoir is shut off and pressure starts to build up in the hydraulic system.

7. Surge Chamber

A surge chamber performs a function similar to an accumulator in that it is a device for modulating pressure surges in the hydraulic system. Also, by storing a supply of fluid under pressure, it may be used to operate some mechanism when the pump is operating at a reduced rpm.

Surge chambers may be of a coiled-spring-and-piston type, or

they may be of the inflatable-rubber-bladder type. Figure 2-8 shows the latter type. Fluid from the pressure line enters the port *A* and compresses the air in the rubber bladder *B*. The bladder is filled with air through an air valve *C*. When the pressure in the system drops, the compressed air expands and forces the fluid back into the system.

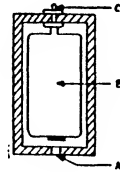

FIG. 2-8. SURGE CHAMBER.

8. Pressure-gauge Snubber

A pressure-gauge snubber is used to dampen oscillations of the pressure gauge. Pressure impulses from the power pump oscillate the indicator making it difficult for the observer of the gauge to get an accurate reading. The snubber, which is usually mounted next to the pressure gauge, absorbs these pulsations from the power pump thereby making it easy to read hydraulic gauges.



Courtesy Ray Pressure Snubber Co.

FIG. 2-9. PRESSURE SNUBBER.

The Ray pressure snubber, Fig. 2-9, manufactured by the Ray Pressure Snubber Co., Charlotte, N. C., is used as standard equipment by practically all American aircraft manufacturers. The snubber is made entirely of metal except for one small synthetic-rubber gasket between the body elements. No maintenance is required with this unit because the continuous movement of the piston in the tube “kicks out” sediment or pipe scale, assuring

years of dependable operation. Actually, there is only one moving part—the piston; since this moves through a distance of less than $\frac{1}{8}$ " , wear on this piston is so very slight that it would require many, many years' wear to occasion replacement.

In operation, the automatic and continuous rise and fall of a piston within a tubular orifice absorbs all shocks, surges, and pulsations usually transmitted to the instrument.

9. *Line Disconnect Valve, or Disconnect Coupling*

A line disconnect valve, or a disconnect coupling as it is sometimes called, is used in a system to avoid the necessity of draining the system when pumps or lines are disconnected. Actually, it consists of a check valve installed in the end of a tube. As long as the tube is connected to another tube, the ball check is held off its seat permitting free flow through the tubes. The ball immediately falls into its seat when the tubes are disconnected and the tube in which it is installed is sealed. Disconnect couplings are generally used at the firewall where connections are made from the engine-assembly hydraulic system to the main hydraulic system.

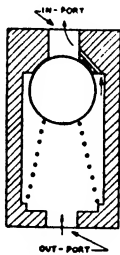

FIG. 2-10 (LEFT). ORIFICE CHECK VALVE.

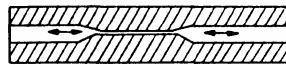

FIG. 2-11 (RIGHT). ORIFICE.

10. *Orifice, and Orifice Check Valve*

When fluid flow must be restricted in order to slow up the movement of some mechanism, an orifice, or an orifice check valve is used. An orifice, also known as a restrictor, restrains the rate of fluid flow in a line in both directions, whereas an orifice check valve is constructed so that in one direction the flow is restrained while in the opposite direction, the flow is unrestricted. As shown in Fig. 2-10, it can be seen that the valve head of an orifice check prevents a perfect seal in its seat. Figure 2-11 shows

a typical orifice in a line. Here, it can be seen plainly that fluid will be slowed up in both directions.

An orifice check valve is commonly used in a wing-flap system where it is desirable that the uptravel of the flaps be delayed against the tendency of the air pressure to force them up. Also, an orifice check may be used in a landing-gear system where it is necessary to delay the extension of the gear against the tendency of the weight of the gear to pull it down too fast. A common employment of an orifice would be with mechanisms whose movement would be too fast with an unrestrained flow, as in the case of cowl flaps.

11. Hydraulic Brake Systems

Brake systems sometimes are connected to the main hydraulic system or else may be a separate and independent system. In the latter case, one master cylinder supplies the energy for each brake. In other words, on a typical installation there is one distinct hydraulic system for each brake assembly. On large airplanes, where high brake pressures are required, the brake system is connected to and obtains its energy from the main hydraulic system. In this case, a power-brake control valve is used in place of a master cylinder, and a deboost器 is usually incorporated in the system.

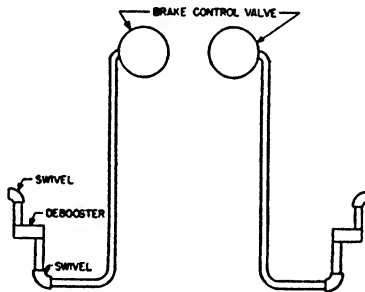

FIG. 2-12. HYDRAULIC BRAKE SYSTEM.

In Fig. 2-12 is shown a typical hydraulic brake system which is connected to the main hydraulic system. There are two individual brake systems which make it possible for either brake to be applied independently by means of two hydraulic, power-brake, control valves. When pressure is applied to the brake pedals in the cockpit, the pressure port on the brake-control valve opens connecting the brake and pressure lines. Fluid flows from the main

system, through the brake valves, to the booster. Here, the relatively high, system, operating pressure is reduced to the relatively low pressure required by the brakes before being applied to them. When the pedal pressure is released, the fluid is allowed to flow back from the brakes into the booster, through the brake-control valve, and back to the reservoir.

Now we will discuss in detail the units in Fig. 2-12.

12. Power-brake Control Valve

Figure 2-13 shows a power-brake control valve which is a device for metering fluid out of the main hydraulic system and directing it to the brakes. In the normal position, fluid enters the unit at *A* but is blocked off by poppet *B*, which is held on its seat by a light spring and also by the fluid under pressure. When

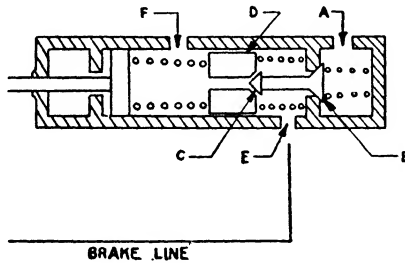

FIG. 2-13. POWER-BRAKE CONTROL VALVE.

the pedal is applied, the sliding piston *D* moves to the right and seats poppet *C* thereby sealing off the return. As the pedal is pushed down further, piston *D* moves further to the right and poppet *B*, which is rigidly connected to poppet *C*, is unseated permitting fluid from inlet port *A* to flow around the poppet *B* and through the outlet port *E* to the brake. As the pressure in the brake line rises, pressure is exerted on the right-hand side of the piston, tending to push it to the left. When this pressure becomes high enough to overcome the pedal pressure, the piston *D* moves to the left enough to allow poppet *B* to become seated, thereby closing off the pressure line. When the piston reaches the position shown in Fig. 2-13, poppet *C* is unseated and the fluid in the brake line is permitted to unload through port *F* and returns to the reservoir. The higher the pressure exerted on the brake pedal, the higher will be the brake-line pressure required to overcome

it and, therefore, the higher will be the brake pressure applied to the brakes.

The Vickers brake-control valve is shown in Fig. 2-14.

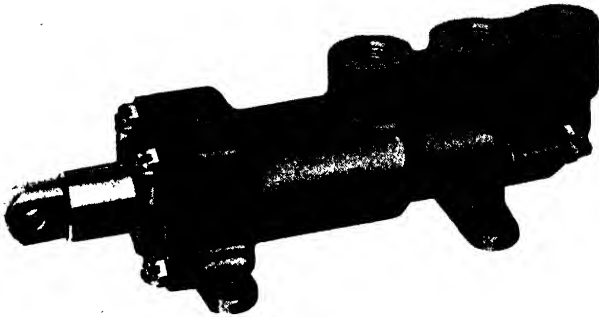

FIG. 2-14. VICKERS BRAKE-CONTROL VALVE.

13. Brake Debooster (Power-brake Master Cylinder)

The purpose of a brake deboster, or a power-brake master cylinder as they are also called, is to reduce the high pressure received from the power-brake control valve to the low pressure required by the brake. Also, the deboster serves the function of insuring a rapid release of the brake when pressure is released by the brake control valve.

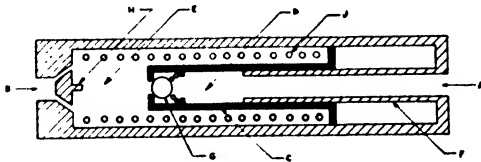

FIG. 2-15. BRAKE DEBOOSTER.

The deboster, Fig. 2-15, contains two ports: inlet port *A* which is connected to the brake control valve, and outlet port *B* which is connected to the brake actuating lines. Inside the unit, a spring-loaded piston *C* divides the cylinder into a small-volume, high-pressure chamber *D* which is connected to the brake control valve through port *A*, and a large-volume, low-pressure chamber *E* which is connected to the brake lines through port *B*. A piston guide sleeve *F* extends about half the cylinder's length and serves

as a guide for the piston. Built into the center of the piston head is a ball-type compensating valve *G*. When the piston reaches its maximum stroke, a pin *H* in the cylinder head operates the compensating valve. A heavy piston return spring *J* tends to hold the piston away from port *B*.

When fluid under pressure from the brake control valve enters the cylinder through port *A*, it acts on the inside of piston *C* forcing it to the left against the force of the heavy spring *J*. As the piston moves, it forces the fluid in the large-volume, low-pressure chamber *E* through port *B* into the brake lines. The pressure acting on the inside of the piston must compress the spring before the piston can be moved to the left and therefore the pressure in chamber *E* is less than that in chamber *D*. Also, any pressure applied to the small inside area will be spread over the larger outside area. The pressure received at outlet port *B* will therefore be much less than the pressure which enters through inlet port *A*. This reduction in pressure results in a smooth brake application which can be obtained with maximum system pressure applied to the brake control valve.

As soon as pressure from the brake control valve is released, the piston return spring *J* forces the piston to the right. This instantaneously reduces the pressure in chamber *E* drawing a corresponding amount of fluid out of the brake lines.

Normally, when the brakes are fully applied, the piston will not move far enough to the left to make the pin *H* come in contact with the compensating valve *G*. However, in case of fluid leakage in the brake system, the piston will move enough to the left so that the pin *H* will open the compensating valve *G*. When this occurs, fluid from chamber *D* will flow into chamber *E* until the loss in fluid is compensated for and the fluid volume in chamber *E* increases sufficiently to move the piston away from the pin and permit the compensating valve to close. The compensating valve will also open in case of fluid expansion in the brake line, and therefore in chamber *E*, when the brake is off. The relieved fluid will flow out through the power-brake control valve to the return line.

14. *Swivel Joint*

A swivel joint serves the same function as flexible hose in that it provides a means of conducting hydraulic fluid from a station-

ary to a movable object. In the hydraulic brake system selected for demonstration in Fig. 2-12, the swivel joint provides a flexible connection for the brake line from the nacelle to the gear. Swivel joints are usually used with large actuating cylinders where flexible hoses would be rather awkward.

15. Master Cylinder

Brake systems which are not connected to the main hydraulic system employ a master cylinder for the energizing unit. Each brake has its own master cylinder. Each master cylinder may be fed from a reservoir integral in the unit, or, in some cases, the

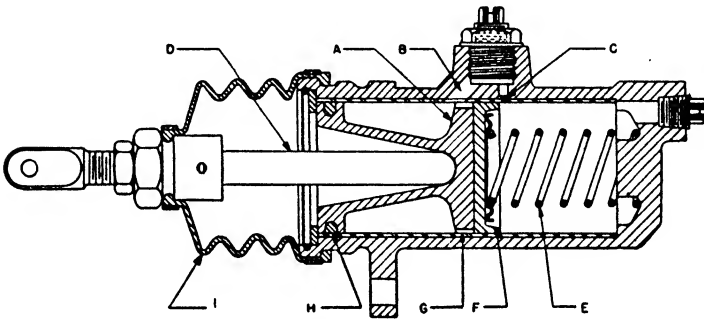

FIG. 2-16. GOODYEAR MASTER CYLINDER.

two cylinders are fed from a common reservoir. A master cylinder is a manually-operated, single-action, reciprocating, piston pump which is operated by a toe pedal mounted one on each of the rudder pedals.

The Goodyear-type master cylinder, Fig. 2-16, constantly maintains the correct volume of fluid under either extreme heat or extreme cold conditions by compensating for the change in volume due to expansion or contraction. It also automatically replaces any fluid lost through leakage and practically insures against air entering the system due to any leaks. The hydraulic pressure necessary to operate the brake is developed in the master cylinder by movement of the piston *A*, usually by means of the brake pedal.

Brake fluid is fed by gravity from the supply tank to the cylinder through the inlet port *B* and compensating port *C*, and thus fills the master cylinder and the connecting line down to the brake cylinder.

Application of the brake pedal causes piston rod *D* to push piston *A* forward. A slight forward movement blocks the compensating port *C* and the building up of pressure begins.

When the brake pedal is released and returns to *OFF* position, the spring *E* returns the piston *A* and front piston seal *F* to the *Full-off* position, and again clears the compensating port. Fluid in the line and brake cylinder is returned to the master cylinder due to pressure of the brake-piston return springs in the brake. Any pressure or excess volume of fluid is relieved by the compensating port and passes back to the supply tank. This insures against the possibility of dragging or locked brakes being caused by the master cylinder. If, due to leakage, any fluid is lost back of, or to the left of the front piston seal *F*, this is automatically replaced by gravity from the supply tank.

Any fluid lost in front of, or to the right of the front piston seal *F* by leaks in the connections, line, or at the brake, is automatically replaced by fluid passing through slots *G* in the piston head and around the lip of the front piston seal when the piston makes the return stroke to the *Full-off* position. (The seal *F* functions as a seal only during the forward stroke.) The rear piston seal *H* prevents air from entering the hydraulic system and keeps dirt from entering.

As long as there is fluid in the supply tank, the master cylinder, connecting line, and brake cylinder are always full of fluid and ready for operation.

The flexible rubber boot *I* is only a dust protector.

The operations of the various other types of master-cylinder brake systems are fundamentally the same; the difference exists in the structural details of the units rather than in their operation.

QUESTIONS

1. Distinguish between an orifice and an orifice check valve.
2. What is a disconnect coupling?
3. Give two functions of an accumulator in a hydraulic system.
4. What is the purpose of a pressure-gauge snubber?
5. When is a brake control valve used in a brake system?
6. What is the purpose of a brake control valve?
7. Why is a brake booster used?
8. Describe the construction of the Vickers accumulator.
9. What is an unloading valve?

10. Distinguish between a balanced-type, and a mechanical-type pressure regulator.
11. How does a pressure regulator differ from a relief valve?
12. What is the purpose of the relief valve in Fig. 2-1?
13. What is a power-control valve? What is its purpose?
14. At what point in a hydraulic system is the pressure regulator located?
15. Explain how pressure is reduced in a power-brake master cylinder.
16. What is the function of a swivel joint?
17. Explain the operation of one type of surge chamber.
18. What is a master cylinder and when is it employed?
19. When does an unloading valve start to bypass fluid to the reservoir?
20. Give a common employment of an orifice check valve.

Chapter III

MISCELLANEOUS AND SPECIFIC UNITS

1. *General*

This chapter will be devoted to a discussion of a variety of specific and miscellaneous aircraft hydraulic equipment present in current hydraulic systems. A knowledge of the operating principles involved should serve as a good foundation for an understanding of any new equipment designed in the future.

2. *Vickers Unloading Valve*

The function of the Vickers Spool-type Unloading Valve is to act as a pressure-control valve or regulator which will automatically divert pump delivery back to the reservoir when the accumulator and therefore the system pressure reaches a desired maximum, or, to direct pump delivery to the accumulator and the hydraulic system when the accumulator pressure drops to a predetermined minimum.

Fluid under pressure from the pump forces check valve *A*, Fig. 3-1 (A), back against a light spring, opening the system line and also putting pressure on the bottom end of pilot valve *B* which is held down by spring *C*. Pump pressure is put on the right-hand end of directional-control valve *D* through porting around piston *E*, forcing piston *D* to the left. Piston *D*, moving over to the left end, opens porting so that pump pressure is put against the left end of unloading valve *E*, assisting the spring in holding the valve to the right-hand end and thus blocking off the pressure from entering the return line.

As the pressure in the system builds up, piston *B* is raised against spring *C* until the porting is changed. See Fig. 3-1 (B). Pressure from the pump is now put against the left-hand end of the piston *D*, forcing it over to the right. Piston *D*, moving to the right, changes the porting so that pump pressure forces piston *E* to the left against a light spring. As piston *E* moves to the left it opens a port so that flow from the pump may bypass into the

return line back to the tank. As the pump flow bypasses to the return line, pressure is relieved, allowing check valve *A* to be closed by the spring behind it. Check valve *A* blocks off the system from the return line. The check valve *A* is grooved, thereby allowing the accumulator pressure to keep the pilot valve *B* in the position shown in View B. As soon as the pressure in the system or accumulator drops below the predetermined minimum, the tension of spring *C* causes the pilot valve *B* to move down, as shown in View A, and the regulator cuts in and starts to charge the system and accumulator.

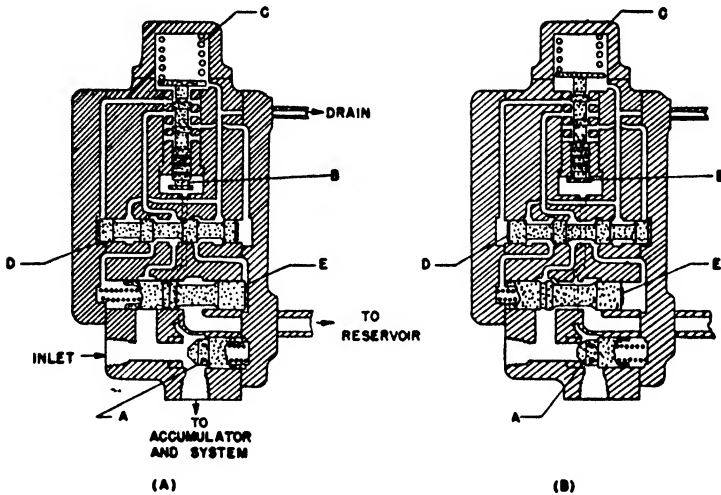

FIG. 3-1. VICKERS UNLOADING VALVE.

The pressure at which the regulator operates is determined by the force of spring *C*. The purpose of the directional-control valve *D* is to insure the regulator being either completely "cut in" or "cut out." Without such a control valve it would be possible for the regulator to find a balanced position between "cut in" and "cut out" where it would "knife" or "throttle" and thus become inoperative. Any fluid trapped in the passageways is relieved through the drain line.

3. Time-lag Valve

The purpose of a time-lag valve is to relieve the power pump of load automatically after the mechanism has reached its desired

position. Actually, it is a power-control valve operating on a time-lag principle. Depending upon the temperature and viscosity of the hydraulic fluid, the time that the valve remains engaged varies widely. It is more important that the valve remain open long enough to permit the mechanism to reach the end of its stroke than for it to remain open longer than necessary. Therefore, a time-lag valve should stay engaged at least twice as long as necessary to complete any operation of landing gear or flaps.

When the valve is in its normal position, fluid under pressure enters the inport *A* and flows directly to the reservoir through the outport *B*. When some mechanism must be operated, the pilot pushes the control lever *D*, Fig. 3-2, inwards and the plunger *E* closes the port *B*. A piston head, which is mounted on

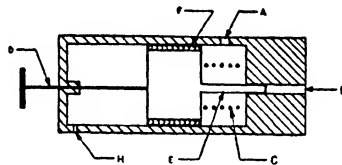

FIG. 3-2. TIME-LAG VALVE.

the plunger, is equipped with a one-way packing cup *F* which allows fluid to flow past the head toward the left only. Therefore, when the plunger is pushed inwards, fluid flows past the packing cup and keeps the space behind the piston head filled with fluid. When the pressure on the control lever is released, a spring *C* tends to force the plunger to its original position. The only opening through which the fluid behind the piston can escape is a variable orifice formed between a needle valve *H* and its seat and therefore, the time required for the plunger to return to its original position depends upon the adjustment of the needle valve. The return port *B* is blocked from the time the plunger is depressed until it returns to its original position. The arrangement for delaying the return of the plunger constitutes the time-lag feature of the valve. As soon as the plunger is returned to its normal position, the outport is opened and fluid is again bypassed to the reservoir.

4. *Emergency Dump Valve*

The purpose of a dump valve is to provide a means of unloading hydraulic fluid from the landing-gear actuating cylinders so

as to provide emergency operation of the gear in case of complete failure of the hydraulic actuating cylinder. When the dump valves are opened, the hydraulic fluid in the actuating cylinders is relieved and the pilot is able to release the landing-gear, up-position locks and “snap” the wheels into their fully extended position either by rocking the ship, or by a sharp pull-up.

The valve is operated by moving a lever which forces a plunger inwards, thereby opening a ball-valve to release the fluid within the valve and actuating cylinder. The released fluid is led overboard through a passageway within the housing.

5. Hydraulic Sequence Valve

A sequence valve, also known as a timing valve, or a load-and-fire check valve, is used in a hydraulic system to control the sequence of operation of two or more hydraulic mechanisms. For instance, a sequence valve may be used to insure that landing-gear-cowl doors are completely open before the gear starts down, and to insure that the gear is completely retracted before the cowl doors start to close. One valve is used to control the sequence of the “down” cycle and one is used to control the sequence of the “up” cycle.

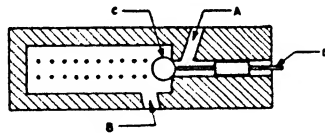

FIG. 3-3. SEQUENCE VALVE.

The unit, Fig. 3-3, consists of a bypass check valve which is automatically operated. At the proper moment, a plunger *D* is automatically pushed in, thereby unseating the ball check *C*. This allows fluid to flow through the inport *A* and out through the outport *B* to the second mechanism to be operated.

The valve is mounted so that some part of the first mechanism will force the plunger “in” when it reaches the end of its stroke. Figure 3-4 shows a typical sequence-valve installation. Valve 1 is mounted so that port *A* is connected to the landing gear up-line and port *B* is connected to the door actuating cylinder. When fluid enters port *A*, it cannot flow to the door-actuating cylinder because the ball in the valve is on its seat. As soon as the landing

gear is completely retracted, the plunger of the sequence valve is pushed inwards forcing the ball off its seat. This permits fluid to flow through the sequence valve, out of port B, and into the door-actuating cylinder. The sequence of operation is automatically reversed by a reversal of pressure application. Valve 2 is

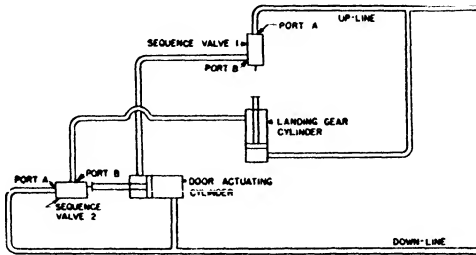

FIG. 3-4. TYPICAL SEQUENCE-VALVE INSTALLATION.

situated so that port A is connected to the landing-gear-down line, and port B is connected to the landing-gear actuating cylinder. When fluid enters port A, it cannot flow to the landing-gear cylinder because the ball in the valve is held on its seat.



FIG. 3-5. VICKERS LOAD-AND-FIRE CHECK VALVE.

When the door reaches the full-open position, the plunger in valve 2 is pushed in and fluid flows to the landing-gear cylinder and lowers the landing gear.

Figure 3-5 shows the Vickers load-and-fire check valve.

6. Shuttle Valve

The function of a shuttle valve is to direct fluid from either the power pump or the emergency source to the actuating cylinder. In event of power-pump failure, the port connected to the normal operating line is closed and there can be no loss of emergency fluid pressure even if there is a leak in the normal operating line.

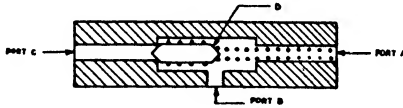

FIG. 3-6. SHUTTLE VALVE.

A typical shuttle valve, Fig. 3-6, consists of three external ports. One inlet port *A* is connected to the normal source and the other inlet port *C* is connected to the emergency source. Port *B* is a common outlet port. During normal operation, a spring-loaded piston *D*, which acts as a check valve, closes port *C* and permits



FIG. 3-7 (LEFT). PESCO SHUTTLE VALVE.



FIG. 3-8 (RIGHT). PESCO FLOW DIVIDER.

flow between ports *A* and *B*. In event of emergency operation, fluid from the hand pump or other emergency source forces the piston to the opposite end of the valve. This closes the normal operating port *A* and allows fluid flow between ports *B* and *C* with no danger of loss of fluid through port *A*. Figure 3-7 shows the Pesco shuttle valve.

7. Hydraulic Flow Divider

The function of a flow divider is to divide hydraulic flow from a single inlet into two outlets with the flow maintained

equally, regardless of external forces. This insures the synchronized actuation of any pair of hydraulically operated units, such as wing flaps, landing gear, or wing-tip floats.

The Pesco flow divider, Fig. 3-8, consists of two motors, each containing two synchronized gears. Spring- and pressure-loaded bypass and check valves in the unit compensate for pressure differentials. Blocking of either discharge line locks the divider and stops the flow in the other line.

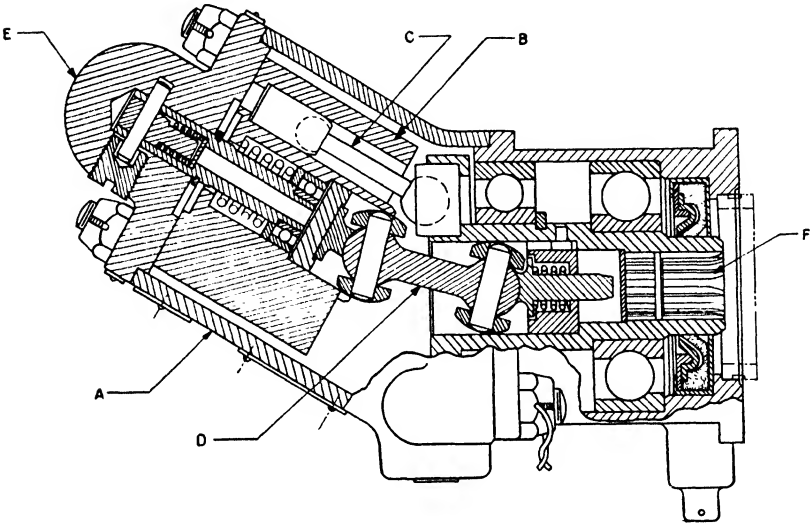

FIG. 3-9. VICKERS PISTON-TYPE POWER PUMP—CROSS SECTION.

8. *Vickers Piston-type Power Pump*

The Vickers piston-type pump (Figs. 3-9 and 3-10) is of the positive-displacement type consisting of a housing *A*, a cylinder barrel *B* (containing seven cylinders), seven pistons *C* and their connecting rods, a drive shaft to which the piston rods are attached by ball-and-socket joints, and the universal drive linkage *D*. The cylinder-barrel housing is attached to the main housing at an angle. A cylinder barrel head *E*, containing the "in," and "out," and "drain" ports, is mounted on the cylinder-barrel housing. A cup-type seal prevents leakage of oil around the drive shaft *F*.

Rotation of the drive shaft *F* turns the universal drive linkage *D*, which is essentially a rigid drive shaft with a flexible coupling

on each end. This drive linkage turns the cylinder barrel *B* containing the seven cylinders. During a one-half revolution of the cylinder barrel, a given cylinder will be moving away from the face of the drive shaft. Each piston *C* is attached to the face of the drive shaft by its connecting rod, so it must always remain the same distance from the drive shaft. As the cylinder moves away from the drive shaft, the piston will move toward the bottom of the cylinder. During this part of the cycle, the cylinder is ported to the inport through a passage in the head. Fluid



FIG. 3-10. VICKERS PISTON-TYPE PUMP.

will therefore flow into the cylinder as the piston moves down. After the cylinder passes the bottommost position, it is ported to the outport by a passage in the head. During the remainder of the revolution the cylinder is moving closer to the face of the drive shaft. The piston will therefore move toward the top of the cylinder. The fluid, which filled the cylinder during the first half of the cycle, will now be forced out of the outport. At all times, three cylinders are connected to the outport, and one cylinder is not connected to either port. As one cylinder ceases pumping, another cylinder begins.

There are no adjustments to be made on these pumps. At the time of installation the pump is filled with the correct type of fluid at the plug in the bottom of the housing. It is extremely important that this fluid be clean because of the small clearances

between working parts of the pump. It must be made certain that the pump is assembled for a direction of rotation corresponding to that of the engine-accessory drive shaft. The system relief or unloading valve must not be set at a higher kickout pressure than that recommended for the pump.

9. *Adel Poppet-type Selector Valve (Mighty Midget)*

The Adel Mighty Midget selector valve, Fig. 3-11, is a four-way, poppet-type, single-shaft valve designed to provide a means of directing fluid flow to or from the hydraulic actuating cylinder. A co-axial assembly of pressure and return poppets makes possible a compact valve. The camshaft is designed so that the lobes on the cam control the upper poppets and the area between the lobes control the lower poppets.

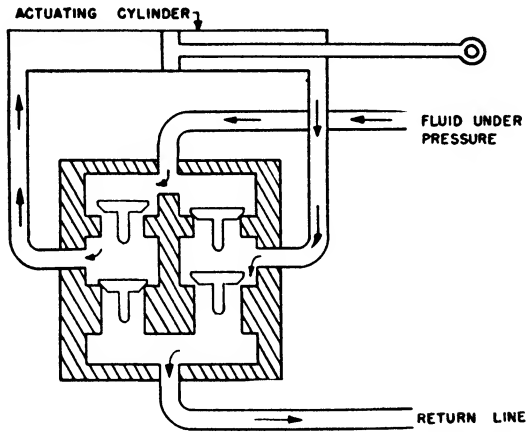

FIG. 3-11. ADEL MIGHTY MIDGET SELECTOR VALVE.

As fluid under pressure enters the pressure area and the valve is in the neutral position, flow is stopped because the poppets are seated. As the handle is turned to a position lifting one of the upper poppets and allowing fluid to flow to the actuating cylinder, it also lifts the lower poppet on the other set of poppets. This is the fluid-return position and allows fluid to pass on to the return port. This design permits a four-way action in an area half the normal size of a four-poppet conventional selector.

10. *Kenyon Multiple-check Relief Valve*

All high-pressure hydraulic lines of airplanes are subject to over-stressing conditions by thermal expansion of the fluid used. Hydraulic systems are usually composed of a number of closed lines which necessitate a safety or thermal-expansion relief valve in each system. The Kenyon multiple-check relief valve, also called the "piccolo valve," Fig. 3-12, simplifies this procedure by centralizing it in one unit in a readily accessible spot in the airplane. It is frequently desirable to insert a check valve on each

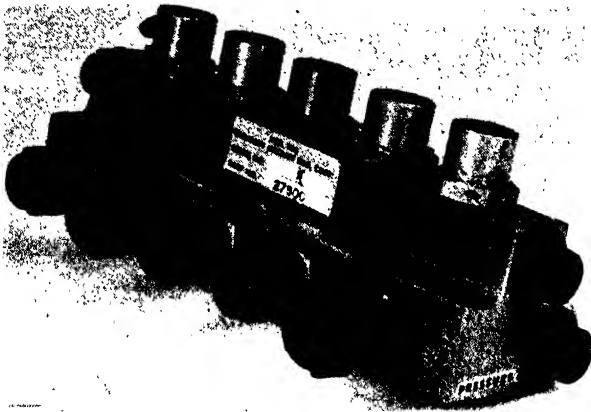

FIG. 3-12. KENYON MULTIPLE-CHECK RELIEF VALVE.

closed hydraulic system to prevent a reversal of the flow. The "piccolo valve" provides a means of solving all of these problems as it encloses in a single, forged, aluminum-alloy housing from one to eight check relief valve assemblies. All valves are supplied from a common or manifold pressure line and all valves discharge into another common or manifold line marked "relief." If, on some lines, a check valve is not desirable, the plastic check-valve poppet and its spring may be omitted.

Each relief valve is individually adjustable and may be set for any desired opening pressure from 100 to 2000 psi. If higher relieving pressures are required, a special spring may be furnished to provide for this. All relief valves are provided with locking means on the adjusting screw and safety-wired caps cover the entire adjustment.

11. Hydraulic-pressure Warning Switch

A pressure warning switch operates at a given pressure and is used to operate warning devices indicating high or low pressure. The unit, Fig. 3-13, contains a spring-loaded piston and a switch. The switch has one port, which is connected to the pressure manifold, and an opening through which the wires to the switch are passed. The switch is connected in series with the warning device.

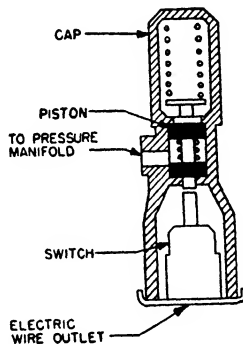

FIG. 3-13. PRESSURE WARNING SWITCH.

When fluid from the pressure manifold enters the unit, the spring is compressed and the piston is held up, as shown in Fig. 3-13, breaking the electrical circuit. Should the pressure in the hydraulic system drop below the value for which the unit is adjusted, the piston will be forced down by the spring. This operates the switch, completing the electrical circuit and causing the warning device to go into operation. The switch goes on or off within a very limited range which may be adjusted slightly by means of the cap.

12. Warning Signals

In order to remind the pilot before landing to lower the landing gear, and also to notify him whether or not the landing gear is down and locked, landing-gear warning signals are employed. A switch is usually associated with each landing wheel and, when the wheel is not down and locked, the switch is closed. When the plane approaches for a landing and the throttle is closed beyond a predetermined value, the throttle lever closes a switch mounted on the throttle control. Unless both wheels are down

and locked, the circuit to the horn is completed and the horn will sound, thereby warning the pilot. If the throttle is closed beyond the predetermined point even though there is no intention of landing, the pilot may disengage the horn.

Some planes employ a combination horn and signal-light warning system. When the throttle is closed beyond a predetermined point and if either wheel is not down and locked, the warning horn will sound and, in addition, the red lamps are lighted. When both wheels are down and locked, the green signal lamps are lighted.

Selsyn instruments are used on some hydraulic systems to show the position of the wing flaps and landing wheels. (Selsyn is a trade name for self-synchronous instruments.) An outline impression of a small airplane is contained on the dial of the instrument and aluminum disks, which carry the figures of a wing flap or a wheel, make or break the lines which form the outline. This provides the pilot with the picture of the actual position of the flaps and landing wheels at all times.

13. *Filters*

At least one filter is present in every hydraulic system in order to remove foreign particles from the fluid. This is absolutely necessary to insure trouble-free operation of the system and minimum wear on pumps, actuating cylinders, and valves. A filter may be installed in the pressure line at a convenient point after the pump, or it may be located in the return line to the reservoir. With some installations, both locations are used. The types of filters most commonly employed in present-day systems are the Cuno Auto-Klean filter and the Purolator filter.

14. *Cuno Auto-Klean Filter*

The Cuno filter element, Fig. 3-14, consists of a stack of flat wheel-shaped disks mounted on a rotatable shaft. Each disk is accurately separated from the next by a thin metal spacer conforming in shape to the hub and spokes of the disks but without a rim. The thickness of this spacer determines the degree of filtration. The stack of disks is closed at one end, the spaces between disk "spokes" forming passages within the cartridge which are open at the other end to the outlet passage.

Cleaner blades are mounted on a stationary rod alongside the stack of disks. These knife-like blades extend into the slots between disks to the inside edge of the disk rim. On all but the smallest cartridges, each cleaner blade is separated from the next by a cleaner-blade spacer, slightly thinner than the disk thickness, thus permitting the cleaner blade assembly to “float” on the rod.

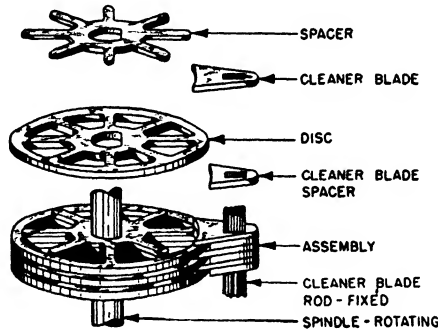

FIG. 3-14. CUNO FILTER ELEMENT.

Referring to Fig. 3-15, fluid flow enters the space surrounding the filter element in the sump or housing and is forced, by differential pressure between inlet and outlet, to flow through the slots between disks and into the passages within the filter element; thence, to the outlet. All solids larger than the thickness of the spacers are retained on the outer edges of the disks. Pressure drop is exceptionally low because the fluid moves in a straight line encountering only a momentary restriction.

The filter is cleaned by a complete revolution of the external handle on the rotatable shaft. (This is done while the filter is operating and may be performed by hand or by motor drive.) As the stack of disks turns, the solids which have accumulated on the cartridge are removed as they reach the stationary cleaner blades and settle to the bottom of the sump from which they can be removed periodically. Because of the shape and location of these blades, all solids stopped by the filter disks are removed, regardless of whether they merely adhere to the edges of the disks, or are actually lodged between them.

The filter contains a bypass valve whose function it is to bypass fluid around the filter element in the event that the element

becomes so obstructed as to restrict the flow of fluid dangerously. Such restriction will increase the pressure drop across the filter element and when this pressure drop exceeds the setting of the

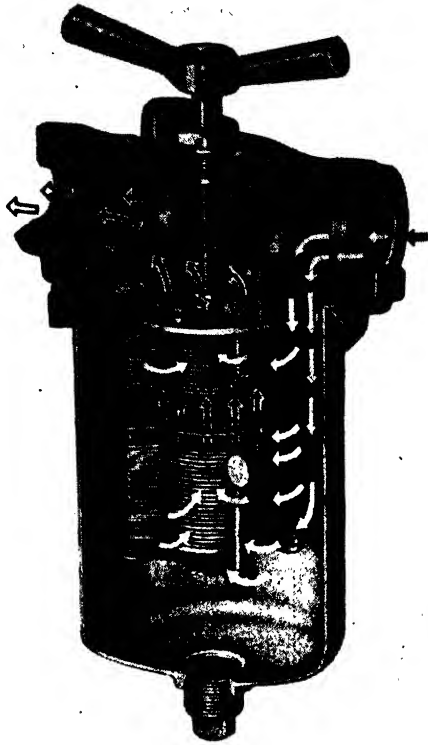

FIG. 3-15. CUNO AUTO-KLEAN FILTER.

bypass valve, the valve opens to permit fluid to flow around the element and make up the deficiency. This same action may take place when the fluid is extremely cold, with resultant high viscosity and pressure drop across the filter.

15. Purolator Filters

There are two types of Purolator filters being used a great deal on hydraulic systems; the difference in the types lies in the construction of the filter element. One type contains a metal element, the other a plastic-impregnated-wood cellulose element.

The Purolator metal element, Fig. 3-16, is constructed on an

entirely new principle. A metallic ribbon of bronze, monel, stainless steel, etc. is wound edgewise on a cylindrical, perforated frame. This ribbon has a flat front edge and tapers in cross section. It is provided at definite intervals with projections of uniform height which support the front edge of the ribbon parallel to the frame on which it is wound. The height of these projections determines the degree of filtration which takes place

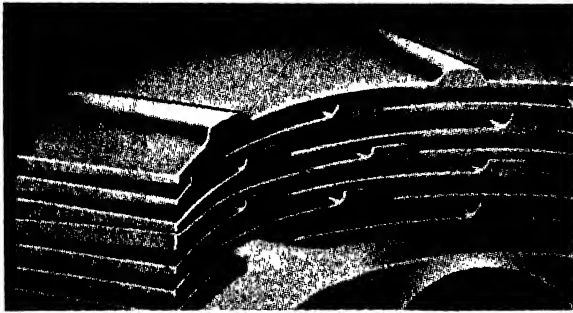

FIG. 3-16. PUROLATOR METAL FILTER ELEMENT.

and can be made as small as .001", thus preventing the passage of particles as small as .001". The filter is cleaned by turning the handle at the top of the filter. The filter operates during cleaning unless the sump is being drained. Two spring-loaded relief valves, built into the filter, bypass fluid around the filter element in the event that the element becomes so obstructed as to restrict the flow of fluid.

The filtering element of the Purolator cellulose-type filter, Fig. 3-17, is made of a specially treated, porous, cellulose sheet

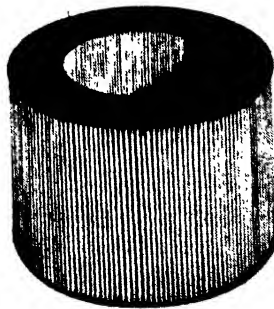

FIG. 3-17. PUROLATOR CELLULOSE FILTER ELEMENT.

containing a high percentage of minute voids and is processed to meet the specifications required for use under extremely variable conditions. The sheet is made of one continuous length cemented at the seam. A large filtering area is obtained by folding the porous sheet into vertical convolutions around the element axis. The ends of the convolutions are attached to a disk at each end of the element by cement to make a one-piece filter-assembly unit with flat surfaces at each end. The elements are then cured into one homogeneous unit. This type filter is designed primarily for installation in the hydraulic reservoir, but can be used in separate individual housing or container, if so desired. The degree of filtration is such as to assure 99% efficiency in the removal of all particles larger than ten microns in size. The filter element is replaceable and should be changed whenever necessary. An internal relief valve bypasses fluid in case the element becomes clogged.

16. *Aircraft Accessories Sliding Selector Valve*

The Aircraft Accessories sliding selector valve is a piston-type, automatic neutral, four-way valve. The valve provides for directing fluid pressure to the proper end of an actuating cylinder while simultaneously directing the fluid from the opposite end of the cylinder into the reservoir return line. A unique feature of this valve is that it automatically returns to neutral immediately upon the actuating cylinder reaching the end of its stroke.

Extending from the piston-body ends are integral piston rods which guide the piston-body ends and provide for connection of operating linkage and indexing mechanism. Located immediately beyond the ends of the piston's stroke are spring-loaded packing glands which close the ends of the housing, seal the piston rod's ends, and form small surge chambers at the piston ends.

The flow diagram, Fig. 3-18, shows the valve with the piston moved to one operating position. The inlet pressure port *A* is registering with the valve cylinder port *D* permitting fluid to flow directly through the valve from the pressure source to one end of the actuating cylinder. Return channel *B* is open to the opposite end of the actuating cylinder, and provides a direct circuit for return of fluid from the opposite end of the actuating cylinder.

The valve remains in the position shown until the actuating

cylinder reaches the end of its stroke, at which time the fluid pressure within the valve will suddenly increase to maximum relief pressure. This full system pressure will be applied to relief valve *E* which is set to open at a value slightly higher than the maximum pressure required to operate the mechanism to which the actuating cylinder is connected. When the pressure overcomes the tension of the spring, the ball *E* is unseated and the fluid pressure will be diverted into the channel connecting the relief valve with the surge chamber *F*. The escape of fluid from this chamber is restricted by the metering valve *G*, while fluid is free to escape from the surge chamber *H* at the opposite end of

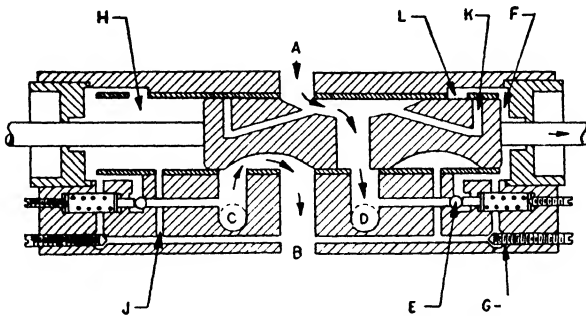

Courtesy Aircraft Accessories Corp.

FIG. 3-18. SLIDING SELECTOR VALVE.

the piston through the back-pressure relief passage *J* with the result that a force is applied against the right-hand end of the piston. This force is of sufficient magnitude to move the piston quickly toward neutral position enough to bring the neutral booster port *K*, in the piston, over the housing port *L*. This provides a volume of fluid at full system pressure into the surge chamber and assures return to neutral.

Automatic return of the piston to neutral is assisted by an indexing cam-and-lever assembly connected to the piston rod. This cam is provided with a low point corresponding to neutral and two high points which correspond to points slightly prior to the full operating positions of the valve. When the valve is moved to an operating position, the spring-loaded, indexing-lever roller passes over the corresponding cam high point and indexes the valve piston at full-open position. When the actuating cylinder piston reaches the end of its stroke, it is only necessary for the

combined surge and boost of the fluid to move the roller a short distance over the cam high point. The force of the indexing spring is sufficient to complete the return to neutral. In the neutral position, the inlet pressure port *A* is open straight through the valve piston center, to the reservoir return port *B* to provide unrestricted reservoir return of the fluid from the pressure supply source.

The operation of the valve when moved to the opposite position is identical with that described.

17. Aircraft Accessories Tail-bumper Jack Lock

The tail-bumper jack lock is used to raise and lower the tail bumper and lock it in the proper position during the landing and takeoff of the airplane. It is controlled by the selector valve operating the landing-gear cylinder.

The flow diagram, Fig. 3-19, shows the unit in one operating position. When fluid under pressure from the selector valve enters through port *B*, shuttle valve *D* moves toward the left, unseating ball *E*. This allows fluid trapped at this end an unobstructed passage to the reservoir return line. As the shuttle valve unseats ball *E*, it reaches the end of its stroke by coming in con-

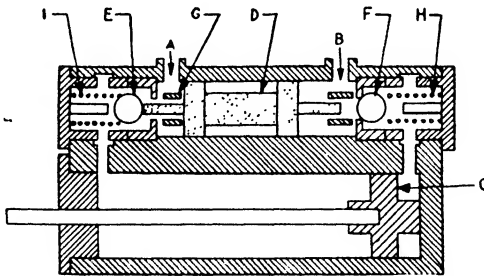

Courtesy Aircraft Accessories Corp.

FIG. 3-19. TAIL-BUMPER JACK LOCK.

tact with stop *G*. Pressure continues to build up at port *B* until it unseats ball *F* allowing full system pressure to be applied to piston *C* moving the piston to the extended position which forces the hydraulic fluid out port *A* to the reservoir return line.

When the piston reaches its full travel, pressure is built up in the cylinder, back through port *B* and the pressure line. When the pressure in the chamber to the right of ball *F* exceeds the

pressure in port *B*, the ball *F*, aided by spring *H* returns to its seat. This traps the fluid in the cylinder and locks the piston in the extended position. At the same time, spring *I* reseats ball *E* moving shuttle valve *D* to neutral. When the selector valve is moved to its opposite position, the operation is identical to that described above with the exception that the system pressure is applied at port *A*.

18. *Sperry Exactor Control*

The Sperry exactor control, Fig. 3-20, is a hydraulic device which is used where it is desirable to obtain exact actuation by remote control. Actually, it is a complete hydraulic system in

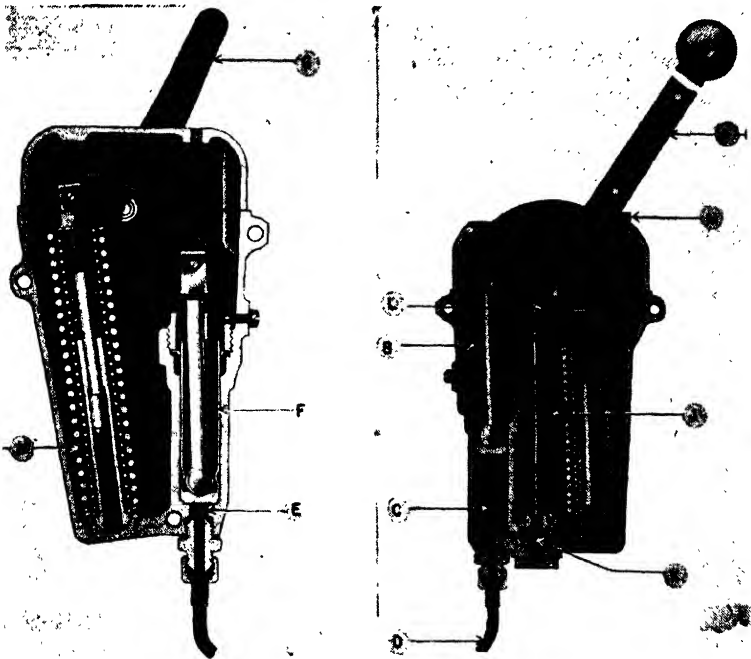

FIG. 3-20. SPERRY EXACTOR CONTROL.

itself and is entirely independent of the airplane hydraulic system. It is a lightweight, compact, hydraulic control adaptable to numerous applications on aircraft today. The "exactor," which consists of a transmitter and a receiver connected by a single tube, is being extensively used for control of throttle, mixture,

propeller, landing lamps, Radar equipment, engine test stands, and many other mechanisms.

The device consists of a hand-operated transmitter and a receiver which reproduces exactly the same degree of motion that has been applied to the transmitter handle. A single tube, which can be bent to pass intervening objects, is the only connection between the transmitter and receiver. When either unit is required to move, flexible tubing may be substituted.

In normal operation, when the transmitter handle *A* is moved to the left, the piston *B* moves down and forces fluid out of the cylinder *C* through the connecting tube *D* and into the cylinder *E* of the receiver. This forces piston *F* to move up in exact reproduction of the downward movement of piston *B* causing the receiver lever *G* to move a corresponding amount. When the transmitter handle is returned to its original position, fluid is forced from the receiver into the transmitter by pressure of the spring *H* on the receiver piston, returning the receiver lever to its original position. The cylinders of the transmitter and receiver are fitted with trunk-type pistons and special packing glands designed to prevent fluid leakage. The two opposing springs of equal force in the transmitter and receiver "balance" the control and eliminate lost motion and backlash. The pressure in the system approximates 200 psi.

Because of the fact that the interconnecting tubing and the cylinders of the transmitter and receiver form a closed system, some provision must be made for volumetric changes of fluid due to temperature changes or leakage. The cylinder *C* of the transmitter is connected to a reservoir *J* through a spring-loaded valve *K*. Normally, the valve is closed, but when the transmitter handle is forced against its spring a few degrees beyond its starting position, the tripper lever *L* is operated and the valve *K* is opened. This opens the system to the reservoir and any deficiency of fluid is replaced or any excess is relieved. This is known as the synchronizing feature of the unit.

Since the normal system pressure is about 200 psi and the fluid is of low viscosity, great care must be taken to make all joints tight. Tube ends must be flared carefully to avoid possible fracture under vibration. The receiver should always be mounted so that, in event of failure in the system (resulting in receiver

piston being forced to bottom of stroke), the actuated arm would be moved in the proper direction. For example, on an engine test stand, the throttle is to be closed in the event of oil line failure.

The type of fluid recommended is a blend of 20% SAE 20 Pennsylvania type motor oil and 80% clean kerosene by volume. To fill the system, station one person at the transmitter and another at the receiver and proceed as follows:

- a. Remove transmitter filler cap *M* (Fig. 3-20).
- b. Fill reservoir with fluid to mark on dip stick.
- c. Disconnect the tube fitting at receiver unit.
- d. Place thumb over end of tube.
- e. Force transmitter handle against its spring to extreme end of stroke. This creates a partial vacuum in the system, and when the spring-loaded valve opens at the end of the stroke, fluid will be sucked in from the reservoir. Hold the handle at end of stroke for two or three seconds to allow fluid to run into system. Care must be taken, while filling, that the *handle does not slip out of hand* and fly back under spring pressure.
- f. Return transmitter handle to opposite end of stroke.
- g. Remove thumb from end of tube to allow air to escape.
- h. Repeat operation (items *d* to *g* above) until tube is filled with fluid, refilling reservoir after each 6 strokes to avoid sucking air into system.
- i. Reconnect tube fitting to receiver unit.
- j. Operate transmitter handle several times with short, rapid strokes; move handle to extreme end of stroke to open valve; repeat procedure until receiver lever moves through its full stroke. This will expel any trapped air, since piston packings have a characteristic of retaining fluid but passing air.
- k. Refill reservoir to mark on dip stick.

QUESTIONS

1. For what reason is a sequence valve used in some hydraulic systems?
2. Describe how a typical sequence action takes place.
3. In the Vickers unloading valve, what determines the pressure at which the valve operates?

4. What is the purpose of the directional-control valve found in the Vickers unloading valve?
5. Explain how a warning horn operates on a landing-gear hydraulic system.
6. When warning lights are used in a landing-gear hydraulic system, what do the red and the green lights signify?
7. In a system equipped with an emergency dump valve, what procedure would a pilot follow if he desired to extend his landing gear in case of complete failure of the hydraulic actuating cylinder?
8. What is a time-lag valve?
9. For what length of time should a time-lag valve stay engaged? On what does this depend?
10. What is the purpose of a shuttle valve?
11. Explain the operation of a shuttle valve.
12. In a pressure-warning switch, how is the electrical circuit completed?
13. Describe the operation of the Vickers piston-type power pump.
14. Why is a hydraulic flow divider sometimes used in a hydraulic system?
15. Explain the feature of the Adel Mighty Midget selector valve which makes possible a compact valve.
16. Why should a filter be installed in every hydraulic system?
17. Describe the filtering action of the Cuno filter.
18. What does one type filter element of the Purolator filter consist of?
19. What is the underlying principle in a Selsyn position indicator?
20. Assume that a Vickers unloading valve is in such a position that the fluid is being bypassed back to the reservoir. When the accumulator pressure starts to drop from the predetermined maximum to below the predetermined minimum for which the valve is set, in what order will the following parts of the unit change their positions: check valve, directional-control valve, piston, pilot valve?
21. What is the Sperry exactor control? For what mechanisms may it be used?
22. What does the exactor control consist of? What is the approximate pressure of the system?

Chapter IV

DESCRIPTION OF TYPICAL HYDRAULIC SYSTEM

1. *Introduction*

This chapter will be devoted to a description of a typical hydraulic system as actually found on a modern military plane. A knowledge and thorough understanding of this system will serve to acquaint the student with the actual operation of all types of systems because fundamentally all systems are similarly constructed.

2. *Hydraulic System—General*

The hydraulic system which we have chosen for our illustration contains approximately 6 gallons of fluid and operates the landing gear, bomb doors, brakes, wing flaps, and cowl flaps. In normal operation, an engine-driven pump supplies the fluid at a pressure of 1000 psi for the operation of the complete hydraulic system. A hand pump, which may be used to operate any of the individual systems in case of emergency or for testing purposes on the ground, is also present in the system. The pressure in the complete hydraulic system may be relieved by operating the wing flaps until the hydraulic system pressure gauge reads zero.

In analyzing a complete hydraulic system, it is best to divide the system into a basic system and three or four sub-systems, depending upon the functions of the complete system. For instance, the hydraulic system which we have selected for demonstration may be broken up into a basic system containing the power unit up to the selector valves, and five sub-systems from the selector valves to the actuating cylinders.

3. *Basic System (Fig. 4-1)*

The basic system consists of lines and units arranged to supply and regulate the fluid pressure to the selector valves of the various sub-systems. A 2.85-gallon reservoir supplies fluid to an engine-driven pump mounted on the accessory drive of the

engine. On either side of the pump there is located a line disconnect valve at which points the system may be disconnected, if necessary, without loss of fluid. From the pump, the fluid flows through a filter which removes all impurities from the fluid. The filter incorporates an internal-relief valve which permits the fluid to bypass the filter element in case of clogging in the filter. From this point, the fluid flows through a check valve and then to an unloader valve. The check valve prevents reverse flow of fluid from the system in the event of an engine or pump failure. The unloader valve acts as a pressure regulator maintaining 850-1000 psi pressure in the system. It operates in conjunction with an accumulator and bypasses fluid to the reservoir when the

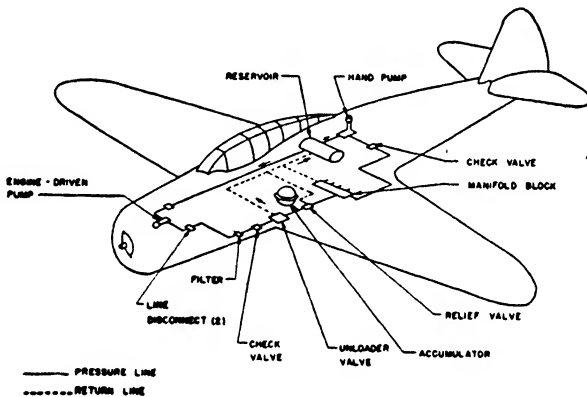

FIG. 4-1. BASIC SYSTEM.

system pressure reaches 1000 psi. It continues to bypass fluid until the system pressure drops to 850 psi at which point the unloader valve “cuts in” and permits the pump to build up system pressure. As soon as the system pressure again reaches 1000 psi, the cycle repeats. Should the unloader valve fail to operate properly and the system pressure exceed 1200 psi, a main relief valve will bypass the excess fluid pressure to the reservoir. After the relief valve, the fluid passes to the manifold block where it is distributed to the various selector valves. A pressure gauge (not shown in Fig. 4-1), located on the instrument panel in the cockpit, is connected into the system between the accumulator and the manifold block and shows the pressure in the system at all times. A pressure-gauge snubber, used in conjunction with the

pressure gauge, dampens the oscillations of the pointer on the gauge.

A hand pump is provided to supplant the engine-driven pump and is used only when the engine-driven pump is inoperative or in case of a hydraulic system failure. Fluid from the hand pump flows through a check valve and into the manifold block where it is distributed to the various selector valves. The purpose of the check valve is to prevent fluid from the main pressure line from flowing into the hand pump and thereby causing possible damage to the unit. When the hand pump is used, the unloader valve and the main relief valve are not operative and the pressure in the hydraulic system is governed by an adjustable relief valve connected in the manifold block. This relief valve is set to relieve at 1200 psi and serves to protect the system against excessive pressures.

4. Landing-gear Hydraulic System (Fig. 4-2)

A selector valve, located at the left side of the pilot's seat, controls the simultaneous retraction or extension of all three units of the landing gear. Two lines that extend from the selector valve

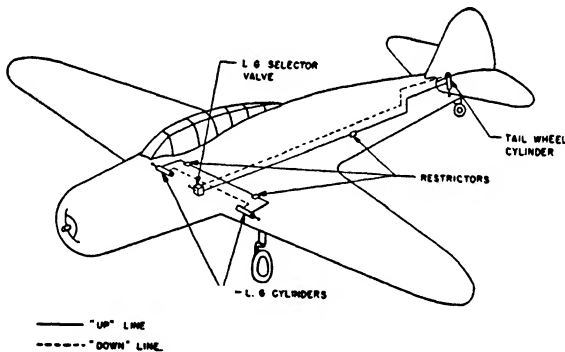

FIG. 4-2. LANDING-GEAR HYDRAULIC SYSTEM.

incorporate cross fittings which direct the fluid through three lines to the tail-wheel cylinder and to the two landing-gear actuating cylinders. Each of the three UP lines to the actuating cylinders contain a restrictor which serves as a means of slowing down the retraction of the landing gear. Where the lines attach to the actuating struts, flexible hoses are used. When the selector-

valve control handle is moved to the UP position, fluid under pressure is applied to the aft ports of the main landing gear and tail-wheel actuating cylinders. The fluid, which is displaced when the pistons move forward, flows out of the forward ports of the cylinders and back to the reservoir as the gear retracts. When the handle of the selector valve is moved to the DOWN position, the flow of the fluid is exactly opposite to that described above. The control handle should be returned to NEUTRAL after the gear has been retracted since this reduces the amount of line under system pressure and subject to failure resulting in loss of fluid. The handle should be left in the DOWN position after the gear has been extended in order to prevent the remotest chance of UP pressure reaching the actuating cylinders.

5. Wing-flap Hydraulic System (Fig. 4-3)

A selector valve located on the panel to the left of the pilot's seat controls the operation of the wing flaps. A tee fitting in the DOWN line directs the fluid through two lines. One of these lines attaches to the side of a relief valve, while the other continues to a flow divider which insures synchronization of the

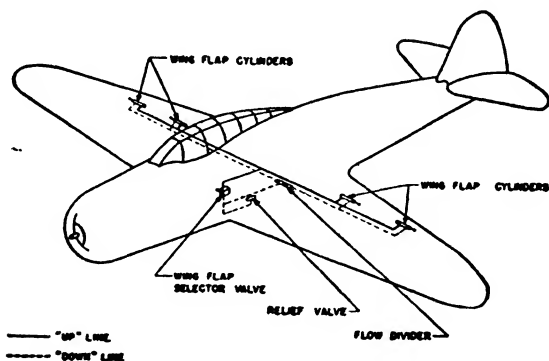

FIG. 4-3. WING-FLAP HYDRAULIC SYSTEM.

wing flaps. From here, the lines are diverted to flexible hoses at the points of attachment to the right and left center section and outer panel wing-flap cylinders. When the pilot moves the selector-valve control handle to the UP position, pressure is applied to the forward port of each actuating cylinder forcing the piston back, and displacing the fluid behind it. The displaced

fluid flows out of the aft port of the cylinder and through the selector valve to the return line to the reservoir. When the selector-valve handle is moved to the DOWN position, the normal flow of fluid is through the selector valve and relief valve to the aft port of the actuating cylinder. However, if the pilot attempts to lower the wing flaps with the airspeed in excess of 190 mph, the air pressure on the flaps builds up the back pressure in the DOWN line in excess of 260 psi. When this occurs, the wing-flap relief valve operates to allow the excess fluid pressure to return to the reservoir through the manifold block shown in Fig. 4-1. The wing flaps may be locked in any desired position between full UP and full DOWN by moving the control handle to NEUTRAL. This valve position locks the fluid in the lines holding the flaps in the desired position.

6. Cowl-flap Hydraulic System (Fig. 4-4)

The upper and lower cowl flaps are controlled independently by two selector valves located on the panel at the right side of the pilot's seat. At points of attachment to the actuating cylinders, the lines terminate in flexible hoses. When either of the

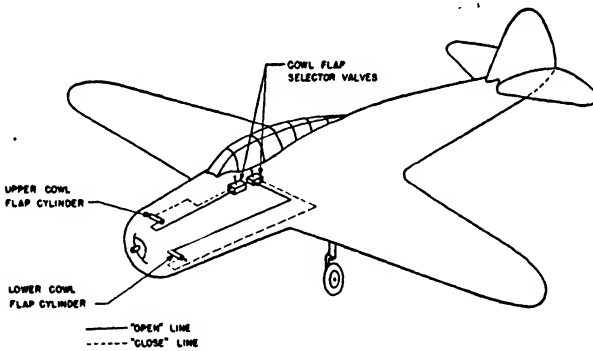

FIG. 4-4. COWL-FLAP HYDRAULIC SYSTEM.

two control handles are moved to the OPEN position, fluid pressure is applied to the forward end of the actuating cylinder. The piston is forced back and the displaced fluid flows out through the port in the opposite end of the cylinder and returns to the reservoir. The flow of fluid is reversed when the control handle is moved to the CLOSE position. If it is desired to lock the cowl flaps at any point between full open to full close, the control

handle should be moved to NEUTRAL after the desired position has been reached. This causes the fluid to be locked in the lines at the desired position.

7. Bomb-door System (Fig. 4-5)

The bomb doors are hydraulically controlled by a selector valve which is located to the left of the pilot's seat. When the selector valve handle is moved to the OPEN position, pressure is applied to the upper port of the actuating cylinder forcing the piston to extend. As the piston extends, the displaced fluid is

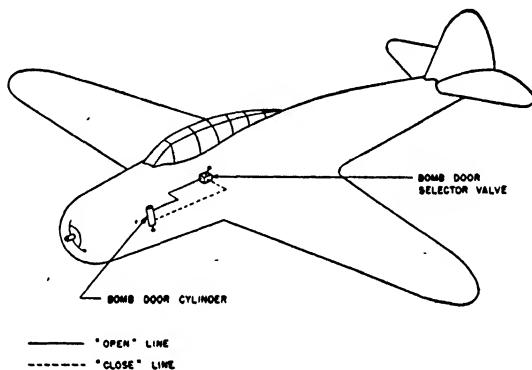

FIG. 4-5. BOMB-DOOR HYDRAULIC SYSTEM.

forced out of the lower port of the cylinder and returns to the reservoir. When the handle of the selector valve is moved to the CLOSE position, the flow of the fluid is opposite to that described above. After the desired operation is completed, the selector-valve handle should be moved to the NEUTRAL position.

8. Brake Hydraulic System (Fig. 4-6)

In normal operation of the brakes, two brake-control valves, operated by toe pressure applied on the pilot's rudder pedals, allow either brake to be applied independently. One line extends from each brake-control valve to a swivel joint and from this point, by means of a flexible hose, it is connected to the brake booster which is mounted in the wheel axle. From the booster, a line extends to a shuttle valve at each main wheel. The purpose of the shuttle valve is to block off the emergency air system when the

hydraulic system is in operation, and to block off the hydraulic system when the emergency air system is in operation.

When the rudder pedals are depressed, the pressure port on the top of the brake-control valve is opened, allowing system pressure to flow through the valve to the brake deboster. Here the system operating pressure is reduced to 150 psi before being applied to the brakes. As the pedal pressure is relieved, the fluid from the brakes is permitted to flow back into the large chamber of the deboster while the spring in the deboster forces the fluid in the small chamber through the brake control valve and back to the reservoir.

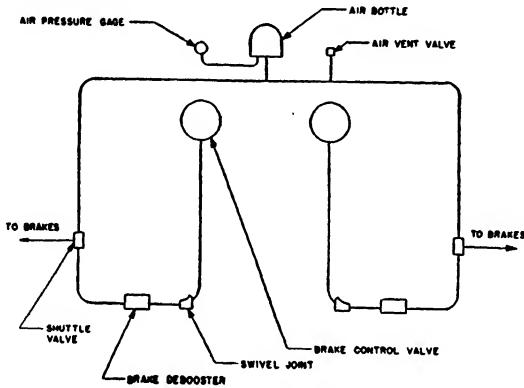

FIG. 4-6. BRAKE HYDRAULIC SYSTEM.

In case of complete hydraulic-system failure, causing the hand pump as well as the power pump to become inoperative, an emergency air system is provided to operate the brakes. When the control handle in the cockpit is operated, the air-vent valve is closed and pressure from the air bottle is directed to the shuttle valve. Here, the air pressure forces the piston in the shuttle valve to block off the hydraulic system and the air pressure is applied to the brakes. The pressure in the air bottle is sufficient for only one stopping of the airplane and must be recharged after being used. When the air bottle is not in use, the air-vent valve serves the purpose of relieving any air pressure in the air line caused by expansion. Otherwise, the pressure in the line might build up sufficiently to cause the shuttle valve to block off the hydraulic line at an inopportune time. An air gauge is connected to the air bottle so that the bottle may be charged to its proper pressure.

QUESTIONS

1. What is the normal operating pressure for the system discussed in this chapter?
2. What mechanisms does the system operate?
3. For what reason does the cowl-flap system have two selector valves?
4. How may the wing flaps be locked in a position between full UP and full DOWN?
5. Why are shuttle valves installed in the brake system?
6. Where is the bomb-door selector valve located?
7. How may the hydraulic system pressure be relieved?
8. At what pressure does the unloader valve "cut-in"?
9. What is the purpose of the check valve in the basic system?
10. In case of complete hydraulic-system failure, what provision is there for emergency application of the brakes?
11. What is the purpose of the hand pump?
12. What is the fluid capacity of the total system?
13. What is the function of the flow divider in the wing-flap system?
14. In what position should the selector valve be put after the gear is retracted?
15. What is the purpose of the relief valve in the basic system?
16. At what pressure does the relief valve operate?
17. Why is a deboost器 installed in the brake system?
18. Where are the line disconnect valves located?
19. What is the purpose of the relief valve in the wing flap system?
20. What purpose does the air-vent valve in the brake system serve?

Chapter V

MAINTENANCE OF TYPICAL HYDRAULIC UNITS

1. *General*

From the mechanic's viewpoint, the most important thing about a hydraulic system is a knowledge of the maintenance procedures for each of the units in the system. This chapter will describe the general and specific troubles encountered with certain units. All units of any one type generally have the same maintenance problems. Therefore, a knowledge of the instructions outlined in this chapter should serve as a basis for servicing any unit. Following is a list of general suggestions and hints which should be kept in mind when servicing any part of the hydraulic system:

a. When removing a hydraulic valve or unit from an airplane, examine the piping connections carefully so that it may be properly reinstalled.

b. A valve should never be disassembled or tampered with as long as it functions properly. Nothing can be gained by unnecessarily disassembling a perfectly-operating valve.

c. Never disassemble a valve unless you are familiar with maintenance instructions for the particular product.

d. When disassembling a valve, try to keep the disassembled parts in their proper order on the bench.

e. When a valve or cylinder is disassembled, be sure that the work bench is cleaned of dirt and filings.

f. Do not drop tools on disassembled parts. Use proper tools at all times.

g. Always wash all parts in clean hydraulic fluid of the same type as that used in the airplane hydraulic system.

h. When reassembling a valve, it's a good idea to install new seals whether or not the old ones are damaged.

2. *Maintenance of Actuating Cylinders*

The actuating cylinder is removed from the airplane by disconnecting the hydraulic lines from the swivel joint or the flex-

ible hose at the end of the cylinder and then removing the bolts at each end of the cylinder.

When leaks appear, replace the packings. Never attempt to stop leaks by tightening the packing-retaining nuts because rapid wear and overheating will result. The most important thing regarding replacement of packings in an actuating cylinder is to avoid excessive tightening of the packings in their groove. The packings, both on the piston and the piston rod, should be adjusted so that when the retaining nuts are locked in place, the packings can be turned in their groove by a light hand pressure. If packings are overtightened, it will be difficult to insert the piston into the barrel, and packings will wear rapidly and will be unable to seat properly against the barrel or piston rod. When replacing packings, always wet each ring thoroughly with the proper hydraulic fluid before installing.

In testing the actuating cylinder, move the piston back and forth in the cylinder with ports open and check for freedom from binding.

Test for leaks by applying approximately $1\frac{1}{2}$ times the system pressure at the piston-rod side of cylinder; no leakage should be apparent at the external gland or from the opposite port. Repeat the test at the opposite end of the piston.

3. *Maintenance of Swivel Joints*

Swivel joints, which are usually furnished with the actuating cylinders, provide a means of conducting hydraulic fluid from a stationary to a movable object so that rotation of the movable object through any angular distance will not affect the seal of the joint.

Swivel joints, when properly installed, ordinarily do not require attention between airplane overhaul periods. External leakage at the packing retainer cap is usually due to worn or deteriorated packing. Internal leakage, resulting in sluggish operation of the hydraulic mechanism, is usually because of worn or deteriorated packing permitting leakage between the fluid passageways. To correct either of the above leaking conditions, replace the packing. In testing the swivel joint, check for binding, and tight or rough spots in the rotation of the joint with no pressure applied. When pressure is applied, there must be no evidence of excessive friction or binding during rotation of the spindle. With

one of the fluid connections plugged, and with $1\frac{1}{2}$ times the system pressure applied for 15 minutes, there should be no evidence of internal or external leakage. Check internal leakage by placing a pressure gauge in the line connected to the joint, and a shut-off valve between the gauge and the pressure supply. A pressure drop at the end of a 15-minute period indicates either external leakage, which can be visually detected, or internal leakage, which is detected at the shut-off valve. The test is repeated at the other hydraulic passageway, applying pressure to one side of the joint at a time.

4. *Maintenance of Vickers Accumulators*

The function of the Vickers accumulator is to act as a hydro-pneumatic unit which will maintain hydraulic system pressure by means of compressed air while the pump is stopped or unloaded.

The accumulator should be checked once every seven days or once each 25 hours of flight, whichever time elapses first. If the accumulator is connected to the brake system, discharge the fluid in the accumulator by operating the brake pedals until the brake-pressure gauge indicates zero. Then, measure the air pressure in each accumulator by applying a pressure gauge to the air valve on the bottom of each spherical accumulator. The proper residual air pressure will vary with a particular installation but will usually range from 300-800 psi. If the air pressure has fallen below its proper value, charge the accumulator with an air booster pump. Do not use gas from CO₂ or oxygen cylinder for this purpose.

It is extremely important to discharge the accumulator completely before attempting to remove it, to safeguard personnel from possible injury due to the high-pressure discharge. In systems with two accumulators, both accumulators must be completely discharged before either unit is removed. This may be accomplished by operating the brake pedals until the pressure gauge drops to zero, then releasing the air in the accumulator through the air valve at the bottom half of the unit. The procedure in removing an accumulator from the airplane is as follows: Discharge air at air valve; disconnect piping; remove attaching bolts; lift out of support.

Following is a table listing the possible troubles, causes, and remedies encountered in the use of a Vickers accumulator:

<i>Trouble</i>	<i>Cause</i>	<i>Remedy</i>
Leakage of oil or air at joint between oil and air chambers.	Chambers not tightly screwed together.	Tighten (right-hand thread) with two special wrenches supplied by Vickers, Inc.
	Damaged sealing ring lip on diaphragm.	Dismantle to check. Replace diaphragm if necessary.
Loss of accumulator cushioning effect on entire system; or frequent "cutting in" and "cutting out" of unloading valve or sudden extreme pressure drops when system is operated.	Loss of air from accumulator.	Check for leaks as above.
	Lack of sufficient air in accumulator.	Charge accumulator to correct required pressure.
	Air pressure in accumulator higher than recommended for given installation.	Check air pressure in accumulator and bleed to correct pressure at air fitting.
Loss of air in air chamber.	Evidenced by chattering of unloading valve, or sudden extreme pressure drop when system is operated.	Check air fitting for leakage and air fitting connections.
	Punctured or torn diaphragm.	Replace valve core of air fitting, gasket, or both. If cause not at air fitting, dismantle and check diaphragm for leaks. Replace if necessary.
Sluggish response of accumulator.	Restricted oil screen.	Dismantle and clean screen but DO NOT REMOVE from oil chamber.
Loss of system pressure.	Leakage of other units in system.	Check all units directly connected to accumulator system for leakage. If all are O.K. check accumulator for above conditions.

5. Maintenance of Vickers Piston-type, Engine-driven Pumps

There are no external or internal adjustments on these pumps. In the event of unsatisfactory operation, check the system to make certain that other components are functioning properly. Then, check pump for damaged parts.

The following chart lists the difficulties which may possibly be experienced with the pump and hydraulic system, and indicates the cause and remedy for each of the troubles listed. It should always be remembered that "pressure" and "delivery" are factors which are usually dependent upon each other. Adequate pressure gauge equipment and a thorough understanding of the operation of the complete hydraulic system is essential to diagnose improper operation.

<i>Trouble</i>	<i>Cause</i>	<i>Remedy</i>
Pump not delivering oil.	Shaft rotating in wrong direction.	Must be reversed immediately to prevent seizure and breakage of parts, due to lack of oil.
	Tank oil level low.	Add recommended oil, and check level to be certain pump suction line is submerged.
	Oil intake pipe plugged.	Check to make certain line is not restricted.
	Air leak in suction line.	Will prevent priming, or cause noise and irregular action of control circuit.
	Oil viscosity too heavy to pick up prime.	Use Sperry Servo, Air Corps Specification 3580-A, or Navy specification M-339.
	Broken pump shaft or internal parts.	Refer to Parts Drawing.
	Pump coupling shaft sheared.	Remove pump and replace coupling shaft.

<i>Trouble</i>	<i>Cause</i>	<i>Remedy</i>
	Spring broken.	Replace.
Pump not developing pressure.	Pump not delivering oil for any of the above reasons.	Check oil circulation by watching oil in tank, or loosening pressure line near pump.
	Relief valve setting not high enough.	Block piston-rod travel, or oil circulation, and test with pressure gauge.
	Relief valve sticking open.	See relief-valve instructions.
	Leak in hydraulic control system (cylinders or valves).	Block off circuit beyond relief valve to test.
	Valving surfaces scored by abrasive in oil.	Replace scored parts or return to manufacturer for repair and complete performance tests.
Air in hydraulic system.	Small air leak at pump-intake piping joints.	Tighten fittings or replace.
	Air leak at pump-shaft oil seal.	Check for broken spring. Replace parts where necessary.
	Air bubbles in intake oil.	Check to be certain return lines to tank are below oil level and well separated from intake line.
	Tank air vent plugged.	Must be open thru breather opening or air filter.

<i>Trouble</i>	<i>Cause</i>	<i>Remedy</i>
	Too high oil viscosity.	Use Sperry Servo, Air Corps Specification 3580-A, or Navy specification M-339.
External leakage around pump.	Shaft oil seal worn.	Replace shaft oil seal by dismantling shaft and assembly.
	Pump-connection cover loose, or a faulty gasket.	Tighten cover or replace gasket.
	Engine-accessory-drive oil seal worn causing discharge at pump drain.	Refer to engine service data.

It is extremely important that hydraulic system oil be absolutely clean and free from foreign matter. If pump shows evidence of abrasive matter in system, complete system should be drained and refilled with clean oil.

6. *Maintenance of Pesco Gear-type Engine-driven Pumps*

At the time of the first 50-hour inspection, the pump should be removed from the airplane. Check for freedom of motion of the rotating parts by turning the drive coupling with the fingers. If excessive resistance is noted, the pump must be overhauled by a person familiar with the pump. At the 100-hour inspection, check that all pipe connections are tight and that all mounting nuts are drawn up tight and properly safetied. The pumps should be removed for complete overhaul at the time the engines are removed for overhaul.

Following is a list of possible troubles, causes, and remedies encountered in the use of this type of pump:

<i>Trouble</i>	<i>Cause</i>	<i>Remedy</i>
Insufficient pressure developed by pump.	Connections are loose or at fault.	Tighten connections and correct installation.
	Too much restriction in pressure line.	Eliminate all unnecessary bends and fittings, or replace with larger diameter lines.
Pump fails to deliver fluid.	Suction and delivery line connections reversed.	Connect lines correctly.
	Wrong direction of rotation.	Replace with correct pump.
	Drive shaft sheared because of overloading.	Replace drive shaft.

7. Maintenance of Reservoirs

Check the fluid level in the sight gauge every day. Refill, if necessary, with correct hydraulic fluid. When adding fluid to the reservoir, all actuating cylinders should be in their OPEN position. The cleaning handle on the top of the hydraulic fluid filter should be turned daily, or at least a few times a week, to avoid clogging of the filter.

8. Maintenance of Hand Pumps

At the 25-hour inspection period, the hand pump is checked for general condition and correct functioning. Inspect for evidence of external leakage, unusual wear in operating linkage, and condition and security of pump mounting.

The packing on the piston rod should be kept tight enough by means of the piston-rod packing nut to avoid leaks. When excessive tightness is required, the packing should be replaced. Adjustment is not usually provided for the piston packing, because the fluid pressure within the pump will force the packings

firmly against the cylinder as long as the packing is in good condition. In the event of internal leakage, do not attempt to stop it by increased tightness of the piston packing. Instead, the packing should be replaced. Before installation, wet the new packing with clean hydraulic fluid. A newly-installed packing should be capable of being turned on the piston with a moderate hand pressure after tightening the piston nut.

Sometimes, hand pumps will fail to deliver fluid from one end of the piston. This is usually due to foreign matter lodging beneath a check valve. If this occurs, disconnect the pump delivery line to permit free movement of the pump, and operate the pump rapidly until the check valve is washed clean of the foreign material. Then, reconnect the delivery line and the pump should function correctly.

9. *Maintenance of Check Valves*

A properly-installed check valve should not require attention between airplane major-overhaul periods. However, evidence of leakage through a check valve is most probably due to particles of foreign matter lodging under the valve ball or poppet. If this occurs, disconnect the line leading to the outlet side of the check and use the hand pump to discharge a considerable volume of fluid through the valve. Any particles of matter holding the valve open should be dislodged by this fluid flow, particularly if the valve body is simultaneously tapped with a rubber hammer.

If this procedure does not remedy the trouble, the check valve should be removed from the airplane and completely disassembled, and tested. If leakage still appears, it should be replaced with a new valve.

10. *Maintenance of Relief Valves*

A properly-installed relief valve should not require attention between airplane major-overhaul periods. Evidence of leakage through the relief valve is most probably due to a particle of foreign matter lodging under the valve ball or poppet. If this occurs, bring the system up to pressure with the hand pump and continue pumping in order to force a considerable quantity of fluid through the relief valve. Any foreign particles holding the valve open should be dislodged by this flow of fluid, particularly

if the valve body is simultaneously tapped lightly with a rubber hammer. If the system installation does not permit the hand pump to deliver fluid to the relief valve, the valve must be removed, disassembled, cleaned, reassembled, and tested.

If the leakage still occurs, the valve should be replaced with a new one unless sufficient facilities are available to allow for repair of the valve.

Relief valves are usually adjusted to open at $1\frac{1}{4}$ times the normal operating system pressure. For a minor adjustment, depending upon the construction of the valve, loosen the locknut and turn the adjusting screw *in*, to *increase* the pressure, and *out*, to *decrease*. After adjustment is complete, tighten the locknut and safety the valve into place. For a major adjustment, in the event that the correct position of the adjusting screw has been lost, loosen the locknut and turn the adjusting screw *in* until the spring is nearly compressed. Then, bring the system pressure up to the desired relief-valve kick-out value and turn the adjusting screw until the relief valve opens. This will be indicated by a pressure drop. Tighten the locknut, bring the system up to pressure again as a check, and make any necessary final minor adjustment.

11. *Maintenance of Brake-control Valves*

Check brake-control valves daily for normal action of brakes. With brakes that have been "parked" for a considerable period of time, check for excessive pedal travel. Excessive travel indicates loss of accumulator pressure through internal leakage.

At the 25-hour inspection periods, the valve should be checked for evidence of external leakage at push rods, push-rod-assembly retainer nuts, inlet-valve caps, housing-end caps, and fluid-line connections. The clearance between the push-rod ends and the actuating levers should be checked with the brake pedals in fully released position. Also, check the general mechanical condition of brake-control valve, as evidenced by surface examination, including security of attaching bolts and control linkage. At the 300-hour inspection, the brake-valve action is inspected by disconnecting the line at the brake booster, disconnecting the reservoir return line at the brake-control valve, and pumping up

the accumulator to normal system pressure in order to check for leakage with the brake off. At the end of a 15-minute period, no leakage should be evident. Set the parking-brake lever and check for pressure drop which should not exceed 5 psi in 30 minutes. In the event of excessive pressure drop, internal leakage is evidenced and the brake-control valve should be removed from the airplane and overhauled.

12. *Maintenance of Deboosters*

The deboosters should be checked daily for normal action of the brakes. At the 25-hour inspection, check for evidence of external leakage at breather holes in inlet-end of cylinder head and also at outlet-end of cylinder head and retaining sleeve.

At the 100-hour inspection, check the functioning of each brake de booster by jacking up the airplane so that the landing wheels are clear of the ground. Observe the drag with the brakes fully released by turning the wheels by hand. Apply full brake pressure and then release as quickly as possible. The brake should release immediately without any unusual drag.

The de booster must be tested at the 250-hour inspection for evidence of leakage, for proper reduction of pressure, and for correct unloading time.

13. *Maintenance of Vickers Unloading Valves*

The Vickers unloading valve operates in such a manner as to keep the accumulator charged with fluid at a pressure ranging between a maximum and a minimum value. When the accumulator pressure reaches the maximum value for which the unloading valve is set, the unloading valve "cuts out" and permits the fluid to flow back to the reservoir. Then it continues to operate in this manner until the accumulator pressure is reduced to the minimum value or less, at which time the unloading valve "cuts in" and causes the accumulator to be fully charged. The adjustment of operating pressure is made at assembly and cannot be changed except by replacing the spring. A variation of cap tightness will alter the pressure adjustments; therefore, the cap should be pulled snugly to its approximate original position. Following is a list of possible troubles, causes, and remedies encountered in the use of a Vickers unloading valve:

<i>Trouble</i>	<i>Cause</i>	<i>Remedy</i>
Valve will not charge accumulator.	Unloading spool or directional spool stuck in "open to tank" position, or broken unloading spring.	Dismantle valve and check operation of internal parts. Spools must be absolutely free in bores. Replace spring if necessary.
	Broken pilot-valve spring.	Check and replace spring if necessary.
Valve will not "unload" pump to tank.	Spools stuck in bores or check valve stuck open.	Dismantle to inspect and clean.
Erratic "cut in" and "cut out" pressure readings.	Spools sticking slightly in bores, but not sufficiently to make valve in-operative.	Dismantle to inspect and clean.
	Spools scored and burrs raised at edges.	Smooth up spools with fine stone and remove burrs. However, do not break sharp corners on spool lands.
Chatter or excessive leakage. Valve not maintaining pressure in accumulator when there is no leakage in remainder of system.	Check valve leaking.	With pressure built up in the accumulator, but pump shut off, disconnect pressure line and observe for leakage. Replace check valve, or lap slightly with seat.
	Leakage past pilot-valve plunger.	If pilot-valve plunger has excessive clearance in its bore, the other bores will also be badly worn and a new unloading valve should be installed.

14. *Maintenance of Aircraft Accessories Pressure Regulators*

The regulator, when properly installed and operated, should not require attention between airplane major-overhaul periods. At each 25-hour inspection of the airplane, a general inspection

for leakage and security should be made. The regulator is adjusted at the factory to maintain the proper system pressure. This value is stamped on the name plate and the adjusting screw is sealed in this position. Under ordinary circumstances the pressure (surge spring) and the cam action (cam spring) should never be tampered with. However, when the regulator is disassembled for repairs, the surge spring and the cam spring can be adjusted. To adjust the surge spring, loosen the locknut at the end of the surge-spring sleeve and tighten the adjusting screw until the system pressure is raised to the proper value. The cam spring should be adjusted if the regulator action is sluggish. To accomplish this adjustment, loosen the locknut at the end of the cam plunger housing and tighten the adjusting screw in increments of $\frac{1}{4}$ turn until the regulator action is sufficiently "snappy." Following is a list of possible troubles, causes, and remedies for this regulator:

<i>Trouble</i>	<i>Cause</i>	<i>Remedy</i>
Regulator cuts in and out continually.	Leaky packing on surge piston.	Replace packing.
	Leaky check valve in exterior line connecting bypass valve and surge barrel.	Repair or replace valve.
Regulator "hangs up" and will not respond to system pressure changes.	Cam roller is worn flat or "brinneled."	Replace cam roller.
	Wrong type of regulator has been installed.	Check type.
	Improper alignment between surge-barrel and bypass-valve housing causes binding of surge piston.	Realign the parts.
Persistent leaks around housing cover gasket.	Drain passageway has become stopped.	Clean passageway.

15. *Maintenance of Electrol Unloader Valves*

When properly installed and operated, this unloader valve should not require attention between airplane major-overhaul periods. The maximum pressure setting may be set for the exact value desired by loosening the sealing nut and turning the adjusting screw in or out until the proper adjustment is obtained.

If there is external leakage around any of the locknuts, it is due to worn or damaged seals. Normally, the valve will require but two replacements: The U-cup on the plunger, and the seal under the adjusting screw. If the valve cuts in and out repeatedly, it is possible that there is a leak or bypass in some other unit of the system and, before condemning the unloader valve, other units should be checked. If the trouble is traced to the unloader valve, it may be caused by the ball check in the system port of the valve being held off its seat by a foreign particle. To remedy this condition, the valve must be disassembled and all parts washed in clean hydraulic fluid. In case the valve will not unload, or will not "cut in," it may be due to internal leakage, excessive wear in upper or lower selector seat, dirty or cracked seat causing ball check to become stuck, or a broken spring. Line hammer or chatter may be caused by a leaky check valve or by a leak in the system itself.

16. *Maintenance of Landing-gear Emergency Dump Valves*

There is very little maintenance required for a dump valve. Occasional replacement of a leaky valve cover or seat gasket, or reseating of the ball valve is all that is usually necessary.

Occasionally, the valve should be checked for general condition and leakage. Particular attention should be paid to checking through the unloading line. If leakage is observed, the valve must be disassembled and the ball valve reseated.

17. *Maintenance of Automatic Couplers*

Automatic couplers should be checked for general condition and leakage at the 50-hour inspection. If either end of the coupling leaks fluid when it is disconnected, this indicates that the check valve in that end is leaking, or the check-valve spring is broken.

If the coupling fails to permit free fluid flow, it can only be due to a broken check-valve release pin because the design of the coupling is usually such that the spring guides bottom when the coupling is connected and force the balls against the release pin, regardless of the condition of the springs.

If either of the check valves appears to be leaking, the leaking ball and its seat must be removed. The ball must be inspected for roughness and corrosion and replaced if either condition exists. Check the condition of the valve seat; if it cannot be satisfactorily reconditioned by lapping, both the seat and ball must be replaced.

18. *Maintenance of Cuno Filters*

When properly installed and operated, Cuno filters will require no attention between engine or airplane overhaul periods, except as provided for in the manufacturer's instructions governing maintenance and operation of the equipment on which the filter is installed. Turn the handle of manually-operated filters at least once every 10 hours of operation.

After 100 hours of operation, remove the filter and disassemble sump from head and cartridge. All cartridges should rotate through 360 degrees with maximum torque variation of 50%. Hard spots or points of catching are cause for rejection. Inspect the cleaner blades to see that they are straight and flat. Bent or torn blades, unless such bending is limited to the extreme edge of the part of the blade most remote from the disks, is cause for rejection. All disks must be flat, evenly spaced, and free from burrs or nicks.

Clean a Cuno filter cartridge each time the filter is removed from the airplane by washing it in a solvent such as kerosene, gasoline, or a half-and-half mixture of carbon tetrachloride and benzol. Be sure to remove all foreign material adhering to the cartridge.

19. *Maintenance of Vickers Load-and-fire Check Valve (Sequence Valve)*

Following is a table listing the possible troubles, causes, and remedies encountered in the use of a Vickers load-and-fire check valve:

<i>Trouble</i>	<i>Cause</i>	<i>Remedy</i>
Evidence of external leakage at valve plunger or cover.	Leaky packing or gasket.	Replace packing or gasket.
Incorrect sequence of operating cycle.	Valve not correctly connected in circuit.	Check installation against circuit requirements to determine if piping is correct. If incorrect, repipe.
	Check valve leaking when pressure is applied to checked flow port.	Dismantle valve and inspect for poor condition of seat and check valve. Replace damaged or worn parts.
	Valve not firing at correct moment, either due to incorrect adjustment of mechanical firing mechanism, or deflection of structure on which valve is mounted.	Adjust mechanical firing cam, or mechanism, or strengthen mounting location of valve.
	Valve not firing open.	Broken spring. Remove threaded housing and replace spring.
	Valve not closing or seating correctly.	Evidenced by second portion of cycle operating too soon. Dismantle valve and check for sticking check valve, and broken spring or poor valve seat. Repair or replace parts as necessary.

20. *Maintenance of Adel Selector Valve—(Mighty Midget)*

At regular inspection periods, a general check should be made of the condition of the valve. Investigate possibility of external

leakage. Check the proper operating condition and security of mounting, along with accurate functioning of the operating handle.

Following is a table listing the possible troubles, causes, and remedies encountered in the use of an Adel Mighty Midget selector valve:

<i>Trouble</i>	<i>Cause</i>	<i>Remedy</i>
1. Fluid leaks around camshaft retainer.	Shaft do-nut seal has deteriorated or cracked.	Replace seal.
	Shaft is badly worn or scored. (Defects of this type are not likely to appear under normal operating conditions.)	Replace camshaft.
2. Fluid leaks around upper cap.	Cap is loose.	Tighten cap.
	Crush washer is badly worn, scored, or broken.	Replace washer.
3. Low pressure at actuating cylinder.	Fluid leaks around upper cap.	Tighten cap or replace washer.
	Leaky return valve due to: a) Foreign matter lodged between poppet and seat. b) Scoring of seat due to foreign matter or excessive wear. c) Faulty do-nut seal. d) Scored pressure poppet stem.	a) Disassemble and clean poppet and body. b) Clean seat and re-lap poppet into place. c) Replace seal d) Except with evidence of extreme corrosion, this condition may be overcome by polishing with crocus cloth or similar material. If poppet stem is severely pitted or scored, replace.

<i>Trouble</i>	<i>Cause</i>	<i>Remedy</i>
4. Valve fails to actuate cylinder.	One pressure poppet has jammed and is held open.	Disassemble and inspect pressure poppet stem, springs, and inner bore of return poppet. Replace defective parts.
5. Valve fails to hold rated pressure.	Fluid leaks around upper cap (see item 2).	Tighten cap or replace washer.
	Jammed pressure poppet (see item 4).	(See item 4)
	Leaky pressure valve due to scored seat or poppet.	Reseat or replace poppet.
	Pressure poppet is resting on camshaft (due to extra-deep reseating).	Check shaft, poppet end, and clearance between the two.

21. *Maintenance of Goodyear Master Cylinders*

At the 25-hour inspection, visually check the cylinder and air valve for leaks. At the 50-hour inspection, the supply tank should be filled when the master cylinder is installed in the airplane with the brakes released. Thereafter, the fluid supply should be replenished as necessary at each 50-hour inspection. At the 100-hour inspection, the master cylinder must be inspected for proper alignment and tightness of fittings, and at the 500-hour inspection, disassemble the unit and check the condition of the seals. If they are scored or out of shape, replace with new seals.

If dirt in the system clogs the compensating port in the master cylinder, the pressure on that brake would not be compensated and the brake would pump up after several strokes of the foot pedal and remain locked. If this should happen, the master cylinder should be removed, all parts cleaned, and the small compensating port ahead of the piston checked to see that it is not blocked.

22. Maintenance of Aircraft Accessories Sliding Selector Valve

Under normal circumstances, it shouldn't be necessary to disassemble or repair the unit except at very rare intervals. The majority of cases will involve only minor repair, such as replacing leaky piston-rod packing, rather than complete overhaul. The valve should never be touched as long as it operates satisfactorily, regardless of the length of time it has been in service. The basic design of the valve is such that sudden or complete failure is impossible and the valve should not be disturbed unless the necessity for repair is clearly indicated. The valve should be kept free from any foreign matter.

At the 25-hour inspection period, check the general condition of the valve for external leakage, proper operation, condition and security of mounting and operating levers and linkage.

Following is a list of the possible troubles, causes, and remedies encountered in the use of this valve:

<i>Trouble</i>	<i>Cause</i>	<i>Remedy</i>
Leakage around piston rod.	Damaged packing ring.	Replace ring.
Leakage around packing gland nut.	Damaged packing ring.	Replace ring.
Valve does not return to neutral.	Metering valve out of adjustment.	Readjust the metering valve.
	Insufficient indexing spring pressure.	Increase indexing spring pressure.
Excessive leakage between piston and cylinder sleeve.	Normal wear causing too great a clearance.	Replace both piston and housing assembly.
	Damaged piston or sleeve.	Replace valve.
Inability to obtain proper relief valve setting.	Damaged relief valve seats.	Relap seat. Use new ball when assembling. If seat is damaged beyond repair, replace with new seat and ball.

23. Maintenance of Aircraft Accessories Tail-bumper Jack Lock

At the 25-hour inspection, check for external leakage, proper operation, condition and security of the mounting and operating linkage. The unit should be kept free from any foreign matter, and should not be disturbed unless the necessity for it is clearly indicated. Following is a list of possible troubles, causes, and remedies encountered in the use of this unit:

<i>Trouble</i>	<i>Cause</i>	<i>Remedy</i>
Leakage past piston shaft.	Damaged packing.	Remove cap, replace packing.
Piston moves slowly with loss of power.	Damaged packing.	Remove piston, replace packing.
Leakage from check-valve end caps.	Damaged packing.	Remove caps, replace packing.
Unit inoperative.	Stuck shuttle valve.	Disassemble and check for damaged bore or packing.
Piston fails to lock or piston creeps.	Leaking check valves.	Disassemble, relap ball seats. Use new ball when assembling. Replace damaged packing.

24. Maintenance of Sperry Exactor Control

Once the Sperry exactor is properly installed and operated, practically no maintenance is required. However, following is a table giving possible troubles, causes, and remedies for the mechanism:

<i>Trouble</i>	<i>Cause</i>	<i>Remedy</i>
Failure to fill the system.	Considerable amount of air in system.	Repeat filling procedure making sure to keep enough fluid in reservoir.
	Incorrect filling procedure.	

<i>Trouble</i>	<i>Cause</i>	<i>Remedy</i>
Failure to hold setting.	Leaky fitting.	Tighten or replace.
	Leaky packing.	Replace.
Failure to synchronize.	Insufficient oil in reservoir.	Refill reservoir and push transmitter handle back and forth several times.
Frequent need for synchronizing.	Leak in system.	Check line for leaks.
	Synchronizing valve held open by particle of dirt.	Disassemble and clean.

QUESTIONS

1. What daily inspection is required for a deboosters?
2. What is the most probable cause of a leaky check valve?
3. What might be the cause of an incorrect sequence of operating cycle of a sequence valve?
4. Give at least 5 general suggestions which should be kept in mind when servicing hydraulic equipment.
5. What is the most important thing regarding replacement of packing in an actuating cylinder?
6. How would you remedy a leakage of oil or air between the two chambers of a Vickers accumulator?
7. How is a Cuno filter cartridge cleaned?
8. In an Adel selector valve, what might cause fluid leaks around the camshaft retainer?
9. What might be the cause of a leaky relief valve?
10. What daily maintenance is recommended for reservoirs?
11. How would an air leak in the suction line affect an engine-driven pump?
12. If a hand pump fails to deliver fluid from one end of the piston, how would you remedy the condition?
13. How is a swivel joint tested?
14. What might cause erratic "cut in" and "cut out" pressure reading with a Vickers unloading valve?
15. In the Electrol unloader valve, how is the exact maximum pressure value set?

16. If an automatic coupling fails to permit free flow, what might be the cause?
17. What must be done if dirt clogs the compensating port in the Goodyear master cylinder?
18. What precaution must be taken before an accumulator is removed?
19. What type of fluid is recommended for a Vickers piston-type pump?
20. How is a brake control valve checked?
21. What might be the cause of an inability to synchronize the Sperry exactor control?
22. In the event the exactor control fails to hold its setting, what should be checked?

Chapter VI

TROUBLE SHOOTING; HYDRAULIC FLUIDS

1. *General*

Hydraulic systems generally require very little servicing and maintenance. This is one of the big advantages in the use of this means of actuation. Most of the inspections required for a hydraulic system call for checking of the general condition and security of all units, ascertaining proper operation of the system, investigation of external leaks in lines and at connections, and maintenance of the proper amount of fluid in the hydraulic reservoir.

2. *Trouble Shooting*

Before looking for possible troubles with a hydraulic system, the mechanic should understand the complete operation of the system in question. A diagram of the system should be studied carefully until the normal operation is clear. In trouble shooting, the mechanic should never jump to conclusions and remove or adjust any unit that he comes across. The exact trouble should be determined first. The system should be operated and the operation checked against one which is known to be the proper operation. The pressure shown on the pressure gauges should be observed. All the possible causes of trouble should be eliminated one by one until the exact fault is located. Only after the exact trouble is located beyond any doubt in the mechanic's mind, should the faulty unit be removed or adjusted. Once a system has operated properly in its original installation, only a very few things can possibly go wrong with the system itself. These may be classified as insufficient fluid in the system, air, leaks, or obstructed lines or fittings in the system.

If the system still functions improperly after all these possibilities are checked, it can be concluded definitely that some unit is at fault rather than the system itself. However, before condemning any particular unit, it should be firmly established ex-

actly what unit is causing the trouble. Obviously, nothing can be gained, and a great deal can be lost, by unnecessarily disassembling a properly operating unit. Generally, the following things will cause a unit to function improperly: internal or external leaks in the unit; foreign particles clogging or restraining some part of the unit; improper adjustment; mechanical damage; or, excessive clearance caused by constant wear.

After the troublesome unit is fairly definitely located, that unit should be removed from the airplane. However, before it is disassembled, it should be flushed with clean hydraulic fluid and then checked on a test bench similar to the one shown in Fig. 6-1.

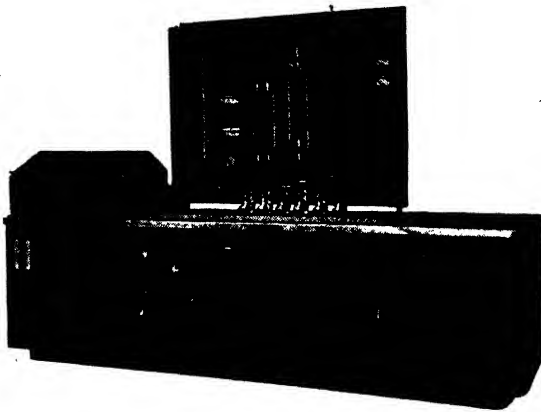

Courtesy Pisco Products, Inc.

FIG. 6-1. HYDRAULIC TEST BENCH.

(A test bench is a system mock-up capable of duplicating the operating conditions of the system itself.) If the unit still functions improperly after it has been bench-tested, it may then be disassembled. However, if it functions properly, it should be reinstalled on the airplane and the system should be tested again for proper operation. If the system still functions improperly, some other unit or the system itself must be examined.

3. *Maintenance of Hydraulic Systems*

Most of the maintenance on a hydraulic system includes checking the general condition and security of all operating mechanisms, eliminating all leaks in lines and at connections, achieving

the proper functioning of the system, and keeping the correct amount of hydraulic fluid in the reservoir.

At the pre-flight inspection, before starting the engine, the operation of the hand pump should be checked by operating some unit with the hand pump. Then the engine is started and the power pump is checked for its ability to develop normal system pressure. At the same time, by operating all mechanisms which can be operated on the ground by means of the power pump, the pressure regulator is checked to determine if it maintains system pressure properly.

If there is an accumulator in the system, it should be checked before starting the engine by pumping it up to normal pressure with the hand pump. Then, with the aid of one of the smaller selector valves, slowly use up the stored pressure in the accumulator. The pressure gauge will indicate the decrease in pressure and then will show a sudden drop to zero. The pressure which is indicated just before this sudden drop to zero is the air pressure in the accumulator. This value should be checked against the value recommended for the accumulator; if it is less than the required amount, it is an indication of an air leak in the accumulator. An external leak will be shown up by the formation of bubbles when soapy water is applied about the air valve and seam of the tank. If there is an internal leak in the accumulator, fluid will emerge from the air valve when the valve is depressed. An internal leak will also be indicated by a complete and sudden depletion of pressure when an attempt is made to operate a mechanism with the pump inactive.

In systems which include power-control valves, if there is an air leak in the accumulator, the power-control valve will kick out prematurely and erratically as sudden pressure loads are imposed upon it.

The quantity of fluid in the reservoir should be checked daily. If there is an appreciable loss of fluid after a single day's flying, it indicates that there is a leak present in the system and this condition should be traced.

Generally, a detailed check of the hydraulic system should be made at the 25-hour inspection. Each mechanism should be operated through at least two complete cycles. When the landing gear system is checked, be sure that the airplane is properly supported. The complete operation checks should be performed

with the hand pump and then with the power pump. An auxiliary source of power, such as a hydraulic test stand, may be used in case it is not convenient or safe to operate the engine-driven pump. Hydraulic system pressure and return lines are usually provided with tap-ins by which corresponding lines from the test stand may be connected. Otherwise, make the connections at the line-disconnect valves. The pressure indicated on the gauge should be checked against the pressure specified for the system. If the time required to operate the mechanism decreases with successive operations, it indicates that air is being worked out of the system. If the hand pump operates with excessive ease, an internal leak in the pump is indicated. If the pressure attained with the engine-driven pump fluctuates, it indicates an inadequate fluid supply to the pump, or an excessive amount of air in the system. If the mechanism operates with a jerky motion, binding or fouling is indicated. The position indicators should be checked against the actual positions of the mechanisms through a complete cycle of operation. The signal light and the warning horn should be checked to see that they go on and off at exactly the proper time.

The mechanism should be operated so as to leave a load on the actuating cylinder, and then with the pump inactive, note whether the mechanism creeps, *i.e.*, whether the landing gear extends, the flaps lower, etc. If creeping is observed, it indicates an internal leak in the actuating cylinder or an internal leak in one of the valves in a near-by section of the system.

At the 25-hour inspection, the condition and security of all system units, plumbing, hose, mounting brackets, clamps, and operating mechanism should be carefully checked. The fluid lines should be shaken to detect loose anchorage. Polished areas and worn spots should be investigated to determine whether the lines have moved out of place or whether they have been damaged by moving parts of the airplane. All lines that are deformed, dented, or kinked must be replaced. Flexible hoses should be checked to see that they are held clear during operation of the mechanism. To detect soft spots and deterioration, at points of suspicion the flexible hoses should be squeezed with the forefinger and the thumb. Flexible hoses should be kept free of oil and grease at all times. Oil and grease are removed with a clean cloth dampened in denatured alcohol.

Trace all fluid leaks to their source and make any necessary repairs. Leaky tubing should be replaced. Leaks at connections can sometimes be stopped by a slight tightening of the fitting. If this action does not stop the leak, break the connection and inspect the tube flare for dents or cracks. Never attempt to stop a leak by excessive tightening of the fitting because this will only cause more damage to the flare. Experience will teach the mechanic just when a connection is adjusted snugly and not tightened excessively. If a torque wrench is used, never use a wrench longer than 4" on ¼" diameter aluminum tubing, 6" on a ⅜" line, and 8" on a ½" line. The following maximum torque values in in-lb should never be exceeded: ¼" line-70 in-lb; ⅜" line-125 in-lb; ½" line-200 in-lb.

4. *Bleeding the Hydraulic System*

The incompressibility of a hydraulic system is partly defeated if air enters the system. Air is compressible and therefore, part of the energy expended is used up in compressing the air. This condition is extremely undesirable and before the system can function normally again, the air must be removed. This process of removing the air from the system is known as "bleeding the system." If air is present in a system, it may be detected by applying pressure to the brakes. If a spongy reaction is obtained, it indicates that air is present and the system must be bled. The compression of the trapped air causes the spongy feeling. The following method may be used to bleed the system:

First, check all fluid lines to make certain that they are properly and securely installed. Fill the reservoir with the proper fluid and check carefully while bleeding the system to make certain that the reservoir does not become empty. Now, remove the cap or screw from the bleeder fitting and unscrew the bleeder valve one-half turn. Slip one end of a piece of rubber tubing over the bleeder fitting and allow the free end to hang into a glass receptacle. Then, pump fluid out of the reservoir and through the system by operating the brake pedal back and forth slowly. Continue this operation until the fluid flowing out of the hose connection on the bleeder is free of air bubbles. Before all the air is removed, at least one pint or more of fluid must be pumped through the system. After the bleeding operation is complete, close and recap the bleeder valve. Then correct the fluid in the

reservoir to its proper level and check the success of the bleeding by pushing down on the brake pedal in order to operate the brakes. The action of the pedals should be "hard." If the action still feels spongy, check fluid lines and connections for leaks. Replace any damaged fittings and then bleed the lines again.

5. *Adjusting Valves*

When it is necessary to adjust several relief valves in a hydraulic system, only one valve should be adjusted at a time. Starting with the valve having the highest kick-out setting, the valves are adjusted in descending order with the valve having the lowest kick-out pressure being adjusted last.

The adjusting screw of the valve to be adjusted is backed out and the adjusting screws of the other relief valves are screwed in. Should there be a power-control valve in the series, it must also be locked and it is adjusted after all the relief valves have been adjusted. The mechanism is operated and, with pressure applied against it, the pressure at which the relief valve kicks out is noted. The adjusting screw of the relief valve is then screwed in until the pressure gauge indicates the required pressure. Several readings should be taken and the average of these readings should be considered as the setting of the valve. The adjusting screw of the next valve to be adjusted is then backed out and the adjusting procedure is repeated.

Usually, a check valve is placed between the hand-pump outlet line and the system-relief and power-control valves. If this is the case, these valves cannot be checked with hand-pump pressure and the engine-driven pump or an external source of power must be used.

6. *Hydraulic Fluids—General*

In the design of hydraulic fluid, numerous things must be taken into account. First of all, nearly all hydraulically-operated mechanisms in a system operate from a central reservoir; therefore, hydraulic fluid must be designed to function satisfactorily in combination with the products of many different manufacturers. Moreover, in a single flight, an airplane may be subjected to variations in temperature ranging from $+ 100^{\circ}$ F to $- 67^{\circ}$ F. Therefore, hydraulic fluid must be able to perform over unusually wide ranges of temperature with a minimum change in physi-

cal characteristics. Also, a variety of cups, seals, gaskets, and diaphragms may be employed and the effect of the fluid on these items must be carefully studied during development. Although lubrication is not the most important function of hydraulic fluid, it should have inherent oiliness to a certain extent in order to minimize wear of moving parts and also to assure continued freedom from leakage.

7. *Types of Hydraulic Fluids*

There are two types of hydraulic fluids in use. One type contains a petroleum base; in the other type, vegetable oil is blended with some of the higher-boiling alcohols. The vegetable-oil type finds little use in aircraft except when natural rubber is employed in the hydraulic units. It *must never* be employed when magnesium is a part of any hydraulic mechanism. Petroleum base fluid is used widely because it is satisfactory for all synthetic rubber, leather and composition seals *except* natural rubber. It is also satisfactory in combination with all metals. A mechanic must be extremely careful to avoid mixing hydraulic fluids of the two different types and should this occur inadvertently, the mechanisms must be completely disassembled and thoroughly washed. Also, if a change is made from vegetable to mineral type of fluid, all parts of the hydraulic system must be washed with alcohol. If a change is made from mineral to vegetable type of fluid, the parts must be washed with gasoline.

Petroleum-base hydraulic fluid can always be identified by its red color brought about by a red dye in the fluid. Vegetable-base fluids are always colored blue.

8. *Fluids for Hydraulic Equipment*

A knowledge of the correct fluid to use at the correct time is extremely important as far as the mechanic is concerned. However, after it has been ascertained which type of fluid is to be used, it is just as important for the mechanic to determine which grade of that particular fluid should be used under certain climatic conditions.

Petroleum-base hydraulic fluid, also known as A.C. Specification No. 3580, Navy Specification M-339, Sperry oil, Univis 40, *et al*, finds great use in hydraulic-brake and hydraulic systems, hydraulic shock absorbers, and automatic-pilot servo units. As

mentioned above, it is always identified by its red color. For hydraulic-brake and hydraulic systems, in localities where the average temperature ranges from 20° below zero to all values above zero, a medium grade of No. 3580 should be used. In localities where the temperature constantly averages less than zero, a light grade of fluid should be used. These same conditions hold true for the use of this fluid in automatic-pilot servo units. For hydraulic shock absorbers, a medium grade of fluid should be used at all temperatures.

Castor-oil-base hydraulic fluid, also known as A. C. Specification No. 3586, Navy Specification M-574, Lockheed brake fluid, *et al*, is identified by its blue color. No. 3586 Grade C (light) is used for hydraulic brakes and hydraulic systems unless excessive leakage is encountered in hot weather, in which case Grade A (heavy) is substituted. For use in hydraulic shock absorbers, Grade A (heavy) is used if the average ground temperature is 20° F and above. Grade C (light) should be used if the temperature constantly averages 40° F and below.

Hydraulic fluid No. AN-VV-O-366 is supplied in one grade only and may be used in all hydraulic equipment in which type No. 3580 fluid, medium- or light-grade, or both are used. This all-purpose, one-grade mineral oil fluid may be used at all temperatures above - 75° F.

Edgewater-ring hydraulic fluid is used in all shock absorbers using Edgewater-ring springs. Since colloidal graphite has been added, the fluid must be thoroughly stirred immediately before use. It comes in only one grade which is used for all temperatures.

9. *Cleaning Hydraulic Equipment*

All hydraulic equipment is disassembled, thoroughly cleaned, and refilled at the time of the airplane overhaul. Depending upon the type of fluid used in the hydraulic system, kerosene, naphtha or alcohol is used to clean the equipment. If the system uses hydraulic fluid No. 3580 or AN-VV-O-366, kerosene or naphtha is used because some of the internal parts of the hydraulic system are made of materials upon which alcohols have a deteriorating effect. For systems which use fluid No. 3586, use special denatured alcohol (United States Treasury Department Formula No. 1) or butyl alcohol; Formula No. 1 is to be preferred.

Cleaning agents other than these alcohols do not mix well with

castor-oil fluids and may cause deterioration of packing. If fluids are changed from one type to another, or if types are erroneously mixed, all packings must be removed and disposed of.

10. *Handling Hydraulic Fluids*

In handling hydraulic fluids, care must be exercised to prevent their contamination. Keep storage containers sealed, and all handling equipment must be kept clean and should be used for handling hydraulic fluid only. Hydraulic fluid must not be exposed to the air for longer periods than absolutely necessary. Hydraulic fluid absorbs dust and grit from the air and this becomes a serious menace in certain localities. If fluid has been exposed to dust contamination, it should be filtered before using. Used fluid should also be filtered before using again. Filtering will remove all metal flakes and grit, as well as sludge from used fluid.

One way to filter hydraulic fluid is by using a ribbed glass or metal funnel of approximately 1-gallon capacity, a sheet of standard commercial filter paper, and a container to support the funnel and catch the filtered fluid. First, fold the filter paper into a funnel shape and place it in the funnel. Since the fluid passes through the filter slowly, it should be protected from contamination by dust particles in the air. This may be done by placing a cloth dampened in hydraulic fluid over the open end of the funnel to serve as a protection for the fluid during the filtering operation. After the fluid is filtered, it should be placed in a clean container properly marked to identify the contents. The container should be kept sealed until required for use.

QUESTIONS

1. Explain the color system for identifying hydraulic fluids.
2. What limitation is there in the use of petroleum-base fluid?
3. What precautions must be taken in the handling of hydraulic fluids?
4. What factors must be taken into consideration in designing hydraulic fluid?
5. What is meant by the phrase "bleeding the system?"
6. Describe one method of bleeding a system.
7. What grade No. 3580 fluid would you recommend for a hy-

draulic system on airplanes stationed in an area where the temperature never goes below 40°F?

8. When may AN-VV-O-366 fluid be used?
9. What precautions must be observed in cleaning hydraulic equipment?
10. What grade red fluid would you recommend at temperatures which constantly average below zero? Under the same conditions, what grade blue fluid should be used?
11. Explain the steps in a general trouble-shooting procedure.
12. Explain the procedure to be followed in adjusting a group of relief valves connected in series.
13. What does most of the maintenance on a hydraulic system include?
14. List the things to be checked at the 25-hour inspection.
15. What is the difference between hydraulic fluid Navy Spec. M-339 and M-574, and why is it not advisable to substitute one for the other?
16. What is Edgewater-ring hydraulic fluid?
17. When should the reservoir fluid quantity be checked?
18. Explain how the accumulator is tested at the pre-flight inspection.
19. How should flexible hoses be checked?
20. What are the maximum permissible torque values for a ¼", ⅜", and ½" line?

HYDRAULIC PLUMBING

1. *Hydraulic Plumbing*

Every mechanic should have a thorough knowledge of hydraulic plumbing details. Design details are not in the scope of the average mechanic's duty and therefore will not be discussed here. Mechanics should be familiar with methods of tube cutting, bending, flaring, fittings, flexible hoses, etc., and these will now be taken up. All of the photographs and much of the material in this chapter has been furnished by courtesy of the Parker Appliance Co.

2. *Types of Tubing*

There are two kinds of tubing in general use for airplane hydraulic systems: stainless-steel tubing for high-pressure hydraulic systems, and aluminum tubing for low-pressure hydraulic systems.

In high-pressure hydraulic systems involving pressures up to 3000 psi, stainless-steel tubing is principally used. This type of tubing has great strength but not too much weight. In fact, because of its great strength, its wall thickness can be comparatively thin. Consequently, it weighs less than an equal length of aluminum tubing because of the necessarily greater wall thickness of the latter. So-called 18-8 stainless steel is corrosive-resistant. Moreover, it needs no heating to soften it for flaring or forming. In fact, the part of the tubing that is flared is actually strengthened because it is strain hardened to some extent. Stainless-steel tubing is used on all landing gears, for brakes, and for "oleo" balance lines because of its resistance to damage by rocks and gravel which are frequently thrown by the wheels during takeoff and landing.

Aluminum tubing (52 SO) is used on low-pressure hydraulic systems. It has certain valuable properties which make it particularly adaptable to aircraft hydraulic systems. However, be-

cause of these very characteristics, additional care must be taken in handling, forming, shipping, storing, and installing this type of tubing. Because of its light weight and softness, it is easily flared and bent to template. Moreover, it is highly corrosive-resistant and has great resistance to fatigue. The fact that it can be hand formed easily at the time of final installation is an important labor cost factor. Because it is soft, a great deal of caution is necessary in handling to safeguard it against dents, scratches, and nicks.

3. *Tube Cutting*

When tubing is cut, it is extremely important to produce an end which is square and free from burrs, especially if a flared-



FIG. 7-1. TUBE CUTTER.

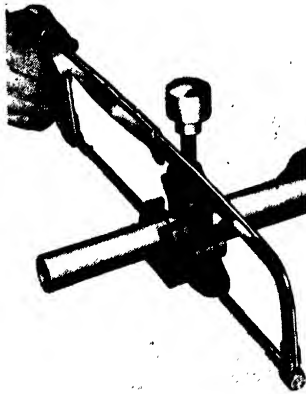

FIG. 7-2. CUT-OFF TOOL.

tube connection is to be made. A clean, square cut may be made with a special tube cutter, as shown in Fig. 7-1. When using this tool, lay the tubing on the two rollers and screw the cutting wheel lightly down against it at the point where the cut is to be

made. Then, rotate the cutter around the tube in a counter-clockwise direction, at the same time maintaining a light and even pressure on the cutting wheel by turning the handle. Be careful not to apply too much pressure to the cutting wheel or else the tube may be deformed.

If a tube cutter is not available, a fine-toothed hacksaw, preferably 32 teeth per inch, may be used to cut the tubing. Figure 7-2 shows a cut-off tool which includes a guide for using a hacksaw to cut tubing squarely and a V-channel which straightens the coil. The tube is clamped firmly in the yoke by means of a screw knob.

4. Tube Bending

Tubes should be bent accurately to the correct radius. A tube that springs out of position when the fitting is disconnected has not been fabricated accurately and is under an initial mechanical stress. For easy assembly and greater assurance against failure of the tube, the tube should be in initial alignment with the fitting. Figure 7-3 shows a tube bent to the correct angle so as to be in correct alignment with the fitting, whereas Fig. 7-4 shows an

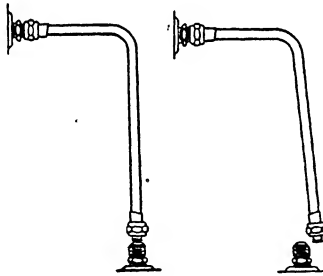

FIG. 7-3. CORRECT BEND.

FIG. 7-4. INCORRECT BEND.

incorrect bend; the tube is not in initial alignment with the fitting.

When bending tubing, the tube must be in a dead soft condition. First, remove all kinks or small bends from the tubing. In duralumin tubing, these are not likely to be found, but they frequently occur with copper or aluminum tubing. The tubing should be straightened as much as possible by use of the hands alone. Then, it should be laid on a perfectly smooth, wooden surface and rapped sharply with a flat piece of wood or a wooden paddle, at the same time rolling it back and forth. Continue the rolling and rapping until the tubing is perfectly straight.

In bending tubing, it is important to produce a smooth, even bend without flattening or buckling the tube. Several devices are used to bend tubing. One of these is a coil of steel wire having an inside diameter which is the same as the outside diameter of the tubing. Slip the coil on the tube and then shape with the hands to the proper degree of bend, with or without the aid of a bending block. When the bend is completed, remove the coil by twisting and pulling it against the spiral to avoid unwinding the spring.

Another convenient device for making a smooth and accurate bend is by using a hand tube bender. Figure 7-5 shows a hand



FIG. 7-5. HAND TUBE BENDER.

tube bender which is a very useful, efficient tool for bending small sizes of tubing. Thin-wall seamless tubes of soft copper, brass, aluminum or fully-annealed steel may be bent quickly and easily with this tool. The sheave block is graduated in angles of 15° from 0° to 180° , so that accurate bends are assured.

When placing the tube in the bender, Fig. 7-6-(1), raise the right handle of the bender as far as it will go so that it rests in a horizontal position as shown. Raise the clip and drop the tube in the space between the handle slide bar and the sheave block. Drop the clip over the tube and turn the handle slide bar about its pin, Fig. 7-6-(2), so that the full length of the groove in the slide bar is in contact with the tube. Note that the zero mark on the sheave block will coincide with the mark on the slide bar. This is the point at which the bend will begin. Proceed to bend the tube to the desired angle, Fig. 7-6-(3). To remove the bent tube from the bender, lift the slide bar handle back to its horizontal position as shown in Fig. 7-6-(1) and raise the clip. This hand tube bender is very useful in inaccessible places where the tube has already been partially connected, and where it is undesirable to remove the tubing for bending.

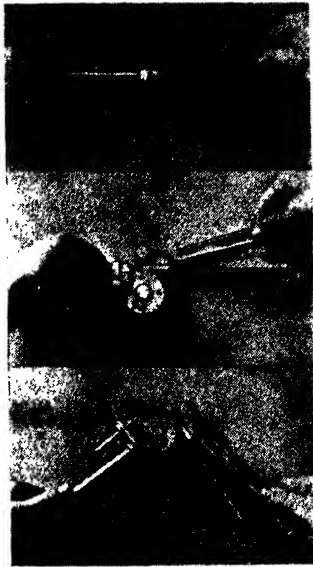

FIG. 7-6. USE OF HAND TUBE BENDER.

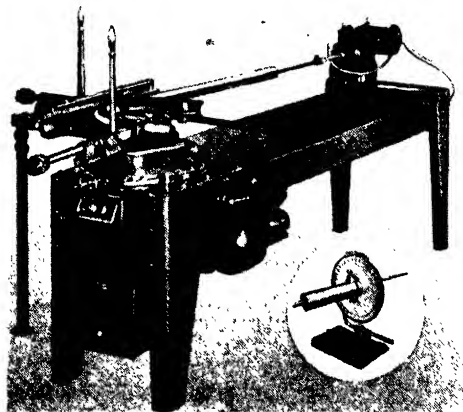

FIG. 7-7. POWER TUBE BENDER.

Where tubing must be bent in large quantities, power and production tube benders are used. The power bender, shown in Fig. 7-7, is driven by a 3 hp reversible electric motor and is capable of making bends of 180° in 10 seconds. An automatic stop controls the angle of bend with unusual accuracy and any number of tubes may be bent to the same exact angle. It may be used for tubing ranging in size from ½" O.D. to 3" O.D. The production tube bender shown in Fig. 7-8 is a manually-operated machine

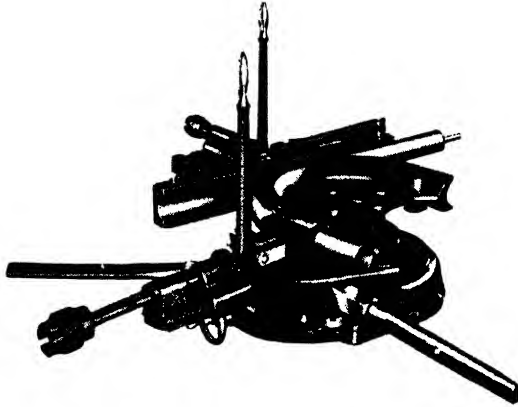

FIG. 7-8. PRODUCTION TUBE BENDER.

which also may be used for tubing ranging in size from ½" O.D. to 3" O.D. A dial indicator on the machine continuously shows the angle of bend and an automatic stop may be set to stop the bender accurately at any desired angle, for single bends and for production runs.

5. Dressing Tube Ends Before Flaring

If the tube has been cut with a tube cutter, the end will appear as shown in Fig. 7-9-(1), and should be filed square across as indicated by the dotted line. If a hacksaw has been used, as in Fig. 7-9-(2), the ends should be filed until all saw marks are removed. Flaring blocks make a good clamp for holding the tube while filing, but they should be inverted to avoid file marks on the top face. To insure filing the tube end square it should be allowed to protrude only slightly from the block and then it should be filed until the file runs flat across the face of the block, Fig. 7-10.

After the tube has been filed square, it must be burred inside and out; otherwise, a leaky joint or a split tube will result. Inside burrs can be removed best with a machinist's scraper or a pocket knife, Fig. 7-11. Burrs along the outside edge can be neatly removed with a flat file, Fig. 7-12. Do not round off the corners excessively.

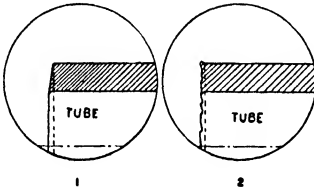

FIG. 7-9. TUBE ENDS AFTER CUTTING.



FIG. 7-10. FILING TUBE ENDS.



FIG. 7-11. BURRING THE
INSIDE EDGE.



FIG. 7-12. BURRING THE
OUTSIDE EDGE.

Remove all filings, chips, burrs, and grit from the inside of the tube to avoid split flares and pock marks on the fitting seats. If available, compressed air blown through the tube provides the best method of cleaning out copper or aluminum tube. Steel tubing, which usually has a protective film of oil or grease on the inside, is better cleaned by ramming a rag completely through the tube. If the tube is partly installed, it is a good policy to stuff a rag part way into the tube to prevent chips and filings from dropping in, and then carefully remove the rag after the filing and burring operations. These methods of cleaning the tube have been found the most satisfactory although other methods may be used. In some instances a long thin brush will prove quite handy for cleaning the inside.

Before proceeding with the flaring of the tube, inspect the tube end to be sure it is round, square, clean, free of draw marks, mill scale, or scratches. Scratches and draw marks are apt to spread and split the tube when it is being flared, especially if the tube is of steel.

6. Tube Flaring

If a tube is not flared properly, the connection may fail because a flared tube fitting is frequently subjected to extremely high pressures. An insufficient flare may leak or pull out whereas an excessive flare will reduce the wall thickness of the tubing thereby interfering with the proper engagement of the screw threads on the fitting. If a tube is cut unevenly, a crooked flare will result. The flare and tubing must be free from all defects such as cracks, dents, nicks, or scratches.

There are several methods of flaring a tube. A combination flaring tool, shown in Fig. 7-13, accommodates tubing ranging from



FIG. 7-13. COMBINATION FLARING TOOL.

$\frac{1}{8}$ " to $\frac{1}{2}$ " O.D. and is recommended for thin-wall, soft-annealed copper or aluminum tubing only. The sleeve and nut are slipped over and down on the tubing before the flare is made. Then the tubing is put in the proper gauge hole, clamped into position, and the flaring pin is centered over the end of the tubing. The tube projects approximately flush with the top of the flaring block jaws. The flare is made by striking the flaring pin several light blows with a medium-weight hammer or rawhide mallet. From experience, the mechanic will learn just how hard to strike the flaring pin. Figure 7-13 shows the steps in this process.

A ball-type flaring tool is used for thin-wall, standard-weight, soft copper or aluminum only, sizes $\frac{3}{8}$ " to $\frac{3}{4}$ " O.D. It should not be used for heavy-wall tubing, or for steel or other hard tubing. Slip the sleeve and nut over the end of the tube and allow the tube to protrude about $\frac{1}{16}$ " for $\frac{1}{2}$ " O.D. tube, increasing this distance for larger size tubes. The nut and tube are then gripped in a vise or held in the hand while flaring. The flaring tool is inserted to shoulder and rotated in the tube, pressing outward and downward

until the flare fits the nut, Fig. 7-14. A slow, circular, wiping motion with firm, even pressure to hold the neck of the tool against the tube produces the best results. Stop flaring when the

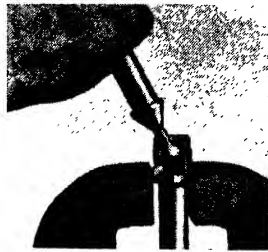

FIG. 7-14. BALL-TYPE FLARING TOOL.

flare fits the nut or it will be rolled thin under the powerful leverage of the tool. After flaring, thread the nut of the tool onto the tube nut to even out the flare.

7. Flare Requirements

Although incorrectly formed flares may seem to make up satisfactorily and pass initial pressure tests, they are not to be depended upon for continuous service. To insure proper seating, all flares should conform to accepted general requirements and also to certain specific requirements as determined by the type of fitting to be used for coupling the tube. These requirements include correct diameter, angle, squareness, concentricity, radius, and surface conditions.

A flare of correct form will appear as shown in Fig. 7-15. Figure 7-16-(1) shows a tube which is flared too short. In this



FIG. 7-15. CORRECT FLARE.

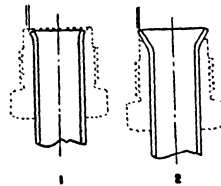

FIG. 7-16. INCORRECT FLARES.

case, the full clamping area of the fitting is not utilized and because of the small area of the tube that is clamped, the flare may be squeezed thin. Such joints do not offer maximum security

against leakage, breakage at the flare, or pullout strains. A tube which is flared too long, Fig. 7-16-(2), will stick and jam on the threads when assembling, and is likely to seat against the bottom of the coupling rather than on the tapered seat. Strong wrench pressure cannot be depended upon to bring such a flare to a tight seat. To check a flare diameter quickly, a "Go and No Go" Flare Gauge may be used. The large (GO) hole corresponds with the maximum diameter and the small (NO GO) hole corresponds with the minimum diameter. An oversize flare will not pass through either hole, an undersize flare passes through both holes and a correct flare passes through the large hole only.

The flare angle of the tube should be the same as the flare angle of the fitting. To insure this, use tools furnished by the manufacturer of the fittings used. An incomplete flare, such as illustrated in Fig. 7-17, cannot be depended upon to draw down



FIG. 7-17. INCOMPLETE FLARE.

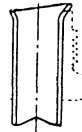

FIG. 7-18. UNEVEN FLARE.

properly on the fitting seats. In such cases, the nut tends to climb up on the flare so that there is very little grip on the tube after the fitting is assembled. For best results, complete all flares with the flaring tool to the proper angle.

Flares must be square and concentric with the tube and tube nut in order to seat properly. Flares may be "out of square" and eccentric because the tube has not been cut off square or because the flare has been formed unevenly in the flaring tool. An uneven flare, as shown in Fig. 7-18, is almost impossible to correct and should be cut off and done over.

If the defective form is due to careless use of the flaring tool, then usually the angle of flare is also faulty. Uneven flares are usually not aligned with the fitting seats and require greater wrench pressure to draw tight. If the flare is large, the elongated side will bottom in the fitting to prevent normal seating, or it will stick in the fitting threads. If the flare is relatively small, the

shorter side will not be gripped securely between the fitting seats and leakage may develop.

The radius at the base of the flare should coincide with that on the tube nut. Otherwise, difficulty in obtaining a proper seat may be experienced. If the tube has been flared into the nut or sleeve of the fitting, the radius will, automatically, be correct. Flaring blocks are originally provided with the correct radius and this radius will be obtained if correct flaring pins are used. Makeshift wooden flaring blocks flatten out quickly at this point and should not be used.

After the flare has been made, it should be given the same inspection for surface markings as before flaring. If chips, filings, or burrs have not been removed before flaring, they will be pounded into the flare and cause pock marks as shown in Fig. 7-19. Pock marks, scratches, draw marks, or other surface ir-

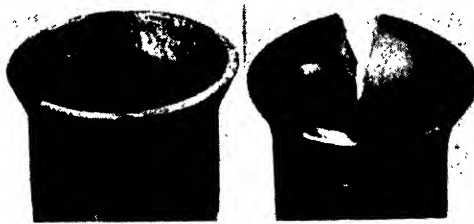

FIG. 7-19. POCK-MARKED FLARE. FIG. 7-20. SPLIT FLARE.

regularities make tight sealing uncertain and should be guarded against as much as possible. If such marks are present, the flare should be cut off and the tube reflared. Split flares, Fig. 7-20, may be caused by the tube being too hard, of uneven texture, or by the opening up of scratches or draw marks.

8. Fittings

A good mechanic should be thoroughly familiar with the names and numbers of all fittings used in hydraulic installations. Also he should be fully aware of exactly where and when certain fittings should be used. Figure 7-21 (1 to 9) shows typical fittings which are used in hydraulic plumbing. A *male* end is a fitting which is threaded on the outside, whereas a *female* end is threaded on the inside. The threads may be either pipe threads or straight

threads. Pipe threads are tapered and are generally used to connect tubes or hose to system units. Fittings with straight threads on both ends are generally used to join tubes together.

The union, Fig. 7-21 (3), is used for a straight connection between sections of tubing. The elbow, Fig. 7-21 (2 and 5) provides an angular connection and obviates bending of the tube. The tee,

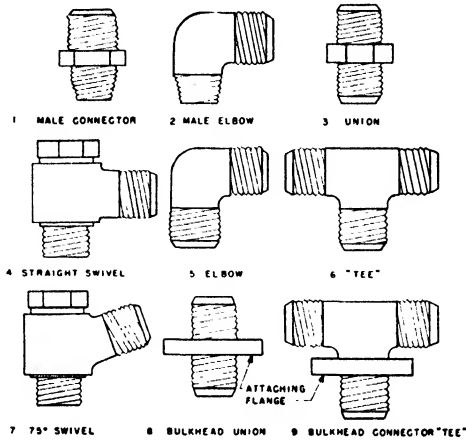

FIG. 7-21. FITTINGS.

Fig. 7-21 (6), is used for a three-way connection. The swivel fittings, Fig. 7-21 (4 and 7) are used to connect tubes and hose to system units. They permit line connections at various angles. Tube clips, not shown in Fig. 7-21, are made of aluminum alloy and are used to support tubing and prevent excessive vibration of the lines during flight. A rubber bushing is installed between the tube and the clip to prevent damage to the tube. Bulkhead fittings, Fig. 7-21 (8 and 9), are used where lines pass through bulkheads or walls.

9. Ports and Threads

From external inspection, it is difficult to distinguish between an AC and AN port. The basic difference is that the AC fitting seals with a crush washer and serration, whereas the AN fitting uses a rubber seal which is forced into a countersink on the upper portion of the port. Thread specifications also differ between NAF ports and AN ports. Essentially, the AN thread has fewer

threads per inch than the NAF in sizes over $\frac{3}{8}$ ". Therefore, NAF and AN fittings may be interchanged in sizes $\frac{3}{8}$ " and under if the sleeve nut does not bottom on the fitting and prevent the tube flare from coming in tight contact with the fitting end. In all sizes over $\frac{1}{4}$ " tube size, the AN thread lead varies from the AC specifications. Thus, AN and AC fittings are interchangeable in sizes $\frac{1}{4}$ " and under, except under the same condition as described for NAF and AN interchangeability.

The thread difference between a $\frac{3}{8}$ " and $\frac{1}{2}$ " fitting is only two threads per inch. Therefore, it is possible to thread an AC fitting into an AN port incorrectly for a distance of about three threads before the fitting becomes tight. The inexperienced mechanic might consider this condition to be just another tight fit and turn it down with a wrench. Under these circumstances, the fitting could be tightened until it moved to the snug position with what would not be considered excessive wrench torque. The mechanic, unknowingly, would have stripped the threads. When disassembled, the abused fitting would bind in the port and tear the threads beyond any possibility of retapping. To avoid this possible confusion, generally, AC fittings are gray in color whereas AN fittings are colored blue.

10. *Flexible Hose*

Wherever there is relative motion between two points connected by tubing, a flexible hose connection is used. Flexible hose has a hollow, synthetic-rubber center covered alternately with layers of wire or cotton braid and synthetic rubber. The number of layers and the material used, whether cotton or wire braid, determine under what maximum pressure the hose will operate safely. Fittings are installed on the hose and are swaged or compressed tightly in order to form a leak-proof connection. A small hole is drilled at the upper end of the swage to enable any seepage to drain out. On many hoses the inner sleeve extends slightly beyond the outer part of the fitting; therefore, hydraulic actuating cylinders must never be handled or hung up loosely by their hoses. A flexible hose must never be bent to a radius of less than six times its diameter or, for maximum safety, nine times its diameter.

On all flexible hoses, there is a white stripe which runs the entire length to indicate twist or torsion. After the hose is installed,

this line must always be straight or else the hose is shown to be under torsion. When a hose is put under pressure, it tends to straighten out and, if it is twisted, it may shear off in the fitting or loosen the nuts holding the fittings. Also, in installing a hose line, it must never be stretched tight between two fittings. At least 5% to 8% of its total length must be allowed as slack in order to give it freedom for operation under pressure. Moreover, a flexible hose shrinks under pressure and if there is not a sufficient amount of slack, it might pull out at the connections. Small cuts or abrasions on the outer cover are not causes for rejection; however, care must be taken to prevent such damage. Obviously, any hose failure, especially in a landing-gear system, may be exceedingly dangerous.

QUESTIONS

1. How may a flare diameter be checked quickly?
2. How is tubing cut?
3. What condition must tubing be in when it is bent?
4. How is tubing straightened?
5. How is an inside burr removed?
6. How is an outside burr removed?
7. When is a tee fitting used?
8. What is the purpose of tube clips?
9. When is a flexible hose connection used?
10. Name the two types of tubing in general use for hydraulic systems and tell when each is used.
11. Why is it important for a tube to be properly flared?
12. What are the requirements for a perfect flare?
13. Distinguish between a pipe thread and a straight thread.
14. What is the purpose of the white stripe on a flexible hose?
15. What is the basic difference between the AC and AN port?
16. In what sizes are the NAF and AN fittings, and the AN and AC fittings interchangeable?
17. When is stainless-steel tubing used?
18. What properties of aluminum tubing are valuable insofar as adaptability to hydraulic systems is concerned?
19. When is a bulkhead fitting used?
20. What are the general identifying colors for AC and AN fittings?

INDEX

- Accumulator, 18
Vickers, 19, 67
- Actuating cylinder, 3, 65
testing of, 66
- Adel* poppet-type selector valve, 43, 80
- Adjusting valves, 92
- Aircraft Accessories*, pressure regulator, 20, 76
selector valve, sliding, 50, 83
tail-bumper jack lock, 52, 84
- Automatic coupler, 27, 78
- Automatic neutral selector valve, 50, 83
- Basic principles, 2
- Basic system, 57
- Bending, tube, 99
- Bleeding hydraulic system, 91
- Bomb-door hydraulic system, 62
- Brake-control valve, maintenance of, 74
- Brake-control valve, *Vickers*, 30
- Brake booster, 30
- Brake hydraulic system, 28, 62
- Check valve, 8, 73
load-and-fire, 38
orifice, 27
- Cleaning hydraulic equipment, 94
- Cowl-flap hydraulic system, 61
- Cuno* filter, 46, 79
- Cutting, tube, 98
- Debooster, brake, 30, 75
- Disconnect coupling, 27, 78
- Dressing tube ends, 102
- Dump valve, emergency, 37, 78
- Electrol* unloader valve, 21, 78
- Emergency dump valve, 37
- Exactor control, *Sperry*, 53, 84
- Filter, 46
Cuno, 46, 79
Purolator cellulose element, 49
Purolator metal element, 48
- Fittings, 107
- Flare requirements, 105
- Flaring, tube, 104
- Flexible hose, 109
- Flow divider, 40
- Fluids, basic principles of, 2
filtering, 95
general, 92
handling, 95
hydraulic equipment, 93
types, 93
- Gauge, pressure, 15
- Gear-type pump, *Pesco*, 12
- Goodyear* master cylinder, 32, 82
- Hand pump, 5, 72
hydraulic system, 2, 4
- Hydraulic system, bleeding, 91
bomb-door, 62
brake, 28, 62
complete, operation of, 22, 24
cowl-flap, 61
general, 1
hand pump, 2, 4
landing-gear, 59
maintenance of, 88
power-pump, 10
typical, 57
wing-flap, 60
- Kenyon* multiple-check relief valve, 44
- Landing-gear hydraulic system, 59
- Line disconnect valve, 27
- Liquids, (*see* fluids)
- Load-and-fire check valve, 38
Vickers, 39, 79

Maintenance, accumulator, *Vickers*, 67
actuating cylinder, 65
automatic coupler, 78
brake-control valve, 74
check valve, 73
debooster, 75
dump valve, 78
extractor control, *Sperry*, 84
filter, *Cuno*, 79
general, 65
hand pump, 72
hydraulic system, 88
load-and-fire check valve, *Vickers*, 79
master cylinder, *Goodyear*, 82
pressure regulator, *Aircraft Accessories*, 76
pump, *Pesco* gear-type, 71
pump, *Vickers* piston-type, 69
relief valve, 73
reservoir, 72
selector valve, *Adel*, 80
selector valve, *Aircraft Accessories*, 83
sequence valve, 79
swivel joint, 66
tail-bumper jack lock, *Aircraft Accessories*, 84
unloader valve, *Electrol*, 78
unloading valve, *Vickers*, 75
Master cylinder, 32
Goodyear, 32, 82
power-brake, 30
Mighty Midgēt selector valve, *Adel*, 43, 80
Orifice, 27
Orifice check valve, 27
Pascal's law, 2
Pesco, flow divider, 41
gear-type pump, 12, 71
shuttle valve, 40
Piccolo valve, *Kenyon*, 44
Piston-type pump, *Vickers*, 41
Piston-type selector valve, 16
Plumbing, hydraulic, 97
Poppet-type selector valve, 15
Adel, 43
Ports and threads, 108
Power-brake control valve, 29
Power-brake master cylinder, 30

Power-control valve, 24
Power pump, general, 11
Power-pump hydraulic system, 10
Pressure gauge, 15
Pressure-gauge snubber, 26
Pressure regulator, 19, (*also see* unloading valve)
Aircraft Accessories, 20, 76
Pressure snubber, *Ray*, 26
Pump, gear-type, *Pesco*, 12, 71
hand, 5, 72
piston-type, *Vickers*, 41, 69
power, general, 11
vane-type, 11
Purolator filter, cellulose element, 49
metal element, 48
Ray pressure snubber, 26
Relief valve, 13, 73
Kenyon multiple-check, 44
Reservoir, 7, 72
Restrictor, 27
Rotor-type selector valve, 9
Selector valve, *Adel* poppet-type, 43, 80
Aircraft Accessories sliding, 50, 83
piston-type, 16
poppet-type 15
rotor-type, 9
Selsyn instruments, 46
Sequence valve, 38, 79
Shuttle valve, 40
Pesco, 40
Signals, warning, 45
Snubber, pressure-gauge, 26
Sperry extractor control, 53, 84
Surge chamber, 25
Switch, warning, 45
Swivel joint, 31, 66
Tail-bumper jack lock, *Aircraft Accessories*, 52, 84
Threads, ports and, 108
Time-lag valve, 36
Timing valve, 38
Trouble shooting, 87
Tube, bending, 99
cutting, 98
dressing, 102
flaring, 104
types of, 97

Unloading valve, (*also see* pressure regulator)

Electrol, 21, 78

Vickers, 35, 75

Valve, check, 8, 73

dump, 37, 78

line disconnect, 27

load-and-fire check, 38, 79

multiple-check relief, *Kenyon*, 44

orifice check, 27

power-brake control, 29, 74

power-control, 24

relief, 13, 73

selector, *Adel* poppet-type, 43, 80

selector, *Aircraft Accessories* sliding, 50, 83

selector, piston-type, 16

selector, poppet-type, 15

selector, rotor-type, 9

sequence, 38, 79

shuttle, 40

time-lag, 36

timing, 38

unloading, (*also see* pressure regulator)

unloading, *Electrol*, 21, 78

unloading, *Vickers*, 35, 75

Vane-type pump, 11

Vickers, accumulator, 19, 67

brake-control valve, 30

load-and-fire check valve, 39, 79

piston-type pump, 41, 69

relief valve, 14

unloading valve, 35, 75

Warning, signals, 45

switch, 45

Wing-flap hydraulic system, 60

DATE OF ISSUE

This book must be returned
within 3, 7, 14 days of its issue. A
fine of ONE ANNA per day will
be charged if the book is overdue.

--

