

Birla Central Library

PILANI (Jaipur State)

Class No :- 597.8

Book No :- C39M

Accession No :- 29946

THE METABOLISM OF THE
FROG'S HEART

EDINBURGH MEDICAL MONOGRAPHS

THE METABOLISM OF THE FROG'S HEART

BY
A. J. CLARK, M. G. EGGLETON,
P. EGGLETON, R. GADDIE,
C. P. STEWART

DEPARTMENTS OF MEDICAL SCIENCES
UNIVERSITY OF EDINBURGH

OLIVER AND BOYD
EDINBURGH: TWEEDDALE COURT
LONDON: 33 PATERNOSTER ROW, E.C.

1938

PRINTED IN GREAT BRITAIN BY
OLIVER AND BOYD LTD., EDINBURGH

CONTENTS

CHAP.	PAGE
INTRODUCTION	ix
I. DESCRIPTION OF THE FROG'S HEART	1
II. INORGANIC CONSTITUENTS OF THE FROG'S HEART	16
III. ORGANIC CONSTITUENTS OF THE FROG'S HEART AND BLOOD	37
IV. FACTORS INFLUENCING THE OXYGEN USAGE OF THE FROG'S HEART	56
V. CARBOHYDRATE METABOLISM OF THE FROG'S HEART	102
VI. NON-CARBOHYDRATE METABOLISM OF THE FROG'S HEART	122
VII. ANAEROBIC METABOLISM OF THE FROG'S HEART	136
VIII. PHOSPHORUS METABOLISM OF THE FROG'S HEART	153
IX. EFFECTS OF ASPHYXIA ON THE MECHANICAL RESPONSE OF THE FROG'S HEART	171
X. RELATIVE EFFECTS OF DEPRESSANT AGENTS ON MECHANICAL RESPONSE AND METABOLISM OF THE FROG'S HEART	192
XI. RELATIONS BETWEEN THE ELECTRICAL AND MECHANICAL RESPONSES AND THE METABOLISM OF THE FROG'S HEART	210
XII. RECOVERY PROCESSES IN FROG'S HEART	238
XIII. COMPARISON OF METABOLISM OF CARDIAC, SKELETAL AND PLAIN MUSCLE	258
APPENDIX—	
I. METHODS OF MEASUREMENT OF THE MECHANICAL RESPONSE OF THE FROG'S HEART	270
II. METHODS OF MEASUREMENT OF THE RESPIRATORY EXCHANGE OF THE FROG'S HEART	275
III. METHODS OF MEASUREMENT OF THE RATE OF ASPHYXIAL EXHAUSTION OF THE FROG'S HEART	281
IV. CHEMICAL METHODS	282
REFERENCES	286
INDEX	298

ILLUSTRATIONS

FIG.	PAGE
1. Structure of frog's heart	2
2. Sections of frog's ventricles	3
3. Section of frog's ventricles	4
4. Oxygen consumption of frog's heart	63
5. Relation between frequency and oxygen consumption	72
6. Frequency and rate of asphyxiation	75
7. Frequency and rate of asphyxiation	76
8. Rate of asphyxiation of arrested ventricle	77
9. Frequency and oxygen consumption	78
10. Relation between filling and oxygen consumption	79
11. Relation between filling and oxygen consumption	79
12. Influence of filling on mechanical response	82
13. Development of hypodynamic condition	96
14. Influence of temperature on rate of asphyxiation	99
15. Influence of temperature on rate of asphyxiation	100
16. Effect of lactate, etc., on exhausted ventricle	119
17. Effect of amino-acids on exhausted ventricle	131
18. Effect of fatty acids on exhausted ventricle	134
19. Effect of asphyxia on mechanical response and lactic acid production	140
20. Effect of asphyxia on mechanical response and lactic acid production	141
21. Effect of glucose, etc., on asphyxiated ventricle	143
22. Effect of glyceric aldehyde, etc., on asphyxiated ventricle	150, 151
23. Effect of glutathione on asphyxiated ventricle	152
24. Rate of asphyxial depression under various conditions	157
25. Effect of asphyxia on phosphagen content	158
26. Rate of asphyxial depression of fresh and exhausted ventricles	174
27. Lactic acid formation in asphyxia	177

FIG.	PAGE
28. Rate of asphyxial depression of normal and I.A.A. poisoned ventricles	182
29. Rate of asphyxial depression of I.A.A. poisoned ventricles	184
30. Action of cyanide on heart	188
31. Action of urethane on heart	200
32. Relative effect of narcotics on mechanical response and metabolism of heart	201
33. Relative effect of calcium lack on mechanical response and metabolism of heart	203
34. Action of potassium excess on heart	203
35. Action of CO ₂ and of asphyxia on mechanical and electrical responses	229
36. Recovery processes of frog's ventricle	247
37. Methods of measuring mechanical response of frog's heart	271
38. Methods of measuring mechanical response of frog's heart	272
39. Methods of measuring mechanical response of frog's heart	274
40. Method of measuring R.Q. of frog's heart	276
41. Method of measuring R.Q. of frog's heart	277
42. Method of measuring oxygen consumption of auricles	278
43. Method of measuring oxygen consumption of heart	280

INTRODUCTION

THE chief aim of this monograph is to give an account of the researches upon the metabolism of the frog's heart which have been carried out in Edinburgh University during the past ten years.

Many of the conclusions given in earlier papers have been modified by subsequent work, and hence it has been thought desirable to collect and revise the data and present them in the form of a monograph. The general line of research followed by the authors has been conditioned chiefly by the peculiarities of the frog's heart. This tissue presents certain outstanding advantages and disadvantages as a subject for metabolic research.

The outstanding advantage of the cold-blooded heart is that it will survive for many hours and even for days when perfused with a few c.c. of Ringer's fluid, always provided that the oxygen supply is adequate. Such a system is very simple and consequently favourable for the estimation of the materials used in metabolism.

Another peculiar and indeed unique advantage of the frog's heart is that its natural mode of supply of oxygen and of food material is from the fluid perfusing its interior. Associated with this peculiarity is the very large internal surface possessed by the ventricle. A frog's heart perfused with oxygenated Ringer's fluid therefore works under conditions much nearer normal than does a skeletal muscle such as the sartorius when suspended in oxygen or in Ringer's fluid, since

the latter preparation is deprived of its normal channel of respiratory exchange and of food supply.

The outstanding advantage of the frog's heart over the mammal's heart is that the latter will only maintain activity approximating to the normal when perfused with well-oxygenated blood, and this fact limits investigations of its metabolic activity.

Unfortunately the frog's heart presents certain equally definite disadvantages. Its size is inconveniently small for chemical estimation, it is an unpaired organ which shows wide individual variation in its chemical composition and, finally, its irregular shape, fragility and intolerance of oxygen deficiency make difficult the measurement of the work it performs. The difficulty as regards size can be avoided by treating several hearts in the same manner and estimating them together. The difficulty as regards individual variation is more serious, since it involves using a sufficient number of experimental and control animals to obtain averages which are statistically significant. Unfortunately in a single batch of frogs the chemical composition of the hearts changes during captivity, and hence it is necessary to make control estimations at the same time as the experimental values are determined. Uncertainty as to whether the control estimations were exactly comparable with the experimental results was found to be a serious source of possible error, and, in general, the authors feel that conclusions based on differences between control and experimental values are not completely satisfactory.

These outstanding characteristics of the frog's heart have largely determined the line of the research described in the present monograph. The general aim of the authors has been to determine the nature of the metabolism of the frog's heart when this works under

conditions approximating as closely to the normal as is possible. In accordance with this attitude chief attention is paid in the present monograph to the behaviour of the whole muscle and less attention to results obtained with muscle pulp, washed muscle, etc.

One of the interesting features of the results described is the difference revealed between cardiac metabolism and the metabolism of the isolated skeletal muscle of the frog. The chief uncertainty about these comparisons is the difference in the experimental conditions used by the authors and those often used in the investigations of skeletal muscle. In the latter case it is usual to suspend the muscle in an atmosphere of nitrogen, but such treatment would paralyse cardiac muscle in a few minutes, for the latter can only be kept in good condition if it is perfused freely with fluid. In general, it may be said that the frog's heart is a delicate tissue which, if exposed to unphysiological conditions responds by paralysis or death, whereas frog's skeletal muscle is a much more robust tissue, which will continue to function under a wide variety of conditions. The authors suspect that many of the differences noted between the metabolism of cardiac and skeletal muscles of the frog are due to the differences in the experimental conditions which usually are employed.

The authors also have endeavoured to analyse the relations between metabolic processes and the contraction process, but the peculiarities of the frog's heart have made it necessary to follow lines of investigation different from those used with skeletal muscle.

The analysis of the contraction process in skeletal muscle is largely based on a study of the relations between heat liberation and the development of isometric tension. Unfortunately the measurement of the heat production of cardiac muscle presents

exceptional experimental difficulties, and many of the results are suspected of being records of experimental errors. Furthermore, it is impossible to arrange conditions which are truly isometric in the case of cardiac muscle.

Hence only a limited amount of information can be obtained from the study of the time relations of heat production and development of tension. On the other hand, the all-or-none character of the response of frog's cardiac muscle makes it a favourable system on which to study the recovery processes, and its relatively slow contraction and prolonged electrical response also favours such studies.

The work described in this monograph was carried out with the assistance of the Medical Research Council, the Moray Fund of the University of Edinburgh and the Carnegie Trust for the Universities of Scotland. Moreover, a grant to aid in the expenses of publication was received from the last mentioned body. We desire to express our thanks to these bodies for their assistance.

Our thanks are also due to the editors of the *Journal of Physiology* for permission to reproduce Figs. 10, 12, 19, 20, 24, 25, 27, 31 to 35, 40, 42 and 43; to the editors of the *Quarterly Journal of Experimental Physiology* for permission to reproduce Figs. 6, 7, 8, 14, 15, 28 and 29; to Mrs A. R. Todd (Dr A. S. Dale) for supplying Fig. 3 and for permission both to use Fig. 35 and to quote unpublished work; to Dr W. G. Millar for preparing the sections shown in Fig. 2, and to Dr I. Chang for permission to quote unpublished work.

CHAPTER I

DESCRIPTION OF THE FROG'S HEART

The Gross Structure—The Ratio between Heart and Body Weights
—The Microscopic Structure—General Physiology.

The Structure of the Frog's Heart

THERE are certain details regarding the gross and microscopic structure and the weight of the frog's heart that are of importance in relation to its metabolism. These special details are considered below, but it has not been thought necessary to give any general account of the anatomy or histology of an organ that is so well known.

The sinus and auricles of the frog are thin membranes strengthened by bands of muscle, but the ventricle has a more complex structure, for its outer wall is a thin membrane whilst the interior is composed of interlacing trabeculæ. The general structure somewhat resembles a hollow sponge enclosed in a thin bag.

The structure of the auricles and ventricle is shown in the drawings by Gompertz (1884) which are reproduced in Fig. 1. The thickness of a tissue is an important factor in all metabolic studies involving measurements of oxygen uptake, and since the thickness of both the frog's auricles and ventricle depend upon the degree of filling, it is necessary to consider the structure of the heart in relation to its filling.

The authors estimated the influence of filling on the thickness of the frog's ventricle by fixing two

2 THE METABOLISM OF THE FROG'S HEART

ventricles, one empty and the other distended with fixing fluid. Sections of these two preparations are shown in Fig. 2. The extent of the internal ventricular

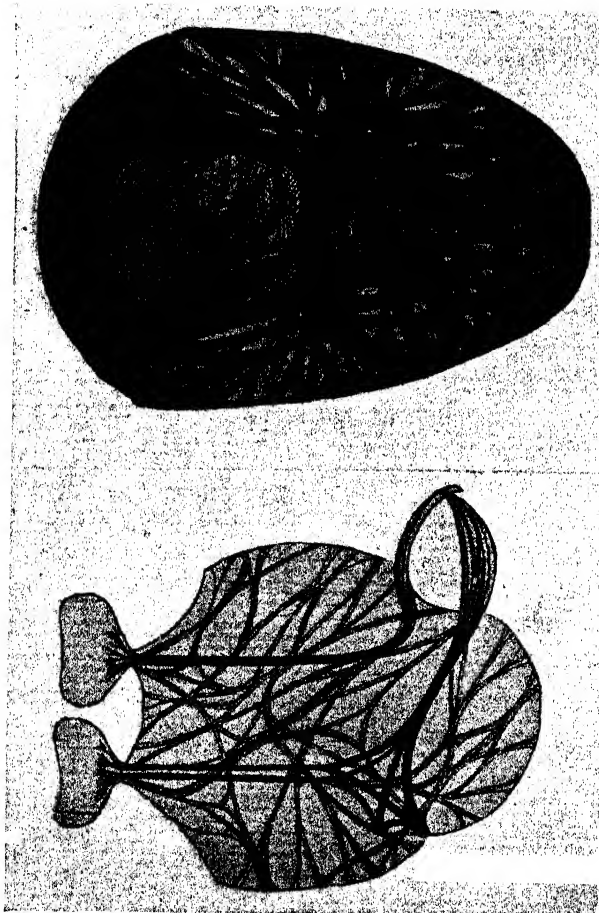

FIG. 1.—Structure of frog's auricle and ventricle (Gompertz, 1884).

surface is also shown in Fig. 3. In this case the heart was perfused for some time with a fine suspension of charcoal in Ringer's fluid, and the adsorbed charcoal particles show the internal surface very clearly.

The total surfaces and thickness of the trabeculæ in the empty and filled heart can be calculated from the sections shown in Fig. 2. The ventricles weighed about 0.11 g. and the distended ventricle contained

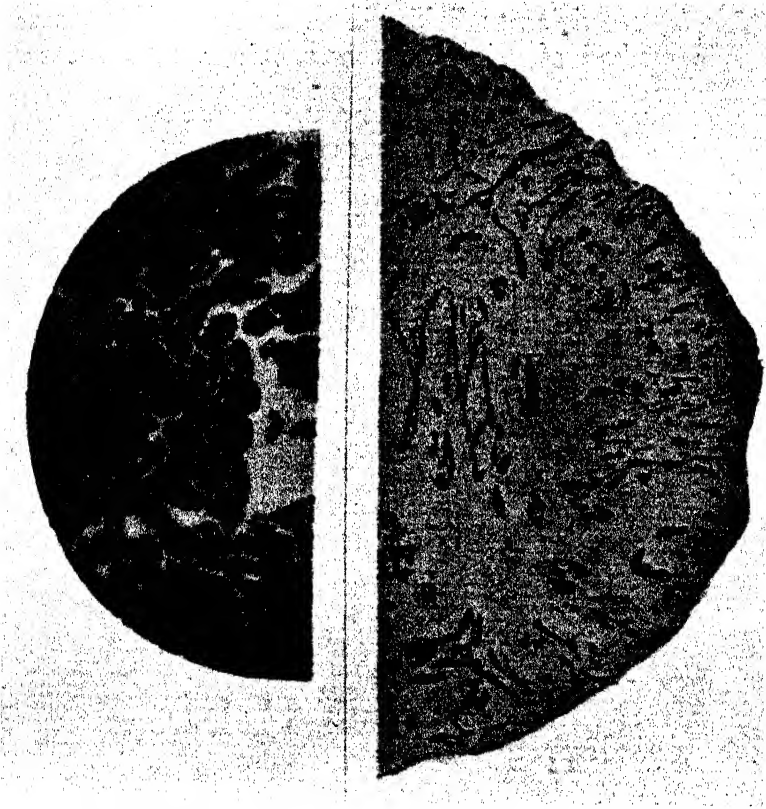

FIG. 2.—Sections of frog's ventricles (mag. 10 diam.). Left, empty. Right, fully distended. (Sections prepared by Dr W. G. Millar.)

between 0.2 and 0.3 c.c. of fluid. The empty ventricle may be taken as a sphere 6.5 mm. in diameter, with a volume of 0.14 c.c. (0.11 g. muscle and 0.03 c.c. fluid), and this corresponds to an external surface of 1.3 sq. cm. The distended ventricle may be regarded as a sphere

4 THE METABOLISM OF THE FROG'S HEART

of 9 mm. diameter, with a volume of 0.38 c.c. (0.11 g. muscle and 0.27 c.c. fluid), and the external surface is 2.5 sq. cm. The total internal surface of the ventricle was estimated approximately by determining the average thickness of the trabeculæ in the sections and assuming that the ventricle was divided into rods of this thickness. This method of calculation showed internal surfaces



FIG. 3.—Section of frog's ventricle (mag. 60 diam.). The heart was perfused with a suspension of charcoal prior to fixation. (Figure supplied by Mrs A. Todd.)

in the empty and filled ventricles of 75 and 110 sq. cm. respectively. An alternative method is to assume that the trabeculæ are sheets and this gives values of one-half of the former method. It seems fairly certain that the true value lies somewhere between these extremes.

The thickness of the frog's sinus was calculated by weighing the sinus and measuring its area when spread out on paper (Kingisepp, 1935). The thickness of the frog's auricle was estimated by measuring its weight

and its volume when empty and when filled (Clark and White, 1930). From these figures the surface area was calculated. The figures for the thickness and surface areas of the empty and filled ventricles and auricles are shown in Table 1.

TABLE 1

Thickness of Structures in Frog's Heart. (The figures apply to a heart of about 0.14 g. weight.)

	Empty.	Distended.
<i>Sinus—</i>		
Thickness in cm.	0.025	...
<i>Auricle—</i>		
Thickness in cm.	0.04	0.011
Surface area in sq. cm. per g. . .	48	176
<i>Ventricle—</i>		
Thickness in cm.	0.3	0.2
Pericardial surface in sq. cm. per g.	12	22
Thickness of trabeculæ in cm. . .	0.006	0.004
Endocardial surface in sq. cm. per g.	Between 330 and 680	Between 500 and 1000

These results show that the thickness of the tissues is considerably greater when they are empty than when filled. This difference does not, however, express the real difference between an empty ventricle or a strip of ventricular tissue on the one hand, and a ventricle contracting regularly with good filling on the other hand. In the case of the contracting ventricle the intraventricular fluid is squeezed out at each contraction and the whole internal surface is thoroughly irrigated. In the case of the empty ventricle or a strip of ventricular tissue the inter-trabecular fluid is more or less stagnant and hence, as regards oxygen uptake, the effective thickness of the tissue is about 0.1 cm. when stretched and 0.3 cm. when unstretched as compared with a thickness of 0.004 cm. in the case of the contracting ventricle.

6 THE METABOLISM OF THE FROG'S HEART

Another important point is that the endocardial surface of the ventricle is about thirty times as great as the pericardial surface, and this explains in part the striking difference in the effect of drugs applied to the inside and the outside of the ventricle respectively. Apart from this the endocardial endothelium also must be more permeable than the pericardium because drugs applied to the internal surface of the auricle act more quickly than when applied to the external surface, although in the case of this chamber the internal and external surfaces have a similar area.

The figures regarding the structure of the frog's heart show that, as long as the heart is circulating fluid freely and is well filled at each diastole, it is excellently arranged for the uptake of oxygen, and indeed the depth of diffusion needed to reach all parts of the trabeculæ is only about 20 micra. This advantage is completely lost when empty hearts or strips of ventricle suspended in air are used, because in this case the oxygen must diffuse 1 mm. or more. The frog's auricle is thicker than are the ventricular trabeculæ, but even here the thickness of the distended auricle is only about 100 micra.

A consideration of the oxygen usage shows that oxygen depletion is likely to occur quickly if the circulation is obstructed. A ventricle of 0.2 g. uses from 3 to 6 c.mm. of oxygen a minute. Such a ventricle contains at moderate diastolic pressure about 0.3 c.c. fluid, and this, when saturated with air, contains about 2 c.mm. of oxygen. Hence in such cases the supply of oxygen in the Ringer's fluid contained in a ventricle only suffices for about half a minute.

The results of these calculations correspond with experimental experience. As long as a frog's heart is adequately perfused with oxygenated fluid it functions

well, but it is impaired by arrest or by being kept empty. Furthermore, a strip of frog's ventricle suspended in oxygenated fluid will only maintain a steady activity if it is well washed with a strong jet of fluid every few minutes. The results of experimental methods which involve the use of heart strips must therefore be received with caution, because the ventricle in such cases probably suffers from partial asphyxia.

A comparison of the surfaces of the frog's ventricle and the frog's sartorius shows certain striking similarities. A sartorius which weighs 0.1 g. has approximately the following dimensions: $3 \times 0.4 \times 0.08$ cm. The surface area is therefore about 25 sq. cm. per g., and since the thickness is 0.08 cm. the greatest depth from the surface is 400 micra. These measurements are similar to those of the empty frog's ventricle (thickness 0.1 to 0.3 cm. and surface 60 to 20 sq. cm. per g.). A frog's sartorius suspended in Ringer's fluid therefore resembles a strip of frog's ventricle similarly suspended. On the other hand, the capillary surfaces of the sartorius, which are the natural route for the supply of oxygen, are of a different order. Krogh (1922) gives the following figures for the capillaries of frog's muscles:

Capillaries per sq. mm.	400
Capillary surface per c.c. muscle	190 sq. cm.
Half average distance between capillaries (radius of oxygen diffusion)	28 micra.

The capillary surface of 190 sq. cm. per c.c. and the radius of oxygen diffusion of 28 micra are similar to the corresponding figures in the ventricle, namely, 500 sq. cm. per g. of endocardial surface and a depth of diffusion of 20 micra. The frog's ventricle perfused with fluid therefore resembles, as regards opportunities

8 THE METABOLISM OF THE FROG'S HEART

for oxygen supply, a sartorius muscle with a full circulation.

The experiments described in this monograph relate to the metabolism of perfused cardiac tissue, and experience shows that ventricular strips rapidly show signs of oxygen lack. The cardiac metabolism found in our experiments shows certain striking differences from the metabolism of frog's skeletal muscle. This latter has, however, been worked out on muscles suspended in gas or in Ringer's solution, and it appears probable that one reason for the differences observed between the two tissues is that the heart receives an oxygen supply which is much nearer the normal than is that of the isolated sartorius muscle.

The Ratio between Heart Weight and Body Weight

The sponge-like nature of the frog's ventricle makes it difficult to weigh accurately. A strip of frog's ventricle dried with gentle pressure between filter paper contains about 30 per cent. of fluid, most of which can be squeezed out with firm pressure. Hence the weight found for a frog's ventricle or heart depends largely on the thoroughness with which it is dried. Furthermore the weight found for the whole heart depends upon how much of the sinus venosus and of the bulbus aortæ are included. The results obtained by different workers are therefore likely to vary extensively, but any single observer using a constant technique can obtain fairly constant results.

Table 2 shows average results obtained by the authors for frogs of various species. The heart ratio (heart weight $\times 1000 \div$ body weight) varies from 1.76 to 2.65. It is higher in males than in females and is somewhat higher in *R. temporaria* than in *R. esculenta*.

The authors' figures show that large frogs have a somewhat smaller heart ratio than small frogs, but this difference is doubtful. Zepp (1923) found that in *R. esculenta* the heart ratio was 1.9 in males and 1.7 in females, and was the same in small (20-30 g.) and

TABLE 2

Body Weights and Heart Weights of Frogs. (Authors' Averages.)

	Number of Individuals.	Body Weight in g.	Heart Weight in g.	Heart Ratio $\frac{H.W. \times 1000}{\text{Body Weight}}$
<i>R. temporaria</i> —				
Male	53	23.1	0.061	2.65
	28	34.0	0.090	2.64
Female	32	20.8	0.048	2.28
	14	36.0	0.075	2.08
<i>R. esculenta</i> (Dutch)—				
Male	9	27.0	0.056	2.00
Female	13	25.5	0.045	1.78
	25	50.0	0.088	1.76
<i>R. esculenta</i> (Hung.)—				
Male	21	71.0	0.183	2.58
	16	95.5	0.203	2.12
Female	16	75.0	0.174	2.32
	11	131.0	0.266	2.03

in large (30-60 g.) frogs. Behrens and Reichelt (1933) measured the heart ratio of 864 frogs (probably *R. temporaria*) whose body weight ranged from 17 to 55 g. They found a constant heart ratio of 4.2 for all sizes. Liang (1934) found that in toads the heart ratio fell with increasing body weight.

As regards the weights of the different chambers of the heart, the authors obtained the following figures with *R. esculenta* (Hung.) with a body weight of about 80 g.

10 THE METABOLISM OF THE FROG'S HEART

	Number of Animals.	Average Weight in g.	$\frac{\text{Weight} \times 1000}{\text{Body Weight}}$
Whole heart after perfusion (male and female)	127	0.15	1.9
Ventricle after perfusion	90	0.11	1.4

Wertheimer (1930) gives data in his tables from which the following averages were calculated :—

	Number of Animals.	Average Body Weight in g.	Average Ventricle Weight in g.	Vent. Wt. $\times 1000$ / Body Weight
<i>R. esculenta</i> (Hung.)—				
Male	36	81	0.125	1.55
Female	27	98	0.117	1.19

These figures show that the ventricular weight is about 70 per cent. of the heart weight. The non-ventricular portion of the heart comprises the sinus, auricles and bulbus arteriosus. Figures given by Clark and White (1930) show that the auricles and sinus together weigh about twice as much as the bulbus arteriosus.

The proportions of the frog's heart are therefore as follows :—

Ventricle	70 per cent.
Auricles and sinus	20 „
Bulbus arteriosus	10 „

The heart ratio varies widely in different species of frogs. This was shown by Latimer (1920) who found a heart ratio of about 4.4 and 4.8 in ten males and nineteen females respectively of *R. pipiens*, whilst Liang (1934) in a young toad found a heart ratio of 20.

The ratios recorded above are only approximate figures, since not only is it difficult to weigh accurately the frog's heart, but the body weight is influenced by such factors as duration of captivity, etc. These ratios are, however, useful in cases where it is necessary to analyse a frog's heart immediately after perfusion, since in such cases it is not always possible to weigh the heart, and its weight may have to be estimated from the body weight.

The individual variation in the heart ratio is considerable. In the case of 53 *R. temporaria* (male) shown in Table 2, the standard deviation of the heart ratios was 18 per cent. of the mean ratio. This implies that if the heart weights of 12 frogs are calculated from their body weights, the chances are 20 to 1 against the error of the mean result exceeding $2 \times 18 / \sqrt{12} = 10$ per cent.

Microscopic Structure of Heart Muscle

The frog's ventricular muscle cells consist of long branching spindles. Each cell contains one nucleus. The cells are developed as a syncytium and must function in the adult as a syncytium, because an excitation can spread in every direction through the cells.

Skramlik (1921) gives the following figures for the average dimensions of the cells of the frog's heart.

Sinus	0.073 × 0.0054 mm.
Auricle	0.193 × 0.0057 "
A-V ring	0.116 × 0.0091 "
Ventricle	0.131 × 0.0092 "
Bulbus	0.130 × 0.0060 "

The cells are spindle-shaped and therefore may be regarded as double cones. The volume of a cone equals one-third × area of base × height, and the surface

of a cone equals area of base \times height/radius of base. From these formulæ and from the figures given above the volume and area of the average ventricular cell can be calculated. The volume is 2.9×10^{-6} c.mm. and the surface area is 19×10^{-4} sq. mm. One g. of moist ventricular tissue therefore contains 345×10^6 cells, and the total cellular surface in this volume of material is 6600 sq. cm.

Fig. 1 suggests that most of the heart cells are arranged in trabeculæ which radiate from the centre; the length of the cells will therefore vary as the radius of the heart when this is varied by different degrees of filling. Measurements taken from Fig. 2 show that a ventricle which, when empty, has a diameter of 6.5 mm., has a diameter of 9 mm. when distended. The diameter of the empty ventricle therefore is increased about 33 per cent. by filling. The surface of the heart cells varies approximately as their length, and hence the cellular surface of a fully distended ventricle is only about 33 per cent. greater than that of an empty ventricle. This point is of interest in relation to the influence of filling on the metabolism of the ventricle.

General Physiology

The study of cardiac metabolism constantly involves reference to the normal metabolism, and hence it is convenient to consider what may be taken as a standard of normal activity for the frog's heart.

The activity of the frog's heart is, in the first place, conditioned by temperature. The Edinburgh climate shows an exceptionally small difference between summer and winter temperatures. The room temperature in summer rarely rises above 18° C., and the great majority of the authors' experiments were performed at

temperatures between 14° and 18° C. In general the writers have not observed any very extensive seasonal changes in frogs, and the probable reason for this is the small seasonal change in temperature, together with the fact that the frogs were kept in a cellar, the temperature of which varied over a relatively small range. These points are mentioned because in some cases differences between our results and those obtained by continental workers may reasonably be attributed to the much higher room temperatures in the latter case.

The frequency of the frog's heart is a function of the temperature, and the frequency of the heart of *R. temporaria in situ* at 15° C. is about 30, whilst the frequency of *R. esculenta* is somewhat less. Izquierdo (1929-30) found that immersion in Ringer's solution increased the heart frequency to about 40, but that after one or two hours' isolation the frequency fell to 20. In prolonged experiments with isolated hearts in which the sinus is intact the usual frequency at 15° C. when perfused with Ringer's fluid is from 25 to 30 and when perfused with frog's serum or plasma from 30 to 40.

The auricles of the frog during life are well filled with blood, and a well-filled auricle produces a pressure equal to about 10 cm. of water. This is sufficient to distend the ventricle fully, and inspection of the heart *in situ* shows that this occurs during life. The systolic blood pressure of the frog is equal to about 40 mm. Hg and inspection of the heart *in situ* shows that the ventricle does not empty itself completely at each beat.

The conditions obtaining in the isolated heart are different from those *in situ*. It is difficult to obtain sufficient frog's blood to use this undiluted, and in most metabolic experiments it is advantageous to use either Ringer's fluid or a Ringer-plasma mixture, since the

absence of red blood corpuscles makes the chemical composition of the heart-fluid system much simpler. Ringer's fluid or Ringer-plasma mixtures contain relatively small quantities of oxygen and in order to avoid depletion of oxygen at the cell surface it is necessary to have as free a circulation as possible. This point is particularly important if serum or plasma is used as a perfusion fluid, because the metabolic rate in this case is higher than with Ringer's fluid, but the oxygen content of the fluid is the same in the two cases.

The usual pressure system, which we have used with the isolated heart, is as follows: a venous pressure of 2-4 cm. of water, which ensures adequate auricular filling and checks return of fluid through the sinus during auricular systole; a systolic resistance as low as possible, which allows complete emptying of the ventricle during systole.

The isolated ventricle is irrigated less efficiently than the isolated heart, and experience has shown that this functions best if the frequency is kept below 20 per min. The diastolic pressure generally employed with the isolated ventricle has been about 5 cm. of water and this does not produce complete diastolic filling when the frequency is greater than 20 per minute.

The heart of the frog *in situ* receives mixed venous and arterial blood and hence the oxygen pressure is probably relatively low. The carbon dioxide is removed chiefly through the skin (Krogh, 1904), and hence the pressure of CO_2 even in the mixed arterio-venous blood is low. Wastl and Seliskar (1925) estimated it to be about 25 mm. Hg.

In the perfused heart the oxygen pressure in the perfusion fluid is higher and the carbon dioxide pressure is lower than in the frog's heart blood. The oxygen

capacity and the buffer power of the perfusion fluids are, however, much lower than those of frog's blood, and hence the pressures of the gases under discussion which occur at the actual cell surfaces *in vivo* and *in vitro* probably do not show such wide differences as are shown by the bulk of the perfusion fluid.

The heart isolated with a double cannula differs from the heart *in situ* in the following respects. It works against a lower resistance and its surfaces are thoroughly irrigated with fluid characterised by a high oxygen and a low carbon dioxide pressure. In the case of hearts perfused with blood the difference in these pressures from those *in vivo* must be considerable, but in the case of hearts perfused with Ringer's fluid, or Ringer-plasma, the differences at the actual cell surface may be less. The question of oxygen and carbon dioxide pressures is of importance because it is probable that changes in these can modify the nature of the cardiac metabolism.

Finally, the remarkable survival powers of the isolated heart of the frog deserve special mention. The auricle, if prepared under aseptic conditions and provided with oxygen and plasma, will continue to contract regularly for a week or more. Even the heart perfused with Ringer's fluid alone will maintain regular activity for 24 to 48 hours. The majority of our experiments have been for 6 hours and in these cases there can be no question of the results being due to the tissue being in a moribund condition.

CHAPTER II

INORGANIC CONSTITUENTS OF THE FROG'S HEART

Water Content—Inorganic Ions—Phosphate Content—Lipoid Phosphorus—Carbonate Content—Buffer Power—Lability of Ions, Potassium, Calcium and Phosphates—Changes produced by Perfusion—Lability of Cations and Buffer Power—Autonomic Nerves and Cation Release.

THE frog's heart provides somewhat scanty material for quantitative analysis and hence data regarding its composition are inadequate. The authors have collected the existing information and have made a certain number of analyses to supplement this. All the results have been expressed in terms of the wet weight and, in cases where the original figures were in terms of dry weight, such figures have been multiplied by one-sixth, since this is the commonest value found for the ratio dry weight/wet weight. In cases where no figures are available for the frog's heart, data relating to the tortoise or turtle hearts are included.

Inorganic Constituents of Frog's Heart

Water Content.—The water content of the frog's heart is shown in Table 3. The question as to whether the water content changes significantly during perfusion is of considerable importance, because any extensive change would constitute a serious source of error in many metabolic experiments. Frey and Tiemann (1926) weighed six frogs' hearts before and after perfusion for

4 hours and found that the average weights only changed from 0.088 to 0.081 g.

Mononobe (1930) gives average figures for the water content of frogs' hearts. He found this to be 79.7 per cent. after 30 minutes' perfusion and 79.9 per cent. after 4 hours' perfusion.

Clark, Gaddie and Stewart (1931) estimated the dry weight as expressed in per cent. of moist weight. In four fresh hearts this figure was 16.45, and in four hearts perfused with Ringer's fluid for 24 hours the figure was 15.3. Gradinesco (1926) compared 20 control hearts with 12 hearts perfused with glucose-Ringer's fluid under aseptic precautions for long periods (average 11 days). He obtained the following figures expressed as per cent. of moist weight.

	Dry Weight.	Nitrogen Content.
20 control hearts . . .	13.7	1.42
12 perfused hearts . . .	14.5	1.31

These results indicate that no significant change occurs in the water content of the frog's heart during prolonged perfusion.

Inorganic Ions.—Table 3 shows a potassium content of 0.2 per cent., and the only figure available indicates that the sodium content is considerably lower. The calcium content of the heart appears to be somewhat higher than the corresponding figure for the plasma.

Urano (1908), Fahr (1908), and Mond and Netter (1932) showed in the case of frog's skeletal muscles that most of the sodium and chloride could be washed out by perfusion for a few minutes with isotonic glucose solution, and it is generally believed that most of the sodium and of the chloride are present in the tissue fluids and not in the cells.

Figures for the ash of mammalian hearts (Lohmann

18 THE METABOLISM OF THE FROG'S HEART

and Weicker, 1933) show a Na/K ratio of about one-half and a chloride content of 0.15 per cent. of original heart weight. These figures are higher than the corresponding figures for mammalian skeletal muscle, a fact which may be due to the heart containing more blood and tissue fluid.

TABLE 3

Percentage Inorganic Composition of Frog's Heart or Ventricle
(*R. esculenta unless otherwise stated*).

(a) *Water content*—

Auricle	90.5 ¹
Ventricle	84.0 ¹
Whole heart	86.0 ² perfused 75 mins.
	83.5 ³
	86.3 ¹⁰
Japanese toad, whole heart	79.5 ⁴

(b) *Sodium*—

Whole heart	0.047 ⁵
-----------------------	--------------------

(c) *Potassium*—

Auricle	0.38 ¹
Ventricle	0.23 ¹
Whole heart	0.21 ⁵ , 0.2 ⁶ , ⁸ , 0.33 ⁹ , 0.22 ¹¹
South American toad	0.11 ⁷

(d) *Calcium*—

Auricle	0.07 ¹
Ventricle	0.025 ¹

¹ Kraus, Wollheim and Zondek (1924).³ Clark, Gaddie and Stewart (1931).⁵ Knynska, Witanowski (1930).⁷ Neuschloss (1926).⁹ Bernard and Richard (1932).¹¹ Clark, Gaddie and Stewart (1934).² Nagaya (1929).⁴ Mononobe (1930).⁶ Clark (1922).⁸ Zeehuisen (1927).¹⁰ Gradinesco (1926).

The figures for the frog's heart are scanty, but are in accordance with the hypothesis that the heart cells contain very little sodium.

Phosphate Content.—The phosphate content of the heart is of special interest on account of the importance of phosphates in relation to the metabolic processes

associated with contraction. Analyses of the acid soluble phosphate fractions are shown in Table 4. Mononobe (1930) estimated the phosphate content of the hearts of toads and tortoises and obtained the following figures (phosphorus as per cent. of moist weight).

	Inorganic Phosphorus.	Total Acid Soluble Phosphorus.
Toad, winter	0.025	0.151
Toad, summer	0.038	0.133
Tortoise, winter	0.027	0.158
Tortoise, summer	0.029	0.128

These figures are considerably higher than most of the corresponding results for frogs shown in Table 4.

TABLE 4

Phosphate Fractions of Frog's Heart expressed as Phosphorus in Percentage of Moist Weight

	Clark, Eggleton and Eggleton (1931, 1932). <i>R. esculenta</i> Hung.		Lohmann (1928). <i>R. temporaria</i> .	Weicker (1934). <i>R. esculenta</i> .	
	Fresh.	Perfused 24 hours with Phosphate-free Ringer's Solution.	Fresh.	Fresh.	Perfused.
Orthophosphate	0.011	0.016	} 0.033	0.017	} 0.044
Creatine phosphate	0.007	0.005		0.005	
Pyrophosphate	0.011	0.008		0.014	
Hexosphosphate	0.013	0.013
Organic phosphates—					
Barium insoluble	0.011	0.010
Barium soluble	0.043	0.049
Total acid soluble	0.085	0.087	0.142	0.100	0.045

Lipoid Phosphorus.—Javillier, Crémieu and Hinglais (1928) found that the frog's heart contained

97 mg./100 g. of lipid-P and 6 mg./100 g. of nucleic-P. The authors (Clark, Gaddie and Stewart, 1937) found 80 mg. of lipid P per 100 g. of heart. Analyses by these authors and by White (1929) show that in the mammal's heart the lipid-P is about 100 mg./100 g. and the total-P about 200 mg./100 g. Table 4 shows that in the frog's heart the total acid soluble-P lies between 85 and 142 mg./100 g.

The frog's heart therefore resembles the mammal's heart, and in both cases the acid soluble phosphorus and the phosphorus present in phospholipins are approximately equal and together amount to about 200 mg./100 g.

Bicarbonate Content.—The high resting metabolism of the frog's heart renders difficult the accurate estimation of its normal carbonate content. For example, if a strip of frog's ventricle be put in a Barcroft apparatus filled with oxygen and left for 10 to 20 minutes to allow equilibrium before acid is run over the tissue then the bicarbonate found is likely to be too low, because a strip under these conditions does not obtain adequate oxygen and may form a considerable quantity of lactic acid which will release carbon dioxide. A heart, when contracting under anoxæmic conditions in contact with a small volume of fluid, forms about 50 mg. lactic acid per 100 g. in 10 minutes (Clark, Gaddie and Stewart, 1934). The resting strip described above might easily form 20 mg./100 g. and this would be equivalent to 3 c.c. CO₂ per 100 g.

The probable bicarbonate content of the heart *in situ* can be calculated indirectly from the carbon dioxide tension of the frog's blood. Krogh (1904 and 1910) concluded that carbon dioxide was excreted chiefly through the frog's skin and that therefore its tension was similar in arterial and in venous blood.

He concluded that the probable carbon dioxide tension was as low as 10 mm. Hg. Wastl and Seliskar (1925) found that the aortic blood of frogs contained 58 vols. per cent. of carbon dioxide, and estimated the probable tension to be between 22 and 29 mm. Hg. They also concluded that the probable pH was 7.48, and that the figure of pH 6.3-7.1 found by Rohde (1920) was incorrect. Argyll Campbell (1931) found the following gas tensions in the subcutaneous tissues of the frog: carbon dioxide 14 mm. Hg, and oxygen 48 mm. Hg.

These figures indicate that the probable CO_2 tension of the blood in the heart during life lies between 10 and 20 mm. Hg. Brody (1930) estimated the relation between the CO_2 tension and the CO_2 content of strips of frog's ventricle. His tables show a CO_2 content of 8 vols. per 100 g. with zero carbon dioxide pressure and about 10 vols. with a CO_2 pressure of 30-40 mm. Hg. He concluded that the buffer power of the frog's heart was between one-half and two-thirds that of skeletal muscle. Fenn (1934) using similar methods found the preformed carbon dioxide in the heart was 7 vols. per cent. in summer frogs and 4 vols. per cent. in winter frogs. In another set of experiments conducted under special precautions he obtained the low value of 1.5 vols. per cent.

The authors (1931) have recorded considerably higher values for the carbon dioxide content of the fresh and the perfused heart (27 vols. and 11 vols. respectively), but in view of Brody and Fenn's results the former figure seems improbable. The experiments of both Brody and Fenn are, however, subject to the criticism that lactic acid formation may cause a considerable loss of carbon dioxide prior to its estimation.

Buffer Power.—The information regarding the buffer power of the frog's heart is scanty, and hence it is

necessary to consider also the results obtained with frog's skeletal muscle and mammalian heart muscle.

The functional activity of the heart is rapidly affected by changes in the pH , and in a solution containing bicarbonate the heart is arrested by a pH between 6.0 and 6.5.

Frog's skeletal muscle when immersed in Ringer's fluid is much less sensitive to acid than is the heart and the former is not paralysed until the pH falls below 4.5 (Grant, 1920). Gellhorn (1933) showed, however, that this apparent difference was due to the experimental conditions, and that when skeletal muscles were perfused with fluid a marked depression in activity was produced by reducing the pH from 7.1 to 6.72. The sensitivity of skeletal muscle to changes in pH is therefore similar to that of cardiac muscle, provided the muscle is perfused with and not merely soaked in the solution.

In the case of skeletal muscle it is generally agreed that acid formed in anaerobiosis is buffered chiefly by proteins and to a lesser extent by bicarbonate. Meyerhof and Lohmann (1926) calculated that about two-thirds of the lactic acid produced in anaerobic fatigue of skeletal muscle was neutralised by proteins. Stella (1929) showed in the case of frog's muscle exposed to an atmosphere of carbon dioxide that three-quarters of the carbon dioxide was neutralised by proteins and only one-quarter by other buffers.

Meyerhof and Lohmann (1926) measured the change in pH and lactic acid content associated with complete fatigue in the skeletal muscle of frogs. Table 5 shows the results which they considered most reliable. The figures indicate that complete fatigue occurs in summer frogs when the pH falls to about 6.8 and that this is caused by the accumulation of about 0.2 per cent.

lactic acid, whereas in autumn frogs the same effect occurs when the pH falls to about 6.5 and this occurs when the lactic acid content is about 0.35 per cent. above normal.

TABLE 5

Lactic Acid Content of Skeletal Muscle.

	Summer Frogs.			Autumn Frogs.		
	pH .	Lactic Acid.		pH .	Lactic Acid.	
		per cent.	m.mols./ 100 c.c.		per cent.	m.mols./ 100 c.c.
Resting . . .	7.0-7.44	7.3	0.03-0.07	0.3-0.8
Exhausted . . .	6.65-6.94	0.23-0.28	2.5-3.1	6.3-6.6	0.36-0.43	4.0-4.8

Katz and Long (1925) measured the lactic acid content of the cardiac and skeletal muscles of cats. The resting values were 0.34 and 0.64 m.mols./100 g. respectively, but on stimulation to exhaustion the lactic acid content of skeletal muscles rose to 3.0 m.mols./100 g., whereas that of the cardiac muscle only rose to 0.85 m.mols./100 g., although in most cases the heart was exhausted by asphyxia.

Furusawa and Kerridge (1927) estimated the buffer power of muscle pulp and found that, whereas 2 m.mols./100 g. lactic acid were needed to change the pH of skeletal muscle from pH 7.0 to pH 6.5, the same change was produced in cardiac muscle by addition of 1 m.mol./100 g. lactic acid. They found that the resting pH of both muscles was similar and about pH 7.05, but that in fatigue the pH of skeletal muscle fell to 6.26, whereas that of cardiac muscle only fell to 6.56. These results agree in showing that cardiac

muscle has only about half the buffer power of skeletal muscle and that the former is arrested by a smaller change in pH than the latter. Consequently the mammalian heart is arrested by an accumulation of lactic acid only about one-quarter as large as that needed to produce the same effect on skeletal muscle. All the evidence available indicates that there is a similar difference between the cardiac and skeletal muscle of the frog. Brody (1930) estimated that the frog's heart had about one-half the buffer power of frog's skeletal muscle. The authors (1934) measured the lactic acid content of the frog's ventricle at various stages of anaerobic depression. The results showed that the mechanical response of the heart was reduced to about half normal when the lactic acid content of the ventricle was 0.15 per cent., the lactic acid content of the fresh heart being 0.06 per cent. (Clark, Gaddie and Stewart, 1932). The results were influenced by the volume and buffer power of the fluid in contact with the heart, but they indicate that the frog's heart can neutralise about 0.1 per cent. of lactic acid. (1.1 m.mol./100 g.) This amount of acid would displace 12 vols. per cent. of CO_2 , but the evidence available indicates that a considerable proportion is neutralised by proteins. Comparison of these results with those shown in Table 5 indicates that the lactic acid maximum in the asphyxiated frog's heart is less than one-half of the corresponding figure in the frog's skeletal muscle.

The Lability of Ions.—The question as to the extent to which the inorganic constituents of heart muscle can diffuse out from the tissue is of importance in many respects.

Theories as to the nature of the cell membrane depend largely on the evidence regarding its relative impermeability to ions. There is, moreover, a con-

siderable amount of evidence relating the release of cations with the action of the autonomic nervous system. Apart from these problems of general physiology, the extent to which tissues can release ions is of importance in two respects, firstly, in respect of the changes in cardiac tissue produced by perfusion and, secondly, in respect of the buffer power of cardiac tissue.

The problem is a complex one and has two aspects. Firstly, the extent to which the inorganic constituents of the heart are modified by prolonged perfusion with solutions containing a normal balance of ions, and, secondly, the effect on the inorganic constituents of exposure to such abnormal influences as acidity, unbalanced solutions, etc.

The frog's heart is an exceptionally favourable tissue on which to study ionic equilibria on account of its very large internal surface which not only favours ionic exchange but also permits adequate oxygenation. There is a considerable amount of evidence to show that asphyxia and consequent acidosis changes the permeability of tissues to ions, and cardiac tissue has an important advantage over isolated skeletal tissue in that the former can be oxygenated much more thoroughly. On the other hand, the frog's heart only weighs about 0.1 g. and hence the accurate chemical estimation of ions is difficult. There is the further difficulty that frog's cardiac muscle contains not only muscle cells but a considerable amount of tissue fluid. This latter probably comprises 30 per cent. of the total. The ionic content of this tissue fluid is completely different from that of the cells. It is, however, impossible to wash the tissue spaces free from inorganic ions (*e.g.* with isotonic sucrose) without producing serious injury to the cells, and furthermore it is uncertain whether such treatment does not wash away ions that

normally are adsorbed on the cell surfaces. For these reasons it is not possible to determine with certainty the normal composition of the heart cells.

Evidence has already been advanced to show that most, if not all, the sodium and chloride found in heart muscle are found in the tissue fluids and not in the cells.

The frog's heart cells are impermeable to hydroxyl ions (Clark 1913 *a*); they are probably impermeable to hydrogen ions because acidity produced by excess of carbon dioxide produces a more rapid and intense effect on the heart than does an equal change of pH produced by inorganic or organic acids such as lactic acid (Smith, 1926). This difference is in accordance with the assumption that the cell wall is permeable to carbon dioxide but not to free hydrogen ions. The manner in which bicarbonates are divided between the tissue fluids and the cells is not known, but the permeability of the cells to CO_2 makes it probable that these contain some carbonate.

It has been shown that the frog's heart contains about 10 vols. CO_2 per 100 g., whereas frog's blood contains about 58 vols. CO_2 per 100 c.c. If we assume that the tissue fluids have a similar CO_2 content to frog's plasma, then these figures indicate that most of the CO_2 content of the heart must be contained in the tissue spaces.

If the composition of the tissue fluid is assumed to be similar to that of frog's plasma, then most of the sodium, chloride and bicarbonate found in the heart must be present in the tissue fluid and not in the cells.

The ions of chief importance inside the cells are calcium, potassium and phosphate. These contrast sharply with the sodium chloride and bicarbonate in that they are difficult to remove by washing with isotonic glucose.

Table 6 shows the authors' estimates of the probable composition of the heart cells of the frog as regards inorganic constituents and simple organic acids.

TABLE 6

Estimated Inorganic Composition of Muscle Cells of Frog's Heart, based on assumption that Heart contains 25 per cent. Tissue Fluid of same Composition as Frog's Plasma.

	Frog's Heart (<i>cf.</i> Table 3).	Frog's Plasma (<i>cf.</i> Table 12).	Estimated composition of cells of heart.
	Per cent.	Per cent.	Per cent.
Na	0·05	0·22	0
K	0·2	0·02	0·24
Ca	0·02	0·01	0·024
Cl ¹	<0·1	0·26	<0·05
Total P	0·2	0·03	0·24
Lactate	0·06	0·09	0·05
HCO ₃	0·02	0·16	0

¹ The Cl content of the frog's heart is estimated as less than 2/3rds of that of the mammal's heart.

The following points regarding the balance of ions within the heart cells are worth noting. The content of potassium in the heart (0·2 per cent.) is higher than any other inorganic constituent. The phosphates inorganic and organic in terms of P amount to 0·2 per cent. The inorganic phosphate amounts only to about 7 per cent. of this total, but as regards ionic balance, it is the total phosphate which must be considered, because the whole is present in the form of salts. The total phosphate is rather more than sufficient to combine at neutrality with the total potassium present.

These estimates are, of course, only intended as a first approximation, and in fact, the number of unknown variables is too great to justify any precise formulation of the nature of the ionic balance.

Since potassium and phosphates are the chief inorganic ions within the heart cells it is of interest to consider in more detail the evidence regarding their mobility.

The Lability of Potassium. — Boehm (1913) and Arima (1914) showed that hearts perfused with potassium-free Ringer's fluid until arrest and then left in contact with a small volume of fluid showed spontaneous recovery. The fact that potassium leaked out from the heart when this was perfused with potassium-free Ringer was proved by analyses of heart by Clark (1922), by Streef (1926) and by Zeehuisen (1927). The results obtained by these workers are in substantial agreement, and Zeehuisen's results, which are shown in Table 7, illustrate the manner in which potassium can be washed out of the heart.

TABLE 7
Loss of Potassium from Heart (Zeehuisen, 1927)

Potassium Content of Perfusion Fluid.	Duration.	Potassium Content Heart in per cent. wet weight.
Control	...	0.2
0.02-0.035	6 hours' normal beat	0.2
0.015	1 hour	0.175
0.0075	1 hour	0.152
nil	Arrest in 30 minutes	0.138
nil	2 hours	0.107
nil	6 hours	0.100

When perfused with normal Ringer's fluid the heart loses no potassium, but when perfused with potassium-free Ringer's fluid it loses one-third of its potassium in 30 minutes and is then arrested. Perfusion for 6 hours with potassium-free Ringer's fluid removes about half the potassium. Zeehuisen perfused 100 frogs' hearts

with potassium-free Ringer fluid for 6 hours and then the circulation was stopped; 85 hearts remained arrested, and their potassium content was calculated to be 0.091 per cent.; 15 hearts showed a partial recovery, and their potassium content was found to be 0.138 per cent. The latter figure therefore approximates to the minimum potassium content which will support spontaneous activity.

Krynska and Witanowski (1930) found that potassium-free Ringer's fluid arrested the frog's heart in 74 minutes and that there was then a loss of 30 per cent. of the potassium content of the heart.

Mehra (1923) found that when Ringer's fluid containing moderate excess of potassium (0.08 per cent.) was introduced into the heart none of this entered the heart.

Neuschloss (1926) found that perfusing the heart of *Bufo marinus* with isotonic KCl (0.85 per cent.) increased its potassium content from the normal of 0.64 per cent. dry weight to 0.89 per cent. dry weight (= 0.15 per cent. wet weight). This last figure is, however, lower than the normal potassium content found by other workers on European frogs. Zwikster and Boyd (1935) soaked strips of turtle's ventricle in solutions containing various concentrations of KCl. With the normal content (0.04 per cent. KCl) there was no loss or gain in 24 hours. With four times the normal content of KCl (0.16 per cent.) there was a gain of potassium of about 1 mg./g. in one hour, but no further gain in 3 hours.

Diffusion of potassium into the tissue fluids of the ventricular strip would only account for an uptake of potassium of 0.2 mg./g.; hence these results indicate a considerable uptake of potassium by the cells.

The evidence summarised shows therefore that the heart loses no potassium during prolonged perfusion with

normal Ringer's fluid, whilst perfusion with potassium-deficient fluid rapidly removes 30 per cent. of the heart potassium and this causes arrest of the heart. Prolonged perfusion with potassium-deficient fluid only removes half the potassium from the heart, and at this stage arrest of the circulation sometimes restores the heart. It appears therefore that about half the potassium of the heart is relatively labile, and as long as any of this is present arrest of the circulation may restore the heart, presumably because traces of potassium are liberated into the perfusion fluid. The quantity of potassium needed to produce partial restoration with 1 c.c. of perfusion fluid is only about 25 γ , whilst a normal heart of 0.1 g. contains 200 γ .

The Lability of Calcium.—Boehm (1913), Arima (1914), and Loewi (1918) found that a heart arrested by calcium lack in contact with a small volume of fluid showed spontaneous recovery. Lieb and Loewi (1919) estimated chemically the calcium excreted under such conditions and found it to be about 0.01 mg. They also found that a heart in contact with Ringer's fluid containing 0.008 per cent. CaCl_2 lost a similar amount of calcium. Arima found that repeated washing out of the heart with calcium-free Ringer's fluid produced an arrest from which the heart did not recover spontaneously. The K/Ca ratio in the heart is about 10/1, and hence it is not surprising that calcium exhaustion is produced more readily than potassium exhaustion. A frog's heart of 0.1 g. contains about 0.02 mg. Ca, and these results indicate that about half this quantity is easily lost, and that this loss produces arrest. The amount of calcium needed to produce partial restoration of a heart arrested by calcium lack is very small. Lanczos (1936) found it to be about 10 γ Ca in 1 c.c. fluid.

The Lability of Phosphates.—The analyses shown in Table 4 prove that the frog's heart does not lose phosphates after prolonged perfusion with phosphate-free Ringer's fluid nor does such perfusion cause any significant change in the relative proportions of the phosphate fractions. Lohmann (1928) found that the pyrophosphate content was nearly the same in controls (0.012 g. P per cent.) as in hearts perfused for 7 hours (0.014 g. P per cent.). Wertheimer (1930) estimated the content of inorganic phosphate in heart strips suspended in Ringer's fluid for periods of 1 to 10 hours. The content of resting and stimulated strips was compared. The averages of 25 experiments show values of 0.006 g. P per cent. for the resting and 0.013 g. P per cent. for the stimulated strips. Only traces of phosphate were found in the surrounding fluid. In later experiments (1931) he found that after prolonged isolation there was no difference between the pyrophosphate content of the resting and of the stimulated heart strips. In these experiments he found a phosphate loss equal to about 0.005 g. P per cent. This is a very small fraction of the total phosphate and might have been derived from either the acid-soluble or from the lipoid phosphorus compounds.

It already has been pointed out that ventricle strips suffer from partial asphyxiation when suspended in Ringer's fluid; this would affect both control and experimental strips and would favour the breakdown of phosphagen in both cases. Wertheimer's results are of chief importance in showing that even under conditions which favour phosphagen breakdown very little diffusion of phosphates occurs from the frog's heart into the surrounding fluid. The comparisons he makes between resting and stimulated heart strips seem, however, to be of doubtful significance.

In the case of frog's skeletal muscles Stella (1928) found that inorganic phosphate was exchanged between muscles and the surrounding saline solution and that a balance occurred when the saline contained 8 mg. P/100 c.c., whilst Semeanoff (1931) found this figure to be 20 mg. P/100 c.c. Eggleton (1933) found that equilibrium occurred in resting muscles with 10 to 15 mg. P/100 c.c. and with fatigued muscles with twice this figure. She also found that only 20 to 30 per cent. of the water of the muscle was involved in the diffusion system and suggested that the muscle cells were bounded by membranes which were impermeable to phosphate under the experimental conditions. She showed that the discrepant results obtained by Stella could be accounted for by the presence of bone which readily took up or gave out phosphate.

The cell membranes of both the heart and skeletal muscle appear therefore to be relatively impermeable to phosphates.

Changes Produced by Perfusion.—The evidence available shows that perfusion for 6 hours or more with normal Ringer's fluid produces no measurable change in the inorganic constituents of the frog's heart, nor does it change the dry weight/wet weight ratio.

Such perfusion produces obvious changes in the mechanical activity and the metabolism of the heart, but the evidence available indicates that the production of this hypodynamic condition is not due to any change in the inorganic constituents of the heart.

Lability of Potassium and Buffer Power of the Frog's Heart.—It has been shown that the frog's heart can lose half its potassium content, namely, 1.0 mg./g., and can continue to function provided traces of potassium are present in the perfusion fluid. This suggests the

possibility that lactic acid formed during asphyxia may be in part excreted as potassium lactate.

Clark, Gaddie and Stewart (1934) asphyxiated three ventricles (total weight 0.38 g.). The asphyxia was continued for from 15 to 20 minutes until the mechanical response was reduced to 30 per cent. of the normal. The asphyxia was repeated once, with a change of fluid. The fluid contained 0.03 per cent. phosphate and the volume used each time with each ventricle was 0.3 c.c. Analyses of the ventricles showed no potassium loss, for the K content was 0.221 per cent. as compared with a control value of 0.220. Analysis of the fluids showed a slight increase in potassium content. Control fluid 0.0096 per cent., fluid after first asphyxia 0.0119 per cent., and after second asphyxia 0.0104 per cent. These figures show a maximum possible loss of potassium of 0.008 per cent. of wet weight of the hearts. It therefore is improbable that potassium release plays any important part in buffering the lactic acid produced during asphyxia.

The release of potassium from the frog's skeletal muscles has been the subject of extensive investigation but, unfortunately, the evidence is conflicting. Some of the chief results obtained are as follows: Urano (1908) found that soaking frog's muscles in isotonic glucose solution for 22 hours reduced the potassium content to one-half (from 0.2 to 0.1 per cent.). Mitchell and Wilson (1921) found, however, that perfusion of frog's legs with potassium-free Ringer's fluid only caused a loss of 10 per cent. of the total potassium. They concluded that further potassium loss could only be produced by stimulation to extreme exhaustion. Ernst and his co-workers found a loss of potassium by direct but not by indirect stimulation (Ernst and Scheffer, 1928; Ernst and Csucs, 1929), but later concluded

(Ernst and Fricker, 1934) that when the permeability was increased by raising the potassium content of the perfusate above normal there was a loss of potassium with indirect stimulation. Fenn and Cobb (1936) concluded that it was difficult to show a loss of potassium in frog's muscles after stimulation *in situ* unless the stimulation was supplied directly to the muscle. Neuschloss and Trelles (1924) concluded that the potassium of frog's skeletal muscle was partly fixed and partly labile. The conclusions of Neuschloss have, however, been criticised and denied by Raab (1927) and by Hoeber (1928). Fenn (1933) found that acidity caused a release of potassium from the skeletal muscle of the frog. The muscle when immersed in fluid at ρH 7.7 was in equilibrium with a potassium content of 10 mg. K/100 c.c., but when the ρH was reduced to 6.3 a content of 70 mg. K/100 c.c. was needed to maintain equilibrium. This result agrees with previous work by Ernst and Takacs (1931) who found that frog's legs when perfused with 1.5 mg. c.c. lactic acid lost three-quarters of their potassium content.

Mond and Netter (1932) concluded that frog's muscles contained a mobile store of sodium which could be excreted as NaHCO_3 . They estimated this store as about 15 mg. Na/100 g. Brookens (1933) was, however, unable to confirm this conclusion. Malorny and Netter (1936) found that intravenous injections of sodium lactate increased the sodium content of the mammal's heart, and concluded that during exercise the heart and other tissues fixed a considerable amount of base.

The evidence regarding the existence of a mobile store of cations in frog's skeletal muscle appears therefore to be doubtful. The evidence existing suggests that perfusion with potassium-free Ringer

reduces the potassium content of the heart more readily than that of the skeletal muscle, but that the permeability of skeletal muscle to potassium is affected more easily by changes in the pH than is the permeability of the heart.

Autonomic Nerves and Release of Cations.—A connection between vagal stimulation and liberation of potassium in the heart was suggested by Howell in 1906, and Howell and Duke (1908) concluded that vagal stimulation caused liberation of potassium from the frog's heart into the perfusion fluid, a result which was confirmed by Zondek (1922, 1929) and by Scheinfinkel (1924). Hemmeter (1914) denied that vagal stimulation released potassium from the elasmobranch heart. Asher (1923) found that vagal stimulation released potassium from frog's heart.

In the case of mammalian tissues, Vogt (1936) concluded that stimulation of sympathetic fibres released potassium in the superior cervical gland. The hypothesis that vagal stimulation releases potassium has been supported by observations upon the effect of acetylcholine. Neuschloss (1926) found that acetylcholine (1 in 10^6) caused the potassium content of the perfused frog's heart to fall from the normal figure of 0.64 to 0.32 per cent. of dry weight. Other workers have found that potassium excess liberates acetylcholine from tissues. For example, Besnak (1934) concluded that potassium ions liberated acetylcholine from the frog's heart, and other workers have since demonstrated this effect in mammalian tissues (Feldberg and Guimaraes, 1936; Brown and Feldberg, 1936).

The influence of potassium excess on the action of acetylcholine and on the response of the frog's heart to vagal stimulation is complex.

Zwaardemaker and Lely (1917), Asher (1923) and

Ten Cate found that potassium lack first augmented and then abolished the action of the vagus. Clark (1927) found that potassium lack augmented the action of acetylcholine, but Davis (1931) found that it reduced the action of acetylcholine

Clark (1927) also found that excess of potassium slightly decreased the sensitivity of the frog's heart to acetylcholine.

Yasutake (1925) and Lanczos (1935, 1936) found that sympathetic stimulation caused liberation of calcium into fluid perfused through the hearts of tortoises and frog respectively.

There is therefore a considerable amount of evidence relating the action of the autonomic nervous system with the release of potassium and calcium from the heart.

The evidence, however, depends on relatively small differences observed between controls and experimental periods, and hence it must be regarded with caution.

CHAPTER III

ORGANIC CONSTITUENTS OF THE FROG'S HEART AND BLOOD

Carbohydrates—Glycogen Content of Mammal's Heart—Lower Carbohydrates—Non - fermentable Reducing Substances—Carbohydrates available for Glycolysis—Inositol Content—Lactic Acid—Proteins—Fats—Respiratory Pigments—Non-protein Nitrogen—Composition of Frog's Blood.

The Carbohydrate Content of the Frog's Heart

THE authors' conclusions in regard to the nature of carbohydrate metabolism depend to a large extent on the changes observed in the carbohydrate content of the heart. Owing to the fact that the heart is an unpaired organ the normal value of the carbohydrate content can only be determined by comparing averages of experimental and of control estimations. Consequently the factors causing variation and the extent of the variation in carbohydrate content are of importance. Furthermore, it is necessary to consider the changes other than glycolysis undergone by carbohydrates.

Our investigations have shown that the glycogen of the frog's heart is broken down fairly quickly, but that the heart contains a considerable quantity of lower carbohydrates. It is probable that some of these latter are derived from glycogen. Hence in the study of carbohydrate metabolism the measurement of the total carbohydrates in the heart is of importance as well as the estimation of glycogen. The number of chemical estimations that can be made on so small quantity of tissue as that provided by frogs' hearts is

limited, and the authors have preferred to estimate the total reducing substances rather than the glycogen in the heart. Such estimations include both glycogen and the lower carbohydrates and also some reducing substances which are not carbohydrates. The term total carbohydrates is used for the sake of convenience, although it is not strictly accurate.

Table 8 shows various values obtained in the estimation of total carbohydrates. These results show wide variations and the standard deviation for each batch is large in all cases (30 to 40 per cent. of the mean). In the case of the 1933 estimations the standard deviation given is less than the true figure, because in many cases a single combined estimation was made of two or three hearts.

TABLE 8

Carbohydrate Content of Unperfused Hearts of Frogs

	Number of Estimations.	Average per cent. (Moist Weight).	Standard Deviation of Individual Measurements.
(a) Glycogen—			
Wertheimer (1930) (ventricles)	15	1.72	0.45
Clark, Gaddie and Stewart (1931)	21	0.546	0.1
(b) Total carbohydrates or total reducing substances—			
Wertheimer (1930)	18	2.18	0.57
Wertheimer (1933):			
Nov.-Dec.	16	2.6	0.64
June-July	22	1.65	0.55
Clark, Gaddie and Stewart:			
(1931)	34	1.42	0.40
(1932 <i>b</i>) April-July	24	1.23	0.34
Oct.-Nov.	20	1.20	0.40
Dec.-Jan.	10	1.55	0.39
(1933 <i>a</i>) Batch I	19	1.52	0.27
II	6	0.89	0.25
III	12	1.50	0.20

The figures of both Wertheimer and the authors show a seasonal variation with higher figures in the winter than in the summer.

The authors also observed that extensive changes might occur in the total carbohydrate content of the hearts of a single batch of frogs during captivity. Provided that the frogs when first obtained (from Hungary) were in good condition the total carbohydrate in the heart was usually low, but this value rose during captivity, and the highest values were obtained with frogs that had been kept in captivity for a long time. Most studies of carbohydrate usage of the heart depend upon the reliability of the controls and the authors found that the only method of obtaining reliable controls was to make control estimations in parallel with the experimental estimations throughout the course of any series of experiments.

Most observers who have estimated the carbohydrate content of the hearts of either frogs or mammals have noted the extensive individual variation, and the factors influencing the glycogen content of the latter will be considered later.

As regards the distribution of carbohydrates in the heart, Wertheimer (1933) found that the base of the frog's ventricle contained 16 per cent. less than the apex. He found that in summer frogs the left half of the ventricle contained less carbohydrate than the right half, but that the two values were equal in winter frogs. The authors (1933) found that there was a fairly close correlation between the carbohydrate content of the auricles and ventricles in individual tortoises. In the case of nine tortoise hearts in which both auricles and ventricles were analysed the mean figure for the auricles was 1.5 and for the ventricles 1.67 per cent. total carbohydrate, whilst the average difference between

each pair of estimations was 0.27 per cent. In the case of 18 ventricles the mean value for the total carbohydrate was 1.77 per cent. with a standard deviation of 0.67 and a range from 0.82 to 3.08 per cent.

One portion of the frog or tortoise heart therefore will serve as a fairly reliable control as regards the carbohydrate content of the remainder. This is not true of the mammal's heart, for in the rat's heart the total carbohydrate content of the auricle is less than half that of the ventricle (Chang, unpublished results).

Factors influencing the Glycogen Content of the Mammal's Heart.

The outstanding feature of estimations of the glycogen content of the mammalian heart is the remarkable variation found both as regards individual variation and as regards the average values obtained for controls. For example, the control value for the glycogen content of rat's hearts was found to be 0.069 per cent. by Houssay and Mazzocco (1927), 0.19 per cent. by Dittmar (1933) and 0.57 per cent. by Lawrence and McCance (1931). Evans (1934) showed that the value found for the glycogen content of the mammal's heart depended entirely on the manner in which the rats were killed. He obtained the following average figures for the glycogen content of the hearts of rats starved for 24 hours when various methods of destruction were employed :—

	Per Cent. Glycogen Content.
Hearts removed after decapitation	0.342
Hearts removed under anæsthesia as rapidly as possible	0.488
Anæsthesia with 30 secs. delay after opening thorax	0.287
Hearts removed after death from asphyxia	0.025

These figures show that estimations of the glycogen content of the mammal's heart have no significance unless the strictest attention is paid to the method of slaughter and of removal. Evans (1934) also showed that asphyxia could remove half the glycogen of the heart in less than a minute and reduce it to 0.083 per cent. in two minutes. He also found that partial anoxæmia (5-6 per cent. oxygen breathed for 3 hours) produced the same effect on the heart glycogen but did not reduce the skeletal muscle glycogen. These results are in accordance with the experiments of Sprague (1933) who found that the isolated rabbit's heart lost half its glycogen in an hour when perfused with Locke's solution, but lost no glycogen when perfused with a suspension of red blood corpuscles for an hour and a half. Chang (1937) found that asphyxia in the absence of adrenaline caused a much slower reduction in glycogen content than did asphyxia when adrenaline was present. He found that adrenaline without asphyxia caused a temporary decrease in cardiac glycogen. The results indicate that either asphyxia or adrenaline cause a reduction in the glycogen of the mammal's heart, but that a combination of the two factors causes an extraordinarily rapid breakdown of glycogen. These observations account for the remarkable variations in the recorded figures for the glycogen content of the mammalian heart. The literature on the glycogen content of the dog's heart has been summarised by Schenk (1924), Junkersdorf and Hanisch (1927) and by Bong, Junkersdorf and Steinborn (1932). Evans (1934) found that feeding reduced the glycogen content of the rat's heart, whilst it increased the glycogen content of the muscles. This agrees with results obtained by Dittmar (1933) and by Lawrence and McCance (1931) on rats, and with the figures collected

by Junkersdorf and Hanisch (1927) for the glycogen content of dogs' hearts.

Evans found that insulin in moderate doses raised the glycogen content of both the heart and skeletal muscle, whereas Lawrence and McCance (1931) found that such doses produced no effect on the heart glycogen. Insulin, in doses which produced hypoglycæmic symptoms, lowered the heart glycogen although the muscle glycogen was above normal (Evans). Excess of thyroid was found by Lawrence and McCance to reduce the glycogen of the heart to about one-third of the normal.

The variations in the glycogen content of the frog's heart are certainly much less rapid than those of the mammalian heart, but the fact that starvation increases the glycogen content of the mammal's heart accords with the observation that the glycogen content of the frog's heart tends to rise during captivity.

The authors have not measured the influence of adrenaline on glycogen removal from the frog's heart, but the following facts are significant in relation to the glycogen content found. The process of isolation of the frog's heart for the purpose of perfusion involves 10 to 15 minutes' manipulation during which time the heart is in contact with the frog's blood and is not receiving much oxygen. This must represent a combination of adrenaline plus oxygen lack, but the total carbohydrate content of hearts which were thus isolated was often found equal to that of the controls which were excised rapidly; hence no process of glycogen removal can occur in the frog's heart comparable in rate with that which occurs in the rat's heart. On the other hand, various authors (Freund and König, 1927) have noted that adrenaline stimulates the mechanical response of asphyxiated

frogs' hearts, and this effect suggests that adrenaline plus asphyxia favours glycogen breakdown in the frog's heart as in the mammal's heart.

A more serious question is whether the presence of adrenaline is an important factor in promoting the usage of cardiac glycogen apart from asphyxia. One of the outstanding and somewhat surprising features of our results has been the fact that the frog's heart does not readily utilise its own carbohydrate stores. The experiments described in this monograph were all conducted in adrenaline-free systems. The general result found in perfused hearts was that the glycogen was broken down fairly rapidly but that the total reducing substances decreased much more slowly. Furthermore, it was found that under anaerobic conditions the frog's heart without adrenaline readily produced lactic acid. The outstanding effect of adrenaline in the mammal's heart is to promote lactic acid production from glycogen during asphyxia, and since this process could occur without adrenaline in the perfused frog's heart there seems no reason to attribute the low aerobic carbohydrate consumption observed in our experiments to adrenaline lack.

Lower Carbohydrates in Frog's Heart

The value of the ratio glycogen/total carbohydrate was found by Wertheimer (1930) to be about 0.75, but the authors found that this ratio was only 0.3. Similar discrepancies have been found in the case of frog's skeletal muscle, since Kerly (1931) found glycogen/total carbohydrate ratios between 0.5 and 0.8, whilst Ochoa (1930) found a ratio of 0.9.

The authors were primarily interested in determining the carbohydrate usage of the perfused heart of the frog. Isolation of the heart involved manipulation

for 10 to 15 minutes with impaired circulation, a procedure likely to cause glycogen breakdown, hence it was considered preferable to rely on measurements of the total reducing substances.

Boyland (1928) found with tortoise heart muscle that incubation caused a fall in the glycogen content and a rise in the lower carbohydrate as well as in the lactic acid content. This shows that glycogen can break down to lower carbohydrates as well as to lactic acid. Similarly, in the case of mammals, Satoh (1929) found in the dog's heart a total carbohydrate content of 0.3 per cent.; in the fresh heart, intermediate substances constituted 20 per cent. of the total, but this rose to 55 per cent. in perfused hearts. Chang (1937) found in the rat's heart the following ratios between glycogen and total reducing substances.

Normal heart	.	.	.	0.517/0.589 = 0.89
Asphyxiated heart	.	.	.	0.101/0.226 = 0.45

Non-fermentable Reducing Substances

The authors found that with their technique the glycogen only represented about one-third of the total reducing substances in the frog's heart. They found (1932) that in fresh non-perfused hearts about 90 per cent. of the total reducing substances was fermentable, whereas pure glucose under similar conditions was completely fermented. After perfusion for 24 hours the hearts showed the same content as did the fresh heart (about 0.150 per cent.) of non-fermentable reducing substances, although such perfusion removed a large proportion of the fermentable reducing substances.

Ochoa (1930) pointed out that frog's skeletal muscle contained about 1 mg./g. of ribose derived from adenylic acid. In the frog's heart the total adenine nucleotide

present is about 1.5 mg./g. and this corresponds to about 0.7 mg./g. of ribose.

It is therefore possible that ribose constitutes about half of the non-fermentable reducing substances. Rimington (1931) found that a number of proteins, on hydrolysis, yielded 3 to 4 per cent. of a trisaccharide which, on further hydrolysis, gave 2 mols. mannose (fermentable) and 1 mol. of glucosamine (non-fermentable).

Our method for estimating total reducing substances involves a fairly prolonged preliminary hydrolysis, which might well split off and hydrolyse most, if not all, of this carbohydrate. The heart contains about 8 per cent. of protein which, on a basis of 3.7 per cent. content of trisaccharide, would account for 0.296 g. per 100 g. heart of reducing substance calculated as glucose, and of this one-third or 0.1 g. would be non-fermentable.

Ribose and glucosamine together would therefore suffice to account for the non-fermentable reducing substances found in the heart.

The Carbohydrate Content of the Frog's Heart available for Hydrolysis during Survival

The effects of prolonged perfusion on the carbohydrate content of the frog's heart are shown in Table 23 (1*a* and 1*b*). The results show, in the first place, that hearts perfused for 24 hours with Ringer's fluid only utilise about two-fifths of their total reducing substances. Moreover, perfusion for 4 hours at low oxygen pressure (Table 22, 3) only removes the same proportion. In the latter case the hearts were arrested by A-V block and hence the ventricles were not driven to exhaustion. The result shows, however, that pro-

longed asphyxiation will not remove the whole of the carbohydrate content of the heart when the ventricle is not forced to work continuously by direct electrical stimulation. On the other hand, in the case of hearts perfused 24 hours with Ringer-serum with or without glucose (Table 23, 3, 4 and 5) the total reducing substance was reduced to between 3 and 5 mg. per g. Since the hearts contain 1.5 mg. per g. of non-fermentable reducing substances this represents nearly complete exhaustion of the fermentable carbohydrates.

The results with Ringer-serum agree in showing that the total carbohydrate usage is considerably greater than the total glycogen originally present in the heart. The results therefore show that the frog's heart can utilise nearly the whole of the fermentable carbohydrate content, and this confirms the fact that estimations of carbohydrate loss must be based on changes in the total carbohydrate rather than on changes in the glycogen content.

The experiments with Ringer's fluid without serum indicate that, although it is possible for the heart to exhaust nearly the whole of its carbohydrate content, yet such exhaustion is not readily produced.

Evans (1934) and Chang (1937) found in rats' hearts that nearly the whole of the glycogen could be glycolysed in asphyxia. Boyland (1928) used the tortoise heart and measured the effect of allowing the minced tissue to stand in alkaline phosphate solution. He found that this caused a fall in the glycogen content from a control figure of 0.35 to 0.12 per cent., while the lower carbohydrates rose from about 0.06 to 0.15 per cent., and the lactic acid rose from about 0.25 to 0.55 per cent. These results show only a 60 per cent. reduction in the glycogen content and a reduction in the total carbohydrates of less than 50 per cent.

Inositol Content of Frog's Heart ·

The inositol content of heart muscle is higher than that of most tissues (Needham, 1926). Boyland (1928) found that vertebrate cardiac muscle produced more lactic acid than could be accounted for by the consumption of carbohydrate and suggested that the excess lactic acid might be derived from inositol.

The authors (1932*a*) estimated the inositol present in the heart of the skate and the bullock and found it to be 0.073 and 0.1 per cent. respectively of the wet weight. Young (1934) found the inositol content of the hearts of sheep and dogs to be 0.16 and 0.17 per cent. respectively. Winter (1934) found in the dog's heart that there was a small amount of free inositol (0.02 per cent.) but that a larger amount (0.12 per cent.) was present in a combined form and was liberated by 5 hours' heating. He also found that when the surviving muscle was kept in an atmosphere of nitrogen a further 0.03 per cent. of inositol was formed. The estimation of inositol is difficult, and Winter's result indicates that the quantity found may depend on the treatment to which the muscle is subjected.

Lactic Acid Content of Heart

The lactic acid content of the fresh heart is of importance in relation to the changes which occur in asphyxia and a selection of figures is shown in Table 9. The authors found that the lactic acid content of hearts excised as rapidly as possible and frozen in carbon dioxide snow was 0.06 per cent., and that in hearts excised and perfused in air the lactic acid content was about 0.09 per cent.

TABLE 9

The Lactic Acid Content of Fresh Hearts

	Number of Experiments.	Lactic Acid per cent.
<i>Rana esculenta</i> ¹ —		
Fresh hearts frozen with CO ₂ snow	3	0·06
Fresh hearts dropped into acid at room temperature	5	0·09
Hearts left soaking for 60 mins. in Ringer at room temperature and then frozen	3	0·09
Hearts perfused 30 mins. and then frozen	1	0·085
Hearts perfused 5 hours with oxygen and then frozen	3	0·09
Turtle's ventricle ²	0·04
„ auricle { terrapin frozen }	0·036
„ ventricle { before death ³ }	0·026
Tortoise's heart ⁴	0·22-0·31
Mammal—		
Rabbit ⁵	0·0·07
Cat ⁶	0·028

¹ Clark, Gaddie and Stewart (1932).² Redfield and Medearis (1926).³ Gemmell (1928).⁴ Boyland (1928).⁵ Schenk (1924).⁶ Katz and Long (1925).**The Protein Content of the Heart**

Gradinesco (1926) found that the total nitrogen of the frog's heart was 10·36 per cent. of the dry weight or 1·43 per cent. of the wet weight.

If the non-protein nitrogen amounts to 0·20 per cent. of the wet weight, then the protein nitrogen is 1·23 per cent., and this is equivalent to a protein content of 7·5 per cent.

The Fat Content of the Heart

Clark, Gaddie and Stewart (1931) estimated the fat content of the frog's heart to be 4·8 per cent. and found that this figure was not changed after 24 hours' perfusion. The method of estimation employed (Stewart and White, 1925) gave too high a figure because it included

in the figure for fatty acids the phosphoric acid derived from the phospholipins, and probably also some acid formed from sugar during the alkaline hydrolysis.

Later experiments (1933) with an improved method (Stewart, Gaddie and Dunlop, 1931) gave a value of 1.34 per cent. of fatty acids (average of 20 hearts, $\sigma = 0.31$). These experiments also showed no fat loss after perfusion for 6 hours. A value of 1.34 per cent. for fatty acids corresponds to a lecithin content of about 2.0 per cent. The phosphorus present in the heart in the form of phospholipins has been shown to be about 0.1 per cent. and this corresponds to a lecithin content of 2.5 per cent.

From these figures it appears probable that all the fatty acids in the heart are combined in phospholipins. In another experiment (4 hearts) the fatty acid content was found to be 1.43 per cent. and the iodine number 126. Bloor (1927) found in the mammal's heart that the phospholipins present were chiefly cephalin and lecithin and that there was more of the former than of the latter.

Lawaczek (1923) found that the cholesterol content of the frog's heart was 0.147-0.151 per cent. The authors (1933) found a content of 0.11 per cent.

Respiratory Pigments

Keilin (1925) found that the muscles and other tissues of a frog were completely devoid of muscle hæmoglobin; he noted that the heart of a frog contained less than did the thorax of a bee. He found, however, that the heart contained more cytochrome than any other tissue in the frog, and estimated the content as 0.5 per cent.

Fenn (1934) found that the frog's heart contained 0.0023 per cent. of iron. If the composition of cyto-

chrome is similar to that of hæmoglobin this quantity would correspond to 0.75 per cent. cytochrome and this could combine with 0.93 c.c. oxygen/100 g. muscle.

Non-Protein Nitrogen

The following values have been found for the ammonia and urea nitrogen in fresh frogs' hearts.

Ostern (1930) 1.4 mg./100 g. of ammonia nitrogen. Clark, Gaddie and Stewart (1931) 33 mg./100 g. of urea-nitrogen in the frog's heart, and (1933) 12 mg./100 g. of urea-nitrogen in the tortoise's heart.

It has been shown that the heart contains about 2.5 per cent. of phospholipins. If these are composed chiefly of lecithin and cephalin this quantity will correspond to about 45 mg./100 g. of nitrogen. Cephalin, which contains no choline, is the largest fraction of the phospholipins in the mammalian heart (Bloor, 1927), and hence probably the choline nitrogen in the frog's heart is between 10 and 20 mg./100 g. The fresh heart contains from 7 to 10 mg./100 g. of creatine-phosphate phosphorus (Clark, Eggleton and Eggleton, 1932) and this quantity is equivalent to about 12 mg./100 g. of creatine nitrogen. Folin and Buckman (1914) found that the creatine content of the turtle's heart was about 100 mg./100 g. which corresponds to 32 mg./100 of creatine nitrogen.

Parnas (1932) found 28 mg./100 g. of adenine nitrogen in the frog's heart. Table 4 shows that the frog's heart contains about 15 mg./100 g. of "pyrophosphate-P" (Clark, Eggleton and Eggleton, 1932; Lohmann, 1928; Weicker, 1934) and this corresponds to about 20 mg./100 g. of adenine nitrogen.

Wachholder and Quensel (1934) found that the heart of *Rana temporaria* contained 24.65 mg./100 g.

of glutathione. This would correspond to between 5 and 10 mg./100 g. of glutathione nitrogen.

No figures are available for the total non-protein nitrogen or the carnosine content of the frog's heart. In the case of the horse's heart Furth and Schwartz (1910) found a non-protein nitrogen content of about 250 mg./100 g. and about one-third of this nitrogen was contained in the carnosine fraction.

Approximate figures observed and estimated for the non-protein nitrogen of the frog's heart are shown in Table 10.

TABLE 10

Nitrogen Extractives of Frog's Heart in mg./100 g. Wet Weight.

Ammonia-N	1.4
Urea-N	30
Creatine-phosphate-N	10
Creatine-N	20
Adenine-N	25
Glutathione-N	7
Phospholipin-N	45
Total	138
Probable carnosine-N.	52
Probable total non-protein-N	<u>190</u>

Composition of Frog's Heart

Table 11 shows the general composition of the frog's heart as estimated by the authors from their own experiments and from the results recorded in the literature.

TABLE 11

General Percentage Composition of Frog's Heart

Water	85
Ash	1
Organic solids	14
Carbohydrates	1-2
Fats	2
Proteins	7-10
Nitrogenous extractives	1

Composition of Frog's Blood

The activity of the isolated frog's heart is maintained better by perfusion with frog's blood or plasma than with any other medium, consequently it is necessary to know the composition of these fluids.

Zepp (1923) gives the following figures for *R. esculenta*:—

	Male.	Female.
Red blood corpuscles per c.mm.	325,000-393,000	260,000-330,000
Hæmoglobin as per cent. of standard human (Sahli).	50-60	35-52

The chief inorganic constituents of frog's plasma are shown in Table 12. Charles (1930) found a Ca content

TABLE 12
Composition of Frog's Plasma, mg./100 g.

	Macallum (1926). <i>R. virescens.</i>	Urano (1908). <i>R. esculenta.</i>	Fenn (1936).	Various Authors.
Na	197	220	236	165 ¹
K	23	20	10	...
Ca	6	9	8	10 ²
Mg	1.5	4	7	...
Cl	268	250	260	239 ¹
SO ₄	90
PO ₄	110
Total P	21	...
HCO ₃	157	...
Lactate	90	...
Sugar	{ 30 ³ 29 <i>R. esc.</i> ⁴ 44 <i>R. temp.</i> ⁴
Depression of freezing point.	-0.4° C.	-0.4° C.

¹ Mond and Netter (1932).

² Clark, Gaddie and Stewart (1931).

³ de Waard (1918).

⁴ Bang (1913).

of 8 mg./100 c.c. and a mg. content of 2 mg./100 c.c. in the plasma of *Xenopus lewis*.

The oxygen capacity of frog's blood has been estimated as 13.5-23 vols. per cent. (Redfield, 1933) and 18-19 vols. per cent. (Krogh, 1910).

Macela and Seliskar (1925) found that the dissociation curve of frog's blood at 15° C. was very similar to that of mammal's blood at 35° C. They found (Fig. 4 *loc. cit.*) the following relation between pressure and saturation at pH 7.4.

Oxygen pressure in mm. Hg	40	20	10	5	2.5	1.25
Per cent. saturation	85	75	60	40	30	20

Haldane and Lorrain Smith (1897) found that frog's blood had an oxygen content of 18 vols. per cent. at an oxygen pressure of 140 mm. Hg. Krogh (1910) found that the oxygen pressure in venous blood was 12 mm. Hg.

As regards the carbon dioxide content of frog's blood, Krogh (1910) showed CO_2 was excreted chiefly by the skin, and hence that the carbon dioxide tension was similar in arterial and in venous blood. Wastl and Seliskar (1925) found 58 vols. per cent. carbon dioxide at a tension of 25 mm. Hg at pH 7.48. Their curves show that blood when thoroughly aerated with carbon-dioxide-free air will have a pH of 8.0 and a carbon dioxide content of about 30 vols. per cent. They also pointed out that Rohde's (1920) figures of 6.3-7 for the pH of frog's blood was improbably low.

Krogh concluded (1910) that the probable CO_2 tension in frog's blood was about 10 mm. Hg. Clark, Gaddie and Stewart (1932) found that fresh frog's blood contained 30 vols. per cent. of carbon dioxide and that after thorough aeration by perfusion through the heart for 6 hours this figure fell to 23 vols. per cent.

Schulz and Krüger (1925) give the following figures regarding the composition of frog's blood :—

Blood volume	5.6 per cent. of body weight
Total solids	10.5 g./100 c.c.

The hæmoglobin content is stated to be four-tenths of that in mammal's blood, but various estimates range from 8 to 14 per cent. The hæmatin content is given as 4.8 per cent. and the iron content as 0.42 per cent. The frog's serum is stated to contain 4.6 per cent. solids and 2.5 per cent. protein.

Blood sugar estimates range from 20 to 65 mg./100 c.c. Adler (1928) gives the following figures for frog's plasma :—

Total protein	2.5 per cent.
Blood sugar—	
Winter	30 mg./100 c.c.
Summer	40 mg./100 c.c.
Lactic acid	23 mg./100 c.c.

Clark, Gaddie and Stewart (1931) obtained the following figures for the carbohydrate content of frog's blood :—

	g./100 c.c. blood.	
	Sugar.	Total Reducing Substances.*
Red blood corpuscles	0.038	0.082
Plasma	0.020	0.053
Total	0.058	0.135

* After acid hydrolysis.

These results show that nearly two-thirds of the total reducing substance present in the blood are contained in the red blood corpuscles. They obtained in other experiments the following average figures :—

	g./100 c.c.	
	Sugar.	Total Reducing Substances.
Blood	0.035	0.167
Plasma	0.026	0.093
Serum	0.044	...

They found that a mixture of equal parts of serum and Ringer's fluid contained 0.16 per cent. of fat, which indicates a serum content of about 0.3 per cent.

Mozolowski and Mann (1932) found that fresh frog's blood contained 0.9 mg./100 g. of ammonia nitrogen. Baglioni (1905) found that the non-protein nitrogen of frog's blood was 11 mg./100 c.c., but this figure is doubtful in that it is much lower than the value for any other vertebrate. He found, on the other hand, the high figure of 160 mg. non-protein nitrogen per 100 c.c. in tortoise blood.

CHAPTER IV

FACTORS INFLUENCING THE OXYGEN USAGE OF THE FROG'S HEART

Adequacy of Oxygen Supply; Oxygen Depletion; Irrigation of the Heart; Lower Limit of Oxygen Pressure; Oxygen Pressure needed for Normal Activity; Body Weight; Frequency; Filling and Resistance: Filling and Work; Comparison between Skeletal and Heart Muscle; Work and Metabolism of Cold-blooded Hearts; Work and Metabolism of Mammalian Hearts; Metabolism of Empty Heart; Resting Metabolism of Skeletal Muscle; Hypodynamic Condition; Temperature.

Factors Influencing Oxygen Usage

THE isolated heart of the frog appears at first sight to be a relatively simple system, but its oxygen consumption depends on a large number of variables, and these must be controlled if it is desired to determine the effect of any particular factor on oxygen consumption.

The chief variables are as follows :—

1. Adequacy of oxygen supply.
2. Body weight.
3. Frequency.
4. Filling.
5. Work performed.
6. Nature of perfusion fluid.
7. Temperature.

Adequacy of Oxygen Supply

The unintentional production of partial oxygen deficiency in the isolated frog's heart is an important experimental error, because under certain conditions

the frog's heart can maintain a fair activity even when the oxygen supply is very deficient, and hence the partial asphyxiation does not produce obvious depression. It will be shown later that the heart under anaerobic conditions can maintain a considerable activity for a long period by means of glycolysis provided it is perfused with alkaline fluid.

The heart when supplied with adequate oxygen oxidises lactates freely but does not readily oxidise glycogen or sugar. This fact is, however, completely obscured if part of the heart is deficient in oxygen, because glycolysis will occur in the anaerobic portion and the lactate will be oxidised in the aerated portion. For these and other reasons it is very important to be certain that all portions of the heart should receive an adequate oxygen supply. This depends on three factors: the thoroughness with which the heart surfaces are irrigated, the pressure of oxygen in the perfusion fluid and the depth of tissue through which the oxygen must diffuse. The last factor is determined by the structure of the tissue, but the relative importance of the first two factors depends on experimental conditions.

If a thin tissue, *e.g.* sinus, is suspended in a large volume of fluid which is vigorously stirred, then the oxygen pressure is the limiting factor for oxygen uptake. If, on the other hand, the heart is perfused with Ringer's fluid or plasma, then the amount of oxygen contained in the fluid coming in contact with the heart is likely to constitute the limiting factor when the oxygen pressure is low, because under these conditions the amount of oxygen present in the fluid is small in comparison with the quantity used by the heart. When blood is used as perfusion fluid the quantity of oxygen is large, and hence the pressure will in this case constitute the limiting factor.

Oxygen depletion is the most serious source of experimental error and therefore will be considered first.

Methods of Perfusion and Oxygen Depletion. — The first essential for normal metabolism is that the perfusion method adopted should ensure that the quantity of oxygen carried to the heart surfaces is sufficient for the needs of the heart. Frog's blood contains about 20 vols. per cent. oxygen and hence depletion is unlikely to occur in hearts perfused with mixtures of blood and Ringer's fluid. Ringer's fluid and plasma have, on the other hand, a low oxygen content (35 c.mm. O_2 per c.c. at 1 atmosphere pressure O_2 and 7 c.mm. O_2 per c.c. at $1/5$ atmosphere pressure O_2). A frog's heart under conditions of moderate activity uses about 1 c.c. of oxygen/g./hour or 16 c.mm. oxygen/g./minute. Hence a frog's heart which weighs 0.16 g. requires 3 c.mm. oxygen per minute, which quantity is contained in 0.4 c.c. of air-saturated Ringer's fluid. The heart is very unlikely to be able to utilise the whole of the oxygen in the fluid which passes through it, and hence the flow needed to supply an adequate quantity of oxygen is probably between 1 and 2 c.c. per minute of air-saturated Ringer's fluid. The amount of fluid coming in contact with the heart surfaces depends very largely on the method of perfusion. The method most nearly approaching the normal circulation is the double cannula method (*cf.* Appendix). In this case a fresh heart weighing 0.16 g. and contracting 30 times a minute will circulate about 10 c.c. of fluid per minute, and hence is unlikely to suffer any oxygen lack. The circulation decreases, however, after the first few hours; after 12 hours the frequency is likely to fall to about 15 per minute and the circulation to 1 to 2 c.c. per minute, which is near the lower limit for effective oxygen supply. Further-

more, in the fresh heart systole is complete and the fluid in the interstices of the ventricle is changed completely at each contraction, but in the partially exhausted heart this does not occur.

These calculations indicate that a heart contracting vigorously will not suffer from oxygen depletion when perfused with air-saturated Ringer's fluid or plasma, but that oxygen depletion is likely to occur when the contractions become feeble. Furthermore, these calculations only apply to the conditions when there is an unobstructed aortic outflow. If there is any resistance to the aortic outflow then systole is incomplete and the fluid between the trabeculæ is not changed completely at each contraction.

The substitution of a plasma-Ringer mixture for Ringer's fluid increases the oxygen consumption of the heart, but the oxygen content of the fluid is not changed and hence this change increases the danger of partial asphyxia.

The isolated ventricle with a cannula in the auriculo-ventricular opening is a more convenient preparation than is the whole heart in cases where it is desired to estimate the work done by the heart. In this case, however, the irrigation of the tissue around the bulbus arteriosus is deficient, and the ventricle as a whole is probably on the verge of oxygen lack. The Straub cannula is even less satisfactory, because the neck of the cannula is comparatively long and there is a considerable volume of tidal fluid. Strips of ventricle in air, in oxygen or in Ringer's fluid, probably always suffer from oxygen lack, but this depends on difficulty of diffusion and not on depletion.

Efficiency of the Irrigation of the Heart.—Some idea of the efficiency of the irrigation of the interior of the heart can be obtained by a comparison of the rate

at which certain effects are produced. For example, Clark (1927) found that acetylcholine introduced into a frog's isolated ventricle took from 15 to 30 seconds to produce its full action, whereas when the drug was applied as a jet to a ventricular strip the same effect was produced in from 5 to 10 seconds. This suggests that mixing by means of the ventricular contraction is only about one-third as effective a method of changing the fluid at the cell surface as is a powerful jet. It therefore seems probable that the oxygen pressure at the cell surfaces of a perfused heart is not more than half the oxygen pressure in the bulk of the solution.

Lower Limit of Oxygen Pressure.—The lower limit of oxygen pressure at which the frog's heart can function depends on various factors, one of which is the lowest oxygen pressure at which the cells can take up oxygen. The other important factors are the amount of oxygen carried to the surface of the heart and the depth of tissue through which the gas must diffuse.

Clark and Kingisepp (1935) measured the effect of low oxygen pressure on the frequency of the isolated sinus. Experiments were made both on normal sinuses and on sinuses poisoned with iodo-acetate. These results are shown in Tables 13 and 14.

The I.A.A. poisoned tissue is a more delicate test of oxygen lack than is the normal tissue, because the latter can maintain anaerobic activity by glycolysis. Tables 13 and 14 agree in showing that the presence of oxygen at 10 mm. Hg causes a considerable delay in asphyxia as compared with pure nitrogen. This was confirmed by experiments in which exposure to pure nitrogen was alternated with exposure to nitrogen plus oxygen at 10 mm. Hg. In the former case (7 experiments) arrest occurred in an average of 4.1 minutes and in the latter case (8 experiments) in 6.6

minutes. The addition of oxygen at 5 mm. Hg had a doubtful effect when tested in this way. The experiments suggest that the lowest oxygen pressure at which

TABLE 13

Effect of Exposure to Low Oxygen Pressures for 40 Minutes on Normal (unpoisoned) Sinuses suspended in Gas (Clark and Kingisepp, 1935).

Oxygen Pressure in mm. Hg.	Number of Experiments.	Result.
0	6	All arrested in average time of 12 minutes.
5	2	One arrested and one contracting at 40 per cent. original frequency.
10	3	All contracting. Average frequency 70 per cent. of original.
20	4	All contracting. Average frequency 80 per cent. of original.

TABLE 14

Effect of Exposure to Low Oxygen Pressures on Sinuses, previously poisoned with 1 in 25,000 I.A.A. and suspended in Gas (Clark and Kingisepp, 1935).

Oxygen Pressure in mm. Hg.	Number of Experiments.	Time of Exposure in Minutes before Arrest.					
		2-4.	4-6.	6-8.	8-10.	10-12.	30+
0	27	13	12	2
5	3	...	3
10	12	3	4	4	1
15	9	1	2	1	1	...	4
20	18	1	3	2	1	1	10
30	5	5

the sinus receives a measurable quantity of oxygen is 5 mm. Hg (0.0066 atmosphere). This is in accordance with the results of Keilin (1925, 1930) who found that the indophenol oxidase, which was essential for

the uptake of oxygen by cytochrome, functioned at 5 mm. Hg.

Gerard (1931), in a review of the oxygen requirements of monocellular organisms, showed that in a variety of cells with diameters ranging from 0.003 to 0.00006 cm. the concentrations of oxygen needed to provide an adequate supply varied between 0.1 and 0.01 atmosphere. According to Warburg's formula for the diffusion of oxygen into tissues these oxygen pressures should have varied between 0.003 and 0.00001 atmosphere. Gerard concluded that either the diffusion coefficient of oxygen through these cells was at least one hundred times smaller than through fascia and muscles or else that some factor other than diffusion limited the oxygen uptake at low tensions. The latter is much the more probable assumption and the results with the frog's sinus suggest that the lowest pressure at which a measurable amount of oxygen is taken up is between 0.005 and 0.01 atmosphere (*i.e.* 3.8 to 7.6 mm. Hg).

A certain doubt is cast on this conclusion by the experiments of Eismayer and Quincke (1930) who measured the oxygen uptake of the frog's heart (Straub cannula) from a small volume (2 c.c.) of mammalian red blood corpuscles suspended in Ringer's fluid. They used varying quantities of corpuscles, and the results given in Fig. 4, which the authors extracted from their data, show that the heart can obtain an adequate oxygen supply until it has utilised about 50 per cent. of the oxygen in the corpuscles, and that a small oxygen consumption may still occur when 80 per cent. of the oxygen has been utilised. Barcroft (1928, p. 176) found that the oxygen pressure of half saturated mammalian blood was 2 mm. at 14° C. and 8 mm. at 20° C. Eismayer and Quincke worked at a room temperature of about 18° C. and therefore their results

show that the frog's ventricle receives an adequate supply of oxygen at a pressure of 5 mm. and that it can utilise oxygen at even lower pressures. The corpuscles were suspended in frog's Ringer's fluid and the fluid would contain a considerable quantity of carbon dioxide and in some cases lactic acid. The dissociation curve of mammalian hæmoglobin under these conditions must be regarded as uncertain, and hence these experiments do not prove that the frog's heart can use oxygen at pressures lower than 5 mm. Hg. The results are, however, very remarkable and deserve further investigation.

Oxygen Pressure needed for Normal Activity.—When determining the lower limit of oxygen pressure at which the frog's heart can maintain an adequate supply of oxygen it is necessary to make certain that the quantity of oxygen brought to the heart surfaces

is adequate. Obviously if the amount of oxygen coming in contact with the heart is inadequate the heart will suffer from oxygen lack irrespective of the pressure. The lower the pressure of oxygen the smaller is the amount of oxygen per unit volume of Ringer's fluid, and hence the larger is the volume of fluid that must come in contact with the heart surfaces in order to supply an adequate quantity of oxygen, irrespective of the question as to whether the heart can utilise the whole of the oxygen in the fluid or whether there is a limiting pressure below which the heart cannot obtain

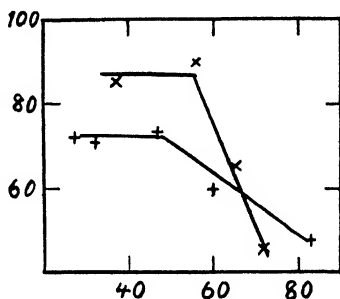

FIG. 4.—Consumption of oxygen by frog's heart from a limited volume of a suspension of mammalian red blood corpuscles (two experiments). Ordinate: oxygen usage in arbitrary units per min. Abscissa: percentage of total available oxygen used. (Data from Eismayer and Quincke, 1930.)

oxygen from the fluid. This difficulty as regards quantity of oxygen in the fluid can be avoided by using suspensions of red blood corpuscles, which ensures a relatively large oxygen content of the fluid at low pressure, but the employment of red blood corpuscles involves a number of technical difficulties.

The relation between the amount of oxygen used by a frog's heart and the amount of oxygen carried to it by a fluid exposed to low oxygen pressures is shown by the following calculations.

It will be shown later that the lowest limit of oxygen pressure at which a strip of frog's auricle suspended in Ringer's fluid can sustain full normal activity is about 40 mm. Hg, but at this pressure Ringer's fluid only contains about 2 c.mm. oxygen per c.c. A frog's heart of 0.16 g. working at moderate activity uses 3 c.mm. of oxygen per minute, and hence 1.5 c.c. of Ringer's fluid containing 2 c.mm. of oxygen per c.c. would need to come in contact with the heart surfaces every minute in order to supply the requisite amount of oxygen. It is therefore very easy to produce oxygen lack with low oxygen pressures simply by providing inadequate amounts of oxygen, and this source of error must always be guarded against if it is desired to estimate the effects due to change of pressure.

The sponge-like structure of the frog's ventricle makes it an unfavourable structure for such types of measurement, because it is difficult to arrange for an adequate rate of flow of fluid through trabeculæ. A strip of auricle or sinus suspended in Ringer's fluid which is vigorously stirred by passage of the gas mixture is more suitable. The simplest test is to determine the lowest oxygen tensions at which the tissue maintains normal activity. This is unsatisfactory in the case of the normal tissue because it can maintain

its activity by glycolysis, but a strip poisoned with iodo-acetate is completely dependent on its oxygen supply and is a suitable object.

Clark and Kingisepp (1935) using this method obtained the results shown in Table 15. The results with the ventricle are not fully reliable on account of the difficulty of avoiding oxygen depletion of the

TABLE 15

Effect of Low Oxygen Pressure on I.A.A. Poisoned Cardiac Tissue of Frog. The Figures for Auricle and Ventricle show Time in Minutes until the Response was reduced to Half Normal (Clark and Kingisepp, 1935).

Oxygen Pressure in mm. Hg.	Sinus.	Auricle.	Ventricle.
0	Arrest in 4 min.	4	1.5
10	Arrest in 6 min. 6 sec.	5	3
20	50 per cent. not arrested in 30 min.	7	20
30	Normal activity	∞	∞
50	...	Normal activity	...

fluid. The results with the sinus and auricle show that the sinus maintains normal activity with an oxygen pressure between 20 and 30 mm. Hg and the auricle with a pressure between 30 and 50 mm. Hg.

The results of Eismayer and Quincke (1930) with suspensions of mammalian red blood corpuscles suggest that, provided oxygen depletion does not occur, the ventricle can maintain normal activity with an oxygen pressure of about 5 mm. Hg. In this case, however, the oxygen pressures were uncertain, for the reasons already mentioned, and hence these results cannot be considered conclusive evidence. Warburg has provided a well-known formula which relates oxygen usage and thickness of tissue with the minimum adequate oxygen pressure. Reference has already been made to this

formula and it seems probable that it does not hold for oxygen pressures below a certain level, but it is of interest to determine whether the formula agrees approximately with the results found with the frog's heart. The formula relates the thickness (in cm.) of the tissues (d), with the oxygen usage in c.c./g./minute (A) and the necessary oxygen pressure in atmospheres (c). The formula is $d = \sqrt{8c \cdot D/A}$, where D = diffusion coefficient of oxygen, which is 1.3×10^{-5} at 15° C.

The question of the general validity of Warburg's formula for the frog's heart tissues is a matter of some importance, because it is such a convenient method of estimating the oxygen pressure needed to supply tissues. In the case of the isolated frog's heart the data of Clark and Kingisepp show that the sinus functions normally with an oxygen pressure between 20 and 30 mm. Hg, and the auricle with a pressure of between 30 and 50 mm. Hg. Both tissues when empty have a thickness of about 0.025 cm. The sinus uses 0.003 c.c. oxygen/g./minute, whilst the empty auricle uses about 0.01 c.c. O_2 /g./minute (Clark and White, 1930). The application of Warburg's formula shows that the theoretical minimum adequate oxygen pressures are 0.018 atmosphere for the sinus and 0.068 atmosphere for the auricle. The pressures found by experiment were for the sinus between 0.026 and 0.04 atmosphere and for the auricle between 0.04 and 0.066 atmosphere. The calculated and observed results are in accordance in the case of the auricle, but in the case of the sinus their divergence supports the view that there is a lower limit of oxygen pressure of about 0.01 atmosphere below which the cells cannot take up oxygen.

Clark and White (1930) measured the oxygen usage of strips of frog's ventricles suspended in gas; the strips

were unstretched and quiescent, and about 0.1 cm. thick. Their oxygen usage was 0.008-0.016 c.c./g./minute when in oxygen, and in air about 0.0016 c.c./g./minute. According to Warburg's formula a strip with an oxygen usage of 0.008 c.c./g./minute should in air receive an adequate oxygen supply to a depth of 0.03 cm. on each side. Hence more than half the strip should have been adequately supplied, and yet the oxygen usage in air was only one-fifth that in oxygen. The probable explanation for this result is that the asphyxiated portion produced lactic acid and that this poisoned the remainder of the strip by causing a change in the pH .

Clark and White (1930) also measured the oxygen uptake of auricles which were exposed to oxygen or air on their outer side only. The thickness of the auricles was 0.025 cm. when empty and 0.012 cm. when filled. The average oxygen consumption in six experiments was as follows:—

		Oxygen Usage in Auricular Tissue in c.c./g./minute.	
		In Oxygen.	In Air.
Filled	0.03	0.027
Empty	0.01	0.007

According to Warburg's formula with this thickness of tissue the oxygen usage in air should be equal to that in oxygen but the figures show a slight decrease.

Experiments upon perfused hearts show similar differences between oxygen consumption in oxygen and in air. The oxygen consumption found by Clark, Gaddie and Stewart (1932) is shown in Table 16, which includes also the values for the thickness of tissue (d) which should receive an adequate oxygen supply.

These results were obtained with hearts which weighed about 0.15 g. and the measurements given

68 THE METABOLISM OF THE FROG'S HEART

in Chapter I show that in such a case the auricles are from 0.012 to 0.015 cm. thick, whilst the thickness of the trabeculæ of the ventricles is less than 0.01 cm.

TABLE 16

Oxygen Usage of Perfused Frogs' Hearts as measured by Clark, Gaddie and Stewart, and the Thickness of Tissue (d) receiving Adequate Oxygenation, according to Warburg's Formula.

Perfusion Fluid.	Air ($c=0.2$).		Oxygen ($c=1$).	
	Oxygen Usage c.c./g. per Minute (A).	d .	Oxygen Usage c.c./g. per Minute (A).	d .
(a) Ringer's fluid (1932) .	0.0133	0.040	0.0150	0.084
(b) Ringer's fluid (1932) .	0.0197	0.033	0.0225	0.068
(c) Ringer's fluid . . .	0.0316	0.026
(d) Ringer's fluid and blood (1931)	0.0252	0.026
(1933)	0.032	0.029	0.038	0.053

The values for d calculated above, indicate that the hearts ought to have received a fully adequate oxygen supply in most cases when perfused with fluid saturated with air. The figures show, however, that in all cases the oxygen consumption was higher in hearts isolated in oxygen than in hearts isolated in air. In actual practice, therefore, the concentration of oxygen needed to maintain optimum activity in an isolated heart appears to be higher than that indicated by Warburg's formula. This conclusion is supported by the further fact that Clark, Gaddie and Stewart (1933) found that substitution of oxygen for air might alter the nature of the metabolism although the total oxygen consumption was only slightly affected. These results which are set out in Table 17 show that the carbohydrate consumption was greater in air than in

oxygen and that the R.Q. was higher in air than in oxygen. The change from air to oxygen therefore produced a definite change in the cardiac metabolism. The simplest explanation for this is that a portion of the heart was not adequately oxygenated in air and that in consequence glycolysis occurred, and the oxygenated portions oxidised the lactate thus liberated.

TABLE 17

Effect of Oxygen Pressure on Frogs' Hearts perfused Six Hours with Ringer's Fluid (Clark, Gaddie and Stewart, 1932).

	In Oxygen.	In Air.	In 95 per cent. Nitrogen + 5 per cent. Oxygen.
Oxygen used c.c./g. . . .	6.15	5.90	2.94
R.Q.	0.75	0.87	...
Lactic acid excreted mg./g. .	0.30	0.56	1.00

It would appear, therefore, that although Warburg's formula indicates correctly the relation between tissue thickness and oxygen pressure at which no gross signs of oxygen deficiency occur, yet changes in oxygen pressure may produce alterations in metabolism even though all the pressures investigated are well above the pressures indicated to be adequate by Warburg's formula.

Oxygen Use and Body Weight

The oxygen usage of warm-blooded animals follows the empirical formula oxygen usage \propto (body weight)^{2/3}, but there is a long standing controversy as to whether this law holds for cold-blooded animals.

Krogh (1916) concluded that: "In reptiles,

amphibia and fish, values of 0.2-0.5 cal. per kilo per hour are generally observed on quiet animals irrespective of size, and the figures for crustacea and cephalopod molluscs are of the same order, but very young animals in all these groups may show much higher values, probably to a greater extent on account of their muscular activity."

Hill (1911) pointed out two important sources of error in calculations of the metabolic rate of cold-blooded animals. Firstly, the metabolic rate of frogs showed a wide seasonal variation. At room temperature in autumn and winter this rate lay between 0.4 and 1.2 cal./kilo/hour. Secondly, the metabolism fell rapidly during the first few weeks of captivity as was shown by the following results.

		Metabolism of <i>R. temporaria</i> at 20° C.		
Days of captivity . . .		4	5	12
Cals./kilo/hour . . .		1.4	1.0	0.35

Rubner (1924) collected figures and concluded that in fishes of varying sizes the metabolic rate was more nearly proportional to the body surface than to the body weight. He quoted figures showing the following heat production for frogs of various sizes :—

Young <i>R. temp.</i> , <i>Bufo cin.</i> , and <i>Bufo</i> <i>variabilis</i> (body weight 1.4 g.) . . .	Cals./kilo/hour at 18° C. =	4
Adults <i>R. temp.</i> and <i>Bufo var.</i> (body weight 20-40 g.)	" " " "	= 1
<i>Rana mugiens</i> (body weight 600 g.) . . .	" " " "	= 0.4

Liang (1934) and Black (1934) gave figures for frogs and toads which showed the following results :—

Body weight . . .	10-20	40-50	70-90	130
Cals./kilo/hour . . .	0.83-0.73	0.65-0.54	0.5	0.23

The evidence indicates that large frogs have a smaller metabolic rate than small ones, but such differences

may be easily swamped by differences in duration of captivity.

The writers used *R. esculenta* (Hung.), whose history prior to arrival was unknown, and no very certain relation between the size of the frog and the metabolic rate of the heart was found. Table 18 shows averages extracted from the figures given by Clark

TABLE 18

Influence of Heart Size in Oxygen Consumption.

	Ringer's Fluid.		Ringer-serum Mixture.	
	Heart Weight in g.	Oxygen Usage cc./g. per Hour.	Heart Weight in g.	Oxygen usage cc./g per Hour.
<i>R. temporaria</i> , small ¹ . . .	0·04	1·6	0·04	2·6
<i>R. temporaria</i> , medium ¹ . . .	0·06	1·4	0·06	2·3
<i>R. esculenta</i> (Dutch) ¹ . . .	0·085	1·0	0·085	1·6
<i>R. esculenta</i> , (Hung.)—				
Medium ²	0·15	1·4	0·147	1·9
Large ²	0·182	1·27

¹ Clark and White (1928 a).

² Clark, Gaddie and Stewart (1932).

and White (1928, 1) and by Clark, Gaddie and Stewart (1931, 1932). These show that the small *R. temporaria* have a higher cardiac metabolism than the large *R. esculenta* (Hung.), but the medium-sized *R. esculenta* (Dutch) show lower metabolic rates than do the Hungarian variety.

In general, the effect of body weight or heart weight on the oxygen consumption per unit weight seems less important than most of the other factors considered in this chapter.

Effect of Frequency on the Oxygen Usage

The influence of frequency on the oxygen usage of the isolated frog's ventricle was measured by Weizsäcker (1912 *b*) and by Clark and White (1928 *a* and *b*) on the frog's heart. The latter workers obtained the following results :—

Frequency per minute	0	15	20	40
Oxygen usage of heart c.c./g./hour—				
(a) Perfused Ringer's fluid	0.33	0.84	0.97	1.02
(b) Perfused Ringer-serum mixture	0.33	1.3	1.6	2.0

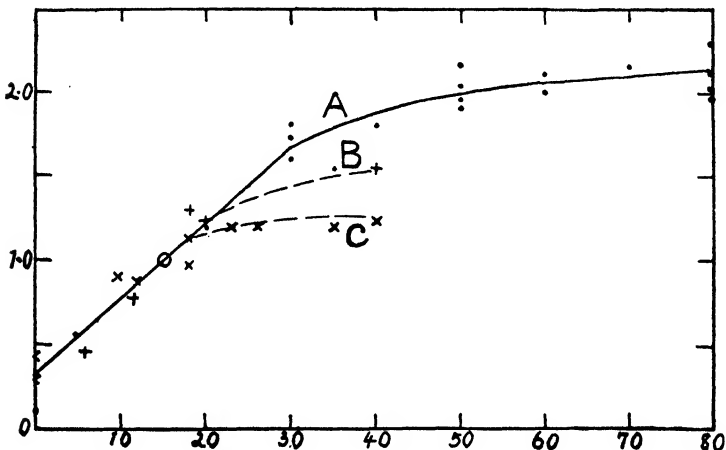

FIG. 5.—Relation between frequency per min. (abscissa) and oxygen usage of frog's heart (ordinate). Figures adjusted to show oxygen usage at 15 per min. equal to 1. A. Blood in frog's ventricle (Weizsäcker, 1912 *b*). B. Ringer-serum mixture in heart (Clark and White, 1928 *b*, Fig. 3). C. Ringer's fluid in heart (Clark and White, 1928 *a*, Fig. 4).

The results of Weizsäcker and of Clark and White are shown together in Fig. 5, where all readings have been reduced to a common basis for the sake of comparison. Weizsäcker used a suspension of ox red blood corpuscles, and his results are more nearly comparable to the results obtained with the Ringer-serum mixture than with those obtained with Ringer's fluid.

The results agree in showing that with low frequencies there is a linear relation between frequency and oxygen consumption, but that when the frequency is increased above a certain value the oxygen consumption per beat decreases. This limiting value of frequency is lowest with Ringer's fluid (about 20 per minute) and highest with Weizsäcker's method (about 40 per minute). This difference is probably due in part to the fact that Weizsäcker employed a fairly high initial pressure, because the oxygen usage depends on the degree of diastolic filling whilst the rate of relaxation depends on the diastolic pressure, hence the higher the diastolic pressure, the greater the frequency at which adequate diastolic filling can occur. Eismayer and Quincke (1930) studied the effects of frequencies from 14 to 100 per minute on oxygen consumption. Their diastolic pressures were relatively high and their figures suggest that a maximum metabolic rate was reached at a frequency of 40 to 50 and that increasing the frequency above 70 reduced the metabolic rate. They found a maximum lactic acid production under anaerobic conditions at frequencies around 50 per minute.

Inspection of Fig. 5 shows at once that the high resting metabolism makes it difficult to calculate the relation between frequency and metabolism.

The figure shows with low frequencies a linear relation between frequency and oxygen usage. If the resting metabolism of the heart be subtracted, then the metabolism per beat is found to be constant at low frequencies. If, however, the relation between total metabolism and frequency is calculated then the metabolism per beat is found to fall steadily as the frequency increases. The resting metabolism of the heart is therefore an important figure in these calculations, but, unfortunately, it is a difficult figure to

estimate accurately. The most obvious source of error is that arrest of the heart favours oxygen depletion and in consequence glycolysis; hence the oxygen consumption under these conditions may not indicate the true metabolic activity. A further complication is that under certain conditions (*e.g.* strips of tissue in gas) the lactic acid formed by glycolysis may poison the heart and decrease its oxygen consumption. This effect was the probable reason why Clark and White (1930 *a*) found that the oxygen consumption of strips of auricles and of ventricles of frogs was higher in oxygen than in air.

The following results have been obtained for the oxygen consumption of frog's hearts, auricles and ventricles filled and arrested. Some of these results are shown in Table 19 (p. 91); all results are expressed as c.c. $O_2/g./hour$.

Frog's ventricle filled with suspension of mammalian erythrocytes, 0.12 (Weizsäcker, 1912), 0.15 (Clark and White, 1928 *a*).

Frog's ventricle filled with Ringer's fluid, 0.3 (Clark and White, 1928 *a*).

Frog's ventricle strip in air, 0.1, in oxygen 0.5 (Clark and White, 1930 *a*); in oxygen, 0.10 (Fenn, 1928).

Frog's auricle, filled Ringer-serum, 0.68 (Clark and White, 1930 *a*).

Frog's heart double cannula method, filled Ringer's fluid, 0.6, (Clark and White, 1928 *a*); Straub cannula, 0.13 (Fukuda and Naito, 1927).

Clark and White's estimates of oxygen consumption range around 0.5 c.c. $O_2/g./hour$, whereas other authors have found values between 0.1 and 0.15 c.c. $O_2/g./hour$. This difference is considerable and is of importance in relation to the calculation of cardiac efficiency. All these estimates are somewhat doubtful on account of the difficulty in maintaining an arrested heart in good

physiological condition long enough to permit the estimation of the oxygen consumption.

Clark (1935 *a*) made experiments to measure indirectly the resting metabolism of the heart. The method used was the determination of the rate at which asphyxial depression was produced at varying frequencies in

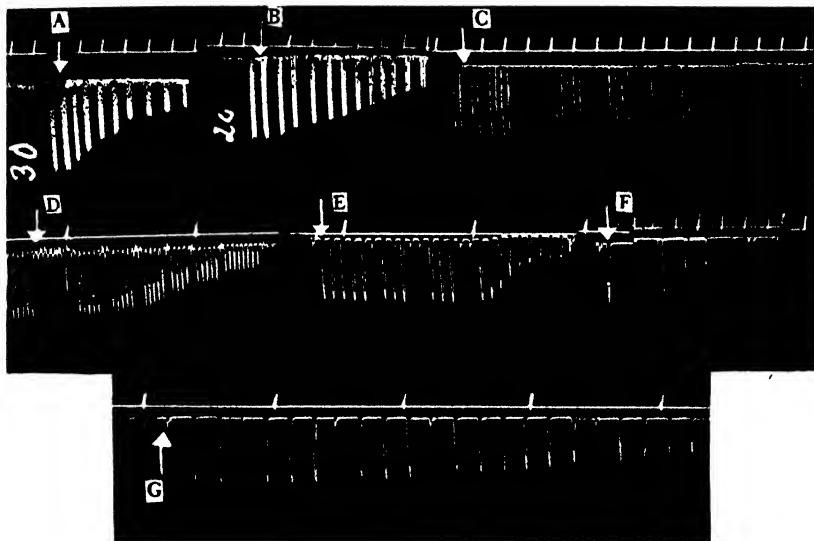

FIG. 6.—Time in min. Arrows mark estimated commencement of asphyxia (0.4 min. after commencement of nitrogen). A, B and C, asphyxiation of normal ventricle at respective frequencies of 30, 20 and 4 per min. D, E, F and G, asphyxiation of same ventricle after poisoning with I.A.A. The respective frequencies are 26, 13, 1 and 5 per min. (Clark, 1935 *a*).

normal ventricles and in ventricles poisoned with iodo-acetate.

In the case of the normal ventricle the rate of asphyxia depended primarily on the total buffer power of the fluid in contact with the ventricle, and care was needed to control this and other variables very exactly; in the case of the I.A.A. poisoned ventricle the rate of asphyxia was unaffected by the buffer power of the

fluid, the asphyxial depression was much more rapidly produced and in general the experimental method was simpler.

Fig. 6 shows the effects on the rate of asphyxial

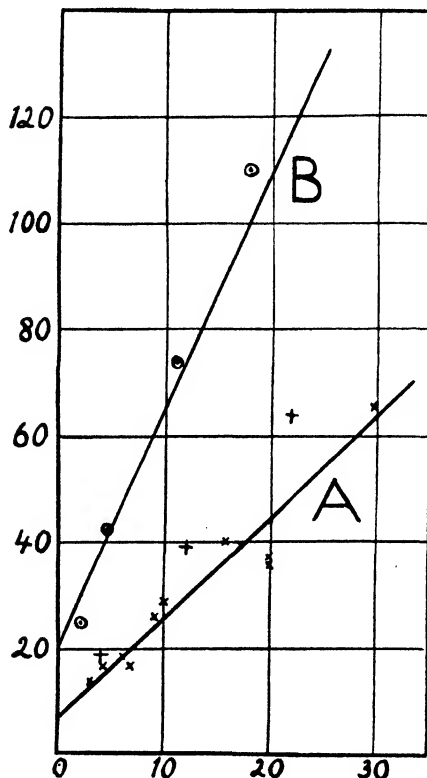

FIG. 7.—Relation between frequency and rate of asphyxiation. Abscissa: frequency per min. Ordinate: $100/T_a$. T_a is the time in min. until asphyxia produces depression to half normal mechanical response. Curve A Average obtained with normal ventricles. The crosses show some of the measurements on which the average is based. Curve B Average obtained with I.A.A. poisoned ventricles. The circles show results obtained in a single experiment (Clark, 1935 a).

paralysis of varying the frequency. The time until half depression is produced (T_a) can be measured from such curves and the reciprocals of these figures ($100/T_a$) measure the metabolic rate. Fig. 7 shows the relation

between frequency and metabolic rate for the normal and for the I.A.A. poisoned ventricle. Extrapolation of the results obtained with low frequencies indicates that the resting metabolism is between 20 and 25 per cent. of the metabolism at a frequency of 15 per minute.

The resting metabolism was also estimated by arresting the ventricle for short periods and measuring

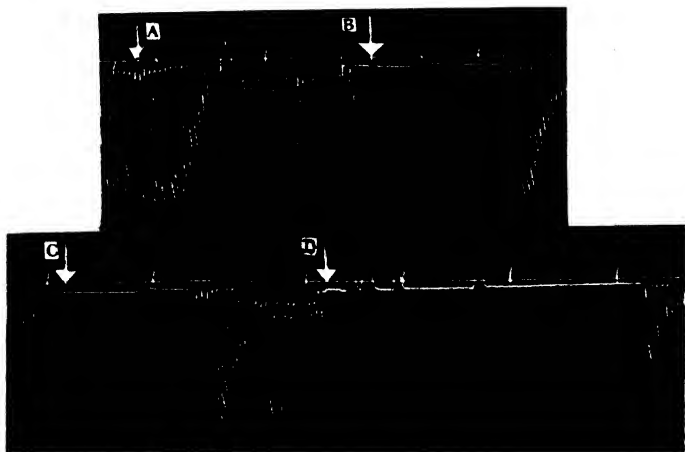

FIG. 8.—Time and arrows as in Fig. 6. I.A.A. poisoned ventricle. Frequency 20 per min. A. Continuous stimulation. Ta 0.6 min. B. Arrest for 1.2 min. Ta 1.6. C. Arrest for 1.2 min. Ta 1.6. D. Arrest for 2.8 min. Ta 2.9. (Clark, 1935 *a*.)

the delay in asphyxial depression and thus calculating the metabolic rate during arrest. Typical curves from this type of experiment are shown in Fig. 8. The resting metabolism thus calculated lay between 20 and 30 per cent. of the metabolism at a frequency of 15 per minute. The results of Weizsäcker (1912 *a*), of Clark and White (1928 *a*) and of Clark (1935) are shown in Fig. 9, plotted on a uniform scale.

Weizsäcker's method did not measure anaerobic metabolism, but extensive glycolysis was likely to occur under the experimental conditions he used, namely, a

considerable volume of well-buffered fluid; hence it seems probable that the higher results obtained by Clark and White and by Clark are more reliable, and that the metabolism of the arrested heart is from 20 to 30 per cent. of the metabolism during moderate

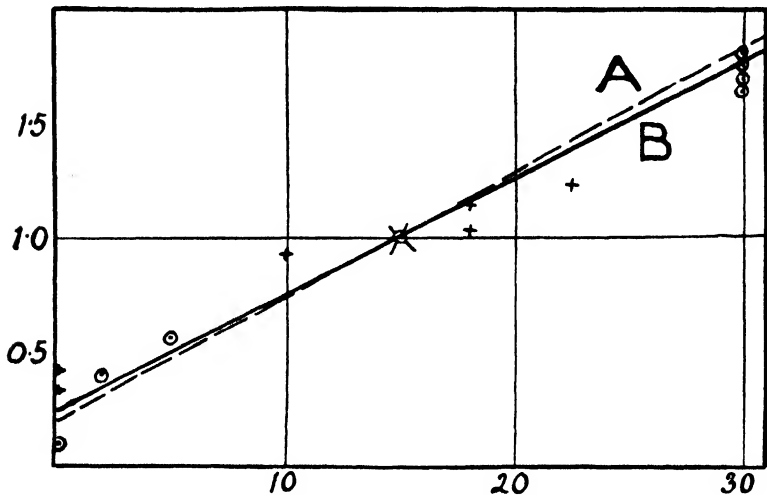

FIG. 9.—Relation between frequency and rate of asphyxial depression and oxygen consumption. Abscissa: frequency per min. Ordinate: metabolic rate expressed as fraction of the value at 15 per min. (Clark, 1935 *a*). A. and B. Average curves relating $100/T_a$ and frequency for I.A.A. poisoned and normal ventricles respectively. Crosses, oxygen consumption of frog's ventricle recorded by Clark and White (1928 *a*, Fig. 4). Circles, oxygen consumption of frog's ventricle recorded by Weizsäcker (1912).

activity. The nature of this resting metabolism is discussed further in Chapter IX.

The Effect of Filling and of Resistance on Oxygen Usage

The effect on oxygen consumption of varying the filling of a chamber of the heart is shown in Fig. 10. This experiment was carried out on the tortoise auricle which, on account of its size and distensibility, is a particularly convenient object for this type of measure-

ment. The effect is shown equally well by the frog's auricle and ventricle as is seen in Fig. 11.

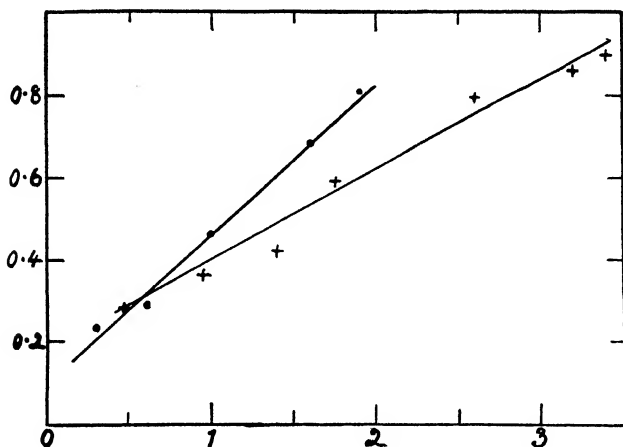

FIG. 10.—Influence of filling upon oxygen usage of isolated tortoise auricle (two experiments). Ordinate: oxygen usage c.c./g./hour. Abscissa: filling in c.c. (Clark and White, 1930 a).

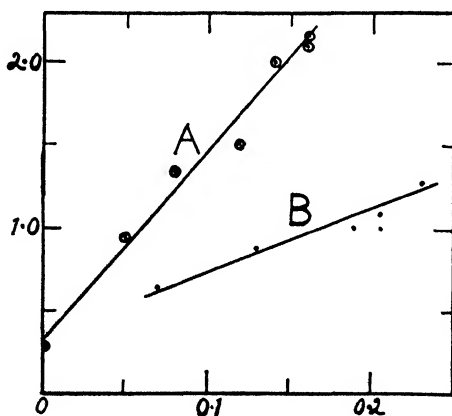

FIG. 11.—Influence of filling on oxygen usage of frog's auricle (A) and of frog's ventricle (B). Ordinate: oxygen used c.c./g./hour. Abscissa: filling in c.c. A. Clark and White (1930 a). B. *Idem* (1928 a).

In all these experiments the frequency was unaltered, and the figures show that the oxygen consumption of

the empty chamber is only a fraction of the oxygen consumption of the well-filled chamber. The experiments on the ventricle are subject to the error that the empty ventricle is unlikely to obtain an adequate oxygen supply, but according to Warburg's formula the empty auricle of either the frog or the tortoise ought to obtain an adequate oxygen supply by diffusion inwards from its external surface. Figs. 10 and 11 A show that the oxygen consumption of the empty auricle is between 12 and 20 per cent. of the oxygen consumption of the fully distended auricle. In the case of the ventricle, however (Fig. 11 B), the oxygen consumption when empty is 30 per cent. of that when fully distended. This difference is probably due to the fact that the auricle when empty shrinks to a much smaller volume than the ventricle. Hence an equal filling (*e.g.* 0.15 c.c.) represents a much greater increase in volume in the case of the frog's auricle than in the case of the frog's ventricle.

Himei (1935) using the frog's auricle found that the oxygen usage was markedly increased by increased filling.

Clark (1935 *b*) measured the rate of asphyxial arrest of the empty and the filled frog's ventricle when contracting and found that the metabolic rate of the empty contracting ventricle was about 60 per cent. of that of the ventricle when moderately filled. The difference between the metabolism of the empty and filled ventricle may therefore be less than is shown in Fig. 11.

All observers agree, however, that increased filling causes a great increase in oxygen consumption in both the cold-blooded and the mammalian heart. Increase of filling is associated with increased work, and the problem arises whether an increase in resistance, and,

consequently, an increase in work done, causes an increase in oxygen consumption when the filling remains unaltered.

The frog's heart is a difficult tissue on which to measure effects of alterations in work done. For example, any considerable increase in resistance is liable to interfere with the irrigation of the heart and also to produce leakage, and either of these errors will invalidate the results. It is necessary, therefore, to rely chiefly on experiments made with the larger hearts of tortoises or mammals for the determination of this question. In the case of experiments with the tortoise's ventricle it must, however, be remembered that this is normally supplied by a coronary circulation and hence, if this is obstructed, a considerable proportion of the ventricle will function anaerobically, and the oxygen consumption will not measure the total metabolism.

Effect of Filling on Work Done.—In the first place, it is necessary to consider shortly the laws relating the mechanical response with the filling of the heart, even though this subject is somewhat outside the scope of the present monograph.

Blix (1891-95) showed that the tension produced by a skeletal muscle depended on its initial length, and about the same time Frank (1895) showed that the same laws held true for the pressure produced by the frog's ventricle. He worked out the curves relating filling and response and also showed that with after-loading conditions the curves obtained were intermediate between the curves obtained with isotonic and isometric responses. These fundamental facts have been confirmed by all subsequent workers, and Fig. 12 shows an example of the curves obtained.

Comparison between Skeletal and Heart Muscle.—It is unsafe to transfer arguments and methods

elaborated with skeletal muscle to cardiac muscle. The mechanical properties of skeletal muscle have been worked out very largely on the frog's sartorius, which is composed of parallel fibres. The gastrocnemius has been found less satisfactory because its fibres are not strictly parallel. Inspection of Fig. 1 shows the

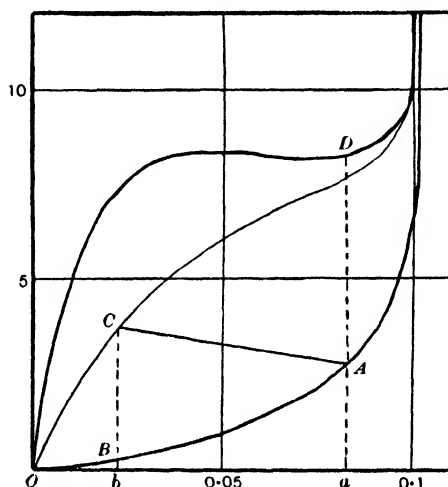

FIG. 12.—Influence of filling on mechanical response. Abscissa: diastolic filling in c.c. Ordinate: pressure in cm. H₂O. The curves from below upwards show (1) diastolic pressure, (2) systolic pressures produced by auxobaric contraction, (3) systolic pressures produced by isochoric contraction. The line AC shows the auxobaric contraction when the diastolic filling is 0.085 c.c. (Clark and White, 1930 a).

extreme complexity of the arrangement of the muscle fibres in the frog's ventricle. It may almost be said that no two fibres run in the same direction. Furthermore, it is not possible to arrange for the ventricle to work under either true isotonic or isometric conditions. Even if the pressure is kept strictly constant, yet the contraction is not truly isotonic, because in the case of a hollow vessel the tension varies as the pressure \times (radius)², and hence when the pressure remains constant the tension decreases as the heart contracts. Conversely,

even if the volume of the heart is maintained constant during contraction, this does not prevent alterations in the length of the fibres, because the frog's ventricle is not a sphere and during isometric contraction it changes from its irregular shape to a more nearly spherical shape, so that the same volume is enclosed by a smaller surface of heart wall. Inspection of Fig. 1 also shows that extensive alterations of length in the trabeculæ can probably occur without any change in volume. Weizsäcker (1911) pointed out these facts and recommended the substitution in the case of the heart of the terms isobaric, isochoric and auxobaric for the usual terms isotonic, isometric and auxotonic. The latter terms are so much more familiar that they are employed in this monograph, but it is important to remember that they are rarely correct when applied to the isolated frog's heart.

Although it is not possible to measure accurately the work done by the frog's heart, or to produce true isotonic or isometric conditions, yet the profound effect of variations in filling on either the pressure produced or on the work done is very obvious.

It may be noted that in the cases of the frog's auricle and ventricle and the tortoise's auricle, an optimum filling is produced by 2 to 3 cm. of water, and even in the case of the ventricle pressures above 5 cm. of water are above the optimum as estimated by the added pressure. The tortoise's ventricle which is much thicker has a wider range as regards diastolic pressures.

Influence of Work on Metabolism of Cold-blooded Heart.—Weizsäcker (1911) found that increasing the initial pressure caused a marked increase in both the work done and the oxygen consumed by the frog's ventricle. He found also that there was no direct proportion between these two increases, for the oxygen

consumption rose rapidly when the initial pressure was increased from 0 to 10 mm. Hg, but reached a maximum at 10 mm. Hg, whilst the work done rose steadily until a pressure of about 30 mm. Hg was attained. Consequently the efficiency of the ventricle (work done/oxygen consumed) was not constant but rose steadily when the pressure was increased from 10 to 30 mm. Hg.

Weizsäcker (1912 *δ*) also studied the effect on oxygen consumption of introducing extrasystoles at varying periods after the normal beat. He obtained the following results when the normal frequency was 25.

Height of extrasystoles (as per cent. normal)	60	20	10	0
Extra oxygen consumption due to extrasystoles (as per cent. of normal) . . .	60	45	23.20	5.35

He concluded that the oxygen consumption was proportional to the mechanical effect it produced, and that unless a stimulus produced a mechanical response it did not affect the oxygen consumption. Weizsäcker did not control the variation in filling, and hence these results are inconclusive as regards the effect of changes in work done, apart from variations in diastolic filling.

Bodenheimer (1916) and Luscher (1919, 1920, 1921) obtained results similar to those of Weizsäcker and the latter writer thought that his results proved that the oxygen consumption of the frog's heart was proportional to the work done. Starling and Visscher (1926-27) showed, however, that the results might equally well be interpreted as meaning that the oxygen consumption varied as the ventricular volume.

Bohnenkamp and co-workers (1926-29) made a series of researches upon the heat production of the isolated frog's ventricle and concluded that the heat produced was constant whatever the filling. Fischer (1926, 1927) made a study of the technical errors of these methods and showed that results obtained with

thermo-electric measurements on the heart were valueless unless a number of very stringent precautions were taken. His criticisms apply not only to the work of Bohnenkamp, but also the previous work of Bruns (1914), Herlitzka (1912, 1915) and of Snyder (1917-1926).

Fischer found that the energy equivalent of the heat produced per beat by a ventricle of 130 mg. weight rose from 1.6 to 2.9 g. cm. when the initial pressure increased from 5 to 15 cm. water, but that a further increase of pressure up to 35 cm. water only raised the energy liberated to 3.2 g. cm. These results agree with the results obtained with measurements of oxygen consumption. Bohnenkamp, Eismayer and Ernst (1928) also measured the oxygen consumption of the frog's ventricle over a range of diastolic pressures and found it to be uniform and unaffected by changes in the pressure or filling. This result disagrees completely with the results obtained by all other workers. Eismayer and Quincke (1929) studied the oxygen consumption and sugar usage of the frog's heart and found a linear relation between diastolic volume and oxygen consumption, but found no relation between work done and sugar usage. Riesser (1928) measured the lactic acid production of hearts poisoned with cyanide and found that this was increased when the diastolic volume was increased but was not increased by increase in the resistance. Clark and White found that variations in filling had the obvious effect on the oxygen consumption that is shown in Figs. 10 and 11. Bauer (1930) made somewhat similar experiments and confirmed the effect of filling on the oxygen consumption.

In these cases the experimental conditions were arranged to favour free irrigation of the cardiac tissue, and the resistance (and consequently the systolic pressure) were kept as low as possible, hence these

experiments are unsuited for estimating the relation between oxygen usage and work done.

Clark and White (1928) tried the effect of introducing an aortic resistance into a frog's heart beating with a circulation and found no increase in oxygen consumption. They investigated this problem more fully on the isolated auricle (1930 *a*). This tissue is so thin that it can obtain an adequate oxygen supply by diffusion from outside when it is suspended in oxygen, and hence the oxygen supply does not depend on the internal irrigation. They found that the oxygen consumption under isometric (or isochoric) conditions was less than the oxygen consumption under isotonic (or rather auxobaric) conditions. They also compared the effect of varying the initial pressure. The following averages are taken from their work (*loc. cit.* Table VI B).

Diastolic pressure . . .	2.1 cm. H ₂ O	7.0 cm. H ₂ O
Diastolic volume . . .	0.133 c.c.	0.15 c.c.
Systolic output . . .	0.08 c.c.	0.05 c.c.
Oxygen consumption c.mm. per hour	18	18

The work done in the two cases is approximately in the ratio of 2.1×0.08 to 7.0×0.05 or 17 to 35. Hence the increased pressure doubled the work done but it did not increase the oxygen consumption. Clark and White, therefore, failed to show any increased oxygen consumption by the frog's ventricle or auricle by increasing the work performed. Eismayer and Quincke (1930) also worked with the frog's ventricle. They noted the deleterious effect of prolonged isometric activity on the ventricle, and therefore when using isometric conditions interspersed isotonic conditions every fourth beat. They found that under isotonic conditions the oxygen use was 1.8 c.c. per g. per hour and that this rose to 3.2 c.c. under conditions that were nearly iso-

metric. These authors suggested that the oxygen consumption was dependent on the speed at which relaxation occurred and that the oxygen consumption rose under nearly isometric conditions because this increased the speed of relaxation. This positive result of Eismayer and Quincke seems more certain than the negative results obtained by Clark and White, for in the latter case it is possible that interference with output caused partial anoxæmia and a consequent production of lactic acid, and this source of error was not eliminated.

Stella (1931) worked with the tortoise's ventricle filled with tortoise blood. He found that increase in diastolic volume produced a large increase in oxygen consumption. His figures showed that if an allowance were made for resting metabolism then the oxygen use due to contraction was doubled when the diastolic volume was doubled. He found also that increased resistance produced an increased oxygen consumption, but when the diastolic volume was kept constant this increase was not so marked as was the increase due to changes in diastolic volume.

Decherd and Visscher (1933) worked with the turtle's ventricles filled with blood. They found that the oxygen usage was a function of the diastolic volume, but found in contradiction to Stella that increase in arterial resistance did not increase the oxygen consumption provided that the diastolic volume was maintained constant.

Wertheimer (1932) found with strips of frog's ventricle that increasing the tension increased the sugar usage, whilst Scheinfinkel (1935) found that altering the work done did not affect the sugar consumption of the frog's ventricle.

The evidence as regards the effect of filling and

work done on the metabolism of the frog's heart may be summarised as follows:—

When both these factors are increased together, as is the case when the diastolic volume is increased, the effect on metabolism is very great. The effect of altering the resistance against which the heart works is much smaller.

Recent advances in our knowledge of cardiac physiology suggest that much of the evidence relating metabolic rate and work is inconclusive. Cardiac tissue, when well supplied with oxygen, oxidises lactates but oxidises little or no carbohydrate, but any shortage in oxygen supply causes glycolysis. Any interference with the irrigation of the frog's ventricle is therefore more likely to cause an increased glycogen or sugar usage (by glycolysis) than to cause an increased oxygen usage.

The wide variations in the carbohydrate content of the frog's heart make it very difficult to determine accurately the usage of carbohydrate, and therefore the tissue is unsuitable for the accurate estimation of the relation between work done and metabolism. The tortoise's ventricle is also unsuitable because its thickness is too great to permit an adequate oxygenation of all portions, and hence the metabolism of the isolated ventricle must be partly aerobic and partly anaerobic.

The authors consider, therefore, that those experiments are inconclusive which have failed to show an increase in oxygen consumption when the work has been increased and the diastolic volume maintained constant. On the other hand, the positive evidence in this connection cannot be considered satisfactory because different workers have obtained such different results with similar systems.

Work and Metabolism of Mammalian Heart.—Rohde (1912), working with the isolated cat's heart, concluded that there was a certain volume of the heart at which the greatest release of energy occurred when the heart contracted and that the energy release was the same under isotonic and isometric conditions.

Evans (1912) and Evans and Matsuoka (1914-15) found in the dog's heart-lung preparation that there was usually a demonstrable parallel between the oxygen usage of the heart and the heart volume, just as there was between cardiac work and volume. They found that increase in arterial resistance, which greatly increased the work done, produced a relatively smaller increase in oxygen consumption and hence the efficiency rose when the resistance was increased.

Starling and Visscher (1926-27) concluded definitely that in the heart-lung preparation the oxygen consumption was determined by its diastolic volume, and therefore by the initial length of its muscular fibres, and that the oxygen consumption was constant for a constant volume irrespective of the work done. Hemingway and Fee (1927) found a linear relation between diastolic volume and oxygen consumption.

Evans (1918) and Gremels (1933) found with the heart-lung preparation that the oxygen usage was increased two- to three-fold when the work was increased five- to seven-fold.

The significance of this earlier work in the heart-lung preparation has been made doubtful by the discovery (McGinty, 1931; Evans *et al.*, 1933; Evans, Grande and Hsu, 1935) that the heart oxidises lactate in preference to carbohydrates and that the lungs produce a considerable quantity of lactate. Hence the energy exchanges in the heart-lung preparation are complex.

Various workers (Cruickshank, 1913; Visscher and

Mulder, 1930) had found that the glycogen usage of the heart-lung preparation was small and irregular. Ruhl (1934) found no certain relation between work done and lactate usage.

Evans, Grande and Hsu (1934) and Bogue, Evans, Grande and Hsu (1935) working with the isolated dog's heart were able to exclude many of the sources of error present in the heart-lung preparation and found that increase of work with constant filling increased the combined usage of sugar and lactic acid, although not in proportion to the increase in work done.

In the case of the isolated heart of the dog, therefore, the evidence appears to be fairly complete that a large increase in work (*e.g.* five-fold) causes the oxygen consumption to be doubled and that a part of this increase is due to increased oxidation of lactates. These changes occur when full precautions are taken to keep the diastolic volume constant.

Unfortunately these results are not absolutely conclusive, because increase of work without change of diastolic volume implies increase in aortic resistance, and this increases the coronary flow. Hence the increased oxygen usage may be due to increased blood flow and improvement in the oxygen supply.

The experiments with cold-blooded hearts have given inconclusive results in regard to this problem, and in view of the more definite results obtained with the mammal's heart it seems best to assume provisionally that the oxygen consumption of cardiac tissue in general is regulated not only by the initial length of the fibre but also by the resistance against which the fibre contracts. It is generally agreed that this is true in the case of skeletal muscle, and the evidence is certainly inadequate to establish any difference in this regard between skeletal and cardiac muscle.

The Metabolism of the Empty Frog's Heart.— The metabolism of the frog's heart both when empty and when arrested is difficult to determine with accuracy, because if there is no circulation the oxygen usage is limited by the amount that can diffuse from outside. Hence the resting metabolism as estimated by the

TABLE 19

Resting Oxygen Usage of Cardiac Tissue.
(All results as c.c. O₂/g. moist weight/hour).

	Filled.		Empty.	
	Contracting.	Arrested.	Contracting.	Arrested.
<i>Frog's heart</i> , perfused with Ringer's fluid. Clark and White (1928 a). Average 4 experiments (average frequency 24)	1·5	0·6	0·7	0·5
Clark, Gaddie and Stewart (1931). Average 10 experiments (average frequency about 25)	1·4	...	0·45	...
<i>Frog's auricle</i> , perfused serum-Ringer fluid. Clark and White (1930 a). Average 6 experiments (frequency about 30)—				
(a) In air	1·6	...	0·44	...
(b) In oxygen	1·77	...	0·59	...
Average 5 experiments (frequency 38, in oxygen)	1·53	...	0·58	0·36
One experiment (frequency 38, in oxygen)	1·98	0·68	0·55	0·32
<i>Tortoise's auricle</i> , perfused serum-Ringer fluid. Clark and White (1930 a). Average 6 experiments (frequency 8)	0·8	...	0·13	...
<i>Turtle's auricle</i> strip, temperature 22°-31° C. Garrey and Boykins (1933)	0·22
<i>Tortoise's ventricle</i> , filled with blood. Stella (1931)	1·0	...	0·23	...

oxygen consumption is likely to be lower than the true value. The experiments already described on the frequency of the heart (Weizsäcker, 1812; Clark and White, 1928 *a*, 1930 *a*; Clark, 1935 *a*) showed that the metabolism of the filled but arrested heart was between 20 and 30 per cent. of the metabolism at a moderate activity (15 per minute).

Two other problems arise, firstly, whether the resting metabolism is affected by the filling, and, secondly, whether the passage of a wave of contraction over the empty heart increases its metabolism.

Table 19 summarises the results obtained by various authors for the influence of emptying and of arrest on the oxygen consumption of cardiac tissue. These results suggest that arrest reduces the oxygen consumption of the filled heart or auricle to the same level as that of the empty contracting tissue, but that the empty and arrested heart has a definitely lower metabolic rate. Clark (1935) estimated the metabolic rate by the indirect method of determining the speed with which asphyxial depression of the frog's ventricle was produced. He obtained the results shown in Table 20. These results show that the passage of the wave of excitation

TABLE 20

*Metabolic Rates of Frog's Ventricle as Estimated by Rate of Asphyxial Depression (i.e. Reciprocal of Time until Mechanical Response Reduced to Half Normal). Figures as per cent. of Metabolic Rate at Moderate Filling and Frequency of 15 per minute (Clark, 1935 *a* and *b*)*

	Normal Ventricle.	I.A.A. Poisoned Ventricle.
Filled and arrested . . .	20	24
Empty and contracting . . .	60	67
Empty and arrested . . .	20	30

over the empty ventricle definitely increases its metabolic rate. They do not show any difference between the

metabolic rate of the empty and filled ventricle when arrested.

The effect of excitation on the empty ventricle shown by this method is much greater than that shown by the experiments on oxygen consumption (Table 19), and is opposed to Weizsäcker's experiments (1912) which showed that extrasystoles did not increase oxygen consumption. The estimation of metabolic rate by the rate of production of asphyxial depression is an indirect method, but it is free from the obvious objection attaching to estimations of oxygen usage, namely, that these do not measure the energy production due to glycolysis.

The effects of stimulation on the metabolism of the empty heart are therefore uncertain, but the evidence available indicates that an increase probably occurs.

Resting Metabolism of Skeletal Muscle.— In the case of skeletal muscle there is a considerable body of evidence which proves that the resting metabolism depends on the length of the muscle and is increased by stretching.

Ernst and Fricker (1931) found that stretching greatly increased the lactic acid formation of skeletal muscle, and that the resting lactic acid formation of stretched muscle was about 30 per cent. of the lactic acid formation during moderate activity. Meyerhof, Gemmill and Benetato (1932) found that stretching increased the resting oxygen consumption.

Feng (1932) and von Euler (1934) showed that stretching increased the resting heat production of muscle. The latter author noted that the effect was shown well with the sartorius of *Rana temporaria* but was not shown by the rectus abdominis and was shown poorly by the sartorius of *Rana esculenta*. Furthermore, the effect was only seen well in the case of frogs in

good condition. These qualifications make the general significance of the effect of stretching on the metabolism of resting skeletal muscle somewhat obscure. It is, however, of interest to note that the resting metabolism of unstretched skeletal muscle is much lower than that of cardiac muscle. Since stretching raises the former but not the latter it reduces the difference between the two. It may therefore be said that, when stretched, cardiac and skeletal muscle have a similar resting metabolic rate, that this rate is not changed when the cardiac muscle is not stretched, but that the resting metabolism of skeletal muscle is greatly reduced when it is not stretched. This difference in the two types of muscle is not surprising, because the reduction in metabolism represents an important economy in the case of skeletal muscle but not in the case of cardiac muscle. The fact that stimulation of the empty heart increases the metabolic rate is in accordance with results obtained on skeletal muscle, for in this case the heat produced by an unstretched muscle contracting against a minimum resistance is between 60 and 70 per cent. of the maximum heat production (Hill, 1925).

In the case of the heart, stimulation of the empty organ causes movements of the trabeculæ, and since the internal resistance in such a network must be considerable, part of the energy released is utilised in this manner. The proportion of energy converted to heat is unknown and hence these results do not provide information regarding the amount of energy needed to restore the membrane potential of the cells. This is probably low, because a heart nearly paralysed by calcium lack can maintain a normal electrical response whilst the metabolic rate is nearly as low as that of the empty arrested heart.

In general the effects of initial length and of resistance

on the metabolism of cardiac muscle show many resemblances to their effects on skeletal muscle.

The chief difference of practical importance is that with skeletal muscle it is easy to arrange the conditions so that the resting metabolism is a very small fraction of the metabolism added by contraction, whilst this is not possible in the case of cardiac muscle. This makes it difficult to calculate the efficiency of cardiac muscle, a difficulty which is increased by the fact that true isotonic or isometric conditions cannot be obtained in the heart.

Furthermore it is extremely difficult to obtain reliable information regarding the heat production of cardiac muscle. These facts together constitute severe limitations on the investigation of the relation between energy release and work performed by heart muscle. Consequently this aspect of metabolism which has been of such dominant importance in the investigation of the metabolism of skeletal muscle is at present of minor importance in the case of cardiac metabolism where the evidence available is so imperfect and uncertain.

Hypodynamic Condition and Effect of Serum

The frog's heart when perfused with Ringer's fluid shows a steady decrease in activity and this is accompanied by a decrease in the oxygen consumption. The character of this decrease is shown in Fig. 13. Its rate depends upon how thoroughly the ventricle is washed out, for it is greatly retarded by the presence of small quantities of serum. In the case of experiments of long duration, such as are required when oxygen consumption is estimated, the heart is in the hypodynamic condition during most of the time.

Clark (1913) showed that a hypodynamic heart

could be restored nearly to normal by addition of either serum or alcoholic extract of serum. Saponification of the alcoholic extract did not destroy its activity.

A similar restorative effect could be produced by lecithin or by certain soaps such as sodium oleate. Danilewski (1907) had previously shown this stimulant action of lecithin. This restorative effect is produced

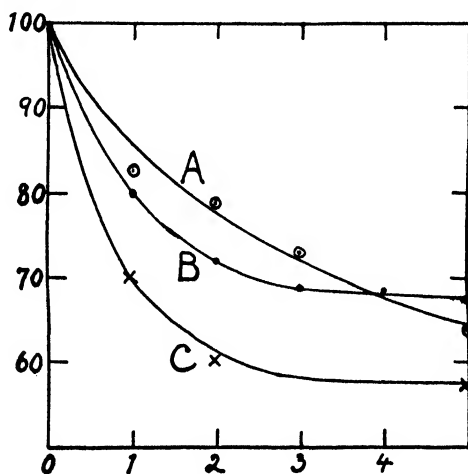

FIG. 13.—Development of hypodynamic condition in frog's heart in contact with Ringer's fluid. Ordinate: activity as per cent. of normal. Abscissa: time in hours. A. Oxygen usage (Clark and White, 1928*b*). B. Frequency. C. Height of isotonic contraction (Clark, 1913).

by impure lecithin but not by purified lecithin (Storm v. Leeuwen and Gyorgyi, 1923) nor is it produced by purified cephalin (Eggleton, 1926).

This action of impure lecithin and of soaps has been confirmed by many authors (Loewi, 1921; Wieland, 1921; Seel, 1926; Rothmann, 1930; Weichardt and Unger, 1929; Lindner and Rigler, 1931; Mauger, 1933).

It has also been shown that a marked stimulant action on the hypodynamic heart is produced by a wide variety of colloidal substances, such as charcoal, colloidal

metals, etc. (Wieland, 1921; Weichart and Unger, 1929; Lindner and Rigler, 1930). Lindner and Rigler (1930) also found that hexose-diphosphate and adenosine triphosphate produced a stimulant action on the hypodynamic frog's heart, an effect confirmed by Freeman (1930).

Vernon (1910) noted the hypodynamic condition produced in the tortoise's heart by prolonged perfusion. He found that the carbon dioxide production was reduced and that this could be increased by the addition of serum.

Clark and White (1928 *a*) found the average fall in oxygen consumption during prolonged perfusion that is shown in Fig. 13. Eismayer and Quincke (1929) found that anaerobic lactic acid production in the hypodynamic heart was about half that in the fresh heart. They found (1930) a similar reduction in the oxygen usage and in the carbon dioxide production.

Clark and White (1928 *b*) showed that addition of serum or of alcoholic extract of serum would restore the oxygen consumption of the hypodynamic heart to the normal level. They concluded that the active substance in serum was a soap. Similar effects were produced by 10 per cent. of ox serum or by 0.004 per cent. sodium oleate. The serum did not appear to increase the resting metabolism of the heart. Small additions of serum only produced a temporary increase in the oxygen consumption, but the action could be repeated several times. Hence the augmentor effect appears to be due to some substance which is used up by the heart.

The mode of action of the stimulant principle present in serum is unknown, but it is interesting to note that Meyerhof (1923) found that addition of phosphatides to muscle *brevi* caused a great increase in oxygen consumption.

Clark's (1913 *b*) results suggested that the action might be due to some alteration in the condition of the calcium which caused fixation of calcium on the heart surfaces. This hypothesis would account for the similar effect produced by a wide variety of different agents.

Influence of Temperature on Metabolism

The frequency of the isolated frog's heart is dependent on the temperature and increases two- or three-fold for every increase of 10° C. Since there is a complex relation between frequency and metabolism it is clearly impossible to obtain a quantitative estimate of the influence of temperature on the metabolic processes unless the frequency is kept constant. Only those experiments will be considered in which this precaution was taken. Weizsäcker (1912) found that the Q_{10} for oxygen usage between 6.5° and 32° C. varied from 1.4 to 1.9 with a mean of 1.6. He concluded that the Q_{10} of the resting metabolism was 2.5. Clark (1935) studied the influence of temperature on the frog's ventricle, both normal and poisoned with I.A.A., by the indirect method of measuring the rate of asphyxial depression. The results which are shown in Figs. 14 and 15 confirm Weizsäcker's conclusion that the resting metabolism is greatly increased by increase of temperature. The results show a $Q/10$ of about 2.

As regards the influence of temperature on the metabolism added by the contraction process (*i.e.* the total metabolism minus resting metabolism) these results are less clear. It seems fairly clear that this added metabolism is less at 5° than at 10° C., but there is no certain difference between 10° and 25° C.

Edsall *et al.* (1932) studied the rate of fall in the mechanical response of the asphyxiated auricle of the

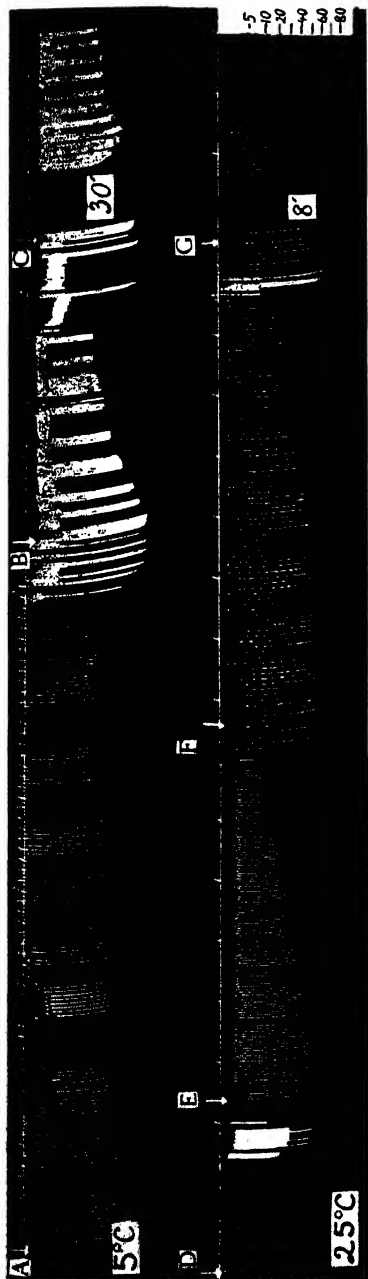

FIG. 4.—Influence of temperature on rate of asphyxiation of normal ventricle. Time and arrows as in Fig. 6. Scale of pressure in cm. H_2O at lower right-hand corner. (Clark, 1935 *b*.)

	Frequency per min.	Initial systolic pressure in cm. H_2O .	T_a in min.	$100/T_a$.
Temp. 5° C. A B C	3	80	29	3.5
	12	80	9	11
	Arrest 30 min. and then 12 per min.	60	30+11 Ta. calc. = 135	0.75
Temp. 25° C. D E F G	3	55	6.5	15.5
	24	50	3	33
	12	60	5.5	18
	Arrest 8 min. and then 12 per min.	50	8+2.2 Ta. calc. = 12.6	7.9

turtle and concluded that this was not altered by changes of temperature between 18° and 32° C. provided that the frequency was maintained constant. In this case the frequency was high, and therefore the resting

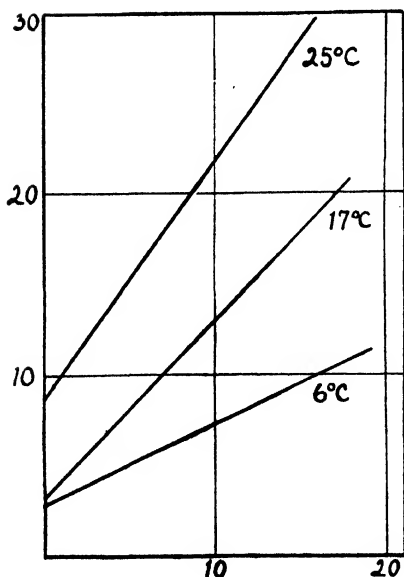

FIG. 15a.—The influence of temperature on the rate of asphyxiation of normal ventricles. Abscissa: frequency per min. Ordinate: $100/Ta$.

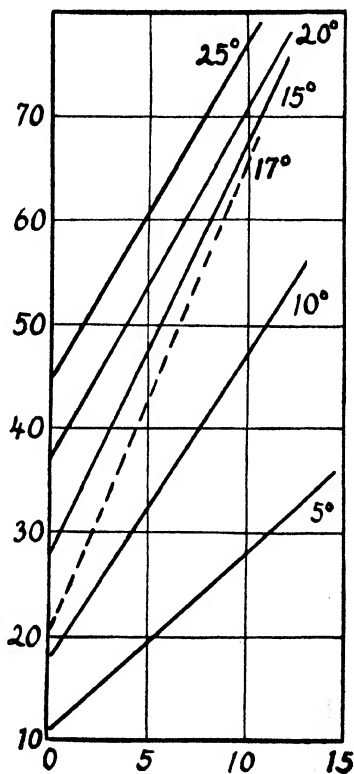

FIG. 15b.—The influence of temperature on the rate of asphyxiation of I.A.A. poisoned ventricles. Abscissa and ordinate as in 15a (Clark, 1935 b).

metabolism would only form a small fraction of the total metabolism, consequently this result is not widely divergent from the results obtained by Clark.

Doi (1920) and Cattell and Edwards (1930) both found that in the heart, as in skeletal muscle, the

mechanical response became greater when the temperature was reduced. Since the metabolism added by contraction is either unaltered or reduced by reduction in temperature this implies that the efficiency rises with a fall of temperature. The most probable reason for this result is that the rate of contraction falls with fall of temperature and hence loss of energy due to internal friction in the muscle is reduced.

CHAPTER V

CARBOHYDRATE METABOLISM OF THE FROG'S HEART

Available Carbohydrate—Glycogen Loss—Total Carbohydrate Loss
—Carbohydrate Balance of Complete System—Path of Carbohydrate
Oxidation.

Carbohydrate Metabolism of the Frog's Heart

THE older view that the contraction of skeletal muscle essentially involves the breakdown of glycogen to lactic acid and the subsequent oxidation of part of the latter, has been replaced in recent years by the view that this reaction does no more than supply energy for more essential processes and that it can be replaced, at least to some extent, by the oxidation of other substances—fatty acids, and possibly proteins or amino-acids.

It is therefore a matter of importance to know whether similar conditions hold in the muscle of the frog's heart; whether contraction takes place at the expense of carbohydrate breakdown, and, if so, to what extent; whether carbohydrate is the fuel of choice; under what conditions the carbohydrate usage varies; and what substances may, or do, supplement or replace it.

These problems may be attacked by direct or indirect means, and the latter is actually, since it is technically the easier, the first line of approach. Determination of the respiratory quotient of the frog's heart gives values, under normal conditions of oxygenation, in the neighbourhood of 0.9, and this figure,

constant over long periods, justifies the assumption that it is derived from complete combustion of metabolites, and therefore indicates the usage of carbohydrate as an important though not the sole source of energy. This being so, attention is, in this chapter, focused mainly upon the direct methods designed to give quantitative information regarding the carbohydrate which disappears from the frog's heart during activity under various conditions.

Actual estimation of the carbohydrate content of the frog's heart presents a number of difficulties. If attention is confined to glycogen, the estimation itself is no easy matter, in view of the small quantities present, since errors due to solubility, etc., which are of little importance when large amounts of material are available, become serious when micro-analysis is attempted. On the other hand, estimation of the "total carbohydrate," though technically easier and less liable to manipulative error, suffers from the disadvantage that it really includes all reducing substances extracted under certain specified conditions, and it becomes necessary to demonstrate what proportion of the total is true carbohydrate. This can actually be done by fermentation, since all carbohydrate present after acid hydrolysis of the muscle may be presumed to be fermentable. We find that the non-carbohydrate substances account for about one-tenth of the so-called "total carbohydrate" in a fresh heart, but since the amount of these substances does not alter appreciably during perfusion of the isolated heart, differences in "total carbohydrate" content may be accepted as indicating alterations in the content of true carbohydrate (Clark, Gaddie and Stewart, 1932).

The non-fermentable reducing substances include, *e.g.*, glutathione, ergothionine and creatine. It cannot,

however, be assumed that the fermentable substances consist solely of the hydrolysed glycogen and pre-existing glucose of the muscle, and, indeed, estimation of these two shows that they do not account for the total. In addition, there may be small amounts of substances formed as intermediates in the breakdown of carbohydrate:—hexose-phosphoric acid, triosephosphoric acids, etc., intermediates (if such exist) in the conversion of glycogen to hexose-diphosphoric acid, and carbohydrate derived from protein hydrolysis. Rimington (1931) found that a number of proteins, on hydrolysis, yielded 3 to 4 per cent. of a trisaccharide made up of 2 mols. of mannose (fermentable) and 1 mol. glucosamine (non-fermentable). Since the heart contains approximately 8 per cent. of protein, it could yield, on this basis, 0.2 per cent. of mannose and 0.1 per cent. of glucosamine. These suggestions go far to account for the curious fact that, even under conditions which would be expected to produce almost complete carbohydrate exhaustion of the heart, we rarely found the perfused heart to contain less than 0.40 per cent. of total reducing substances (calculated as glucose), or about 25 per cent. of the average amount present in the fresh heart.

Probably the main source of error in experiments involving direct determination of carbohydrate changes lies in the difficulty of securing adequate controls. It is important to realise, in the first place, that the heart *plus* perfusion fluid must be considered as the complete system under examination, and that leakage of carbohydrate into the fluid or, in other circumstances, absorption from the fluid must be taken into account. Further, the breakdown of carbohydrate may not be entirely oxidative, and lactic acid, produced anaerobically and diffusing into the fluid, may cause a misleading

diminution in the total carbohydrate content of the heart, and indeed of the system as a whole. Lactic acid production is to be discussed in a later chapter, but we may anticipate that discussion to the extent of pointing out that it is minimal under conditions of oxygenation which most nearly approach the perfect, and that a considerable accumulation of lactic acid indicates some degree of asphyxia.

Experimental conditions must, of course, be kept strictly comparable; the manner in which such factors as oxygen pressure, rate of work, temperature and composition of the perfusion fluid can influence the metabolic rate was discussed in Chapter IV.

The total carbohydrate content varies very much from one individual heart to another. This is true even for batches analysed at the same time, but the variability is even greater between batches taken at different times of the year and after different periods of captivity. The extent of this variation was discussed in Chapter III. It was found necessary on account of this variation to include in each series a considerable number of individuals both experimental and control; moreover, fresh series of control estimations had to be made for each experimental series, at the same time, and from the same batch of frogs.

Table 21 shows the results of our first series of experiments in which we found that during perfusion with Ringer's fluid, the heart lost glycogen, though not at a steady rate, since the loss was almost confined to the first 6 hours of perfusion. Even during the first 6 hours the glycogen loss was only sufficient to account for about a quarter of the oxygen consumption. Attempts were made, by altering the composition of the perfusion fluid, to improve the conditions under which the heart was working; addition of frog's serum,

however, made no difference to the glycogen loss. Nor did the addition of glucose, of insulin with glucose, or of glucose and serum, affect in any way the disappearance of glycogen. In fact, the addition of glucose

TABLE 21

Glycogen Loss of Hearts perfused in Air under Various Conditions. Figures for Oxygen Usage are taken from other Comparable Experiments.

Conditions.	Number of Experiments.	Glycogen Loss. Mg./g. Heart.	Per cent. of Total Oxygen Usage accounted for by Glycogen.
<i>A. 6 hours' perfusion—</i>			
Ringer's fluid . . .	8	3.0	39
Ringer+0.1 per cent. glucose	4	3.5	30
Ringer+serum+0.1 per cent. glucose	3	2.9	24
Ringer + glucose + insulin	4	3.2	...
<i>B. 24 hours' perfusion—</i>			
Ringer's fluid . . .	10	3.4	16
Ringer+serum . . .	6	2.7	10
Ringer+serum+0.1 per cent. glucose	12	2.5	6
Ringer+0.1 per cent. glucose+insulin	15	2.9	...

usually resulted in the death of the heart after 20 to 30 hours' perfusion, and did not markedly increase the oxygen consumption; the presence of insulin appeared to abolish the toxic effect of the glucose but had no other obvious action; and the presence of serum allowed the prolonged survival of the hearts, with an increase of about 25 per cent. in the oxygen consumption.

As will be seen later, the effect of serum on the rate of uptake of oxygen was apparently enhanced by the addition of glucose to the perfusion fluid as well.

This extra effect, however, was not very marked in perfusion experiments of 6 hours' duration, though in 20 hours the increase in total oxygen consumption in presence of glucose was some 60 or 70 per cent. This phenomenon is discussed later (p. 113).

These results were not very satisfactory since the estimation of glycogen in very small amounts is subject to considerable error, and since estimations of the total carbohydrate in control hearts suggested the presence in the heart of carbohydrates, other than glycogen, concerning whose utilisation the early experiments gave no information. In other experiments we therefore estimated the total carbohydrate content of the heart after perfusion under a variety of conditions, including those which were thought to be the most likely to favour carbohydrate usage.

Tables 22 and 23 give a general survey of the results we published in the years 1932-1934. These tables include certain important modifications made after a general revision of the whole mass of data. In the first place, certain corrected figures have been calculated for the controls, and in the second place, we have taken into account the production of lactic acid and the changes in the sugar content of the perfusion fluid, factors which were not recognised when our earlier experiments were performed.

The detailed nature of these modifications is as follows:—

In a few series of experiments we have recalculated the data originally published in the light of our later knowledge of the seasonal variability among the control hearts. Originally we took, for all experiments, the mean of the whole series of controls obtained over a long period; now we have taken the mean only of those controls analysed at the time of the perfusion

TABLE

Carbohydrate Balance.

Conditions.	No. of Expts.	O ₂ used. Cc./g./6 hrs.	R.Q.	Total Carbohydrate Mg./g. Heart.	
				Controls.	Perfused Hearts.
1. Ringer's fluid. Oxygen ³ . . .	27	5.3	0.75	12.4 [11.70]	10.95
2a. " " Air ³ . . .	18	5.2	0.90	12.4 [12.1]	9.10
2b. " " " ² . . .	11	8.3	0.89	12.30	8.70
2c. " " " ¹ . . .	6	6.4	0.88	16.9 [14.2]	14.40
3. " " 95 per cent. N ₂ ³ 5 per cent. O ₂	12	2.9	...	8.90	5.70
4. Ringer + serum or plasma. Oxygen	12	7.2	0.74	12.40 [15.0]	10.40
5a. Ringer + serum or plasma. Air ³	12	7.1	0.91	12.40 [15.0]	7.80
5b. " " " " ¹	12	10.4	0.84	14.20	10.50
6a. Ringer + serum + 0.1 per cent. glucose. Air ¹	4	9.90	0.87	16.40 [14.20]	10.30
6b. " " " " ⁴	10	6.06	0.87	12.43	8.75
7. Frog's blood. Air ¹ . . .	11	10.6	0.90	16.40 [14.20]	15.40
8. Frog's blood + glucose + 1.2 units of insulin. Air ¹	12	8.1	0.90	16.40 [14.20]	17.10
9. Ringer's fluid, Ca. lack. Air ³ .	12	2.65	...	12.10	13.70
10. Ringer's fluid + 0.9 m. ethyl alcohol. Air ³	6	2.96	...	12.0	10.0

¹ A. J. Clark, R. Gaddie and C. P. Stewart, *J. Physiol.*, lxxii., 443.² *Ibid.*, lxxv., 311

22

Perfusion for 6 Hours.

Change in Sugar Content of Heart. Mg./g. Heart.	Change in Sugar Content of Fluid. Mg./g. Heart.	Lactic Acid Produced. Mg./g. Heart.	Total Carbohydrate Loss from System. Mg./g. Heart.	Per cent. of Oxygen used by Carbohydrate.
-1.45 [-0.75]	+1.34	0.30	0	0
-3.30 [-3.0]	+1.10	0.60	-1.60 [-1.30]	25 [20]
-3.60	+0.40	(0.5)	-2.70	27
-2.50 [+0.2]	+0.60	(0.5)	-1.40 [+1.30]	18 [0]
-3.20	+1.80	1.0	-0.40	11
-2.0 [-4.6]	-0.1	0.5	-1.6 [-4.2]	18 [48]
-4.60 [-7.2]	0	0.5	-4.1 [-6.7]	48 [78]
-3.70	0	(0.5)	-3.2	26
-6.1 [-3.9]	0	(0.5)	-5.6 [-3.4]	47 [29]
-3.7	0	(0.5)	-3.2	39
-1.20 [+1.20]	-2.60	(0.5)	-3.1 [-0.9]	24 [7]
+0.70 [+2.90]	-3.0	(0.5)	-1.8 [+0.4]	18 [0]
+1.60	+0.6	(0.5)	+2.7	0
-2.0	+1.9	(0.5)	+0.4	0

³ A. J. Clark, R. Gaddie and C. P. Stewart, *J. Physiol.*, lxxvii., 432.

⁴ A. J. Clark, R. Gaddie and C. P. Stewart, unpublished experiments.

TABLE 23
Carbohydrate Balance. Perfusion for 24 hours.

Conditions.	No. of Experiments.	O ₂ used. Cc./g. per 24 hours.	R.Q.	Total Carbo- hydrate. Mg./g. Heart.		Change in Carbohydrate Content of Heart. Mg./g. Heart.	Change in Sugar Content Mg./g. Heart.	Lactic Acid Pro- duced. Mg./g. Heart.	Total Carbo- hydrate Loss from System. Mg./g. Heart.	Per cent. of Oxygen used by Carbo- hydrate.
				Controls.	Per- fused.					
1a. Ringer's fluid. Air. ²	9	14.0	...	15.50	9.60	-5.90	+1.0	(0.7)	-4.2	22.4
1b. " " fluid + glucose (0.1 per cent.). Air ¹	19	18.0	...	14.20	7.30	-6.90	+3.0	(0.7)	-3.2	13.3
2. Ringer's fluid + glucose (0.1 per cent.). Air ¹	4	28.4	0.83	-6.2
3. Ringer's fluid + serum. Air ¹	5	22.8	0.85	14.20	4.80	-9.4	0	(0.7)	-8.7	28.8
4. Ringer's fluid + serum + glucose (0.1 per cent.). Air ¹	7	40.1	0.89	16.4 [14.2]	4.0	-12.4 [-10.2]	-8.2	(0.7)	-19.9 [-17.7]	41 [37]
5. Ringer's fluid + serum + glucose (0.1 per cent.) + insulin. Air ³	5	40	...	16.4 [14.2]	2.8	-13.6 [-11.4]	-9.3	(0.7)	-22.2 [-20.0]	46 [42]

¹ A. J. Clark, R. Gaddie, and C. P. Stewart, *J. Physiol.*, lxxii. 443.

² *Ibid.*, lxxv. 311.

³ *Ibid.*, lxxvii. 432.

experiments described. This procedure, which is undoubtedly more accurate than the older one, actually makes the final results of the calculations more uniform, but does not alter any of the main conclusions drawn from them, though it abolishes certain minor anomalies. We give the original figures in square brackets.

In Tables 22 and 23 we have summarised the results not only of these experiments, but also of many later ones in which both the alterations in the sugar content of the perfusion fluid and the lactic acid content of the system were taken into account. We have applied these later results to the earlier ones in order to gain an approximate idea of the real carbohydrate usage in them, and have indicated, by the use of brackets—()—which figures have been thus transferred. Actually this does not involve any great error, since the amounts involved are small and have been adequately shown not to vary greatly. In any case, the final estimate of carbohydrate usage is very approximate on account of the manifold experimental difficulties which have already been discussed.

In general, Tables 22 and 23 show quite clearly that the heart utilises carbohydrate, both from its own stores and also from the perfusion fluid, when the latter contains more than a certain (small) amount of glucose. It is equally obvious, however, that even under the most favourable conditions we could devise, the carbohydrate usage never accounted for the whole of the oxygen used, and, indeed, never accounted for more than 50 per cent. of this quantity. It appears, too, that the rate at which carbohydrate is used remains fairly steady, that is, that carbohydrate is not the fuel of choice, to be used almost exclusively at first and replaced later by other metabolites only when the supply is becoming exhausted. Nevertheless, when the

heart is perfused with Ringer's solution only in air, the rate of carbohydrate disappearance from the heart is greater during the first 6 hours than subsequently. Part of this carbohydrate loss is accounted for by the appearance of sugar in the perfusion fluid, and part by the production of lactic acid (which is greater during the early part of the perfusion). Even so, there is a tendency for the rate of carbohydrate oxidation to be greater during the first 6 hours than during the succeeding 18 hours.

Experiments *2a*, *2b* and *2c* in Table 22 give an average loss of 1.9 mg. of carbohydrate per g. of heart during the first 6 hours of perfusion. On the assumption that carbohydrate is utilised at a steady rate, this would give the carbohydrate loss of the heart as 7.6 mg./g./24 hours. The actual figure, however, calculated from the data of Table 23 (series *1a* and *1b*), is 3.7 mg./g./24 hours. It is true that the oxygen consumption is not constant during the whole of a 24 hours' experiment, being approximately 6 c.c. per g. for the first 6 hours, and 16 c.c. per g. for the whole 24 hours. Nevertheless this conclusion that carbohydrate usage is greater during the earlier hours of perfusion is supported by the fact that carbohydrate accounts for 23 per cent. of the total oxygen usage during the first 6 hours of perfusion, but only for 18 per cent. during 24 hours.

The figures for carbohydrate usage when the heart is perfused with a mixture of serum and Ringer's solution (1 vol. serum, 19 vols. Ringer's solution) suggest a similar conclusion, but further consideration shows that it is not really justified in this case. The total carbohydrate remaining in the heart after 24 hours' perfusion amounts only to some 4 mg./g. of heart, and, as we have shown (see pp. 45, 103), it is probable that

this represents non-carbohydrate reducing substances together with non-available carbohydrate. Hence the available carbohydrate in the heart has all been used at the end of the 24 hours of perfusion, but we have no information as to the exact time at which the stores were exhausted. This probably affords the explanation of the fact that, in a 24 hours' perfusion, the addition of glucose has a very marked effect on the amount of oxygen used, although it has no definite effect when the perfusion lasts only 6 hours. In the former case, as the carbohydrate stores of the heart become seriously depleted, metabolism must either proceed exclusively at the expense of the available non-carbohydrate metabolites (which are themselves being oxidised throughout the experiment) or may be maintained, apparently at a higher level, by usage of sugar supplied by the perfusion fluid. In the latter case, shortage of carbohydrate in the heart itself does not reach an acute stage and the supply from outside is relatively unimportant. Thus, although the results in general indicate that carbohydrate is not the "exclusive fuel of choice" for the muscle of the frog's heart, they suggest that it is desirable for some carbohydrate to be used.

So far as the source of the carbohydrate oxidised is concerned, it seems that, in general, utilisation of glucose from the perfusion fluid is governed mainly by concentration. When the perfusion fluid consisted of Ringer's solution, containing no glucose, sugar was excreted from the heart to give a concentration of some 5 mg. per 100 c.c. of perfusion fluid. When the heart was perfused with a mixture of Ringer's solution and 5 or 10 per cent. frog's serum (*i.e.* with a fluid containing 2 to 6 mg. glucose per 100 c.c.) there was no appreciable change in the glucose content of the fluid. Addition of sugar to the perfusion fluid, however, or the use of

frog's blood, led to disappearance of sugar from the fluid and the sugar appeared to be oxidised. An exception to this general statement appears in Table 22, series 6a. In this series the perfusion fluid consisted of Ringer's solution + serum + 0.1 per cent. glucose, yet there was no disappearance of glucose from the fluid. Only four hearts were used in this series but recently repetition of the experiment (series 6b) has given the same result. It is difficult to interpret this result, and we feel that at present it is safer merely to record it.

A further point of interest arises from a detailed consideration of the effects of added insulin. No useful information can be derived from the experiments of 24 hours' duration (Ringer's solution and serum) for whether insulin was added or not, the whole of the available carbohydrate was consumed. When the perfusion lasted 6 hours under normal conditions, carbohydrate always disappeared from the heart except when insulin had been added. In the presence of insulin there was a slight increase in the carbohydrate content of the heart (or at least, if one allows a reasonable margin of error, no loss). On the other hand, there was a definite loss of carbohydrate from the perfusion fluid, and the amount oxidised was of the same order as without insulin. The experiments thus suggest that insulin favours carbohydrate storage without affecting oxidation.

The action of adrenaline in favouring the usage of carbohydrate by the isolated dog's heart has been demonstrated by Bogue *et al.* (1935). Unfortunately our experimental conditions did not permit the continuous addition of adrenaline, and the addition of a single dose of a readily oxidisable substance at the beginning of experiments lasting 6 hours or more was

obviously unsatisfactory. We therefore have no data regarding the extent to which the low carbohydrate usage of the isolated frog's heart is due to the absence of this hormone.

As regards the evidence provided by the respiratory quotient, inspection of Tables 22 and 23 show that in all cases where hearts were perfused in air this lay between 0.83 and 0.91, but that in the two cases where the hearts were perfused in oxygen the R.Q.s were 0.75 and 0.74.

These results with oxygen (Table 22, 1 and 4) were controlled by parallel experiments in air (Table 22, 2*a* and 5*a*) and the figures show that the oxygen consumption was not increased in oxygen; the reduction of the R.Q. in oxygen depended, therefore, on a reduction in the carbon dioxide production and not upon an increase in oxygen consumption. The figures for carbohydrate consumption also show that this was decreased in oxygen. Table 24 shows the general averages of the results given in Table 22. These averages show the striking effect on the R.Q. and on the carbohydrate consumption of substituting oxygen for air. They also show that although the addition of serum or of frog's blood markedly increases the total oxygen consumption, yet it does not affect the R.Q.

A comparison of I*b* with II*b* in Table 24 shows that the addition of serum slightly decreases the R.Q. but more than doubles the carbohydrate usage. This result is obviously contradictory and indicates the difficulties we have encountered in reconciling the R.Q. measurements and the carbohydrate estimation. It seems likely that the addition of serum to the perfusion fluid increases carbohydrate usage without affecting very much the usage of other metabolites, for in series I*b* and II*b* (Table 24) the oxygen used for non-carbo-

hydrate substances is 5.15 c.c. and 5.55 c.c./g. heart respectively. On this basis the R.Q. to be expected in series II*b* is 0.93 if the figure of 0.89 for series I*b* is accepted.

TABLE 24

Revised Average Calculations of Percentage of Oxygen Usage required to Account for Carbohydrate Disappearance during 6 Hours' Perfusion.

Conditions.	No. of Experiments Averaged.	R.Q.	Total Oxygen used. Cc./g. per 6 Hours.	Per cent. of Oxygen to account for Carbohydrate Loss.
I. Ringer's Fluid—				
(a) Oxygen	27	0.75	5.3	0
(b) Air	35	0.89	6.6	22
(c) 95 per cent. N ₂ 5 per cent. O ₂	12	...	2.9	11
II. Ringer's Fluid plus Serum or Plasma—				
(a) Oxygen	12	0.74	7.2	18
(b) Air	24	0.87	8.8	37
(c) Air, with 0.1 per cent. glucose added to fluid	14	0.87	8.0	44
III. Frog's Blood—				
(a) Air	11	0.90	10.6	24
(b) Air, with 0.1 per cent. glucose and 1-2 units of insulin added to fluid	12	0.90	8.1	18

The R.Q. of 0.87 found with hearts perfused with Ringer-serum in air (Table 24, II*b*) is in good agreement with the estimate that the carbohydrate usage accounts for 37 per cent. of the total metabolism. The R.Q. of 0.89 found with hearts perfused with Ringer's fluid is much higher than would be expected with a carbohydrate loss only equal to 22 per cent. of the total metabolism.

Measurements both of the R.Q. and the carbohydrate usage are subject to many experimental errors, and the difficulty of obtaining reliable controls for the latter measurements has been stressed repeatedly.

The metabolism of hearts perfused with simple Ringer's fluid was taken as the basis for comparison in these experiments and from the first we found a serious discrepancy between the R.Q.s obtained and the estimated carbohydrate usage. Repeated series of experiments were made to try to explain this discrepancy but we have not succeeded in doing this. In this system the R.Q. found suggests that half the metabolism is carbohydrate, whereas the carbohydrate loss equals less than one quarter of the total metabolism. Table 22 (2a, 2b and 2c) show that the results of three sets of experiments carried out in three different years agree very closely, but all show this same discrepancy between the two sets of measurements.

A further problem on which experiments with the isolated frog's heart may throw some light is that of the path by which carbohydrate is oxidised, and perhaps the most important thing to be decided is whether or not lactic acid is an intermediate in the oxidation of carbohydrate as well as the product of its anaerobic breakdown.

There is no doubt that the frog's heart can oxidise lactic acid, possibly even in preference to other metabolites. Evans *et al.* (1935) have shown this to be true in the case of the dog's isolated heart, and we ourselves have shown that it is the case not only with the normal frog's heart, but also when the heart has been poisoned by iodo-acetic acid. (Table 25). For the poisoned heart we have demonstrated it not only by methods of direct analysis but also by the recovery produced when sodium lactate is added to an isolated

ventricle, poisoned by iodo-acetic acid and stimulated in air to complete exhaustion (Fig. 16).

TABLE 25

Oxidation of Lactic Acid by Normal Hearts and by Hearts poisoned by Iodo-acetic Acid. Hearts perfused for Six Hours with Ringer's Fluid + Serum (Clark, Gaddie and Stewart, 1937).

Conditions.	No. of Experiments.	Change in Carbohydrate Content of Heart. Mg./g. Heart.	Change in Lactic Acid Content of System. Mg./g. Heart.	Total Oxygen used. Cc./g. Heart.	R. Q.	Lactic Acid accounted for		
						as Chy.	by Oxidation.	Total.
<i>Unpoisoned—</i>								
+0.1 % glucose	10	-3.68	0	6.0	0.87	9.52
+0.1 % lactate	10	+1.58	-10.26	9.2	0.69	5.26	4.26	...
<i>Poisoned by Iodo-acetate—</i>								
+0.1 % glucose	12	-3.43	0	4.02	0.78
+0.1 % lactate	16	-2.69	-4.75	7.85	0.74	0	5.13	5.13

This indirect method of investigation is analogous to that which had previously been used by Gaddie and Stewart (1934) in work on the anaerobic formation of lactic acid (Chapter VII). The ventricle, perfused with Ringer's solution (p. 145) in nitrogen and stimulated to contract (12 to 16 per minute) was poisoned by addition of sodium iodo-acetate (1:30,000) to the fluid, and, when the effect of the poison was plainly shown by a rapid and progressive decrease in the size of the contraction, air was admitted. As soon as the contraction was restored to its original size the perfusion fluid was replaced by normal Ringer solution—a procedure which we adopted to avoid mere *in vitro* reaction between the excess of iodo-acetate and the substances

we wished to add later. The changing of the perfusion fluid had, of course, been shown previously not to remove the iodo-acetate already absorbed by the heart, or rather not to abolish its poisonous effect. The ventricle was then left until continued stimulation had

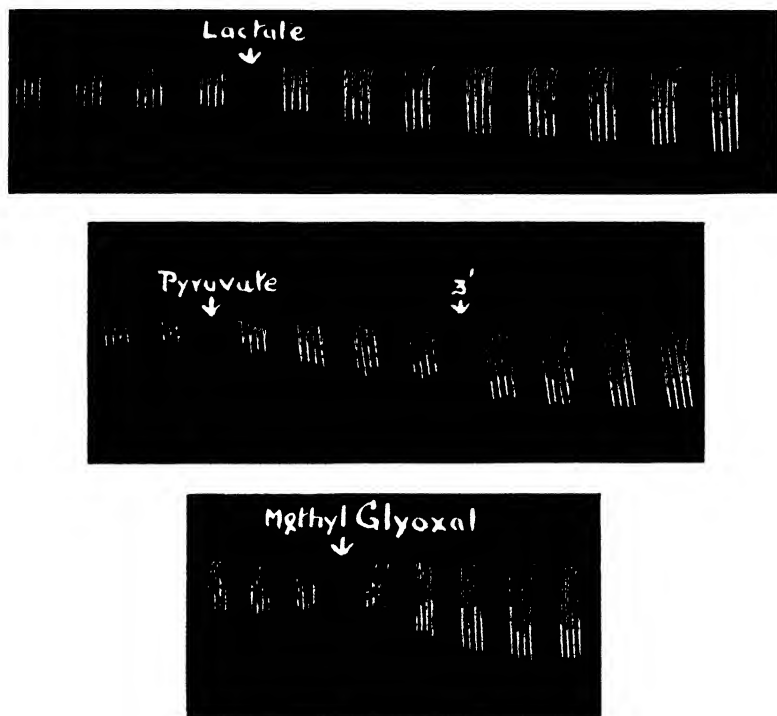

FIG. 16.—Effect of addition of lactate, etc. (0.05 per cent.), on the isolated frog's ventricle, poisoned I.A.A. and exhausted by aerobic perfusion for some hours.

resulted in the exhaustion of the available metabolites as shown by progressive decrease in the size of the contractions. At this stage addition of lactate, or any other substance capable of oxidation by the poisoned heart with liberation of available energy, caused a return towards normal in the size of the contractions, and a continued maintenance of the muscle activity

at the higher level. Absence of such a response was taken as evidence that the poisoned ventricle was not capable of oxidising the substance added to the fluid. (In such cases a subsequent addition of lactate was made to show that the failure was not due to some irretrievable damage to the ventricle.)

Using this method we found (Fig. 16) that besides sodium lactate, sodium pyruvate and methyl glyoxal were capable of being oxidised, whereas glycogen, glucose, and the sodium salts of hexose-diphosphoric acid, dihydroxyacetone phosphoric acid, and glycerophosphoric acid were without effect. It has previously been shown by Parnas, Ostern and Mann (1934) that phosphoglyceric acid can be utilised by the poisoned ventricle.

If we accept the Embden-Meyerhof scheme for the anaerobic production of lactic acid from carbohydrate, these results strongly suggest that lactic acid is also produced during carbohydrate oxidation by heart muscle. Iodo-acetate prevents the formation of lactic acid by inhibiting the two stages at which dehydrase activity occurs—namely, (1) the conversion of triosephosphoric acid to phosphoglyceric acid (oxidation) and glycerophosphoric acid (reduction); (2) the conversion of pyruvic acid to lactic acid (reduction) with reconversion of glycerophosphoric acid to triosephosphoric acid (oxidation) or with, in place of that, the conversion of more triosephosphoric acid to phosphoglyceric acid (oxidation). No substance prior to phosphoglyceric acid can be oxidised by the poisoned ventricle. Iodo-acetate, in the concentrations which suffice to inhibit anaerobic lactic acid formation, does not appear to affect aerobic oxidations. It seems fair to conclude, therefore, that the aerobic and the anaerobic metabolism of carbohydrate are identical, at least as

far as the formation of phosphoglyceric acid. It seems, further, that the oxidation of triosephosphoric acid to phosphoglyceric acid involves the use of a hydrogen acceptor other than oxygen (normally a second molecule of triosephosphoric acid or pyruvic acid). If, therefore, the normal heart muscle oxidised phosphoglyceric acid directly or after hydrolysis and dehydration to pyruvic acid, an accumulation of glycerophosphoric acid would be expected, unless this substance were independently oxidised. Yet the iodo-acetate poisoned heart, at least, does not readily oxidise either glycerol or glycerophosphoric acid. It seems likely, therefore, that in the normal heart, lactic acid is formed by the anaerobic mechanism and is then re-oxidised aerobically to pyruvic acid and thence to carbon dioxide and water. In the poisoned heart, *added* phosphoglyceric acid is apparently converted to pyruvic acid which is then oxidised direct.

CHAPTER VI

NON-CARBOHYDRATE METABOLISM OF THE FROG'S HEART

Ammonia and Urea—Utilisation of Amino-Acids—Utilisation of Fats.

SINCE the carbohydrate oxidised by the isolated frog's heart, perfused in air, fails to account for a very considerable part of the oxygen used, it is necessary to consider what other fuel is utilised. The obvious alternatives are protein (or protein breakdown products) and fat. As in other tissues, it may be supposed that protein breakdown occurs continually in the heart muscle, and that, therefore, there is a continuous production of ammonia and (or) urea. The problems to be solved are whether this protein breakdown is of sufficient magnitude to contribute appreciably to the oxygen usage and to the energy requirements of the muscle, whether the energy liberated is in fact utilised, and, if so, to what extent and under what conditions.

Ostern (1930) found that the frog's heart produced 0.10 mg. ammonia-nitrogen per heart in 6 hours' perfusion, and 0.028 mg. per heart in 24 hours. Similar results were later obtained by Parnas and Ostern (1931) (0.10-0.20 mg. $\text{NH}_3\text{-N/g. heart}$ in 24 hours), Ostern (1931) (0.15-0.40 mg. $\text{NH}_3\text{-N/g. heart}$ in 24 hours), and by Parnas and Ostern (1932) (0.07-0.12 mg. $\text{NH}_3\text{-N/g. heart}$ in 7 hours). These figures are very similar to our own (Clark, Gaddie and Stewart, 1931). We found that for hearts perfused with Ringer's solution, the ammonia-nitrogen excreted amounted to 0.085

mg./g. heart in 6 hours, and 0.135 mg./g. heart in 24 hours. Our figures include ammonia which after being excreted into the perfusion fluid was carried on by the current of air used for oxygenation, and was then trapped by strips of filter paper soaked in dilute hydrochloric acid. It is probable, however, that they should be slightly increased, since Ostern (1930) found that the ammonia content of the heart itself increased during 24 hours' perfusion by 0.007 mg./g. heart.

It is important to remember that this ammonia does not represent de-amination of adenylic acid, since Ostern and Parnas (1932) found that 15 hours' perfusion was without effect on the concentration of the nucleotide in the frog's heart (0.28 mg./g. in fresh hearts, 0.26 mg./g. after perfusion). Similarly, Clark and Eggleton (1936) found that after 24 hours' perfusion the adenosinetriphosphate phosphorus only decreased by an amount equal to 8 per cent. of the total acid-soluble phosphorus, an amount equivalent to about 0.07 mg. A.T.P-P per g., which is equivalent to about 0.015 mg. of nitrogen. Post-mortem, of course, adenylic acid is rapidly de-aminated (0.05 mg./g. remain after 20 hours' incubation of ground muscle). It is, of course, quite possible that the adenylic acid is de-aminated during perfusion, and is resynthesised; the point is that the *ultimate* source of the ammonia produced during perfusion must be sought elsewhere.

The ammonia production found by ourselves and by Parnas *et al.* can, if it is derived from the oxidation of protein (or amino-acids), account for an appreciable percentage of the total oxygen consumption. We found, for a 6 hours' perfusion, an ammonia-nitrogen production of 0.014 mg./g. heart/hour. This corresponds to an oxygen usage of about 0.1 c.c./g. heart/hour, or about 10 per cent. of the total.

Similarly, for a 24 hours' perfusion, the ammonia-N production averages 0.006 mg./g./hour, and accounts for 0.04 c.c. oxygen/g./hour, or about 5 per cent. of the total. These amounts, though appreciable, only account for a small fraction of the non-carbohydrate metabolism, for under the conditions in which they were obtained (perfusion with Ringer's fluid in air) carbohydrate oxidation accounted for only some 20 per cent. (in 6-hour experiments) or 15 per cent. (in 24-hour experiments) of the oxygen usage.

We found, however, that the ammonia present in the perfusion fluid represented only part of the non-protein nitrogen excreted into it by the heart. In our earlier experiments we measured the non-protein nitrogen of the fluid, removing protein (which was present in small amounts) by tungstic acid. We believe, however, that the results so obtained were too high, and that the manipulation failed to remove traces of protein which, though negligible under ordinary conditions, could not be ignored when we were dealing with such small quantities of urea and ammonia. Certainly, all our later experiments in which urea was measured by a urease-method, gave much lower figures for the significant nitrogenous substances excreted—urea and ammonia. Thus, Table 26, 4 shows that the total N.P.N. in the perfusion fluid after 24 hours amounted to 1.84 mg./g. heart (average of 16 experiments) whereas the combined urea and ammonia-nitrogen, estimated directly, amounted to 0.7 mg./g. heart. The latter figure we believe to be the more correct, and is therefore the one used in subsequent calculations. This belief is supported by the fact that in shorter experiments of 6 hours' duration the difference between the total N.P.N. excreted (0.51 mg./g./heart) and the combined urea and ammonia-nitrogen (0.42 mg./g. heart) is much smaller

TABLE 26
Excretion of Nitrogen by Frog's Heart perfused with Ringer's Solution. (Number of Experiments in Brackets.)

Conditions.	Duration of Experiments (Hours).	Total N.P.N. excreted. Mg./g. Heart.	Ammonia Nitrogen. Mg./g. Heart.	Urea Nitrogen. Mg./g. Heart.	Ammonia + Urea Nitrogen. Mg./g. Heart.	Per cent. of Oxygen Usage accounted for by Ammonia and Urea.
1. Ringer's fluid. Air . . .	6	0.51 (14)	0.085 (4)	0.335	0.420	38.0
2. " " " . . .	6	0.54 (6)	66.0
3. " " Oxygen . . .	6	0.59 (12)	66.0
4. " " Air . . .	24	1.84 (16)	0.135 (16)	0.565 (8)	0.70	30.0
5. " " + plasma. Air . . .	6	0.27 (4)	24.0
6. " " + " " Oxygen . . .	6	0.20 (16)	18.0
7. " " + glycine. Air . . .	24	...	0.570 (5)	0.660 (5)	1.23	55.0
8. " " + leucine. Air . . .	24	...	0.43 (6)	0.420 (5)	0.850	36.0
9. " " + serum. Air . . .	6	0.11 (12)	11.3
10. " " + serum. Air. Poisoned by iodo-acetic acid	6	0.15 (10)	31.4

than is the 24-hour experiments—a result which suggests the later excretion of some other nitrogenous substance (*e.g.* protein) and negatives the supposition that the discrepancy is due to analytical errors. The urea excretion, it should be noted, is about three times as big as the ammonia excretion.

Taking the figures given by Lusk for the relation between urinary nitrogen and oxygen usage (1 mg. N \equiv 6 c.c. O₂), it appears that in the 6-hour experiments, nitrogen production may account for 2.5 c.c. O₂, or about 38 per cent. of the total metabolism. In the 24 hours' experiments, the nitrogen may account for 4.2 c.c. O₂, or 20 per cent. of the total. It is perhaps worth recalling that, during a 6 hours' perfusion, the combined urea and ammonia excretion is of the same order as that of a man on a normal diet. Taking the weight of the man as 70 kilos, and his daily nitrogen excretion as 15 g., the output per g. per 6 hours is 0.54 mg., which compares with 0.42/g./6 hours for the isolated frog's heart. The agreement is not good for the 24 hours' perfusion experiments, but in these a number of factors may be expected to interfere—notably the partial exhaustion of readily available nitrogenous metabolites. The figures considered so far were derived from experiments in which the hearts were perfused with Ringer's fluid in air. When pure oxygen was used, the excretion of urea and ammonia was substantially unaltered. Thus twelve experiments with oxygen gave a mean urea-N + ammonia-N excretion of 0.59 mg./g. heart during a perfusion period of 6 hours, an amount which accounts for 66 per cent. of the oxygen used. This is higher than the general average for perfusion in air, but almost exactly equal to the percentage in a series of experiments made at the same time in air.

The addition of plasma to the Ringer's solution results, as has been pointed out (p. 95), in an increased usage of oxygen. Instead of a corresponding increase in urea and ammonia excretion, our experiments showed a decrease of about 50 per cent., irrespective of whether the atmosphere consisted of air or pure oxygen. Consequently, under these circumstances, the urea and ammonia excretion was able to account for only some 20 per cent. of the total metabolism.

Under anaerobic conditions, the frog's heart, perfused with Ringer's solution containing 0.1 per cent. glucose, excreted only traces of nitrogen which was almost entirely in the form of ammonia. Six experiments gave a mean excretion of 0.12 mg. N/g. heart/6 hours, an amount about a quarter of that found under aerobic conditions. This figure, however, is not reliable, and merely indicates that some very small quantity of ammonia-nitrogen was present. It is probably derived from adenylic acid pyrophosphate, since the hearts were exhausted at the end of the experiments.

It is, of course, important to show that the urea found in the perfusion fluid is actually produced during the perfusion and does not merely diffuse out from the heart. This has been shown to be true of the ammonia (p. 123). That the urea is really produced is strongly suggested by the marked diminution in $(\text{NH}_3 + \text{urea})$ N excretion under anaerobic conditions, and that it does not merely diffuse from the heart is shown by the fact that in anaerobiosis urea excretion is practically nil. Actually, perfusion of the frog's heart for 24 hours has been found (Clark, Gaddie and Stewart, 1931) to cause no significant decrease in the urea content of the heart. For fresh hearts, the average urea-nitrogen was found to be 0.33 mg./g. heart, and after 24 hours' perfusion this figure fell to 0.30 mg./g. heart. The

difference, 0.03 mg./g. heart accounts for only about 6 per cent. of the observed increase of urea-nitrogen in the perfusion fluid.

Confirmatory evidence of the oxidation of nitrogenous matter by the isolated heart of the frog can be obtained by addition of amino-acids to the perfusion fluid.

We found, in the first place, that amino-acids had no toxic action on the heart, for hearts continued to function well for 24 to 48 hours when perfused with amino-acids in concentrations up to 0.5 per cent. This is a marked contrast to the effect of glucose which regularly killed the hearts in 20 to 24 hours. We also found that the addition of amino-acids to hearts perfused with Ringer's fluid had a striking effect on the respiration. The total oxygen consumption was not altered, but the R.Q. was changed; the addition of glycine and alanine raised the R.Q. whilst the addition of leucine lowered the R.Q. These effects are shown in Table 27.

TABLE 27

Effect of Amino-Acids on the Oxygen Consumption and R.Q. of the Frog's Heart perfused with Ringer's Solution in Air.

Amino-Acid Added.	Number of Experiments.	Per cent. Concentration (in 2 c.c. Ringer's Fluid).	Respiration for 3 Hours before Addition of Amino-Acid.		Respiration for 3 Hours after Addition of Amino-Acid.	
			O ₂ Usage c.c. per hour.	R.Q.	O ₂ Usage c.c. per hour.	R.Q.
Glycine	7	0.5	·243	·86	·243	·94
Alanine	2	0.5	·208	·855	·246	·95
Leucine	7	0.5	·290	·85	·263	·83

Analyses of the nitrogen excretion showed that addition of amino-acids did not greatly alter the amount of urea excreted, but trebled the ammonia excretion (Table 26). These facts indicate that the frog's heart de-aminises and oxidises amino-acids when these are added to the perfusion fluid, and that part, if not all, the nitrogen is excreted as ammonia. The extra excretion of nitrogen was capable of accounting for about 30 per cent. of the oxygen used in the case of glycine, and 25 per cent. in the case of leucine.

The theoretical R.Q.s of various amino-acids are as follows :—

	Theoretical R.Q. if Nitrogen excreted as	
Amino-Acid	NH ₃	Urea
Glycine	1·3	1·00
Alanine	1·0	0·83
Leucine	0·8	0·73
Glutamic Acid	1·1	1·00
Aspartic Acid	1·3	1·17

If the nitrogen of amino-acids is excreted as ammonia, then the introduction of glycine and of alanine ought to raise the R.Q. of a heart whose R.Q. previously was 0·85, whilst the introduction of leucine ought to reduce the R.Q. slightly, and these were the changes actually observed (Table 27).

Consideration of the figures for oxygen consumption indicates clearly that the added amino-acids did not increase the total amount of oxidation appreciably, but were exerting a sparing effect upon other metabolites. It is important to note that the hearts in these experiments were not previously exhausted, and still contained adequate amounts of their normal oxidisable materials. The carbohydrate usage, however, was not greatly affected, for whereas, after 24 hours' perfusion with Ringer's solution *plus* amino-acids the total carbo-

hydrate content of 14 hearts was 7.9 mg./g., the corresponding figure after perfusion with Ringer's solution alone was 7.3 mg./g. In the case of glycine and alanine, the calculated increase in the R.Q. on the basis of the extra ammonia excretion is 0.04, whereas the observed increase is about twice this. The probable explanation of this is that the sparing action is general, so that while a little less carbohydrate may be oxidised (and replaced by amino-acid with an R.Q. of 1.3 in the case of glycine or 1.0 in the case of alanine), there is also rather less oxidation of available protein (R.Q. 0.8 to 0.9) and of fat (R.Q. 0.7). Accurate calculation of the R.Q. to be expected on this basis is not possible since no direct observations are available on the amount of fat and protein actually spared.

It is not sufficient to show merely that amino-acids can be oxidised. Although, especially in view of the sparing action they exert, it is probable that oxidation of amino-acids implies utilisation of the released energy and not merely wastage, the analytical data do not prove that these substances are actually utilised by the heart.

It must be recorded that the isolated heart, poisoned with iodo-acetate, produces ammonia under aerobic conditions to about the same extent as does the unpoisoned heart (Table 26, 10).

Lussana (1908) showed that glycine and alanine had a marked augmentor effect on the mechanical response of the isolated heart of the frog, and Clark (1913) confirmed this in the case of the hypodynamic heart and concluded that the action of glycine was not merely due to its buffer action as Lussana had suggested. Clark suggested that glycine might act by increasing the ionisation of the calcium in the Ringer.

Evidence that the amino-acids are actually utilised for the supply of energy to the heart is yielded by our experiments with the isolated ventricle, poisoned by iodo-acetate, and stimulated to exhaustion in air (Chapter V). Under these conditions the power of contraction is restored by the addition of certain amino-acids to the perfusion fluid. Fig. 17 shows the effect of alanine and glutamic acid.



FIG. 17.—Effect of amino-acids under conditions as in Fig. 16.

The combined carbohydrate and protein oxidation demonstrated by direct analysis fails by a considerable margin to account for the oxygen usage of the frog's heart. Thus for the heart perfused with Ringer's solution in air for six hours the average figures are:—

C.c. O ₂ used/g./hour	1·10
C.c. O ₂ used for carbohydrate loss	0·24 ¹
C.c. O ₂ used for nitrogen excreted	0·41
C.c. O ₂ not accounted for	0·45

¹ It is possible, though not probable, that this figure is too low and that the carbohydrate loss is really greater than that found, owing to the (possible) presence of trioses after perfusion.

If the oxygen not accounted for by carbohydrate and protein were used by fat, which is the most obvious and probable supposition, the calculated R.Q. would be 0·81, whereas the average value found for these experi-

mental conditions was 0.88. Similar calculations for other conditions—perfusion with Ringer's fluid for 24 hours, perfusion with serum-Ringer mixture—indicate a similar amount of oxygen not accounted for, but again calculation of the R.Q. on the assumption that this extra oxygen is used for fat oxidation gives a value below that found experimentally. Part, though not all, of the discrepancy between the observed and calculated values for the R.Q. is due to the use of Lusk's figure for the oxygen value of nitrogen. This figure is derived from the observation that nitrogen is excreted in the urine mainly as urea. Allowance for the distribution we have found in the perfusion fluid between ammonia and urea would increase the calculated R.Q. by .02 or .03. Table 28 summarises

TABLE 28

Fat Metabolism of Frog's Heart perfused in Oxygen for 6 Hours.

	Number of Hearts.	Fat Content of Heart. Mg./g. Heart.	Fat removed from Perfusion Fluid. Mg./g. Heart.
<i>(a) Unpoisoned Hearts (Clark, Gaddie and Stewart, 1934)</i>			
Unperfused controls . . .	20	13.4	...
Ringer's fluid . . .	8	13.5	...
Ringer's fluid + plasma . . .	12	16.4	1.56
Ringer's fluid + blood . . .	12	17.0	...
<i>(b) Hearts Poisoned I.A.A. (Clark, Gaddie and Stewart, 1937)</i>			
Unperfused controls . . .	8	16.8	...
Ringer's fluid + 10 per cent. serum	8	16.9	1.8
Ringer's fluid + 20 per cent. serum	8	...	1.5

the results of experiments we made to determine directly the usage of fat by the isolated frog's hearts.

Cruickshank and McClure (1936) working with dog's hearts have reported very considerable losses of fat. In our own experiments, however, the amounts involved are very small. Thus, in a 6-hour perfusion the amount of oxygen to be accounted for is about 2.7 c.c./g. heart, and this is equivalent to about 1.3 mg. of fat. Since the heart contains, on the average, 13 to 15 mg./g. of fat, and the fluid (Ringer-serum) some 2 to 3 mg. more, the expected loss, to be calculated from the mean of four series of analyses is less than 10 per cent. of the original amount present. Experiments with unpoisoned hearts (Table 28) showed a loss of fat from Ringer-plasma mixture of the order indicated above, but since the hearts appeared to gain about the same amount the results were inconclusive.

Experiments with I.A.A. poisoned hearts showed a similar loss of fat from the fluid, and in this case there was no evidence of a compulsory gain of fat by the hearts. The quantities involved in these experiments are small and the chances of error are obvious, hence we do not lay great stress on these results, but they support the indirect evidence that the frog's heart can and does oxidise fat.

Addition of higher fatty acids (as sodium salts) to the perfusion fluid of normal hearts was barren of results. There was an increase in the oxygen consumption of 10 per cent. or rather more, but the R.Q. was either unaltered or was even increased (*e.g.* sodium linoleate, 0.01 per cent. increased the O₂ consumption of a heart from 0.25 to 0.28 c.c./g./hour, and the R.Q. from 0.89 to 0.95). The suggestion offered by this observation is that the fatty acid permits an increase

of the oxidation of other metabolites without itself being oxidised. It agrees with the older hypothesis of Clark

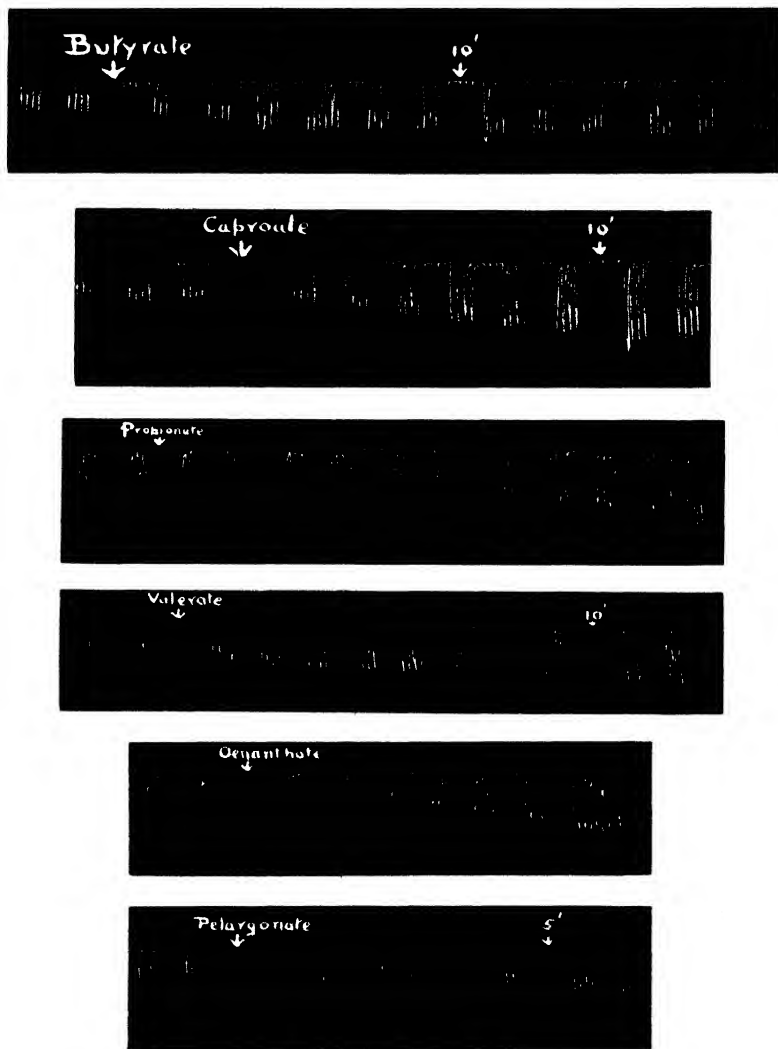

FIG. 18.—Effect of fatty acids under conditions as in Fig. 16.

(1913) that the soap restores some constituent of the cell surface which is removed by perfusion.

Positive evidence that fatty acids can be oxidised by the frog's heart was, however, obtained from experiments with the isolated ventricle, poisoned with iodo-acetate and stimulated to exhaustion in air (p. 118). Under these circumstances addition of any fatty acid from propionic to decoic, irrespective of the number of carbon atoms in the chain, produced an immediate and sustained restoration of the power of contraction (Fig. 18). It seems, therefore, that although the direct evidence is inconclusive, the isolated frog's heart is quite capable of oxidising fatty acids. Taking into account the small quantities involved and the difficulties of the analytical processes, it seems fair to accept the indirect evidence provided by the effect of fatty acids on the exhausted ventricle, and to conclude that part of the oxygen usage of the heart is, in fact, due to fatty acid oxidation.

CHAPTER VII

ANAEROBIC METABOLISM OF THE FROG'S HEART

Source of Energy : Lactic Acid Formation—Amount and Conditions of Glycolysis—Path of Anaerobic Carbohydrate Breakdown.

A STUDY of the literature regarding the effect of oxygen lack on the frog's heart shows that different workers have obtained very contradictory results. Some authors state that oxygen lack produces an immediate and progressive depression, whilst others find that isolated frogs' hearts can maintain fair activity for more than a day when deprived of oxygen.

Preliminary experiments showed us that the effects produced by oxygen lack on the isolated frog's heart were due to two independent variables, namely, the amount of carbohydrate available for use by the heart and the reaction of the perfusion fluid. It was found that, by adjustment of these two variable factors, it was possible to reproduce almost all the widely varying effects of oxygen lack reported by previous workers. Given an adequate supply of carbohydrate (which could be supplied as glucose) and an alkaline perfusion fluid (renewed when the reaction fell to neutral) activity could be maintained for many hours.

It is evident that an acid metabolite is produced, and analogy with skeletal muscle immediately suggests that it is lactic acid. Table 9 shows figures given by various authors for the lactic acid content of the fresh hearts of various animals.

We measured the lactic acid content of the excised frog's heart both in the fresh condition and after keeping, in order to discover how readily the lactic acid production could be induced.

Our results, which are shown in Table 9, agree with those already quoted (except those of Boyland). Perfectly fresh frogs' hearts frozen immediately, contained 0.06 per cent. lactic acid. Under most other conditions a value of 0.09 per cent. lactic acid was obtained, but values higher than this were not found except where the conditions were definitely anaerobic.

Table 29 shows the figures obtained by various authors for the lactic acid maxima of the hearts of various animals.

TABLE 29

Maximum Lactic Acid Content of Heart.

		Lactic Acid. Mg. per g.
<i>Turtles' and Tortoises' Hearts—</i>		
Turtle ventricle strip suspended in nitrogen and stimulated to exhaustion (Redfield and Medearis, 1926; Gemmell, 1928)	...	1.60
	Auricle	1.37
	Ventricle	1.41
Chloroform rigor (Arning, 1927)	Ventricle	2.80
Incubation with alkaline phosphate (Boyland, 1928)	...	4.9-6.1
<i>Frog's Heart—</i>		
Chloroform rigor (Arning, 1927)	...	1.43-3.25
<i>Rabbits' and Cats' Hearts—</i>		
Stimulated to exhaustion with asphyxia (Katz and Long, 1925)	...	0.72
Rigor mortis (Hines, Katz and Long, 1925)	...	2.30

Boyland's figures show the effects of incubation with alkaline phosphate and are higher than the rest, but the others show that in rigor the lactic acid of the heart does not rise above 2.8 mg./g., and that the cold-blooded heart may be arrested when the lactic acid content reaches about 1.4 mg./g. These figures

are less than half the corresponding figures found with skeletal muscle (*cf.* Chapter III).

It is evident, therefore, that the frog's heart does produce lactic acid under anaerobic conditions, and the questions remaining to be decided are :—

- (1) Is the lactic acid production an important, or the sole source of energy ?
- (2) Which factors control its production ?
- (3) How is it formed ?

The answer to the first of these questions is given quite definitely by experiments on the quantitative production of lactic acid in relation to the mechanical response of the heart, by experiments on the cause of the asphyxial arrest of the heart, and by experiments on the behaviour of the ventricle when exhausted of carbohydrate.

Nagaya (1929) found a lactic acid production of about 10 mg./g. heart/hour by frogs' hearts perfused in the presence of glucose and of KCN (M/1000). Wertheimer (1930) under similar conditions found a lactic acid production of about 4 mg./g. during an unspecified time (probably about an hour), and added the observation that the lactic acid was almost entirely excreted into the perfusion fluid ; and Eismayer and Quincke (1930) found a lactic acid production of 4.1 mg./g./hour by frog's ventricles perfused in nitrogen.

Provided that the perfusion fluid is alkaline, we find Wertheimer's observation to be correct, since ventricles (1.31 g.), perfused for 60 minutes in nitrogen, contained 0.98 mg. of lactic acid, *i.e.* 0.75 mg./g., an amount no greater than that in the controls. On the other hand, considerable amounts of lactic acid were excreted into the perfusion fluid, though not at

a steady rate (Table 30), and this lactic acid was produced from the carbohydrate of the hearts (Clark, Gaddie and Stewart, 1932).

TABLE 30

<i>(a) Relation of Lactic Acid Production and Time</i>						
Duration of anaerobiosis in mins.	10	20	40	60	80	120
Number of observations	6	6	4	3	5	4
Average lactic acid excretion in mg. per g. of ventricle	0.61	1.84	2.8	2.2	2.3	3.5
<i>(b) Relation of Lactic Acid Production and Carbohydrate Loss</i>						
Material.	No.	Duration.	Carbohydrate Loss. Mg./g.	Lactic Acid found. Mg./g.		
Ventricles (perfused in N ₂)	6	120 mins.	5.0	3.5		
Hearts (double cannula ; subjected to vacuum)	15	240 ,,	4.6	5.45		

Fig. 19 shows the effect of anaerobiosis in alkaline sugar-free Ringer's fluid on the mechanical activity of the heart, and also the lactic acid production under these conditions. The lactic acid production/g./hour is as follows: 1st hour, 3 mg.; 2nd hour, 1.3 mg.; 3rd and 4th hours, less than 0.5 mg.

In these experiments the volume of the perfusion fluid was 10 c.c., and later experiments showed a similar relationship between lactic acid production and the mechanical response when volumes between 10 c.c. and 0.2 c.c. were used (Fig. 20) (Clark, Gaddie and Stewart, 1934). The oxygen consumption of ventricles isolated and perfused in a similar manner, but in presence of air, is about 0.017 c.c./g./minute (Clark and White, 1928), an amount which allows of the oxidation

of 0.022 mg. of carbohydrate. It is not possible to correlate this figure exactly with the lactic acid production during the various stages of anaerobic activity owing to the altered mechanical response and the unknown fraction of the metabolism required for basal processes. On the average, however, it appears that the amount of lactic acid is adequate for the energy

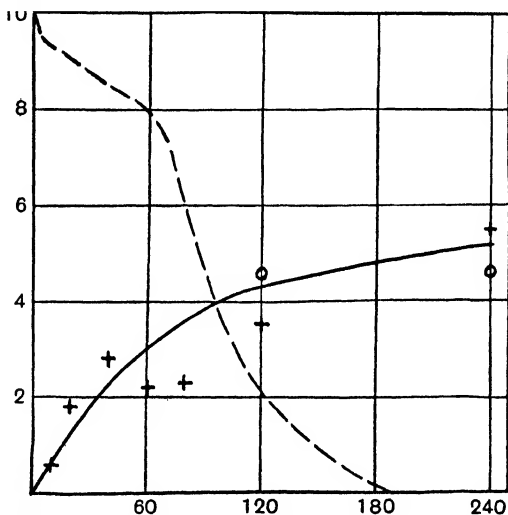

FIG. 19.—The effect of anaerobiosis on the isolated frog's ventricle perfused with alkaline Ringer's fluid (pH 8.5). Abscissa: time in minutes. Dotted line: mechanical response (normal = 10). Continuous line: lactic acid production in mg./g. Crosses = direct estimations: circles = production as calculated from carbohydrate loss. (Clark, Gaddie and Stewart, 1932 *b*.)

requirements of the heart. Thus in the earlier experiments (Fig. 19) the lactic acid produced during the first hour amounted to about 3 mg., whereas the carbohydrate oxidisable during the same period in air (but with a 25 per cent. greater mechanical response) is 1.3 mg. Fig. 20 shows that during the first few minutes of anaerobiosis the lactic acid produced is seven or eight times as great as the amount of carbohydrate which would be oxidised in air during a

similar period ; later the ratio of lactic acid produced to carbohydrate oxidised in air falls to about 1·5, but since during this time the mechanical response is less than half the normal, the true ratio is certainly much higher. The experimental results, therefore, strongly support the view that the formation of lactic acid is an important source of energy to the anaerobic ventricle.

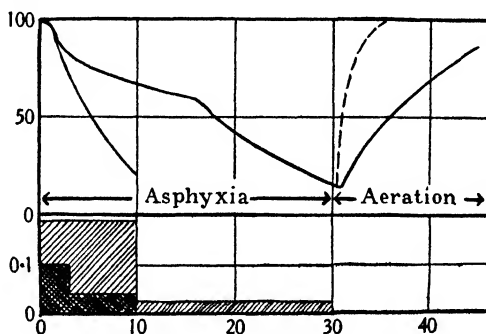

FIG. 20.—Lactic acid production and mechanical response during asphyxia. Abscissa: time in minutes. Ordinates: above, mechanical response as per cent. normal; below, lactic acid production in mg. per g. ventricle per min. Upper curve and lightly hatched area, results with 1 c.c. fluid. Dotted line shows recovery when fluid changed. Lower curve and darkly hatched area, results with 0·2 c.c. fluid. (Clark, Gaddie and Stewart, 1934.)

Freund and König (1927) found that hearts perfused with oxygen-free alkaline Ringer's fluid were arrested in 2 to 3 hours, but that when glucose was present the hearts maintained good contractions for at least 6 hours. They also showed that hearts arrested with oxygen lack could be revived by addition of glucose. Backmann (1927) found that hearts perfused with a solution containing sugar could survive anaerobically for as long as 61 hours. We confirmed Freund and König's conclusions, for we found that the addition of glucose enabled the heart to maintain a good activity for 6 hours, and that a heart arrested by lack of oxygen could be revived by glucose. The addition of as

small a quantity as 2 mg. to 10 c.c. perfusion fluid produced an immediate stimulant effect on the exhausted anaerobic heart. The tracings published by Freund and König show that the stimulant effect produced by addition of sugar to the frog's heart exhausted by lack of oxygen is very dramatic as regards the rapidity and completeness of the recovery. Our results (Clark, Gaddie and Stewart, 1932) showed effects of similar intensity. This effect was only produced in alkaline Ringer's fluid, and the addition of glucose to a heart arrested by oxygen lack in neutral Ringer's solution produced no benefit. The figures given in Table 31 show that the anaerobic heart converts considerable quantities of glucose to lactic acid.

TABLE 31

Effect of Perfusion with Oxygen Lack for 6 Hours, using Ringer's Solution with 0.1 per cent. Glucose.

Number of Experiments.	Average Heart Weight g.	Average Total Carbohydrate. Mg./g. Heart.		Lactic Acid recovered from Ringer's Fluid. Mg./g. Heart per hour.	Nitrogen excreted. Mg./g. Heart per hour.
		Control.	Perfused.		
6	0.076	15.50	15.90	5.7	0.02

The total carbohydrate content of the hearts after anaerobic perfusion with glucose for 6 hours, was no less than that of the controls taken at the same time. Therefore, when the heart is perfused with an alkaline fluid containing glucose under anaerobic conditions, it does not exhaust its own carbohydrate but obtains energy by converting the glucose present in the perfusion fluid to lactic acid.

Gaddie and Stewart (1934) extended these observations (Fig. 21) and found that while the effect of

glucose on the exhausted ventricle stimulated in nitrogen was shared by mannose and certain intermediates in the production of lactic acid, it was given

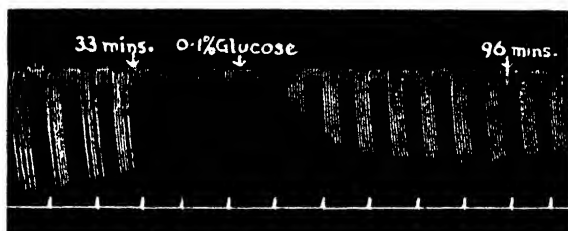

I. Typical recovery of an exhausted ventricle on addition of glucose (anaerobic).

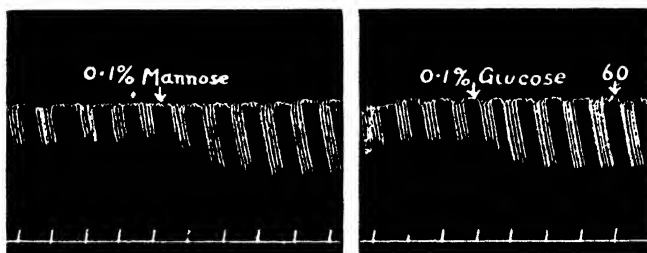

II. The action of mannose on an exhausted ventricle (in absence of oxygen) compared with the action of glucose on the same ventricle.



III. Failure of alanine and glycine to cause recovery of the exhausted ventricle in nitrogen. Glucose restores power of contraction.

FIG. 21.

by no other carbohydrate, nor (contrary to the observation of Freund and König) by amino-acids nor by fatty acids. It is true that soaps produced a

slight transitory recovery, but it was quite evident from the nature of the recovery and from the fact that it could be obtained only once from the same ventricle, that the fatty acid was not acting as a source of energy.

The completely negative results with amino-acids indicate that the small ammonia production of anaerobic ventricles found by Clark, Gaddie and Stewart (1932) was not due to the utilisation of amino-acids for the production of energy. (It could not, in any case, have supplied more than a small fraction of the energy required.) These experiments show, therefore, that lactic acid production from carbohydrate is the sole important source of energy for the frog's heart working in absence of oxygen.

Our results show, therefore, that a frog's heart when deprived of oxygen can sustain moderate activity by glycolysis. This activity is naturally limited by the supply of carbohydrate. When no sugar is supplied the mechanical response begins to fall rapidly after about an hour. We believe that this is due to exhaustion of the more readily available portion of the cardiac carbohydrates, and, if sugar is supplied, the activity can be maintained longer.

This maintenance of activity is dependent, however, on the maintenance of an alkaline reaction in the perfusion fluid, for when this becomes acid glycolysis is arrested. Since the lactic acid produced by the anaerobic heart is excreted into the fluid, the maintenance of activity is dependent on the buffer capacity of the fluid (*i.e.* buffer power \times volume). This subject will be dealt with in Chapter IX.

In the experiments quoted earlier in this chapter, it was emphasised that the hearts were perfused with alkaline Ringer's fluid. It was noted by Martin (1905) that the effects of oxygen lack on strips of turtle's

ventricle were partially antagonised by excess of alkali, and a similar observation was made by Drury and Andrus (1924) in the case of the isolated dog's heart. We found (Clark, Gaddie and Stewart, 1932) that if the isolated frog's heart was perfused in nitrogen with unbuffered Ringer's solution (10 c.c.) oxygen lack led to an immediate diminution in the mechanical response, and to complete arrest within an hour, whereas with alkaline Ringer's solution (NaHCO_3 0.05 per cent. ; pH 8.5) activity continued without much diminution for two or three hours—until, indeed, the carbohydrate reserves were exhausted. Occasionally, replacement of the perfusion fluid with fresh alkaline Ringer's solution allowed the resumption of contractions, and in these cases (as in others when the arrest of the heart occurred) the pH of the perfusion fluid had fallen very considerably. Usually, however, the arrest of the heart perfused with alkaline Ringer's solution was due to lack of carbohydrate, and the addition of glucose was required to restore the power of anaerobic contraction.

It was evident that the alkaline perfusion fluid was necessary for a continuance of contraction, and, since this appeared to be dependent on the production of lactic acid, for the continued formation of that substance. Now analysis of the perfusion fluid and of the hearts showed that when an unbuffered fluid was used lactic acid accumulated in the heart, but was not excreted to any great extent in the fluid, whereas with the alkaline buffered fluid, considerable amounts of lactic acid were excreted while the accumulation in the muscle itself was slow. These facts led us to suppose that the eventual arrest of the heart was due to the accumulation of lactic acid within the tissues (when that arrest occurred before exhaustion of the available carbohydrate), and this idea was supported by the finding

that even in the unbuffered Ringer solution, the ρH did not fall below 6.9. We supposed, therefore, that excretion of the lactic acid as it was formed was necessary for the continued action of the heart, and that this excretion was easier into a medium capable of neutralising the excreted acid than into one already at ρH 7.

Although this explanation was incorrect, the early experiments established quite definitely that the effect of oxygen lack on the frog's heart depends primarily on the supply of an alkaline perfusion fluid and that if this condition is satisfied the duration of activity depends on the amount of carbohydrate available.

In 1933 Gottdenker and Wachstein showed that asphyxial arrest of isolated rabbit's auricles could occur without any measurable accumulation of lactic acid within the tissue. We therefore reinvestigated the cause of asphyxial arrest in the frog's heart, using small volumes of fluid (0.2 to 2.0 c.c.), and taking care to use only fresh hearts so that carbohydrate exhaustion played no part in causing stoppage of contraction. Table 32 summarises experiments in which we measured the lactic acid content of both ventricles and perfusion

TABLE 32

Vol. of perfusion fluid (c.c.)	0.25	0.5	1.0	2.0
Time (mins.) required for asphyxia to reduce the mechanical response by 50 per cent.	5	9	18	30
Total lactic acid (mg./g. heart) produced in this period	0.4	1.2	2.0	4.0
Lactic acid concentration in fluid (mg./c.c.) at end of the period	0.21	0.26	0.25	0.24
Lactic acid concentration in ventricle (mg./g. ventricle) at end of the period [control value 0.8 mg./g.]	1.1	...	2.0	...
ρH of fluid	6.7	...	6.6	...
ρH of fluid when mechanical response almost ceases	6.5	...	6.5	...

fluid (Ringer's solution containing 0.03 per cent. Na_2HPO_4 + 5 per cent. frog's plasma), and the pH of the fluid when asphyxia was so far advanced as to reduce the normal mechanical response by 50 per cent.

It is evident that, as Gottdenker and Wachstein found, asphyxial arrest may occur without any great increase in the lactic acid content of the heart. On the other hand, variation in the volume of perfusion fluid causes a parallel variation in the time taken for asphyxial arrest, but a similar final concentration of lactic acid (and a similar pH) is attained in the fluid in all cases. It seems, therefore, that acidity of the perfusion fluid prevents the production of lactic acid, an effect which is practically complete at a pH about 6.5. This is confirmed by the finding that addition of acid to the perfusion fluid increases the rate at which asphyxial arrest is produced (Table 33) and by the finding that the total lactic acid produced by a heart with a perfusion fluid of pH 6.6 is only half that produced by a similar heart at pH 8.0 (Table 34).

TABLE 33

Effect on Ventricle of Reaction of Fluid (1 c.c. volume).
(Clark, Gaddie and Stewart (1934).)

Initial Reaction of Fluid (pH).	Aerobic Height of Mechanical Response (as per cent. original) after 20 minutes' Perfusion.	Anaerobic.				Aerobic Recovery Duration of Aerobiosis needed for Recovery of Mechanical Response to 66 per cent. of Original.
		Time (min.) until Mechanical Response is reduced 50 per cent.	Duration (min.) of anaerobiosis.	Final Mechanical Response as per cent. of Original.	Final Reaction of Fluid.	
8.0	100	18.0	25	40	6.7	6
7.0	100	15.0	18	40	6.6	6
6.6	100	8.0	15	27	6.6	9
6.2	70	4.5	7	25	6.4	No recovery

TABLE 34. (Clark, Gaddie and Stewart, 1934).

pH of Fluid.	Duration of Asphyxia.	Lactic Acid Production. Mg./g. Ventricle.		
		Ventricle.	Fluid.	Total.
6.6	15 mins.	1.05	0.125	1.18
8.0	15 „	1.75	0.25	2.0

It is intended to consider the causes and conditions of asphyxial arrest of the heart in greater detail at a later stage, and it is more convenient to discuss then such matters as the form in which lactic acid is removed from the heart, the means by which it may be neutralised, and so on. Here our concern is to demonstrate that lactic acid formation provides the sole considerable source of energy to the heart in anaerobiosis, and that failure in the lactic acid producing mechanism, whether from improper conditions of acidity or from exhaustion of the precursors must lead to arrest of the heart.

It remains to discuss briefly the route by which carbohydrate is converted to lactic acid. The main route, according to the work of Meyerhof and his collaborators, developed from Embden's suggestions may be summarised as follows:—

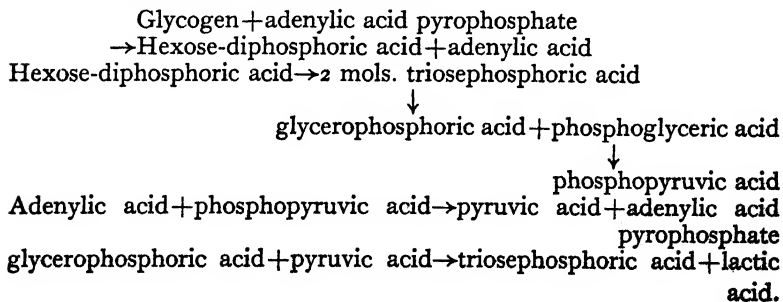

This last reaction, however, is needed only to initiate the series of changes, and later the production

of glycerophosphoric acid ceases and the process consists of :—

triosephosphoric acid + pyruvic acid =
phosphoglyceric acid + lactic acid.

The phosphoglyceric acid is then transformed to more pyruvic acid as before.

An alternative possibility is the production, probably from triosephosphoric acid, of methyl glyoxal which is convertible by glyoxalase to lactic acid. A number of publications suggest that both of these routes may be possible, their relative importance varying perhaps in different tissues, in different conditions, and even with different substrates, for there are suggestions that glycogen and glucose do not necessarily behave in the same way (*e.g.* Ashford (1933), Case and Cook (1931), Barrenscheen *et al.* (1931, 1933), etc.).

In the case of the frog's heart, Gaddie and Stewart (1934) investigated this question, using the isolated ventricle exhausted of carbohydrate by perfusion in nitrogen with alkaline (*p*H 8) Ringer's solution. As has already been mentioned, addition of glucose at this stage restored the power of the ventricle to respond to stimulation by contracting. It was a fair inference that, since the conversion of carbohydrate to lactic acid was the source of energy for contraction, intermediate substances on this conversion should act in the same way as glucose. There is, of course, the proviso that the conversion of the intermediate to lactic acid must release an adequate amount of energy. This, however, merely prevents the inference that a substance failing to restore the power of contraction is therefore not an intermediate in lactic acid formation. Results of tests made in this way are shown in Fig. 22. It is evident that while the intermediates postulated by the Embden-Meyerhof scheme are capable of bringing

about some recovery in the exhausted ventricle, methyl glyoxal is much more effective. This supports the view

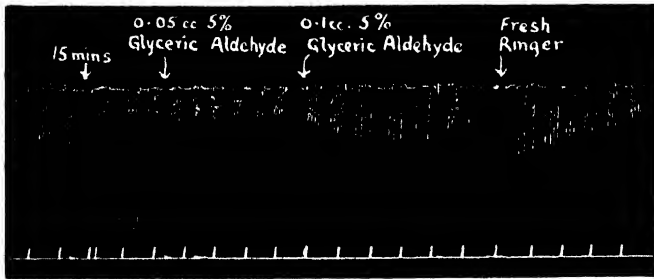

- I. The action of glyceric aldehyde on the exhausted ventricle in nitrogen, increase in the force of contraction, but irregularity in the response to stimulation.

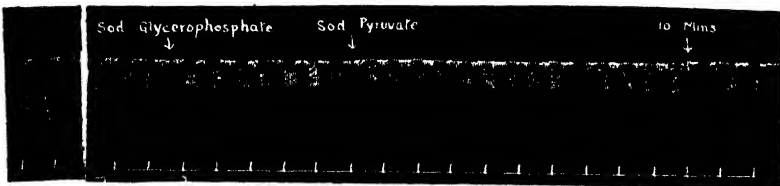
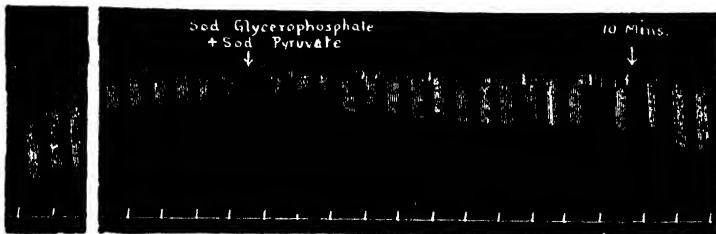

- II. Partial recovery of the ventricle exhausted in nitrogen by means of equimolecular mixture of sodium pyruvate and sodium glycerophosphate. The upper tracing shows the most complete recovery obtained, the lower shows the usual response. Note that sodium glycerophosphate alone is without effect. Sodium pyruvate alone (not shown) is equally ineffective.

FIG. 22.

of the dual route for the production of lactic acid, as does the fact (Fig. 23) that the ventricle poisoned by iodo-acetic acid or by arsenic can be restored to activity

by addition of glutathione (*plus* glucose in the case of arsenic). This result indicates the importance of glutathione, which is the coenzyme of glyoxalase, but has no rôle in the formation of lactic acid *via* phosphoglyceric and pyruvic acids. It is, of course, possible to argue that the glutathione in these experiments merely reacts with the iodoacetic acid or arsenic and so inhibits their toxic action, but the further work of Gaddie and Stewart (1936) on skeletal muscle suggests strongly that the glyoxalase system can play a separate part in lactic acid production. The cumulative effect of the evidence is thus to support strongly, without, however, proving definitely, the existence of more than one mechanism for the formation of lactic acid.

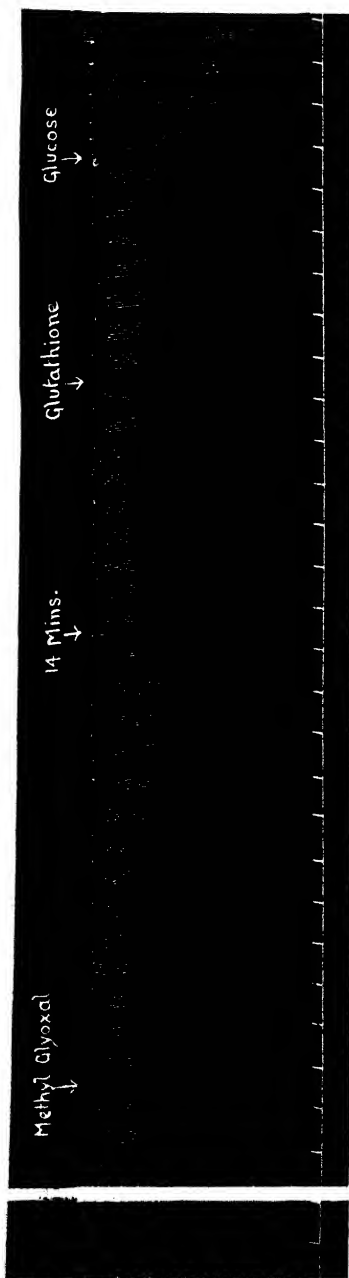

III. Partial recovery brought about by methyl glyoxal, increased somewhat by glutathione (which is without effect alone) and completed by glucose.

FIG. 22—continued.



I. Ventricle (unexhausted of carbohydrate) in nitrogen, poisoned by iodo-acetic acid; activity restored by glutathione.

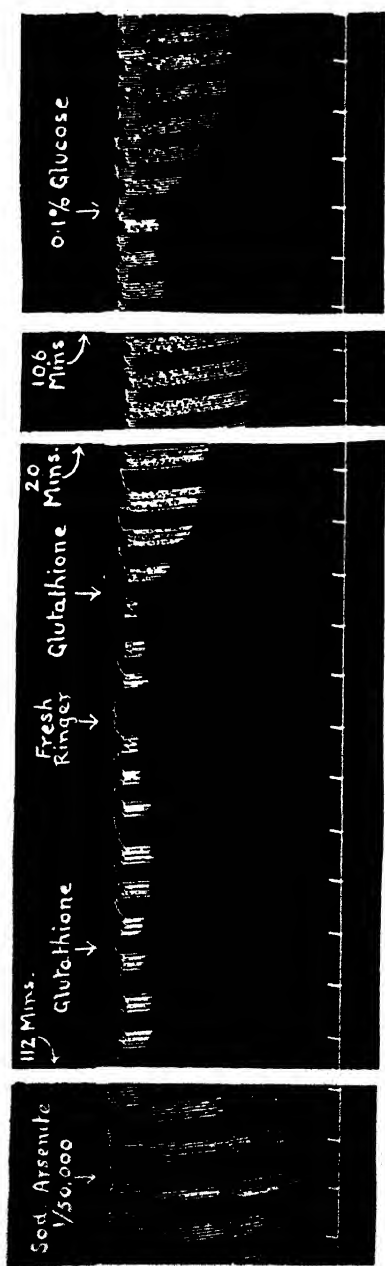

II. As I., but poisoned by sodium arsenite.

FIG. 23.

CHAPTER VIII

PHOSPHORUS METABOLISM OF THE FROG'S HEART

Classes of Phosphates—Phosphagen Loss in Asphyxia—Adenosine-triphosphate—Phosphagen Loss in Mammal's Heart.

THE total phosphorus content of the frog's heart, which is about 2 mg./g., does not differ markedly from the corresponding figure for frog's skeletal muscle. The proportion of lipid phosphorus is, however, greater in the heart and hence the content of the latter in acid-extractable phosphorus, namely 0.85 mg./g., is considerably lower than the corresponding figure in skeletal muscle which is 1.4 mg./g. The acid-extractable fraction includes at least five phosphorus compounds and there may be traces of many more. These compounds may be fairly sharply divided into two categories (Eggleton and Eggleton, 1929): those with barium salts soluble in water at pH 8.0 and those with insoluble barium salts.

The first group contains all the phosphagen and any hexose-monophosphate or adenylic acid present in the original tissue; the second group contains the inorganic phosphate and the adenosinetriphosphoric acid of which the latter can be determined approximately by the amount of orthophosphate split off by hydrolysis in boiling normal HCl solution within 7 minutes (the adenosinetriphosphoric acid loses two of its three phosphorus atoms in these circumstances). Table 35 shows the manner in which the acid-soluble phosphorus

is distributed amongst these different groups of compounds in the frog's heart and skeletal muscle.

TABLE 35
Percentage Distribution of Acid-soluble Phosphorus in the Frog's Heart and Skeletal Muscle.

	Soluble Ba Salts.		Insoluble Ba Salts.		
	Phosphagen.	Remainder.	Inorganic.	A.T.P. ¹	Remainder.
Heart ²	9	48	13	24	6
Gastrocnemius ³	48	5	14	33	0

¹ Calculated as $3/2 \times$ phosphorus hydrolysed off in 7 minutes' boiling with \times normal HCl.

² Clark, Eggleton and Eggleton (1932).

³ Eggleton and Eggleton (1929).

There is a striking difference in the distribution of the soluble barium salts, for the heart as compared with skeletal muscle contains much less phosphagen but much more phosphorus in the form of some other ester or esters with soluble barium salts.

No complete analyses are available of plain muscle from the frog, but plain muscle in general is known to contain phosphagen and adenosinetriphosphate, the former in rather less amounts than characterise cardiac muscle.

It should be remembered that no phosphorus compound in the frog's heart has ever been identified by isolation and only three have been identified by analogy with skeletal muscles. Indeed, on the physiological as well as on the chemical side of the problem, there is not enough direct evidence on which to construct any hypothesis as to the function of phosphorus in cardiac function: it is only by comparison with the much larger body of knowledge derived from the study of

skeletal muscles that any working hypothesis can be reached.

When a muscle, isolated from the leg of a frog, is caused to contract rhythmically in an oxygen-free medium, there occurs a progressive disappearance of phosphagen and an approximately compensating increase in the content of creatine and of orthophosphate. Such a process must release energy, for the hydrolysis of phosphagen is a markedly exothermic reaction; but measurement shows that the process does not account, on the average, for more than about one-third of the total energy produced. The fraction of the total energy supplied by phosphagen hydrolysis changes progressively from something near to unity in a fresh muscle to practically zero in a fatigued one, for in the later twitches of a long series there is no further loss of phosphagen. Relative to the energy output, this process is most rapid at the beginning of the series of twitches; it diminishes as the muscle approaches fatigue, and comes to a stop when most (but never all) of the phosphagen has been destroyed. There is a compensating increase in the lactic acid production per twitch, as the muscle fatigues, and this exothermic reaction accounts fairly satisfactorily for the energy released by activity in excess of the energy provided by phosphagen hydrolysis.

The ventricle of the frog's heart will beat for many hours in an oxygenated Ringer's solution, and its phosphagen content is not appreciably diminished, as is shown by the result given in Table 4. Indeed no significant change occurs in the content of any identifiable phosphorus-containing constituent (Clark and Eggleton, 1936).

If the oxygen supply is shut off, there is a progressive destruction of phosphagen, which comes to a stop in

15 to 20 minutes when about one-quarter of the phosphagen is left. If the Ringer's solution is unbuffered, the ventricle is by this time practically arrested. The situation is qualitatively similar to the case of the skeletal muscle stimulated to fatigue in an atmosphere of nitrogen. Readmission of oxygen to the almost arrested ventricle brings about full recovery, both of activity and of phosphagen content, in 10 to 15 minutes (Table 36). Fig. 24 shows the manner in which the effect of asphyxia depends on the conditions to which the heart is subject.

TABLE 36

The Resynthesis of Phosphagen in the Frog's Ventricle perfused with Ringer's Solution, when O₂ is Readmitted after a Period of Anaerobiosis.

	Number of Hearts Analysed.	Ortho-phosphate (mg. P per 100 g.).	Phosphagen (mg. P per 100 g.).	Phosphagen Index. ¹
(1) Control hearts ²	20	11.6	7.3	0.39
(1) Ventricle deprived of oxygen for 15 minutes	3	12.3	0.9	0.07
(3) Ditto, with subsequent oxygenation for 10 minutes	3	6.2	3.8	0.38

$$^1 \text{ Phosphagen Index} = \frac{\text{Phosphagen-P}}{\text{Phosphagen-P} + \text{Inorganic P}}$$

² From Clark, Eggleton and Eggleton (1931).

In the presence of a large volume of alkaline fluid, mechanical activity is maintained for 2 hours after asphyxia, but this period is greatly reduced in neutral fluid. The figure shows arrest of the I.A.A. poisoned ventricle in about 8 minutes. This period, although short in comparison with the other asphyxial survivals shown in Fig. 24, is really unduly long, owing to incomplete poisoning. The duration of asphyxial

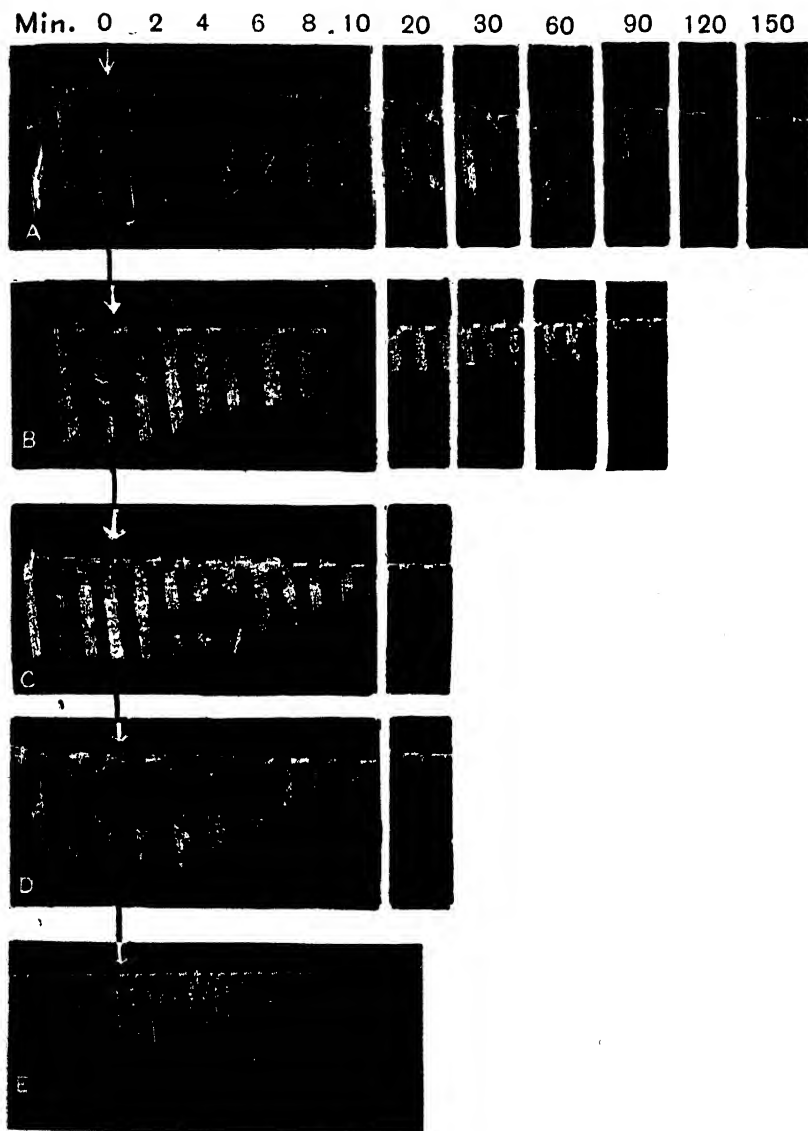

FIG. 24.—Effect of anoxæmia on isolated frog ventricle perfused with various Ringer's fluids (10 c.c. vol.). Nitrogen commenced at zero time. A. Buffered alkaline fluid (pH 8.5). B. Buffered neutral fluid (pH 7.0). C. Buffered acid fluid (pH 6.5). D. Unbuffered fluid. E. Buffered alkaline fluid (pH 8.5) plus 1 in 50,000 monoiodoacetic acid (Clark, Eggleton and Eggleton, 1932).

survival in a heart fully poisoned by I.A.A. is really about 2 or 3 minutes, and this period is not prolonged by making the perfusion fluid alkaline.

In the case of the normal heart perfused with alkaline Ringer's solution the mechanical response persists for an hour or two in the absence of oxygen with the phosphagen

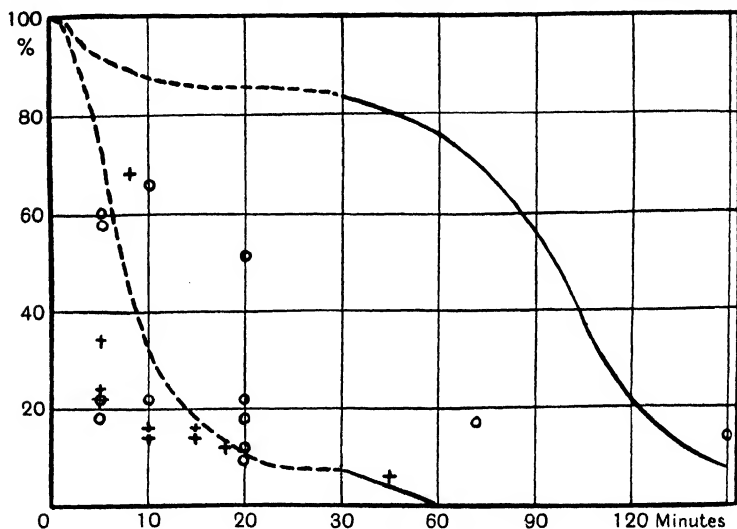

FIG. 25.—The effect of O_2 lack on phosphagen content and activity, of the frog's ventricle, in neutral and alkaline conditions. Ordinate: per cent. of normal. Abscissa: time after exposure to nitrogen. Upper line: mechanical response with alkaline Ringer. Lower line: mechanical response with neutral Ringer. The crosses and circles show the phosphagen index expressed as the percentage of the normal value (Phosp. P/Inor. P = 0.63 = normal phosphagen index). Circles: results with alkaline Ringer's fluid. Crosses: results with neutral Ringer's fluid. (Clark, Eggleton and Eggleton, 1932.)

constant at the reduced level (Fig. 25). An alkaline bathing fluid similarly greatly increases the "stamina" of the frog's sartorius muscle, provided the rate of stimulation is slow (Hill and Kupalov, 1929), but the phosphagen content of the muscle in these conditions has not been measured. In both cases, however, an acid (mainly, if not entirely lactic) diffuses out from the tissue.

These facts suggest at first sight that the muscle, skeletal or cardiac, changes over from phosphagen breakdown to glycogen breakdown for its energy as the oxygen debt increases. But certain facts suggest that phosphagen breakdown is throughout the more immediate source of energy, and that lactic acid production finances an anaerobic restitution of phosphagen which is carried out with increasing thoroughness as the stock of phosphagen diminishes.

In the case of skeletal muscles such an anaerobic resynthesis has been demonstrated to occur during the 20 seconds following a short tetanus (Nachmannsohn, 1928). Such a demonstration is not possible with cardiac muscle, for it cannot be tetanised, and the changes accompanying a single heart beat (or muscle twitch) are too small to be measured.

The small residue of phosphagen present in a muscle or heart with a large oxygen debt may be supposed therefore to be used over and over again. The amount (about 2 to 3 mg. phosphagen-P per 100 g. muscle—see Table 37) is considerably more than is needed to provide energy for one contraction, as is shown by the following calculation:—

Heat of hydrolysis 12,000 cal./g. mol. (31 g. Phosphagen-P).

∴ 2 to 3 mg. Phosphagen-P gives 1 cal.

∴ potential energy available in one heart (0.2 g.) = 0.002 cal. = 80 g. cm.

A single contraction of such a ventricle releases about 20 g. cm.

On this view the ultimate arrest of the muscle (skeletal or cardiac) in absence of oxygen is not attributable to lack of phosphagen, unless the increasing inefficiency of the muscle results finally in its content of phosphagen ceasing to be adequate for even one contraction.

Valuable information has been obtained from skeletal muscles poisoned with sodium iodo-acetate (I.A.A.), a drug which suppresses lactic acid formation and so renders unavailable this anaerobic source of energy. According to Lundsgaard (1930) such muscles perform contractions in the absence of oxygen as well as normal ones, but give only about one-third as many contractions before being arrested by fatigue. The total energy developed is proportional throughout to the amount of phosphagen decomposed, and arrest occurs when there is no phosphagen left. There is some decomposition of adenosinetriphosphoric acid toward the end, but to a first approximation the energy released is accounted for by the heat of hydrolysis of the phosphagen destroyed.

Energy production cannot be readily measured in the frog's isolated ventricle, but a strikingly similar behaviour is observed. If a ventricle, beating in an *aerated* saline solution, is treated with I.A.A. in a concentration of 1 : 20,000, no effect is produced on

TABLE 37

The Effect of Iodo-Acetate Poisoning of the Frog's Ventricle, in Aerobic and Anaerobic Conditions.

No of Expts.	Vol. of Ringer's Fluid. c.c.	Concentration of I.A.A.	Atmosphere.	Time Mins.	Strength of Beat.	Phosphagen P mg. per 100 g.	Inorganic P mg. per 100 g.	Phosphagen Index.
3	10	{ 1 : 12,500 1 : 25,000	Air	40-100	Normal	4.9	8.2	0.37
2	2	1 : 50,000	N ₂
1	2	1 : 10,000	N ₂	10-20	Nil	1.8	11.0	0.14
1	2	1 : 5,000	N ₂	5	Very feeble	2.2	8.7	0.27
1	2	1 : 5,000	N ₂	5	Very feeble	1.9	11.2	0.15
1	10	1 : 10,000	N ₂	10	Steady contraction	0	12.0	0
2	10	1 : 100,000	N ₂	...	Nil
...	Followed by O ₂	...	Normal	6.0	13.4	0.31

From Clark, Eggleton and Eggleton, 1932.

the mechanical response—at least for an hour or more—and the phosphagen content does not diminish (Table 37). This proves that, in the frog's heart, the mechanism destroyed by I.A.A. poisoning is not needed provided there is adequate oxygenation. This effect cannot easily be demonstrated on isolated skeletal muscles owing to the difficulty of providing adequate oxygenation in this case. When, however, the I.A.A. poisoned ventricle is deprived of oxygen by the passage of a stream of nitrogen the mechanical response begins to decrease after a latent period of about a minute and diastolic arrest occurs within 50 beats of the first appearance of depression of the mechanical response.

The factors responsible for the latent period mentioned above will be discussed in detail in Chapter IX. Under ordinary experimental conditions the chief factor is the delay in removal of oxygen. The phosphagen content of the ventricle arrested by oxygen lack after I.A.A. poisoning is the same (within the limits of experimental error) as in the case of arrest by oxygen lack alone, and administration of oxygen to the arrested ventricle brings about functional recovery and increased phosphagen content (Clark, Eggleton and Eggleton, 1932).

It seems then that the phosphagen loss in anaerobic circumstances is the same whether I.A.A. is used or not: the difference lies in the speed. In the former case arrest occurs in 2 to 4 minutes; in the latter, in 15 to 20 minutes.

No case has yet been observed of a ventricle beating in any circumstances without any phosphagen content. It seems that a quantity of about 2 mg. (in terms of P) per 100 g. must be present to allow of beating, but a ventricle may fail to beat even though it contains this and more.

The figures in Table 38 show that a number of depressant agencies can produce arrest of the frog's

TABLE 38

Phosphagen Content of Hearts partly Paralysed by Depressant Agents.

Depressant Agent.	Time of Action. (mins).	Strength of Beat.	Weight of Heart. g.	Phosphagen P. mg./100g.	Inorganic P. mg./100g.	Phosphagen Index.
Calcium lack . . .	35	Nil	0.2	5.4	6.8	0.44
Potassium excess . . .	30	50 % (irreg.)	0.3	6.0	5.0	0.54
Potassium excess . . .	10	Nil	0.22	4.6	10.5	0.31
Ethyl urethane 0.2 M	20	Nil	0.35	4.8	10.9	0.31
Ethyl urethane 0.15 M	15	Nil	0.23	4.4	12.2	0.27
Acetylcholine . . .	25	40 %	0.26	4.7	10.3	0.31
Acetylcholine . . .	10	40 %	0.37	4.5	9.6	0.32

From Clark, Eggleton and Eggleton, 1932.

heart without any diminution in the phosphagen content. It has been shown that these agencies can produce arrest of the frog's ventricle in a few seconds (calcium lack, De, 1928; narcotics, Pickford, 1926; acetylcholine, Clark, 1926). This is a much more rapid effect than is ever produced by oxygen lack. Hence these forms of arrest must be due to some interference with the contractile mechanism and not to exhaustion of any known form of energy.

The arrest, accompanied by systolic contraction, which ultimately occurs in the I.A.A. poisoned heart in presence of oxygen, appears to be a phenomenon quite distinct from anaerobic arrest; it is not due to phosphagen exhaustion, since the phosphagen content is normal. It may be due to interference with carbohydrate metabolism, since hearts in which the carbohydrate is completely exhausted by prolonged asphyxia often pass into systolic arrest. The case

of the partially anaerobic I.A.A. ventricle is also instructive in this connection. Complete anaerobiosis will arrest an I.A.A. poisoned ventricle in about 2 minutes: an oxygen pressure of 10 mm. postpones arrest to 10 to 20 minutes, and the heart contains in this case its full complement of phosphagen (Table 39). Two points become evident: (a) it is not lack of

TABLE 39

Dissociation of Rigor from Phosphagen Depletion in Ventricles poisoned with I.A.A. (1 in 10,000 to 1 in 20,000) and killed after appearance of Rigor.

Date.	Controls.		Experiments.			
	No. of Ventricles.	Phosphagen Index.	No. of Ventricles.	Treatment.	Duration of Poisoning.	Phosphagen Index.
1935. May	4	0.35	4	Air	2-3 hrs.	0.44
1935. June-July	3	0.43	3	Air	1-7 "	0.52
	14	0.35	2	Oxygen press. 20 mm. Hg	6-30 min.	0.43
1935. Nov.	5	Oxygen press. 10 mm. Hg	6-25 "	0.32
1936. Mar.						

From Clark and Eggleton, 1936.

phosphagen which arrests the heart, and (b) the oxidative reaction energising the phosphagen resynthesis can occur in oxygen pressures too low to support continued activity. One other thing is known about this oxidative reaction, namely, that it is inhibited by cyanide, for I.A.A. poisoned ventricles react towards cyanide exactly as towards oxygen lack in respect of phosphagen loss and loss of mechanical response (Table 40).

No reference has been made so far to the function of adenosinetriphosphoric acid in the heart muscle. Very little information can be obtained on this point

from the analysis of either cardiac or skeletal muscles in different physiological states. In extreme fatigue some loss is observed in the case of skeletal muscles

TABLE 40

Showing that Cyanide inhibits the Oxidative Resynthesis of Phosphagen in Ventricles poisoned with I.A.A. (1 in 10,000 to 1 in 40,000). (From Data given by Clark and Eggleton, 1936.)

Number of Ventricles.	Atmosphere.	Phosphagen P.
		Phosphagen P+Inorganic P.
14	Air	0.35
7	N ₂	0.25
3	O ₂ +NaCN	0.12

(Lohmann, 1934), and a similar effect is obtained both in mammalian (Weicker, 1934) and in frog's heart (Clark and Eggleton, 1936) as a result of prolonged asphyxiation or I.A.A. poisoning (see Table 41). The importance of adenosinetriphosphoric acid in the present theory of muscular contraction rests largely upon evidence derived from experiments with minced muscle and muscle extracts. Such experiments bring to light four reactions in which adenosinetriphosphoric acid (A.T.P.) is involved.

1. 2 phosphopyruvic acid + adenylic acid → A.T.P. + 2 pyruvic acid.
2. A.T.P. + 2 creatine ⇌ 2 phosphagen P + adenylic acid.
3. A.T.P. + glycogen → fructose diphosphate + adenylic acid.
4. A.T.P. + H₂O → adenylic acid + inorganic P.

Reactions 2 and 4 together constitute the "Lohmann" reaction. According to Lohmann (1934) the inorganic phosphate which appears in a muscle during activity comes from reaction 4. The adenylic acid simultaneously released reacts at once with phosphagen

TABLE 41.—*Effect of Perfusion, I.A.A. Poisoning, and Asphyxia on Adenosinetriphosphate Content (A.T.P.-P expressed as Percentage of Total Acid-Soluble-P). (From Clark and Eggleton, 1936.)*

Controls.		Experiments.		Difference in A.T.P.-P.	Remarks.
No. of Ventricles.	A.T.P.-P.	No. of Ventricles.	A.T.P.-P.		
<i>A. Normal ventricles. Short perfusions ½-6 hours.</i>					
6	17·9	6	14·4	-3·5	Anaerobic.
...	...	3	13·8	-4·1	Aerobic. Alkaline
3	23·4	3	18·7	-4·7	Anaerobic
6	19·5	2	21·7	+2·2	Aerobic. Alkaline
2	23·5	3	16·8	-6·7	" "
			Average	-3·3	
<i>B. Normal ventricles. Long perfusions 20-24 hours.</i>					
6	17·9	3	9·3	-8·6	Aerobic. Acid
...	...	6	8·9	-9·0	" Alkaline
6	19·5	2	13·8	-5·7	" "
			Average	-7·8	
<i>C. I.A.A. poisoned ventricles. Aerobic perfusion ¼-4 hours.</i>					
3	14·1	3	14·2	+0·1	Good beat at end
6	19·5	2	19·6	+0·1	" "
...	...	4	17·6	-1·9	Arrested
2	23·5	4	18·0	-5·5	Feeble beat
...	...	2	17·5	-6·0	Rigor
4	15·8	2	15·9	+0·1	Feeble beat
			Average	-2·2	
<i>D. I.A.A. poisoned ventricles. Anaerobic perfusion 5-10 minutes.</i>					
3	23·4	3	15·5	-7·9	Arrested
3	14·1	3	11·6	-2·5	" "
...	...	3	8·2	-5·9	Rigor
4	15·8	2	15·0	-0·8	...
			Average	-4·3	

(reaction 2), giving creatine and regenerating adenosinetriphosphoric acid. Reaction 2 has practically no heat accompaniment (Lohmann, 1934) and probably occurs in two stages with the intermediary formation of adenosinediphosphate (Lohmann, 1935 and 1936). It has been reported that from cardiac muscle no A.T.P. can be isolated, but only a related substance, which from the incomplete analytical data available appears to be diadenosinepentaphosphate (Beattie and Milroy, 1934; Ostern and Baranowski, 1935). It is not impossible, however, that the substance is a mixture of adenosine di- and tri-phosphates (Sato, 1935).

Reaction 3 above may be regarded as initiating the chain of reactions leading from glycogen to lactic acid, and reaction 1 is the penultimate link (for the pyruvic acid formed in it can react with glycerophosphate or triosephosphoric acid to become lactic acid). Adenosinetriphosphate is therefore concerned in lactic acid production to the extent that it donates phosphate to the carbohydrate molecule early in the process and receives it back again toward the end. With respect to the whole process

Glycogen → lactic acid

the A.T.P. is therefore acting as a coenzyme. It is, in fact, the "coenzyme of the lactic acid ferment" discovered by Meyerhof some years before it was identified by Lohmann.

An accumulation of adenylic acid is never tolerated by a living muscle, and if it cannot for any reason be rephosphorylated it is rendered harmless by deamination, the product being inosinic acid. Adenylic acid can be regenerated from this inosinic acid only in aerobic conditions, according to Parnas (1935), and never by the use of free NH_3 .

If we may apply to cardiac muscle the results obtained by Parnas and his school from skeletal muscle, we shall expect the time-course of chemical events in a single beat of the heart to be

1. A.T.P. \rightarrow adenylic acid + phosphate + energy.
2. adenylic acid + phosphagen \rightarrow A.T.P. + creatine.
3. glycogen \rightarrow lactic acid + energy.
4. creatine + phosphate + energy \rightarrow phosphagen.

The phosphate cycle postulated by Lohmann and Parnas is of great theoretical interest, but the authors in the present monograph have deliberately concentrated their attention on the behaviour of living cardiac muscle, and this provides no evidence that adenosinetriphosphate supplies energy to the contraction process. Table 41 shows that there is a well-marked decrease in the A.T.P.-P fraction in normal ventricles partially exhausted by aerobic perfusion for 24 hours, but anaerobic arrest both in normal and I.A.A. poisoned ventricles produces a smaller decrease in this fraction. The six estimations on I.A.A. poisoned ventricles arrested in asphyxia show an average value for the A.T.P.-P fraction which is 27 per cent. less than that of the corresponding controls. On the other hand, the normal ventricles after prolonged perfusion were still contracting when the A.T.P.-P figure was 11 per cent. of the total acid-soluble P, which corresponds to a loss of 41 per cent. of the control value.

It is difficult to reconcile these results with the hypothesis that asphyxial arrest is due to failure to resynthesise adenosinetriphosphate.

As regards the rôle played by phosphagen in the contraction process, our results show that the frog's ventricle can maintain an effective beat with a very low phosphagen content (ventricle asphyxiated in alkaline Ringer's fluid, *cf.* Fig. 25) and that asphyxial

arrest may occur with low oxygen pressures, without any marked fall in phosphagen (Table 39).

These facts show that the mechanical activity of the ventricle is not dependent in any simple manner on its phosphagen content.

On the other hand, the mechanical activity and the phosphagen content fall together both in normal ventricles asphyxiated in neutral Ringer's fluid and in I.A.A. poisoned ventricles when asphyxiated; moreover, when asphyxiated ventricles are provided with oxygen, the mechanical response and the phosphagen content recover together. These facts indicate some definite connection between phosphagen and the mechanical response.

Recent work by Dr I. Chang on the rabbit's isolated auricle is suggestive in this connection and he has kindly permitted us to quote certain of his unpublished results. Table 42 shows the effect of asphyxia on the mechanical response of the rabbit's auricle. The effects of asphyxia on the I.A.A. poisoned tissue and on the normal auricle in neutral Ringer's solution are similar

TABLE 42

Effect of Asphyxia on the Mechanical Response (Isotonic) of Strip of Rabbit's Auricle.

Condition.	Time in Minutes until Response reduced by	
	50 per cent.	90 per cent.
Normal auricle suspended in Locke's fluid at pH 8.2 .	7.0	22.0
Ditto at pH 6.8	5.0	12.0
I.A.A. poisoned auricle .	4.5	5.5

(Unpublished results kindly lent by Dr I. Chang.)

to the corresponding effects observed in the frog's heart. In the former case there is a short latent period and then a rapid fall, whilst in the latter case there is a die-away decrease similar but more rapid than that shown in Fig. 25 (lower curve). The effect of asphyxia on the normal rabbit's auricle suspended in a large volume of alkaline Ringer's fluid is, however, quite different from its effect on the normal frog's ventricle under such conditions (Fig. 25, upper curve), for in the latter case a steep fall on mechanical response does not occur until after a latent period of about an hour, whereas in the former case there is an immediate fall similar in shape, though somewhat slower than the fall which occurs in neutral Ringer's fluid.

Estimations made by Dr Chang on the phosphagen content show that in all three cases the phosphagen decreases in proportion to the decrease in the mechanical response. The results may be thus summarised:—

- | | | |
|---|---|--|
| (1) Asphyxiation of I.A.A. poisoned tissue. | } | In both frog's ventricle and rabbit's auricle the mechanical response and the phosphagen content fall together. |
| (2) Asphyxiation of normal tissue in neutral Ringer's fluid. | | |
| (3) Asphyxiation of normal tissue in alkaline Ringer's fluid. | } | (a) In the rabbit's auricle the mechanical response and phosphagen content fall together. |
| | | (b) In the frog's ventricle the phosphagen content falls fairly rapidly but the mechanical response is maintained for a long period. |

It appears, therefore, that under the special conditions of an alkaline perfusion fluid, conditions which are very favourable to free glycolysis, the frog's ventricle has the power to maintain mechanical activity after its phosphagen has been reduced greatly, but that the rabbit's auricle has no such power.

The most obvious difference between these preparations is the frequency of contraction. The rabbit's auricle has a frequency about 300 per minute, whereas the frog's ventricle was stimulated at 12 per minute.

The results suggest the possibility that phosphagen is essential for a rapid recovery process, and that it is the low frequency of the frog's ventricle that makes it possible for it to maintain contractions with a low phosphagen content when the experimental conditions are favourable for obtaining energy from glycolysis. This correlation of phosphagen with rate of contraction and recovery is tentative but is in accordance with the outstanding facts regarding the differences in the phosphagen content of different types of muscle.

Figures for the phosphagen content of skeletal, cardiac and plain muscle are given by Eggleton and Eggleton (1928 and 1929), and comparative figures for the phosphagen content of red and white muscles of hens are given by Ferdmann and Feinschmidt (1928), and of guinea-pigs by Palladin and Epelbaum (1928). These figures show that, in general, muscles which are characterised by rapid recovery processes have the highest phosphagen content, and as regards both these properties we have the same series :

White skeletal muscle > red skeletal muscle > cardiac muscle > plain muscle.

CHAPTER IX

EFFECTS OF ASPHYXIA ON THE MECHANICAL RESPONSE AT THE FROG'S HEART

Asphyxia of the Normal Heart: Conditions influencing Rate of Arrest—Asphyxia of the Iodo-acetic-acid Poisoned Heart: Action of Cyanides. Summary.

Effect of Asphyxia on the Mechanical Response of the Heart

THE effect of asphyxia on cardiac metabolism was described in Chaps. V and VII, and the present chapter is concerned chiefly with the more detailed problem of the manner in which the change from aerobic to anaerobic metabolism influences the mechanical response of the heart.

It has been shown that the normal heart when asphyxiated can obtain energy by glycolysis and that the duration of maintenance of anaerobic activity depends on two factors:—

- (a) Amount of carbohydrate available for glycolysis.
- (b) The amount of buffer available for neutralisation of the lactic acid produced.

It has also been shown that when glycolysis is abolished by iodo-acetate poisoning the heart can obtain energy adequate for two or three minutes' activity and that the hydrolysis of phosphagen is probably the chief source of such energy.

Fig. 24 (p. 157) shows the striking contrast in the effect

of asphyxia on the normal and on the I.A.A. poisoned heart. This figure does not, however, show the effects of complete I.A.A. poisoning, but the action of asphyxia in such a case is shown in Fig. 8, (p. 77) where asphyxia produced arrest in less than one minute.

In view of the complete difference in the effects of asphyxia on normal and on I.A.A. poisoned hearts, it is convenient to consider these separately.

(1) **Asphyxia of the Normal Heart.**—The fact that asphyxia produces a more rapid effect in neutral than in alkaline solution has been noted by many authors (Martin, 1905, turtle's ventricle strip; Drury and Andrus, 1924, dog's heart; Freund and König, 1927, frog's heart).

The authors' experiments have confirmed this result (Figs. 24 and 25, pp. 157, 158). A point which appears of some practical importance is that the carbohydrate stores of the heart are not all equally available for glycolysis. The anaerobic frog's heart, when supplied with glucose-containing fluid, glycolyses a quantity of glucose which appears equivalent, as regards energy production, to the material oxidised under aerobic conditions.

In the case of 6 hearts perfused anaerobically with Ringer's solution containing 0.1 per cent. glucose, we found that the total carbohydrate content of the hearts was the same as that of the controls (1.59 per cent.), but that the hearts had produced lactic acid at the rate of 5.7 mg./g./hour.

The usual oxygen consumption of the heart is about 1 c.c./g./hour, a quantity which would oxidise 1.3 mg. lactic acid. Hence these figures show a ratio between anaerobic lactic acid production and carbohydrate oxidation of about 4.

The heart, when perfused with glucose-free Ringer's solution under anaerobic conditions, glycolyses its own

carbohydrates, but Fig. 19 shows that from the first the lactic acid production is lower than when glucose is present in the perfusion fluid and, moreover, this rate declines rapidly after the first hour.

During the first hour the lactic acid production shown in Fig. 19 (p. 140) is about 3 mg./g./hour and the activity maintained is equal to about 80 per cent. of the normal aerobic activity. After one hour of anaerobiosis the lactic acid production and the mechanical response both decrease rapidly.

Estimations of the total reducing substances in the heart showed a content of 0.73 per cent. after 2 hours' and 0.77 per cent. after 4 hours' anaerobiosis. These results indicate that the anaerobic heart can glycolyse fairly readily about half the total reducing substances present, but that the remainder is glycolysed very slowly, and the energy thus obtained is only adequate to maintain a small activity.

Experiments with aerobic exhaustion of hearts showed that the total reducing substances could be reduced as low as 0.4 per cent. after 24 hours' perfusion.

These results indicate that part of the total carbohydrates can be glycolysed nearly as readily as can glucose added to the perfusion fluid, but this fraction is exhausted in about an hour, and after this time the rate at which the remaining carbohydrates are glycolysed decreases steadily.

Evans (1934) and Chang (1937) have shown that a combination of adrenaline and asphyxia will remove nearly the whole of the glycogen from the rat's heart in two or three minutes.

It is possible that the failure of the frog's heart to utilise fully its carbohydrate store in asphyxia is due to the absence of adrenaline. This hypothesis is supported by the fact that Freund and König (1927)

found that adrenaline stimulated the mechanical response of the frog's heart when this was asphyxiated either by nitrogen or by cyanides.

Fig. 26 shows the manner in which the effect of asphyxia on the normal frog's heart depends on its carbohydrate store, for the normal heart, when its carbohydrate store is exhausted, is arrested by asphyxia as rapidly as is the I.A.A. poisoned heart.

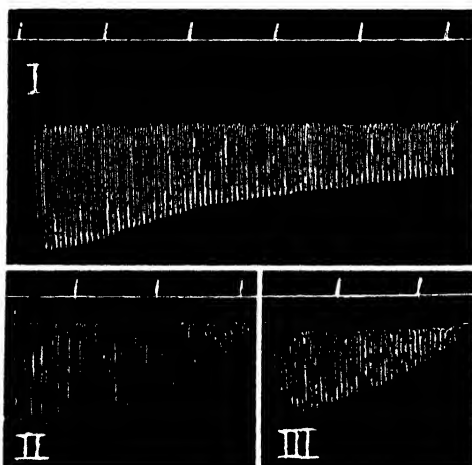

FIG. 26.—Rate of asphyxial depression of frog's ventricles in contact with 0.15 c.c. Ringer's fluid. I. Fresh ventricle. II. Ventricle after carbohydrate exhausted by prolonged isolation (24 hours) and repeated asphyxiation. III. Fresh ventricle poisoned with I.A.A. Time in mins.

The variations in the mechanical response of the heart observed in these experiments can all be explained on the simple hypothesis that the amount of mechanical response is limited by the supply of energy from glycolysis, whilst this is limited by the amount of freely available carbohydrate present in the tissue-fluid system.

The effects described above occur with the anoxæmic heart when it is in contact with a volume of fluid sufficiently great for its pH not to be altered by the lactic acid produced. When the volume of fluid is

small (1.0 c.c. or less) and its buffer power is low, asphyxia produces a much more rapid effect.

It has been shown (Table 32 and Fig. 20) that both the lactic acid production and the time until asphyxia produces a given amount of depression of the mechanical response depend upon the amount of buffer present (*i.e.* volume and buffer concentration of the perfusion fluid). The figures in Table 32 show that, as a first approximation, the time until half asphyxia is proportional to the volume of fluid in contact with the heart, and that 50 per cent. depression occurs when a certain concentration of lactic acid has been produced in the fluid in contact with the ventricle. Measurements of the pH of the fluid showed that 50 per cent. depression occurred with varying concentrations of fluid when the pH was reduced to about 6.6.

Table 34 shows that asphyxial lactic acid production is greatly reduced by perfusion with a fluid at pH 6.6. This agrees with Lohmann's (1926) conclusion that pH 6.5 inhibited lactic acid production by minced muscles of frogs.

These results together show that, as a first approximation, the depression produced by oxygen lack on the frog's ventricle in contact with a small volume of fluid can be accounted for by the production and excretion of lactic acid. When the latter reduces the pH of the surrounding fluid to about 6.6, then glycolysis is arrested and the heart is deprived of all available sources of energy.

The change from aerobic to anaerobic activity regularly causes an immediate decrease of about 10 per cent. in the amplitude of the mechanical response. This effect indicates that anaerobic glycolysis is not as efficient a mode of energy supply as is aerobic metabolism.

The action of acids on the heart is complicated by

the fact that a change of reaction produced by increased carbon dioxide tension produces a more rapid and greater depression of the heart than does a change of reaction produced by other acids, including lactic acid (Smith, 1926). A change of reaction will therefore produce more effect when the Ringer's fluid is buffered with carbonate than when a carbonate-free Ringer's solution is used. In the experiments described in Table 33, carbonate-free Ringer's solution was employed; and since no carbon dioxide can be produced by the heart under anaerobic conditions, therefore the increased sensitivity to acid observed under anaerobic conditions was not due to the presence of carbon dioxide.

The hypothesis that anaerobic depression of the normal frog's ventricle depends on the excretion of lactic acid, which changes the reaction of the perfusion fluid in contact with the ventricle and thereby inhibits glycolysis, is not adequate to explain all the facts observed.

The authors (1934 *b*) noted that the concentration of lactic acid found in the heart fluid after asphyxia was greater than that calculated from the change in pH ; and measurements showed that in the case of a ventricle asphyxiated in contact with 1 c.c. of fluid, about half the lactic acid excreted was excreted in neutral form. A comparison between the lactic acid excretion into 1 c.c. and 0.25 c.c. of fluid showed that under the latter condition the total amount of lactic acid formed before the occurrence of mechanical arrest was less than the lactic acid excreted in neutral form by the ventricle in contact with 1 c.c. of fluid. The contrast between the two conditions is shown in Fig. 27.

This result shows that asphyxial depression must be more complex than is indicated by the hypothesis put forward above.

It would appear that when lactic acid is formed a portion is excreted; if this portion can diffuse away into a considerable volume of fluid, the ventricle has the power to neutralise a considerable additional amount of acid, but if no such diffusion away is possible, the lactic acid rapidly inhibits any further glycolysis.

The nature of the buffer substance that neutralises the lactic acid is not known. It is not potassium, because the authors found that the amount of potassium

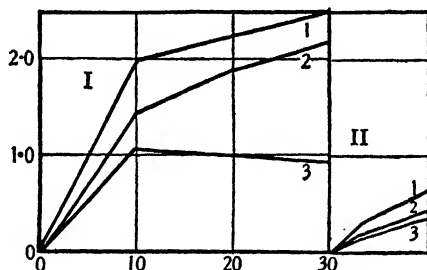

FIG. 27.—Fate of lactic acid formed during asphyxia. Abscissa: time in minutes. Ordinate: lactic acid (mg. per g. ventricle). I, open method, 1 c.c. fluid. II, plug method, 0.2 c.c. fluid. The curves show (1) total lactic acid formed; (2) total lactic acid excreted; (3) lactic acid excreted as lactate (Clark, Gaddie and Stewart, 1934).

excreted during asphyxia was not more than 0.04 mg./g., and this quantity would not account for more than one-quarter of the lactic acid excreted in neutral form.

When a ventricle is asphyxiated repeatedly the rate at which arrest occurs increases and the times until half depression with successive asphyxiations show the approximate ratios of 1.0, 0.7, 0.6, 0.55, 0.5. This time becomes constant after about 4 asphyxiations and continues constant until the carbohydrate stores become exhausted, when a further shortening occurs. This initial change in rate of asphyxiation can most easily be explained as being due to the exhaustion of some buffer substance in the ventricle.

The rate of asphyxial depression of the frog's ventricle appears to depend not only on the amount of lactic acid formed, but also on the ease with which this can be excreted from the heart tissue into the surrounding fluid, and this hypothesis will explain the fact that partial recovery is possible when the rate of stimulation and therefore the rate of metabolism is reduced.

Scheinfinkel (1926) and Bachmann (1927) showed that a normal frog's heart contracting rapidly was quickly arrested by asphyxia, but that if the frequency were reduced a partial recovery occurred. De (1928) obtained a similar result with heart strips poisoned by cyanide and perfused with alkaline Ringer's solution.

These results suggest that the neutralisation and excretion of lactic acid are relatively slow processes, and that when the rate of metabolism is increased, some form of toxic accumulation occurs inside the tissue which prevents the heart using its available stores of energy.

Experiments on asphyxia of the turtle's heart have given results which agree with those obtained with the frog's heart. Redfield and Medearis (1926) found that ventricle strips from the turtle when stimulated to exhaustion in nitrogen showed accumulation of lactic acid. Edsall, Hunt, Read and Redfield (1932) found, with auricle strips from the turtle suspended either in gas or in bicarbonate-free Ringer's fluid, that asphyxia caused a mechanical depression which followed a die-away curve, and their results show that half depression occurred after 150 to 220 contractions. On the other hand, strips suspended in Ringer's fluid containing bicarbonate only showed a partial depression with asphyxia.

Experiments with isolated mammalian tissues have provided results which are more difficult to interpret.

Gottdenker and Wachstein (1933) found, with the rabbit's auricle suspended in Locke's solution, that asphyxia caused rapid failure of the mechanical response and that there was some lactic acid excretion but no accumulation of lactic acid in the tissue.

Table 43 shows the results they obtained when asphyxia was produced by bubbling nitrogen through the fluid.

TABLE 43

Asphyxiation of Rabbit's Isolated Auricle (Gottdenker and Wachstein, 1933).

	Time of Maintenance of Contraction during Asphyxia.	Mean per cent. Increase in Lactic Acid in Tissue and Fluid.
Unbuffered Locke's fluid (pH 6.8), no glucose	6 mins.	29
Tyrode's fluid, no glucose	17 mins.	142
Tyrode's fluid, with glucose	37 mins.	219

Gottdenker and Wachstein found a control value for the lactic acid content of 0.12 g./100 g., and the lactic acid production found after asphyxiation in alkaline glucose-containing fluid corresponded to about 0.2 g./100 g. after 37 minutes or about 0.4 g./100 g./hour.

Clark, Gaddie and Stewart (1932 *δ*), however, found that the frog's heart under conditions comparable to those described above produced lactic acid equal to 0.57 g./100 g./hour. These results indicate that the rabbit's isolated auricle has poor powers of glycolysis even under the most favourable conditions.

Dr Chang has kindly permitted us to quote certain unpublished results he has obtained with the rabbit's auricle. His results, which are shown in Table 42,

indicate that the rates of asphyxiation of the normal and of the I.A.A. poisoned rabbit's auricle are not greatly different. He has also shown that the phosphagen content falls in proportion to the fall of the mechanical response.

In the case of the rabbit's auricle, therefore, it would appear that mechanical activity cannot be maintained when the phosphagen is depleted, and that, as the phosphagen store cannot be sustained by glycolysis, arrest is produced under all circumstances by asphyxiation. Hence the asphyxial arrest of the isolated and unpoisoned rabbit's auricle resembles that of the I.A.A. poisoned frog's heart more nearly than that of the normal frog's heart.

Prasad (1935 *a* and *b*) found that the isolated rabbit's gut contained little carbohydrate available for glycolysis, and hence in sugar-free perfusion fluid the normal gut was arrested by asphyxia almost as rapidly as the I.A.A. poisoned muscle. In this case the cause of asphyxial arrest appeared to be exhaustion of the carbohydrate available for hydrolysis.

These facts indicate that vertebrate tissues differ widely as regards their power to withstand asphyxia. It would appear that the frog's heart is exceptional in this respect in that it can maintain asphyxial activity for long periods by glycolysis provided that it can get rid of the lactic acid thus formed. The mammalian heart appears to lack this power. From a teleological point of view this difference is not surprising, because the frog lives for long periods under water with a very poor oxygen supply. For such a mode of existence the utilisation by the heart of anaerobic sources of energy must be a valuable faculty.

(2) Asphyxia of the Iodo-acetic acid Poisoned Heart.
—Poisoning with I.A.A. abolishes glycolysis, and

since this is the only important source of anaerobic energy, therefore asphyxia of the I.A.A. poisoned ventricle naturally produces rapid arrest, an effect which is shown in Fig. 28.

The authors found that I.A.A. produced a fairly rapid and irreversible action on the frog's heart. The power of glycolysis was abolished by exposure of the heart to I.A.A. 1 in 30,000 for 20 minutes. If the drug was left in contact with the heart it produced further toxic effects which caused arrest in systole after about 40 to 60 minutes. If, however, the drug was washed out after 20 minutes the heart would survive for many hours and maintain a normal mechanical activity provided oxygen was supplied. The survival power of the heart was increased if sodium lactate 0.1 per cent. was added to the perfusion fluid.

The action of I.A.A. was completely irreversible and the hearts never showed any signs of regaining the power of glycolysis. Hearts thus poisoned with I.A.A. were found to be exceptionally convenient experimental material.

The rate at which asphyxial depression develops in the normal heart has been shown to depend both upon the available store of carbohydrate and upon the total buffer power of the perfusion fluid, *i.e.* the concentration of buffer substances and the volume of the fluid.

These factors do not affect the I.A.A. poisoned heart and, as is shown in Fig. 28, asphyxial arrest occurs in about 2 minutes when nitrogen is passed irrespective of the amount of buffer substances present. The rate of asphyxiation is, however, dependent on the rate of metabolism of the ventricle, and consequently is influenced by all the factors mentioned in Chapter III, *i.e.* amount of filling, frequency, temperature, etc.

If these factors are standardised, then it is possible to measure the effect of any single variable on the rate of asphyxial depression of the I.A.A. poisoned ventricle.

Standard conditions which approximate to normal activity are 5 cm. diastolic pressure, a frequency of

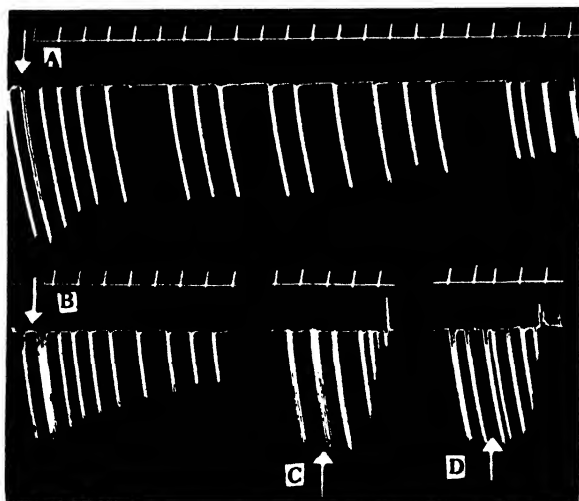

FIG. 28.—Time in mins. Arrows mark beginning of asphyxia (0.4 min. after commencement of nitrogen). Frequency 12 per min. The records show the response under isochoric conditions, which were introduced for short periods at irregular intervals. Downstroke = systole. A. Normal ventricle filled 0.3 c.c. of equal parts plasma and Ringer's fluid. B. Normal ventricle filled 0.3 c.c. unbuffered Ringer's fluid. C. Ventricle after poisoning with I.A.A., 1 part in 20,000. Filling as in B. D. Ventricle poisoned I.A.A. filled with 2 c.c. equal parts plasma and Ringer's fluid (Clark, 1935 *a*.)

15 per minute, and a temperature of 14°C . The most convenient measurement is the time in minutes until half depression is produced (T_a) and the reciprocal of this figure ($100/T_a$) provides a measure of the rate at which asphyxial depression occurs.

When the ventricle is asphyxiated repeatedly, the value T_a falls, and declines asymptotically to about half its original value. Average figures obtained for

successive asphyxiations are 2.0, 1.3, 1.2, 1.1—1.0 minute. If the first one or two results are ignored, then subsequent results are sufficiently uniform for comparative purposes. These effects are shown in Fig. 29, which also shows that aeration for 20 minutes does not restore the rate of asphyxiation to its original value.

This increase in the rate of asphyxial arrest in the I.A.A. poisoned heart is very similar to that seen with the normal heart. The time scales in the two cases are, however, comparatively different. For example, if asphyxia in a normal heart in contact with 2 c.c. Ringer's fluid produces half depression in 30 minutes, it will produce the same effect in the same heart after repeated asphyxia in about 18 minutes. The corresponding times for the same effects in the fresh and exhausted I.A.A. poisoned heart are 2 minutes and 1 minute.

The authors are unable to suggest any explanation for this difference between the rates of asphyxiation of the fresh and partly exhausted heart which would apply both to the normal heart and to the I.A.A. poisoned heart. In particular the suggestion that the change in the normal heart is due to depletion of buffers cannot be true in the case of the I.A.A. poisoned heart.

It is of interest to consider the possible sources of energy which maintain activity of the I.A.A. poisoned heart during the period of 1 to 2 minutes, which intervene between asphyxiation and arrest.

The removal of oxygen from the perfusion fluid and from the water in the ventricle is obviously not an instantaneous process, and the following results were obtained when the concentration of oxygen perfused before asphyxiation was varied (Clark, 1935 *a*):—

Oxygen pressure (mm. Hg) in gas perfused before asphyxiation	760	150	30
Time in minutes until half depres- sion by asphyxia	3.0	1.3	1.0

These results indicate that 2.0 minutes is occupied in removing oxygen from the solution, when this is saturated with oxygen and 0.3 minute when this is saturated with air, and the time of 1.0 minute may be taken as an average value for the period before the

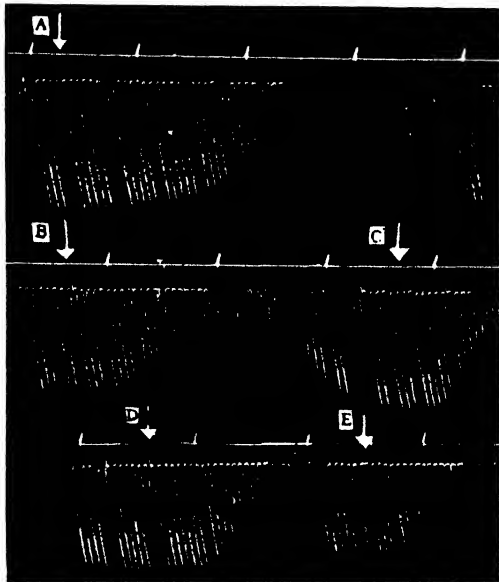

FIG. 29.—Time and arrows as in Fig. 28. Ventricle poisoned I.A.A. A. First asphyxiation of fresh ventricle. Ta 1.7 min. B. Second asphyxiation after 20 min. aeration. Ta 0.9 min. C. Third asphyxiation after 1 min. aeration. Ta 0.6 min. D. Sixth asphyxiation after 20 min. aeration. Ta 0.75 min. E. Seventh asphyxiation after 0.5 min. aeration. Ta 0.45 min. (Clark, 1935 *a.*)

mechanical response of the ventricle falls to half the normal value. Fig. 29 shows that complete arrest occurs soon after half depression, and therefore it may be assumed that the total activity of the ventricle subsequent to oxygen deprivation is equivalent to about 1 minute of full activity.

This is probably an overestimate, because Dale (1936) found that a strip of auricle poisoned with I.A.A.

and suspended in Ringer's fluid was half paralysed by cyanide in about one-half minute. This system was free from errors due to delay in fluid mixing and in oxygen wash-out, and therefore is probably nearer the truth than the experiment with the ventricle.

The oxygen usage of an isolated ventricle, working under the conditions described, is about 10 c.mm./g./minute, and this is equivalent to about 0.05 cal. Since no recovery process occurs in the asphyxiated I.A.A. poisoned ventricle, its energy production is probably half the above figure, or 0.025 cal./g./minute.

The duration of activity after all oxygen supply has ceased is probably somewhat less than a minute, and hence we may take 0.02 cal./g. as a probable figure for the total energy released by an I.A.A. poisoned ventricle after its oxygen supply has been cut off.

It has been shown (Clark, Eggleton and Eggleton, 1932, and Clark and Eggleton, 1936) that in asphyxia of the I.A.A. poisoned ventricle the phosphagen-P is reduced in 5 minutes from 5 to 2 mg. per 100 g., which is a loss of 30 γ per g.

The hydrolysis of 1 g. mol. phosphagen (31 g. phosphagen-P) liberates 12,000 calories and hence the hydrolysis of 30 γ phosphagen-P would supply about 0.01 cal. The observed phosphagen loss would therefore account for about half the anaerobic energy release.

A further possible source of energy after oxygen deprivation is the reduction of cytochrome. Keilin (1925, 1930) estimated that the frog's heart contained 0.5 per cent. cytochrome, and Fenn (1934) found that the iron content of the frog's heart was 2.3 mg./100 g. These two figures are in accordance, and this content of cytochrome is equivalent to an oxygen content of 9.3 c.mm./g. This quantity is sufficient to supply the normal oxygen requirements of the

ventricle for one minute, but there is no evidence as to how completely the cytochrome is reduced during rapid asphyxia.

There is therefore no difficulty in finding sources of energy adequate to maintain the heart's activity during the period before asphyxial arrest. In view of the fact that experimental errors would in general tend to delay asphyxia, the rapidity with which asphyxial arrest is produced is surprising.

It seems probable that asphyxia deranges the metabolism of the cardiac muscle so that it is unable to utilise fully the sources of energy that are theoretically available. This would explain results obtained by Clark and Eggleton (1936) who found that when asphyxial arrest was produced in the I.A.A. poisoned heart with low oxygen pressures there was very little decrease in the phosphagen content. Apparently certain oxygen pressures are adequate to maintain the phosphagen, but yet are inadequate to maintain some other process that is essential for contraction.

The process of recovery from asphyxia in the I.A.A. poisoned ventricle is extremely rapid. Full recovery of the mechanical response occurs in about 30 seconds. The recovery of the substances which support anaerobic activity is somewhat slower as is shown by Fig. 29. These results suggest that half recovery occurs in about one-half minute and two-thirds recovery in a minute. Clark, Eggleton and Eggleton (1932) showed that when an I.A.A. poisoned ventricle was arrested by asphyxia and then restored with oxygen, the phosphagen content returned to normal after a few minutes.

(3) **Action of Cyanides.**—The introduction of cyanides is a well-recognised method of inhibiting oxygen uptake and this method has been used by many authors in the

study of asphyxia. Some of the effects produced by cyanide cannot, however, be explained as a simple consequence of oxygen deprivation. De (1928) found, for example, that 0.001 molar NaCN reduced the response of the frog's ventricle to half normal in about 5 minutes. In this case the ventricle was not poisoned with I.A.A. and was irrigated with a jet of Ringer's fluid. Under such conditions complete lack of oxygen would have taken at least an hour to produce the effect observed. Cyanide must therefore interfere with other cardiac mechanisms in addition to those concerned with the uptake of oxygen.

De showed that the time until 0.001 molar NaCN produced 50 per cent. reduction in the frog's ventricle depended on the frequency. He obtained the following results :—

Frequency per minute	12	30	50
Time in minutes till half arrest	5	2½	1½
Number of contractions	60	75	62

These figures show that an equal effect is produced after an approximately equal number of contractions have occurred. This fact indicates that cyanides act by interfering with the supply of energy rather than by a direct inhibition of the contractile mechanism.

Although cyanides must act on other mechanisms in addition to the oxygen uptake, yet they depress the latter more readily than any other function.

This fact is shown by the results of Weizsäcker (1912) who measured the effect of cyanide on the oxygen consumption and mechanical response of frog's ventricles. His results are shown in Fig. 30, curves A and D.

He used ventricles in contact with 2 to 3 c.c. of blood, and the buffer power of such a system would be adequate to neutralise any lactic acid formed. The curves show

that a concentration of cyanide, sufficient to abolish almost completely the oxygen consumption, reduced the mechanical response by less than 50 per cent.

Weizsäcker also found that the lactic acid production in presence of cyanide was only equivalent, as a source of energy, to a small fraction of the normal oxygen usage, and this result suggests that the cyanide

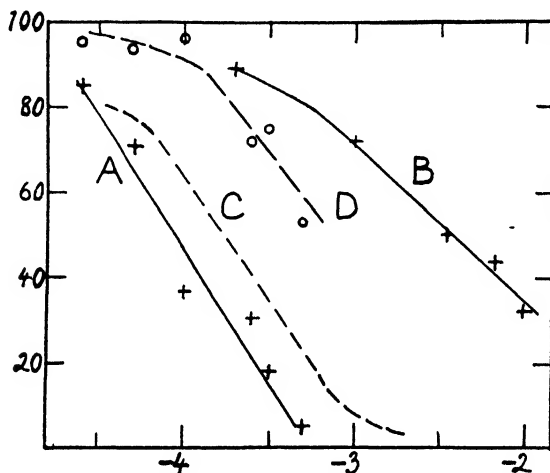

FIG. 30.—Action of cyanide on normal cardiac tissue. Ordinate: per cent. inhibition. Abscissa: log molar concentration NaCN. A. Inhibition of oxygen consumption of frog's ventricle (Weizsäcker, 1912). B. Inhibition of oxygen consumption of turtle's auricle (Garrey and Boykin, 1935). C. Inhibition of mechanical response of strip of frog ventricle (Pickford, 1927). D. Inhibition of mechanical response of frog ventricle (Weizsäcker, 1912).

partly inhibited glycolysis in addition to abolishing the oxygen consumption.

This assumption would explain the results obtained by De, since a partial inhibition of glycolysis combined with complete inhibition of oxygen uptake would rapidly produce depression of the mechanical response of the heart.

Curves D and B in Fig. 30 show a graded relation between cyanide concentration and inhibition of the

mechanical response over a wide range of cyanide concentration, and the concentration \times mechanical inhibition curves run parallel to the concentration \times oxygen usage curves. This result can be accounted for on the assumption that cyanide inhibits the oxidative enzyme system and also inhibits some second enzyme system essential for anaerobic metabolism, and that the former is between 10 and 100 times as sensitive as the latter.

The results of Weizsäcker (1912) and of Garrey and Boykin (1935), shown in Fig. 30, curves A and B, indicate that cyanide completely abolishes oxygen uptake.

Dale (1936) considered the problem as to the occurrence in the frog's heart of a cyanide resistant form of metabolism. This is a question of general interest, because Dixon and Elliott (1929) concluded that one-third of the metabolism of slices of various mammalian tissues, including heart muscle, was not inhibited by cyanide. Kisch (1933), using similar technique, with mammalian tissues, found a residual cyanide resistant respiration which was higher with heart muscle than any other tissue tested.

Dale (1937) found that complete arrest of the I.A.A. poisoned frog's auricle under aerobic conditions was rapidly produced by N/1000 NaCN. Hence the cyanide resistant respiration must have been less than that needed to support contraction. She also found that the relation between frequency and rate of arrest in asphyxia produced by cyanide and that produced by pure nitrogen was different, and the difference indicated that a certain fraction of the resting metabolism was cyanide resistant.

Summary

The effects of oxygen deprivation on the frog's heart can be easily interpreted as the results of interference with metabolic processes.

In the normal heart the first effect of asphyxiation is a rapid reduction by about 20 per cent. in the amplitude of the mechanical response. This suggests that anaerobic glycolysis is a less efficient method for the supply of energy than are the oxidative mechanisms.

If sugar is supplied and an alkaline pH is maintained a heart can maintain anaerobic energy for many hours. It seems reasonable to associate this somewhat remarkable performance with the exceptional ability of the frog to survive for long periods with a very small oxygen supply.

If no sugar is supplied and an alkaline pH is maintained, the lactic acid production and the mechanical response gradually decline and complete mechanical failure occurs after 2 or 3 hours, after about half the total carbohydrates in the heart have been utilised.

If the heart is kept in contact with a limited volume of fluid, arrest occurs as soon as the lactic acid excretion reduces the pH of the fluid to about 6.6. The time of this occurrence depends upon the amount of acid the fluid can neutralise (vol. of fluid \times conc. of buffers), and upon the rate of lactic acid production by the heart.

More detailed analysis shows that the heart itself can neutralise and excrete a certain quantity of lactic acid and also can fix an additional quantity of lactic acid.

The power of anaerobic survival decreases on repeated asphyxiation, and the exhaustion of this buffering mechanism is suggested as a possible cause for this change.

Abolition of glycolysis by poisoning with iodoacetic acid completely alters the response of the heart to asphyxia. The asphyxia produces depression after 1 to 2 minutes irrespective of the amount of fluid or its buffer power.

The asphyxial arrest is reversed rapidly by introduction of oxygen. The rate of asphyxial arrest is due to the exhaustion of non-carbohydrate sources of anaerobic energy. The chief chemical change demonstrated during this arrest is the hydrolysis of about half the phosphagen content of the heart. It is possible that the cytochrome in the heart may furnish a certain amount of oxygen. The time till asphyxial arrest in a heart after repeated asphyxia is about half of that found with a fresh heart. The nature of the non-carbohydrate source of anaerobic energy that is thus depleted irreversibly is unknown, but it does not appear to be phosphagen.

The rate of asphyxial arrest of the I.A.A. poisoned heart can be altered by altering factors which change the metabolic rate such as frequency, diastolic volume, temperature, etc.

Addition of cyanide to the I.A.A. poisoned heart produces the same effects as oxygen deprivation. The results indicate that cyanide abolishes 80 to 90 per cent. of the oxygen uptake, but that a small residual respiration continues.

The effect of cyanide on the normal heart is to abolish oxygen uptake, but in addition it produces a fairly rapid depression of the mechanical response even when the perfusion fluid is alkaline. This effect cannot be due to inhibition of oxygen uptake, but appears to be due to an additional action of cyanide in abolishing glycolysis.

CHAPTER X

RELATIVE EFFECTS OF DEPRESSANT AGENTS ON MECHANICAL RESPONSE AND METABOLISM OF FROG'S HEART

Types of Depressant Action—Depressants and Restoring Metabolisms
—Action of Various Drugs on Metabolism—Summary.

Types of Depressant Action

DEPRESSION of the mechanical response of the frog's heart is produced by a number of changes which are of physiological interest, *e.g.* oxygen deprivation or cyanide, acidity, increase in potassium ions, decrease in calcium ions, narcotics, etc.

A comparison of the effects of these changes on metabolism and on the mechanical response shows that the depressant actions can be divided into three classes :—

- (a) Inhibition of metabolism.
- (b) Inhibition of the contractile process.
- (c) Inhibition of the recovery process.

(a) **Inhibition of Metabolism.** — The nature of asphyxial arrest has already been discussed, and it has been shown that both in the normal and in the I.A.A. poisoned heart the arrest may be attributed to the exclusion or exhaustion of available sources of energy. Moreover, it has been shown that acidity inhibits glycolysis in the anaerobic heart and thereby accelerates asphyxial arrest.

These, therefore, are types of depression that are due chiefly to interference with the supply of energy.

The hypothesis that the dominant factor in causing asphyxial depression is the exhaustion of available energy stores is supported by the fact that the rate of reduction in the mechanical response is dependent on the frequency of contraction, in the case both of the normal and of the I.A.A. poisoned tissues (De, 1928; Clark, 1935 *a*; Dale, 1937). Furthermore, the rate of depression depends on the temperature and shows a Q_{10} of about 3 (Clark, 1935 *b*).

The rate of action of these drugs therefore depends on two factors, namely, the sources of energy available and the rate of utilisation of energy. Consequently the rate of action varies over a very wide range, from hours in the case of asphyxia of a normal ventricle perfused with a large volume of Ringer's fluid to about a minute in the case of an I.A.A. poisoned ventricle.

It is, however, important to note that in the case of an I.A.A. poisoned ventricle at room temperature and contracting at a moderate rate (*e.g.* 15 per minute), asphyxia requires more than 30 seconds to produce half depression, a time of action which is considerably longer than the time taken to produce a similar action by many of the depressants of the class that will be considered next.

(*b*) **Direct Inhibition of the Mechanical Response.**—Many authors have noted the speed with which such agents as acetylcholine, or narcotics, produce depression of the mechanical response of the frog's heart.

Clark (1926 *a*) noted that strong concentrations of acetylcholine produced half depression of the frog's ventricle in less than a second, and showed later (1927) that if a jet of solution were played upon an isolated ventricle strip a solution of 10^{-6} molar acetylcholine produced half action in 2 seconds.

Pickford (1927) found that concentrations of ethyl

alcohol of about 0.5 molar produced half action in 1.5 seconds. On the other hand, butyl chloral hydrate took 2 minutes to produce half action (Pickford, 1927), and the urethanes and the alcohols higher than octyl also acted relatively slowly (Clark, 1930). Rapid action, therefore, is not a universal characteristic of narcotics, but the delay in the action of the narcotics with larger molecules may be due to physico-chemical causes such as delay in adsorption.

De (1928), using the method described above, found that calcium lack could produce half depression of the mechanical response in about 3 seconds. He also showed that the rate of reduction in the mechanical response produced by calcium lack was not affected by the frequency, since it occurred at the same rate with frequencies of 50 and of 8 per minute.

It has already been shown that deprivation of oxygen in a normal heart in contact with a large volume of fluid takes more than an hour to produce half depression. Moreover, even when glycolysis is inhibited by I.A.A. poisoning, oxygen deprivation or cyanide poisoning takes more than 30 seconds to produce half depression of the mechanical response; moreover, the rate of depression is dependent on the rate of metabolism and consequently on the frequency. Since the depressant changes described above act so much more rapidly than do changes which deprive the heart of sources of energy, therefore the depressant action in these cases must be attributed to some direct paralysis of the contractile mechanism and not to interference with the supply of energy. This view is supported by the fact that arrest in these cases is not accompanied by any reduction in the phosphagen content (Clark, Eggleton and Eggleton, 1932).

Keilin (1925) showed that narcotics inhibited the

reduction of cytochrome, but this action will not account for the depressant action of ethyl alcohol on the heart, because this drug acts much more rapidly than does complete deprivation of oxygen; moreover, narcotics act equally rapidly on the normal and on the I.A.A. poisoned tissue, and there is no reason why inhibition of cytochrome reduction should interfere with anaerobic glycolysis in the former case.

It is, of course, possible that these agents act by inhibiting all mechanisms supplying energy to the heart. This is, however, very improbable, because as will be shown later, calcium lack does not abolish the resting metabolism of the heart, and it is improbable that a change should completely inhibit the supply of energy for the mechanical response and leave the resting metabolism unaffected. It is much more probable that the depressant changes inhibit the mechanical response directly and in consequence the metabolism falls to the resting level.

(c) **Inhibition of the Recovery Processes.**—In the discussion on the factors influencing asphyxial depression it was shown that glycolysis was inhibited when the pH fell to about 6.6. Acidity will therefore cause rapid depression of the mechanical response of the asphyxiated heart. Acidity, however, also produces depression of the mechanical response of the heart under aerobic conditions and this effect cannot be due to inhibition of glycolysis because the heart continues to function normally under aerobic conditions after glycolysis has been arrested by I.A.A.

Smith (1926) showed that there was a great difference between the rate of action of excess of carbon dioxide and that of other acids both organic and inorganic.

De (1928) showed that when the pH of phosphate Ringer's fluid was reduced to 6.0 by HCl, the fluid

ultimately arrested the frog's heart but took 5 minutes or more to produce half depression. The effect of acid was therefore about 100 times slower than that of calcium lack. Dale (1936) found that although perfusion of carbon dioxide (15 per cent. in air) through Ringer's fluid produced a more rapid effect on the frog's heart than did inorganic acids, yet it took 1 or 2 minutes to produce half its depressant effect on the frog's ventricle.

The rate of action of acids is therefore of different order from that of the depressants considered in the previous section.

De (1928) found that potassium excess (0.09 per cent. KCl) produced half depression in 10 seconds or more, which was quicker than the action of acids but slower than the actions of the other depressants he tested.

In the case both of acidity and of potassium excess De found that the rate and intensity of action were increased when the frequency was increased. The contrast between these drugs and calcium lack was very marked. With calcium lack a 50 per cent. depression was produced in 3 seconds both when the frequency was 8 per minute and when it was 50 per minute, whereas with acidity (pH 6.0) a 50 per cent. depression was produced in 15 minutes at a frequency of 10 per minute and in 3 minutes at a frequency of 50 per minute.

In the case of potassium excess (0.09 per cent.) the intensity of action was markedly affected by the frequency, since in 30 seconds a 10 per cent. depression was produced at a frequency of 8 per minute and a 70 per cent. depression at a frequency of 50 per minute. In the case of both acidity and of potassium excess, stopping the stimulus for a short time resulted in a partial recovery of the mechanical response.

This influence of frequency on the rate of action of excess of potassium and of excess of acid suggests that these agents delay the recovery process. This hypothesis is in accordance with the results of Ringer and Salisbury (1883), Bazett (1908), Boehm (1914) and Dennig (1920), who showed that potassium excess increased the absolute refractory period of the frog's heart.

Daly and Clark (1921) and Dale (1935) found that small increases in hydrogen-ion concentration increased the durations of the electrical response; whilst Carter and Dieuaide (1926) found that this change increased the duration of the absolute refractory period.

The marked influence of frequency on the depressant action of acidity and of potassium excess can be accounted for on the assumption that the relative refractory period is prolonged as well as the absolute refractory period and hence recovery is not complete except when the frequency is very low.

Depressants and the Resting Metabolism

The evidence regarding the extent of the resting metabolism of the frog's heart was discussed in Chapter III and is summarised in Tables 19 and 20.

As a first approximation it may be said that the metabolism of the empty arrested heart is about 20 per cent. of the metabolism of the heart during moderate activity. It is doubtful whether filling of the heart increases the resting metabolism, but stimulation of the empty heart probably doubles this metabolism.

The resting metabolism of the frog's heart is considerably greater than that of the frog's skeletal muscle.

Meyerhof (1930) stated that the latter at 15° C. was from 12 to 40 c.mm. O₂/g./hour and that the winter value was half of the summer value. Fenn (1927-28 and 1930) found a somewhat higher average value, namely, 60 c.mm./g./hour, but even this figure is only one-quarter of the resting metabolism of cardiac muscle.

Estimates of the resting metabolism of the dog's heart-lung preparation have been made by extrapolation of figures for metabolism at different frequencies. Evans (1917) obtained figures of 1.7 and 1.8 c.c. per g. per hour, and Cohn and Steele (1935) figures of 1.6 and 2.23 c.c. per g. per hour. These results indicate a resting metabolism of between one-third and one-half of the metabolism at moderate activity.

There is no evidence for any qualitative difference between the resting metabolism and the metabolism added by contraction since the respiratory quotient is the same in the two cases (Clark, Gaddie and Stewart, 1931 *a*). Moreover, the sources of energy which maintain the anaerobic activity of the heart are depleted during arrest (Clark, 1935 *b*) and the proportion between the rates of depletion during arrest and during activity is similar to the proportion between the rates of oxygen consumption in these two conditions.

The resting metabolism of the heart has a temperature coefficient ($Q/10$) between 2 and 3 (Weizsäcker, 1912 ; Clark, 1935 *b*).

Weizsäcker also found that the temperature coefficient of the metabolism added by activity when the frequency was kept constant was about 1.6. Clark found that the oxygen usage per beat in excess of the basal metabolism remained nearly constant at varying temperatures above 10° C., but was reduced by lowering the temperatures below this figure.

These results suggest that the ratio between resting

metabolism and metabolism during activity rises slightly when the temperature is raised, provided that the frequency is kept constant. The spontaneous frequency is, however, a function of the temperature with a $Q/10$ of about 3. Hence the ratio between resting metabolism and metabolism at natural frequency would fall rather than rise with increasing temperature.

The effects of temperature change do not provide evidence for any qualitative distinction between resting metabolism and metabolism due to the contraction process.

This high resting metabolism of cardiac tissue is of importance in relation to the mode of action of cardiac depressants.

For example Rohde and Ogawa (1912) found that light narcosis with chloral hydrate depressed the mechanical activity of the isolated cat's heart but produced little effect on the oxygen consumption.

A differential effect of this character would be of considerable theoretical interest, but it is necessary to consider the probable influence of the high resting metabolism.

The difficulties are shown most simply by a consideration of Fig. 31, which shows the action of ethyl urethane on the oxygen uptake and the mechanical response of the frog's heart. The figure shows that complete arrest occurs when the metabolism is reduced by about 80 per cent. of the normal, hence at all concentrations of drug the percentage inhibition of the mechanical response is greater than the percentage inhibition of the metabolism.

A calculation of this type shows that the efficiency of the heart decreases steadily as the drug concentration increases. Inspection of the whole curve shows, however, that there is a linear relation between drug

concentration and metabolism until the latter is reduced to between 20 and 30 per cent. of the normal, and that there is a residual metabolism which is highly resistant to the action of the drug.

Fig. 32 shows that there is a simple linear relation between the reduction in mechanical response and the reduction in metabolism.

The simplest explanation of this effect is to suppose

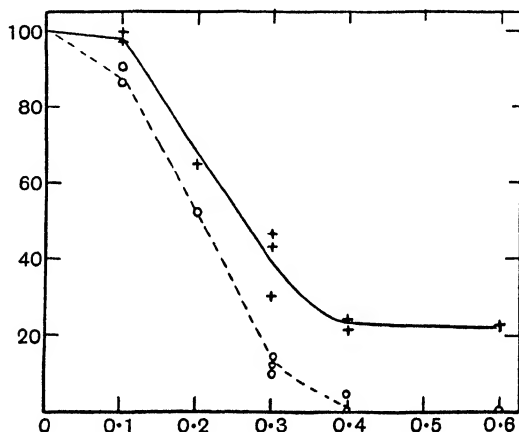

FIG. 31.—Action of ethyl urethane on oxygen consumption (continuous line) and on mechanical response of frog's ventricle. Ordinate : per cent. normal. Abscissa : molar conc. ethyl urethane (Clark and White, 1928 *b*).

that the narcotic depresses the contractile mechanism but has little direct action on the metabolic processes.

A consideration of the relative rates of action of oxygen lack and of narcotics showed that the latter acted much more rapidly than the former and therefore the depression of mechanical response they produced could not be attributed to inhibition of oxygen uptake.

According to this hypothesis the narcotic inhibits some primary chemical or physical change associated with contraction, and hence reduces the secondary restorative chemical changes associated with oxygen usage.

The facts observed are in accordance with this hypothesis, since there is a constant proportion between the amount of depression of the mechanical response and the amount of depression of the oxygen consumption added by the contractile process, *i.e.* total metabolism minus resting metabolism. Moreover, when mechanical arrest occurs, the residual metabolism is

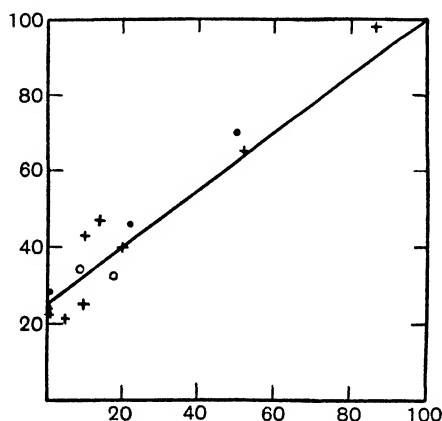

FIG. 32.—Relative effects of narcotics on mechanical response (abscissa = per cent. normal), and on oxygen consumption (ordinate = per cent. normal) of frog's heart. Crosses = ethyl urethane; dots = ethyl alcohol circles = butyl chloral hydrate (Clark and White, 1928 *b*).

approximately equal to the resting metabolism of the unpoisoned tissue.

Clark and White (1928 *b* and 1930 *b*) concluded that their results with depressants proved that the resting metabolism differed from the contractile metabolism in being more resistant to drugs, but the hypothesis outlined above explains the facts without necessitating the assumption of two forms of metabolism in the heart.

Experiments on the rate of action of drugs showed that calcium lack, potassium excess, narcotics and acetylcholine all produced a far more rapid action on the heart than did oxygen deprivation.

The experiments of Clark and White on the frog's ventricle (1928 δ) and on the frog's auricle (1930 δ) showed that calcium lack, potassium excess, narcotics and acidity were similar as regards the effects they produced on the mechanical response and on the metabolism.

The effects of calcium lack and of potassium excess are shown in Figs. 33 and 34.

Clark (1935 δ) determined the influence on the rate of asphyxial arrest of some of these depressants in concentrations sufficient to abolish the mechanical response.

The results quoted are summarised in Table 44. Experiments of this type can only be approximately accurate, but the results show that various depressants

TABLE 44

Metabolism (as per cent. of Normal) in presence of Depressants just sufficient to abolish the Mechanical Response.

Depressant.	(a) Estimated by Oxygen Usage.		(b) Estimated by Rate of Asphyxial Arrest of Ventricle.	
	Auricle.	Ventricle.	Normal.	I.A.A. poisoned.
Calcium lack	< 40 ³	30, ³ 32 ⁴	40 ⁵	40 ⁵
Potassium excess	30 ³	30-40 ³
Acidity	40 ¹
Ethyl urethane	20 ³	30 ³
Ethyl alcohol	30, ³ 36 ⁴
Acetylcholine	12	12

¹ Clark and White (1928 a).

² *Idem* (1928 b).

³ *Idem* (1930 b).

⁴ Clark, Gaddie and Stewart (1932).

⁵ Clark (1935 b).

in concentrations just sufficient to abolish visible contractions reduce the metabolism to between 30 and 40 per cent. of the normal. This figure is higher than the metabolic rate of the arrested heart muscle, but is

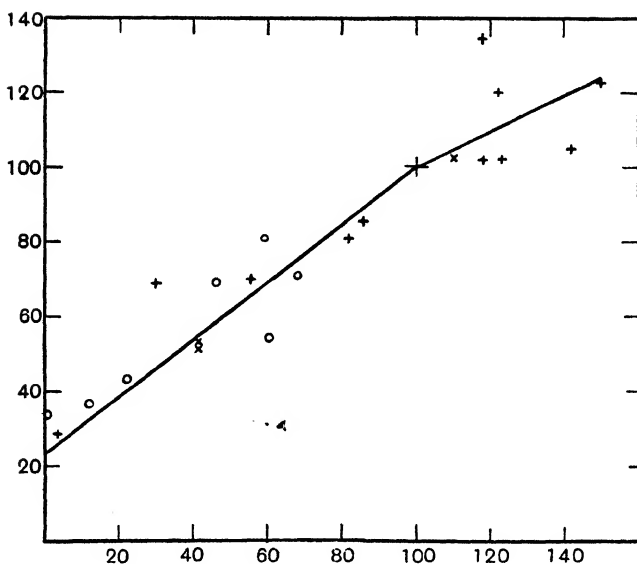

FIG. 33.—Relative effect of variation of calcium content on mechanical response (abscissa) and on oxygen consumption (ordinate) of heart (circles) and of ventricle of frog (crosses). All figures reduced to per cent. of activity with 2 m.mol. Ca (Clark and White, 1928 *b*).

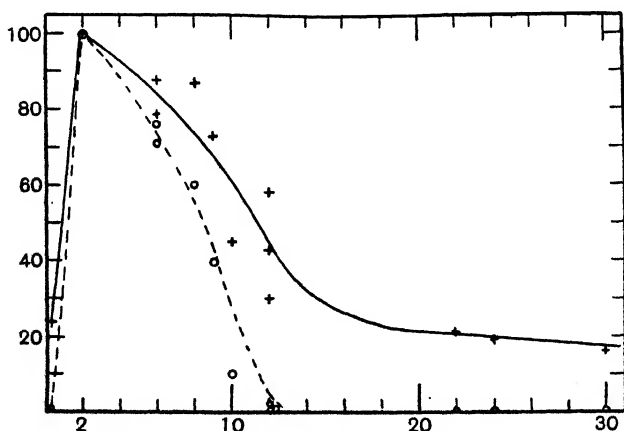

FIG. 34.—Effect of alternations in potassium content on oxygen consumption (continuous line) and on mechanical response (dotted line) of frog's heart or ventricle. Ordinate: per cent. normal activity. Abscissa: m.mol. conc. potassium (Clark and White, 1928 *b*).

not greater than that of the empty and contracting muscle.

The action of calcium lack, potassium excess, acidity and narcotics can therefore be interpreted as an inhibition of the contractile process with little direct action upon the oxygen uptake.

This contrasts sharply with the action of cyanides, in which case the oxygen uptake is nearly abolished by concentrations which only produce a 50 per cent. depression in the mechanical response (*cf.* Fig. 30). In this case the evidence indicates an action at low concentrations on the oxygen uptake and a further inhibitory effect on anaerobic metabolism at a higher concentration.

Acetylcholine differs from the other agents shown in Table 44 in that it reduces the metabolism to far below the normal resting level. This conclusion is in accordance with the results of Garrey and Boykins (1933, 1934) who found that vagal stimulation reduced to one-half the resting metabolism of the turtle's auricle. On the other hand, Solandt (1936) found that acetylcholine did not affect the heat production of the unstimulated skeletal muscle of frogs.

The facts described regarding the relative action of depressants on the metabolism and the mechanical response of the frog's heart agree with most of the previous work on cardiac tissue.

Rohde and Ogawa (1912) found that light narcosis with chloral hydrate depressed the mechanical activity of the isolated cat's heart, but produced little effect on the oxygen consumption, and Fischer (1917) obtained a similar result with ethyl alcohol on the cat's heart.

Weizsäcker (1917) found in the case of the frog's heart that the concentrations of ethyl and amyl alcohol and of ethyl and propyl urethane required to abolish

the oxygen consumption were twice as great as those which sufficed to arrest the heart.

Bohnenkamp (1927) found that alcohol and chloral hydrate depressed the mechanical activity more than the oxygen consumption of the frog's heart, but that ethyl urethane reduced the two factors equally. Fukuda and Naito (1927) found that chloral hydrate diminished the oxygen consumption of the frog's heart more than its mechanical activity. These last results differ from those of other workers.

Similar results, showing greater depression of mechanical activity than of metabolism, have been obtained with other tissues (Loeb and Wastenys (1913): chloroform on fundulus embryos; Gray (1921): chloral hydrate on the cilia of *Mytilus*).

In the case of skeletal muscle, the results are conflicting. Meyerhof (1923*a*) found that narcotics reduced the contractile tension of the frog's sartorius far more than they reduced the oxygen consumption. Weizsäcker (1914) found that ethyl alcohol reduced the tension more than it reduced the initial heat production, but Gasser and Hartree (1924) found that alcohol produced an equal reduction in these two factors.

The action of calcium lack and of potassium excess has been investigated by a few authors.

Locke and Rosenheim (1907) noted that the isolated rabbit's heart arrested by calcium lack continued to produce carbon dioxide. Rohde (1912) found that when the cat's isolated heart was arrested by calcium lack or by potassium excess, the oxygen consumption was approximately halved.

McDonald and McDonald (1935) investigated the actions of ionic changes on the oxygen consumption of the turtle's auricle. They found that potassium

lack produced a 50 per cent. increase in the oxygen usage above the normal, and that lack of both potassium and calcium also produced an increase of 36 per cent., whereas calcium lack alone decreased the oxygen consumption, but only by 20 per cent.

The turtle's heart is a much thicker tissue than the frog's heart, and hence ionic depletion is produced more slowly in the former case. Clark and White (1928 *δ*) found in the frog's heart that potassium lack decreased the oxygen consumption, and the reason for this qualitative difference in the results obtained on the two tissues is not clear. In the case of calcium lack the results on the turtle's heart are qualitatively similar to those obtained with the frog's heart.

The results with potassium excess (Fig. 34) are of interest, because they show that the resting metabolism of the frog's heart is strikingly different from that of the frog's skeletal muscle. In the latter case, excess of potassium causes a great increase in both the oxygen consumption (Hegnauer, Fenn and Cobb, 1934) and in the heat production (Solandt, 1936).

This difference in the effect of potassium excess on the resting metabolism of cardiac and of skeletal muscle respectively suggests that the resting metabolism of these two types of muscle are different in character.

Action of Various Drugs on Metabolism of Frog's Heart

David (1930) found that pilocarpine (1 in 10^8) caused a 50 per cent. decrease in the oxygen consumption of the isolated auricle of the frog. This direct measurement agrees with the conclusion that acetylcholine greatly depresses the metabolism and that vagal stimulation produces a similar effect.

David (1930) found that adrenaline (1 in 100,000)

increased the oxygen consumption of the isolated frog's auricle by about 20 per cent. It also increased the amplitude of contraction by 10 to 20 per cent. and the frequency by 5 per cent. In the case of the mammalian heart perfused with saline, Rohde and Ogawa (1912) found that adrenaline did not increase the oxygen consumption, but in the heart-lung preparation Evans and Ogawa (1914) found that adrenaline usually increased the oxygen usage, and this was confirmed later by Evans (1917) and by Gremels (1933). Bogue, Evans, Grande and Hsu (1935) showed that addition of adrenaline greatly increased the carbohydrate usage of the isolated dog's heart. There was an increase in the utilisation of blood sugar and glycogen removal was accelerated.

Rohde and Ogawa (1912) found that strophanthin caused a slight increase in the oxygen consumption of the cat's isolated heart, whilst Gottschalk (1913) found that strophanthin caused a decrease in the oxygen consumption of the frog's isolated ventricle when administered in concentrations from 1 to 8 parts per million.

Eismayer and Quincke (1930 *b*) found that low concentrations of strophanthin (1 in 10^7) increased the oxygen consumption of the frog's ventricle by 20 per cent., whilst high concentrations (1 in 10^5) decreased it by 30 per cent. David (1930) found that strophanthin at a medium concentration (1 in 10^6) caused in the frog's isolated auricle an initial 20 per cent. increase in the oxygen consumption, which was followed after about an hour by a decrease. Higher concentrations caused a decrease from the commencement.

These few observations on the effect of drugs on the cardiac metabolism indicate that they produce similar changes in the mechanical response and in the metabolism.

Summary

The analysis of the action of depressants shows that some of these produce their effect by depriving the heart of available sources of energy.

Cyanides abolish oxygen uptake and make the heart dependent on glycolysis, and at higher concentrations apparently inhibit glycolysis. Iodo-acetic acid abolishes glycolysis and makes the heart dependent on non-carbohydrate aerobic metabolism. Moderate acidity (pH 6.5) abolishes glycolysis, but higher acidity appears to have an additional direct action on the contractile mechanism.

The effects produced by these agents can be explained as due to interference with metabolism, and they are characterised by the fact that the rate of inhibition of the mechanical response can be altered by varying the frequency and thus varying the metabolic rate.

The action of various other depressants cannot be due to interference with metabolic processes, such as oxygen uptake or glycolysis, for the following reasons.

In the first place, the action of such agents as calcium lack, narcotics, acetylcholine or potassium excess, is much more rapid than any effect produced by deprivation of sources of energy. For example, the I.A.A. poisoned heart is entirely dependent on oxidative processes for its energy supply, but half depression of such a tissue by asphyxia takes at least 30 seconds.

Furthermore, in the case of calcium lack, the rate of action is not affected by the frequency.

Calcium lack must therefore either depress the contractile mechanism or else inhibit some unknown process which is responsible for the immediate supply of the energy needed for contraction. The same argument applies to acetylcholine and to narcotics.

In the case of potassium excess and acidity, the rate of action is dependent on the frequency, and there is evidence which indicates that in these cases the drugs interfere with the recovery process.

The relations observed between the depression of the mechanical response and the depression of oxygen uptake are consistent with the hypothesis that the depressants in this second class act primarily on the contractile process and that the reduction in metabolism is a secondary consequence.

CHAPTER XI

RELATIONS BETWEEN THE ELECTRICAL AND MECHANICAL RESPONSES AND THE METABOLISM OF THE FROG'S HEART

1. Relations between Electrical and Mechanical Responses: (*a*) Relation between Extents of Electrical and Mechanical Responses; (*b*) Dissociation of Electrical and Mechanical Responses; (*c*) Do the Electrical and Mechanical Responses Commence Simultaneously? (*d*) Relation between Duration of Electrical Response and the Absolute Refractory Period; (*e*) Relation between the Heights and Durations of the Electrical and Mechanical Responses. 2. Relations between the Electrical Response and Metabolism: (*a*) Height of Electrical Response and Metabolism; (*b*) The Relation between the Form and Duration of the Electrical Response and Metabolism. 3. Relations between Mechanical Response and Metabolism: (*a*) Cardiac Efficiency; (*b*) Action of Depressants on Mechanical Response and Metabolism; (*c*) Fenn Effect.

Relations between the Electrical and the Mechanical Responses and Metabolism

THE frog's heart has been such a favourite subject for experiment that there is a wide range of information available concerning the variations that can be produced in its activities.

The tissue shows certain outstanding advantages and disadvantages. The chief advantages are its prompt response to drugs or to ionic changes, and the fact that its electrical response is slow and prolonged and in consequence easy to measure.

On the other hand, the form of the heart and the irregular distribution of its fibres make it impossible

to arrange truly isometric or isotonic conditions. Furthermore, measurements of the heat production of the frog's heart are attended with so many experimental difficulties that the results are too doubtful to be of much service in the analysis of cardiac function. Finally, the high resting metabolism of cardiac tissue makes difficult the calculation of the relation between energy expended and work performed.

In consequence of these facts, the investigation of the nature of the contraction process in cardiac muscle is forced to follow lines different from those which have proved to be of chief value in the case of skeletal muscle.

The following events in the contractile process can be measured fairly accurately in cardiac tissue :—

- (1) Extent and duration of electrical variation.
- (2) Extent and duration of the mechanical response.
- (3) Extent and nature of the metabolism.

The fundamental nature of the contractile process is unknown, but the hypothesis of Keith Lucas (1912) has been generally accepted, namely, that there is a local excitatory process, which causes a propagated disturbance accompanied by a change in electrical potential, and the latter precedes and releases contraction.

The analysis of the contraction process in skeletal muscle has shown that the contraction is accompanied by heat production and is followed by a slower recovery process. The nature of the primary change that provides energy for contraction is unknown. It cannot be an oxidative process or lactic acid production; moreover, Lundsgaard (1934) has provided evidence which shows that phosphagen breakdown probably occurs after the contractile process in skeletal muscle.

The following provisional hypothesis is therefore

adopted regarding the sequence of events in the contraction of cardiac muscle :—

- (1) Local excitatory process.
- (2) Propagated electrical disturbance.
- (3) Contractile process of unknown nature.
- (4) Recovery processes associated with known metabolic changes, such as phosphagen breakdown, lactic acid formation and oxidative changes.

The chief problems that will be considered in this chapter are the relations between the electrical and mechanical response, the relations between metabolism and the electrical response, and the relations between metabolism and the mechanical response.

1. Relations between Electrical and Mechanical Responses.—This subject has been studied intensively for the last twenty-five years and the literature has been swollen by a number of controversies which have arisen. General summaries of this literature have been provided by Katz (1928) and by Schütz (1928, 1936), hence reference in this chapter will only be made to work that appears to be of particular significance. The chief controversial questions that require consideration are as follows :—

- (a) Is the extent of the change in electrical potential proportional to the pressure produced by the mechanical response ?
- (b) Can an electrical response occur without the production of any mechanical response ?
- (c) Do the electrical and mechanical responses commence simultaneously ?
- (d) What is the relation between the duration of the electrical response and the absolute refractory period.

- (e) What is the relation between the durations of the electrical response and the mechanical response ?

(a) *Relation between the Extent of the Electrical and Mechanical Responses.*—The only accurate method for the comparison of these two responses is to compare the height of the monophasic electrical response with the pressure produced under approximately isometric conditions. In the case of the electrical response, it is moreover essential, when a string galvanometer is used, that the excursion of the string should be calibrated against known changes in potential.

In actual fact a large proportion of the experimental work reported in the literature does not comply with these elementary requirements, and this has been the cause of much of the controversy that has arisen.

Einthoven (1924-25) pointed out that the energy needed to produce a mechanical response was of a totally different order from the energy needed to produce an electrical response. He described the relation as follows :—

“ If the weight of a frog’s heart is put at 100 mg., we may say that the energy required to produce a visible deviation of the string corresponds to that of the lifting of one ten-thousandth part of the heart to a height of one millionth of a micron.”

This enormous quantitative difference suggests that any exact correlation between the height of the electrical response and the amplitude of the mechanical response is unlikely, and, if such correlations do occur, their significance is doubtful.

Mines (1913) investigated the action of calcium lack on the frog’s heart and found that the electrical response was unaltered when all visible mechanical response had been abolished. He also showed (1913 c)

that muscarine produced a typical shortening of the electrical response and that this effect was produced in a heart that had been immobilised by calcium lack.

This result shows very clearly the dissociation of effects produced on the electrical response from effects produced on the mechanical response.

The methods used by Mines were subject to various technical errors, and a number of authors have contested his conclusion and have stated that the changes produced by calcium lack in the mechanical and in the electrical responses are similar in extent. This view has been supported by Einthoven and Hugenholz (1921), Arbeiter (1921), Einthoven (1924-25) and de Jongh (1926).

On the other hand, Klewitz (1917) and Daly and Clark (1921) confirmed Mines' findings on the frog's heart. The latter authors used an imperfect technique, but considered that the differences in the changes produced by calcium lack on the mechanical and on the electrical responses were too gross and obvious to need detailed proof of their existence.

Fulton (1926) summarised the controversy as follows: "The size of the electrical response varies with the initial length of the muscle fibre in much the same way as heat liberation varies; also the duration of any given mechanical response varies with the size of the electrical response. This again suggests that the mechanism of the reproduction of the electrical response and the mechanism controlling initial heat production are one and the same."

This author was concerned primarily with the contractile response of skeletal muscle, but the conclusions stated above outline a general theory of the nature of the contraction process, and therefore it is necessary to consider carefully whether they are true in respect of cardiac muscle.

Willigen (1926) investigated the effect of calcium lack on the frog's heart. He used a delicate recorder and standardised the deflections of the galvanometer. He found that extensive depression of the mechanical response could occur without any change in the electrical response.

Bogue and Mendez (1930) used approximately isometric conditions for recording the mechanical response and obtained both diphasic and monophasic electrical responses. The string tension of the galvanometer was carefully standardised in these experiments. They found that when the mechanical response was nearly completely abolished by calcium lack, the electrical response was the same as the normal, both as regards its extent and its duration.

Baetjer and McDonald (1932), using the terrapin sinus and a method which magnified the mechanical response 1400 times, found that an electrical response could be detected when all traces of a mechanical response had been abolished by calcium lack. Bay, McLean and Hastings (1933) obtained a similar result with the rabbit's isolated heart. Hogben (1925), working with invertebrate hearts, found that in these the mechanical response could be nearly abolished by calcium lack without the electrical response being changed from normal.

These results provide formal evidence for the obvious experimental fact that the mechanical response of the frog's heart can be nearly completely abolished by calcium lack without any certain change being produced in the electrical response.

Bogue and Mendez (1930) investigated a number of conditions which reduced the mechanical response and obtained the following results.

	Alteration produced in Electrical Response as regards Height of Initial Deflection.
Calcium lack	None
Acetylcholine (10^{-6} molar)	None
Excess of potassium	Abnormal
Octyl alcohol	} Abnormal and smaller
Acid (pH 6.0)	
Emptying of heart	Increase

The following results have been obtained by other workers. Trendelenburg (1912) and Klewitz (1917) concluded that muscarine could abolish the mechanical response without abolishing the electrical response, and Hoffmann (1910) found the same effect in curare poisoning. Kristenson (1928) repeated this work and showed that with both muscarine and curare the mechanical and electrical responses disappeared simultaneously. He stated that his methods were unsuitable for exact measurement of the amplitude of the mechanical response, but he found a fair agreement in the decrease of the two responses. Bertha (1928) measured the action of muscarine and found a parallel fall in the mechanical and electrical responses. She used, however, the heart *in situ* (Mines' method) and this is unsuitable for the quantitative estimation of the extent of the mechanical response.

Various workers have studied the effects of increased diastolic tension and of resistance on the electrical response of the heart. Daly (1923) showed that increased filling of the isolated tortoise's heart reduced the height of the electrical response, but increased its duration.

Eismayer and Quincke (1930 *b*) found that increasing the initial tension in the frog's heart decreased the height of the electrical response but did not alter its duration. Werz (1935) found that alterations in the

arterial resistance did not affect the height of the monophasic electrical response. Schütz (1936) reviewed the evidence as regards the effect of changes in arterial resistance on the electrocardiogram of the mammalian heart *in situ*, and concluded that there was no parallel between the height of the electrical response and the resistance. Bertha and Schütz (1930) studied the effect of heat paralysis on the mechanical and electrical responses of the frog's heart and showed that the mechanogram could be depressed without any alteration in the height of the electrogram.

The general result of this work is to show that in a variety of conditions there is no obvious correlation between the height of the electrical response and the extent of the mechanical response in the frog's heart.

On the other hand, there is a general agreement that both potassium excess and acidity, when sufficient to depress extensively the mechanical response, also distort the electrical response.

Einthoven and Hugenholtz (1921), Arbeiter (1921) and Daly and Clark (1921) noted the gross distortion of the electrical response produced by potassium excess, and Schütz (1928) noted that this caused first a shortening and then a lengthening of the monophasic electrical response.

Daly and Clark (1921) and Dale (1935) found that acidity at first produced a prolongation of the duration of the electrical response and later produced a short and irregular response.

It is clear, therefore, that certain depressant agents, namely, potassium excess, acidity and narcotics all produce depression of the mechanical response, together with a considerable distortion of the electrical response. The chief feature in the latter change is a decrease in the rate of rise of the R wave. This effect suggests a

decrease in the rate of conduction through the tissue, and these agents have been shown to produce this effect.

Seliskar (1926) showed that potassium excess and ethyl alcohol both reduced the rate of conduction in the tortoise's auricle. Andrus and Carter (1924) showed that small decreases in pH (*e.g.* from 7.4 to 7.1) increased the P-R interval in the terrapin heart, and Drury and Andrus (1924) showed that similar changes decreased the rate of intra-auricular conduction in the dog's heart.

The action of these agents in distorting the electrical response therefore is probably due to their action in interfering with the conduction of the electrical disturbance through the tissue.

The fact that calcium lack does not produce much alteration in the electrical response, whereas potassium excess distorts this in a marked manner, is interesting, because it shows that although these two changes produce the same action on the mechanical response, yet their actions on the tissue must be of a different nature.

(b) *Dissociation of Electrical and Mechanical Responses*.—The question whether an electrical response can occur without causing any mechanical response is difficult to decide. A consideration of the structure of the frog's ventricle shows that it is a most unsuitable tissue for the determination of the presence or absence of very small movements in its trabeculæ. Baetjer and MacDonald (1932), using the sinus and a method which multiplied the mechanical response 1400 times, recorded electrical responses when all detectable movement had ceased, hence the complete separation of these two factors cannot be regarded as finally disproved. The evidence that there is no necessary relation between

the extent of the changes in the mechanical and electrical responses can, on the other hand, be regarded as fairly conclusive.

It therefore is necessary to regard the electrical changes as separate events from the mechanical changes. Presumably the electrical changes depend on the depolarisation of the cell membranes, and the duration of the electrical response depends on the duration of this depolarisation. This change causes mechanical and metabolic changes, but the extent of the electrical change does not indicate the extent of the mechanical or metabolic response.

(c) *Do the Electrical and Mechanical Responses commence Simultaneously?*—Most of the earlier work shows a considerable interval between the commencement of the electrical response and the commencement of the mechanical response. De Jongh (1923) showed that if delicate methods were used for the recording of the mechanical response, the E-M interval was certainly very short, and he concluded that the responses were simultaneous. Bogue and Mendez (1930) concluded that the E-M interval was not more than 2σ . Max (1931) used a torsion wire method that multiplied the mechanical response 100 to 1400 times. He found with the frog's ventricle that the electrical response might appear before, simultaneously with, or after the mechanical response. Using the turtle's sinus, he found that in all cases the electric response appeared before the mechanical response.

Einthoven supported the view that the latent period of muscular contraction was apparent rather than real, and de Jongh (1926) confirmed this in the frog's heart. Tschermak (1930) concluded that the electrical response had a latent period of 10σ .

There appears therefore to be good evidence that

the stimulation produces both an electrical and mechanical response within about 10 to 20 σ .

The more careful workers all agree, however, that measurements of periods of this duration in the case of cardiac tissue have little significance unless extraordinary precautions are taken to eliminate experimental errors. In view of the number of these latter that have been demonstrated, it seems unlikely that these time relations can be defined more accurately.

The evidence therefore shows that the interval between electric stimulation and mechanical response is very short, but it is not possible to decide if the electrical and mechanical responses are simultaneous. This is unfortunate, because such information would provide important evidence regarding the possible nature of the contraction process.

(d) *Relation of Duration of Electrical Response (D.E.R.) and the Absolute Refractory Period (A.R.P.)*.—It is well known that in normal cardiac muscle the durations of the electrical response, the mechanical response and the absolute refractory period (A.R.P.) are approximately equal, and hence the tissue cannot be tetanised.

Samojloff (1910, 1912), Seemann (1913), Trendelenburg (1912), Adrian (1921) and Pohl (1930) all found that strong stimuli could produce a second response before the electrical response had terminated. Drury and Love (1926) showed that this effect could be obtained in a frog's ventricle poisoned by veratrin, but concluded that the effect was due to depression of conduction, so that a stimulus produced a local effect which was only transmitted over a portion of the tissue.

Schütz (1936) has summarised the evidence as follows: Earlier experiments made with induction currents (Schellong and Schütz, 1928; Schütz, 1928;

and Damblé, 1932) showed an absolute refractory period extending nearly till the end of the monophasic electrical response, followed by a relative refractory period which extended considerably beyond the duration of the electrical response. Schütz (1936) concluded that during the excitation process a second stimulus could not produce a further increase in the cell wall permeability, and that such an effect first became possible during the last portion of the fall of the monophasic response. Later experiments made by Schütz and Lueken (1935, 1936) with currents with a vertical rise and of short duration gave different results, for the absolute refractory period was found to coincide with the commencement of the steep fall in the monophasic response. Furthermore, the relative refractory period was found to be very short and its duration coincided with the duration of the fall of the monophasic response.

Schütz and Lueken (1936) also found that the duration of the relative R.P. could be greatly increased by acidity or by excess of potassium. Excess of calcium greatly increased the length of the absolute R.P. but did not prolong the relative R.P. These results therefore showed that the absolute R.P. and the relative R.P. could vary independently as regards their duration.

Recent evidence therefore agrees in showing that the absolute R.P. lasts until the end of the plateau of the monophasic response and that in the normal heart full excitability is regained at the termination of the fall of the monophasic response.

(e) *The Relation between the Heights and Durations of the Electrical (D.E.R.) and the Mechanical Responses (D.M.R.).*—The duration of the electrical response is much shorter than that of the mechanical response in

skeletal and in plain muscle, but in normal cardiac muscle the two are of similar duration.

Accurate measurements of the duration of these responses presents certain difficulties, to which reference has already been made.

If the electrical response is measured with the electrodes close together, the duration obviously measures the duration of depolarisation at one point. Usually the electrodes are separated and then the duration of the electrical response includes the time of passage of excitation from one point to another. In the case of normal auricles or ventricles, the rate of conduction is from 100 to 200 mm. per second and the length of tissue is not more than 10 mm. Hence this error is not more than 0.1 second, which is about one-tenth of the total duration of the electrical response. Such agents as excess of potassium or acidity may, however, reduce the rate of conduction to less than 40 mm. per second (Seliskar, 1926), and in this case the error due to time of conduction is correspondingly greater.

The end of the electrical response indicates the time at which all portions of the tissue between the electrodes have returned to normal, and it is possible that the tissue under one electrode may have recovered in an appreciably shorter time.

Monophasic records give the most accurate measurements, but it is extremely difficult to maintain true monophasic conditions in cardiac tissue.

The monophasic records show a sharp rise, and a plateau terminated by a sharp fall. The simplest method of measurement is from the middle of the rise to the middle of the fall. In the case of diphasic electrical responses, Bogue and Mendez (1930) concluded that the most satisfactory measurement was

from the tip of the initial deflection (R wave) to the tip of the final deflection (T wave).

The measurement of the duration of the mechanical response also presents difficulties. It has been shown that the interval between the commencements of the electrical and mechanical responses is not more than 10σ . The interval shown by ordinary methods of recording is much greater than this, hence it is usually best to estimate the duration of the mechanical response from the same point as the commencement of the electrical response.

The mechanical response terminates by a fall, and the shape of this fall depends largely on the method of recording. Hartree and Hill (1921) described an "angle" which terminated the plateau of the mechanical response of skeletal muscle, and Fulton (1926) claimed that this represented the end of the contractile process. Cooper and Eccles (1930) concluded, however, that the angle was an artefact and an unreliable point of measurement. Bogue and Mendez (1930) showed that it was easy to obtain a marked angle with cardiac muscle, but accurate mechanical records in this case are far more difficult than in the case of skeletal muscle. Hence it seems best to take the point of maximum rate of fall as indicating the termination of the mechanical response.

These considerations are important because they show that it is impossible to measure accurately the exact duration of either the electrical or the mechanical responses.

It is easy to determine whether any gross change in these durations occurs, but it is not possible to determine exactly the moment of their termination, hence arguments which depend on time differences of a few sigma are of little significance.

Many agents produce gross changes in the durations of the electrical and mechanical responses. Certain of these effects are summarised in Table 45. These results show, in the first place, that there is no obvious correlation between changes in the height of contraction

TABLE 45

Change.	Percentage Change from Control.		
	Mechanical Response.		Electrical Response Duration.
	Height.	Duration.	
A			
NaCl reduced to 0.16 per cent. ¹	+50	+90	+50
KCl reduced to 0.004 per cent. ¹	+80	+25	+40
CaCl ₂ increased to 0.048 ¹	+100	+30	+30
Alkalinity pH 9.0 ¹	nil.	+15	-20
B			
KCl increased to 0.064 ¹	-60	?	-10
KCl increased to 0.064 ²	-75	-35	-35
CaCl ₂ reduced to 0.003 ¹	-90	?	+4
CaCl ₂ absent ²	-85	nil	nil
Acidity pH 6.5 ¹	-60	?	+10
Emptying heart ²	-30	+23	+20
Acetylcholine ²	-80	-38	-58
Octyl alcohol ²	-90	-50	-50
C			
Increase of frequency from 10 to 52 ²	-20	-33	-25
Temperature raised 17° C. to 21° C.	+5	-20	-36
Frequency constant ²			

¹ Daly and Clark (1921).² Bogue and Mendez (1930).³ Clark (1920).

and changes in the durations of either the electrical or mechanical responses. For example, the mechanical response can be nearly completely abolished by calcium lack without any change being produced in the duration of the electrical response. Similarly, the amplitude of the mechanical response can be greatly reduced by

emptying the heart without causing any change in the duration of the electrical or mechanical responses.

There is therefore no necessary relation between the amplitude of the mechanical response and the duration of either the electrical or the mechanical responses.

Adrian (1921) and Schütz and Lueken (1935) have shown that during the relative refractory period the height of the monophasic electrical response returns to normal before the amplitude of the mechanical response or the durations of either the electrical or mechanical responses have returned to normal. This fact shows that there is no direct correlation between the H.E.R. and the D.E.R. or D.M.R., since different relations are obtained at different points in the period of recovery.

There is, however, an obvious correlation between the changes induced in the duration of the mechanical response and those induced in the duration of the electrical response.

In every case, except increased alkalinity, these are qualitatively similar.

The relation, however, is not exact; for example, acetylcholine reduces the duration of the electrical response more than the duration of the mechanical response. The same effect can also be obtained with narcotics, and in both these cases it is possible to produce a condition in which the heart can be tetanised because the electrical response and refractory period are of shorter duration than the mechanical response.

Similarly, alkalinity increases the duration of the mechanical response and decreases that of the electrical response, and hence systole is easily produced in this condition. The same effect is produced by strophanthin, where the duration of the electrical response may be

halved at a stage of poisoning at which the duration of the mechanical response is but little altered (Daly and Clark, 1920).

It is therefore clear that the termination of the electrical response does not necessarily involve the termination of the mechanical response, although these two events frequently coincide.

As regards the changes in duration shown in Table 45, it is important to note that in a large number of cases changes in ionic content cause diphasic effects. Dennig (1920) found that excess of calcium prolonged the D.M.R. beyond the A.R.P. and that excess of potassium prolonged the A.R.P. beyond the D.M.R. Schütz (1936) showed that excess of calcium prolonged the A.R.P. and that excitability returned at the end of the plateau of the monophasic response. Previously (1928) he had found that a large excess of calcium shortened the D.E.R. and that excess of potassium first shortened and then prolonged the D.E.R. His more recent work (1936) showed that moderate excess of potassium did not alter the D.E.R.

2. Relations between Electrical Response and Metabolism

—(a) *Height of Electrical Response and Metabolism.*—

As will be shown later, there is a close relation between the action of depressants in reducing metabolism and in reducing the mechanical response. It has been shown that there is little relation between the change in the amplitude of the electrical and mechanical responses, and consequently there cannot be any close relation between changes in metabolism and changes in the electrical response.

Depressants such as calcium lack, potassium excess or narcotics reduce the metabolism to about 30 per cent. of the normal when they nearly completely abolish the mechanical response. It has been shown that such

an effect may or may not produce an alteration in the electrical response.

The results with calcium lack show that a normal electrical response may be obtained in the heart when the metabolism can only be about 30 per cent. of normal.

The general conclusion drawn from the evidence regarding the relation between the electrical response and the mechanical response and the metabolism is that the electrical response is a separate event.

Energy is undoubtedly needed to restore the potential of the cell membrane to normal after excitation, but there seems no obvious connection between the amount of potential set up by the depolarisation of the membrane and the amount of chemical change which the excitation process causes.

(b) *The Relation between the Form and Duration of the Electrical Response and Metabolism.*—Many attempts have been made in the past to correlate the different phases of the electrocardiogram with other events in the cardiac cycle and with metabolic processes such as the production of lactic acid. References to this literature are given by Katz (1928) and by Schütz (1932).

The discovery that iodo-acetic acid abolishes glycolysis has made it possible to determine whether there is a correlation between any phase of the electrocardiogram and the formation of lactic acid.

Various workers described the effect of I.A.A. poisoning on cold-blooded and mammalian hearts *in situ* (Siegel and Unna, 1931 *a* and *b*; Rothberger and Goldenberg, 1931; de Boer and Spanhoff, 1933; Holz and Misske, 1934), but in all these cases the effects observed were a combination of the primary effect of I.A.A. poisoning and the secondary effects of asphyxia due to circulatory failure. Siegel and Unna (1931) concluded that the T wave of the mammalian

electrocardiogram was abolished when glycolysis was inhibited by I.A.A. This conclusion was criticised by Löwenbach (1931), Rothberger and Goldenberg (1931), Frey, Berger and Pfister (1932), de Boer and Spanhoff (1933), Maltesos (1934) and Nahum and Hoff (1934). Edwards and Sanger (1933) found that I.A.A. poisoning reduced the refractory period of the isolated turtle's auricle, and Gupta (1935) found the same with the isolated frog's ventricles. The possibility of asphyxia was not excluded in these experiments and therefore the significance of the results is uncertain.

Dale (1935) made a systematic investigation of the influence of the character of the metabolism on the electrocardiogram of the isolated frog's heart ventricle.

She studied the following conditions :—

- (a) Normal oxidative metabolism.
- (b) Non-carbohydrate oxidative metabolism (I.A.A. poisoned *plus* oxygen).
- (c) Anaerobic glycolysis (asphyxia of normal heart perfused with alkaline Ringer's fluid).
- (d) Exhaustion of all anaerobic sources of energy (prolonged asphyxia of normal ventricle).
- (e) Exhaustion of non-carbohydrate anaerobic sources of energy (asphyxia of I.A.A. poisoned ventricle).

She also determined the effect of acidity on the electrocardiogram, a point which is of importance in relation to the estimation of the effects of asphyxia on the normal ventricle. There was a small initial lengthening of the D.E.R. which was followed by a marked decrease. The latter effect is shown in Fig. 35 *a*. She found that the electrical response was not altered by I.A.A. poisoning provided that an adequate supply of oxygen was maintained.

Asphyxia of the normal heart caused a small increase in the D.E.R.; this effect was probably due to the production of acid by the heart.

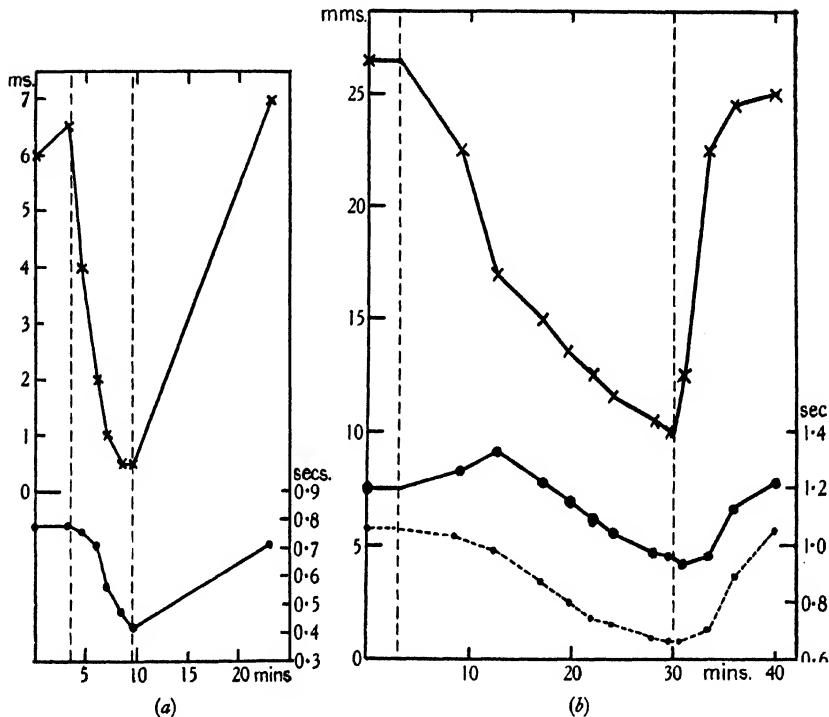

FIG. 35*a*.—Effect of CO_2 (15 per cent. in air) on height of mechanical response (H.M.R.) ($\times-\times$) and on duration of electrical response (D.E.R.) ($\bullet-\bullet$) of isolated ventricular strip. CO_2 on at first vertical dotted line. At second dotted line CO_2 off and strip washed. Rate 13 per min.

FIG. 35*b*.—Effect of asphyxia of the isolated frog's ventricle in neutral Ringer's fluid on H.M.R. ($\times-\times$), D.E.R. ($\bullet-\bullet$) and time from stimulating shock to beginning of final fall of electrical response ($\bullet---\bullet$). The vertical dotted lines indicate beginning and end of asphyxia. Rate 15 per min. (A. S. Dale, 1935.)

Exhaustion by asphyxia of either the normal heart or the I.A.A. poisoned heart caused a progressive shortening of the electrical response, and shortly before complete exhaustion the form of the electrical response became very abnormal.

These results provide clear evidence that the form and duration of the electrical response are not dependent on the occurrence of glycolysis. In particular, they show that the production of the T wave is not dependent on lactic acid formation.

Various facts prove that the duration of the electrical response and of the absolute refractory period are independent of the amount of energy liberated by the contractile process. For example, when the frequency is varied between 1 and 20 per minute (at 15° C.) the height of the mechanical response and the amount of metabolic change added per contraction remain approximately constant, but the duration of the electrical response at 20 per minute is only about 70 per cent. of its duration at 6 per minute (Mines, 1913 *b*).

On the other hand, decrease of filling decreases the mechanical response and the metabolism, and when the frequency is constant the metabolism of the empty heart is not more than half the metabolism of the heart when filled but not greatly distended. The influence of variation in filling on the duration of the mechanical response of the heart is uncertain. Segall and Anrep (1926) concluded that increase of filling of the frog's isolated ventricle increased the periods of rising and falling pressure by about 25 and 30 per cent. respectively. Daly (1923) found that increased filling increased the durations of the mechanical responses of the tortoise's heart. Tso (1930) and Bogue and Mendez (1930) concluded that variations in filling caused little change in the duration of the mechanical response, but the latter authors found that the duration was somewhat greater in the filled ventricle.

Eismayer (1930) found that increase of initial pressure at low frequencies (30 to 40) shortened the

duration of the mechanical response but did not affect this at frequencies of more than 50.

As regards the effect of increased filling on the duration of the electrical response, Daly (1923) found an increase in the tortoise's heart, but most workers have found no increase. Hafkesbring and Ashman (1928) measured the effect of variations of filling on the duration of the response of the turtle's isolated ventricle, and found this to be unaltered when the filling was increased. Bogue and Mendez (1930) found that the D.E.R. was slightly less in the filled than in the empty heart, and Tso (1930) found the refractory periods (both absolute and relative) to be identical in the two cases.

There appears therefore to be no direct connection between the amount of chemical change induced by excitation and the duration of the refractory period or of the electrical response.

This conclusion does not apply, however, to conditions in which the basal metabolism of the heart is depressed below normal, as occurs for instance in the terminal stages of asphyxia. In terminal stages of poisoning of this type, the duration of the electrical response and of the refractory period is decreased.

In the case of acetylcholine, the drug appears to have an equal effect in shortening the duration of the electrical response and in reducing both the metabolism and the mechanical response, and the same may be true in the case of narcotics.

There would appear, therefore, to be at least three varieties of depressant action :—

- (i) Inhibition of sources of energy, *e.g.* asphyxia.
- (ii) Inhibition of contractile process, *e.g.* calcium lack.

- (iii) Inhibition of both contractile process and of processes maintaining the surface potential, *e.g.* acetylcholine.

The second class does not necessarily interfere with the electrical response. The first class only interferes with the electrical response when the energy supply is reduced to a level below the normal basal metabolism. The third class depresses both contractile processes and processes maintaining potential simultaneously.

3. Relations between Mechanical Response and Metabolism — (a) *Cardiac Efficiency.* — It was shown in Chapter III that the energy mobilisation per contraction of the heart was dependent on the initial length of the cardiac fibres, and that there was a linear relation between the amount of metabolism and the volume of the heart. It was there shown also that the influence of fibre length on the resting metabolism of the heart was uncertain, but the evidence available suggested that changes in volume produced little change on the resting metabolism.

Weizsäcker (1911) and Stella (1931) agreed in finding the efficiency of the heart under optimum conditions to lie between 15 and 25 per cent. These figures express the relation between the work done and the total metabolism of the heart.

Clark and White (1930 *a*) estimated the efficiency of the isolated auricles of the tortoise and of the frog. The latter tissue is so small that the results must be considered doubtful. In the case of the tortoise's auricle, they obtained the results shown in Table 46.

These calculations show a slight decrease in efficiency with small fillings, but greater differences were seen in other experiments on the auricles of the tortoise and the frog. The high efficiency calculated in Table 46 is

due to the fact that the oxygen consumption in excess of the basal metabolism was compared with the potential energy released under isochoric conditions and not with the actual work performed.

TABLE 46

Oxygen Consumption and Work done by Tortoise's Auricle filled with Serum-Ringer and suspended in Oxygen. Frequency, 14 to 16 per minute ; weight, 0.140 g.

Filling in c.c.	Oxygen Usage in c.mm./g. per hour.	Oxygen Usage per minute (in excess of Basal Metabolism.)	Work equivalent of Oxygen Usage per Beat (in excess of Basal Metabolism).	Potential Energy released per Beat in g. cm. calculated from Isochoric Response.	Efficiency per cent.
0	0.18
0.3	0.23	7	1.8	0.5	28
0.6	0.29	16	4.0	1.5	37
1.0	0.46	39	8.6	3.3	39
1.6	0.68	70	15.5	6.2	38
1.9	0.8	86	19.2	7.5	39

Stella (1928) found that the efficiency rose as the work done by the ventricle was increased. This is a natural consequence of the high resting metabolism of the heart.

For example, in one experiment (Fig. 5 *loc. cit.*) the figures obtained show the following results :—

Diastolic volume	1	2	3	4 c.c.
Efficiency per cent. . . .	7	11	11.5	12

Extrapolation of the figures shows a resting metabolism equal to half the metabolism at 3 c.c. filling ; if this resting metabolism be subtracted, then the following results are obtained :—

Diastolic volume	1	2	3	4 c.c.
Efficiency per cent. . . .	17	19	17	16

Examination of Stella's results shows that in general, if the resting metabolism be subtracted and the efficiency calculated from the relation between work done and additional energy release due to contraction, then the efficiency remains nearly constant when either the filling or the resistance is varied.

It may be said that the high "overhead cost" of maintenance of cardiac tissue makes it a very difficult matter to assess the true cost of its activity. In view of this uncertainty, the variations observed in the calculated efficiency with different forms of activity have a doubtful theoretical significance.

(b) *Action of Depressants on Mechanical Response and Metabolism.*—The action of depressants on metabolism and on the mechanical response was discussed in Chapter IX, where it was shown that certain agents, such as cyanides, acted by interfering with the supply of energy, and that the changes in the mechanical response could be attributed to the deprivation of energy.

In the case of other depressants, such as calcium lack, narcotics and acetylcholine, it was shown that these probably exerted their primary effect on the contractile process and that the reduction in metabolism observed was probably a secondary effect caused by reduction in the amount of chemical change induced by stimulation.

A comparison between the total metabolism and the amount of mechanical response, expressed either as work done or as pressure produced, showed that depressants steadily reduced the efficiency of the heart until this became zero at the point when the mechanical response was abolished. At this point the metabolism was about 30 per cent. of the normal metabolism.

A comparison, however, of the amount of pressure

produced with the amount of metabolism in excess of the resting metabolism showed a linear relation, which suggested that the efficiency remained approximately constant.

These results are therefore consistent with the hypothesis outlined, namely, that the depressants inhibit the contractile process and reduce the metabolism as a secondary effect; hence the metabolism falls in proportion to the reduction in the mechanical response.

This view is supported by observations on the effect of asphyxia on the electrical response.

Variations in the nature of metabolism produced by asphyxia, I.A.A. poisoning, etc., do not affect the electrical response as long as an adequate quantity of energy is available, but as soon as the sources of available energy are reduced below a certain level, the electrical response becomes abnormal.

Clark and White thought that stimulation of the empty heart did not increase its oxygen consumption, but these experiments did not exclude lactic acid production. More recent work by Clark (1935*a*) indicates that the metabolic rate of the empty or unstretched heart is increased by stimulation.

The breakdown and restoration of the electrical potential on the heart cells is therefore a process which appears to involve a considerable expenditure of energy.

(c) *Fenn Effect*.—The influence of work on the oxygen consumption of the frog's heart is of theoretical interest in relation to the Fenn effect.

Fenn (1923) showed that a skeletal muscle liberated more energy per contraction when it was allowed to shorten against resistance than when it contracted under isometric conditions.

These experiments were done on the frog's sartorius, and Fenn noted that it was necessary to make the

comparison with conditions that were accurately isometric, since a shortening of 3 per cent. might increase the heat formation by 18 per cent. He concluded that the energy liberated by a skeletal muscle, even in a twitch, depended on two factors, (a) the length of its fibres, not only at the moment of stimulation but throughout the contraction; and (b) the work done. Fischer (1930) came to the same conclusion.

More recent work has shown, however, that the relation between the energy liberated by skeletal muscles under isotonic and isometric conditions is more complex than was formerly imagined.

Rothschild (1930) showed that the gastrocnemius produced 30 to 50 per cent. more lactic acid under isometric than under isotonic conditions, but that these amounts were about equal in the case of the sartorius.

Hill (1930) measured the heat production of a series of muscles and explained the various contradictory results that had been obtained, for he showed that the relation between the energy production under isotonic and isometric conditions differed under different conditions. He concluded that all muscles with a sufficiently small initial load showed a greater energy production under isometric conditions, and all muscles with a sufficiently large initial load showed a greater energy production under isotonic conditions (Fenn effect). Over an intermediate zone the energy production was equal, a result previously obtained by Hartree and Hill (1928).

Hill's results show that the energy liberated under isometric conditions is the greater up to an initial load of 50 to 100 g. with the semi-membranous (*R. esculenta*) but only up to about an initial load of 20 g. with the sartorius (*R. esculenta*), and he pointed out that with small sartorii (*R. temporalis*) this limit would be reached

with a load of a few grammes. These conclusions were confirmed by Cattell (1932).

As regards the frog's heart, it may be pointed out that it is impossible to produce accurately isometric conditions, and hence it is impossible to judge whether this does or does not show the Fenn effect.

The more general question as to whether the energy release of cardiac muscle is dependent on the conditions existing at the moment of excitation, or whether it is also influenced by the resistance against which the heart contracts, has already been discussed in Chapter III.

It was there shown that the evidence obtained with cold-blooded hearts was contradictory and doubtful. In the case of mammalian hearts, the oxygen consumption is increased by increased resistance even when the filling is kept constant. In this case, however, it is very difficult to exclude the effect of changes in the coronary flow consequent on the changes in resistance.

In general, the evidence obtained with heart muscle is too inconclusive to provide a sound basis for the discussion of this interesting theoretical question.

CHAPTER XII

RECOVERY PROCESSES IN THE FROG'S HEART

Duration of Absolute Refractory Period—Recovery of Excitability—Recovery of the Duration of the Electrical Response—Recovery of the Mechanical Response—Discussion—Nature of the Primary Contraction Process.

Recovery Processes

MEASUREMENTS of heat production have proved in the case of skeletal muscle that there is an initial anaerobic heat production which is followed by a much slower oxidative recovery process. In the case of a single twitch of the frog's sartorius at 0° to 5° C. the following time relations have been proved. The times are measured from the stimulus.

Maximum production of initial contraction heat ends at 0.1 second (Hartree, 1931). Maximum height of monophasic electric response is attained at about 0.1 second (Adrian, 1921). Maximum isometric tension is attained at about 0.25 second (Hartree, 1931).

These relations show an initial process which releases energy at about the same speed as the occurrence of the change in membrane potential and is followed by mechanical changes.

The oxidative processes are very much slower and may take some minutes for their completion.

The evidence in the case of muscles other than skeletal is less complete. Bozler (1930) used the retractor of the pharynx of *Helix pomatia*, and found an initial heat production which was nearly completed

after 2 seconds and a recovery process lasting several minutes. The maximum tension was attained in about 1 second. These results show that plain muscle resembles striated muscle in that there is a relatively rapid initial heat production which is followed by a much slower recovery process.

Unfortunately cardiac muscle is unsuited for heat measurements. Fischer (1926, 1927) with great difficulty obtained results with the frog's heart which he believed to be quantitatively reliable. He only measured the initial heat, and his records show the rise in the galvanometer deflection outlasting the mechanical response. In the case of cardiac muscle, therefore, the occurrence of recovery heat has not been directly demonstrated, and the true relations of the initial heat production are uncertain. No essential difference in the heat production of the different types of muscle has, however, been demonstrated. The contraction process in cardiac muscle may therefore be assumed to consist of some primary contraction process which is relatively rapid and which is followed by a variety of recovery processes.

In our present state of knowledge it seems wisest to regard the nature of the primary contraction process as being completely unknown.

The time relations of various recovery processes can be measured, and it is of interest to determine how many separate recovery processes appear to exist, and whether any of these can be linked with the metabolic changes which are assumed to be concerned with the restoration of the tissue to normal.

Excitation causes three primary changes in muscular tissue, namely, electrical and mechanical responses, together with temporary loss of excitability. Cardiac muscle differs from skeletal and plain muscle in that

these three processes are all of similar duration. It was shown in the last chapter that the balance of evidence indicates that, within the limits of error of time measurement, the end of the electrical response coincides with the end of the relative refractory period. The durations of the electrical and mechanical responses usually are similar, but these can be separated by various agents, and since these periods are widely different in other forms of muscle, it seems unlikely that their similarity in cardiac muscle is of fundamental significance.

The discussion of the time relations of the events occurring in the frog's heart muscle is complicated by its structure, which produces certain errors which are very difficult to eliminate.

The duration of the monophasic electrical response in a strip of fresh ventricle is a measurement of relatively high accuracy, since the response shows a steep rise and a plateau terminating with an abrupt fall.

This sharp effect is due to the fact that the conduction in such a tissue is rapid (100 to 200 mm. per second) and if the electrodes are not more than 10 mm. apart, then the period occupied by the spread of the current from one electrode to another is small in comparison with the duration of the response. In a ventricle that is depressed the conduction is much slower and hence the rate of rise of the potential is slower, whilst the decline of the potential may change from an abrupt fall to a die-away curve.

Schellong (1924) showed that the form of the electrical response depended on the speed of conduction through heart strips, and that there was a close correlation between excitability, speed of conduction and the rate of rise and of fall of the electrical potential. He also showed (1928) that the D.E.R. depended partly on the

distance apart of the electrodes ; if the electrodes were 5 mm. apart, the D.E.R. was about 0.1 second longer than when the distance was 2 mm. The combined periods of invasion and retreat of excitation over the distance $5 - 2 = 3$ mm. were therefore about 0.1 second, which corresponds to a conduction rate of 60 mm. per second.

These effects are all such as may be anticipated if the structure of heart tissue be considered. It is essentially a network of cells, through which the wave of excitation passes. A monophasic response can only be obtained with electrodes at some distance apart, and hence the response is the expression of the average behaviour of a large population of cells. When the excitability of the cells is normal, then the commencement and ending of the electrical response throughout the population is fairly uniform, but any depression of excitability causes delay in the transmission of excitation from cell to cell and both the rise and fall of the change of potential approximates to S-shaped curves, which presumably express the individual variation in the responses of the cells.

The considerations indicate that in the case of a ventricle strip in good condition, the termination of the D.E.R. cannot be defined accurately to within a limit of less than ± 0.05 second and that when excitability is depressed, the accuracy possible is considerably less.

The other time measurements that can be made on the frog's ventricle are less accurate than the measurements of the electrical response. For example, the mechanical response is terminated by a process of relaxation which varies greatly in its rate, and it is not possible to measure exactly the moment at which active contraction ceases and relaxation begins.

These considerations are important, since they show that disputes about the time of events which depend on measurements of less than 0.1 second have very little significance in the case of the frog's ventricle.

Duration of the Absolute Refractory Period.—Schütz (1936) showed that different results were obtained with induced currents and with rectangular currents of short duration. The former showed that the absolute refractory period ended near the end of the monophasic electric response, whilst the latter showed that excitability returned at the commencement of the steep fall of the monophasic electric response.

Drury and Love (1926) showed that if a stimulus was introduced before the end of the A.R.P., it might prolong this period, even though it produced no measurable electrical response. This phenomenon was seen very clearly in the veratrin poisoned frog's ventricle, but could not be demonstrated with certainty with normal muscle. Schütz (1936) discussed this evidence and concluded that its significance was doubtful, because it was only obtained in poisoned hearts in which conduction was depressed. It has already been pointed out that when the conduction is slowed the significance of time measurements becomes more uncertain. Even if these results be disregarded, it is difficult to fix the true duration of the absolute refractory period in view of the fact that this differs with different forms of current. The question naturally arises whether the difference in response to the different forms of stimulus depends on the chronaxie of the heart muscle being changed during the relative refractory period. Schütz (1936) reviewed the evidence on this difficult subject. He considered that the results were too uncertain to permit of any definite conclusion.

For the purposes of discussion in this chapter it is

desirable to choose some definite point as the commencement of the recovery process, but this is difficult, and it seems best to assume that the recovery process commences at the termination of the absolute refractory period as determined by the methods used in the experiments under discussion. This means that the absolute refractory period as measured by experiments with induced currents is some 20 or 30 per cent. longer than when measured by Schütz and Lueken's method.

Recovery of Excitability.—The termination of the absolute refractory period is followed by a period of recovery during which various functions of the heart, such as excitability, force of contraction, etc., return to normal.

Chief attention has been paid to the recovery of excitability and the period during which it recovers is termed the relative refractory period. There does not appear, however, to be any reason to regard the recovery of excitability as more important than the recovery of other cardiac functions.

The relative refractory period has been studied by many authors. Adrian (1920, 1921) made a comparative study of the recovery of excitability in a variety of tissues. His figures, which are given in Table 47, show that in nerve and skeletal muscle the recovery process is long in comparison with the duration of the A.R.P.

In cardiac tissue the A.R.P. is much longer than in other tissues. The R.R.P. as determined by induced currents is relatively short in comparison with the A.R.P. The methods of Schütz and Lueken show an A.R.P. somewhat shorter than the older methods and an R.R.P. very much shorter.

These differences are shown in Table 47. The ratios for the heart are approximate since the duration of the A.R.P. depends on the frequency of stimulation,

and may be twice as great at a slow as at a rapid frequency. On the other hand, the rate of recovery of excitability (R.R.P.) is not affected by the frequency and is the same whether the A.R.P. is long or short (Schellong and Schütz, 1928).

TABLE 47

Relative Durations of Absolute and Relative Refractory Periods in Frog's Tissues; temp. about 16° C.; time in seconds

	(a) Absolute Refractory Period.	(b) Relative R.P. (from end of A.R.P. till 90 per cent. Recovery of Excitability).	Ratio a/b.
Sciatic nerve (Adrian, 1921)	0·0022	0·005	0·45
Sartorius (Adrian, 1921)	0·04	0·09	0·45
Ventricle—			
(a) Induced currents. Adrian (1921)			
Schellong and Schütz (1928), Tso (1930), Pohl and Schellong (1930)	1·3	0·3	4·3
(b) Rectangular currents (Schütz and Lueken, 1935)	1·0	0·1	10

If the results of Schütz and Lueken (1935) be accepted they imply that the recovery of excitability and the fall of the monophasic electric response are simultaneous events of equal duration, which both express the re-establishment of membrane potential of the cells. This hypothesis is supported by the fact that Adrian (1921) and Schütz and Lueken (1935) both agree that the height of the monophasic response returns to normal almost immediately on the recovery of excitability. Adrian's figures indicate that the amplitude of the mechanical response recovers more slowly than does the excitability, whilst Schellong and Schütz (1928) found that the recovery of the former was very much slower.

Schellong (1931) found that the recovery of conduction occurred at the same rate as recovery of excitability. The evidence indicates, therefore, that the fall of the monophasic electrical response shows the restoration of the membrane potential of the cells, and in the same period the heart recovers its excitability and rate of conduction. This period is less than 10 per cent. of the duration of the absolute refractory period.

Recovery of the Duration of the Electrical Response.—All workers agree that the recovery of the D.E.R. is a very much slower process than is the recovery of excitability.

Mines (1913 *b*) pointed out that the recovery in the duration of the electrical response was a very slow process. His figures show a steady increase in the D.E.R. until the interval from the termination of the last response amounted to 4 seconds.

Schellong and Schütz (1928) and Pohl and Schellong (1930) compared the recovery of excitability and the recovery of the duration of the electrical response. They found that after a maximum response the recovery time for the duration of the second response was from one to one and a half times the duration of the primary response, whilst excitability recovered much more quickly. They also found that the rate of this recovery as measured from the end of the primary response was the same whether the latter was a maximum response or a short response.

Recovery of the Mechanical Response.—Unfortunately this measurement is beset with a number of technical difficulties. When the whole ventricle is used, isochoric conditions are essential, since otherwise variations in filling modify the extent of the mechanical response. When either isochoric ventricles or ventricular strips

are used, care is necessary to avoid production of asphyxia.

Adrian's (1921) figures showed that the recovery period of the mechanical response from the end of the A.R.P. to 90 per cent. normal response was equal to about 40 per cent. of the A.R.P. Blum (1927) used strips of turtles' ventricles and his figures showed this recovery period to be about 2 seconds and equal to the A.R.P. Mines (1913 δ) obtained a similar proportion with the frog's heart under isotonic conditions.

The recovery of the mechanical response is complicated by the question of the occurrence of a supernormal phase and of a partial paralysis following inactivity. The latter phenomenon is usually termed "treppe."

The variations that occur when the interval between the first and second stimulus are gradually increased have been described as follows: Mines (1913 δ) found that the D.E.R. increased steadily and that the mechanical response returned to normal fairly rapidly and showed a decrease with longer periods. Adrian (1921) described recovery of excitability and contractility followed by a supernormal phase which lasted some seconds.

Blum (1927) found that the mechanical response of the turtle's ventricle returned to the control value in about 2 seconds and then showed a slight but steady increase, so that the contraction after a period of 25 seconds was about 15 per cent. greater than the control.

Clark (unpublished results) measured the influence of change of frequency on the recovery process of the frog's ventricle. The results are given in Fig. 36, which shows the D.E.R. and height of the mechanical response at various periods after the termination of

the electrical response. This time is plotted on a logarithmic scale for the sake of convenience.

The figure shows that the D.E.R. increases slowly to a maximum. The mechanical response increases to a maximum much more rapidly. The time for 90 per cent. recovery of the mechanical response is about 0.5 second, whereas the corresponding time for the D.E.R. is about 2.5 seconds. If the frequency is

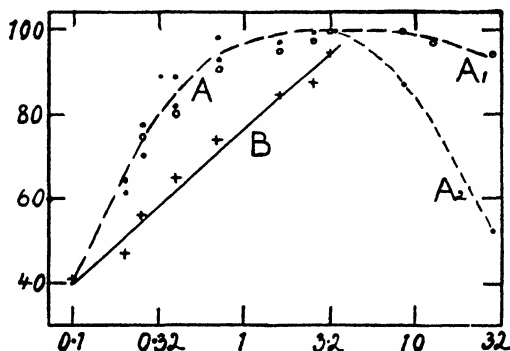

FIG. 36.—Recovery of frog's ventricle at 15° C. Ordinate: height of mechanical response (A) or duration of electrical response (B) as per cent. of maximum observed. Abscissa: time in secs. (log. scale) from end of refractory period to stimulus. A₁ fresh ventricle, A₂ exhausted ventricle. (Clark, unpublished experiment.)

reduced below about 6 per minute, the duration of the electrical response is unchanged, but the height of the mechanical response may show a marked reduction (treppe phenomenon). In the case illustrated in Fig. 36, the ventricle when fresh did not show this effect, but the effect became very marked after the ventricle had been isolated for some hours.

Discussion

The evidence reviewed shows clearly that various recovery processes in the frog's ventricle occur at markedly different rates.

At least three different groups of recovery processes can be distinguished.

- (1) The recovery of membrane potential, of conduction and of excitability occur rapidly.
- (2) The recovery of the amplitude of contraction and of the amount of metabolism added by contraction occur more slowly.
- (3) The recovery of the duration of the electrical response occurs much more slowly.

This conclusion accords with the evidence reviewed in Chapters IX and X regarding the action of depressants on the frog's ventricle. It was there shown that the membrane potential (height of monophasic electrical response), the amplitude of contraction and the duration of the electrical response could all vary independently.

It would appear, therefore, that although the contraction process cannot occur until the membrane potential is re-established, yet the amount of potential change gives no indication of the amount of the contraction process that will follow the excitation.

It is therefore necessary to assume that the process of excitation is distinct from the contraction process which it provokes.

The clear separation of the recovery of excitability from the recovery of the D.E.R. is surprising and difficult to explain. The difficulty is increased by the fact that there is no constant relation between the amount of the contraction process and its duration.

The slow recovery of the duration of the response suggests some change in colloidal state. Edwards and Cattell (1930) measured the influence of high pressures (up to 1500 lb. per sq. cm.) on the turtle's ventricle and auricle. These pressures caused increases in the tension produced of 70 to 140 per cent. of the normal, but the duration of the contraction was only slightly increased (10 to 20 per cent.).

They suggested that their results depended on

pressure limiting the freedom of molecular movements, and since the pressure produced little change in the duration of the response, the latter would appear not to be dependent on viscosity.

The D.E.R. shows a relatively high temperature coefficient ($Q_{10} > 2$) and this is in favour of the duration being determined by a chemical rather than a physical process.

The D.E.R. is also influenced by changes in the ionic concentration of Ringer's fluid. It is increased by calcium excess and potassium lack. It is decreased markedly in the hypodynamic condition (Junkmann, 1925; Tso, 1930).

These results suggest some relation between the D.E.R. and the lipin-calcium content of the surface of the heart cells.

The study of the effect of change of temperature is a well-known method for the differential analysis of processes, but this method does not provide much help in this case.

Kronecker and Stirling (1874) believed that at low temperatures the A.R.P. lasted far into diastole, and Adrian (1921) accepted this view. Schütz (1928) found with temperatures varying from 10° to 30° C. that the A.R.P. and the D.E.R. were equal in length in all cases.

The tension developed by the contraction process is greater at low than at room temperatures (Bernstein, 1908; Clark, 1920; Eckstein, 1920; Doi, 1920; Cattell and Edwards, 1930).

The increase of metabolism added by the contraction process increases, however, with increase of temperature (Clark, 1936 *b*). Decrease of temperature, therefore, produces a considerable increase in the efficiency of the frog's heart.

A comparison between the effects of changes in two physical conditions, namely, temperature and pressure, shows the following results:—

Cattell (1934) found that pressures up to 2000 lb. per sq. in. caused a 30 per cent. increase of both the tension and heat produced by the frog's sartorius. The increase of pressure, therefore, does not markedly alter the efficiency, and it may be assumed that the same is true for cardiac muscle.

Reduction in temperature and increase in pressure therefore cause, in the heart muscle, the complex changes shown below:—

	Reduction in Temperature.	Increased Pressure.
Tension developed .	25 per cent. increase.	50 per cent. increase.
Metabolic change .	Decreased.	Increased.
Duration of response .	Large increase.	Small increase.

It does not appear possible to correlate variations so divergent as these with any simple physico-chemical process.

The chief fact demonstrated by a study of the recovery processes in the frog's ventricle is that this is complex, and that there are several recovery processes which proceed at different rates.

It seems fair to assume that the increase of metabolism caused by the contraction process is proportional to the amplitude of the contraction process, *i.e.* pressure produced under isochoric conditions.

The evidence collected shows that this added pressure is not necessarily proportional to either the membrane potential or to the duration of the electric response. These three factors can be influenced independently by drug action and also recover at different rates.

The question next arises as to what factors regulate the extent of the mechanical response, since the quantity of this response does not appear to be regulated by the electrical changes. The simplest explanation is to assume the re-formation of some chemical substance. Phosphagen at one time appeared a probable substance, but recent work makes this somewhat doubtful.

The fact, however, that the amount of the mechanical response varies according to the surface of the muscle cells suggests that the amplitude of the mechanical response will not vary according to the amount of the unknown chemical, but rather according to the amount that is arranged or orientated in some particular relation to the cell surface.

The simplest possible picture of the course of the recovery processes appears to be somewhat as follows:—

A rapid restoration of surface potential which results in recovery of excitability. This is followed by a much slower process of recovery on which depends the duration of the electrical response.

At the same time restoration of the primary substance responsible for contraction occurs, and it proceeds independently of the other two processes.

The chief result of this analysis is the postulation of at least three independent variables. This is obviously unsatisfactory, but it seems impossible to account for the phenomena observed on any simpler hypothesis.

The nature of the Primary Contraction Process.—The events connected with the contraction process can be divided into electrical, mechanical and metabolic changes. The simplest hypothesis is that the electrical stimulus provokes some rapid chemical reaction, that this produces contraction and restorative processes occur subsequently. The search for the primary

chemical event thus postulated has proceeded for many years. It was first shown that all oxidative changes were recovery processes. The discovery of substances such as iodo-acetic acid, which inhibit glycolysis, proved that lactic acid formation was not the primary event. Evidence is now accumulating to show that phosphagen breakdown probably is not the primary event. It seems wisest in the present state of knowledge to assume that all the known metabolic changes are recovery processes, and to regard the process which liberates the energy used in contraction as of completely unknown nature. The electrical changes either precede or are simultaneous with the primary contraction process.

Unfortunately the frog's cardiac tissue is unsuitable for the accurate measurement of the time of events, and hence the evidence available only suffices to prove that the commencement of the mechanical response follows not more than about 10σ after the commencement of the electrical response.

Cardiac muscle differs from other forms of muscle in that the durations of the electrical and mechanical responses and of the absolute refractory period are very similar. Analysis by means of depressant agents shows, however, that the duration of the mechanical response can vary independently of the other two durations. The heart is inexcitable until the membrane potential is partially restored, and full excitability appears to coincide with complete restoration of the membrane potential. Hence there is a close relation between the durations of the electrical response and the refractory period.

The effects of depressants and other changes on metabolism and on the mechanical response can most simply be interpreted on the hypothesis that the majority of these act in one of two ways:—

(a) Inhibition of metabolic restorative changes, *e.g.* cyanides or iodo-acetic acid. The effect of such agencies is complicated by the fact that cardiac tissue can obtain energy either by oxidation of a considerable variety of materials or by the anaerobic breakdown of either carbohydrate or phosphagen. The general effect of deprivation of sources of energy on the heart is first to reduce the mechanical response and later to derange the electrical response.

(b) Inhibition of contractile process, *e.g.* calcium lack. This inhibits the contractile process and consequently reduces the metabolism until this falls to the resting level. It is possible with a wide variety of methods to reduce the contractile process and metabolism without changing the form of the electrical response, either as regards amplitude or duration. In some cases it is possible to reduce the duration of the electrical response without reducing the duration of the mechanical response. For these reasons it seems necessary to regard the electrical changes as separate events from the primary contraction process.

There is, however, a considerable amount of evidence which indicates that the maintenance of surface potential involves expenditure of considerable energy in cardiac tissue. Consequently any interference with metabolism will interfere with the electrical changes once the metabolism is depressed below the normal level of resting metabolism. The sequence of events in the contraction process is therefore postulated as follows:—

(a) Excitation.

(b) Spread of excitatory process. The surface membrane is depolarised and this persists for a length of time that is dependent on the state of the surface membrane at the time of excitation. The tissue is inexcitable for the duration of the electrical change.

(c) Primary contraction process of unknown nature. This change produces the mechanical response. The amount of this change is not directly dependent on either the amount of change of electrical potential or on the duration of the change in electrical potential. The duration of the contraction is not dependent on the amount of the contraction process but is usually, though not always, similar to the duration of the electrical change.

(d) Recovery processes. Two groups of recovery processes appear to proceed, namely,

- (1) Those associated with re-establishment of the membrane potential.
- (2) Those associated with re-establishment of the primary contraction process.

The membrane potential is re-established quickly and excitability and rate of conduction and amplitude of the electrical response are re-established at the same rate. The duration of the electrical response is re-established much more slowly. The extent of the primary contraction process is re-established at a rate intermediate between the two groups dependent on the membrane potential.

The scheme put forward postulates a number of independent variables, but a study of the evidence shows that these are actually found. It will be seen that the conclusions regarding the nature of the primary contraction process are almost entirely negative in character. The extent of the primary contraction process is not directly dependent either on the extent of the membrane potential as measured by the amplitude of the electrical response, nor is it necessarily proportional to the duration of the breakdown of the electrical potential (D.E.R.). On the other hand, the primary

contraction process cannot be identified with any of the known metabolic processes.

It has generally been assumed that contraction is produced by some primary chemical change and that this is followed by other chemical recovery processes. Ritchie (1932, 1933) has put forward an attractive alternative theory, namely, that contraction is due to the liberation of electrical or mechanical potential energy. According to this view, the known chemical recovery processes establish the potential energy and excitation releases the energy.

Physical Hypothesis.—The following appear to be the salient points in favour of this hypothesis. In the first place, there is the very important piece of negative evidence that the primary contraction process has not been identified with any known chemical change.

Another difficulty regarding the chemical theory is the shortness of the latent period between excitation, electrical response and mechanical response. In the case of the frog's gastrocnemius, Roos (1932) concluded that the electrical and mechanical responses were simultaneous and that the latent period was shorter than 0.4σ . Cardiac tissue is unsuitable for delicate time measurements, but in this case the interval between the electrical and the mechanical responses appears to be not more than 10σ . Any chemical change which produces the contraction must therefore be very rapid.

Another fundamental difficulty pointed out by Ritchie in the chemical theory is the enormous variation in the duration of contraction of different muscles. Tortoise's muscle and insect's wing muscle are two familiar examples. Similarly, the duration of contraction of the ventricle in the tortoise is several seconds, whereas in the canary it is not more than 30σ . It is difficult

to imagine how any single chemical process could be regulated to proceed at such entirely different speeds.

This argument would be more convincing if the factors regulating the duration of muscular contraction were known. The evidence regarding the relation of the D.E.R. and other measurable activities of the frog's heart, collected in the last two chapters, were, however, almost entirely of a negative character. If the chemical theory be adopted it is necessary to assume that the duration of the contraction represents the duration of the effects produced by the primary chemical change rather than the time required for the change to occur.

There are other points which are in better accordance with the physical than the chemical hypothesis. For example, the resting metabolism of the heart which is presumably a chemical recovery process has a relatively high temperature coefficient, whereas the amount of energy released by excitation has a low temperature coefficient.

The chief difficulty in accepting the physical hypothesis is that it postulates that the relaxation of the heart is an active process, hence paralysis of the heart should result in contracture. Some lethal agents produce contracture (*e.g.* I.A.A. and strophanthin), but in the latter case contraction can occur with partial contracture whereas the majority of depressant agents abolish contraction without producing contracture. Acetylcholine, for example, can abolish contraction and reduce the resting metabolism far below its normal value without producing contracture, and in this case the physical hypothesis of contraction does not explain what force is keeping the paralysed heart in a relaxed condition.

If the physical hypothesis be adopted, it is important

to note that the physical process assumed cannot be identified with the membrane potential, since the latter is restored after a contraction so much more rapidly than is the amplitude of contraction. Moreover, it shows no close relation to the D.E.R., because this recovers after a contraction more slowly than does the amplitude of contraction.

Our knowledge of muscular contraction is at present inadequate to provide formal proof for either the chemical or the physical hypothesis. It is merely a question of finding a possible explanation which explains a reasonable proportion of the facts. The difficulties of the chemical hypothesis are so familiar that an alternative is naturally welcome, but the number of new difficulties raised by the physical hypothesis seems to be as large as the number of old difficulties which it solves.

CHAPTER XIII

COMPARISON OF METABOLISM OF CARDIAC, SKELETAL AND PLAIN MUSCLE

Introduction—Mammalian Heart—Skeletal Muscle—Plain Muscle—
Resting Metabolism of Muscles—Discussion

Introduction

THE experiments carried out by the authors on the metabolism of the frog's heart were commenced in 1927. At that date there was a firmly established theory of muscular metabolism, namely, that a primary anaerobic glycolysis supplied the energy for contraction and that this was followed by an oxidative recovery process in which a portion of the lactic acid was oxidised and the energy thus obtained was employed in the re-synthesis of glycogen.

At a fairly early stage in our experiments it became obvious that this hypothesis would not explain the process of contraction in cardiac muscle, and it appeared that the metabolism of cardiac muscle was completely different from that of skeletal muscle. Lundsgaard, however, had meanwhile shown that muscular contraction could occur when glycolysis was inhibited by iodoacetic acid. This important discovery revolutionised all conceptions of muscular metabolism and to-day it would appear probable that the metabolism of all forms of muscle is fundamentally similar although differing in certain important details.

The outstanding fact observed with the frog's heart

is its power to maintain activity by means of a variety of metabolic processes. The heart can contract vigorously for an hour when dependent solely on either (*a*) the oxidation of non-carbohydrate material (I.A.A. poisoned), or (*b*) the anaerobic breakdown of carbohydrate.

Our observations suggest that the frog's heart can oxidise sugar, lactate, amino-acids and fats. It seems probable that this tissue has an exceptionally wide metabolic range, and possesses an exceptional number of enzymes. For example, the frog's heart can destroy atropine, but the hearts of the rabbit, rat and cat cannot do this (Clark, 1912). The study of the metabolic activity of a tissue with such characteristics obviously involves two questions: (*a*) What is the full possible range of metabolic activity? (*b*) What is the normal metabolism?

Our results suggest that the frog's heart can metabolise a wide variety of substances and hence the determination of its normal activity is difficult. In particular it is not possible to determine the normal metabolism by the removal of sources of energy, because when one material is removed the heart can adapt its metabolism and use something else. For example, the rôle of lactates in metabolism is as follows: When supplied with lactates and oxygen the heart uses lactates very readily, and it therefore seems probable that these constitute an important normal fuel. The I.A.A. poisoned heart may, however, be completely deprived of lactates and yet function for hours.

The general trend of evidence as regards sugar usage is that the higher the oxygen pressure the less the sugar consumption. This suggests the possibility that the heart does not oxidise sugar directly but that some glycolysis occurs under normal oxygen pressures and the lactate thus formed is oxidised.

Our experimental conditions which most nearly approached normal were those in which frog's blood was perfused. The chief abnormalities in this system were: low CO_2 pressure, and probable absence of adrenaline after the first hour. Under these conditions the heart oxidised lactate and utilised both blood sugar and glycogen. As a rough average our figures suggest that lactate and carbohydrate metabolism account for half the oxygen used, nitrogenous metabolism for one-quarter and unknown forms of metabolism for the remainder. This standard form of metabolism can be modified in a wide variety of ways by change in the experimental conditions. The fact that relatively small changes in environment can change the metabolism of the frog's heart indicates that in this case the normal metabolism can only be determined by the study of the intact tissue. The study of the metabolism of slices of tissue may provide invaluable evidence regarding the enzymes present in tissues, but it is obvious that it provides highly uncertain evidence regarding the metabolic processes which occur normally in a tissue such as the frog's heart.

Metabolism of Mammalian Heart

This subject has been reviewed by Evans (1936) and by Cruickshank (1936). Evans (1914) and Starling and Evans (1914) showed that the R.Q. of the dog's heart-lung preparation was about 0.85. Visscher (1928) and Visscher and Mulder (1930) found that the carbohydrate used during 4 hours' perfusion by the dog's heart-lung preparation was only sufficient to account for 20 per cent. of the total oxygen consumption. Witting, Markowitz and Mann (1930) found, with the rabbit's perfused heart, that hearts which had been rendered almost free from glycogen survived as well

as did normal hearts. These results proved that the mammal's heart could metabolise non-carbohydrate material. On the other hand, experiments by Bayliss, Müller and Starling (1928) and by Cruickshank and Startup (1933) showed that with a high blood sugar a R.Q. of between 0.95 and 1.0 could be attained. In general, these results with the heart-lung preparation show that the heart can range from a purely non-carbohydrate metabolism (R.Q. 0.70) to an almost pure carbohydrate metabolism (R.Q. 0.95 to 1.0).

Himwich, Koskoff and Nahum (1928) showed that the mammal's heart used lactates, a fact which was confirmed by McGinty (1931), whilst Evans *et al.* (1934, 1935) showed that in the heart-lung preparation glycolysis occurred in the lungs and the lactate thus formed was oxidised by the heart.

Evans and his co-workers also showed that the heart oxidised lactate more readily than sugar, and when both were present the average usage was 70 mg. glucose and 200 mg. lactic acid/100 g./hour. These quantities were together equivalent to 200 c.c. oxygen and the heart used 350 c.c. oxygen/100 g./hour. The lactate and sugar metabolism accounted, therefore, for some 60 per cent. of the total metabolism. The nature of the residual metabolism in this case was uncertain. In the case of the frog's heart the authors found a production of about 0.1 mg./g./hour of non-protein nitrogen; of this quantity about five-sixths was urea-N and one-sixth ammonia-N. The figures suggest a probable formation of urea from ammonia. Klisiecki (1934) concluded that the dog's heart-lung produced large quantities of urea. Cruickshank and McClure (1936) reviewed the evidence and showed that a large number of authors had found non-protein nitrogen formation by a variety of tissues including cardiac and

skeletal muscle. They found, however, no increase in either the $\text{NH}_3\text{-N}$ or the urea-N in the blood circulating through the heart-lung preparation. They also found that this preparation did not utilise any amino-acids. The evidence at present therefore indicates that the mammal's heart differs from the frog's heart in that it cannot oxidise amino-acids.

Cruickshank and McClure (1936) found that with insulin the dog's glycaemic heart-lung preparation had a R.Q. of 0.7, and Cruickshank (1936) concluded that it must be able to oxidise fat although no certain and direct evidence for this had been obtained. The situation as regards the frog's heart is very similar, since fat utilisation seems almost certain and yet cannot be proved beyond doubt.

The utilisation of heart glycogen appears at first sight to differ in the frog and the mammal. The frog's heart can maintain anaerobic activity by glycolysis of its own carbohydrate. The results of Gottdenker and Wachstein (1933) suggested that the rabbit's auricle might be arrested by asphyxia before its glycogen store was exhausted, and this has been proved by Chang (unpublished experiments). Bogue *et al.* (1935) showed that adrenaline caused a rapid loss of glycogen from the heart-lung preparation, and the work of Evans (1934) and of Chang (1937) indicates that the presence of adrenaline is essential for the rapid glycolysis of glycogen. These results suggest that the rapid usage of cardiac glycogen in the mammal is dependent on adrenaline, and this may be one reason why the power of the isolated mammalian heart to sustain anaerobic activity is less than that of the frog's heart.

In general, it would appear that the metabolism of the mammalian heart is very similar to that of the frog's heart, but that the latter has powers of

maintaining anaerobic activity which are not shared by the mammal's heart.

Metabolism of Skeletal Muscle

Meyerhof (1930) concluded that the isolated frog's muscle had a R.Q. of nearly unity. Ochoa (1930) showed, however, that if the glycogen content of frog's muscles was reduced by insulin the survival power of the muscle was not affected, and Meyerhof (1931) found that in isolated muscles with low glycogen content the energy release was greater than the carbohydrate usage. Meyerhof and Boyland (1931) found that poisoning the isolated sartorius with I.A.A. reduced its R.Q. from 0.95 to 0.7.

In the case of mammalian muscle, Himwich and Castle (1927) found that resting dog's muscle *in situ* had a R.Q. of about 0.71, whilst Himwich and Rose (1929) found that the R.Q. of exercising muscle, in the case of fasting dogs, was about 0.8 and in the case of fed dogs was over 0.9. Gemmill (1934-35, 1935) studied the respiratory exchange of the resting and stimulated frog's isolated sartorius, when the muscle was immersed in oxygenated Ringer's fluid and obtained the following figures:—

	Oxygen Usage c.c./g per hour.	R.Q.
Resting	0.017-0.026	0.80
Stimulated—		
(a) 7 times a minute (1934-35)	0.275	0.90
(b) 9 times a minute (1935)	0.606	...

The carbohydrate loss was found to be equivalent to 42 per cent. of the oxygen usage.

These experiments were carried through under conditions likely to prevent asphyxiation, since the muscles were immersed in Ringer's fluid and were

stimulated 12 times a minute or less. Both the oxygen consumption and the R.Q. of the stimulated muscle are very similar to the results obtained with a frog's ventricle. The outstanding difference is the much lower resting metabolism found with the sartorius. Gemmill's results show that an isolated frog's muscle under reasonably physiological conditions has a mixed metabolism. The high R.Q.'s obtained with frog's isolated muscles prior to 1930 may reasonably be attributed to partial oxygen lack, and the more recent results with skeletal muscle indicate that this, when it receives an adequate oxygen supply, has a mixed metabolism somewhat similar to that of cardiac muscle.

Plain Muscle

The data regarding plain muscle metabolism are relatively scanty, because of the following experimental difficulties. Firstly, it is in most cases difficult to obtain plain muscle separated from mucous membranes without extensive manipulation. Secondly, plain muscle usually shows spontaneous activity, and hence it is difficult to determine its oxygen consumption in the resting condition.

In many cases the oxygen consumption of plain muscle has been described in terms of dry weight, but in order to make the figures comparable with those obtained with other tissues such results, when quoted in the following paragraph, have been divided by 5 to show the oxygen consumption per g. wet weight.

Rosenthal and Lasnitzki (1928) found that the oxygen consumption of the rabbit colon muscle was 0.5 c.c./g./hour, whereas the corresponding figure for the mucosa was 1.9. The oxygen usage of the frog's bladder is 0.25 c.c./g./hour (David, 1931), that of the frog's gut 0.24 to 0.3 c.c./g./hour, and that of the frog's

stomach 0.16-0.22 c.c./g./hour (Fenn, 1928). David found that the oxygen usage of the frog's bladder was not increased by stretching it with increased filling. Dickens and Greville (1933) found the oxygen usage of the rat's spleen to be 2 c.c./g./hour, and the R.Q. 0.83 in absence of glucose and 0.91 in presence of glucose. The lactic acid production in oxygen in absence of glucose was low (oxygen equivalent 0.1 c.c./g./hour) but in the presence of glucose it was ten times as great. The corresponding figures in nitrogen were, without glucose, 0.6 c.c./g./hour and 1.6 c.c./g./hour.

Prasad (1935 *a*) found that strips of cat's colon muscle free from mucosa contained only about 0.25 per cent. of carbohydrate available for glycolysis, and that in absence of glucose it oxidised about 1 mg./g./hour of its own carbohydrate. In presence of glucose it produced about 1 mg. lactic acid/g./hour in presence of oxygen, and about twice this quantity when asphyxiated with nitrogen.

These results show that even in presence of oxygen plain muscle has a considerable glycolytic activity. This agrees with the results of Evans *et al.* (1934, 1935) who concluded that in the dog's heart-lung preparation the lungs produced considerable quantities of lactate. Prasad (1935 *b*) studied the effect of asphyxia on the mechanical activity of the gut muscle. The normal gut muscle in absence of glucose has little power to maintain mechanical activity, but in presence of glucose it can do so for a considerable period. The gut poisoned with I.A.A. maintains a normal activity when supplied with oxygen, but is immediately arrested by asphyxia whether glucose is present or not.

These results show that the gut muscle can maintain activity by metabolism of non-carbohydrate material. Prasad did not find any evidence of lactates producing

a beneficial effect on the activity of gut muscle, either normal or poisoned with I.A.A., whereas glucose produced a marked beneficial action in the former condition. This indicates that the gut muscle oxidises carbohydrates in preference to lactates. Plain muscle therefore appears to differ from cardiac muscle in two respects: firstly, gut muscle has a considerable glycolytic activity in the presence of oxygen, and secondly, it oxidises glucose in preference to lactate.

Resting Metabolism of Muscles

Riesser (1936) pointed out that skeletal muscle is peculiar in that it has a much lower resting metabolism than other forms of muscle. This fact is shown by the figures in Table 48. The figure for mammalian heart muscle was obtained by extrapolation of curves and halving the result to allow for the metabolism added by the contraction in the empty heart. It is interesting

TABLE 48

Resting Metabolism of Muscles. (O_2 usage, c.c./g. moist weight, hour.)

	Frog.	Mammal.
Skeletal muscle . . .	0.03 ¹	0.06 ⁴
Cardiac muscle . . .	0.2-0.3 ²	about 1.5 ⁵
Plain muscle . . .	0.2-0.3 ³	0.5 ⁶

¹ Gemmill (1935).

² Fenn (1928), David (1931).

³ Evans and Matsuoka (1915).

⁴ Clark and White (1928).

⁵ Victor (1934).

⁶ Rosenthal and Laznitzki (1928).

to note that the diaphragm has a much higher resting metabolism than ordinary skeletal muscles, namely about 1.0 c.c./g./hour (Kisch, 1935), and the duck's

muscles also have a high resting metabolism (0.6 c.c./g./hour, Victor, 1934). Riesser pointed out that red muscles had a higher resting oxygen usage than white and that the highest resting metabolism was found with the heart and plain muscle, which were particularly rich in glutathione. It would appear that the low resting metabolism of the frog's sartorius is an exceptional property which is shown by some skeletal muscles but not by others.

Discussion

This short comparative review of the metabolism of different forms of muscle indicates that in all cases the nature of the substances used can vary widely according to the experimental conditions. It is of interest to note that similar variations are found even with such primitive forms as protozoa. Brand (1935) gives a table of 12 determinations of the R.Q. of different protozoa. In some cases the medium contained little sugar and in other cases an abundance. The average R.Q.s were with little sugar 0.84 and with abundance of sugar 0.92. This range is very similar to that found with the frog's heart. The evidence shows that skeletal, cardiac and plain muscle all can sustain activity in presence of oxygen when carbohydrate usage is inhibited by iodo-acetic acid poisoning. Both skeletal muscle and cardiac muscle may, if supplied with glucose, show a R.Q. of nearly unity. Hence it would appear that most, if not all, forms of muscle can vary their metabolism from a pure carbohydrate to an entirely non-carbohydrate form. The normal metabolism of muscles is difficult to determine because of the difficulty in establishing normal conditions. The simpler the experimental conditions the easier it is to measure the metabolism, but the further they are removed from the normal.

The indications available suggest that the resting skeletal muscles have a mixed metabolism which changes to a nearly pure carbohydrate metabolism when the oxygen usage is increased by stimulation, whilst glycolysis readily occurs when the oxygen demand rises above the oxygen supply.

The heart's resting metabolism is high in proportion to its metabolism during moderate activity. It would appear that its resting metabolism is mixed, since in the case of the frog's heart, the authors have not succeeded in demonstrating any difference between the R.Q. of resting and of contracting hearts.

The most striking difference between skeletal and cardiac muscle is that the former alone shows the phenomenon of extensive oxygen debt. A skeletal muscle can maintain full activity for some time with an inadequate oxygen supply. The lactic acid formed is buffered by the muscle and is oxidised after the termination of the exercise. The heart, on the other hand, has a feeble buffer power and any accumulation of acid depresses its activity. Clark and White (1928 *a*) were unable to demonstrate any oxygen debt, in the case of a heart worked to exhaustion and then rested. It must, however, be recognised that the high resting metabolism of the heart makes the demonstration of an oxygen debt much more difficult in this tissue than in skeletal muscle.

The most striking peculiarity of plain muscle is the way in which it produces lactic acid even when the oxygen supply would appear to be adequate. Cardiac and plain muscle differ in that the former readily oxidises lactates, whereas it is doubtful whether the latter does so.

In general, the evidence suggests that the contraction process is similar in all forms of muscle, but that the

metabolic processes used normally to provide energy for the recovery processes differ. In all cases, however, these metabolic processes can be varied widely by varying the experimental conditions, and hence there are few clear-cut distinctions between the metabolism of different forms of muscle.

APPENDIX

I. Methods of Measurement of the Mechanical Response of the Frog's Heart. II. Methods of Measurement of the Respiratory Exchange of the Frog's Heart. III. Methods of Measurement of the Rate of Asphyxial Exhaustion. IV. Chemical Methods.

I. Methods of Recording Mechanical Response of the Frog's Heart

THE great advantage of the frog's heart as experimental material is that it has no coronary circulation and normally obtains its oxygen supply through its endocardium. A frog's heart contracting vigorously is well irrigated, and hence can obtain an adequate oxygen supply, but any interference with contraction immediately cuts down the irrigation and in consequence diminishes the oxygen supply. It is therefore necessary to arrange experimental conditions so that alternations of frequency or of amplitude of contraction do not interfere too extensively with the internal irrigation of the heart, because otherwise secondary effects due to oxygen lack will be produced.

The relative merits of the different methods of isolation of the frog's heart depend largely on the efficiency and uniformity of the irrigation which they permit.

The following are the chief methods which can be used.

A. Strips of Heart Tissue.—The simplest form of isolated heart tissue is a strip of ventricle or auricle suspended as shown in Fig. 37.

It is preferable to remove the sinus from the auricle and in the case of both ventricle and auricle to maintain a constant contraction rate by electrical stimulation. A Lewis rotary contact maker or a Condon tipper will provide regular stimuli and the make shock should be cut out by some appropriate device.

The movement is best recorded by a thin slip of cane

fastened on a taut watch-spring. This gives a response proportional to the force of contraction, but the structure of these strips makes it impossible to produce true isometric conditions, and in actual fact a light isotonic straw lever gives results very similar to the isometric lever.

The objection to this method is that the ventricle strip immersed in Ringer's fluid through which oxygen is bubbled suffers from partial anoxæmia owing to its thickness. If

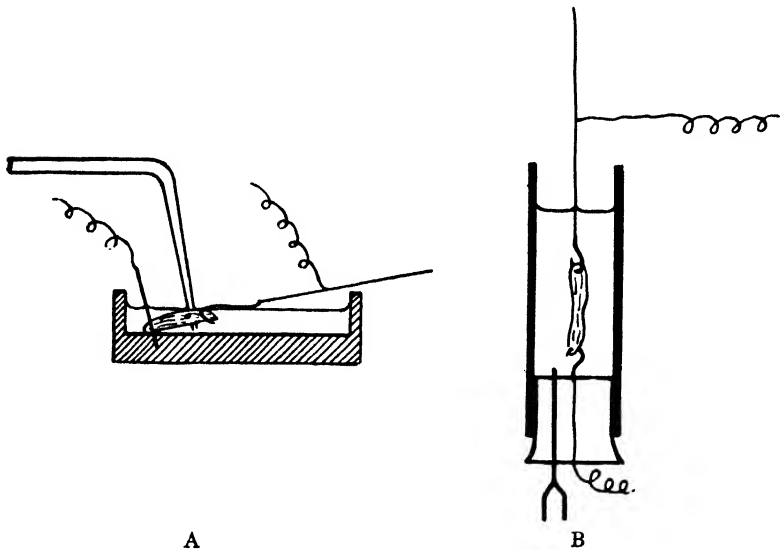

FIG. 37.—Measurement of mechanical responses of ventricular strip (A) and of auricular strip (B). In the latter case oxygen is supplied through a fine needle of rustless steel.

left alone the response gradually declines, but can be at once restored by irrigating the strip with a jet of fluid from a fine pipette with a teat attached.

Auricle strips can be used in an even simpler manner, as is shown in Fig. 37 B. The essential advantage of this preparation is that the auricle is so thin that it receives an adequate oxygen supply by diffusion inwards from the surrounding fluid. An auricle prepared in this manner will maintain a steady mechanical response for 12 hours. The method is very convenient for the administration of drugs and for the exposure of the tissue to gas mixtures.

The advantages of the method are that the frequency can be controlled, and that the oxygen supply does not depend on the activity of the strip. The disadvantage of the method is that the auricle is too small for quantitative chemical estimations.

B. Isolated Ventricle or Auricle.—The isochoric response of the isolated frog's ventricle can most easily be obtained by tying in a cannula into the auriculo-ventricular opening.

Fig. 38 B shows a ventricle mounted in this manner. This preparation is one of the most convenient methods for measuring the effects of drugs on the mechanical response.

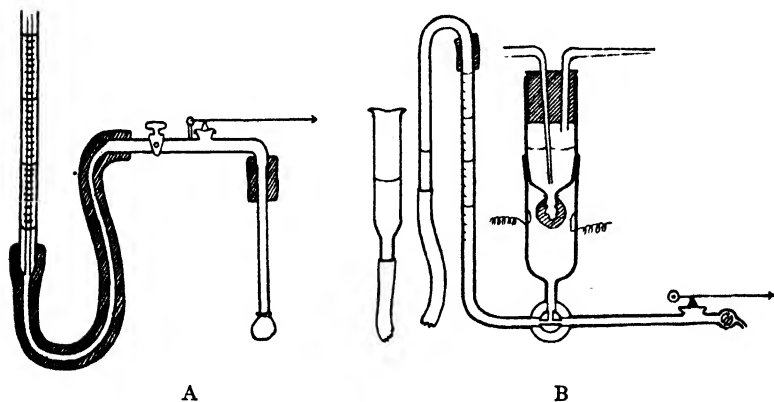

FIG. 38.—Apparatus for measuring the mechanical response of frog's auricle (A) and frog's ventricle (B). The graduated pipette in A is attached to a reservoir as in B. The taps can be adjusted to provide either an auxobaric or isochoric response. The filling and extent of the auxobaric response are measured on the graduated pipette.

The diastolic filling and the diastolic pressure can be regulated at will and either the isochoric response or the auxobaric response can be measured.

The tambour (Fig. 38 B) is about 4 mm. in diameter and made of condom rubber. The excursion of the lever in response to known pressures is measured and thus the isochoric response can be estimated as negative pressure. The chief limitation of this method is that isochoric conditions prevent free irrigation and consequently cause asphyxiation of the ventricle. Consequently it is necessary to alternate isochoric and auxobaric conditions. The auxobaric response

can be measured by the excursion of fluid in the graduated tube shown in the figure.

Even under isobaric conditions the irrigation of the isolated ventricle is not wholly satisfactory. This subject is of particular importance in relation to the study of the respiratory exchange. The outstanding advantage of the isolated ventricle is that its mechanical activity can be regulated exactly. Frequency, diastolic pressure and resistance to systolic pressure can all be varied as desired, and the mechanical response either under isochoric or auxobaric conditions can be measured exactly.

Hence this method is of great value for measuring the influence of drugs, etc., on the mechanical response of cardiac tissue. The auricle can be isolated in the same manner as the ventricle. The ventricle is cut off about 1 mm. below the auriculo-ventricular junction and a cannula is passed into the auricle (Fig. 38 A). If the cannula has a sufficiently wide neck, both auricles empty and fill freely.

With this method the amplitude of the auxobaric response can be measured, but isochoric conditions cannot be maintained for long because the tissue is so thin that it soon commences to leak.

The tortoise's auricles can be prepared in the same manner as the frog's auricles. In this case it is necessary to incise the inter-auricular septum for about 0.5 cm. before introducing the cannula to avoid the septum closing the cannula mouth.

The tortoise's auricle gives an extensive auxobaric response, but is too thin to permit continued isochoric conditions.

C. Double Cannula Method.—In this method a venous cannula is placed in the sinus venosus and an arterial cannula in the aorta.

The method of isolation used by the writer is as follows: The heart is exposed, one aorta is ligatured and a loop of thread placed round the other. The pericardium is opened up and the ventricular vein ligatured. The ligaments and pericardium on each side of the sinus are cut away and a double thread passed under the sinus. The sinus is opened, and the cannula inserted and one thread is used to tie in the cannula. One or two c.c. of Ringer's fluid are passed through the heart to empty it of blood and prevent clotting. The

aortic cannula is next inserted. This is quite easy, provided a cannula of the correct size for the frog is used. The aortæ are next cut and the heart turned back. The remaining thread under the sinus is used to tie off the pulmonary vessels and then the heart is cut free. The aortic cannula often needs adjusting to ensure that there is a free flow without obstruction.

This latter point is very important if it is required to use the preparation for several hours, because obstruction usually results in leakage after a few hours.

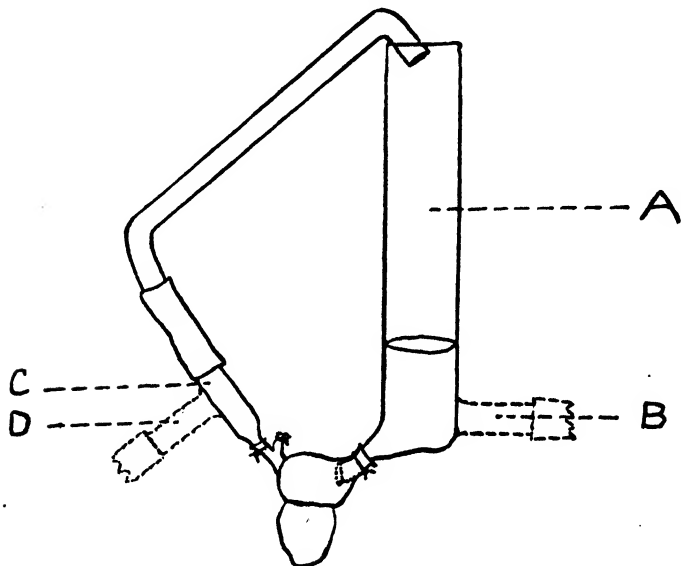

FIG. 39.—Double cannula method, arranged for alternation of continuous perfusion and circulation.

The sinus ligature can be tied either to leave in the sinus to act as a pacemaker or alternatively to exclude it, in which case artificial stimulation can be used.

Fig. 39 shows cannulæ which permit either continuous perfusion of a large volume of fluid or the circulation of a small volume. For enclosure in a Barcroft apparatus smaller cannulæ without side tubes of the pattern shown in Fig. 40 are employed. This method provides excellent irrigation of the whole heart, and hearts perfused with serum-Ringer's fluid survive for 24 or 48 hours. It has been found of great service

for the measurement of metabolic exchange and for measurements of the electrical response in which case it is of particular value because it permits measurement of the P-R interval.

The mechanical response of the ventricle cannot be controlled, however, because the ventricular filling depends on the auricular contraction; moreover, it is only possible to measure the auxobaric response.

The tortoise's heart can be prepared in the same manner as the frog's heart. The arterial cannula is tied into the right systemic arch and the other two arteries are tied off. The tortoise's heart functions satisfactorily if suspended in oxygen, but does not obtain an adequate oxygen supply from air. It will function with either Ringer's fluid or Ringer-serum mixture, but contracts more forcibly and regularly with the latter. In general the preparation gives an irregular mechanical response and is of value chiefly in metabolism experiments in which a larger amount of tissue is needed than is provided by the frog's heart.

D. Straub's Cannula.—In this method a cannula is passed through the aorta and the fluid passes up and down from the ventricle into the cannula. The method only permits the measurement of the auxobaric response. The frequency is regulated by the pacemaker and this may or may not be affected by a drug introduced into the cannula. Hence the method is not very suitable for measuring quantitatively the effect of drugs on the mechanical response. The oxygen supply is dependent on the amplitude of the contraction and if the ventricle is arrested its oxygen supply is cut off. This effect is accentuated by the dead space in the relatively long aortic cannula.

II. Methods of Measurement of Respiratory Exchange of the Cold-blooded Heart

Three methods have been used by the authors.

- (a) Whole heart with double cannula in Barcroft apparatus.
- (b) Isolated ventricle or auricle in Barcroft apparatus.
- (c) Isolated ventricle in contact with blood (Weizsäcker's method).

(a) Whole Heart with Double Cannula in Barcroft Apparatus.—Fig. 40 shows the apparatus used for measurement of the R.Q. of the heart. The oxygen consumption is measured by connecting the bulb with a Barcroft manometer. The carbon dioxide production is calculated from the change of resistance in the sodium hydrate solution. It is necessary to make the apparatus of hard glass and to make careful controls to ensure that the resistance of the sodium hydrate is not changed by combination with material in the glass.

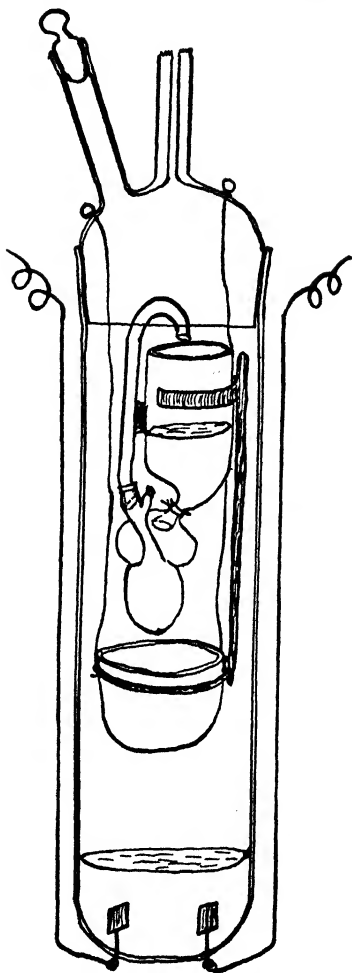

FIG. 40.—Frog's heart attached to double perfusion cannula suspended in large bulb of Barcroft apparatus with a bucket below to catch any leakage. Two electrodes at the bottom, which are immersed in 4 c.c. $M/20$ NaOH. The side tube permits the introduction of drugs. (Clark, Gaddie and Stewart, 1931.)

A further development of this method is shown in Fig. 41. For this case three hearts were suspended together. This arrangement constitutes an important saving in time when material sufficient for chemical analysis is required. The volume of the container is about 400 c.c. The chief experimental difficulty found with this method was the avoidance of leakage from the hearts. In the single heart method shown in Fig. 40 this danger was serious, since a single drop of perfusion fluid falling into the caustic soda completely ruined the experiment. The apparatus shown in Fig. 40 has the further disadvantage that the respiratory exchange occurs at the top of the apparatus and the carbon dioxide has to diffuse

of the apparatus and the

carbon dioxide has to diffuse

downwards to the bottom. For these reasons the apparatus shown in Fig. 41 was found preferable. This method is quite satisfactory for determining the respiratory exchange of hearts in good condition and when the observations extend

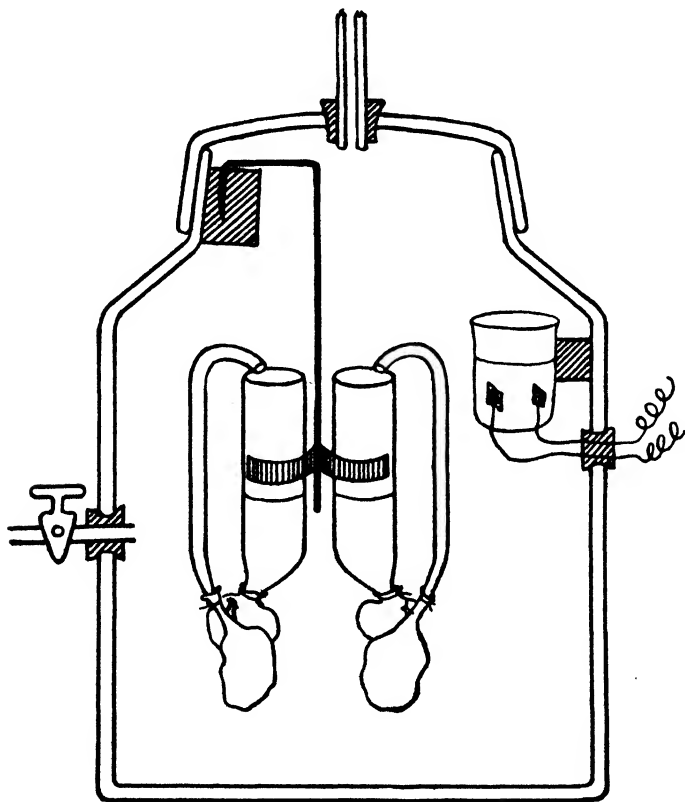

FIG. 41.—Apparatus for measuring respiratory quotient of three frogs' hearts simultaneously. The hearts are suspended on a wire framework. The container measures about 400 c.c., both it and the control vessel are fixed on a carrier which also carries the manometer.

over a period of 6 hours. The method used was to allow an hour for equilibrium and to take readings for the subsequent 5 hours. Under these conditions the large size of the bulbs did not constitute a serious experimental error.

This method has, however, certain obvious limitations.

The only way in which the mechanical activity of the hearts can be estimated is the counting of the number of drops per minute, which is a very crude method of measurement. Since an hour is required for equilibrium, the method is useless for measurement of the immediate effects produced by depressants; moreover, any depression of the heart interferes with its oxygen uptake.

If the measurement of the R.Q. is not necessary, it is

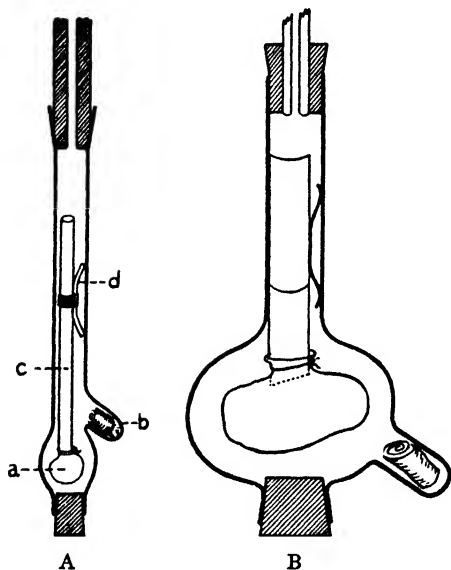

FIG. 42.—Apparatus for measurement of oxygen consumption of auricles. A. Frog's auricle. B. tortoise's auricle. a. auricle; b. NaOH and filter paper; c. cannula; d. spring. (Clark and White, 1930 *a.*)

possible to use the apparatus shown in Fig. 43 *a* (p. 280) where the bulb is much smaller than that shown in Fig. 40. Since the side tube containing NaOH (5 per cent.) on filter paper is close to the upper part of the cannula, the rate of absorption of carbon dioxide is relatively rapid and reliable measurements of oxygen consumption can be obtained after allowing 15 minutes for equilibrium.

This method is more suited for measurement of the effect of drugs on oxygen consumption.

The chief limitation of this method is that the oxygen supply of the heart depends on the circulation and hence depression of the mechanical response is likely to cause partial asphyxia.

(*b*) **Isolated Auricle.**—The isolated auricle of the frog or the tortoise can be suspended in a suitably shaped bulb of a Barcroft apparatus (Fig. 42). The oxygen consumption is small and hence it is desirable to use a small bulb. Moreover, the frog's auricle is too small for convenience as regards chemical estimations. For these reasons the authors did not measure the CO₂ consumption with this preparation.

The special value of this preparation is that it can obtain an adequate supply by diffusion through the external surface when exposed to an atmosphere of oxygen. The preparation, therefore, is very convenient for the measurement of the effects on respiration of depressant agents. The auxobaric response can be measured fairly accurately by measuring the amplitude of movement in the cannula. Hence simultaneous measurement of oxygen usage and mechanical response can be made.

(*c*) **Isolated Ventricle.**—The measurement of the oxygen consumption of the isolated ventricle was made by means of a modified Barcroft apparatus of the pattern shown in Fig. 43 *b*.

The mixing of the fluid in the cannula was the chief difficulty. This was effected by means of a ball filled with iron filings which was moved up and down by an electromagnet (Fig. 43 *b*).

When depressant agents were used, the ventilation of the ventricle was particularly difficult. In such cases it was possible to empty and fill the heart by moving the reservoir which regulates diastolic pressure up and down by a wind-screen wiper. This precaution was also recommended by Weizsäcker.

The great advantage of the method is that it permits accurate measurement of the mechanical response of the ventricle. In other respects it is inferior to the other methods, and the authors were always doubtful whether with this method the whole ventricle received an adequate oxygen supply.

(*d*) **Isolated Ventricle filled with Blood.**—Weizsäcker (1911) used the frog's ventricle filled with ox-blood and measured

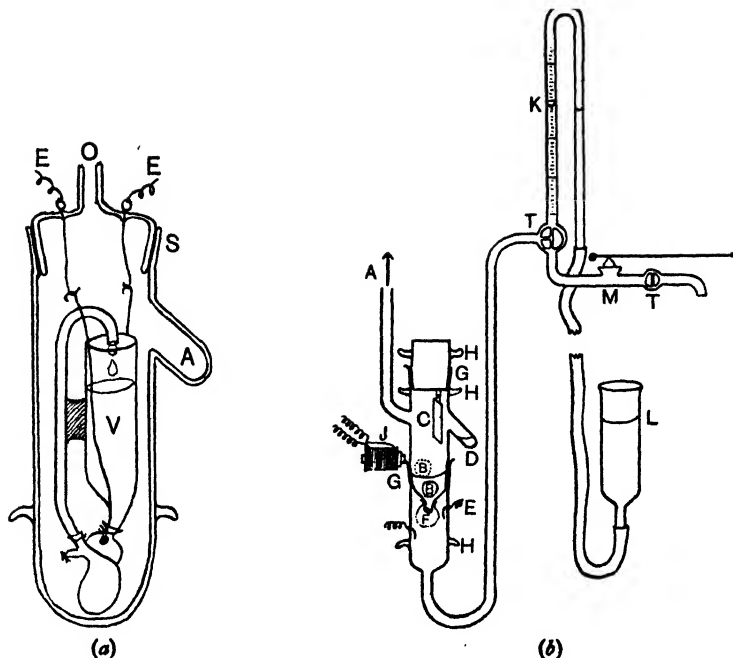

FIG. 43*a*.—Modified bulb of Barcroft apparatus (Method 1). O, connection to three-way tap of Barcroft apparatus of usual pattern. E, E, electrodes. These are hooked on to electrodes which run down to the auricle. The termination of one electrode is shown. S, ground glass joint. A, recess to hold 0.5 c.c. 10 per cent. caustic soda. After this fluid has been put in, the recess is plugged lightly with a roll of filter paper. The orifice of the recess is greased to prevent creeping of the caustic solution. V, venous reservoir. The aortic cannula and the electrodes are held in place by telegraphic cement and silk ligatures. The stopper is held on to the bulb by elastic bands passing over the hooks at the bottom.

FIG. 43*b*.—Apparatus used for Method 2. The cannula, to which the frog's ventricle (F) is attached, fits into a second cannula filled with boiled saline and is closed by a stopper. The joints (G, G) are ground glass and the three pieces are held together by elastic bands passing over the hooks (H, H, H). The side tube D contains caustic soda. The Ringer's fluid in the cannula (0.5 c.c.) is aerated by the glass ball (B, B) which is filled with iron filings, and which is made to jump up and down by currents passing through the electromagnet (J). The air in the cannula is stirred by the flapper C, which is an iron strip coated with collodion. The upper cannula is connected by A to the three-way tap of a Barcroft manometer. A dummy tube is fixed to the other tap of the Barcroft manometer. The lower cannula is connected through the three-way tap (T) to the graduated tube (K), or to a membrane manometer (M). The diastolic pressure is regulated by altering the level of the vessel (L). (Clark and White, 1928*a*.)

the oxygen usage by estimating the oxygen content of the blood.

One disadvantage of this method is that when ox-blood is diluted with water to make it isotonic with frog's serum, potassium salts gradually escape from the corpuscles and thus depress the heart. Hence the method is unsuitable for prolonged experiments.

Another more serious difficulty is that the blood does not mix thoroughly and the lower layers become reduced more quickly than the upper layers. The blood, however, contains powerful buffers and also sugar, and hence the system is likely to encourage glycolysis.

These errors are particularly important in the case of depressed or arrested hearts, and the authors consider that this method of measurement of the oxygen consumption in such conditions is unlikely to provide a true measure of the amount of metabolism.

III. Measurement of the Rate of Asphyxial Exhaustion

The rate at which the mechanical response of cardiac tissue decreases on asphyxia is remarkably constant, and this can be used as a measure of the rate of metabolism.

In the case of normal cardiac tissue, the limiting factor in asphyxia may be either exhaustion of carbohydrate material or change of reaction in the perfusion fluid. The most convenient method is to use a ventricle set up as in Fig. 38 with a small volume (about 0.3 c.c.) of unbuffered Ringer's fluid in the cannula. With this arrangement rapid asphyxial depression is produced, and since the quantity of carbohydrate glycolysed is small the asphyxial depression can be repeated a large number of times on the same tissue.

The only preparation which is suitable for this type of experiment is the isolated ventricle. In this case the fluid outside the ventricle must be oxygen-free and unbuffered. Probably a certain leakage of acid into the external fluid occurs, but the large volume of fluid prevents any marked change in its pH and the error is therefore a constant one. The importance of a small error such as this is reduced by

measuring the asphyxia until only half depression of the mechanical response has occurred. The external surface of the ventricle is so small in comparison with the internal surface that ionic exchange through the external surface cannot support more than a small fraction of the normal cardiac response.

In the case of cardiac tissue poisoned with iodo-acetic acid, the rate of asphyxia is unaffected by the volume or buffer power of the fluid with which it is in contact. In this case either (*a*) the isolated ventricle (Fig. 38 B), or (*b*) the isolated auricle strip (Fig. 37 A) can be used. The latter constitutes an extremely convenient preparation for all purposes in which measurement of the isochoric response is not necessary.

The estimation of the metabolic rate in various conditions by the measurement of the speed with which asphyxial arrest occurs is an indirect method and its validity depends on a number of assumptions.

As far as we have tested the method, however, the results agree well with the results obtained by other methods. The outstanding advantage of this method is that in the case of an I.A.A. poisoned ventricle or auricle an experiment only occupies 15 minutes and twenty or more experiments can be made on a single preparation. This permits a large number of experiments to be made on a single preparation, and errors due to individual variation can thus be avoided.

IV. Chemical Methods

Glycogen.—The glycogen content of the frog's heart was estimated by a micro-modification of the method described by W. O. Kermack, C. G. Lambie, and R. H. Slater (1929). The weighed heart was treated with 2 ml. of 60 per cent. potassium hydroxide on a boiling-water bath until a clear brown solution resulted. 5 ml. of water and 20 ml. of absolute alcohol were added and the mixture allowed to stand for 24 hours. The precipitated glycogen was centrifuged down, washed with 66 per cent. alcohol (twice), absolute alcohol, and ether. After hydrolysis of the glycogen by heating for 3 hours on the boiling-water bath with 5 ml. 2 per cent. hydro-

chloric acid, the glucose formed was estimated by the method of H. C. Hagedorn and B. N. Jensen (1923).

Total Reducing Substance.—The method used to estimate the total reducing substance in muscle and perfusion fluids was that described by S. Ochoa (1930). The weighed muscle or measured fluid was heated with 6 ml. of 6 per cent. sulphuric acid on the boiling-water bath for 3 hours. After dilution to 25 ml. an aliquot of 20 ml. was deproteinised by adding 5 ml. of a 3 per cent. solution of neutral mercuric sulphate in 10 per cent. sulphuric acid. The sulphuric acid was neutralised (to litmus) by solid barium carbonate and after standing for 20 minutes the mixture was filtered. Traces of barium were removed from the filtrate by adding 2 drops of a hot saturated solution of sodium sulphate, and traces of mercury by adding a small quantity of powdered zinc and shaking for 15 minutes. After filtration, reducing substance in the filtrate was estimated as glucose by the method of Hagedorn and Jensen (1923).

The nature of the Total Reducing Substance.—The fraction of the total reducing substance which was fermentable sugar was estimated by the method of M. Somogyi (1927). The sugar present in the final filtrate obtained during estimation of the total reducing substance was estimated before and after incubation at room temperature for 10 minutes with well-washed yeast. The difference represented as glucose the amount of fermentable carbohydrate present.

Total Fatty Acid.—The total fatty acid content of the frog's heart and perfusion fluid was estimated by the method of C. P. Stewart, R. Gaddie and D. M. Dunlop (1931). Perfusion fluids were treated in the same way as blood. The hearts were dried by pressing gently between filter papers, weighed, ground with sand, and transferred quantitatively to 50 ml. standard flasks, 30 ml. of alcohol-ether mixture (3 : 1) added, and the whole heated on the water-bath with constant shaking until the ether began to boil. After cooling, the heating and cooling were repeated twice, the volume made up to 50 ml. with alcohol-ether mixture, and 25 ml. of the clear extract used for estimation as in the method for blood.

After evaporation of the alcohol-ether the fat was saponified with sodium hydroxide and alcohol. The fatty acids were

precipitated by addition of a slight excess of hydrochloric acid, filtered off, washed with sodium chloride solution, dissolved in alcohol, and an aliquot of the solution titrated with N/10 sodium hydroxide from a Rehberg burette.

The method thus estimates the number of fatty acid carboxyl groups liberated by hydrolysis from the total fat of the heart or perfusion fluid.

Ammonia-N and Urea-N.—The ammonia-N *plus* urea-N present in perfusion fluids was estimated by digestion with urease, aeration, absorption of ammonia in N/100 sulphuric acid and titration with N/100 sodium hydroxide. Since all samples of urease contain appreciable quantities of ammonia, a blank estimation on the reagents was carried out each time. To obtain results of reasonable accuracy it was necessary to combine the fluids from two experiments.

Ammonia-N alone was estimated by the method of J. K. Parnas and J. Heller (1924). This consists of steam distillation *in vacuo* of ammonia under suitable conditions of pH in a special silica apparatus, and the estimation of ammonia in the distillate by Nesslerisation.

Lactic Acid.—The method used for the estimation of lactic acid was founded on the usual oxidation to acetaldehyde by potassium permanganate in the presence of sulphuric acid and sulphate, absorption of the distilled aldehyde in bisulphite, and titration of the bound bisulphite with iodine. The iodine was standardised each day by estimation of lithium lactate, and the method was periodically checked by estimation of lithium lactate, the iodine being then standardised by one of the usual methods. The actual recovery of lactic acid was found to be between 94 and 96 per cent. of that known to be present.

As shown by C. P. Stewart, J. P. Dickson, and R. Gaddie (1934) this method estimates methyl glyoxal as well as lactic acid. By the use of their modified method it was shown that the amounts of methyl glyoxal present in fresh hearts, and in hearts perfused under a variety of conditions, were constant and amounted to less than 10 per cent. of the total lactic acid.

Inositol.—The inositol content of heart tissue was estimated by a slight modification of the method described

by J. Needham (1936). Minced tissue was extracted for 24 hours with acetone, sufficient being used to give, with the water already present, a concentration of 70 per cent. acetone. The acetone was then removed *in vacuo* and the aqueous residue precipitated with lead acetate, and finally with basic lead acetate and a little ammonia (freshly prepared). The former precipitate was discarded and the latter, which contained inositol, thoroughly decomposed with hydrogen sulphide. The clear filtrate obtained after removal of lead sulphide was concentrated to a few ml. on the water-bath. Inositol was precipitated by alcohol and ether, filtered off, dried and weighed.

REFERENCES

- ADLER, E., 1928, *Bethe-Embden Handb. Norm. Path. Physiol.*, VI. i. 235.
- ADRIAN, E. D., 1920, *J. Physiol.*, liv. 1.
- ADRIAN, E. D., 1921, *Ibid.*, lv. 193.
- ANDRUS, E. C., and CARTER, E. P., 1924, *Heart*, xi. 97.
- ARBEITER, W. C. A., 1921, *Arch. neerl. Physiol.*, v. 185.
- ARGYLL CAMPBELL, J., 1931, *Physiol. Rev.*, xi. 1.
- ARIMA, R., 1914, *Pflüger's Arch.*, clvii. 531.
- ARNING, D., 1927, *J. Physiol.*, lxxiii. 107.
- ASHER, L., 1923, *Z. Biol.*, lxxviii. 60.
- ASHFORD, C. A., 1933, *Biochem. J.*, xxvii. 903.
- BÄCKMANN, H., 1927, *Pflüger's Arch.*, ccxvii. 151.
- BAETJER, A. M., and McDONALD, C. H., 1932, *Amer. J. Physiol.*, xcix. 666.
- BAGLIONI, S., 1905, *Centralbl. Physiol.*, xix. 385.
- BANG, I., 1913, "Der Blut-Zucker, Wiesbaden," quoted from *Tab. Biolog.*, 1923, iii. 398.
- BARCROFT, J., 1928, *The Respiratory Function of the Blood*, vol. ii., Camb. Univ. Press.
- BARRENSCHEEN, H. K., and BERESCHOVSKY, 1933, *Biochem. Z.*, cclxv. 159.
- BARRENSCHEEN, H. K., BRAUN, K., and DREGUSS, M., 1931, *Biochem. Z.*, ccxxxii. 165.
- BAUER, L., 1930, *Z. Biol.*, lxxxix. 513.
- BAY, E. B., McLEAN, F. C., and HASTINGS, A. B., 1933, *Proc. Soc. exp. Biol. Med.*, xxx. 1346.
- BAYLISS, L. E., MULLER, E. A., and STARLING, E. H., 1928, *J. Physiol.*, lxxv. 33.
- BAZETT, H. C., 1908, *J. Physiol.*, xxxvi. 414.
- BEATTIE, F., MILROY, T. H., and STRAIN, R. W. M., 1934, *Biochem. J.*, xxviii. 84.
- BEHRENS, B., and REICHEL, E., 1933, *Z. ges. exp. Med.*, xci. 417.
- BERNARD, A., and RICHARD, A., 1932, *C. R. Soc. Biol. Paris*, cx. 837.
- BERNSTEIN, J., 1908, *Pflüger's Arch.*, cxxii. 129.
- BERTHA, H., 1928, *Z. Biol.*, lxxxviii. 369.
- BERTHA, H., and SCHÜTZ, E., 1930, *Z. Biol.*, lxxxix. 555.
- BEZNAK, A. B. L., 1934, *J. Physiol.*, lxxxii. 129.
- BLACK, H., 1934, *Pflüger's Arch.*, ccxxxiv. 310.

- BLIX, M., 1891, *Skand. Arch. Physiol.*, iii. 295.
BLIX, M., 1893, *Ibid.*, iv. 399.
BLIX, M., 1895, *Ibid.*, v. 150, 173.
BLIX, M., 1895, *Ibid.*, vi. 240.
BLOOR, W. R., 1927, *J. Biol. Chem.*, lxxii. 327.
BLUM, H. F., 1927, *Amer. J. Physiol.*, lxxxii. 157.
BODENHEIMER, W., 1916, *Arch. exp. Path. Pharmac.*, lxxx. 77.
BOEHM, R., 1913, *Arch. exp. Path. Pharmac.*, lxxv. 230.
BOEHM, R., 1914, *Ibid.*, lxxv. 309.
DE BOER, S., and SPANHOFF, R. W., 1933, *Z. ges. exp. Med.*, lxxxiv. 260.
BOGUE, J. Y., EVANS, C. L., GRANDE, F., and HSU, F. Y., 1935, *Quart. J. exp. Physiol.*, xxv. 213.
BOGUE, J. Y., and MENDEZ, R., 1930, *J. Physiol.*, lxix. 316.
BOHNENKAMP, H., and EICHLER, O., 1926, *Pflüger's Arch.*, ccxii. 707.
BOHNENKAMP, H., 1926, *Z. Biol.*, lxxxiv. 79.
BOHNENKAMP, H., 1927 a, *Munch. med. Wschr.*, lxxiv. 175.
BOHNENKAMP, H., 1927 b, *Arch. exp. Path. Pharmac.*, 119, *Verh. dtsch. Pharmak. ges.*, 32.
BOHNENKAMP, H., EISMAYER, G., and ERNST, H. W., 1928, *Z. Biol.*, lxxxvii. 489.
BOHNENKAMP, H., and ERNST, H. W., 1926, *Ibid.*, lxxxiv. 436.
BOHNENKAMP, H., ERNST, H. W., and NAMETO, A., 1928, *Ibid.*, lxxxvii. 498.
BOHNENKAMP, H., ERNST, H. W., and NAMETO, A., 1929, *Ibid.*, lxxxviii. 429.
BONG, E., JUNKERSDORFF, J., and STEINBORN, H., 1932, *Z. ges. exp. Med.*, cxii. 265.
BOYLAND, E., 1928, *Biochem. J.*, xxii. 376.
BOZLER, E., 1930, *J. Physiol.*, lxxix. 442.
BRAND, T. v., 1935, *Ergebn. Biol.*, xii. 161.
BRODY, H., 1930, *Amer. J. Physiol.*, xciii. 190.
BROOKENS, N., 1933, *Biochem. Z.*, cclxvii., 347.
BROWN, G. L., and FELDBERG, W., 1936, *J. Physiol.*, lxxxvi. 290.
BRUNS, O., 1914, *Sitzungsber. Gesell. Beförd. ges. Naturw. Marburg.*, 21.
CARTER, E. P., and DIEUAIDE, F. R., 1926, *Bull. Johns Hopkins Hosp.*, xxxix. 99.
CASE, E. M., and COOK, R. P., 1931, *Biochem. J.*, xxv. 1319.
CATTELL, MCK., 1932, *J. Physiol.*, lxxv. 264.
CATTELL, MCK., 1934, *Amer. J. Physiol.*, cix. 18.
CATTELL, MCK., and EDWARDS, D. J., 1930, *Amer. J. Physiol.*, xciii. 97.

- CHANG, I., 1937, *Quart. J. exp. Physiol.*, xxvi. 285.
- CHARLES, E., 1930, *Proc. Roy. Soc. B.*, cvii. 504.
- CLARK, A. J., 1912, *Quart. J. exp. Physiol.*, v. 385.
- CLARK, A. J., 1913 *a*, *J. Physiol.*, xlvi. 20 P.
- CLARK, A. J., 1913 *b*, *Ibid.*, xlvi. 66.
- CLARK, A. J., 1920, *Ibid.*, liv. 275.
- CLARK, A. J., 1922, *J. Pharmacol.*, Baltimore, xviii. 423.
- CLARK, A. J., 1926 *a*, *J. Physiol.*, lxi. 530.
- CLARK, A. J., 1926 *b*, *Ibid.*, lxi. 547.
- CLARK, A. J., 1926 *c*, *J. Pharmacol.*, Baltimore, xxix. 311.
- CLARK, A. J., 1927, *J. Physiol.*, lxiv. 123.
- CLARK, A. J., 1935 *a*, *Quart. J. exp. Physiol.*, xxv. 167.
- CLARK, A. J., 1935 *b*, *Ibid.*, xxv. 181.
- CLARK, A. J., and EGGLETON, M. G., 1936, *Quart. J. exp. Physiol.*, xxvi. 119.
- CLARK, A. J., EGGLETON, M. G., and EGGLETON, P., 1931 *a*, *J. Physiol.*, lxxii. 25 P.
- CLARK, A. J., EGGLETON, M. G., and EGGLETON, P., 1931 *b*, *Ibid.*, lxxiv. 7 P.
- CLARK, A. J., EGGLETON, M. G., and EGGLETON, P., 1932, *Ibid.*, lxxv. 332.
- CLARK, A. J., GADDIE, R., and STEWART, C. P., 1930 *a*, *J. Physiol.*, lxx, 7 P.
- CLARK, A. J., GADDIE, R., and STEWART, C. P., 1930 *b*, *Proc. Roy. Soc. Edin.*, l. 297.
- CLARK, A. J., GADDIE, R., and STEWART, C. P., 1931, *J. Physiol.*, lxxii. 443.
- CLARK, A. J., GADDIE, R., and STEWART, C. P., 1932 *a*, *Ibid.*, lxxv. 311.
- CLARK, A. J., GADDIE, R., and STEWART, C. P., 1932 *b*, *Ibid.*, lxxv. 321.
- CLARK, A. J., GADDIE, R., and STEWART, C. P., 1933, *Ibid.*, lxxvii. 432.
- CLARK, A. J., GADDIE, R., and STEWART, C. P., 1934, *Ibid.*, lxxxii. 265.
- CLARK, A. J., and KINGISEPP, G., 1935, *Quart. J. exp. Physiol.*, xxv. 279.
- CLARK, A. J., and WHITE, A. C., 1928 *a*, *J. Physiol.*, lxvi. 185.
- CLARK, A. J., and WHITE, A. C., 1928 *b*, *Ibid.*, lxvi. 203.
- CLARK, A. J., and WHITE, A. C., 1930 *a*, *Ibid.*, lxviii. 406.
- CLARK, A. J., and WHITE, A. C., 1930 *b*, *Ibid.*, lxviii. 433.
- COHN, A. E., and STEELE, J. M., 1935, *Amer. J. Physiol.*, cxiii. 654.
- COOPER, S., and ECCLES, J. C., 1930, *J. Physiol.*, lxix. 3 P.

- CRUICKSHANK, E. W. H., 1913, *Ibid.*, xlvii. 1.
CRUICKSHANK, E. W. H., 1936, *Physiol. Rev.*, xvi. 597.
CRUICKSHANK, E. W. H., and McCLURE, G. S., 1936, *J. Physiol.*, lxxxvi. 1.
CRUICKSHANK, E. W. H., and STARTUP, C. W., 1933, *J. Physiol.*, lxxvii. 365.
DALE, A. S., 1935, *J. Physiol.*, lxxxiv. 433.
DALE, A. S., 1937, *Ibid.*, lxxxix. 316.
DALY, I. DE B., 1923, *Proc. Roy. Soc.*, B, xcv. 279.
DALY, I. DE B., and CLARK, A. J., 1921, *J. Physiol.*, liv. 367.
DAMBLÉ, K., 1932, *Z. Biol.*, cxii. 254.
DANILEWSKI, B., 1907, *J. Physiol. Path. gen.*, ix. 909.
DANILEWSKI, B., 1907, *Pflüger's Arch.*, cxx. 181.
DAVID, J. C., 1930, *J. Pharmacol.*, Baltimore, xl. 229.
DAVID, J. C., 1931, *Quart. J. exp. Physiol.*, xxi. 181.
DAVIS, E., 1931, *J. Physiol.*, lxxi. 431.
DE, P., 1928, *J. Pharmacol.*, Baltimore, xxxiii. 115.
DECHERD, G., and VISSCHER, M. B., 1933, *Amer. J. Physiol.*, ciii. 400.
DENNIG, H., 1920, *Z. Biol.*, lxxii. 187.
DICKENS, F., and GREVILLE, G. D., 1933, *Biochem. J.*, xxvii. 832.
DITTMAR, 1933, *Arch. exp. Path. Pharmacol.*, clxxi. 496.
DIXON, M., and ELLIOTT, K. A. C., 1929, *Biochem. J.*, xxiii. 812.
DOI, Y., 1920, *J. Physiol.*, liv. 218.
DRURY, A. N., and ANDRUS, E. C., 1924, *Heart*, xi. 389.
DRURY, A. N., and LOVE, W. S., 1926, *Ibid.*, xiii. 77.
ECKSTEIN, A., 1920, *Pflüger's Arch.*, clxxxiii. 40.
EDDY, N. B., and DOWNS, A. W., 1921, *Amer. J. Physiol.*, lvi. 182, 188.
EDSALL, J. T., HUNT, H. B., READ, W. P., and REDFIELD, A. C., 1932, *J. Cell. Comp. Physiol.*, i. 475.
EDWARDS, D. J., and CATTELL, MCK., 1930, *Amer. J. Physiol.*, xciii. 90.
EDWARDS, D. J., and SANGER, G., 1933, *Amer. J. Physiol.*, cv. 29.
EGGLETON, G. P., and EGGLETON, P., 1928, *J. Physiol.*, lxxv. 15.
EGGLETON, G. P., and EGGLETON, P., 1929, *Ibid.*, lxxviii. 193.
EGGLETON, M. G., 1933, *Ibid.*, lxxix. 31.
EGGLETON, P., 1926, *Biochem. J.*, xx. 395.
EINTHOVEN, W., 1924-25, Harvey Lectures, xx. 111.
EINTHOVEN, W., and HUGENHOLTZ, F. W. W., 1921, *Arch. neerl. Physiol.*, v. 176.
EISMAYER, G., 1930, *Ergebn. Physiol.*, xxx. 126.
EISMAYER, G., and QUINCKE, H., 1929, *Z. Biol.*, lxxxiii. 130.
EISMAYER, G., and QUINCKE, H., 1929, *Klin. Wschr.*, viii. 1853.

- EISMAYER, G., and QUINCKE, H., 1930, *Z. Biol.*, lxxxix. 523.
 EISMAYER, G., and QUINCKE, H., 1930 a, *Ibid.*, xc. 57.
 EISMAYER, G., and QUINCKE, H., 1930 b, *Arch. exp. Path. Pharmacol.*, cl. 308.
 EISMAYER, G., and QUINCKE, H., 1930 c, *Ibid.*, clii. 177.
 ERNST, E., and CSUCS, L., 1929, *Pflüger's Arch.*, ccxxiii. 663.
 ERNST, E., and FRICKER, J., 1931, *Ibid.*, ccxxviii. 700.
 ERNST, E., and FRICKER, J., 1934, *Ibid.*, ccxxxiv. 399.
 ERNST, E. and SCHEFFER, L., 1928, *Ibid.*, ccxx. 655.
 ERNST, E., and TAKACS, I., 1931, *Pflüger's Arch.*, ccxxviii. 690.
 EULER, U. S. VON, 1934, *J. Physiol.*, lxxxiv. 1.
 EVANS, C. L., 1912, *Ibid.*, xlv. 213.
 EVANS, C. L., 1914, *Ibid.*, xlvii. 407.
 EVANS, C. L., 1917, *Ibid.*, li. 91.
 EVANS, C. L., 1918, *Ibid.*, lii. 6.
 EVANS, C. L., 1936, *Recent Advances in Physiology*, Chapter II. Churchill, London.
 EVANS, C. L., DE GRAAF, A. C., KOSAKA, T., MACKENZIE, K., MURPHY, G. E., VACEK, T., WILLIAMS, D. H., and YOUNG, F. G., 1933-34, *J. Physiol.*, lxxx. 4.
 EVANS, C. L., GRANDE, F., and HSU, F. Y., 1935, *Quart. J. exp. Physiol.*, xxiv. 283.
 EVANS, C. L., GRANDE, F., and HSU, F. Y., 1935, *Ibid.*, xxiv. 347.
 EVANS, C. L., GRANDE, F., HSU, F. Y., LEE, D. H. K., and MULDER, A. G., 1935, *Ibid.*, xxiv. 365.
 EVANS, C. L., and MATSUOKA, Y., 1915, *J. Physiol.*, xlix. 378.
 EVANS, C. L., and OGAWA, S., 1914, *Ibid.*, xlvii. 446.
 EVANS, G., 1934, *Ibid.*, lxxxii. 468.
 FAHR, G., 1908, *Z. Biol.*, lii. 72.
 FELDBERG, W., and GUIMARAIS, J. A., 1936, *J. Physiol.*, lxxxvi. 306.
 FENG, T. P., 1932, *J. Physiol.*, lxxiv. 441.
 FENN, W. O., 1923-24, *Ibid.*, lviii. 175, 373.
 FENN, W. O., 1927-28, *Amer. J. Physiol.*, lxxxiii. 309.
 FENN, W. O., 1928, *Ibid.*, lxxxiv. 110.
 FENN, W. O., 1930, *Ibid.*, xciii. 124.
 FENN, W. O., 1934, *J. Cell. Comp. Physiol.*, v. 347.
 FENN, W. O., 1936, *Physiol. Rev.*, xvi. 450.
 FENN, W. O., and COBB, D. M., 1936, *Amer. J. Physiol.*, cxv. 345.
 FERDMANN, D., and FEINSCHMIDT, O., 1928, *Z. Physiol. Chem.*, clxxviii. 173.
 FISCHER, E., 1926, *Proc. Roy. Soc., B.*, xcix. 325.
 FISCHER, E., 1927, *Pflüger's Arch.*, ccxvi. 123.
 FISCHER, E., 1930, *Amer. J. Physiol.*, xcvi. 78.

- FISCHER, W., 1917, *Arch. exp. Path. Pharmac.*, lxxx. 93.
- FOLIN, O., and BUCKMANN, T. E., 1914, *J. Biol. Chem.*, xvii. 483.
- FRANK, O., 1895, *Z. Biol.*, xxxii. 370.
- FREEMAN, N. E., 1930, *Amer. J. Physiol.*, xcii. 107.
- FREUND, H., and KÖNIG, W., 1927, *Arch. exp. Path. Pharmac.*, cxxv. 193.
- FREY, E., BERGER, W., and PFISTER, H., 1932, *Schweiz. med. Wschr.*, i. 230.
- FREY, W., and TIEMANN, F., 1926, *Z. ges. exp. Med.*, liii. 639.
- FUKUDA, T., and NAITO, T., 1927, *Proc. Japan. Pharmac. Soc.*, i. 40.
- FULTON, J. F., 1926, *Muscular Contraction and Reflex Control of Movements*, p. 246. Baillière, Tindall & Cox.
- FURTH, O., and SCHWARTZ, C., 1910, *Biochem. Z.*, xxx. 413.
- FURUSAWA, K., and KERRIDGE, P. M. T., 1927, *J. Physiol.*, lxiii. 33.
- GADDIE, R., and STEWART, C. P., 1934, *J. Physiol.*, lxxx. 457.
- GADDIE, R., and STEWART, C. P., 1935, *Biochem. J.*, xxix. 2101.
- GARREY, W. E., and BOYKINS, J. T., 1933, *Amer. J. Physiol.*, cv. 35.
- GARREY, W. E., and BOYKINS, J. T., 1934, *Ibid.*, cix. 286.
- GASSER, H. S., and HARTREE, W., 1924, *J. Physiol.*, lviii. 396.
- GELLHORN, E., 1933, *Amer. J. Physiol.*, cv. 353.
- GEMMILL, C. L., 1928, *Ibid.*, lxxxiii. 415.
- GEMMILL, C. L., 1934-35, *J. Cell. Comp. Physiol.*, v. 277.
- GEMMILL, C. L., 1935, *Amer. J. Physiol.*, cxii. 294.
- GERARD, R. W., 1931, *Biol. Bull.*, lx. 244.
- GOMPERTZ, C., 1884, *Arch. (Anat.) Physiol., Lps.*, i. 242.
- GOTTDENKER, F., and WACHSTEIN, M., 1933, *Biochem. Z.*, cclxvii. 192.
- GOTTSCHALK, G., 1913, *Arch. exp. Path. Pharmac.*, lxxv. 33.
- GRADINESCO, A., 1926, *C. R. Soc. Biol. Paris*, xcv. 1043.
- GRANT, M. H., 1920, *J. Physiol.*, liv. 79.
- GRAY, J., 1921, *Proc. Roy. Soc., B.*, xcvi. 95.
- GREMELS, H., 1933, *Arch. exp. Path. Pharmac.*, clxviii. 689.
- GUPTA, J. C., 1933, *Arch. exp. Path. Pharmac.*, clxxi. 206.
- HAFKESBRING, R., and ASHMAN, R., 1928, *Amer. J. Physiol.*, lxxxvii. 305.
- HAGEDORN, H. C., and JENSEN, B. N., 1923, *Biochem. Z.*, cxxxv. 46; cxxxvii. 42.
- HALDANE, J. S., and LORRAIN SMITH, J., 1897, *J. Physiol.*, xxii. 231.
- HARTREE, W., 1931, *Ibid.*, lxxii. 1.
- HARTREE, W., and HILL, A. V., 1921, *Ibid.*, lv. 389.
- HARTREE, W., and HILL, A. V., 1928, *Proc. Roy. Soc., B.*, civ. 1.

- HEGNAUER, A. H., FENN, W. O., and COBB, D.M., 1934, *J. Cell. Comp. Physiol.*, iv. 505.
- HEMINGWAY, A., and FEE, A. R., 1927, *J. Physiol.*, lxiii. 299.
- HEMMETER, —, 1914, *Biochem. Z.*, lxiii. 118, 140.
- HERLITZKA, A., 1912, *Arch. Fisiol.*, x. 501.
- HERLITZKA, A., 1915, *Pflüger's Arch.*, clxi. 997.
- HILL, A. V., 1911, *J. Physiol.*, xliii. 379.
- HILL, A. V., 1925, *Ibid.*, lx. 237.
- HILL, A. V., 1930, *Proc. Roy. Soc.*, B., cvii., 115.
- HILL, A. V., and KUPALOV, P. S., 1929, *Ibid.*, B., cv. 313.
- HIMEI, I., 1935, *Jap. J. med. Sci.*, Part 4 *Pharmacol.*, p. 159.
- HIMWICH, H. E., and CASTLE, W. B., 1927, *Amer. J. Physiol.*, lxxxiii. 92.
- HIMWICH, H. E., and ROSE, M. I., 1929, *Ibid.*, lxxxviii. 663.
- HINES, H. K., KATZ, L. N., and LONG, C. N. H., 1925, *Proc. Roy. Soc.*, B., xcix. 20.
- HOEBER, R., 1928, *Pflüger's Arch.*, ccxxi. 478.
- HOFFMANN, A., 1910, *Ibid.*, cxxxiii. 552.
- HOGBEN, L. T., 1925, *Quart. J. exp. Physiol.*, xv. 263.
- HOLZ, B., and MISSKE, B., *Arch. exp. Path. Pharmak.*, clxxvi. 199.
- HOUSSAY, B. A., and MAZZOCCO, P., 1927, *C. R. Soc. Biol. Paris*, xcvi. 1252.
- HOWELL, W. H., 1906, *Amer. J. Physiol.*, xv. 291.
- HOWELL, W. H., and DUKE, W. W., 1908, *Ibid.*, xxi. 51.
- IZQUIERDO, J. J., 1929-30, *J. Physiol.*, lxviii. 363.
- JAVILLIER, M. M., CRÉMIEU, A., and HINGLAIS, H., 1928, *Bull. Soc. Chim. Biol.*, x. 327.
- DE JONGH, C. L., 1923, *Quart. J. exp. Physiol.*, *Suppl.*, p. 154.
- DE JONGH, C. L., 1926, *Pflüger's Arch.*, ccxiii. 216.
- JUNKERSDORF, P., and HANISCH, S., 1927, *Arch. exp. Path. Pharmak.*, cxiii. 231.
- JUNKMANN, K., 1925, *Ibid.*, cviii. 148.
- KATZ, L., 1928, *Physiol. Rev.*, viii. 447.
- KATZ, L. N., and LONG, C. N. H., 1925, *Proc. Roy. Soc.*, B., xcix. 8.
- KEILIN, D., 1925, *Ibid.*, B., xcvi. 312.
- KEILIN, D., 1930, *Ibid.*, cvi., 442.
- KERLY, M., 1931, *Biochem. J.*, xxv. 671.
- KERMACK, W. O., LAMBIE, C. G., and SLATER, R. H., 1929, *Biochem. J.*, xxiii. 416.
- KINGISEPP, G., 1935, *Quart. J. exp. Physiol.*, xxv. 291.
- KISCH, B., 1933, *Biochem. Z.*, cclxiii. 187.
- KISCH, B., 1935, *Ibid.*, cclxxx. 55.
- KLEWITZ, F., 1912, *Z. Biol.*, lxvii. 279.

- KLISIECKI, A. J., 1934, *Quart. J. exp. Physiol.*, xxiv. 225.
- KRAUS, F., WOLLHEIM, E., and ZONDEK, S. G., 1924, *Klin. Wschr.*, iii. 735.
- KRISTENSON, A., 1928, *Skand. Arch. Physiol.*, liv. 189.
- KROGH, A., 1904, *Ibid.*, xv. 328.
- KROGH, A., 1910, *Ibid.*, xxiii. 179.
- KROGH, A., 1916, *The Respiratory Exchange of Animals*. London.
- ✓KROGH, A., 1922, *Anatomy and Physiology of Capillaries*. Yale University Press.
- KRYNSKA, H. P., and WITANOWSKI, W. R., 1930, *Acta Biol. Exp. Warsaw*, vi. 53. Quoted from *Ber. ges. Physiol.*, 1932, lxxviii. 725.
- LANCZOS, A., 1935, *Arch. exp. Path. Pharmak.*, clxxvii. 752.
- LANCZOS, A., 1936, *Ibid.*, clxxx. 312.
- LATIMER, H. B., 1920, *Anat. Record*, xviii. 35.
- LAWACZEK, H., 1923, *Z. Physiol. Chem.*, cxxv. 210.
- LAWRENCE, R. D., and McCANCE, R. A., 1931, *Biochem. J.*, xxv. 570.
- LEEUWEN, W., STORM, VAN, and GYÖRGYI, V. S., 1923, *J. Pharmacol.*, Baltimore, xxi. 85.
- LEHMANN, H., 1936, *Biochem. Z.*, cclxxxvi. 337.
- LIANG, C. M., 1934, *Pflüger's Arch.*, ccxxxiv. 302.
- LIEB, H., and LOEWI, O., 1919, *Ibid.*, clxxiii. 152.
- LINDNER, F., and RIGLER, R., 1931, *Ibid.*, ccxxvi. 697.
- LOCKE, F. S., and ROSENHEIM, O., 1904, *J. Physiol.*, xxxi. 14 P.
- LOEB, J., and WASTENYS, H., 1913, *Biochem. Z.*, lvi. 295.
- LOEWI, O., 1918, *Pflüger's Arch.*, clxx. 677.
- LOEWI, O., 1921, *Ibid.*, clxxxvii. 123.
- LOHMANN, K., 1926, *Biochem. Z.*, clxxxviii. 444.
- LOHMANN, K., 1928 a, *Ibid.*, ccii. 466.
- LOHMANN, K., 1928 b, *Ibid.*, cciii. 164.
- LOHMANN, K., 1934, *Ibid.*, cclxxi. 264.
- LOHMANN, K., 1935, *Ibid.*, cclxxxii. 109.
- LOHMANN, K., and WEICKER, B., 1933, *Oppenheimer's Handb. Biochem. Ergänz.*, ii. 243.
- LÖWENBACH, H., 1931, *Klin. Wschr.*, xxvii. 2299.
- LUCAS, KEITH, 1912, *Proc. Roy. Soc., B.*, lxxxv. 495.
- LUNDSGAARD, E., 1930, *Biochem. Z.*, ccxvii. 162.
- LUNDSGAARD, E., 1934, *Ibid.*, cclxix. 308.
- LUSCHER, E., 1919, *Z. Biol.*, lxx. 245.
- LUSCHER, E., 1920, *Ibid.*, lxxii. 107.
- LUSCHER, E., 1921, *Ibid.*, lxxiii. 67.
- LUSK, G., 1928, *Science of Nutrition*, 4th Ed. Saunders, London.
- LUSSANA, F., 1908, *Arch. Fisiol.*, vi. 1.

- MACALLUM, A. C., 1926, *Physiol. Rev.*, vi. 316.
- MCDONALD, C. H., and MCDONALD, A. C., 1935, *Amer. J. Physiol.*, cxi. 51.
- MACELA, I., and SELISKAR, A., 1925, *J. Physiol.*, lx. 428.
- MCGINTY, D. A., 1931, *Amer. J. Physiol.*, xcvi. 244.
- MALORNY, G., and NETTER, H., 1936, *Pflüger's Arch.*, ccxxxviii. 153.
- MALTESOS, C., 1934, *Z. Biol.*, xcv. 205.
- MARTIN, E. G., 1905, *Amer. J. Physiol.*, xv. 303.
- MAUGER, J., 1933, *Arch. exp. Path. Pharmacol.*, clxix. 268.
- MAX, L. W., 1931, *Amer. J. Physiol.*, xcvi. 318.
- MEHRA, E., 1923, *Pflüger's Arch.*, cxix. 194.
- MEYERHOF, O., 1923 a, *Ibid.*, cxci. 128.
- MEYERHOF, O., 1923 b, *Ibid.*, cxci. 531.
- MEYERHOF, O., *Die chemische Vorgänge im Muskel*. Springer, Berlin.
- MEYERHOF, O., 1931, *Biochem. Z.*, ccxxxvii. 427.
- MEYERHOF, O., and BOYLAND, E., 1931, *Ibid.*, ccxxxvii. 406.
- MEYERHOF, O., GEMMILL, C., and BENETATO, G., 1932, *Ibid.*, cclviii. 371.
- MEYERHOF, O., and LOHMANN, K., 1926, *Ibid.*, clxviii. 128.
- MINES, G. R., 1913 a, *J. Physiol.*, xlv. 188.
- MINES, G. R., 1913 b, *Ibid.*, xlv. 349.
- MINES, G. R., 1913 c, *J. Pharmacol.*, Baltimore, v. 425.
- MITCHELL, P. H., and WILSON, J. W., 1921, *J. gen. Physiol.*, iv. 45.
- MOND, R., and NETTER, H., 1932, *Pflüger's Arch.*, ccxxx. 42.
- MONONOBE, K., 1930, *Fol. Pharm. Jap.*, xi. Orig. 1.
- MOZOŁOWSKI, W., and MANN, T., 1932, *Biochem. Z.*, ccxlix. 161.
- NACHMANNSSOHN, O., 1928, *Biochem. Z.*, cxv. 73.
- NAGAYA, T., 1929, *Pflüger's Arch.*, ccxxi. 733.
- NAHUM, L. H., and HOFF, H. E., 1934, *Amer. J. Physiol.*, cx. 56.
- NEEDHAM, J., 1926, *Ergebn. Physiol.*, xxv. 1.
- NEUSCHLOSS, S. M., 1926, *Pflüger's Arch.*, ccxxiii. 19.
- NEUSCHLOSS, S. M., and TRELLES, R. A., 1924, *Ibid.*, cciv. 374.
- NEUSCHLOSS, S. M., 1926, *Ibid.*, ccxxiii. 9.
- NEUSCHLOSS, S. M., 1926, *Ibid.*, ccxxiii. 17.
- NILSSON, L., 1906, *Zbl. Physiol.*, xx. 202.
- OCHOA, S., 1930, *Biochem. Z.*, ccxxvii. 116.
- OSTERN, P., 1930, *Ibid.*, ccxxviii. 401.
- OSTERN, P., and BARANOWSKI, T., 1935, *Ibid.*, cclxxx. 157.
- OSTERN, P., and PARNAS, J. K., 1932, *Biochem. Z.*, ccxlviii. 389.
- PALLADIN, A., and EPELBAUM, S., 1928, *Z. Physiol. Chem.*, clxxviii. 179.
- PARNAS, J. K., 1932, *Biochem. Z.*, ccxlviii. 398.

- PARNAS, J. K., 1935, *Klin. Wschr.*, xiv. 1017.
- PARNAS, J. K., and HELLER, J., 1924, *Biochem. Z.*, clii. 1.
- PARNAS, J. K., and OSTERN, P., 1931, *Biochem. Z.*, ccxxxiv. 307.
- PARNAS, J. K., and OSTERN, P., 1932, *Ibid.*, ccxlviii. 398.
- PARNAS, J. K., OSTERN, P., and MANN, T., 1934, *Ibid.*, cclxxv. 74.
- PICKFORD, L. M., 1927, *J. Physiol.*, lxiii. 19.
- POHL, R., and SCHELLONG, F., 1930, *Z. ges. exp. Med.*, lxx. 590.
- PRASAD, B. N., 1935 a, *J. Physiol.*, lxxxv. 239.
- PRASAD, B. N., 1935 b, *Ibid.*, lxxxv. 249.
- PRASAD, B. N., 1936, *Ibid.*, lxxxvi. 425.
- RAAB, E., 1927, *Pflüger's Arch.*, ccxvi. 540.
- REDFIELD, A. C., 1933, *Quart. Rev. Biol.*, viii. 31.
- REDFIELD, A. C., and MEDEARIS, P. N., 1926, *Amer. J. Physiol.*, lxxvii. 662.
- RIESSER, O., 1928, *Arch. exp. Path. Pharmak.*, cxxxviii. 136.
- RIESSER, O., *Ergebn. Physiol.*, xxxviii. 133.
- RIMINGTON, C., 1931, *Biochem. J.*, xxv. 1062.
- RINGER, S., and SAINSBURY, H., 1883, *J. Physiol.*, iv. 350.
- RITCHIE, A. D., 1932, *Nature*, cxxix. 165.
- RITCHIE, A. D., 1933, *J. Physiol.*, lxxviii. 323.
- ROHDE, E., 1912, *Arch. exp. Path. Pharmak.*, lxviii. 401.
- ROHDE, E., 1920, *Pflüger's Arch.*, clxxxii. 114.
- ROHDE, E., and OGAWA, S., 1912, *Arch. exp. Path. Pharmak.*, lxix. 200.
- ROOS, J., 1932, *J. Physiol.*, lxxiv. 17.
- ROSENTHAL, O., and LASNITZKI, A., 1928, *Biochem. Z.*, cxcvi. 340.
- ROTHBERGER, J., and GOLDENBERG, M., 1931, *Z. ges. exp. Med.*, lxxix. 687.
- ROTHMANN, H., 1930, *Arch. exp. Path. Pharmak.*, clv. 129.
- ROTHSCHILD, P., 1930, *Biochem. Z.*, ccxxii. 21.
- RUBNER, M., 1924, *Biochem. Z.*, cxlviii. 222, 268.
- RUHL, A., 1934, *Klin. Wschr.*, xiii. 1529.
- SAMOJLOFF, A., 1910, *Pflüger's Arch.*, cxxxv. 450.
- SAMOJLOFF, A., 1912, *Ibid.*, cxlvii. 255.
- SATOH, H., 1929, *Tohoku J. exp. Med.*, xiii. 292.
- SATOH, I., 1935, *J. Biochem.*, xxi. 19.
- SCHEINFINKEL, N., 1924, *Z. Biol.*, lxxxii. 285.
- SCHEINFINKEL, N., 1935, *Ibid.*, xcvi. 178.
- SCHELLONG, F., 1924, *Z. Biol.*, lxxxii. 27, 174, 435.
- SCHELLONG, F., 1928, *Z. ges. exp. Med.*, lxi. 278.
- SCHELLONG, F., 1931, *Ibid.*, lxxviii. 1.
- SCHELLONG, F., and SCHUTZ, E., 1928, *Ibid.*, lxi. 285.
- SCHENK, P., 1924, *Pflüger's Arch.*, ccii. 315.

- SCHULZ, F. N., and KRUGER, FR. V., 1925, *Winterstein's Handb. Vergl. Physiol.*, I., i. 1111.
- SCHÜTZ, E., 1928, *Z. Biol.*, lxxxvii. 219.
- SCHÜTZ, E., 1932, *Ibid.*, xcii. 441.
- SCHÜTZ, E., 1936, *Ergebn. Physiol.*, xxxviii. 493.
- SCHÜTZ, E., and LUEKEN, B., 1935, *Z. Biol.*, xcvi. 364, 502.
- SCHÜTZ, E., and LUEKEN, B., 1936, *Vortr. Tagg. deutsch. Physiol. Ges. Giessen und Bad Nauheim*.
- SEEL, H., 1926, *Arch. exp. Path. Pharmak.*, cxvii. 282.
- SEEMANN, J., 1913, *Z. Biol.*, lix. 53.
- SEGALL, H. N., and ANREP, G. V., 1926, *Heart*, xiii. 61.
- SELISKAR, A., 1926, *J. Physiol.*, lxi. 172.
- SEMEANOFF, E., 1931, *Quart. J. exp. Physiol.*, xxi. 187.
- SEGEL, R., and UNNA, Z., 1931 *a*, *Klin. Wschr.*, xxvii. 171, 920.
- SIEGEL, R., and UNNA, Z., 1931 *b*, *Z. ges. exp. Med.*, lxxviii. 278.
- SKRAMLIK, E. VON, 1921, *Ibid.*, xiv. 246.
- SMITH, H. W., 1926, *Amer. J. Physiol.*, lxxvi. 411.
- SNYDER, C. D., 1917, *Amer. J. Physiol.*, xlv. 421.
- SNYDER, C. D., 1918, *Ibid.*, xlvii. 156.
- SNYDER, C. D., 1922, *Ibid.*, lix. 254.
- SNYDER, C. D., 1923, *Ibid.*, lxiii. 581.
- SNYDER, C. D., 1926, *Ibid.*, lxxvi. 170.
- SOLANDT, D. Y., 1936, *J. Physiol.*, lxxxvi. 162.
- SOMOGYI, —, 1927, *J. Biol. Chem.*, lxxv. 33.
- SPRAGUE, P. H., 1933, *Amer. J. Physiol.*, cv. 402.
- STARLING, E. H., and EVANS, C. L., 1914, *J. Physiol.*, xlix. 67.
- STARLING, E. H., and VISSCHER, M. B., 1925-26, *Ibid.*, lxii. 243.
- STELLA, G., 1928, *Ibid.*, lxvi. 19.
- STELLA, G., 1931, *Ibid.*, lxxii. 247.
- STEWART, C. P., DICKSON, J. P., and GADDIE, R., 1934, *Biochem. J.*, xxviii. 1945.
- STEWART, C. P., GADDIE, R., and DUNLOP, D. M., 1931, *Biochem. J.*, xxv. 733.
- STEWART, C. P., and WHITE, A. C., 1925, *Biochem. J.*, xix. 840.
- STREEF, G. M., 1926, Diss. quoted from *Bev. ges. Physiol.*, 1927, xxxviii. 637.
- TEN CATE, J., 1924, *Arch. Neerland. Physiol.*, ix. 558.
- TRENDELENBURG, W., 1912, *Pflüger's Arch.*, cxliv. 39.
- TSCHERMAK, A., 1930, *Ibid.*, ccxxiv. 337.
- TSO, T. M., 1930, *J. Physiol.*, lxviii. 441.
- URANO, F., 1908 *a*, *Z. Biol.*, l. 212.
- URANO, F., 1908 *b*, *Ibid.*, li. 483.
- VERNON, H. M., 1910, *J. Physiol.*, xl. 295.

- VICTOR, J., 1934, *Amer. J. Physiol.*, cviii. 229.
- VISSCHER, M. B., 1928, *Ibid.*, lxxxv. 410.
- VISSCHER, M. B., and MULDER, A. G., 1930, *Ibid.*, xciv. 630.
- VOGT, M., 1936, *J. Physiol.*, lxxxvi. 258.
- DE WAARD, 1918, *Nederl. Tijdschr. Geneesk.*, II. 992.
- WACHHOLDER, K., and QUENSEL, W., 1934, *Pflüger's Arch.*, ccxxxv. 70.
- WASTL, H., and SELISKAR, A., 1925, *J. Physiol.*, lx. 264.
- WEICHARDT, W., and UNGER, H., 1929, *Z. ges. exp. Med.*, vii. 746.
- WEICKER, B., 1934, *Arch. exp. Path. Pharmac.*, clxxiv. 383.
- WEIZSÄCKER, V., 1911, *Pflüger's Arch.*, cxli. 457.
- WEIZSÄCKER, V., 1912 a, *Ibid.*, cxlvii. 135.
- WEIZSÄCKER, V., 1912 b, *Ibid.*, cxlviii. 535.
- WEIZSÄCKER, V., 1914, *J. Physiol.*, xlviii. 352.
- WEIZSÄCKER, V., 1914, *Ibid.*, xlviii. 396.
- WEIZSÄCKER, V., 1917, "S.B. Akad. Wiss. Heidelberg, Kl. B.," 2 Abt., quoted from *Handb. Norm. Path. Physiol.*, vii. 698, 1926.
- WERTHEIMER, E., 1930, *Pflüger's Arch.*, ccxxv. 429.
- WERTHEIMER, E., 1931, *Ibid.*, ccxxvii. 100.
- WERTHEIMER, E., 1932, *Ibid.*, ccxxix. 744.
- WERTHEIMER, E., 1933, *Ibid.*, ccxxxii. 120.
- WERZ, R. VON, 1935, *Arch. exp. Path. Pharmac.*, clxxvii. 183.
- WHITE, A. C., 1929, *Z. Physiol. Chem.*, clxxxiii. 184.
- WIELAND, H., 1921, *Arch. exp. Path. Pharmac.*, lxxxix. 47.
- WILLIGEN, —, 1926, *Onder. Physiol. Utrecht.*, vi. 170.
- WINTER, L., 1934, *Biochem. J.*, xxviii. 6.
- WITTING, V., MARKOWITZ, J., and MANN, F. C., 1930, *Amer. J. Physiol.*, xciv. 34.
- YASUTAKE, T., 1925, *Amer. J. Phys.*, lxxxii. 605.
- YOUNG, L., 1934, *Biochem. J.*, xxviii. 1435.
- ZEEHUISEN, H., 1927, *Arch. Neerl. Physiol.*, xii. 295.
- ZEEHUISEN, H., and STREEF, G. M., 1927, *Pflüger's Arch.*, ccxv. 170.
- ZEPP, P., 1923, *Z. ges. Anat.*, I., lxix. 84.
- ZIGANOW, S. W., 1926, *Z. ges. exp. Med.*, liii. 73.
- ZONDEK, S. G., 1929, *Arch. exp. Path. Pharmac.*, cxliiii. 192.
- ZONDEK, S. G., 1922, *Biochem. Z.*, cxxxii. 362.
- ZWAARDEMAKER, H., and LELY, J. W., 1917, *Arch. Neerland. Physiol.*, i. 748.
- ZWIKSTER, G. H., and BOYD, T. E., 1935, *Amer. J. Physiol.*, cxiii. 560.

INDEX

*The page references in heavy type refer to
Tables and Figures*

- Acetylcholine, duration of electrical and mechanical responses with, **224**, 225, 231
electrical and mechanical responses of heart with, **266**
heart arrest and phosphagen with, **162**
heart metabolism and action of, **202**, 204
potassium and action of, 35
rate of action of, 60
- Acid, electrical and mechanical responses of heart with, **216**, 217
- Acidity, conduction rate of heart with, 218, 222
duration of electrical and mechanical responses with, **224**
electrical response of heart with, 228, **229**
heart frequency and action of, 196
heart metabolism and, **202**
perfused heart and, **157**
refractory period of heart and, 221
- Acids, heart and action of, 195-196
- Adenine, heart and content of, 50
- Adenosinetriphosphate, estimation of, 153
function in muscle, 164-167
hypodynamic heart and, 97
- Adenylic acid, perfused heart and loss of, 123
phosphate changes in heart and, 164-167
- Adrenaline, glycogen usage by heart and, 262
heart, glycogen and, 41, 42-43
heart metabolism and action of, 206
heart stimulation by, 173-174
- Alanine, anoxæmic heart and, **143**
perfused heart on addition of, **128**
- Alcohol, carbohydrate balance of heart with, **108-109**
conduction rate of heart with, 218
heart metabolism and action of, **201**, **202**
- Alcohols, heart and rate of action of, 193-194
- Alkalinity, anoxæmia of heart and, 142-145
duration of electrical and mechanical responses with, **224**, 225
perfused heart and, **157**, **158**
- Amino-acid, R.Q. of, **129**
- Amino-acids, perfused heart reaction to, **128**
- Ammonia, blood and content of, 55
heart and content of, 50
method of estimation of, 284
perfused heart production of, 122-123, **125**
production, amino-acids on perfused heart and, 129
- Anæsthesia, heart glycogen and, 40
- Anoxæmia, carbohydrate balance of heart in, **108-109**
carbohydrate usage by heart in, 45
heart frequency and spread of with I.A.A., **75**, **76**, **77**, **78**
heart glycogen and, 41, 42
glucose effect on heart in, 141-143
lactic acid production in, 20, 24, 138-139, **140**, **141**
protein metabolism of heart in, 127
summary of effects on heart of, 190-191
- Anoxæmic perfused heart. *See* Perfused heart, anoxæmic
- A.R.P. = Absolute refractory period
- Arsenic, anoxæmic heart and, **152**
- Asphyxia. *See* Anoxæmia
- Asphyxial arrest, repeated effect on, 183-**184**
depression, measurement of rate of, 281-282
- Atropine, destruction by heart of, 259
- Auricle, cell size in, **11**
inorganic constituents of, **18**
optimum pressure for, 83
oxygen pressure necessary for, **65**
oxygen usage, measurement in, **278**, 279
oxygen usage, with filling of, **79-80**, **91**
oxygen usage, Warburg's formula and, **66**

- Auricle**, perfusion method of, 272
 pressure with filling of, 13
 survival powers of, 15
 thickness of, 5
 weight of, 10
- Auricular strip**, preparation and perfusion of, 270-271
 cyanide rate of action on, 184-185
- Auxobaric**, definition of, 83
 -response, registration of, 272
- Bicarbonate**, blood content of, 20-21
 plasmic content of, 52
- Blood**, carbon dioxide content of, 53
 composition of, 54
 oxygen capacity of, 53
 oxygen content of, 58
 oxygen dissociation curve of, 53
 perfused heart, oxygen pressure and uptake in, 62-63
 perfusion, carbohydrate balance of heart in, 108-109
 perfusion, oxygen usage and heart frequency with, 72
 perfusion of heart, method of, 279-281
 pressure, systolic, 13
- Buffer**, perfused heart, anoxæmia and, 175
 power of heart, 21-24
- Bufo marinus* heart, potassium diffusion into, 29
- Bufo variabilis*, metabolic rate of, 70
- Bulbus arteriosus**, cell size in, 11
 arteriosus, weight of, 10
- Bullock heart**, inositol content of, 47
- Butyric acid**, I.A.A. poisoned heart and, 134
- Calcium**, duration of electrical and mechanical responses with, 224, 226
 excess, refractory period of heart and, 221
 heart's content of, 18
 hypodynamic heart and, 98
 lack, carbohydrate balance of heart with, 108-109
 lack, electrical response of heart and, 213, 215, 216
 lack, electrical response and metabolism of heart with, 227
 lack, heart arrest and phosphagen in, 162
 lack, heart metabolism and action of, 202-203
 lack, mechanical response of heart and, 194
 loss in heart on perfusion, 30
 plasma and content of, 52
 sympathetic stimulation and liberation of, 36
- Canary heart**, latent period of, 255
- Caproic acid**, I.A.A. poisoned heart and, 134
- Captivity**, carbohydrate variation in heart with, 39
 metabolic rate and, 70
- Carbohydrate balance** in perfused heart, 108, 109, 110
 blood and content of, 54
 estimation of, in heart, 102-103
 loss, lactic acid production and, 139, 142
 metabolism, oxygen pressure and, 69, 259
 metabolism, plain muscle and, 265
 normal heart and content of, 38-40
- Carbon dioxide**, blood and content of, 53
 heart and action of, 196
 heart permeability to, 26
 pressure in frog, 14
 tension in frog, 20-21
- Cardiac efficiency**, 232-234
- Cat heart**, calcium lack on metabolism of, 205
 chloral hydrate action on, 199
 depressants on metabolism of, 204
 lactic acid content of, 48
 lactic acid production in, 23, 137
 strophanthin on metabolism of, 207
 work and filling of, 89
- Cells**, oxygen pressure necessary for, 62
- Cephalin**, hypodynamic heart and, 96
- Chloride**, plasma and content of, 52
- Cholesterol**, heart and content of, 49
- Cilia**, depressants and metabolism of, 205
- Colloidal state**, recovery of heart and, 248
- Colloids**, hypodynamic heart and, 96
- Contraction process**, sequel of events in, 251-254
 Ritchie's theory of, 255
- Creatine**, phosphate changes in heart and, 164-167
 heart and content of, 50
- Curare**, electrical and mechanical responses of heart with, 216
- Cyanide**, heart frequency and action of, 187
 heart metabolism and action of, 204
 I.A.A. poisoning and action of, 163-164
 -resistant metabolism, 189
 summary of effects on heart of, 191
- Cytochrome**, anoxæmia of heart and energy from, 185-186
 heart and content of, 49
 narcotics and, 194-195
 oxygen pressure necessary for, 62

- Depressants, efficiency of heart with, 234-235
 electrical response of heart with, 231-232
 mode of action of, 252-253
- D.E.R. = Duration of electrical response
- Diadenosinepentaphosphate, heart and occurrence of, 166
- D.M.R. = Duration of mechanical response
- Dog's heart, anoxæmia and alkalinity of, 145
 carbohydrate usage and adrenaline in, 114
 glycogen content of, 41
 inositol content of, 47
 lactic acid, usage by, 117
 metabolism and work done by, 90
 oxygen usage with filling of, 89
- Double cannula perfusion method, 274
- Duck muscle, resting metabolism of, 267
- Electrical response duration, factors controlling, 248-249
- Electrical response, duration in relation to duration of mechanical response, 221-226
 filling of heart and, 231
 latent period of, 219
 measurement in heart, 240-241
 mechanical response relation to, 212-226
 metabolism of heart and, 226-232
 recovery of, 254
 recovery of, duration of, 245, 247
 refractory period of heart and, 220-221
- Embden-Meyerhof carbohydrate cycle, 120, 148
- Empty heart, duration of electrical and mechanical responses in, 224
 heart, metabolism with stimulation of, 235
- Endocardium, permeability of, 6
- Ethyl alcohol, heart and rate of action of, 193-194
 urethane, heart arrest and phosphagen in, 162
 urethane, heart metabolism and action of, 200-201, 202
- Fat metabolism, heart and, 262
 method of estimation of, 283
 perfused heart and, 48-49
 perfused heart and usage of, 132
- Fatty acids, anoxæmic heart and, 143-144
 I.A.A. poisoned heart response to, 134-135
 perfused heart usage of, 133-134
- Fenn effect, heart and, 237
- Filling, heat production of heart and, 84-85
 mechanical response of heart and, 82-83
 structure of heart in relation to, 2, 3
- Frog, carbon dioxide pressure in, 14
 ventricle, I.A.A. and refractory period of, 228
- Frog's auricle. *See* Auricle
 blood. *See* Blood
 heart. *See* Heart
 sinus. *See* Sinus
- Glucosamine, heart and content of, 45
 heart and presence of, 103
- Glucose, anaerobic heart recovered by, 141-143
 anoxæmic heart and, 151
 carbohydrate balance of heart with, 108-109, 110
 glycogen loss from heart on addition of, 105-106
 method of estimation of, 283
- Glucose-perfused heart, lactic acid production in, 172
- Glutamic acid, I.A.A. poisoned heart and, 131
- Glutathione, anoxæmic heart and, 151
 I.A.A. poisoned heart, anoxæmic and, 152
 resting metabolism and, 267
- Glyceric aldehyde, anoxæmic heart and, 149-150
- Glycerophosphate, anoxæmic heart and, 149-150
- Glycine, anoxæmic heart and, 143
 perfused heart on addition of, 125, 128
- Glycogen, heart and content of, 38
 mammalian hearts and content of, 40-43
 method of estimation of, 282
 perfused heart loss of, 105-106
 phosphate changes in heart and, 164-167
 total carbohydrate ratio in heart, 43
- Glyoxalase, glutathione and, 151
- Hæmatin, blood and content of, 54
- Hæmoglobin, blood and content of, 54
- Heart, absolute refractory period of, 242
 activity, respiratory quotient and, 198
 adenine content of, 50
 aerobic production of lactic acid by, 120-121
 amino-acids sparing action on, 129-130
 ammonia content of, 50
 anaerobic production of lactic acid in, 138-139, 140, 141
 anoxæmic. *See* Anoxæmic heart

- Heart, arrested, oxygen usage and filling of, **91, 92-93**
 asphyxial depression in, 175-177
 asphyxial depression measurement in, 281-282
 atropine destruction by, 259
 beat, phosphagen function in, 167-168
 bicarbonate content of, 20-21
 buffer power of, 21-24
 buffer substances in, 177
 calcium loss on perfusion, 30
 carbohydrate content of, 37, **38-40**
 carbohydrate estimation in, 102-103
 carbohydrate metabolism and oxygen pressure in, **69**
 carbon dioxide content of, 26
 cells, composition of, **27**
 chemical methods used with, 282-285
 cholesterol content of, 49
 composition of, **51**
 conduction rate in, 222
 conduction rate with potassium excess, 218
 contraction, sequence of events in, 212
 creatine content of, 50
 cyanide-resistant metabolism in, 189
 cytochrome content of, 49
 depressants, mode of action of, 192, 252-253
 depressants, summary of action of, 208-209
 diffusion of ions through, 24-28
 double cannula perfusion method for, **274**
 duration of electrical and mechanical responses in, 221-226
 duration of electrical response, recovery of, 245, **247**
 efficiency of, 232-234
 efficiency, temperature effect on, 249
 efficiency with pressure in, 83-84
 electrical and mechanical responses, relation in, 212-226; simultaneous nature of, 219-220
 electrical response with filling of, 231
 electrical response and metabolism of, 226-232
 empty, metabolism on contraction of, **91, 92-93**
 emptying *in situ*, 13
 energy of contraction of, 159
 fat content of, 48-49
 Fenn effect in, 237
 filling and heat production of, 84-85
 filling and mechanical response of, 82-83
 filling and work done by, 88
 filling, duration of mechanical response, with, 230
- Heart, filling, efficiency increase with, **233**
 frequency, acidity and, 196
 frequency, asphyxial depression in, 178
 frequency, asphyxia with I.A.A. and, **75, 76, 77, 78**
 frequency, duration of electrical response with, 230
 frequency, lactic acid production and, 73
 frequency, metabolic rate and, 73
 frequency, oxygen usage and, **72**
 frequency, phosphagen function in, 170
 frequency, potassium excess and, 196
 frequency, refractory period duration with, 243-244
 frequency, temperature effect on, 13
 glutathione content of, 50-51
 glycogen content of, **38**
 glycogen: total carbohydrate ratio in, 43
 heat production in, 239
 heat production with filling of, 84-85
 high pressure, effect on, 248, 251
 hypodynamic condition of, 95-98
 inorganic constituents of, **18, 19**
 inositol content of, 47
 iron content of, 49
 lactic acid, content of, 47-48
 lactic acid production with filling of, 85
 lactic acid usage by, 117-118
 latent period of, 255
 latent period of electrical and mechanical responses in, 219
 lecithin content of, 49
 -lung preparation, adrenaline on metabolism of, 207; metabolism of, 89-90, 260; resting metabolism of, 198
 mechanical response and phosphagen in, 169
 mechanical response with filling of, **82-83**
 mechanical response, recovery in, 246-247
 metabolic range of, 259
 metabolism, adrenaline action on, 206
 metabolism, depressants, **202-203, 253**
 metabolism, electrical response of, 226-232
 metabolism, mechanical efficiency of, 232-237
 metabolism, narcotics, action on, **200-201**
 metabolism, pilocarpine action on, 206
 metabolism, strophanthin action on, 207
 metabolism, temperature and, 98-101
 metabolism, vagus action and, 204
 microscopic structure of, 11-12

- Heart, narcotics on oxygen usage and mechanical response of, 200-201
 non-fermentable reducing substances in, 44-45
 normal metabolism of, 260
 oxygen debt in, 268
 oxygen pressure, minimum for, 60-61, 65
 oxygen supply, factors limiting, 56-57
 oxygen usage of, 58
 oxygen usage with filling of, 79-80
 oxygen usage and mechanical response of, 84
 oxygen usage, variables controlling, 53
 oxygen usage, Warburg's formula and, 66
 oxygen usage and work done, 86-87
 perfused. *See* Perfused heart
 perfusion, method of, 272
 pH effect on, 22
 phosphagen function in, 159
 phosphate, content of, 27
 phosphate loss on perfusion of, 31
 phosphorus content of, 19, 20
 phosphorus distribution in, 153-154
 potassium/calcium ratio in, 30
 potassium content of, 27
 potassium loss and buffer power of, 32-33
 potassium loss on perfusion of, 28-29
 potassium and vagal stimulation of, 35
 protein content of, 48
 protein metabolism of, 125
 ratios, 8-9
 recovery of excitability in, 244-245
 recovery processes, nature of, 247-248, 251, 254
 refractory periods, absolute and relative, in, 243-244
 refractory period duration in, 242-243
 refractory period and electrical response in, 220-221
 refractory period, factors affecting, 197
 repeated asphyxial arrest in, 183-184
 respiratory exchanges, measurement of, 276, 277, 278
 respiratory quotient of, 102
 resting, metabolism of, 74, 76, 77, 78, 197, 266
 resting metabolism, depressants on, 197-206
 rigor and lactic acid content of, 137
 size, oxygen usage and, 71
 skeletal muscle, comparison, length and metabolism of, 94-96
 sympathetic stimulation and calcium of, 36
 temperature effect on, 12-13
 temperature on electrical and mechanical responses of, 249
- Heart, temperature on metabolism of, 98-101
 urea content of, 50
 water content of, 17
 weight : body weight ratios, 8-9
 work and filling of, 88
 work done and oxygen usage of, 86-87
 Heat production, filling of heart and, 84-85
 H.E.R. = Height of electrical response
 Hexose-diphosphate, hypodynamic heart and, 97
 H.M.R. = Height of mechanical response
 Horse heart, carnosine content of, 51
 heart, non-protein nitrogen content of, 51
 Hydrogen ions, heart permeability to, 26
 Hydroxyl ions, heart permeability to, 26
 Hypodynamic heart, electrical response duration in, 249
 glycine action on, 130
 inorganic constituents of, 32
 production of, 95-96
- I.A.A. = Iodo-acetic acid
 asphyxia and heart frequency with, 75, 76, 77, 78
 effective dose of, 181
 mode of action of, 120
 plain muscle, activity in, 265
 poisoned heart, acetylcholine on metabolism of, 202
 poisoned heart, adenosinetriphosphate changes in, 165
 poisoned heart, alanine action on, 131
 poisoned heart, ammonia production by, 130
 poisoned heart, anoxæmia and, 157
 poisoned heart, anoxæmia and glutathione on, 152
 poisoned heart, anoxæmic energy, supply of, 185-186
 poisoned heart, anoxæmic, summary of changes in, 191
 poisoned heart, buffering of fluid and, 181-182
 poisoned heart, calcium lack on metabolism of, 202
 poisoned heart, electrical changes in, 227-228, 229
 poisoned heart, energy sources in anoxæmia of, 185-186
 poisoned heart, fat usage by, 133, 134
 poisoned heart, frequency effect on, 75, 76, 77, 78
 poisoned heart, glutamic acid action on, 131

- I.A.A. = Iodo-acetic acid
 poisoned heart, lactic acid usage by, 117-118, 119
 poisoned heart, low oxygen pressures on, 61, 65
 poisoned heart, mechanical response in anoxæmia of, 174
 poisoned heart, method for measuring asphyxial changes in, 282
 poisoned heart, minimum oxygen pressure and, 60-61, 65
 poisoned heart, oxygen pressure and phosphagen in, 163
 poisoned heart, phosphagen changes in, 160-161
 poisoned heart, protein metabolism of, 125
 poisoned heart, recovery from asphyxia in, 186
 poisoned heart, repeated asphyxial arrest in, 183-184
 poisoned hearts, substances oxidised by, 119-120
 poisoned heart, temperature effect on, 99, 100
 poisoned rabbit heart, anoxæmia in, 168
 skeletal muscle R.Q. and, 263
 Indophenol oxidase, oxygen pressure necessary for, 61-62
 Inosinic acid, heart and function of, 166
 Inositol, method of estimation of, 284
 Insulin, carbohydrate balance of heart with, 108-109, 110
 glucose usage by the heart and, 114
 glycogen loss from heart with, 105-106
 heart glycogen and, 42
 Invertebrate hearts, electrical and mechanical responses, relation in, 215
 Invertebrate muscle, initial heart and electrical changes in, 238-239
 Iron, blood and content of, 54
 Isobaric, definition of, 83
 Isochoric, definition of, 83
 Isochoric response, registration of, 272
- Lactic acid, aerobic production by heart of, 120-121
 anoxæmic heart on production of, 146, 148
 blood and content of, 54
 buffer power of heart and, 24
 formation, electrical changes and, 227-228
 heart and content of, 48
 heart metabolism of, 259
 heart usage of, 117-118
 mammalian heart, usage of, 261
- Lactic acid, method of estimation of, 284
 neutralisation in heart, 176-177
 phosphate changes in heart and, 164-167
 plain muscle usage of, 265; plasma and content of, 52
 production, buffering and, 175
 production, carbohydrate balance of heart and, 109, 110
 production, carbohydrate loss and, 139, 142
 production, filling of heart and, 85
 production, function of, 159
 production, glucose-perfused heart and, 172
 production, hypodynamic heart and, 97
 skeletal muscle contraction and, 155
 skeletal muscle production with pH , 23
- Lecithin, heart and content of, 49
 hypodynamic heart and, 96
 perfused heart on addition of, 128
- Lipoid phosphorus, heart and skeletal muscle and, 153
- Lohmann-Parnas cycle, 167
- Magnesium, plasma and content of, 52
 Mammalian heart, anoxæmia effect in, 180
 glycogen content of, 40-43
 I.A.A. and electrocardiogram of, 227-228
 metabolism of, 260-261
 phosphorus content of, 20
 work and metabolism of, 89-90
- Mannose, anoxæmic heart and, 143
 heart and presence of, 103
- Metabolic inhibitors, heart and action of, 192-193
- Metabolic rate, factors affecting, 70
 heart frequency and, 73
 measurement in heart, 276, 277, 278
 of heart. *See* Heart metabolism
- Methyl glyoxal, anoxæmic heart and, 150-151
 I.A.A. poisoned heart usage of, 119-120
- Monocellular organisms, oxygen pressure necessary for, 62
- Muscarine, electrical response of heart and, 214, 216
- Muscle *brevi*, phosphatides action on, 97
 pulp, buffer, power of, 23
 resting metabolism in different forms of, 266
- Narcotics, duration of electrical and mechanical responses with, 224, 225
 heart and action of, 193-194
- Nerve, refractory periods, absolute and relative, in, 244

- Oxygen, blood and content of, 53
 heart metabolism and, 115-116
 minimum pressure for heart of, 60-61, 65
 pressure, heart function and, 60-69
 pressure, I.A.A. poisoning and phosphagen with, 163
 pressure, sugar metabolised by heart and, 259
 pressure, metabolic alteration in heart with, 69
 supply, pressure and, 64
 supply to heart, factors limiting, 56-57
 ventricle requirement for, 6
- Oxygen consumption, carbohydrate usage
 by heart and, 109, 110
 filling of heart and, 79-80
 glycogen loss in relation to, 106
 heart frequency and, 72
 heart size and, 71
 hypodynamic heart and, 95-96
 measurement of, 276, 277, 278, 280
 narcotics action on heart and, 200-201
 plain muscle and, 264-265
 resting heart and, 74, 78
 work of heart and, 86-87
- Oxygen debt, heart muscle and, 268
- Parnas-Lohmann cycle, 167
- Pelargonic acid, I.A.A. poisoned heart and, 134
- Perfused heart, acid action on, 195-196
 adenosinetriphosphate changes in, 165
 adrenaline and carbohydrate breakdown in, 43
 alanine action on, 128
 alcohol action on, 193-194
 ammonia production by, 122-123, 125
 anaerobic, energy sources in, 185-186
 anoxæmia, carbohydrate depletion and mechanical response of, 174
 anoxæmic, 128; amino-acids on, 143, 144
 anoxæmic, alkalinity and, 142-145, 157
 anoxæmic, buffering and, 175
 anoxæmic, carbohydrate used by, 173
 anoxæmic, electrical response in, 229
 anoxæmic, frequency and depression of, 178
 anoxæmic, glucose effect on, 141-143
 anoxæmic, glucose used by, 172
 anoxæmic, glutathione action on, 151
 anoxæmic, glyceric aldehyde on, 149-150
 anoxæmic, glycerophosphate, 149-150
 anoxæmic, I.A.A. and phosphagen changes in, 160-161
 anoxæmic, lactic acid production in, 146-148, 172
- Perfused heart, anoxæmic, mechanical response in, 190
 anoxæmic, mechanical response of, 171-174
 anoxæmic, mechanical response and cause of, 176
 anoxæmic, neutral lactate excreted by, 176-177
 anoxæmic, pH and, 147, 148
 anoxæmic, phosphagen depletion of, 155-156
 anoxæmic, phosphagen and mechanical activity of, 158
 anoxæmic, pyruvic acid on, 149-150
 anoxæmic, reaction of fluid and, 157
 anoxæmic, repeated arrest of, 177
 anoxæmic, summary of state of, 190-191
 asphyxial arrest and volume of perfusion fluid in, 146
 asphyxial depression measurement in, 281-282
 calcium lack and metabolism of, 202-203
 calcium loss in, 30
 carbohydrate balance in, 108, 109, 110
 carbohydrate loss and lactic acid production in, 139
 carbohydrate metabolism and oxygen pressure in, 69
 carbohydrate usage by, 45
 circulation rate in, 58
 conduction rate, factors affecting, 218
 cyanide action on, 186-189
 cyanide effect on oxygen and mechanical response of, 187-188
 double cannula method for, 274
 efficiency of, 232-234
 electric response with filling of, 216, 231
 fat loss in, 48-49
 fat usage by, 132
 fatty acids action on, 133-134
 glucose action on, 128
 glucose usage by, 113-114
 glycine, action on, 125, 128
 glycogen loss in, 105-106
 lactic acid content of, 48
 lactic acid production in, 138-139, 140, 141
 lactic acid production and anoxæmia of, 146, 148
 leucine action on, 128
 mechanical response and phosphagen in, 169
 metabolism inhibition in, 192-193
 narcotics and metabolism of, 200-201
 normal heart compared with, 15
 oxygen on R.Q. of, 115-116
 oxygen pressure and metabolism in, 69

- Perfused heart, oxygen supply to, factors limiting, 56-57
 oxygen supply and pressure in, 64
 oxygen usage in air and oxygen, 67-68
 oxygen usage and protein metabolism of, 125
 pH in anoxæmia of, 147, 148
 phosphagen changes in, 155-156
 phosphagen and mechanical response in, 169
 phosphate loss in, 31
 potassium excess and metabolism of, 202, 203
 potassium loss in, 28-29
 pressure in, 14
 rate of action of drugs on, 60
 R.Q. measurement in, 276, 277
 R.Q. and oxygen supply to, 115-116
 sartorius compared with, 7
 survival time of, 15
 urea production by, 125, 127
 volume of fluid and asphyxial arrest of, 146
 water content of, 17
- Perfused ventricle, oxygen supply to, 59
 pressure in, 14
- pH , anaerobic heart reaction to, 147
- Phosphagen, adenosinetriphosphate relation to, 164-167
 anaerobic heart and recovery, 155-156
 contraction and essential nature of, 161
 energy supply from, 185
 heart arrest and, 162
 heart beat and function of, 167-168
 heart frequency and, 170
 heart and skeletal muscle, comparison of, 154
 mechanical activity in relation to, 158
 mechanical response of heart and, 169
 oxygen pressure in relation to, 163
 resynthesis, lactic acid production and, 159
 skeletal muscle contraction and, 155
- Phosphate, heart's content of, 19, 20
 Phosphate, plasma and content of, 52
 Phosphoglyceric acid, I.A.A. poisoned heart usage of, 120
- Phospholipins, heart and content of, 49
 Phosphorus, heart and distribution of, 153-154
- Pilocarpine, heart metabolism and action of, 206
- Plain muscle, anoxæmia and mechanical response of, 180
 initial heat and electrical changes in, 238-239
 metabolism of, 264-266
- Plasma, carbohydrate content of, 54
 composition of, 27, 52
 perfusion. *See* Serum perfusion
- Plasma-Ringer perfusion, oxygen supply to heart and, 59
- Potassium, acetylcholine and action of, 35
 duration of electrical and mechanical responses with, 224, 226
 excess, cardiac and skeletal muscle comparison, 206
 excess, conduction rate in heart with, 218, 222
 excess, electrical response of heart with, 217
 excess, heart metabolism and action of, 202-203
 excess, heart and rate of action on, 196
 excess, refractory period of heart and, 221
 heart arrest and phosphagen in, 162
 heart-content of, 18
 heart excretion in anoxæmia, 177
 loss in heart on perfusion, 28-29
 plasma and content of, 52
 skeletal muscle, pH and, 34
 vagus stimulation and liberation of, 35
- Pressure, heart and effect of, 248, 251
- Propionic acid, I.A.A. poisoned heart and, 134
- Protein, blood and content of, 54
 heart-content of, 48
 metabolism, mammalian heart and, 261-262
- Protozoa, respiratory quotient of, 267
- Pyruvate, anoxæmic heart and, 149-150
 I.A.A. poisoned heart, usage of, 119-120
- Rabbit auricle, frequency of, 170
 heart, anoxæmia and lactic acid production in, 179
 heart, anoxæmia and phosphagen content of, 180
 heart, asphyxia and glycogen of, 262
 heart, asphyxial arrest and lactic acid in, 146
 heart, calcium lack on metabolism of, 205
 heart, electrical and mechanical responses in, 215
 heart, glycogen content of, 40
 heart, glycogen function in, 260
 heart, glycogen loss on perfusion of, 41
 heart, I.A.A. and anoxæmia in, 168
 heart, lactic acid content of, 48
 heart, lactic acid production in, 137
 heart, phosphagen changes in, 169
 intestine, anoxæmia and mechanical response of, 180

- Rat's heart, asphyxia and glycogen loss in, 46
glycogen content of, 40
glycogen: total carbohydrate ratio in, 44
- Recovery period, depressants affecting, 196-197
process, phosphagen and, 156
processes, nature of, 247-248, 251, 254
- Reducing substances, method of estimation of, 283
- Refractory periods, absolute and relative, in different tissues, 244
period, acidity and, 197
period, duration of, 242
period, duration of electrical and mechanical responses and, 225
period, electrical response of heart and, 220-221
period, potassium excess and, 197
period, temperature effect on, 249
- R. esculenta*, blood composition of, 52
(Dutch), heart ratio in, 9
heart frequency in, 13
heart oxygen usage in, 71
(Hung.), heart ratio in, 9, 10
- Respiratory quotient, amino-acids on perfused heart and, 128
heart and, 102
heart activity and, 198
measurement in heart, 276, 277
oxygen on perfused heart and, 115-116
skeletal muscle and, 263-264
- Resting metabolism of heart, determination of, 75, 76, 77, 78
depressants and, 197-206
muscle comparison of, 266
- Ribose, heart and content of, 44-45
- Ringer's fluid, oxygen content of, 58
- Ringer-serum perfusion, carbohydrate usage of heart in, 46
- Ritchie's theory of contraction, 255
- R. mugiens*, metabolic rate of, 70
- R. pipiens*, heart ratio in, 10
- R.R.P. = Relative refractory period
- R. temporaria*, glutathione content of, 50-51
heart frequency in, 13
heart oxygen usage in, 71
heart ratio in, 9
metabolic rate of, 70
- Sartorius, capillary surface in, 7
ventricle compared with, 7
- Season, carbohydrate variation in heart with, 38-39
- Serum, carbohydrate content of, 54
fat content of, 55
- Serum, hypodynamic heart and, 95-96
perfusion, carbohydrate balance of heart in, 108-109, 110
perfusion, glycogen loss from heart in, 105-106
perfusion, heart metabolism with, 14
perfusion, protein metabolism of heart with, 125, 127
perfusion, R.Q. of heart with, 115-116
- Serum-Ringer perfusion, oxygen usage and heart frequency with, 72
- Sheep heart, inositol content of, 47
- Sinus, cell size in, 11
oxygen pressure necessary for, 60-61, 65
oxygen usage, Warburg's formula and, 66
thickness of, 5
weight of, 10
- Skate heart, inositol content of, 47
- Skeletal muscle, alkalinity on survival of, 158
depressants on metabolism of, 205
electrical and mechanical responses, relation in, 214
Fenn effect in, 235-236
I.A.A. and phosphagen in, 160
initial heat and electrical changes in, 238
lactic acid production and pH in, 23
latent period of, 255
metabolism of, 263-264
 pH effect on, 22
phosphagen and contractile process in, 211
phosphagen and lactic acid changes in contraction of, 155
phosphate diffusion into, 32
phosphorus distribution in, 153-154
potassium diffusion from, 33-34
potassium excess on metabolism of, 206
pressure effect on contraction of, 250
refractory periods, absolute and relative in, 244
resting metabolism of, 198
sodium diffusion into, 34
stretching on metabolism of, 93-94
- Soaps, hypodynamic heart and, 96
- Sodium, heart's content of, 18
oleate, hypodynamic heart and, 96, 97
plasma and content of, 52
skeletal muscle, permeability to, 34
- Starvation, heart glycogen and, 41, 42
- Strophanthin, duration of electrical and mechanical responses with, 225-226
heart metabolism and action of, 207
- Straub cannula, oxygen supply with use of, 59
use of, 275

- Sugar, blood, and content of, 54
 heart metabolism of, 259
 plasma and content of, 52
- Sulphate, plasma, and content of, 52
- Sympathetic ganglia, potassium and stimulation of, 35
- Temperature coefficient, heart metabolism and, 198-199
 duration of electrical and mechanical responses with, 224
 electrical and mechanical responses of heart and, 249
 electrical response, duration and, 249
 heart variations with, 12-13
- Terrapin heart, conduction rate with pH of, 218
 heart, electrical and mechanical responses, relation in, 215
- Thyroid, heart glycogen and, 42
- Toad, heart ratio in, 9, 10
 heart, metabolic rate of, 7c
 heart, phosphate content of, 19
 heart, potassium content of, 18
 heart, water content of, 18
- Tortoise blood, non-protein nitrogen content of, 55
 auricle, oxygen usage with filling of, 78-79
 heart, carbohydrate content of, 39-40
 heart, duration of mechanical response with filling of, 230
 heart, efficiency of, 232-233
 heart, electric response with filling of, 216
 heart, glycogen loss on incubation of, 46
 heart, glycogen: total carbohydrate ratio in, 44
 heart, hypodynamic condition in, 97
 heart, lactic acid content of, 48
 heart, lactic acid production in, 137
 heart, latent period of, 255
 heart, optimum pressure for, 83
 heart, oxygen usage with filling of, 87, 91, 233
 heart, oxygen usage measurement in, 278, 279
 heart perfusion, method of, 273, 275
 heart, phosphate content of, 19
 heart, potassium excess and rate of conduction in, 218
 heart, sympathetic stimulation and calcium of, 36
 heart, urea in, 50
 "Treppe" effect, 246, 247
- Turtle heart, anoxæmia and alkalinity of, 144-145
- Turtle heart, anoxæmia and lactic acid production in, 178
 heart, creatine content of, 50
 heart, cyanide effect on, 188
 heart, electrical and mechanical responses in, 219
 heart, high atmospheric pressure effect on, 248
 heart, I.A.A. and refractory period of, 228
 heart, ionic changes on metabolism of, 205-206
 heart, lactic acid content of, 48
 heart, lactic acid production in, 137
 heart, mechanical response recovery in, 246
 heart, oxygen usage and filling of, 91
 heart, oxygen usage and work done by, 87
 heart, potassium diffusion into, 29
 heart, temperature and metabolism of, 99-100
- Urea, heart and content of, 50
 method of estimation of, 284
 perfused heart production of, 125, 127
- Valeric acid, I.A.A. poisoned heart and, 134
- Vagus, potassium and stimulation of, 35
 heart metabolism and, 204
- Ventricle: body weight ratio, 10
 carbohydrate content of, 39
 cell size in, 11-12
 calcium lack and metabolism of, 202-203
 conduction rate in, 240
 cyanide effect on, 188
 filling on size of, 3-4, 5
 inorganic constituents of, 18
 optimum pressure for, 83
 oxygen diffusion into, 6
 oxygen pressure necessary for, 65
 oxygen usage with filling of, 79-80
 oxygen usage measurement of, 279-280
 perfused. *See* Perfused ventricle size with filling of, 3-4, 5
 structure of, 1, 2, 3
 sugar usage and work done by, 87
 surface area of, 4, 6
 thickness of, 5
 weight of, 9-10
- Ventricular strip, acetylcholine rate of action of, 193
 strip, anoxæmia and frequency of beat in, 178
 strip, asphyxia in, 7
 strip, cyanide effect on, 188

- Ventricular strip, electrical response with acidity of, 229
strip, electrical response measurement in, 240-241
strip, lactic acid production in, 20
strip, oxygen pressure necessary for, 65
strip, oxygen usage in air and oxygen, 66-67
strip, phosphate loss from, 31
strip, potassium diffusion into, 29
strip, preparation and perfusion of, 270-271
strip, rate of action of drugs on, 60
- Ventricular strip, sugar usage with tension of, 87
strip, thickness of, 5
- Veratrin, heart conduction and action of, 220
refractory period of heart with, 242
- Viscosity, electrical response duration and, 249
- Warburg's formula, oxygen usage of heart and, 66
- Weizsäcker perfusion method, 279-281
- Xenopus laevis*, plasma composition in, 52

DATE OF ISSUE

15.9.1948

This book must be returned
within 3, 7, 14 days of its issue. A
fine of ONE ANNA per day will
be charged if the book is overdue.

-B 302 1954

19 No '58 70

50

949

